

Contents

These pages give an overview of the contents of your owner's manual. The first page of each section lists the topics covered in that section.

Motorcycle Safety..... 1

Important safety information you should know, plus a look at the safety-related labels on your motorcycle.

Instruments & Controls..... 9

The location and function of indicators, gauges, and controls on your motorcycle and operating instructions for various controls and features.

Before Riding..... 29

The importance of wearing a helmet and other protective gear, how to make sure you and your motorcycle are ready to ride, and important information about loading.

Basic Operation & Riding..... 39

How to start and stop the engine, shift gears, and brake. Also, riding precautions and important information about riding with a passenger or cargo.

Servicing Your Honda 55

Why your motorcycle needs regular maintenance, what you need to know before servicing your Honda, an owner maintenance schedule, and instructions for specific maintenance and adjustment items.

Tips..... 147

How to store and transport your motorcycle and how to be an environmentally responsible rider.

Taking Care of the Unexpected..... 155

What to do if you have a flat tire, your engine won't start, etc.

Technical Information 185

ID numbers, technical specifications, and other technical facts.

Consumer Information 209

Information on warranties, emission controls, how to get Honda service manuals, and...

“Reporting Safety Defects” 218

Table of Contents 220

Sequential listing of topics in this owner's manual.

Index..... 224

Quick Reference

Handy facts about fuel, engine oil, tire sizes, and air pressures.

**2010
Honda VT1300CX
Fury
OWNER'S MANUAL**

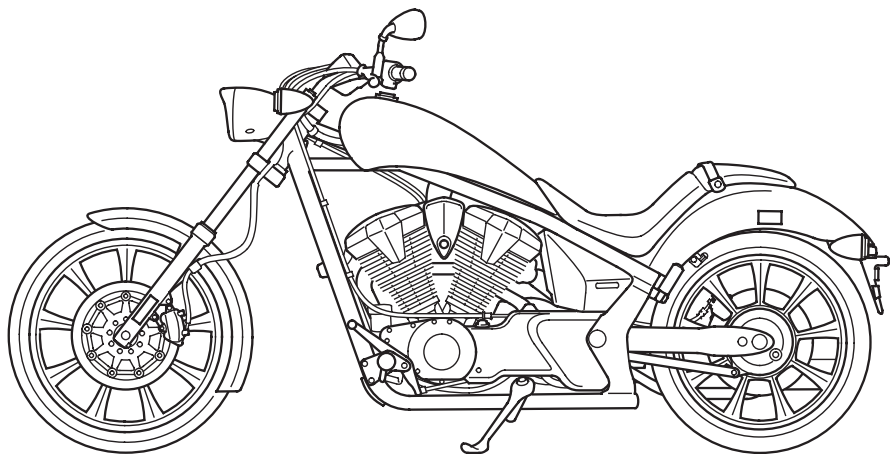

Introduction

Congratulations on choosing your Honda motorcycle.

When you own a Honda, you're part of a worldwide family of satisfied customers — people who appreciate Honda's reputation for building quality into every product.

Before riding, take time to get acquainted with your motorcycle and how it works. To protect your investment, we urge you to take responsibility for keeping your motorcycle well maintained. Scheduled service is a must, of course. But it's just as important to observe the break-in guidelines, and perform all pre-ride and other periodic checks detailed in this manual.

We also recommend that you read this owner's manual before you ride. It's full of facts, instructions, safety information, and helpful tips. To make it easy to use, the manual contains a detailed list of topics at the beginning of each section, and both an in-depth table of contents and an index at the back of the book.

As you read this manual, you will find information that is preceded by a **NOTICE** symbol. This information is intended to help you avoid damage to your Honda, other property, or the environment.

Read the Warranties Booklet (page 213) thoroughly so you understand the coverages that protect your new Honda and are aware of your rights and responsibilities.

If you have any questions, or if you ever need special service or repairs, remember that your Honda dealer knows your motorcycle best and is dedicated to your complete satisfaction.

Please report any change of address or ownership to your Honda dealer so we will be able to contact you concerning important product information.

You may also want to visit our website at www.honda.com.

Happy riding!

California Proposition 65 Warning

WARNING: This product contains or emits chemicals known to the State of California to cause cancer and birth defects or other reproductive harm.

A Few Words About Safety

Your safety, and the safety of others, is very important. And operating this motorcycle safely is an important responsibility.

To help you make informed decisions about safety, we have provided operating procedures and other information on labels and in this manual. This information alerts you to potential hazards that could hurt you or others.

Of course, it is not practical or possible to warn you about all hazards associated with operating or maintaining a motorcycle. You must use your own good judgment.

You will find important safety information in a variety of forms, including:

- **Safety Labels** — on the motorcycle.
- **Safety Messages** — preceded by a safety alert symbol  and one of three signal words: **DANGER**, **WARNING**, or **CAUTION**.

These signal words mean:

Safety Messages

A Few Words About Safety

DANGER

You **WILL** be **KILLED** or **SERIOUSLY HURT** if you don't follow instructions.

WARNING

You **CAN** be **KILLED** or **SERIOUSLY HURT** if you don't follow instructions.

CAUTION

You **CAN** be **HURT** if you don't follow instructions.

- **Safety Headings** — such as Important Safety Reminders or Important Safety Precautions.
- **Safety Section** — such as Motorcycle Safety.
- **Instructions** — how to use this motorcycle correctly and safely.

This entire manual is filled with important safety information — please read it carefully.

This section presents some of the most important information and recommendations to help you ride your motorcycle safely. Please take a few moments to read these pages. This section also includes information about the location of safety labels on your motorcycle.

| | |
|------------------------------------|---|
| Important Safety Information | 2 |
| Accessories & Modifications | 5 |
| Safety Labels | 7 |

Important Safety Information

Your motorcycle can provide many years of service and pleasure — if you take responsibility for your own safety and understand the challenges you can meet while riding.

There is much that you can do to protect yourself when you ride. You'll find many helpful recommendations throughout this manual. The following are a few that we consider to be most important.

Always Wear a Helmet

It's a proven fact: helmets significantly reduce the number and severity of head injuries. So always wear an approved motorcycle helmet and make sure your passenger does the same. We also recommend that you wear eye protection, sturdy boots, gloves, and other protective gear (page 30).

Important Safety Information

Take Time to Learn & Practice

Even if you have ridden other motorcycles, take time to become familiar with how this motorcycle works and handles.

Practice in a safe area until you build your skills and get accustomed to the motorcycle's size and weight.

Because many crashes involve inexperienced or untrained riders, we urge all riders to take a motorcycle operator course approved by the Motorcycle Safety Foundation (MSF). See page 32 .

Ride Defensively

The most frequent motorcycle collision happens when a car turns left in front of a motorcycle. Another common situation is a car moving suddenly into your lane.

Always pay attention to other vehicles around you, and do not assume that other drivers see you. Be prepared to stop quickly or make an evasive maneuver. For other riding tips, see the booklet, *You and Your Motorcycle Riding Tips*, which came with your new motorcycle (USA only).

Make Yourself Easy to See

Some drivers do not see motorcycles because they are not looking for them. To make yourself more visible, wear bright reflective clothing, position yourself so other drivers can see you, signal before turning or changing lanes, and use your horn when it will help others notice you.

Important Safety Information

Ride within Your Limits

Pushing limits is another major cause of motorcycle crashes. Never ride beyond your personal abilities or faster than conditions warrant. Remember that alcohol, drugs, fatigue, and inattention can significantly reduce your ability to make good judgments and ride safely.

Don't Drink and Ride

Alcohol and riding don't mix. Even one drink can reduce your ability to respond to changing conditions, and your reaction time gets worse with every additional drink. So don't drink and ride, and don't let your friends drink and ride either.

Keep Your Honda in Safe Condition

It's important to keep your motorcycle properly maintained and in safe riding condition. To help avoid problems, inspect your motorcycle before every ride and perform all recommended maintenance. Never exceed load limits (page 37), and do not modify your motorcycle (page 6) or install accessories that would make your motorcycle unsafe (page 5).

Modifying your motorcycle or using non-Honda accessories can make your motorcycle unsafe. Before you consider making any modifications or adding an accessory, be sure to read the following information.

WARNING

Improper accessories or modifications can cause a crash in which you can be seriously hurt or killed.

Follow all instructions in this owner's manual regarding accessories and modifications.

Accessories

We strongly recommend that you use only Honda Genuine Accessories that have been specifically designed and tested for your motorcycle. Because Honda cannot test all other accessories, you must be personally responsible for proper selection, installation, and use of non-Honda accessories.

Check with your Honda dealer for assistance and always follow these guidelines:

- Make sure the accessory does not obscure any lights, reduce ground clearance and lean angle, limit suspension travel or steering travel, alter your riding position, or interfere with operating any controls. (cont'd)

Accessories & Modifications

- Do not install any fairing or windscreen unless it was designed and tested by Honda for your motorcycle. Some fairings or windscreens, even smaller ones, can cause unstable handling of your motorcycle. This is especially true if the fairing or windscreen is poorly designed or improperly mounted.
- Do not add any electrical equipment that will exceed the motorcycle's electrical system capacity (page 194). A blown fuse can cause a loss of lights or engine power (page 178).
- Do not pull a trailer or sidecar with your motorcycle. This motorcycle was not designed for these attachments, and their use can seriously impair your motorcycle's handling.

Modifications

We strongly advise you not to remove any original equipment or modify your motorcycle in any way that would change its design or operation. Such changes could seriously impair your motorcycle's handling, stability, and braking, making it unsafe to ride.

Removing or modifying your lights, exhaust system, emission control system, or other equipment can also make your motorcycle illegal.

Safety Labels

Safety labels on your motorcycle either warn you of potential hazards that could cause serious injury or they provide important safety information. Read these labels carefully and don't remove them.

If a label comes off or becomes hard to read, contact your Honda dealer for a replacement.

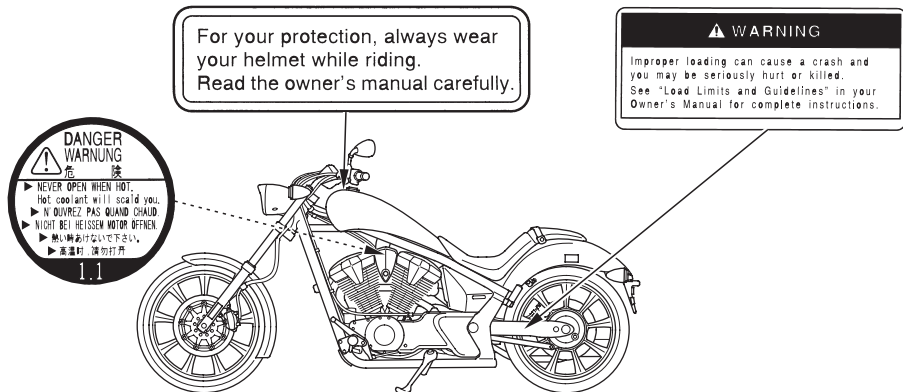

Safety Labels

| TIRE INFORMATION | | | |
|---|--------|--------|--|
| COLD TIRE PRESSURES : | | | |
| [UP TO MAXIMUM WEIGHT CAPACITY] | FRONT | 225kPa | 2.25kgf/cm ² 33psi. |
| | REAR | 280kPa | 2.80kgf/cm ² 41psi. |
| [UP TO 90kg(200 lbs.) LOAD] | | | |
| | FRONT | 225kPa | 2.25kgf/cm ² 33psi. |
| | REAR | 280kPa | 2.80kgf/cm ² 41psi. |
| MAXIMUM WEIGHT CAPACITY : 146 kg (322 lbs.) | | | |
| TIRE SIZE : FRONT 90/90-21M/C 54H REAR 200/50R18M/C 76H | | | |
| TIRE BRAND | FRONT | REAR | <i>Read Owner's Manual</i> |
| DUNLOP | ELITE3 | ELITE3 | |
| MIN. RECOMMEND TIRE CENTER TREAD DEPTH | | | THIS MOTORCYCLE IS EQUIPPED WITH TUBELESS TIRES. |
| FRONT 1.5mm(0.06in.) REAR 2.0mm(0.08in.) | | | |

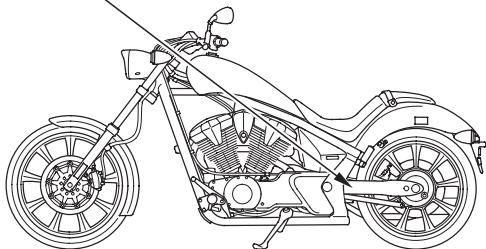

Instruments & Controls

This section shows the location of all gauges, indicators, and controls you would normally use before or while riding your motorcycle.

The items listed on this page are described in this section. Instructions for other components are presented in other sections of this manual where they will be most useful.

| | |
|-------------------------------------|----|
| Operation Component Locations | 10 |
| Gauges, Indicators & Displays..... | 13 |
| Odometer/Tripmeter A & B/Digital | |
| Clock Display | 19 |
| Odometer | 20 |
| Tripmeter A & B | 20 |
| Digital Clock | 22 |
| Controls & Features..... | 25 |
| Ignition Switch | 25 |
| Start Button..... | 26 |
| Engine Stop Switch | 26 |
| Headlight Dimmer Switch | 27 |
| Turn Signal Switch..... | 27 |
| Horn Button | 28 |

Operation Component Locations

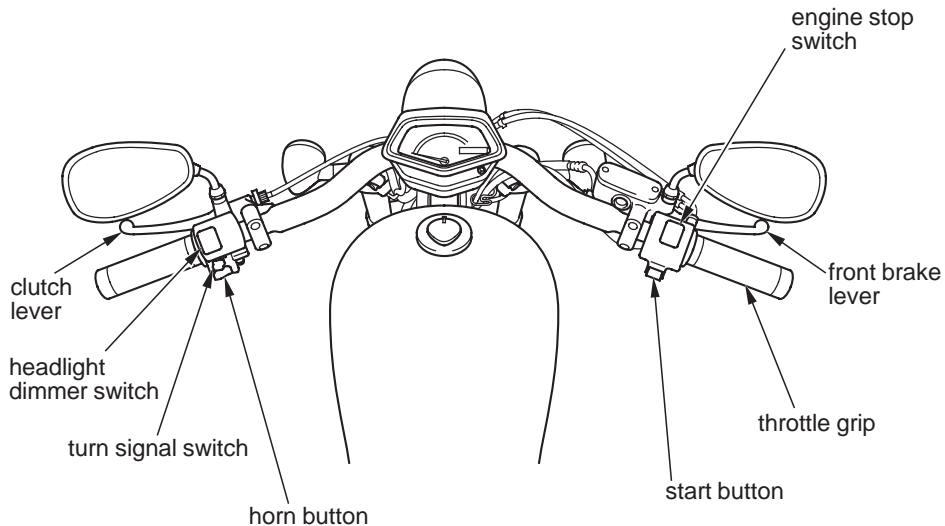

Operation Component Locations

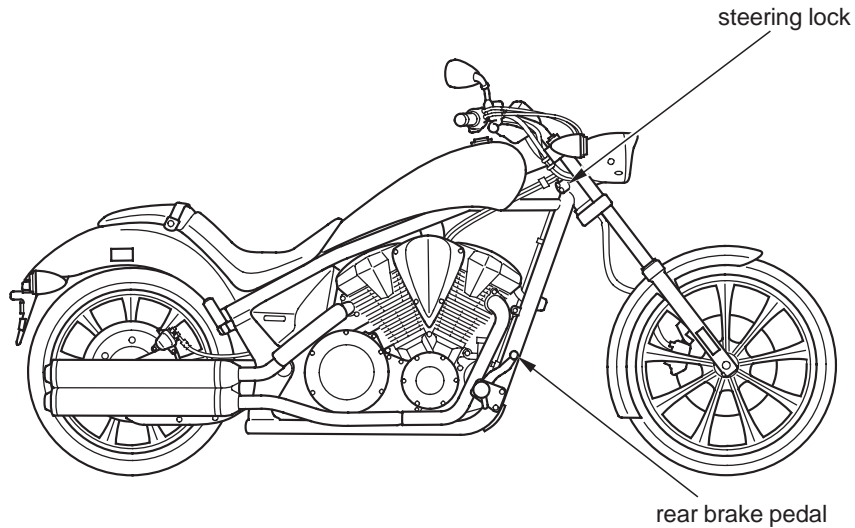

Operation Component Locations

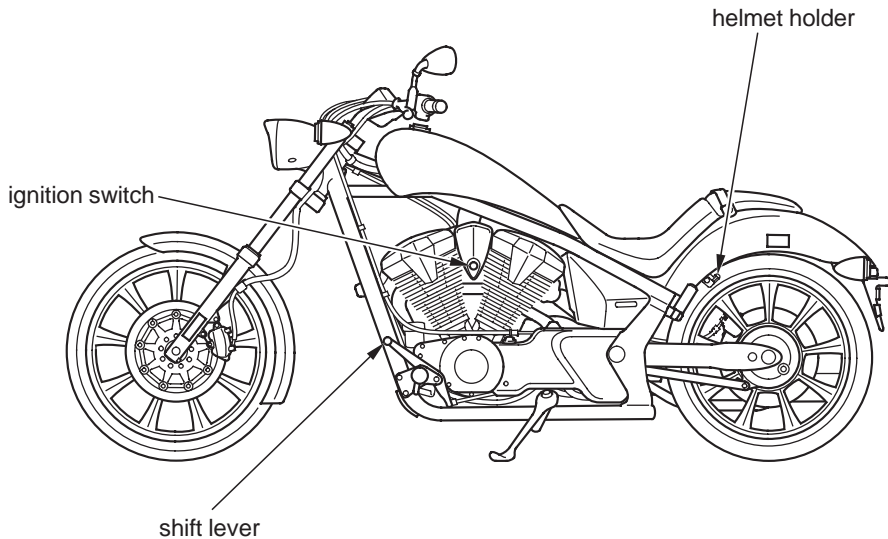

Gauges, Indicators & Displays

The gauges and indicators on your motorcycle keep you informed, alert you to possible problems, and make your riding safer and more enjoyable. Refer to the gauges and indicators frequently. Their functions are described on the following pages.

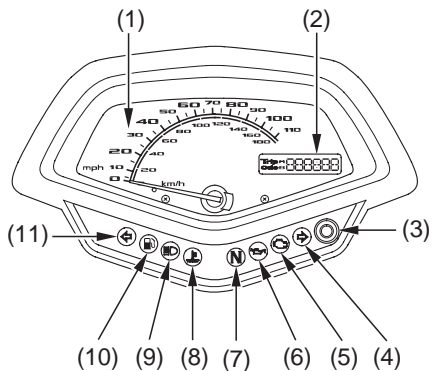

- (1) speedometer
- (2) odometer/tripmeter A & B /digital clock display
- (3) odometer/tripmeter/digital clock select and reset button
- (4) right turn signal indicator
- (5) PGM-FI malfunction indicator lamp (MIL)
- (6) low oil pressure indicator
- (7) neutral indicator
- (8) high coolant temperature indicator
- (9) high beam indicator
- (10) fuel reserve indicator
- (11) left turn signal indicator

USA: Odometer & tripmeter read in miles.

Canada: Odometer & tripmeter read in kilometers.

Gauges, Indicators & Displays

Lamp Check

The low oil pressure indicator and PGM-FI malfunction indicator lamp (MIL) come on when you turn the ignition switch ON so you can check that they are working.

The low oil pressure indicator remains on until after the engine is started. The PGM-FI malfunction indicator lamp (MIL) lights for a few seconds and then goes off when you turn the ignition switch ON. These indicators are identified in the table on pages 16 – 18 with the words: *Lamp Check*.

When applicable, the high beam and neutral indicators come on when you turn the ignition switch ON and remain on until you select the low beam or shift out of neutral.

If one of these indicators does not come on when it should, have your Honda dealer check for problems.

Meter Check

The speedometer needle will swing to the maximum scale on the dial once when you turn the ignition switch ON.

The meter is identified in the table on page 16 with the words: *Meter Check*.

If the speedometer needle does not swing to the maximum scale on the dial once when it should, have your Honda dealer check for problems.

Gauges, Indicators & Displays

| | | |
|---|---|---|
| 1 | speedometer | Shows riding speed in miles (USA) or kilometers (Canada) per hour. <i>Meter Check</i> . |
| 2 | odometer/tripmeter A & B/ digital clock display | |
| | odometer | Shows the total miles (USA) or kilometers (Canada) ridden (page 20). |
| | tripmeter A & B | Shows the number of miles (USA) or kilometers (Canada) ridden since you last reset the meter. The tripmeter has two sub modes, ‘A’ and ‘B’. To zero (0) the tripmeter, push and hold the select and reset button (page 20). |
| | digital clock | Shows hour and minute (page 22). |
| 3 | odometer/tripmeter/ digital clock select and reset button | Resets the tripmeter to zero (0) (page 21). Selects the odometer, tripmeter A, tripmeter B and digital clock (page 20). Also used to set the digital clock (pages 22 – 24). |

Gauges, Indicators & Displays

| | | |
|---|---|--|
| 4 | right turn signal indicator (green) | Flashes when the right turn signal operates. |
| 5 | PGM-FI malfunction indicator lamp (MIL) (amber) | Lights when there is any abnormality in the PGM-FI (Programmed Fuel Injection) system. Should also light for a few seconds and then go off when the ignition switch is turned ON and the engine stop switch is at RUN. If the indicator comes on at any other time, reduce speed and take your motorcycle to a Honda dealer as soon as possible. <i>Lamp Check</i> . |
| 6 | low oil pressure indicator (red) | Lights when engine oil pressure is low enough to cause engine damage. If the low oil pressure indicator lights during operation, pull safely to the side of the road. See page 177 for instructions and cautions. <i>Lamp Check</i> . |
| 7 | neutral indicator (green) | Lights when the transmission is in neutral. |

Gauges, Indicators & Displays

| | | |
|----|--|--|
| 8 | high coolant temperature indicator (red) | Lights when the coolant is over the specified temperature. If the indicator comes on, pull safely to the side of the road. See page 175 for instructions and cautions. |
| 9 | high beam indicator (blue) | Lights when the headlight is on high beam. |
| 10 | fuel reserve indicator (amber) | When this indicator comes on while riding, fuel reserved in the tank is about: 0.66 US gal (2.5 ℓ) |
| 11 | left turn signal indicator (green) | Flashes when the left turn signal operates. |

Odometer/Tripmeter A & B/ Digital Clock Display

The odometer/tripmeter A & B/digital clock display (1) has three functions:

- odometer
- tripmeter
- digital clock

The clock will display 0:00 if the battery is disconnected.

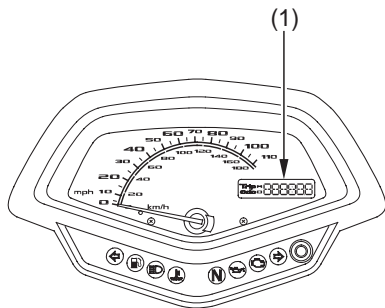

(1) odometer/tripmeter A & B/
digital clock display

(cont'd)

Gauges, Indicators & Displays

Push the button (2) to select the odometer (3), tripmeter A (4), tripmeter B (5) and digital clock (6).

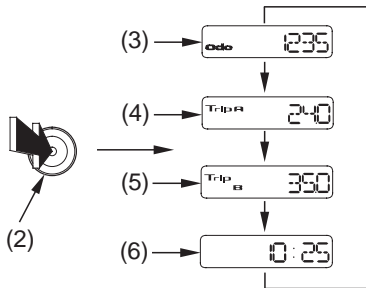

- (2) odometer/tripmeter/digital clock select and reset button
- (3) odometer
- (4) tripmeter A
- (5) tripmeter B
- (6) digital clock

Odometer

The odometer shows the total miles or kilometers ridden.

Tripmeter A & B

The tripmeter shows number of miles or kilometers ridden since you last reset the tripmeter.

The tripmeter has two sub modes, A and B.

To reset the tripmeter, push and hold the button (1) for more than 2 seconds when the display in the tripmeter A or tripmeter B mode.



(1) odometer/tripmeter/digital clock
select and reset button

Gauges, Indicators & Displays

Digital Clock

Shows hour and minute. To adjust the time, proceed as follows:

1. Turn the ignition switch ON.
2. Show the digital clock (1).
3. Push and hold the button (2) for more than 2 seconds. The clock will be set in the adjust mode with the hour display flashing.

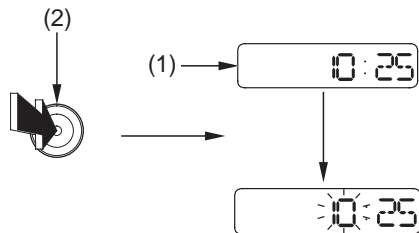

- (1) digital clock
(2) odometer/tripmeter/digital clock
select and reset button

Gauges, Indicators & Displays

4. To set the hour, push the button until the desired hour is displayed.
- The time is advanced by one hour, each time the button is pushed.

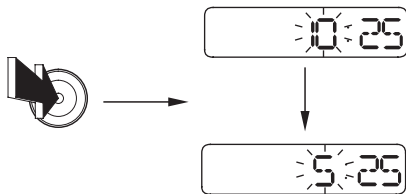

5. Push and hold the button for more than 2 seconds. The minute display will start flashing.

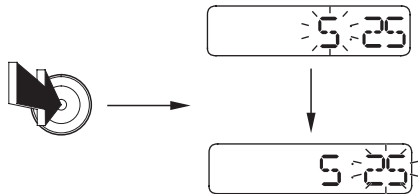

(cont'd)

Gauges, Indicators & Displays

6. To set the minute, push the button until the desired minute is displayed. The minute display will return to “00” when “60” is reached without affecting the hour display.
- The time advances by one minute, each time the button is pushed.

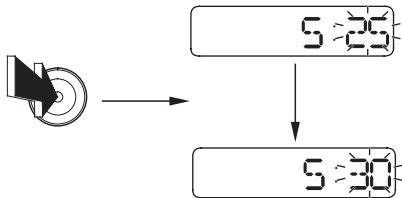

7. To end the adjustment, push and hold the button for more than 2 seconds or turn the ignition switch OFF. The display will stop flashing automatically and the adjustment will be cancelled if the button is not pressed for about 30 seconds.

Ignition Switch

The ignition switch (1) is used for starting and stopping the engine (page 41). Insert the key and turn it to the right for the ON position.

| Key Position | Function |
|--------------|----------------------------------|
| ON | Electrical circuits on. |
| OFF | No electrical circuits function. |

LEFT SIDE

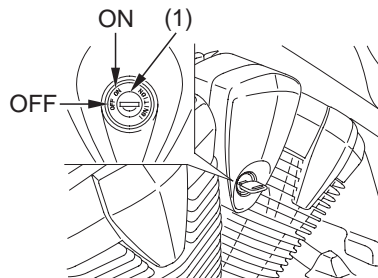

(1) ignition switch

If a key ring is used, we recommend a fabric or leather type with just the key attached. Using a metal key ring or attaching additional keys to any type of key ring may damage the finish of the ignition switch cover while inserting the key or riding.

Controls & Features

Start Button



The start button (1) is used for starting the engine. Pushing the button in starts the engine. See *Starting Procedure*, page 42.

When the start button is pushed, the starter motor will crank the engine; the headlight will automatically go out, but the taillight will stay on.

The starter motor will not operate if the engine stop switch is in the OFF position when the start button is pushed.

Engine Stop Switch



RIGHT HANDLEBAR

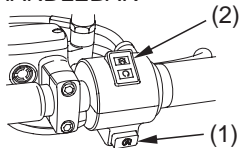

(1) start button

(2) engine stop switch

 OFF

 RUN

The engine stop switch (2) is used to stop the engine in an emergency. To operate, push the switch to the OFF position. The switch must be in the RUN position to start the engine, and it should normally remain in the RUN position even when the engine is OFF.

If your motorcycle is stopped with the ignition switch ON and the engine stop switch OFF, the headlight and taillight will remain on, resulting in battery discharge.

Headlight Dimmer Switch

The headlight dimmer switch (1) is used to change between the high and low beams of the headlight. To operate, turn the switch to HI for high beam, LO for low beam.

Turn Signal Switch



The turn signal switch (2) is used to signal a turn or a lane change. To operate, move the switch all the way in the proper direction and release it. The appropriate turn signal lights will start blinking. To cancel the light, push the switch in.

LEFT HANDLEBAR

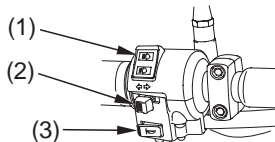

(1) headlight dimmer switch



(2) turn signal switch

(3) horn button

Controls & Features

Horn Button



The horn is used to alert other motorists.
To operate, push the horn button (3).

Before each ride, you need to make sure you and your Honda are both ready to ride. To help get you prepared, this section discusses how to evaluate your riding readiness, what items you should check on your motorcycle, and adjustments to make for your comfort, convenience, or safety. This section also includes important information about loading.

For information about adjusting the suspension on your Honda, see page 115 .

| | |
|---|----|
| Are You Ready to Ride? | 30 |
| Protective Apparel..... | 30 |
| Rider Training | 32 |
| Is Your Motorcycle Ready to Ride? | 33 |
| Pre-ride Inspection | 33 |
| Load Limits & Guidelines..... | 36 |
| Loading..... | 36 |
| Load Limits | 37 |
| Loading Guidelines | 37 |

Are You Ready to Ride?

Before you ride your motorcycle for the first time, we urge you to:

- Read this owner's manual.
- Make sure you understand all the safety messages.
- Know how to operate all the controls.

Before each ride, be sure:

- You feel well and are in good physical and mental condition.
- You are wearing an approved motorcycle helmet (with chin strap tightened securely), eye protection, and other protective clothing.
- You don't have any alcohol or drugs in your system.

Make sure your passenger is ready to ride, too, and is wearing proper gear including a helmet.

If you must carry an extra helmet while riding, use a commercially available elastic cord, strap, or net to secure the helmet to the seat.

Protective Apparel

For your safety, we strongly recommend that you always wear an approved motorcycle helmet, eye protection, boots, gloves, long pants, and a long-sleeved shirt or jacket whenever you ride.

Although complete protection is not possible, wearing proper gear can reduce the chance of injury when you ride.

Following are suggestions to help you choose the proper gear.

Are You Ready to Ride?

Helmet and Eye Protection

Your helmet is your most important piece of riding gear because it offers the best protection against head injuries. A helmet should fit your head comfortably and securely. A bright-colored helmet and reflective strips can make you more noticeable in traffic.

An open-face helmet offers some protection, but a full-face helmet offers more. Regardless of the style, look for a DOT (Department of Transportation) sticker on any helmet you buy (USA only). Always wear a face shield or goggles to protect your eyes and help your vision.

⚠ WARNING

Not wearing a helmet increases the chance of serious injury or death in a crash.

Be sure you and your passenger always wear a helmet, eye protection, and other protective apparel when you ride.

Additional Riding Gear

In addition to a helmet and eye protection, we also recommend:

- Sturdy boots with non-slip soles to help protect your feet and ankles.
- Leather gloves to help protect your hands.

(cont'd)

Are You Ready to Ride?

- A motorcycle riding suit or jacket for comfort as well as protection. Bright-colored and reflective clothing can help make you more noticeable in traffic. Avoid loose clothes that could get caught on any part of your motorcycle.

Rider Training

Developing your riding skills is an on-going process. Even if you have ridden other motorcycles, take time to become familiar with how this motorcycle works and handles. Practice riding the motorcycle in a safe area to build your skills. Do not ride in traffic until you get accustomed to the motorcycle's controls, and feel comfortable with its size and weight.

We urge all riders to take a motorcycle operator course approved by the Motorcycle Safety Foundation (MSF). New riders should start with the basic course, and even experienced riders will find the advanced course beneficial. For information about the MSF training course nearest you, call the national toll-free number: (800) 446-9227.

Other riding tips can be found in the *Riding Tips* booklet that came with your motorcycle (USA only).

Is Your Motorcycle Ready to Ride?

Before each ride, it's important to inspect your motorcycle and make sure any problem you find is corrected. A pre-ride inspection is a must, not only for safety, but because having a breakdown, or even a flat tire, can be a major inconvenience.

WARNING

Improperly maintaining this motorcycle or failing to correct a problem before riding can cause a crash in which you can be seriously hurt or killed.

Always perform a pre-ride inspection before every ride and correct any problems.

Pre-ride Inspection

Check the following items before you get on the motorcycle:

Tires & Wheels Look at the tires. If a tire appears low, use an air pressure gauge to check its pressure. Also look for signs of excessive wear (page 126) or damage to the tires and wheels.

(cont'd)

Is Your Motorcycle Ready to Ride?

*Leaks,
Loose
Parts*

Walk around your motorcycle and look for anything that appears unusual, such as a leak or loose cable.

Lights

Make sure the headlight, brakelight, taillight, and turn signals are working properly.

*Crankcase
Breather*

Service the crankcase breather more frequently if your motorcycle is ridden in the rain or often at full throttle. Service the breather if you can see deposits in the transparent section of the drain tube.

If you are carrying a passenger or cargo, also check the following:

Load Limits

Make sure you do not exceed the load limits (page 37).

Cargo

Check that all cargo is secure.

Adjustments

Adjust the rear suspension (page 115) according to your load.

Is Your Motorcycle Ready to Ride?

Check these items after you get on the motorcycle:

- Throttle* Rotate the throttle to check it moves smoothly without binding.
- Brakes* Pull the brake lever and press on the brake pedal to check that they operate normally.
- Indicators* Turn the ignition on and check for normal operation of the indicators (page 13).

If you haven't ridden the motorcycle in over a week, you should also check other items, such as the oil level and other fluids. See *Periodic Maintenance* (page 62). Periodic maintenance should also be done at least once a month, no matter how often you ride.

Remember, be sure to take care of any problem you find, or have your Honda dealer correct it before you ride.

Load Limits & Guidelines

Your motorcycle has been designed to carry you and one passenger. When you carry a passenger, you may feel some difference during acceleration and braking. But so long as you keep your motorcycle well-maintained, with good tires and brakes, you can safely carry loads within the given limits and guidelines.

However, exceeding the weight limit or carrying an unbalanced load can seriously impair your motorcycle's handling, braking, and stability. Non-Honda accessories, improper modifications, and poor maintenance can also reduce your safety margin.

Loading

How much weight you put on your motorcycle, and how you load it, are important to your safety. Anytime you ride with a passenger or cargo, you should be aware of the following information.

WARNING

Overloading or improper loading can cause a crash and you can be seriously hurt or killed.

Follow all load limits and other loading guidelines in this manual.

Load Limits

Following are the load limits for your motorcycle:

maximum weight capacity:

322 lbs (146 kg)

includes the weight of the rider, passenger, all cargo, and all accessories.

maximum cargo weight:

7 lbs (3 kg)

The weight of added accessories will reduce the maximum cargo weight you can carry.

Loading Guidelines

Your motorcycle is primarily intended for transporting you and a passenger. You may wish to secure a jacket or other small items to the seat when you are not riding with a passenger.

If you wish to carry more cargo, check with your Honda dealer for advice, and be sure to read the information regarding accessories on page 5 .

Improperly loading your motorcycle can affect its stability and handling. Even if your motorcycle is properly loaded, you should ride at reduced speeds and never exceed 80 mph (130 km/h) when carrying cargo.

Load Limits & Guidelines

Follow these guidelines whenever you carry a passenger or cargo:

- Check that both tires are properly inflated, and that pressure in the rear tire is increased to suit the load (page 124).
- If you change your normal load, you may need to adjust the rear suspension (page 115).
- To prevent loose items from creating a hazard, make sure that all cargo is tied down securely before you ride.
- Place cargo weight as low and close to the center of your motorcycle as possible.
- Balance cargo weight evenly on both sides.

- Do not attach large or heavy items (such as a sleeping bag or tent) to the handlebar, forks, or fender.

Basic Operation & Riding

This section gives basic riding instructions, including how to start and stop your engine, and how to use the throttle, clutch, and brakes. It also provides important information on riding with a passenger or cargo.

To protect your new engine and enjoy optimum performance and service life, refer to Break-in Guidelines (page 197).

To protect the catalytic converters in your motorcycle's exhaust system, avoid extended idling and the use of leaded gasoline.

| | |
|--|----|
| Safe Riding Precautions | 40 |
| Starting & Stopping the Engine | 41 |
| Preparation..... | 41 |
| Starting Procedure | 42 |
| Flooded Engine | 43 |
| Bank Angle Sensor Ignition Cut-off System | 43 |
| How to Stop the Engine | 44 |
| Shifting Gears..... | 45 |
| Braking | 47 |
| Parking | 49 |
| Theft-prevention Tips | 52 |
| Riding with a Passenger or Cargo..... | 53 |

Safe Riding Precautions

Before riding your motorcycle for the first time, please review the *Motorcycle Safety* section beginning on page 1, and the *Before Riding* section beginning on page 29.

Even if you have ridden other motorcycles, take time to become familiar with how this motorcycle works and handles. Practice in a safe area until you build your skills and get accustomed to the motorcycle's size and weight.

Make sure flammable materials such as dry grass or leaves do not come in contact with the exhaust system when riding, idling, or parking your motorcycle.

Starting & Stopping the Engine

Always follow the proper starting procedure described below.

For your safety, avoid starting or operating the engine in an enclosed area such as a garage. Your motorcycle's exhaust contains poisonous carbon monoxide gas which can collect rapidly in an enclosed area and cause illness or death.

Your motorcycle can be started with the transmission in gear by pulling in the clutch lever before operating the starter.

Your motorcycle is equipped with a side stand ignition cut-off system. If the side stand is down — the engine cannot be started unless the transmission is in neutral. If the side stand is up — the engine can be started in neutral, or in gear with the

clutch lever pulled in. After starting with the side stand down, the engine will stop if the transmission is put in gear before raising the side stand.

Preparation

Before starting, insert the key, turn the ignition switch ON, and confirm the following:

- The transmission is in neutral (neutral indicator is ON).
- The engine stop switch is set to RUN.
- The low oil pressure indicator is ON.
- The PGM-FI malfunction indicator lamp (MIL) is OFF.
- The high coolant temperature indicator is OFF.

(cont'd)

Starting & Stopping the Engine

The low oil pressure indicator should go off a few seconds after the engine starts. If the low oil pressure indicator lights during operation, stop the engine immediately and check the engine oil level.

Starting Procedure

This motorcycle has a fuel-injected engine with an automatic choke. Follow the procedure indicated below.

Any Air Temperature

- Press the start button with the throttle completely closed.

The engine will not start if the throttle is fully open (because the electronic control module cuts off the fuel supply).

Starting & Stopping the Engine

Flooded Engine

If the engine fails to start after repeated attempts, it may be flooded with excess fuel. To clear a flooded engine:

1. Leave the engine stop switch set to RUN.
2. Open the throttle fully.
3. Press the start button for 5 seconds.
4. Follow the normal starting procedure.
5. If the engine starts, then open the throttle slightly if idling is unstable. If the engine does not start, wait 10 seconds, then follow steps 1 – 4 again.

If the engine still won't start, refer to *If Your Engine Quits or Won't Start*, page 157.

Bank Angle Sensor Ignition Cut-off System

Your motorcycle's banking (lean angle) sensor system is designed to automatically stop the engine and fuel pump if the motorcycle is overturned.

Before restarting the engine, you must turn the ignition switch to the OFF position and then back to ON. The engine will not restart until you perform this procedure.

Starting & Stopping the Engine

How to Stop the Engine

Normal Engine Stop

To stop the engine, shift into neutral and turn the ignition switch OFF.

The engine stop switch should normally remain in the RUN position even when the engine is OFF.

If your motorcycle is stopped with the engine stop switch OFF and the ignition switch ON, the headlight and taillight will remain on, resulting in battery discharge.

Emergency Engine Stop

To stop the engine in an emergency, use the engine stop switch. To operate, press the switch to the OFF position.

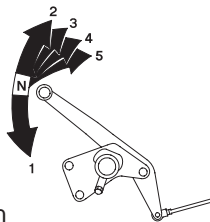

shifting pattern

Your motorcycle has five forward gears in a one-down, four-up shift pattern which is coordinated with a cable-operated clutch system.

Learning when to shift gears comes with experience. Keep the following tips in mind:

- As a general rule, shift while moving in a straight line.
- Close the throttle and pull the clutch lever in completely before shifting. Improper shifting may damage the engine, transmission, and drive train.
- Learn to recognize the engagement point as you release the clutch lever. It is at this point the transmission of power to the rear wheel resumes.
- Upshift to a higher gear or reduce throttle before engine rpm (speed) gets too high. Learn the relationship between engine sound and the normal shifting points.
- Downshift to a lower gear before you feel the engine laboring (lugging) at low rpm.

(cont'd)

Shifting Gears

- Avoid downshifting to help slow your motorcycle when engine rpm is high. Downshifting when engine speed is near its allowable maximum may over-rev the engine and cause possible damage.
- To prevent transmission damage, do not coast or tow the motorcycle for long distances with the engine off.

Recommended Shift Points

Ride in the highest gear that lets the engine run and accelerate smoothly. This will give you good fuel economy and effective emissions control. When changing gears under normal conditions, use these recommended shift points:

Shifting Up:

| | |
|------------------|------------------|
| From 1st to 2nd: | 12 mph (20 km/h) |
| From 2nd to 3rd: | 19 mph (30 km/h) |
| From 3rd to 4th: | 25 mph (40 km/h) |
| From 4th to 5th: | 31 mph (50 km/h) |

Shifting Down:

| | |
|------------------|------------------|
| From 5th to 4th: | 22 mph (35 km/h) |
| From 4th to 3rd: | 16 mph (25 km/h) |

Pull the clutch lever in when speed drops below 9 mph (15 km/h), when engine roughness is evident, or when engine stalling is imminent; and shift down to 1st gear for acceleration.

Your motorcycle is equipped with disc braking systems which are hydraulically activated. Operating the brake lever applies the front disc brake. Depressing the brake pedal applies the rear disc brake.

As a general rule, the front braking system provides about 70 percent of total stopping power.

For full braking effectiveness, use both the pedal and lever simultaneously. Using both braking systems will stop your motorcycle faster with greater stability.

To slow or stop, apply the brake lever and brake pedal smoothly, while downshifting to match your speed.

Gradually increase braking as you feel the brakes slowing your speed. The increase in engine compression from downshifting will help slow your motorcycle.

To prevent stalling the engine, pull the clutch lever in before coming to a complete stop. For support, put your left foot down first, then your right foot when you have finished braking.

Applying the brakes too hard may cause the wheels to lock and slide, reducing control of your motorcycle. If this happens, release the brake controls, steer straight ahead until you regain control, then reapply the brakes more gently.

Braking

When possible, reduce your speed or complete braking before entering a turn. Avoid braking or closing the throttle quickly while turning. Either action may cause one or both wheels to slip and reduce your control of your motorcycle.

Your ability to brake in a turn and to brake hard in an emergency situation are important riding skills. We suggest attending a Motorcycle Safety Foundation experienced rider training course (page 32) to retain these skills.

When riding in wet or rainy conditions, or on loose surfaces, the ability to maneuver and stop will be reduced. All of your actions should be smooth under these conditions. Rapid acceleration, braking or turning may cause loss of control.

For your safety, exercise extreme caution when braking, accelerating or turning.

When descending a long, steep grade, use engine compression braking by downshifting, with intermittent use of both brakes. Continuous brake application can overheat the brakes and reduce their effectiveness.

Riding with your foot resting on the brake pedal or your hand on the brake lever may actuate the brakelight, giving a false indication to other drivers. It may also overheat the brakes, reducing effectiveness.

1. Look for a level parking area. If you can't park on a paved surface, make sure the ground surface is firm, especially under the side stand. If you must park on a hill, leave the transmission in gear and position the rear tire against the curb at a 45 degree angle.

Make sure flammable materials such as dry grass or leaves do not come in contact with the exhaust system when parking your motorcycle. Refer to *Catalytic Converters*, page 205 .

2. Use the side stand to support the motorcycle while parked.
 - To lower the side stand, use your foot to guide it down. Remember that lowering the side stand with the transmission in gear will stop the engine, even if the clutch lever is pulled in. That is a function of the side stand ignition cut-off system.
 - Check that the side stand is down all the way so that the side stand ignition cut-off system (page 41) is activated.
 - If you have to park on a soft surface, insert something solid under the side stand for support.

(cont'd)

Parking

- Use the steering lock (1), which locks the handlebar in place. Turn the handlebar all the way to the left. Insert the steering lock key (2) in the lock, turn the key counterclockwise. Push and turn the key clockwise. Remove the key.

To unlock the steering lock, insert the steering lock key in the lock and turn it counterclockwise. Remove the key.

RIGHT FRONT

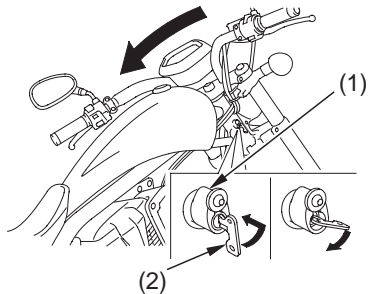

(1) steering lock (2) steering lock key

4. Use the helmet holder (3) to secure your helmet with your motorcycle:
- Insert the ignition key (4) and turn it counterclockwise to unlock the holder.
 - Hang your helmet on the holder pin (5).
 - Push in on the holder pin. Remove the key.

LEFT REAR

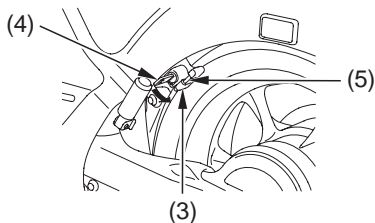

- (3) helmet holder (5) holder pin
(4) ignition key

⚠ WARNING

Riding with a helmet attached to the holder can interfere with the rear wheel or suspension and could cause a crash in which you can be seriously hurt or killed.

Use the helmet holder only while parked. Do not ride with a helmet secured by the holder.

Parking

Theft-prevention Tips

- Park your motorcycle in a locked garage whenever possible. If a garage isn't available, park in a concealed area or in a well-lit area with enough pedestrian traffic to discourage a thief.
 - Always take the ignition key with you.
 - Always use the steering lock (page 50), even if you're parking for just a minute or two. A thief can easily push an unlocked motorcycle to a waiting truck.
 - In addition to the steering lock, use a good quality anti-theft device made specifically to lock a motorcycle to a secure object.
- If you decide to use an anti-theft device, select one of good quality and be sure to follow the manufacturer's instructions.
 - Keep your owner's manual, current registration, and insurance information with your motorcycle. This will make it easier for the authorities to find you if your motorcycle is stolen and recovered.

Riding with a Passenger or Cargo

Your motorcycle is designed to carry you and one passenger. Whenever you add a passenger or cargo, you must be careful not to exceed the total load limits for this vehicle (*Load Limits*, page 37). Make sure your cargo is properly secured (*Loading Guidelines*, page 37).

Also consider adjusting the suspension (page 115) for the extra load.

Be aware that carrying a passenger or heavy cargo can affect acceleration, braking, and handling.

Before riding with a passenger, make sure your passenger is wearing the proper protective apparel (page 30).

Tell your passenger to hold the seat strap or your waist, lean with you in the turns, and keep their feet on the passenger footpegs at all times, even when the motorcycle is stopped at a traffic light.

To help keep your motorcycle in good shape, this section includes a Maintenance Schedule for required service, a list of periodic checks you should perform at least once a month, and step-by-step instructions for specific maintenance tasks. You'll also find important safety precautions, information on fuels and oils, and tips for keeping your Honda looking great.

For information about the exhaust emission and noise emission requirements of the U.S. Environmental Protection Agency (EPA), the California Air Resources Board (CARB), and Environment Canada (EC), see page 198 .

For information about replacing fuses, see page 178 .

USA only

Maintenance, replacement or repair of the emission control devices and systems may be performed by any motorcycle repair establishment or individual using parts that are “certified” to EPA standards.

Before You Service Your Honda

| | |
|-------------------------------------|----|
| The Importance of Maintenance | 58 |
| Maintenance Safety | 59 |
| Important Safety Precautions..... | 60 |
| Periodic Maintenance | 62 |
| Maintenance Schedule | 64 |
| Maintenance Record..... | 69 |

(cont'd)

Servicing Your Honda

Service Preparations

| | |
|---------------------------------------|----|
| Maintenance Component Locations | 71 |
| Side Cover Removal..... | 74 |
| Tool Kit..... | 76 |
| Owner's Manual Storage..... | 77 |
| Seat Removal..... | 78 |
| Clip Removal..... | 80 |

Service Procedures

Fluids & Filters

| | |
|--------------------------|-----|
| Fuel | 81 |
| Engine Oil & Filter..... | 84 |
| Coolant..... | 93 |
| Air Cleaner | 98 |
| Crankcase Breather | 100 |
| Final Drive Oil..... | 101 |

Engine

| | |
|--------------------|-----|
| Throttle | 104 |
| Clutch System..... | 106 |
| Spark Plugs..... | 110 |

Chassis

| | |
|-----------------|-----|
| Suspension..... | 115 |
| Brakes | 120 |
| Tires | 124 |
| Side Stand..... | 134 |

Electrical

| | |
|---------------|-----|
| Battery | 135 |
|---------------|-----|

| | |
|-----------------------|-----|
| Appearance Care | 140 |
|-----------------------|-----|

Servicing Your Honda

The following table summarizes the three types of inspections and servicing recommendations for your motorcycle. Both the pre-ride inspection and the scheduled maintenance at the recommended intervals are necessary to assure safe and dependable performance. The periodic checks provide additional confidence in your motorcycle's performance.

| Type of Inspection/Service | Refer to page: | When Performed | Who Performs |
|----------------------------|----------------|----------------------|---------------------|
| Pre-ride Inspection | 33 | before every ride | you |
| Periodic Maintenance | 62 | monthly* | you |
| Maintenance Schedule | 64 | interval on schedule | your Honda dealer** |

* more often if you ride frequently or long distances; or anytime you clean your motorcycle

** unless you have the proper tools and service data and are mechanically qualified

The Importance of Maintenance

Keeping your motorcycle well-maintained is absolutely essential to your safety. It's also a good way to protect your investment, get maximum performance, avoid breakdowns, and have more fun. A properly maintained motorcycle will also help to reduce air pollution.

Remember, proper maintenance is the owner's responsibility. Be sure to inspect your motorcycle before each ride, perform the periodic checks, and follow the Maintenance Schedule in this section.

WARNING

Improperly maintaining this motorcycle or failing to correct a problem before you ride can cause a crash in which you can be seriously hurt or killed.

Always follow the inspection and maintenance recommendations and schedules in this owner's manual.

If your motorcycle overturns or is involved in a crash, be sure your Honda dealer inspects all major parts, even if you are able to make some of the repairs yourself.

This section includes instructions on how to perform some important maintenance tasks. If you have basic mechanical skills, you can perform many of these tasks with the tools provided with your motorcycle.

Other tasks that are more difficult and require special tools are best performed by professionals. Wheel removal should normally be handled only by a Honda technician or other qualified mechanic. Instructions are included in this manual only to assist in emergency service.

Some of the most important safety precautions follow. However, we cannot warn you of every conceivable hazard that can arise in performing maintenance. Only you can decide whether or not you should perform a given task.

WARNING

Failure to properly follow maintenance instructions and precautions can cause you to be seriously hurt or killed.

Always follow the procedures and precautions in this owner's manual.

Maintenance Safety

Important Safety Precautions

- Make sure the engine is off before you begin any maintenance or repairs. This will help eliminate several potential hazards:

Carbon monoxide poisoning from engine exhaust. Be sure there is adequate ventilation whenever you operate the engine.

Burns from hot motorcycle parts. Let the engine and exhaust system cool before touching.

Injury from moving parts. Do not run the engine unless instructed to do so.

- Read the instructions before you begin, and make sure you have the tools and skills required.
- To help prevent the motorcycle from falling over, park it on a firm, level surface, using the side stand or a maintenance stand to provide support.
- To reduce the possibility of a fire or explosion, be careful when working around gasoline. Use only non-flammable solvent, not gasoline, to clean parts. Keep cigarettes, sparks, and flames away from all fuel-related parts.

Remember that your Honda dealer knows your motorcycle best and is fully equipped to maintain and repair it. To ensure the best quality and reliability, use only new Honda Genuine Parts or their equivalents for repair and replacement. If you have the tools and skills required for additional maintenance jobs, you can purchase an official Honda Service Manual (page 210).

Periodic Maintenance

In addition to the regularly scheduled maintenance (page 64) and daily pre-ride inspection (page 33), consider performing the periodic checks on the following page at least once a month, even if you haven't ridden your motorcycle, or as often as once a week if you ride frequently or for long distances. It's a good idea to perform this maintenance any time you clean your motorcycle.

Check the odometer reading and perform any scheduled maintenance checks that are needed (page 64). Remember, more frequent checks may be needed for riding in severe conditions.

Periodic Maintenance

| | |
|--------------------|---|
| Tires & Wheels | <p>Check the air pressure with a gauge and add air if needed (page 124). Examine the tread for wear (page 126). Look closely for nails, embedded objects, cuts, and other types of damage (page 126). Roll your motorcycle so you can inspect the entire surface.</p> <p>Check the condition of the wheels.</p> |
| Fluids | <p>Check the levels of the engine oil (page 88), coolant (page 95), brake fluid (page 121), and final drive oil (page 101). Add the correct fluid as necessary, and investigate the cause of any low fluid level.</p> |
| Lights | <p>Make sure the headlight, brakelight, taillight, and turn signals are working properly.</p> |
| Freeplay | <p>Check the freeplay of the clutch lever (page 106) and throttle grip (page 104).</p> |
| Fuses | <p>Make sure you have a full supply of spare fuses.</p> |
| Nuts & Bolts | <p>Check the major fasteners and tighten as needed.</p> |
| Crankcase Breather | <p>Service the crankcase breather more frequently if your motorcycle is ridden in the rain or often at full throttle. Service the breather if you can see deposits in the transparent section of the drain tube.</p> |

Maintenance Schedule

The required Maintenance Schedule that follows specifies how often you should have your motorcycle serviced, and what things need attention. It is essential to have your motorcycle serviced as scheduled to maintain safe, dependable performance and proper emission control.

The service intervals in this Maintenance Schedule are based on average riding conditions. Some items will need more frequent service if you ride in unusually wet or dusty areas or at full throttle. Consult your Honda dealer for recommendations applicable to your individual needs and use.

Some items in the Maintenance Schedule can be performed with basic mechanical skills and hand tools. Procedures for these items are provided in this manual. Other items involve more extensive procedures and may require special training, tools, and equipment. We recommend that you have your Honda dealer perform these tasks unless you have advanced mechanical skills and the required tools and equipment. Procedures for such items in this schedule are provided in an official Honda Service Manual available for purchase (page 210).

Maintenance Schedule

If you do not feel capable of performing a given task or need assistance, remember that your Honda dealer knows your motorcycle best and is fully equipped to maintain and repair it. If you decide to do your own maintenance, use only Honda Genuine Parts or their equivalents for repair or replacement to ensure the best quality and reliability.

Perform the pre-ride inspection (page 33) and owner maintenance (page 64) at each scheduled maintenance period.

Each item on the maintenance schedule requires some mechanical knowledge. Certain items (particularly those marked * and **) may require more technical information and tools. Consult your Honda dealer.

- * Should be serviced by your Honda dealer, unless you have the proper tools and service data and are mechanically qualified. Refer to the official Honda Service Manual (page 210).
- ** In the interest of safety, we recommend these items be serviced only by your Honda dealer.

Maintenance Schedule

Summary of Maintenance Schedule Notes & Procedures:

NOTES:

1. At higher odometer readings, repeat at the frequency interval established here.
2. Service more frequently if the motorcycle is ridden in unusually wet or dusty areas.
3. Service more frequently if the motorcycle is ridden often at full throttle or in the rain.
4. California type only.
5. Replace every 2 years, or at indicated odometer interval, whichever comes first. Replacement requires mechanical skill.

Maintenance Procedures:

- I: inspect and clean, adjust, lubricate, or replace, if necessary
- C: clean
- A: adjust
- L: lubricate
- R: replace

Maintenance Schedule

| ITEM | | FREQUENCY NOTE | ODOMETER READING (Note 1) | | | | | | | | Refer to page | |
|-------------------------|-------------------------------------|--------------------|---------------------------|-----------|--|----------|-----------|-----------|-----------|-----------|------------------|----|
| | | | × 1,000 mi × 100 km | 0.6 10 | 4 64 | 8 128 | 12 192 | 16 256 | 20 320 | 24 384 | | |
| EMISSIONS-RELATED ITEMS | * | FUEL LINE | | | | I | | I | | I | — | |
| | * | THROTTLE OPERATION | | | | I | | I | | I | — | |
| | | AIR CLEANER | 2 | | | | R | | | R | 98 | |
| | | CRANKCASE BREATHER | 3 | | C | C | C | C | C | C | 100 | |
| | | SPARK PLUGS | | | I | R | I | R | I | R | 110 | |
| | * | VALVE CLEARANCE | | | I | | I | | I | | I | — |
| | | ENGINE OIL | | | INITIAL=600 mi (1,000 km) or 1 month: R REGULAR=EVERY 8,000 mi (12,800 km) or 12 months: R | | | | | | 84 | |
| | | ENGINE OIL FILTER | | | R | | R | | R | | R | 89 |
| | * | ENGINE IDLE SPEED | | | I | I | I | I | I | I | I | — |
| | | RADIATOR COOLANT | 5 | | | | I | | I | | R | 93 |
| | * | COOLING SYSTEM | | | | | I | | I | | I | — |
| * | SECONDARY AIR SUPPLY SYSTEM | | | | | I | | I | | I | — | |
| * | EVAPORATIVE EMISSION CONTROL SYSTEM | 4 | | | | | I | | | I | — | |

* Should be serviced by your Honda dealer, unless you have the proper tools and service data and are mechanically qualified. Refer to the official Honda Service Manual (page 210).

Maintenance Schedule

| ITEM | | FREQUENCY | NOTE | ODOMETER READING (Note 1) | | | | | | | Refer to page | |
|----------------------------|----|------------------------|------|---------------------------|-----|----|-----|-----|-----|-----|---------------|-----|
| | | | | × 1,000 mi | 0.6 | 4 | 8 | 12 | 16 | 20 | | 24 |
| | | | | × 100 km | 10 | 64 | 128 | 192 | 256 | 320 | 384 | |
| NON-EMISSION-RELATED ITEMS | | FINAL DRIVE OIL | | | | | | | | | R | 101 |
| | | BRAKE FLUID | 5 | | | | | R | | | R | 120 |
| | | BRAKE PAD WEAR | | | | | | | | | | 123 |
| | | BRAKE SYSTEM | | | | | | | | | | 120 |
| | * | BRAKELIGHT SWITCH | | | | | | | | | | — |
| | * | HEADLIGHT AIM | | | | | | | | | | — |
| | | CLUTCH SYSTEM | | | | | | | | | | 106 |
| | | SIDE STAND | | | | | | | | | | 134 |
| | * | SUSPENSION | | | | | | | | | | — |
| | * | NUTS, BOLTS, FASTENERS | | | | | | | | | | — |
| | ** | WHEELS/TIRES | | | | | | | | | | — |
| | ** | STEERING HEAD BEARINGS | | | | | | | | | | — |

* Should be serviced by your Honda dealer, unless you have the proper tools and service data and are mechanically qualified. Refer to the official Honda Service Manual (page 210).

**In the interest of safety, we recommend these items be serviced only by your Honda dealer.

Maintenance Record

Keeping an accurate maintenance record will help ensure that your motorcycle is properly maintained. Retain detailed receipts to verify the maintenance was performed. If the motorcycle is sold, these receipts should be transferred with the motorcycle to the new owner. Make sure whoever performs the maintenance completes this record. All scheduled maintenance, including the 600 mile (1,000 km) initial maintenance, is considered a normal owner operating cost and will be charged for by your dealer. Use the space under Notes to record anything you want to remind yourself about or mention to your dealer.

| Miles (km) | Odometer | Date | Performed By: | Notes |
|-------------------|-----------------|-------------|----------------------|--------------|
| 600 (1,000) | | | | |
| 4,000 (6,400) | | | | |
| 8,000 (12,800) | | | | |
| 12,000 (19,200) | | | | |
| 16,000 (25,600) | | | | |
| 20,000 (32,000) | | | | |

Maintenance Record

| Miles (km) | Odometer | Date | Performed By: | Notes |
|-------------------|-----------------|-------------|----------------------|--------------|
| 24,000 (38,400) | | | | |
| 28,000 (44,800) | | | | |
| 32,000 (51,200) | | | | |
| 36,000 (57,600) | | | | |
| 40,000 (64,000) | | | | |
| 44,000 (70,400) | | | | |
| 48,000 (76,800) | | | | |
| 52,000 (83,200) | | | | |
| 56,000 (89,600) | | | | |
| 60,000 (96,000) | | | | |
| 64,000 (102,400) | | | | |
| 68,000 (108,800) | | | | |

Maintenance Component Locations

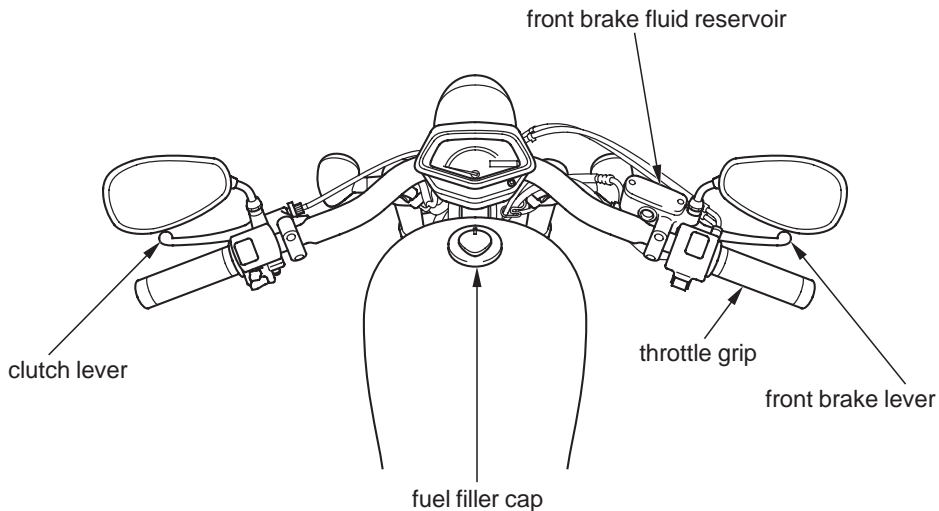

Maintenance Component Locations

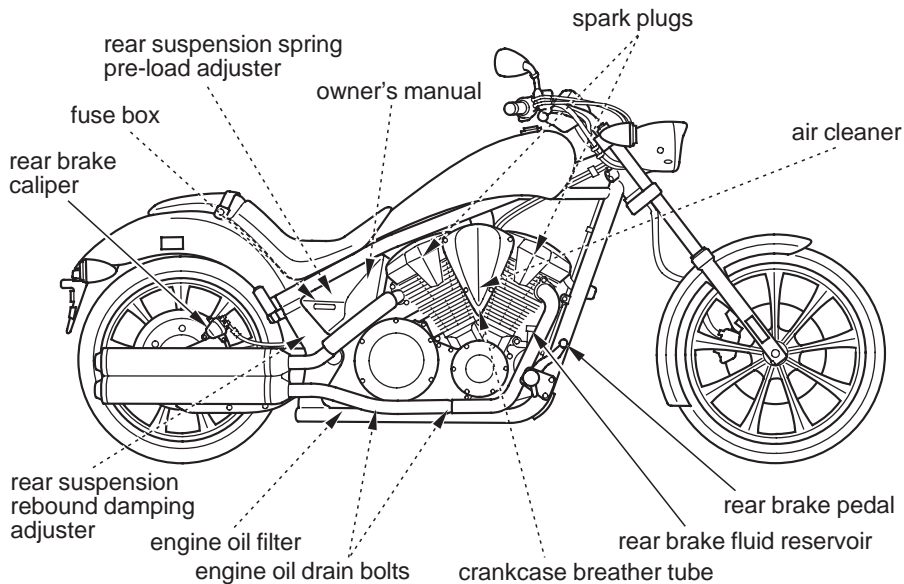

Maintenance Component Locations

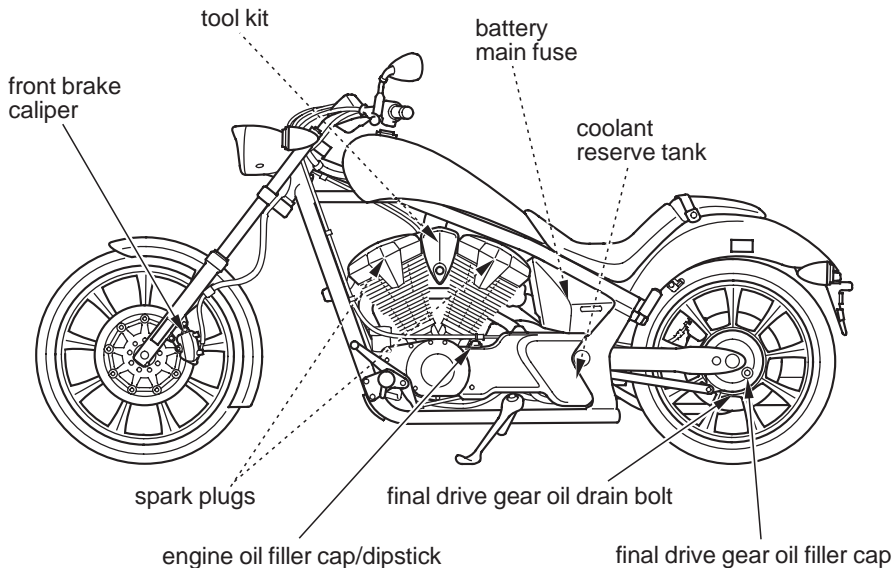

Side Cover Removal

Refer to *Safety Precautions* on page 60 .

The left side cover (1) must be removed to service the main fuse and the battery.

LEFT SIDE

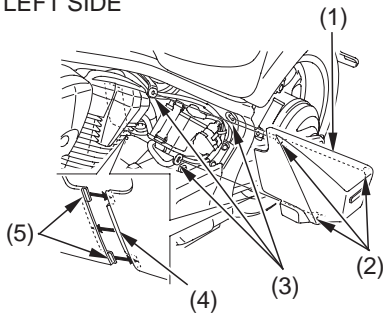

- | | |
|---------------------|---------------------------|
| (1) left side cover | (4) left side cover tab |
| (2) prongs | tab |
| (3) frame grommets | (5) right side cover tabs |

Left Side Cover Removal

1. Carefully pull the left side cover out until the prongs (2) are clear of the frame grommets (3).
2. Remove the left side cover.

Left Side Cover Installation

1. Align the left side cover tab (4) with the right side cover tabs (5).
2. Position the left side cover so the prongs are aligned with the frame grommets.
3. Push the prongs in.

Side Cover Removal

Refer to *Safety Precautions* on page 60 .

The right side cover (1) must be removed to service the circuit fuses, suspension adjustment or to access the owner's manual.

RIGHT SIDE

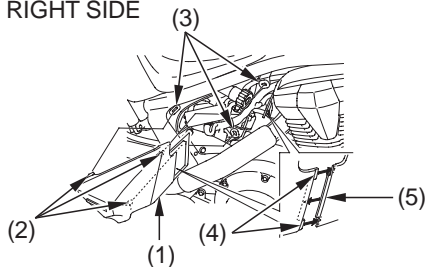

- | | |
|----------------------|---------------------------|
| (1) right side cover | (4) right side cover tabs |
| (2) prongs | |
| (3) frame grommets | (5) left side cover tab |

Right Side Cover Removal

1. Carefully pull the right side cover out until the prongs (2) are clear of the frame grommets (3).
2. Remove the right side cover.

Right Side Cover Installation

1. Align the right side cover tabs (4) with the left side cover tab (5).
2. Position the right side cover so the prongs are aligned with the frame grommets.
3. Push the prongs in.

Tool Kit

The tool kit (1) is stored on the face of the ignition switch case (2) behind the ignition switch cover (3).

Ignition Switch Cover Removal

1. Remove the clips (4) (page 80).
2. Remove the ignition switch cover.

Ignition Switch Cover Installation

1. Install the ignition switch cover.
2. Install the clips.

An optional, larger tool kit may be available. Check with your Honda dealer's parts department.

LEFT SIDE

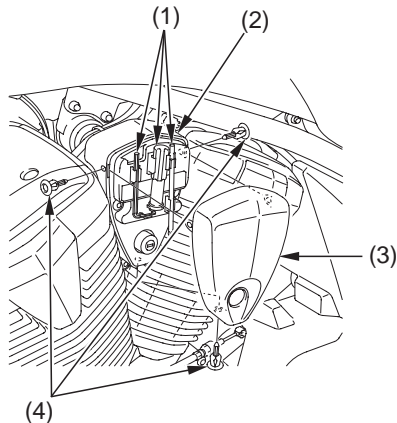

- | | |
|--------------------------|---------------------------|
| (1) tool kit | (3) ignition switch cover |
| (2) ignition switch case | (4) clips |

Owner's Manual Storage

Your motorcycle provides storage for the owner's manual so you'll have it with you for easy reference. Store your owner's manual in the plastic storage bag (1) attached to the inside of the right side cover (page 75).

Store your other documents in the plastic storage bag attached to the rear fender under the seat (page 78).

RIGHT SIDE

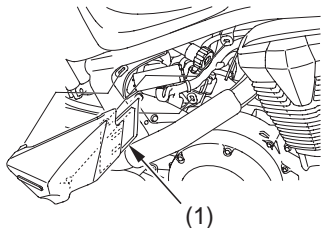

UNDER SEAT

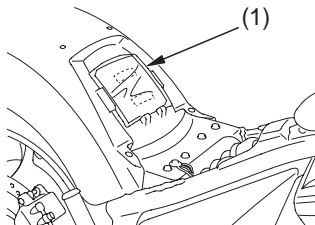

(1) plastic storage bag

Seat Removal

Refer to *Safety Precautions* on page 60 .

The seat must be removed to access the other documents and to check the color label.

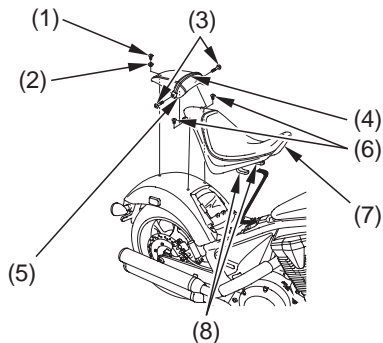

- (1) seat mounting bolt A
- (2) collar
- (3) seat mounting bolts B
- (4) seat strap
- (5) rear seat
- (6) seat mounting bolts C
- (7) front seat
- (8) tabs

Removal

1. Remove the seat mounting bolt A (1) and collar (2).
2. Remove the seat mounting bolts B (3) and seat strap (4).
3. Remove the rear seat (5).
4. Remove the seat mounting bolts C (6).
5. Pull the front seat (7) back and up.

Installation

1. Insert the tabs (8) into the recess under the frame.
2. Install and tighten the seat mounting bolts C.
3. Install the rear seat.
4. Install the seat mounting bolts B and seat strap. Tighten the seat mounting bolts B to the specified torque:
16 lbf·ft (22 N·m , 2.2 kgf·m)

5. Install the seat mounting bolt A and collar.
6. Tighten the seat mounting bolts securely.
 - Be careful not to scratch the rear fender during seat installation or removal.
 - Be careful not to get the seat caught between the stay and bolts while installing the seat.

Clip Removal

Clip removal and installation:

Removal

- ① Press down on the center pin to release the lock.
- ② Pull the clip out of the hole.

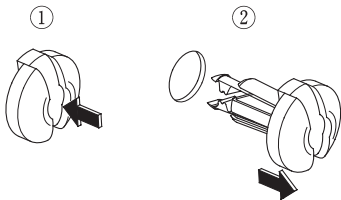

Installation

- ① Slightly open the retaining pawls and then push them out.
- ② Insert the clip into the hole.
- ③ Lightly press down on the center pin to lock the clip.

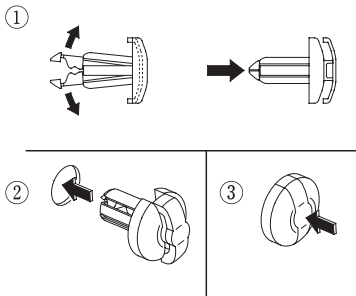

Refer to *Safety Precautions* on page 60.

Fuel Recommendation

| | |
|--------------------|----------------|
| type | unleaded |
| pump octane number | 86 (or higher) |

Use only unleaded fuel in your Honda. Use of leaded fuel will damage the catalytic converter(s). If you ride your Honda in a country where leaded fuel might be available, use precautions to use only unleaded fuel.

Your engine is designed to use any unleaded gasoline that has a pump octane number of 86 or higher. Gasoline pumps at service stations normally display the pump octane number. For information on the use of oxygenated fuels, see page 207.

Use of lower octane gasoline can cause persistent “pinging” or “spark knock” (a loud rapping noise) which, if severe, can lead to engine damage. Light pinging experienced while operating under a heavy load, such as climbing a hill, is no cause for concern.

If pinging or spark knock occurs at a steady engine speed under normal load, change brands of gasoline. If pinging or spark knock persists, consult your Honda dealer.

Fuel

Never use stale or contaminated gasoline or an oil/gasoline mixture. Avoid getting dirt, dust, or water in the fuel tank.

Fuel Capacity

Fuel tank capacity, including reserve:
3.38 US gal (12.8 ℓ)

The tank should be refilled as soon as possible when the fuel reserve indicator comes on.

Refueling Procedure

Refer to *Safety Precautions* on page 60 .

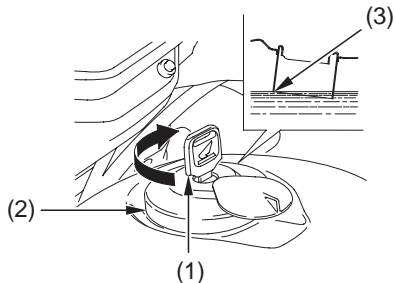

- (1) ignition key (3) filler neck
(2) fuel filler cap

1. Insert the ignition key (1) in the fuel filler cap (2) and turn it clockwise.

2. Open the fuel filler cap.
3. Add fuel until the level reaches the bottom of the filler neck (3). Avoid overfilling the tank. There should be no fuel in the filler neck.

WARNING

Gasoline is highly flammable and explosive. You can be burned or seriously injured when handling fuel.

- Stop the engine and keep heat, sparks and flame away.
- Handle fuel only outdoors.
- Wipe up spills immediately.

4. After refueling, align the latch in the cap with the slot in the filler neck. Push the cap into the filler neck until it snaps and locks.
5. Remove the ignition key from the cap.

Engine Oil & Filter

Engine oil quality is a major factor that affects both the performance and the service life of the engine.

Using the proper oil (page 85) and filter, and regularly checking, adding, and changing oil will help extend your engine's life. Even the best oil wears out. Changing oil helps get rid of dirt and deposits in the engine. Operating the engine with old or dirty oil can damage your engine. Running the engine with insufficient oil can cause serious damage to the engine and transmission.

Change the engine oil as specified in the maintenance schedule on page 67 .

When running in very dusty conditions, oil changes should be performed more frequently than specified in the maintenance schedule.

Oil Recommendation

| | |
|---------------------|---|
| API classification | SG or higher except oils labeled as energy conserving on the circular API service label |
| viscosity (weight) | SAE 10W-30 |
| JASO T 903 standard | MA |

suggested oil *

Pro Honda GN4 4-stroke oil (USA & Canada), or Honda 4-stroke oil (Canada only), or an equivalent motorcycle oil.

* Suggested oils are equal in performance to SJ oils that are not labeled as energy conserving on the circular API service label.

Engine Oil & Filter

- Your motorcycle does not need oil additives. Use the recommended oil.
- Do not use oils with graphite or molybdenum additives. They may adversely affect clutch operation.
- Do not use API SH or higher oils displaying a circular API “energy conserving” service label on the container. They may affect lubrication and clutch performance.



NOT RECOMMENDED



OK

- Do not use non-detergent, vegetable, or castor based racing oils.

Other viscosities shown in the following chart may be used when the average temperature in your riding area is within the indicated range.

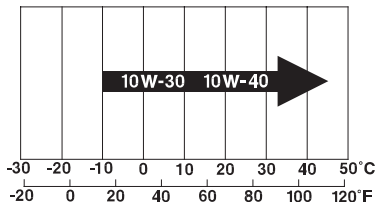

JASO T 903 standard

The JASO T 903 standard is an index for engine oils for 4-stroke motorcycle engines.

There are two classes: MA and MB.

Oil conforming to the standard is labeled on the oil container. For example, the following label shows the MA classification.

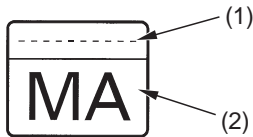

PRODUCT MEETING JASO T 903
COMPANY GUARANTEEING THIS MA PERFORMANCE:

- (1) code number of the sales company of the oil
- (2) oil classification

Engine Oil & Filter

Checking & Adding Oil

Refer to *Safety Precautions* on page 60 .

LEFT SIDE

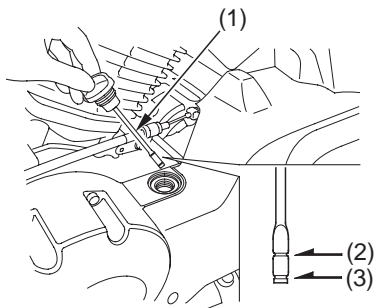

- (1) oil filler cap/dipstick
- (2) upper level mark
- (3) lower level mark

1. Park your motorcycle on its side stand on a firm, level surface.
2. Start the engine and let it idle for 3–5 minutes. Make sure the low oil pressure indicator goes off. If the indicator remains on, stop the engine immediately.
3. Stop the engine and wait 2–3 minutes.
4. Remove the oil filler cap/dipstick (1) and wipe it clean.
5. Hold the motorcycle in an upright position.
6. Insert the oil filler cap/dipstick until it seats, but don't screw it in.

7. Remove the oil filler cap/dipstick and check the oil level.
 - If the oil is at or near the upper level mark (2) — you do not have to add oil.
 - If the oil is below or near the lower level mark (3) — add the recommended oil until it reaches the upper level mark. (Do not overfill.)
8. Reinstall the oil filler cap/dipstick.
9. Check for oil leaks.

Changing Engine Oil & Filter

Refer to *Safety Precautions* on page 60 .

Your motorcycle's oil filter has very specific performance requirements. Use a new Honda Genuine oil filter or a filter of equal quality specified for your model.

NOTICE

Using the wrong oil filter may result in leaks or engine damage.

(cont'd)

Engine Oil & Filter

This procedure requires mechanical skill and professional tools such as a torque wrench and oil filter wrench, as well as a means for disposing of the drained fluid (page 153). If you do not have the skills or the tools, see your Honda dealer.

Drain the Engine Oil:

1. Park the motorcycle on its side stand on a firm, level surface.
2. If the engine is cold, start it and let it idle for 3–5 minutes. Turn the engine off. Wait 2–3 minutes for the oil to settle.

3. Place a drain pan under the crankcase.
4. To drain the oil, remove the oil filler cap/dipstick, drain bolts (1), (2) and sealing washers (3).

RIGHT FRONT, UNDER ENGINE

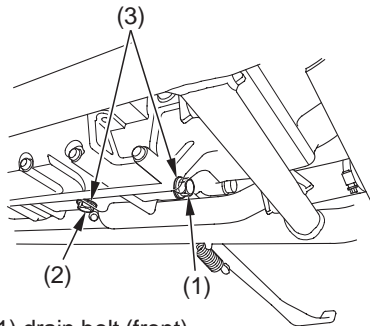

- (1) drain bolt (front)
(2) drain bolt (rear)
(3) sealing washers

Engine Oil & Filter

Install a New Oil Filter:

5. Remove the oil filter (4) with a filter wrench and let the remaining oil drain out. Discard the oil filter in an approved manner (page 153).
6. Pour the drained oil into a suitable container and dispose of it in an approved manner (page 153).

NOTICE

Improper disposal of drained fluids is harmful to the environment.

RIGHT REAR, UNDER ENGINE

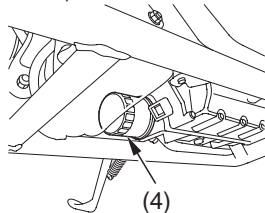

(4) oil filter

7. Apply a thin coat of engine oil to the rubber seal (5) of a new oil filter.

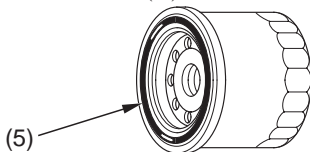

(5) rubber seal

(cont'd)

Engine Oil & Filter

8. Install the new oil filter and tighten it by hand.
9. Using an oil filter wrench attachment and a torque wrench, tighten the new oil filter to the specified torque:
19 lbf·ft (26 N·m , 2.7 kgf·m)
10. Check the condition of the sealing washers on the drain bolts. Replace the washers every other time the oil is changed.
Install the drain bolts and tighten them to the specified torque:
22 lbf·ft (30 N·m , 3.1 kgf·m)

Add Engine Oil:

11. Fill the crankcase with the recommended oil (page 85), approximately:
3.9 US qt (3.7 ℓ)

12. Install the oil filler cap/dipstick securely.
13. Start the engine and let it idle for 3–5 minutes.
14. Stop the engine and wait 2–3 minutes.
15. Hold the motorcycle upright and check that the oil level is at the upper level mark on the oil filler cap/dipstick (page 88).
16. Check that there are no oil leaks.

If a torque wrench is not used for installation, see your Honda dealer as soon as possible to verify proper assembly.

Your motorcycle's liquid cooling system dissipates engine heat through the coolant jacket that surrounds the cylinder and cylinder head.

Maintaining the coolant will allow the cooling system to work properly and prevent freezing, overheating, and corrosion.

Coolant Recommendation

Use Pro Honda HP coolant or an equivalent high quality ethylene glycol antifreeze containing corrosion protection inhibitors specifically recommended for use in aluminum engines. Check the antifreeze container label.

Use only distilled water as a part of the coolant solution. Water that is high in mineral content or salt may be harmful to the aluminum engine.

NOTICE

Using coolant with silicate inhibitors may cause premature wear of water pump seals or blockage of radiator passages. Using tap water may cause engine damage.

The factory provides a 50/50 solution of antifreeze and water in this motorcycle. This coolant solution is recommended for most operating temperatures and provides good corrosion protection.

Coolant

Decreasing the concentration of antifreeze to less than 40% will not provide proper corrosion protection.

Increasing the concentration of antifreeze is not recommended because it decreases cooling system performance. Higher concentrations of antifreeze (up to 60%) should only be used to provide additional protection against freezing. Check the cooling system frequently during freezing weather.

Checking & Adding Coolant

Refer to *Safety Precautions* on page 60.

LEFT CENTER

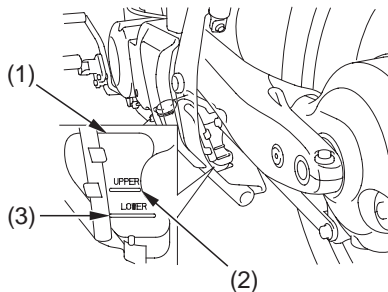

- (1) reserve tank
- (2) UPPER level mark
- (3) LOWER level mark

1. With the engine at normal operating temperature, check the coolant level in the reserve tank (1). It should be between the UPPER (2) and LOWER (3) level marks.

If the reserve tank is empty, or if coolant loss is excessive, check for leaks and see your Honda dealer for repair.

(cont'd)

Coolant

LEFT SIDE

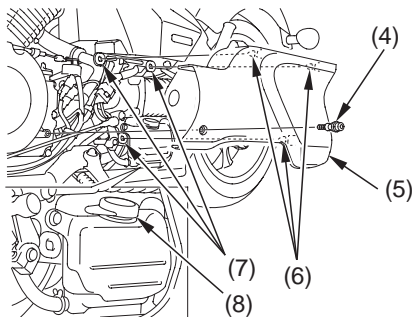

- (4) bolt
(5) left rear cover
(6) prongs
(7) frame grommets
(8) reserve tank cap

2. Remove the bolt (4).
3. Carefully pull the left rear cover (5) out until the prongs (6) are clear of the frame grommets (7).
4. Remove the left rear cover.
5. Remove the reserve tank cap (8).
Always add coolant to the reserve tank.
Do not attempt to add coolant by removing the radiator cap.
6. Add coolant to the reserve tank as required to bring the coolant level to the UPPER level mark.
7. Install the reserve tank cap.
8. Position the left rear cover so the prongs are aligned with the frame grommets.
9. Push the prongs in.
10. Install the bolt.

Coolant Replacement

Refer to *Safety Precautions* on page 60 .

Coolant should be replaced by your Honda dealer, unless you have the proper tools and service data and are mechanically qualified. Refer to the official Honda Service Manual (page 210).

WARNING

Removing the radiator cap while the engine is hot can cause the coolant to spray out, seriously scalding you.

Always let the engine and radiator cool down before removing the radiator cap.

To properly dispose of drained coolant, refer to *You & the Environment*, page 153 .

NOTICE

Improper disposal of drained fluids is harmful to the environment.

Air Cleaner

Refer to *Safety Precautions* on page 60 .

Service the air cleaner more frequently if you ride in unusually wet or dusty areas. Your Honda dealer can help you determine the correct service interval for your riding conditions.

Your motorcycle's air cleaner has very specific performance requirements. Use a new Honda Genuine air cleaner specified for your model or an air cleaner of equivalent quality.

NOTICE

Using the wrong air cleaner may result in premature engine wear.

Proper air cleaner maintenance can prevent premature engine wear or damage, expensive repairs, low engine power, poor gas mileage, and spark plug fouling.

NOTICE

Improper or lack of proper air cleaner maintenance can cause poor performance and premature engine wear.

Replacement

1. Remove the bolts (1), washers (2) and air cleaner housing cover (3).
2. Remove the air cleaner (4).
3. Discard the air cleaner.
Thoroughly clean the inside of the air cleaner case (5).
4. Install a new air cleaner and reinstall the air cleaner housing cover.
5. Reinstall the washers and make sure the bolts are tightened securely to the specified torque:
1.1 lbf·ft (1.5 N·m , 0.2 kgf·m)

RIGHT SIDE

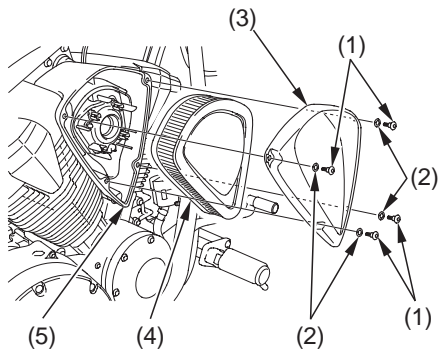

- | | |
|-------------------------------|----------------------|
| (1) bolts | (4) air cleaner |
| (2) washers | (5) air cleaner case |
| (3) air cleaner housing cover | |

Crankcase Breather

Refer to *Safety Precautions* on page 60 .

Service the crankcase breather more frequently if your motorcycle is ridden in the rain or often at full throttle. Service the breather if you can see deposits in the transparent section of the drain tube.

Draining

RIGHT FRONT

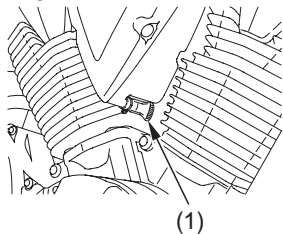

(1) crankcase breather tube plug

1. Place a drain pan under the crankcase breather tube plug (1).
2. Remove the plug to drain the deposits in the tube.
3. Reinstall the crankcase breather tube plug.

Oil Recommendation

| | |
|-----------------------|-----------------|
| type | hypoid gear oil |
| viscosity (weight) | SAE 80 |

Checking & Adding Oil

Refer to *Safety Precautions* on page 60 .

LEFT REAR

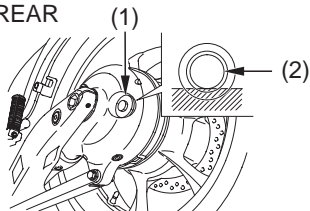

(1) oil filler cap

(2) oil filler inspection hole

1. Place the motorcycle on its side stand on a firm, level surface.
2. Remove the oil filler cap (1).
3. Check the oil level. It should be flush with the lower edge of the oil filler inspection hole (2).
4. If the level is low, check for leaks. Add the recommended oil through the oil filler inspection hole until it reaches the lower edge of the opening.
5. Install the oil filler cap and tighten to the specified torque:
9 lbf·ft (12 N·m , 1.2 kgf·m)

Final Drive Oil

Changing Oil

Refer to *Safety Precautions* on page 60 .

LEFT REAR

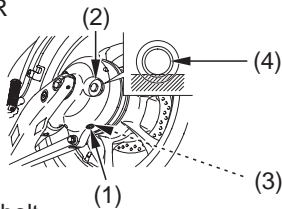

- (1) oil drain bolt
- (2) oil filler cap
- (3) sealing washer
- (4) oil filler inspection hole

Change the oil with the final drive at normal operating temperature to assure complete and rapid draining.

1. Place the motorcycle on its side stand on a firm, level surface.
2. Place a drain pan under the oil drain bolt (1).
3. Remove the oil filler cap (2) and the oil drain bolt.
4. After the oil has completely drained, check that the sealing washer (3) is in good condition. Reinstall the oil drain bolt with its sealing washer (or a new washer, if necessary) and tighten it to the specified torque:
9 lbf·ft (12 N·m , 1.2 kgf·m)
5. Pour the drained oil into a suitable container and dispose of it in an approved manner (page 153).

NOTICE

Improper disposal of drained fluids is harmful to the environment.

6. Fill the final drive with the recommended oil:
4.4 US oz (130 cm³)
Make sure the final drive oil level is at the lower edge of the oil filler inspection hole (4).
7. Install the oil filler cap and tighten to the specified torque:
9 lbf·ft (12 N·m , 1.2 kgf·m)

Throttle

Throttle Freeplay

Refer to *Safety Precautions* on page 60.

RIGHT HANDLEBAR

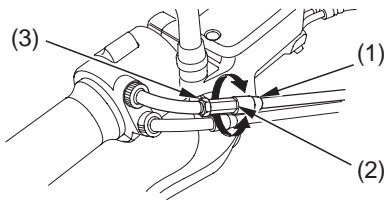

- (1) throttle cable boot
- (2) adjuster
- (3) lock nut

Inspection

Check freeplay at the throttle grip flange.

Freeplay:

1/16 – 1/4 in (2 – 6 mm)

If necessary, adjust to the specified range.

Adjustment

1. Slide the throttle cable boot (1) off the adjuster (2).
2. Loosen the lock nut (3).
3. Turn the adjuster.
4. After adjustment, check for smooth rotation of the throttle grip from fully closed to fully open in all steering positions.
5. Tighten the lock nut and return the throttle cable boot securely over the adjuster.

Throttle Inspection

Refer to *Safety Precautions* on page 60 .

1. Check that the throttle assembly is positioned properly and the securing bolts are tight.
2. Check for smooth rotation of the throttle from fully open to fully closed in all steering positions. If there is a problem, see your Honda dealer.

Clutch System

Your motorcycle's manually activated, wet, multiplate clutch is part of the primary drive system. Proper freeplay adjustment allows a smooth, gradual engagement when shifting gears.

Improper freeplay adjustment can cause premature clutch wear.

Clutch Freeplay

Refer to *Safety Precautions* on page 60 .

LEFT HANDLEBAR

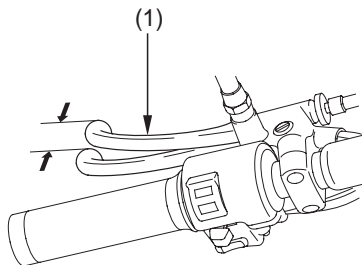

(1) clutch lever

Clutch System

Inspection

1. Check freeplay:
3/8 – 13/16 in (10 – 20 mm)
If necessary, adjust to the specified range.

Upper Adjustment

Attempt adjustment with the upper clutch cable adjuster first.

LEFT HANDLEBAR

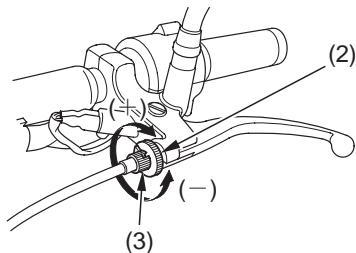

- (2) upper lock nut
- (3) upper clutch cable adjuster
- (+) increase freeplay
- (-) decrease freeplay

1. Loosen the upper lock nut (2).
2. Turn the upper clutch cable adjuster (3) to obtain the specified freeplay.
3. Tighten the upper lock nut and check the freeplay again.

Clutch System

Lower Adjustment

If the upper clutch cable adjuster is threaded out near its limit, or the correct freeplay cannot be obtained, attempt adjustment with the lower clutch cable adjuster.

LEFT SIDE

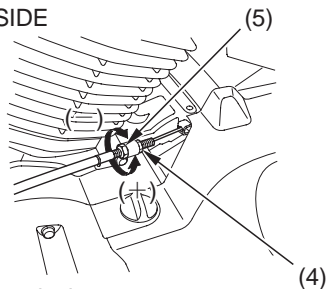

(4) lower lock nut

(5) lower adjusting nut

(+) increase freeplay

(-) decrease freeplay

1. Loosen the upper lock nut (2) and turn the upper clutch cable adjuster (3) all the way in (to provide maximum freeplay). Tighten the upper lock nut.
2. Loosen the lower lock nut (4).
3. Turn the lower adjusting nut (5) to obtain the specified freeplay.
4. Tighten the lower lock nut and check the adjustment.

5. Start the engine, pull the clutch lever in, and shift into gear. Make sure the engine does not stall and the motorcycle does not creep. Gradually release the clutch lever and open the throttle. Your motorcycle should move smoothly and accelerate gradually.

If you cannot get proper adjustment, or the clutch does not work properly, the cable or clutch friction discs may be worn. See your Honda dealer or refer to the official Honda Service Manual (page 210).

Other Inspections & Lubrication

- Check that the clutch lever assembly is positioned properly and the securing bolts are tight.
- Check the clutch cable for kinks or signs of wear. If necessary, have it replaced.
- Lubricate the clutch cable with a commercially available cable lubricant to prevent premature wear and corrosion.

Spark Plugs

Spark Plug Recommendation

| | |
|--------------------------------|-----------------------------------|
| standard spark plug | DCPR6E (NGK) or XU20EPR-U (DENSO) |
| for extended high speed riding | DCPR7E (NGK) or XU22EPR-U (DENSO) |

Use only the recommended type of spark plugs in the recommended heat range.

NOTICE

Using spark plugs with an improper heat range can cause engine damage.

Spark Plug Inspection & Replacement

Refer to *Safety Precautions* on page 60 .

RIGHT SIDE

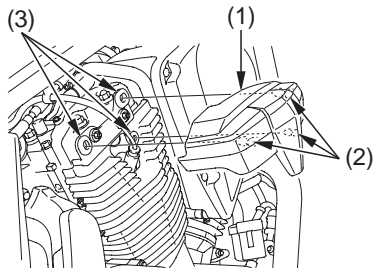

- (1) rear over head cover
- (2) prongs
- (3) engine grommets

Spark Plugs

1. Carefully pull the rear over head covers (1) on both sides out until the prongs (2) are clear of the engine grommets (3).
2. Remove the caps (4), bolts (5) and washers (6).
3. Carefully pull the front over head covers (7) on both sides out until the prongs (8) are clear of the engine grommets (9).
4. Remove the front over head center cover (10).

RIGHT SIDE

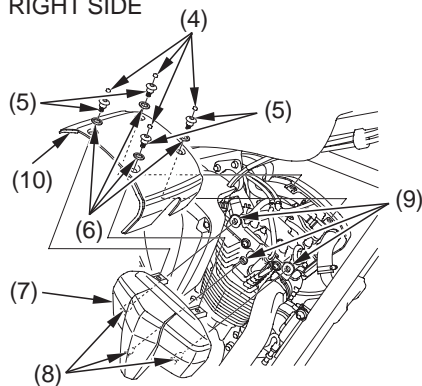

- | | |
|---------------------------|-----------------------------------|
| (4) caps | (8) prongs |
| (5) bolts | (9) engine |
| (6) washers | grommets |
| (7) front over head cover | (10) front over head center cover |

(cont'd)

Spark Plugs

- Clean any dirt from around the spark plug bases.
- Disconnect the spark plug caps (11).
Take care to avoid damaging the spark plug wire when disconnecting the caps.
- Using a spark plug wrench, remove the spark plugs.
- Inspect the electrodes and center porcelain for deposits, corrosion, or carbon fouling. If the corrosion or deposits are heavy, replace the plug. Clean a carbon or wet-fouled plug with a plug cleaner, if available, or a wire brush.

RIGHT SIDE

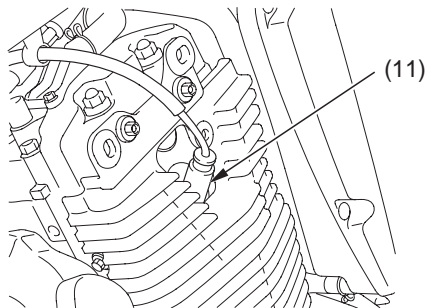

(11) spark plug cap

9. Check the spark plug gap (12) of each new plug, using a wire-type feeler gauge. If adjustment is necessary, bend the side electrode (13) carefully.

The gap should be:

0.031 – 0.035 in (0.80 – 0.90 mm)

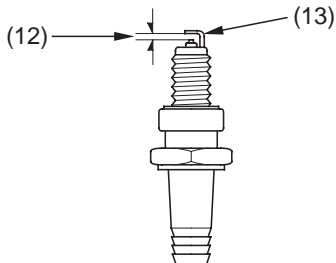

(12) spark plug gap (13) side electrode

10. With the plug washers attached, thread the spark plugs in by hand to prevent cross-threading.

11. Tighten each spark plug:

- If the old plug is good:
 - 1/8 turn after it seats.
- If installing a new plug, tighten it twice to prevent loosening:
 - a) First, tighten the plug:
 - NGK: 3/4 turn after it seats.
 - DENSO: 1/2 turn after it seats.
 - b) Then loosen the plug.
 - c) Next, tighten the plug again:
 - 1/8 turn after it seats.

NOTICE

Improperly tightened spark plugs can damage the engine. If a plug is too loose, a piston may be damaged. If a plug is too tight, the threads may be damaged.

(cont'd)

Spark Plugs

12. Reinstall the spark plug caps. Take care to avoid pinching any cables or wires.
13. Install the front over head center cover.
14. Position the front over head covers on both sides so the prongs are aligned with the engine grommets.
15. Push the prongs in.
16. Install the caps, bolts and washers.
17. Position the rear over head covers on both sides so the prongs are aligned with the engine grommets.
18. Push the prongs in.

Your front and rear suspension systems use springs and hydraulic damping devices that suspend your weight and most of the weight of your motorcycle.

The spring pre-load for your rear suspension system adjusts the amount of force required to begin compression of the spring.

The oil damper systems hydraulically control the natural compression and rebound of the suspension springs so that traction and comfort are maintained as the wheels ride over road surfaces.

Consider adjusting your suspension whenever you change your normal load, by adding or subtracting a passenger, cargo, or accessories, or when the road or riding conditions change.

The way you ride your motorcycle and the type of ride you want to experience can also influence your suspension needs.

You may adjust the spring pre-load and the rebound damping of rear suspension system.

Suspension

Lower spring pre-load and softer damping provide a softer ride and are usually preferred for light loads and smooth roads. Higher spring pre-load and firmer damping provide a firmer ride and are recommended for heavy loads, rough road conditions, and faster, more challenging riding.

Rear Suspension Adjustment

The rear suspension can be adjusted for rider (and passenger) weight and riding conditions by changing the spring pre-load and rebound damping.

The rear shock absorber includes a damper unit that contains high pressure nitrogen gas. Do not attempt to disassemble, service, or dispose of the damper; see your Honda dealer. The instructions found in this owner's manual are limited to adjustments of the shock assembly only.

Rear Suspension Spring Pre-load

Refer to *Safety Precautions* on page 60 .

RIGHT SIDE

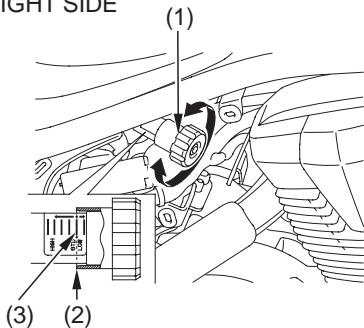

- (1) adjuster knob
- (2) end of adjuster knob
- (3) indicator line

The spring pre-load adjuster knob (1) has 35 spring pre-load positions (clicks) or more for different load or riding conditions.

To adjust the spring pre-load, turn the adjuster knob.

To adjust to the standard position:

1. Remove the right side cover (page 75).
2. Turn the spring pre-load adjuster knob counterclockwise until it will no longer turn (lightly seats).
This is the full LOW setting.
3. Turn the adjuster clockwise by 6 clicks. At that position, the end of the adjuster knob (2) should be aligned with the indicator line (3). This is the standard position.

(cont'd)

Suspension

To Reduce Spring Pre-load (LOW):

For a light load and smooth road conditions, turn the adjuster counterclockwise toward LOW.

To Increase Spring Pre-load (HIGH):

For a firmer ride and rough road conditions, turn the adjuster clockwise toward HIGH.

Rear Suspension Damping

Refer to *Safety Precautions* on page 60 .

Rebound Damping

RIGHT SIDE

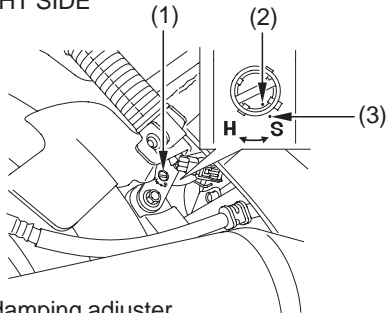

- (1) damping adjuster
- (2) punch mark
- (3) reference punch mark

To adjust to the standard position:

1. Turn the damping adjuster (1) clockwise until it will no longer turn (lightly seats). This is the full hard setting.
2. Turn the adjuster counterclockwise approximately $3/4$ turns so that the punch mark (2) on the adjuster aligns with the reference punch mark (3). This is the standard position.

To Reduce Rebound Damping (SOFT):

For a light load and smooth road conditions, turn the adjuster counterclockwise toward SOFT (S).

To Increase Rebound Damping (HARD):

For a firmer ride and rough road conditions, turn the adjuster clockwise toward HARD (H).

Brakes

The hydraulic braking systems on your motorcycle dissipate the heat generated by the friction of the brake pads on the brake discs as the wheels are slowed.

As the brake pads wear, the brake fluid level will drop. A leak in the system will also cause the level to drop.

Frequently inspect the system to ensure there are no fluid leaks. Periodically inspect the brake fluid level and the brake pads for wear.

If the brake lever or brake pedal freeplay does not feel within the normal range while riding, check the brake pads for wear (page 123). Worn pads should be replaced. If the pads are not worn beyond the recommended limit, there is probably

air in the brake system. See your Honda dealer to have the air bled from the system.

Brake Fluid Recommendation

| | |
|-------------|-------------------------|
| brake fluid | Honda DOT 4 Brake Fluid |
|-------------|-------------------------|

The recommended brake fluid is Honda DOT 4 Brake Fluid, or any brake fluid of equal quality and performance. Use fresh brake fluid from a sealed container. Be sure to read the label before opening the sealed container. An opened container may be contaminated or may have absorbed moisture from the air.

Fluid Level Inspection

Refer to *Safety Precautions* on page 60 .

If your inspection indicates a low fluid level, have your Honda dealer add the recommended brake fluid.

Do not add or replace brake fluid, except in an emergency. If you do add fluid, have your Honda dealer check the system as soon as possible.

NOTICE

Brake fluid can damage plastic and painted surfaces. Handle with care.

Wipe up spills immediately. Avoid brake fluid contact with skin or eyes. If it comes in contact with your eyes, wash them out with clean water and immediately call a doctor. If it comes in contact with your skin, wash with clean water and, if necessary, call a doctor.

RIGHT HANDLEBAR (Front Brake)

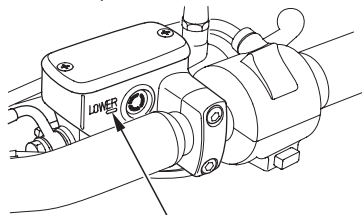

(1)
(1) LOWER level mark

(cont'd)

Brakes

RIGHT SIDE
(Rear Brake)

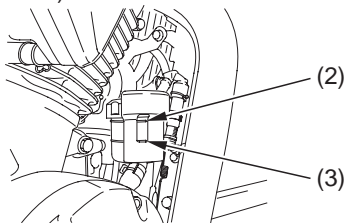

(2) UPPER level mark
(3) LOWER level mark

1. Place your motorcycle in an upright position on a firm, level surface.
2. Check the fluid level.
Front : It should be above the LOWER level mark (1).
Rear : It should be between the UPPER (2) and LOWER level (3) marks.

If the level is at or below the LOWER level mark, check the brake pads for wear (page 123).

Worn pads should be replaced. If the pads are not worn beyond the recommended limit, have your brake system inspected for leaks.

Other Inspections

- Make sure there are no fluid leaks.
- Check for deterioration or cracks in the hoses and fittings.

Brake Pad Wear

Refer to *Safety Precautions* on page 60 .

Brake pad wear depends upon the severity of usage, the type of riding, and road conditions. Generally, the pads will wear faster on wet and dirty roads. Inspect the pads at each regular maintenance interval (page 68).

Check the cutouts (1) in each pad. It may be helpful to use a small mirror to view the cutout on the inside brake pad of the rear brake. If either pad is worn to the cutout, replace both pads as a set. See your Honda dealer for this service.

LEFT FRONT

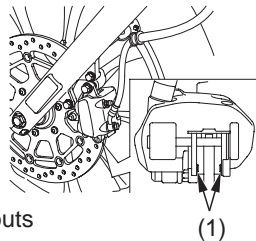

(1) cutouts

RIGHT REAR

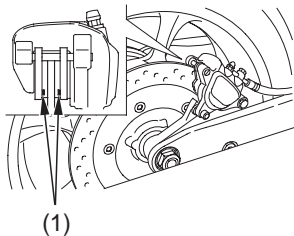

(1) cutouts

Tires

To safely operate your motorcycle, your tires must be the proper type and size, in good condition with adequate tread, and correctly inflated for the load you are carrying.

WARNING

Using tires that are excessively worn or improperly inflated can cause a crash in which you can be seriously hurt or killed.

Follow all instructions in this owner's manual regarding tire inflation and maintenance.

The following pages give detailed information on how and when to check

your air pressure, how to inspect your tires for wear and damage, and our recommendations for tire repair and replacement.

Air Pressure

Refer to *Safety Precautions* on page 60 .

Properly inflated tires provide the best combination of handling, tread life, and riding comfort. Generally, underinflated tires wear unevenly, adversely affect handling, and are more likely to fail from being overheated. Overinflated tires make your motorcycle ride harshly, are more prone to damage from road hazards, and wear unevenly.

We recommend that you visually check your tires before every ride and use an air pressure gauge to measure the air pressure at least once a month or any time you think the tires might be low. Even tires that are in good condition may lose one to two psi per month if not checked and adjusted regularly.

Tubeless tires have some degree of self-sealing ability if they are punctured. However, because leakage is often very slow, you should look closely for punctures whenever a tire is not fully inflated.

Always check air pressure when your tires are “cold”, after the motorcycle has been parked for at least three hours. If you check air pressure when your tires are “warm” — even if your motorcycle has only been ridden for a few miles — the readings will be higher. If you let air out of warm tires to match the recommended cold pressures, the tires will be underinflated.

Tires

The recommended “cold” tire pressures are:

| | |
|-------|---|
| front | 33 psi (225 kPa , 2.25 kgf/cm ²) |
| rear | 41 psi (280 kPa , 2.80 kgf/cm ²) |

Inspection

Refer to *Safety Precautions* on page 60 .

Whenever you check the tire pressures, you should also look for:

- Bumps or bulges in the side of the tire or the tread. Replace any tire that has a bump or bulge.
- Cuts, slits, or cracks in the tires. Replace the tire if you can see fabric or cord.
- Nails or other foreign objects embedded in the side of the tire or tread.
- Excessive tread wear.

Also, if you hit a pothole or hard object while riding, pull to the side of the road as soon as you safely can and carefully inspect the tires for damage.

Tread Wear

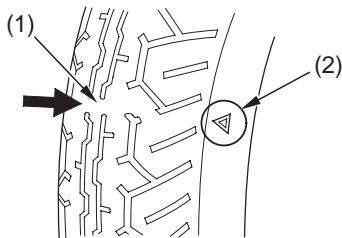

- (1) wear indicator
- (2) wear indicator location mark

For the best performance, you should replace a tire before the tread depth at the center reaches the following limits:

| | |
|-------|------------------|
| front | 0.06 in (1.5 mm) |
| rear | 0.08 in (2.0 mm) |

If the wear indicators are visible, replace the tire immediately as it is no longer safe.

Tires

Tire Service Life

The service life of your tires is dependent on many factors, including, but not limited to, riding habits, road conditions, vehicle loading, tire pressure, maintenance history, speed, and environmental conditions (even when the tires are not in use).

In addition to your regular inspections and tire pressure maintenance, it is recommended that you have annual inspections performed once the tires reach 5 years old. It is also recommended that all tires be removed from service after 10 years from the date of manufacture, regardless of their condition or state of wear.

The last four digits of the TIN (tire identification number) (1) are found on the sidewall of the tire, and indicate the date of manufacture.

Tire Identification Number (TIN)

The tire identification number (TIN) is a group of numbers and letters that look like the following example.

The TIN is located on the sidewall of the tire.

DOT ×××× ×××× 22 07
(2) (3) (4)

DOT — This indicates that the tire meets all requirements of the U.S. Department of Transportation.

- (2) ×××× — Factory code
- (3) ×××× — Tire type code
- (4) 22 07 — Date of manufacture
 - Year
 - Week

TIRE LABELING EXAMPLE

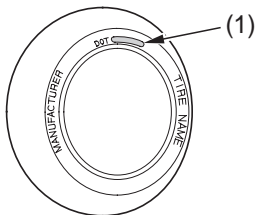

(1) tire identification number (TIN)

Tires

Tire Repair

Refer to *Safety Precautions* on page 60 .

We strongly recommend that you replace, not repair, any tire that is punctured or damaged. As discussed below, a tire that is repaired, either temporarily or permanently, will have lower speed and performance limits than a new or undamaged tire.

A temporary repair can sometimes be made in an emergency situation. However, since a temporary repair may not hold, you must ride very slowly, preferably without any cargo or passenger, and have the tire replaced or permanently repaired as soon as possible. (For more information on temporary repairs, see *If You Have a Flat Tire*, page 162 .)

A permanent repair, such as an internal plug patch, can be made if a tire has only a small puncture in the tread area. With such a repair, you should not exceed 50 mph (80 km/h) for the first 24 hours, or 80 mph (130 km/h) at any time thereafter. In addition, you may not be able to safely carry as much weight. If you choose to have a tire repaired, be sure the repair work is performed by a professional and that the wheel is balanced before you ride.

If you have a tire professionally repaired at a non-Honda facility, we recommend that you have the work checked by your Honda dealer.

Tires

Tire Replacement

Refer to *Safety Precautions* on page 60 .

The tires that came on your motorcycle were designed to match the performance capabilities of your motorcycle and provide the best combination of handling, braking, durability, and comfort.

When replacing, use the original equipment tires or equivalent tires of the same size, construction, speed rating, and load range as the originals.

WARNING

Installing improper tires on your motorcycle can affect handling and stability. This can cause a crash in which you can be seriously hurt or killed.

Always use the size and type of tires recommended in this owner's manual.

The recommended tires for your motorcycle are:

| | |
|-------|------------------------------------|
| front | 90/90 – 21M/C 54H DUNLOP ELITE3 |
| type | bias-ply, tubeless |
| rear | 200/50R18M/C 76H DUNLOP ELITE3 |
| type | radial, tubeless |

Whenever you replace a tire, remember:

- Have the wheel balanced after the tire is installed.
- Have the tire replaced by your Honda dealer if possible.

If you have a tire professionally replaced at a non-Honda facility, we recommend that you have the work checked by your Honda dealer.

Important Safety Reminders

- Do not install a tube inside a tubeless tire on this motorcycle. Excessive heat build-up can cause the tube to burst.
- Use only tubeless tires on this motorcycle. The rims are designed for tubeless tires, and during hard acceleration or braking, a tube-type tire could slip on the rim and cause the tire to rapidly deflate.

Side Stand

Refer to *Safety Precautions* on page 60 .

LEFT SIDE

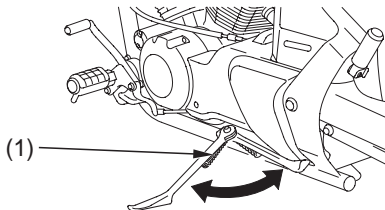

(1) side stand spring

- Check that the side stand assembly is working properly. If the side stand is stiff or squeaky, clean the pivot area and lubricate the pivot bolt with clean grease.

- Check the spring for damage or loss of tension.
- Check the side stand ignition cut-off system:
 1. Sit on the motorcycle and put the transmission in neutral.
 2. Raise the side stand.
 3. Start the engine.
 4. Pull the clutch lever in.
 5. Shift the transmission into gear.
 6. Lower the side stand all the way.The engine should stop as you lower the side stand. If the engine doesn't stop, see your Honda dealer for service.

Your motorcycle has a maintenance-free type battery. You do not have to check the battery electrolyte level or add distilled water as you would with a conventional-type battery.

NOTICE

Your battery is a maintenance-free type and can be permanently damaged if the cap strip is removed.

Electrical accessories use current from the battery, even when the ignition is OFF. Limited operation also allows the battery to discharge. If you have electrical accessories on your motorcycle or do not ride frequently, we recommend that you charge the battery frequently (see *Battery Charging*, page 139).

If you do not expect to ride your motorcycle for at least two weeks, we recommend you remove the battery, or at least disconnect the battery cables (negative cable first).

If you plan to store your motorcycle, see *Battery Storage*, page 136 .

If your battery seems weak and/or is leaking electrolyte (causing slow starting or other electrical problems), see your Honda dealer.

WARNING: Battery posts, terminals and related accessories contain lead and lead compounds. **Wash your hands after handling.**

Battery

Battery Storage

Refer to *Safety Precautions* on page 60 .

If you plan to store your motorcycle, we recommend you remove the battery and store it where it can be charged at least every 30 days to maintain its service life.

If you do not remove the battery, we recommend disconnecting the battery cables (negative cable first).

You will get the best storage results from removing the battery and slow charging it every 30 days (see *Battery Charging*, page 139).

Before you remove the battery, be sure to read all the information that follows, as well as the information on the battery label.

WARNING

The battery gives off explosive hydrogen gas during normal operation.

A spark or flame can cause the battery to explode with enough force to kill or seriously hurt you.

Wear protective clothing and a face shield, or have a skilled mechanic do the battery maintenance.

The battery is located in the battery box behind the left side cover.

Removal

1. Make sure the ignition switch is OFF.
2. Remove the left side cover (page 74).
3. Remove the battery band (1).
4. Disconnect the negative (-) terminal lead (2) from the battery first.
5. Disconnect the positive (+) terminal lead (3).
6. Pull the battery (4) out of the battery box.

LEFT SIDE

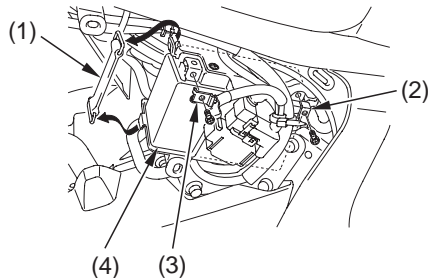

- (1) battery band
- (2) negative (-) terminal lead
- (3) positive (+) terminal lead
- (4) battery

(cont'd)

Battery

7. Charge the battery (see following section), unless you have been riding regularly.
8. Store your battery in an easy-to-reach location off the floor, in an area protected from freezing temperatures and direct sunlight.
9. Clean the battery box after removing the battery for storage. Dry the battery box and, if paint is missing, re-paint the area.
10. Slow charge the battery (see following section) once every 30 days.

Installation

1. Reinstall in the reverse order of removal. Be sure to connect the positive (+) terminal first, then the negative (-) terminal.
2. Check all bolts and other fasteners are secure.

Battery Charging

Refer to *Safety Precautions* on page 60 .

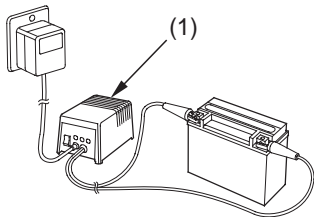

(1) charger

Be sure to read the information that came with your battery charger and follow the instructions on the battery. Improper charging may damage the battery.

We recommend using a charger (1) designed specifically for your Honda, which can be purchased from your Honda dealer. These units can be left connected for long periods without risking damage to the battery. However, do not intentionally leave the charger connected longer than the time period recommended in the charger's instructions.

Avoid using an automotive-type battery charger. An automotive charger can overheat a motorcycle battery and cause permanent damage.

Appearance Care

Frequent cleaning and polishing will keep your Honda looking newer longer. Frequent cleaning also identifies you as an owner who values your motorcycle. A clean motorcycle is also easier to inspect and service.

General Recommendations

Refer to *Safety Precautions* on page 60 .

- To clean your motorcycle, you may use:
 - water
 - a mild, neutral detergent and water
 - a mild spray and wipe cleaner/polisher
 - a mild spray and rinse cleaner/degreaser and water

- Avoid products that contain harsh detergents or chemical solvents that could damage the metal, paint, and plastic on your motorcycle.
- If your motorcycle is still warm from recent operation, give the engine and exhaust system time to cool off.
- Park in a shady area. Washing your motorcycle in bright sunlight may cause the finish to fade because water droplets intensify the sun's brightness. Spotting is also more likely because surface water can dry before you have time to wipe it off.
- Clean your motorcycle regularly to protect surface finishes.

- We recommend the use of a garden hose to wash your motorcycle. High pressure washers (like those at coin-operated car washes) can damage certain parts of your motorcycle.
- Do not direct water at the air intake. The water could enter the air cleaner or be drawn into the throttle body. After washing, inspect for the crankcase breather drain tube. If water is in the tube, clean the crankcase breather tube plug (page 100).

NOTICE

High pressure water (or air) can damage certain parts of your motorcycle.

- After cleaning, inspect for damage, wear, and leaks (fuel, oil, coolant, and brake fluid).

Washing Your Motorcycle with a Mild Detergent

Refer to *Safety Precautions* on page 60 .

1. Rinse your motorcycle thoroughly with cool water to remove loose dirt.
2. Fill a bucket with cool water. Mix in a mild, neutral detergent, such as dish washing liquid or a product made especially for washing motorcycles or automobiles.
3. Wash your motorcycle with a sponge or a soft towel. As you wash, check for heavy grime. If necessary, use a mild cleaner/degreaser to remove the grime.
4. After washing, rinse your motorcycle thoroughly with plenty of clean water to remove any residue. Detergent residue can corrode alloy parts. (cont'd)

Appearance Care

5. Dry your motorcycle with a chamois or a soft towel. Leaving water on the surface to air dry can cause dulling and water spots. As you dry, inspect for chips and scratches.
6. Start the engine and let it idle for several minutes. The engine heat will help dry moist areas.
7. As a precaution, ride your motorcycle at a slow speed and apply the brakes several times. This will help dry the brakes and restore normal braking performance.

If the inside of the headlight lens appears clouded immediately after washing, it should clear after a few minutes of riding.

Spray Cleaning Your Motorcycle

Refer to *Safety Precautions* on page 60 .

Avoid using spray cleaner products on the tires or suspension components.

Suggestions for using spray cleaner(s) follow:

Appearance Care

| Motorcycle Condition | Recommended Cleaning |
|-------------------------------------|--|
| Dust and fingerprint smudges. | Apply a spray cleaner/polish and wipe the paint, chrome, glass, and clear plastic. |
| Light road grime. | Spray any difficult-to-reach or very dirty areas with a spray cleaner/degreaser. Rinse and dry. Apply a spray cleaner/polish and wipe with a non-abrasive cloth. |
| Heavy grime. Oil leaks. Brake dust. | Use a spray cleaner/degreaser. If necessary, rub with a sponge. Rinse and dry. Apply a spray cleaner/polish and wipe with a non-abrasive cloth. |
| Dull, corroded chrome or aluminum. | Apply a high quality chrome/aluminum polish and wipe with a non-abrasive cloth. |

Appearance Care

Painted Aluminum Wheel Maintenance

Refer to *Safety Precautions* on page 60 .

Aluminum may corrode from contact with dirt, mud, or road salt. Clean the wheels after riding through any of these substances. Use a wet sponge and mild detergent. Avoid stiff brushes, steel wool, or cleaners containing abrasives or chemical compounds.

After washing, rinse with plenty of water and dry with a clean cloth.

If the paint is chipped, apply touch-up paint.

Clean the Matte Painted Surface

Refer to *Safety Precautions* on page 60 .

Use a soft cloth or sponge, plenty of water, and a mild detergent to clean the matte paint. Dry with a soft, clean cloth.

Do not use polishing compounds or wax containing polishing compounds. These can damage or discolor the paint.

To keep your Honda looking new, clean and polish it frequently.

Exhaust Pipe Maintenance

Refer to *Safety Precautions* on page 60 .

The exhaust pipe is stainless steel, but may become stained by oil or mud. If necessary, remove heat stains with a liquid kitchen abrasive.

Finishing Touches

Refer to *Safety Precautions* on page 60 .

After washing your motorcycle, consider using a commercially available spray cleaner/polish or quality liquid or paste wax to finish the job. Use only a non-abrasive polish or wax made specifically for motorcycles or automobiles. Apply the

polish or wax according to the instructions on the container.

If a surface on your motorcycle is chipped or scratched, your Honda dealer has touch-up paint to match your motorcycle's color. Be sure to use your motorcycle's color code (page 188) when you buy touch-up paint.

If the frame has a chip that exposes the metal, first apply primer (to prevent corrosion) and then apply the touch-up paint. Several thin layers of touch-up paint are better than one thick coat.

Here's a few helpful tips on how to store and transport your Honda, and how to be an environmentally responsible motorcycle owner.

| | |
|------------------------------------|-----|
| Storing Your Honda | 148 |
| Transporting Your Motorcycle | 152 |
| You & the Environment | 153 |

Storing Your Honda

If you won't be riding for an extended period, such as during the winter, thoroughly inspect your motorcycle and correct any problem before storing it. That way, needed repairs won't be forgotten and it will be easier to get your motorcycle running again.

For more information about storage, refer to the *Honda Winter Storage Guide*, available from your Honda dealer (USA only).

We suggest you perform the following procedures to keep your motorcycle in top condition. These storage procedures will reduce the deterioration that can occur during storage.

Preparation for Storage

Refer to *Safety Precautions* on page 60 .

1. Change the engine oil and filter (page 89).
2. Make sure the cooling system is filled with a 50/50% antifreeze solution (page 93).
3. Fill the fuel tank. Make sure the fuel fill cap is properly installed.

Storing Your Honda

4. To prevent rusting in the cylinders, perform the following:
 - Remove the spark plug caps from the spark plugs. Using tape or string, secure the caps to any convenient plastic body part so that they are positioned away from the spark plugs.
 - Remove the spark plugs from the engine and store them in a safe place. Do not connect the spark plugs to the spark plug caps.
 - Pour a tablespoon (15 – 20 cc) of clean engine oil into each cylinder and cover the spark plug holes with a piece of cloth.
- With the engine stop switch in the RUN position, press the start button several times to crank the engine and distribute the oil.
- Reinstall the spark plugs and spark plug caps.
5. Remove the battery and charge it fully. Store it in an area protected from freezing temperatures and direct sunlight. Slow charge the battery (page 139) once a month.
6. Wash and dry your motorcycle. Wax all painted surfaces (except matte painted surfaces). Apply rust-inhibiting oil to the chrome pieces.
7. Inflate the tires to their recommended pressures (page 124).

(cont'd)

Storing Your Honda

8. Store your motorcycle in an unheated area, free of dampness, away from sunlight, with a minimum of daily temperature variation.
9. Place your motorcycle on blocks to lift both tires off the floor.
10. Cover your motorcycle with a porous material. Avoid using plastic or similar non-breathing, coated materials that restrict air flow and allow heat and moisture to accumulate.

Removal from Storage

Refer to *Safety Precautions* on page 60 .

1. Uncover and clean your motorcycle.
2. If your motorcycle has been stored for more than four months — change the engine oil (page 89).
3. If your motorcycle has been stored for more than two months — ask your Honda dealer to drain and replace the fuel.
4. Charge the battery (page 139) as required. Install the battery.
5. Perform a pre-ride inspection (page 33), then test-ride your motorcycle at low speeds.

Transporting Your Motorcycle

If your motorcycle needs to be transported, it should be carried on a motorcycle trailer, or a truck or trailer with a flatbed area. Do not tow your motorcycle, as towing can seriously damage the transmission.

When contacting a towing or transporting service, be sure to ask if they have a flatbed area, a loading ramp or power ramp to safely lift the motorcycle, and motorcycle tie-down straps.

Owning and riding a motorcycle can be enjoyable, but you must do your part to protect nature.

Following are tips on how you can be an environmentally responsible motorcycle owner.

- **Choose Sensible Cleaners.** Use a biodegradable detergent when you wash your motorcycle. Avoid aerosol spray cleaners that contain chlorofluorocarbons (CFCs) which damage the atmosphere's protective ozone layer. Don't throw cleaning solvents away; see the following guidelines for proper disposal.

- **Recycle Wastes.** It's illegal and thoughtless to put used engine oil in the trash, down a drain, or on the ground. Used oil, gasoline, coolant, and cleaning solvents contain poisons that can hurt refuse workers and contaminate our drinking water, lakes, rivers, and oceans. Before changing your oil, make sure you have the proper containers. Put oil and other toxic wastes in separate sealed containers and take them to a recycling center. Call your local or state office of public works or environmental services to find a recycling center in your area, and to get instructions on how to dispose of non-recyclable wastes.

Taking Care of the Unexpected

This section discusses the more common problems that can occur with your motorcycle while you're riding. It tells you how to evaluate each problem and what actions you can take to try to resume riding. If the problem cannot be safely solved, this section also gives instructions on the proper way to have your motorcycle transported.

For information about transporting your motorcycle, see page 152 .

| | |
|--|-----|
| General Guidelines..... | 156 |
| If Your Engine Quits or Won't Start .. | 157 |
| If You Have a Flat Tire..... | 162 |
| If Your Engine Overheats..... | 175 |
| If the Low Oil Pressure Indicator Lights..... | 177 |
| If a Fuse Blows..... | 178 |
| If You Crash..... | 182 |
| If You Lose Your Key | 183 |
| If Your Battery Is Low (or Dead)..... | 184 |

Taking Care of the Unexpected

General Guidelines

Keeping your motorcycle well-maintained is the best way to reduce the possibility of having a problem on the road.

Remember to take along your owner's manual, the tool kit that came with your motorcycle, and any other items (such as tire repair supplies and additional tools) that might help you solve a problem on your own.

Should you ever have a problem while riding, please follow these guidelines:

- Always put personal safety first.
- Take time to assess the situation and your options before deciding what to do.
- If the problem is relatively minor and you have the tools, supplies, and skills to make a temporary repair, be sure to have permanent repairs made as soon as possible.
- Do not continue riding if you are hurt or your motorcycle is not in safe riding condition.

Additional recommendations for specific problems follow.

If Your Engine Quits or Won't Start

Proper operation and maintenance can prevent starting and engine performance problems. In many cases, the cause of the problem may be a simple operational oversight.

If you have a problem starting the engine — or experience poor engine performance — the following information may help you. If you can't correct the problem, see your Honda dealer.

If your motorcycle won't start, listen as you press the start button. If you don't hear the starter motor turning, refer to the *Starter motor doesn't operate* symptom. If you can hear the starter motor working normally, refer to the *Starter motor works, but the engine won't start* symptom.

If Your Engine Quits or Won't Start

| SYMPTOM: Starter motor doesn't operate. | |
|--|--|
| POSSIBLE CAUSE | WHAT TO DO |
| ignition switch OFF | Turn the ignition switch ON. |
| engine stop switch OFF | Turn the engine stop switch to RUN. |
| transmission not in neutral | Shift into neutral. |
| side stand down (when transmission not in neutral) | Put the transmission in neutral or raise the side stand and pull the clutch lever in. |
| blown fuse | Replace with a new fuse of the same rating (page 178). |
| battery lead loose | Tighten the battery lead. |
| low (or dead) battery | Charge the battery (page 139). If charging doesn't help, see your Honda dealer. |
| faulty starter motor | If all possible causes are negative, the starter motor may be faulty. See your Honda dealer. |

If Your Engine Quits or Won't Start

| SYMPTOM: Starter motor works, but the engine won't start. | |
|--|---|
| POSSIBLE CAUSE | WHAT TO DO |
| out of fuel | Fill the fuel tank. |
| flooded engine | See <i>Flooded Engine</i> (page 43). |
| loose or unconnected spark plug caps | Install the spark plug caps securely. If the engine still won't start, see your Honda dealer. |
| loose battery cables | Tighten the battery terminal bolts. |
| weak battery | Charge the battery (page 139). If charging doesn't help, see your Honda dealer. |

If Your Engine Quits or Won't Start

| SYMPTOM: Engine starts, but stalls as you shift into gear. | |
|---|------------------------------------|
| POSSIBLE CAUSE | WHAT TO DO |
| side stand down | Raise the side stand. Start again. |

| SYMPTOM: Engine starts, but runs poorly. | |
|---|---|
| POSSIBLE CAUSE | WHAT TO DO |
| idles roughly, too fast, stalls | See your Honda dealer. |
| overheating | Check the high coolant temperature indicator. Refer to <i>If Your Engine Overheats</i> , page 175 . |
| low oil pressure | Check the low oil pressure indicator. Refer to <i>If the Low Oil Pressure Indicator Lights</i> , page 177 . |
| runs erratically, misfires | May damage catalytic converters. See your Honda dealer. |
| blubbers (rich fuel mixture) | See your Honda dealer. |

If Your Engine Quits or Won't Start

| SYMPTOM: Engine starts, but runs poorly (cont'd). | |
|--|---|
| POSSIBLE CAUSE | WHAT TO DO |
| sooty exhaust (rich fuel mixture) | See your Honda dealer. |
| detonates or pings under load | If applicable, switch to the recommended octane gasoline (page 81) or change your brand of gasoline. If the problem persists, see your Honda dealer. |
| afterfires (backfires) | May damage catalytic converters. See your Honda dealer. |
| pre-ignition (runs on after ignition switched OFF) | May damage catalytic converters. See your Honda dealer. |

If You Have a Flat Tire

A flat tire is always unwelcome, especially if you are far from help. If you think you are losing air, or you hit a pothole or hard object, pull safely to the side of the road so you can inspect the tires and assess the situation. (Be sure to park on a firm, level surface and use the side stand for support.) You should examine the tire treads and sidewalls for foreign objects or damage. If you find a tire that has been punctured or damaged, you have two options.

Option 1:

Have Your Motorcycle Transported

If a tire has a major puncture or a cut in the tread or sidewall, or the bead has come loose from the rim, there is probably not much you can do except have your motorcycle transported to a Honda dealer

or other qualified service facility. Even with a simple puncture, this may be the safest and least troublesome solution. For transporting instructions, see page 152 .

Option 2:

Make a Temporary Roadside Repair

If a tire has only a minor nail puncture and is not completely flat, you may be able to make an emergency repair that could allow you to continue riding to where you can get the tire replaced or permanently repaired.

If You Have a Flat Tire

WARNING

Riding your motorcycle with a temporary tire repair can be risky. If the temporary repair fails, you can crash and be seriously injured or killed.

If you must ride with a temporary tire repair, ride slowly and carefully and do not exceed 30 mph (50 km/h) until the tire is permanently repaired or replaced.

Due to the uncertainty of any temporary repair, you should ride slowly (not over 30 mph, 50 km/h) and carefully (preferably without a passenger or cargo) until the tire is replaced or permanently

repaired. Stop frequently and check the air pressure. If the tire is losing pressure, it may be unsafe to continue riding. As the tire gets low, it will affect the handling of your motorcycle (especially with a passenger and cargo), and it may overheat and blow out.

Types of Temporary Repairs

The following types of temporary repairs generally require a source of air to inflate the tire. Possible sources include CO₂ cartridges or cans of compressed air designed to inflate a tire.

If You Have a Flat Tire

- **Inflate the tire:** Tubeless tires have some self-sealing ability if they are punctured and the result is usually just a slow leak. If this is the case, you can try inflating the tire to see if it will hold air pressure. If you can see a nail or other object embedded in the tire tread, do not remove it at this time.
- **Plug the hole:** The idea here is to do something to temporarily stop the leak. If you have a tubeless tire repair kit, you can pull out the nail and try inserting an external plug in the puncture. Follow the instructions that came with the repair kit and be sure to inflate the tire to the correct pressure.

Should You Repair or Replace a Tire?

We strongly recommend that you replace, not permanently repair, any tire that is punctured or damaged, even if the tire has only a minor puncture. For a full discussion of repairs and replacement, see page 130 .

If You Have a Flat Tire

Emergency Front Wheel Removal/Installation

Refer to *Safety Precautions* on page 60 .

We recommend wheel removal be done only by your Honda dealer or another qualified mechanic. Do not attempt to remove the wheel on your own. Wheel removal requires mechanical skill and professional tools.

Removal

1. Park your motorcycle on a firm, level surface.
2. Carefully raise the center of the motorcycle with a chain hoist.

LEFT SIDE

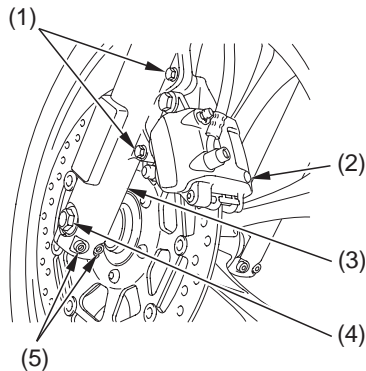

- (1) fixing bolts
- (2) brake caliper assembly
- (3) fork leg
- (4) front axle bolt
- (5) axle pinch bolts

(cont'd)

If You Have a Flat Tire

3. Remove the fixing bolts (1) and remove the left brake caliper assembly (2) from the fork leg (3).
 - To avoid damage to the brake hose during removal, support the caliper assembly so that it doesn't hang from the hose. Do not twist the brake hose.
 - Avoid getting grease, oil, or dirt on the disc or pad surfaces. Any contamination can cause poor brake performance or rapid pad wear after reassembly.
4. Remove the front axle bolt (4), and then loosen the right and left axle pinch bolts (5).
5. Remove the front axle shaft (6), wheel and side collars.
 - Avoid pressing the brake lever when the wheel is off the motorcycle. This will force the caliper pistons out of the cylinders. The result will be loss of brake fluid. If this occurs, the brake system will require service. See your Honda dealer for this service.

If You Have a Flat Tire

RIGHT FRONT

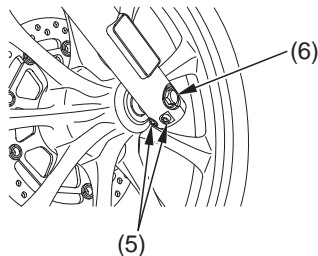

(5) axle pinch bolts (6) front axle shaft

Installation

1. Install the side collars and position the wheel between the fork legs. Insert the front axle shaft from the right side, through the right fork leg and wheel hub.
2. Align the index line (7) of the front axle shaft with the recessed surface (8) of the fork leg.

RIGHT FRONT

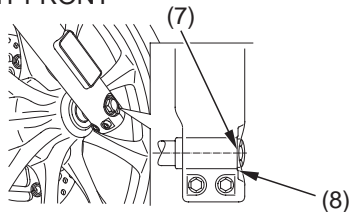

(7) index line (8) recessed surface
(cont'd)

If You Have a Flat Tire

3. Tighten the axle pinch bolts on the right fork leg to the specified torque:
16 lbf·ft (22 N·m , 2.2 kgf·m)
4. Tighten the front axle bolt to the specified torque:
47 lbf·ft (64 N·m , 6.5 kgf·m)
5. Install the brake caliper onto the fork leg.
To avoid damaging the brake pads, carefully fit the brake disc (9) between the pads.
6. Install the caliper fixing bolts and tighten to the specified torque:
23 lbf·ft (31 N·m , 3.2 kgf·m)
7. Operate the front brake and pump the fork several times. Check for free wheel rotation after the brake is released. Recheck the wheel if the brake drags or the wheel does not rotate freely.

8. If the clearances between each surface of the brake disc and the brake bracket (10) (not the brake pads) are symmetrical, follow next step.

If the clearances are not symmetrical, loosen the right axle pinch bolts and pull the right fork outward or push inward to adjust the clearance. Then follow the next step.

If You Have a Flat Tire

9. Tighten the axle pinch bolts on the left fork leg to the specified torque:
16 lbf·ft (22 N·m , 2.2 kgf·m)
- Visually check that the clearances between each surface of the brake disc and the brake bracket (not the brake pads) are symmetrical.

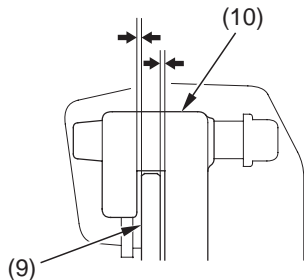

(9) brake disc

(10) brake bracket

If a torque wrench was not used for installation, see your Honda dealer as soon as possible to verify proper assembly. Improper assembly may lead to loss of braking capability.

If You Have a Flat Tire

Emergency Rear Wheel Removal/Installation

Refer to *Safety Precautions* on page 60 .

We recommend wheel removal be done only by your Honda dealer or another qualified mechanic. Do not attempt to remove the wheel on your own. Wheel removal requires mechanical skill and professional tools.

Removal

1. Park your motorcycle on a firm, level surface.
2. Carefully raise the center of the motorcycle with a chain hoist.

3. Remove the exhaust pipe joint nuts (1).

RIGHT SIDE

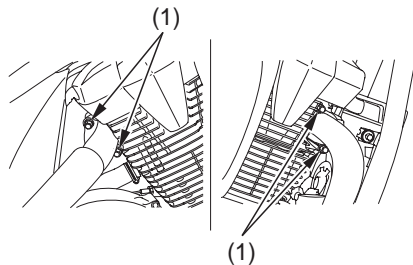

(1) exhaust pipe joint nuts

If You Have a Flat Tire

4. Remove the muffler bracket bolt A (2), B (3), nuts (4) and washers (5).
5. Remove the muffler.

RIGHT REAR

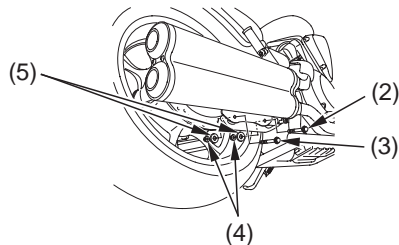

- (2) muffler bracket bolt A
- (3) muffler bracket bolt B
- (4) muffler bracket nuts
- (5) washers

6. Remove the axle holding bolt (6) and washer (7).
7. While holding the other end of the rear axle shaft (8) with a wrench, remove the rear axle nut (9) and washer (10).

LEFT REAR

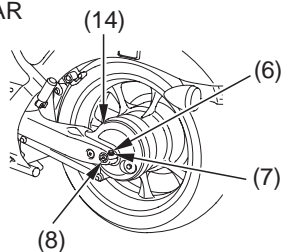

- (6) axle holding bolt
- (7) washer
- (8) rear axle shaft
- (14) final drive gear case

(cont'd)

If You Have a Flat Tire

RIGHT REAR

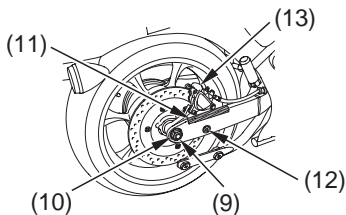

- | | |
|----------------------|------------------------------|
| (9) rear axle nut | (12) rear brake bracket bolt |
| (10) washer | (13) rear brake bracket |
| (11) protective tape | |

8. Cover the right swingarm with protective tape (11) or an equivalent.
9. Remove the rear brake bracket bolt (12).

10. Slide the rear axle shaft to the left side until the rear wheel can be removed. Do not pull the rear axle shaft out completely.

11. Remove the rear brake bracket (13).
12. Move the wheel to the right to separate it from the final drive gear case (14).
13. Remove the wheel and side collar.

- To avoid damage to the brake hose during removal, support the caliper assembly so that it doesn't hang from the hose. Do not twist the brake hose.
- Avoid getting grease, oil, or dirt on the disc or pad surfaces. Any contamination can cause poor brake performance or rapid pad wear after reassembly.

If You Have a Flat Tire

- Avoid depressing the brake pedal when the wheel is off the motorcycle. This will force the caliper piston out of the cylinder. The result will be a loss of brake fluid. If this occurs, the brake system will require service. See your Honda dealer for this service.

Installation

Before installing the wheel, check that the wheel hub and final drive gear splines are coated with molybdenum disulfide paste (USA only: Pro Honda Moly 60 Paste, or equivalent).

1. Install the side collar and position the wheel between the swingarm and the final drive gear case. Be sure the splines on the wheel hub fit into the final drive gear case.
2. Install the rear brake bracket and rear brake bracket bolt.
 - To avoid damaging the brake pads while setting the brake caliper assembly over the brake disc, carefully fit the brake disc between the pads.
3. Push the rear axle shaft from the left side, through the wheel hub and rear brake bracket.
4. Remove the protective tape or an equivalent.

(cont'd)

If You Have a Flat Tire

5. Tighten the rear brake bracket bolt to the specified torque:
51 lbf·ft (69 N·m , 7.0 kgf·m)
 6. Install the rear axle nut and washer.
 7. Tighten the rear axle nut to the specified torque:
94 lbf·ft (127 N·m , 13.0 kgf·m)
 8. Install the axle holding bolt and washer.
 9. Tighten the axle holding bolt to the specified torque:
20 lbf·ft (27 N·m , 2.8 kgf·m)
 10. After installing the wheel, apply the brake several times. Check for free wheel rotation after the brake is released. Recheck the wheel if the brake drags or the wheel does not rotate freely.
11. Install the muffler, muffler bracket bolt A, B, nuts and washers.
 - Before installing the muffler, replace the muffler gasket with a new gasket. Tighten the nuts and bolts to the specified torques:
exhaust pipe joint nuts:
17 lbf·ft (23 N·m , 2.3 kgf·m)
muffler bracket bolt A, B and nuts:
20 lbf·ft (27 N·m , 2.8 kgf·m)
- If a torque wrench was not used for installation, see your Honda dealer as soon as possible to verify proper assembly. Improper assembly may lead to loss of braking capability.

If Your Engine Overheats

Normally, the temperature of the coolant in the cooling system will rise to a level about midway between cold and boiling. Hot weather may cause the temperature to rise higher than normal. So will temporary stress such as climbing a hill. If you're stuck in stop-and-go traffic, the temperature may climb some, but the radiator fan is designed to prevent overheating. Be aware of these variations.

If the high coolant temperature indicator (page 13) comes on for no apparent reason, pull safely to the side of the road. If possible, park in a shady area.

NOTICE

Continuing to ride with an overheated engine can cause serious engine damage.

- A steaming engine indicates a coolant leak. Shut the engine off and wait until the steaming stops. Look for a leak, but don't touch the engine or radiator system. Let everything cool off first.
- If there's no obvious problem, leave the engine on so the fan and coolant circulating system can continue working. Monitor the high coolant temperature indicator. The indicator may turn off after a brief stop with no load on the engine.

(cont'd)

If Your Engine Overheats

- Check the radiator fan.
If the fan is not working, turn the engine off. Open the fuse box (page 180) and check the radiator fan fuse. If the fuse is blown, replace it with the proper (same rating) spare fuse. Start the engine. If the high coolant temperature indicator comes on and stays on, turn the engine off.
If the radiator fan is working, visually check the coolant level in the reserve tank, located just behind the crankcase. It isn't necessary to touch the radiator system.
- If the reserve tank is low or empty, don't ride without adding coolant (page 95). After adding coolant, turn the engine on and check the high coolant temperature indicator.
If the indicator doesn't turn off, do not

ride. The engine needs repair. Transport your motorcycle to a Honda dealer (page 152).

If the temperature drops to normal, check the coolant level. If it has gone down, add more coolant.

If you are able to resume riding, continue to monitor the high coolant temperature indicator frequently.

If there's a mild leak, you can ride for awhile, carefully watching the high coolant temperature indicator. Be prepared to stop and add more coolant or water. If the leak is bad, transport your motorcycle to a Honda dealer (page 152).

If the Low Oil Pressure Indicator Lights

If you check your engine oil level regularly, you should never see the low oil pressure indicator while riding. Normally, it will only light momentarily when you turn the ignition switch ON. Occasionally, it may flicker at or near idling speed.

Low oil pressure may be caused by an oil leak, a low oil level, or some problem in the engine's lubrication system.

If the indicator comes on while you're riding, don't ignore it. Pull safely to the side of the road. If possible, pull the clutch lever in and coast to a stop. Stop the engine as soon as it's safe to do so.

NOTICE

Continuing to ride with low oil pressure can cause serious engine damage.

- Check for an oil leak.
- Then check the oil level. If necessary, add the recommended oil (page 85) to the upper level mark. If you must leave your motorcycle to get oil, secure it as much as possible.
- After adding oil, start the engine, and check that the low oil pressure indicator goes off. Check for a possible leak.

If the indicator goes off and there is no leak — resume riding. If there is a leak — do not ride the motorcycle until the leak is repaired by a Honda dealer.

If a Fuse Blows

All of the electrical circuits on your motorcycle have fuses to protect them from damage caused by excess current flow (short circuit or overload).

If something electrical on your motorcycle stops working, the first thing you should check for is a blown fuse.

Determine from the chart on the circuit fuse box cover which fuse or fuses control that component. Check those fuses first, but check all the fuses before looking elsewhere for another possible cause of the problem. Replace any blown fuses and check component operation.

- The main fuse and spare are located on the starter magnetic switch behind the left side cover.
- The circuit fuse box (including spare fuses) is located behind the right side cover.

Recommended Fuses

| | |
|-------------|----------|
| main fuse | 30A |
| other fuses | 20A, 10A |

1. To prevent an accidental short circuit, turn the ignition switch OFF before checking or replacing the fuses.

If a Fuse Blows

LEFT SIDE

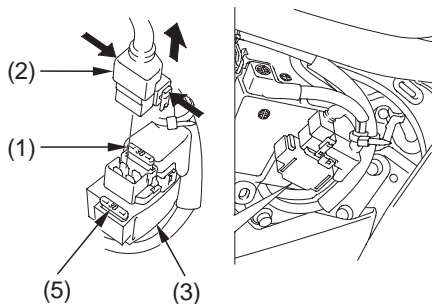

- (1) main fuse
- (2) wire connector
- (3) starter magnetic switch
- (5) spare main fuse

Main Fuse Access:

2. To access the main fuse (1), remove the left side cover (page 74).
3. Disconnect the wire connector (2) of the starter magnetic switch (3).
4. Pull the main fuse out. If it is blown (4), install the spare main fuse (5).
5. Reconnect the wire connector.
6. Install the left side cover.

MAIN FUSE

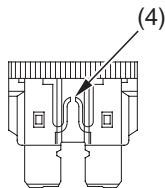

- (4) blown fuse

(cont'd)

If a Fuse Blows

Circuit Fuse Access:

- To access the circuit fuses, remove the right side cover (page 75).
- Remove the fuse box cover (6).

RIGHT SIDE

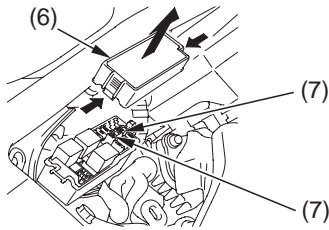

(6) fuse box cover (7) spare fuses

- To check or replace a circuit fuse, pull the old fuse out of its retaining clips. Look for a burned wire inside the fuse. If the fuse is blown (8), replace it with a spare fuse (7) of the same rating.

CIRCUIT FUSE

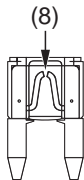

(8) blown fuse

If you do not have a replacement fuse with the proper rating for the circuit, install one with a lower rating.

NOTICE

Replacing a fuse with one that has a higher rating greatly increases the chance of damage to the electrical system.

- Install the fuse box cover.
- Install the right side cover.

If a Fuse Blows

If you do not have a spare fuse and you cannot ride the motorcycle without fixing the problem, take a fuse of the same rating or a lower rating from one of the other circuits that you can do without temporarily.

If you replace a blown fuse with a spare fuse that has a lower rating, replace the fuse with the correct rating as soon as you can. Also remember to replace any spare fuses that were installed.

If the replacement fuse of the same rating burns out in a short time, there is probably a serious electrical problem on your motorcycle. Leave the blown fuse in that circuit and have your motorcycle checked by your Honda dealer.

If You Crash

Personal safety is your first priority after a crash. If you or anyone else has been injured, take time to assess the severity of the injuries and whether it is safe to continue riding. Call for emergency assistance if needed. Also follow applicable laws and regulations if another person or vehicle is involved in the crash.

If you decide that you are capable of riding safely, first evaluate the condition of your motorcycle. If the engine is still running, turn it off and look it over carefully; inspect it for fluid leaks, check the tightness of critical nuts and bolts, and secure such parts as the handlebar, control levers, brakes, and wheels.

If there is minor damage, or you are unsure about possible damage, ride slowly and cautiously. Sometimes, crash damage is hidden or not immediately apparent, so you should have your motorcycle thoroughly checked at a qualified service facility as soon as possible. Also, be sure to have your Honda dealer check the frame and suspension after any serious crash.

If your motorcycle cannot be ridden, see *Transporting Your Motorcycle*, page 152 .

If You Lose Your Key

This motorcycle has ignition keys (1) and steering lock keys (2).

You should receive a steering lock key number plate (3) with your keys. Store this plate in a safe place.

Be sure to record your key number in the Quick Reference section at the rear of the manual. You'll need this number to have a duplicate key made.

A lost key won't be a problem if you take preventative action. Store one duplicate key in a safe place at home and carry a second duplicate in your wallet.

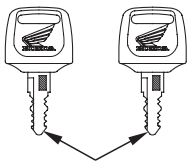

(1) ignition keys (1)

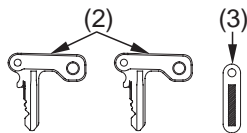

(2) steering lock keys

(3) steering lock key number plate

If you lose your key and aren't carrying a duplicate, either get your spare or have one made. If you don't know your key number, call the dealer where you purchased your Honda. They may have it listed in their records. If they don't, transport your motorcycle to them or the nearest Honda dealer. The dealer will probably have to remove the ignition switch assembly to find the key number so they can make a key for you.

If Your Battery Is Low (or Dead)

Jump starting is not recommended, especially if you use an automobile battery. The greater amperage of an automobile battery when the car engine is running can damage your motorcycle's electrical system.

Bump starting is also not recommended.

If you can't charge the battery or it appears unable to hold a charge, contact your Honda dealer.

Technical Information

This section contains dimensions, capacities, and other technical data, plus information on government requirements and how to break-in your motorcycle.

| | |
|--------------------------------|-----|
| Vehicle Identification..... | 186 |
| Specifications | 189 |
| Break-in Guidelines | 197 |
| Emission Control Systems | 198 |
| Catalytic Converters..... | 205 |
| Oxygenated Fuels..... | 207 |

Vehicle Identification

Serial Numbers

The VIN and engine serial number are required when you register your motorcycle. They may also be required when ordering replacement parts. You may record these numbers in the Quick Reference section at the rear of this manual.

The VIN (vehicle identification number) is stamped on the right side of steering head and also appears on the Safety Certification Label attached to the left side of the down tube.

LEFT SIDE

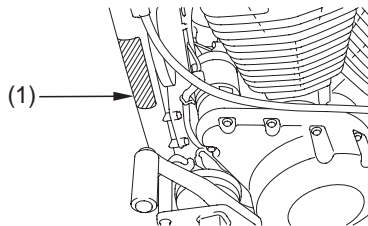

(1) VIN

Vehicle Identification

RIGHT SIDE

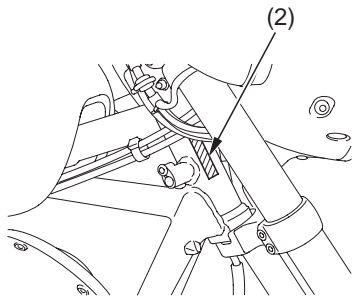

(2) VIN

The engine number (3) is stamped on the top of the crankcase.

LEFT SIDE

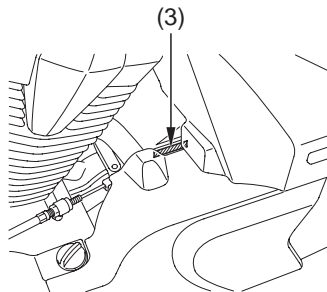

(3) engine number

Vehicle Identification

Color Label & Code

The color label (1) is attached to the frame under the seat. Remove the seat (page 78) to check the label.

The color code is helpful when ordering replacement parts. You may record the color and code in the Quick Reference section at the rear of this manual.

UNDER SEAT

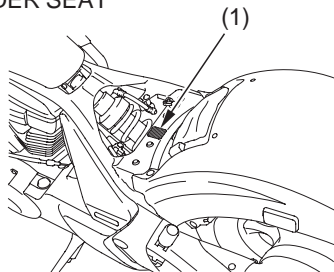

(1) color label

Specifications

| Dimensions | |
|-------------------|---------------------|
| overall length | 100.5 in (2,552 mm) |
| overall width | 35.3 in (897 mm) |
| overall height | 45.3 in (1,151 mm) |
| wheelbase | 71.0 in (1,804 mm) |
| ground clearance | 4.9 in (125 mm) |

Specifications

| Fuel & Lubricants | |
|--------------------------------|--|
| fuel recommendation | unleaded gasoline, pump octane number of 86 or higher |
| fuel tank capacity | 3.38 US gal (12.8 ℓ) including reserve |
| engine oil capacity | after disassembly: 4.5 US qt (4.3 ℓ) after draining: 3.7 US qt (3.5 ℓ) after draining & oil filter change: 3.9 US qt (3.7 ℓ) |
| engine oil recommendation | API Service Classification SG or higher except oils labeled as energy conserving on the circular API service label, SAE 10W-30, JASO T 903 standard MA, Pro Honda GN4 4-stroke oil (USA & Canada) or Honda 4-stroke oil (Canada only), or an equivalent motorcycle oil |
| final drive oil capacity | after draining: 4.4 US oz (130 cm ³) |
| cooling system, recommendation | Pro Honda HP Coolant or an equivalent high quality ethylene glycol antifreeze containing corrosion protection inhibitors specifically recommended for use in aluminum engines |
| cooling system, capacity | 2.68 US qt (2.54 ℓ) |

Specifications

| Capacities | |
|-------------------------|---|
| passenger capacity | Operator and one passenger |
| maximum weight capacity | 322 lbs (146 kg) rider, passenger, all cargo and accessories |

| Engine Specifications | |
|--------------------------------|---|
| displacement | 80.0 cu-in (1,312 cm ³) |
| bore & stroke | 3.52 × 4.11 in (89.5 × 104.3 mm) |
| compression ratio | 9.2 : 1 |
| spark plug (standard) | DCPR6E (NGK) or XU20EPR-U (DENSO) |
| spark plug (high speed riding) | DCPR7E (NGK) or XU22EPR-U (DENSO) |
| spark plug gap | 0.031 – 0.035 in (0.80 – 0.90 mm) |
| valve clearance (cold) | intake 0.006 in (0.15 mm) exhaust 0.012 in (0.30 mm) |
| idle speed | 930 ± 100 rpm (no adjustment) |

Specifications

| Power Transmission | |
|---------------------------|-------|
| primary reduction | 1.935 |
| secondary reduction | 0.944 |
| final reduction | 2.818 |
| gear ratio, 1st | 1.900 |
| 2nd | 1.231 |
| 3rd | 0.909 |
| 4th | 0.757 |
| 5th | 0.676 |
| final drive | shaft |

| Chassis & Suspension | |
|---------------------------------|--|
| caster | 32°00' |
| trail | 3.6 in (92 mm) |
| tire size, front | 90/90 – 21M/C 54H DUNLOP ELITE3 |
| tire type | bias-ply, tubeless |
| tire size, rear | 200/50R18M/C 76H DUNLOP ELITE3 |
| tire type | radial, tubeless |
| tire pressure, front (cold) | 33 psi (225 kPa , 2.25 kgf/cm ²) |
| tire pressure, rear (cold) | 41 psi (280 kPa , 2.80 kgf/cm ²) |

Specifications

| Electrical | |
|-------------------|--------------------|
| battery | 12V – 11.2Ah |
| generator | 0.381 kW/5,000 rpm |

| Lights | |
|--------------------|---|
| headlight | 12V – 60/55W |
| brake/tail light | LED |
| license light | 12V – 5W |
| turn signal lights | 12V – 21/5W (front) 12V – 21W (rear) |

| Fuses | |
|--------------|----------|
| main fuse | 30A |
| other fuses | 20A, 10A |

| Torque Specifications | |
|-------------------------------------|----------------------------------|
| engine oil drain bolts | 22 lbf·ft (30 N·m , 3.1 kgf·m) |
| engine oil filter | 19 lbf·ft (26 N·m , 2.7 kgf·m) |
| air cleaner housing cover bolts | 1.1 lbf·ft (1.5 N·m , 0.2 kgf·m) |
| final drive oil drain bolt | 9 lbf·ft (12 N·m , 1.2 kgf·m) |
| final drive oil filler cap | 9 lbf·ft (12 N·m , 1.2 kgf·m) |
| front wheel axle bolt | 47 lbf·ft (64 N·m , 6.5 kgf·m) |
| front wheel caliper fixing bolts | 23 lbf·ft (31 N·m , 3.2 kgf·m) |
| front wheel axle pinch bolts | 16 lbf·ft (22 N·m , 2.2 kgf·m) |
| rear wheel axle nut | 94 lbf·ft (127 N·m , 13.0 kgf·m) |
| rear brake bracket bolt | 51 lbf·ft (69 N·m , 7.0 kgf·m) |
| rear wheel axle holding bolt | 20 lbf·ft (27 N·m , 2.8 kgf·m) |

Specifications

| Torque Specifications | |
|---------------------------------------|--------------------------------|
| exhaust pipe joint nuts | 17 lbf·ft (23 N·m , 2.3 kgf·m) |
| muffler bracket bolt A, B and nuts | 20 lbf·ft (27 N·m , 2.8 kgf·m) |
| seat mounting bolts B | 16 lbf·ft (22 N·m , 2.2 kgf·m) |

Help assure your motorcycle's future reliability and performance by paying extra attention to how you ride during the first 300 miles (500 km).

During this period, avoid full-throttle starts and rapid acceleration.

Emission Control Systems

Exhaust Emission Requirements

The U.S. Environmental Protection Agency (EPA), the California Air Resources Board (CARB), and Environment Canada (EC) require that your motorcycle comply with applicable exhaust emissions standards during its useful life, when operated and maintained according to the instructions provided.

The Vehicle Emission Control Information label (1) (2) is attached to the left side of the frame.

LEFT SIDE

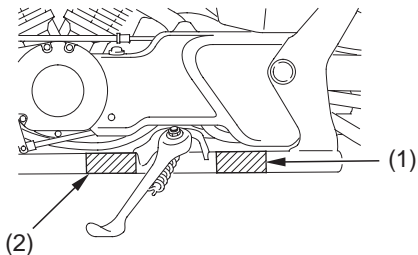

- (1) vehicle emission control information label
- (2) vehicle emission control information label (Canada only)

Noise Emission Requirements

The EPA also requires that motorcycles built after January 1, 1983 comply with applicable noise emission standards for one year or 3,730 miles (6,000 km) after the time of sale to the ultimate purchaser, when operated and maintained according to the instructions provided.

Warranty Compliance

Compliance with the terms of the Distributor's Warranties for Honda Motorcycle Emission Control Systems is necessary in order to keep the emissions system warranty in effect. (USA only)

Source of Exhaust Emissions

The combustion process produces carbon monoxide (CO), oxides of nitrogen (NO_x) and hydrocarbons (HC). Control of hydrocarbons and oxides of nitrogen is very important because, under certain conditions, they react to form photochemical smog when subjected to sunlight. Carbon monoxide does not react in the same way, but it is toxic.

Honda Motor Co., Ltd. utilizes various systems to reduce carbon monoxide, oxides of nitrogen and hydrocarbons.

Emission Control Systems

Exhaust Emission Control System

The exhaust emission control system includes a secondary air injection system, a PGM-FI system and two oxidation catalytic converters.

No adjustment to these systems should be made although periodic inspection of the components is recommended.

PGM-FI System

The PGM-FI system uses sequential multiport fuel injection. It has four subsystems: Air Intake, Engine Control, Fuel Control, and Exhaust Control. The Engine Control Module (ECM) uses various sensors to determine how much air is going into the engine. It then controls how much fuel to inject under all operating conditions.

Ignition Timing Control System

The system constantly adjusts the ignition timing, reducing the amount of HC, CO and NO_x produced.

Secondary Air Injection System

The secondary air injection system introduces filtered air into the exhaust gases in the exhaust port. The secondary air injection system helps improve emission control performance.

Oxidation Catalytic Converters

The oxidation catalytic converters are in the exhaust system. Through chemical reactions, they convert HC and CO in the engine's exhaust to carbon dioxide (CO₂) and water vapor.

Evaporative Emission Control System (California only)

This motorcycle complies with the requirements of the California Air Resources Board (CARB) evaporative emission regulations. Fuel vapor from the fuel tank is directed into the charcoal canister and air cleaner where it is absorbed and stored while the engine is stopped. When the engine is running and the purge control solenoid valve is open, fuel vapor in the charcoal canister and air cleaner is drawn into the engine through the throttle body.

Emission Control Systems

Crankcase Emission Control System

The engine is equipped with a closed crankcase system to prevent discharging crankcase emissions into the atmosphere. Blow-by gas is returned to the combustion chamber through the air cleaner and the intake manifold.

Problems That May Affect Motorcycle Exhaust Emissions

If you are aware of any of the following symptoms, have the vehicle inspected and repaired by your authorized Honda motorcycle dealer.

Symptoms:

1. Hard starting or stalling after starting
2. Rough idle
3. Misfiring or backfiring during acceleration
4. After-burning (backfiring)
5. Poor performance (driveability) and poor fuel economy

Noise Emission Control System

TAMPERING WITH THE NOISE CONTROL SYSTEM IS PROHIBITED:

U. S. federal law prohibits, or Canadian provincial laws may prohibit the following acts or the causing thereof: (1) The removal or rendering inoperative by any person, other than for purposes of maintenance, repair or replacement, of any device or element of design incorporated into any new vehicle for the purpose of noise control prior to its sale or delivery to the ultimate purchaser or while it is in use; or (2) the use of the vehicle after such device or element of design has been removed or rendered inoperative by any person.

AMONG THOSE ACTS PRESUMED TO CONSTITUTE TAMPERING ARE THE FOLLOWING ACTS:

1. Removal of, or puncturing the muffler, baffles, header pipes or any other component which conducts exhaust gases.
2. Removal of, or puncturing of any part of the intake system.
3. Lack of proper maintenance.
4. Replacing any moving parts of the vehicle, or parts of the exhaust or intake system, with parts other than those specified by the manufacturer.

Emission Control Systems

Fuel Permeation Emission Control System

This vehicle complies with the Fuel Permeation Emission Control regulations of the U.S. Environmental Protection Agency (EPA), the California Air Resources Board (CARB), and Environment Canada (EC). The fuel tank, fuel hoses, and fuel vapor charge hoses used on this vehicle incorporate fuel permeation control technologies.

Tampering with the fuel tank, fuel hoses, or fuel vapor charge hoses to reduce or defeat the effectiveness of the fuel permeation technologies is prohibited by federal regulations.

Catalytic Converters

This motorcycle is equipped with oxidation catalytic converters. Each catalytic converter contains precious metals that serve as catalysts, promoting chemical reactions to convert the exhaust gasses without affecting the metals.

Catalytic converters act on HC and CO. Replacement parts must be original Honda parts or equivalents.

The catalytic converters must operate at high temperature for the chemical reactions to take place. They can set fire to any combustible materials that come near them. Park your motorcycle away from high grasses, dry leaves, or other flammables.

Catalytic Converters

Defective catalytic converters contribute to air pollution, and can impair your engine's performance. Follow these guidelines to protect your motorcycle's catalytic converters.

- Always use unleaded gasoline. Even a small amount of leaded gasoline can contaminate the catalyst metals, making the catalytic converters ineffective.
- Keep the engine in good running condition.
A poorly running engine can cause the catalytic converter to overheat causing damage to the converter or the motorcycle.

- If your engine is misfiring, backfiring, stalling, or otherwise not running properly, stop riding and turn off the engine. Have your motorcycle serviced as soon as possible.

Some conventional gasolines are being blended with alcohol or an ether compound. These gasolines are collectively referred to as oxygenated fuels. To meet clean air standards, some areas of the United States and Canada use oxygenated fuels to help reduce emissions. If you use an oxygenated fuel, be sure it is unleaded and meets the minimum octane rating requirement.

Before using an oxygenated fuel, try to confirm the fuel's contents. Some states/provinces require this information to be posted on the pump.

The following are the EPA-approved percentages of oxygenates:

ETHANOL (ethyl or grain alcohol) 10%
by Volume

You may use gasoline containing up to 10% ethanol by volume. Gasoline containing ethanol may be marketed under the name "Gasohol".

MTBE (Methyl Tertiary Butyl Ether) 15%
by Volume

You may use gasoline containing up to 15% MTBE by volume.

Oxygenated Fuels

METHANOL (methyl or wood alcohol)
5% by Volume

You may use gasoline containing methanol containing up to 5% methanol by volume as long as it also contains cosolvents and corrosion inhibitors to protect the fuel system. Gasoline containing more than 5% methanol by volume may cause starting and/or performance problems. It may also damage metal, rubber, and plastic parts of your fuel system.

If you notice any undesirable operating symptoms, try another service station or switch to another brand of gasoline.

Fuel system damage or performance problems resulting from the use of an oxygenated fuel containing more than the percentages of oxygenates mentioned above are not covered under warranty.

Oxygenated fuels can damage paint and plastic. Be careful not to spill fuel when filling the fuel tank. Wipe up any spills immediately.

NOTICE

Oxygenated fuels can damage paint and plastic. Damage caused by spilled fuel is not covered by warranty.

Consumer Information

This section contains information on your warranty and how to get an official Honda Service Manual.

| | |
|--|-----|
| Authorized Manuals | 210 |
| Warranty Coverage | 213 |
| Warranty Service..... | 214 |
| Contacting Honda..... | 215 |
| Your Honda Dealer | 216 |
| The Honda Rider's Club (USA only) | 217 |
| Reporting Safety Defects (USA only) | 218 |

Authorized Manuals

The Service Manual used by your authorized Honda dealer is available from Helm, Inc. (USA only, Canada: See your Honda dealer to order authorized manuals.)

Also available but not necessary to service your model is the Honda Common Service Manual which explains theory of operation and basic service information for various systems common to all Honda motorcycles, motor scooters and ATVs.

These Honda manuals are written for the professional technician, but most mechanically capable owners should find them easy to use if they have the proper tools and observe proper safety standards. Special Honda tools are necessary for some procedures.

| Publication Item No. | Description | Price Each* |
|--|------------------------------|-------------|
| 61MFR00 | 2010 VT1300CX Service Manual | \$60.00 |
| 61CM002 | Common Service Manual | \$48.00 |
| 31MFR600 | 2010 VT1300CX Owner's Manual | \$16.00 |
| <i>* Prices are subject to change without notice and without incurring obligation.</i> | | |

Order On-Line: www.helminc.com

Order Toll Free: 1-888-CYCLE93 (1-888-292-5393)

(NOTE: For Credit Card Orders Only)

Monday — Friday 8:00 AM — 6:00 PM EST

OR

By completing this form you can order the materials desired. You can pay by check or money order, or charge to your credit card. Mail to Helm, Inc. at the address shown on the back of this order form (USA only).

Canada: See your Honda dealer to order authorized manuals.

| Publication Item No. | Item Description | Qty. | Price Each* | Total Price |
|--|------------------------------|-------------|------------------------|------------------------|
| | | | | |
| | | | | |
| | | | | |
| *Prices are subject to change without notice and without incurring obligation. Orders are mailed within 10 days. Please allow adequate time for delivery. | Sub Total | | | |
| | Purchaser's Sales Tax | | | |
| | Mich. add 6 % | | | |
| | Calif. add 7.25 % | | | |
| | | | Handling Charge | \$3.75 |
| | | | Grand Total | |

**S
H
I
P
T
O**

NOTE: Dealers and Companies please provide dealer or company name, and also the name of the person to whose attention the shipment should be sent.

Customer Name _____ Attention _____

Street address/P. O. BOX _____ Apartment Number _____

City _____ State _____ Zip Code _____

Daytime Telephone Number () _____

**P
A
Y
M
E
N
T**

Check or money order enclosed payable to Helm Inc.
U.S. funds only. Do not send cash.

Check here if your billing address is different from the
shipping address shown above.

MasterCard

Account Number

Expiration: Mo. Yr.

VISA

Discover

Security Code

Customer Signature _____ Date _____

These Publications cannot be returned for credit without receiving advance authorization within 14 days of delivery. For returns, a restocking fee may be applied against the original order.

HELM P.O. BOX 07280, DETROIT, MICHIGAN 48207

Warranty Coverage

Your new Honda is covered by these warranties:

- Motorcycle Limited Warranty
- Emission Control System Warranty
- Noise Control Warranty

There are responsibilities, restrictions, and exclusions which apply to these warranties. Please read the Warranties Booklet given to you by your Honda dealer at the time of purchase. Be sure to keep your Honda owner's card with your Warranties Booklet (USA only).

It is important to realize that your warranty applies to defects in material or workmanship of your Honda. Your warranty coverage does not apply to normal wear or deterioration associated with using the motorcycle.

Your warranty coverage will not be voided if you choose to perform your own maintenance. However, you should have the proper tools and service information and be mechanically qualified. Failures that occur due directly to improper maintenance are not covered.

Almost all of your warranty coverage can be extended through the Honda Protection Plan (USA only). For more information, see your Honda dealer.

Warranty Service

Please remember that recommended maintenance interval servicing is not included in your warranty coverage. Additionally, your warranty does not apply to the normal wear of items (such as brakes, tires, etc.).

If you believe you have a problem with your motorcycle, call the service department of your Honda dealer. Make an appointment for an inspection and diagnosis. Remember, as the owner of the motorcycle, you will be asked to authorize that inspection. Your dealer will give you the results of the inspection. If the problem is covered under warranty, your dealer will perform the warranty repairs for you.

If you have questions about warranty coverage or the nature of the repair, it is best to talk to the Service Manager of your Honda dealer.

Sometimes, in spite of the best intentions of all concerned, a misunderstanding may occur. If you aren't satisfied with your dealer's handling of the situation, we suggest you discuss your problem with the appropriate member of the dealership's management team. If the problem has already been reviewed with the Service Manager, Parts Manager, Sales Manager, etc., contact the Owner of the dealership or their designated representative.

Contacting Honda

Your owner's manual was written to cover most of the questions you might ask about your Honda. Any questions not answered in the owner's manual can be answered by your Honda dealer. If your dealer doesn't have the answer right away, they will get it for you.

If you have a difference of opinion with your dealer, please remember that each dealership is independently owned and operated. That's why it's important to work to resolve any differences at the dealership level.

If you wish to comment on your experiences with your Honda or with your dealer, please send your comments to the following address (USA only):

Motorcycle Division, American Honda Motor Co., Inc., P.O. Box 2200, Torrance, CA 90509-2200, Mailstop: 100-4C-7B, Telephone: (866) 784-1870.

Canada: Refer to the Warranties Booklet that was supplied with your vehicle.

Please include the following information in your letter:

- name, address, and telephone number
- product model, year, and VIN
- date of purchase
- dealer name and address

We will likely ask your Honda dealer to respond, or possibly acknowledge your comments directly.

Your Honda Dealer

Once you purchase your new Honda, get familiar with the organization of your Honda dealer so you can utilize the full range of services available.

The service department is there to perform regular maintenance and unexpected repairs. It has the latest available service information from Honda. The service department will also handle warranty inspections and repairs.

The parts department offers Honda Genuine Parts, Pro Honda products, Honda Genuine Accessories (USA only), and Honda accessories and products (Canada only). The same quality that went into your Honda can be found in Honda Genuine replacement parts. You'll also find comparable quality in the accessories

and products available from the parts department.

The sales department offers the Honda Protection Plan to extend almost all of your warranty coverage (USA only). Your Honda dealer can inform you about competition and other riding events in your area. You'll also find that your dealer is a source of information about safety training available in your local area and the Honda Rider's Club of America (USA only).

We're sure you'll be as pleased with the service your Honda dealer continues to provide after the sale as you are with the quality and dependability of your Honda.

The Honda Rider's Club (USA only)

You may be eligible for a Honda Rider's Club of America (HRCA) membership with the purchase of your new Honda. You can log on to the HRCA Clubhouse website for details at *www.hrca.honda.com*.

Reporting Safety Defects (USA only)

If you believe that your vehicle has a defect which could cause a crash or could cause injury or death, you should immediately inform the National Highway Traffic Safety Administration (NHTSA) in addition to notifying American Honda Motor Co., Inc.

If NHTSA receives similar complaints, it may open an investigation, and if it finds that a safety defect exists in a group of vehicles, it may order a recall and remedy campaign. However, NHTSA cannot become involved in individual problems between you, your dealer, or American Honda Motor Co., Inc.

To contact NHTSA, you may call the Vehicle Safety Hotline toll-free at 1-888-327-4236 (TTY: 1-800-424-9153); go to <http://www.safercar.gov>; or write to: Administrator, NHTSA, 1200 New Jersey Avenue, SE., Washington, DC 20590.

You can also obtain other information about motor vehicle safety from <http://www.safercar.gov>.

Table of Contents

The following presents the contents of each section of your owner's manual.

| | |
|---|----------|
| MOTORCYCLE SAFETY | 1 |
| Important Safety Information | 2 |
| Accessories & Modifications..... | 5 |
| Safety Labels | 7 |
| | |
| INSTRUMENTS & CONTROLS | 9 |
| Operation Component Locations | 10 |
| Gauges, Indicators & Displays..... | 13 |
| Odometer/Tripmeter A & B/Digital | |
| Clock Display | 19 |
| Odometer | 20 |
| Tripmeter A & B | 20 |
| Digital Clock | 22 |
| Controls & Features..... | 25 |
| Ignition Switch | 25 |
| Start Button..... | 26 |
| Engine Stop Switch | 26 |

| | |
|-------------------------------|----|
| Headlight Dimmer Switch | 27 |
| Turn Signal Switch..... | 27 |
| Horn Button | 28 |

| | |
|---|-----------|
| BEFORE RIDING..... | 29 |
| Are You Ready to Ride? | 30 |
| Protective Apparel..... | 30 |
| Rider Training | 32 |
| Is Your Motorcycle Ready to Ride? | 33 |
| Pre-ride Inspection | 33 |
| Load Limits & Guidelines..... | 36 |
| Loading | 36 |
| Load Limits | 37 |
| Loading Guidelines | 37 |

Table of Contents

BASIC OPERATION & RIDING.....39

| | |
|--|----|
| Safe Riding Precautions | 40 |
| Starting & Stopping the Engine | 41 |
| Preparation..... | 41 |
| Starting Procedure | 42 |
| Flooded Engine | 43 |
| Bank Angle Sensor Ignition Cut-off System | 43 |
| How to Stop the Engine | 44 |
| Shifting Gears..... | 45 |
| Braking | 47 |
| Parking..... | 49 |
| Theft-prevention Tips | 52 |
| Riding with a Passenger or Cargo..... | 53 |

SERVICING YOUR HONDA55

Before You Service Your Honda

| | |
|------------------------------------|----|
| The Importance of Maintenance..... | 58 |
| Maintenance Safety..... | 59 |
| Important Safety Precautions..... | 60 |

| | |
|----------------------------|----|
| Periodic Maintenance..... | 62 |
| Maintenance Schedule | 64 |
| Maintenance Record..... | 69 |

Service Preparations

| | |
|---------------------------------------|----|
| Maintenance Component Locations | 71 |
| Side Cover Removal..... | 74 |
| Tool Kit..... | 76 |
| Owner's Manual Storage..... | 77 |
| Seat Removal..... | 78 |
| Clip Removal..... | 80 |

(cont'd)

Table of Contents

SERVICING YOUR HONDA (cont'd)

Service Procedures

Fluids & Filters

| | |
|---------------------------|-----|
| Fuel | 81 |
| Engine Oil & Filter | 84 |
| Coolant..... | 93 |
| Air Cleaner | 98 |
| Crankcase Breather | 100 |
| Final Drive Oil..... | 101 |

Engine

| | |
|--------------------|-----|
| Throttle | 104 |
| Clutch System..... | 106 |
| Spark Plugs..... | 110 |

Chassis

| | |
|-----------------|-----|
| Suspension..... | 115 |
| Brakes | 120 |
| Tires | 124 |
| Side Stand..... | 134 |

Electrical

| | |
|---------------|-----|
| Battery | 135 |
|---------------|-----|

| | |
|-----------------------|-----|
| Appearance Care | 140 |
|-----------------------|-----|

TIPS 147

| | |
|------------------------------------|-----|
| Storing Your Honda | 148 |
| Transporting Your Motorcycle | 152 |
| You & the Environment..... | 153 |

Table of Contents

| | |
|--|------------|
| TAKING CARE OF THE UNEXPECTED | 155 |
| General Guidelines..... | 156 |
| If Your Engine Quits or Won't Start .. | 157 |
| If You Have a Flat Tire..... | 162 |
| If Your Engine Overheats..... | 175 |
| If the Low Oil Pressure Indicator Lights | 177 |
| If a Fuse Blows..... | 178 |
| If You Crash..... | 182 |
| If You Lose Your Key | 183 |
| If Your Battery Is Low (or Dead)..... | 184 |
| | |
| TECHNICAL INFORMATION | 185 |
| Vehicle Identification..... | 186 |
| Specifications | 189 |
| Break-in Guidelines | 197 |
| Emission Control Systems | 198 |
| Catalytic Converters..... | 205 |
| Oxygenated Fuels..... | 207 |

| | |
|---|------------|
| CONSUMER INFORMATION | 209 |
| Authorized Manuals..... | 210 |
| Warranty Coverage | 213 |
| Warranty Service..... | 214 |
| Contacting Honda..... | 215 |
| Your Honda Dealer | 216 |
| The Honda Rider's Club (USA only) | 217 |
| Reporting Safety Defects (USA only) | 218 |
| | |
| TABLE OF CONTENTS | 220 |
| | |
| INDEX | 224 |

QUICK REFERENCE

Index

A

| | |
|---------------------------------|-----|
| accessories | 5 |
| air cleaner..... | 98 |
| air pressure, tires..... | 124 |
| American Honda, contacting..... | 215 |
| apparel, protective | 30 |
| appearance care | 140 |
| authorized manual | 210 |

B

| | |
|-----------------------------|----------------|
| battery | 135 |
| brakes, | |
| fluid..... | 120 |
| pad wear..... | 123 |
| braking | 47 |
| break-in guidelines | 197 |
| button, | |
| odometer/tripmeter/digital | |
| clock select and reset..... | 13, 20, 21, 22 |

C

| | |
|---------------------------------|-----|
| capacity, fuel | 82 |
| care, appearance | 140 |
| cleaner, air..... | 98 |
| cleaning, appearance care | 140 |
| clip..... | 80 |
| clutch system | 106 |
| color label | 188 |
| compartment, | |
| owner's manual | 77 |
| tool kit..... | 76 |
| consumer information | 209 |
| controls & features | 25 |
| coolant..... | 93 |
| crankcase breather | 100 |
| customer service | 215 |

D

| | |
|---------------------------------|------------|
| defects, reporting safety | 218 |
| digital clock | 22 |
| display, odometer/tripmeter | |
| A & B/digital clock | 13, 16, 19 |
| drive, final..... | 101 |

Index

E

| | |
|-------------------------------|-----|
| emission control systems..... | 198 |
| engine, | |
| flooded..... | 43 |
| low oil pressure..... | 177 |
| number | 187 |
| oil | 84 |
| overheats..... | 175 |
| pinging | 81 |
| starting | 41 |
| stop switch..... | 26 |
| stopping..... | 44 |
| won't start..... | 157 |
| environment..... | 153 |

F

| | |
|----------------------|-----|
| final drive..... | 101 |
| flat tire..... | 162 |
| flooded engine | 43 |
| fuel, | |
| oxygenated..... | 207 |
| recommendation | 81 |
| tank capacity..... | 82 |
| fuses | 178 |

G

| | |
|----------------------|-----|
| gap, spark plug..... | 113 |
| gasohol..... | 207 |
| gasoline..... | 81 |
| gauges..... | 13 |

H

| | |
|--|-------------|
| headlight dimmer switch..... | 27 |
| helmet holder..... | 51 |
| high beam indicator..... | 13, 18 |
| high coolant temperature indicator..... | 13, 18, 175 |
| Honda, contacting..... | 215 |
| dealer..... | 216 |
| Rider's Club..... | 217 |
| Honda service manual..... | 210 |
| horn button..... | 28 |

Index

I

| | |
|--|-----|
| identification, vehicle..... | 186 |
| ignition cut-off system, side stand..... | 41 |
| ignition switch | 25 |
| indicators..... | 13 |
| inspection, pre-ride..... | 33 |

K

| | |
|----------------|-----|
| key, lost..... | 183 |
| kit, tool..... | 76 |

L

| | |
|---|----|
| labels, safety | 7 |
| limit, weight..... | 37 |
| load limits | 37 |
| loading guidelines..... | 37 |
| lock, steering..... | 50 |
| low oil pressure indicator... 13, 14, 17, 177 | |

M

| | |
|----------------------------|-----|
| maintenance, | |
| component locations..... | 71 |
| importance | 58 |
| periodic | 62 |
| record | 69 |
| safety..... | 59 |
| schedule | 64 |
| manual, authorized | 210 |
| manual, service | 210 |
| maximum weight limit | 37 |
| modifications | 6 |

N

| | |
|------------------------|--------|
| neutral indicator..... | 13, 17 |
| numbers, serial..... | 186 |

O

| | |
|-------------------------------------|------------|
| odometer | 13, 16, 20 |
| oil, | |
| engine..... | 84 |
| final drive | 101 |
| low pressure..... | 177 |
| operation component locations | 10 |
| overheat, engine..... | 175 |
| owner's manual storage..... | 77 |
| oxygenated fuels..... | 207 |

Index

P

- parking 49
- PGM-FI indicator 13, 14, 17
- pinging, engine 81
- plugs, spark 110
- pre-load, rear suspension 117
- pre-ride inspection 33
- problems, unexpected 155
- protective apparel 30

R

- removal,
 - clip 80
 - seat 78
 - side cover 74, 75
- reporting safety defects 218
- rider training 3, 32
- Rider's Club, Honda 217
- riding,
 - basic operation 39
 - clothing 30
 - safety 2
 - safety precautions 40
 - with a passenger or cargo 53

S

- safety,
 important precautions 60
 labels 7
 reporting defects 218
 riding precautions 40
schedule, maintenance 64
seat removal 78
serial numbers 186
service,
 customer 215
 manuals 210
 warranty 214
shifting gears 45
side cover removal 74, 75
side stand 134
side stand ignition cut-off system 41
spark knock 81
spark plugs 110
specifications 189
speedometer 13, 15, 16
stand, side 134
start button 26
starting,
 engine 41
 troubleshooting 157
steering lock 50
stop switch, engine 26
stopping engine 44
storage,
 motorcycle 148
 owner's manual 77
suspension,
 rear damping 119
 rear spring pre-load 117

(cont'd)

Index

| | |
|-----------------------|----|
| switch, | |
| engine stop..... | 26 |
| headlight dimmer..... | 27 |
| ignition..... | 25 |
| turn signal | 27 |

T

| | |
|------------------------------------|------------|
| theft-prevention tips | 52 |
| throttle, | |
| lever | 104 |
| tire identification no. (TIN)..... | 128 |
| tires, | |
| air pressure..... | 124 |
| flat..... | 162 |
| replacing | 132 |
| tool kit..... | 76 |
| training, rider | 3, 32 |
| transporting your motorcycle | 152 |
| tripmeter..... | 13, 16, 20 |
| trouble, unexpected | 155 |
| troubleshooting, starting..... | 157 |
| turn signal indicators | 13, 17, 18 |

V

vehicle identification no. (VIN)... 186, 187

W

warranty,
 coverage..... 213
 extended..... 213
 service 214
washing your motorcycle 141
weight limit..... 37
wheels,
 front removal..... 165
 rear removal..... 170

Quick Reference

The following is a brief, but important collection of information you need to know about your Honda. You'll also find space to record important notes.

How to Avoid Costly Repairs

The engine of your Honda can be the most expensive component to repair. Proper maintenance, especially the use of the recommended fluids and filters, prevents premature wear and damage.

Frequent causes of costly repairs are:

- Engine oil — insufficient quantity, improper oil.
- Air cleaner — dirty, leaking because of improper installation (poor seal).

Record important information on the following page:

Quick Reference

| | |
|------------------|--|
| VIN | |
| Engine No. | |
| Ignition Key No. | |
| Color Label | |
| Owner's Name | |
| Address | |
| City/State | |
| Phone | |
| Dealer's Name | |
| Address | |
| City/State | |
| Phone | |
| Service Mgr. | |

Quick Reference

| | |
|-------------------------|--|
| Scheduled Maintenance | Initial: 600 miles (1,000 km) Regular: every 4,000 miles (6,400 km) |
| Pre-ride Inspection | Check the following items each time before you ride (page 33): tires & wheels, leaks, loose parts, lights, throttle, brakes, indicators. |
| Periodic Checks | Check the following items monthly (page 62): tires & wheels, fluids, lights, freeplay, fuses, nuts & bolts. |
| Fuel/Capacity | unleaded gasoline, pump octane number 86 or higher 3.38 US gal (12.8 l) |
| Engine Oil | API Service Classification SG or higher except oils labeled as energy conserving on the circular API service label, SAE 10W-30, JASO T 903 standard MA, Pro Honda GN4 4-stroke oil or equivalent |
| Maximum Weight Capacity | 322 lbs (146 kg) rider, passenger, all cargo and accessories |







Quick Reference

Quick Reference

| | |
|-------------------------|--|
| Tires | Front: 90/90 – 21M/C 54H DUNLOP ELITE3 Type: bias-ply, tubeless Rear: 200/50R18M/C 76H DUNLOP ELITE3 Type: radial, tubeless |
| Tire Pressure (cold) | Front: 33 psi (225 kPa , 2.25 kgf/cm ²) Rear: 41 psi (280 kPa , 2.80 kgf/cm ²) |
| Spark Plugs | standard: DCPR6E (NGK) or XU20EPR-U (DENSO) high speed riding: DCPR7E (NGK) or XU22EPR-U (DENSO) |
| Coolant | ethylene glycol antifreeze (silicate-free) for aluminum engines in 50/50 solution with Pro Honda HP Coolant or an equivalent distilled water |
| Fuses | main: 30A other: 20A, 10A |
| Final Drive Oil | Hypoid Gear Oil SAE 80 |

Quick Reference

These symbols are used in Controls & Features section:

| SYMBOL | COMPONENT | SEE PAGE |
|---|------------------------------|----------|
|  | START button | 26 |
|  | RUN — engine stop switch | 26 |
|  | OFF — engine stop switch | 26 |
|  | HI — headlight dimmer switch | 27 |
|  | LO — headlight dimmer switch | 27 |
|  | turn signal switch | 27 |
|  | horn button | 28 |