

**SAMSUNG**

# USER MANUAL

SM-R820  
SM-R825F  
SM-R830  
SM-R835F

# Table of Contents

## Getting Started

### 5 About the Galaxy Watch Active2

### 5 Read me first

### 10 Device layout

10 Package contents

11 Galaxy Watch Active2

13 Wireless charger

### 14 Battery

14 Charging the battery

16 Wireless charging

17 Charging the battery using Wireless PowerShare

19 Power saving mode

### 19 Wearing the Galaxy Watch Active2

19 Putting on the Galaxy Watch Active2

20 Band tips and precautions

21 Connecting or replacing the band

### 23 Turning the Galaxy Watch Active2 on and off

### 24 Connecting the Galaxy Watch Active2 to a mobile device

24 Installing the Galaxy Wearable app

24 Connecting the Galaxy Watch Active2 to a mobile device via Bluetooth

26 Remote connection

### 27 Using the Galaxy Watch Active2 without a mobile device

### 28 Controlling the screen

28 Bezel

30 Touchscreen

33 Screen composition

34 Turning the screen on and off

34 Switching the screen

36 Lock screen

### 36 Watch

36 Watch screen

37 Changing the watch face

38 Activating the watch always on feature

38 Watch only mode

### 39 Notifications

39 Notification panel

40 Viewing incoming notifications

41 Selecting apps for receiving notifications

### 41 Quick panel

### 48 Entering text

48 Introduction

49 Using the voice input

50 Using emoticons

50 Using handwriting input mode or the keyboard

51 Changing the input mode

## Apps and features

<b>52</b>	<b>Messages</b>		
<b>54</b>	<b>Phone</b>		
54	Introduction		
54	Receiving calls		
56	Making calls		
56	Options during calls		
<b>57</b>	<b>Contacts</b>		
<b>59</b>	<b>Samsung Pay</b>		
<b>60</b>	<b>Samsung Health</b>		
60	Introduction		
63	Daily activity		
64	Steps		
66	Floors		
67	Exercise		
74	Calories		
74	Sleep		
76	Heart rate		
78	Stress		
80	Food		
81	Weight management		
82	Water		
83	Caffeine		
84	Together		
85	Settings		
85	Additional information		
<b>86</b>	<b>GPS</b>		
<b>87</b>	<b>Music</b>		
87	Introduction		
87	Playing music		
87	Importing music		
88	Playing music with your Galaxy Watch Active2		
88	Playing music with your mobile device		
88	Playing music without connecting to a mobile device		
<b>89</b>	<b>Reminder</b>		
<b>90</b>	<b>Calendar</b>		
<b>91</b>	<b>Bixby</b>		
91	Introduction		
91	Starting Bixby		
92	Using Bixby		
<b>93</b>	<b>Weather</b>		
<b>93</b>	<b>Alarm</b>		
<b>94</b>	<b>World clock</b>		
<b>95</b>	<b>Timer</b>		
<b>95</b>	<b>Stopwatch</b>		
<b>96</b>	<b>Gallery</b>		
96	Importing and exporting images		
97	Viewing images		
97	Deleting images		
<b>98</b>	<b>Find My Phone</b>		
<b>98</b>	<b>Find My Watch</b>		
<b>99</b>	<b>SOS messages</b>		
<b>101</b>	<b>Email</b>		
<b>101</b>	<b>Galaxy Store</b>		
<b>102</b>	<b>Settings</b>		
102	Introduction		
102	Watch faces		
103	Sound and vibration		
104	Display		
104	Advanced		
106	Connections		
111	Apps		
112	Security		
113	Account (Account and backup)		

- 114 Accessibility
- 114 General
- 116 Battery
- 116 About watch
- 117 Connect to new phone
- 117 Connect to phone

## Galaxy Wearable app

### 118 Introduction

### 120 Home

- 120 Introduction
- 120 Payment
- 120 Notifications
- 121 Apps
- 122 Widgets
- 122 Sound and vibration
- 123 Display
- 124 Advanced
- 125 Add content to your watch
- 125 Send SOS requests
- 126 Find My Watch
- 126 Mobile networks
- 127 General
- 127 Accessibility
- 127 Samsung Pay
- 127 Bixby
- 128 Account and backup
- 130 Sync phone settings
- 130 Watch software update
- 130 Tips and user manual
- 131 About watch

### 132 Watch faces

### 133 Discover

## Using the Galaxy Watch Active2

### 134 Introduction

### 134 Using as a personal coach for your health

- 134 Achieving your daily activity target
- 135 Managing stress and sleep quality
- 135 Experiencing enhanced exercises

### 136 Using as an intelligent planner

- 136 Checking out today's information
- 136 Managing my daily life
- 138 Using dual clock when you are abroad
- 138 Using a convenient reminder

## Appendix

### 139 Troubleshooting

### 143 Removing the battery

# Getting Started

## About the Galaxy Watch Active2



The Galaxy Watch Active2 is a smartwatch that can analyse your exercise pattern, manage your health and allows you to use a variety of convenient apps for making phone calls and playing music. You can easily browse the various features by swiping the bezel or launch a feature by simply tapping the screen and also change the watch face to match your taste.

Connect your Galaxy Watch Active2 to your mobile device to expand your mobile device experience, or use the Galaxy Watch Active2 by itself, without connecting to a mobile device.

## Read me first

Please read this manual before using this device to ensure safe and proper use.

- Descriptions are based on the device's default settings.
- Some content may differ from your device depending on the region, service provider, model specifications, or device's software.
- Content (high quality content) that requires high CPU and RAM usage will affect the overall performance of the device. Apps related to the content may not work properly depending on the device's specifications and the environment that it is used in.
- Samsung is not liable for performance issues caused by apps supplied by providers other than Samsung.
- Samsung is not liable for performance issues or incompatibilities caused by edited registry settings or modified operating system software. Attempting to customise the operating system may cause the Galaxy Watch Active2 or apps to work improperly.
- Software, sound sources, wallpapers, images, and other media provided with this Galaxy Watch Active2 are licensed for limited use. Extracting and using these materials for commercial or other purposes is an infringement of copyright laws. Users are entirely responsible for illegal use of media.

- You may incur additional charges for data services, such as messaging, uploading and downloading, auto-syncing, or using location services depending on your data plan. For large data transfers, it is recommended to use the Wi-Fi feature.
- Default apps that come with the Galaxy Watch Active2 are subject to updates and may no longer be supported without prior notice. If you have questions about an app provided with the Galaxy Watch Active2, contact a Samsung Service Centre. For user-installed apps, contact service providers.
- Modifying the Galaxy Watch Active2's operating system or installing softwares from unofficial sources may result in Galaxy Watch Active2 malfunctions and data corruption or loss. These actions are violations of your Samsung licence agreement and will void your warranty.
- Some functions may not work as described in this manual depending on the maker and model of the mobile device you connect to the Galaxy Watch Active2.
- You can see the touchscreen clearly even in strong outdoor sunlight by automatically adjusting the contrast range based on the surrounding environment. Due to the nature of the Galaxy Watch Active2, displaying fixed graphics for extended periods may result in afterimages (screen burn-in) or ghosting.
  - It is recommended not to use fixed graphics on part or all of the touchscreen for extended periods and turn off the touchscreen when not using the Galaxy Watch Active2.
  - You can set the touchscreen to turn off automatically when you are not using it. Tap  (**Settings**) on the Galaxy Watch Active2's Apps screen, tap **Display** → **Screen timeout**, and then select the length of time you want the device to wait before turning off the touchscreen.
  - To set the touchscreen to automatically adjust its brightness based on the surrounding environment, tap  (**Settings**) on the Galaxy Watch Active2's Apps screen, tap **Display** → **Auto low brightness**, and then tap the switch to activate it.
- Depending on the region or model, some devices are required to receive approval from the Federal Communications Commission (FCC).

If your device is approved by the FCC, you can view the FCC ID of the Galaxy Watch Active2. To view the FCC ID, tap  (**Settings**) on the Galaxy Watch Active2's Apps screen, tap **About watch** → **Device**. If your device does not have an FCC ID, it means that the device has not been authorized for sale in the U.S. or its territories and may only be brought to the U.S. for the owner's personal use.

- Depending on the region, you can view the regulatory information on the Galaxy Watch Active2. To view the information, tap  (**Settings**) on the Galaxy Watch Active2's Apps screen and tap **About watch** → **Regulatory info**.

## Maintaining water and dust resistance

Your device supports water- and dust-resistance. Follow these tips carefully to maintain the water- and dust-resistance of your device. Failure to do so may result in damage to your device.

- Do not expose the device to **water moving with force**. Do not suddenly apply water pressure to the device, such as when diving.
- Do not use your device while diving into the water, playing water sports, or moving in fast-flowing water. It is designed for regular use in normal swimming conditions, such as for swimming pools or beaches.
- If the device or your hands are wet, dry them thoroughly before handling the device.
- If the device is exposed to fresh water, dry it thoroughly with a clean, soft cloth. If the device is exposed to other liquids, such as salt water, swimming pool water, soapy water, oil, perfume, sunscreen, hand cleaner, or chemical products such as cosmetics, rinse it with fresh water and dry it thoroughly with a clean, soft cloth. If you do not follow these instructions, the device's performance and appearance may be affected.
- Do not disassemble your device. The water- and dust-resistant features of the device can be damaged.
- Do not expose your device to a dramatic change in air temperature or water temperature.
- Do not dry your device with a heating machine like a hair drier.
- The water-resistant feature of the device can be damaged in the sauna.
- **If the device has been immersed in water or the microphone or speaker is wet, sound may not be heard clearly during a call.**
- Some features such as the touchscreen may not work properly **if the device is used in water.**
- **Your device has been tested in a controlled environment and certified to be water- and dust-resistant in specific situations and conditions. (Meets the requirements of the water-resistance in a 50 m deep water as described by the international standard ISO 22810:2010 and your device can be used in shallow water. Meets the requirements of the dust-resistance as described by classification IEC 60529 IP6X.)**

## Precautions for overheating

If you feel discomfort due to overheating while using the device, stop using it immediately and remove it from your wrist.

To avoid problems, such as device malfunction, skin discomfort or damage, and battery draining, a warning will appear on the device if it reaches a specific temperature. When the initial warning appears, device functions will be disabled until the device cools down to a specific temperature. However, the emergency call feature will be available on the LTE model.

If the device temperature continues to increase, a second warning will appear. At this time, the device will shut down. Do not use the device until it cools down to a specific temperature. However, when using the LTE model, the emergency call feature that has been previously connected will remain active until you are finished, even though the second warning will appear.

## Cleaning and managing the Galaxy Watch Active2

Follow the points below to ensure your Galaxy Watch Active2 functions correctly and maintains its appearance. Failure to do so may damage the Galaxy Watch Active2 and cause the skin irritation.



The supplied band may vary depending on the region or model. Be sure to properly clean and maintain your band accordingly.

- Turn off the Galaxy Watch Active2 and remove the band before cleaning it.
- Prevent the device from being exposed to dust, sweat, ink, oil, and chemical products such as cosmetics, antibacterial spray, hand cleaner, detergent, and insecticides. The Galaxy Watch Active2's exterior and interior parts may be damaged or it could result in poor performance. If your Galaxy Watch Active2 is exposed to any of the previously mentioned substances, use a lint-free, soft cloth to clean it.
- Do not use soap, cleaning agents, abrasive materials and compressed air when cleaning your Galaxy Watch Active2 and do not clean it with the ultrasonic waves or the external heat sources. Doing so may damage the Galaxy Watch Active2. Skin irritation may be caused by soap, detergents hand sanitizers, or cleaning agents left on the Galaxy Watch Active2.
- When you remove sun block, lotion, or oil, use a soap-free detergent, then rinse and dry your Galaxy Watch Active2 thoroughly.



- Clean your wrist and band after exercising or sweating. Clean the rubber band with freshwater, wipe it with a little rubbing alcohol and dry it thoroughly.
- If the rubber band gets stained or contains any materials, wipe it with a moistened soft bristle toothbrush.
- The leather band is not water-resistant. Do not swim or take a shower while using the leather band.
- The leather band can get stained by oil and cosmetics due to leather's natural characteristics. Be careful to not expose the leather band to those materials.
- Avoid exposing the Galaxy Watch Active2's leather band to direct sunlight, hot or humid environments, or water. The leather band's colour and form may change if you do so. If the leather band gets wet, wipe it with a soft, lint-free cloth immediately and dry it in a well-ventilated and shaded place.
- When your leather band get stained, wipe it with a soft, lint-free cloth. If necessary, slightly dampen a cloth with fresh water.

### **Use caution if you are allergic to any materials on the Galaxy Watch Active2**

- Samsung has tested the noxious materials found on the Galaxy Watch Active2 through the internal and external certificate authorities, including the test for all materials which contact with skin, skin toxicity test, and the Galaxy Watch Active2-wearing test.
- The Galaxy Watch Active2 includes nickel. Take the necessary precautions if your skin is hypersensitive or you have an allergy to any materials found on the Galaxy Watch Active2.
  - **Nickel:** The Galaxy Watch Active2 contains a small amount of nickel, which is below its reference point limited by the Europe REACH regulation. You will not be exposed to the nickel inside the Galaxy Watch Active2 and the Galaxy Watch Active2 has passed the international certificated test. However, if you are sensitive to nickel, be careful to use the Galaxy Watch Active2.
- Only the materials observed the standards of the U.S Consumer Product Safety Commission (CPSC), the regulations of the European countries, and other international standards are used to make a Galaxy Watch Active2.
- For more information about how Samsung manages chemicals, refer to the Samsung website (<https://www.samsung.com/uk/aboutsamsung/sustainability/environment/>).

## Instructional icons



**Warning:** situations that could cause injury to yourself or others



**Caution:** situations that could cause damage to your device or other equipment



**Notice:** notes, usage tips, or additional information

## Device layout

### Package contents

Refer to the quick start guide for package contents.



- The items supplied with the Galaxy Watch Active2 and any available accessories may vary depending on the region or service provider.
- The supplied items are designed only for this Galaxy Watch Active2 and may not be compatible with other devices.
- Appearances and specifications are subject to change without prior notice.
- You can purchase additional accessories from your local Samsung retailer. Make sure they are compatible with the Galaxy Watch Active2 before purchase.
- Except the Galaxy Watch Active2 and some accessories may not have the same water- and dust-resistance certification.
- Use only Samsung-approved accessories. Using unapproved accessories may cause the performance problems and malfunctions that are not covered by the warranty.
- Availability of all accessories is subject to change depending entirely on manufacturing companies. For more information about available accessories, refer to the Samsung website.

## Galaxy Watch Active2

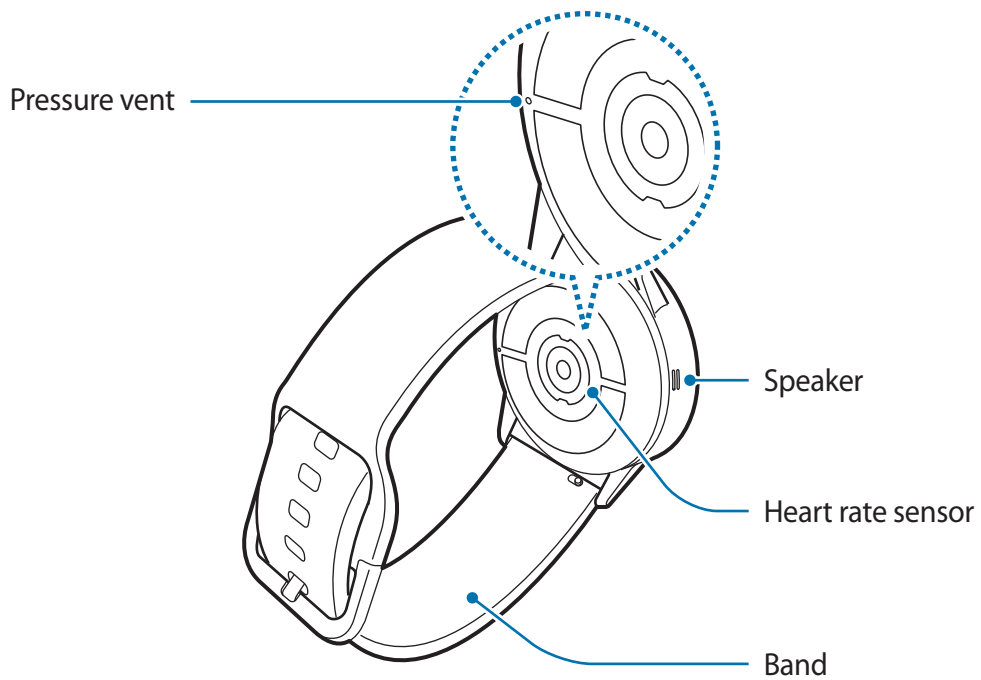
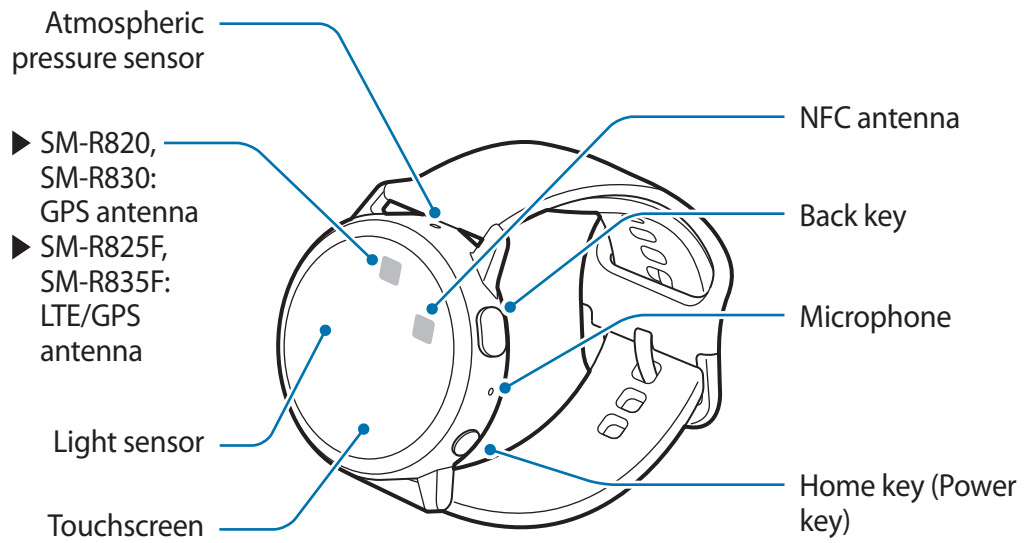



- Your device contains magnets, which may affect medical devices, such as pacemakers or implantable cardioverter defibrillators. If you are using any of these medical devices, keep your device a safe distance from them and consult with your physician before you use the device.
- Keep a safe distance between your device and objects that are affected by magnets. Objects such as credit cards, passbooks, access cards, boarding passes, or parking passes may be damaged or disabled by the magnets in the device.





- When using the speakers, such as when playing media files or during calls, do not place the Galaxy Watch Active2 close to your ears.
- Ensure that the band is kept clean. Contact with contaminants, such as dust and dye, can cause stains on the band that may not be fully removed.
- Do not insert sharp objects into the atmospheric pressure sensor, the pressure vent, speaker, or the microphone. Inner components of the Galaxy Watch Active2 may be damaged along with the water-resistance feature.
- If you use the device with its glass or acrylic body broken, there may be a risk of injury. Use the device only after it has been repaired at a Samsung Service Centre.



- Connectivity problems and battery drain may occur in the following situations:
  - If you attach metallic stickers on the antenna area of the Galaxy Watch Active2
  - If you cover the Galaxy Watch Active2's antenna area with your hands or other objects while using certain features, such as calls or the mobile data connection
- Do not cover the light sensor area with screen accessories, such as a screen protector or stickers. Doing so may cause the sensor to malfunction.
- Make sure the Galaxy Watch Active2's microphone is not obstructed when you are speaking into it.
- The pressure vent ensures that Galaxy Watch Active2's inner parts and sensors work correctly when you use the Galaxy Watch Active2 in environment where the atmospheric pressure changes.

## Keys

Key	Function
 <b>Home/Power</b>	<ul style="list-style-type: none"> <li>• Press and hold to turn the Galaxy Watch Active2 on or off.</li> <li>• Press to turn on the screen.</li> <li>• Press and hold for more than 7 seconds to restart the Galaxy Watch Active2.</li> <li>• Press to open the Apps screen when you are on the Watch screen.</li> <li>• Press to open the Watch screen when you are on any other screen.</li> </ul>
 <b>Back</b>	<ul style="list-style-type: none"> <li>• Press to return to the previous screen.</li> </ul>

## Wireless charger

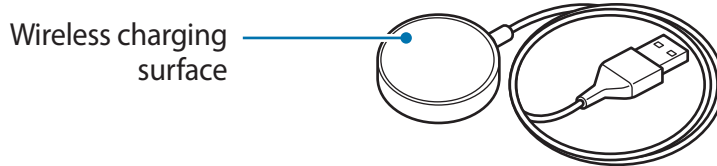

Do not expose the wireless charger to water because the wireless charger does not have same water-resistance certification as your Galaxy Watch Active2.

## Battery

### Charging the battery

Charge the battery before using it for the first time or when it has been unused for extended periods.



Use only Samsung-approved battery, charger, and cable specifically designed for your Galaxy Watch Active2. Incompatible battery, charger, and cable can cause serious injuries or damage to your Galaxy Watch Active2.



- Connecting the charger improperly may cause serious damage to the device. Any damage caused by misuse is not covered by the warranty.
- Use only wireless charger and charger supplied with the device. The Galaxy Watch Active2 cannot be charged properly with a third-party wireless charger and charger.



To save energy, unplug the charger when not in use. The charger does not have a power switch, so you must unplug the charger from the electric socket when not in use to avoid wasting power. The charger should remain close to the electric socket and be easily accessible while charging.

- 1 Connect the wireless charger to the charger and plug the charger into an electric socket.
- 2 Place the Galaxy Watch Active2 on the wireless charger aligning the centre of your Galaxy Watch Active2's back side with the centre of the wireless charger.

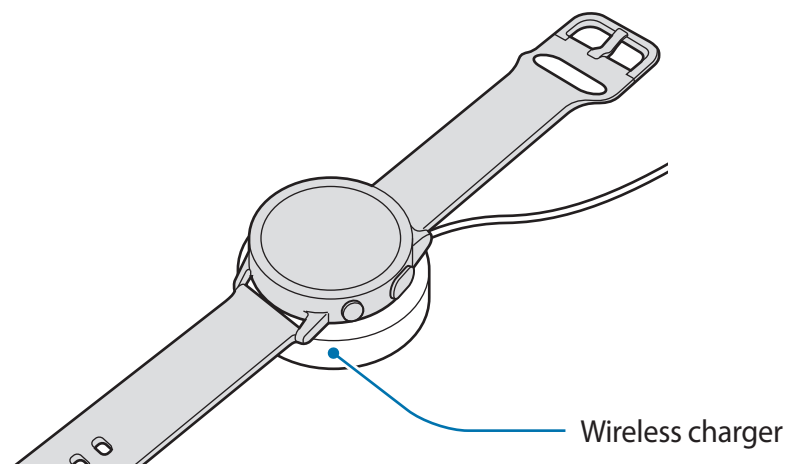

- 3 After fully charging, disconnect the Galaxy Watch Active2 from the wireless charger. First, disconnect the wireless charger from the charger and then unplug the charger from the electric socket.

## Checking the charging status

Press any of the Galaxy Watch Active2's keys to turn on the screen while it is on the wireless charger.

While charging the battery when the Galaxy Watch Active2 is turned off, press any key to check the charging status on the screen.

## Battery charging tips and precautions

- If there are obstructions between the Galaxy Watch Active2 and the wireless charger, the Galaxy Watch Active2 may not charge properly. Prevent the Galaxy Watch Active2 and the wireless charger from coming into contact with sweat, liquids, or dust.
- When the battery power is low, the battery icon appears empty.
- If the battery is completely discharged, the Galaxy Watch Active2 cannot be turned on immediately when the charger is connected. Allow a depleted battery to charge for a few minutes before turning on the Galaxy Watch Active2.
- If you use multiple apps at once, the battery will drain quickly. To avoid losing power during a data transfer, always use these apps after fully charging the battery.
- Using a power source other than the charger, such as a computer, may result in a slower charging speed due to a lower electric current.
- If the Galaxy Watch Active2 is being charged with other devices via a multi charger, charging may take longer.
- The Galaxy Watch Active2 can be used while it is charging, but it may take longer to fully charge the battery.

- If the Galaxy Watch Active2 receives an unstable power supply while charging, the touchscreen may not function. If this happens, disconnect the Galaxy Watch Active2 from the wireless charger.
- While charging, the Galaxy Watch Active2 may heat up. This is normal and should not affect the Galaxy Watch Active2's lifespan or performance. If the battery gets hotter than usual, the charger may stop charging for your safety. If this happens, continue charging the Galaxy Watch Active2 after allowing it to cool down by removing it from the wireless charger.
- If you charge the Galaxy Watch Active2 while the multipurpose jack is wet, the Galaxy Watch Active2 may be damaged. Thoroughly dry the multipurpose jack before charging the Galaxy Watch Active2.
- If the Galaxy Watch Active2 is not charging properly, take the Galaxy Watch Active2 to a Samsung Service Centre.
- Avoid using a bent or damaged USB cable. If the USB cable is damaged, stop using it.

## Wireless charging

The Galaxy Watch Active2 has a built-in wireless charging coil. You can charge the battery by using a wireless charging pad or another device that functions as a wireless charging pad. The wireless charging pad and other devices that function as wireless charging pads are sold separately.

### Charging the battery with a wireless charging pad

- 1 Place the centre of the Galaxy Watch Active2's back on the centre of the wireless charging pad.

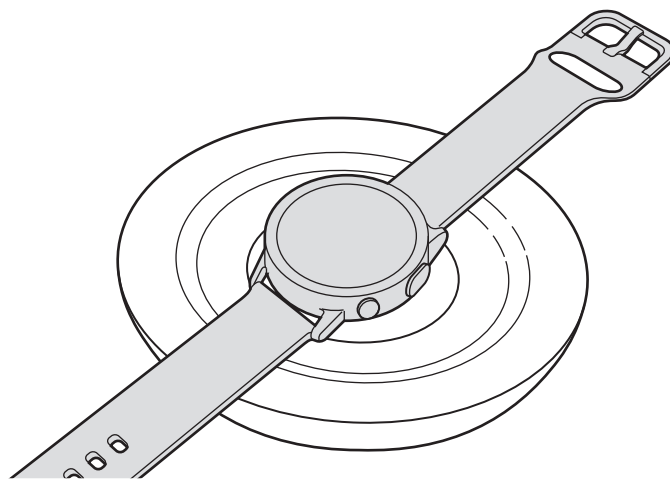



2 After fully charging, disconnect the Galaxy Watch Active2 from the wireless charging pad.



### **Precautions for wireless charging**

Do not place the Galaxy Watch Active2 on the wireless charging pad when conductive materials, such as metal objects and magnets, are placed between the Galaxy Watch Active2 and the wireless charging pad.

The Galaxy Watch Active2 may not charge properly or may overheat, or the Galaxy Watch Active2 may be damaged.



- If you use the wireless charging pad in areas with weak network signals, you may lose network reception.
- Use Samsung-approved wireless charging pad. If you use other wireless charging pads, the battery may not charge properly.
- For more information about available wireless charging pads, refer to the Samsung website.

## **Charging the battery using Wireless PowerShare**

You can charge your Galaxy Watch Active2 with the battery of the device that functions as a wireless charging pad. You can still charge your Galaxy Watch Active2 even while charging the device that functions as a wireless charging pad. Depending on the type of cover being used, the Wireless PowerShare feature may not work properly. It is recommended to remove any cover being used from the device that functions as a wireless charging pad before using this feature.



Do not use the Bluetooth headset while sharing power. Doing so may affect nearby devices.

- 1 Place the centre of the Galaxy Watch Active2's back on the device that functions as a wireless charging pad.



- The location of the wireless charging coil may vary by device model. Adjust the device or Galaxy Watch Active2 to connect with each other properly.
- Some features that work while wearing the Galaxy Watch Active2 are not available while sharing power.

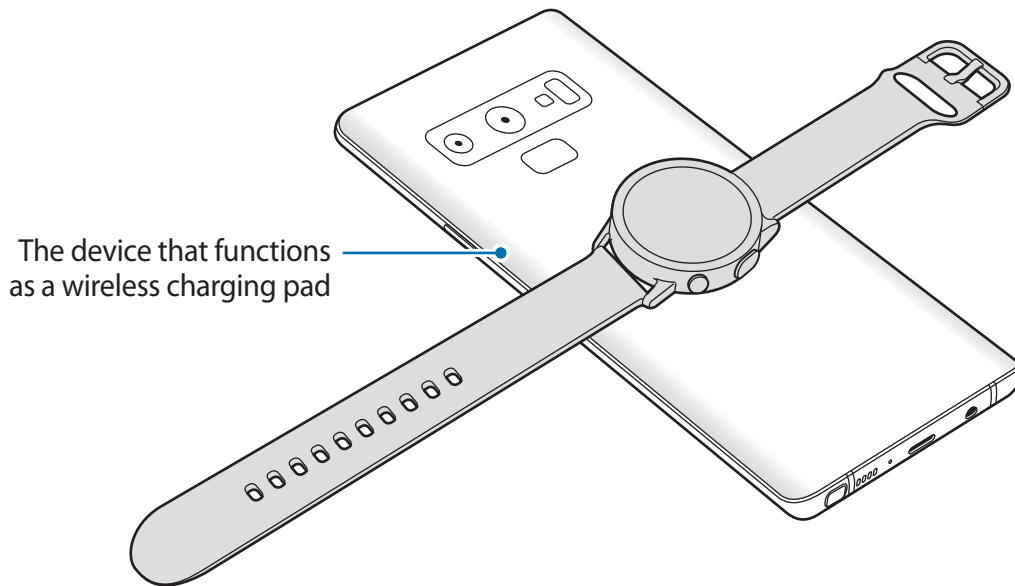

- 2 After fully charging, disconnect the Galaxy Watch Active2 from the device.









- To charge properly, do not move or use the device or Galaxy Watch Active2 while charging.
- The power charged to your Galaxy Watch Active2 may be less than the amount shared to it by the device that is functioning as a wireless charging pad.
- If you charge the Galaxy Watch Active2 while charging the device that functions as a wireless charging pad, the charging speed may decrease or the Galaxy Watch Active2 may not charge properly, depending on the charger type.
- The charging speed or efficiency may vary depending on the condition of the device that functions as a wireless charging pad or the surrounding environment.
- If the remaining battery power of the device that functions as a wireless charging pad drops below a certain level, power sharing will stop.
- For more information about available devices that functions as wireless charging pads, refer to the Samsung website.

## Power saving mode

Activate power saving mode to extend the battery's usage time.

- Displays colours on the screen as grey tones.
- Deactivates the mobile network and Wi-Fi feature.
- Limits all functions except for call, message, and notification features.
- Limits the performance of the Galaxy Watch Active2's CPU.

On the Apps screen, tap  (**Settings**) → **Battery** → **Power saving** → . Alternatively, tap  →  on the quick panel to activate power saving mode. Refer to [Quick panel](#) for more information about how to open the quick panel.

To deactivate this mode, tap **Turn off** at the bottom of the power saving mode screen and tap . Alternatively, tap  on the quick panel to deactivate power saving mode.

## Wearing the Galaxy Watch Active2

### Putting on the Galaxy Watch Active2

Open the buckle and place the band around your wrist. Fit the band to your wrist, insert the pin into an adjustment hole, and then secure the buckle to close it. If the band is too tight on your wrist, use the hole one further out.

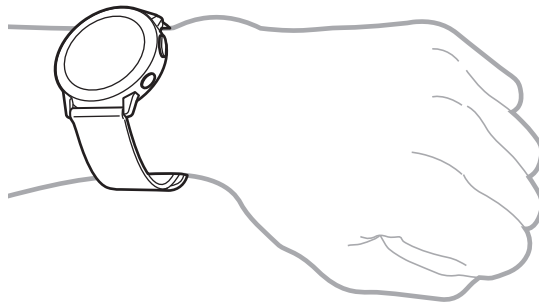



Do not bend the band excessively. Doing so may damage the Galaxy Watch Active2.



- To measure your heart rate more accurately with the Galaxy Watch Active2, wear the Galaxy Watch Active2 firmly around your lower arm just above the wrist. Refer to [Wearing the Galaxy Watch Active2 correctly](#) for more information.
- When certain materials come into contact with the back of the Galaxy Watch Active2, your Galaxy Watch Active2 may recognise that you are wearing it on your wrist.
- If your Galaxy Watch Active2 does not register that a motion has occurred for more than 10 minutes, your Galaxy Watch Active2 may recognise that you are not wearing it on your wrist.

## Band tips and precautions

- When you wear the Galaxy Watch Active2 for a long time or do a high-intensity exercise while wearing it, skin irritation may occur due to friction and pressure. If you wearing your Galaxy Watch Active2 for a long time, remove the Galaxy Watch Active2 from your wrist and do not wear your Galaxy Watch Active2 for several hours.
- Skin irritation may occur due to an allergy, environment factors, other factors, or when your skin is exposed to soap or sweat for long periods. In this case, stop using your Galaxy Watch Active2 and wait 2 or 3 days for the symptoms to ease. If the symptoms persist or worsen, immediately call your doctor.
- Make sure your skin is dry before wearing your Galaxy Watch Active2. If you wear a wet Galaxy Watch Active2 for a long time, your skin may be affected.
- If you use your Galaxy Watch Active2 in the water, remove foreign materials from your skin and Galaxy Watch Active2 and dry them thoroughly to prevent the skin irritation.
- Do not use any accessories except the Galaxy Watch Active2 in the water.

## Connecting or replacing the band

Connect the band before using your Galaxy Watch Active2. You can detach the band from the Galaxy Watch Active2 and replace it with a new one.



- The supplied band may vary depending on the region or model.
- The supplied band's size may vary depending on the model. Use the proper band which fits your model's size.

### Connecting the band

- 1 Insert one end of the band's spring bar into the Galaxy Watch Active2's lug.

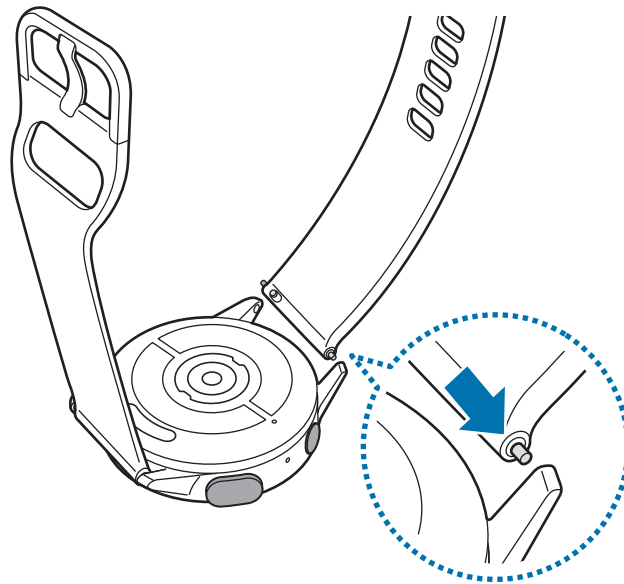

- 2 Slide the spring bar inwards and connect the band.

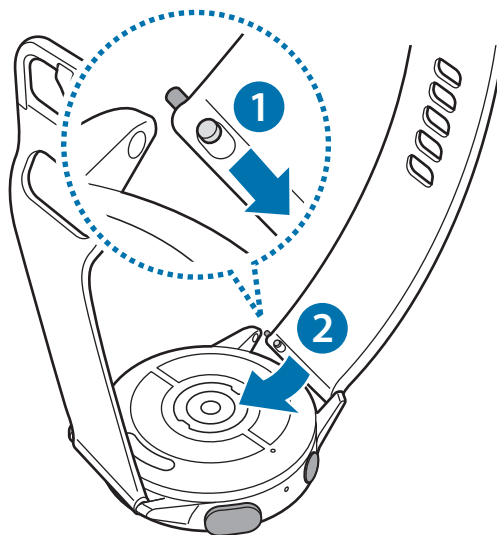

## Replacing the band

- 1 Slide the band's spring bar inwards.

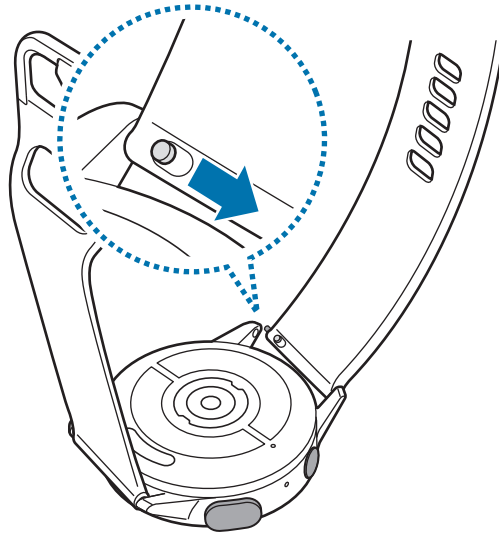

- 2 Pull the band away from the Galaxy Watch Active2's body.

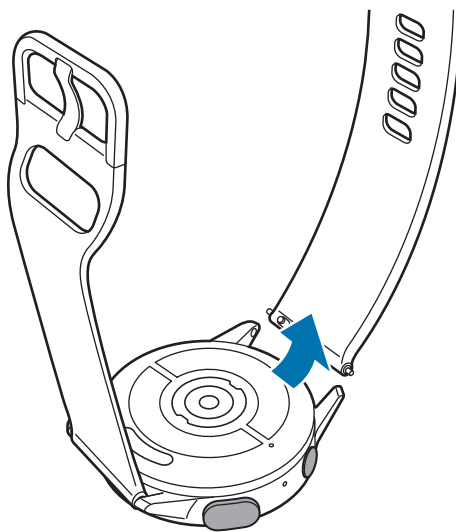

- 3 Connect the new band to your Galaxy Watch Active2.

## Turning the Galaxy Watch Active2 on and off

Press and hold the Home key (Power key) for a few seconds to turn on the Galaxy Watch Active2.

When you turn on the Galaxy Watch Active2 for the first time or reset it, on-screen instructions will appear to download and install the Galaxy Wearable app on your mobile device. Refer to [Connecting the Galaxy Watch Active2 to a mobile device](#) for more information.

To turn off the Galaxy Watch Active2, press and hold the Home key (Power key), and then tap **Power off**.

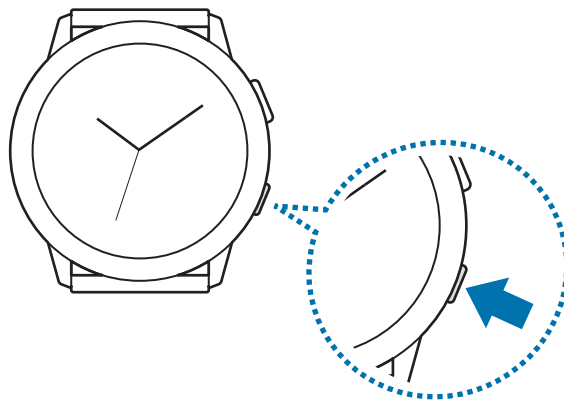

Follow all posted warnings and directions from authorised personnel in areas where the use of wireless devices is restricted, such as aeroplanes and hospitals.

### Restarting the Galaxy Watch Active2

If your Galaxy Watch Active2 is frozen and unresponsive, press and hold the Home key (Power key) for more than 7 seconds to restart it.

# Connecting the Galaxy Watch Active2 to a mobile device

## Installing the Galaxy Wearable app

You can use other various features after connecting your Galaxy Watch Active2 to a mobile device. To connect your Galaxy Watch Active2 to a mobile device, install the Galaxy Wearable app on the mobile device.

Depending on your mobile device, you can download the Galaxy Wearable app from the following places:

- Samsung Android devices: **Galaxy Store**, **Play Store**
- Other Android devices: **Play Store**



You cannot install the Galaxy Wearable app on the mobile devices that do not support Galaxy Watch Active2 syncing. Ensure that your mobile device is compatible with a Galaxy Watch Active2.

## Connecting the Galaxy Watch Active2 to a mobile device via Bluetooth

### Galaxy Watch Active2

- 1 Turn on the Galaxy Watch Active2 and swipe upwards from the bottom of the screen. A screen will appear about downloading and installing the Galaxy Wearable app.
- 2 Tap  to select a language to use and follow the on-screen instructions.



If you want to use your Galaxy Watch Active2 without connecting it to a mobile device, refer to [Using the Galaxy Watch Active2 without a mobile device](#).

### Mobile device

- 3 Launch the **Galaxy Wearable** app.  
If necessary, update the Galaxy Wearable app to the latest version.



4 Tap **Get started**.

5 Select your device on the screen.

If you cannot find your device, tap **Mine's not here**.

6 Follow the on-screen instructions to complete the connection.

When completing the connection, an on-screen tutorial will appear on both the Galaxy Watch Active2's screen and the mobile device. Follow the on-screen instructions to learn the Galaxy Watch Active2's basic controls.

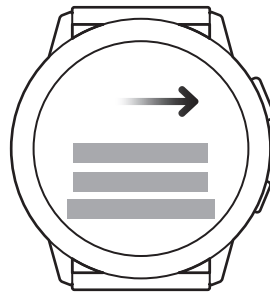

- Connection methods and screen may vary depending on your mobile device and software version.
- The Galaxy Watch Active2 is smaller than normal mobile devices so the network quality may be lower, especially in areas with weak signals or poor reception. When using your Galaxy Watch Active2 without connecting to a mobile device or when a Bluetooth connection is unavailable, your cellular network or Internet connection may be poor or become disconnected.
- When you connect your Galaxy Watch Active2 to a mobile device for the first time after resetting it, the Galaxy Watch Active2's battery may drain more quickly while syncing data, such as contacts.
- Supported mobile devices and features may vary depending on your region, service provider, or device manufacturer.

## Connecting the Galaxy Watch Active2 to a new mobile device

When you connect the Galaxy Watch Active2 to a new mobile device, the Galaxy Watch Active2 will be reset. When the prompt appears before connecting your Galaxy Watch Active2 to a new mobile device, tap **Back up data** to securely back up the stored data. Refer to [Managing the data in the Galaxy Watch Active2](#) for more information about backing up your Galaxy Watch Active2.

- 1 On the Apps screen, tap  (**Settings**) → **Connect to new phone** → .

The connection between your Galaxy Watch Active2 and your mobile device will end. After a light reset, it will automatically enter Bluetooth pairing mode.

- 2 On your new mobile device, launch the **Galaxy Wearable** app to connect to your Galaxy Watch Active2.



If the mobile device you want to connect to is already connected to another device, launch the **Galaxy Wearable** app on your mobile device and tap  → **Add new device** to connect with a new device.

## Remote connection

Your Galaxy Watch Active2 and mobile device are connected via Bluetooth. When a Bluetooth connection is not available, you can remotely connect the Galaxy Watch Active2 to your mobile device by using your Samsung account via the mobile network or the Wi-Fi network. This allows you to continue receiving notifications from your mobile device.



If this feature is not turned on, launch the **Galaxy Wearable** app on your mobile device, tap **Home** → **Account and backup**, and then tap the **Remote connection** switch to activate it.

## Using the Galaxy Watch Active2 without a mobile device

You can use the Galaxy Watch Active2 without connecting it to a mobile device. Use your Galaxy Watch Active2 conveniently without connecting to a mobile device while doing outdoor activities such as climbing a mountain or exercise. You can set to use the Galaxy Watch Active2 without a mobile device when you turn on the Galaxy Watch Active2 for the first time or you reset it.



- Some features are not available when you using your Galaxy Watch Active2 without connecting to a mobile device.
- Visit [www.samsung.com](http://www.samsung.com) to view legal notices provided when setting Without phone connection mode for the first time.

- 1 Turn on the Galaxy Watch Active2 and swipe upwards from the bottom of the screen.
- 2 Tap  and select a language to use.
- 3 Tap , scroll down the screen, and tap **here**.
- 4 Check the notice and tap **Continue**.
- 5 Read the compulsory terms and conditions and tap **Agree**.
- 6 Read the additional terms and conditions, select the terms and conditions that you agree to, and then tap **Next**.
- 7 Login with your Samsung account.
- 8 If you need to restore data, restore another Galaxy Watch Active2's data stored in your Samsung account.
- 9 Connect to your mobile network.



This step does not appear when you use the Bluetooth model.



10 Set a time zone, date, and time.



This step does not appear when you use the LTE model.

11 Set a PIN for restoring or backing up data.



On the Apps screen, tap  (**Settings**) → **Connect to phone** →  and enter the PIN to connect the Galaxy Watch Active2 to a mobile device while using the Galaxy Watch Active2 without a mobile device.

## Controlling the screen

### Bezel

Your Galaxy Watch Active2's screen includes the bezel, located on the edge of the screen. Swipe the bezel clockwise or anticlockwise to easily control the Galaxy Watch Active2's various functions.

On the Apps screen, tap  (**Settings**) → **Advanced** → **Touch bezel**, and tap the switch to activate it.



Do not use the bezel near magnetic fields as they may interfere with the bezel's internal magnets and cause it to malfunction.



If the bezel does not work, take it to a Samsung Service Centre without disassembling the Galaxy Watch Active2.

## Scrolling through screens

Swipe the bezel to view other screens. On the Watch screen, swipe the bezel anticlockwise to view notifications.

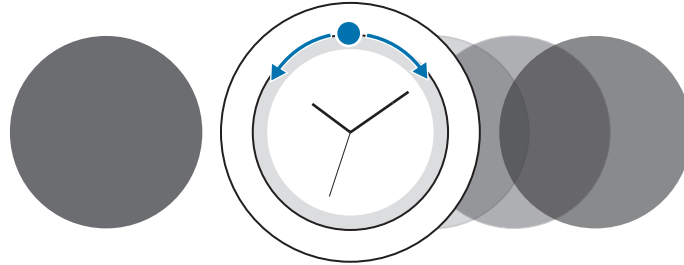

## Selecting an item

Swipe the bezel to move from item to item. When you swipe the bezel, the highlight indicator will move in same direction and an item will be highlighted.

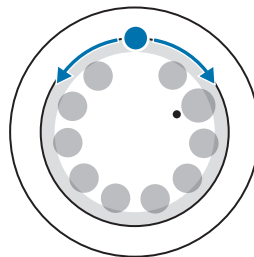

## Adjusting the input value

Swipe the bezel to adjust the volume or brightness. When adjusting the brightness, swipe the bezel clockwise to make the screen brighter.

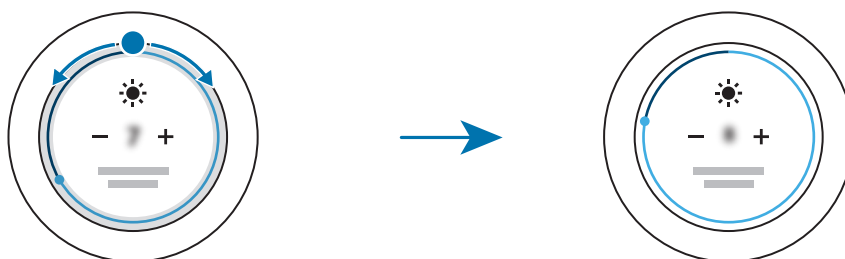

## Touchscreen



- Do not allow the touchscreen to come into contact with other electrical devices. Electrostatic discharges can cause the touchscreen to malfunction.
- To avoid damaging the touchscreen, do not tap it with anything sharp or apply excessive pressure to it with your fingertips.
- It is recommended not to use fixed graphics on part or all of the touchscreen for extended periods. Doing so may result in afterimages (screen burn-in) or ghosting.



- The Galaxy Watch Active2 may not recognise touch inputs close to the edges of the screen, which are outside of the touch input area.
- It is recommended to use fingers when you use the touchscreen.
- The touchscreen may not be available when water lock mode is activated.

## Tapping

To open an app, to select a menu item, or to press an on-screen button, tap it with your finger.

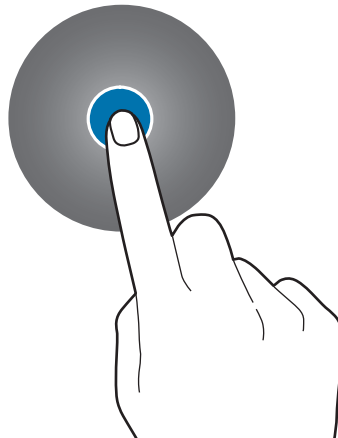

## Tapping and holding

Tap and hold the screen for two or more seconds to access the edit mode or to view available options.

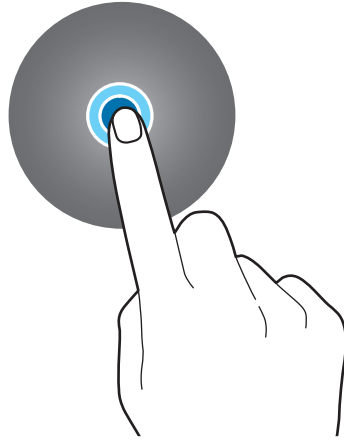

## Dragging

To move an item, tap and hold it and drag it to the target position.

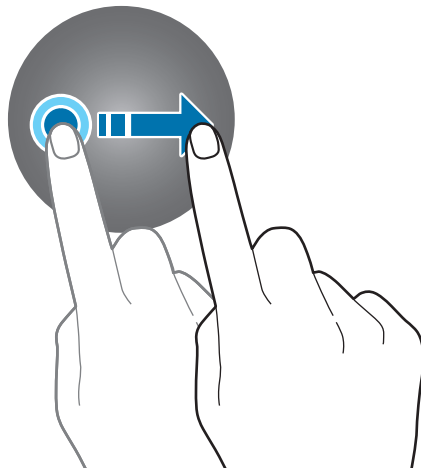

## Double-tapping

Double-tap on an image to zoom in or out.

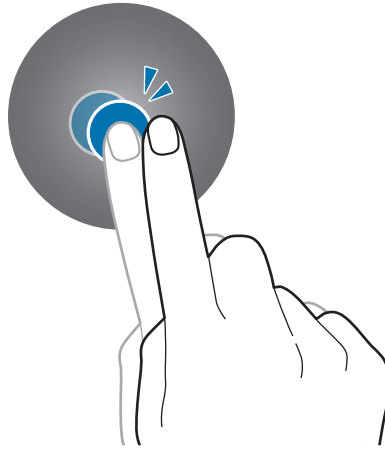

## Spreading and pinching

Spread two fingers apart or pinch on an image to zoom in or out.

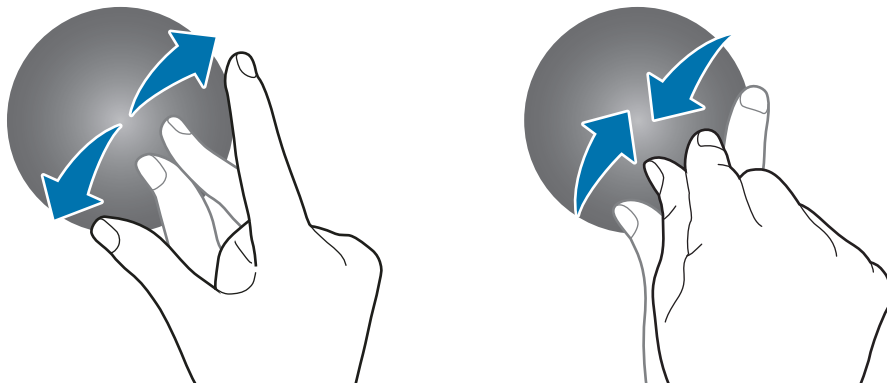

## Swiping

Swipe to the left or right to view other panels.

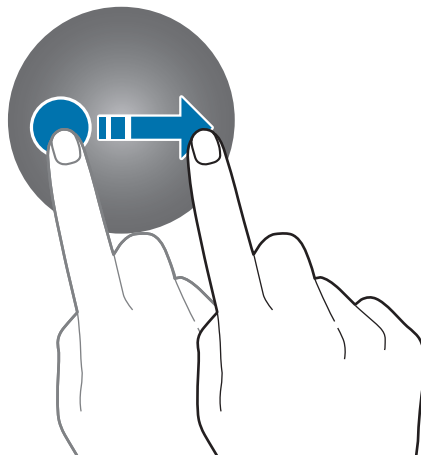



## Screen composition

The Watch screen is the starting point for accessing all of the Galaxy Watch Active2's many screens.

You can view widgets or open the notification panel by swiping on the screen or bezel.

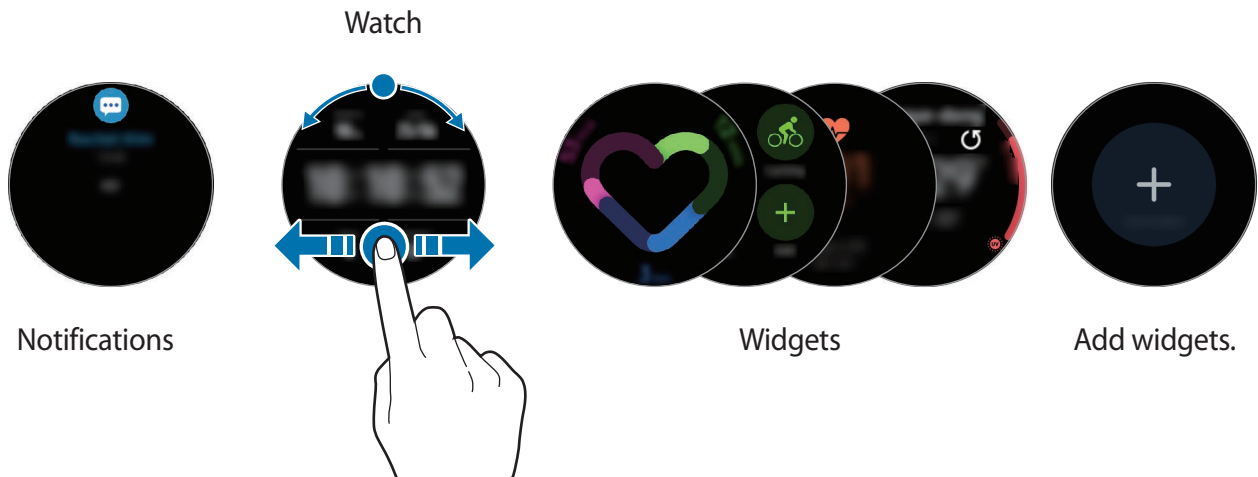

Available widgets, notifications, and their arrangement may vary depending on the software version.

### Adding widgets

You can add more widgets on the Home screen.

Scroll left on the screen, tap **+**, and select a widget. The selected widget will appear in a new panel.

### Moving widgets

Tap and hold a widget and then drag it to the desired location.

### Removing widgets

Tap and hold a widget and then tap **-**.

## Turning the screen on and off

To turn on the screen, press the Home key or the Back key.

You can also turn on the screen by tapping it. If the screen does not turn on after you tap the screen, tap  (**Settings**) on the Apps screen, tap **Advanced** → **Touch wake-up**, and then tap the switch to activate the it.

To turn off the screen, cover it with your palm. Also, the screen will automatically turn off if the Galaxy Watch Active2 is not used for a specified period.

You can also turn on the screen using the wake-up gesture feature. On the Apps screen, tap  (**Settings**) → **Advanced** → **Wake-up gesture** and tap the switch to activate it.

## Switching the screen

### Switching between the Watch and Apps screen

To open the Apps screen, press the Home key on the Watch screen.

To return to the Watch screen, press the Home key.

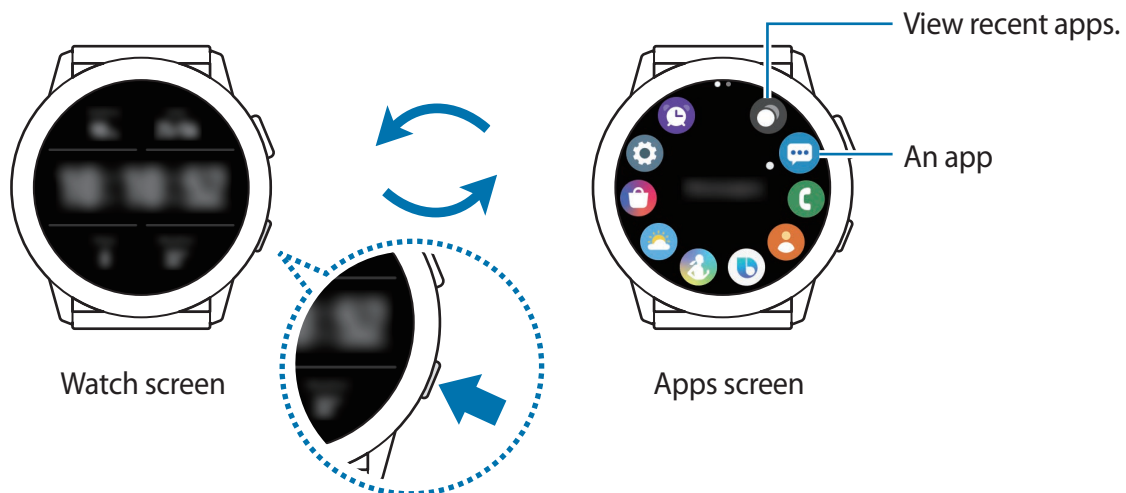

### Apps screen

The Apps screen displays icons for all apps installed on the Galaxy Watch Active2.

To move to the next or previous app, swipe the bezel or swipe to the left or right on the screen.



The available apps may vary depending on the software version.



## Opening apps

On the Apps screen, tap an app icon to launch the app.



To launch an app from the list of recently used apps, tap  (**Recent apps**) on the Apps screen.

Alternatively, swipe the bezel clockwise or swipe on the screen to the left on the Watch screen and select the recently launched app or frequently used app from the **App shortcuts** widget to launch the app.



To add an app you want to the **App shortcuts** widget, tap  and add the app. If there is no space to add the frequently used app, tap and hold the screen, tap **Edit**, and then tap  on the previously added app to add another app.

## Closing apps

- 1 On the Apps screen, tap  (**Recent apps**).
- 2 Swipe the bezel or swipe to the left or right on the screen to move to the app to close.
- 3 Tap .

To close all running apps, tap **Close all**.

## Returning to the previous screen

To return to the previous screen, press the Back key.

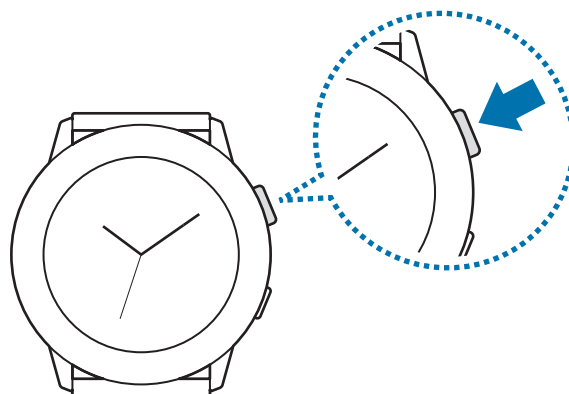

## Lock screen

Use the screen lock feature to protect your personal information by preventing others from accessing your Galaxy Watch Active2. After activating the screen lock feature, the Galaxy Watch Active2 will require an unlock code whenever unlocking it.

### Setting the screen lock

On the Apps screen, tap  (Settings) → Security → Lock → Type and select the lock method.

- **Pattern:** Draw a pattern with four or more dots to unlock the screen.
- **PIN:** Enter a PIN with numbers to unlock the screen.

## Watch

### Watch screen

You can check the current time or view other information. When you are not on the Watch screen, press the Home key to return to the Watch screen.

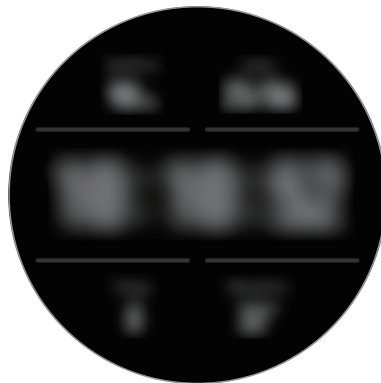

## Changing the watch face

Tap and hold the Watch screen and swipe the bezel or swipe on the screen to the left or right, and then select a watch face.

To customise the watch face, tap **Customise**, swipe the bezel or swipe the screen to the left or right to move to desired option, and then customise it.

To view and select the available watch faces, tap and hold the Watch screen and rapidly swipe the bezel. However, the **Customise** feature will be unavailable.

To download more watch faces from the **Galaxy Store** app, tap **Galaxy Store**.

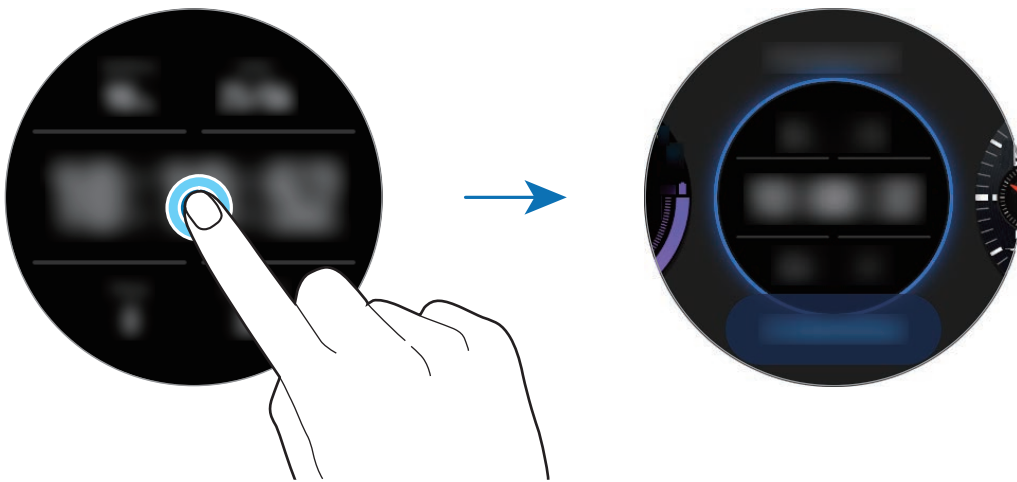

You can also change the watch face. On the Apps screen, tap  (**Settings**) → **Watch faces** → **Select watch face**.

You can also change the Galaxy Watch Active2's watch face from your mobile device. Launch the **Galaxy Wearable** app on your mobile device and tap **Watch faces** or **Discover**.

To download more watch faces from the **Galaxy Store** app, tap **Discover** → **View more on Top watch faces**.

## Customise a watch face with a photo

Apply a photo as your watch face after importing a photo from your mobile device. Refer to [Importing images from your mobile device](#) for more information about importing photos from a mobile device.

1 Tap and hold the Watch screen and swipe the bezel or swipe to the left or right on the screen, and then tap **Customise** of the **My Photo+** watch face.

2 Tap the screen and tap **Add photo**.

3 Select a photo to apply as a watch face and tap **OK** → **OK**.

You can zoom in or out of the photo by swiping the bezel. Alternatively, double-tap the image, spread two fingers apart, or pinch an image. When the photo is zoomed in, swipe the screen to make a part of the photo appear on the screen.





To add extra photos, swipe the bezel clockwise or swipe to the left on the screen and select **Add photo**. Up to twenty photos can be added as the watch face. The photos you add will rotate in a row.

4 Swipe the screen to change the colour or font and tap **OK**.



## Activating the watch always on feature

You can set the screen to always display the time when the screen is turned off while you are wearing your Galaxy Watch Active2.

On the quick panel, tap . Alternatively, on the Apps screen, tap  (**Settings**) → **Watch faces** → **Watch always on**, and then tap the switch to activate it.

## Watch only mode

You can use your Galaxy Watch Active2 in watch only mode. In watch only mode, only the time will display and all other functions cannot be used.

On the quick panel, tap . Alternatively, on the Apps screen, tap  (**Settings**) and tap **Battery** to open the battery management menu. Then select **Watch only** and tap .

To deactivate watch only mode, press and hold the Home key for more than three seconds.

## Notifications

### Notification panel

Check a notification such as a new message or a missed call on the notification panel. On the Watch screen, swipe the bezel anticlockwise or swipe to the right on the screen to open the notification panel. When there are unchecked notifications, an orange dot will be visible on the Watch screen.

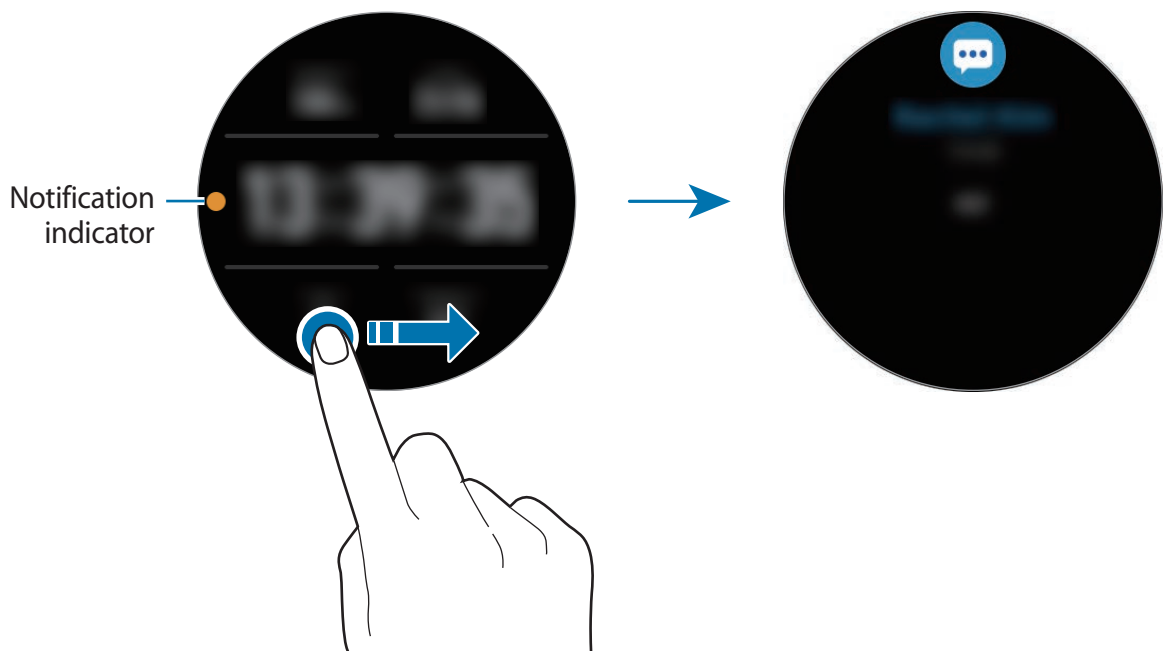

## Viewing incoming notifications

When you receive a notification, information about the notification, such as its type or the time you received it, will appear on the screen. If more than two notifications are received, swipe the bezel or swipe to the left or right on the screen to view more notifications.

Tap the notification to view details.

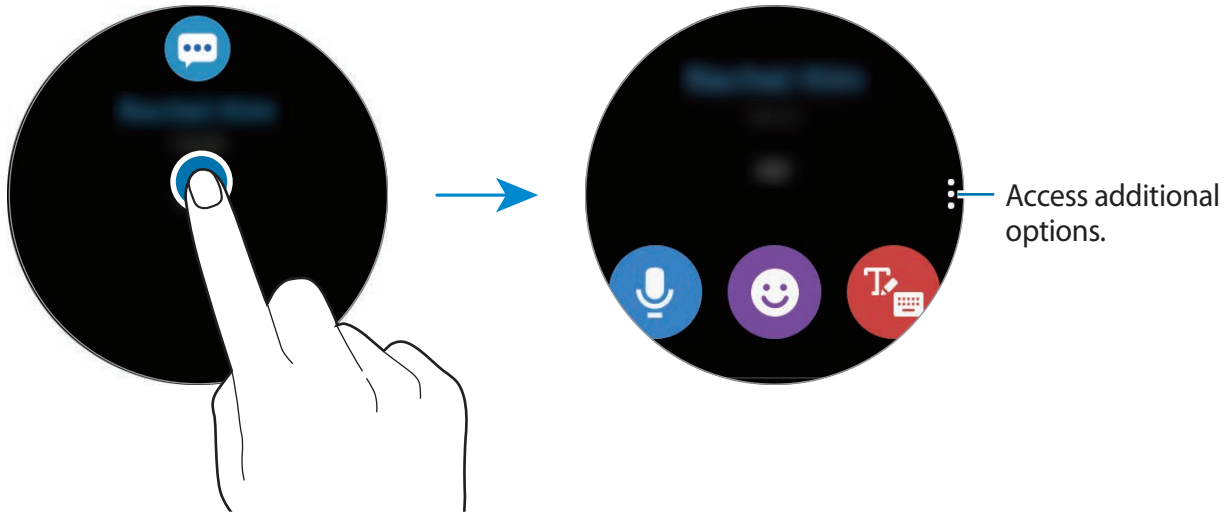

## Deleting notifications

Delete a notification by swiping upwards on the screen while viewing a notification.

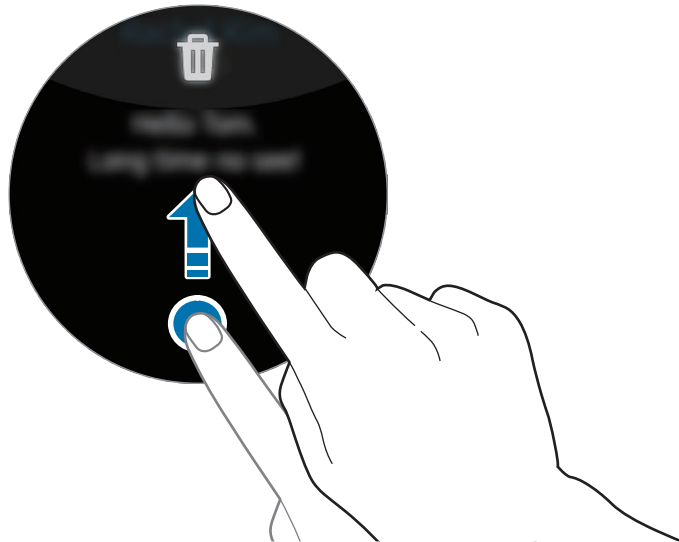



## Selecting apps for receiving notifications

Select an app from your mobile device to receive notifications on your Galaxy Watch Active2.

- 1 Launch the **Galaxy Wearable** app on your mobile device and tap **Home** → **Notifications**, and tap the switch.
- 2 Tap **Apps to get notifications from** and tap the switch next to apps to receive notifications from them on your Galaxy Watch Active2.

## Quick panel

This panel allows you to view the Galaxy Watch Active2's current status and configure settings.

Swipe downwards from the top edge of the screen.

Swipe the bezel or swipe to the left or right on the screen to move to the next or previous quick panel.

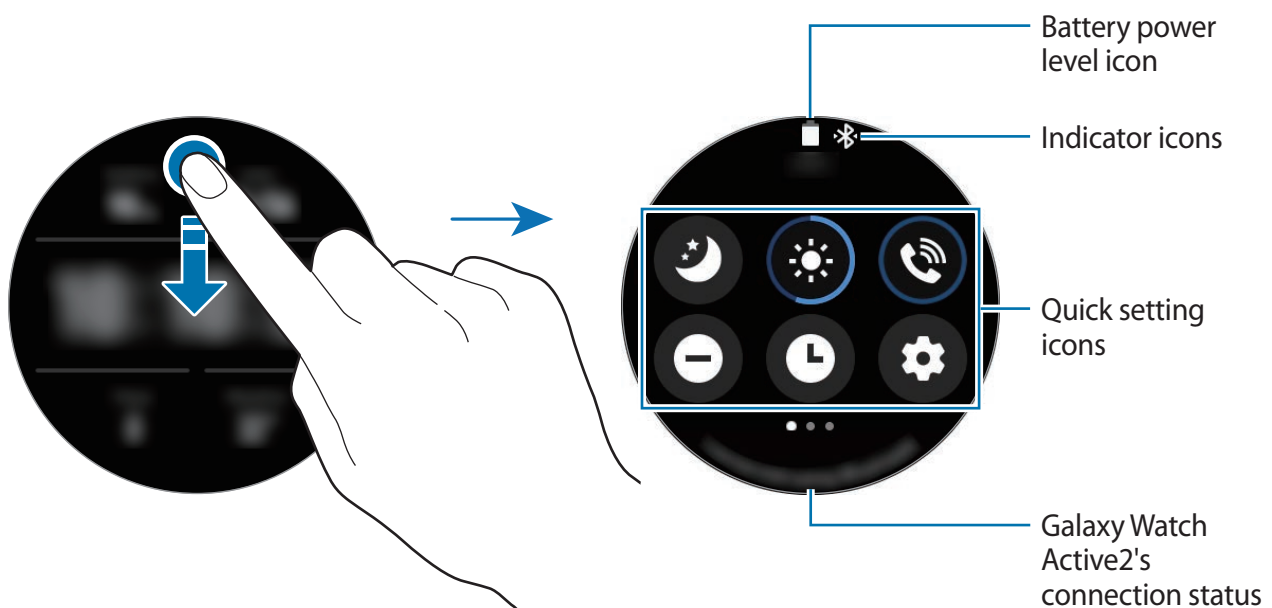







## Checking the indicator icons

Indicator icons appear at the top of the quick panel and let you know the Galaxy Watch Active2's current status. The icons listed in the table below are most common.









The indicator icons may appear differently depending on the region, service provider, or model.















Icon	Meaning
	Bluetooth connected
	Bluetooth disconnected
	Signal strength
	Bluetooth headset connected
<b>3G</b>	3G network connected
<b>LTE</b>	LTE network connected
	Wi-Fi connected
	Battery power level

## Checking quick setting icons

Quick setting icons appear on the quick panel. Tap the icon to change the basic settings or launch the function conveniently.

Refer to [Editing the quick setting icons](#) for more information about adding the new icons on the quick panel.

Icon	Meaning
	Activate goodnight mode
	Adjust the brightness
	Open the volume menu
	Activate do not disturb mode
	Activate the watch always on feature
	Launch the <b>Settings</b> app
	Activate theatre mode

Icon	Meaning
	Activate the flash feature
	Activate power saving mode
	Activate flight mode
	Activate water lock mode
	Connect the Wi-Fi network or connect the Wi-Fi network automatically
	Connect the Bluetooth headset
	Activate the location information feature
	Open the battery management menu
	Launch the <b>Find My Phone</b> app
	Activate sound, vibrate, or silent mode
	Connect the mobile network (only for LTE models)
	Activate the NFC feature
	Play or pause music
	Activate the touch sensitivity feature

## Editing the quick setting icons

You can edit the icons on the quick panel.

### Adding a quick setting icon

Tap and hold a quick setting icon on the quick panel and tap , then select a feature you want to add on the quick panel.

The icon for the feature you select will be added on the quick panel.

### Removing a quick setting icon

Tap and hold a quick setting icon you want to delete on the quick panel and tap .

The quick setting icon will be removed.



You can also edit the quick panel. On the Apps screen, tap  (**Settings**) → **Advanced** → **Edit quick settings**.

## Activating goodnight mode

Activate goodnight mode for sleeping.

On the quick panel, tap .

Incoming calls will be muted and the screen will not turn on when receiving incoming calls. Also, all notifications will be muted, except for alarms, and the screen will not turn on when notifications are received. Also, the wake-up gesture feature and watch always on feature will be deactivated automatically.

## Adjusting the brightness

You can adjust the Galaxy Watch Active2's brightness as desired.

On the quick panel, tap  and adjust the brightness by swiping the bezel or tapping **+** or **-**.

## Opening the volume menu

Adjust the volume level of the Galaxy Watch Active2.

On the quick panel, tap , swipe the bezel or swipe to the left or right on the screen to move to desired volume option, and then adjust the volume by swiping the bezel or tapping **+** or **-**.



When the Voice Assistant feature is activated, you can also adjust the accessibility volume.

## Activating do not disturb mode

Incoming calls will be muted and the screen will not turn on when receiving incoming calls. Also, all notifications will be muted, except for alarms, and the screen will not turn on when notifications are received.

On the quick panel, tap  and select the do not disturb option you want.

The  icon will appear at the top of the Watch screen.

## Activating the watch always on feature

Set the screen to always display the time when the screen is turned off while you are wearing your Galaxy Watch Active2.

On the quick panel, tap .

If you activate this feature, the battery will drain more quickly than normal.

## Launching the Settings app

Launch the **Settings** app to configure the Galaxy Watch Active2's various features.

On the quick panel, tap .

The **Settings** app will launch.

## Activating theatre mode

Activate theatre mode for watching movies.

On the quick panel, tap  and select the theatre mode option you want.

The  icon will appear at the top of the Watch screen. Incoming calls will be muted and the screen will not turn on when receiving incoming calls. Also, all notifications will be muted, including alarms, and the screen will not turn on when notifications are received or when there is an alarm. Also, the wake-up gesture feature and watch always on feature will be deactivated automatically.

## Activating the flash feature

You can use the Galaxy Watch Active2's screen as a flash.

On the quick panel, tap .

Tap the screen to adjust the flash brightness.

## Activating power saving mode

Activate power saving mode to restrict some Galaxy Watch Active2 features and reduce the battery usage.

On the quick panel, tap .

Displays colours on the screen as grey tones. Refer to [Power saving mode](#) for more information.

## Activating the flight mode

Activate the flight mode when you board an aeroplane. Activating this feature will restrict apps that require an network connection, but allow you to use other features as normal.

On the quick panel, tap .

The  icon will appear at the top of the Watch screen.

## Activating water lock mode

Activate water lock mode when you exercise in water.

On the quick panel, tap .

The touchscreen, the wake-up gesture feature, and the watch always on feature will be deactivated automatically.

Press and hold the Home key until the circle disappears to turn off water lock mode.

## Connecting to a Wi-Fi network

Connect to a Wi-Fi network manually or set the Wi-Fi network to connect automatically.

On the quick panel, tap  or .

The Wi-Fi network will be connected or disconnected. The Wi-Fi network will be connected automatically when  appears.



 does not appear and the Wi-Fi network does not connect automatically when you use the Galaxy Watch Active2 without connecting to a mobile device.

## Connecting the Bluetooth headset

Connect the Bluetooth headset and you can listen music and have a phone conversations through it.

On the quick panel, tap .

The Bluetooth feature is activated and the available Bluetooth headsets list will be searched. If the previously used Bluetooth is available, it will be connected automatically.

## Activating the location information feature

Activate the location information to use GPS data and location data with certain apps.

On the quick panel, tap .

## Opening the battery management menu

Open the battery management menu to manage the battery consumption easily.

On the quick panel, tap .

The battery management menu will be appear.

## Launching the Find My Phone app

Launch the **Find My Phone** app and find your mobile device when you misplace it.

On the quick panel, tap .

The mobile device will emit sound and turn on the screen. Refer to [Find My Phone](#) for more information.



This feature is not displayed when you use the Galaxy Watch Active2 without connecting to a mobile device.

## Activating sound, vibrate, or silent mode

Activate sound, vibrate, or silent mode.

On the quick panel, tap ,  or .

## Connecting to a mobile network

You can connect to a mobile network.

On the quick panel, tap .

Your Galaxy Watch Active2 will be connected to the mobile network.



This feature is not displayed on the Bluetooth model.

## Activating the NFC feature

Activate the NFC feature.

On the quick panel, tap .

The NFC feature can be used conveniently with the NFC antenna. Refer to [NFC](#) for more information.

## Playing or pausing music

Play or pause music.

On the quick panel, tap  or .

Music is played or paused on the Galaxy Watch Active2 or the connected mobile device. You can also listen to music after connecting the Bluetooth headset.

## Activating the touch sensitivity feature

Activate the touch sensitivity feature to use the touchscreen while wearing gloves.

On the quick panel, tap .



Depending on the type of gloves, the touchscreen might not recognise your touch and the feature may not activate.

## Entering text

### Introduction

A text input screen will appear when you are able to enter text, such as when sending a message.



- The text input screen may be different depending on the app you launch.
- When the Galaxy Watch Active2 is connected to a mobile device via Bluetooth, the language settings applied on the mobile device are applied to the Galaxy Watch Active2.

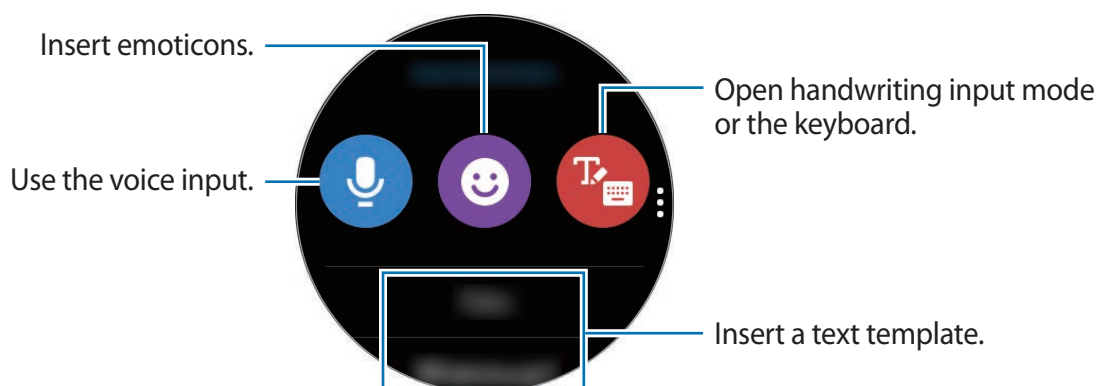



## Using the voice input

Tap  and speak to enter your message.

To change the language recognised, tap  → **Input languages**.

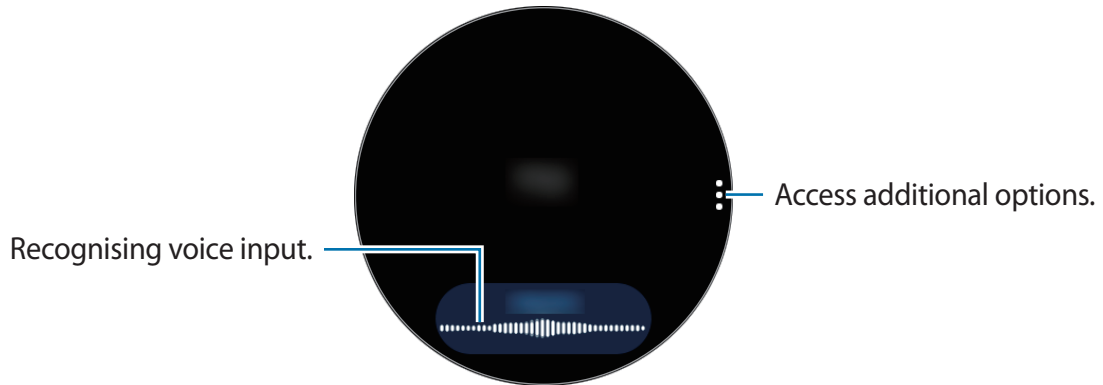

- This feature is not supported in some languages.

- **Tips for better voice recognition**



- Speak clearly.
- Speak in quiet places.
- Do not use offensive or slang words.
- Avoid speaking in dialectal accents.

The Galaxy Watch Active2 may not recognise your spoken message depending on your surroundings or how you speak.

## Using emoticons

Tap  and select the category. The emoticon list of the selected category will appear.

To draw a picture, tap **Doodle** at the top of the screen, and draw your message.

Swipe the bezel anticlockwise bezel, or tap  while the touch bezel feature is deactivated to delete your input stroke by stroke. To recover a stroke, swipe the bezel clockwise, or tap  while the touch bezel feature is deactivated.

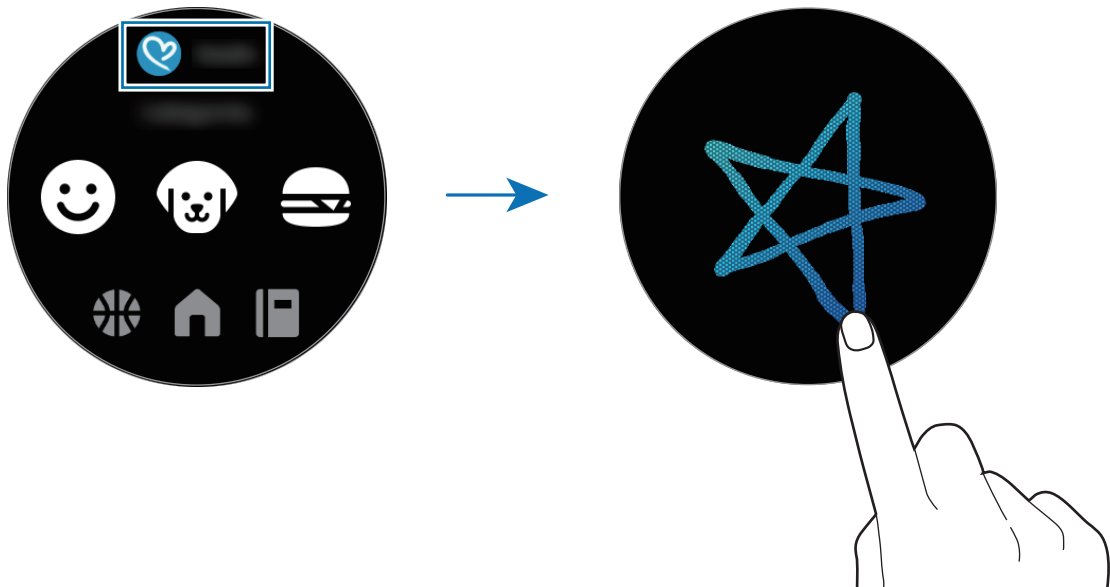

## Using handwriting input mode or the keyboard

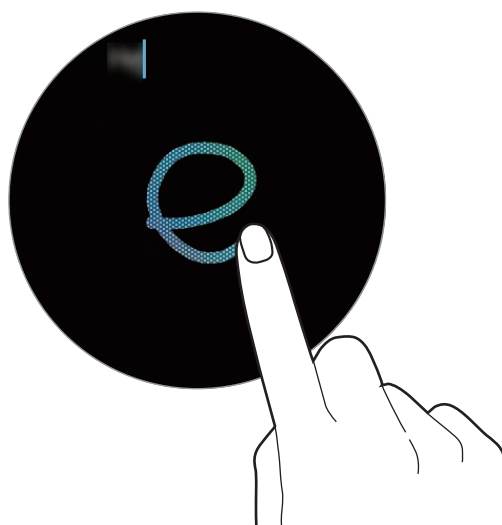

### Using handwriting input mode

Tap  to open handwriting mode and write on the screen.



This feature may not be available depending on the region.

## Using the keyboard

Tap  to open the keyboard. If handwriting input mode appears, swipe on the screen to the right from the left edge of the text input screen and select .

The keyboard will appear.



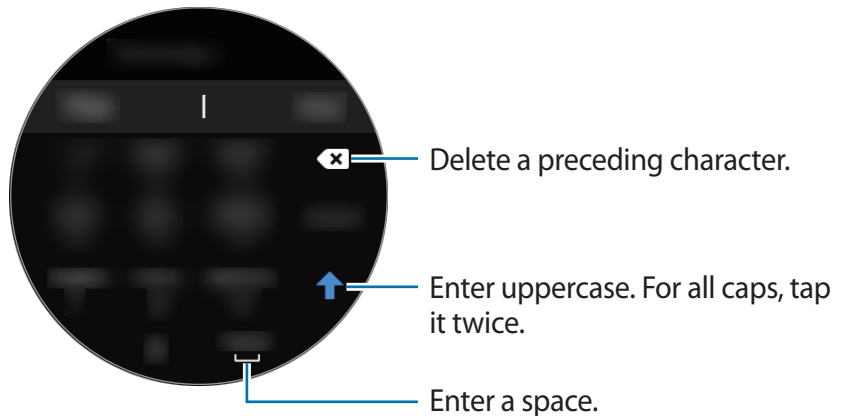

- Text entry is not supported in some languages. To enter text, you must change the input language to one of the supported languages.
- The keyboard layout may differ depending on the region.



## Changing the input language

Drag the space key to the left or right while tapping and holding it to change the input language in text mode.

To add more languages, swipe the screen to the right from the left edge of the text input screen. Then, tap  → **Input languages** →  → **Languages** and select a language to add. You can use up to two languages.

## Changing the input mode

Swipe the screen to the right from the left edge of the text input screen and select an input mode you want. You can switch between text mode, emoticon mode, number mode, voice input mode, handwriting mode, and punctuation mode.



Handwriting input mode may not be available depending on the region.

# Apps and features

## Messages

View messages and reply to using the Galaxy Watch Active2.

### Viewing messages



You may incur additional charges for receiving messages while you are roaming.

1 Tap  (**Messages**) on the Apps screen.

Or, swipe the bezel anticlockwise or swipe the screen to the right on the Watch screen to open the notification panel and view a new message.

2 Scroll through the message list, and then select a contact to view your conversations.

To view a message on your mobile device, tap , swipe the bezel or swipe upwards or downwards on the screen, and then tap **Show on phone**.

To reply a message, select an input mode and enter your message.

### Sending messages



You may incur additional charges for sending messages while you are roaming.

- 1 Tap  (**Messages**) on the Apps screen.

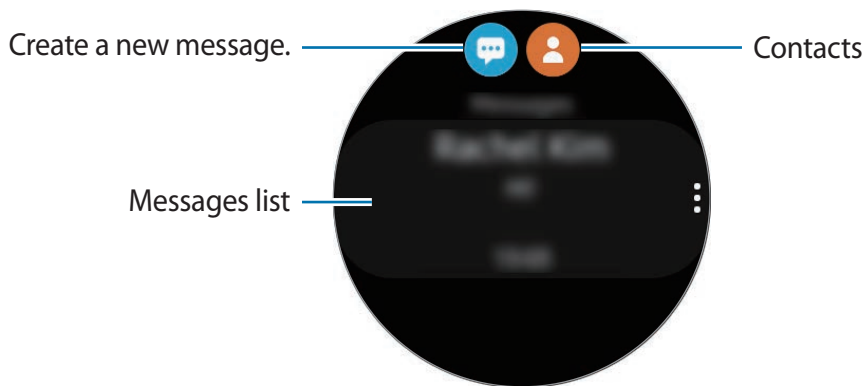

- 2 Tap .

Or, you can choose a message recipient by tapping  on the contacts list.

- 3 Add a recipient and tap **Next**.

- 4 Select an input mode, and enter your message, and then tap **Send**.

When you select a text template, tap .

When you select an emoticon, the message will automatically be sent to the recipients.

When you enter text by voice, you can select between text and audio for the message format. If the message format selection screen does not appear, on the Apps screen, tap  (**Settings**) → **Apps** → **Messages**, and then tap the **Send as audio** switch to activate it.

## Deleting messages

- 1 Tap  (**Messages**) on the Apps screen.

- 2 Scroll through the message list, and then select a contact to view your conversations.

- 3 Tap , swipe the bezel or swipe upwards or downwards on the screen, and then tap **Delete**.

The message will be deleted both from the Galaxy Watch Active2 and the connected mobile device.

# Phone

## Introduction

You can make calls and check incoming calls and receive them. You can have phone conversations via the internal microphone, speaker, or connected Bluetooth headset.



The sound may not be heard clearly during a call and only brief calls are available in areas with weak signals.

## Receiving calls

### Answering a call

When a call comes in, drag  outside the large circle.

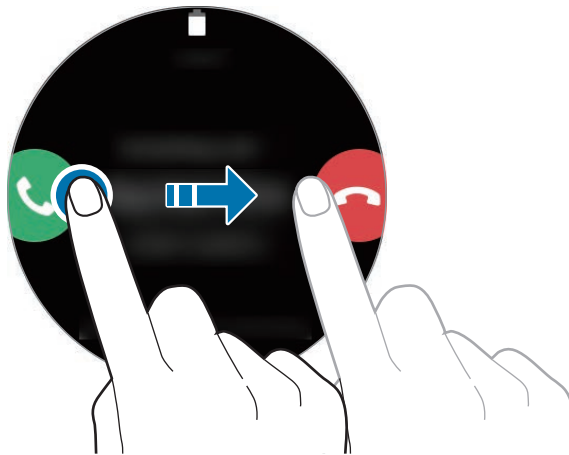

You can have phone conversations via the internal microphone, speaker, or a connected Bluetooth headset.

## Rejecting a call

You can reject incoming calls and send a rejection message to the caller.

When a call comes in, drag  outside the large circle.

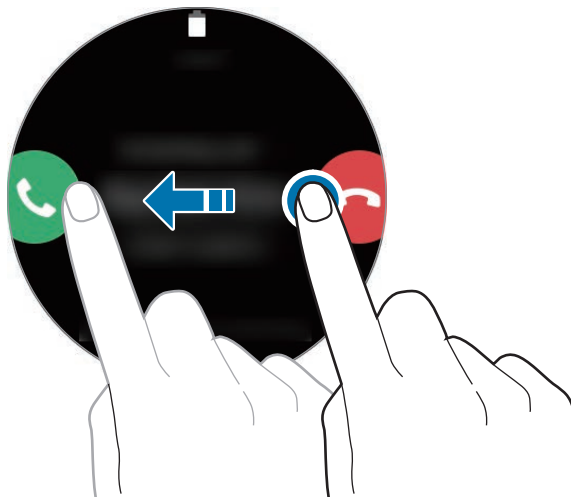

To send a message when rejecting an incoming call, swipe upwards from the bottom edge of the screen and select the message you want.

## Missed calls



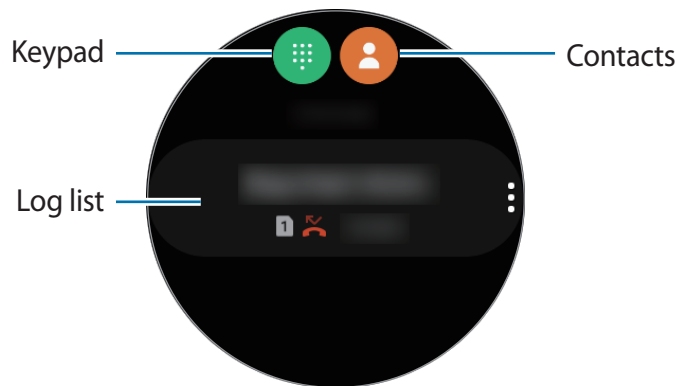

If a call is missed, a missed call notification is displayed on the notification panel. Swipe the bezel anticlockwise or swipe the screen to the right on the Watch screen to open the notification panel and view missed call notifications. Alternatively, tap  (Phone) on the Apps screen to view missed calls.

## Making calls

Tap  (Phone) on the Apps screen.



Use one of the following methods:

- Tap , enter a number using the keypad, and then tap .
- Tap , swipe the bezel or scroll through the contact list, select a contact, and then tap .
- Swipe the bezel or scroll through the log list, select a log entry, and then tap .

## Options during calls

### Using the call screen

The following actions are available:

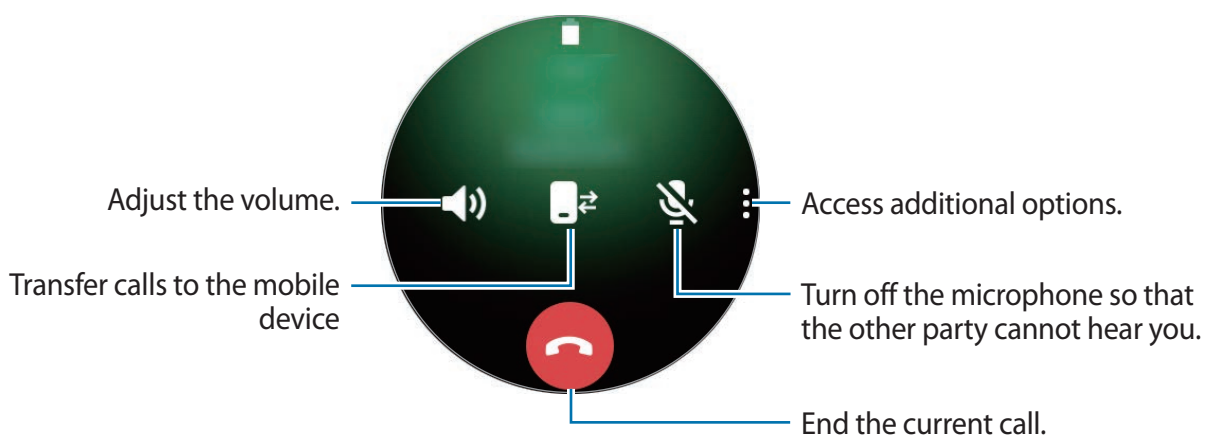



## Making a phone call with a Bluetooth headset

When a Bluetooth headset is connected to the Galaxy Watch Active2, you can make phone calls with a Bluetooth headset.

If a Bluetooth headset is not connected to the Galaxy Watch Active2, on the Apps screen, tap  (**Settings**) → **Connections** → **Bluetooth** → **Bluetooth audio**. When the available Bluetooth headsets list appears, select a Bluetooth headset you want to use.

To have phone conversations via the internal microphone or speaker, tap  on the call screen.



This feature is available when you use the LTE model without connecting to a mobile device.

## Opening the keypad

Tap  → **Keypad**.

## Contacts

You can make a call or send a message to a contact. The contacts saved on your mobile device will be also saved to your Galaxy Watch Active2 after you connect them.

Tap  (**Contacts**) on the Apps screen.





The favourites list contacts on the mobile device will display on the top of the contacts list.



Use one of the following search methods:

- Tap  and enter the search criteria on the top of the contacts list.
- Scroll through the contacts list.
- Swipe the right scroll bar while the touch bezel feature is deactivated. The list scrolls quickly.
- Swipe the bezel. When you swipe the bezel quickly, the list scrolls by the alphabet of the first letter.

Once a contact is selected, take one of the following actions:

-  : Make a voice call.
-  : Compose a message.

## Adding contacts

- 1 Tap  (**Contacts**) on the Apps screen.
- 2 Tap  on the top of the contacts list and enter the contact information.
- 3 Tap **Save**.

## Selecting the frequently used contacts on the widget

Swipe the bezel clockwise or swipe the screen to the left on the Watch screen and add the frequently used contacts from the **Contacts** widget to contact them directly via a text message or phone call. Tap **Add**, select contact, and then tap **Done**.



- To use the **Contacts** widget, you must first add it. Refer to [Adding widgets](#) for more information.
- Up to four contacts can be added on the widget.

## Adding medical information to my profile

Add medical information to my profile for the rescuer to quickly see it in an emergency situation.

On your mobile device, launch the **Contacts** app, select your profile, and then enter your medical information. To view your medical information on your Galaxy Watch Active2, on the Apps screen tap  (**Contacts**) and select your profile, and then swipe upwards from the bottom edge of the screen.

In an emergency situation, press and hold the Galaxy Watch Active2's Home key (Power key) and tap **Emergency medical info**.



- You may not use this feature depending on the mobile device that you connect to the Galaxy Watch Active2.

## Samsung Pay

Register frequently used cards to Samsung Pay, a mobile payment service, to make payments quickly and securely. Samsung Pay supports near field communication (NFC) to allow payment through standard credit card readers.

You can view more information, such as cards that support this feature at [www.samsung.com/samsung-pay](http://www.samsung.com/samsung-pay).



- This app's availability and supported features may vary depending on the region or service provider.
- The procedures for the initial setup and card registration may vary depending on the region or service provider.

### Setting up Samsung Pay

- 1 On your mobile device, launch the **Galaxy Wearable** app.
- 2 Tap **Samsung Pay** and follow the on-screen instruction to complete your card registration.

### Making payments

- 1 To make a payment on your Galaxy Watch Active2, press and hold the Back key.
- 2 Enter the PIN.
- 3 Scroll through the cards list, select a card and tap **PAY**.

#### 4 Place your Galaxy Watch Active2 close to the card reader.

When the card reader recognises the card information, the payment will be processed.



- Payments may not be processed depending on your network connection.
- The verification method for payments may vary depending on the card readers.

## Samsung Health

### Introduction

Samsung Health records and manages your 24-hour activity and sleep pattern to cultivate a healthy habit. When connecting your Galaxy Watch Active2 to your mobile devices, you can save and manage the health-related data on the Samsung Health app.

With the activated automatic exercise recognition feature, after you exercise for more than 10 minutes while wearing the Galaxy Watch Active2, it will notify you and show you some stretching motions to follow or it will show you a screen encouraging you to take a light stroll when the Galaxy Watch Active2 recognises inactivity for more than one hour. When your Galaxy Watch Active2 recognises you are driving, it may not display an encouraging message or stretches.

Tap  (**Samsung Health**) on the Apps screen.



- Samsung Health features are intended only for leisure, well-being, and fitness purposes. They are not intended for medical use. Before using these features, read the instructions carefully.
- Any information that is obtained from use of the Galaxy Watch Active2 or the Fit Software or any application preloaded within may not be suitable, accurate, complete or reliable.

## Wearing the Galaxy Watch Active2 correctly

- When you activate the auto heart rate tracking feature, or when you start to use the exercise features, the Galaxy Watch Active2 will automatically track your heart rate. When measuring your heart rate, wear the Galaxy Watch Active2 snugly on your arm above your wrist as shown in the figure below.
- If you fasten the Galaxy Watch Active2 too tightly, the skin irritation may occur and if you fasten it too loosely, friction may occur.

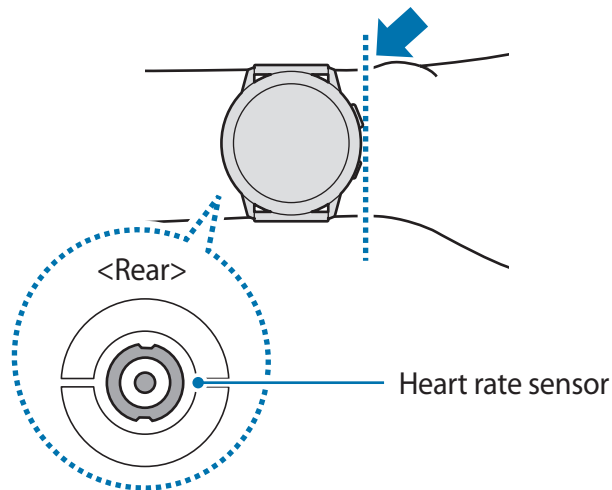

- Do not look directly at the heart rate sensor's lights. Doing so may impair your vision. Make sure children do not look directly at the lights.
- If your Galaxy Watch Active2 becomes hot to the touch, please remove it until it cools. Exposing skin to a hot surface of the Galaxy Watch Active2 for a long time may cause skin burn.



- The accuracy of the heart rate sensor may be diminished depending on measurement conditions and surroundings.
- Use the HR feature only for measuring your heart rate.
- Cold ambient temperatures may affect your measurement; during winter or cold weather, keep yourself warm when checking your heart rate.
- Smoking or consuming alcohol before taking measurements may cause your heart rate to be different from your normal heart rate.
- Do not talk, yawn, or breathe deeply while taking heart rate measurements. Doing so may cause your heart rate to be recorded inaccurately.
- Because the heart rate sensor uses light to approximate heart rate, its accuracy may vary due to physical factors that affect light absorption and reflection, such as blood circulation/blood pressure, skin condition and location and concentration of blood vessels. In addition, if your heart rate is extremely high or low, measurements may be inaccurate.
- Users with thin wrists may receive inaccurate heart rate measurements when the device is loose, causing the light to be reflected unevenly. If heart rate measurement is not working properly, adjust the position of the device's heart rate sensor to the right, left, up, or down on your wrist, or wear the device on your inner arm so that the sensor is in contact with your skin.

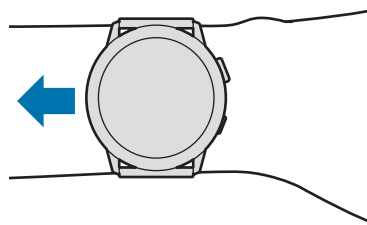

- If the heart rate sensor is dirty, wipe the sensor and try again. Obstructions between the device's band and your wrist, such as body hair, dirt, or other objects may prevent the light from reflecting evenly. Please make sure you remove such obstructions before use.

## Daily activity

Check your daily activity goal based on your target, such as the calories burned, exercise time, or activity time at a glance.

### Checking the daily activity

Tap  (Samsung Health) on the Apps screen, swipe the bezel or swipe upwards or downwards on the screen, and then open the daily activity tracker screen. Alternatively, swipe the bezel clockwise or swipe the screen to the left on the Watch screen and select the **Daily activity** widget to launch it.

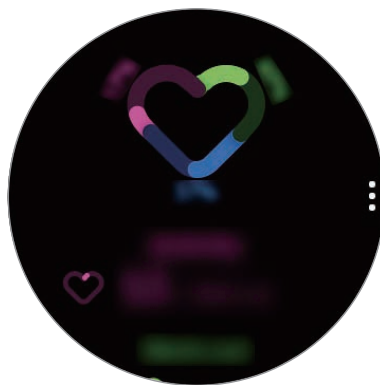

- **Activity:** Check your daily calories burned through activities you did throughout your day. As you approach your calorie goal, the graph will increase.
- **Work out:** Check your total workout times for activities you did throughout your day. Times for various exercises will be recognised automatically and the times for manually started exercises will be included. As you approach your workout goal, the graph will increase.
- **Move hourly:** Check how long you were active by hour throughout the day. As you approach your time goal by doing light activities, such as stretching and walking, the graph will increase.

To view weekly records with a graph, swipe the bezel or swipe upwards or downwards on the screen.

## Setting the daily activity target

- 1 Swipe the bezel or swipe upwards or downwards on the daily activity tracker screen and tap **Settings**.
- 2 Tap **Daily target** and select an activity option.
- 3 Tap the target input field and swipe the bezel or swipe upwards or downwards on the screen to set the target.
- 4 Tap **DONE**.

## Setting up notifications

To receive a notification when reaching a target you set, swipe the bezel or swipe upwards or downwards on the screen, tap **Settings**, and then tap the **Notifications** switch to activate it.

## Steps

The Galaxy Watch Active2 counts the number of steps you have taken and measures the distance travelled.

## Measuring your step count and distance you walk

Tap  (**Samsung Health**) on the Apps screen, swipe the bezel or swipe upwards or downwards on the screen, and then open the steps tracker screen.

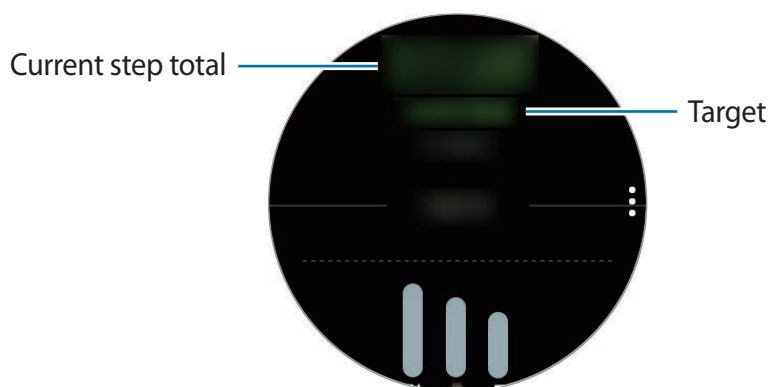



To view weekly records with a graph, swipe the bezel or swipe upwards or downwards on the screen.



- When you start to measure your step, the step tracker monitors your steps and displays your step account after a brief delay because your Galaxy Watch Active2 accurately recognises your movement after you walk for a while. Also, for an accurate step count, you may experience a brief delay before the pop-up window indicates that a certain goal has been reached.
- If you use the steps tracker while travelling by car or train, vibration may affect your step count.

### Setting the step target

- 1 Swipe the bezel or swipe upwards or downwards on the step tracker screen and tap **Settings**.
- 2 Tap **Step target**.
- 3 Tap the target input field and swipe the bezel or swipe upwards or downwards on the screen to set the target.
- 4 Tap **Done**.

### Setting up notifications

To receive a notification when reaching a target you set, swipe the bezel or swipe upwards or downwards on the screen, tap **Settings**, and then tap the **Notifications** switch to activate it.

## Floors

Record and track how many floors you climb.

### Measuring the floors you climb

Tap  (Samsung Health) on the Apps screen, swipe the bezel or swipe upwards or downwards on the screen, and then open the floors tracker screen.

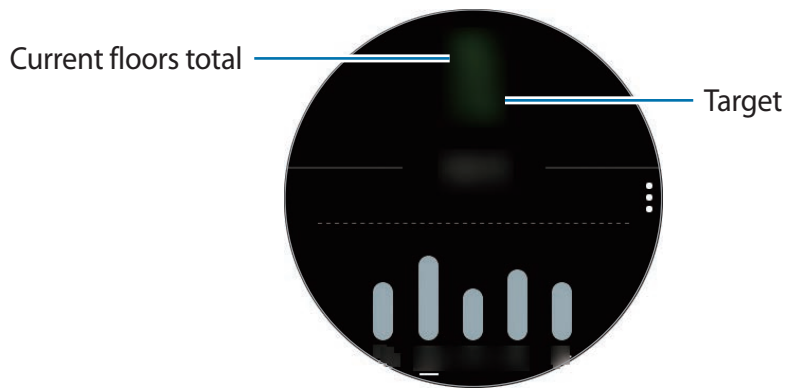

To view weekly records with a graph, swipe the bezel or swipe upwards or downwards on the screen.



- One floor is calculated as approximately 3 metres. The floors measured may not match the actual floors you climb.
- The floors measured may not be accurate depending on the environment, the user's movements, and the conditions of buildings.
- The floors measured may not be accurate if water (shower and water activity) or foreign materials enter the atmospheric pressure sensor. If there is any detergent, sweat, or raindrops on the Galaxy Watch Active2, rinse it with clean water and dry the atmospheric pressure sensor thoroughly before use.

### Setting the target for climbing floors

- 1 Swipe the bezel or swipe upwards or downwards on the floors tracker screen and tap **Settings**.
- 2 Tap **Floor target**.

3 Tap the target input field and swipe the bezel or swipe upwards or downwards on the screen to set the target.

4 Tap **DONE**.

## Setting up notifications

To receive a notification when reaching a target you set, swipe the bezel or swipe upwards or downwards on the screen, tap **Settings**, and then tap the **Notifications** switch to activate it.

## Exercise

Record your exercise information and check the results, such as burned calories, with the exercise feature.



- Before using this feature, pregnant women, the elderly, and young children, users suffering from conditions, such as chronic heart disease or high blood pressure, are recommended to seek the advice of a licensed medical professional.
- If you feel dizzy, experience pain, or have difficulty breathing during exercise, stop using this feature and seek the advice of a licensed medical professional.
- If you have just purchased or have reset the Galaxy Watch Active2, create your profile.

### Be aware of following conditions before exercising in cold weather conditions:

- Avoid using the device in cold weather. If possible, use the device indoors.
- If you use the device outside in cold weather, cover the Galaxy Watch Active2 with your sleeves before using it.

## Starting the exercises

1 Tap  (**Samsung Health**) on the Apps screen.

2 Swipe the bezel or swipe upwards or downwards on the screen, open the exercise tracker screen, and then tap **Work out**.



Swipe the bezel clockwise or swipe the screen to the left on the Watch screen and start exercising directly from the **Multi-workouts** widget. Tap **Add** to add up to four different types of exercises.

3 Tap ●●● on the exercise type you want from the exercise type list.

The screen where you can set the details of the exercise, such as the target, will appear.

When you want to start exercising immediately, tap the exercise type.

When there is no exercise type you want, tap **More workouts** and select an exercise type you want.

4 Tap **Target**, select a target type, and then set the details of the target.



If you select **Basic workout** as the target, you can work out as much as you want without a limit on time or distance.

5 Tap **Workout screen** to customise the workout screen.



- Refer to [Customising the workout screen](#) for more information.
- You cannot change the workout screen during a workout.

6 Set the various options for each exercise type.

- **Location:** Set the Galaxy Watch Active2's GPS antenna to track your current location when you work out outside.
- **High location accuracy:** Set the Galaxy Watch Active2 to calculate your location more precisely by using various processes.
- **Auto pause:** Set the Galaxy Watch Active2's exercise feature to pause automatically when you stop working out.
- **Lap:** Set to record the lap time manually by pressing the Back key twice or automatically at regular distances or time interval while working out.
- **Guide frequency:** Set to receive the guide whenever you reach the distance or time you set.
- **Coaching msgs:** Set to receive coaching messages for proper pacing while working out.
- **Screen always on:** Set the Galaxy Watch Active2's screen to remain on during workouts so you can view the workout screen.
- **Pool length:** Set the pool length.

7 Tap  to start exercising.



- Set whether to use your location information when you use your Galaxy Watch Active2 for the first time after purchasing or resetting it. Enabling the location information is set as the default.
- Your heart rate is measured in seconds when you start exercising. To measure your heart rate more accurately with the Galaxy Watch Active2, wear the Galaxy Watch Active2 firmly around your lower arm just above your wrist.
- Do not move until your heart rate displays on the screen so it can be measured more accurately.
- Your heart rate may not be visible temporarily due to various conditions such as the environment, your physical state, or how the Galaxy Watch Active2 is worn.
- When you select **Swimming (pool)** or **Swimming (outdoor)**, water lock mode will be activated automatically.

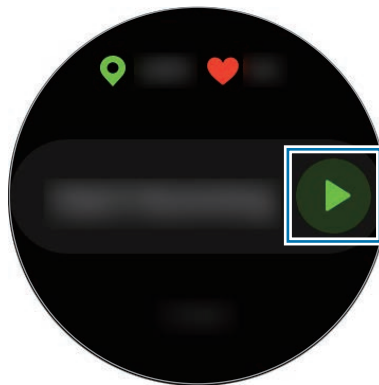

8 Swipe the bezel or swipe to the left or right on the screen to view exercise information, such as your heart rate, distance, or time, on the workout screen.

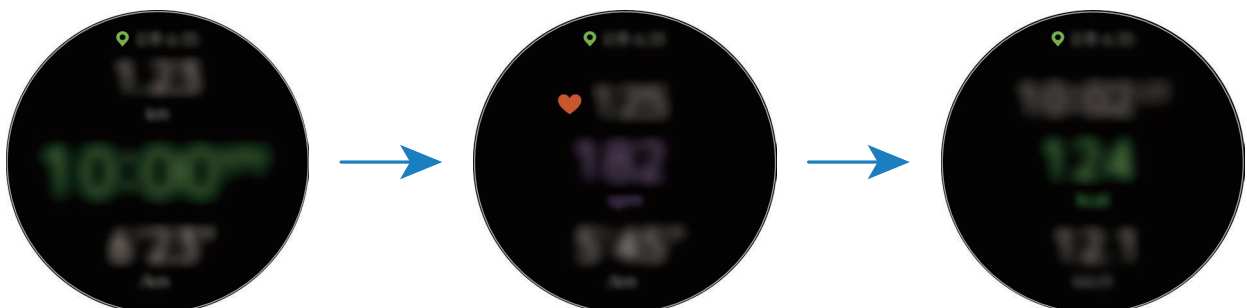

When you are swimming, you can check additional exercise information, such as the length information.

To listen to music, swipe the bezel anticlockwise or swipe to the right on the screen.



- When you select **Swimming (pool)** or **Swimming (outdoor)**, water lock mode will be automatically activated and the touchscreen will be disabled. The screen will change automatically and you can check your exercise information.
- When you select **Swimming (pool)** or **Swimming (outdoor)**, the recorded value may not be accurate in following cases:
  - If you stop swimming before reaching the completion point
  - If you change your swimming stroke midstream
  - If you stop moving your arms before reaching the completion point
  - If you kick with your legs on a kickboard or swim without moving your arms
  - If you swim with only one arm
  - If you swim under water
  - If you do not pause or restart the exercise by pressing the Back key, but finish the exercise by pressing the Back key and tapping **Finish**



9 Press the Back key to pause the exercise.

To restart the exercise, tap the Back key again after pausing the exercise.

To finish exercising, tap **Finish** → ✓ after pausing the exercise.

To finish swimming, tap and hold the Home key to deactivate water lock mode first, shake your Galaxy Watch Active2 to remove water completely from it in order to ensure that the atmospheric pressure sensor will work properly, and then tap **OK** → **Finish** →



- Music will continue to play even if you finish exercising. To stop playing music, stop music before finishing exercising or launch  (**Music**) to stop playing music.
- If your Galaxy Watch Active2 does not emit sound well, you can remove the water inside of the speaker with a loud sound. On the Apps screen, tap  (**Settings**) → **Advanced** → **Water lock mode** → **Eject water** → **Play sound**.

10 Swipe the bezel or swipe upwards or downwards on the screen after finishing the exercise and view your exercise information.



## Doing multiple exercises

You can log various exercises and go straight through an entire routine by starting another exercise right after finishing the current exercise.

- 1 Press the Back key to pause the current exercise.
- 2 Tap **Finish** → **NEW WORKOUT** >.
- 3 Select the exercise type and start the next exercise.

## Starting repetitive exercises

You can perform repetitive exercises such as the squat or dead lift. Your Galaxy Watch Active2 will count how many times you repeat the motion with vibrations and beeps.

- 1 Tap  (**Samsung Health**) on the Apps screen.
- 2 Swipe the bezel or swipe upwards or downwards on the screen, open the exercise tracker screen, and then tap **Work out**.
- 3 Tap ●●● on the repetitive exercise type you want from the exercise type list.  
The screen where you can set the details of the exercise, such as the target, will appear.  
When you want to start exercising immediately, tap the exercise type.  
When there is no repetitive exercise type you want, tap **More workouts** and select an exercise type you want.
- 4 Tap **Target**, select a target type, and then set the details of the target.  
 If you select **Basic workout** as the target, you can work out as much as you want without a limit on time or repetitions.
- 5 Tap **Workout screen** to customise the workout screen.

6 Set the various options for each exercise type.

- **Rep counter:** Count the number of repetitions with beeps.
- **Wrist worn on:** Select the wrist that you wear your Galaxy Watch Active2 to improve the counting accuracy.
- **Screen always on:** Set the Galaxy Watch Active2's screen to remain on during workouts so you can view the workout screen.

7 Tap  to start exercising.

Tap **OK** after you get into the proper position to start it by following the pose on the screen.



For some repetitive exercises, the exercise will begin right after you get into the proper position by imitating the pose on the screen.

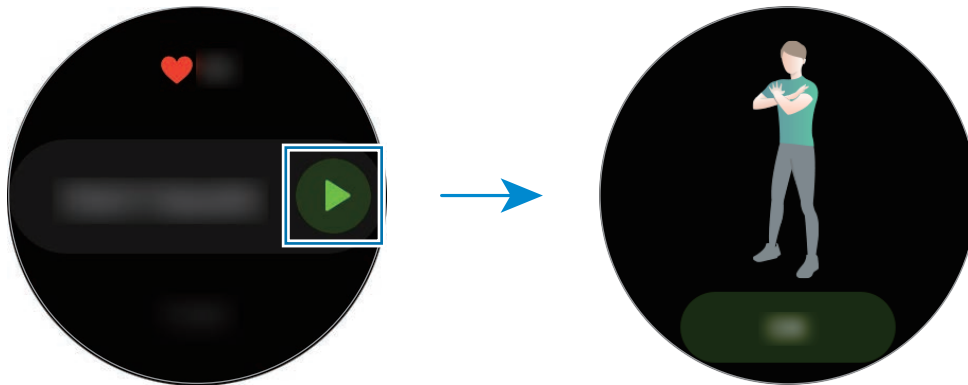

8 Counting will begin with vibrations and beeps.

Take a rest after completing a set. Or, tap **Skip** if you want to skip to the next set. The exercise will begin after you get into the proper position to start it by following the pose on the screen.

9 Press the Back key to pause the exercise.

To finish exercising, tap **Finish** →  after pausing the exercise.

10 Swipe the bezel or swipe upwards or downwards on the screen after finishing the exercise and view your exercise information.



## Customising the workout screen

Customise the workout screen that appears while exercising with the information that you want to preview.



You cannot change the workout screen during a workout.

- 1 Tap  (**Samsung Health**) on the Apps screen.
- 2 Swipe the bezel or swipe upwards or downwards on the screen, open the exercise tracker screen, and then tap **Work out**.
- 3 Tap **●●●** on the exercise type you want from the exercise type list.  
The screen where you can set the details of the exercise, such as the target, will appear.
- 4 Tap **Workout screen**, select the type of workout screen, set whether to use it, and then select the information to display on the screen.

## Automatic exercise recognition

Once you have engaged in an activity for more than ten minutes while wearing the Galaxy Watch Active2, it automatically recognises that you are exercising and records exercise information such as the exercise type, duration and calories burned.

When you stop doing some exercises for more than one minute, the Galaxy Watch Active2 automatically recognises that you have stopped exercising and this feature is deactivated.



- You can check the list of exercises which are supported by the automatic exercise recognition feature. On the Apps screen, tap  (**Samsung Health**) and tap **Settings** → **Workout detection** → **Activities to detect**.
- The automatic exercise recognition feature measures the distance travelled and calories burnt using the acceleration sensor. The measurements may not be accurate depending on your manner of walking, exercise routines, and lifestyle.

## Calories

You can check your calories burned by day or week.

Tap  (**Samsung Health**) on the Apps screen, swipe the bezel or swipe upwards or downwards on the screen, and then open the calories screen.



- The total calories you burn includes your basal metabolism calculated based on the profile you registered. When you launch the **Samsung Health** app for the first time, the basal metabolism you expend until the time you launch the app will be displayed as the calories you burn.
- The calories burned during the activity are the result of the exercise or other activities you do.

## Sleep

Analyse your sleep and record it by measuring your heart rate while you are sleeping.



- The sleep pattern will have its four states (Awake, REM, Light, Deep) analysed by using your movement and changes in your heart rate. A graph will be provided with recommended ranges for each measured sleep state.
- If your heart rate is irregular, your Galaxy Watch Active2 cannot recognise your heart rate properly, or when you turn off the record REM sleep feature, the sleep pattern will be analysed into three states (Restless, Light, Motionless).
- Sleep patterns are analysed and recorded with your heart rate. To measure your sleep patterns with your body movements, swipe the bezel or swipe upwards or downwards on the sleep tracker screen, tap **Settings**, and then tap the **Record REM sleep** switch to deactivate it.
- To measure your heart rate more accurately with the Galaxy Watch Active2, wear the Galaxy Watch Active2 firmly around your lower arm just above the wrist. Refer to [Wearing the Galaxy Watch Active2 correctly](#) for more information.

## Measuring your sleep

- 1 Sleep while wearing the Galaxy Watch Active2.  
The Galaxy Watch Active2 will start to measure your sleep.
- 2 Tap  (Samsung Health) on the Apps screen after you wake up.
- 3 Swipe the bezel or swipe upwards or downwards on the screen and open the sleep tracker screen.
- 4 View all information related to your measured sleep.



## Heart rate

Measure and record your heart rate.



- The Galaxy Watch Active2's heart rate tracker is intended for fitness and informational purposes only and is not intended for use in the diagnosis of disease or other conditions, or in the cure, mitigation, treatment, or prevention of disease.
- To measure your heart rate more accurately with the Galaxy Watch Active2, wear the Galaxy Watch Active2 firmly around your lower arm just above the wrist. Refer to [Wearing the Galaxy Watch Active2 correctly](#) for more information.

### **Be aware of following conditions before measuring your heart rate:**

- Rest for 5 minutes before taking measurements.
- If the measurement is very different from the expected heart rate, rest for 30 minutes and then measure it again.
- During winter or in cold weather, keep yourself warm when measuring your heart rate.
- Smoking or consuming alcohol before taking measurements may cause your heart rate to be different from your normal heart rate.
- Do not talk, yawn, or breathe deeply while taking heart rate measurements. Doing so may cause your heart rate to be recorded inaccurately.
- Heart rate measurements may vary depending on the measurement method and the environment they are taken in.
- If the heart rate sensor is not working, check the Galaxy Watch Active2's position on your wrist and make sure nothing is obstructing the sensor. If the heart rate sensor continues to have the same problem, visit a Samsung Service Centre.

## Measuring your heart rate

- 1 Tap  (Samsung Health) on the Apps screen.
- 2 Swipe the bezel or swipe upwards or downwards on the screen and open the heart rate tracker screen.

Your heart rate is measured every 10 minutes while resting. Check your measured heart rate on the screen.

To measure your heart rate manually, tap **Measure** to begin measuring your heart rate.

-  Swipe the bezel clockwise or swipe the screen to the left on the Watch screen and check the measured heart rate directly from the **Heart rate** widget.

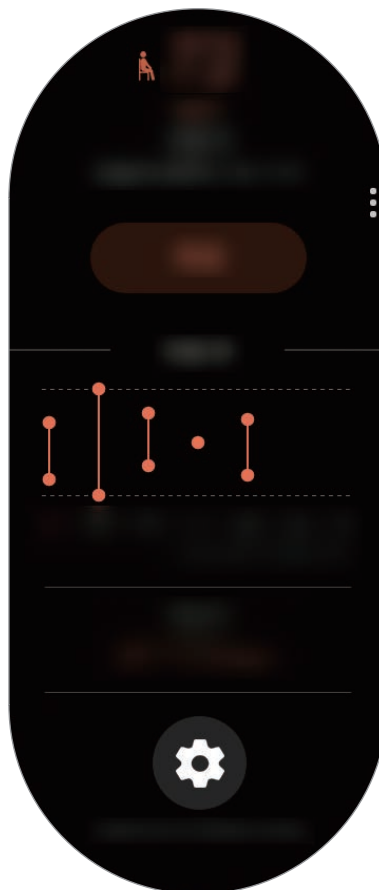

To view weekly records with a graph, swipe the bezel or swipe upwards or downwards on the screen.

## Measuring your heart rate continuously

You can set your Galaxy Watch Active2 to automatically measure your heart rate continuously. On the heart rate tracker screen, tap **HR and stress measurement** and select **Measure continuously**.

Your heart rate will be measured continuously and you can check your heart rate, heart rate changes by day in a graph, maximum heart rate, and the time information for each activity section divided by intensity.

## Stress

Calculate and record your stress level by using changes in your heart rate and reduce your stress by following the breathing instructions that Galaxy Watch Active2 provides.



- You can get more accurate stress level results when your stress level data accumulates by measuring your stress levels automatically.
- Your measured stress level is not necessarily related to your emotional state.
- Your stress level may not be measured while you are sleeping, working out, moving a lot, or immediately after you finish a workout.
- To measure your heart rate more accurately with the Galaxy Watch Active2, wear the Galaxy Watch Active2 firmly around your lower arm just above the wrist. Refer to [Wearing the Galaxy Watch Active2 correctly](#) for more information.
- This feature may not be available depending on the region.

## Measuring your stress level

- 1 Tap  (Samsung Health) on the Apps screen.
- 2 Swipe the bezel or swipe upwards or downwards on the screen and open the stress tracker screen.  
Your stress level is measured. Check your current stress level on the screen.  
To measure your stress level manually, tap **Measure** to begin measuring your stress level.



To view weekly records with a graph, swipe the bezel or swipe upwards or downwards on the screen.

## Alleviating stress

You can reduce stress with a deep and slow breathing by following the Galaxy Watch Active2.

- 1 Tap **BREATHE** > on the stress tracker screen.
- 2 Tap **Start** and start breathing.  
To stop to breathe, tap on the screen and tap **Stop**.

## Food

Record the calories you eat in a day and compare with your target or the daily recommended calories to get help to manage your weight.



If you have just purchased or have reset the Galaxy Watch Active2, create your profile. The Galaxy Watch Active2 will let you know your daily recommended calories based on the age, gender, and the physical conditions you entered in your profile.

## Recording the calories

- 1 Tap  (Samsung Health) on the Apps screen.
- 2 Swipe the bezel or swipe upwards or downwards on the screen, open the food tracker screen, and then tap **Add**.
- 3 Tap the input field, swipe the bezel or swipe upwards or downwards on the screen to set the calories you have consumed, and then tap **Done**.



To change the meal type, tap the meal type on the top of the screen and select an option.

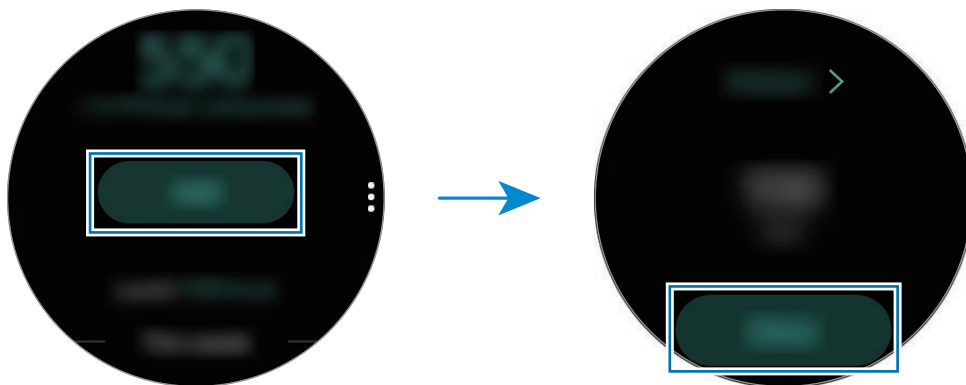

To view weekly records with a graph, swipe the bezel or swipe upwards or downwards on the screen.

## Deleting logs

- 1 Tap  on the food tracker screen, swipe the bezel or swipe upwards or downwards on the screen, and then tap **Delete today's log**.
- 2 Select data to delete and tap **DELETE**.



## Setting your target calories

- 1 Swipe the bezel or swipe upwards or downwards on the food tracker screen and tap **Set target**.
- 2 Tap the input field, swipe the bezel or swipe upwards or downwards on the screen to set the daily target calories, and then tap **DONE**.

## Weight management

Check the calories you intake and the calories burned through exercise or other activities you do throughout your day and helps you to reach the goal weight you set. You can also check the weight you entered in the Samsung Health app on your connected mobile device.



- Set your goal weight in the Samsung Health app on your mobile device to check information on your Galaxy Watch Active2.
- This feature is not available when you use the Galaxy Watch Active2 without connecting to a mobile device.

- 1 Tap  (**Samsung Health**) on the Apps screen.
- 2 Swipe the bezel or swipe upwards or downwards on the screen and open the weight management tracker screen.
- 3 View the information on the screen and adjust your exercise program and food intake accordingly.





To view weekly records with a graph, swipe the bezel or swipe upwards or downwards on the screen.

## Water

Record and track how many glasses of water you drink.

### Recording water consumption

- 1 Tap  (Samsung Health) on the Apps screen.
- 2 Swipe the bezel or swipe upwards or downwards on the screen and open the water tracker screen.
- 3 Tap  when you drink a glass of water.  
If you accidentally added an incorrect value, you can fix it by tapping .

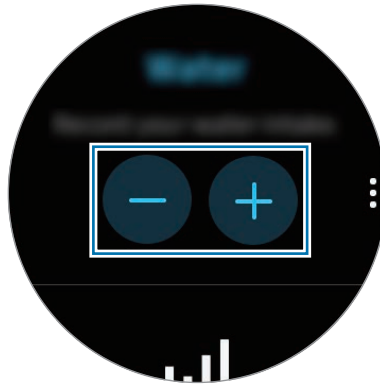

To view weekly records with a graph, swipe the bezel or swipe upwards or downwards on the screen.



### Setting your target consumption

- 1 Swipe the bezel or swipe upwards or downwards on the water tracker screen and tap **Set target**.
- 2 Tap the switch to activate it.
- 3 Tap **Daily target**.
- 4 Tap the input field, swipe the bezel or swipe upwards or downwards on the screen to set the daily target, and then tap **DONE**.

## Caffeine

Record and track how many cups of coffee you drink.

### Recording your coffee consumption

- 1 Tap  (Samsung Health) on the Apps screen.
- 2 Swipe the bezel or swipe upwards or downwards on the screen and open the caffeine tracker screen.
- 3 Tap  when you drink a cup of coffee.  
If you accidentally added an incorrect value, you can fix it by tapping .

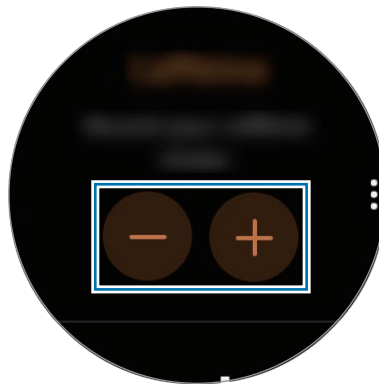

To view weekly records with a graph, swipe the bezel or swipe upwards or downwards on the screen.

### Setting your caffeine consumption limit

- 1 Swipe the bezel or swipe upwards or downwards on the caffeine tracker screen and tap **Set target**.
- 2 Tap the switch to activate it.
- 3 Tap **Daily target**.
- 4 Tap the input field, swipe the bezel or swipe upwards or downwards on the screen to set the daily target, and then tap **DONE**.

## Together

Compare your step count records with other Samsung Health users. You can set a goal, compete with your friends, and view the challenge status on your Galaxy Watch Active2.



- Activate the together feature in the Samsung Health app on your mobile device to check information on your Galaxy Watch Active2.
- This feature is not available when you use the Galaxy Watch Active2 without connecting to a mobile device.

1 Tap  (Samsung Health) on the Apps screen.

2 Swipe the bezel or swipe upwards or downwards on the screen and open the together screen.

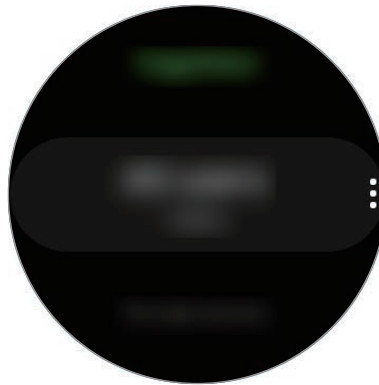

Tap the screen to view detailed information such as your or your friends' challenges status or your or your friends' weekly step count ranking.

## Settings

You can set the various setting options related to the exercise.

Tap  (**Samsung Health**) on the Apps screen, swipe the bezel or swipe upwards or downwards on the screen, and then tap **Settings**.

- **Profile:** Enter your profile information, such as your gender, height, and weight.
- **Units:** Set the unit to use in the **Samsung Health** app of your Galaxy Watch Active2.
- **Workout detection:** Set your Galaxy Watch Active2 to recognise your workout automatically.
- **Inactive time alerts:** Alerts you of your inactive time when you are not moving for a period of time while wearing your Galaxy Watch Active2.
- **HR and stress measurement:** Change the measurement options for your heart rate and stress.
- **Data permissions:** Set the apps' permissions for accessing the data saved on the **Samsung Health** app of the Galaxy Watch Active2.
- **Help:** View information about the **Samsung Health** app.

## Additional information

- The purpose for such data collection is limited to providing the service that you have requested, including providing additional information to enhance your wellness, back up/sync data, data analysis and statistics or to develop and provide better services. (But if you sign in to your Samsung account from Samsung Health, your data may be saved on the server for data backup purposes.) Personal information may be stored until the completion of such purposes. To delete any data you have shared with social networks or transferred to storage devices, you must delete them separately.
- You assume full responsibility for the inappropriate use of data shared on social networks or transmitted to others. Use caution when sharing your personal data with others.
- If the Galaxy Watch Active2 is connected to a mobile device, verify the communication protocol to confirm proper operation. If you use a wireless connection, such as Bluetooth, the Galaxy Watch Active2 may be affected by electronic interference from other devices. Avoid using the Galaxy Watch Active2 near other devices that transmit radio waves.

- The content used in the Samsung Health app may vary depending on the software version of the app. The services provided with the app are subject to change or the cancellation of support without prior notice.
- Available Samsung Health functions and services may vary depending on the local laws and regulations in your region.
- Some functions of Samsung Health may not be provided depending on your region.
- Samsung Health functions are intended for fitness and informational purposes only and is not intended for use in the diagnosis of disease or other conditions, or in the cure, mitigation, treatment, or prevention of disease.



- Measured distance may differ from the actual distance due to uneven strides, walking in place, and pacing around.
- Only records from the past 28 days are saved. You can view previous data on the mobile device where the Samsung Health app is installed.

## GPS

The Galaxy Watch Active2 has a GPS antenna so that you can check your real-time location information without connecting to a mobile device. When you are using your Galaxy Watch Active2 without connecting to a mobile device, the GPS antenna in your Galaxy Watch Active2 will be used.

On the Apps screen, tap  (**Settings**) → **Connections** → **Location** and tap the switch to activate it.

To select a method to use for locating, swipe the bezel or swipe upwards or downwards on the screen and select an option.



- When your Galaxy Watch Active2 and mobile device are connected, this feature uses your mobile device's GPS. Activate the mobile device's location feature to use the GPS sensor.
- The GPS antenna in your Galaxy Watch Active2 will be used when using the Samsung Health feature, even though your Galaxy Watch Active2 is connected to your mobile device.
- GPS signal strength may decrease in locations where the signal is obstructed, such as between buildings or in low-lying areas, or in poor weather conditions.

## Music

### Introduction

Listen to music saved in the Galaxy Watch Active2 and in the mobile device.

### Playing music

Tap  (**Music**) on the Apps screen.

When listening to music saved in the Galaxy Watch Active2, swipe upwards from the bottom edge of the screen to open the library screen. On the library screen, you can view the currently playing song and playlist, and arrange music by tracks, albums, and artists.

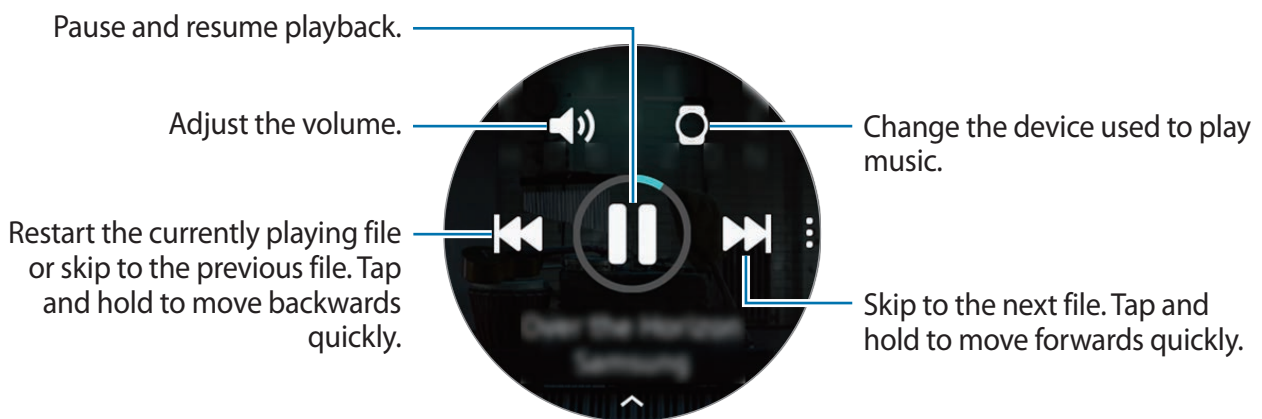

### Importing music





Import music saved in your mobile device to your Galaxy Watch Active2.

- 1 Launch the **Galaxy Wearable** app on your mobile device.
- 2 Tap **Home** → **Add content to your watch**.
- 3 Tap **Add tracks**.
- 4 Select a category at the bottom of the screen, select files, and then tap **Done**.

To sync music in your mobile device with your Galaxy Watch Active2, tap the **Auto sync** switch under **Music**. The music in your mobile device will be synced automatically with your Galaxy Watch Active2 when it has more than 15 % of remaining battery power.

## Playing music with your Galaxy Watch Active2

Play music saved on your Galaxy Watch Active2 via the internal speaker. You can also play music via a connected Bluetooth headset.

- 1 Tap  (**Music**).
- 2 Tap  to play the music saved in your Galaxy Watch Active2.  
The  icon appears.
- 3 Tap .





## Playing music with your mobile device

Play music saved on your mobile device and control it with your Galaxy Watch Active2.

### Mobile device

- 1 Launch the music player app.

### Galaxy Watch Active2

- 2 Tap  (**Music**).
- 3 Tap  to play the music saved in your mobile device.  
The  icon appears.
- 4 Tap .

To change the music player app used from your Galaxy Watch Active2, tap  → **Music player** and select the app among the music player app installed on the mobile device.

## Playing music without connecting to a mobile device

Listen to music or radio using the Galaxy Watch Active2 by itself. You must download music or a radio streaming app on the Galaxy Watch Active2.

On the Apps screen, tap  (**Galaxy Store**). Browse and download music or a radio streaming app in **Galaxy Store** and launch the app.



## Reminder

Add reminders for events such as buying tickets, going to the laundromat, or taking medicine, without using your calendar app. You can set up notifications to receive reminders at specified times.

### Creating a reminder

- 1 On the Apps screen, tap  (**Reminder**) → **Add**.  
If you have a saved reminder, tap **Create** on the top of the reminders list.
- 2 If your Galaxy Watch Active2 supports voice input, speak a schedule to create a reminder. When you are finished, tap **Done**.  
Or, tap **Write memo**, enter text, and then tap **Done**.
- 3 Tap **Set time** to set a notification.
- 4 Tap the input field, swipe the bezel or swipe upwards or downwards on the screen to set the time, and tap **Next**.
- 5 Set other notification options, such as selecting the date on which the notification will repeat, and tap **Done**.
- 6 Tap **Save**.  
The saved reminder is added to the reminders list.

### Viewing the reminder alarm

When an alarm appears, check the reminder details. Or, swipe the bezel anticlockwise or swipe the screen to the right on the Watch screen to open the notification panel and view a reminder.



- All reminders on your Galaxy Watch Active2 will be synced with the connected mobile device automatically so that you can receive alarms and check them from the mobile device.
- Select a reminder and tap **Edit time** to set a reminder again.

## Completing or deleting the reminder

When you have finished your task, you can set the reminder as completed or delete it.

To complete the reminder, tap **Complete** after viewing the reminder's details. Alternatively, select a completed reminder from the reminder list to complete it.

To delete the reminder, tap , swipe the bezel or swipe upwards or downwards on the screen, and then tap **Delete**.

## Calendar

You can check the schedules of events that you saved on your mobile device or Galaxy Watch Active2 on your Galaxy Watch Active2.



All events scheduled on your Galaxy Watch Active2 will be synced with the connected mobile device automatically to check them, and receive alarms from the mobile device.

- 1 Tap  (**Calendar**) on the Apps screen. Alternatively, swipe the bezel clockwise or swipe the screen to the left on the Watch screen and select the **Calendar** widget to launch it.
- 2 Tap anywhere on the monthly calendar.  
The current day's events list will be shown.
- 3 Tap **Add** to add the schedule.  
If you have a saved schedule, tap **Create** on the top of the list.
- 4 Select an input mode you want, enter event details, and then tap **Save**.

# Bixby

## Introduction



Bixby is a voice service that helps you use the Galaxy Watch Active2 more conveniently. You can talk to Bixby to launch a function or provide you with information.



- Bixby may not be available depending on the region.
- Bixby may not be available when you use the Galaxy Watch Active2 without connecting to a mobile device.
- Make sure the Galaxy Watch Active2's microphone is not obstructed when you are speaking into it.
- To use Bixby, your mobile device must be connected to a Wi-Fi or mobile network.

## Starting Bixby

When you launch Bixby for the first time, the Bixby intro page will appear. You must select the language to use with Bixby, check your Samsung account, and then agree to the terms and conditions.

- 1 Tap  (**Bixby**) on the Apps screen.
- 2 Select the language to use with Bixby and tap .
- 3 Check your registered Samsung account and tap .



If your Samsung account is not registered on your mobile device, you cannot use Bixby. Before using Bixby, register your Samsung account on your mobile device first.

- 4 Follow the on-screen instructions to complete the setup.  
The Bixby screen will appear.

## Using Bixby

When you say what you want to Bixby, Bixby will launch corresponding functions or show the information you requested.

From any screen press the Home key twice quickly and say what you want. If you cannot launch Bixby with the Home key, on the Apps screen, tap  (**Settings**) → **Advanced** → **Double press Home key** and select **Bixby**.

Alternatively, turn on the screen, say "Hi, Bixby", and then say what you want.

For example, say "How's the weather today?" The weather information will appear on the screen with voice feedback.

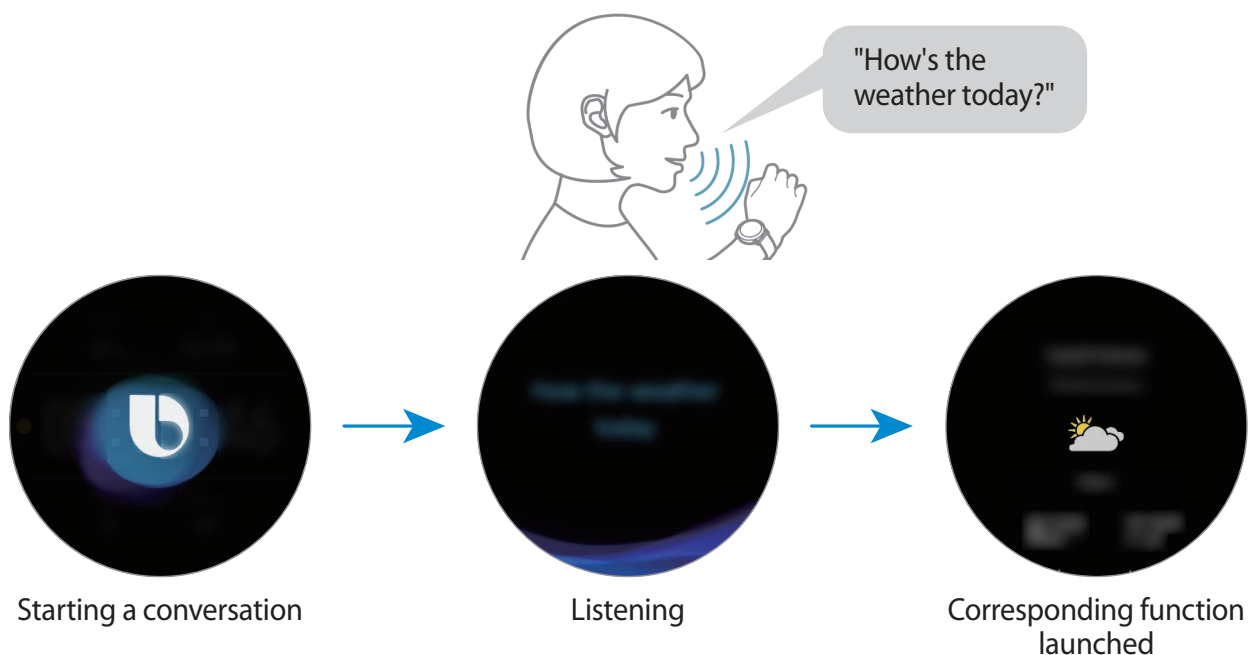

If you want to see additional information, swipe the bezel or swipe upwards or downwards on the screen. Tap the command if you have any follow-up questions.

Bixby will show you additional information that matches the selected command.



### Tips for better voice recognition

- Speak clearly.
- Speak in quiet places.
- Do not use offensive or slang words.
- Avoid speaking in dialectal accents.

The Galaxy Watch Active2 may not recognise your commands or may perform unwanted commands depending on your surroundings or how you speak.

## Weather

View weather information on the Galaxy Watch Active2 for locations set on the Galaxy Watch Active2 or the connected mobile device.

Tap  (**Weather**) on the Apps screen. Alternatively, swipe the bezel clockwise or swipe the screen to the left on the Watch screen and select the **Weather** widget to launch it.

To view the current day's weather information, tap the screen and swipe the bezel or swipe upwards or downwards on the screen.

To add another city's weather information, swipe the bezel clockwise or swipe the screen to the left, tap **Add**, and then add the city from the connected mobile device.



You cannot add a city when you use the Galaxy Watch Active2 without connecting to a mobile device.

## Alarm

Set alarms and manage them.

### Setting alarms

- 1 Tap  (**Alarm**) on the Apps screen.
- 2 Tap **Add**.  
If you have a saved alarm, tap **Add** on the top of the alarms list.
- 3 Tap the input field, swipe the bezel or swipe upwards or downwards on the screen to set the alarm time, and tap **Next**.
- 4 Select the days for the alarm to repeat and tap **Save**.  
The saved alarm is added to the alarms list.

To activate or deactivate alarms, tap the switch next to the alarm in the alarms list.

## Stopping alarms

Drag  outside the large circle to stop an alarm.

If you want to use the snooze function, drag  outside the large circle.

## Deleting alarms

In the alarms list, tap and hold an alarm, and then tap **Delete**.

# World clock



## Creating world clocks

- 1 Tap  (**World clock**) on the Apps screen.
- 2 Tap **Add**.  
If you have a saved world clock, tap **Add** on the clocks list.
- 3 Swipe the bezel or swipe to the left or right on the screen and select a time zone on the map.  
You can also tap **All cities** and tap **Search** to search for a city or select a city from the list.
- 4 Tap the city name representing the selected time zone.

## Deleting world clocks

On the world clocks list, tap and hold a world clock, and then tap **Delete**.

## Timer

- 1 Tap  (**Timer**) on the Apps screen.
- 2 Tap **Custom**.
- 3 Tap the input field to set the duration and tap **Start**.  
Or, select a frequently used timer.
- 4 Drag  outside the large circle when timer goes off.

## Stopwatch

- 1 Tap  (**Stopwatch**) on the Apps screen.
- 2 Tap **Start** to time an event.  
To record lap times while timing and event, tap **Lap**.
- 3 Tap **Stop** to stop timing.
  - To restart the timing, tap **Resume**.
  - To clear lap times, tap **Reset**.

# Gallery



## Importing and exporting images

### Importing images from your mobile device

- 1 Launch the **Galaxy Wearable** app on your mobile device.
- 2 Tap **Home** → **Add content to your watch**.
- 3 Tap **Send images**.
- 4 Select a category at the bottom of the screen, select files, and then tap **Done**.

To sync images on your mobile device with your Galaxy Watch Active2, tap the **Auto sync** switch under **Images**, tap **Albums to sync**, select albums to import to your Galaxy Watch Active2, and then tap **Done**. The selected albums will be automatically synced with your Galaxy Watch Active2 when it has more than 15 % of remaining battery power.

### Exporting images to your mobile device

- 1 Tap  (**Gallery**) on the Apps screen.
- 2 Tap an image and then tap and hold the image again to export it.
- 3 Swipe the bezel or swipe to the left or right on the screen and select any images to export more.  
To select all images, tap  → **Select all**.
- 4 Tap  → **Send to phone**.  
You can view the exported images in apps like Gallery on your mobile device.



## Viewing images

View and manage the images saved on your Galaxy Watch Active2.



- 1 Tap  (**Gallery**) on the Apps screen.
- 2 Swipe the bezel or swipe to the left or right on the screen to scroll through the image list and select an image.

## Zooming in or out

You can zoom in on or out from an image. While viewing an image, double-tap the image quickly, spread your two fingers apart, or pinch on an image to zoom in or out.

When an image is magnified, you can view the rest of the image by scrolling around the screen.

## Deleting images

- 1 Tap  (**Gallery**) on the Apps screen.
- 2 Tap an image and then tap and hold the image again to delete it.
- 3 Swipe the bezel or swipe to the left or right on the screen and select any images to delete more.  
To select all images, tap  → **Select all**.
- 4 Tap **Delete** → .

## Find My Phone

If you misplace the mobile device, the Galaxy Watch Active2 can help you find it.



This feature is not available when you use the Galaxy Watch Active2 without connecting to a mobile device.

1 Tap  (**Find My Phone**) on the Apps screen.

2 Tap .

The mobile device emits sounds and turns on the screen. Tap **Dismiss** and drag it on the mobile device, or tap  on the Galaxy Watch Active2.

## Viewing the location of your mobile device

Tap  → **Locate phone**.

The Galaxy Watch Active2 will display your mobile device's location.

## Find My Watch

If you misplace your Galaxy Watch Active2, the Galaxy Wearable app on your mobile device can help you find it.



This feature is not available when you use the Galaxy Watch Active2 without connecting to a mobile device.

1 Launch the **Galaxy Wearable** app on your mobile device and tap **Home** → **Find My Watch**.

2 Tap .

The Galaxy Watch Active2 make a sound and vibrate, and the screen will turn on.

To stop making sound and vibrating, drag  outside the large circle on the Galaxy Watch Active2, or tap  on the mobile device.

## Controlling the Galaxy Watch Active2 remotely

If you cannot find your Galaxy Watch Active2, launch the **Galaxy Wearable** app on your mobile device and tap **Home** → **Find My Watch** → **Get location** to check the current location of the Galaxy Watch Active2.

When your Galaxy Watch Active2 is lost or stolen, you can control it remotely. Launch the **Galaxy Wearable** app on your mobile device, tap **Home** → **Find My Watch** → **Set security**, and then select a feature.



This feature is available after registering the Samsung account on both your Galaxy Watch Active2 and mobile device.

## SOS messages

In an emergency situation, you can send an SOS message to the previously registered emergency contact by quickly pressing the Galaxy Watch Active2's Home key three times. You can also set the Galaxy Watch Active2 to automatically call your emergency contacts.

### Setting up SOS messages

- 1 Launch the **Galaxy Wearable** app on your mobile device and tap **Home** → **Send SOS requests**, and tap the switch to activate it.
- 2 Follow the on-screen instructions to add emergency contacts if you have not already done so.

### Adding emergency contacts

- 1 Launch the **Galaxy Wearable** app on your mobile device and tap **Home** → **Send SOS requests** → **Send SOS messages to** → **Add**.
- 2 Tap **Create contact** and enter the contact information or tap **Select from Contacts** to add an existing contact as an emergency contact.

## Activating SOS calls

Set the Galaxy Watch Active2 to automatically call your emergency contact after sending an SOS message. You can only call one of your emergency contacts.

Launch **Galaxy Wearable** on your mobile device, tap **Home** → **Send SOS requests**, tap the **Make SOS calls to** switch, and then select an emergency contact.

## Setting the SOS message delay

Set the Galaxy Watch Active2 to send an SOS messages after a while to cancel the request when you quickly press the Galaxy Watch Active2's Home key three times.

Launch the **Galaxy Wearable** app on your mobile device, tap **Home** → **Send SOS requests**, and then tap the **Count down before sending** switch to activate it.

## Sending SOS messages

In an emergency situation, quickly press the Galaxy Watch Active2's Home key three times.

If the **Make SOS calls to** feature is activated, the Galaxy Watch Active2 will automatically call the selected emergency contact.

If you send an SOS message, the  icon will display on the Watch screen while sending the message and you can view the result of your SOS request on the notification panel after the message has been sent.



If the GPS feature is not activated on your Galaxy Watch Active2 or mobile device when sending an SOS message, the GPS feature will be activated automatically to send the location information.

## Email

View emails received on the mobile device and reply to them.



This app may not be available when you use the Galaxy Watch Active2 without connecting to a mobile device.

### Reading emails

1 Tap  (**Email**) on the Apps screen.

2 Select an email to open the email screen.

To view an email on the mobile device, tap ; swipe the bezel or swipe upwards or downwards on the screen, and then select **Show on phone**.



To reply an email, select an input mode and enter your email.



You may not be able to reply to emails depending on the mobile device that you connect to the Galaxy Watch Active2.

## Galaxy Store

Download specialised apps and watch faces on your Galaxy Watch Active2, not through the connected mobile device.

On the Apps screen, tap  (**Galaxy Store**). Swipe the bezel or swipe upwards or downwards on the screen to scroll through the list and select an app to download or watch face or tap  to search for apps by keyword.

Swipe the bezel or swipe upwards or downwards on the screen, and then select **Show on phone**. The **Galaxy Store** app will be launched on your mobile device. Then, browse and select an app or watch face to download.



Before you use this app, register your Samsung account on your mobile device first.

# Settings

## Introduction

Customise settings for functions and apps. Set your Galaxy Watch Active2 depending on your usage pattern by configuring the various settings.

Tap  (**Settings**) on the Apps screen.

## Watch faces

Customise the watch face.

On the Settings screen, tap **Watch faces**.

- **Select watch face:** Select a watch type. You can also select items to display on the watch face and download more watch faces from **Galaxy Store**.
- **Watch always on:** Set the Galaxy Watch Active2 to display a watch when the screen is turned off.



The **Watch always on** feature only works while you are wearing the Galaxy Watch Active2.

- **Watch face order:** Select how to arrange the watch faces.
- **Hourly chime:** Set the Galaxy Watch Active2 to notify you every hour with a sound and vibration.
- **Notification indicator:** Set the Galaxy Watch Active2 to display an orange dot on the Watch screen to alert you to notifications that you have not checked.
- **Show status:** Set the status indicators to display on the Watch screen.
- **Ongoing icons:** Set the icons that show the currently used feature to display on the Watch screen when using a feature, such as working out or calling.

## Sound and vibration

Change the Galaxy Watch Active2's sound and vibration settings.

On the Settings screen, tap **Sound and vibration**.



Some options are not displayed or available when you use the Bluetooth model without connecting to a mobile device.

- **Sound mode:** Set the Galaxy Watch Active2 to use sound mode, silent mode, or vibrate mode.
- **Vibrate with sound:** Set the Galaxy Watch Active2 to vibrate and play a ringtone for incoming calls and notifications.
- **Volume:** Adjust the volume level of the Galaxy Watch Active2.



When the Voice Assistant feature is activated, you can also adjust the accessibility volume.

- **Vibration intensity:** Adjust the intensity of the vibration notification.
- **Long vibration:** Set the Galaxy Watch Active2 to vibrate longer for incoming calls and notifications.
- **Ringtone:** Change the ringtone.
- **Ringtone vibration:** Select a vibration pattern for incoming calls.
- **Notification sound:** Change the notification sound.
- **Notification vibration:** Select a vibration pattern for notifications.
- **Touch sounds:** Set the Galaxy Watch Active2 to make a sound when apps or options are selected on the touchscreen.

## Display

Change the Galaxy Watch Active2's display settings and the Apps screen.

On the Settings screen, tap **Display**.

- **Brightness:** Adjust the brightness for the display.
- **Auto low brightness:** Set the Galaxy Watch Active2 to automatically adjust the brightness depending on the ambient light conditions.
- **Screen timeout:** Set the length of time the Galaxy Watch Active2 waits before turning off the display's backlight.
- **Show last app:** Select the length of time to display a recently used app when the screen is back on after it turned off.
- **Background style:** Change the wallpaper.
- **Font:** Change the font style and size.

## Advanced

Activate the Galaxy Watch Active2's advanced features and change the control settings.

On the Settings screen, tap **Advanced**.

- **Double press Home key:** Select an app or feature to launch when you press the Galaxy Watch Active2's Home key twice.
- **Touch bezel:** Set the Galaxy Watch Active2's screen to be controlled by swiping the bezel.
- **Wake-up gesture:** Set the Galaxy Watch Active2 to turn on the screen when you raise your wrist that is wearing the Galaxy Watch Active2.

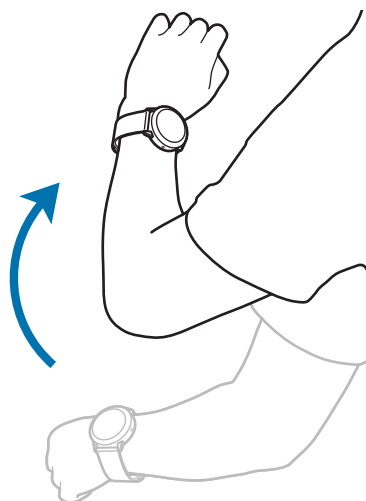



- **Touch wake-up:** Set the Galaxy Watch Active2 to turn on the screen when you tap the screen.
- **Water lock mode:** Activate water lock mode before entering the water. The touchscreen, the wake-up gesture feature, and the watch always on feature will be deactivated.
- **Touch sensitivity:** Set the Galaxy Watch Active2 to allow use of the touchscreen with gloves on.
- **Do not disturb:** Activate do not disturb mode. Incoming calls will be muted and the screen will not turn on when receiving incoming calls. Also, all notifications will be muted, except for alarms, and the screen will not turn on when notifications are received.
- **Theatre mode:** Activate theatre mode for watching movies. Incoming calls will be muted and the screen will not turn on when receiving incoming calls. Also, all notifications will be muted, including alarms, and the screen will not turn on when notifications are received or when there is an alarm. Also, the wake-up gesture feature and watch always on feature will be deactivated automatically.
- **Goodnight mode:** Activate goodnight mode for sleeping. Incoming calls will be muted and the screen will not turn on when receiving incoming calls. Also, all notifications will be muted, except for alarms, and the screen will not turn on when notifications are received. Also, the wake-up gesture feature and watch always on feature will be deactivated automatically.
- **Daily briefing:** Set the Galaxy Watch Active2 to send the daily information after you wake up and before you sleep, or twice when you want during the day.
- **Edit quick settings:** Edit the Galaxy Watch Active2's quick panel.
- **Screen capture:** Swipe right on the screen while pressing the Home key to capture the screen.

## Connections

### Bluetooth

Connect to a mobile device via Bluetooth. You can also connect a Bluetooth headset to your Galaxy Watch Active2 and listen to music or have a phone conversation.



- Samsung is not responsible for the loss, interception, or misuse of data sent or received via Bluetooth.
- Always ensure that you share and receive data with devices that are trusted and properly secured. If there are obstacles between the devices, the operating distance may be reduced.
- Some devices, especially those that are not tested or approved by the Bluetooth SIG, may be incompatible with your device.
- Do not use the Bluetooth feature for illegal purposes (for example, pirating copies of files or illegally tapping communications for commercial purposes).  
Samsung is not responsible for the repercussion of illegal use of the Bluetooth feature.

On the Settings screen, tap **Connections** → **Bluetooth**.

- **Bluetooth:** Turn the Bluetooth feature on or off.
- **Bluetooth audio:** Search for Bluetooth headsets and connect them to the Galaxy Watch Active2.

### Mobile networks

Customise settings to control networks.

On the Settings screen, tap **Connections** → **Mobile networks**.



**Mobile networks** will not be displayed on the Bluetooth model.

- **Mobile networks:**

- **Auto on/off:** Set the Galaxy Watch Active2 to automatically connect to or disconnect from the mobile network depending on the Galaxy Watch Active2's connection to the mobile device via Bluetooth.



- When the Galaxy Watch Active2 is connected to the mobile device via Bluetooth, the Galaxy Watch Active2's mobile network is turned off to save battery power. Then, the Galaxy Watch Active2 will not receive messages and calls made to the Galaxy Watch Active2's phone number.
- The Galaxy Watch Active2's mobile network is automatically turned on after a moment when no Bluetooth connection is detected. Then, you can receive messages and calls made to the Galaxy Watch Active2's phone number.
- **Auto on/off** will not be displayed when you use the Galaxy Watch Active2 without connecting to a mobile device.

- **Always on:** Set the Galaxy Watch Active2 to connect to the mobile network. When this option enabled, you can receive incoming calls and messages to the Galaxy Watch Active2 and mobile devices' phone numbers.



When you enable the **Always on** option, the Galaxy Watch Active2's battery consumption may increase.

- **Always off:** Set the Galaxy Watch Active2 not to connect to the mobile network. When this option is enabled, you cannot receive incoming calls and messages to the Galaxy Watch Active2's phone number. If the Galaxy Watch Active2 is connected to the mobile device via Bluetooth, you can receive incoming calls or notifications from your mobile device's phone number.

- **Mobile data:** Set the Galaxy Watch Active2 to use data connections on any mobile network.
- **Data roaming:** Set the Galaxy Watch Active2 to use data connections when you are roaming.
- **Network mode:** Select a network type to connect to between LTE and 3G.
- **Network operators:** Search for available networks and manually register a network.
- **Access Point Names:** Set up access point names (APNs).

## Wi-Fi

Activate the Wi-Fi feature to connect to a Wi-Fi network.

This feature is available when the Galaxy Watch Active2 is not connected to the mobile device via Bluetooth.

1 On the Settings screen, tap **Connections** → **Wi-Fi**.

2 Tap **Wi-Fi** and select **Auto** or **Always on** to connect to a Wi-Fi network.

If you select **Auto**, the Wi-Fi network will be disconnected automatically when your Galaxy Watch Active2 is connected to your mobile device via Bluetooth. If you select **Always off**, you can use your Galaxy Watch Active2 after connecting it to your mobile device via Bluetooth instead of using a Wi-Fi network.



- When you select the **Always on** option, the battery will drain more quickly than normal.
- **Auto** will not be displayed and you cannot connect to a Wi-Fi network automatically when you use the Galaxy Watch Active2 without connecting to a mobile device.

3 Tap **Wi-Fi networks** and select a network from the Wi-Fi networks list.

Networks that require a password appear with a lock icon.

4 Tap **Connect**.



- Once the Galaxy Watch Active2 connects to a Wi-Fi network, the Galaxy Watch Active2 will reconnect to that network each time it is available without requiring a password. To prevent the Galaxy Watch Active2 connecting to the network automatically, select it from the list of networks and tap **Forget**.
- If you cannot connect to a Wi-Fi network properly, restart your device's Wi-Fi feature or the wireless router.

## NFC

You can use the NFC feature.

On the Settings screen, tap **Connections** → **NFC**.



The Galaxy Watch Active2 contains a built-in NFC antenna. Handle the Galaxy Watch Active2 carefully to avoid damaging the NFC antenna.



This feature may not be available depending on the region or service provider.

### Making payments with the NFC feature

Before you can use the NFC feature to make payments, you must register for the mobile payment service. To register or get more information about the service, contact your service provider.

- 1 On the Settings screen, tap **Connections** → **NFC** and tap the switch to activate it.
- 2 Touch the NFC antenna area of the Galaxy Watch Active2 to the NFC card reader.

To set the default app, open the Settings screen and tap **Connections** → **NFC** → **Tap and pay**, and then select an app.



The payment services list may not include all available payment apps.

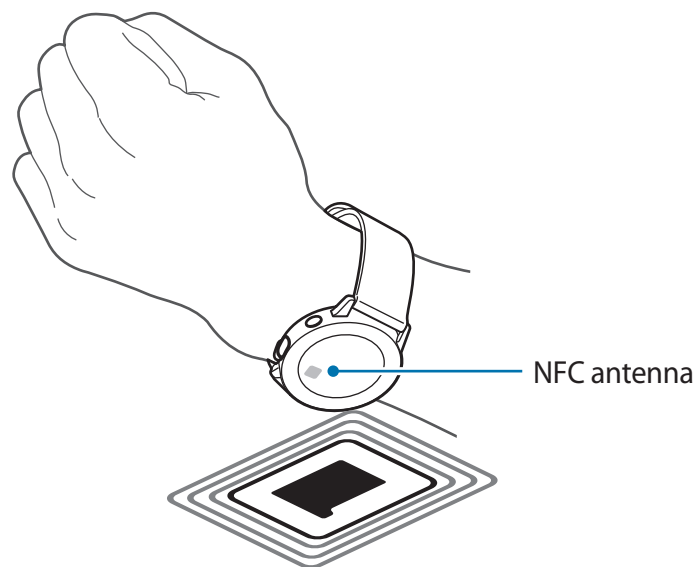

## Alerts

Set the Galaxy Watch Active2 to vibrate when it is disconnected from your mobile device.

On the Settings screen, tap **Connections** and tap the **Alerts** switch to activate it.



**Alerts** will not be displayed when you use the Galaxy Watch Active2 without connecting to a mobile device.

## Flight mode

This disables all wireless functions on your device. You can use only non-network services.

On the Settings screen, tap **Connections** → **Flight mode** and tap the switch to activate it.



Follow the regulations provided by the airline and the instructions of aircraft personnel. In cases where it is allowed to use the device, always use it in flight mode.

## Data usage

Keep track of your data usage amount and customise the settings for the limitation.

On the Settings screen, tap **Connections** → **Data usage**.



**Data usage** will not be displayed on the Bluetooth model.

- **Mobile data:** Set the Galaxy Watch Active2 to use data connections on any mobile network.
- **Data limit:** Set a limit for mobile data usage.
- **Data usage cycle:** Set a data reset cycle to monitor data usage between usage periods.
- **Start date:** Set the start date of the data usage cycle.
- **Usage details:** View your total data usage for the current cycle.

## Location

Set the Galaxy Watch Active2 to allow apps to use your current location information.

On the Settings screen, tap **Connections** → **Location**.

Tap the switch to activate it and select a method to collect your location data.

## Apps

### Layout

Select the Apps screen's layout.

On the Settings screen, tap **Apps** → **Layout**.

- **Rotary view:** Arrange the apps in a circular formation.
- **List view:** Arrange the apps as a list.

### App order

Select how to arrange the apps on the Apps screen.

On the Settings screen, tap **Apps** → **App order**.

- **Most recent first:** Set the recently used apps to appear first.
- **Custom:** Arrange the apps to your preference.

### Auto open apps

Set an app to launch automatically by bringing it into focus without tapping the app.

On the Settings screen, tap **Apps** → **Auto open apps** and tap the switch to activate it.

### Permissions

For some apps to operate properly, they may need permission to access or use information on your Galaxy Watch Active2. View your app permission settings for each app and change the settings.

On the Settings screen, tap **Apps** → **Permissions**.

## Messages

Change the message feature settings.

On the Settings screen, tap **Apps** → **Messages**.



- **Messages** will not be displayed when you use the Bluetooth model without connecting to a mobile device.
- Some options are not displayed on the Bluetooth model.
- **Send as audio**: Set the Galaxy Watch Active2 to send a voice message as an audio file.
- **Blocked numbers and messages**: View the blocked numbers and messages from the blocked number.

## Security

### Lock

Change the settings for securing the Galaxy Watch Active2. When you use this feature, the Galaxy Watch Active2 may be locked automatically when it does not move for a period of time.

On the Settings screen, tap **Security** → **Lock**.

- **Type**: Select the Galaxy Watch Active2 lock method.
- **Use for**: Select when to use the lock feature.



This option is not displayed depending on your region or service provider.

- **Help**: View information about locking your Galaxy Watch Active2.



## Account (Account and backup)

You can use various features of the Galaxy Watch Active2 after registering your Samsung account on your connected mobile device. Check the Samsung account registered on your connected mobile device and set the customisation service feature. You can also back up the data in your Galaxy Watch Active2 on the Samsung Cloud or restore the Galaxy Watch Active2's data saved on your Samsung Cloud on your Galaxy Watch Active2.

On the Settings screen, tap **Account** or **Account and backup**.

- **Samsung account:** Enter your Samsung account to sign in or check the Samsung account registered on your connected mobile device.



When using your Galaxy Watch Active2 without connecting it to a mobile device, you can enter your Samsung account.

- **Backup and restore:** Back up the data saved in your Galaxy Watch Active2 on the Samsung Cloud or restore data on your Galaxy Watch Active2.



- **Backup and restore** will be displayed when using your Galaxy Watch Active2 without connecting it to a mobile device.

- If you use the Galaxy Watch Active2 while connected to a mobile device, back up and restore the data on your mobile device with the same Samsung account as your mobile device. For more information, refer to [Managing the data in the Galaxy Watch Active2](#).

- **Customisation Service:** Set the Galaxy Watch Active2 to provide the proper feature depending on the location and situation after analysing your lifestyle pattern.



- **Customisation Service** will not be displayed when you use the Galaxy Watch Active2 without connecting to a mobile device.

- This feature is available after connecting the Galaxy Watch Active2 to a mobile device that supports the customisation service platform 2.2 or later. After making an agreement to use the customisation service, launch the **Settings** app on your mobile device, tap **Accounts and backup** → **Accounts** → **Samsung account** → **Privacy** → **Customization Service**, and then tap the **Customisation Service** switch to activate it.

## Accessibility

Configure various settings to improve accessibility to the Galaxy Watch Active2.

On the Settings screen, tap **Accessibility**.

- **Screen reader:** Activate Voice Assistant, which provides voice feedback. To view help information to learn how to use this feature, tap **Tutorial**.
- **Visibility enhancements:** Customise the settings to improve accessibility for visually impaired users.
- **Hearing enhancements:** Customise the settings to improve accessibility for users with hearing impairment.
- **Advanced settings:** Configure settings for Direct access and notification features.

## General

### Input

Change the text input settings.

On the Settings screen, tap **General** → **Input**.

- **Default keyboard:** Check the default keyboard for entering the characters.
- **Keyboard settings:** Configure the Samsung keyboard's settings.

### Text-to-speech

Change the settings for text-to-speech features, such as languages, speed, and more.

On the Settings screen, tap **General** → **Text-to-speech**.

- **Language:** Select a language to use.
- **Speech rate:** Set the reading speed.
- **Read notifications aloud:** Set the Galaxy Watch Active2 to read out the received notification on your Galaxy Watch Active2. However, you can listen to the audio only through the connected Bluetooth headset.
- **Check for updates:** Update the supported audio languages.

## Date and time

You can set the date and time manually.

On the Settings screen, tap **General** → **Date and time**.



**Date and time** will be available only when you use the Galaxy Watch Active2 without connecting to a mobile device.

- **Automatic:** Set the time zone provided by network or GPS to be applied when travelling to a different time zone.
- **Set date:** Set the date manually.
- **Set time:** Set the time manually.
- **Select time zone:** Select the time zone manually.
- **Use 24-hour format:** Display time in 24-hour format.

## Language

Select a language to use on your Galaxy Watch Active2.

On the Settings screen, tap **General** → **Language**.



**Language** will be displayed only when you use the Galaxy Watch Active2 without connecting to a mobile device.

## Reset

Delete all data on your Galaxy Watch Active2.

On the Settings screen, tap **General** → **Reset**.

## Update watch software

Update Galaxy Watch Active2 to the latest software.

On the Settings screen, tap **General** → **Update watch software**.



**Update watch software** will be displayed only when you use the Galaxy Watch Active2 without connecting to a mobile device.

## Battery

Select the Galaxy Watch Active2's battery mode. Using certain battery modes allows you to reduce battery consumption and use your Galaxy Watch Active2 much longer.

On the Settings screen, tap **Battery**.

- **Standard:** Select when using your Galaxy Watch Active2 normally. You can use all features of the Galaxy Watch Active2.
- **Power saving:** Select when activating power saving mode. Displays colours on the screen as grey tones and some feature are restricted to reduce the battery consumption. Refer to [Power saving mode](#) for more information.
- **Watch only:** Only the watch displays on the screen and all other features will be deactivated to reduce the battery consumption. Press the Home key to view the watch. Press and hold the Home key for three seconds to deactivate Watch only mode.

## Optimise battery

Close apps running in the background and change settings that have a large effect on battery consumption to extend the battery usage time.

On the Settings screen, tap **Battery** → **Optimise battery**.

## About watch

View the Galaxy Watch Active2's additional information.

On the Settings screen, tap **About watch**.

- **Device:** View the Galaxy Watch Active2's information, such as the Wi-Fi MAC address, Bluetooth address, and serial number.
- **Legal info:** View legal information related to the device, such as the open source licence. You can also set the Galaxy Watch Active2 to automatically send the device's diagnostic and usage information to Samsung.
- **Software:** View your Galaxy Watch Active2's software and security status.
- **Battery:** View the Galaxy Watch Active2's battery information.

## Connect to new phone

Connect your Galaxy Watch Active2 to a new mobile device. The Galaxy Watch Active2 can connect to another mobile device after performing a light reset to delete data except media files and personal data.

On the Settings screen, tap **Connect to new phone**.





**Connect to new phone** will be displayed only when the Galaxy Watch Active2 is connected to a mobile device.

## Connect to phone

Connect to a mobile device while you are using the Galaxy Watch Active2 by itself. You can select whether to restore the Galaxy Watch Active2's data that is saved on the mobile device.

On the Settings screen, tap **Connect to phone**.

-  : Connect your Galaxy Watch Active2 to a mobile device and sync your health information, setting values, and contacts information saved in the Galaxy Watch Active2.
-  : Connect your Galaxy Watch Active2 to a mobile device after resetting all the data saved in the Galaxy Watch Active2.



**Connect to phone** will be displayed only when you use the Galaxy Watch Active2 without connecting to a mobile device.

# Galaxy Wearable app

## Introduction

To connect your Galaxy Watch Active2 to a mobile device, you must install the Galaxy Wearable app on your mobile device. You can check the Galaxy Watch Active2's status and download recommended watch faces and apps. You can also customise your Galaxy Watch Active2's various settings, such as your notification settings.

Launch the **Galaxy Wearable** app on your mobile device.



Some features may not be available depending on the type of connected mobile device.

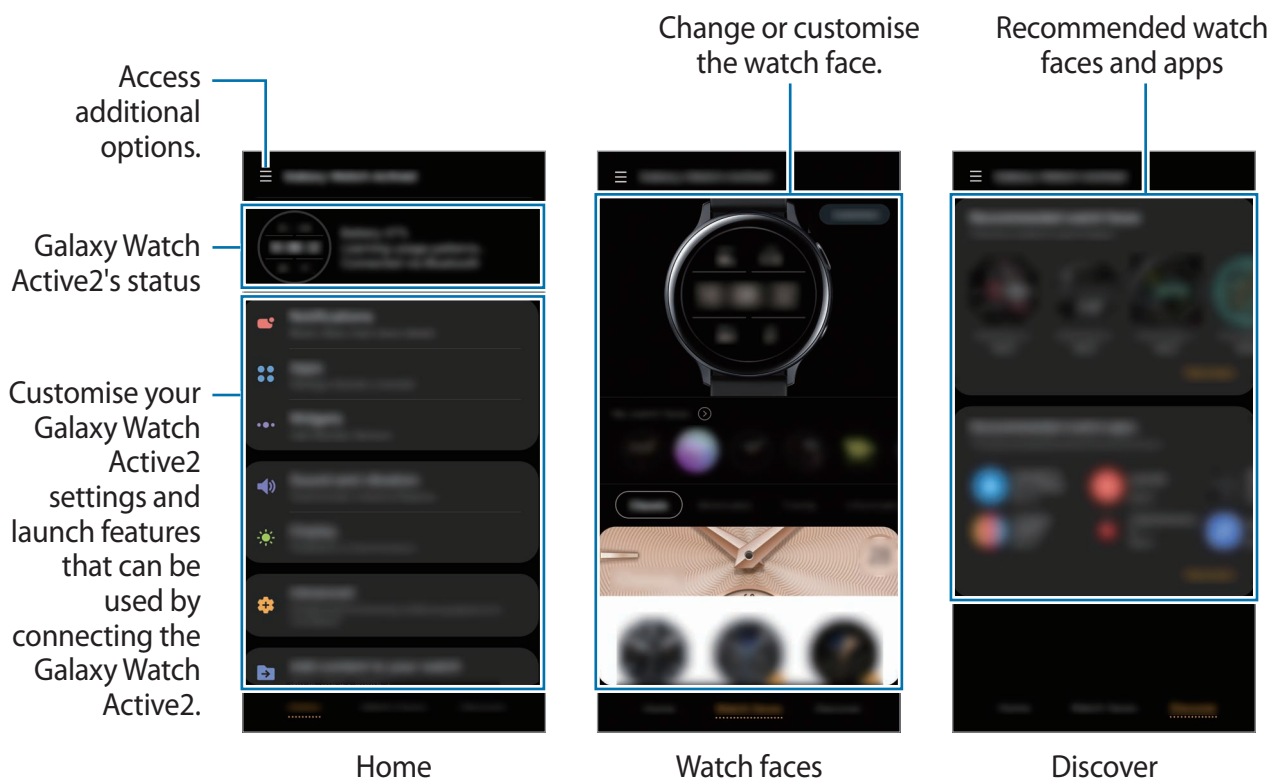

Tap  to use the following options:

- **Add new device:** Disconnect your device from the currently connected mobile device and connect a new device. Select your device on the screen or tap **Mine's not here** if you cannot find your device, and then follow the on-screen instructions to connect to the new device.
- **Disconnect:** Disconnect your Galaxy Watch Active2 from the currently connected mobile device.
- **Auto switch:** The Galaxy Watch Active2 will still automatically connect to your mobile device if you wear it on your wrist.



**Auto switch** will be displayed only when more than two devices that support the auto switch feature are paired to your mobile device.

- **Manage devices:** Manage the devices connected to your mobile device. To disconnect a device from your mobile device, select a device and tap **Remove**.



**Manage devices** will be displayed only when more than two devices are paired to your mobile device.

- **App notifications:** Change the various Galaxy Wearable app notification settings on the mobile device.
- **Contact us: Samsung Members** offers support services to customers, such as device problem diagnosis, and lets users submit questions and error reports. You can also share information with others in the Galaxy users' community or view the latest Galaxy news and tips. **Samsung Members** can help you solve any problems you might encounter while using your device.



**Contact us** may not be available depending on the region, service provider or model that does not support the **Samsung Members** app.

- **About Galaxy Wearable:** View version information of the Galaxy Wearable app.

# Home

## Introduction

View your Galaxy Watch Active2's status and customise your Galaxy Watch Active2 settings. You can also launch usable apps by connecting the Galaxy Watch Active2.

Launch the **Galaxy Wearable** app on your mobile device and tap **Home**.

## Payment

You can conveniently make payments with the **Samsung Pay** app by using a mobile payment service.

Launch the **Galaxy Wearable** app on your mobile device and tap **Home** → **Open Samsung Pay**.



This option may not be available depending on your region or service provider.

## Notifications

Change settings for the notification feature. Stay up to date with a variety of events, such as new messages received on the mobile device.

Launch the **Galaxy Wearable** app on your mobile device, tap **Home** → **Notifications**, tap the switch to activate it, and then activate items.

- **Apps to get notifications from:** Select apps on the mobile device to send notifications to the Galaxy Watch Active2.
- **Show only while wearing:** Set the Galaxy Watch Active2 to show notifications only while you are wearing it.
- **Show while using phone:** Set the Galaxy Watch Active2 to show notifications while using your mobile device.
- **Advanced notification settings:** Set the various additional features related to notifications.



## Apps

Customise the Galaxy Watch Active2's Apps screen. You can also change the settings for launching apps automatically.

Launch the **Galaxy Wearable** app on your mobile device and tap **Home** → **Apps**.

### Arranging apps

- 1 Tap **App order** → **Custom**.
- 2 Tap **Reorder** and swipe the screen left or right to move to the editing screen.
- 3 Tap and hold an app, drag it to the desired position, and then tap **Save**.

If you tap **App order** → **Most recent first**, the Apps screen of the Galaxy Watch Active2 will be automatically arranged in the order of recently used apps.

### Launching app automatically

Set an app to launch automatically on your Galaxy Watch Active2 by bringing it into focus without tapping the app.

Tap the **Auto open apps** switch to activate it.

### Uninstalling apps

Tap **Manage apps**, tap , select the app you want to remove from the Galaxy Watch Active2, and then tap **Uninstall**.

### Hiding apps

Hide an app to not have it displayed on the Galaxy Watch Active2's Apps screen.

Tap **Manage apps**, tap  next to the apps you want to hide, and then tap **Save**.

The app will appear under **Hidden apps** and will not appear on the Galaxy Watch Active2's Apps screen.

## Unhiding apps

Tap **Manage apps**, tap **+** next to the apps you want to unhide, and then tap **Save**.

The app will disappear under **Hidden apps** and will appear on the Galaxy Watch Active2's last Apps screen.

## Customising apps

Tap  on the app to customise the basic settings related to the app.

## Widgets

Customise the widgets on the Galaxy Watch Active2. You can also rearrange widgets.

Launch the **Galaxy Wearable** app on your mobile device and tap **Home** → **Widgets**.

### Adding or removing widgets

Tap **—** on the widget to remove it or tap **+** on the widget to add it and tap **SAVE**.

The widget will be added or removed from the Galaxy Watch Active2.

### Reordering widgets

Tap  next to a widget, drag it to desired position, and then tap **SAVE**.

The widget's order will be changed on the Galaxy Watch Active2.

## Sound and vibration

Change the Galaxy Watch Active2's sound and vibration settings.

Launch the **Galaxy Wearable** app on your mobile device and tap **Home** → **Sound and vibration**.

- **Sound mode:** Set the Galaxy Watch Active2 to use sound mode, silent mode, or vibrate mode.
- **Vibrate with sound:** Set the Galaxy Watch Active2 to vibrate and play a ringtone for incoming calls and notifications.

- **Volume:** Adjust the volume level of the Galaxy Watch Active2.



When the Voice Assistant feature is activated, you can also adjust the accessibility volume.

- **Vibration intensity:** Adjust the intensity of the vibration notification.
- **Long vibration:** Set the Galaxy Watch Active2 to vibrate longer for incoming calls and notifications.
- **Ringtone:** Change the ringtone.
- **Ringtone vibration:** Select a vibration pattern for incoming calls.
- **Notification sound:** Change the notification sound.
- **Notification vibration:** Select a vibration pattern for notifications.
- **Touch sounds:** Set the Galaxy Watch Active2 to make a sound when apps or options are selected on the touchscreen.

## Display

Change the Galaxy Watch Active2's display settings and the Apps screen.

Launch the **Galaxy Wearable** app on your mobile device and tap **Home** → **Display**.

- **Brightness:** Adjust the brightness for the display.
- **Auto low brightness:** Set the Galaxy Watch Active2 to automatically adjust the brightness depending on the ambient light conditions.
- **Screen timeout:** Set the length of time the Galaxy Watch Active2 waits before turning off the display's backlight.
- **Show last app:** Select the length of time to display a recently used app when the screen is back on after it turned off.
- **Background style:** Change the wallpaper.

## Advanced

Activate the Galaxy Watch Active2's advanced features and change the control settings.

Launch the **Galaxy Wearable** app on your mobile device and tap **Home** → **Advanced**.

- **Double press Home key:** Select an app or feature to launch when you press the Galaxy Watch Active2's Home key twice.
- **Touch bezel:** Set the Galaxy Watch Active2's screen to be controlled by swiping the bezel.
- **Wake-up gesture:** Set the Galaxy Watch Active2 to turn on the screen when you raise your wrist that is wearing the Galaxy Watch Active2.
- **Touch wake-up:** Set the Galaxy Watch Active2 to turn on the screen when you tap the screen.
- **Water lock mode:** Activate water lock mode before entering the water. The touchscreen, the wake-up gesture feature, and the watch always on feature will be deactivated.
- **Touch sensitivity:** Set the Galaxy Watch Active2 to allow use of the touchscreen with gloves on.
- **Do not disturb:** Activate do not disturb mode. Incoming calls will be muted and the screen will not turn on when receiving incoming calls. Also, all notifications will be muted, except for alarms, and the screen will not turn on when notifications are received.
- **Theatre mode:** Activate theatre mode for watching movies. Incoming calls will be muted and the screen will not turn on when receiving incoming calls. Also, all notifications will be muted, including alarms, and the screen will not turn on when notifications are received or when there is an alarm. Also, the wake-up gesture feature and watch always on feature will be deactivated automatically.
- **Good night mode:** Activate goodnight mode for sleeping. Incoming calls will be muted and the screen will not turn on when receiving incoming calls. Also, all notifications will be muted, except for alarms, and the screen will not turn on when notifications are received. Also, the wake-up gesture feature and watch always on feature will be deactivated automatically.
- **Edit quick settings:** Edit the Galaxy Watch Active2's quick panel.
- **Screen capture:** Swipe right on the screen while pressing the Home key to capture the screen.

## Add content to your watch

Transfer saved audio or image files from your mobile device to your Galaxy Watch Active2 manually or automatically.

Launch the **Galaxy Wearable** app on your mobile device and tap **Home** → **Add content to your watch**.

- **Music**

- **Add tracks:** Select audio files and manually send them from the mobile device to the Galaxy Watch Active2.
- **Auto sync:** Set the device to sync recently added audio files with the Galaxy Watch Active2 when it has more than 15 % of remaining battery power.



If the music files saved on the Galaxy Watch Active2 take up more than 1 GB, it deletes files that you have not set as your favourites in order from the music files you first added.

- **Playlists to sync:** Select a playlist to sync with the Galaxy Watch Active2.



**Playlists to sync** is available only when the Samsung Music app is installed on your mobile device and it is activated when you turn on the **Auto sync** feature.

- **Images**

- **Send images:** Select images and manually send them from the mobile device to the Galaxy Watch Active2.
- **Auto sync:** Set the device to sync images with the Galaxy Watch Active2 when it has more than 15 % of remaining battery power.
- **Image limit:** Select the number of images to send to your Galaxy Watch Active2 from a mobile device.
- **Albums to sync:** Select an image album to sync with the Galaxy Watch Active2.

## Send SOS requests

Set the Galaxy Watch Active2 to send an SOS message to the previously registered emergency contact by quickly pressing the Galaxy Watch Active2's Home key three times. You can also set it to automatically call your emergency contacts.

Launch the **Galaxy Wearable** app on your mobile device, tap **Home** → **Send SOS requests**, and then tap the switch to activate it. Refer to [SOS messages](#) for more information.

## Find My Watch

Remotely control your Galaxy Watch Active2 when it is lost or misplaced.

Launch the **Galaxy Wearable** app on your mobile device and tap **Home** → **Find My Watch**.



Register your Samsung account on the connected mobile device first to use this feature.

- **Get location:** Check where the Galaxy Watch Active2 is placed.
- **Set security:**
  - **Remote lock:** Remotely lock the Galaxy Watch Active2 to prevent unauthorised access. This feature can be used when your mobile device is connected to your Galaxy Watch Active2 via Bluetooth or a remote connection. When your Galaxy Watch Active2 is locked, connect your mobile device to the Galaxy Watch Active2 via Bluetooth. The lock will be deactivated automatically.
  - **Reset watch:** Remotely delete all personal information stored in the Galaxy Watch Active2. After the Galaxy Watch Active2 is reset, you cannot restore the information or use the Find My Watch feature.
  - **Reactivation lock:** Set the Galaxy Watch Active2 to require your Samsung account information after the device has been reset. This prevents others from using your Galaxy Watch Active2 to access the personal information saved on your Galaxy Watch Active2 if it is lost or stolen.

## Mobile networks

Use various other services through the mobile network after activating it on the Galaxy Watch Active2.

Launch the **Galaxy Wearable** app on your mobile device and tap **Home** → **Mobile networks**.



**Mobile networks** will not be displayed on the Bluetooth model.

## General

Customise the Galaxy Watch Active2's text-to-speech language settings or reset the Galaxy Watch Active2.

Launch the **Galaxy Wearable** app on your mobile device and tap **Home** → **General**.

- **Languages:** Select Galaxy Watch Active2's text-to-speech language and download the available one.
- **Speech rate:** Adjust the speech rate.
- **Reset:** Perform a factory data reset of the connected Galaxy Watch Active2.

## Accessibility

Configure various settings to improve accessibility to the Galaxy Watch Active2.

Launch the **Galaxy Wearable** app on your mobile device and tap **Home** → **Accessibility**.

- **Screen reader:** Activate Voice Assistant, which provides voice feedback. To view help information to learn how to use this feature, tap **Tutorial**.
- **Visibility enhancements:** Customise the settings to improve accessibility for visually impaired users.
- **Hearing enhancements:** Customise the settings to improve accessibility for users with hearing impairment.
- **Advanced settings:** Configure settings for Direct access and notification features.

## Samsung Pay

Make payments conveniently and securely by using a mobile payment service.

Launch the **Galaxy Wearable** app on your mobile device and tap **Home** → **Samsung Pay**.



This option may not be available depending on your region or service provider.

## Bixby

Launch Bixby on your mobile device and find out what you can do with Bixby.

Launch the **Galaxy Wearable** app on your mobile device and tap **Home** → **Bixby**.

## Account and backup

Register your Samsung account and sign in to back up, or restore your Galaxy Watch Active2's data using Samsung Cloud. You can also remotely connect to your Galaxy Watch Active2 with your Samsung account.

Launch the **Galaxy Wearable** app on your mobile device and tap **Home** → **Account and backup**.

- **Samsung account:** Add your Samsung account to use with your Galaxy Watch Active2.
- **Back up and restore:** Keep your personal information, app data, and settings safe on your Galaxy Watch Active2. You can back up your sensitive information and access it later. You must sign in to your Samsung account to back up or restore data. Refer to [Managing the data in the Galaxy Watch Active2](#) for more information.
- **Remote connection:** Set the Galaxy Watch Active2 to remotely connect with the mobile network or a Wi-Fi network when a Bluetooth connection between devices is not available. To use this feature, sign in to your Samsung account.



Regularly back up your data to a safe location, such as Samsung Cloud or a computer, so that you can restore it if the data is corrupted or lost due to an unintended factory data reset.

## Managing the data in the Galaxy Watch Active2

Keep your personal information, app data, and settings safe on your Galaxy Watch Active2. You can back up your sensitive information and access it later, as well as back up your Galaxy Watch Active2's data automatically to access it from other devices whenever you want.



- Music and images saved on the Galaxy Watch Active2 will not be backed up.
- For the Samsung Health app, only records from the previous 28 days are saved in your Galaxy Watch Active2. To view saved record older than 28 days, install the Samsung Health app on the connected mobile device and back up data automatically.



## Backing up data

- 1 Launch the **Galaxy Wearable** app on your mobile device and tap **Home** → **Account and backup**.
- 2 Tap **Back up and restore** → **Back up data**.
- 3 Tick items you want to back up and tap **Backup**.  
The Galaxy Watch Active2's data will be backed up to Samsung Cloud.

## Restoring data

- 1 Launch the **Galaxy Wearable** app on your mobile device and tap **Home** → **Account and backup**.
- 2 Tap **Back up and restore** → **Restore data**.
- 3 Tap ▼ to select a device to restore the data.
- 4 Tick items you want to restore and tap **Restore**.  
Backed up data will be restored to your Galaxy Watch Active2.

## Backing up data automatically

- 1 Launch the **Galaxy Wearable** app on your mobile device and tap **Home** → **Account and backup**.
- 2 Tap **Back up and restore** → **Back up data**.
- 3 Tap the **Auto back up** switch to activate it.

## Sync phone settings

Change the sync settings of your Galaxy Watch Active2 and the connected mobile device.

Launch the **Galaxy Wearable** app on your mobile device, tap **Home** → **Sync phone settings**.



Some mobile devices may not support the **Sync phone settings** feature or some options of this feature.

- **Sync Do not disturb:** Set to sync the do not disturb settings of your Galaxy Watch Active2 and connected mobile device.
- **Sync Wi-Fi networks:** Set to automatically sync the Wi-Fi list saved on the mobile device with your Galaxy Watch Active2.

## Watch software update

The Galaxy Watch Active2 can be directly updated to the latest software by the firmware over-the-air (FOTA) service. You can also change the update settings.

Launch the **Galaxy Wearable** app on your mobile device and tap **Home** → **Watch software update**.

- **Download and install:** Check for and install updates manually.
- **Auto download over Wi-Fi:** Set the Galaxy Watch Active2 to download updates automatically when connected to a Wi-Fi network.

## Tips and user manual

View basic operations or tips for using the Galaxy Watch Active2 and its user manual. You can also use various other services through the mobile network after activating it on the Galaxy Watch Active2.

Launch the **Galaxy Wearable** app on your mobile device and tap **Home** → **Tips and user manual**.

- **Get more from your watch:** View your Galaxy Watch Active2's usage tips.
- **User manual:** View details about using your Galaxy Watch Active2.
- **Setting up a mobile network:** Activate the mobile network on your Galaxy Watch Active2.



**Setting up a mobile network** will not be displayed on the Bluetooth model.

## About watch

View your Galaxy Watch Active2's status and other information.

Launch the **Galaxy Wearable** app on your mobile device and tap **Home** → **About watch**.

- **Battery:** Check the remaining battery and usage time, and also activate the power saving mode.



The expected usage time left shows the time remaining before the battery power runs out. Usage time left may vary depending on your device settings and operating conditions.

- **Storage:** Check the status of the used and available memory. To delete unnecessary files, tap **Clean now**.



The actual available capacity of the internal memory is less than the specified capacity because the operating system and default apps occupy part of the memory. The available capacity may change when you update the device.

- **RAM:** Check the status of the used and available RAM. To speed up your Galaxy Watch Active2 by reducing the amount of RAM you are using, tick apps from the apps list, and tap **Clean now**.
- **Device:** View various Galaxy Watch Active2's information, such as the Wi-Fi MAC address, Bluetooth address, and serial number.
- **Legal information:** View legal information related to the device, such as the open source licence. You can also set the Galaxy Watch Active2 to automatically send the device's diagnostic and usage information to Samsung.
- **Software information:** View the Galaxy Watch Active2's software and security status.
- **Battery information:** View the Galaxy Watch Active2's battery information.
- **Install unknown apps:** Set the Galaxy Watch Active2 to allow the installation of apps from unknown sources.

## Watch faces

You can change the type of watch to be displayed on the Watch screen.

Launch the **Galaxy Wearable** app on your mobile device and tap **Watch faces**. Then, select a category and select a desired watch face. The watch face you selected will be downloaded or applied on the Watch screen.

Tap **Customise** to change the background and set items to display on the watch face.

### Making My style watch faces

Change your Galaxy Watch Active2's watch face into a pattern image that uses a colour combination abstracted from the photo you took. You can match your Galaxy Watch Active2's watch face with any fashion you want.



This feature is only available on Samsung or Android devices.

- 1 Launch the **Galaxy Wearable** app on your mobile device and tap **Watch faces**.
- 2 Tap **My watch faces** and select **My style**.
- 3 Tap **Customise** → **Camera**.  
To select a photo saved on your mobile device, tap **Gallery**.
- 4 Tap  to take a photo and then tap **OK**.
- 5 Drag the circular frame over the photo to the collection of colours you wish to use.  
To resize the circular frame, drag a corner of the frame.
- 6 Select a pattern type and tap **Done**.
- 7 Tap **Save**.  
The watch face of your Galaxy Watch Active2 will be changed into the My style one.

## Discover

You can download recommended watch faces and apps from the **Galaxy Store** app.

Launch the **Galaxy Wearable** app on your mobile device and tap **Discover**.

Download the watch faces and apps you want. Tap **View more** to view more watch faces and apps.

# Using the Galaxy Watch Active2

## Introduction

Use the helpful features of the Galaxy Watch Active2 to add convenience to your daily life and manage your health. Also, the customisation service of the Galaxy Watch Active2 analyses your usage patterns and status to provide services and information according to your location and place.

Enjoy the many features of the Galaxy Watch Active2.

## Using as a personal coach for your health

Take care of your health with the Galaxy Watch Active2. The heart rate sensor measures your heart rate and analyses your stress level and sleep pattern. You can also manage your personal health based on the profile data you entered.



You can use various other exercises and health managing features when you use the Galaxy Watch Active2 while connected to a mobile device.

## Achieving your daily activity target

Check your daily activity goal based on your target, such as the calories burned, exercise time, or activity time, and also with the entered profile at a glance.

You can check your daily target at a glance with the daily activity graph from the **Daily activity** widget or **Samsung Health** app. You can use this information to track your health and do more activities to create a well-balanced daily routine and become healthier.

Refer to [Daily activity](#) for more information.

## Managing stress and sleep quality

A more accurate heart rate sensor measures your stress levels and sleep patterns.

### Managing stress

When the stress level measurement is completed, you can relax by following the breathing directions that the Galaxy Watch Active2 provides. After you measure your stress level, tap **BREATHE >** to breathe and relieve stress.

### Checking your sleeping patterns

Your sleeping pattern will be measured and divided into four states. After waking up in the morning, you can check your sleep pattern on the sleep tracker screen or through the **Sleep** widget. Find out your sleep pattern through constant observation.

Refer to [Sleep](#) for more information.



The sleep pattern will have its four states (Awake, REM, Light, Deep) analysed by using your movement and changes in your heart rate. A graph will be provided with recommended values for each measured sleep state based on results for people in your same age group.

## Experiencing enhanced exercises

### Using the various exercise features

The Galaxy Watch Active2 supports about 40 indoor and outdoor exercises and activities. Exercise efficiently with the Galaxy Watch Active2 at home, outside, or at a fitness centre. The Galaxy Watch Active2 helps you achieve your set target by carefully checking your workout time, distance, speed, heart rate, and calorie consumption during exercising.

Refer to [Exercise](#) for more information about starting various exercise.

### Doing multiple exercises in one session

You can effectively continue through several exercises in one session. After finishing one exercise, start the next exercise immediately.

Refer to [Doing multiple exercises](#) for more information.

## Using as an intelligent planner

### Checking out today's information

Use the Galaxy Watch Active2 on an important day. You can view information such as schedules, reminders, and the alarm time on the Watch screen even if you do not run any applications.

Tap and hold the Watch screen and swipe the bezel or swipe to the left or right on the screen to select the **My day** watch face. You can view your daily schedule and manage it on the **My day** watch face.

You can view the following information on the watch face:

- Today's schedule you have set on the calendar
- Items you have saved as reminders
- Alarm times

Refer to [Calendar](#), [Reminder](#), or [Alarm](#) for more information about registering a schedule or reminder, or setting up an alarm.



You can only check schedule and alarm information that has been set within 10 hours of the current time.

### Managing my daily life

The Galaxy Watch Active2 helps you enjoy your life comfortably. The customisation service of the Galaxy Watch Active2 identifies your lifestyle and taste and provides appropriate features according to your location or situation. Start and end your day with the Galaxy Watch Active2. The Galaxy Watch Active2 will provide you with what you need the most anytime, anywhere.



- This feature is available after connecting the Galaxy Watch Active2 to a mobile device that supports the customisation service platform 2.2 or later. After making an agreement to use the customisation service, launch the **Settings** app on your mobile device, tap **Accounts and backup** → **Accounts** → **Samsung account** → **Privacy** → **Customization Service**, and then tap the **Customisation Service** switch to activate it.
- If the previously analysed lifestyle pattern changes, the Galaxy Watch Active2 will provide the service and feature based on the changed pattern.



## Being briefed twice a day

You can be briefed after waking up and before going to bed on useful information you need for the day.

On the Apps screen, tap  (**Settings**) → **Advanced** → **Daily briefing** → **Get briefings automatically** and tap the switch to activate it.

After waking up, the Galaxy Watch Active2 notifies you of today's important events or weather. Before you go to bed, the Galaxy Watch Active2 notifies you of your exercise status, tomorrow's weather, and reminds you of any unfinished reminders items.

Refer to [Calendar](#) or [Reminder](#) for more information about registering a schedule or a reminder for a briefing.



You can also be briefed twice a day when you want. On the Apps screen, tap  (**Settings**) → **Advanced** → **Daily briefing** → **Set briefing times**, tap the switch to activate it, and then tap **Briefing times** to set the time to be briefed. However, this feature is available only when you deactivate the **Get briefings automatically** features first.

## Launching recommended apps by location and time

Launch your favourite apps conveniently with widgets. The Galaxy Watch Active2 analyses your usage patterns by time and place to automatically add your favourite apps that you have used at specific times or places to the **App shortcuts** widget.

For example, when you arrive at a bus stop during rush hour, your frequently used maps or transit-related apps and your music app are automatically added to the widget.

Swipe the bezel clockwise or swipe the screen to the left on the Watch screen and launch automatically added apps from the **App shortcuts** widget.

## Activating goodnight mode to sleep more comfortably

Before bedtime, the Galaxy Watch Active2 notifies you to go to sleep. Activate goodnight mode optimised for sleep.

On the Apps screen, tap  (**Settings**) → **Advanced** → **Goodnight mode** and tap the **Turn on now** switch to activate it. When you receive the notification for activating goodnight mode, follow the screen to activate it.

The following features are disabled:

- Ringtones and screen waking during incoming calls
- All notifications, except for alarms
- Screen waking when a notification is received
- The watch always on feature
- The wake-up gesture feature

Goodnight mode is automatically disabled after you wake up.

## Using dual clock when you are abroad

If you are travelling abroad or travelling on a business trip, the Galaxy Watch Active2 automatically detects the changed time zone and suggests that you switch to the dual clock screen to see both the local time and your country's time. Use the dual clock feature by changing the watch face according to the notifications.



This feature is available after connecting the Galaxy Watch Active2 to a mobile device that supports the customisation service platform 2.2 or later. After making an agreement to use the customisation service, launch the **Settings** app on your mobile device, tap **Accounts and backup** → **Accounts** → **Samsung account** → **Privacy** → **Customization Service**, and then tap the **Customisation Service** switch to activate it.

## Using a convenient reminder

Register a reminder quickly with your voice and get briefed on today's reminders.

### Registering reminders with your voice

You can easily save what you need to remember with your voice.

For example, say 'Call my mom at 3 o'clock' and make a reminder. At 3 o'clock, you will be notified that it is time to call mom.

Refer to [Creating a reminder](#) for more information about registering for reminders.

# Appendix

## Troubleshooting

Before contacting a Samsung Service Centre, please attempt the following solutions. Some situations may not apply to your Galaxy Watch Active2.

### The quick panel displays network or service error messages

- When you are in areas with weak signals or poor reception, you may lose reception. Move to another area and try again. While moving, error messages may appear repeatedly.
- You cannot access some options without a subscription. For more information, contact your service provider.

### Your Galaxy Watch Active2 does not turn on

When the battery is completely discharged, your Galaxy Watch Active2 will not turn on. Fully charge the battery before turning on the Galaxy Watch Active2.

### The touchscreen responds slowly or improperly

- If you attach a screen protector or optional accessories to the touchscreen, the touchscreen may not function properly.
- If you are wearing gloves, if your hands are not clean while touching the touchscreen, or if you tap the screen with sharp objects or your fingertips, the touchscreen may malfunction.
- The touchscreen may malfunction in humid conditions or when exposed to water.
- Restart your Galaxy Watch Active2 to clear any temporary software bugs.
- Ensure that your Galaxy Watch Active2 software is updated to the latest version.
- If the touchscreen is scratched or damaged, visit a Samsung Service Centre.

## Your Galaxy Watch Active2 freezes or has errors

Try the following solutions. If the problem is still not resolved, contact a Samsung Service Centre.

### Restarting the Galaxy Watch Active2

If your Galaxy Watch Active2 freezes or hangs, you may need to close apps or turn off the Galaxy Watch Active2 and turn it on again.

### Forcing restart

If your Galaxy Watch Active2 is frozen and unresponsive, press and hold the Home key (Power key) for more than 7 seconds to restart it.

### Resetting the Galaxy Watch Active2

If the methods above do not solve your problem, perform a factory data reset.

On the Apps screen, tap  (Settings) → **General** → **Reset**. Alternatively, launch the **Galaxy Wearable** app on your mobile device and tap **Home** → **General** → **Reset** → **Reset**. Before performing the factory data reset, remember to make backup copies of all important data stored in the Galaxy Watch Active2.

## Another Bluetooth device cannot locate your Galaxy Watch Active2

- Ensure that the Bluetooth wireless feature is activated on your Galaxy Watch Active2.
- Reset your Galaxy Watch Active2 and try again.
- Ensure that your Galaxy Watch Active2 and the other Bluetooth device are within the Bluetooth connection range (10 m). The distance may vary depending on the environment the devices are used in.

If the tips above do not solve the problem, contact a Samsung Service Centre.

## **A Bluetooth connection is not established or your Galaxy Watch Active2 and the mobile device are disconnected**

- Ensure that the Bluetooth feature on both devices is activated.
- Ensure there are no obstacles, such as walls or electrical equipment, between the devices.
- Ensure that the latest version of the Galaxy Wearable app is installed on the mobile device. If necessary, update the Galaxy Wearable app to the latest version.
- Ensure that your Galaxy Watch Active2 and the other Bluetooth device are within the Bluetooth connection range (10 m). The distance may vary depending on the environment the devices are used in.
- Restart both devices and launch the Galaxy Wearable app on the mobile device again.

## **Calls are not connected**

- Ensure that your Galaxy Watch Active2 is connected to a mobile device via Bluetooth. If your Galaxy Watch Active2 is connected to your mobile device remotely, you cannot receive incoming calls.
- Ensure that your mobile device and Galaxy Watch Active2 have accessed the right cellular network.
- Ensure that you have not set call barring for the phone number you are dialling on the mobile device.
- Ensure that you have not set call barring for the incoming phone number on the mobile device.
- Check if do not disturb mode, theatre mode, or goodnight mode is activated. If one of these modes has been activated, the touchscreen does not turn on during incoming calls. Press the Home key or Back key to turn on the screen and check the incoming call.

## **Others cannot hear you speaking on a call**

- Ensure that you are not covering the built-in microphone.
- Ensure that the microphone is close to your mouth.
- If using a Bluetooth headset, ensure that it is properly connected.

## Sound echoes during a call

Adjust the volume or move to another area.

## A cellular network or the Internet is often disconnected or audio quality is poor

- Ensure that you are not blocking the Galaxy Watch Active2's internal antenna.
- When you are in areas with weak signals or poor reception, you may lose reception. You may have connectivity problems due to issues with the service provider's base station. Move to another area and try again.
- When using the device while moving, wireless network services may be disabled due to issues with the service provider's network.

## The battery does not charge properly (For Samsung-approved chargers)

- Ensure that you connect the Galaxy Watch Active2 to the wireless charger properly.
- Visit a Samsung Service Centre and have the battery replaced.

## The battery depletes faster than when first purchased

- When you expose the Galaxy Watch Active2 or the battery to very cold or very hot temperatures, the useful charge may be reduced.
- Battery consumption increases when you use some apps.
- The battery is consumable and the useful charge will get shorter over time.

## Your Galaxy Watch Active2 is hot to the touch

When you use apps that require more power or use apps on your Galaxy Watch Active2 for an extended period of time, your Galaxy Watch Active2 may feel hot to the touch. This is normal and should not affect your Galaxy Watch Active2's lifespan or performance.

If the Galaxy Watch Active2 overheats or feels hot for a prolonged period, do not use it for a while. If the Galaxy Watch Active2 continues to overheat, contact a Samsung Service Centre.

## Your Galaxy Watch Active2 cannot find your current location

The Galaxy Watch Active2 uses your mobile device's location information. GPS signals may be obstructed in some locations, such as indoors. Set the mobile device to use Wi-Fi or a mobile network to find your current location.

## Data stored in the Galaxy Watch Active2 has been lost

Always make backup copies of all important data stored in the Galaxy Watch Active2. Otherwise, you cannot restore data if it is corrupted or lost. Samsung is not responsible for the loss of data stored in the Galaxy Watch Active2.

## A small gap appears around the outside of the Galaxy Watch Active2 case

- This gap is a necessary manufacturing feature and some minor rocking or vibration of parts may occur.
- Over time, friction between parts may cause this gap to expand slightly.

## There is not enough space in the Galaxy Watch Active2's storage

Delete unnecessary data, such as cache, using the Galaxy Wearable app or manually delete unused apps or files to free up storage space.

## Removing the battery

- **To remove the battery, contact an authorised service centre. To obtain battery removal instructions, please visit [www.samsung.com/global/ecodesign\\_energy](http://www.samsung.com/global/ecodesign_energy).**
- For your safety, you **must not attempt to remove** the battery. If the battery is not properly removed, it may lead to damage to the battery and device, cause personal injury, and/or result in the device being unsafe.
- Samsung does not accept liability for any damage or loss (whether in contract or tort, including negligence) which may arise from failure to precisely follow these warnings and instructions, other than death or personal injury caused by Samsung's negligence.

## Copyright

Copyright © 2019 Samsung Electronics

This manual is protected under international copyright laws.

No part of this manual may be reproduced, distributed, translated, or transmitted in any form or by any means, electronic or mechanical, including photocopying, recording, or storing in any information storage and retrieval system.

## Trademarks

- SAMSUNG and the SAMSUNG logo are registered trademarks of Samsung Electronics.
- Bluetooth® is a registered trademark of Bluetooth SIG, Inc. worldwide.
- Wi-Fi®, Wi-Fi Direct™, Wi-Fi CERTIFIED™, and the Wi-Fi logo are registered trademarks of the Wi-Fi Alliance.
- All other trademarks and copyrights are the property of their respective owners.