

Operating Manual

C 170 (E3)

CO₂ Incubator

with FPI-sensor system
and display controller RP1

Model	Model version	Door hinges	Art. No.
C 170	C170-230V-R	right	9040-0112, 9140-0112
C 170	C170-230V-L	left	9040-0115, 9140-0115
C 170-UL	C170UL-120V-R	right	9040-0113, 9140-0113
C 170-UL	C170UL-120V-L	left	9040-0116, 9140-0116

BINDER GmbH

- ▶ Address: Post office box 102, 78502 Tuttlingen, Germany ▶ Phone: +49 7462 2005 0
- ▶ Fax: +49 7462 2005 100 ▶ Internet: <http://www.binder-world.com>
- ▶ E-mail: info@binder-world.com ▶ Service Hotline: +49 7462 2005 555
- ▶ Service Fax: +49 7462 2005 93 555 ▶ Service E-Mail: service@binder-world.com
- ▶ Service Hotline USA: +1 866 885 9794 or +1 631 224 4340 x3
- ▶ Service Hotline Asia Pacific: +852 390 705 04 or +852 390 705 03
- ▶ Service Hotline Russia and CIS: +7 495 988 15 16

Contents

1. SAFETY	5
1.1 Legal considerations	5
1.2 Structure of the safety instructions	5
1.2.1 Signal word panel	5
1.2.2 Safety alert symbol	6
1.2.3 Pictograms	6
1.2.4 Word message panel structure	7
1.3 Localization / position of safety labels at the chamber	7
1.4 Type plate	8
1.5 General safety instructions on installing and operating the chamber	9
1.6 Precautions when working with CO ₂ gas	11
1.7 Precautions when handling gas cylinders	11
1.8 Intended use	12
2. CHAMBER DESCRIPTION	13
2.1 The CO ₂ measuring principle	13
2.2 Chamber overview	14
2.3 Connection panel at the rear of the chamber	16
2.4 Chamber doors	16
3. COMPLETENESS OF DELIVERY, TRANSPORTATION, STORAGE, AND INSTALLATION	17
3.1 Unpacking, and checking equipment and completeness of delivery	17
3.2 Guidelines for safe lifting and transportation	18
3.3 Storage	18
3.4 Location of installation and ambient conditions	18
4. INSTALLATION AND CONNECTIONS	21
4.1 Shelf holder and shelves	21
4.2 CO ₂ sensor	22
4.2.1 Connecting the CO ₂ sensor	22
4.2.2 General notes	22
4.3 Water pan	23
4.4 Gas connection	24
4.4.1 Connecting the CO ₂ gas cylinder	25
4.4.2 Connecting the gas hose to the chamber rear	26
4.4.3 Gas cylinder connection kit (option)	27
4.5 Electrical connection	28
5. START UP	29
6. FUNCTION OVERVIEW OF THE RP1 CONTROLLER	29
6.1 Preset factory parameters	30
6.2 Performance after turning on the chamber	30
7. CONTROLLER RP1 OPERATING MODES	31
7.1 Selecting and setting the operating functions	32
7.2 Operating mode HAND	32
7.3 Operating mode USER: Advanced settings	34
7.4 Operating mode LOCK: Locking/unlocking of the operating functions' settings by operating mode HAND	38
7.5 Performance during and after power failures and shut down	39

8.	CONTROLLER RP1 SETTINGS	39
8.1	Altitude of the installation site above sea level	39
8.2	Entering the set points of temperature and CO ₂	41
9.	TEMPERATURE SAFETY DEVICES.....	42
9.1	Over temperature protective device (class 1)	42
9.2	Safety controller (temperature safety device class 3.1).....	42
9.2.1	Setting the safety controller set point type.....	43
9.2.2	Setting the safety controller set point.....	44
10.	ALARM FUNCTIONS	46
10.1	Alarm functions overview	46
10.2	Resetting the alarm messages	46
10.3	Zero-voltage relay alarm output	47
10.4	Safety controller temperature alarm.....	48
10.5	Temperature tolerance range alarm (high and low temperature)	48
10.6	Door open	49
10.7	CO ₂ tolerance range alarm (CO ₂ over/under concentration)	50
10.8	CO ₂ pressure too low	50
10.9	Temperature sensor failure	51
10.10	Failure of CO ₂ sensor.....	52
11.	ERROR MESSAGES.....	52
12.	REFERENCE MEASUREMENTS	53
12.1	CO ₂ reference measuring	53
12.1.1	Measuring the CO ₂ concentration indirectly via the pH of the cell medium.....	53
12.1.2	Measuring CO ₂ directly via chemical indicator tubes	54
12.1.3	Measuring CO ₂ directly with an electronic infrared measuring device	55
12.2	Temperature reference measurement	55
13.	OPTIONS.....	55
13.1	Silicone access ports 30 mm / 1.18 in, closable with 2 silicone plugs (8012-0558 rear, 8012-0559 left, 8012-0560 right) (option).....	55
13.2	Base on castors (option)	56
13.3	Stacking adapter for direct thermal decoupled stacking (option).....	56
13.1	Analog outputs for temperature and CO ₂ (option)	56
14.	AVOIDING MICROBIAL CONTAMINATION.....	57
14.1	Cells and media	57
14.2	Laboratory conditions / equipment around the incubator.....	57
14.3	Working and behavior in the lab	57
14.4	Chamber design and equipment.....	58
14.5	Handling the CO ₂ incubator	59
15.	CLEANING, DECONTAMINATION / DISINFECTION, AND STERILIZATION....	60
15.1	Cleaning	60
15.2	Decontamination / chemical disinfection of the CO ₂ incubator	61
15.3	Disinfection of the CO ₂ sensor.....	63
15.4	Hot-air sterilization at 180 °C / 356 °F.....	64
15.4.1	Overview	64
15.4.2	Procedure for hot-air sterilization:.....	64
15.5	Aborting the hot-air sterilization	67
15.5.1	Aborting the hot-air sterilization manually.....	68
15.5.2	Aborting the hot-air sterilization by opening the outer door.....	69
15.5.3	Aborting the hot-air sterilization using the main power switch.....	69



16. MAINTENANCE, AND SERVICE	70
16.1 Maintenance intervals, service.....	70
16.2 Checking the air jacket heating fan.....	70
16.3 Gas inlet fine filter	70
16.4 Sending the chamber back to BINDER GmbH	71
17. DISPOSAL	72
17.1 Disposal of the transport packing.....	72
17.1.1 Outer chamber packing	72
17.1.2 Packing inside the chamber, equipment.....	72
17.2 Decommissioning.....	73
17.3 Disposal of the chamber in the Federal Republic of Germany	73
17.4 Disposal of the chamber in the member states of the EU except for the Federal Republic of Germany.....	74
17.5 Disposal of the chamber in non-member states of the EU	75
18. TROUBLESHOOTING	76
19. TECHNICAL DESCRIPTION	79
19.1 Factory calibration and adjustment	79
19.2 Over current protection	79
19.3 Definition of usable volume	79
19.4 C 170 technical data	80
19.5 Important conversion data for non-SI units.....	81
19.6 Conversion table for gas inlet pressures, bar – psi.....	81
19.7 Equipment and options (extract).....	82
19.8 Accessories and spare parts (extract)	83
19.9 Dimensions C 170.....	84
20. EU DECLARATION OF CONFORMITY	85
21. PRODUCT REGISTRATION	87
22. CONTAMINATION CLEARANCE CERTIFICATE	88
22.1 For chambers located outside the USA and Canada	88
22.2 For chambers in the USA and Canada.....	91

Dear Customer,

For the correct operation of the CO₂ incubator C 170, it is important that you read this operating manual completely and carefully and observe all instructions as indicated. Failure to read, understand and follow the instructions may result in personal injury. It can also lead to damage to the chamber and/or poor equipment performance.

1. Safety

This operating manual is part of the components of delivery. Always keep it handy for reference. The device should only be operated by laboratory personnel especially trained for this purpose and familiar with all precautionary measures required for working in a laboratory. Observe the national regulations on minimum age of laboratory personnel. To avoid injury and damage observe the safety instructions in the operating manual.

	 WARNING
<p>Failure to observe the safety instructions. Serious injuries and chamber damage.</p> <ul style="list-style-type: none">➤ Observe the safety instructions in this operating manual➤ Carefully read the complete operating instructions for the chamber.	

1.1 Legal considerations

This operating manual is for informational purposes only. It contains information for installing, start-up, operation and maintenance of the product. Note: the contents and the product described are subject to change without notice.

Understanding and observing the instructions in this operating manual are prerequisites for hazard-free use and safety during operation and maintenance. In no event shall BINDER be held liable for any damages, direct or incidental arising out of or related to the use of this manual.

This operating manual cannot cover all conceivable applications. If you would like additional information, or if special problems arise that are not sufficiently addressed in this manual, please ask your dealer or contact us directly by phone at the number located on page one of this manual

Furthermore, we emphasize that the contents of this operating manual are not part of an earlier or existing agreement, description, or legal relationship, nor do they modify such a relationship. All obligations on the part of BINDER derive from the respective purchase contract, which also contains the entire and exclusively valid statement of warranty administration. The statements in this manual neither augment nor restrict the contractual warranty provisions.

1.2 Structure of the safety instructions

In this operating manual, the following safety definitions and symbols indicate dangerous situations in accordance with the standards ISO 3864-2 and ANSI Z535.6.

1.2.1 Signal word panel

Depending on the seriousness and probability of serious consequences, potential dangers are identified with a signal word, the corresponding safety color, and if appropriate, the safety alert symbol.

 DANGER
<p>Indicates an imminently hazardous situation that, if not avoided, will result in death or serious (irreversible) injury.</p>

WARNING

Indicates a potentially hazardous situation which, if not avoided, could result in death or serious (irreversible) injury

CAUTION

Indicates a potentially hazardous situation which, if not avoided, may result in moderate or minor (reversible) injury

CAUTION

Indicates a potentially hazardous situation, which, if not avoided, may result in damage to the product and/or its functions or to property in its proximity.

1.2.2 Safety alert symbol







Use of the safety alert symbol indicates a **risk of injury**.

Observe all measures that are marked with the safety alert symbol in order to avoid death or injury.

1.2.3 Pictograms

Warning signs			
Electrical hazard	Hot surface	Explosive Atmosphere	Stability hazard
Lifting hazard	Gas cylinders	CO ₂ suffocation and poisoning hazard	Pollution Hazard
Harmful substances	Biohazard	Risk of corrosion and / or chemical burns	
Mandatory action signs			
Mandatory regulation	Read operating instructions	Disconnect the power plug	Lift with several persons
Environment protection	Wear protective gloves	Wear safety goggles	

Prohibition signs			
 Do NOT touch	 Do NOT spray with water	 Do NOT climb	
	Information to be observed in order to ensure optimum function of the product.		



1.2.4 Word message panel structure

Type / cause of hazard. Possible consequences. ☒ Instruction on how to avoid the hazard: prohibition ➤ Instruction on how to avoid the hazard: mandatory action

Observe all other notes and information not necessarily emphasized in the same way, in order to avoid disruptions that could result in direct or indirect injury or property damage.

1.3 Localization / position of safety labels at the chamber

The following labels are located on the chamber:

Pictograms (Warning signs)	Service label
 Hot surface	
 Risk of injury (UL chambers only). Observe the safety instructions in the operating manual.	

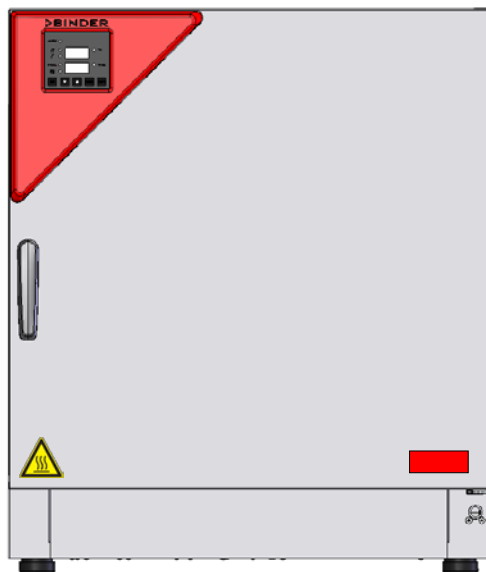

Figure 1: Position of labels on the CO₂ incubator C 170

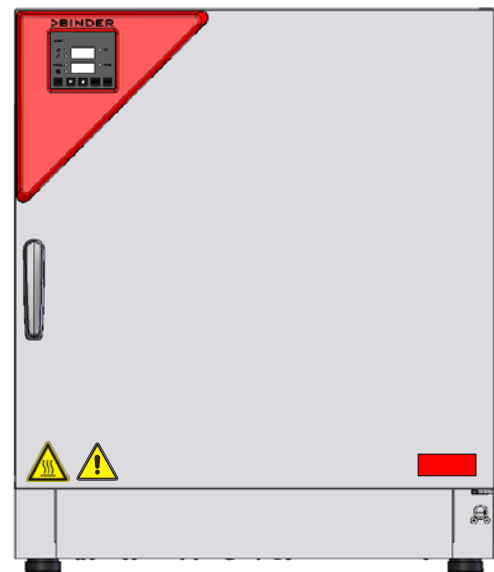

Figure 2: Position of labels on the CO₂ incubator C 170-UL



Keep safety labels complete and legible.

Replace safety labels that are no longer legible. Contact BINDER Service for these replacements.

1.4 Type plate

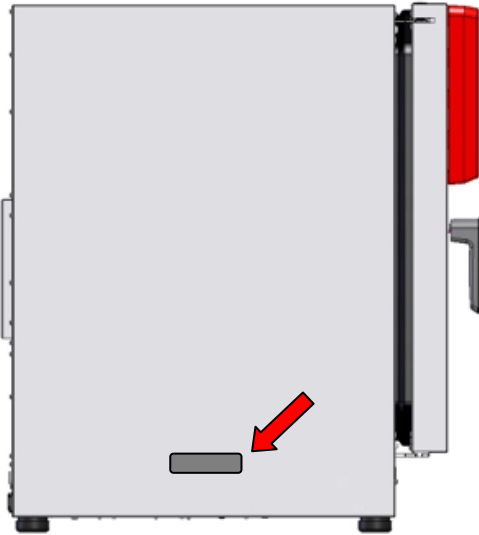





Figure 3: Position of type plate

Nominal temp.	190 °C	1,10 kW / 6,1 A		
	374 °F	230 V / 50 Hz		
IP protection	20	230 V / 60 Hz		
Safety device	DIN 12880	1 N ~		
Class	3.1			
Art. No.	9040-0112			
Project No.				
Built	2017	CO2 Incubator		



BINDER GmbH
Im Mittleren Ösch 5
78532 Tuttlingen / Germany
www.binder-world.com

C170
E3







Serial No. 00000000000000

Made in Germany

Figure 4: Type plate C 170 (standard chamber, door hinged right)

Indications of the type plate (example)		Information
BINDER		Manufacturer: BINDER GmbH
C 170		Model designation
CO2 Incubator		Device name: CO ₂ Incubator
Serial No.	000000000000	Serial No. of the chamber
Built	2017	Year of construction
Nominal temperature	190 °C 374 °F	Nominal temperature
IP protection	20	Type of IP protection acc. to standard EN 60529
Temp. safety device	DIN 12880	Temperature safety device acc. to standard DIN 12880:2007
Class	3.1	Class of temperature safety device
Art. No.	9040-0112	Art. No. of the chamber
Project No.	---	Optional: Special application acc. to project no.

Indications of the type plate (example)	Information
1,10 kW	Nominal power
6,1 A	Nominal current
230 V / 50 Hz	Nominal voltage $\pm 10\%$ at the indicated power frequency
230 V / 60 Hz	
1 N ~	Current type

Symbol on the type plate	Information
	CE conformity marking
 	Electrical and electronic equipment manufactured / placed on the market in the EU after 13 August 2005 and to be disposed of in a separate collection according to Directive 2012/19/EU on waste electrical and electronic equipment (WEEE).
 (UL chambers only)	The chamber is certified by Underwriters Laboratories Inc. [®] according to the following standards: CAN/CSA-C22.2 No. 61010-1, 2 nd Edition, 2004-07 UL 61010-1, 2 nd Edition, 2005-07-22 IEC 61010-1:2001, 2 nd Edition and IEC 61010-2-10

1.5 General safety instructions on installing and operating the chamber



With regard to operating the chamber and to the installation location, please observe the DGUV guidelines 213-850 on safe working in laboratories (formerly BGI/GUV-I 850-0, BGR/GUV-R 120 or ZH 1/119, issued by the employers' liability insurance association) (for Germany).

BINDER GmbH is only responsible for the safety features of the chamber provided skilled electricians or qualified personnel authorized by BINDER perform all maintenance and repair, and if components relating to chamber safety are replaced in the event of failure with original spare parts.



To operate the chamber, use only original BINDER accessories or accessories from third-party suppliers authorized by BINDER. The user is responsible for any risk caused by using unauthorized accessories.

	CAUTION
	<p>Danger of overheating. Damage to the chamber.</p> <ul style="list-style-type: none"> ⊘ Do NOT install the chamber in unventilated recesses. ➤ Ensure sufficient ventilation for dispersal of the heat.

Do not operate the chamber in hazardous locations.



	 DANGER
	<p>Explosion hazard. Danger of death.</p> <ul style="list-style-type: none"> ⊘ Do NOT operate the chamber in potentially explosive areas. ⊘ KEEP explosive dust or air-solvent mixtures AWAY from the chamber.

The chamber does not dispose of any measures of explosion protection.

	 DANGER
	<p>Explosion hazard. Danger of death.</p> <ul style="list-style-type: none"> ∅ Do NOT introduce any substance into the CO₂ incubator which is combustible or explosive at working temperature. ∅ NO explosive dust or air-solvent mixture in the inner chamber.



Any solvent contained in the charging material must not be explosive or inflammable. I.e., irrespective of the solvent concentration in the steam room, NO explosive mixture with air must form. The temperature inside the chamber must lie below the flash point or below the sublimation point of the charging material. Familiarize yourself with the physical and chemical properties of the charging material, as well as the contained moisture constituent and its behavior with the addition of heat energy and humidity.



Familiarize yourself with any potential health risks caused by the charging material, the contained moisture constituent or by reaction products that may arise during the temperature process. Take adequate measures to exclude such risks prior to putting the CO₂ incubator into operation.

	 DANGER
	<p>Electrical hazard. Danger of death.</p> <ul style="list-style-type: none"> ∅ The chamber must NOT become wet during operation or maintenance.

The chambers were produced in accordance with VDE regulations and were routinely tested in accordance to VDE 0411-1 (IEC 61010-1).



During and shortly after operation, the temperature of the inner surfaces almost equals the set-point.

	 CAUTION
	<p>The glass door, the glass door handle and the inner chamber will become hot during operation. Danger of burning.</p> <ul style="list-style-type: none"> ∅ Do NOT touch the glass door, the glass door handle, the inner surfaces or the charging material during operation.

 	 WARNING
	<p>Stability hazard. Danger of injury. Damage to the chamber and the charging material. Housing cover breakaway.</p> <ul style="list-style-type: none"> ∅ Do NOT climb on the lower housing cover. ∅ Do NOT load the lower housing cover with heavy objects while the chamber door is open.

1.6 Precautions when working with CO₂ gas



Carbon dioxide (CO₂) in high concentrations is hazardous to health. It is colorless and almost odorless and therefore practically imperceptible. Vent out any CO₂ gas that may escape via good room ventilation or a suitable connection to an exhaust system. We recommend installing a CO₂ warning system.

	 WARNING
	<p>High concentration of CO₂ (> 4 Vol.-%). Risk of death by suffocation. Danger of poisoning.</p> <ul style="list-style-type: none"> ∅ Do NOT set up chambers in non-ventilated recesses ➤ Ensure technical ventilation measures ➤ Observe the relevant regulations for handling CO₂.



1.7 Precautions when handling gas cylinders

	<p>General information for safe handling of gas cylinders:</p> <ul style="list-style-type: none"> • Store and use gas cylinders only in well-ventilated locations. • Open the gas cylinder valve slowly to avoid pressure surges • Secure gas cylinders during storage and use against falling (chaining). • Transport gas cylinders with a cylinder cart, do not carry, roll, or throw them. • Always close the valve even with apparently empty cylinders; screw on the cap when not in use. Return gas cylinders with the valve closed. • Do not open gas cylinders by force. Mark them when damaged • Protect gas cylinders against fire, e.g. do not store together with flammable liquids • Observe relevant regulations for dealing with gas cylinders.
-----------------------------------------------------------------------------------	----------------------------------------------------------------------------------------------------------------------------------------------------------------------------------------------------------------------------------------------------------------------------------------------------------------------------------------------------------------------------------------------------------------------------------------------------------------------------------------------------------------------------------------------------------------------------------------------------------------------------------------------------------------------------------------------------------------------------------------------------------------------------------------------------------------------------------------------

Secure the gas cylinders against falling and other mechanical damage.

	 WARNING
	<p>Safety valve tearing off. Sudden release of the stored pressure energy. Risk of injury.</p> <ul style="list-style-type: none"> ➤ Secure gas cylinders against falling (chaining). ➤ Transport gas cylinders with a cylinder cart.

The valve of the gas cylinder **always** must be closed before screwing on or unscrewing the gas hose.

	 WARNING
	<p>Opening the cylinder valve when the cylinder is not connected. Sudden release of the stored pressure energy. Risk of injury.</p> <ul style="list-style-type: none"> ➤ Close the gas cylinder valve before connecting or removing the gas hose.

	<p>After connecting the gas cylinder, check all gas connections for leaks (e.g. with leak spray or diluted soap solution).</p>
-------------------------------------------------------------------------------------	--------------------------------------------------------------------------------------------------------------------------------

1.8 Intended use

CO₂ incubators C 170 are suitable for the cultivation of mammal cells under typical conditions of approx. 37 °C / 98.6 °F. The incubator permits setting defined pH conditions by common NaHCO₃ buffer systems of commercial cell media by keeping an exact CO₂ atmosphere inside. The chambers guarantee high humidity inside to avoid osmolarity increasing caused by the evaporation of the cell media.



Observing the instructions in this operating manual and conducting regular maintenance work (chap. 16) is part of the intended use.

Other applications are not approved.

The chambers are not classified as medical devices as defined by the Medical Device Directive 93/42/EEC.



Due to the special demands of the Medical Device Directive (MDD), these ovens are not qualified for sterilization of medical devices as defined by the directive 93/42/EWG.





WARNING: If customer should use a BINDER chamber running in non-supervised continuous operation, we strongly recommend in case of inclusion of irrecoverable specimen or samples to split such specimen or samples and store them in at least two chambers, if this is feasible.



Always use proper protective equipment (clothing, gloves, safety glasses, etc.).
Always follow good hygienic practices according to GLP/SOP protocols.
Each individual operating the chamber is responsible for his or her own safety

Any component of the charging material must NOT be able to release toxic gases.

 	 DANGER
	<p>Explosion or implosion hazard. Danger of poisoning. Danger of death.</p> <ul style="list-style-type: none"> ⊘ Do NOT introduce any substance combustible or explosive at working temperature into the chamber, in particular no energy sources such as batteries or lithium-ion batteries. ⊘ NO explosive dust or air-solvent mixture in the inner chamber. ⊘ Do NOT introduce any substance which could lead to release of toxic gases.

In case of foreseeable use of the device there is no risk for the user through the integration of the chamber into systems or by special environmental or operating conditions in the sense of EN 61010-1:2010. For this, the intended use of the chamber and all its connections must be observed.

2. Chamber description

The CO₂ incubators C 170 are equipped with a microprocessor controller for temperature and CO₂ levels and a digital display accurate to one-tenth of a degree resp. 0.1 vol.-%

The inner chamber, the pre-heating chamber and the inside of the doors are all made of stainless steel V2A (German material no. 1.4301, US equivalent AISI 304). The inner surfaces are smooth and therefore easy to clean. The inner chamber is deep-drawn from one piece, polished (suitable for pharmaceutical applications) and has no welds or inaccessible corners. The hinges and the seal of the inner glass door are glued from the outside to aid cleaning of the inner chamber. When operating the chamber at high temperatures (sterilization), the impact of the oxygen in the air may cause discoloration of the metallic surfaces (yellowish-brown or blue) by natural oxidation processes. These colorations are harmless and will in no way impair the function or quality of the chamber.

The perforated shelves and the shelf holder are also made of stainless steel (German material no. 1.4016, US equivalent AISI 430). You can insert a maximum of 8 shelves. The shelf holder is demountable without any tool. In this way, you can clean it hygienically in every laboratory dishwasher before hot-air sterilization.

The housing is RAL 7035 powder-coated. All corners and edges are also completely coated.

The heating system of the CO₂ incubator permits hot-air auto-sterilization at 190 °C / 374°F. Thus, a temperature of at least 180 °C / 356°F is maintained on all internal surfaces, resulting in sterilization of the entire inner chamber.

Thanks to the standard safety device (class 3.1 according to DIN 12880:2007), the set temperature is maintained in case of failure.

The gas enters the chamber via a fine filter (aseptic filter) with a high filtration efficiency that also filters the smallest particles.

A highly precise, drift-free CO₂ infrared measuring system in combination with the permanent mixture of CO₂ gas through a special proprietary gas mixing head developed by BINDER allows precise and constant CO₂ concentrations for long periods. This creates optimum growth conditions for cultures. The CO₂ sensor can be removed from the inner chamber by hand and cleaned with suitable detergents if needed.

The CO₂ incubator can be operated in a temperature range from 7 °C / 12.6 °F above ambient temperature up to +50 °C / 122°F and a CO₂ range of 0 vol.-% up to 20 vol.-%.

2.1 The CO₂ measuring principle

Fast reaction times, as well as the highest accuracy and selectivity, characterize the CO₂ measuring procedure of the C 170 incubator. The accuracy of the CO₂ measuring system is based on a single-beam infrared measuring cell, which measures in differential mode using the permanently alternating transmission feature of its semi-conductor filter.

Due to this highly developed single-beam principle with Fabry-Perot interferometer (FPI), disturbance variables and aging phenomena in the measuring system are almost completely eliminated, so that this measuring system, in contrast to other measuring procedures, remains practically drift-free between calibrations and is absolutely selective for CO₂.

The CO₂ measuring cell contains a measuring section inside, in which the absorption of infrared light depends on the number of CO₂ molecules in the beam path. This number of CO₂ molecules changes with the ambient pressure in relation to a constant volume. The distances between the molecules are consequently pressure-dependent. The collision frequency of the IR-beam with CO₂ molecules increases therefore by increasing pressure. For this reason, the ambient pressure must be compensated in order to correct the display reading of the CO₂ concentration in vol.-%. This is achieved by entering the altitude of the site above the sea (chap. 8.1).

2.2 Chamber overview

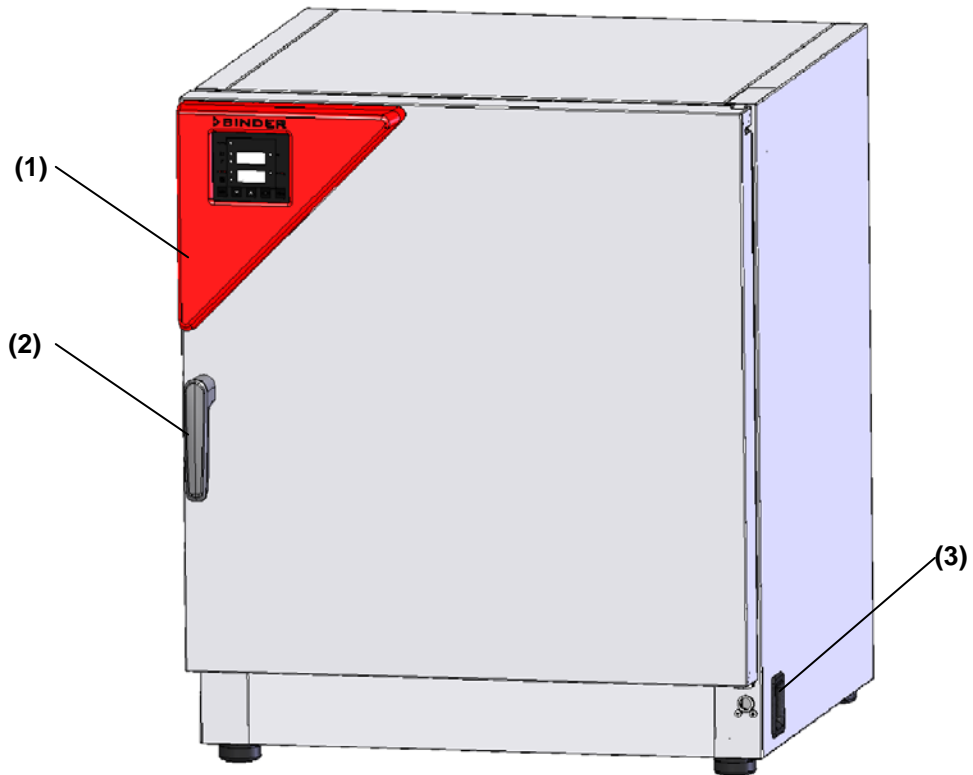

Figure 5: CO₂ incubator C 170, closed

- (1) Triangle instrument panel with RP1 controller for temperature and CO₂ and
- (2) Door handle
- (3) Main power switch

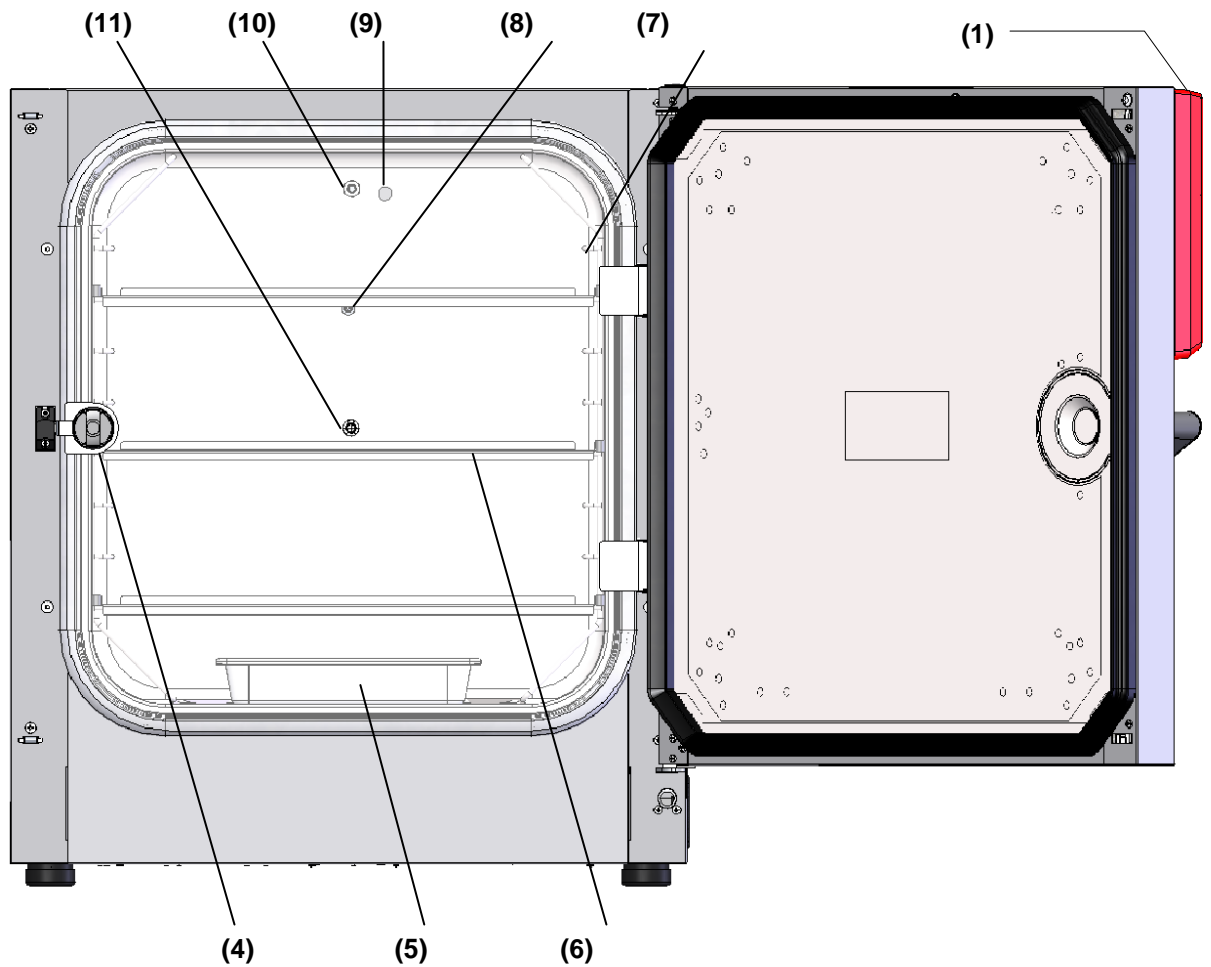

Figure 6: CO₂ incubator C 170, outer door open

- (4) Glass door handle
- (5) Water pan
- (6) Shelves
- (7) Shelf holder
- (8) Pt 100 temperature sensor
- (9) CO₂ sensor
- (10) Gas mixing head for CO₂
- (11) Silicone measuring port in the glass door

2.3 Connection panel at the rear of the chamber

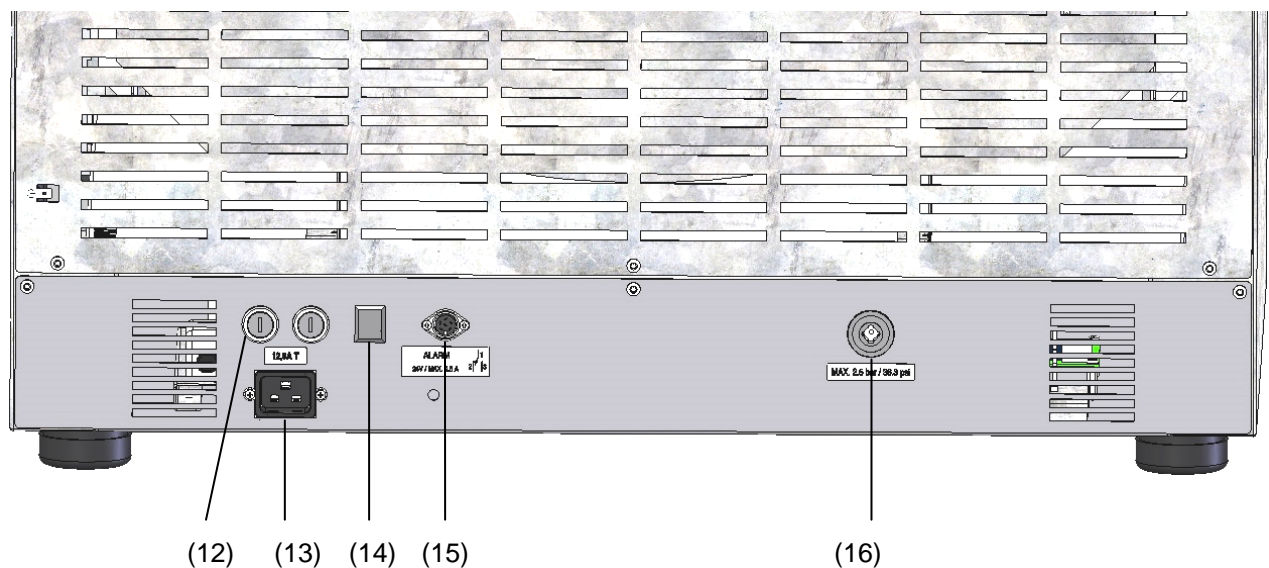

Figure 7: Rear connection panel

- (12) Miniature fuses
- (13) Connection for IEC connector plug
- (14) Ethernet interface for computer communication (option)
- (15) Connection socket for zero-voltage relay alarm contact
- (16) Quick acting closure socket for CO₂ gas cylinder

2.4 Chamber doors

The outer chamber door is equipped with a heater on its inner side. The door must be closed while the chamber is operating normally in order to ensure stable climatic conditions in the inner chamber.

An additional glass door enables viewing of the samples without disturbing the temperature in the interior and contaminating the samples sealing the interior of the chamber.

When the outer door is open, the CO₂ intake valve automatically closes.



Delay time for the temperature and CO₂ tolerance range alarm :

After closing the outer door, the tolerance range alarm is turned off for a programmable delay time. This prevents alarms being constantly triggered during the unstable operating phase after opening the outer door.

3. Completeness of delivery, transportation, storage, and installation

3.1 Unpacking, and checking equipment and completeness of delivery





After unpacking, please check the chamber and its optional accessories, if any, based on the delivery receipt for completeness and for transportation damage. Inform the carrier immediately if transportation damage has occurred.

The final tests of the manufacturer may have caused traces of the shelves on the inner surfaces. This has no impact on the function and performance of the chamber.

Please remove any transportation protection devices and adhesives in/on the chamber and on the doors and remove the operating manuals and accessory equipment.

For transport purpose, a silica gel bag for drying purpose was added. Do not eat! Do not open the silica gel bag and dispose of it with normal waste.

	Remove any protective lamination sheet on the inner metal surfaces prior to commissioning.
-----------------------------------------------------------------------------------	--------------------------------------------------------------------------------------------

	 CAUTION
	<p>Sliding or tilting of the chamber. Damage to the chamber. Risk of injury by lifting heavy loads.</p> <ul style="list-style-type: none"> ⊘ Do NOT lift or transport the chamber using the door handle or the door. ➤ Lift the chamber from the pallet at the four lower corners with the aid of four people.
	

If you need to return the chamber, please use the original packing and observe the guidelines for safe lifting and transportation (chap. 3.2).

For disposal of the transport packing, see chap. 17.1.

Note on second-hand chambers (Ex-Demo-Units):





Second-hand chambers are chambers that were used for a short time for tests or exhibitions. They are thoroughly tested before resale. BINDER ensures that the chamber is technically sound and will work flawlessly.

Second-hand chambers are marked with a sticker on the chamber door. Please remove the sticker before commissioning the chamber.

3.2 Guidelines for safe lifting and transportation

After operation, please observe the guidelines for temporarily decommissioning the chamber (chap. 17.2).

Empty the water pan before moving the incubator. In case of any spilling of the contents, shut down the incubator and dry it out carefully and completely

  	 CAUTION
<p>Sliding or tilting the chamber. Damage to the chamber. Risk of injury by lifting heavy loads.</p> <ul style="list-style-type: none"> ➤ Transport the chamber in its original packaging only. ➤ Secure the CO₂ incubator with transport straps for transport. ⊘ Do NOT lift or transport the chamber using the door handle or the door. ➤ Lift the chamber at the four lower corners with the aid of 4 people and place it on a rolling pallet. ➤ Move the chamber to the desired location and lift it from the rolling pallet with the aid of four people. 	

- Permissible ambient temperature range for transport: -10 °C / 14°F to +60 °C / 140°F.

You can order transport packing and rolling pallets for transportation purposes from BINDER Service.

3.3 Storage

Intermediate storage of the chamber is possible in a closed and dry room. Observe the guidelines for temporary decommissioning (chap. 17.2).

- Permissible ambient temperature range for storage: -10 °C / 14°F to +60 °C / 140°F.
- Permissible ambient humidity: max. 70% r.H., non-condensing

When after storage in a cold location you transfer the chamber to its warmer installation site, condensation may form in the inner chamber, on the housing or in the sensor compartment of the CO₂ measurement. Before start-up, wait at least one hour until the CO₂ incubator has attained ambient temperature and is completely dry.

3.4 Location of installation and ambient conditions

Notes on the location of installation

Set up the CO₂ incubator on a flat, even surface, free from vibration and in a well-ventilated, dry location. The chambers are designed for setting up inside a building (indoor use).

Freestanding chambers are suitable for installation on tables or on the optionally available stand. Note: The site of installation must be capable of supporting the chamber's weight (see technical data, chap. 19.4).

Align the chamber using a spirit level to ensure even covering of the cell-cultures with the medium. For this purpose, manually adjust the four incubator feet.



In order to avoid contamination, never place the chamber directly on the floor.

	CAUTION
	<p>Danger of overheating. Damage to the chamber.</p> <ul style="list-style-type: none"> ⊘ Do NOT set up chambers in non-ventilated recesses. ➤ Ensure sufficient ventilation for dispersal of the heat.

To completely separate the chamber from the power supply, you must disconnect the power plug. Install the chamber in a way that the power plug is easily accessible and can be easily pulled in case of danger.

For the user there is no risk of temporary overvoltages in the sense of EN 61010-1:2010.

Do not install or operate the chamber in potentially explosive areas.

	 DANGER
	<p>Explosion hazard. Danger of death.</p> <ul style="list-style-type: none"> ⊘ Do NOT operate the chamber in potentially explosive areas. ⊘ KEEP explosive dust or air-solvent mixtures AWAY from the vicinity of the chamber.

Ambient conditions

- Permissible ambient temperature range for operation: +18 °C / 64.4 °F up to +30 °C / 86 °F. At elevated ambient temperature values, fluctuations in temperature can occur.
- Ideal ambient temperature: by at least 7 °C / 12.6 °F below the intended working temperature. E.g., working temperature 37 °C / 98.6 °F – resulting permitted ambient temperature 30 °C / 86 °F and lower

In the event of working temperatures of less than 7 °C / 12.6 °F above the ambient temperature, the set point can be exceeded.



	<p>The ambient temperature should not be substantially higher than the indicated ambient temperature of +22 °C +/- 3 °C / 71.6 °F ± 5.4 °F to which the specified technical data relate. For other ambient conditions, deviations from the indicated data are possible.</p>
-------------------------------------------------------------------------------------	-----------------------------------------------------------------------------------------------------------------------------------------------------------------------------------------------------------------------------------------------------------------------------

	<p>Avoid direct solar radiation on the chamber.</p>
-------------------------------------------------------------------------------------	-----------------------------------------------------

- Permissible ambient humidity: 70% r.H. max., non-condensing.
- Installation height: max. 2000 m / 6562 ft. above sea level. After the incubator has been turned on for the first time, enter the altitude of the site above sea level into the RP1 controller (chap. 8.1).
- Wall distances: rear 100 mm / 3.94 in, sides 50 mm / 1.97 in.

Notes on handling carbon dioxide (CO₂)

Carbon dioxide (CO₂) in high concentrations is hazardous to health. It is colorless and almost odorless and therefore practically imperceptible. Vent out any CO₂ gas that may escape via good room ventilation or a suitable connection to an exhaust system. We recommend installing a CO₂ warning system.

	 WARNING
<p>High concentration of CO₂ (> 4 Vol.-%). Danger of death by suffocation. Danger of poisoning.</p> <ul style="list-style-type: none"> ⊘ Do NOT set up chambers in non-ventilated recesses. ➤ Ensure technical ventilation measures. ➤ Observe the relevant regulations for handling CO₂. 	

Observe the **occupational exposure limit OEL** for CO₂ set by the national authorities (formerly maximum permitted workplace concentration). Check compliance when operating all chambers located in the room.

- OEL for Germany: 5000 ml/m³ (ppm) = 0,5 Vol.-%
- CO₂ lost with each door opening: about 16.4 g, i.e. 0.0084 cubic meters / 0.296 cubic feet (under normal pressure)
- CO₂ lost during 12h at 5 vol.-% without door opening: approx. < 2 g, i.e. 0.001 cubic meters / 0.035 cubic feet (under normal pressure 1013 mbar / 14.7 psi)

An example of how to evaluate laboratory volume and air change rate:

Question: Is an air change rate of 1/h sufficient for a lab with a volume of 100 cubic meters / 3,531.5 cubic feet with 10 CO₂ incubators, opened 4 times per hour?

Calculation: CO₂ concentration = CO₂ lost by door opening, multiplied by 10 chambers, multiplied by 4 door openings per hour, divided by lab volume

0.0084 cubic meters x 10 x 4 div. 100 cubic meters = 0.00336, i.e. 0.336% or 3360 ppm.

0.296 cubic feet x 10 x 4 div. 3,531.5 cubic feet = 0.00336, i.e. 0.336% or 3360 ppm.

Result: The maximum permissible value of 5000 ppm is not exceeded under these operation conditions.

Even when CO₂ or systems operated with CO₂ are handled carefully and appropriately, a residual risk remains, which can lead to life-threatening situations under certain circumstances. Therefore we strongly recommend continuous monitoring of CO₂ concentration in the ambient air of the CO₂ incubator. It must be ensured permanently that the maximum permissible occupational exposure limit OEL for CO₂ (0.5 vol.-% CO₂ for Germany) is not exceeded.

4. Installation and connections

4.1 Shelf holder and shelves

The shelf holder consists of two identical side parts. Insert them alongside the lateral walls of the inner chamber. They are fixed by cams on the bottom of the inner chamber. For assembly and disassembly, fold both side parts towards the middle.

Then you can insert the shelves into the shelf holder. Hold the shelf straight and then insert it so it will go smoothly inside the chamber.

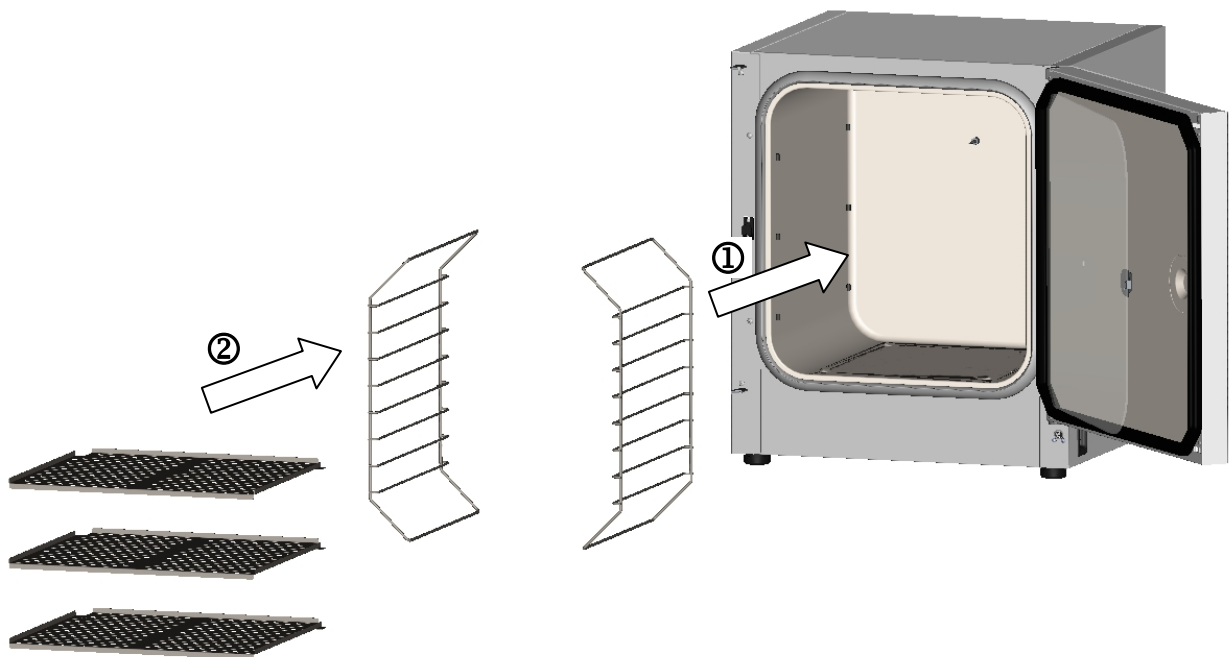

Figure 8: Installation of the shelves and shelf holder



If just one of the three supplied shelves shall be used in one of the three lower positions, we recommend inserting a supplementary shelf as high as possible into the shelf holder for stabilizing purpose.

To remove the shelf holder, remove the shelves first.

It is not possible to take out the shelf holder entirely together with the shelves.

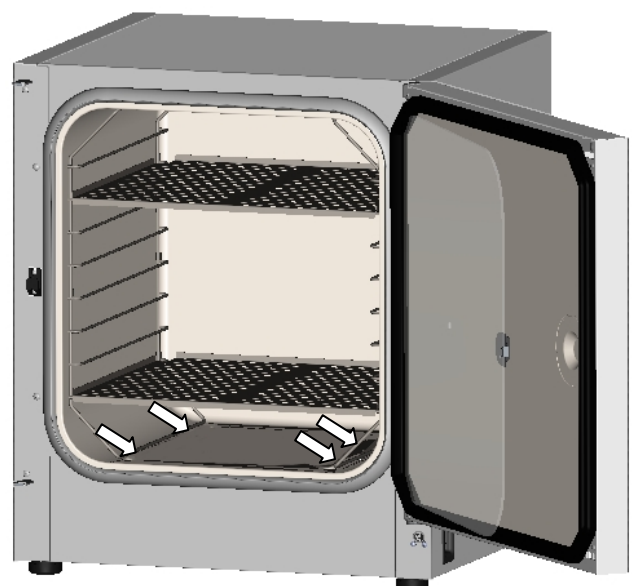

Figure 9: View of the interior with inserted shelves and the position of the cams to fix the shelf holder

Permitted shelf loads:

Maximum load on one single shelf: 10 kg / 22 lb

Maximum total load on all shelves: 30 kg / 66 lb

4.2 CO₂ sensor

4.2.1 Connecting the CO₂ sensor

Turn off the chamber. Open the door of the inner chamber and plug the CO₂ sensor (4) into the permanently installed holding tube located in the upper part of the rear of the inner chamber.



Figure 10: Plugged-in CO₂ sensor (right) and gas mixing head for CO₂

The sensor must click in correctly and sit tightly in the connection socket.

	CAUTION
	<p>Connecting or removing the CO₂ sensor during operation. Damage to the CO₂ sensor.</p> <ul style="list-style-type: none"> ➤ Connect or remove the CO₂ sensor only with the chamber turned off.

4.2.2 General notes

Connect or remove the CO₂ sensor without rotating and only when the incubator is turned off. Remove the CO₂ sensor before removing or replacing its filter cap. The PTFE filter of the CO₂ sensor prevents dirt and humidity from intruding into the measuring cell. It is available as a spare part. Replace it whenever it is damaged or soiled.

	<p>The accuracy of the indicated values of CO₂ depends on the ambient air pressure (approx. 0.08 vol.-% per 10 mbar / 0.15 psi). In order to compensate this effect when measuring the CO₂ concentration, the altitude of the installation site above sea level can be entered into the controller (chap. 8.1).</p>
-------------------------------------------------------------------------------------	-------------------------------------------------------------------------------------------------------------------------------------------------------------------------------------------------------------------------------------------------------------------------------------------------------------------------------------------

The CO₂ sensor is temperature resistant up to a maximum temperature of 60 °C / 140 °F.

	CAUTION
	<p>Excess temperature. Damage to the CO₂ sensor.</p> <ul style="list-style-type: none"> ⊘ Do NOT autoclave the CO₂ Sensor. ⊘ Do NOT expose the CO₂ sensor to hot-air sterilization.

The CO₂ sensor head was especially adjusted for the specific chamber. To avoid confusion, an adhesive label with a serial number is adhered to the sensor head. When exchanging the sensor, you must repeat the CO₂ adjustment.

	CAUTION
	<p>Different CO₂ sensor. Invalid calibration.</p> <ul style="list-style-type: none"> ⊘ Do NOT change the CO₂ sensor head. ➤ Note down the serial number of the CO₂ sensor.

Avoid strong shocks when handling the CO₂ sensor.

	CAUTION
	<p>Shocks of the CO₂ sensor. Damage to the CO₂ sensor.</p> <ul style="list-style-type: none"> ⊘ Avoid strong shocks of the CO₂ sensor (by putting it down hard, or dropping).

4.3 Water pan

The water pan permits high humidity without condensation on the inner walls of the CO₂ incubator.

Place the water pan in central position on the bottom of the inner chamber. Place the water pan with its narrow side centrally between the front cams on the bottom of the inner chamber.

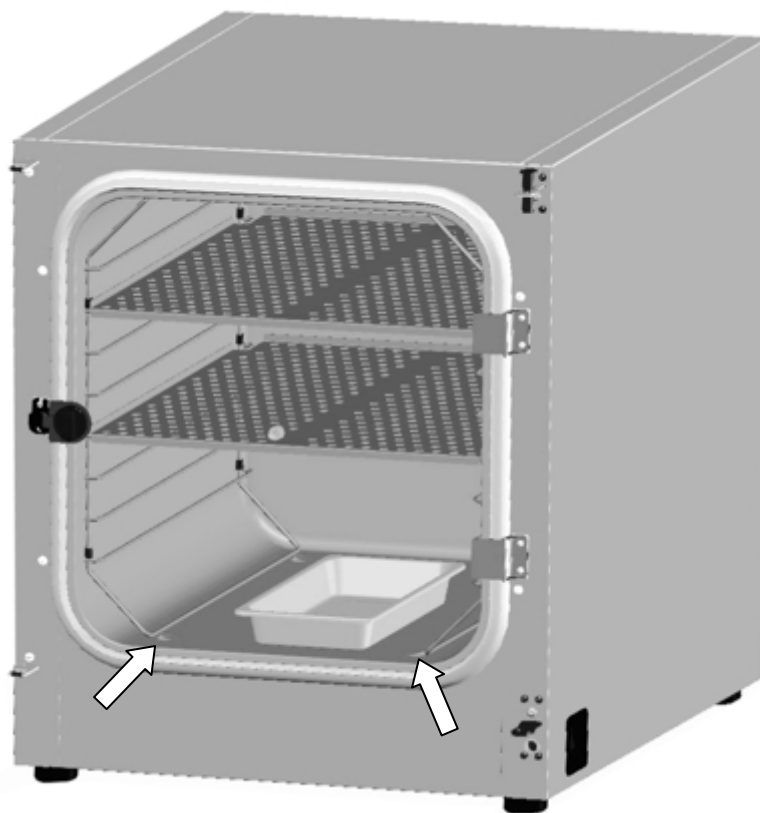

Figure 11: Position of the water pan centrally between the front cams (arrows)

Make sure that the water pan has firm contact with the inner chamber bottom and rests tightly on it.

Fill the water pan with 1 liter of distilled, sterilized water.

We recommend cleaning (chap. 15.1) and refilling the pans 2 to 3 times a week. For evacuation, remove the water pan.

We recommend using distilled, sterile water to achieve optimum growth results. Any corrosive damage that may arise following use of water of different quality or by additives is excluded from the liability agreement.



If required, you can add microbiologically inhibiting substances such as copper chips, copper sulphate or ethylene diamine tetra-vinegar acid (EDTA) in a concentration of 1 to 5 mmol/l.

Empty the water pan before moving the incubator. In case of the contents spilling, immediately shut down the incubator and dry it carefully and completely.



4.4 Gas connection

	<p>General information for safe handling of gas cylinders:</p> <ul style="list-style-type: none"> • Store and use gas cylinders only in well ventilated areas. • Open the gas cylinder valve slowly to avoid pressure surges • Secure gas cylinders during storage and use against falling (chaining). • Transport gas cylinders with a cylinder cart, do not carry, roll, or throw them • Always close the valve even with apparently empty cylinders; screw on the cap when not in use. Return gas cylinders with the valve closed • Do not open gas cylinders by force. Mark them when damaged • Protect gas cylinders against fire, e.g. do not store together with flammable liquids • Observe relevant regulations for dealing with gas cylinders.
-----------------------------------------------------------------------------------	----------------------------------------------------------------------------------------------------------------------------------------------------------------------------------------------------------------------------------------------------------------------------------------------------------------------------------------------------------------------------------------------------------------------------------------------------------------------------------------------------------------------------------------------------------------------------------------------------------------------------------------------------------------------------------------------------------------------------------------------------------------------------------------------------------------------------------------

Secure the gas cylinders against falling and other mechanical damage.

	 WARNING
	<p>Safety valve tearing off. Sudden release of the stored pressure energy. Risk of injury.</p> <ul style="list-style-type: none"> ➤ Secure gas cylinders against falling (chaining). ➤ Transport gas cylinders with a cylinder cart.



The valve of the gas cylinder **always** must be closed before screwing on or unscrewing the gas hose.

	 WARNING
	<p>Opening the cylinder valve when the cylinder is not connected. Sudden release of the stored pressure energy. Risk of injury.</p> <ul style="list-style-type: none"> ➤ Close the gas cylinder valve before connecting or removing the gas hose.

	<p>After connecting the gas cylinder, check all gas connections for leaks (e.g. with leak spray or diluted soap solution).</p>
-------------------------------------------------------------------------------------	--------------------------------------------------------------------------------------------------------------------------------

4.4.1 Connecting the CO₂ gas cylinder

Carbon dioxide (CO₂) in high concentrations is hazardous to health. It is colorless and almost odorless and therefore practically imperceptible. Vent out any CO₂ gas that may escape via good room ventilation or a suitable connection to an exhaust system. We recommend installing a CO₂ warning system.

	 WARNING
	<p>High concentration of CO₂ (> 4 Vol.-%). Danger of death by suffocation. Danger of poisoning.</p> <ul style="list-style-type: none"> ⊘ Do NOT set up chambers in non-ventilated recesses. ➤ Ensure technical ventilation measures. ➤ Observe the relevant regulations for handling CO₂.

	The CO ₂ gas necessary for operation must have a technical grade of 99.5 %.
-----------------------------------------------------------------------------------	----------------------------------------------------------------------------------------

	The gas connections must be established by qualified personnel who are trained in handling the respective gases and familiar with the required safety measures.
-----------------------------------------------------------------------------------	-----------------------------------------------------------------------------------------------------------------------------------------------------------------

The following steps are required:

Ensuring the correct CO₂ output pressure

	A gas supply pressure above 2.5 bar / 36 <i>psi</i> will result in chamber damage.
-------------------------------------------------------------------------------------	------------------------------------------------------------------------------------

Use a pressure reducer and make sure to avoid any excessive outlet pressure when connecting the gas hose to the incubator.

The real outlet pressure of gas cylinders, sets of gas cylinders or central gas supplies am on the second manometer must **not** exceed 2.5 bar / 36 *psi*.

	CAUTION
	<p>Excessive outlet pressure > 2.5 bar / 36 <i>psi</i>. Damage to the chamber.</p> <ul style="list-style-type: none"> ⊘ The outlet pressure must NOT exceed the indicated value of 2.5 bar / 36 <i>psi</i>. ➤ Before connecting, check the outlet pressure on the pressure reducer of the cylinder. ➤ Adjust the outlet pressure to 2.0 bar / 29 <i>psi</i> above the ambient pressure.

Observe the correct outlet pressure also when replacing the gas cylinders.

Establishing the connection to the incubator

Connect the supplied gas hose (internal diameter 6 mm / 0.24 *inches*) to the pressure reducer of the gas cylinders or central gas supply and secure the connection with the supplied hose clamp.

Connect the pre-assembled hose nozzle of the gas hose to the quick acting closure socket (14) DN 6 on the chamber rear, as described in chap. 4.4.2.

Leak test

After connecting the gas cylinder, check all gas connections for leaks (e.g. with leak spray or diluted soap solution).



The recovery times of the gas concentrations inside the chamber after opening the door are indicated in the technical data (chap. 19.4) and refer to a connection pressure of 2.0 bar / 29 *psi*. Decreasing supply pressure will result in longer recovery times.

Conversion table for gas inlet pressures, bar – psi, see chap. 19.6.

4.4.2 Connecting the gas hose to the chamber rear

The gas hose, which will be used to establish the connection to a gas cylinder, is already attached to the hose nozzle and secured by a hose clamp. Plug the hose nozzle into the corresponding quick acting closure socket (a) located at the rear of the chamber. This quick acting closure socket is closed by a rubber cover (b).



Only use the supplied hose nozzle to connect to the quick acting closure socket. Otherwise, the quick acting closure socket may leak, and/or it may become impossible to connect the original hose nozzle. In this case, please contact BINDER Service.

Remove the rubber cover (b) by pulling it off.

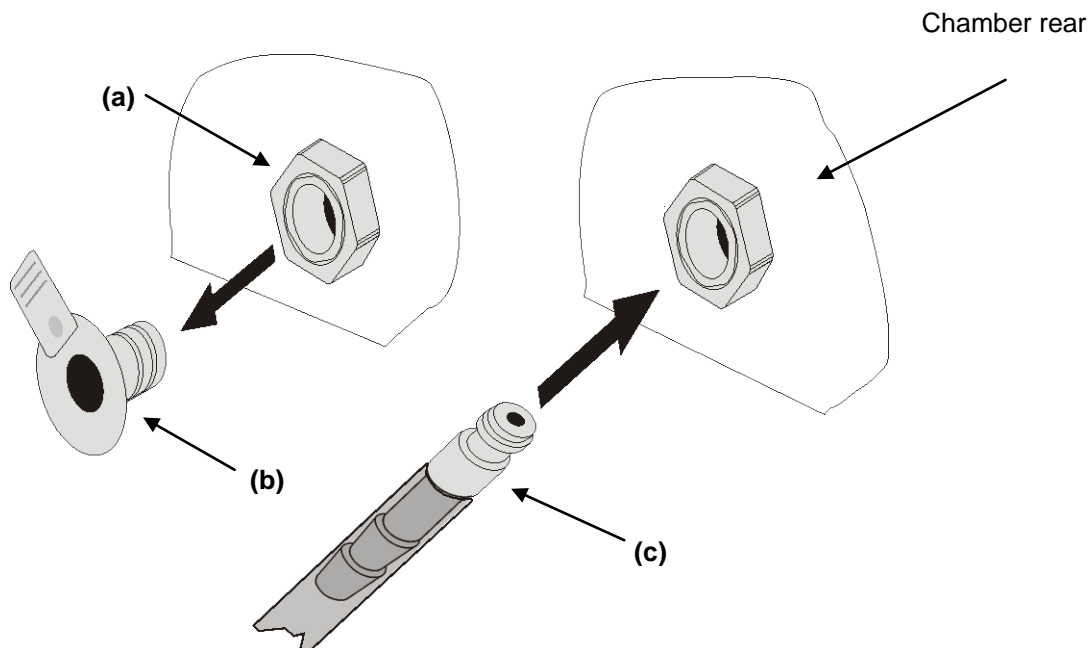
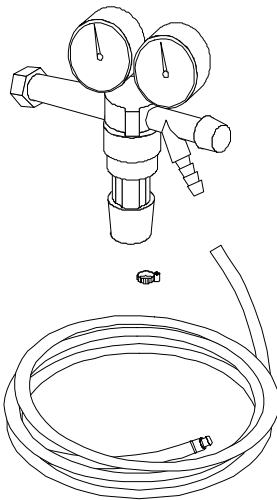

Figure 12: Connection of the hose lead to the gas cylinder

Now fit the hose nozzle (c) in the quick acting closure socket. To remove the connection, pull the hose nozzle off the quick acting closure socket.

4.4.3 Gas cylinder connection kit (option)





The gas cylinder connection kit for CO₂ (Art. no. 8012-0014) includes the following parts for connecting a gas cylinder to the CO₂ incubator:

- Pressure reducer with manometers for cylinder pressure (high pressure gauge) and outlet pressure (low pressure gauge)
- 5 m pressure hose with pre-assembled hose nozzle for quick acting closure socket
- 1 hose clamp to connect the gas hose to the pressure reducer

The pressure reducer is also available as an individual accessory.

Figure 13: Gas cylinder connection kit

	<p>Instructions 7001-0249 included with the connection kit describe connecting and setting the gas cylinder connection kit.</p>
	<p style="text-align: center;">CAUTION</p> <p>Excessive outlet pressure > 2.5 bar / 36 psi. Damage to the chamber.</p> <ul style="list-style-type: none"> ⊘ The outlet pressure must NOT exceed the indicated value of 2.5 bar / 36 psi. ➤ Before connecting, check the outlet pressure on the pressure reducer of the cylinder. ➤ Adjust the outlet pressure to 2.0 bar / 29 psi above the ambient pressure.
	<p>The gas connections must be established by qualified personnel who are trained in handling the respective gases and familiar with the required safety measures.</p>

4.5 Electrical connection

The chambers are supplied ready for connection. They come with an IEC connector plug.

Model	Power plug	Nominal voltage $\pm 10\%$ at the indicated power frequency	Current type	Chamber fuse
C 170	Shock-proof plug	230 V at 50 Hz 230 V at 60 Hz	1N~	10 A
C 170-UL	NEMA 5-20P	120 V at 60 Hz	1N~	16 A

- The domestic socket must also provide a protective conductor. Make sure that the connection of the protective conductor of the domestic installations to the chamber's protective conductor meets the latest technology. The protective conductors of the socket and plug must be compatible!
- Prior to connection and start-up, check the power supply voltage. Compare the values to the specified data located on the chamber's type plate (centrally located at the bottom of the left-hand side of the chamber, see chap. 1.4)
- When connecting, please observe the regulations specified by the local electricity supply company and as well as the VDE directives (for Germany). We recommend the use of a residual current circuit breaker.
- Pollution degree (acc. to IEC 61010-1): 2
- Over-voltage category (acc. to IEC 61010-1): II

	CAUTION
	<p>Danger of incorrect power supply voltage. Damage to the equipment.</p> <ul style="list-style-type: none"> ➤ Check the power supply voltage before connection and start-up. ➤ Compare the power supply voltage with the data indicated on the type plate.

See also electrical data (chap. 19.4).

	<p>To completely separate the chamber from the power supply, you must disconnect the power plug. Install the chamber in a way that the power plug is easily accessible and can be easily pulled in case of danger.</p>
-------------------------------------------------------------------------------------	------------------------------------------------------------------------------------------------------------------------------------------------------------------------------------------------------------------------

5. Start up

After connecting the supply lines, turn on the chamber by the main power switch (2).

After turning on the incubator for the first time, enter the altitude of the site above sea level into the controller RP1 (chap. 8.1).

Warming chambers may release odors in the first few days after commissioning. This is not a quality defect. To reduce odors quickly we recommend heating up the chamber to its nominal temperature for one day and in a well-ventilated location.

6. Function overview of the RP1 controller

The RP1 controller controls the following values inside the CO₂ incubator:

- Temperature in °C (range 7 °C / 12.6 °F above ambient temperature up to 50 °C / 122 °F)
- Carbon dioxide concentration in vol.-% (range 0 vol.-% up to 20 vol.-%)

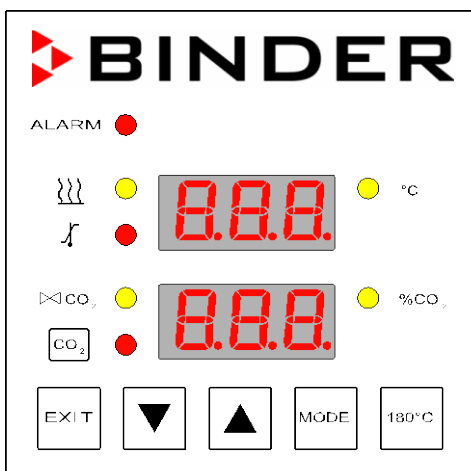











Figure 14: Overview controller RP1

Controller alarm and status LEDs

Symbol	LED	Meaning
ALARM	red	General alarm
	yellow	Heating active
	red	Temperature alarm
	yellow	CO ₂ valve open
	red	CO ₂ alarm

Controller buttons

Button	Function
	Turn off the alarm sound
	Reduce value
	Increase value
	Confirm entry and call up next operating function
	Start / stop the sterilization cycle

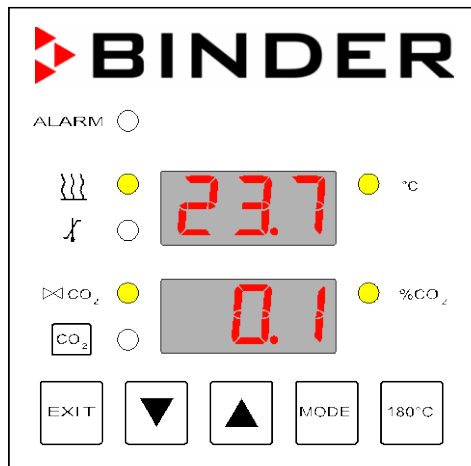

Figure 15: Normal Display of controller

Upper display: current inner chamber temperature

LED " °C" lit: inner chamber temperature displayed in °C

Lower display: current CO₂ concentration

LED "%CO₂" lit: CO₂ concentration displayed in vol.-% CO₂

6.1 Preset factory parameters

The chamber is supplied with the following basic preset parameters:

Temperature set point	37 °C / 98.6°F
CO ₂ set point	5 vol.-%
Safety controller class 3.1	Set point type "Offset" 2.0 °C
Set point sterilization temperature	190 °C / 374 °F
Installation height above sea level	0.65 km / 2132.54 ft
The maximum permitted deviation from the temperature set point for tolerance range alarm	1.0 K
Delay time tolerance range alarm temperature after opening the door	15 min
The maximum permitted deviation from the CO ₂ set point for tolerance range alarm.	1.0 vol.-%
Delay time tolerance range alarm CO ₂ after opening the door	15 min
Password to lock / unlock the HAND operating functions	0
Password to access operating mode USER	1

6.2 Performance after turning on the chamber

During the equilibration phase of 2 hours after turning on the chamber, undefined temperature and CO₂ conditions occur within the chamber. During this phase, do not place any sample materials in the chamber.

	CAUTION
	<p>Danger of samples being destroyed.</p> <p>➤ Charge the chamber only after equilibration of temperature and CO₂.</p>

Check that the interior of the chamber is empty, including the trays and the water pan. If you do not know what the chamber was last used for, for hygiene purposes you should clean and disinfect or sterilize the interior (chap. 15).

	<p>WARNING: If customer should use a BINDER chamber running in non-supervised continuous operation, we strongly recommend in case of inclusion of irrecoverable specimen or samples to split such specimen or samples and store them in at least two chambers, if this is feasible.</p>
-------------------------------------------------------------------------------------	------------------------------------------------------------------------------------------------------------------------------------------------------------------------------------------------------------------------------------------------------------------------------------------------

Open the CO₂ supply's pressure reducer valve and set a CO₂ primary pressure of 2.0 bar / 29 psi.

Set the main power switch (2) to position I. The pilot lamp shows the chamber is ready for operation. There is a subsequent brief startup phase in which the display items at the edges of the upper controller display light up successively.

After a few seconds, the upper display shows the current interior temperature of the chamber and the lower display shows the current CO₂ interior concentration. The lit LEDs at the right of the display show that the temperature is displayed in °C and the CO₂ concentration is displayed in vol.-% CO₂.

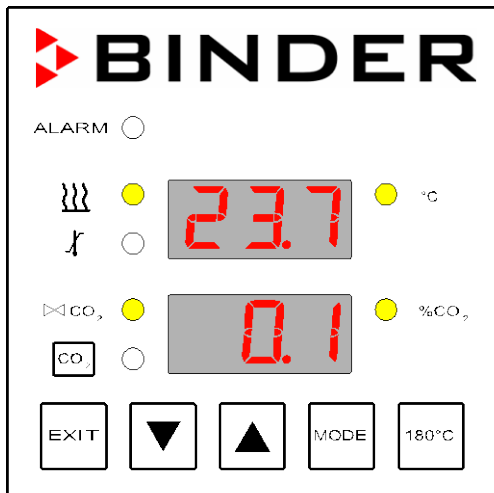



Figure 16: Normal display of controller after turning on the incubator, showing the current temperature and CO₂ values (example)

Set the controller to the desired temperature and CO₂ set points that are to be used to operate the chamber.

The yellow LED  indicates that the heating is active, and the yellow LED  indicates that the CO₂ valve is open.

Only insert samples into the chamber when it has reached its stable operating state:

Temperature: Equilibration time is approx. 2 hours.

CO₂: After approx. 5 minutes, the CO₂ concentration equilibrates automatically to the preset value.



If there is no accordance between the actual and set value shown in the display, proper operation of the chamber is not guaranteed.

Instructions when observing leakage of condensate from the CO₂ sensor system and CO₂ fluctuation:

In the case of CO₂ fluctuations and concomitant condensate leakage from the injection and suction nozzle of the CO₂ sensor compartment after start-up or when taking the chamber back into service, the chamber should be left to dry open for at least an hour running at 37 °C with the water pan empty. This will result in flushing the sensor compartment and tubing from humid air. Removing the condensate from the CO₂ sensor system will ensure a turbulence-free CO₂ measurement.

7. Controller RP1 operating modes

The controller provides three operating modes HAND (chap. 7.2), USER (chap. 7.3), and LOCK (chap. 7.4). In operating modes HAND and USER, you can call up several operating functions and set / modify their values.

Operating mode USER is password protected. On delivery, the password is set to "1" (factory setting). You can change the password in operating function "PA.U" (chap. 7.3).

You can also implement password protection for operating mode HAND (chap. 7.4).

7.1 Selecting and setting the operating functions

The controller's lower display always shows the operating function (e.g. "SP" = temperature set point) and the upper display shows the associated value (e.g. 37.0).

When the value in the upper display shows the temperature in °C or a CO₂ concentration in % CO₂, the corresponding yellow LED to the right of the display will light up.

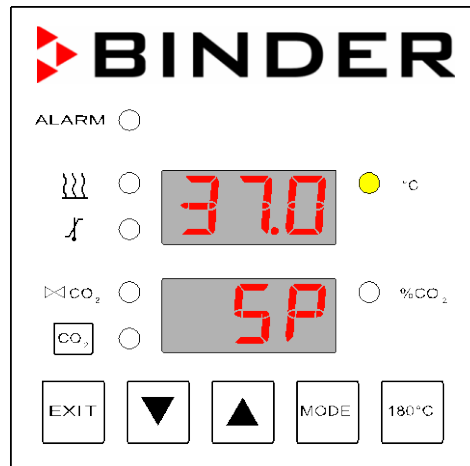

Upper display: value of the operating function to be set

Lower display: type of operating function to be set

LED "°C" lit: operating function value displayed in °C

LED "%CO₂" lit: operating function value displayed in vol.-% CO₂

LED "°C" and LED "%CO₂" off: no or other unit of operating function value

Figure 17: Controller display when setting operating functions, here: setting of temperature set point

In operating modes HAND and USER, access the next operating function by pressing "MODE".

Pressing "MODE" will confirm the changed value of the current operating function, i.e., the chamber will from now on regulate at the new value.

	<p>If you do not want to accept the modification of a value, wait 30 seconds without pressing any button. The controller reverts to Normal Display automatically without accepting the modification.</p>
-------------------------------------------------------------------------------------	----------------------------------------------------------------------------------------------------------------------------------------------------------------------------------------------------------

Use "▲" and "▼" to change the value of the selected operating function or to select between defined values.

	<p>To change numerical values by tenths, press "▲" and "▼" for a very short time. To change them by whole numbers, press "▲" and "▼" for longer.</p>
-------------------------------------------------------------------------------------	------------------------------------------------------------------------------------------------------------------------------------------------------

In some operating functions, you can read but not change the value (for service and maintenance purposes).

To go back to the Normal display, press "MODE" repeatedly.

If a button for 30 seconds is not pressed after access to an operating function or changing a value, the controller toggles back to Normal display automatically. If the "MODE" button is not pressed after changing a value in the displayed operating function, the value reverts to its previous value.

7.2 Operating mode HAND

- In Normal display, press button "MODE" to toggle to operating mode HAND.
- Use "MODE" to successively call up the operating functions.
- Use "▲" or "▼" to set the values of the operating functions.

Operating functions that can be set in operating mode HAND

Display	Setting range	Operating function
SP	0.0 °C to 50.0 °C	Temperature set point Must be at least 7 °C / 12.6°F above the ambient temperature in order to ensure a stable temperature inside the chamber.



CO2	0.0 vol.-% to 20.0 vol.-%	CO₂ set point Common value: 5.0 vol.-% (factory setting), or depending on the NaHCO ₃ concentration of the culture medium (Figure 23 page 53).
------------	---------------------------	--------------------------------------------------------------------------------------------------------------------------------------------------------------------------------



ALS	0.0 °C to 60.0 °C	Safety controller set point when set point type is "Limit" (Lit) Limit value, i.e., maximum permitted absolute temperature value. When exceeded, the safety controller triggers an alarm. For technical reasons, the limit value should exceed the temperature set point by at least 2 °C. Typical value: 39.0 °C / 102.2°F.
------------	-------------------	----------------------------------------------------------------------------------------------------------------------------------------------------------------------------------------------------------------------------------------------------------------------------------------------------------------------------------------

Or

Ot.S	0.1 K to 10 K	Safety controller set point when set point type is "Offset" (OFS) Offset value, i.e. maximum over temperature above the selected set point When exceeded, the safety controller triggers an alarm. For technical reasons, the offset value should be at least 2 °C (factory setting).
-------------	---------------	----------------------------------------------------------------------------------------------------------------------------------------------------------------------------------------------------------------------------------------------------------------------------------------------------



PAH	0 to 999	Max. 3-digit numeric password for locking/unlocking the operating function setting in operating mode LOCK (chap. 7.4) To permit temporary unlocking: select any password ≠ 0. To permit permanent unlocking: set password to "0".
------------	----------	------------------------------------------------------------------------------------------------------------------------------------------------------------------------------------------------------------------------------------------------

	<p>The operating function "At.S" in operating mode USER (chap. 7.3) specifies the safety controller set point type "Limit" (Lit) or "Offset" (OFS).</p> <ul style="list-style-type: none"> • With set point type "Limit" (Lit), operating function "AL.S" (safety controller set point as limit value) is displayed in operating modes HAND and USER. You can set a limit value. • With set point type "Offset" (OFS), operating function "Ot.S" (safety controller set point as offset value) is displayed in operating modes HAND and USER. You can set an offset value.
-------------------------------------------------------------------------------------	-------------------------------------------------------------------------------------------------------------------------------------------------------------------------------------------------------------------------------------------------------------------------------------------------------------------------------------------------------------------------------------------------------------------------------------------------------------------------------------------------------------------------------------------------------------------------------------------------------------------------

	<p>With set point type "Limit", set the safety controller each time the set point for the temperature is changed. Set the safety controller set point approx. 2 °C above the controller temperature set point.</p> <p>Factory setting: set point type "Offset" with safety controller set point 2 °C.</p>
-------------------------------------------------------------------------------------	-----------------------------------------------------------------------------------------------------------------------------------------------------------------------------------------------------------------------------------------------------------------------------------------------------------

7.3 Operating mode USER: Advanced settings

- In Normal display, press “MODE” and “EXIT” simultaneously for 3 seconds to access the options for selecting the chamber's operating modes.

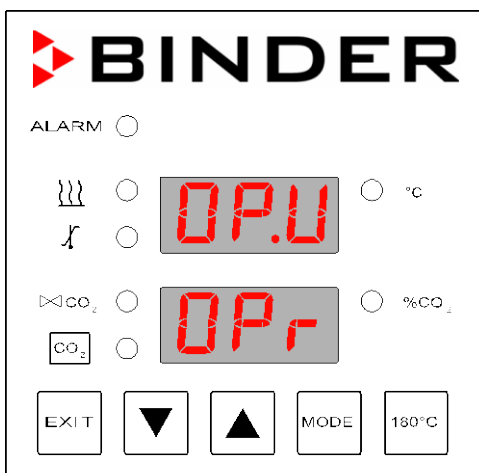

Figure 18: Selecting the operating mode

- Press “▲” until the value “OP.U” (operating mode USER) appears in the upper display.
- Press “MODE”. The display to enter the password appears.

The operating mode USER is password-protected by a number. The password is preset to "1" in factory. You can change the password in operating function “PA.U”.

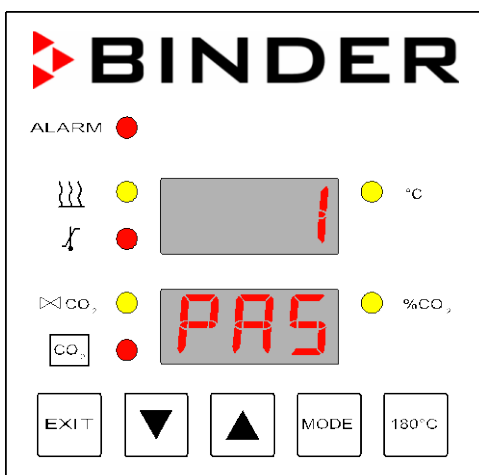

Figure 19: Password request

- Use “▲” or “▼” to enter the password and press “MODE”.
- Use “MODE” to successively call up the operating functions.
- Use “▲” or “▼” to set the values of the operating functions.

Operating functions in operating mode USER

Display	Setting range	Operating function
SP	0.0 °C to 50.0 °C	Temperature set point Must be at least 7 °C / 12.6 °F above the ambient temperature in order to ensure a stable temperature inside the chamber.
MODE	↓	
CO ₂	0.0 vol.-% to 20.0 vol.-%	CO₂ set point Common value: 5.0 vol.-% (factory setting), or depending on the NaHCO ₃ concentration of the culture medium (Figure 23 page 53).
MODE	↓	
ALT	0.0 km to 2.0 km	Altitude of the installation site above sea level For adjusting the displayed CO ₂ concentration depending on the air pressure
MODE	↓	
AL.1	0.1 K to 10.0 K	Temperature alarm threshold The maximum permitted deviation from the temperature set point in K, Deviations trigger a tolerance range alarm (chap. 10.5) on the main controller. For technical reasons, the deviation should be at least 1.0K.
MODE	↓	
dt.1	0 to 999 min	Temperature alarm-delay time Period until the main controller triggers a tolerance range alarm after closing the door. This prevents alarms constantly being triggered during the unstable operating phase after closing the door. This has no effect on the safety controller, which can still trigger a limit alarm or offset alarm.
MODE	↓	
AL.2	0.1 vol.-% to 5.0 vol.-%	CO₂ alarm threshold The maximum permitted deviation from the CO ₂ set point in vol.-%. Deviations trigger a tolerance range alarm on the main controller. For technical reasons, the value should be at least 1.0 vol.-%.
MODE	↓	
dt.2	0 to 999 min	CO₂ alarm - delay time Period until the main controller triggers a tolerance range alarm after closing the door. This prevents alarms constantly being triggered during the unstable operating phase after closing the door.
MODE	↓	
AL.4	0.1 K to 10.0 K	Setting the offset value for door heating Offset to the temperature set-point (inner chamber), standard setting 1.5 K. You can use this value to increase (setting 1.0 K) or decrease (setting 2.0 K) inner chamber humidity.
MODE	↓	

Display	Setting range	Operating function
AL.S	0.0 °C to 60.0 °C	Safety controller set point when set point type is "Limit" (Lit) Limit value, i.e., maximum permitted absolute temperature value. When exceeded, the safety controller triggers an alarm. For technical reasons, the limit value should exceed the temperature set point by at least 2 °C. Typical value: 39.0 °C / 102.2°F.

Or

OL.S	0.1 K to 10 K	Safety controller set point when set point type is "Offset" (OFS) Offset value, i.e., maximum over temperature above the selected set point. When exceeded, the safety controller triggers an alarm. For technical reasons, the offset value should be at least 2 °C (factory setting).
-------------	---------------	---------------------------------------------------------------------------------------------------------------------------------------------------------------------------------------------------------------------------------------------------------------------------------------------------



IL.S	----	Inhibit time. This operating function is not required to operate the chamber. Its value should always be zero.
-------------	------	-----------------------------------------------------------------------------------------------------------------------



AL.S	Lit	Set point type for safety controller: "Limit" (Lit) In operating modes USER and HAND you can define the limit value ("AL.S").
	OFS	Set point type for safety controller: "Offset" (OFS) In operating modes USER and HAND you can define the offset value ("OL.S").



PAH	0 to 999	Max. 3-digit numeric password for locking/unlocking the operating function setting in operating mode LOCK (chap. 7.4) To permit temporary unlocking: select any password ≠ 0. To permit permanent unlocking: set password to "0".
------------	----------	------------------------------------------------------------------------------------------------------------------------------------------------------------------------------------------------------------------------------------------------



PAU	0 to 999	Password setting for access to operating mode USER Remember the modified password or you will no longer be able to access operating mode USER.
------------	----------	----------------------------------------------------------------------------------------------------------------------------------------------------------









Adr	1 to 254	Setting the chamber address Addressing serves for data transfer e.g. via the communication software APT-COM™ 3 DataControlSystem. Do not change standard setting "1".
------------	----------	---------------------------------------------------------------------------------------------------------------------------------------------------------------------------------



d.v.l		Firmware revision of main controller for service / maintenance purposes.
--------------	--	---------------------------------------------------------------------------------



Display	Setting range	Operating function
d 1.2		Firmware revision of safety controller for service / maintenance purposes.
 ↓		
d 1.3		Data record (year) for service / maintenance purposes.
 ↓		
d 1.4		Data record (month) for service / maintenance purposes.
 ↓		
d 1.5		Data record (day) for service / maintenance purposes.
 ↓		
d 1.6		Data set version for service / maintenance purposes.
 ↓		
1C.r	OFF, or -199,9 °C to +300 °C	Temperature adjustment serves to adjust the temperature sensor.
 ↓		
CH.r	OFF, or -10.0 vol.-% to 110.0 vol.-%	CO₂ final value adjustment serves to adjust the CO ₂ sensor.
	<p>The operating function “At.S” specifies the safety controller set point type “Limit” (Lit) or “Offset” (OFS).</p> <ul style="list-style-type: none"> • With set point type “Limit” (Lit), operating function “AL.S” (safety controller set point as limit value) is displayed in operating modes HAND and USER. You can set a limit value . • With set point type “Offset” (OFS), operating function “Ot.S” (safety controller set point as offset value) is displayed in operating modes HAND and USER. You can set an offset value. 	

7.4 Operating mode LOCK: Locking/unlocking of the operating functions' settings by operating mode HAND

To avoid operating functions being changed by unauthorized persons, you can lock the operating functions' settings.

- In operating mode HAND, define a 3-digit numeric password in operating function "PA.H".

Locking the operating functions of operating mode HAND:

- In Normal display, press "EXIT" and "MODE" simultaneously for 3 seconds to access operating mode selection. In the upper display, "OP.H" (operating mode HAND) or "OP.U" (operating mode USER) is displayed.
- Press "▼". In the upper display, "OP.L" (operating mode LOCK) is now displayed. It is visible only if a password was set in operating mode HAND via operating function "PA.H".
- Confirm the selected operating mode with the "MODE" button. The controller returns to Normal display. Setting the operating functions in operating mode HAND is now locked.

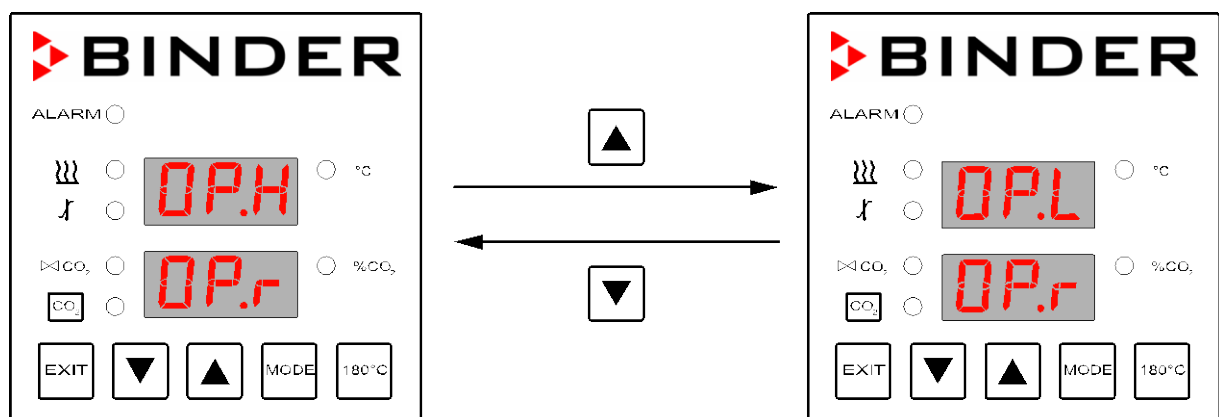

Figure 20: Locking and unlocking the operating functions' settings

Unlocking the operating functions of operating mode HAND:

- In Normal display, press "EXIT" and "MODE" simultaneously for 3 seconds to access operating mode selection. In the upper display, "OP.L" (operating mode LOCK) is displayed.
- Press "▼" to enter operating mode HAND. In the upper display, "OP.H" (operating mode HAND) is displayed.
- Press "MODE". The menu to enter the password is displayed.

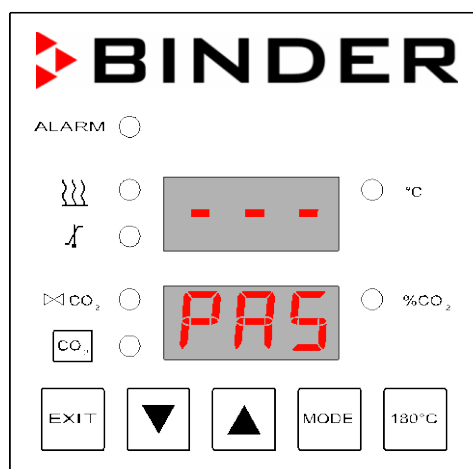



Figure 21: Password request

- Enter the password using the “▲” and “▼” buttons.
- Confirm the entry with “MODE”. The controller returns to Normal display.

If you have selected any password other than zero, operating mode HAND is temporarily unlocked. Changing the operating functions in operating mode HAND is now possible until a period of 30 sec. has passed with no activity. 30 seconds after the last keypad entry, the operating functions are relocked (display “OP.L”).

 To permanently unlock the settings, set operating function “PA.H” to “0” in HAND mode (chap. 7.2).

Display	Setting range	Operating function
	0 to 999	Password request Entry of the password that has been defined in operating mode HAND in operating function “PA.H” (chap. 7.2). The operating functions’ settings in operating mode HAND are temporarily unlocked.

7.5 Performance during and after power failures and shut down

In the event of power failure, all controller functions are taken out of operation. The gas inlet valves are closed so that no gas can escape into the ambient air. The zero-voltage relay alarm output (13) (chap. 10.3) is switched to alarm position indicating the alarm for the whole duration of the power failure.

After the power returns or after turning on the chamber by hand, the incubator regulates the temperature and CO₂ to the last entered set points.

If the chamber was in sterilization mode, the process is cancelled and the chamber continues normal operating mode with the original set points previously entered .

 All settings and set point values remain in the memory during power failure after power off.

8. Controller RP1 settings



8.1 Altitude of the installation site above sea level

After first turning on the incubator, enter the altitude of the site above sea level into the controller RP1. This entry serves to correct the calculation of CO₂ concentration in vol.-% from the measurement of partial pressure. The setting will remain stored after shutting the power off.

Procedure:

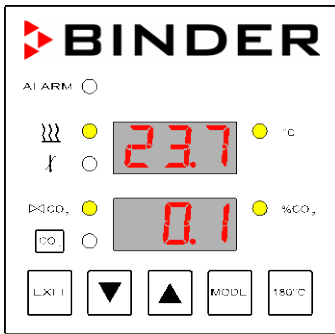
Normal Display



   simultaneously for 3 seconds

Toggle to operating mode USER

Operating mode HAND

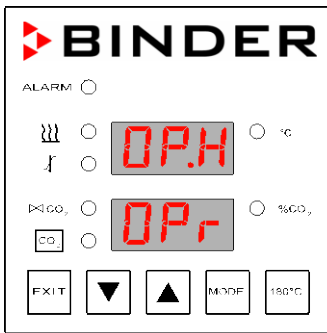

Operating mode USER

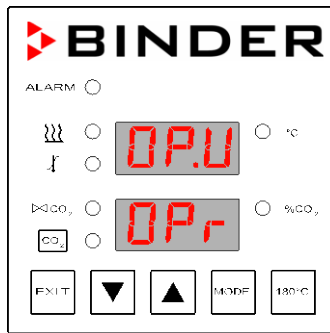

If operating mode HAND appears, toggle to operating mode USER with the arrow keys.

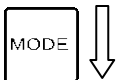

Password request

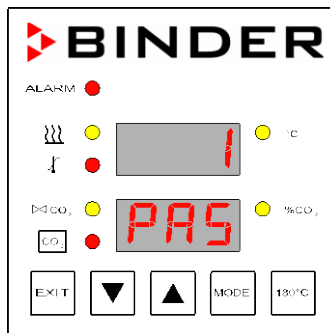
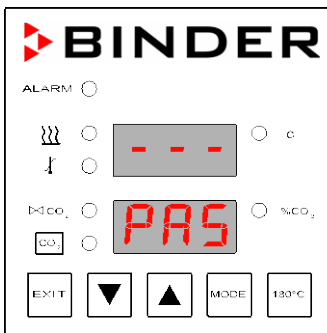

Password entry (factory setting: "1").

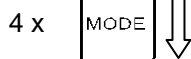

Entry of altitude

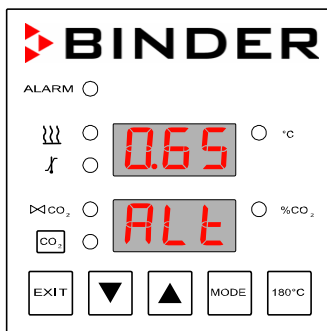

Entry of the current altitude [km] above sea level with arrow keys.



After 30 seconds the controller reverts to Normal Display automatically.

Unit of altitude above sea level for entry and displayed value: kilometer [km]

Correlation feet [ft] to kilometer [km]: see chap. 19.5.

8.2 Entering the set points of temperature and CO₂

Normal Display

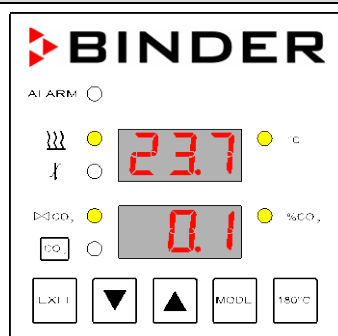

Entry of temperature set point

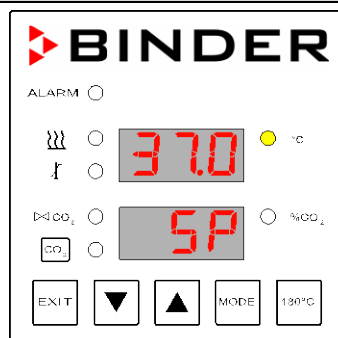

Entry of temperature set point with arrow keys.



Entry of CO₂ set point

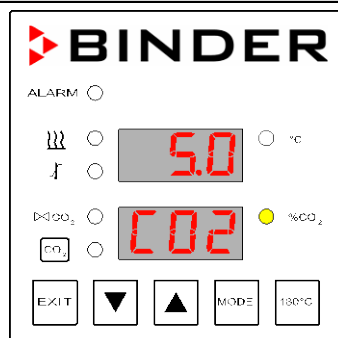

Entry of CO₂ set point with arrow keys.



After 30 seconds the controller reverts to Normal Display automatically.



When setting a lower temperature set point, in order to save time, we recommend cooling down the chamber by turning it off and opening both doors of the chamber.





When setting a lower CO₂ set point, the CO₂ gas must be able to escape first. Open both doors of the chamber for this purpose.



If the CO₂ concentration is indicated as "-0.4", the CO₂ sensor is defective. Please contact BINDER Service.

Note when setting high gas concentrations

Carbon dioxide (CO₂) in high concentrations is hazardous to health. It is colorless and almost odorless and therefore practically imperceptible. Any CO₂ gas that may escape must be safely led out via good room ventilation or a suitable connection to an exhaust system. We recommend installing a CO₂ warning system.

	 WARNING
	<p>High concentration of CO₂ (> 4 Vol.-%). Danger of death by suffocation. Danger of poisoning.</p> <ul style="list-style-type: none"> ⊘ Do NOT set up chambers in non-ventilated recesses. ➤ Ensure technical ventilation measures. ➤ Observe the relevant regulations for handling CO₂.

If CO₂ is released, leave the area und inform the security service or fire department.

9. Temperature safety devices

9.1 Over temperature protective device (class 1)

The CO₂ incubator is equipped with two internal temperature safety devices class 1 acc. to DIN 12880. They serve to protect the chamber and prevent dangerous conditions caused by major defects.

If one of the over temperature protective devices permanently turns off the chamber, the user cannot restart the device again. The protective cut-off devices are located internally. Only a service specialist can replace them. Therefore, please contact an authorized service provider or BINDER Service.

9.2 Safety controller (temperature safety device class 3.1)

The incubator is equipped with an over temperature safety device class 3.1 acc. to DIN 12880. It is designated as the "safety controller". This second, electrically independent temperature controller takes over at a selectable set point in case of a faulty condition. It serves to protect the charging material against extremely high temperatures.

In addition to the temperature set-point (main controller set-point), you can enter an independent safety controller set-point. Example with setting "Limit": set-point = 37 °C, safety controller set-point = 39 °C. During proper operation, the controller controls temperature to the temperature set-point (37 °C). In the event of a defect, which causes temperature to rise above the safety controller set-point of 39 °C, the safety controller takes over and acts independently, limiting the temperature to 39 °C.

The message "otc" on the controller display indicates safety controller activity. The LED "ALARM" flashes, the LED "⚡" is lit. At the same time there is an additional audible alert (buzzer). Pressing the "EXIT" button turns off the audible alarm. When the temperature falls below the safety controller set-point (39 °C), the safety controller hands over to the main controller. Then the alarm message "otc" and the LEDs "ALARM" and "⚡" go off.

	<p>Regularly check the safety controller setting for set point type "Limit" or "Offset". Set the safety controller set point by approx. 2 °C above the desired temperature set point.</p>
-------------------------------------------------------------------------------------	------------------------------------------------------------------------------------------------------------------------------------------------------------------------------------------------

Safety controller set point types:

Limit	<p>Absolute maximum permitted temperature value Example: temperature set point 37 °C / 98.6°F, safety controller set point 39 °C / 102.2°F</p>
Offset	<p>Maximum over temperature above any active temperature set point (e.g., 2 °C). The maximum temperature changes internally and automatically with every set point change.</p>

Factory setting: set point type "Offset" with safety controller set point 2 °C.

 The settings of the safety controller are inactive during sterilization (chap. 15.4). They become functional again following abortion of the sterilization and/or the restart of the chamber at the main power switch.

9.2.1 Setting the safety controller set point type

Select the safety controller set point type in operating mode USER (chap. 7.3). The operating function “At.S” specifies the safety controller set point type “Limit” (Lit) or “Offset” (OFS).

- With set point type “Limit” (Lit), operating function “AL.S” (safety controller set point as limit value) is displayed in operating modes HAND and USER. You can set a limit value.
- With set point type “Offset” (OFS), operating function “Ot.S” (safety controller set point as offset value) is displayed in operating modes HAND and USER. You can set an offset value.

Normal Display



EXIT MODE ↓ simultaneously for 3 seconds

Toggle to operating mode USER

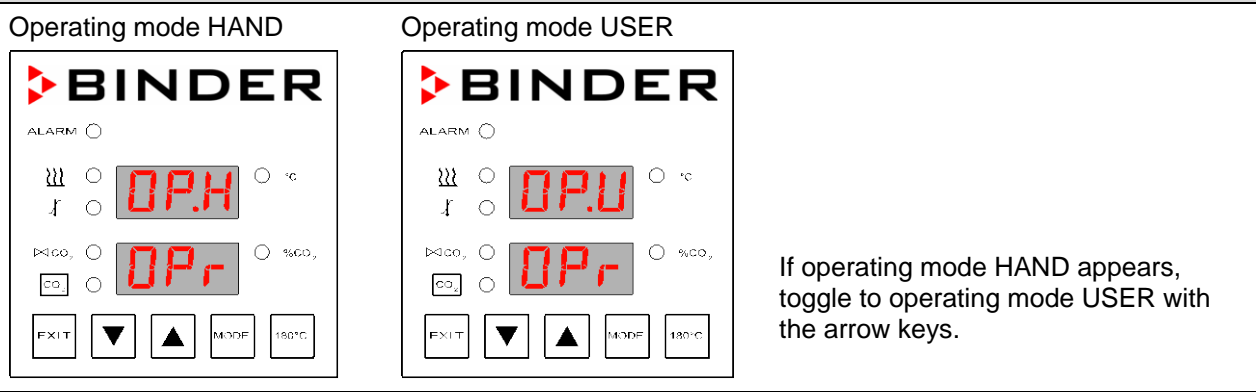

MODE ↓

Password request

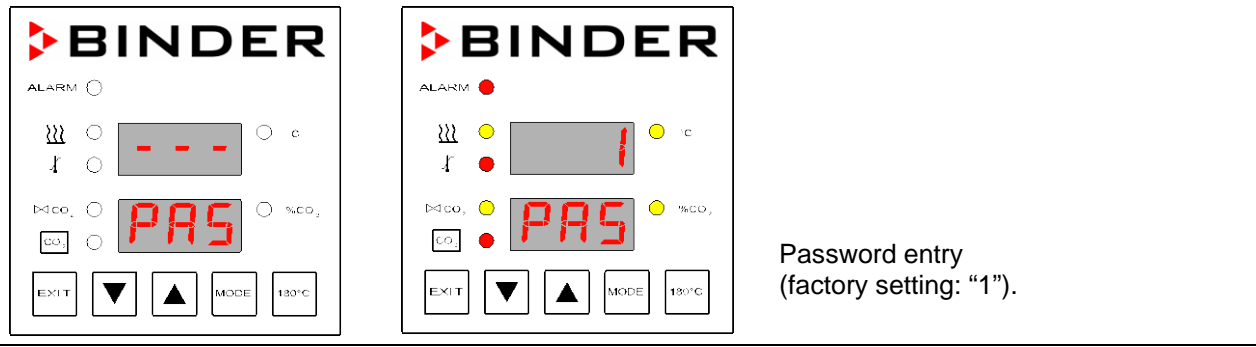

12 x ↓

Selecting the set point type

Selecting set point type "Limit"

Change using the arrow keys

Selecting set point type "Offset"

Select the desired set point type.

↓

After 30 seconds the controller reverts to Normal Display automatically.

9.2.2 Setting the safety controller set point

You can check and set the safety controller set point in operating modes HAND (chap. 7.2) or USER (chap. 7.3).

- With set point type "Limit" (Lit), operating function "**AL.S**" (safety controller set point as limit value) is displayed in operating modes HAND and USER. You can set a limit value.
- With set point type "Offset" (OFS), operating function "**Ot.S**" (safety controller set point as offset value) is displayed in operating modes HAND and USER. You can set an offset value.

The settings of the safety controller are inactive during sterilization (chap. 15.4). They become functional again following abortion of the sterilization and/or the restart of the chamber at the main power switch.

Normal Display

↓ simultaneously for 3 seconds

Toggle to operating mode USER

Operating mode HAND

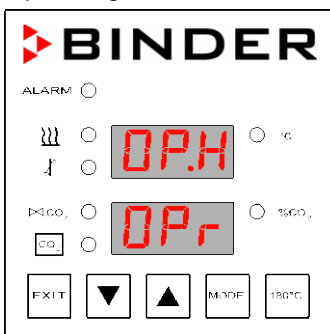

Operating mode USER

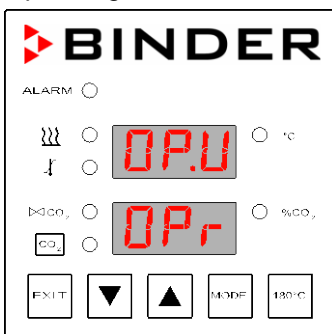

If operating mode HAND appears, toggle to operating mode USER with the arrow keys.

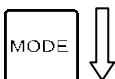

Password request

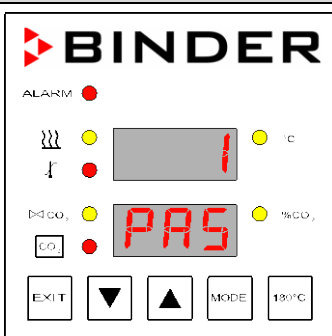
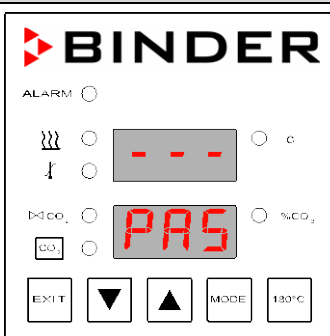

Password entry (factory setting: "1").



Depending on the selected set point type (chap. 9.2.1) a different display appears:

Entry of limit value or offset value

With set point type Limit:
Enter a limit value

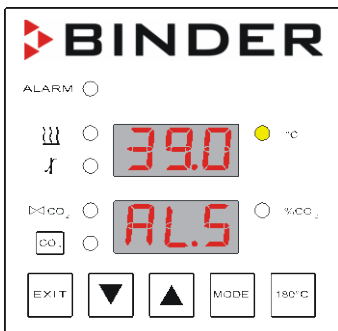

or

With set point type Offset:
Enter an offset value

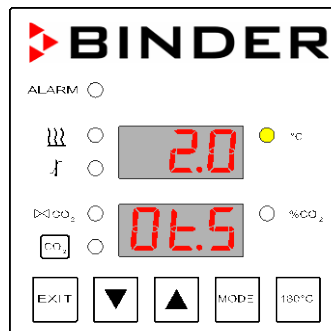

Entry of limit value using the arrow keys.

Entry of offset value using the arrow keys.



After 30 seconds the controller reverts to Normal Display automatically.

10. Alarm functions

10.1 Alarm functions overview

When operational faults occur, the controller triggers visual and audible alarm signals. The LED “ALARM” always flashes when an alarm signal is emitted.

A zero-voltage relay alarm output (13) (chap. 10.3) permits transmission of the alarm e.g., to a central monitoring system.

Display	Event
o t c	Safety controller alarm (set value of the safety controller exceeded)
t o l	Temperature tolerance range alarm
d o r	Door open
c o n	CO ₂ tolerance range alarm
P.L o	CO ₂ pressure too low
997	Failure of temperature sensor for door heating
998	Failure of temperature sensor for safety controller
999	Failure of temperature sensor for interior heating
- - -	CO ₂ sensor not connected
L o c	Sterilization program started with operating mode HAND locked (LOCK) or Sterilization program started with the CO ₂ sensor still plugged-in.

If more than one alarm signal is sent simultaneously, they are displayed in a cycle, except for alarms 995 to 999. These take priority over all other operational displays and alarm signals of the controller.

Except for the tolerance range alarms, all alarms are displayed immediately when the fault occurs. The tolerance range alarms are suppressed for a selected time (delay times set for temperature alarm and for CO₂ alarm) after opening the chamber door or turning on the chamber.

10.2 Resetting the alarm messages

- Remove the cause of the alarm or wait until the chamber compensates for the reason of the error.
- The visual alarm disappears, when the cause of the fault has been remedied or the monitored operating function returns within its tolerance limits.
- Press the “EXIT” button to turn off the audible alarm signals.

10.3 Zero-voltage relay alarm output

Collective alarm output via the zero-voltage relay alarm contact

The CO₂ incubator is equipped at the rear with a zero-voltage relay output for temperature and CO₂, which permits the transmission of alarms to an external monitoring system in order to monitor and record the alarm signals.

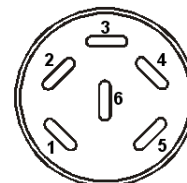

A DIN socket (15) serves to establish this connection.

Figure 22: Pin configuration of the DIN socket (15)

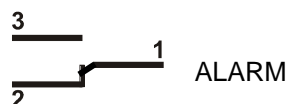

Pin 1: Pole

Pin 2: Break relay



Pin 3: Make contact

In case there is no alarm, contact 1 closes with contact 3.

Closing contact 1 with contact 2 switches the zero-voltage relay alarm output.

The zero-voltage relay alarm output switches immediately, as soon as the red “ALARM” LED lights up on the controller display. The zero-voltage relay alarm output switches for alarm instances listed in chap. 10.1 and in case of power failure.

Maximum loading capacity of the switching contacts: 24V AC/DC – 2.5 Amp.

	 DANGER
	<p>Electrical hazard. Danger of death. Damage to switching contacts and connection socket.</p> <ul style="list-style-type: none"> ∅ Do NOT exceed the maximum switching load of 24V AC/DC – 2.5 Amp. ∅ Do NOT connect any devices with a higher loading capacity.

The alarm message on the controller display remains displayed during transmission of an alarm via the zero-voltage relay outputs.

As soon as the cause of the alarm is identified and resolved, the alarm transmission via the zero-voltage relay outputs resets automatically together with the alarm message on the controller display.

In case of a power failure, transmission of the alarm via zero-voltage relay outputs remains active for the duration of the power failure. Afterwards, contact 1 will close automatically with contact 3.

Connection to an external monitoring system

To ensure short-circuit-proof alarm monitoring that will trigger the alarm when the chamber is connected to an external alarm monitor, connect the external alarm monitoring system to the chamber via the contacts 1 and 3.

10.4 Safety controller temperature alarm

The set temperature value (set point type “Limit” or “Offset”) was exceeded.

- Immediate alarm
- Visual display

LED		Upper display, alternating	
		Temperature	Alarm code
ALARM	Flashes	39.9	otc
	continually lit		

- Audible alarm: buzzer (ongoing sound)
- Switching the zero-voltage relay alarm output.

Actions:

- Check the setting of the operating function “**Al.S**” (limit temperature) or “**Ot.S**” (offset temperature) in operating modes HAND (chap. 7.2) or USER (chap. 7.3). The limit temperature should be at least 2 °C above the temperature set point; the offset temperature should be ≥ 2 °C. If necessary, adjust the relevant value.
- Check whether samples were inserted into the chamber that produce heat under the climatic conditions in the chamber.
- Check the ambient conditions. The ambient temperature must be at least by 7 °C / 12.6°F below the temperature set point of the chamber. Protect the chamber from direct sunlight. Ensure sufficient ventilation around the installation location to prevent any buildup of heat in the chamber.
- Check whether the sterilization cycle was aborted and the chamber has returned to its standard operational status before the chamber has cooled down.
- If points 1 to 4 do not reveal the source of the fault, it may be that the chamber is faulty. Please contact BINDER Service.

10.5 Temperature tolerance range alarm (high and low temperature)

Main controller temperature alarm: The temperature has risen above or fallen below the temperature alarm threshold.

- Immediate alarm

	No alarm signal is emitted during the temperature delay time after the outer door is closed
-------------------------------------------------------------------------------------	---------------------------------------------------------------------------------------------

- Visual display

LED		Upper display, alternating	
		Temperature	Alarm code
ALARM	Flashes	38.2	tol
	Flashes		

- Audible alarm: buzzer (intermittent sound)
- Switching the zero-voltage relay alarm output

Actions:

- Check the setting of the operating function “**AL.1**” (temperature alarm threshold) in operating mode USER (chap. 7.3). The value should be $\geq 1K$. Adjust the value if necessary.
- Use the displayed temperature to verify whether the temperature alarm threshold has been breached, i.e., too cold or too warm.

Temperature too low (under temperature alarm):

- Check that the outer door is closed properly.
- Check the door's seals for any damage. Replace any damaged seals.

Temperature too high (over temperature alarm):

- Check whether samples were inserted into the chamber that produce heat under the climate conditions in the chamber.
- Check the ambient conditions.

The ambient temperature must be at least by 7 °C / 12.6 °F below the temperature set point of the chamber. Protect the chamber from direct sunlight. Ensure sufficient ventilation around the installation location to prevent any buildup of heat in the chamber.

- If points 1 to 6 do not reveal the source of the fault, it may be that the chamber is faulty. Please contact BINDER Service.
- To decrease the temperature, proceed as follows: Turn off the chamber. Open both chamber doors for approx. 5 minutes. Turn on the chamber again. You can restart normal operation as soon as the requested values have equilibrated.



If the same alarm recurs, please contact BINDER Service.

10.6 Door open

The open and closed position of the chamber door is controlled via the door contact switch. If the door is open, the temperature and CO₂ controls turn off.

- Immediate alarm
- Visual display:

LED		Upper display, alternating	
		Temperature	Alarm code
ALARM	flashes	37.0	dor

- Audible alarm: buzzer (intermittent sound, beginning 5 minutes after the door is opened)
- Switching the zero-voltage relay alarm output (beginning 5 minutes after the door is opened)

Actions:



- Close the outer door.
- Use the "EXIT" button to turn off the buzzer even when the door is open.
- The alarm message is cancelled.
- The zero-voltage relay alarm output switches off.

10.7 CO₂ tolerance range alarm (CO₂ over/under concentration)

The main controller CO₂ alarm.

The CO₂ concentration has risen above or fallen below the CO₂ alarm threshold.

- The alarm signal is usually emitted immediately upon the fault occurring, but no alarm signal is emitted during the CO₂ alarm delay time after the outer door is closed.
- Visual display:

LED		Lower display, alternating	
		Percentage CO ₂	Alarm code
ALARM	Flashes		
	Flashes		

- Audible alarm: buzzer (intermittent sound)
- Switching the zero-voltage relay alarm output

Actions:

- Check the setting of the operating function "AL.2" (CO₂ alarm-threshold). The value should be ≥ 1 vol.-% CO₂. If necessary, adjust the value.
- Check that the outer door is closed properly.
- Check the door's seals for any damage. Replace any damaged seals.
- If the above points do not reveal the source of the fault, it may be that the chamber is faulty. Please contact BINDER Service.

In case of a **CO₂ over concentration** alarm, proceed as follows:

- Open both chamber doors for approx. 30 seconds. Respect the precautions when working with CO₂ gas (chap. 1.6).
- Normal operation can be restarted, as soon as the requested values have been readjusted.





If the same alarm recurs, please contact BINDER Service.

10.8 CO₂ pressure too low

The CO₂ primary pressure at the intake valve is less than 0.3 bar / 4.4 psi below the ambient air pressure.

The alarm displays show a pressure drop of CO₂ admission below 0.3 bar / 4.4 psi. Check whether the gas cylinder is open.

- Immediate alarm
- Visual display:

LED		Lower display, alternating	
		Percentage CO ₂	Alarm code
ALARM	Flashes		
	Flashes		

- Audible alarm: buzzer (intermittent sound)
- Switching the zero-voltage relay alarm output

Actions:

- Check that you have set the pressure on the pressure reducer at 2.0 bar / 29 *psi* above the ambient air pressure, and that all the valves are open for the gas supply.
- Where the CO₂ supply is a pressurized gas cylinder, check that the cylinder still contains sufficient CO₂. If necessary, replace the gas cylinder. Observe the precautions when handling gases and the correct outlet pressure (chap. 4.4).
- Check whether the primary pressure is high enough at the central CO₂ supply.
- Check that the gas tube has no damage, kinks, blockages or soiling.
- Check when the gas filter was last replaced. Replace the gas filter every year to avoid it blocking. A qualified service engineer should replace the gas filter.
- If points 1 to 5 do not reveal the source of the fault, it may be that the chamber is faulty. Please contact BINDER Service.

The outlet pressure of the gas cylinder must be 2.0 bar / 29 *psi* above the ambient pressure.

	CAUTION
	<p>Excessive outlet pressure > 2.5 bar / 36 <i>psi</i>. Damage to the chamber.</p> <ul style="list-style-type: none"> ⊘ The outlet pressure must NOT exceed the indicated value of 2.5 bar / 36 <i>psi</i>. ➤ Before connecting, check the outlet pressure on the pressure reducer of the cylinder. ➤ Adjust the cylinder outlet pressure to 2.0 bar / 29 <i>psi</i> above the ambient pressure.

The recovery times of the gas concentrations inside the chamber following the door being opened, which are indicated in the technical data (chap. 19.4), refer to a connection pressure of 2.0 bar / 29 *psi*. Decreasing supply pressure down to the alarm point of 0.3 bar / 4.4 *psi* results in longer recovery times. Check the pressure displays of your gas supply. If very short recovery times are required or the door is opened frequently, replace the gas cylinders promptly when the pressure decreases below 2.0 bar / 29 *psi*.

10.9 Temperature sensor failure

A sensor fault alarm display takes priority over all other operational displays and alarm signals on the controller.

- Immediate alarm
- Visual display:

LED	Upper Display, flashing Alarm code	Meaning
ALARM Flashes	999	Failure of temperature sensor for interior heating: interior heater is turned off
	990	Failure of the safety controller's temperature sensor: all heaters are turned off
	997	Failure of temperature sensor for door heating: door heater is turned off

- Audible alarm: buzzer (intermittent sound)
- Switching the zero-voltage relay alarm output

Actions:

- Turn off the chamber.
- If necessary, clean and disinfect the chamber. Automatic sterilization is not possible with this fault.
- Please contact BINDER Service.

10.10 Failure of CO₂ sensor

If the CO₂ concentration is indicated as "-0.4", the CO₂ sensor is defective (sensor rupture).

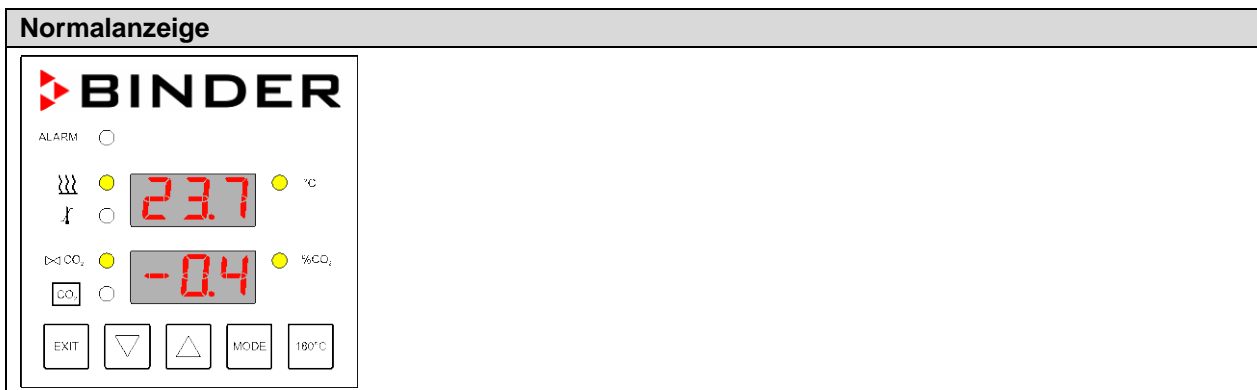

Actions:

- Turn off the chamber.
- If necessary, clean, disinfect and sterilize the chamber.
- Please contact BINDER Service.

11. Error messages

While the controller is operating, or when you turn it on or change the operation mode, fault signals may be emitted that are caused by the controller malfunctioning internally.

Visual display (examples):

LED		Upper display	Lower display
ALARM	Flashes	Er.	5
ALARM	Flashes	Er.5	168
ALARM	Flashes	3.	
ALARM	Flashes	A.	

Actions:

- Turn off the chamber with the main power switch.
- Disconnect the power plug.
- Wait for 1 minute.
- Replace the power plug.
- Turn on the chamber with the main power switch.
- If the fault shows again, the chamber could be faulty. Please contact BINDER Service.

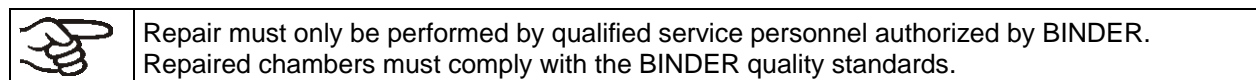

12. Reference measurements

You can take reference measurements of the temperature and CO₂ via the silicone measuring port (8) located the inner glass door. Reference temperature measurements always take place under equilibrated conditions with both doors closed.

12.1 CO₂ reference measuring

There are three possibilities to perform CO₂ test measurements between the recommended annual maintenance procedures. To test the CO₂ concentration inside an incubator, see chapters 12.1.1 to 12.1.3.

12.1.1 Measuring the CO₂ concentration indirectly via the pH of the cell medium

By using the indirect determination of CO₂ concentration via the pH-value of the nutrient, it is possible to check the CO₂ concentration inside the chamber. This is a simple method to test the correct CO₂ concentration without any special CO₂ measuring equipment. You need only use an accurate pH indicator or a pH-measuring electrode, which are standard equipment in cell culture laboratories.



This method is not suitable for calibrating the BINDER FPI sensor system.

This method is based on the acid base equilibrium of the buffer system in the culture media.

NaHCO₃ buffers the common media. From the pH value of the medium, it is possible to conclude its CO₂ concentration. Figure 23 shows the relationship between CO₂ concentration in vol.-% and the pH of different NaHCO₃ buffered media.

Recommended procedure:

- Incubate an empty sample with medium for 1/2 day under the same conditions as the cells. You can perform the incubation in a cell culture bottle or in a 50 ml Falcon tube with open lid.
- After gassing, remove the empty sample from the incubator and within 5 minutes measure the pH-value with a glass electrode.

During the measurement, the medium should have the least possible surface contact with the ambient air, so that the CO₂ can evaporate only slightly. A significant downward movement will happen only after 5 minutes, permitting sufficient time for measurement.

- In addition, you can of course use pH-test strips (pH range 6 to 8, non-bleeding).

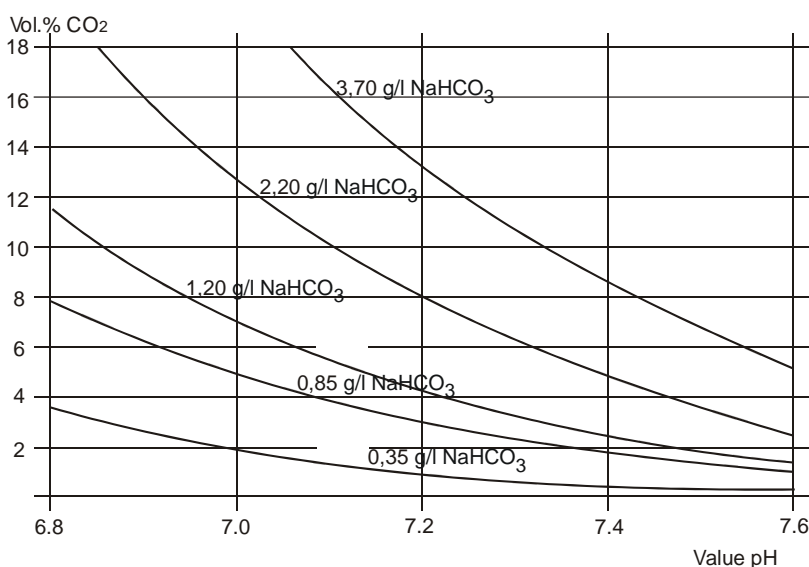

Trade names of common media:	
	NaHCO ₃ [g/l]
DMEM	3.70
BME	2.20
MEM	2.20
Medium 199	2.20
Mc Coy	2.20
F10	1.20
F12	1.20

Figure 23: Value pH of NaHCO₃ buffered media as a function of the CO₂ concentration:

Example:

If a pH of 7.2 is measured in a medium buffered with 2.20 g NaHCO₃ per liter, there must be 8 vol.-% CO₂ surrounding this medium.

12.1.2 Measuring CO₂ directly via chemical indicator tubes

This is a common do-it-yourself test for many users. A chemical color reaction in a glass tube shows the CO₂ concentration. A standardized volume of air from inside the incubator has to be suctioned through this glass tube to get a quantitative test result. Therefore, use a special hand pump with a standardized suction volume.

Procedure (example):

- (1) Break off both ends of the glass tube or remove the plugs.
- (2) Pin the end with the higher end of the scale to the adapter of the hand pump that belongs to that test system.
- (3) Pin the other end through the silicone access port of the inner chamber door.
- (4) Take one sample volume out of the inner chamber volume by pressing the pump fully together and releasing it afterwards.
- (5) The standardized volume is suctioned through the glass tube and the chemical indicator changes its color beginning from the side pinned into the chamber in the direction of the hand pump.
- (6) The more CO₂ is inside the chamber the more the chemical reaction will cause a color change of the chemical reactor.
- (7) You can read the CO₂ concentration by the scale directly printed on the glass tube or a delivered reference-reading rule.
- (8) The result must then be corrected to the current ambient pressure. The required formula is printed on the instruction sheet of such systems.

All the necessary equipment must be supplied by one manufacturer only and in a defined test system.

Note: These test systems are not very accurate. A typical accuracy is around 10% of the full-scale value.

 These test systems are not suitable for calibrating the BINDER FPI sensor system.



Figure 24: Example of chemical indicator tubes



Figure 25: Example of a hand pump (foreground) and electrical pump (background)

12.1.3 Measuring CO₂ directly with an electronic infrared measuring device

The easiest way of measuring the CO₂ concentration is by electronic sensor systems. BINDER offers the portable measuring device model CTM 01 that was specifically designed to measure temperature and CO₂ concentration inside CO₂ incubators. The CTM 01 is suitable both for reference measurements in certified laboratories, and for service purposes. Please contact the BINDER INDIVIDUAL team.

12.2 Temperature reference measurement

When performing a temperature reference measurement using an electronic measuring, and temperature display device, it is important to use a device traceable to an acknowledged standards/calibration institution (DKD, PTB for Germany) with valid calibration certificate.

Note: The cable of the sensor must be thin enough to lay it over the door gasket of the incubator without causing any leakages.

13. Options

13.1 Silicone access ports 30 mm / 1.18 in, closable with 2 silicone plugs (8012-0558 rear, 8012-0559 left, 8012-0560 right) (option)

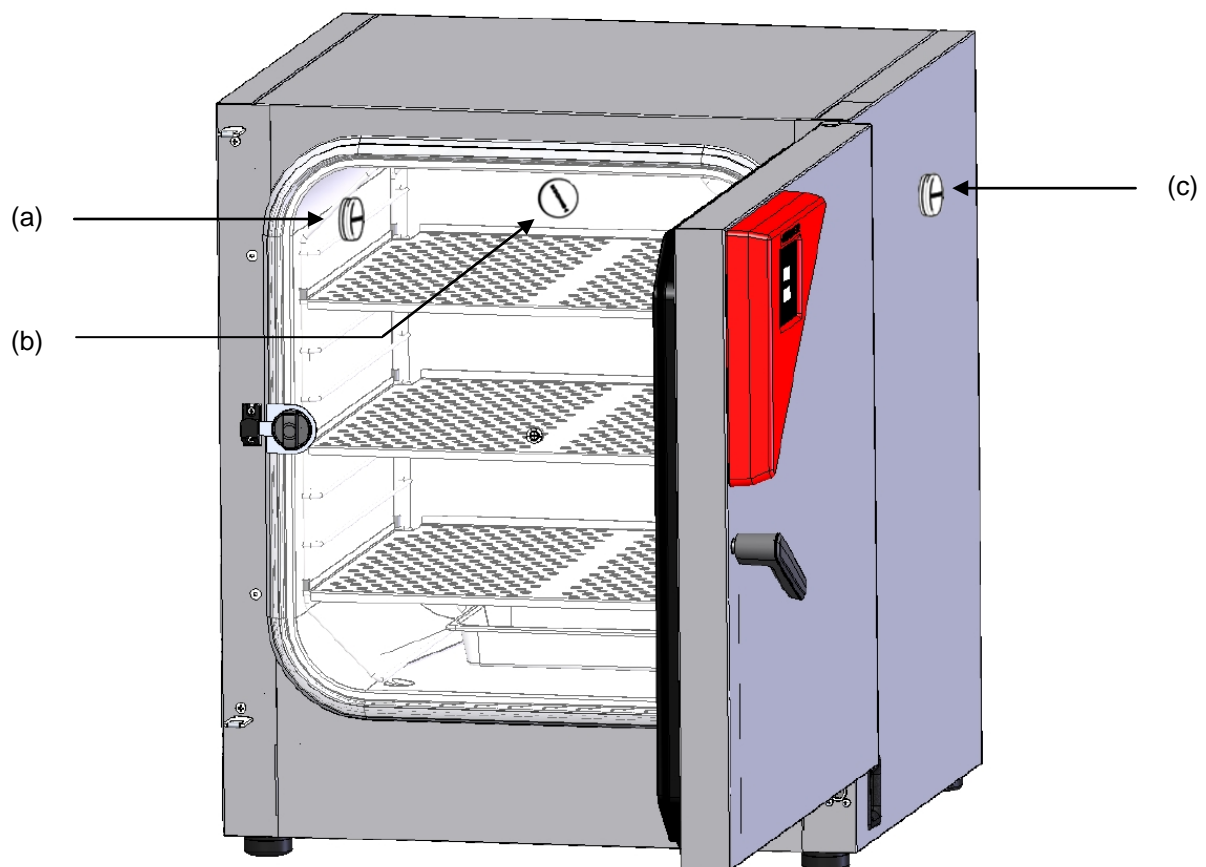



Figure 26: Positions of the optional silicon access ports left (a), rear (b), and right (c)

A warning sticker is located above each access port.

When operating a chamber with silicon access ports, both silicon plugs must tightly close the access ports. If the plugs are inserted in a not-gastight manner, or if plugs are missing, CO₂ gas may escape into the environment. The CO₂ control only turns off when the chamber door is opened.

	 WARNING
	<p>High concentration of CO₂ (> 4 Vol.-%). Risk of death by suffocation. Danger of poisoning.</p> <p>➤ Tightly close each access port with two plugs during operation.</p>

13.2 Base on castors (option)

In order to obtain easy access to the incubator and to avoid contamination of the incubator caused by soil pollution, BINDER recommends using the base on castors.

	<p>The mounting instructions 7001-0147 delivered with the base on castors describe its installation (Art. No. 9051-0024).</p>
-----------------------------------------------------------------------------------	-------------------------------------------------------------------------------------------------------------------------------

13.3 Stacking adapter for direct thermal decoupled stacking (option)

We recommend not stacking CO₂ incubators directly on top of one another in order to avoid transmission of shocks and vibrations from one chamber to the other. This could happen e.g. while opening or closing the door, cleaning, loading and unloading the chamber. BINDER offers a stacking adapter for direct thermal decoupled stacking of two incubators.

The stacking adapter ensures the exact maintenance of the set incubation parameters also during sterilization of the other chamber in the same stacking stand (chap. 15.4).

	<p>The mounting instructions 7001-0145 delivered with the stacking adapter describe its installation (Art. No. 9051-0025 for 2 C 170, Art. No. 9051-0027 for C 170 on top of CB 150/160).</p>
-------------------------------------------------------------------------------------	-----------------------------------------------------------------------------------------------------------------------------------------------------------------------------------------------

13.1 Analog outputs for temperature and CO₂ (option)

With this option, the CO₂ incubator is equipped with analog outputs 4-20 mA for temperature and CO₂. These outputs allow transmitting data to external data registration systems or devices.

The connection is realized as a DIN socket at the rear of the CO₂ incubator as follows:

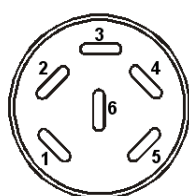

ANALOG OUTPUT 4-20 mA DC

PIN 1: Temperature –
 PIN 2: Temperature +'
 PIN 3: CO₂ –
 PIN 4: CO₂ +

CO₂ range: 0 vol.-% up to 20 vol.-%
 Temperature range: 0 °C / 32 °F up to +200 °C / 392 °F

A suitable DIN plug is enclosed.

Figure 27: Pin allocation of DIN socket for option analog outputs

14. Avoiding microbial contamination

The main types of microbial contaminants in cell and tissue culture are bacteria, fungi, yeast, mycoplasma, and viruses. This chapter gives an overview of potential sources of contamination and precautions and measures to eliminate them.

14.1 Cells and media

- Primary cultures from the original tissue
- Cells/cell lines from unknown sources or from cell banks: Use only cells of known and tested origin. Monitoring and routine screening of new cultures.
- Media and sera: Use only sera of known and tested origin (mycoplasma free, e.g., UV or γ radiated).
- Virus suspensions, antibody solutions etc. Use only reagents of known and tested origin.
- Laboratory instruments, media and reagents, which were exposed to possible contaminated cultures must be sterilized / autoclaved / disposed.
- Antibiotics in the cell culture media may prevent bacteria detection: Use antibiotics selectively and economically.

14.2 Laboratory conditions / equipment around the incubator

Possible sources of contamination in the cell culture lab are airborne germs, lab equipment, building features, and the lab personnel.

- Keep pipettes and instruments sterile after autoclaving.
- Bio safety cabinets (laminar air flow) should have a minimum of items apart from aspirator tube and burner. Items shall be positioned within easy reach and separate from each other. Disinfect surfaces with an alcohol-based disinfectant before and after use, clean the space underneath the bench, and carry out regular sterility tests of the filters.
- Regular cleaning / disinfection of laboratory equipment such as a centrifuge, microscope, water bath, refrigerator, and telephone.
- No equipment should be placed on the floor.
- Rough or humid walls are not suitable.
- Identify leaking doors and windows and make them airtight.
- Use air conditioning with special filters.
- Reduce the number of personnel and their movements in the lab by careful positioning all relevant equipment. For practical reasons, install the CO₂ incubator close to the laminar air flow bench.
- Regular microbiological monitoring of the cell culture laboratory.

14.3 Working and behavior in the lab

Sources of contamination are often the laboratory personnel themselves (surface germs, oral flora droplet transfer) and handling the equipment and cultures. We recommend staff training in aseptic techniques, laboratory safety and good laboratory practice (GLP).

Examples of general rules to reduce the contamination risks

- Reduce hand germ count (wash hands with antimicrobial soap, dry with paper tissues, and rub dry hands with alcoholic solution).
- Wear appropriate clothing (work coat, shoes, face mask)
- Keep as few personnel as possible in the cell culture lab.

Examples of sterile working method

- Work "clean-to-dirty", i.e., handle confirmed uncontaminated cells first, unknown or untested cells next, and lastly, if necessary, cells suspected to be contaminated.
- Perform daily microscopic observations of cultures and specific tests for the bacteria and fungi as part of a controlled routine. Test cultures for sterility before starting work.
- Keep working surfaces clean. Immediately wipe spilled liquids with alcohol solutions.
- No mouth contact on pipettes.
- Never work on top of open sterile containers.

14.4 Chamber design and equipment

The design concepts behind the CO₂ incubator C 170 considerably reduce the risk of contamination. Among them are:

Even surfaces for easy manual cleaning

- The inner surfaces are smooth and therefore easy to clean. The inner chamber is deep-drawn from a single piece of steel, polished (suitable for pharmaceutical work) and has no welds or inaccessible corners. The hinges and the seal of the inner glass door are glued from the outside, which also aids cleaning of the inner chamber.

Removable parts for cleaning and autoclaving

- The shelves and the shelf holder are easily removed without screws. In this way, you can clean them hygienically in every laboratory dishwasher before hot-air sterilization. It is possible to autoclave the shelves. But this is generally not necessary because they can remain inside the incubator during sterilization.

Door gasket

- The inner door gasket is removable and autoclavable.

Gas fine filter

- The incoming gas used in the operation passes through a fine filter (aseptic filter, filtration efficiency 99.99%, particle size 0.45 µm) with a high filtration efficiency, which can also filter the smallest particles (chap. 16.3).

CO₂ measuring system in the inner chamber

- You can remove the CO₂ sensor from the inner chamber by hand for disinfection (chap. 15.3).

Condensation prevention

- Condensation in the inner chamber represents a particular risk of contamination. The humidifying system with water pan with integrated condensation point developed by BINDER is an effective and easy way to ensure high humidity (95 ± 2% r.H.) inside the incubator without any condensation forming on the inner surfaces.

Hot air sterilization at 180 °C / 356 °F

- The heating system of the chamber permits hot-air auto-sterilization (chap. 15.4). Thus, a temperature of 180 °C / 356 °F is maintained for a 30-minute period on all internal surfaces during its cycle, resulting in sterilization of the entire inner chamber. Therefore, this procedure meets all international guidelines regarding hot air sterilization, e.g. AAMI ST63, DIN 58947, European Pharmacopoeia.

14.5 Handling the CO₂ incubator

Any manipulation of the CO₂ incubator involves some contamination risks, from installation to opening of the doors and regular cleaning.

Installation away from sources of contamination

- Do not place the CO₂ incubator on the floor or close to windows and doors. Use the optional stand, if appropriate.

Reduce the periods in which the door is open.

- Do not open the door too frequently.
- Placing items in order inside the incubator results in shorter door opening times.

Water pan

- Fill the water pan with distilled, sterilized water (chap. 4.3). Never use ion exchange water; ion exchangers are propagation sites for bacteria.
- Clean and refill the pans 2 to 3 times a week. For evacuation, remove the water pan. It is autoclavable.
- If desired, you can add microbiologically inhibiting substances such as copper chips, copper sulphate or ethylene diamine tetra-vinegar acid (EDTA) in a concentration of 1 to 5 mmol/l.

Avoiding condensation caused by ambient conditions

- Ambient room conditions have an effect on condensation inside the incubator, which can be caused by insufficient wall clearances, preventing even dissipation of heat, air movement or direct sunlight. If the temperature distribution inside the chamber becomes uneven, condensation may form on the cooler surfaces.
- Maintain distances from the wall: rear 100 mm / 3.94 in, sides 50 mm / 1.97 in.
- Do not place the chamber in front of a window. No direct sunlight. No air movement.
- Permissible ambient temperature range for operation: +18 °C / 64.4°F to +30 °C / 86°F. Ideal ambient temperature: at least 7 degrees below the intended working temperature. E.g., working temperature 37 °C / 98.6°F = ambient temperature 30 °C / 86°F and less.
- The incubator should be precisely calibrated / adjusted.

Regular cleaning, decontamination, and sterilization





- Clean the shelves, glass door, gaskets, and inner chamber weekly (for cleaning see chap. 15.1, for decontamination see chap. 15.2). You can clean the shelves in a laboratory dishwasher and, if needed, individually autoclave them.
- Regularly use the hot air sterilization function (chap. 15.4) following cleaning. Shelves, shelf holders and the emptied water pan can remain inside the incubator during this operation.
- Replace the CO₂ sterile filter (once or twice a year depending on usage).

What to do in case of contamination?

- Throw away / autoclave contaminated cultures.
- Carefully inspect cultures that seem to be uncontaminated.
- Clean the incubator as described. Wipe the inner chamber and the doors with a disinfectant and allow to dry. Autoclave the shelves. Empty the water pan and autoclave it.
- Perform hot air sterilization.

15. Cleaning, decontamination / disinfection, and sterilization

Clean the chamber after each use to avoid potential corrosion damage by ingredients of the charging material.

  	 DANGER
	<p>Electrical hazard. Danger of death.</p> <ul style="list-style-type: none"> Ø Do NOT spill water or cleaning agents over the inner and outer surfaces. ➤ Before cleaning, turn off the chamber at the main power switch (2) and disconnect the power plug. ➤ Completely dry the appliance before turning it on again.

15.1 Cleaning

Disconnect the CO₂ incubator from the power supply before cleaning. Disconnect the power plug.

	The interior of the chamber must be kept clean. Thoroughly remove any residues of the charging material.
-----------------------------------------------------------------------------------	----------------------------------------------------------------------------------------------------------

Wipe the surfaces with a moistened towel. In addition, you can use the following cleaning agents:

Exterior surfaces, instrument panel:	Standard commercial cleaning detergents free from acid or halides. Alcohol-based solutions. We recommend using the neutral cleaning agent Art. No. 1002-0016.
Inner chamber, shelf holders, shelves, water pan:	Standard commercial cleaning detergents free from acid or halides. Copper sulphate solutions or alcohol-based solutions. We recommend using the neutral cleaning agent Art. No. 1002-0016.
CO ₂ sensor	Alcohol-based solutions Do not immerse the CO ₂ sensor into the solution. Disinfection with alcohol or an alcohol-based surface disinfectant without corrosive effect, free from acid or halides. We recommend using the disinfectant spray Art. No. 1002-0022.
Silicone door gasket:	Alcohol-based solutions or neutral cleaning agent Art. No. 1002-0016.
Zinc coated hinge parts, rear chamber wall	Standard commercial cleaning detergents free from acid or halides. Do NOT use a neutral cleaning agent on zinc coated surfaces.

Do not use cleaning agents that may cause a hazard due to reaction with components of the device or the charging material. If there is doubt regarding the suitability of cleaning products, please contact BINDER service.

	We recommend using the neutral cleaning agent Art. No. 1002-0016 for a thorough cleaning. Any corrosive damage that may arise following use of other cleaning agents is excluded from liability by BINDER GmbH.
-------------------------------------------------------------------------------------	-----------------------------------------------------------------------------------------------------------------------------------------------------------------------------------------------------------------

	CAUTION
	<p>Danger of corrosion. Damage to the chamber.</p> <ul style="list-style-type: none"> Ø Do NOT use acidic or chlorine cleaning detergents. Ø Do NOT use the neutral cleaning agent on other kind of surfaces e.g., the zinc coated hinge parts or the rear chamber wall.

	For surface protection, perform cleaning as quickly as possible. After cleaning completely, remove any cleaning agents from the surfaces with a moistened towel. Let the chamber dry.
-----------------------------------------------------------------------------------	------------------------------------------------------------------------------------------------------------------------------------------------------------------------------------------



	Soapsuds may contain chlorides and must therefore NOT be used for cleaning.
-----------------------------------------------------------------------------------	-----------------------------------------------------------------------------

	With every cleaning method, always use adequate personal safety controls.
-----------------------------------------------------------------------------------	---------------------------------------------------------------------------

Following cleaning, leave the chamber door open or remove the access port plugs.

	The neutral cleaning agent may cause health problems in contact with skin and if ingested. Follow the operating instructions and safety hints labeled on the bottle of the neutral cleaning agent.
-----------------------------------------------------------------------------------	----------------------------------------------------------------------------------------------------------------------------------------------------------------------------------------------------

Recommended precautions: To protect the eyes use sealed protective goggles. Suitable protective gloves with full contact: butyl or nitrile rubber, penetration time >480 minutes.

	 CAUTION
	<p>Contact with skin, ingestion. Skin and eye damage due to chemical burns.</p> <ul style="list-style-type: none"> Ø Do not ingest. Keep away from food and beverages. Ø Do NOT empty into drains. ➤ Wear protective gloves and goggles. ➤ Avoid skin contact.

	Following use of the neutral cleaning agent and prior to hot-air sterilization, remove any agent residues by using a moistened towel in order to avoid formation of permanent residues.
-------------------------------------------------------------------------------------	-----------------------------------------------------------------------------------------------------------------------------------------------------------------------------------------

15.2 Decontamination / chemical disinfection of the CO₂ incubator

The operator must ensure that proper decontamination is performed in case a contamination of the chamber by hazardous substances has occurred.

Disconnect the CO₂ incubator from the power supply prior to chemical decontamination / disinfection. Pull the power plug.

Do not use decontamination agents that may cause a hazard due to reaction with components of the device or the charging material. If there is doubt regarding the suitability of cleaning products, please contact BINDER service.

You can use the following disinfectants:

Inner chamber	Standard commercial surface disinfectants free from acid or halides. Alcohol-based solutions. We recommend using the disinfectant spray Art. No. 1002-0022.
---------------	-------------------------------------------------------------------------------------------------------------------------------------------------------------------

	For chemical disinfection, we recommend the disinfectant spray Art. No. 1002-0022. Any corrosive damage that may arise following use of other disinfectants is excluded from liability by BINDER GmbH.
-------------------------------------------------------------------------------------	--------------------------------------------------------------------------------------------------------------------------------------------------------------------------------------------------------



With every decontamination / disinfection method, always use adequate personal safety controls.

In case of contamination of the interior by biologically or chemically hazardous material, there are two possible procedures depending on the type of contamination and charging material.

1. Spray the inner chamber with an appropriate disinfectant.



Before start-up, the chamber must be absolutely dry and ventilated, as explosive gases may form during the decontamination process.

2. You can sterilize the shelves and the shelf holder in a sterilizer or autoclave.



In case of eye contact, the disinfectant spray may cause eye damage due to chemical burns. Follow the operating instructions and safety hints labeled on the bottle of the disinfectant spray.

Recommended precautions: To protect the eyes use sealed protective goggles.

	<p style="text-align: center;"> VORSICHT</p> <p>Eye contact. Eye damage due to chemical burns.</p> <ul style="list-style-type: none"> ⊘ Do NOT empty into drains. ➤ Wear protective goggles.
------------------------------------------------------------------------------------	---------------------------------------------------------------------------------------------------------------------------------------------------------------------------------------------------------------------------------------------------------------------------------------------------------------------------------



Following frequent use of the disinfectant spray and prior to hot-air sterilization, remove any agent remainder by using the neutral cleaning agent and then a moistened towel to avoid formation of permanent residues.



After using the disinfectant spray, allow the incubator to dry thoroughly, and aerate it sufficiently.

15.3 Disinfection of the CO₂ sensor

To ensure complete disinfection and proper function of the sensor, BINDER recommends a wipe disinfection of the sensor head with pure alcohol or non-corrosive alcohol-based surface disinfectants. The disinfectant must be non-corrosive and free of chlorine or any acid. We recommend using the disinfectant Art. No. 1002-0022. Avoid strong shocks when handling the CO₂ sensor.

	CAUTION
	<p>Excess temperature. Immersion of sensor into liquids. Shocks of the CO₂ sensor. Damage to the CO₂ sensor.</p> <ul style="list-style-type: none"> ⊘ Do NOT immerse the CO₂ sensor into liquids. ⊘ Do NOT expose the CO₂ sensor to autoclaving. ⊘ Do NOT expose the CO₂ sensor to hot-air sterilization. ➤ Avoid strong shocks of the CO₂ sensor (by putting it down hard, or dropping).

We recommend regular disinfection of the CO₂ sensor.

	CAUTION
	<p>Connecting or removing the CO₂ sensor during operation. Damage to the CO₂ sensor.</p> <ul style="list-style-type: none"> ➤ Connect or remove the CO₂ sensor only with the chamber turned off.

Recommended procedure:

- Turn off the chamber
- Pull out the sensor
- Spray the sensor head with alcohol or wipe it clean with a soaked cloth. Observe the reaction time of the disinfectant used.
- Before reinserting the CO₂ sensor, it must be completely dry.
- The filter in the front of the sensor only needs replacing when damaged or dirty.

The CO₂ sensor head was especially adjusted for the specific chamber. To avoid confusion, an adhesive label with a serial number is adhered to the sensor head. When exchanging the sensor, repeat CO₂ adjustment.

	CAUTION
	<p>Different CO₂ sensor. Invalid calibration.</p> <ul style="list-style-type: none"> ⊘ Do NOT change the CO₂ sensor head. ➤ Write down the serial number of the CO₂ sensor.

15.4 Hot-air sterilization at 180 °C / 356 °F



The very first sterilization after operation may cause an odor. This is not a quality defect. We recommend ventilating well the room during sterilization.

15.4.1 Overview

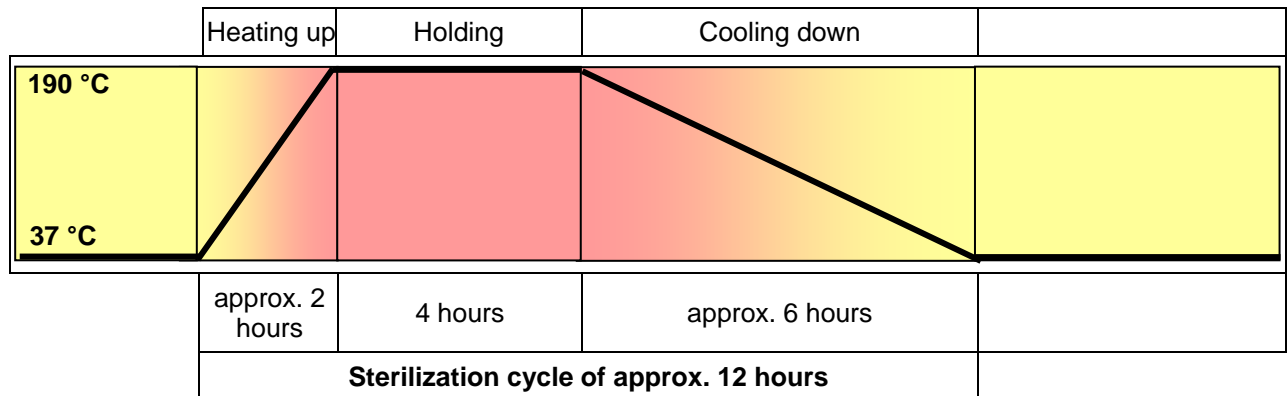

Figure 28: Set-point profile during the sterilization cycle

The chamber can perform an automatically controlled hot-air sterilization cycle. This procedure will take approx. 12 hours and consists of the following steps:

- **Heating up phase:** The incubator heats up the inner chamber as fast as possible to the sterilization set-point temperature
- **Holding phase:** Constant sterilization set-point temperature
The sterilization set-point temperature is pre-set in factory to 190 °C / 374 °F. When this temperature is reached, the holding phase begins. The duration of the holding phase is in total 4 hours. This ensures that 180 °C / 356 °F is maintained on all internal surfaces for at least 30 minutes.
- **Cooling down phase:** until 37 °C / 98.6°F is reached.

When 37 °C / 98.6 °F ± 1 ° is reached, the display "End" in the lower controller display (Figure 32 page 67) indicates the end of the sterilization procedure.

The precise duration of the entire sterilization cycle depends on the ambient temperature at the installation site and can thus vary. At an ambient temperature of 25 °C / 77 °F, the total duration is approx. 12 hours. You can shorten the cooling-down time by aborting the sterilization cycle (chap. 15.5) during the cooling-down phase, i.e. no sooner than after 6 hours.

During sterilization, the CO₂ valve is closed and the CO₂ controller turns off entirely.

15.4.2 Procedure for hot-air sterilization:



Before carrying out the first hot-air sterilization, remove any protective lamination sheet from the inner metal surfaces.



When starting a hot-air sterilization, CO₂ control automatically becomes inactive.



The safety controller settings are inactive during sterilization. They become functional again following abortion of the sterilization and/or restart of the chamber at the main power switch.

Recommended procedure:

- Turn off the chamber
- Pull out the CO₂ sensor without any rotation from the connection socket in the upper part of the rear and remove it from the inner chamber.



The CO₂ sensor is temperature resistant up to a maximum temperature of 60 °C / 140 °F. It is therefore required to remove it before performing a hot-air sterilization.

	CAUTION
	<p>Excess temperature. Damage to the CO₂ sensor.</p> <p>∅ Do NOT expose the CO₂ sensor to hot-air sterilization.</p>

The CO₂ sensor head was especially adjusted for your specific chamber. To avoid confusion, an adhesive label with a serial number is adhered to the sensor head. When exchanging the sensor, repeat CO₂ control adjustment.

	CAUTION
	<p>Different CO₂ sensor. Invalid calibration.</p> <p>∅ Do NOT change the CO₂ sensor head. ➤ Write to down the serial number of the CO₂ sensor.</p>

- Empty the water pan.

	 WARNING
	<p>Danger of implosion. Damage to the chamber.</p> <p>➤ Empty the water pan before starting the hot-air sterilization.</p>

- Clean the chamber.
- Water pan, shelf holder, and shelves must be inside the incubator, the water pan at its usual place on the bottom.
- Close the inner glass door and the outer chamber door.
- Turn on the chamber.
- Activate the sterilization procedure: Press the controller button “180 °C” for 3 seconds to access the sterilization program.

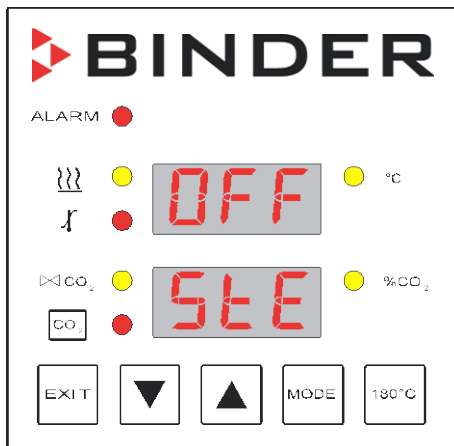
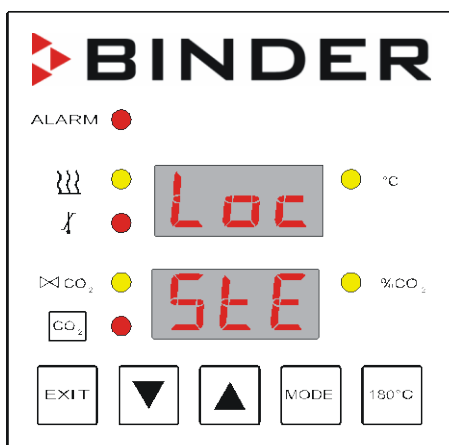

Figure 29: Initial sterilization display

No sterilization can be started if the CO₂ sensor is still plugged-in.



You cannot start the sterilization if the operating mode HAND is locked. This is displayed by an error message. If this happens, unlock the operating mode HAND (chap. 7.4).

Figure 30: Error message if operating mode HAND is locked or if the CO₂ sensor is still plugged-in.

- Press “▲”.
The upper display toggles from “OFF” to “ON”.
- Press “MODE” to start the sterilization cycle.
The upper display toggles between the current interior temperature in °C and “StE”.
The indication “ - - - ” in the lower display shows that the CO₂ sensor is disconnected.

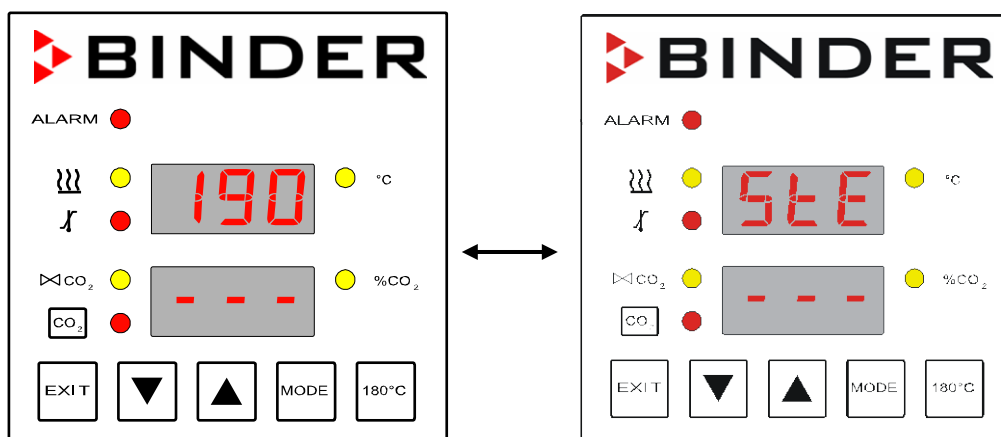

Figure 31: Alternating display during sterilization

	CAUTION
	<p>The glass door and inner chamber become hot during sterilization. Danger of burning.</p> <p>∅ Do NOT touch the glass door and inner surfaces during sterilization.</p>

	CAUTION
	<p>Interruption of the temperature reaction time. Ineffective sterilization.</p> <p>∅ Do NOT open the chamber doors during sterilization.</p>

- The sterilization cycle ends after approx. 12 hours, when the lower display shows “End”.

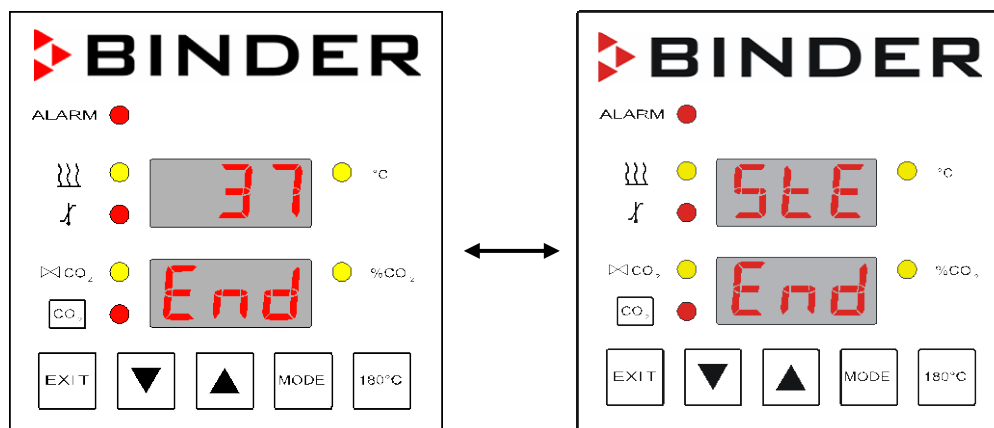

Figure 32: Alternating display at the end of sterilization

- Turn off the chamber or press “180 °C”, or open the outer door.
- When the inner chamber has cooled down to a value below 60 °C / 140 °F, turn off the chamber and plug in the CO₂ sensor.

	<p>The CO₂ sensor is temperature resistant up to a maximum temperature of 60 °C / 140 °F</p>
--	---------------------------------------------------------------------------------------------------------

- Turn on the chamber (chap. 5).

The chamber is now ready to operate.



15.5 Aborting the hot-air sterilization

If the sterilization procedure is aborted prematurely, whether effective sterilization has occurred depends on the time that has elapsed:

- Aborting sterilization after less than 6 hours: Prevents effective sterilization.
- Aborting sterilization after more than 6 hours: The chamber is definitely in the cooling-down phase, meaning that the necessary duration for the proper sterilization phase has occurred.

Aborting sterilization during the cooling-down phase (after more than 6 hours)



The duration of the entire sterilization is approx. 12 hours. If you want to shorten the sterilization procedure in order to save time, you can abort it during the cooling-down phase, i.e. no sooner than after 6 hours. At this point, the inner temperature is still approx. 140 °C / 284 °F.

	 CAUTION
	<p>Glass door and inner chamber become hot during sterilization. Danger of burning.</p> <p>⊘ Do NOT touch the glass door and inner surfaces for approx. 4 hours after aborting sterilization.</p>

Aborting sterilization after less than 6 hours

When aborting the sterilization prematurely, it may be that the cells/pathogens inside the chamber have not all been killed. You should repeat the sterilization.

	CAUTION
	<p>Interruption of temperature reaction time. Ineffective sterilization.</p> <p>➤ Repeat the sterilization.</p>

	 CAUTION
	<p>Glass door and inner chamber become hot during sterilization. Danger of burning.</p> <p>⊘ Do NOT touch the glass door and inner surfaces for approx. 7 hours after aborting sterilization.</p>

- When the inner chamber has cooled down to a value below 60 °C / 140 °F, turn off the chamber and plug in the CO₂ sensor.



The CO₂ sensor is temperature resistant up to a maximum temperature of 60 °C / 140 °F

- Turn on the chamber (chap. 5).

Three events which can abort the automatic sterilization cycle prematurely:

- A manual abortion (chap. 15.5.1)
- Opening the outer door (chap. 15.5.2)
- Turning off the power to the chamber or a brief power failure (chap. 15.5.3)

15.5.1 Aborting the hot-air sterilization manually

You can abort the sterilization cycle manually.

- Press the controller button "180 °C" for three seconds during the sterilization cycle.
 The lower display will show the operating function "StE", and the value "ON" will appear in the upper display.
- Press "▲".
 The upper display toggles from "ON" to "OFF".
- Press "MODE" to end the sterilization cycle.
- Do not open the chamber doors until the interior temperature has dropped to 37 °C / 98.6°F.

- After a manual abortion, the chamber reverts to its standard operational status. The indication “ - - - ” in the lower display shows that the CO₂ sensor is disconnected.

As long as the interior temperature remains above the temperature set to trigger the temperature alarm, the chamber will trigger alarm signals. You can ignore this alarm and turn off the buzzer of the safety controller by pressing “EXIT”.

- If necessary, repeat the sterilization.
- When the inner chamber has cooled down to a value below 60 °C / 140 °F, turn off the chamber and plug in the CO₂ sensor.



The CO₂ sensor is temperature resistant up to a maximum temperature of 60 °C / 140 °F

- Turn on the chamber (chap. 5).

15.5.2 Aborting the hot-air sterilization by opening the outer door

For safety reasons, the sterilization cycle is automatically aborted if you open the outer chamber door.

- Do not open the glass door and close the outer door immediately.
- After an abortion caused by opening the outer door, the chamber reverts to its standard operational status. The indication “ - - - ” in the lower display shows that the CO₂ sensor is disconnected.

As long as the interior temperature remains above the temperature set to trigger the temperature alarm, the chamber will trigger alarm signals. You can ignore this alarm and turn off the buzzer of the safety controller by pressing “EXIT”.

- If necessary, repeat the sterilization.
- When the inner chamber has cooled down to a value below 60 °C / 140 °F, turn off the chamber and plug in the CO₂ sensor.



The CO₂ sensor is temperature resistant up to a maximum temperature of 60 °C / 140 °F

- Turn on the chamber (chap. 5).

15.5.3 Aborting the hot-air sterilization using the main power switch

For safety reasons, the sterilization cycle is aborted if the chamber is turned off or if there is a power failure.

Normally you should not terminate sterilization in this way.

- Do not open the chamber doors until the interior temperature has dropped to 37 °C / 98.6 °F.
- After turning on again the chamber, it reverts to its standard operational status. The indication “ - - - ” in the lower display shows that the CO₂ sensor is disconnected.

As long as the interior temperature remains above the temperature set to trigger the temperature alarm, the chamber will trigger alarm signals. You can ignore this alarm and turn off the buzzer of the safety controller by pressing “EXIT”.

- If necessary, repeat the sterilization.
- When the inner chamber has cooled down to a value below 60 °C / 140 °F, turn off the chamber and plug in the CO₂ sensor.





The CO₂ sensor is temperature resistant up to a maximum temperature of 60 °C / 140 °F

- Turn on the chamber (chap. 5).

16. Maintenance, and service

16.1 Maintenance intervals, service

 	 DANGER
<p>Electrical hazard. Danger of death.</p> <ul style="list-style-type: none"> ∅ The chamber must NOT become wet during operation or maintenance work. ∅ Do NOT remove the chamber's rear panel. ➤ Before conducting maintenance work, turn off the chamber at the main power switch (2) and disconnect the power plug ➤ Ensure all maintenance work is conducted by licensed electricians or experts authorized by BINDER. 	

Ensure regular maintenance work is performed at least once a year.

	The warranty becomes void if maintenance work is conducted by non-authorized personnel.
-----------------------------------------------------------------------------------	-----------------------------------------------------------------------------------------

	Replace the door gasket only when cold. Otherwise, the door gasket may become damaged.
-----------------------------------------------------------------------------------	----------------------------------------------------------------------------------------

The CO₂ sensor was especially adjusted for the specific chamber. When exchanging the sensor, you must repeat the CO₂ adjustment.

We recommend taking out a maintenance agreement. Please consult BINDER Service.

BINDER telephone hotline:	+49 (0) 7462 2005 555
BINDER fax hotline:	+49 (0) 7462 2005 93555
BINDER e-mail hotline:	service@binder-world.com
BINDER service hotline USA:	+1 866 885 9794 or +1 631 224 4340 x3 (toll-free in the USA)
BINDER service hotline Asia Pacific:	+852 390 705 04 or +852 390 705 03
BINDER service hotline Russia and CIS:	+7 495 988 15 16
BINDER Internet website:	http://www.binder-world.com
BINDER address:	BINDER GmbH, post office box 102, D-78502 Tuttlingen

International customers, please contact your local BINDER distributor.

16.2 Checking the air jacket heating fan

The user should regularly perform the following checks:

When the chamber is operating, you will be able to observe the air jacket heating fan centered at the top of the chamber by looking through the ventilation slides at the rear. During operation, the fan must turn counter-clockwise continuously. For better monitoring, you can turn off the chamber and wait until the fan has stopped.

16.3 Gas inlet fine filter

When the chamber is operating, the incoming gas passes through a fine gas filter (aseptic filter, filtration efficiency 99.99%, particle size 0.45 µm). The gas fine filter prevents dirt accumulating in the gas inlet valves and the tubes leading into the inner chamber, which could be in the gas cylinder or in the supply tubes.

Service personnel authorized by BINDER will check this filter for pollution at each maintenance interval and replace it, if appropriate, but at least once a year.

16.4 Sending the chamber back to BINDER GmbH

If you return a BINDER product to us for repair or any other reason, we will only accept the product upon presentation of an **authorization number** (RMA number) that has previously been issued to you. An authorization number will be issued after receiving your complaint either in writing or by telephone **prior** to your sending the BINDER product back to us. The authorization number will be issued following receipt of the information below:

- BINDER product type and serial number
- Date of purchase
- Name and address of the dealer from which you bought the BINDER product
- Exact description of the defect or fault
- Complete address, contact person and availability of that person
- Exact location of the BINDER product in your facility
- A contamination clearance certificate (chap. 22) must be faxed in advance

The authorization number must be applied to the packaging in such a way that it can be easily recognized or be recorded clearly in the delivery documents.



For security reasons we cannot accept a chamber delivery if it does not carry an authorization number.

Return address:

BINDER GmbH
Abteilung Service

Gänsäcker 16
78502 Tuttlingen
Germany

17. Disposal

17.1 Disposal of the transport packing

17.1.1 Outer chamber packing

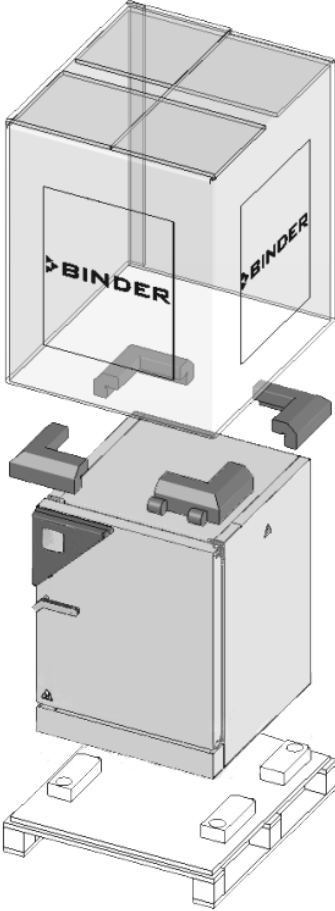
Packing element	Material	Disposal
	Straps to fix packing on pallet (no image)	Plastic Plastic recycling
	Shipping box	Cardboard Paper recycling
	Edge stuffing, top	PE foam Plastic recycling
	Pallet with foamed plastic stuffing	PE foam Plastic recycling
		Solid wood (IPPC standard) Wood recycling

17.1.2 Packing inside the chamber, equipment

Packing element	Material	Disposal
Door protection	PE foam	Plastic recycling
Packing box equipment	Cardboard	Paper recycling
Insulating air cushion foil	PE foil	Plastic recycling
Paperboard	Cardboard	Paper recycling
Silica gel bag	Paper with silica gel	Do not open. Dispose of with normal waste
Sensor packing	Cardboard	Paper recycling
	PE foam	Plastic recycling
Bag for operating manuals	PE foil	Plastic recycling



If recycling is not possible, all packing parts can also be disposed of with normal waste.

17.2 Decommissioning

- Turn off the main power switch (2) and disconnect the chamber from the power supply (pull the power plug).
- Turn off the CO₂ supply. Remove the gas connection.
- Let the inner chamber sufficiently cool down before removing any parts.
- The water pan must not remain filled while the incubator is out of operation. Otherwise condensation may occur on the inner surfaces, as well as in the injection and suction nozzle of the CO₂ sensor compartment. If condensation formation has occurred, drops of condensate would leak from the openings of injection and suction nozzle of the CO₂ sensor. In this case, clean and dry the incubator running at 37 °C / 98.6 °F with doors open for at least one hour before loading it with samples. BINDER recommends performing a hot air sterilization of the chamber before commissioning.
- Disassembling the shelf holder takes place inside the chamber. Remove the shelves. Then fold both lateral parts to the middle and remove them.



You cannot take out the shelf holder of the incubator entirely together with the shelves.

- Temporal decommissioning: See indications for appropriate storage, chap. 3.3.
- Final decommissioning: Dispose of the chamber as described in chap. 17.3 to 17.5.

When restarting the chamber, please pay attention to the corresponding information in chap. 6.2.

17.3 Disposal of the chamber in the Federal Republic of Germany

According to Annex I of Directive 2012/19/EU of the European Parliament and of the Council on waste electrical and electronic equipment (WEEE), BINDER devices are classified as “monitoring and control instruments” (category 9) only intended for professional use“. They must not be disposed of at public collecting points.

The chambers bear the symbol for the marking of electrical and electronic equipment manufactured / placed on the market in the EU after 13 August 2005 and be disposed of in separate collection according to Directive 2012/19/EU on waste electrical and electronic equipment (WEEE) and German national law for electrical and electronic equipment (Elektro- und Elektronikgerätegesetz, ElektroG). WEEE marking: crossed-out wheeled bin with solid bar under. A significant part of the materials must be recycled in order to protect the environment.

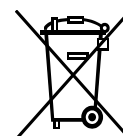



At the end of the device's service life, have the chamber disposed of according to the German national law for electrical and electronic equipment (Elektro- und Elektronikgerätegesetz, ElektroG from 20 October 2015, BGBl. I p. 1739) or contact BINDER service who will organize taking back and disposal of the chamber according to the German national law for electrical and electronic equipment (Elektro- und Elektronikgerätegesetz, ElektroG from 20 October 2015, BGBl. I p. 1739).

	<h3>CAUTION</h3>
	<p>Violation against existing law.</p> <ul style="list-style-type: none"> ⊘ Do NOT dispose of BINDER devices at public collecting points. ➤ Have the device disposed of professionally at a recycling company which is certified according to the German national law for electrical and electronic equipment (Elektro- und Elektronikgerätegesetz, ElektroG from 20 October 2015, BGBl. I p. 1739). <li style="text-align: center;"><i>or</i> ➤ Instruct BINDER Service to dispose of the device. The general terms of payment and delivery of BINDER GmbH apply, which were valid at the time of purchasing the chamber.

Certified companies disassemble waste (used) BINDER equipment in primary substances for recycling according to Directive 2012/19/EU. The devices must be free from toxic, infectious or radioactive substances in order to eliminate any health hazards to the employees of the recycling companies.

	<p>Prior to handing the chamber over to a recycling company, it is the user's responsibility that it is free from toxic, infectious or radioactive substances.</p> <ul style="list-style-type: none"> • Prior to disposal, clean all introduced or residual toxic substances from the chamber. • Prior to disposal, disinfect the chamber from all sources of infection. Be aware that sources of infection may also be located outside the inner chamber. • If you cannot safely remove all toxic substances and sources of infection from the chamber, dispose of it as "special" waste according to national law. • Fill out the contamination clearance certificate (chap. 22) and enclose it with the chamber.
-----------------------------------------------------------------------------------	---------------------------------------------------------------------------------------------------------------------------------------------------------------------------------------------------------------------------------------------------------------------------------------------------------------------------------------------------------------------------------------------------------------------------------------------------------------------------------------------------------------------------------------------------------------------------------------------------------------------------------------------------------------------------------------------------------------------------------------------------------------

	 WARNING
	<p>Contamination of the device with toxic, infectious or radioactive substances. Danger of intoxication. Danger of infection.</p> <ul style="list-style-type: none"> ⊘ NEVER take a chamber contaminated with toxic substances or sources of infection for recycling according to Directive 2012/19/EU. ➤ Prior to disposal, remove all toxic substances and sources of infection from the chamber. ➤ A chamber from which all toxic substances or sources of infection cannot be safely removed must be considered as "special" waste according to national law. Dispose of it accordingly.

17.4 Disposal of the chamber in the member states of the EU except for the Federal Republic of Germany

According to Annex I of Directive 2012/19/EU of the European Parliament and of the Council on waste electrical and electronic equipment (WEEE), BINDER devices are classified as "monitoring and control instruments" (category 9) only intended for professional use". They must not be disposed of at public collecting points.

The chambers bear the symbol for the marking of electrical and electronic equipment manufactured / placed on the market in the EC after 13 August 2005 and be disposed of in separate collection according to the Directive 2012/19/EU on waste electrical and electronic equipment (WEEE). WEEE marking: crossed-out wheeled bin with solid bar under.

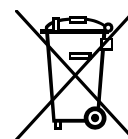



At the end of the device's service life, notify the distributor who sold you the device, who will take back and dispose of the chamber according to the Directive 2012/19/EU on waste electrical and electronic equipment (WEEE).

	CAUTION
	<p>Violation against existing law.</p> <ul style="list-style-type: none"> ⊘ Do NOT dispose of BINDER devices at public collecting points. ➤ Have the device disposed of professionally at a recycling company that is certified according to conversion of the Directive 2012/19/EU into national law. <i>or</i> ➤ Instruct the distributor who sold you the device to dispose of it. The agreements apply that were agreed with the distributor when purchasing the chamber (e.g. his general terms of payment and delivery). ➤ If your distributor is not able to take back and dispose of the chamber, please contact BINDER service.

Certified companies disassemble waste (used) BINDER equipment in primary substances for recycling according to Directive 2012/19/EU. The devices must be free from toxic, infectious or radioactive substances in order to eliminate any health hazards to the employees of the recycling companies.

	<p>Prior to handing the chamber over to a recycling company, it is the user's responsibility that it is free from toxic, infectious or radioactive substances.</p> <ul style="list-style-type: none"> • Prior to disposal, clean all introduced or residual toxic substances from the chamber. • Prior to disposal, disinfect the chamber from all sources of infection. Be aware that sources of infection may also be located outside the inner chamber. • If you cannot safely remove all sources of infection and toxic substances from the chamber, dispose of it as "special" waste according to national law. • Fill out the contamination clearance certificate (chap. 22) and enclose it with the chamber.
-----------------------------------------------------------------------------------	---------------------------------------------------------------------------------------------------------------------------------------------------------------------------------------------------------------------------------------------------------------------------------------------------------------------------------------------------------------------------------------------------------------------------------------------------------------------------------------------------------------------------------------------------------------------------------------------------------------------------------------------------------------------------------------------------------------------------------------------------------------

	<div style="background-color: #FFA500; text-align: center; padding: 5px;"> WARNING</div> <p>Contamination of the device with toxic, infectious or radioactive substances. Danger of intoxication. Danger of infection.</p> <ul style="list-style-type: none"> ⊘ NEVER take a chamber contaminated with toxic substances or sources of infection for recycling according to Directive 2012/19/EU. ➤ Prior to disposal, remove all toxic substances and sources of infection from the chamber. ➤ A chamber from which all toxic substances or sources of infection cannot be safely removed must be considered as "special" waste according to national law. Dispose of it accordingly.
-----------------------------------------------------------------------------------	-----------------------------------------------------------------------------------------------------------------------------------------------------------------------------------------------------------------------------------------------------------------------------------------------------------------------------------------------------------------------------------------------------------------------------------------------------------------------------------------------------------------------------------------------------------------------------------------------------------------------------------------------------------------------------------------------------------------------------------------------------------------------------------------------------------------------------------------------

17.5 Disposal of the chamber in non-member states of the EU

	<div style="background-color: #FFFF00; text-align: center; padding: 5px;">CAUTION</div> <p>Alteration of the environment.</p> <ul style="list-style-type: none"> ➤ For final decommissioning and disposal of the CO₂ incubator, please contact BINDER Service. ➤ Follow the statutory regulations for appropriate, environmentally friendly disposal.
-------------------------------------------------------------------------------------	--------------------------------------------------------------------------------------------------------------------------------------------------------------------------------------------------------------------------------------------------------------------------------------------------------------------------------------------------------------------------------------------------------

The main board of the CO₂ incubator includes a lithium cell. Please dispose of it according to national regulations.

18. Troubleshooting

Fault description	Possible cause	Required measures
General		
Chamber without function.	No power supply.	Check connection to power supply.
	Wrong voltage.	Check power supply for voltage of 120 V / 230 V.
	Nominal temperature exceeded by 10 °C due to chamber failure. Over temperature protective device (class 1) responds (chap. 9.1).	Contact BINDER service.
	The miniature fuse for overcurrent protection has triggered (chap. 19.2).	Check chamber fuse and replace it if appropriate. If it responds again, contact BINDER service.
	Controller defective.	Contact BINDER service.
Message "dor" is displayed.	The outer chamber door is not closed properly.	Close chamber door properly.
Heating		
Chamber does not heat up.	Pt 100 sensor defective.	Contact BINDER service.
	Heating element defective.	
	Semiconductor relay defective.	
Temperature inside too low.	Doors not closed.	Close door properly.
	Door gaskets defective.	Replace door gaskets.
	Controller defective.	Contact BINDER service.
	Pt 100 sensor defective.	
	Controller not adjusted.	Calibrate and adjust controller.
Temperature inside too low. Message "tol" is displayed (temperature tolerance range alarm)	Doors not closed.	Close door properly.
	Door gaskets defective.	Replace door gaskets.
	Wrong controller setting.	Check and, if appropriate, set the operating function "AL.12" (temperature alarm threshold) (chap. 7.3). Value should be ≥ 1 K.
Temperature inside too high.	Installation site too warm.	Select cooler place of installation (chap. 3.4).
	Difference between the set temperature and the ambient temperature too low.	Difference between the set temperature and the ambient temperature at least 7°.
	Too much external heat load.	Reduce heat load.
	Controller defective.	Contact BINDER service.
	Semiconductor relay defective.	
	Controller not adjusted.	Calibrate and adjust controller
Temperature inside too high. Message "tol" is displayed (temperature tolerance range alarm).	Installation site too warm.	Select cooler place of installation (chap. 3.4).
	Difference between the set temperature and the ambient temperature too low.	Difference between the set temperature and the ambient temperature at least 7°.
	Too much external heat load.	Reduce heat load.
	Semiconductor relay defective.	Contact BINDER service.
	Wrong controller setting.	Check and, if appropriate, set the operating function "AL.12" (temperature alarm threshold) (chap. 7.3). Value should be ≥ 1 K.

Fault description	Possible cause	Required measures
Heating (continued)		
Temperature inside too low. Message "otc" is displayed (safety controller alarm).	Limit temperature reached. Safety controller (chap. 9.2) set too low.	Check the setting of the safety controller. Choose a suitable limit value (chap. 9.2).
Temperature inside too high. Message "otc" is displayed (safety controller alarm).	Controller defective.	Contact BINDER service.
	Safety controller (chap. 9.2) defective.	
Chamber heating permanently, set point not held.	Semiconductor relay defective.	Contact BINDER service.
	Controller defective.	
Message "End" is displayed	Sterilization cycle completed.	Start up the chamber (chap. 5).
Gas		
Pressure alarm. Message "P.Lo" is displayed (low pressure alarm).	CO ₂ cylinder is not connected correctly.	Correctly connect the gas cylinder.
	Connected gas cylinder is closed or empty.	Open or replace gas cylinder.
	Gas hose is dirty or obstructed.	Check the tube system for dirt accumulation or obstruction, clean or replace it.
	Pressure sensor system defective	Contact BINDER service.
CO ₂ concentration inside too low (controller display).	Doors not closed.	Close door properly.
	Door gaskets defective.	Replace door gaskets.
	CO ₂ cylinder is not connected correctly.	Correctly connect the gas cylinder.
	Connected gas cylinder is closed or empty.	Open or replace gas cylinder.
	Gas hose is dirty or obstructed.	Check the tube system for dirt accumulation or obstruction, clean or replace it.
	CO ₂ sensor defective.	Contact BINDER service.
	Controller not adjusted.	Calibrate and adjust controller
CO ₂ concentration inside too low (controller display). Message "con" is displayed (CO ₂ tolerance range alarm)	Doors not closed.	Close door properly.
	Door gaskets defective.	Replace door gaskets.
	Wrong controller setting.	Check and, if appropriate, set the operating function "AL.2" (CO ₂ alarm threshold) (chap. 7.3). Value should be $\geq 1.0 \text{ vol.-%CO}_2$.
CO ₂ concentration inside too high (controller display).	CO ₂ sensor defective.	Contact BINDER service.
	Controller defective	
	Controller not adjusted.	Calibrate and adjust controller
CO ₂ concentration inside too high (controller display). Message "con" is displayed (CO ₂ tolerance range alarm)	Wrong controller setting.	Check and, if appropriate, set the operating function "AL.2" (CO ₂ alarm threshold) (chap. 7.3). Value should be $\geq 1.0 \text{ vol.-%CO}_2$.
Actual value of CO ₂ deviates largely compared with a reference method. The pH indicator of the cell medium changes its normal color	CO ₂ sensor system defective.	Transfer the cultures to another incubator and contact BINDER Service.
Recovery time (up to 5 vol.-% CO ₂) after doors were open for 2 minutes is < 2 minutes.	CO ₂ sensor system defective.	Contact BINDER service.
Recovery time (up to 5 vol.-% CO ₂) after doors were open for 2 minutes is > 10 minutes.	Obstructed gas supply.	Check gas supply (cylinder, connections, hose system).
	Insufficient CO ₂ input pressure.	
	Gas fine filter obstructed.	Contact BINDER service.

Fault description	Possible cause	Required measures
Heating (continued)		
Unusually high gas consumption.	Door gaskets defective.	Replace door gaskets.
	Gas sensor defective.	Contact BINDER service.
	Gas fine filter not connected correctly	Contact BINDER service.
Humidity		
No or too low humidity inside.	Water pan empty.	Fill the water pan with water up to the marking on the inner pan with distilled, sterile water. The pan must have thorough contact to the bottom of the inner chamber (chap. 4.3).
Condensations inside the chamber.	Water pan filled with water when incubator is not operating	Empty water pan when incubator is not operating.
	Doors not closed.	Close door properly.
	Door gaskets defective.	Replace door gaskets.
Condensation on the door.	Chamber placed on very cold floor.	Place the chamber on a BINDER stand to increase the distance to the floor.
	Doors not closed.	Close door properly.
	Door gaskets defective.	Replace door gaskets.
	Door heating defective	Contact BINDER service.
Controller		
No chamber function. Dark display.	Main power switch is off.	Turn on the main power switch.
No entries to controller keypad possible.	Keyboard locking activated.	Unlock keyboard locking (chap. 7.4).
No access to menu "USER".	User code incorrect.	Contact BINDER service.
EXIT button does not cancel the alarm indication.	Cause of disturbance not removed correctly The EXIT button permits resetting alarm messages for temperature and CO ₂ only with in a tolerance sector of +/- 1 °C resp. +/- 1 vol.-%	Remove cause of disturbance. If the EXIT button still does not cancel the indication, contact BINDER service.
CO ₂ concentration shown as "-0.4"	Failure of CO ₂ sensor.	Contact BINDER service.
Alarm message "997" is displayed	Failure of temperature sensor for door heating	Contact BINDER service.
Alarm message "998" is displayed	Failure of temperature sensor for safety controller	Contact BINDER service.
Alarm message "999" is displayed	Failure of temperature sensor for interior heating	Contact BINDER service.
Alarm message " - - - " is displayed	CO ₂ sensor not connected	Connect the CO ₂ sensor.
Alarm message "Loc"	Sterilization program started with operating mode HAND locked (LOCK).	Enter the password for unlocking and then start again the sterilization.
	Sterilization program started with the CO ₂ sensor still plugged-in.	Pull the CO ₂ sensor and remove it from the incubator.



Only qualified service personnel authorized by BINDER must perform repair. Repaired chambers must comply with the BINDER quality standards.

19. Technical description

19.1 Factory calibration and adjustment

This chamber was calibrated and adjusted in the factory. Calibration and adjustment were performed using standardized test instructions, according to the QM DIN EN ISO 9001 system applied by BINDER (certified since December 1996 by TÜV CERT). All test equipment used is subject to the administration of measurement and test equipment that is also a constituent part of the BINDER QM DIN EN ISO 9001 systems. They are controlled and calibrated to a DKD-Standard at regular intervals.

A record of this calibration and adjustment is part of the BINDER test certificate of the chamber.

Adjustment in factory:

- **Temperature:** 37 °C / 98.6 °F measured in the center of the usable volume
- **CO₂:** 0 vol.-% CO₂ (100 vol.-% N₂) and 5 vol.-% CO₂ (sensor head directly exposed to analyzed test gas)

Suitable reference methods applicable for the user for comparison between reference measuring results and the display readings of the controller(s) are explained in chap. 12.

During factory calibration and adjustment, an electronic temperature measuring and display device is used, which is traceable to an acknowledged standards/calibration institution (DKD or PTB for Germany), bearing a valid calibration certificate.

During factory calibration and adjustment, test gases with an analyzed concentration and with adapted flow quantity serve to calibrate the sensor system for CO₂. The sensor head is exposed directly to the test gas.

19.2 Over current protection

A miniature fuse accessible from the outside protects the device against over current. The miniature fuse is located at the rear of the chamber below the strain relief of the power cord. The fuse holder is equipped with a fuse clip 5mm x 20 mm. Replace the fuse only with a substitute of the same ratings. Refer to the technical data of the respective device type. If the fuse is blown, please inform an electronic engineer or BINDER service.

19.3 Definition of usable volume

The usable volume illustrated below is calculated as follows:

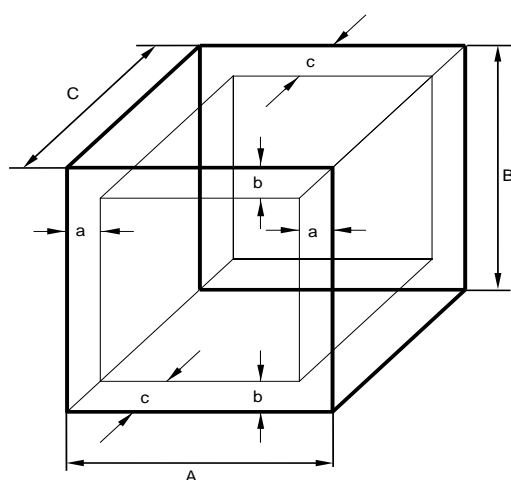

A, B, C = internal dimensions (W, H, D)
a, b, c = wall separation

$$a = 0.1 \cdot A$$

$$b = 0.1 \cdot B$$

$$c = 0.1 \cdot C$$

$$V_{\text{USE}} = (A - 2 \cdot a) \cdot (B - 2 \cdot b) \cdot (C - 2 \cdot c)$$

Figure 33: Determination of the useable volume

The technical data refers to the so defined usable volume.

	<p>Do NOT place samples outside this usable volume.</p> <p>Do NOT load this volume by more than half to enable sufficient airflow inside the CO₂ incubator.</p> <p>Do NOT divide the usable volume into separate parts with large area samples.</p> <p>Do NOT place samples too close to each other in order to permit circulation between them and thus obtain a homogenous distribution of temperature and CO₂.</p>
-----------------------------------------------------------------------------------	---------------------------------------------------------------------------------------------------------------------------------------------------------------------------------------------------------------------------------------------------------------------------------------------------------------------------------------------------------------------------------------------------------------------------------------------

19.4 C 170 technical data

Exterior dimensions		
Width, net	mm / inch	740 / 29.13
Height including feet	mm / inch	870 / 34.25
Depth, net	mm / inch	715 / 28.15
Depth including door handle, I-triangle, and connections	mm / inch	795 / 31.30
Wall clearance rear (minimum)	mm / inch	100 / 3.94
Wall clearance side (minimum)	mm / inch	50 / 1.97
Doors		
Number of doors		1
Number of inner glass doors		1
Interior dimensions		
Width	mm / inch	560 / 22.05
Height	mm / inch	600 / 23.62
Depth	mm / inch	500 / 19.69
Interior volume	l / cu.ft.	168 / 5.93
Shelves		
Number of shelves, series		3
Number of shelves, max.		8
Size of shelf, width x depth	mm x mm inch x inch	538 x 447 21.18 x 17.60
Weight		
Weight (empty)	kg / lbs	110 / 242.5
Temperature data		
Temperature range, 7 °C / 12.6 °F above ambient, up to	°C / °F	50 / 122
Temperature fluctuation	≤ +/- K	0.1
Temperature uniformity (variation) at 37 °C / 98.6 °F	+/- K	0.3
Recovery time after door open for 30 sec at 37 °C / 98.6 °F	minutes	6
Humidity data		
Humidity range	% r.H.	90 to 95
CO₂ data		
CO ₂ range	vol.-% CO ₂	0 to 20
Setting accuracy	vol.-% CO ₂	0.1
Recovery time after door open for 30 sec at 5 vol.-% CO ₂	minutes	7
CO ₂ measurement	Drift-free CO ₂ infrared absorption measurement system	
Connection hose nozzle DN6 for CO ₂ Connection to the chamber for hose with internal diameter	mm / inch	6 / 0.24

Electrical data (model versions C170-230V-R, C170-230V-L)		
IP system of protection acc. to EN 60529	IP	20
Nominal voltage (+/-10%)	at 50 Hz power frequency	V
	at 60 Hz power frequency	V
Current type		1N~
Nominal power	kW	1.10
Power plug (IEC connector plug)		Shock-proof plug
Installation category acc. to IEC 61010-1		II
Pollution degree acc. to IEC 61010-1		2
Chamber fuse	5x20mm / semi time-lag / 10 A	
Different electrical data for C 170-UL constructed for the USA and Canada (model versions C170UL-120V-R, C170UL-120V-L)		
Nominal voltage ($\pm 10\%$) at 60 Hz power frequency	V	120
Power plug (IEC connector plug)	NEMA	5-20P
Chamber fuse	6.3 X 32 mm / 250V / super-time-lag TT / 16A	
Environment-specific data		
Energy consumption at 37 °C / 98.6°F	Wh/h	90

The recovery times of the gas concentrations inside the chamber following the door being opened coincide with a connection pressure of 2.0 bar / 29 *psi*. Decreasing supply pressure results in longer recovery times.

All technical data is specified for unloaded chambers with standard equipment at an ambient temperature of +22 °C +/- 3 °C / 71.6 °F +/- 5.4 °F and a power supply voltage fluctuation of +/-10. The recovery times are determined in accordance to BINDER Factory Standard Part 1:2015 following DIN 12880:2007. The other technical data is determined in accordance to BINDER Factory Standard Part 2:2015 and DIN 12880.

All indications are average values, typical for chambers produced in series. We reserve the right to change technical specifications at any time.

19.5 Important conversion data for non-SI units

1 ft = 0.305 m = 0.000305 km

1 m = 100 cm = 3.28 ft = 39.37 inch

1 km = 1000 m = 3280.83 ft

1 mbar = 0.0145 psi

19.6 Conversion table for gas inlet pressures, bar – psi

bar	psi	bar	psi	bar	psi
1	14.5	3	43.5	5	72.5
1.5	21.7	3.5	50.7	5.5	79.7
2	29.0	4	58.0	6	87.0
2.5	36.3	4.5	65.2		

19.7 Equipment and options (extract)



To operate the chamber, use only original BINDER accessories or accessories / components from third-party suppliers authorized by BINDER. The user is responsible for any risk arising from using unauthorized accessories.

Regular equipment
Microprocessor display controller with 2-channel technology for temperature and CO ₂
CO ₂ infra-red absorption measuring system
Fan-assisted air jacket system
Hot-air sterilization at 180 °C / 356°F
Gas mixing head
Weldless deep-drawn inner chamber made of stainless steel V2A (German material no. 1.4301, US equivalent AISI 304), polished
Electronic error auto-diagnosis system with zero-voltage relay output
Temperature safety device class 3.1 acc. to DIN 12880:2007
Tightly closing inner glass door
3 perforated shelves, stainless steel (German material no. 1.4016, US equivalent AISI 430)
C 170-UL: cUL test mark

Options / accessories
Perforated shelf, stainless steel
Door hinged left (option only available when ordering the chamber, no retrofitting)
Silicone access ports, closable with 2 silicone plugs 30 mm / 1.18 in , rear, left or right side
Analog outputs 4-20mA for temperature and CO ₂ , with DIN socket 6-poles, DIN plug included
Base on castors
Stacking adapter for direct, thermally decoupled stacking
Gas cylinder connection kit
Pressure reducer
Cleaning kit (neutral cleaning agent, disinfection spray and lint-free disposable wipes, protective gloves and safety goggles)
Calibration of temperature and CO ₂ including certificate
Spatial temperature measurement including certificate
Spatial temperature measurement acc. to DIN 12880:2007 including certificate
Qualification folder

19.8 Accessories and spare parts (extract)



BINDER GmbH is responsible for the safety features of the chamber only, provided skilled electricians or qualified personnel authorized by BINDER perform all maintenance and repair, and if components relating to chamber safety are replaced in the event of failure with original spare parts. The user is responsible for any risks arising from using unauthorized accessories/components.

Description	Art. no.
Perforated shelf, stainless steel	6004-0142
Base on castors	9051-0029
Stacking adapter for direct, thermally decoupled stacking	9051-0036
Gas cylinder connection kit for CO ₂	8012-0014
Pressure reducer	6013-0016
Calibration certificate for temperature and CO ₂	8012-0228
Cleaning kit (neutral cleaning agent, disinfection spray and lint-free disposable wipes), protective gloves and safety goggles	8012-0503
Neutral cleaning agent, 1 kg	1002-0016
Shelf holder, stainless steel	6004-0145
Door gasket chamber door	6005-0243
Door gasket glass door	6005-0508
Water pan	4022-0325
Chamber fuse 5x20mm 250V 10A semi time-lag (M) (C 170 230V)	5006-0012
Chamber fuse 6.3 x 32 mm 250V 16A time-lag (T) (C 170-UL)	5006-0033
CO ₂ sensor	5002-0066
Filter cap for CO ₂ sensor	6014-0033
Gas fine filter	8009-0369
Power cable with IEC connector plug for EU	5023-0222
Power cable with IEC connector plug for Switzerland	8012-0218
Power cable with IEC connector plug for England	8012-0220
Power cable with IEC connector plug for USA	5023-0220

Validation service	Art. no.
Qualification folder IQ-OQ	8012-0875
Qualification folder IQ-OQ-PQ	8012-0962
Execution of IQ-OQ	DL410200
Execution of IQ-OQ-PQ	DL440500

Calibration service	Art. no.
Calibration of CO ₂ including certificate	DL300401
Calibration of temperature including certificate (1 measuring point)	DL300101
Spatial temperature measurement including certificate (9 measuring points)	DL300109
Spatial temperature measurement including certificate (18 measuring points)	DL300118
Spatial temperature measurement including certificate (27 measuring points)	DL300127

19.9 Dimensions C 170

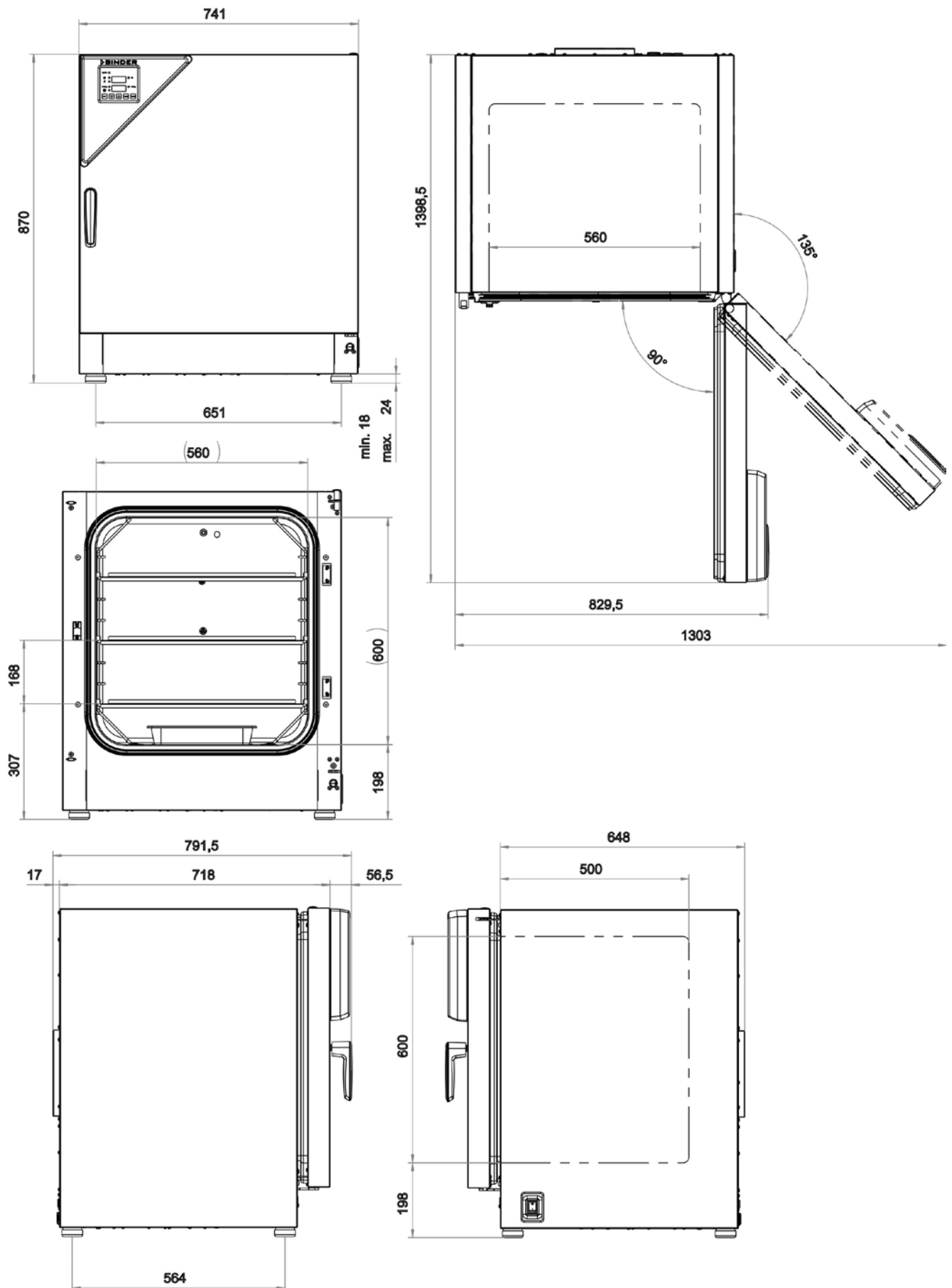

20. EU Declaration of Conformity

CE EU-Konformitätserklärung / EU Declaration of Conformity / Déclaration de conformité UE / Declaración de conformidad UE / Dichiarazione di conformità UE / Декларация соответствия EU

Hersteller / Manufacturer / Fabricant / Fabricante / Fabbicante / Производитель	BINDER GmbH
Anschrift / Address / Adresse / Dirección / Indirizzo / Адрес	Im Mittleren Ösch 5, 78532 Tuttlingen, Germany
Produkt / Product / Produit / Producto / Prodotto / Продукт	CO ₂ -Inkubatoren CO ₂ Incubators Incubateurs à CO ₂ Incubadoras de CO ₂ Incubatori a CO ₂ CO ₂ инкубаторы
Typenbezeichnung / Type / Type / Tipo / Tipo / Тип	C 170

Das oben beschriebene Produkt ist konform mit folgenden EU-Richtlinien:

The product described above is in conformity with the following EU Directives:

Le produit décrit ci-dessus est conforme aux directives UE suivantes:

El producto descrito arriba cumple con las siguientes directivas de la UE:

Il prodotto sopra descritto è conforme alle seguenti direttive UE:

Продукты, указанные выше, полностью соответствуют следующим EU руководствам:

- **2014/35/EU**
Niederspannungsrichtlinie 2014/35/EU / Low voltage directive 2014/35/EU / Directive basse tension 2014/35/UE / Directiva sobre baja tensión 2014/35/UE / Direttiva Bassa tensione 2014/35/UE / Директива по низкому напряжению 2014/35/EU
- **2014/30/EU**
EMV-Richtlinie 2014/30/EU / EMC Directive 2014/30/EU / Directive CEM 2014/30/UE / Directiva CEM 2014/30/UE / Direttiva EMC 2014/30/UE / Директива ЭМС 2014/30/EU
- **2011/65/EU**
RoHS-Richtlinie 2011/65/EU / RoHS Directive 2011/65/EU / Directive RoHS 2011/65/UE / Directiva RoHS 2011/65/UE / Direttiva RoHS 2011/65/UE / Директива RoHS 2011/65/EU

Die oben beschriebenen Produkte tragen entsprechend die Kennzeichnung CE.

The products described above, corresponding to this, bear the CE-mark.

Les produits décrits ci-dessus, en correspondance, portent l'indication CE.

Los productos descritos arriba, en conformidad, llevan la indicación CE.

I prodotti sopra descritti, conformi a quanto sopra, portano il marchio CE.

Данные продукты в соответствии с изложенным выше маркированы знаком CE.

1 / 2

Die oben beschriebenen Produkte sind konform mit folgenden harmonisierten Normen:
The products described above are in conformity with the following harmonized standards:
Les produits décrits ci-dessus sont conformes aux normes harmonisées suivantes:
Los productos descritos arriba cumplen con las siguientes normas:
I prodotti sopra descritti sono conformi alle seguenti normative armonizzate:
Продукты, указанные выше, полностью соответствуют следующим стандартам:

Sicherheit / Safety / Sécurité / Seguridad / Sicurezza / Нормативы по безопасности
<ul style="list-style-type: none">• EN 61010-1:2010• EN 61010-2-010:2014
EMV / EMC / CEM / CEM / EMC / ЭМС
<ul style="list-style-type: none">• EN 61326-1:2013
RoHS
<ul style="list-style-type: none">• EN 50581:2012

78532 Tuttlingen, 03.07.2017
BINDER GmbH



P. M. Binder
Geschäftsführender Gesellschafter
Managing Director
Directeur général
Director general
Direttore Generale
Генеральный Директор



J. Bollaender
Leiter F & E
Director R & D
Chef de service R&D
Responsable I & D
Direttore R & D
Глава департамента R&D

2 / 2

BINDER GmbH Postfach 102 D-78502 Tuttlingen Address: BINDER GmbH Im Mittleren Ösch 5 78532 Tuttlingen Germany
Contact: Phone: +49 (0) 74 62 / 20 05 - 0 | Fax: +49 (0) 74 62 / 20 05 - 100 | info@binder-world.com | www.binder-world.com
Managing Director: Dipl.-Ing. Peter M. Binder | District court Stuttgart, HRB 727150 | Company head office: Tuttlingen Germany
Payment Details: Kreissparkasse Tuttlingen Account no.: 2266 BAN: 643 500 70 | IBAN-Code: DE05643 500700 000002266 | SWIFT-Code: SOLA DE S1TUT
\$-Account no. 2202 611 55 | IBAN-Code: DE7464350070 0220 261155 | SWIFT-Code: SOLA DE S1TUT
Deutsche Bank Tuttlingen Account no.: 2 138 709 BAN: 653 700 75 | IBAN-Code: DE56853 70075 0213870900 | SWIFT-Code: DEUT DE SS603
Recycling of old equipment according to WEEE-Reg.-no. DE 37004983

21. Product registration

Online Product Registration

Register your BINDER now!

www.binder-world.com/register

The registration is free and takes just a few seconds

Advantages:

- ▶ Short response times if service is needed
- ▶ Fair prices when relocating or installing equipment
- ▶ Calibration as required at no charge in case of recalls
- ▶ Free information on news, product upgrades and accessories

Easy registered in 3 steps:



1. List serial number here:

 -

2. Go online: www.binder-world.com/register

3. Register serial number

22. Contamination clearance certificate

Unbedenklichkeitsbescheinigung

22.1 For chambers located outside the USA and Canada

Declaration regarding safety and health

Erklärung zur Sicherheit und gesundheitlichen Unbedenklichkeit

The German Ordinance on Hazardous Substances (GefStofV), and the regulations regarding safety at the workplace require that this form be filled out for all products that are returned to us, so that the safety and the health of our employees can be guaranteed.

Die Sicherheit und Gesundheit unserer Mitarbeiter, die Gefahrstoffverordnung GefStofV und die Vorschriften zur Sicherheit am Arbeitsplatz machen es erforderlich, dass dieses Formblatt für alle Produkte, die an uns zurückgeschickt wird.



Note: A repair is not possible without a completely filled out form.
Ohne Vorliegen des vollständig ausgefüllten Formblattes ist eine Reparatur nicht möglich.

- A completely filled out form must be transmitted via Fax (+49 (0) 7462 2005 93555) or by letter in advance, so that this information is available before the equipment/component part arrives. A second copy of this form must accompany the equipment/component part. In addition, the carrier should be notified.

Eine vollständig ausgefüllte Kopie dieses Formblattes soll per Telefax (Nr. +49 (0) 7462 2005 93555) oder Brief vorab an uns gesandt werden, so dass die Information vorliegt, bevor das Gerät/Bauteil eintrifft. Eine weitere Kopie soll dem Gerät/Bauteil beigelegt sein. Ggf. ist auch die Spedition zu informieren.

- Incomplete information or non-conformity with this procedure will inevitably lead to substantial delays in processing. Please understand the reason for this measure, which lies outside our area of influence and will help us to speed up this procedure.

Unvollständige Angaben oder Nichteinhalten dieses Ablaufs führen zwangsläufig zu beträchtlichen Verzögerungen in der Abwicklung. Bitte haben Sie Verständnis für Maßnahmen, die außerhalb unserer Einflussmöglichkeiten liegen und helfen Sie mit, den Ablauf beschleunigen.

- **Please print and fill out this form completely.**

Bitte unbedingt vollständig ausfüllen!

1. Unit/ component part / type: / Gerät / Bauteil / Typ:
2. Serial No./ Serien-Nr.:
3. Details about utilized substances / biological substances / Einzelheiten über die eingesetzten Substanzen/biologische Materialien:
3.1 Designations / Bezeichnungen:
a) _____
b) _____
c) _____
3.2 Safety measures required for handling these substances / Vorsichtsmaßnahmen beim Umgang mit diesen Stoffen:
a) _____
b) _____
c) _____

3.3	Measures to be taken in case of skin contact or release into the atmosphere / Maßnahmen bei Personenkontakt oder Freisetzung: a) _____ b) _____ c) _____ d) _____
3.4	Other important information that must be taken into account / Weitere zu beachtende und wichtige Informationen: a) _____ b) _____ c) _____
4.	Declaration on the risk of these substances (please checkmark the applicable items) / Erklärung zur Gefährlichkeit der Stoffe (bitte Zutreffendes ankreuzen) :
<input type="checkbox"/>	4.1 For non toxic, non radioactive, biologically harmless materials / für nicht giftige, nicht radioaktive, biologisch ungefährliche Stoffe: We hereby guarantee that the above-mentioned unit / component part... / Wir versichern, dass o.g. Gerät/Bauteil... <input type="checkbox"/> Has not been exposed to or contains any toxic or otherwise hazardous substances / weder giftige noch sonstige gefährliche Stoffe enthält oder solche anhaften. <input type="checkbox"/> That eventually generated reaction products are non-toxic and also do not represent a hazard / auch evtl. entstandene Reaktionsprodukte weder giftig sind noch sonst eine Gefährdung darstellen. <input type="checkbox"/> Eventual residues of hazardous substances have been removed / evtl. Rückstände von Gefahrstoffen entfernt wurden.
<input type="checkbox"/>	4.2 For toxic, radioactive, biologically harmful or hazardous substances, or any other hazardous materials / für giftige, radioaktive, biologisch bedenkliche bzw. gefährliche Stoffe oder anderweitig gefährliche Stoffe. We hereby guarantee that ... / Wir versichern, dass ... <input type="checkbox"/> The hazardous substances, which have come into contact with the above-mentioned equipment/component part, have been completely listed under item 3.1 and that all information in this regard is complete / die gefährlichen Stoffe, die mit dem o.g. Gerät/Bauteil in Kontakt kamen, in 3.1 aufgelistet sind und alle Angaben vollständig sind. <input type="checkbox"/> That the unit /component part has not been in contact with radioactivity / das Gerät/Bauteil nicht mit Radioaktivität in Berührung kam
5.	Kind of transport / transporter / Transportweg/Spediteur: Transport by (means and name of transport company, etc.) / Versendung durch (Name Spediteur o.ä.) _____ Date of dispatch to BINDER GmbH / Tag der Absendung an BINDER GmbH: _____

We hereby declare that the following measures have been taken / Wir erklären, dass folgende Maßnahmen getroffen wurden:

- Hazardous substances were removed from the unit including component parts, so that no hazard exists for any person in the handling or repair of these items / das Gerät/Bauteil wurde von Gefahrstoffen befreit, so dass bei Handhabung/Reparaturen für die betreffenden Person keinerlei Gefährdung besteht
- The unit was securely packaged and properly identified / das Gerät wurde sicher verpackt und vollständig gekennzeichnet.
- Information about the hazardousness of the shipment (if required) has been provided to the transporter / der Spediteur wurde (falls vorgeschrieben) über die Gefährlichkeit der Sendung informiert.

We hereby commit ourselves and guarantee that we will indemnify BINDER GmbH for all damages that are a consequence of incomplete or incorrect information provided by us, and that we will exempt BINDER GmbH from eventual damage claims by third parties./ Wir versichern, dass wir gegenüber BINDER für jeden Schaden, der durch unvollständige und unrichtige Angaben entsteht, haften und BINDER gegen eventuell entstehende Schadenansprüche Dritter freistellen.

We are aware that, in accordance with Article 823 of the German Civil Code (BGB), we are directly liable with regard to third parties, in this instance especially the employees of BINDER GmbH, who have been entrusted with the handling / repair of the unit / component. / Es ist uns bekannt, dass wir gegenüber Dritten – hier insbesondere mit der Handhabung/Reparatur des Geräts/des Bauteils betraute Mitarbeiter der Firma BINDER - gemäß §823 BGB direkt haften

Name: _____

Position/Title: _____

Date / Datum: _____

Signature / Unterschrift: _____

Company stamp / Firmenstempel:



Equipment that is returned to the factory for repair must be accompanied by a completely filled out contamination clearance certificate. For service and maintenance on site, you must submit such a contamination clearance certificate to the service technician before the start of any work. No repair or maintenance of the equipment is possible, without a properly filled out contamination clearance certificate.

22.2 For chambers in the USA and Canada

Product Return Authorization Request

Please complete this form and the Customer Decontamination Declaration (next 2 pages) and attach the required pictures. E-mail to: IDL_SalesOrderProcessing_USA@binder-world.com

After we have received and reviewed the complete information we will decide on the issue of a RMA number. Please be aware that size specifications, voltage specifications as well as performance specifications are available on the internet at www.binder-world.us at any time.

Take notice of shipping laws and regulations.

	Please fill:	
Reason for return request	<input type="radio"/> Duplicate order	
	<input type="radio"/> Duplicate shipment	
	<input type="radio"/> Demo	<i>Page one completed by sales</i>
	<input type="radio"/> Power Plug / Voltage	115V / 230 V / 208 V / 240V
	<input type="radio"/> Size does not fit space	
	<input type="radio"/> Transport Damage	Shock watch tripped? (<i>pictures</i>)
	<input type="radio"/> Other (specify below)	

Is there a replacement PO?	<input type="radio"/> Yes <input type="radio"/> No	
<i>If yes -> PO #</i>		
<i>If yes -> Date PO placed</i>		
Purchase order number		
BINDER model number		
BINDER serial number		
Date unit was received		
Was the unit unboxed?	<input type="radio"/> Yes <input type="radio"/> No	
Was the unit plugged in?	<input type="radio"/> Yes <input type="radio"/> No	
Was the unit in operation?	<input type="radio"/> Yes <input type="radio"/> No	
<i>Pictures of unit attached?</i>	<input type="radio"/> Yes <input type="radio"/> No	Pictures have to be attached!
<i>Pictures of Packaging attached?</i>	<input type="radio"/> Yes <input type="radio"/> No	

	Customer Contact Information	Distributor Contact Information
Name		
Company		
Address		
Phone		
E-mail		

Customer (End User) Decontamination Declaration

Health and Hazard Safety declaration

To protect the health of our employees and the safety at the workplace, we require that this form is completed by the user for all products and parts that are returned to us. (Distributors or Service Organizations cannot sign this form)

	<p>NO RMA number will be issued without a completed form. Products or parts returned to our NY warehouse without a RMA number will be refused at the dock.</p>
-----------------------------------------------------------------------------------	----------------------------------------------------------------------------------------------------------------------------------------------------------------

A second copy of the completed form must be attached to the outside of the shipping box.

1.	Unit/ component part / type:
2.	Serial No.
3.	List any exposure to hazardous liquids, gasses or substances and radioactive material
3.1	List with MSDS sheets attached where available or needed (if there is not enough space available below, please attach a page):
a)	_____
b)	_____
c)	_____
3.2	Safety measures required for handling the list under 3.1
a)	_____
b)	_____
c)	_____
3.3	Measures to be taken in case of skin contact or release into the atmosphere:
a)	_____
b)	_____
c)	_____
d)	_____
3.4	Other important information that must be considered:
a)	_____
b)	_____
c)	_____

4. Declaration of Decontamination

For toxic, radioactive, biologically and chemically harmful or hazardous substances, or any other hazardous materials.

We hereby guarantee that

- 4.1 Any hazardous substances, which have come into contact with the above-mentioned equipment / component part, have been completely listed under item 3.1 and that all information in this regard is complete.
- 4.2 That the unit /component part has not been in contact with radioactivity
- 4.3 Any Hazardous substances were removed from the unit / component part, so that no hazard exists for a persons in the shipping, handling or repair of these returned unit
- 4.4 The unit was securely packaged in the original undamaged packaging and properly identified on the outside of the packaging material with the unit designation, the RMA number and a copy of this declaration.
- 4.5 Shipping laws and regulations have not been violated.

I hereby commit and guarantee that we will indemnify BINDER Inc for all damages that are a consequence of incomplete or incorrect information provided by us, and that we will indemnify and hold harmless BINDER Inc. from eventual damage claims by third parties..

Name: _____

Position: _____

Company: _____

Address: _____

Phone #: _____

Email: _____

Date: _____

Signature: _____



Equipment returned to the NY warehouse for repair must be accompanied by a completed customer decontamination declaration. For service and maintenance works on site, such a customer decontamination declaration must be submitted to the service technician before the start of work. No repair or maintenance of the equipment is possible without a completed form.