

2 1/2" x 3" CYLINDER TURN PIECE RECTANGULAR ESCUTCHEONS

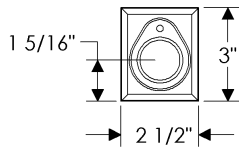

DB507

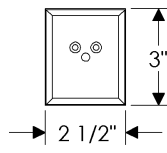

IP418

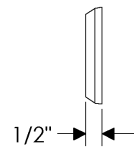

3 9/16" x 3 9/16" CYLINDER TURN PIECE DIAMOND ESCUTCHEONS

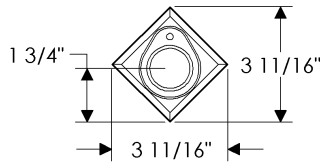

DB509

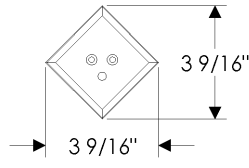

IP415

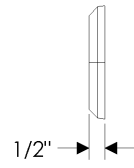

2 5/8" x 2 5/8" SQUARE ESCUTCHEON



E416

3 9/16" x 3 9/16" DIAMOND ESCUTCHEON

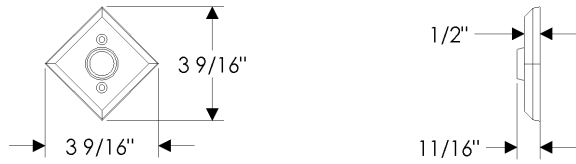

E415

2 1/2" x 4 1/2" RECTANGULAR ESCUTCHEON

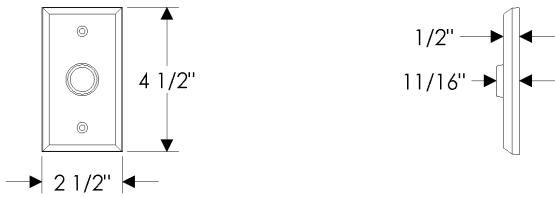

E414

2 1/2" x 8" RECTANGULAR ESCUTCHEON

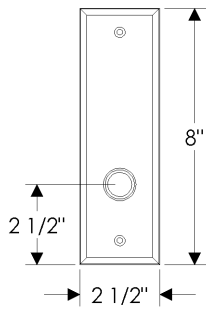

E410

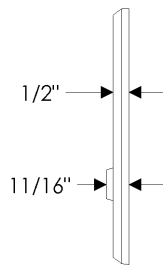

DIMENSIONS ALSO APPLICABLE FOR THE FOLLOWING:

- E411 (ER)
- E412 (TP)

2 1/2" x 10" RECTANGULAR ESCUTCHEONS

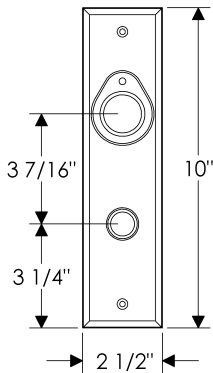

E433

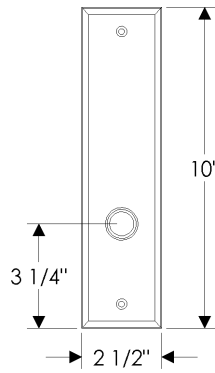

E408

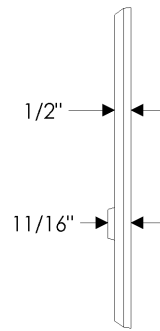

DIMENSIONS ALSO APPLICABLE FOR THE FOLLOWING:

- E431 (TP)
- E432 (ER)

2 1/2" x 13" RECTANGULAR ESCUTCHEONS

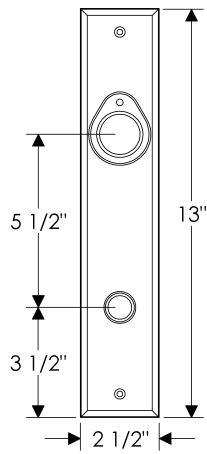

E438

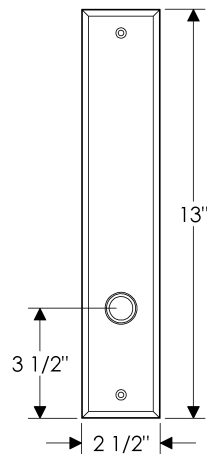

E436

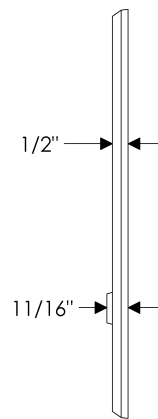

DIMENSIONS ALSO APPLICABLE FOR THE FOLLOWING:

- E437 (TP)
- E439 (ER)

3" x 10" RECTANGULAR ESCUTCHEONS

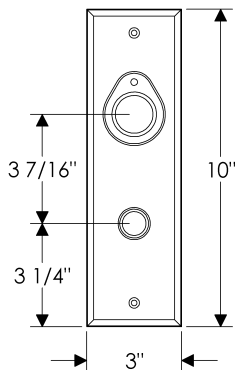

E423

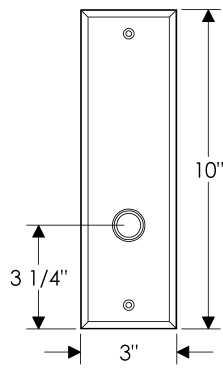

E404

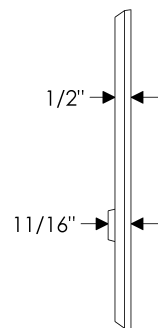

DIMENSIONS ALSO APPLICABLE FOR THE FOLLOWING:

- E421 (TP)
- E422 (ER)

3 1/2" x 13" RECTANGULAR ESCUTCHEONS

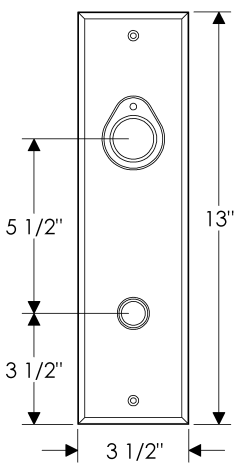

E475

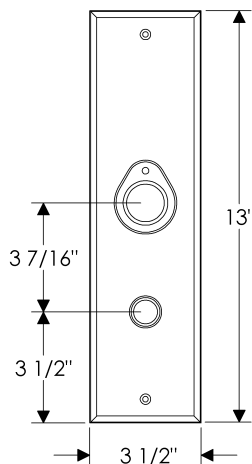

E462

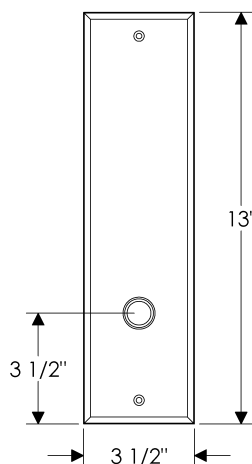

E460

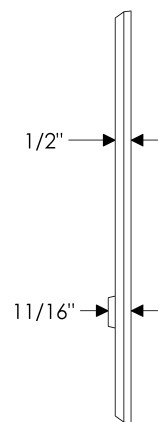

DIMENSIONS ALSO APPLICABLE FOR THE FOLLOWING:

- E463 (TP)
- E464 (ER)

3 1/2" x 19 5/8" RECTANGULAR ESCUTCHEONS

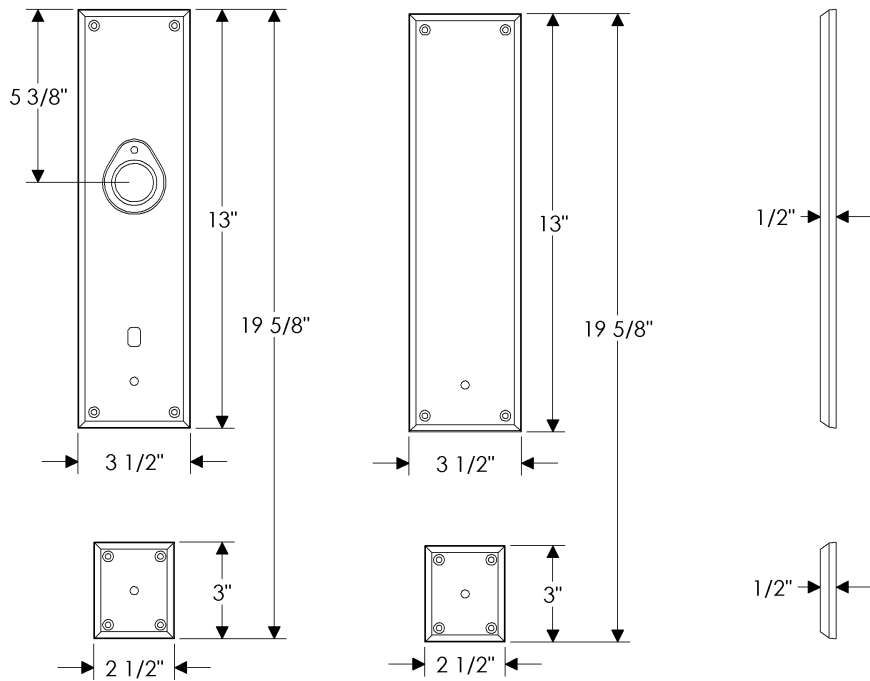

G542

G546

DIMENSIONS ALSO APPLICABLE FOR THE FOLLOWING:

G544 (TP)

2 3/4" x 18" RECTANGULAR ESCUTCHEONS

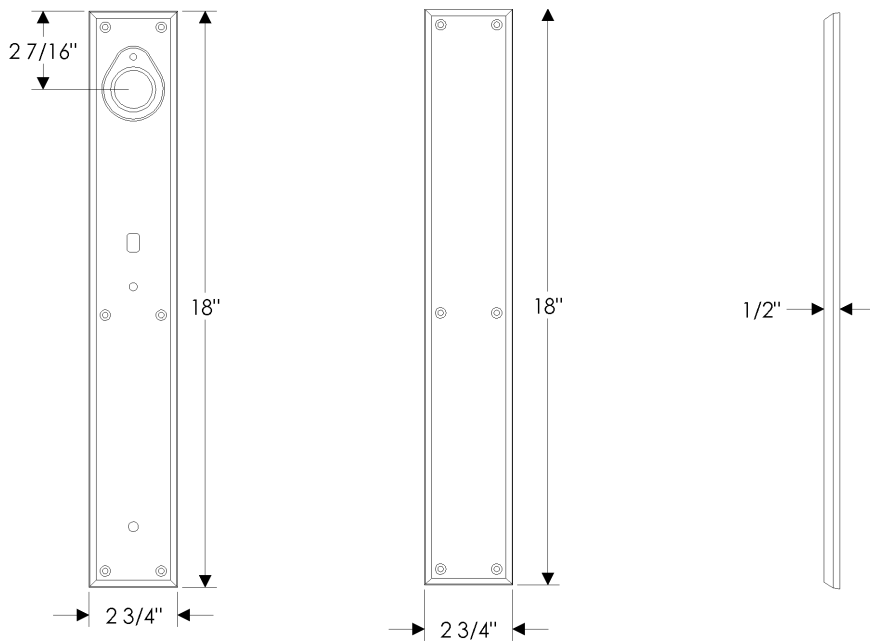

G641

G644

DIMENSIONS ALSO APPLICABLE FOR THE FOLLOWING:

G642 (TP)

3 1/2" x 18" RECTANGULAR ESCUTCHEONS

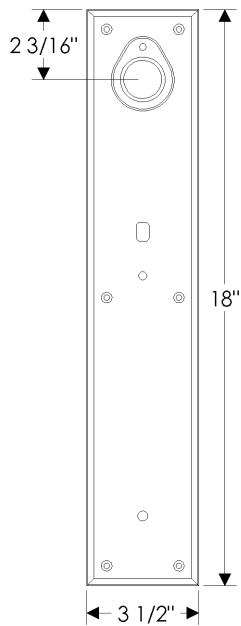

G601

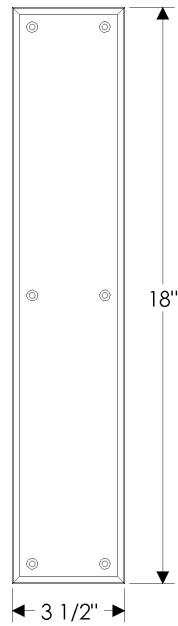

G604

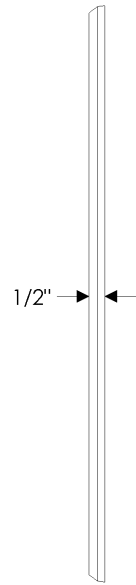

DIMENSIONS ALSO APPLICABLE FOR THE FOLLOWING:

G602 (TP)

3 1/2" x 24" RECTANGULAR ESCUTCHEONS



G681



G684

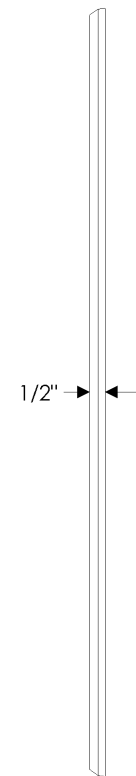

DIMENSIONS ALSO APPLICABLE FOR THE FOLLOWING:

G682 (TP)

2" x 6" RECTANGULAR SCREEN DOOR ESCUTCHEONS

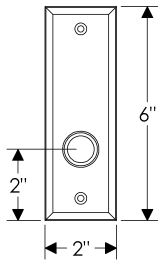

E405

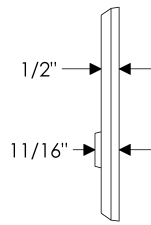

DIMENSIONS ALSO APPLICABLE FOR THE FOLLOWING:

- E406 (TP)
- E407 (ER)

1 3/8" x 11" RECTANGULAR MULTI-POINT ESCUTCHEONS

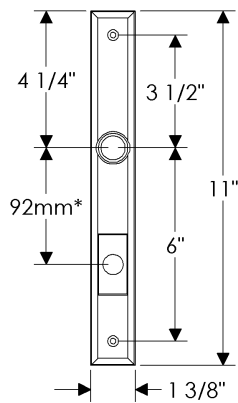

E481

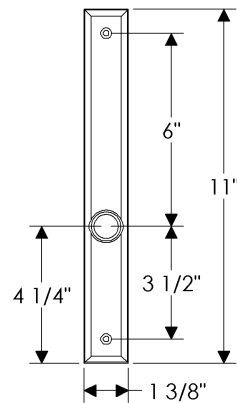

E489

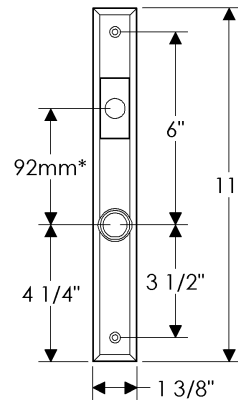

E486

DIMENSIONS ALSO APPLICABLE FOR THE FOLLOWING:

- E487 (LHi) (TP)
- E488 (LLo) (TP)

\* This center-to-center dimension will need to be verified before set can be ordered.

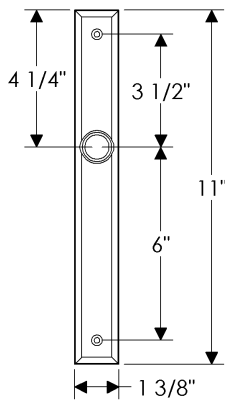

E456

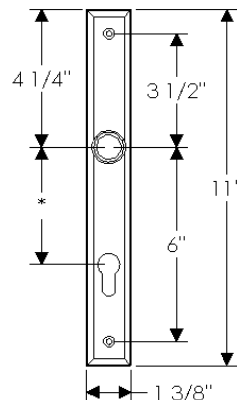

E455

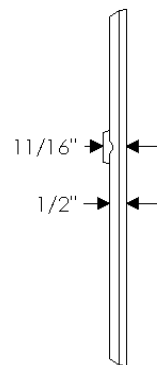

1 3/4" x 10" RECTANGULAR MULTI-POINT ESCUTCHEONS

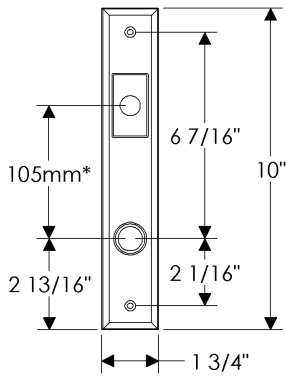

E425

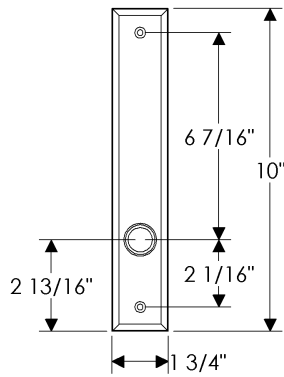

E426

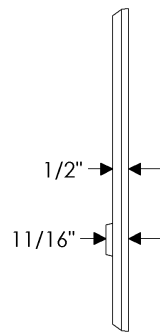

DIMENSIONS ALSO APPLICABLE FOR THE FOLLOWING:

E427 (LLo) (TP)

\* This center-to-center dimension will need to be verified before set can be ordered.

1 3/4" x 11" RECTANGULAR MULTI-POINT ESCUTCHEONS

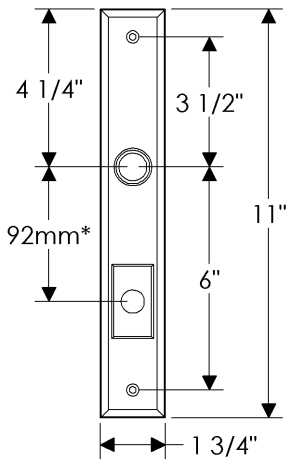

E445

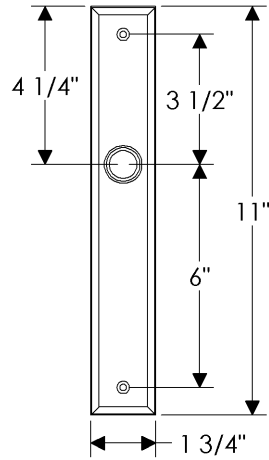

E446

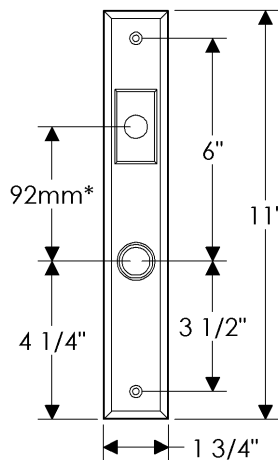

E443

DIMENSIONS ALSO APPLICABLE FOR THE FOLLOWING:

E447 (LHi) (TP)

E442 (LLo) (TP)

\* This center-to-center dimension will need to be verified before set can be ordered.

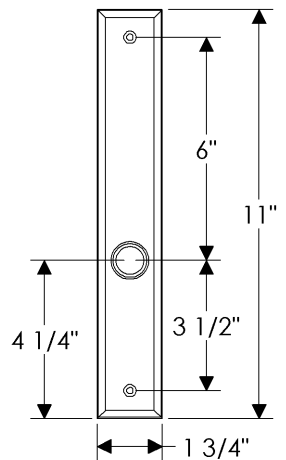

E441

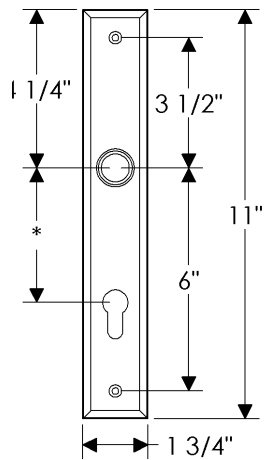

E448

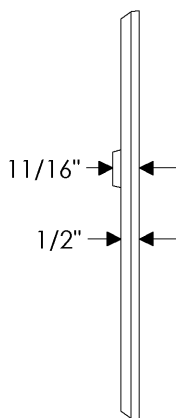



2 1/2" x 11" RECTANGULAR MULTI-POINT ESCUTCHEONS

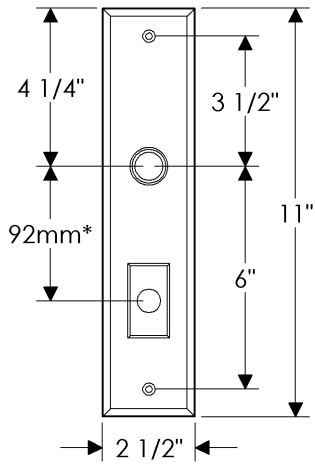

E450

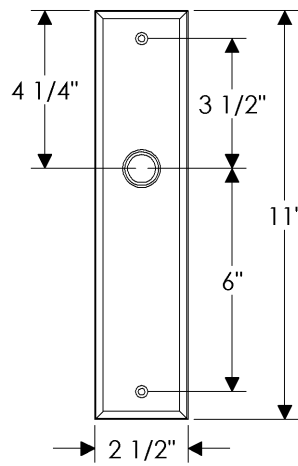

E451

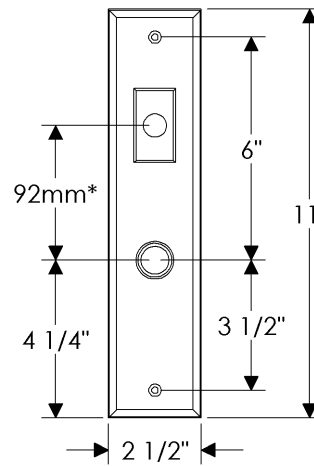

E459

DIMENSIONS ALSO APPLICABLE FOR THE FOLLOWING:

E453 (LHi) (TP)  
E458 (LLo) (TP)

\* This center-to-center dimension will need to be verified before set can be ordered.

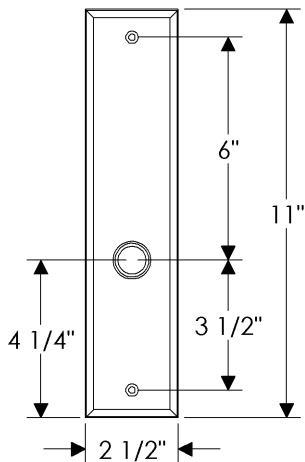

E452

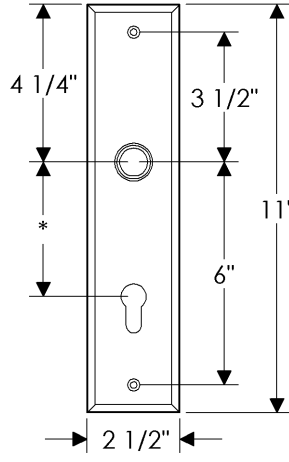

E457

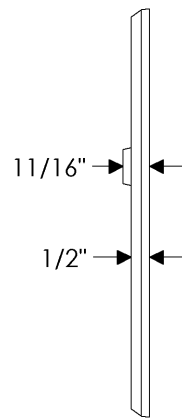

1 3/8" x 11" RECTANGULAR SLIDING DOOR ESCUTCHEONS

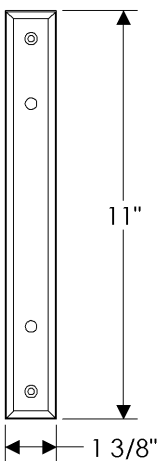

E468

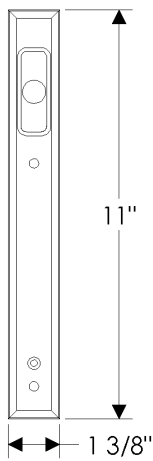

E485

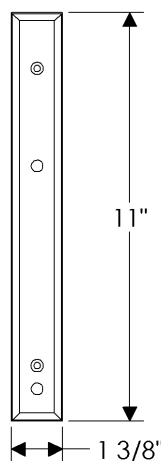

E484

DIMENSIONS ALSO APPLICABLE FOR THE FOLLOWING:

E469 (Gctr) (TP)  
E482 (GLo) (TP)

\* This center-to-center dimension will need to be verified before set can be ordered.

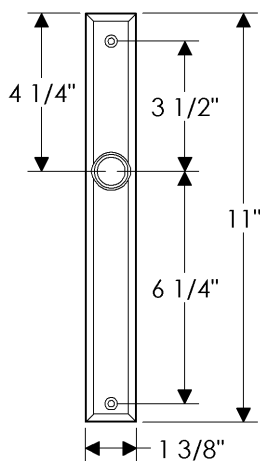

E456

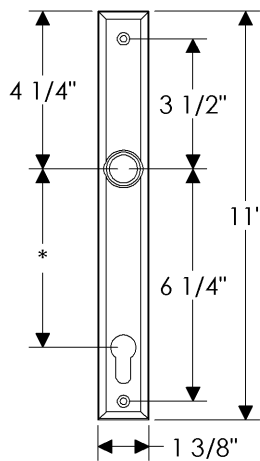

E440

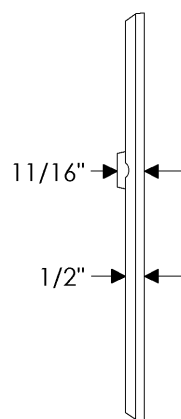

1 3/4" x 11" RECTANGULAR SLIDING DOOR ESCUTCHEONS



E444

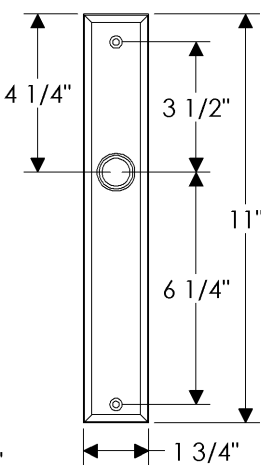

E446

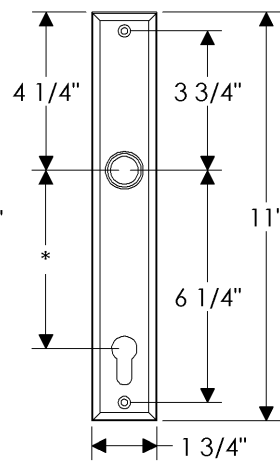

E449

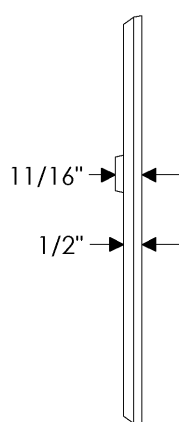

DIMENSIONS ALSO APPLICABLE FOR THE FOLLOWING:

E466 (Gctr) (TP)

\* This center-to-center dimension will need to be verified before set can be ordered.

1 3/4" x 13" RECTANGULAR SLIDING DOOR ESCUTCHEONS

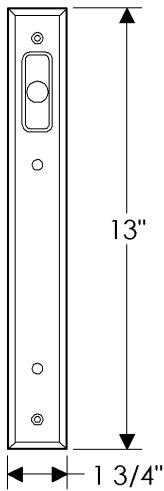

E498

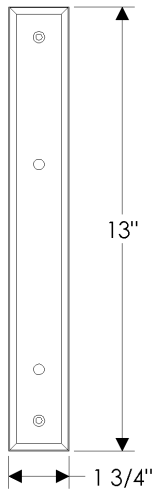

E496

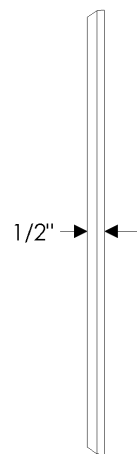

DIMENSIONS ALSO APPLICABLE FOR THE FOLLOWING:

E497 (GLo) (TP)

2 1/2" x 13" RECTANGULAR SLIDING DOOR ESCUTCHEONS

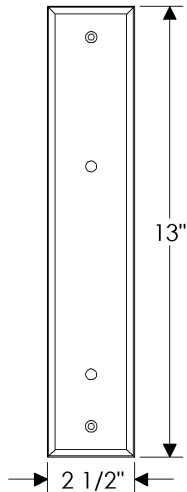

E490

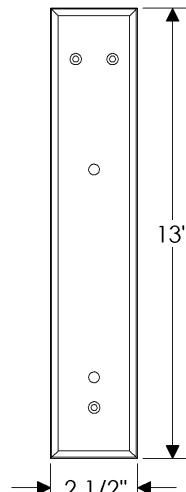

E493

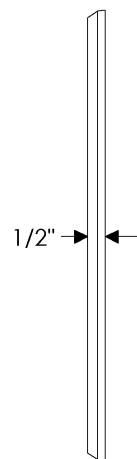

DIMENSIONS ALSO APPLICABLE FOR THE FOLLOWING:

E491 (GLo) (TP)

E494 (GLo) (TP)

2 1/2" x 13" RECTANGULAR ESCUTCHEON

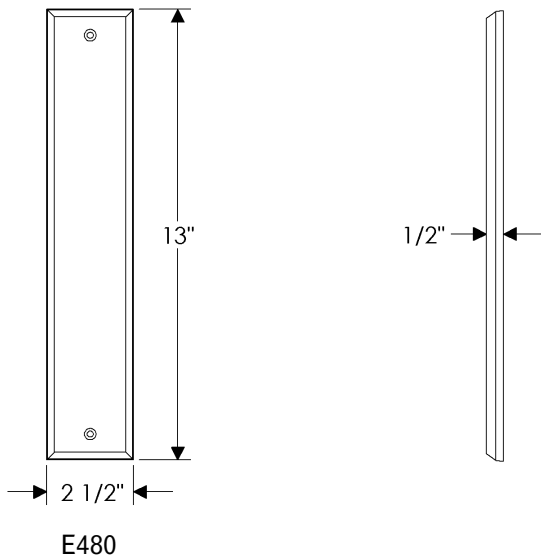

3 1/2" x 13" RECTANGULAR ESCUTCHEON

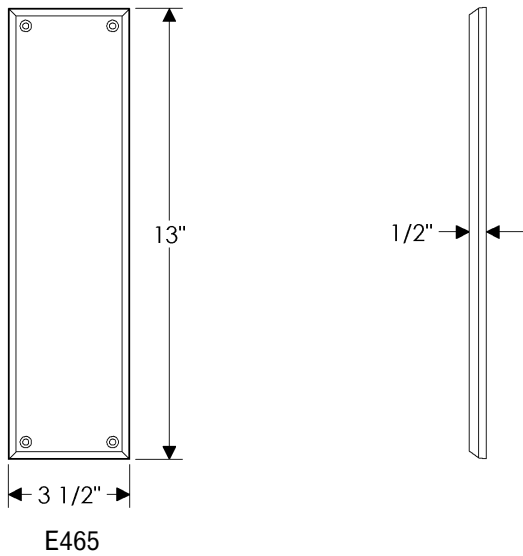

2 1/2" x 11" RECTANGULAR CREMONE BOLT ESCUTCHEONS

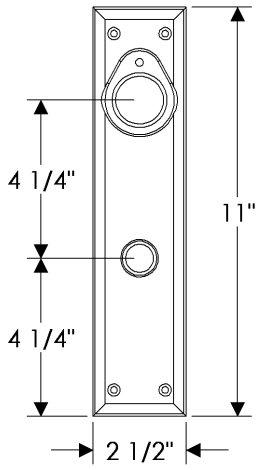

CE413

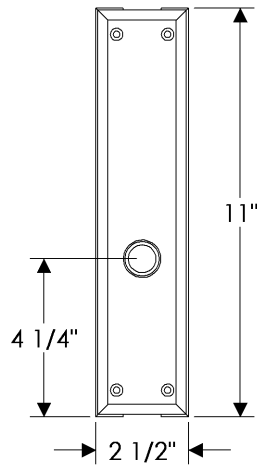

CE410

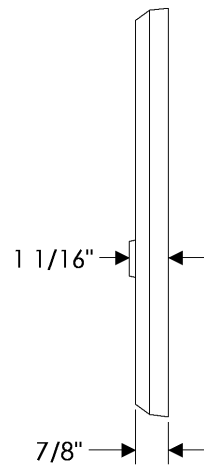

DIMENSIONS ALSO APPLICABLE FOR THE FOLLOWING:

CE409 (DU/PA)  
CE411 (TP)

3" x 11" RECTANGULAR CREMONE BOLT ESCUTCHEONS

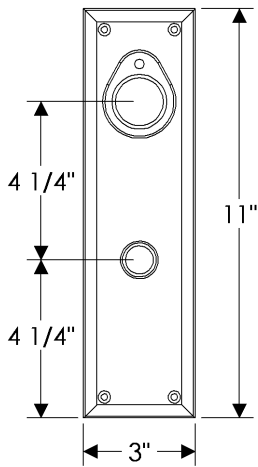

CE423

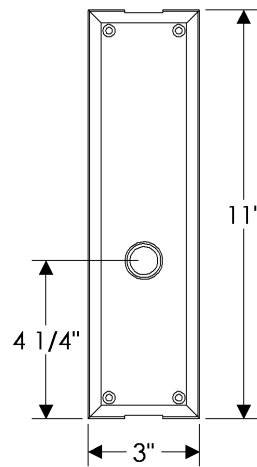

CE420

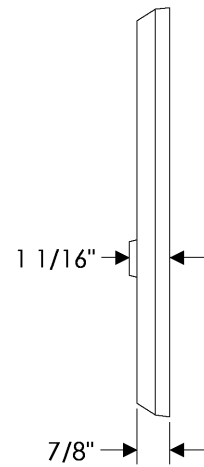

DIMENSIONS ALSO APPLICABLE FOR THE FOLLOWING:

CE419 (DU/PA)  
CE421 (TP)

2 1/2" x 3 1/8" CYLINDER TURN PIECE ESCUTCHEONS

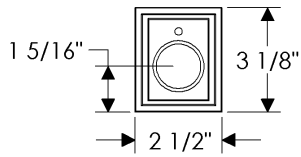

DB312

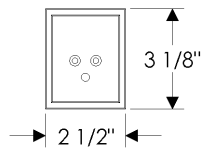

IP318

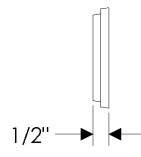

2 1/2" x 4 1/2" STEPPED ESCUTCHEON

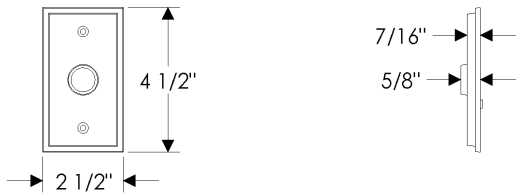

E304

2 1/2" x 8" STEPPED ESCUTCHEONS

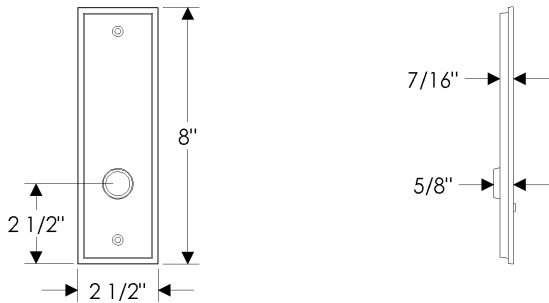

E308

DIMENSIONS ALSO  
APPLICABLE FOR  
THE FOLLOWING:

- E306 (TP)
- E307 (ER)

2 1/2" x 11" STEPPED ESCUTCHEONS

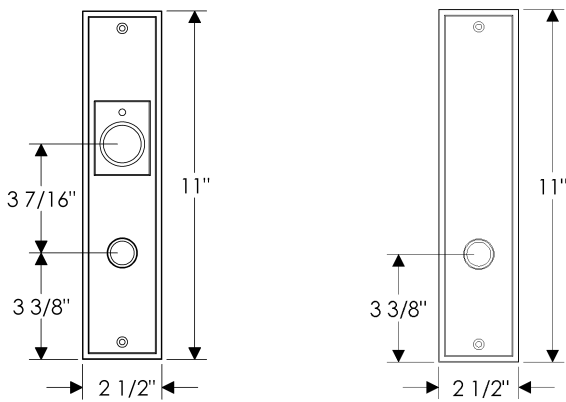

E311

E312

DIMENSIONS ALSO  
APPLICABLE FOR  
THE FOLLOWING:

- E313 (TP)
- E314 (ER)

2 1/2" x 13" STEPPED ESCUTCHEONS

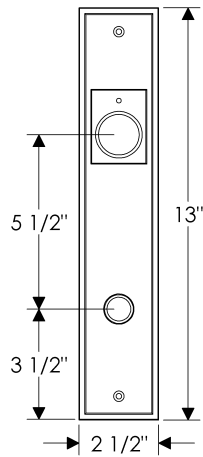

E358

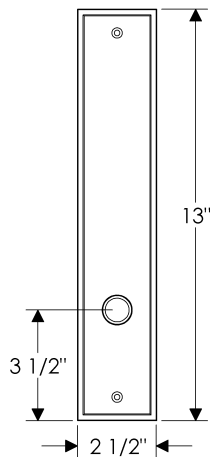

E356

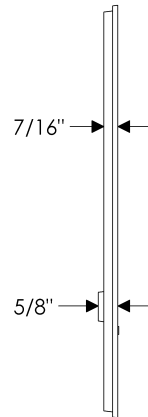

DIMENSIONS ALSO APPLICABLE FOR THE FOLLOWING:

- E357 (TP)
- E359 (ER)

3 1/2" x 13" STEPPED ESCUTCHEONS

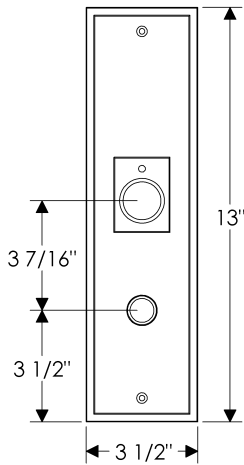

E362

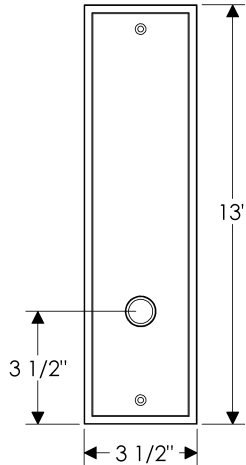

E360

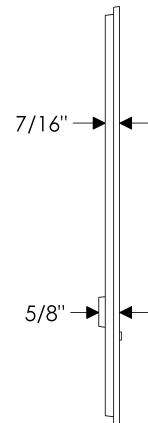

DIMENSIONS ALSO APPLICABLE FOR THE FOLLOWING:

- E363 (TP)
- E364 (ER)



2 3/4" x 20" STEPPED ESCUTCHEONS

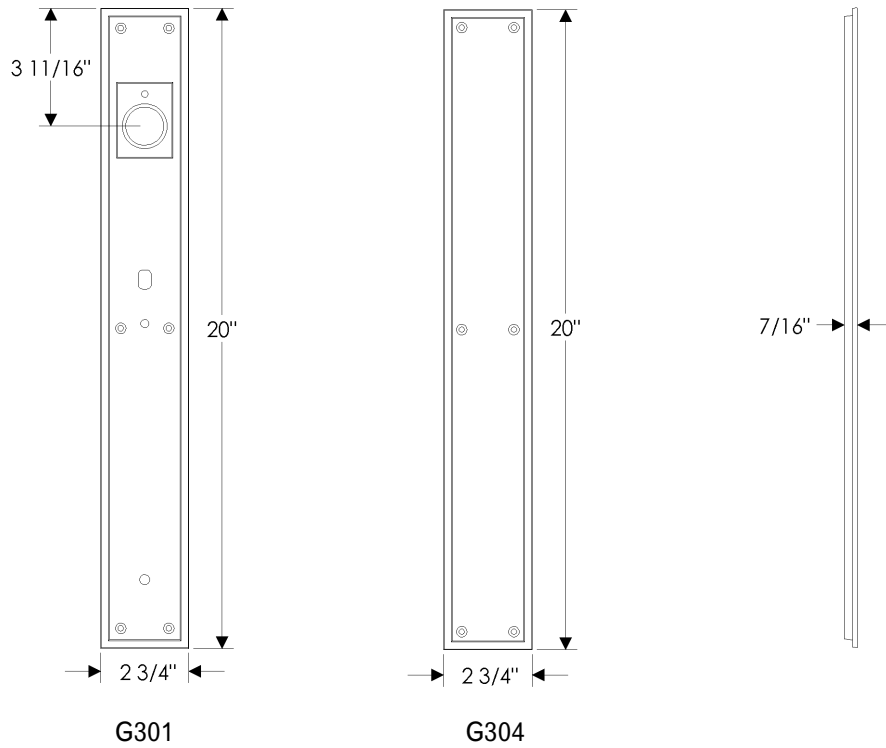

DIMENSIONS ALSO APPLICABLE FOR THE FOLLOWING:

G302 (TP)

3 1/2" x 20" STEPPED ESCUTCHEONS

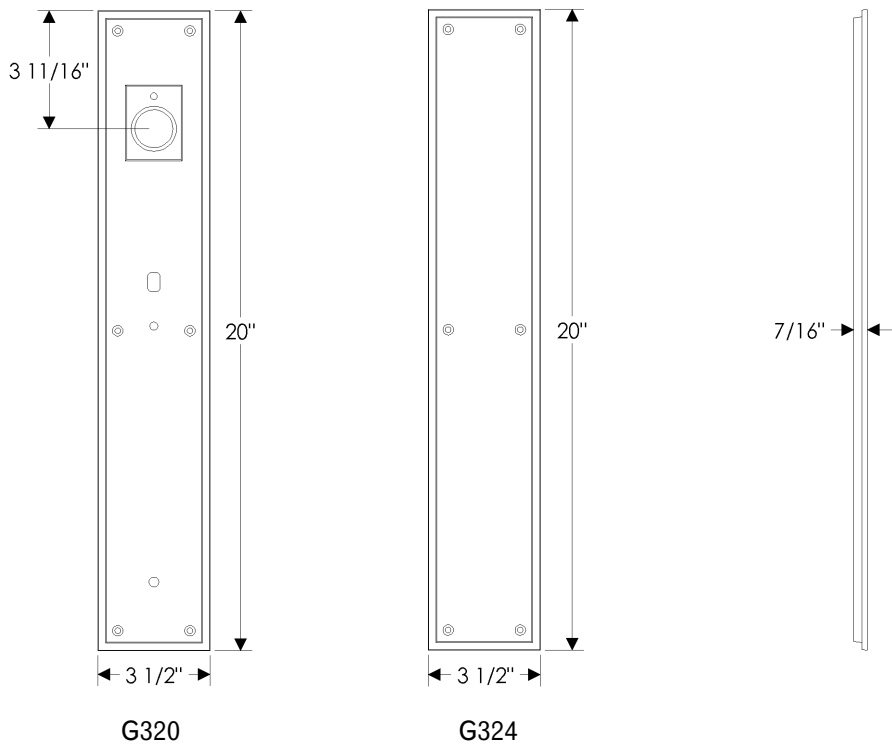

DIMENSIONS ALSO APPLICABLE FOR THE FOLLOWING:

G322 (TP)

3 1/2" x 24" STEPPED ESCUTCHEONS

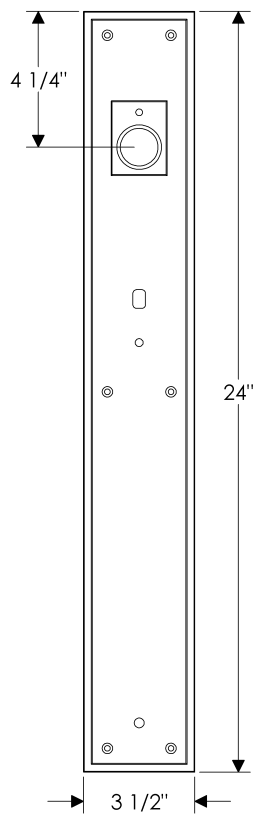

G326

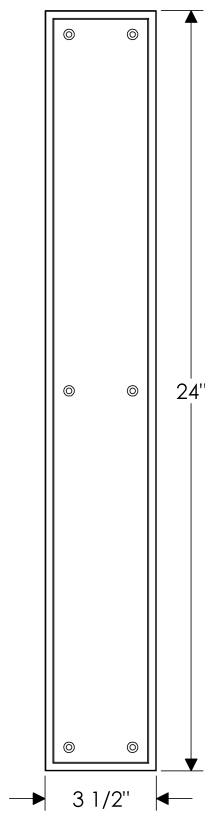

G327

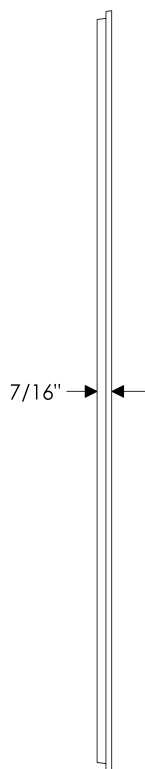

DIMENSIONS ALSO APPLICABLE FOR THE FOLLOWING:

G328 (TP)

2" x 6" STEPPED SCREEN DOOR ESCUTCHEONS

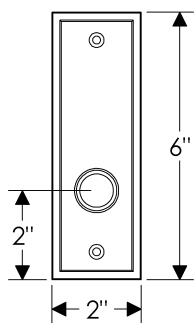

E315

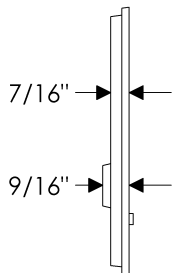

DIMENSIONS ALSO APPLICABLE FOR THE FOLLOWING:

E316 (TP)

E317 (ER)

1 3/8" x 11" STEPPED MULTI-POINT ESCUTCHEONS

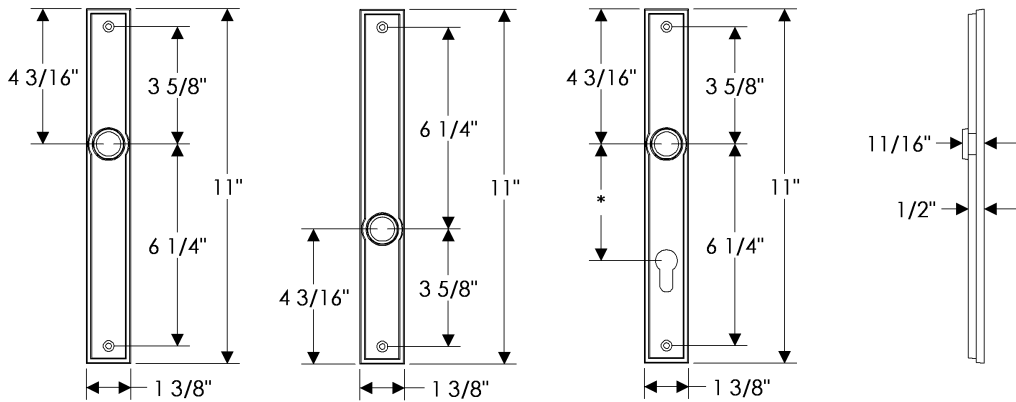

E376

E327

E375

DIMENSIONS ALSO APPLICABLE FOR THE FOLLOWING:

E377 (LHi) (TP)  
E328 (LLo) (TP)

\* This center-to-center dimension will need to be verified before set can be ordered.

1 3/4" x 11" STEPPED MULTI-POINT ESCUTCHEONS

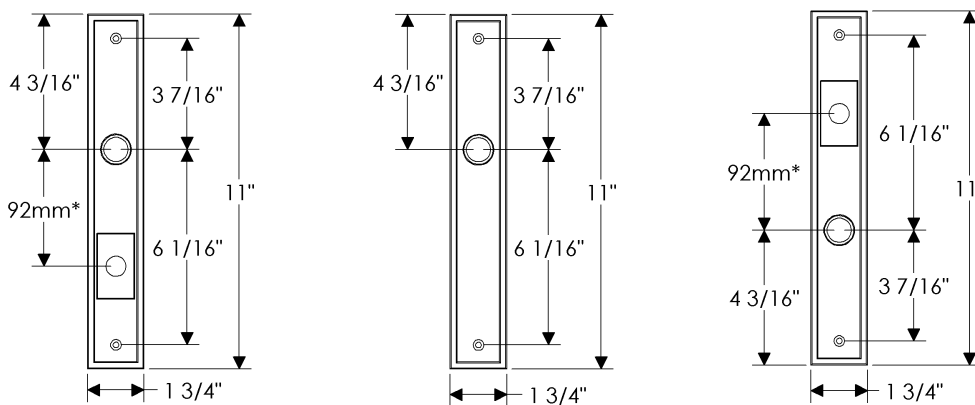

E338

E330

E339

DIMENSIONS ALSO APPLICABLE FOR THE FOLLOWING:

E336 (LHi) (TP)  
E337 (LLo) (TP)

\* This center-to-center dimension will need to be verified before set can be ordered.

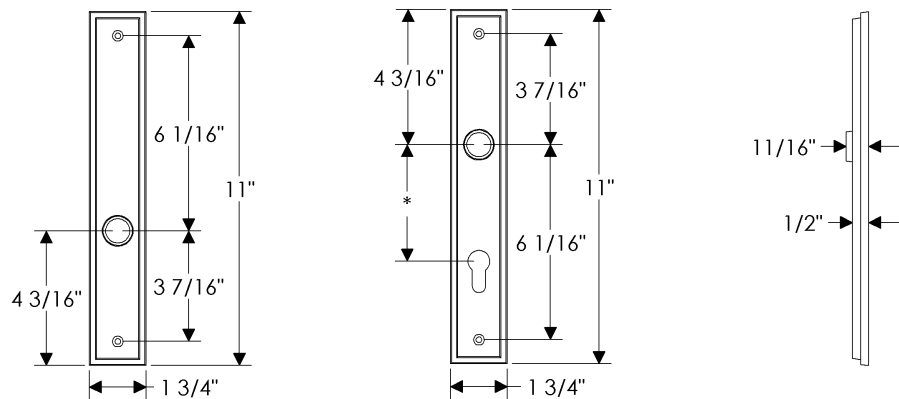

E331

E332

1 3/8" x 11" STEPPED SLIDING DOOR ESCUTCHEONS

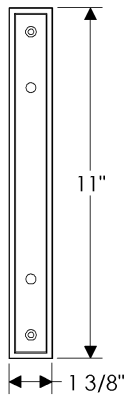

E318

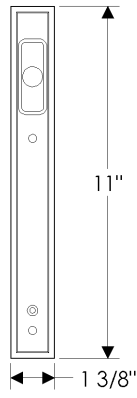

E326

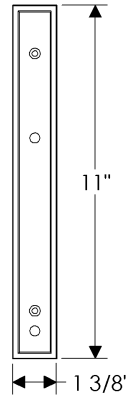

E320

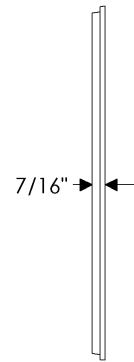

DIMENSIONS ALSO APPLICABLE FOR THE FOLLOWING:

- E319 (Gctr) (TP)
- E321 (GLo) (TP)

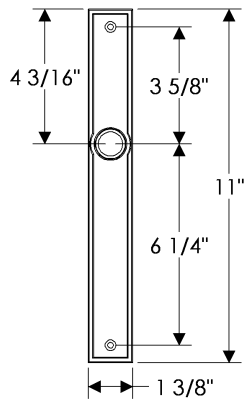

E376

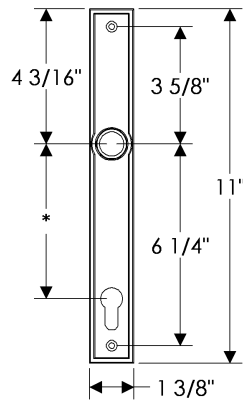

E375

1 3/8" x 13" STEPPED SLIDING DOOR ESCUTCHEONS

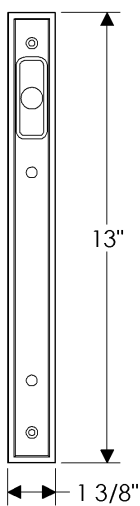

E372

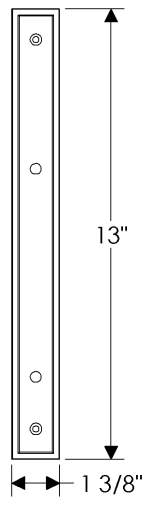

E370

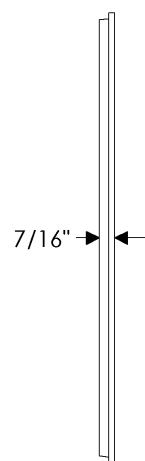

DIMENSIONS ALSO APPLICABLE FOR THE FOLLOWING:

- E371 (GLo) (TP)

1 3/4" x 11" STEPPED SLIDING DOOR ESCUTCHEONS

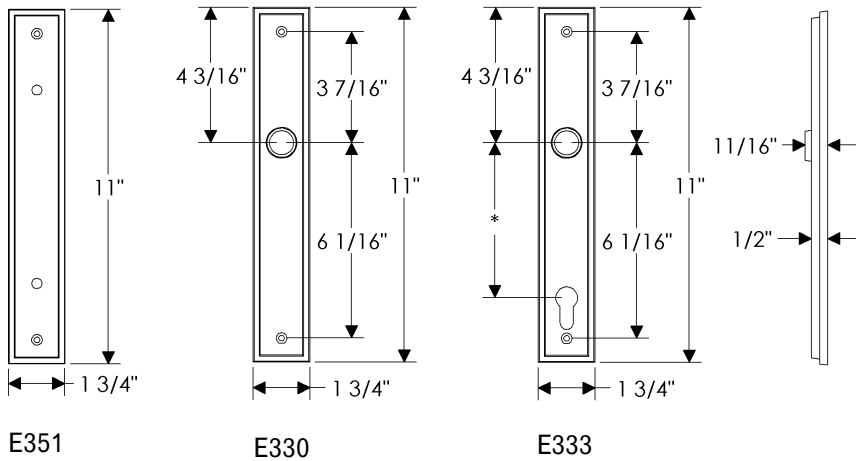

DIMENSIONS ALSO APPLICABLE FOR THE FOLLOWING:

E352 (GCtr) (TP)

\* This center-to-center dimension will need to be verified before set can be ordered.

1 3/4" x 13" STEPPED SLIDING DOOR ESCUTCHEONS

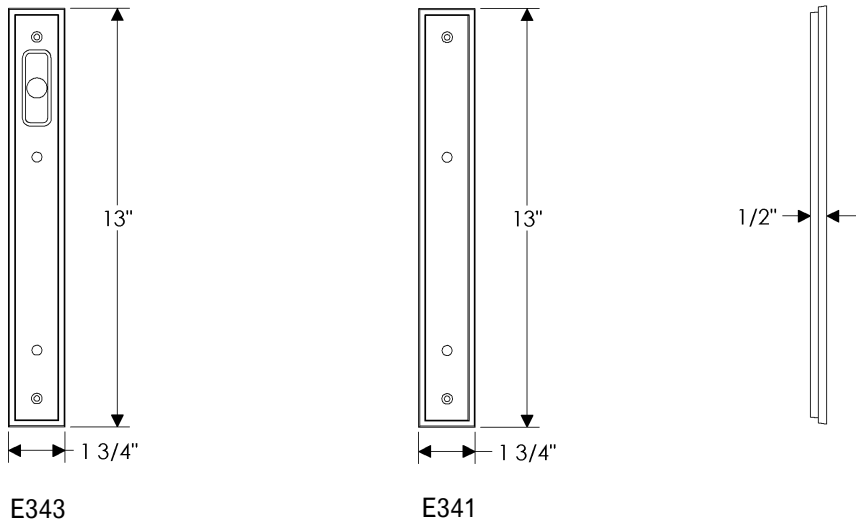

DIMENSIONS ALSO APPLICABLE FOR THE FOLLOWING:

E342 (GLo) (TP)



Ø2 1/4" ROUND CYLINDER TURN PIECE ESCUTCHEONS

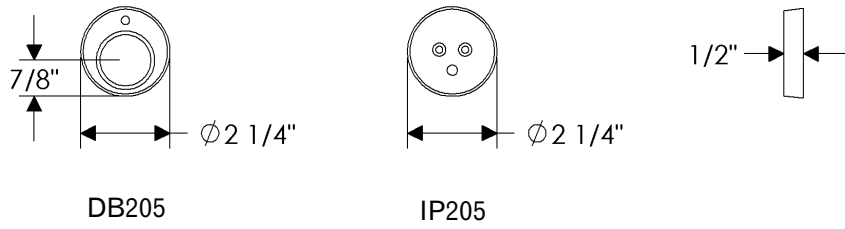

2 1/4" x 3 1/4" CYLINDER TURN PIECE ESCUTCHEONS

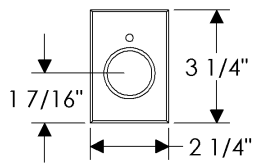

DB202

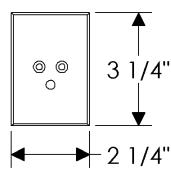

IP214

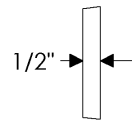

2 1/2" x 3 1/4" CYLINDER TURN PIECE ESCUTCHEONS

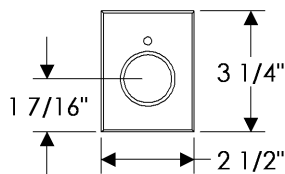

DB250

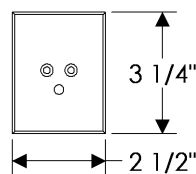

IP250

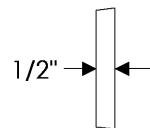

2 1/4" ROUND METRO ESCUTCHEON

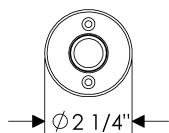

E201

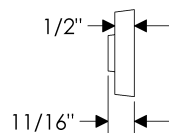

2 1/4" x 2 1/4" SQUARE METRO ESCUTCHEON

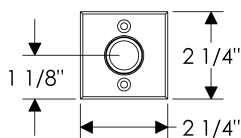

E204

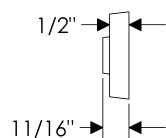

2 1/4" x 3 1/4" METRO ESCUTCHEON

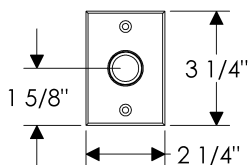

E205

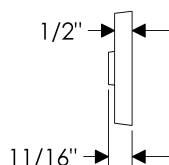



2 1/4" x 10" METRO ESCUTCHEONS

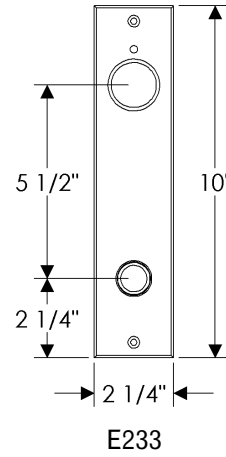
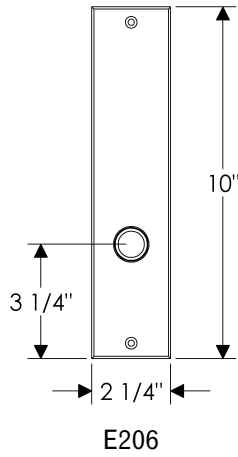
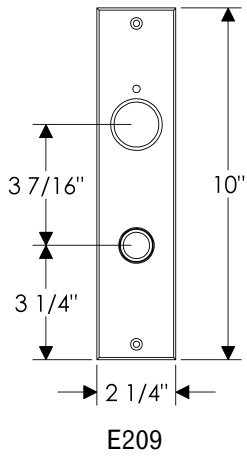

DIMENSIONS ALSO APPLICABLE FOR THE FOLLOWING:

E207 (TP)  
E208 (ER)

E231 (TP55)

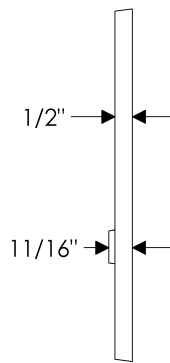
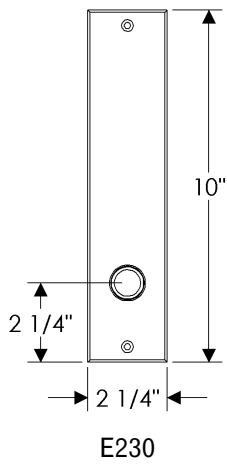

2 1/2" x 4 1/2" METRO ESCUTCHEON

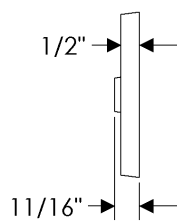
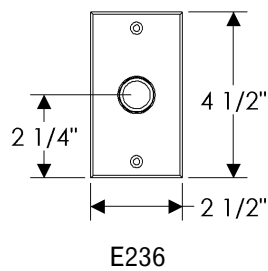

2 1/2" x 13" METRO ESCUTCHEONS

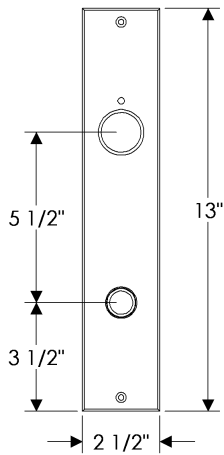

E258

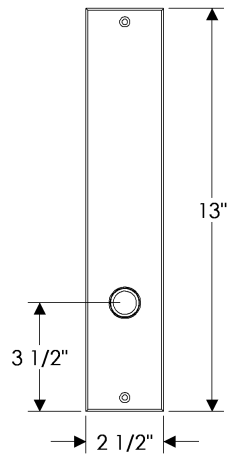

E256

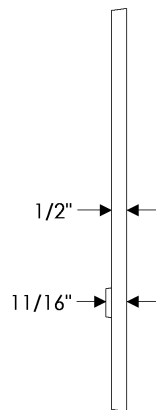

DIMENSIONS ALSO APPLICABLE FOR THE FOLLOWING:

- E257 (TP)
- E259 (ER)

3 1/2" x 13" METRO ESCUTCHEONS

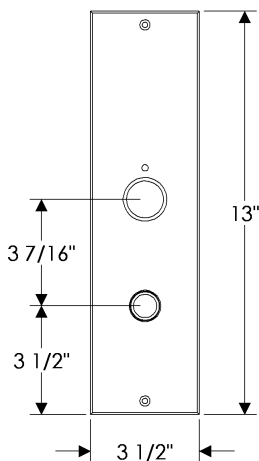

E260

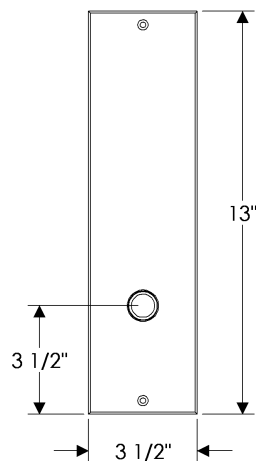

E264

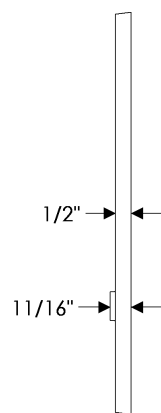

DIMENSIONS ALSO APPLICABLE FOR THE FOLLOWING:

- E262 (TP)
- E261 (ER)



2 1/4" x 17" METRO ESCUTCHEONS

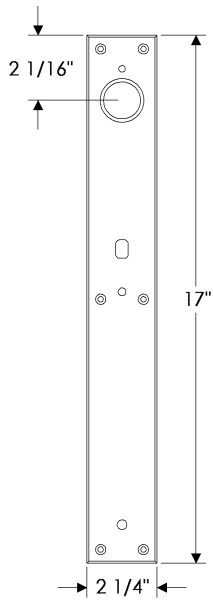

G225

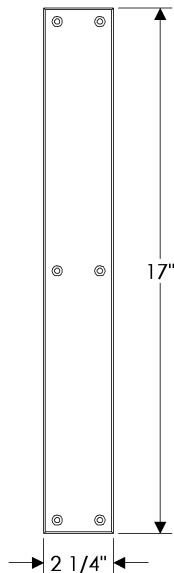

G227

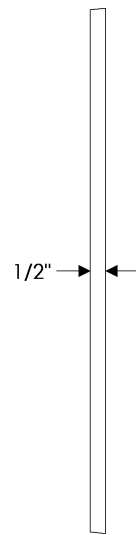

DIMENSIONS ALSO  
APPLICABLE FOR  
THE FOLLOWING:

G226 (TP)

2 1/4" x 20" METRO ESCUTCHEONS

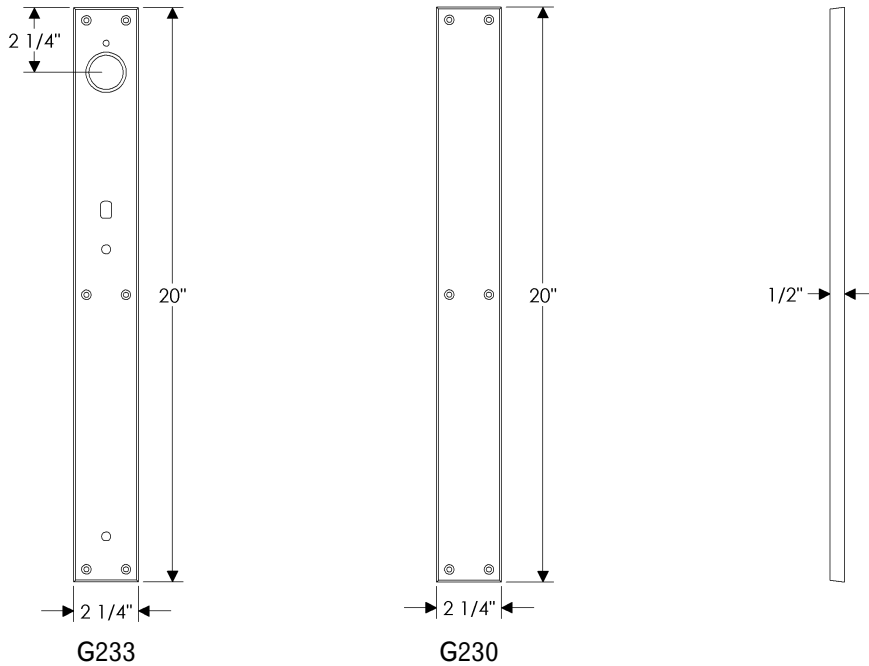

DIMENSIONS ALSO APPLICABLE FOR THE FOLLOWING:  
G231 (TP)

2 1/4" x 30" METRO ESCUTCHEONS

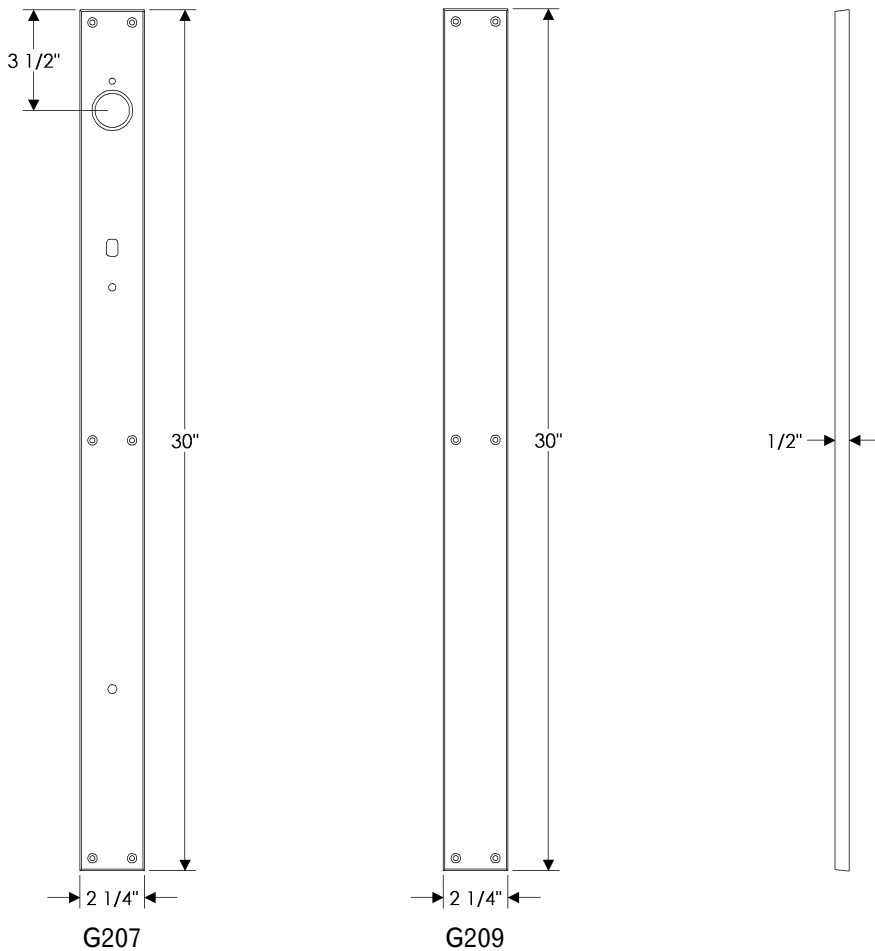

DIMENSIONS ALSO APPLICABLE FOR THE FOLLOWING:  
G208 (TP)

3 1/2" x 30" METRO ESCUTCHEONS

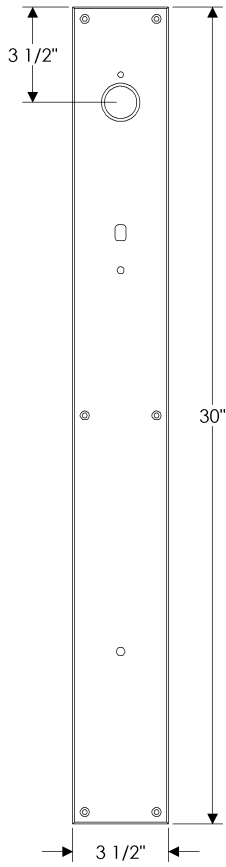

G201

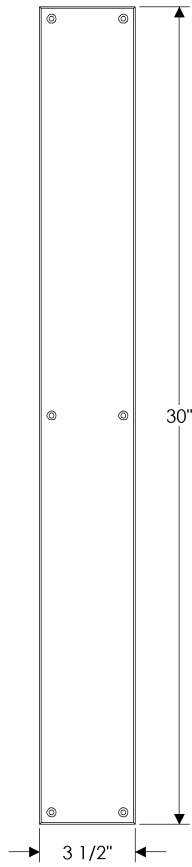

G203

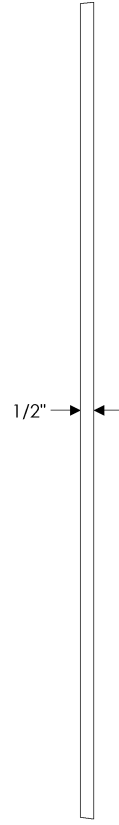

DIMENSIONS ALSO  
APPLICABLE FOR  
THE FOLLOWING:  
G202 (TP)

2" x 6" METRO SCREEN DOOR ESCUTCHEON

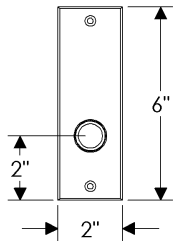

E215

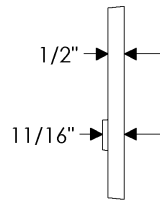

DIMENSIONS ALSO APPLICABLE FOR THE FOLLOWING:

- G216 (TP)
- G217 (ER)

1 3/4" x 11" METRO MULTI-POINT ESCUTCHEONS

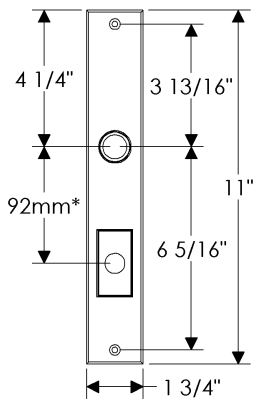

E245

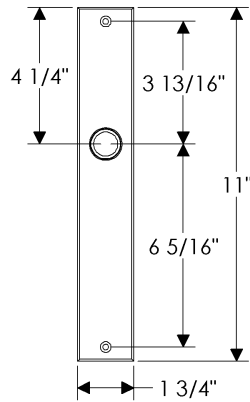

E241

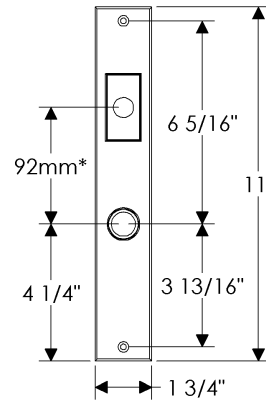

E244

DIMENSIONS ALSO APPLICABLE FOR THE FOLLOWING:

- E243 (LHi) (TP)
- E242 (LLo) (TP)

\* This center-to-center dimension will need to be verified before set can be ordered.

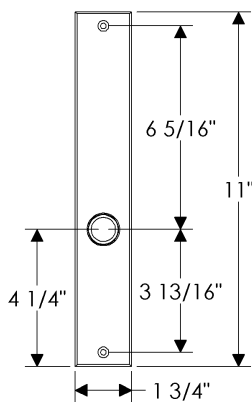

E240

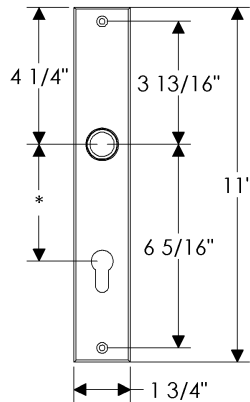

E246

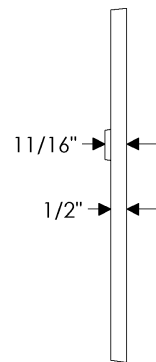

1 3/8" x 11" METRO SLIDING DOOR ESCUTCHEONS

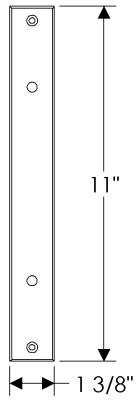

E218

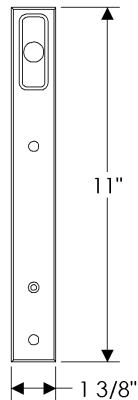

E235

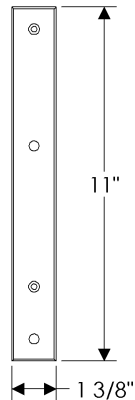

E220

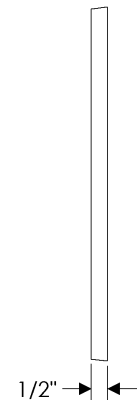

DIMENSIONS ALSO APPLICABLE FOR THE FOLLOWING:

E219 (Gctr) (TP)  
E234 (GLo) (TP)

1 3/4" x 11" METRO SLIDING DOOR ESCUTCHEONS

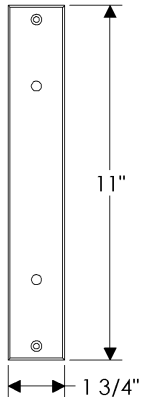

E227

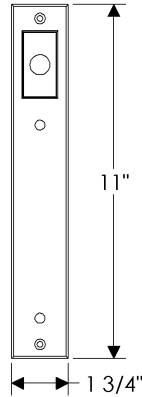

E223

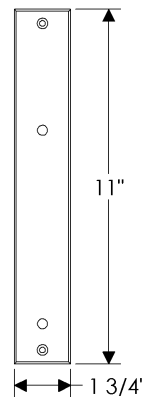

E221

DIMENSIONS ALSO APPLICABLE FOR THE FOLLOWING:

E228 (Gctr) (TP)  
E222 (GLo) (TP)

\* This center-to-center dimension will need to be verified before set can be ordered.

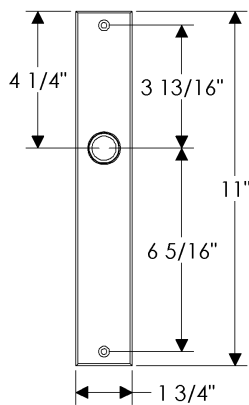

E241

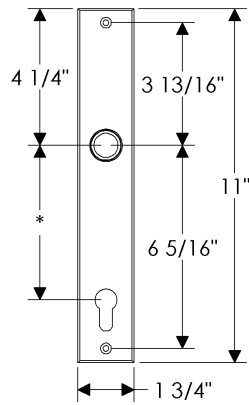

E248

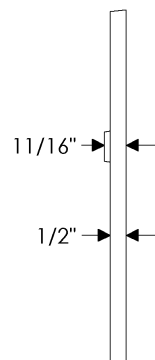



1 3/4" x 13" METRO SLIDING DOOR ESCUTCHEONS

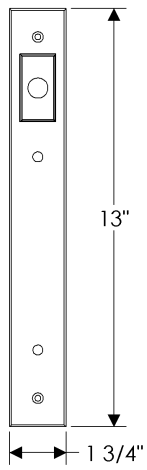

E226

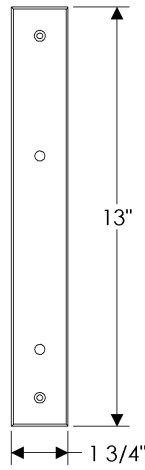

E224

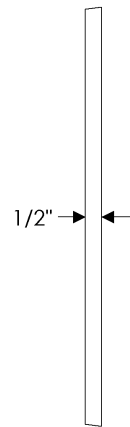

DIMENSIONS ALSO  
APPLICABLE FOR  
THE FOLLOWING:

E225 (GLo) (TP)

2 1/2" x 2 13/16" TEARDROP CYLINDER ESCUTCHEON

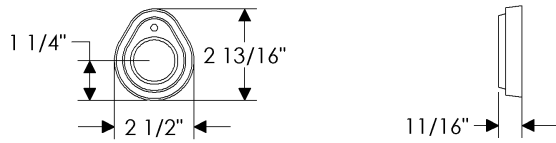

DB506

2 5/8" ROUND TURN PIECE ESCUTCHEON



IP417

2 1/2" x 3 3/4" ARCHED CYLINDER ARCHED ESCUTCHEONS

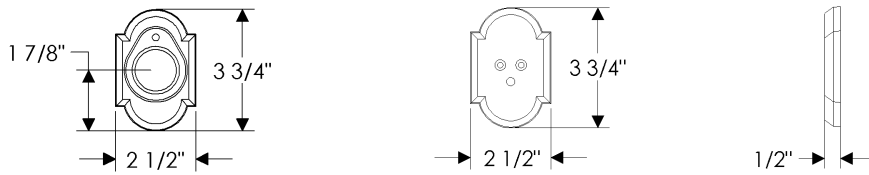

DB508

IP716

2 1/2" ROUND ESCUTCHEON

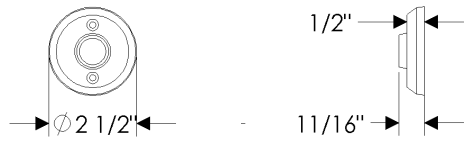

E417

3 1/4" ROUND ESCUTCHEON

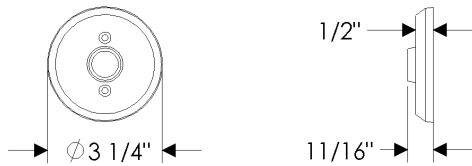

E418

2 5/8" x 5 1/4" OVAL ESCUTCHEON

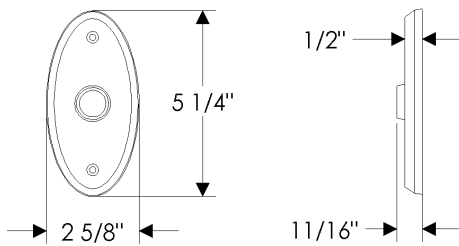

E501

2 1/2" x 5 1/2" ARCHED ESCUTCHEON

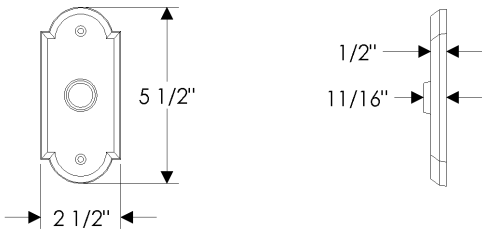

E701

2 1/2" x 9" ARCHED ESCUTCHEONS

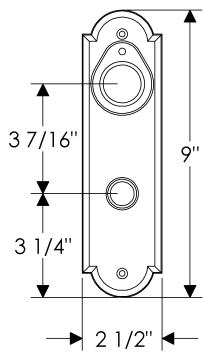

E726

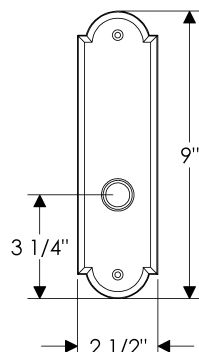

E702

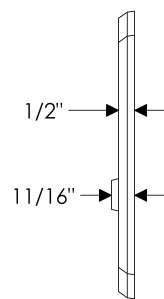

DIMENSIONS ALSO APPLICABLE FOR THE FOLLOWING:

- E722 (ER)
- E723 (TP)

2 1/2" x 11" ARCHED ESCUTCHEONS

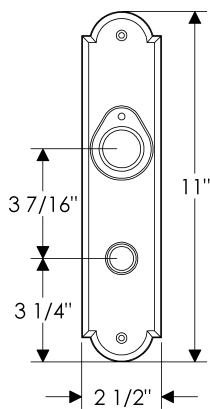

E727

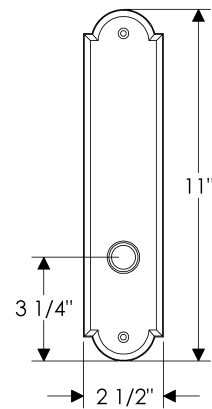

E704

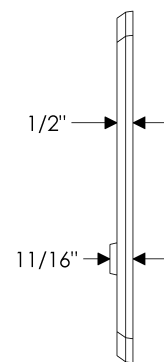

DIMENSIONS ALSO APPLICABLE FOR THE FOLLOWING:

- E721 (TP)
- E724 (ER)

2 1/2" x 13" ARCHED ESCUTCHEONS

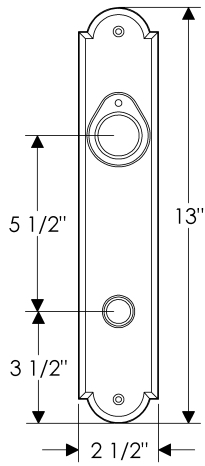

E738

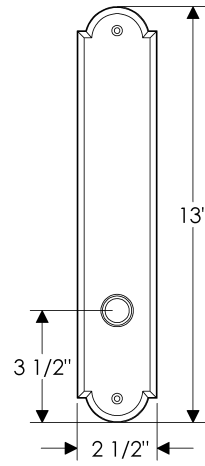

E736

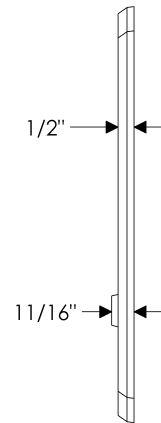

DIMENSIONS ALSO APPLICABLE FOR THE FOLLOWING:

E737 (TP)  
E739 (ER)

3" x 13" ARCHED ESCUTCHEONS

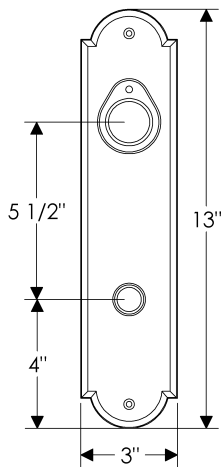

E735

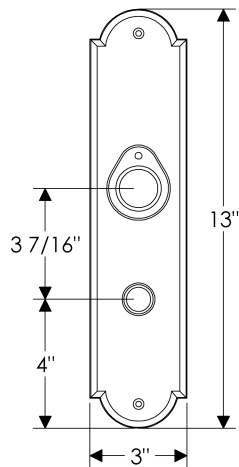

E729

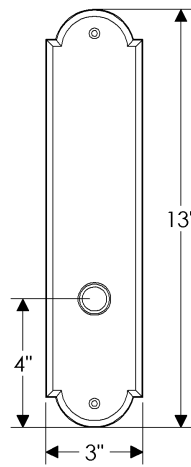

E706

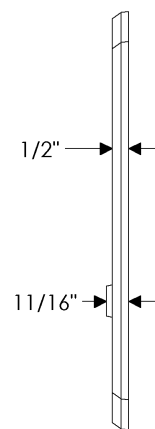

DIMENSIONS ALSO APPLICABLE FOR THE FOLLOWING:

E725 (ER)  
E728 (TP)

3" x 20" ARCHED ESCUTCHEONS

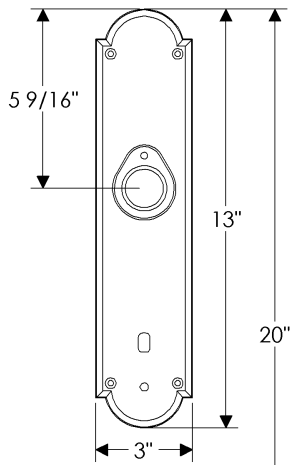

G572

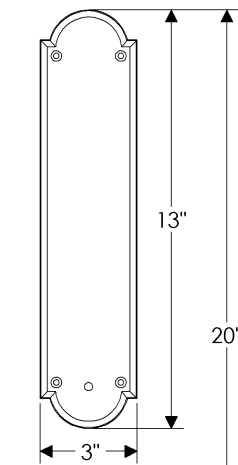

G576

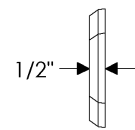
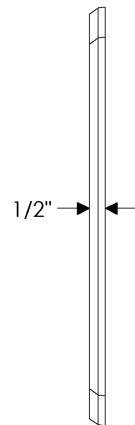
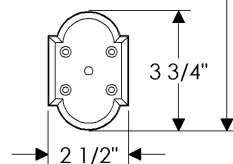
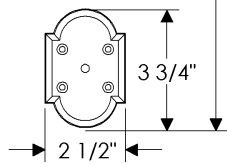

DIMENSIONS ALSO APPLICABLE FOR THE FOLLOWING:

G574 (TP)

2 3/4" x 20" ARCHED ESCUTCHEONS

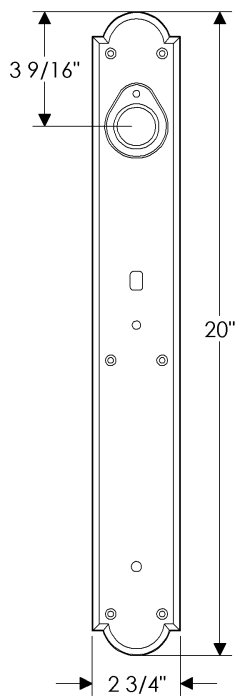

G761

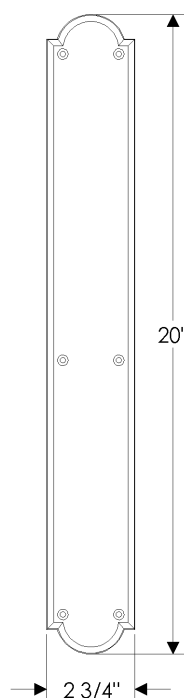

G763

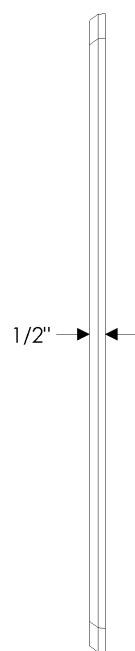

DIMENSIONS ALSO APPLICABLE FOR THE FOLLOWING:

G762 (TP)

3 1/2" x 20" ARCHED ESCUTCHEONS

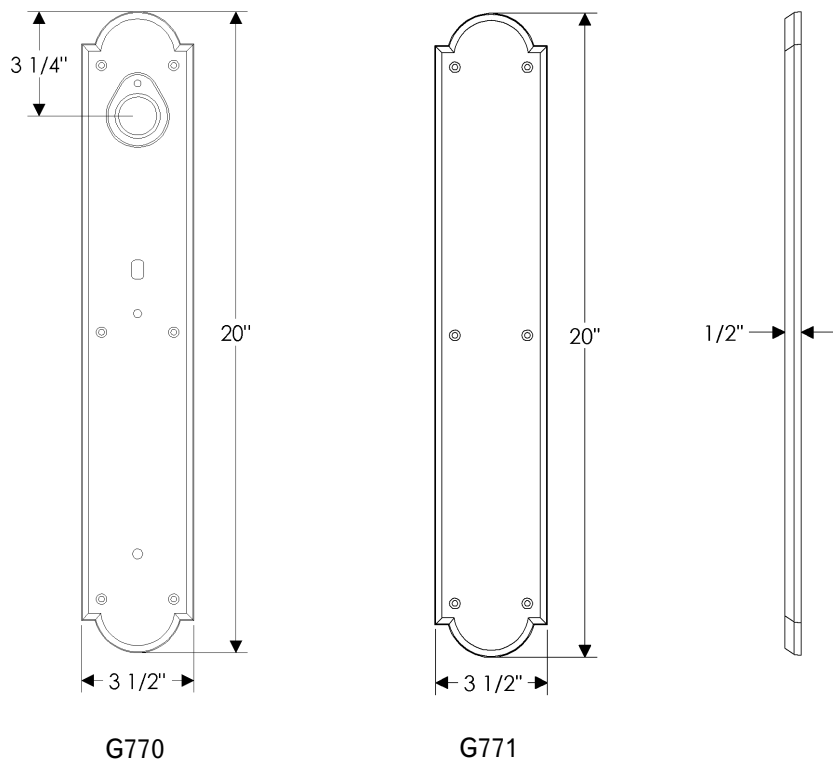

DIMENSIONS ALSO  
 APPLICABLE FOR  
 THE FOLLOWING:  
 G772 (TP)

3 1/2" x 26" ARCHED ESCUTCHEONS



G781

G784

DIMENSIONS ALSO  
APPLICABLE FOR  
THE FOLLOWING:

G782 (TP)

2" x 6" ARCHED SCREEN DOOR ESCUTCHEON

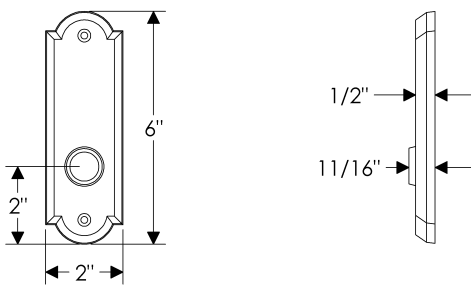

E710

DIMENSIONS ALSO  
APPLICABLE FOR  
THE FOLLOWING:

E711 (TP)

E712 (ER)



1 3/8" x 11" ARCHED MULTI-POINT ESCUTCHEONS

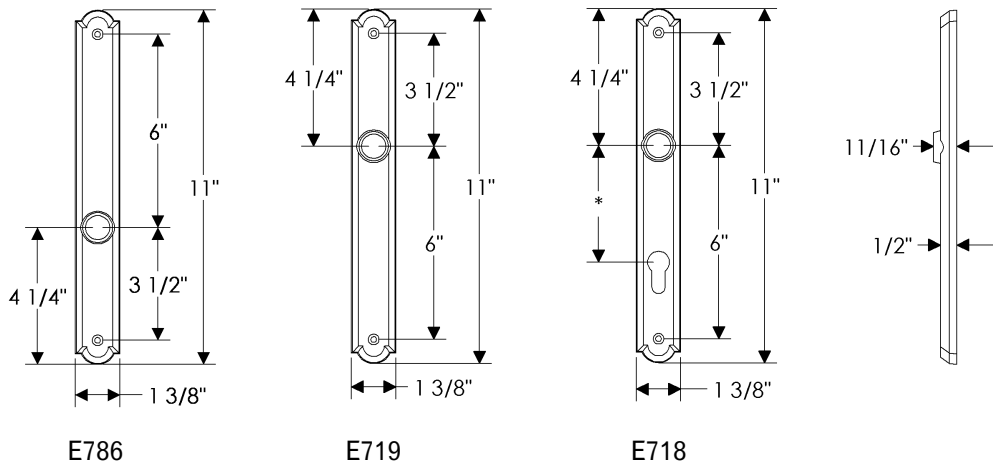

DIMENSIONS ALSO APPLICABLE FOR THE FOLLOWING:

E785 (LHi) (TP)  
E787 (LLo) (TP)

\* This center-to-center dimension will need to be verified before set can be ordered.

1 3/4" x 10" ARCHED MULTI-POINT ESCUTCHEONS

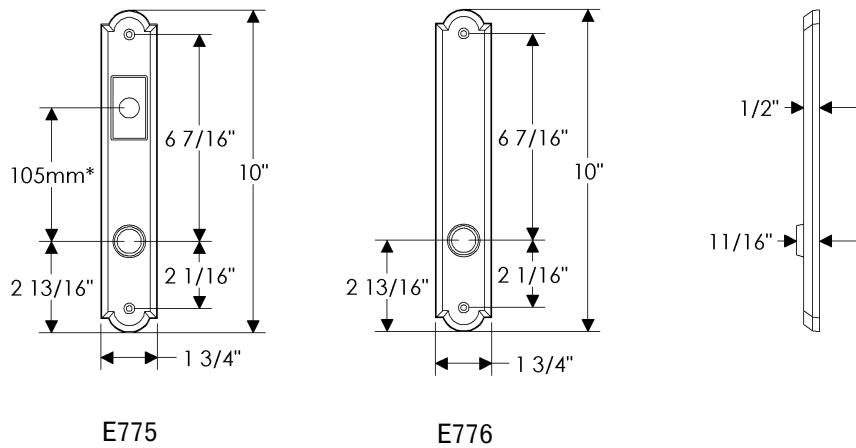

DIMENSIONS ALSO APPLICABLE FOR THE FOLLOWING:

E777 (LLo) (TP)

\* This center-to-center dimension will need to be verified before set can be ordered.

1 3/4" x 11" ARCHED MULTI-POINT ESCUTCHEONS

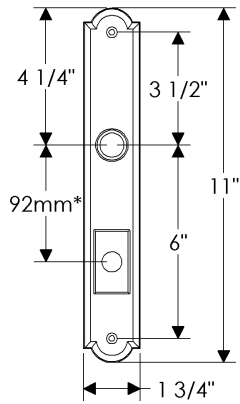

E745

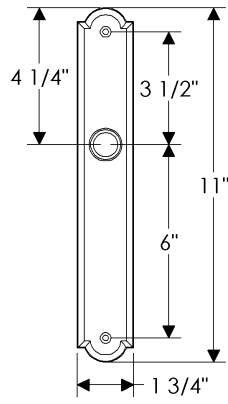

E746

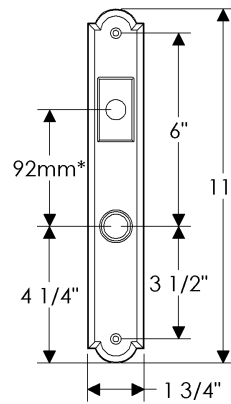

E743

DIMENSIONS ALSO APPLICABLE FOR THE FOLLOWING:

E747 (LHi) (TP)  
E742 (LLo) (TP)

\* This center-to-center dimension will need to be verified before set can be ordered.

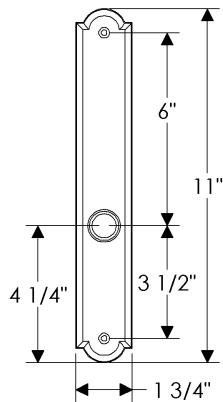

E741

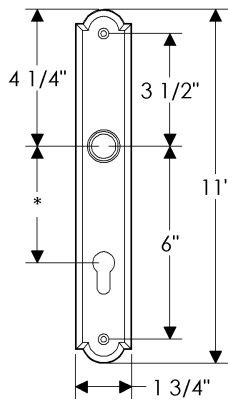

E748

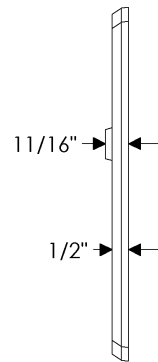

2 1/2" x 11" ARCHED MULTI-POINT ESCUTCHEONS

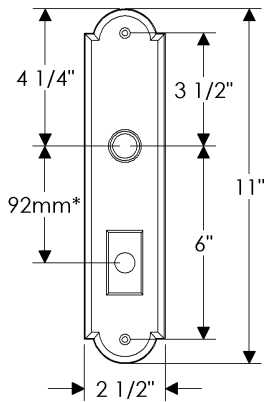

E750

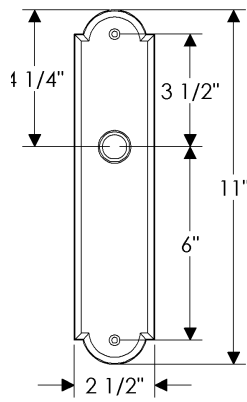

E751

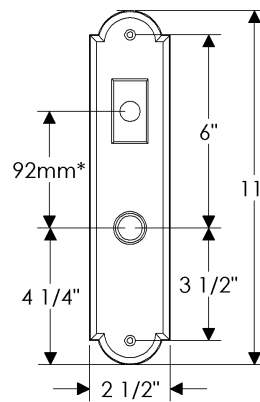

E757

DIMENSIONS ALSO APPLICABLE FOR THE FOLLOWING:

E753 (LHi) (TP)  
E756 (LLo) (TP)

\* This center-to-center dimension will need to be verified before set can be ordered.

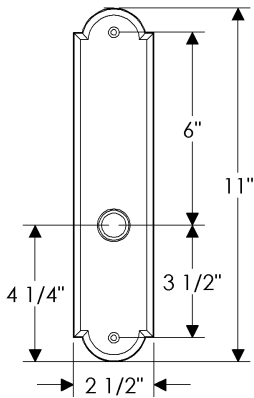

E755

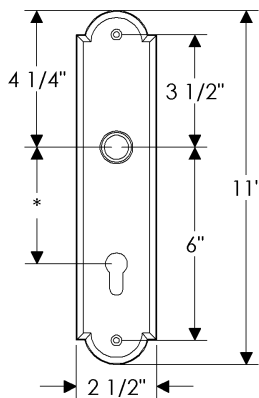

E754

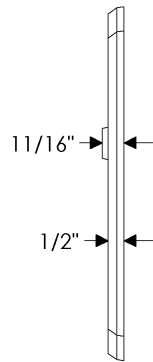

1 3/8" x 11" ARCHED SLIDING DOOR ESCUTCHEONS

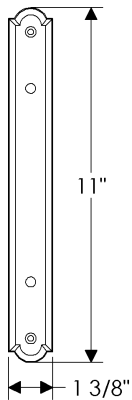

E708

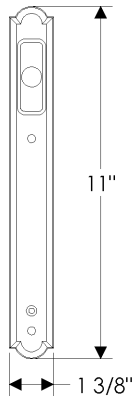

E714

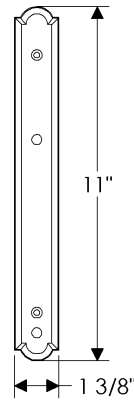

E715

DIMENSIONS ALSO APPLICABLE FOR THE FOLLOWING:

E709 (Gctr) (TP)  
E717 (GLo) (TP)

\* This center-to-center dimension will need to be verified before set can be ordered.

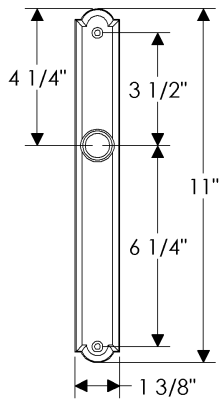

E718

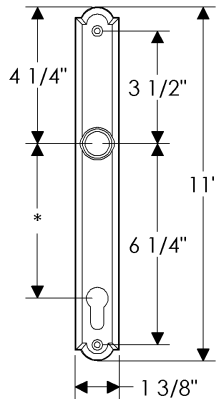

E720

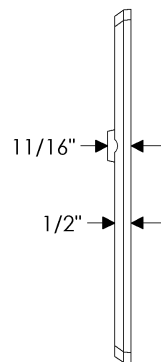

1 3/4" x 11" ARCHED SLIDING DOOR ESCUTCHEONS

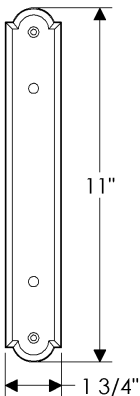

E760

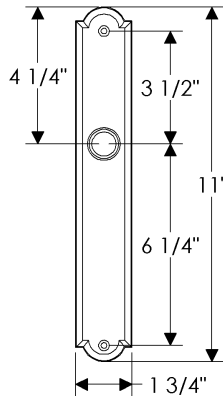

E746

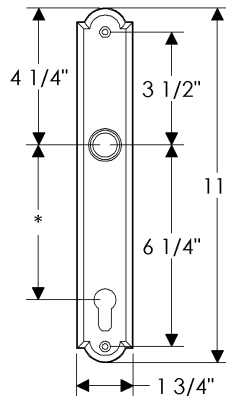

E740

DIMENSIONS ALSO APPLICABLE FOR THE FOLLOWING:

E762 (Gctr) (TP)

\* This center-to-center dimension will need to be verified before set can be ordered.

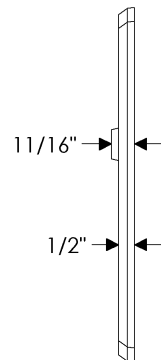

1 3/4" x 13" ARCHED SLIDING DOOR ESCUTCHEONS

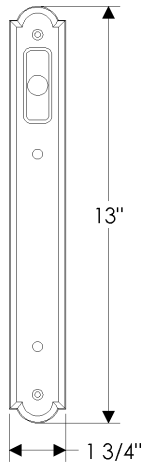

E798

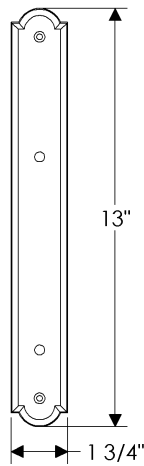

E796

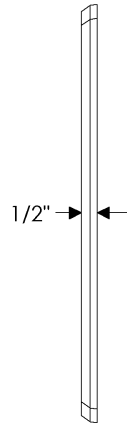

DIMENSIONS ALSO  
APPLICABLE FOR  
THE FOLLOWING:

E797 (GLo) (TP)

2 1/2" x 13" ARCHED SLIDING DOOR ESCUTCHEONS

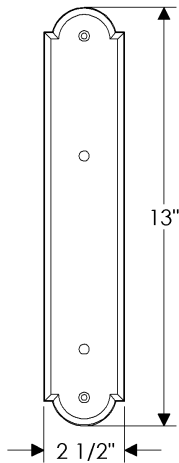

E790

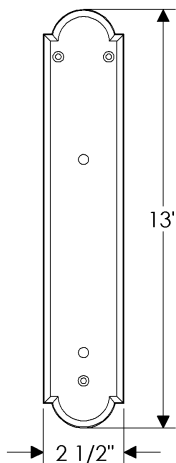

E793

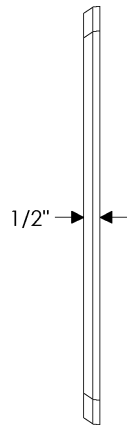

DIMENSIONS ALSO  
APPLICABLE FOR  
THE FOLLOWING:

E791 (GLo) (TP)

E794 (GLo) (TP)

2 1/2" x 13" ARCHED ESCUTCHEON

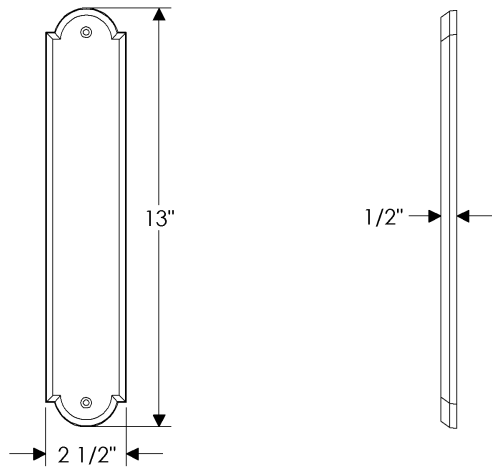

E780

3" x 13" ARCHED ESCUTCHEON

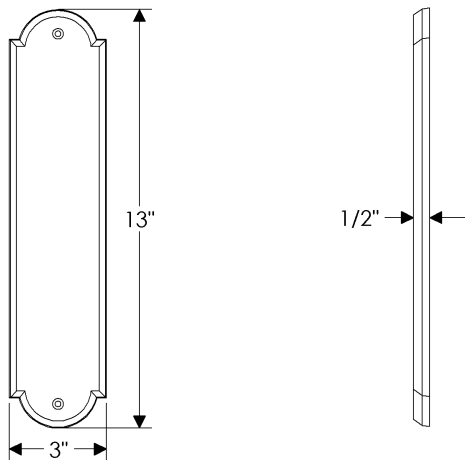

E707

2 1/2" x 11" ARCHED CREMONE BOLT ESCUTCHEONS

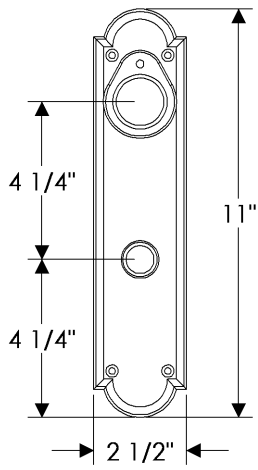

CE713

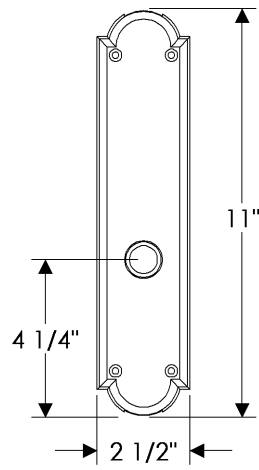

CE710

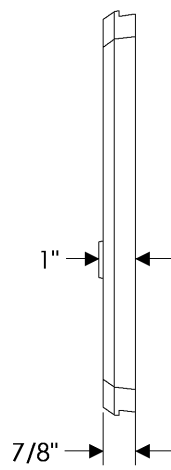

DIMENSIONS ALSO APPLICABLE FOR THE FOLLOWING:

- CE709 (DU/PA)
- CE711 (TP)

2 1/2" x 3 3/8" CURVED CYLINDER TURN PIECE ESCUTCHEONS

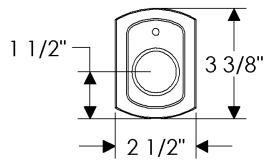

DB511

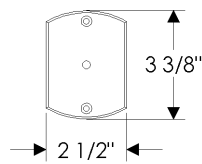

IP512

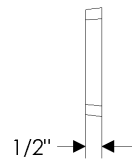

2 1/2" x 4 1/2" CURVED ESCUTCHEON

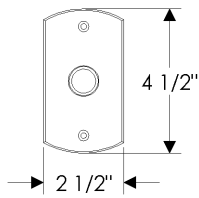

E504

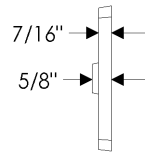

2 1/2" x 8" CURVED ESCUTCHEON

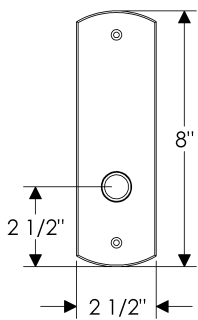

E508

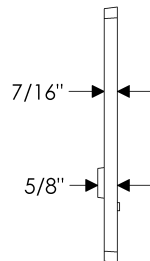

DIMENSIONS ALSO  
APPLICABLE FOR  
THE FOLLOWING:

E506 (TP)  
E507 (ER)



2 1/2" x 11" CURVED ESCUTCHEONS

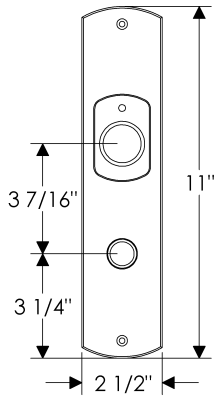

E511

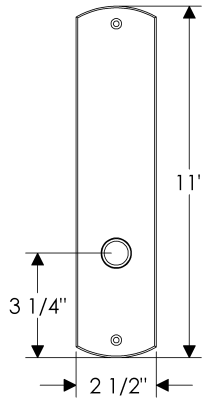

E512

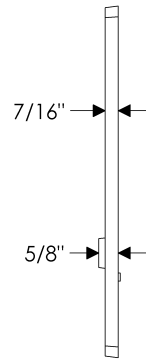

DIMENSIONS ALSO APPLICABLE FOR THE FOLLOWING:

- E513 (TP)
- E514 (ER)

2 1/2" x 13" CURVED ESCUTCHEONS

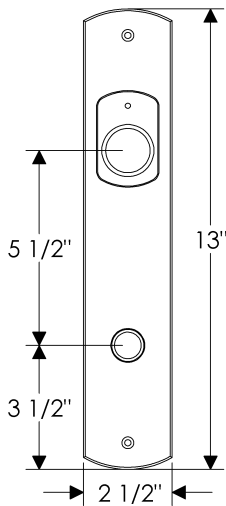

E558

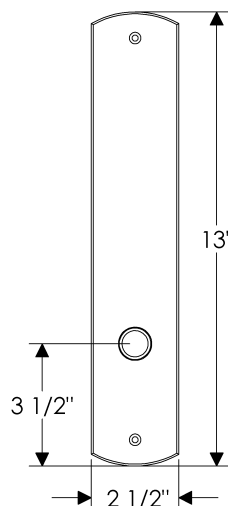

E556

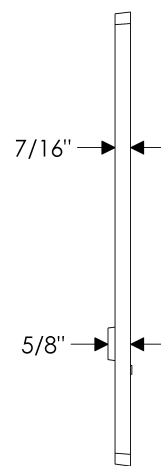

DIMENSIONS ALSO APPLICABLE FOR THE FOLLOWING:

- E557 (TP)
- E559 (ER)

2 3/4" x 20" CURVED ESCUTCHEONS

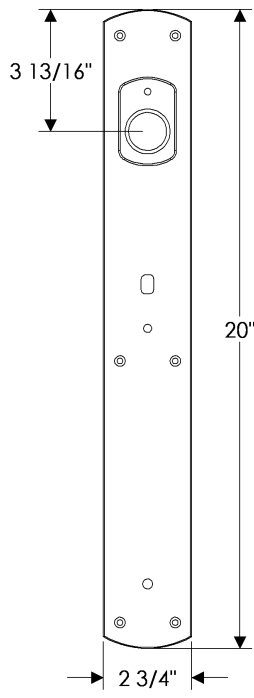

G501

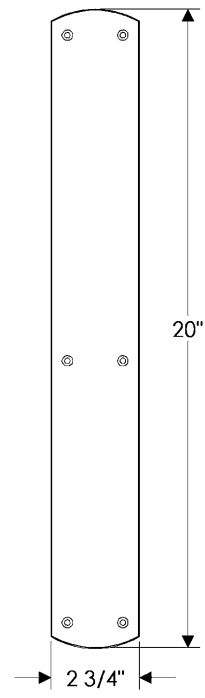

G504

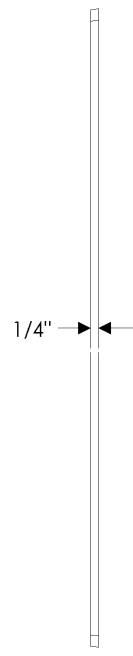

DIMENSIONS ALSO APPLICABLE FOR THE FOLLOWING:

G502 (TP)

3 1/2" x 26" CURVED ESCUTCHEONS

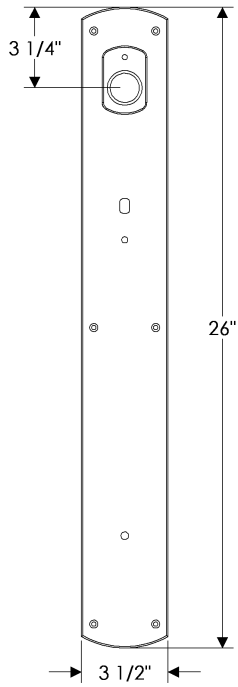

G505

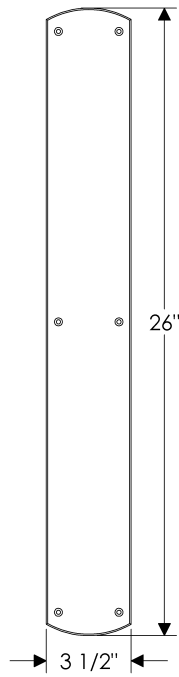

G508

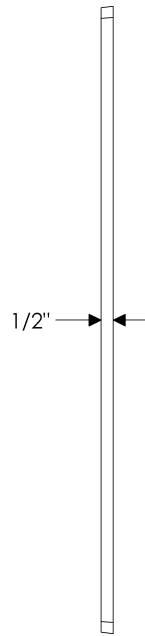

DIMENSIONS ALSO  
APPLICABLE FOR  
THE FOLLOWING:

G507 (TP)

2" x 6" CURVED SCREEN DOOR ESCUTCHEONS

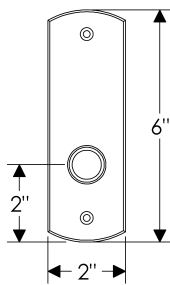

E515

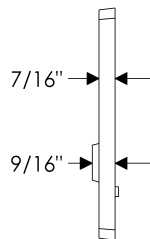

DIMENSIONS ALSO  
APPLICABLE FOR  
THE FOLLOWING:

E516 (TP)

E517 (ER)

1 3/8" x 11" CURVED MULTI-POINT ESCUTCHEONS

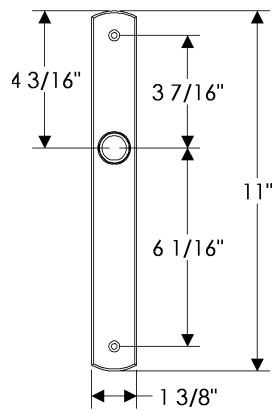

E576

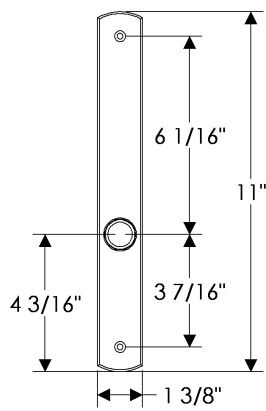

E527

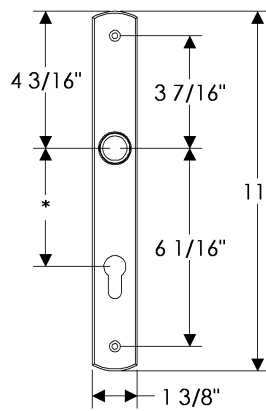

E575

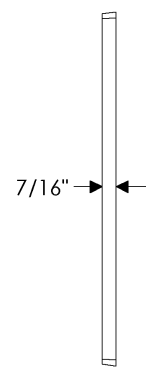

DIMENSIONS ALSO APPLICABLE FOR THE FOLLOWING:

- E577 (LHi) (TP)
- E528 (LLo) (TP)

\* This center-to-center dimension will need to be verified before set can be ordered.

1 3/4" x 11" CURVED MULTI-POINT ESCUTCHEONS

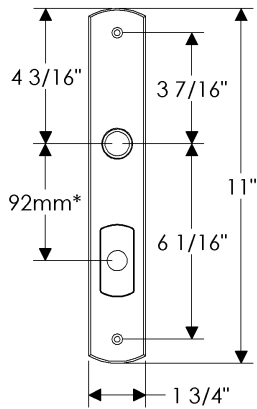

E538

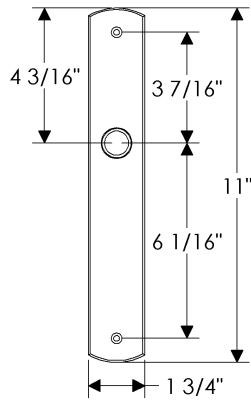

E530

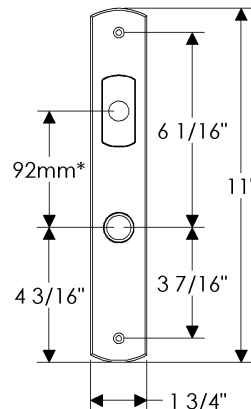

E539

DIMENSIONS ALSO APPLICABLE FOR THE FOLLOWING:

- E536 (LHi) (TP)
- E537 (LLo) (TP)

\* This center-to-center dimension will need to be verified before set can be ordered.

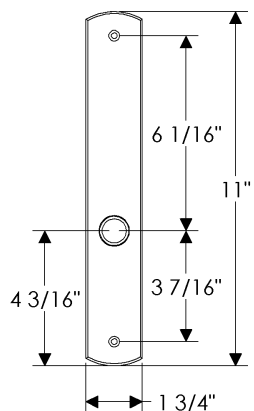

E531

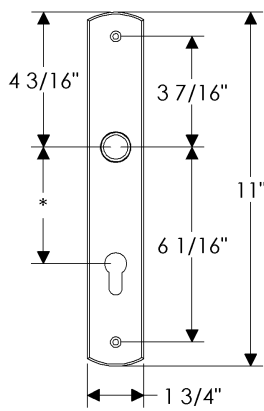

E532

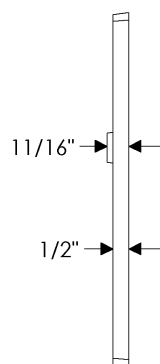

1 3/8" x 11" CURVED SLIDING DOOR ESCUTCHEONS

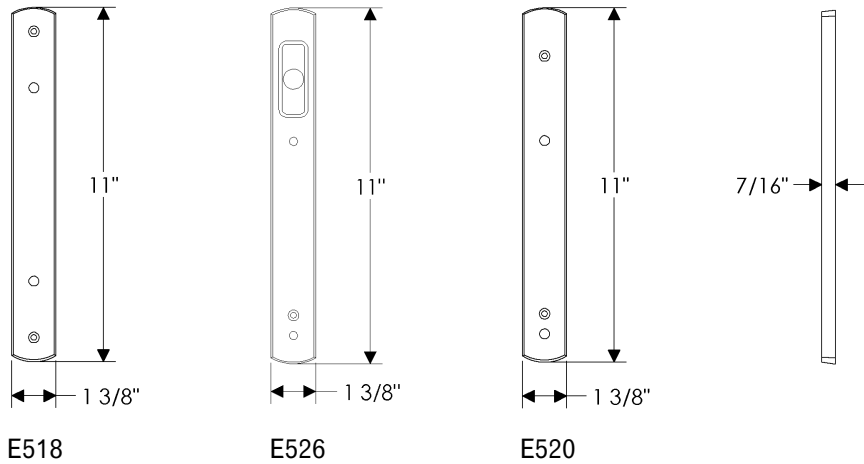

DIMENSIONS ALSO APPLICABLE FOR THE FOLLOWING:  
E519 (GCtr) (TP)  
E521 (GLo) (TP)

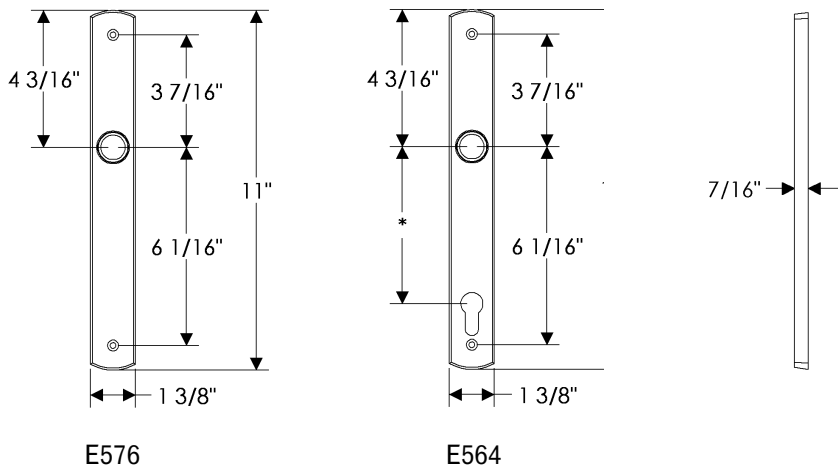

\* This center-to-center dimension will need to be verified before set can be ordered.

1 3/4" x 11" CURVED SLIDING DOOR ESCUTCHEONS

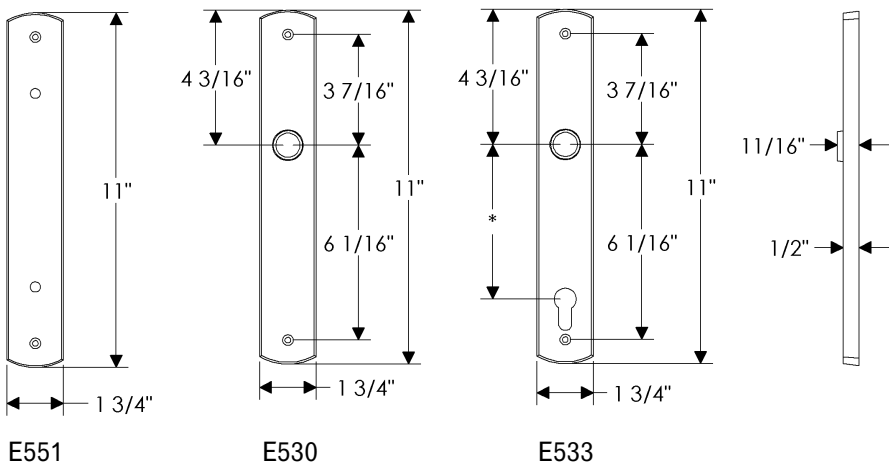

DIMENSIONS ALSO APPLICABLE FOR THE FOLLOWING:  
E552 (GCtr) (TP)

\* This center-to-center dimension will need to be verified before set can be ordered.

1 3/4" x 13" CURVED SLIDING DOOR ESCUTCHEONS

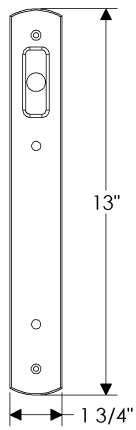

E563

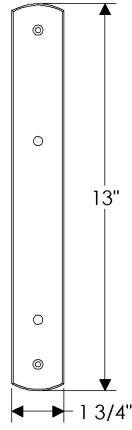

E561

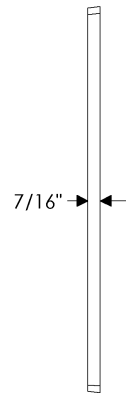

DIMENSIONS ALSO  
APPLICABLE FOR  
THE FOLLOWING:

E562 (GLo) (TP)

2 3/4" x 13" CURVED ESCUTCHEON

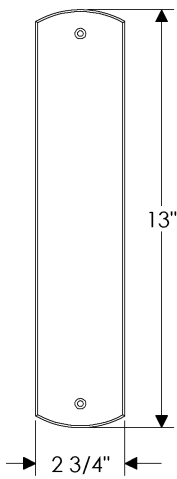

G560

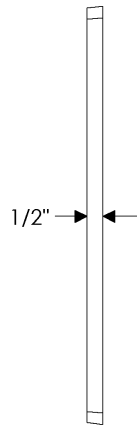

2 1/2" x 11" CURVED CREMONE BOLT ESCUTCHEONS

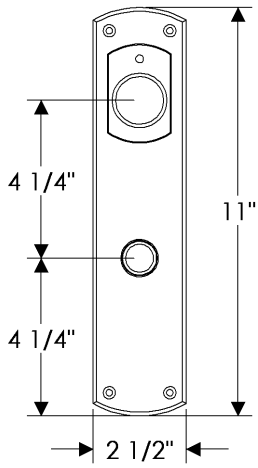

CE513

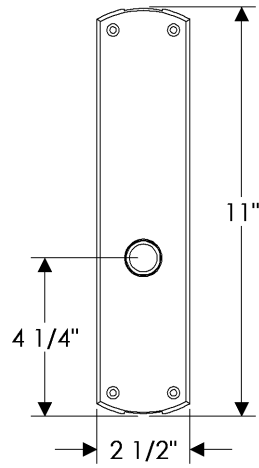

CE510

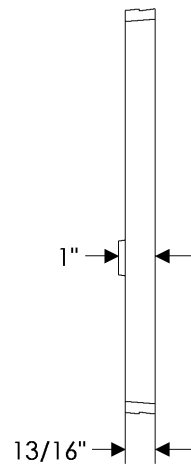

DIMENSIONS ALSO APPLICABLE FOR THE FOLLOWING:

CE509 (DU/PA)  
CE511 (TP)

2" x 8" FLEUR DE LIS ESCUTCHEON

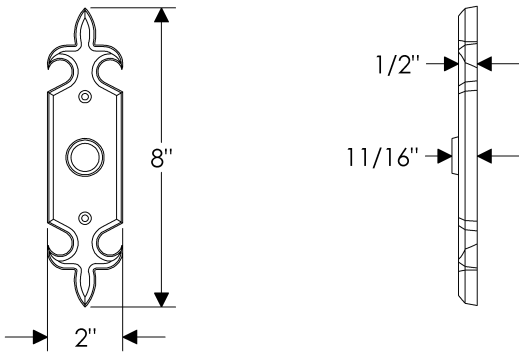

E828

2" x 15" FLEUR DE LIS ESCUTCHEONS

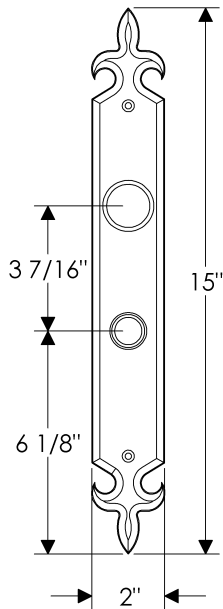

E823

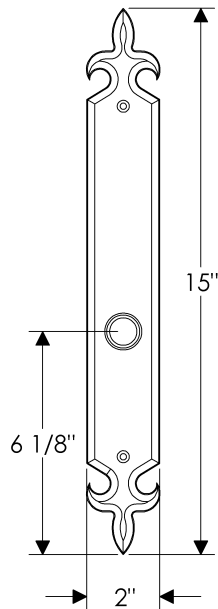

E820

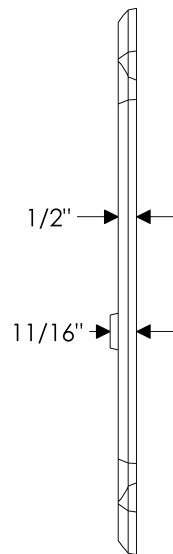

DIMENSIONS ALSO APPLICABLE FOR THE FOLLOWING:

- E821 (TP)
- E822 (ER)



2 1/2" x 15" FLEUR DE LIS ESCUTCHEONS

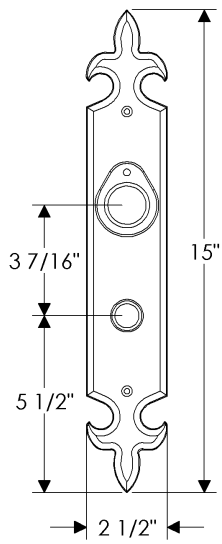

E843

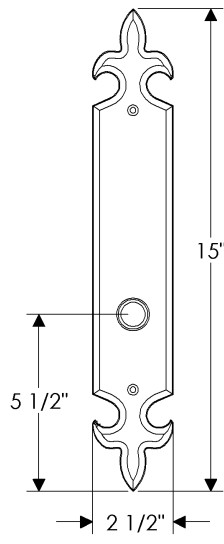

E841

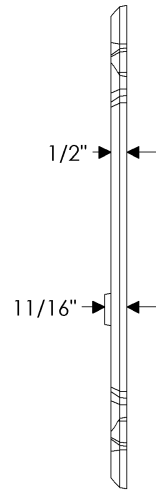

DIMENSIONS ALSO APPLICABLE FOR THE FOLLOWING:

E842 (TP)  
E844 (ER)

3" x 21" FLEUR DE LIS ESCUTCHEONS

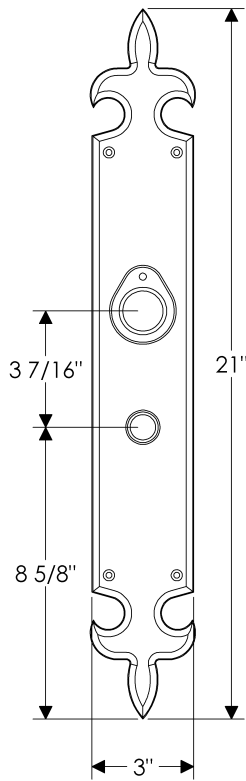

E830

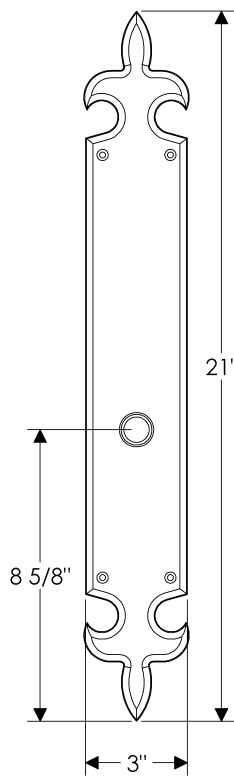

E832

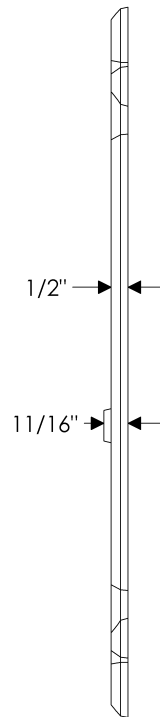

DIMENSIONS ALSO APPLICABLE FOR THE FOLLOWING:

E831 (TP)  
E833 (ER)

3 1/4" x 27" FLEUR DE LIS ESCUTCHEONS

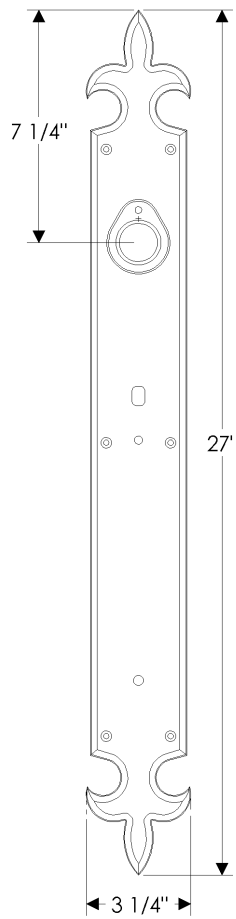

G841

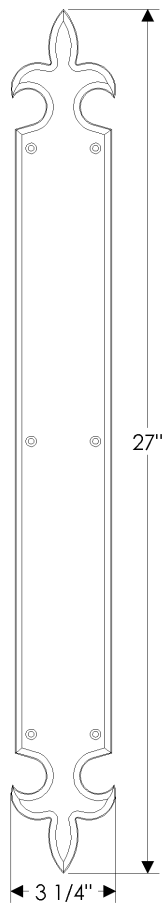

G843

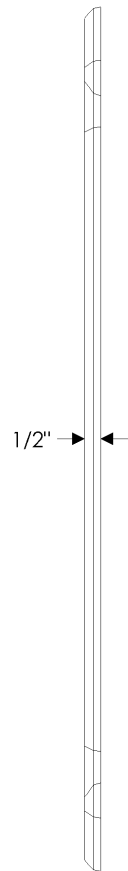

DIMENSIONS ALSO  
APPLICABLE FOR  
THE FOLLOWING:

G842 (TP)

2" x 15" FLEUR DE LIS MULTI-POINT ESCUTCHEONS

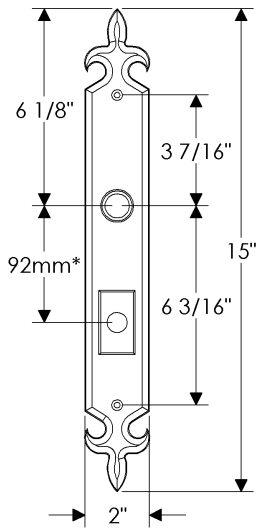

E826

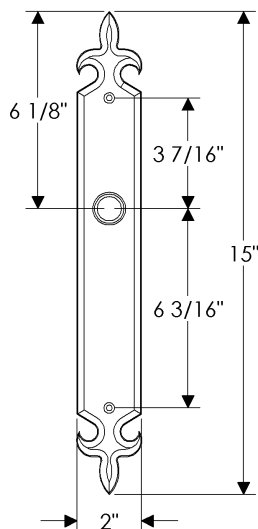

E824

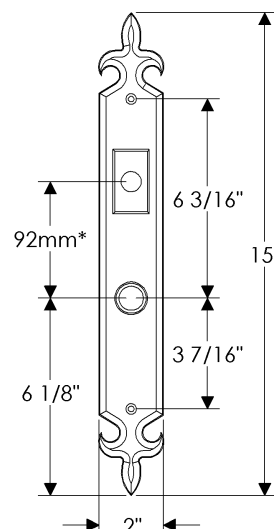

E819

DIMENSIONS ALSO APPLICABLE FOR THE FOLLOWING:

E827 (LHi) (TP)  
E818 (LLo) (TP)

\* This center-to-center dimension will need to be verified before set can be ordered.

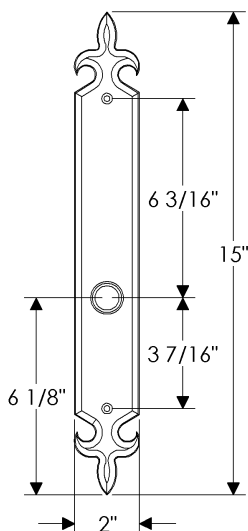

E817

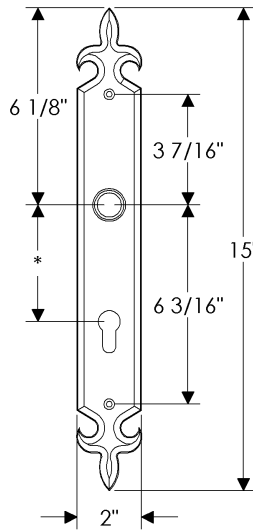

E825

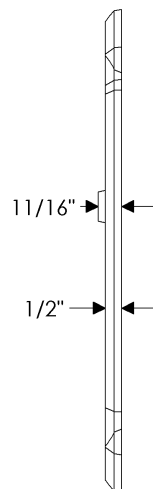

4 3/16" x 18" GOTHIC ESCUTCHEONS

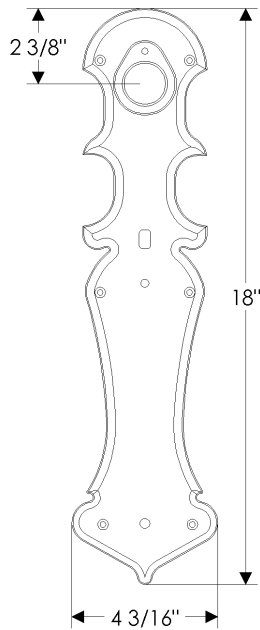

G801

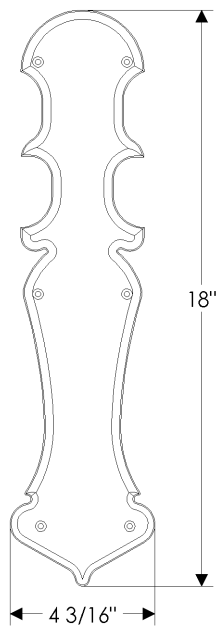

G804

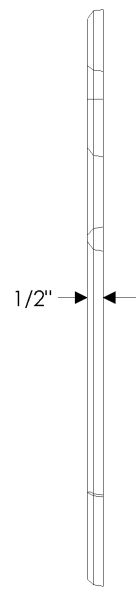

DIMENSIONS ALSO  
APPLICABLE FOR  
THE FOLLOWING:

G802 (TP)

2 1/2" x 5 1/8" BRIGGS CYLINDER TURN PIECE ESCUTCHEONS

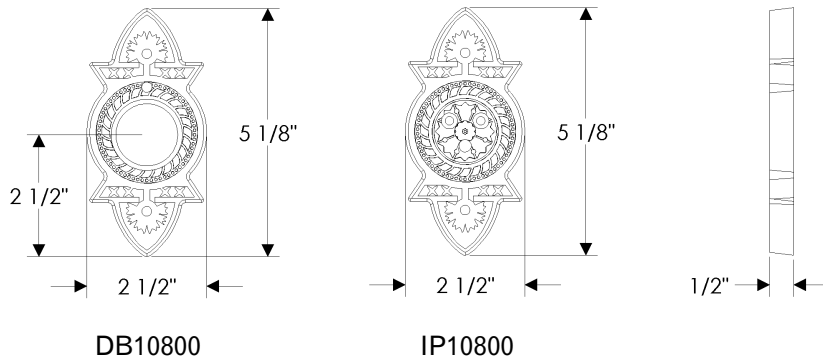

2 1/2" ROUND BRIGGS ESCUTCHEON

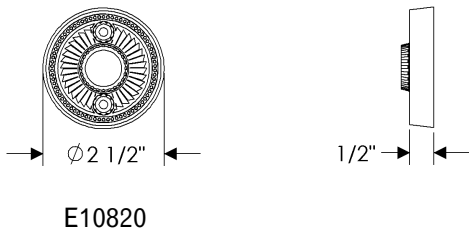

2 3/8" x 7" BRIGGS ESCUTCHEON

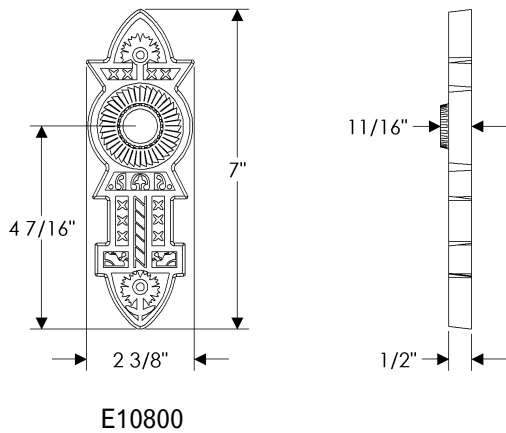

2 3/8" x 10" BRIGGS ESCUTCHEON

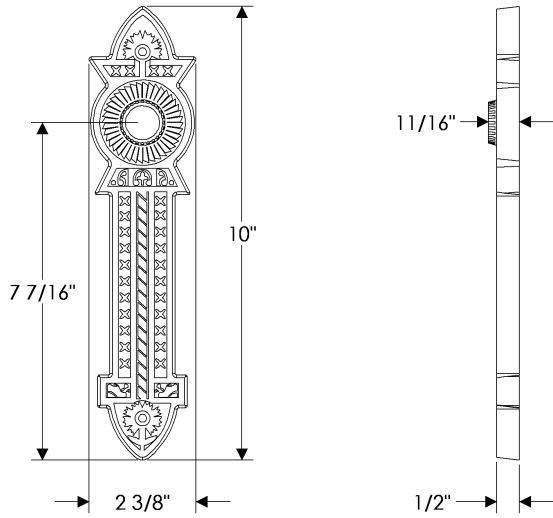

E10810

3" x 13" BRIGGS ESCUTCHEON

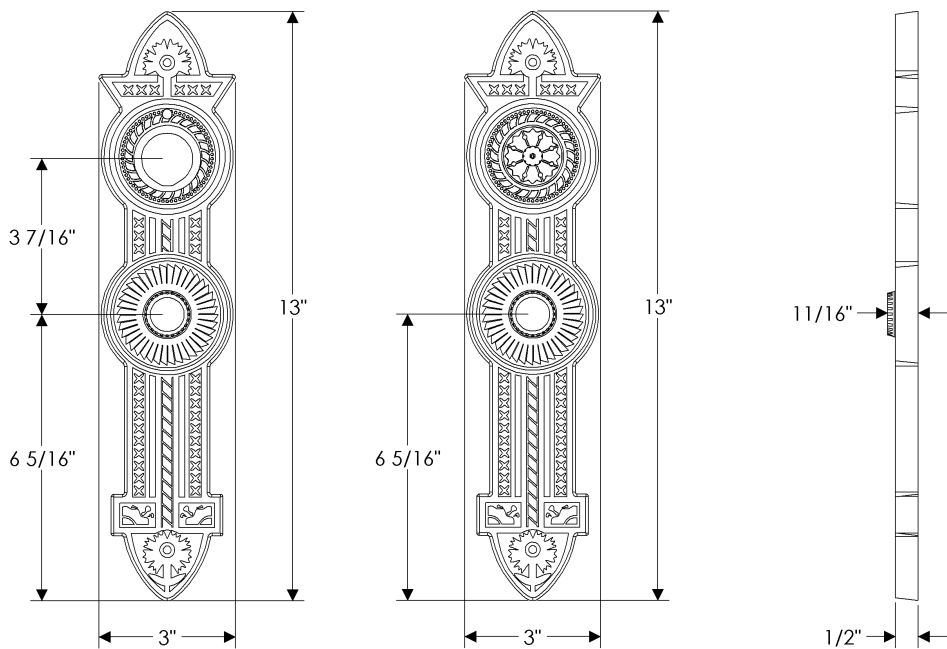

E10830

E10831

DIMENSIONS ALSO APPLICABLE FOR THE FOLLOWING:

- E10832 (TP)
- E10833 (ER)

3 9/16" x 23 1/4" BRIGGS ESCUTCHEON

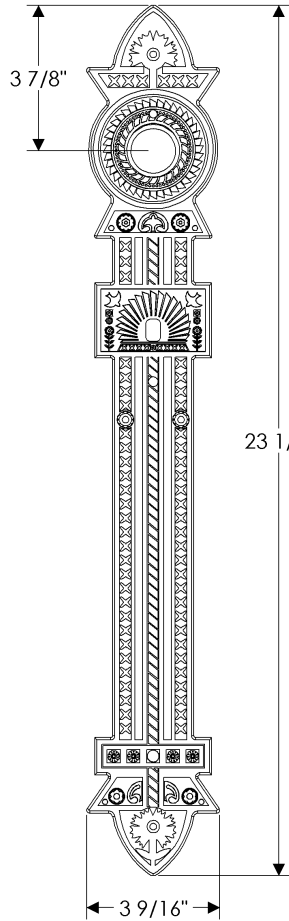

G10850

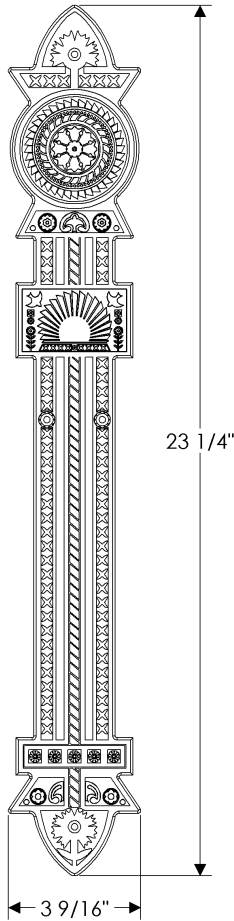

G10852

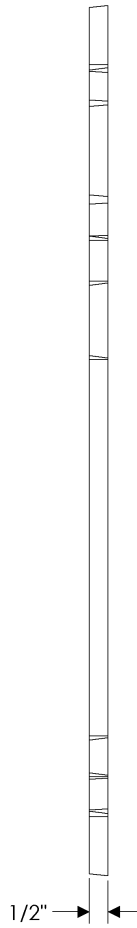

DIMENSIONS ALSO  
APPLICABLE FOR  
THE FOLLOWING:  
G10851 (TP)

2" x 15" BRIGGS MULTI-POINT ESCUTCHEONS

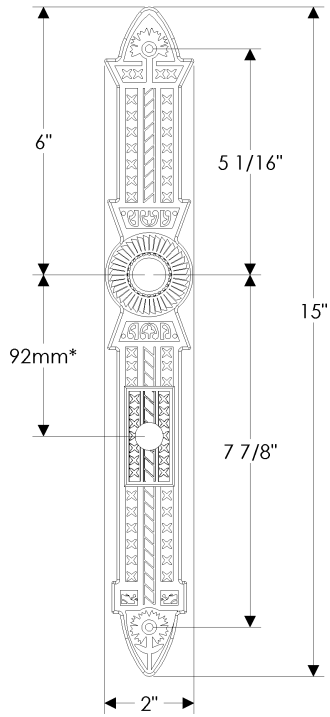

E10870

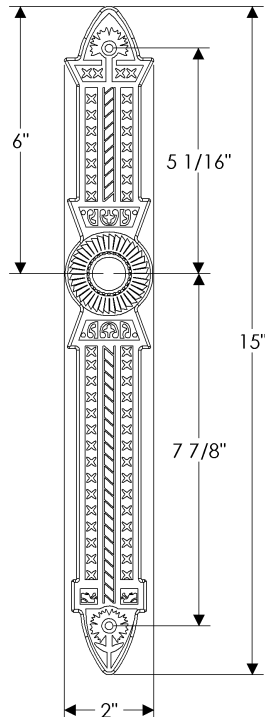

E10871

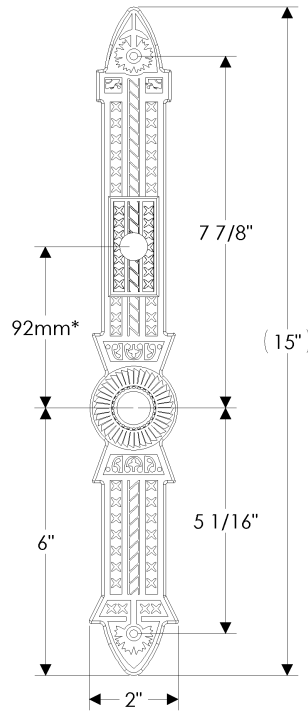

E10875

DIMENSIONS ALSO APPLICABLE FOR THE FOLLOWING:

- E10872 (TP)
- E10876 (TP)

\* This center-to-center dimension will need to be verified before set can be ordered.

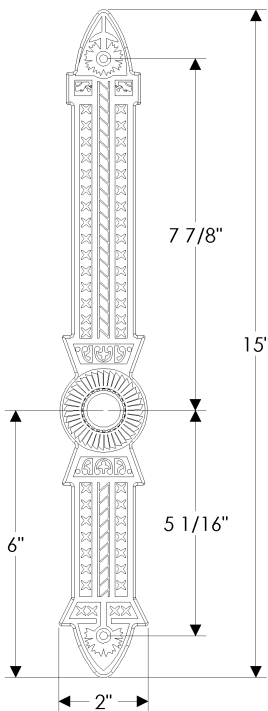

E10874

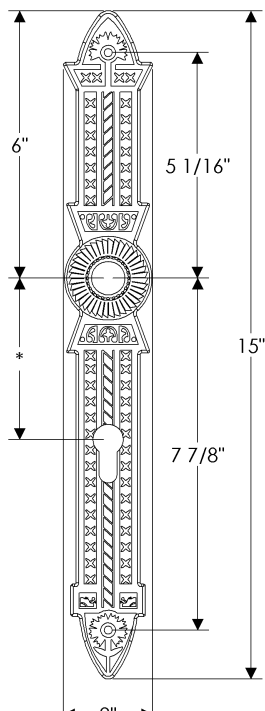

E10873

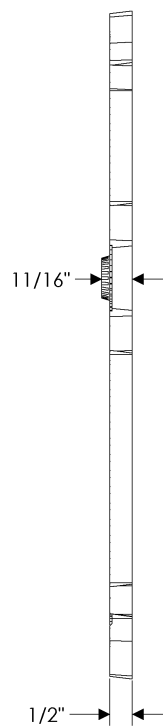



2" x 15" BRIGGS SLIDING DOOR ESCUTCHEONS

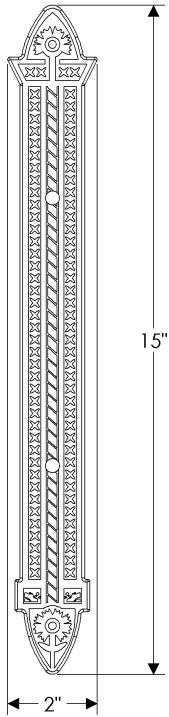

E10879

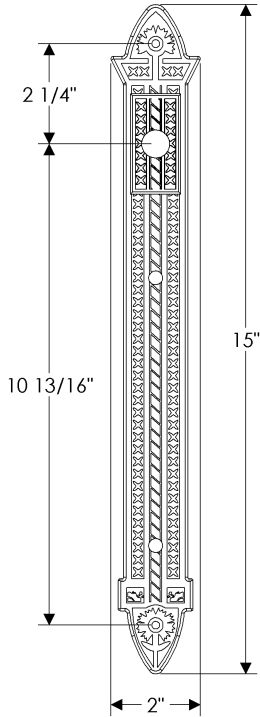

E10881

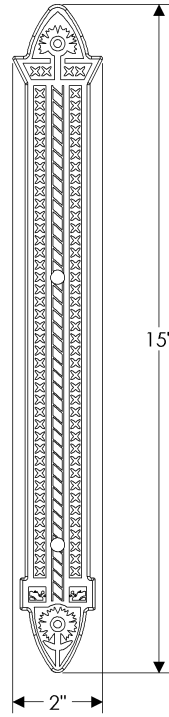

E10883

DIMENSIONS ALSO APPLICABLE FOR THE FOLLOWING:

E10880 (G<sub>ctr</sub>)(TP)  
E10882 (G<sub>lo</sub>)(TP)

\* This center-to-center dimension will need to be verified before set can be ordered.)

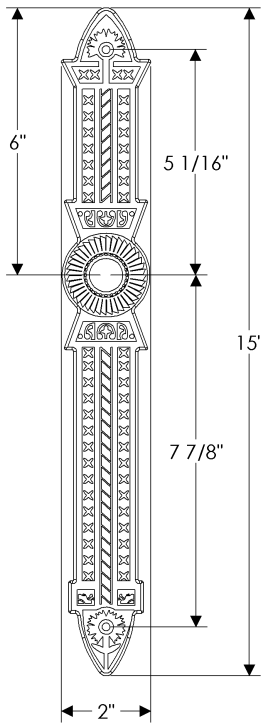

E10871

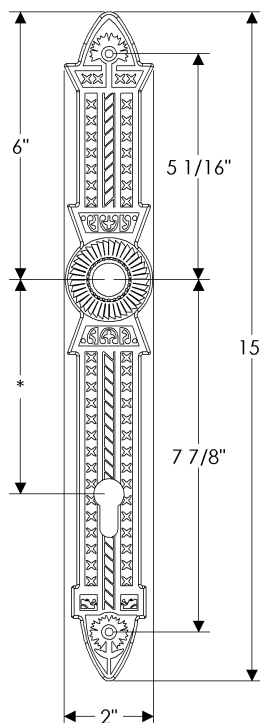

E10885

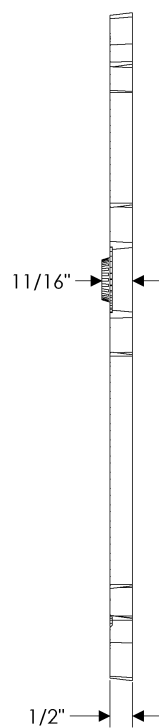

2 3/8" X 3 5/16" MADDOX CYLINDER TURN PIECE ESCUTCHEON

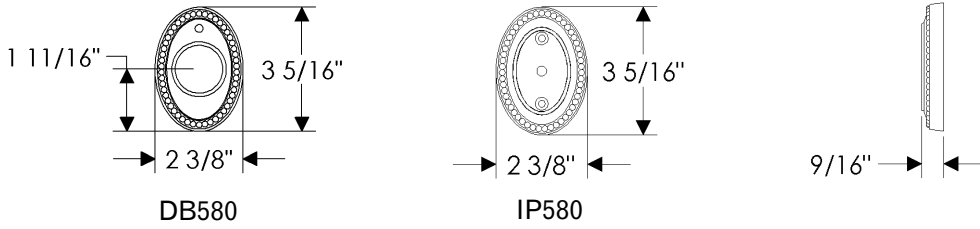

3 1/8" ROUND MADDOX ESCUTCHEON

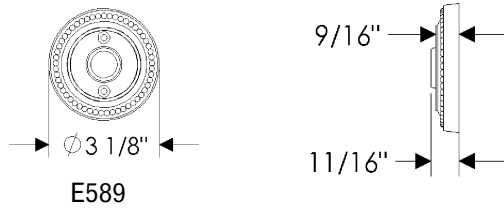

2 3/8" x 7 1/2" MADDOX ESCUTCHEON

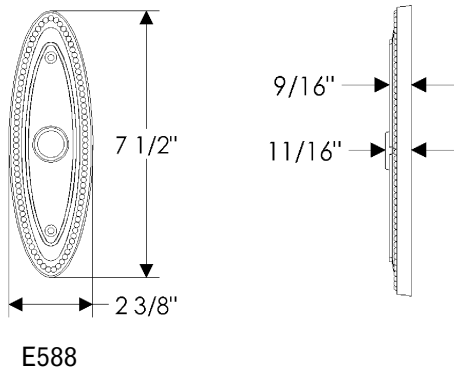

2 1/2" x 10" MADDOX ESCUTCHEON

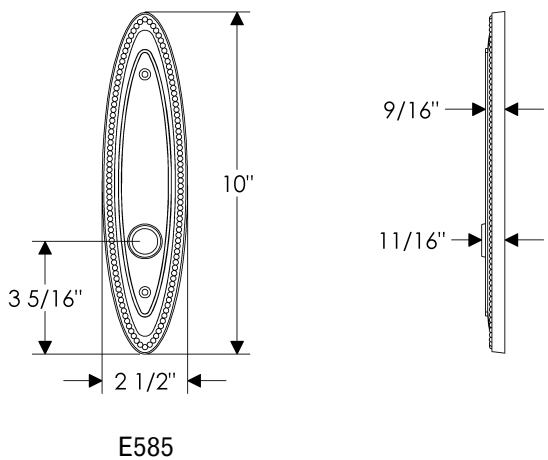

DIMENSIONS ALSO  
APPLICABLE FOR  
THE FOLLOWING:

E586 (ER)  
E587 (TP)

3" x 12 1/2" MADDOX ESCUTCHEONS

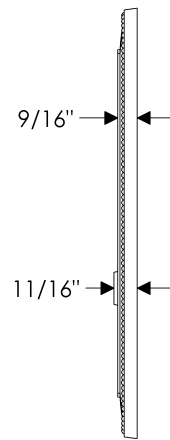
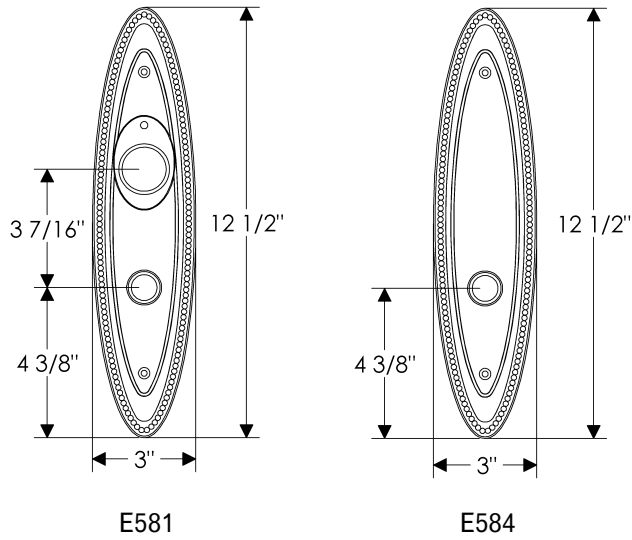

DIMENSIONS ALSO APPLICABLE FOR THE FOLLOWING:

E582 (TP)  
E583 (ER)

3 1/2" x 22" MADDOX ESCUTCHEONS

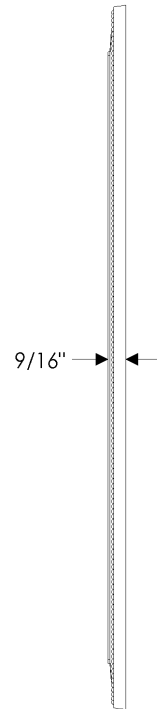
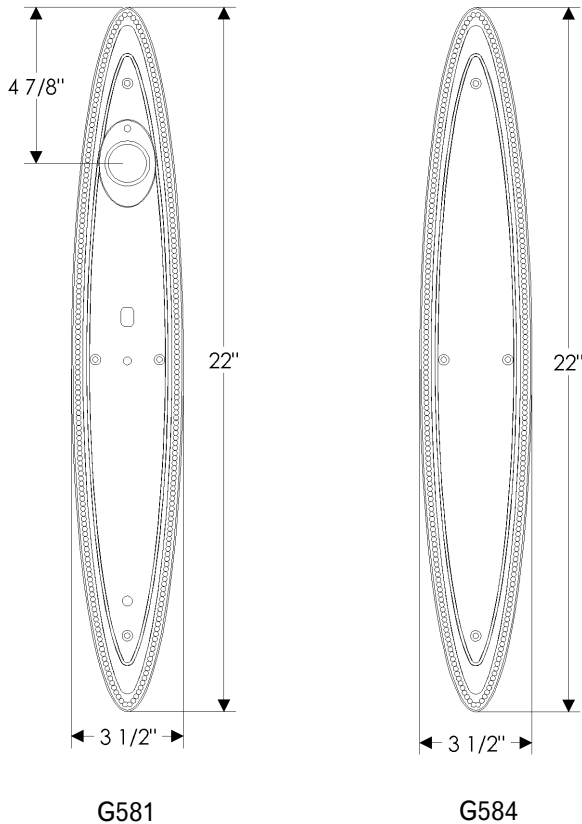

DIMENSIONS ALSO APPLICABLE FOR THE FOLLOWING:

G582 (TP)

1 3/4" x 11" MADDOX MULTI-POINT ESCUTCHEONS

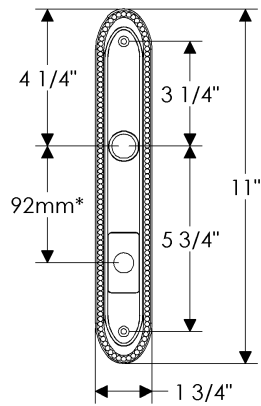

E595

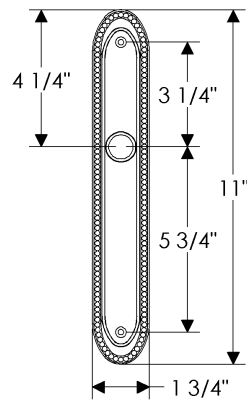

E591

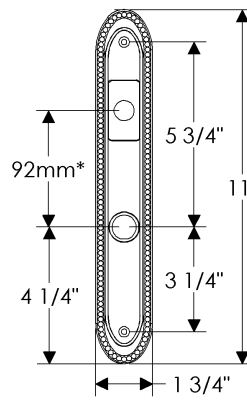

E594

DIMENSIONS ALSO APPLICABLE FOR THE FOLLOWING:

E597 (LHi) (TP)  
E596 (LLo) (TP)

\* This center-to-center dimension will need to be verified before set can be ordered.

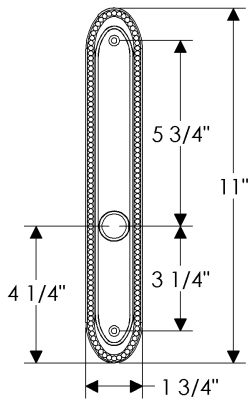

E590

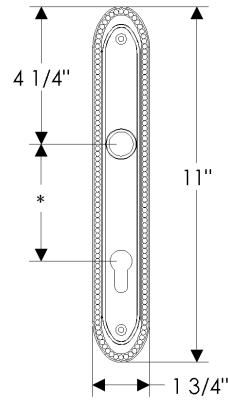

E592

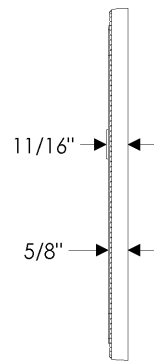

1 3/4" x 11" MADDOX SLIDING DOOR ESCUTCHEONS

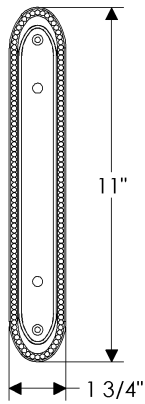

E598

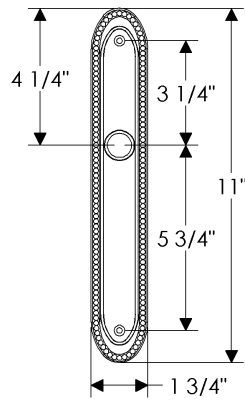

E591

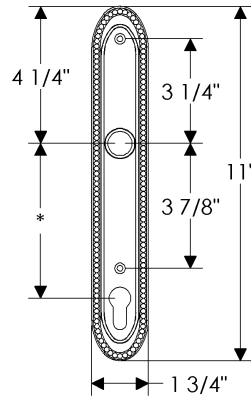

E593

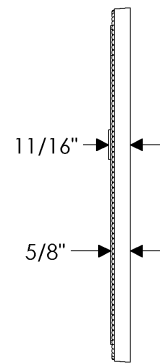

DIMENSIONS ALSO APPLICABLE FOR THE FOLLOWING:

E599 (GCtr) (TP)

\* This center-to-center dimension will need to be verified before set can be ordered.

3 1/2" ROUND DESIGNER ESCUTCHEON

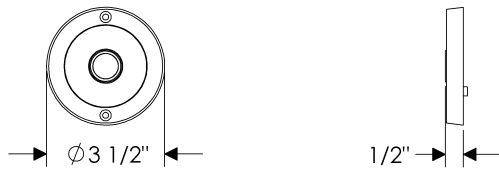

E101

3" x 3" SQUARE DESIGNER ESCUTCHEON

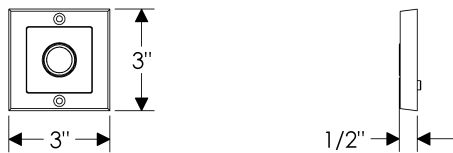

E103

3" x 8" DESIGNER ESCUTCHEON

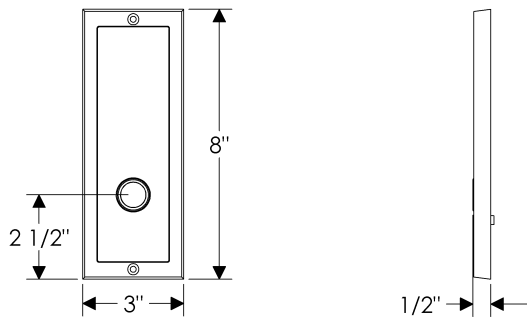

E110

DIMENSIONS ALSO  
APPLICABLE FOR  
THE FOLLOWING:

E112 (TP)  
E113 (ER)

3" x 10" DESIGNER ESCUTCHEONS

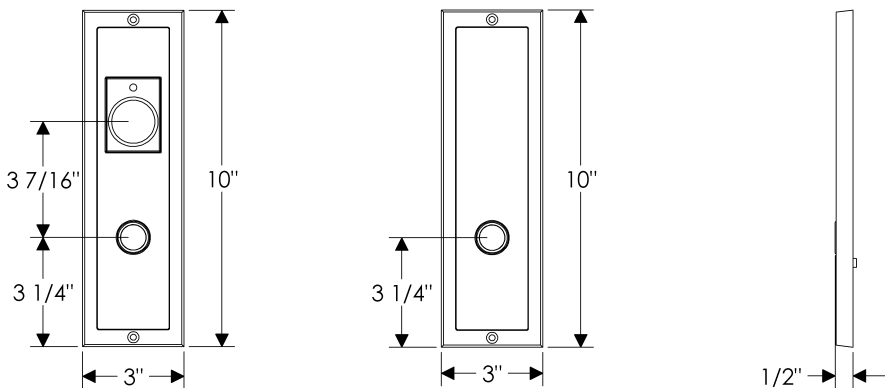

E118

E115

DIMENSIONS ALSO  
APPLICABLE FOR  
THE FOLLOWING:

E116 (TP)  
E117 (ER)

3 1/2" x 18" DESIGNER ESCUTCHEONS

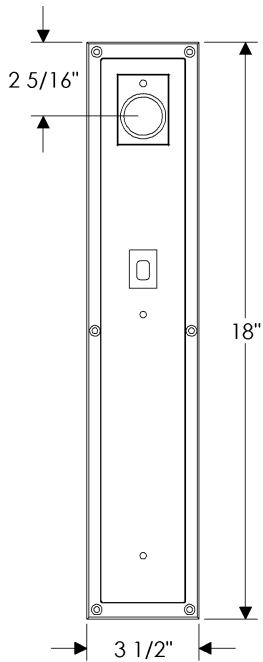

G130

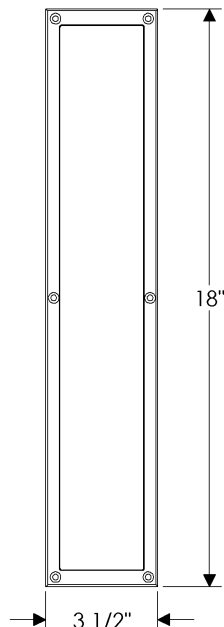

G133

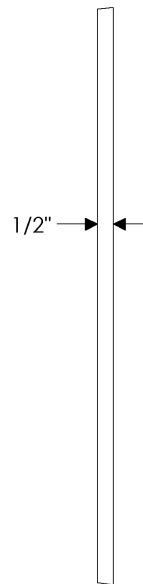

DIMENSIONS ALSO  
APPLICABLE FOR  
THE FOLLOWING:

G132 (TP)

3 1/2" x 24" DESIGNER ESCUTCHEONS

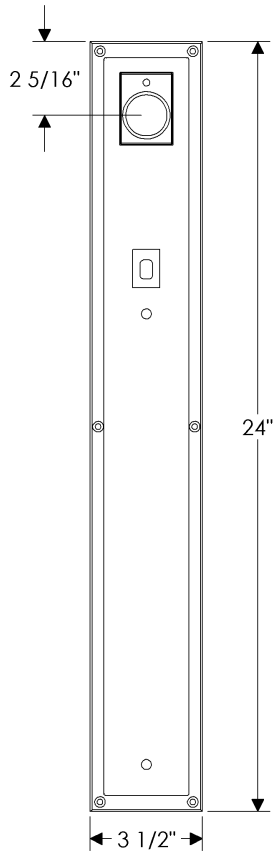

G135

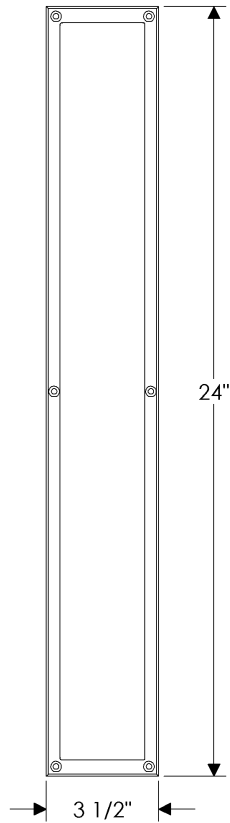

G137

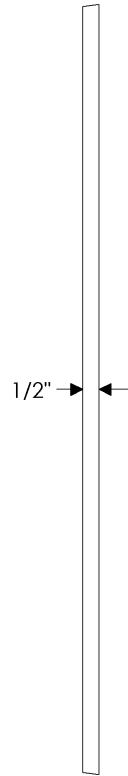

DIMENSIONS ALSO  
APPLICABLE FOR  
THE FOLLOWING:

G136 (TP)



3 1/2" x 33 7/8" DESIGNER ESCUTCHEONS

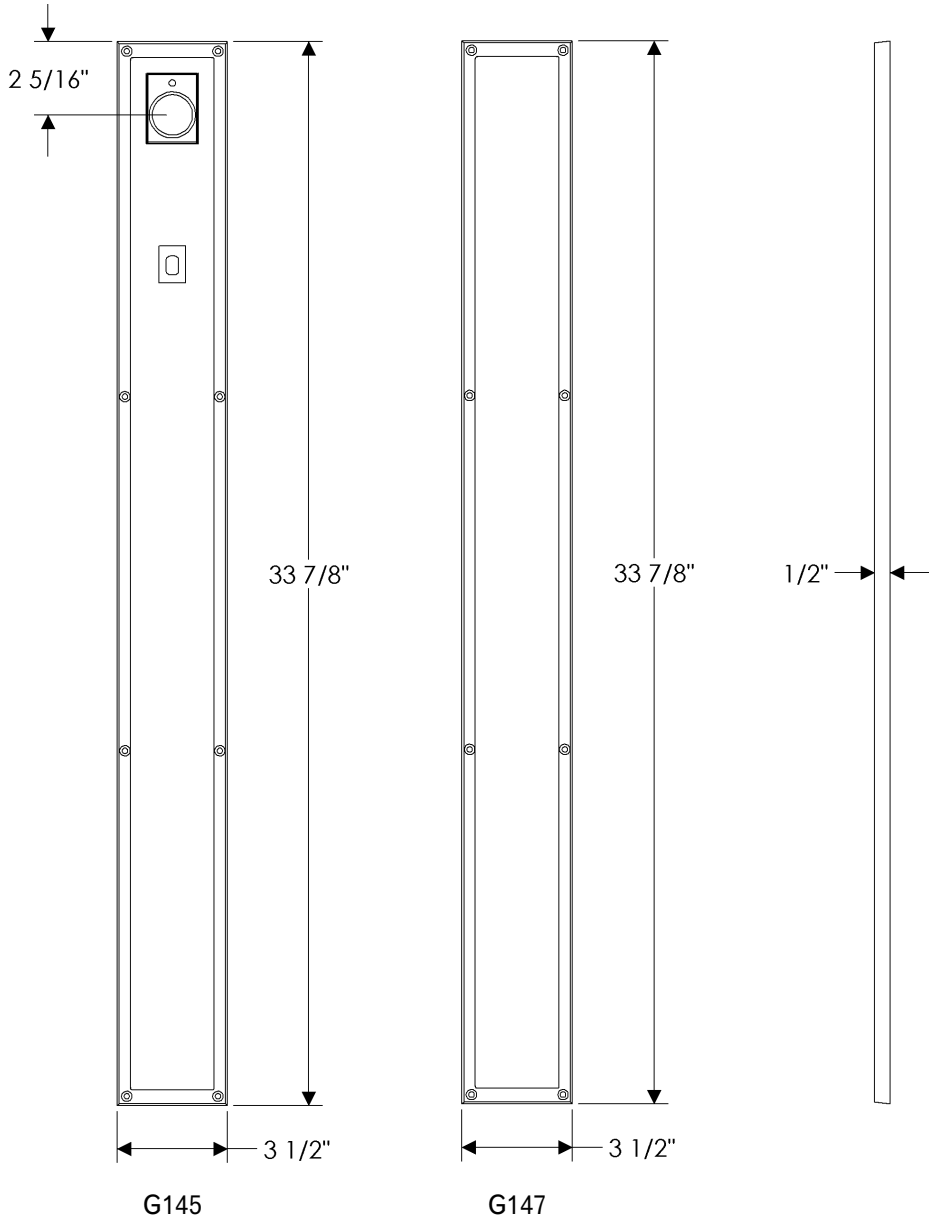

DIMENSIONS ALSO  
APPLICABLE FOR  
THE FOLLOWING:

G146



3" x 3 3/4" ELLIS CYLINDER TURN-PIECE ESCUTCHEONS

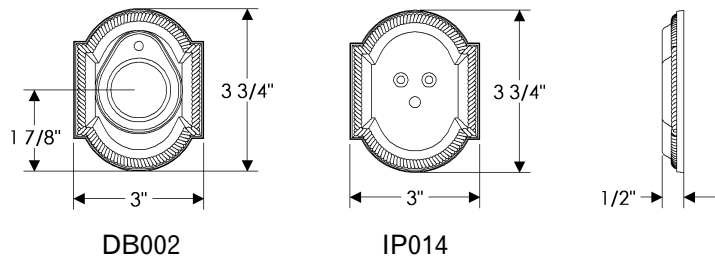

3" x 5" ELLIS ESCUTCHEON

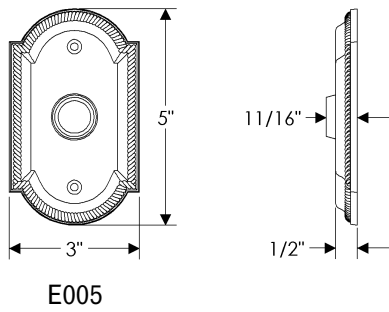

3" x 11" ELLIS ESCUTCHEONS

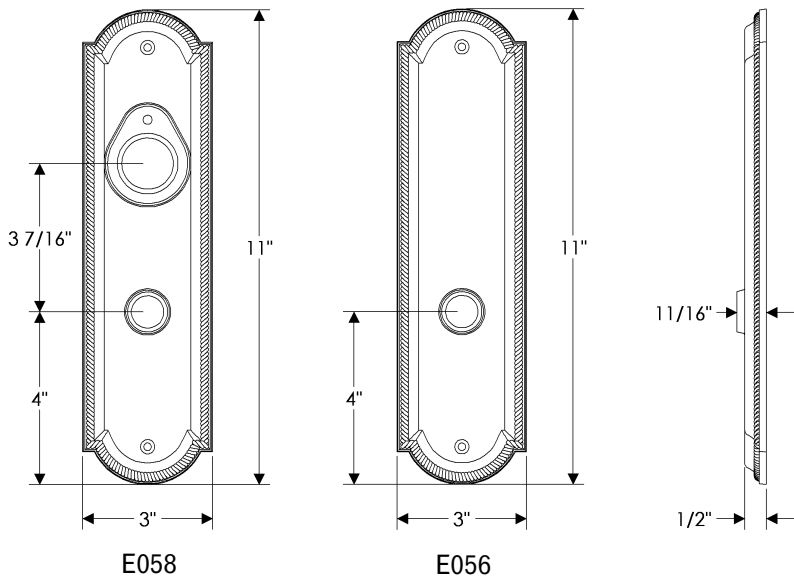

DIMENSIONS ALSO  
APPLICABLE FOR  
THE FOLLOWING:

E057 (TP)  
E059 (ER)

3" x 13" ELLIS ESCUTCHEONS

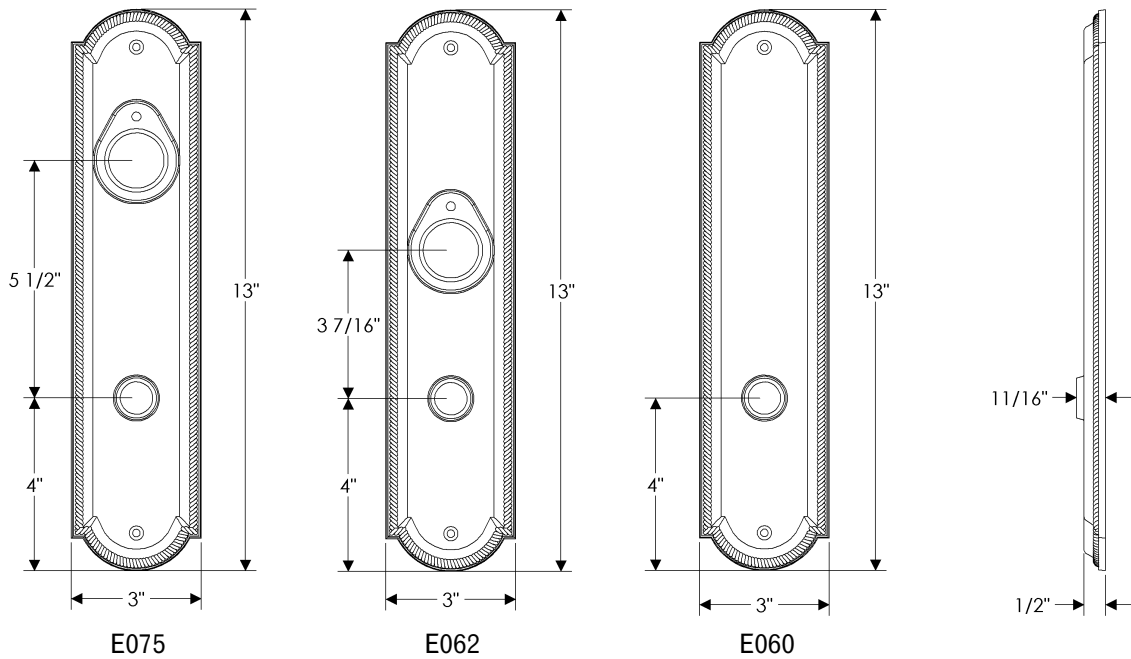

DIMENSIONS ALSO APPLICABLE FOR THE FOLLOWING:

E063 (TP)  
E064 (ER)

3 1/2" x 20" ELLIS ESCUTCHEONS

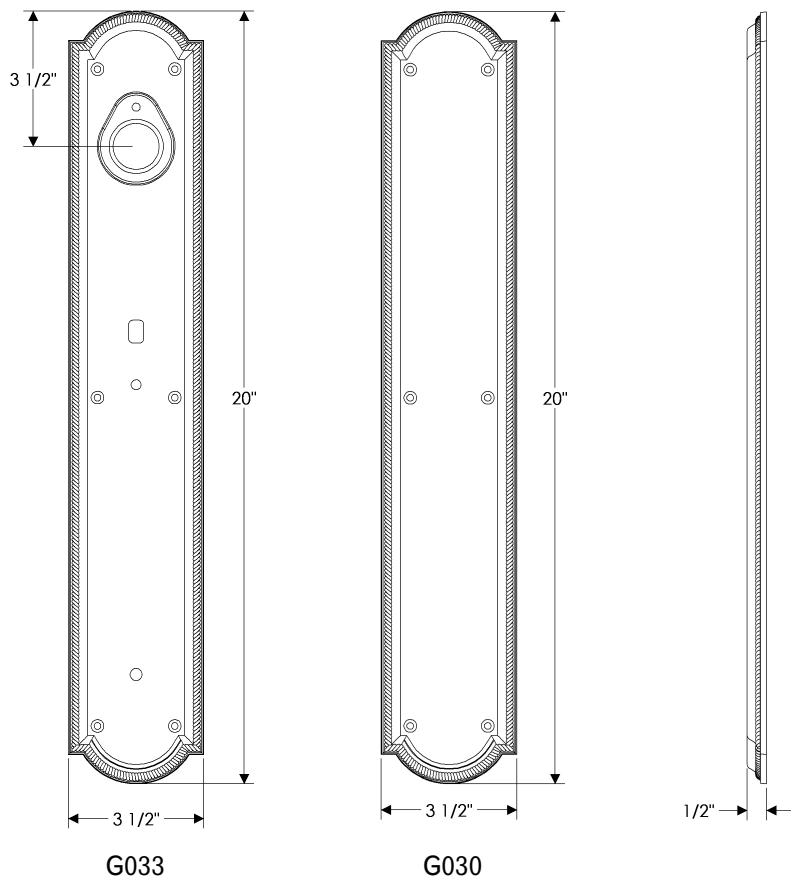

DIMENSIONS ALSO APPLICABLE FOR THE FOLLOWING:

G031 (TP)

2" x 6" ELLIS SCREEN DOOR ESCUTCHEON

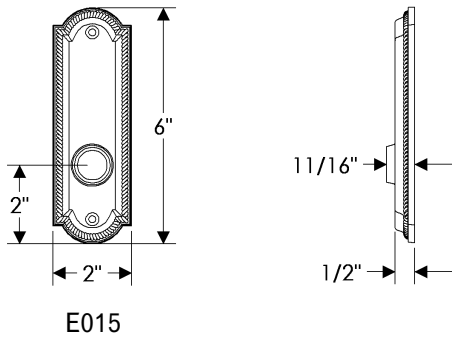

DIMENSIONS ALSO APPLICABLE FOR THE FOLLOWING:

- E016 (TP)
- E017 (ER)

1 3/4" x 11" ELLIS MULTI-POINT ESCUTCHEONS

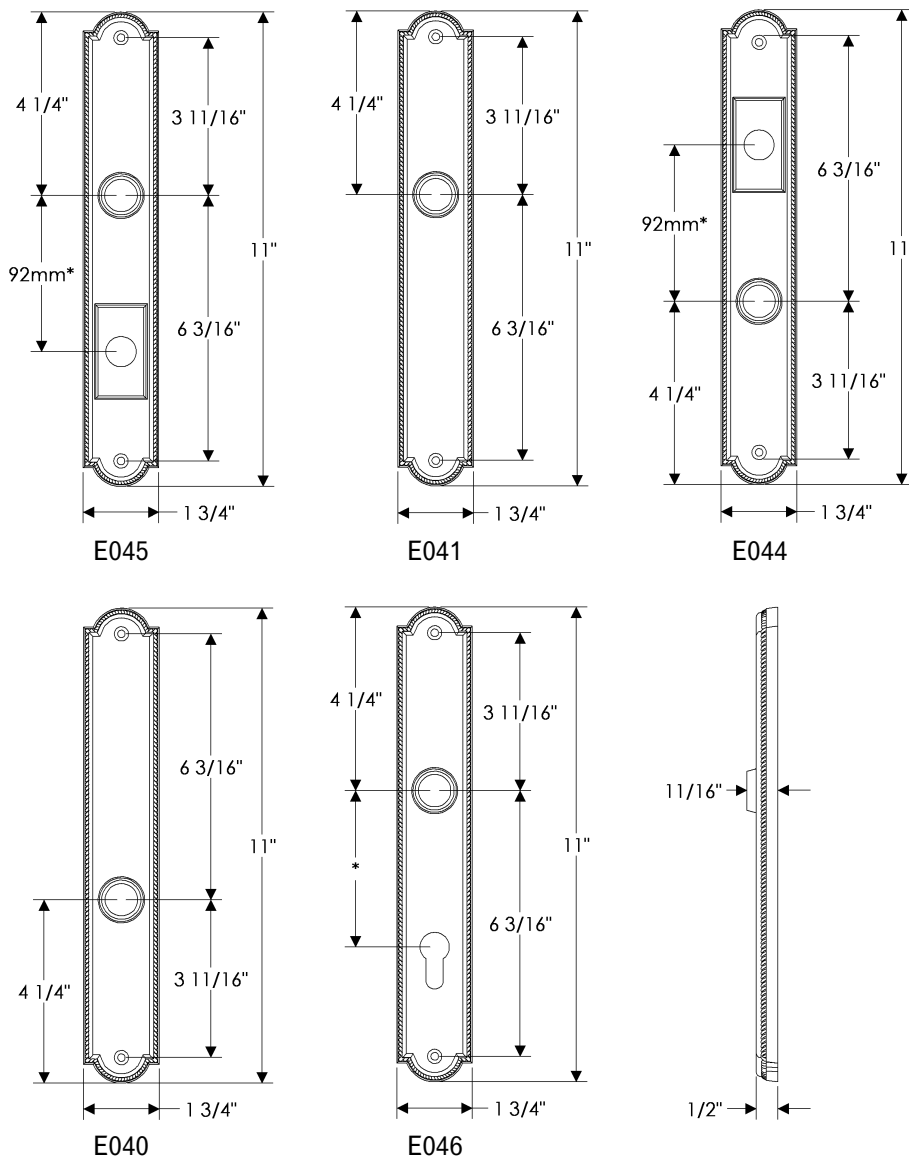

DIMENSIONS ALSO APPLICABLE FOR THE FOLLOWING:

- E043 (LHi) (TP)
- E042 (LLo) (TP)

\* This center-to-center dimension will need to be verified before set can be ordered.

1 3/4" x 11" ELLIS SLIDING DOOR ESCUTCHEONS

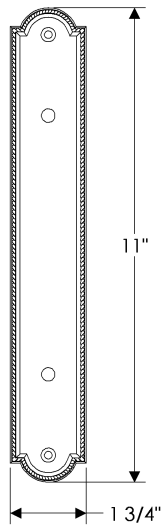

E027

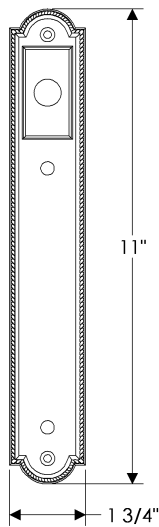

E023

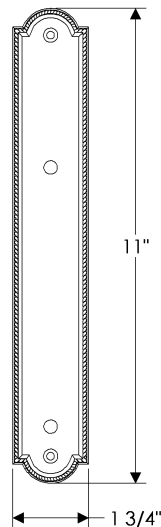

E021

DIMENSIONS ALSO APPLICABLE FOR THE FOLLOWING:

E028 (Gctr) (TP)  
E022 (GLo) (TP)

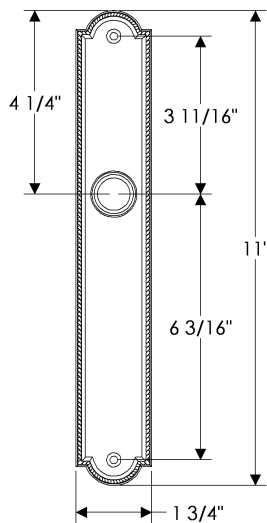

E041

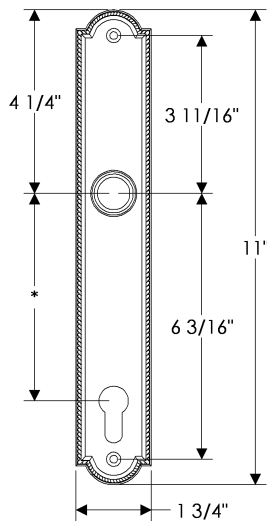

E048

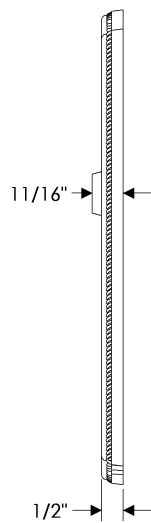

\* This center-to-center dimension will need to be verified before set can be ordered.

2 1/2" x 6" PARIS ESCUTCHEONS

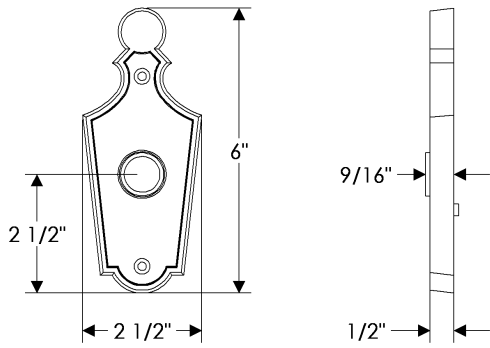

E10010

2 1/2" x 9 1/4" PARIS ESCUTCHEONS

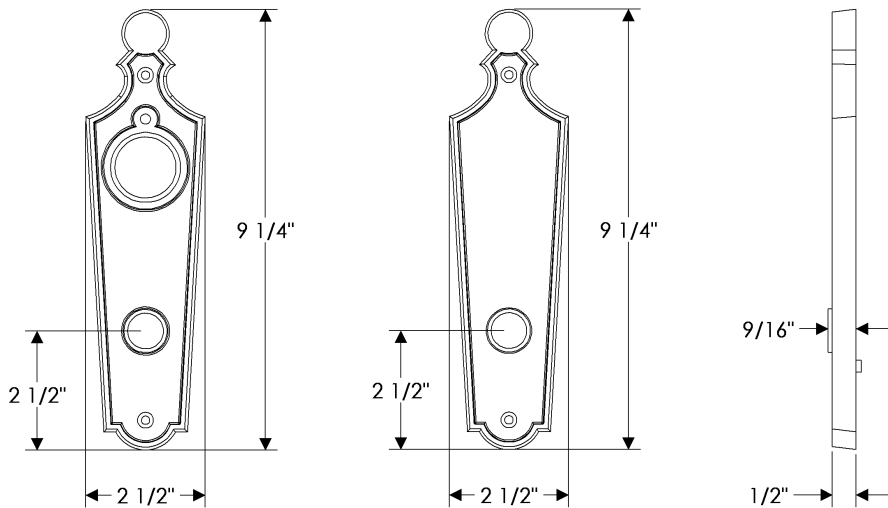

E10018

E10015

DIMENSIONS ALSO  
APPLICABLE FOR  
THE FOLLOWING:

E10016 (TP)  
E10017 (ER)

