



Installation Guide

Single Phase Inverter with HD- Wave Technology

with SetApp Configuration

For North America

Version 1.3



Disclaimers

Important Notice

Copyright © SolarEdge Inc. All rights reserved.

No part of this document may be reproduced, stored in a retrieval system or transmitted, in any form or by any means, electronic, mechanical, photographic, magnetic or otherwise, without the prior written permission of SolarEdge Inc.

The material furnished in this document is believed to be accurate and reliable. However, SolarEdge assumes no responsibility for the use of this material. SolarEdge reserves the right to make changes to the material at any time and without notice. You may refer to the SolarEdge web site (<https://www.solaredge.com/us/>) for the most updated version.

All company and brand products and service names are trademarks or registered trademarks of their respective holders.

Patent marking notice: see <https://www.solaredge.com/us/patent>

The general terms and conditions of delivery of SolarEdge shall apply.

The content of these documents is continually reviewed and amended, where necessary. However, discrepancies cannot be excluded. No guarantee is made for the completeness of these documents.

The images contained in this document are for illustrative purposes only and may vary depending on product models.

FCC Compliance

This equipment has been tested and found to comply with the limits for a Class B digital device, pursuant to part 15 of the FCC Rules.

These limits are designed to provide reasonable protection against harmful interference in a residential installation. This equipment generates, uses and can radiate radio frequency energy and, if not installed and used in accordance with the instructions, may cause harmful interference to radio communications. However, there is no guarantee that interference will not occur in a particular installation. If this equipment does cause harmful interference to radio or television reception, which can be determined by turning the equipment off and on, you are encouraged to try to correct the interference by one or more of the following measures:

- Reorient or relocate the receiving antenna.
- Increase the separation between the equipment and the receiver.
- Connect the equipment into an outlet on a circuit different from that to which the receiver is connected.
- Consult the dealer or an experienced radio/TV technician for help.

Changes or modifications not expressly approved by the party responsible for compliance may void the user's authority to operate the equipment.

Revision History

Version 1.3 (June 2020)

- Updated the Optimizer Installation Guidelines.
- Updated Activating, Commissioning and Configuring the System.

Version 1.2 (November 2019)

- The inverter can be connected in parallel with a generator.
- Added step - Turn ON the Safety Unit switch before activation.
- Link to application note describing how to install and activate the export/import metering function in an inverter with an integrated production and export/import meter

Contents

Disclaimers	1
Important Notice	1
FCC Compliance	2
Revision History	3
HANDLING AND SAFETY INSTRUCTIONS	6
Safety Symbols Information	6
IMPORTANT SAFETY INSTRUCTIONS	7
Chapter 1: Introducing the SolarEdge Power Harvesting System	11
Power Optimizer	11
SolarEdge Inverter	12
Monitoring Platform	12
Supported AC Grids	12
Installation Procedure	13
Installation Equipment List	13
Inverter Transport and Storage	14
Chapter 2: Installing the Power Optimizer	15
Safety	15
Package Contents	17
Installation Guidelines	18
Step 1: Mounting and Grounding the Power Optimizers	20
Step 2: Connecting a PV module to a Power Optimizer	23
Step 3: Connecting Power Optimizers in Strings	23
Step 4: Verifying Proper Power Optimizer Connection	24
Chapter 3: Installing the Inverter	26
Inverter Package Contents	26
Identifying the Inverter	26
Inverter Interfaces	27
Opening Conduit Drill Guides	31
Mounting the Inverter	32
Chapter 4: Connecting the AC and the Strings to the Safety Switch	36
Grid Connection Guidelines	37
Connecting the AC Grid to the Safety Switch	37
Connecting the Strings to the Safety Switch	38
Chapter 5: Activating, Commissioning and Configuring the System	40
Step 1: Activating the Installation	40
Step 2: Commissioning and Configuring the Installation	41
Step 3: Verifying Proper Activation and Commissioning	43

Reporting and Monitoring Installation Data	43
Chapter 6: Setting Up Communication to the Monitoring Platform	47
Communication Options	47
Communication Connectors	49
Removing the Inverter Cover	51
Removing the Safety Switch Cover	51
Creating an Ethernet (LAN) Connection	53
Creating an RS485 Bus Connection	56
Verifying the Connection	60
Appendix A: Errors and Troubleshooting	61
Identifying Errors	61
Troubleshooting Communication	62
Power Optimizer Troubleshooting	64
Appendix B: Mechanical Specifications	66
Appendix C: Replacing and Adding System Components	67
Replacing an Inverter	67
Replacing the Safety Switch	69
Adding, Removing, or Replacing Power Optimizers	70
Technical Specifications - Single Phase Inverters with HD-Wave Technology (North America)	72
Recommended OCPD Size per Grid	77
Default Trip Limits and Times According to IEEE1547	78
Support Contact Information	79

HANDLING AND SAFETY INSTRUCTIONS

During installation, testing and inspection, adherence to all the handling and safety instructions is mandatory. **Failure to do so may result in injury or loss of life and damage to the equipment.**

Safety Symbols Information

The following safety symbols are used in this document. Familiarize yourself with the symbols and their meaning before installing or operating the system.

WARNING!

Denotes a hazard. It calls attention to a procedure that, if not correctly performed or adhered to, could result in **injury or loss of life**. Do not proceed beyond a warning note until the indicated conditions are fully understood and met.



AVERTISSEMENT!

Dénote un risque: il attire l'attention sur une opération qui, si elle n'est pas faite ou suivie correctement, pourrait causer des blessures ou un danger de mort. Ne pas dépasser une telle note avant que les conditions requises soient totalement comprises et accomplies.

CAUTION!

Denotes a hazard. It calls attention to a procedure that, if not correctly performed or adhered to, could result in **damage or destruction of the product**. Do not proceed beyond a caution sign until the indicated conditions are fully understood and met.



ATTENTION!

Dénote un risque: il attire l'attention sur une opération qui, si elle n'est pas faite ou suivie correctement, pourrait causer un dommage ou destruction de l'équipement. Ne pas dépasser une telle note avant que les conditions requises soient totalement comprises et accomplies.

NOTE

Denotes additional information about the current subject.



IMPORTANT SAFETY FEATURE

Denotes information about safety issues.



IMPORTANT SAFETY INSTRUCTIONS

SAVE THESE INSTRUCTIONS

CONSIGNES DE SÉCURITÉ IMPORTANTES

CONSERVEZ CES INSTRUCTIONS

WARNING!



The inverter cover must be opened only after switching the inverter ON/OFF/P switch located at the bottom of the inverter to OFF. This disables the DC voltage inside the inverter. Wait five minutes before opening the cover. Otherwise, there is a risk of electric shock from energy stored in the capacitors.

AVERTISSEMENT!

Ne pas ouvrir le couvercle de l'onduleur avant d'avoir coupé l'interrupteur situé en dessous de l'onduleur. Cela supprime les tensions CC et CA de l'onduleur. Attendre cinq minutes avant d'ouvrir le couvercle. Sinon, il y a un risque de choc électrique provenant de l'énergie stockée dans le condensateur.

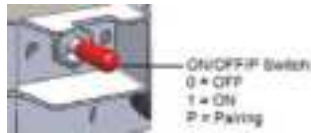

WARNING!



Before operating the inverter, ensure that the inverter is grounded properly. This product must be connected to a grounded, metal, permanent wiring system, or an equipment-grounding conductor must be run with the circuit conductors and connected to the equipment grounding terminal or lead on the product.

AVERTISSEMENT!

Avant d'utiliser l'onduleur monophasé, assurez-vous que l'onduleur est correctement mis à la terre. Ce produit doit être raccordé à un système de câblage fixe, métallique, l'équipement-le conducteur de mise à la terre doit être exécuté avec les conducteurs de circuit et raccordé à l'équipement borne de mise à la terre ou de plomb sur le produit.

WARNING!



Opening the inverter and repairing or testing under power must be performed only by qualified service personnel familiar with this inverter.

AVERTISSEMENT!

L'unité ne doit être ouverte que par un technicien qualifié dans le cadre de l'installation et de la maintenance.

WARNING!

The Safety Switch meets all requirements for a code-compliant installation of this system. The DC Disconnect Switch disconnects both the positive and negative conductors.

AVERTISSEMENT!

Le sectionneur externe (inclus) répond aux exigences de conformité pour l'installation de ce système. Le coupeur CC ouvre les conducteurs positifs et négatifs.

WARNING!

The inverter input and output circuits are isolated from the enclosure. This system does not include an isolation transformer and should be installed with an ungrounded PV array in accordance with the requirements of NEC Articles 690.35 and 690.43 National Electric Code, ANSI/NFPA 70, 2011 (and Canadian Electrical Code, Part I, for installations in Canada).

Equipment grounding is the responsibility of the installer and must be performed in accordance with all applicable Local and National Codes.

AVERTISSEMENT!

Les circuits d'entrée et de sortie de l'onduleur sont isolés de l'enveloppe. Ce système n'inclut pas d'isolation galvanique (transformateur) et devra être installé sans mise à la terre du champ PV et en accord avec les articles 690.35 et 690.43 du National Electric Code (NEC), ANSI/NFPA 70, 2011 (et du Code Electrique Canadien, Partie 1, pour les installations faites au Canada). La mise à la terre des équipements est la responsabilité de l'installateur et doit être faite en accord avec les toutes les règles locales et nationales applicables.

WARNING!

The inverter must be connected to a dedicated AC branch circuit with a maximum Overcurrent Protection Device (OCPD) of 50A.

The SE10000H-US and SE11400H-US must be connected to a dedicated AC branch circuit with a maximum Overcurrent Protection Device (OCPD) of 80A.

AVERTISSEMENT!

Les onduleurs doivent être connectés à un branchement AC dédié avec un disjoncteur de 50A.

Les onduleurs SE10000H-US et SE11400H-US doivent être connectés à un branchement AC dédié avec un disjoncteur de 80A

WARNING!

SolarEdge products can expose you to chemicals including antimony trioxide, which is known to the State of California to cause cancer. For more information, go to www.P65Warnings.ca.gov.

**AVERTISSEMENT!**

Les produits SolarEdge peut vous exposer à des agents chimiques, y compris trioxyde d'antimoine, identifiés par l'État de Californie comme pouvant causer le cancer. Pour de plus amples informations, prière de consulter www.P65Warnings.ca.gov.

CAUTION!

This unit must be operated according to the technical specification datasheet provided with the unit.

ATTENTION!

Cette unité doit être utilisée selon les spécifications de fonctionnement, comme décrit dans la dernière fiche technique des spécifications.

CAUTION!

HEAVY OBJECT. To avoid muscle strain or back injury, use proper lifting techniques, and if required - a lifting aid.

**ATTENTION!**

Objet lourd. Pour éviter la fatigue musculaire ou des blessures au dos, utilisez des techniques de levage appropriées et, si nécessaire - un auxiliaire de levage lors du retrait.

**NOTE**

Use only copper conductors rated for a minimum of 75°C/ 167°F.

**NOTE**

This inverter is provided with an IMI (Isolation Monitor Interrupter) for ground fault protection.

**NOTE**

The symbol  appears at grounding points on the SolarEdge equipment. This symbol is also used in this manual.

NOTE

A SolarEdge inverter may be installed in a site with a generator. SolarEdge requires installing a physical or electronic interlock, which will signal to the inverter when the grid has been disconnected. Interlock procurement, installation, maintenance and support are the responsibility of the installer.



Damage to the inverter due to incorrect interlock installation or use of an interlock that is incompatible with the SolarEdge system will render the SolarEdge warranty invalid.

For more information, refer to

<https://www.solaredge.com/sites/default/files/se-inverter-support-of-voltage-sources.pdf>.

**IMPORTANT SAFETY INFORMATION**

To perform Rapid Shutdown, shut down AC power to the inverter. This can be done by turning off the AC breaker in the main service panel, which is an approved AC disconnect as described in the NEC.

Chapter 1: Introducing the SolarEdge Power Harvesting System

The SolarEdge power harvesting solution maximizes the power output from any type of solar photovoltaic (PV) installation while reducing the average cost per watt. The following sections describe each of the system's components.



Figure 1: The SolarEdge power harvesting system components

Power Optimizer

The power optimizers are DC-DC converters connected to PV modules in order to maximize power harvesting by performing independent Maximum Power Point Tracking (MPPT) at the module level.

The power optimizers regulate the string voltage at a constant level, regardless of string length and environmental conditions.

The power optimizers include a safety voltage function that automatically reduces the output of each power optimizer to 1 Vdc in the following cases:

- During fault conditions
- The power optimizers are disconnected from the inverter
- The inverter ON/OFF/P switch is turned OFF
- The inverter AC breaker is turned OFF
- The Rapid Shutdown (PVRSS) is initiated by one of the following methods:
 - Inverter AC breaker is turned OFF, or AC to the inverter is disconnected by another method (intentionally or as result of a fault)
 - Inverter ON/OFF/P switch is turned OFF
 - The Safety Switch is turned OFF

Each power optimizer also transmits module performance data over the DC power line to the inverter.

Two types of power optimizers are available:

- Panel Module Add-on power optimizer – connected to one or more modules
- Smart modules - the power optimizer is embedded into a module

SolarEdge Inverter

The SolarEdge inverter efficiently converts DC power from the modules into AC power that can be fed into the main AC service of the site and from there to the grid. The inverter also receives the monitoring data from each power optimizer and transmits it to a central server (the SolarEdge monitoring platform; requires Internet connection).

Monitoring Platform

The monitoring platform enables monitoring the technical and financial performance of one or more SolarEdge sites. It provides past and present information on the system performance both at the system and module levels.

Supported AC Grids

The following figures illustrate grids that are supported by SolarEdge single phase inverters. Refer to *Setting Country, Grid and Language* on page 41).

Ground connection is required for all grids, as described in *Connecting the AC Grid to the Safety Switch* on page 37.

Note that in some cases L1 and L2 are not interchangeable. In these places, L1 and L2 locations appear in the drawing.

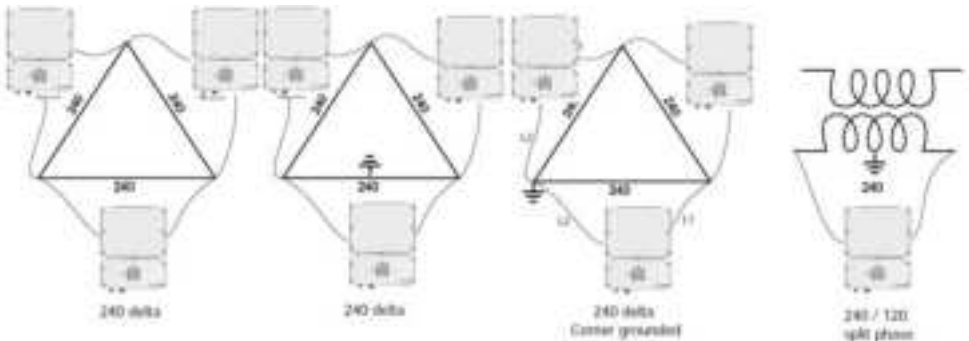

Figure 2: 240V AC grids supported by SolarEdge single phase inverter

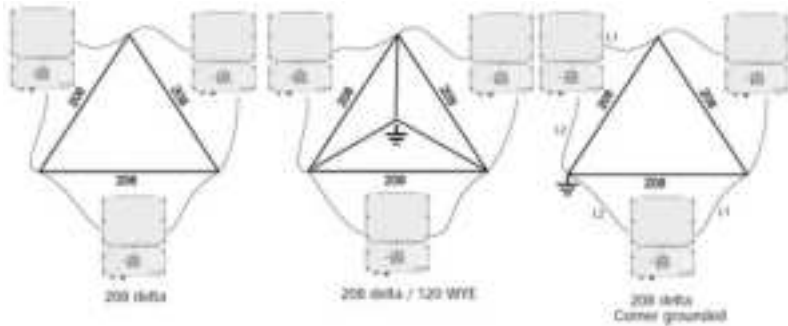

Figure 3: 208V AC grids supported by SolarEdge single phase inverter⁽¹⁾

Installation Procedure

The following is the procedure for installing and setting up a new SolarEdge site. Many of these also apply to modification of an existing site.

1. [Connecting Power Optimizers in Strings](#), page 23
2. [Recording power optimizer serial numbers \(optional\)](#), page 44
3. [Mounting the inverter](#), Page 32
4. [Connecting the AC and the String to the DC Safety Unit](#), page 36
5. [Commissioning and activating the installation](#), page 40
6. [Connecting the inverter to the monitoring platform](#), page 45

Installation Equipment List

Standard tools can be used during the installation of the SolarEdge system. The following is a recommendation of the equipment needed for installation:

- Allen screwdriver for 4 mm screw type for the inverter cover, side screws, and Safety Switch cover
- Standard flat-head screwdrivers set
- Non-contact voltage detector
- Cordless drill (with a torque clutch) or screwdriver and bits suitable for the surface on which the inverter and optimizers will be installed and for opening the Safety Switch drill guides. Use of an impact driver is *not* allowed.

⁽¹⁾208V AC grids are only supported by some inverter models. Refer to the specification supplied with the inverter.

- Appropriate mounting hardware (for example: stainless bolts, nuts, and washers) for attaching:
 - the inverter mounting bracket to the mounting surface
 - the power optimizer to the racking (not required for smart modules)
- Wire cutters
- Wire strippers
- Voltmeter
- Mobile phone with latest SetApp version

For installing the communication options, you may also need the following:

- For Ethernet:
 - CAT5/6 twisted pair Ethernet cable with RJ45 connector
 - If using a CAT5/6 cable spool: RJ45 plug and RJ45 crimper
- For RS485:
 - Four- or six-wire shielded twisted pair cable
 - Watchmaker precision screwdriver set

Inverter Transport and Storage

Transport the inverter in its original packaging, facing up and without exposing it to unnecessary shocks. If the original package is no longer available, use a similar box that can withstand the weight of the inverter (refer to the inverter weight in the specification datasheet provided with the unit), has a handle system and can be closed fully.

Store the inverter in a dry place where ambient temperatures are -13°F to 140°F / -25°C to +60°C.

Chapter 2: Installing the Power Optimizer

Safety

The following notes and warnings apply when installing the power optimizers. Some of the following may not be applicable to smart modules:

WARNING!

The metallic enclosure of the power optimizer must be grounded in accordance with the product's listing and local and national codes.

AVERTISSEMENT!

L'enceinte métallique de l'optimiseur de puissance doit être mise à la terre en accord avec les réglementations locales et nationales.

WARNING!

When modifying an existing installation, turn OFF the inverter ON/OFF/P switch, the Safety Switch and the AC circuit breaker on the main AC distribution panel.

AVERTISSEMENT!

Avant de faire ces étapes, éteignez l'onduleur monophasé en mettant sur OFF l'interrupteur ON/OFF/P situé au bas de l'onduleur.

CAUTION!

Power optimizers are IP68/NEMA6P rated. Choose a mounting location where optimizers will not be submerged in water.

ATTENTION!

Les optimiseurs de puissances sont compatibles à la norme IP68/NEMA6P. Choisissez le lieu de montage tel que l'optimiseur ne puisse pas être submergé par l'eau.

CAUTION!

This unit must be operated according to the operating specifications provided with the unit.

ATTENTION!

Cette unité doit être opérée suivant les instructions trouvées dans le manuel fourni avec le produit.

CAUTION!

Cutting the power optimizer input or output cable connector is prohibited and will void the warranty.

ATTENTION!

Sectionner les câbles d'entrées ou de sortie de l'optimiseur est interdit et annule sa garantie.

**CAUTION!**

All PV modules must be connected to a power optimizer.

ATTENTION!

Tous les modules doivent être connectés à un optimiseur de puissance.

CAUTION!

If you intend to mount the optimizers directly to the module or module frame, first consult the module manufacturer for guidance regarding the mounting location and the impact, if any, on module warranty. Drilling holes in the module frame should be done according to the module manufacturer instructions.

ATTENTION!

Pour installation à même le module ou la monture du module, consultez d'abord le fabricant du module sur la position et son impact sur la garantie du module. Le perçage de trous dans le cadre du module devra se faire suivant les instructions du fabricant.

CAUTION!

Installing a SolarEdge system without ensuring compatibility of the module connectors with the optimizer connectors may be unsafe and could cause functionality problems such as ground faults, resulting in inverter shut down. To ensure mechanical compatibility of the power optimizers' connectors with the PV module' connectors to which they are connected:

- Use identical connectors from the same manufacturer and of the same type on both the power optimizers and on the modules; or
- Verify that the connectors are compatible in the following way:
 - The module connector manufacturer should explicitly verify compatibility with the SolarEdge optimizer connector; and
 - A third-party test report by one of the listed external labs (TUV, VDE, Bureau Veritas UL, CSA, InterTek) should be obtained, verifying the compatibility of the connectors.



For more information, refer to

<https://www.solaredge.com/sites/default/files/optimizer-input-connector-compatibility.pdf>



ATTENTION!

Les connecteurs du module doivent être mécaniquement compatibles avec les optimiseurs de puissance. Sinon, le système SolarEdge installé peut être dangereux ou causer des problèmes fonctionnels, tels que les défauts de terre, qui peuvent provoquer un arrêt de l'onduleur. Afin d'assurer la compatibilité mécanique entre les optimiseurs de puissance SolarEdge et les modules auxquels ils sont connectés:

- Utiliser des connecteurs identiques du même fabricant et du même type aussi bien pour les optimiseurs de puissance que pour les modules.
- Vérifiez que les connecteurs sont compatibles de la manière suivante:
 - Le fabricant du connecteur doit explicitement vérifier la compatibilité avec le connecteur SolarEdge.
 - Un rapport de test de tierce partie doit être effectué par l'un des laboratoires externes indiqués ci-dessous:(TUV, VDE, Bureau Veritas UL, CSA, Intertek), qui vérifiera la compatibilité des connecteurs.



Pour plus d'informations, consultez

<https://www.solaredge.com/sites/default/files/optimizer-input-connector-compatibility.pdf>

IMPORTANT SAFETY FEATURE

Modules with SolarEdge power optimizers are safe. They carry only a low safety voltage before the inverter is turned ON. As long as the power optimizers are not connected to the inverter or the inverter is turned OFF, each power optimizer will output a safe voltage of 1V.

Package Contents

- Power optimizers
- Stainless steel grounding lock washers

Installation Guidelines

- For the minimum and maximum number of power optimizers in a string (string length), see the power optimizer datasheets. Refer to the Designer for string length verification. The Designer is available on the SolarEdge website at: <https://www.solaredge.com/us/products/installer-tools/designer#/>.

- The length of home-run cables from the first and last power optimizer to the inverter (total cable length) may not exceed the following values:

Single Phase Inverters	Three Phase Inverters
All - 1000 ft. /300 m	SE9KUS, SE20KUS - 1000 ft. /300 m SE14.4KUS, SE17.3KUS, SE33.3KUS, SE40KUS - 2300 ft. /700 m

- Do not use extension cables between a module and a power optimizer, between two modules connected to the same power optimizer, or between two power optimizers other than in the following cases:

- Power optimizers with the 4-type suffix in their part number (Pxxx-4xxxxxx) - extension cables of up to 16 m can be installed per optimizer (8 m for DC+ and 8 m for DC-).

- Power optimizers manufactured starting from working week 42, 2019, as indicated in the serial number (Example: S/N SJ5019A-xxxxxxx - working week 50, 2019) - extension cables of up to 16 m can be installed per power optimizer (8 m for DC+ and 8 m for DC-).

- Extension cables can be installed between power optimizers only from row to row, around obstacles or pathways within a row, and from the end of the string to the inverter, as long as the total cable length is not exceeded.

- For connecting power optimizers to the inverter, use cables with a minimum cross-section of 11 AWG/ 4 mm² DC cables.

- Frame-mounted power optimizers are mounted directly on the module frame, regardless of racking system (rail-less or with rails). For installation of frame-mounted power optimizers, refer to http://www.solaredge.com/sites/default/files/installing_frame_mounted_power_optimizers.pdf.

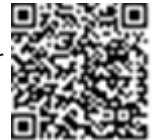

- The power optimizer can be placed in any orientation.

- If connecting more modules than power optimizer inputs in parallel, use a branch cable. Some commercial power optimizer models have a dual input.

- Position the power optimizer close enough to its module so that their cables can be connected.
- Make sure to use power optimizers that have the required output conductor length.
- Completely shaded modules may cause their power optimizers to temporarily shut down. This will not affect the performance of the other power optimizers in the string, as long as the minimum number of unshaded power optimizers connected in a string of modules is met. If under typical conditions fewer than the minimum power optimizers are connected to unshaded modules, add more power optimizers to the string.
- Equipment grounding tightening torques: 4-6 AWG: 45 lb-in, 8 AWG: 40 lb-in, 10-14 AWG: 35 lb-in.
- To allow for heat dissipation, maintain clearance as specified below.

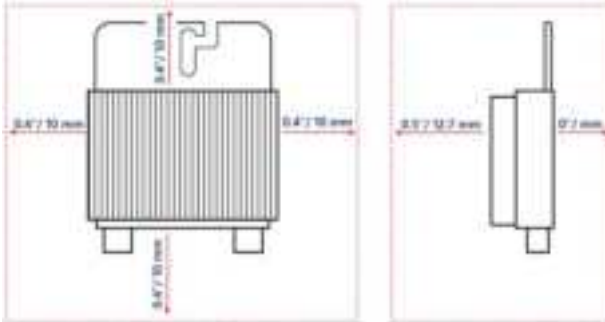

Figure 4: Power optimizer clearance

- When installing modules in a confined space, for example, if installing Building-integrated photovoltaic (BIPV) modules, ventilation measures may be needed to ensure the power optimizers are not be exposed to temperatures outside their specifications.

Step 1: Mounting and Grounding the Power Optimizers

For each of the power optimizers⁽¹⁾:

1. Determine the power optimizer mounting location and use the power optimizer mounting brackets to attach the power optimizer to the support structure (See *Figure 5*). It is recommended to mount the power optimizer in a location protected from direct sunlight. For frame-mounted power optimizers follow the instructions supplied with the optimizers, or refer to https://www.solaredge.com/sites/default/files/installing_frame_mounted_power_optimizers.pdf.
2. If required, mark the mounting hole locations and drill the hole.



CAUTION!



Drilling vibrations may damage the power optimizer and will void the warranty. Use a torque wrench or an electric drill with adjustable clutch that meets the mounting torque requirements. *Do not* use impact drivers for mounting the power optimizer.

Do not drill through the power optimizer or through the mounting holes.

ATTENTION!

Les vibrations résultant du perçage peuvent endommager l'optimiseur de puissance et annulera la garantie. Utilisez une clé dynamométrique ou une perceuse électrique avec embrayage adaptable compatible avec les moments indiqués. Ne pas utiliser des tournevis à percussion pour fixer l'optimiseur. Ne pas percer à travers l'optimiseur de puissance ou ses trous de fixation.

3. Attach each power optimizer to the rack using M6 (1/4") stainless steel bolts, nuts and washers or other mounting hardware. Apply torque of 9-10 N*m / 6.5-7 lb*ft. For 3NA series power optimizers, SolarEdge recommends mounting the power optimizer on a rail with the smooth side facing out, so that the power optimizer body will prevent its rotation.

⁽¹⁾Not applicable to smart modules.

4. Use the following methods⁽¹⁾ to ground the power optimizer:

WARNING!



The metallic enclosure of the power optimizer must be grounded in accordance with the requirements of the local and national codes.

AVERTISSEMENT!

L'enceinte métallique de l'optimiseur de puissance doit être mise à la terre en accord avec les réglementations locales et nationales.

- **For mounting on a grounded metal rail:** Use the provided 5/16" stainless steel grounding star washer between the railing and the flat side of the mounting bracket. The grounding washer should break through the anodize coating of the railing to ensure low resistive connection. Apply a torque of 9.5 N*m / 7 lb*ft.

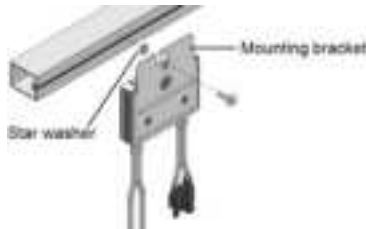

Figure 5: Power optimizer installation and grounding using a star washer

⁽¹⁾These methods have been evaluated by a nationally recognized testing laboratory as part of the optimizer evaluation. The SolarEdge-supplied grounding lug kit has been evaluated only for use with SolarEdge power optimizers. It is not intended or listed to be used as a general purpose grounding lug with other electrical equipment.

- For mounting on rails with sliding nut fasteners:** If the star washer cannot be used, use the SolarEdge grounding plate (purchased separately) between the railing and the flat side of the mounting bracket. Use mounting specific hardware as needed. Apply a torque of 9.5 N*m / 7 lb*ft. See Figure 6.

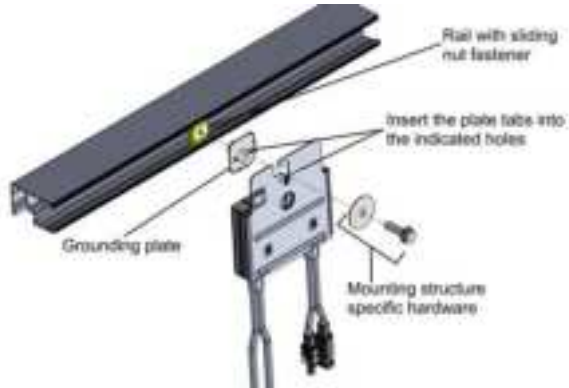

Figure 6: Power optimizer installation and grounding using a grounding plate

- For mounting on un-grounded structures** (such as a wooden structure): If the star washer or the plate cannot be used, use the SolarEdge grounding lug (purchased separately) with an equipment-grounding conductor according to the supplied instructions. The grounding terminal accepts a wire size of 6-14 AWG, and must be sized for equipment grounding per NEC 250.122 requirements. Tighten the screws connecting the power optimizer to the frame and the grounding terminal screw. Apply a torque of 9.5 N*m / 7 lb*ft.



Figure 7: Power optimizer grounding terminal

5. Verify that each power optimizer is securely attached to the module support structure.
6. Record power optimizer serial numbers and locations, as described in *Reporting and Monitoring Installation Data* on page 43.

Step 2: Connecting a PV module to a Power Optimizer



NOTE

Images are for illustration purposes only. Refer to the label on the product to identify the plus and minus input and output connectors.

For each of the power optimizers:

- Connect the Plus (+) output connector of the module to the Plus (+) input connector of the power optimizer.
- Connect the Minus (-) output connector of the module to the Minus (-) input connector of the power optimizer.

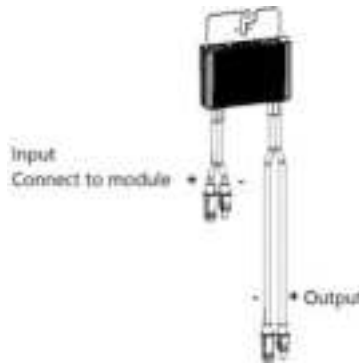

Figure 8: Power optimizer connectors

Step 3: Connecting Power Optimizers in Strings

You can construct parallel strings of unequal length, that is, the number of power optimizers in each string does not have to be the same. The minimum and maximum string lengths are specified in the power optimizer datasheets. Refer to the [Designer](#) for string length verification.



1. Connect the Minus (-) output connector of the string's first power optimizer to the Plus (+) output connector of the string's second power optimizer.
2. Connect the rest of the power optimizers in the string in the same manner.

**WARNING!**

If using a dual-input power optimizer and some inputs are not used, seal the unused input connectors with the supplied pair of seals.

AVERTISSEMENT!

Si un optimiseur à double entrées est utilisé et que certaines entrées ne sont pas connectées, fermez ces entrées avec la paire de couvercles fournie.

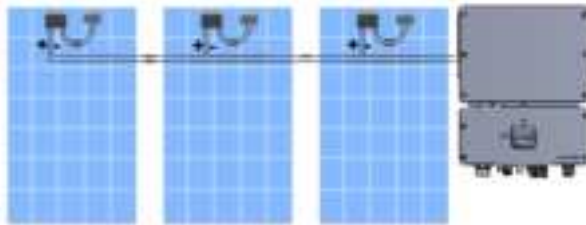

Figure 9: Power optimizers connected in series

3. If you intend to monitor the installation, using the monitoring platform, record the physical location of each power optimizer, as described in *Creating Logical and Physical Layout using Installation Information* on page 44.

Step 4: Verifying Proper Power Optimizer Connection

When a module is connected to a power optimizer, the power optimizer outputs a safe voltage of 1V ($\pm 0.1V$). Therefore, the total string voltage should equal 1V times the number of power optimizers connected in series in the string. For example, if 10 power optimizers are connected in a string, then 10V should be produced.

Make sure the PV modules are exposed to sunlight during this process. The power optimizer will only turn ON if the PV module provides at least 2W.

In SolarEdge systems, due to the introduction of power optimizers between the PV modules and the inverter, the short circuit current I_{SC} and the open circuit voltage V_{OC} hold different meanings from those in traditional systems.

For more information about the SolarEdge system's string voltage and current, refer to the V_{OC} and I_{SC} in *SolarEdge Systems Technical Note*, available on the SolarEdge website at:

https://www.solaredge.com/sites/default/files/isc_and_voc_in_solaredge_systems_technical_note.pdf



 To verify proper power optimizer connection:

- Measure the voltage of each string individually before connecting it to the other strings or to the inverter. Verify correct polarity by measuring the string polarity with a voltmeter. Use a voltmeter with at least 0.1V measurement accuracy.



NOTE

Since the inverter is not yet operating, you may measure the string voltage and verify correct polarity on the DC wires inside the Safety Switch.

For troubleshooting power optimizer operation problems, refer to *Power Optimizer Troubleshooting* on page 64.

Chapter 3: Installing the Inverter

Install the inverter either before or after the modules and power optimizers have been installed.



NOTE

Use only copper conductors rated for a minimum of 75°C/ 167°F.

Inverter Package Contents

- One inverter with Safety Switch (if applicable)
- Mounting bracket kit
- Safety Switch sealing cover (if applicable, for use in case of inverter replacement)
- Quick Installation guide

Identifying the Inverter

Refer to the sticker on the inverter that specifies its **Serial Number** and its **Electrical Ratings**. Provide the serial number when contacting SolarEdge support. The serial number is also required when opening a new site in the monitoring platform.

Inverter Interfaces

The following figure shows the inverter connectors and components, located at the bottom of the inverter.

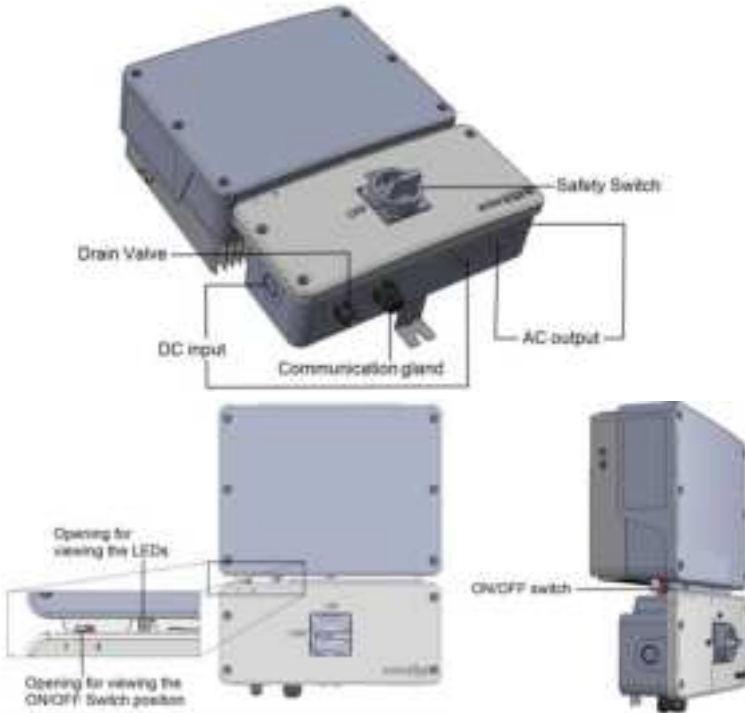

Figure 10: Inverter Interfaces

- **Communication gland:** For connection of inverter communication options. Refer to *Setting Up Communication to the Monitoring Platform* on page 47 for more information.
- **Drain valve:** Drains any moisture that may be accumulated in the unit.
- **ON/OFF/P switch:**



Figure 11: ON/OFF/P switch

- **ON (1)** - Turning this switch ON (after power optimizer pairing) starts the operation of the power optimizers, enables power production and allows the inverter to begin exporting power to the utility grid.
- **OFF (0)** - Turning this switch OFF reduces the power optimizer voltage to a low safety voltage and inhibits exportation of power. When this switch is OFF, the control circuitry remains powered up.
- **P** - Moving and releasing the switch allows viewing system information via the LEDs, and performing the following functions:

P Position Duration	Function	Comments
Switch moved to P for 2 seconds , then released.	<ul style="list-style-type: none"> ■ Displays (via LEDs) production information for 5 seconds, or error type indications (if exist) for 5 seconds. ■ Activates the Wi-Fi access point for connecting to the SetApp 	<p>While the switch is in P, all LEDs are ON.</p> <p>When the switch is released all LEDs turn OFF for 0.5 sec and then display the production or error indication.</p>
Switch moved to P for more than 5 seconds , then released.	Starts pairing	Pairing is indicated by all 3 LEDs blinking simultaneously.

- **LEDs:** three LEDs indicate, by color and state (on/ off/ blinking⁽¹⁾/ flickering⁽²⁾/alternating⁽³⁾), different system information, such as errors or performance indications.

(1)Blinking = Turns ON and OFF for the same duration

(2)Flickering = Turns ON for 100 mS and turns OFF for 5 seconds

(3)Alternating = alternate LED flashes

For more information, refer to <https://www.solaredge.com/leds>.

The main LED indications are:

- Blue ON - the inverter is communicating with the monitoring platform
- Green ON - the system is producing
- Green blinking - AC is connected but the system is not producing
- Red ON - system error

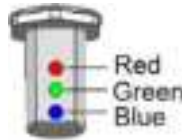

Figure 12: LEDs

The following table describes system performance information by LED color and ON/OFF/P switch position.

Indication	ON/ OFF/ P Switch Position	LED Color			Comment
		Red	Green	Blue	
Power optimizers not paired	ON (1)	OFF	Blinking	<ul style="list-style-type: none"> ■ S_OK: ON ■ No S_OK: OFF 	S_OK: ON communication with the monitoring platform is established.
Pairing		Blinking	Blinking	Blinking	
Wake-up/ Grid Monitoring		OFF	Blinking	Blinking	
System Producing		OFF	ON	<ul style="list-style-type: none"> ■ S_OK: ON ■ No S_OK: OFF 	
Night mode (no production)		OFF	Flickering	<ul style="list-style-type: none"> ■ S_OK: ON ■ No S_OK: OFF 	

Indication	ON/ OFF/ P Switch Position	LED Color			Comment
		Red	Green	Blue	
Inverter is OFF (Safe DC)	OFF (0)	OFF	Blinking	<ul style="list-style-type: none"> ▪ S_OK: ON ▪ No S_OK: OFF 	
Inverter is OFF (DC not safe)		Blinking	Blinking	<ul style="list-style-type: none"> ▪ S_OK: ON ▪ No S_OK: OFF 	
Inverter configuration or reboot	ON / P	ON	ON	ON	
Inverter firmware upgrade	ON / P	Alternating	Alternating	Alternating	The upgrade process can take up to 5 minutes
Error	Any	ON	ON/ OFF/ Blinking/ Flickering	ON/ OFF / Blinking	Refer to <i>Errors and Troubleshooting</i> on page 61

The following table describes production percentage of AC information by LED color and ON/OFF/P switch position.

Indication	ON/ OFF/ P Switch Position	LED Color			Comment
		Red	Green	Blue	
Percentage of AC Production: 0 %	ON (1)	OFF	OFF	OFF	This indicates power production as percentage of rated peak AC output power
Percentage of AC Production: 0 - 33 %		OFF	ON	OFF	
Percentage of AC Production: 33 - 66 %		OFF	OFF	ON	
Percentage of AC Production: 66 - 100 %		OFF	ON	ON	

Opening Conduit Drill Guides

This step may be performed before or after mounting the inverter.

➔ To open conduit drill guides:

1. Move the Safety Switch ON/OFF/P switch and the inverter ON/OFF/P switch to OFF.
2. Loosen the screws on the front cover of the Safety Switch, as shown below:



Figure 13: Opening the Safety Switch cover

3. Remove the Safety Switch cover.
4. Open the required AC and DC conduit drill guides according to the conduits used in the installation: The drill guides are located at the bottom and sides of the enclosure, each with two sizes: $\frac{3}{4}$ " and 1". Open the required drill guides, taking care not to interfere with any of the internal components. It is recommended to use a Unibit drill.

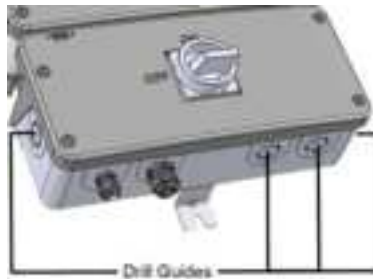

Figure 14: Safety Switch drill guides



NOTE

Unused conduit openings and glands should be sealed with appropriate seals.

Mounting the Inverter

The inverter is supplied with a mounting bracket kit:



Figure 15: Mounting bracket



NOTE

Make sure the mounting surface or structure can support the weight of the inverter.



CAUTION!

SolarEdge inverters and power optimizers can be installed at a minimum distance of 50 m/ 164 ft from the shoreline of an ocean or other saline environment, as long as there are no direct salt water splashes on the inverter or power optimizer.

ATTENTION!

Les onduleurs SolarEdge peuvent être installés à une distance minimum de 50m de la ligne d'eau de l'océan ou autre environnement salin, tant qu'il n'y a pas d'éclaboussements d'eau salée directs sur l'onduleur.

1. Determine the inverter mounting location, on a wall, stud framing or pole. It is recommended to mount the inverter in a location protected from direct sunlight.

- To allow proper heat dissipation, maintain the following minimum clearance areas between the inverter and other objects:

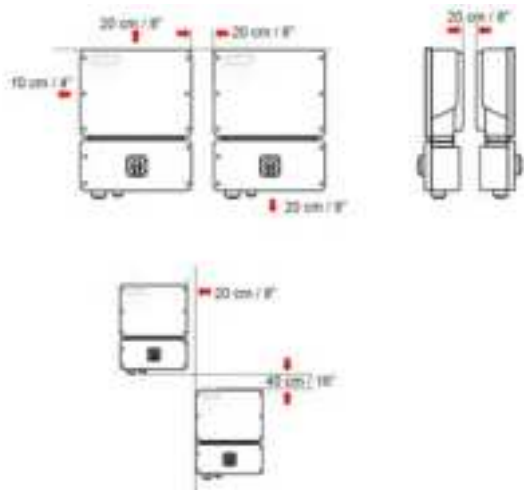

Figure 16: Clearance areas

- If installing a single inverter:
 - 8" (20 cm) from the top of the inverter.
 - At least 4" (10 cm) from the bottom of the inverter; if conduit entry to the Safety Switch will be from the bottom, leave sufficient clearance for the conduits as well.
 - 4" (10 cm) from the right and left of the inverter.
 - If installing multiple inverters:
 - When installing inverters side by side, leave at least 20 cm (8") between inverters.
 - When installing inverters one above of the other, leave at least 16" (40 cm) between inverters.
- Position the mounting bracket against the wall/ pole and mark the drilling hole locations (refer to *Mechanical Specifications* on page 66 for inverter and mounting bracket dimensions).
 - Drill the holes and mount the bracket. Verify that the bracket is firmly attached to the mounting surface.
 - Hang the inverter on the bracket:

- a. Lift the inverter from the sides, or hold it at the top and bottom of the inverter to lift the unit into place. Do not lift holding the Safety Switch as it may be damaged.
- b. Lower the inverter onto the U-shaped indentations, as shown below. Let the inverter lay flat against the wall or pole.
- c. Insert the two supplied screws through the outer heat sink fin on both sides of the inverter and into the bracket. Tighten the screws with a torque of 4.0 N*m / 2.9 lb.*ft.

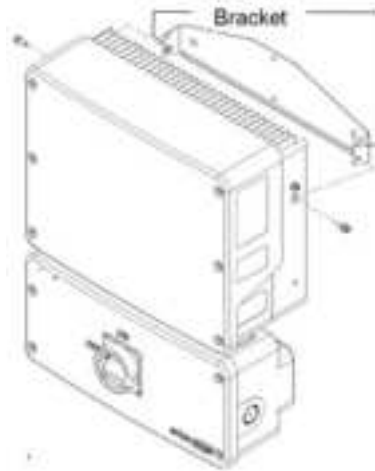

Figure 17: Hanging the inverter on the brackets

6. Optionally, secure the Safety Switch bracket to the wall/pole, using 3 screws:



NOTE

In case of inverter replacement with the Safety Switch still mounted, it is recommended to use all 3 holes.

- a. Mark the location of the bracket screw for the Safety Switch, and optionally the two additional bracket holes.



Figure 18: Safety Switch bracket

- b. Remove the inverter from the wall/ pole.
 - c. Drill the hole for the Safety Switch bracket.
 - d. Hang the inverter on the mounted brackets.
 - e. Fasten the Safety Switch bracket using a standard bolt.
7. Insert the screws at the top of the inverter brackets and fasten the brackets together.
 8. Verify that all the brackets are firmly attached to the mounting surface.

Chapter 4: Connecting the AC and the Strings to the Safety Switch

The Safety Switch disconnects all ungrounded DC conductors of the circuit to which it is connected in compliance with the National Electric Code, and specifically NEC690.35, which addresses ungrounded PV arrays. The Safety Switch is rated to the maximum operating conditions of the inverter.

NOTE



For systems with an integrated production and export/import meter:

To install and activate the export/import metering function, refer to the document:

<https://www.solaredge.com/sites/default/files/se-inverters-with-rgm-and-export-import-meter-na.pdf>



The following figure illustrates the Safety Switch

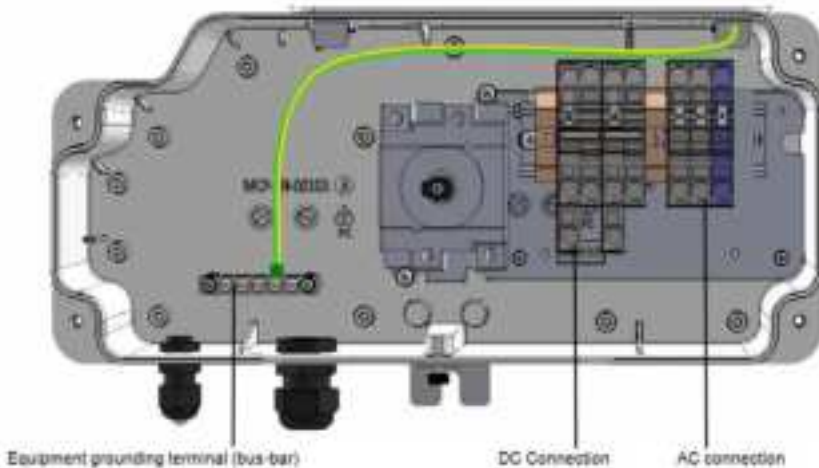

Figure 19: Inside the Safety Switch

Grid Connection Guidelines

- In single phase inverters connected to corner grounded grids, connect the L2 terminal to the grounded conductor. When connecting to other grids, L1 and L2 are interchangeable.
- The conduits, hubs and fittings must be suited for field wiring systems.
- The hubs and other fittings must comply with UL514B.
- Use the conduit and wiring appropriate for the installation location per the NEC. Outdoor installations must use components that are rated NEMA 3R or higher.

NOTE



For more wiring information refer to the *SolarEdge Recommended AC Wiring Application Note*, available on the SolarEdge website at <https://www.solaredge.com/sites/default/files/application-note-recommended-wiring.pdf>



Connecting the AC Grid to the Safety Switch

1. Strip 5/16" (8mm) of the AC wire insulation.
2. Insert the AC conduit into the AC-side drill guide that was opened.

NOTE



Connect the equipment grounding before connecting the AC wires to the AC terminal block.

Veillez à relier le conducteur de PE (la terre) avant de connecter les fils CA au bornier CA.

3. Connect the wires to the appropriate terminal blocks according to the labels on the terminal blocks (N, , L1 and L2).
4. Use a standard flat-blade screwdriver to connect the wires to the spring-clamp terminals. The screwdriver blade should fit freely in the terminal opening. Too large a blade can crack the plastic housing.
 - a. Insert the screwdriver and press the release mechanism and open the clamp.
 - b. Insert the wire into the round opening and remove the screwdriver – the wire is automatically clamped.
5. Verify that there are no unconnected wires.

Connecting the Strings to the Safety Switch

You can connect systems with multiple DC strings in parallel to the DC input terminals of the Safety Switch. Inverters may have a different number of pairs of DC input terminals, depending on the inverter power rating. If more strings are required, they can be connected in parallel using an external combiner box before connecting to the Safety Switch. When connecting multiple strings, it is recommended to run separate circuits to the Safety Switch or to position the combiner box near the Safety Switch. This simplifies commissioning by allowing testing and servicing near the inverter.



NOTE

Use 16-6 AWG, 75-90°C copper wires only.

To connect the strings to the Safety Switch:

1. Equipment grounding: Connect the DC equipment ground conductor to the equipment grounding terminal block in the Safety Switch.

NOTE



Functional Electrical Earthing of DC-side negative or positive is prohibited because the inverter has no transformer. Equipment grounding of exposed conductive surfaces in the array is required per the NEC.

2. Insert the DC conduit into the DC-side opening on the Safety Switch (left side at the bottom of the Safety Switch).
3. Connect the DC wires to the DC+ and DC- terminal blocks, according to the labels on the terminals, connect two wires (DC+ and DC-) per string:
 - a. Use a standard flat-blade screwdriver to connect the wires to the spring-clamp terminals. The screwdriver blade should fit freely in the terminal opening. Too large a blade can crack the plastic housing.
 - b. Insert the screwdriver and firmly tilt it to press the release mechanism and open the clamp.
 - c. Insert the wire into the top opening.
 - d. Remove the screwdriver – the wire is automatically clamped.

CAUTION!



Ensure that the Plus (+) wire is connected to the + terminal and that the Minus (-) wire is connected to the Minus (-) terminal connector.

ATTENTION!

Veillez à ce que le câble Plus (+) soit connecté au terminal + et que le câble - soit connecté au connecteur terminal.

NOTE

For systems with four PV strings per unit or more, fuses may need to be installed in both the positive and negative conductors as required by NEC Article 690.9. For more information, refer to the “String Fusing Requirements in SolarEdge Systems” technical note at http://www.solaredge.com/files/pdfs/string_fusing_requirements.pdf.



NOTE

SolarEdge's fixed input voltage architecture enables the parallel strings to be of different lengths. Therefore, they do not need to have the same number of power optimizers, as long as the length of each string is within the permitted range.



Figure 20: DC Spring-clamp terminals

4. Close the Safety Switch cover: Attach the switch cover and secure it by tightening the four screws with a torque of 1.2 N*m/ 0.9 lb*ft.
5. Ensure proper conduit sealing; inspect the entire conduit run and use standard conduit sealants to avoid water penetration.

Chapter 5: Activating, Commissioning and Configuring the System

You can connect communication options at this stage, as described in *Setting Up Communication to the Monitoring Platform* on page 47.

After completing all connections, activate and commission the system using the inverter SetApp mobile application. You can download the SetApp from the Apple App Store and Google Play before arriving at the site.



Internet connection is required for the download, one-time registration, and logging in, but not required for using the SetApp.

Step 1: Activating the Installation

During system activation, a Wi-Fi connection is created between the mobile device and the inverter and the system firmware is upgraded.

Before activation

- Download, register (first time only) and log-in to SetApp on your mobile device. Verify that the application is updated with the latest version.
- If applicable, turn on all devices (battery, Energy Meter, Backup Interface) connected to the inverter, so that the devices may be auto-detected.

➤ To activate the inverter:

1. Turn ON the AC circuit breaker on the main distribution panel.
2. Move the Safety Switch switch to the ON position.
3. Open SetApp and follow the on-screen instructions.

SetApp creates a Wi-Fi connection, upgrades the inverter firmware and activates the inverter.

4. When the activation is complete, do one of the following:
 - Select **Connect to Another Device** to continue activating additional inverters.
 - Select **Start Commissioning** for pairing and other system configuration.

Step 2: Commissioning and Configuring the Installation

This section describes how to use the SetApp menus for commissioning and configuring the inverter settings.

Menus may vary in your application depending on your system type.

➤ To access the Commissioning screen:

Do one of the following:

- During first time installation: Upon activation completion, in the SetApp, tap **Start Commissioning**.
- If the inverter has already been activated and commissioned:
 - If not already ON - turn ON AC to the inverter by turning ON the circuit breaker on the main distribution panel.
 - Open SetApp and follow the on-screen instructions (scan the inverter QR code, move the ON/OFF/P switch to P position for 2 seconds and release).
The mobile device creates a Wi-Fi connection with the inverter and displays the main Commissioning screen.

In the main menus, tap the menu red arrows (➤) to perform the system commissioning or configuration task. Tap the **Back** arrow (◀) to return to the previous menu.

The next sections provide more information about configuration options (in addition to **Country and Language** and **Pairing**, described in *Step 2: Commissioning and Configuring the Installation* on page 41).

Setting Country, Grid and Language

The inverter must be configured to the proper settings in order to ensure that it complies with the country grid code and functions.

1. From the **Commissioning** screen select **Country & Grid**.
2. From the **Country & Grid** drop-down list, select the required option and tap **Set Country & Grid**.
3. From the **Language** drop-down list, select your language and tap **Set Language**.

Pairing

1. From the **Commissioning** menu, select **Pairing**.
2. Tap **Start Pairing**.
3. When **Pairing Complete** is displayed, the system startup process begins:
Since the inverter is ON, the power optimizers start producing power and the inverter starts converting AC.

WARNING!



When you turn ON the inverter ON/OFF/P switch, the DC cables carry a high voltage and the power optimizers no longer output a safe output.

AVERTISSEMENT!

Après avoir mis l'interrupteur ON/OFF/P de l'onduleur monophasé sur ON, les câbles DC portent une haute tension et les optimiseurs de puissance ne génèrent plus la tension de sécurité.

When the inverter starts converting power after the initial connection to the AC, the inverter enters Wakeup mode until its working voltage is reached. This mode is indicated by the flickering green inverter LED.

When working voltage is reached, the inverter enters Production mode and produces power. The steadily lit green inverter LED indicates this mode.

4. Tap **OK** to return to the **Commissioning** menu.

Communication

Communication settings can be configured only after communication connections are complete. Refer to *Setting Up Communication to the Monitoring Platform* on page 47.

- Select **Monitoring Communication** to configure communication with the monitoring platform.
- Select **Site Communication** to configure communication between multiple SolarEdge devices or external non-SolarEdge devices, such as batteries or loggers.

Power Control

Power control options are detailed in the *Power Control Application Note*, available on the SolarEdge website at .

The Grid Control option may be disabled. Enabling it opens additional options in the menu.

The Energy Manager option is used for setting power export limitation, as described in the *Export Limitation Application Note*, available on the SolarEdge website at

https://www.solaredge.com/sites/default/files/export_limitation_application_note_NA.pdf.



For P(Q) diagram refer to

https://www.solaredge.com/sites/default/files/application_note_p_q_diagram_of_se_inverters_en_and_na.pdf.



NOTE



SolarEdge inverters with “Grid Support” functionality (as marked on the inverter certification label), are compliant with UL 1741 Supplement A. The functionality is built into the inverter and no additional external device is required.

Step 3: Verifying Proper Activation and Commissioning

1. Select **Information** and verify that the correct firmware versions are installed on each inverter.
2. Select **Status** and verify that inverter is operating and producing power.
3. Verify that additional configurations were properly set by viewing the relevant Status screens.
4. Verify that the green inverter LED is steadily lit.

Your SolarEdge power harvesting system is now operational.

Reporting and Monitoring Installation Data

Monitoring the site requires connecting the inverter to the monitoring platform, using any of the wired or wireless options available from SolarEdge. Refer to *Setting Up Communication to the Monitoring Platform* on page 47.

The Monitoring Platform

The monitoring platform provides enhanced PV performance monitoring and yield assurance through immediate fault detection and alerts at the module, string and system level.

Using the platform, you can:

- View the latest performance of specific components.
- Find under-performing components, such as modules, by comparing their performance to that of other components of the same type.
- Pinpoint the location of alerted components using the physical layout.

The monitoring platform enables accessing site information, including up-to-date information viewed in a physical or logical view:

- **Logical Layout:** Shows a schematic tree-layout of the components in the system, such as: inverters, strings, modules, meters and sensors, as well as their electrical connectivity. This view enables you to see which modules are connected in each string, which strings are connected to each inverter, and so on.
- **Physical Layout:** Provides a bird's eye view of the actual placement of modules in the site, and allows pinpoint issues to the exact location of each module on a virtual site map.

If you do not report the mapping of the installed power optimizers, the monitoring platform will show the logical layout indicating which power optimizers are connected to which inverter, but will not show strings or the physical location of power optimizers.

The monitoring platform includes a built-in help system, that guides you through the monitoring functionality.

For more information, refer to [https://www.solaredge.com/products/pv-monitoring#/.](https://www.solaredge.com/products/pv-monitoring#/)



Creating Logical and Physical Layout using Installation Information

To display a logical layout, insert the inverter serial number in the new site created in the monitoring platform. When the communication between the inverter and the monitoring server is established, the logical layout is displayed.

To display a physical layout, you need to map the locations of the installed power optimizers. To map the locations, use one of the methods described in the next sections.

Designer

Designer recommends inverter and power optimizer selection per site size and enables report generation. You can create a project in Designer and export the site design with the string layout to the monitoring platform.

For more information, refer to

<https://www.solaredge.com/products/installer-tools/designer#/>.



Mapper Application

Use the Mapper smart phone application to scan the power optimizer and inverter 2D bar-codes and create a virtual map of a PV site for enhanced monitoring and easier maintenance.

The Mapper application is integrated with the monitoring platform and enables:

- Simple on-site registration of new systems.
- Creating, editing and verifying system physical layout.
- Scanning and assigning the power optimizer serial number to the correct module in the system physical layout.

For detailed information, refer to the *Mapper* demo movies:

- [Creating new sites using the Mapper mobile application](#)
- [Mapping existing sites using the Mapper mobile application](#)



Physical Layout Editor

1. If you are a registered installer, access the monitoring platform site creation page at <https://monitoring.solaredge.com/solaredge-web/p/home#createSites>. If you have not yet signed up, go to <https://monitoring.solaredge.com/solaredge-web/p/createSelfNewInstaller>.
2. Fill out all required information in the screen, which includes information about your installation, as well as details about its logical and physical mapping.



Using a Paper Template

Fill out the Physical Layout Template (downloadable from the SolarEdge website <http://www.solaredge.com/files/pdfs/physical-layout-template.pdf>) using the detachable 2D barcode stickers on each power optimizer. Once the form is completed, use the Mapper to scan the 2D codes and create the map in the monitoring platform. Optionally, you can send the sticker sheet to SolarEdge Support for physical layout creation.



Chapter 6: Setting Up Communication to the Monitoring Platform

The inverter sends the following information to the monitoring platform:

- Power optimizer information received via the DC power lines (the PV output circuit)
- Inverter information
- Information of any other connected devices

This chapter describes how to set up communication between:

- The inverter and the monitoring platform through the Internet (wired/ wireless)
- Multiple inverters for a leader-follower configuration

Communication setup is not required for power harvesting, however it is needed for using the monitoring platform .

CAUTION!



When connecting the communication cables, make sure that the ON/OFF switch on the Safety Switch is turned OFF, and the AC is turned OFF.

When configuring the communication parameters, make sure that the ON/OFF switch on the Safety Switch is OFF, and the AC is turned ON.

ATTENTION!

Lors de la connexion des câbles de communication, assurez-vous que l'interrupteur MARCHE/ARRÊT à la base de l'onduleur soit en position ARRÊT, et le CA est en position ARRÊT. Lors de la configuration des paramètres de communication, assurez-vous que l'interrupteur MARCHE/ARRÊT soit en position ARRÊT, et le CA est en position MARCHE.

Communication Options

The following types of communication can be used to transfer the monitored information from the inverter to the monitoring platform.

Only communication products offered by SolarEdge are supported.

Ethernet

Ethernet is used for a LAN connection. For connection instructions refer to *Creating an Ethernet (LAN) Connection* on page 53.

RS485

RS485 is used for the connection of multiple SolarEdge devices on the same bus in a leader-follower configuration. RS485 can also be used as an interface to external devices, such as meters and third party data loggers.

For connection instructions refer to *Creating an RS485 Bus Connection* on page 56.

Wireless Gateway, Wireless Repeater(s)

The Wireless Gateway collects inverter data using a dedicated Wi-Fi connection and connects to the monitoring platform with the help of a home router. Wireless Repeater(s) extend the Wi-Fi signal range between the Wireless Gateway and inverter. Wireless Gateway and Wireless Repeaters can be purchased separately from SolarEdge. For more information, refer to <https://www.solaredge.com/sites/default/files/se-wireless-gateway-wireless-repeater-installation-guide.pdf>.



Cellular

This wireless communication option enables using a cellular connection to connect one or several devices (depending on the data plan used) to the monitoring platform.

The Cellular Plug-in is provided with a user manual, which should be reviewed prior to connection. Refer to <https://www.solaredge.com/sites/default/files/se-cellular-plug-in-for-inverters-with-setapp-installation-guide.pdf>



ZigBee

This option enables wireless connection to one or several Smart Energy products, which automatically divert PV energy to home appliances.

The Smart Energy ZigBee connections require a ZigBee plug-in and an external antenna, available from SolarEdge.

The ZigBee Plug-in for Smart Energy is provided with an installation guide, which should be reviewed prior to connection. Refer to <https://www.solaredge.com/sites/default/files/se-zigbee-plug-in-for-setapp-installation-guide.pdf>



Communication Connectors

A communication gland with multiple openings is used for connection of the various communication options. The table below describes the functionality of each gland opening. Unused openings should remain sealed.

Opening for cable size (diameter)	Connection type
2.5 - 5 mm	RS485
4.5 - 7 mm, with cut	Ethernet (CAT5/6)
2 - 4 mm, with cut	Antenna cable for wireless communication

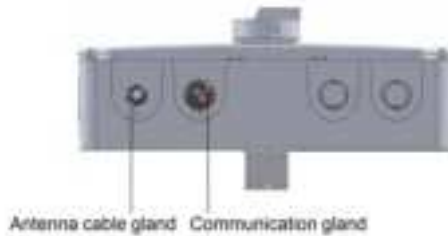

Figure 21: Communication Gland

The communication board has the following connectors:

- Standard RJ45 terminal block for Ethernet connection
- USB
- RS485 connector
- 8-pin connector for power control devices

The SolarEdge Wi-Fi antenna, ZigBee or Cellular Plug-ins can be connected to the communication board for optional wireless connection.

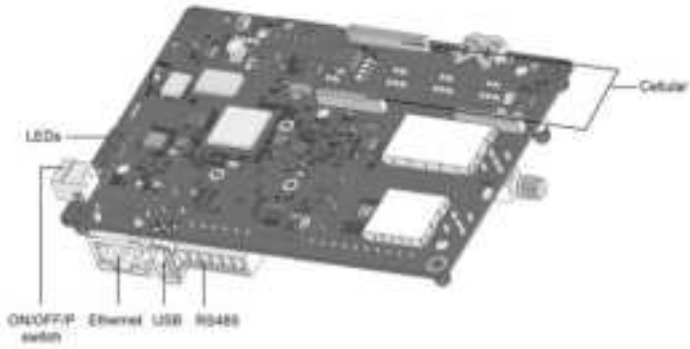

Figure 22: Communication board connectors

Removing the Inverter Cover

1. Switch the inverter ON/OFF/P switch to OFF. Wait 5 minutes for the capacitors to discharge.
2. Turn the Safety Switch (if applicable) to OFF.
3. Disconnect the AC to the inverter by turning OFF the circuit breakers on the distribution panel.
4. Open the Allen screws of the inverter cover and carefully pull the cover horizontally before lowering it.
5. Open the inverter cover (see *Figure 23*).

CAUTION!

When removing the inverter cover, make sure not to damage the internal components. SolarEdge will not be held responsible for any components damaged as a result of incautious cover removal.



ATTENTION!

Lors du retrait du couvercle, assurez-vous de ne pas endommager les composants internes. SolarEdge ne peut être tenue pour responsable des composants endommagés à la suite d'une imprudence dans le retrait du couvercle.

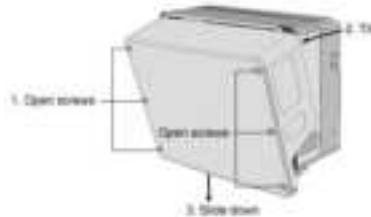

Figure 23: Removing the inverter cover

Removing the Safety Switch Cover

1. Turn OFF the AC breaker of the distribution panel and the safety switch (if applicable).
2. Open the Safety Switch cover: Release the four Allen screws and remove the cover.

CAUTION!

When removing the Safety Switch cover, make sure not to damage the internal components. SolarEdge will not be held responsible for any components damaged as a result of incautious cover removal.

**ATTENTION!**

Lors du retrait du couvercle, assurez-vous de ne pas endommager les composants internes. SolarEdge ne peut être tenue pour responsable des composants endommagés à la suite d'une imprudence dans le retrait du couvercle.

Creating an Ethernet (LAN) Connection

This communication option enables using an Ethernet connection to connect the inverter to the monitoring platform through a LAN.

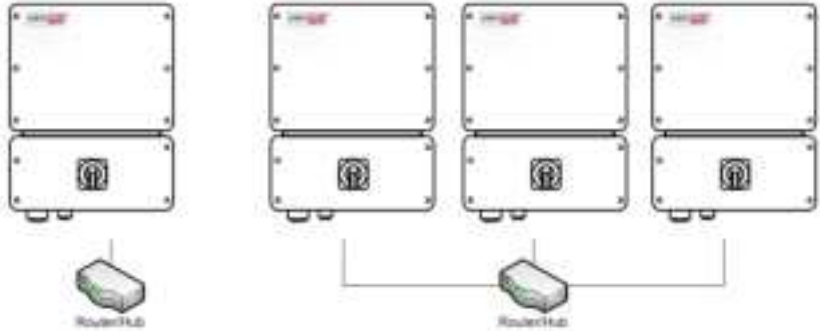

Figure 24: Example of Ethernet connection

Ethernet cable specifications:

- Cable type – a shielded Ethernet cable (Cat5/5E STP) may be used
- Maximum distance between the inverter and the router – 100 m/ 330 ft.

NOTE

If using a cable longer than 10 m / 33 ft in areas where there is a risk of induced voltage surges by lightning, it is recommended to use external surge protection devices.

For details refer to:

https://www.solaredge.com/sites/default/files/overvoltage_surge_protection_na.pdf.



➔ To connect the Ethernet cable:

1. Remove the inverter covers as described in *Removing the Inverter Cover* on page 51.
2. Open the communication gland #1.

CAUTION!

The gland includes a rubber waterproof fitting, which should be used to ensure proper sealing.

ATTENTION!

Le cote interne du gland contient une rondelle qui doit être utilisée pour une bonne étanchéité.

3. Remove the plastic seal from one of the large openings.
4. Remove the rubber fitting from the gland and insert the CAT5/6 cable through the gland and through the gland opening in the inverter.
5. Insert the cable through the opening in the Safety Switch towards the communication board.
6. Push the cable into the cut opening of the rubber fitting.

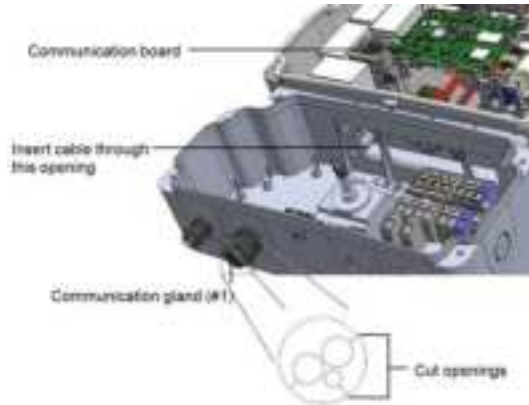

Figure 25: Communication gland and rubber fitting

CAT5/6 standard cables have eight wires (four twisted pairs), as shown in the diagram below. Wire colors may differ from one cable to another. You can use either wiring standard, as long as both sides of the cable have the same pin-out and color-coding.

RJ45 Pin #	Wire Color ⁽¹⁾		10Base-T Signal 100Base-TX Signal
	T568B	T568A	
1	White/Orange	White/Green	Transmit+
2	Orange	Green	Transmit-
3	White/Green	White/Orange	Receive+
4	Blue	Blue	Reserved
5	White/Blue	White/Blue	Reserved
6	Green	Orange	Received-

(1)The inverter connection does not support RX/TX polarity change. Supporting crossover Ethernet cables depends on the switch capabilities.

RJ45 Pin #	Wire Color ⁽¹⁾		10Base-T Signal 100Base-TX Signal
	T568B	T568A	
7	White/Brown	White/Brown	Reserved
8	Brown	Brown	Reserved

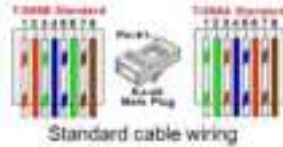

Figure 26: Standard cable wiring

7. Use a pre-crimped cable to connect via gland #1 to the RJ45 plug on the inverter's communication board or, if using a spool of cable, connect as follows:
 - a. Insert the cable through the gland.
 - b. Remove the cable's external insulation using a crimping tool or cable cutter and expose eight wires.
 - c. Insert the eight wires into an RJ45 connector (see *Figure 26*).
 - d. Use a crimping tool to crimp the connector.
 - e. Connect the Ethernet connector to the RJ45 port on the communication board (see *Figure 22*).

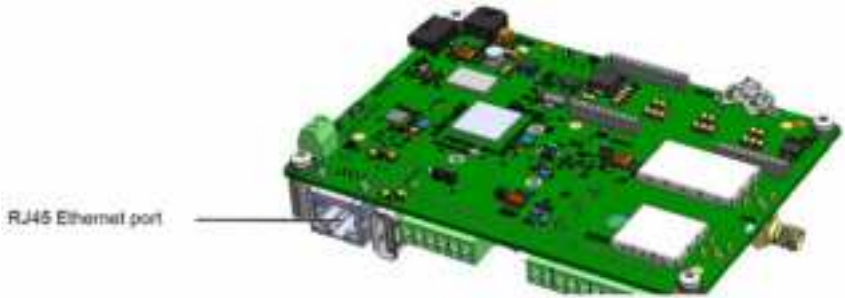

Figure 27: The RJ45 Ethernet connection

8. For the switch/router side, use a pre-crimped cable or use a crimper to prepare an RJ45 communication connector: Insert the eight wires into the RJ45 connector in the same order as above (see *Figure 26*).

⁽¹⁾The inverter connection does not support RX/TX polarity change. Supporting crossover Ethernet cables depends on the switch capabilities.

9. Connect the cable RJ45 connector to the RJ45 port of the Ethernet switch or router. You can connect more than one inverter to the same switch/router or to different switches/routers, as needed. Each inverter sends its monitored data independently to the SolarEdge monitoring platform.
10. The inverter is configured by default to LAN. If reconfiguration is required:
 - a. Make sure the ON/OFF/P switch is OFF.
 - b. Turn ON the AC to the inverter by turning ON the circuit breaker on the main distribution panel.
 - c. Turn ON the Safety Switch.

**WARNING!**

ELECTRICAL SHOCK HAZARD. Do not touch uninsulated wires when the inverter cover is removed.

- d. Configure the connection as described in *Communication* on page 42.

NOTE

If your network has a firewall, you may need to configure it to enable the connection to the following address:

- Destination Address: prod.solaredge.com
- TCP Port: 22222 (for incoming and outgoing data)

11. Verify the connection, as described in *Verifying the Connection* on page 60.

Creating an RS485 Bus Connection

The RS485 option enables creating a bus of connected inverters, consisting of up to 31 follower inverters and 1 leader inverter. Using this option, inverters are connected to each other in a bus (chain), via their RS485 connectors. The first and last inverters in the chain must be terminated as described on page 58.

RS485 wiring specifications:

- Cable type: Min. 3-wire shielded twisted pair (a shielded Ethernet cable (Cat5/5E STP) may be used)
- Wire cross-section area: 0.2- 1 mm²/ 24-18 AWG (a CAT5 cable may be used)
- Maximum nodes: 32
- Maximum distance between first and last devices: 1 km /3300 ft.

NOTE

If using a cable longer than 10 m/33 ft in areas where there is a risk of induced voltage surges by lightning, it is recommended to use external surge protection devices. For details refer to: https://www.solaredge.com/sites/default/files/overvoltage_surge_protection_na.pdf.



If grounded metal conduits are used for routing the communication wires, a lightning protection device is not required.

If not using surge protection, connect the grounding wire to the first inverter in the RS485 chain; make sure the grounding wire is not in contact with other wires. Connect the grounding wire to the grounding bus-bar in the Safety Switch.

The following sections describe how to physically connect the RS485 bus and how to configure the bus.

 **To connect the RS485 communication bus:**

1. Remove the inverter cover as described in *Removing the Inverter Cover* on page 51.
2. Remove the seal from one of the openings in communication gland and insert the wire through the opening.
3. Pull out the RS485 terminal block connector, as shown below.



Figure 28: RS485 terminal block on the communication board

4. Loosen the screws of pins A(+), B(-), and G on the left of the RS485 terminal block (RS485-1).

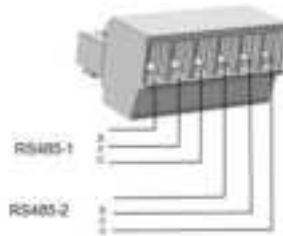

Figure 29: RS485 terminal block

5. Insert the wire ends into the **G**, **A** and **B** pins shown above. Use Four- or six-wire twisted pair cable for this connection.

You can use any color wire for each of the **A**, **B** and **G** connections, as long as:

- The same color wire is used for all A pins the same color for all B pins and the same color for all G pins
- The wire for G is not from the same twisted pair as A or B.

6. For creating an RS485 bus - connect all B, A and G pins in all inverters. The following figure shows this connection schema:



Figure 30: Connecting the inverters in a chain

**NOTE**

Do not cross-connect B, A and G wires.

7. Tighten the terminal block screws.
8. Check that the wires are fully inserted and cannot be pulled out easily.
9. Push the RS485 terminal block firmly all the way into the connector on the right side of the communication board.
10. Terminate the first and last SolarEdge device in the chain by switching a termination DIP-switch inside the inverter to ON (move the left switch up). The switch is located

on the communication board and is marked SW2.

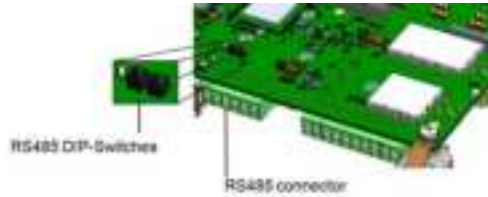

Figure 31: RS485 termination switch

NOTE



Only the first and last SolarEdge devices in the chain should be terminated. The other inverters in the chain should have the termination switch OFF (down position).

11. If not using surge protection, connect the grounding wire to the first inverter in the RS485 chain; make sure the grounding wire is not in contact with other wires. For inverters with a Safety Switch, connect the grounding wire to the grounding bus-bar in the Safety Switch.

➡ To connect to the monitoring platform:

1. Designate a single inverter as the connection point between the RS485 bus and the monitoring platform. This inverter will serve as the leader inverter.
2. Connect the leader to the monitoring platform via the LAN option (refer to) or any of the other options.

➡ To configure the RS485 bus:

All inverters are configured by default as followers. To configure the leader:

1. Verify the ON/OFF/P switch is OFF.
2. Verify that AC is on.
3. Use SetApp to access the **Commissioning** menu screen as described in *Communication* on page 42.
4. From the **Commissioning** menu tap **Communication**. The Communication screen is displayed.
5. Select the following to configure the connection:
 - Server → LAN, Cellular or Wi-Fi
 - RS485- → Protocol → SolarEdge → **SolarEdge Leader**
 - RS485- → Follower Detect

The system starts automatic detection of the follower inverters connected to the leader inverter. The inverter should report the correct number of followers. If it does not, verify the connections and terminations.

6. To check the follower IDs and last communication time, select **RS485** → **Follower List**.
7. Verify the connection of the leader to the monitoring platform, as described in the next section.

Verifying the Connection

After connecting and configuring a communication option, perform the following steps to check that the connection to the monitoring server has been successfully established.

1. Go to **Commissioning > Status**.
2. In the **Summary** section, under **Server Comm.**, make sure **S_OK** is displayed together with the selected communication option.
3. Scroll down to the **Communication** section and check that the communication options are as required.

Appendix A: Errors and Troubleshooting

This chapter describes general system problems, and how to troubleshoot them. For further assistance, contact SolarEdge Support.

Identifying Errors

Errors may be indicated in various system interfaces: On the inverter bottom panel, a red LED indicates an error. In the monitoring platform and SetApp, errors are displayed with codes.

For more information on the codes displayed for error and warning messages, refer to

https://www.solaredge.com/sites/default/files/troubleshooting_for_se_inverter_installation_guide_addendum_na.pdf. This document describes errors that appear in SetApp, monitoring platform, and LCD (for inverters with LCD). To identify the error types, use the methods described below.



➡ To identify the error type using the inverter LEDs:

1. Move the ON/OFF/P switch to **P** position for **2 seconds** and release it.
2. Observe the LED lights and use the following table to identify the error type. For more information, refer to <https://www.solaredge.com/us/leds>.



Error type	LED color and state		
	Red	Green	Blue
Arc detected	ON	OFF	OFF
Isolation or RCD problem	Blinking	OFF	OFF
Grid error	OFF	ON	OFF
High temperature	OFF	Blinking	OFF
Pairing failed	OFF	OFF	ON
Other issue	OFF	OFF	Blinking

➡ To identify the error type using the monitoring platform:

1. Open the site dashboard and click the **Layout** icon.
2. Right-click the inverter and select **Info** from the menu. The inverter details window is displayed.
3. Click the **Errors** tab. The list is displayed.

Troubleshooting Communication

Troubleshooting Ethernet (LAN) Communication

The possible errors and their troubleshooting are detailed in the following table:

Error Message	Possible Cause and Troubleshooting
LAN cable disconnected	Physical connection fault. Check the cable pin-out assignment and cable connection.
No DHCP	IP settings issue. Check the router and configuration. Consult your network IT.
Configure Static IP or set to DHCP	
Gateway not responding	Ping to router failed. Check the physical connection to the switch/ router. Check that the link LED at the router /switch is lit (indicating phy-link). If OK - contact your network IT, otherwise replace the cable or change it from cross to straight connection.
No Internet connection	Ping to google.com failed. Connect a laptop and check for internet connection. If internet access is unavailable, contact your IT admin or your internet provider.

Troubleshooting RS485 Communication

- If the message **RS485 Leader Not Found** appears in the Status screen, check the connections to the leader device and fix if required.
- If after follower detection the number of followers displayed for the leader under **RS485-2 Conf → Follower Detect** is lower than the actual number of followers, refer to the following application note to identify missing followers and troubleshoot connectivity problems: https://www.solaredge.com/sites/default/files/troubleshooting_undetected_RS485_devices.pdf



Additional Troubleshooting

1. Check that the modem or hub/router is functioning properly.
2. Check that the connection to the internal connector on the communication board is properly done.
3. Check that the selected communication option is properly configured.
4. Use a method independent of the SolarEdge device to check whether the network and modem are operating properly. For example, connect a laptop to the Ethernet router and connect to the Internet.
5. Check whether a firewall or another type of network filter is blocking communication.

Power Optimizer Troubleshooting

Malfunction	Possible Cause and Corrective Action
Pairing failed	<p>Power optimizers are shaded.</p> <p>If you connected the inverter to the monitoring platform, retry pairing remotely (during sunlight). Make sure to leave the inverter ON/OFF/P switch ON and that S_OK appears in the status screen.</p>
String voltage is 0V	<p>Power optimizer (s) output is disconnected.</p> <p>Connect all power optimizer outputs.</p>
String voltage not 0V but lower than number of optimizers	<p>Power optimizer(s) not connected in the string.</p> <p>Connect all power optimizers.</p>
	<p>Panel(s) not connected properly to power optimizer inputs (not applicable to smart modules).</p> <p>Connect the modules to the optimizer inputs.</p>
	<p>String reverse polarity.</p> <p>Check string polarity using a voltmeter and correct if needed.</p>

Malfunction	Possible Cause and Corrective Action
<p>String voltage is higher than number of optimizers</p> <p>WARNING! If the measured voltage is too high, the installation may not have a safe low voltage. PROCEED WITH CARE! A deviation of $\pm 1\%$ per string is reasonable.</p>  <p><i>Si la tension mesurée est trop haute, la tension basse de sécurité pourrait manquer dans l'installation. REDOUBLEZ DE PRECAUTION. Une déviation de $\pm 1\%$ par string est raisonnable.</i></p>	<p>Extra power optimizer(s) connected in the string (not applicable to smart modules). Check if an extra power optimizer is connected in the string. If not – proceed to next solution.</p> <p>A module is connected directly to the string, without a power optimizer (not applicable to smart modules). Verify that only power optimizers are connected in the string and that no module outputs are connected without a power optimizer. If the problem persists, proceed to the next step.</p> <p>Power optimizer(s) malfunction.</p> <ol style="list-style-type: none"> 1. Disconnect the wires connecting the power optimizers in the string. 2. Measure the output voltage of each power optimizer to locate the power optimizer that does not output 1V safety voltage. If a malfunctioning power optimizer is located, check its connections, polarity, module, and voltage. 3. Contact SolarEdge Support. Do not continue before finding the problem and replacing the malfunctioning power optimizer. If a malfunction cannot be bypassed or resolved, skip the malfunctioning power optimizer, thus connecting a shorter string.

Appendix B: Mechanical Specifications

The following figure provides inverter dimensions in mm [in].

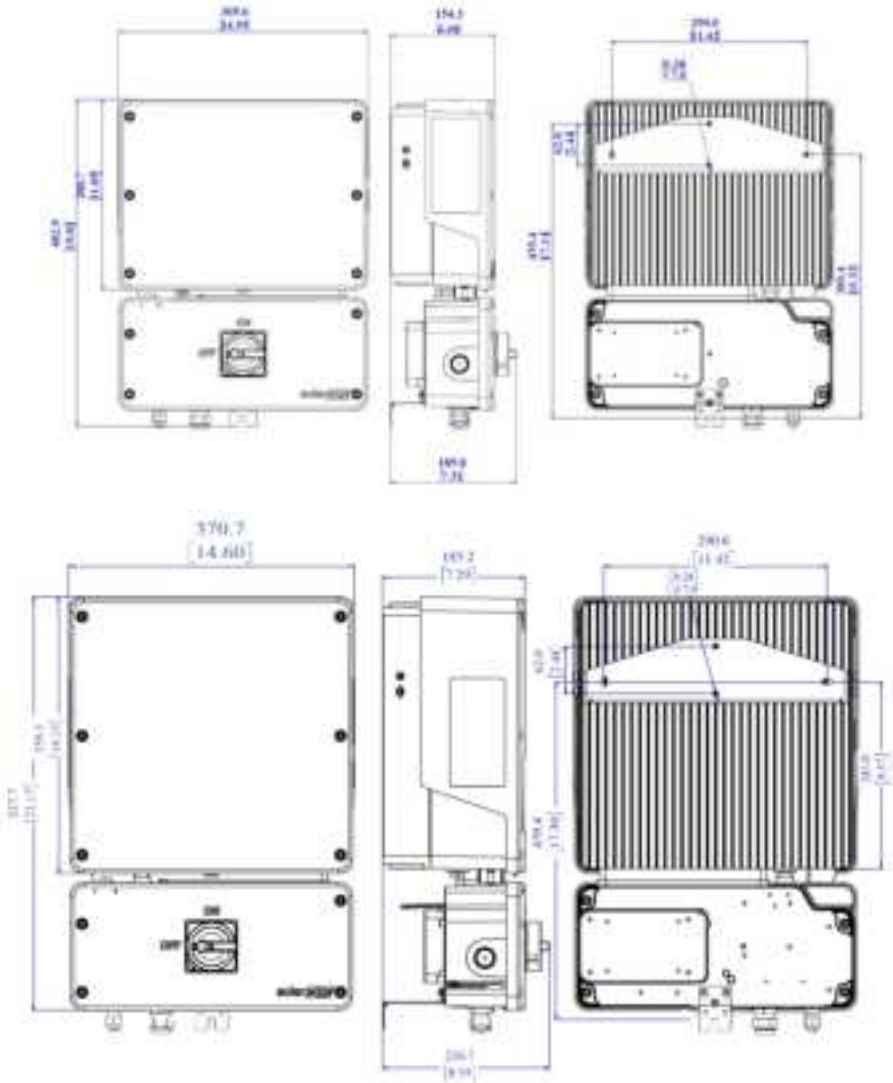

Figure 32: SE10000H-SE11400H inverter dimensions

Appendix C: Replacing and Adding System Components

This appendix includes replacement procedures for the SolarEdge system components.



NOTE

If you are permanently disassembling the installation or part of it, make sure to use the disposal methods dictated by local regulations.

Replacing an Inverter

1. Turn OFF the inverter ON/OFF/P switch, and wait until the green LED is blinking , indicating that the DC voltage is safe (<50V), or wait five minutes before continuing to the next step.
2. Disconnect the AC to the inverter by turning OFF the AC circuit breaker of the distribution panel.
3. Turn OFF the Safety Switch.
4. Open the Safety Switch cover : Release the four Allen screws and remove the cover.
5. Open the inverter cover as described in *Removing the Inverter Cover* on page 51.
6. Disconnect the DC and AC cables from the Safety Switch .
7. Disconnect the wires connected to the inverter or between the inverter and the Safety Switch:
 - Antenna cable from the communication board
 - DC and AC wires in the Safety Switch
 - Grounding cable
8. Disconnect the Safety Switch from the inverter by opening the two clips securing the Safety Switch to the inverter: Carefully place a screwdriver between the clip and the enclosure and pull the clip.

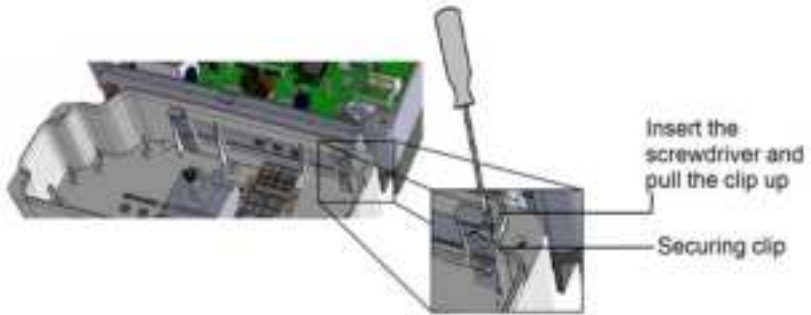

Figure 33: Disconnecting the Safety Switch from the inverter

9. Remove the screws securing the inverter to the mounting brackets and lift the inverter from the mounting bracket.

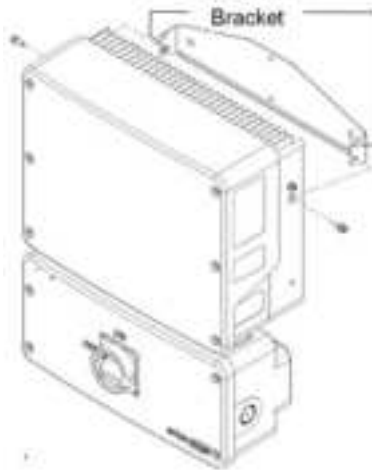

Figure 34: Mounting brackets

NOTE

If you remove the old inverter and do not immediately install a new one, then:

- Lock the Safety Switch in the OFF position using a lock on the switch.
- Secure the Safety Switch bracket to the wall/pole, using 3 screws
- Use insulation tape to isolate each of the AC and DC wires.
- Seal the open conduits using duct tape.
- Install the Safety Switch sealing cover supplied with the inverter and secure with retaining clips.



10. Place the new inverter on the mounting brackets and secure it using the screws.
11. Insert the wires from the Safety Switch into the openings in the inverter and the ferrite bead.
12. Fasten the two clips securing the Safety Switch to the inverter.
13. Reconnect the cables: Follow the instructions of .
14. Close the inverter and Safety Switch covers.
15. Perform the commissioning steps as described in *Activating, Commissioning and Configuring the System* on page 40.

Replacing the Safety Switch

1. Turn OFF the inverter ON/OFF/P switch, and wait until the green LED is blinking, indicating that the DC voltage is safe (<50V), or wait five minutes before continuing to the next step.
2. Turn OFF the AC breaker of the distribution panel and the Safety Switch.
3. Open the Safety Switch cover: Release the four Allen screws and remove the cover.
4. Open the inverter cover as described in *Removing the Inverter Cover* on page 51.
5. Disconnect the DC wires from the inverter and the AC wires from the Safety Switch.
6. Disconnect the wires between the inverter and the Safety Switch.
 - Antenna cable from the communication board
 - RS485 and/or Ethernet connection from the communication board
 - Grounding cable

7. Open the Safety Switch bracket screws.



Figure 35: Safety Switch bracket

8. Disconnect the Safety Switch from the inverter by opening the two clips securing the Safety Switch to the inverter: Carefully place a screwdriver between the clip and the enclosure and pull the clip.
9. Detach the Safety Switch from the inverter.
10. Place the new Safety Switch and secure it to the inverter using the clips.
11. Insert the wires from the inverter into the openings in the Safety Switch and the ferrite bead.
12. Reconnect the cables: Follow the instructions of *Installing the Inverter* on page 26.
13. Close the inverter cover.
14. Fasten the Safety Switch bracket using a standard bolt.
15. Perform the commissioning steps as described in *Activating, Commissioning and Configuring the System* on page 40.

Adding, Removing, or Replacing Power Optimizers

1. Turn OFF the inverter ON/OFF/P switch, and wait until the green LED is blinking , indicating that the DC voltage is safe (<50V), or wait five minutes before continuing to the next step.
2. Disconnect the AC to the inverter by turning OFF the circuit breakers on the distribution panel.
3. Turn OFF the Safety Switch .
4. Disconnect and connect the necessary power optimizers.
5. Perform pairing and other procedures described in *Activating, Commissioning and Configuring the System* on page 40 on all inverters to which power optimizers were added or from which power optimizers were removed.

6. In the monitoring platform, use the **Replace** button in the **logical layout** tab (in site Admin). Replace the serial number of the removed power optimizer with the serial number of the newly installed power optimizer. Refer to <https://www.solaredge.com/sites/default/files/se-monitoring-portal-site-admin.pdf>



Technical Specifications - Single Phase Inverters with HD-Wave Technology (North America)

	SE3000H-US	SE3800H-US	SE5000H-US	SE6000H-US	SE7600H-US	SE10000H-US	SE11400H-US	Unit
OUTPUT								
Rated AC Power Output	3000	3800 @ 240V 3300 @ 208V	5000	6000 @ 240V 5000 @ 208V	7600	10000	11400 @ 240V 10000 @ 208V	VA
Maximum AC Power Output	3000	3800 @ 240V 3300 @ 208V	5000	6000 @ 240V 5000 @ 208V	7600	10000	11400 @ 240V 10000 @ 208V	VA
AC Output Voltage Min.-Nom.-Max. (211 - 240 - 264)	✓	✓	✓	✓	✓	✓	✓	Vac
AC Output Voltage Min.-Nom.-Max. (183 - 208 - 229)	-	✓	-	✓	-	-	✓	Vac
Maximum Continuous Output Current @240V	12.5	16	21	25	32	42	47.5	A
Maximum Continuous Output Current @208V	-	16	-	24	-	-	48.5	A
Max. output fault current and duration @240V	14 / 20	17.5 / 20	23 / 20	27.5 / 20	40 / 20	56.6 / 20		A / ms

	SE3000H-US	SE3800H-US	SE5000H-US	SE6000H-US	SE7600H-US	SE10000H-US	SE11400H-US	Unit
Maximum output fault current and duration @208V	-	17.5 / 20	-	27.5 / 20	-	-	56.6 / 20	A / ms
AC Frequency (Nominal)	59.3 - 60 - 60.5 ⁽¹⁾							Hz
Synchronization inrush current AC (5 cycles)	24 / 5 / 83		30 / 5.34 / 83			34 / 5.74 / 83		Aac (max) / Aac (rms) / ms
Maximum output overcurrent protection	35		48		55	80		A
Power factor range	1 (adjustable from -0.85 to +0.85)							
Total harmonic distortion	< 3%							
GFDI Threshold	1							A
Utility Monitoring, Islanding Protection, Country Configurable Thresholds	Yes							
INPUT								
Maximum DC Power @240V	4650	5900	7750	9300	11800	15500	17650	W

(1) For other regional settings please contact SolarEdge support

	SE3000H-US	SE3800H-US	SE5000H-US	SE6000H-US	SE7600H-US	SE10000H-US	SE11400H-US	Unit	
Maximum DC Power @208V	-	5100	-	7750	-	-	15500	W	
Transformer-less, Ungrounded	Yes								
Maximum Input Voltage	480							Vdc	
Nominal DC Input Voltage	380				400			Vdc	
Operating voltage range	270-480							Vdc	
Maximum Input Current 240V ⁽¹⁾	8.5	10.5	13.5	16.5	20	27	30.5	Adc	
Maximum Input Current 208V ⁽¹⁾	-	9	-	13.5	-	-	27	Adc	
Maximum Input Short Circuit Current	45							Adc	
Reverse-Polarity Protection	Yes								
Ground-Fault Isolation Detection	600 kΩ Sensitivity								
Maximum Inverter Efficiency	99	99.2							%
CEC Weighted Efficiency	99						99 @ 240V 98.5 @ 208V	%	

(1) A higher current source may be used; the inverter will limit its input current to the values stated

	SE3000H-US	SE3800H-US	SE5000H-US	SE6000H-US	SE7600H-US	SE10000H-US	SE11400H-US	Unit
Nighttime Power Consumption	< 2.5							W
ADDITIONAL FEATURES								
Supported Communication Interfaces	RS485, Ethernet, ZigBee (optional), Cellular (Optional)							
Revenue Grade Data, ANSI C12.20	Optional ⁽¹⁾							
Inverter Commissioning	with the SetApp mobile application using built-in Wi-Fi access point for local connection							
Rapid Shutdown - NEC 2014 and 2017 690.12	Automatic Rapid Shutdown upon AC Grid Disconnect							
STANDARD COMPLIANCE								
Safety	UL1741, UL1741 SA, UL1699B, CSA C22.2, Canadian AFCEI according to T.I.L. M-07							
Grid Connection Standards	IEEE1547, Rule 21, Rule14 (HI)							
Emissions	FCC part15 class B							
RoHS	Yes							
INSTALLATION SPECIFICATIONS								
AC output conduit size / AWG range	1" minimum / 14 - 6 AWG					1" minimum / 14-4 AWG		
DC input conduit size / # of strings / AWG range	1" minimum / 1-2 strings / 14-6 AWG					1" minimum / 1-3 strings / 14-6 AWG		
Dimensions with Safety Switch (HxWxD)	17.7 x 14.6 x 6.8 / 450 x 370 x 174					21.3 x 14.6 x 7.3 / 540 x 370 x 185		in/mm

(1) Inverter with Revenue grade meter P/N: SExxxxH-US000BNC4; Inverter with Revenue grade and Export/Import meter P/N: SExxxxH-US000BNI4

	SE3000H-US	SE3800H-US	SE5000H-US	SE6000H-US	SE7600H-US	SE10000H-US	SE11400H-US	Unit	
Weight with Safety Switch	22 / 10	25.1 / 11.4		26.2 / 11.9		38.8 / 17.6		lb / kg	
Noise	< 25				< 50				dB(A)
Cooling	Natural Convection								
Operating Temperature Range	-40 to +140 / -40 to +60 ⁽¹⁾								°F / °C
Protection Rating	NEMA 4X (Inverter with Safety Switch)								

⁽¹⁾Full power up to at least 50° C / 122° F. For power de-rating information refer to: <https://www.solaredge.com/sites/default/files/se-temperature-derating-note-na.pdf>

Recommended OCPD Size per Grid

Inverter	Maximum Output Current (A)	Minimum Fuse Rating (A)	Maximum Fuse Rating (A)
SE3000H-US	12.5	20	50
SE3800H-US	16	20	50
SE5000H-US	24 @ 208V 21 @ 240V	30	50
SE6000H-US	24 @ 208V 25 @ 240V	30 @ 208V 35 @ 240V	50
SE7600H-US	32	40	50
SE10000H-US	42	60	80
SE11400H-US	48.5 @ 208V 47.5 @ 240V	70 @ 208V 60 @ 240V	80

Default Trip Limits and Times According to IEEE1547

NOTE



The inverters are equipped with adjustable utility protective function set-points, and can be aggregated above 30kW on a single Point of Common Connection. The default settings are in compliance with IEEE1547. Utility authorization is required to change these set-points.

Voltage Range (% of Base Voltage)	Maximum Clearing Time (Sec) ⁽¹⁾
V < 50%	0.16
50 % < V < 88%	2.00
110% < V < 120%	1.00
V > 120 %	0.16
Frequency Range (Hz)	Maximum Clearing Time (Sec) ⁽¹⁾
> 60.5	0.16
< 59.3 (Hawaii – 57)	0.16

⁽¹⁾Time accuracy is +-30ms

Support Contact Information

If you have technical problems concerning SolarEdge products, please contact us:



<https://www.solaredge.com/service/support>

Before contact, make sure to have the following information at hand:

- Model and serial number of the product in question.
- The error indicated on the product SetApp mobile application or on the monitoring platform or by the LEDs, if there is such an indication.
- System configuration information, including the type and number of modules connected and the number and length of strings.
- The communication method to the SolarEdge server, if the site is connected.
- The product's software version as it appears in the status screen.

solar**edge**