



MSA

The Safety Company

Fall Protection Solutions

WE KNOW WHAT'S AT STAKE.



Fall Protection Safety Solutions

Fall Protection personal protective equipment is used by workers in many industries. It is designed and used to prevent accidents at work or to protect against consequences of accidents at work.

MSA has been in the business of safety at height since 1930. Today it is at the forefront in both the supply and the range of innovative fall protection products.

MSA is truly a global manufacturer of fall protection. With manufacturing operations on five continents and with more than 40 locations worldwide, MSA serves customers in more than 140 countries. All MSA products meet local and international standards. With MSA's worldwide presence we deliver the right safety solution to the right place, at the right time.

Our extensive range includes textiles, such as the innovative V-Series™ line of full body harnesses, engineered lifelines with our MSA Latchways® range, and a selection of hard goods, including self-retracting lanyards and confined space equipment. These are complemented by MSA rescue products, to enable workers at height have the protection they need at all times.



What's your Fall Protection Plan?

Employees who feel safe and protected when working at height bring confidence to their toughest jobs. That confidence translates into productivity. Productivity means less downtime, more cost savings.

Hierarchy of Fall Protection

It's common sense, really, but also clearly highlighted by the European Directive 2009/104/EC: The hierarchy of fall protection starts by determining what type of fall protection system is truly required— and why.

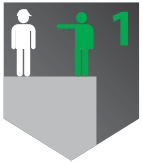

Eliminate the Risk

Avoid working at height where possible or locate plant and equipment in safe locations where there's no risk of a fall. If the height factor is removed the effect of gravity becomes less relevant.



Guard the Hazard

When working at height is essential, ensure that workers aren't exposed to unnecessary risks by providing a parapet or guardrail (such as Latchways VersiRail®) to eliminate fall hazards.



Protect the Worker

If it's not possible to eliminate the risk of falling, use the appropriate fall protection system to help minimize the consequences of a fall. This is achievable through either a fall arrest or fall restraint system.

"Fall restraint" and "fall arrest" are commonly used terms in the industry. Identifying the difference between the two is crucial in terms of understanding where and why a particular system should be used.

Designing a system in fall restraint is necessary when users are required to access a position where a fall could occur. It's generally suited for persons who need to work at the edge of a hazard—for example, maintaining gutters along the edge of a roof.

Designing a system in fall arrest is necessary when the requirement is for users to access or pass a position where there is a fall risk. A fall arrest system will safely arrest a fall, this must be accompanied by an appropriate rescue plan and the means to implement that plan.

The ABC's of Fall Protection

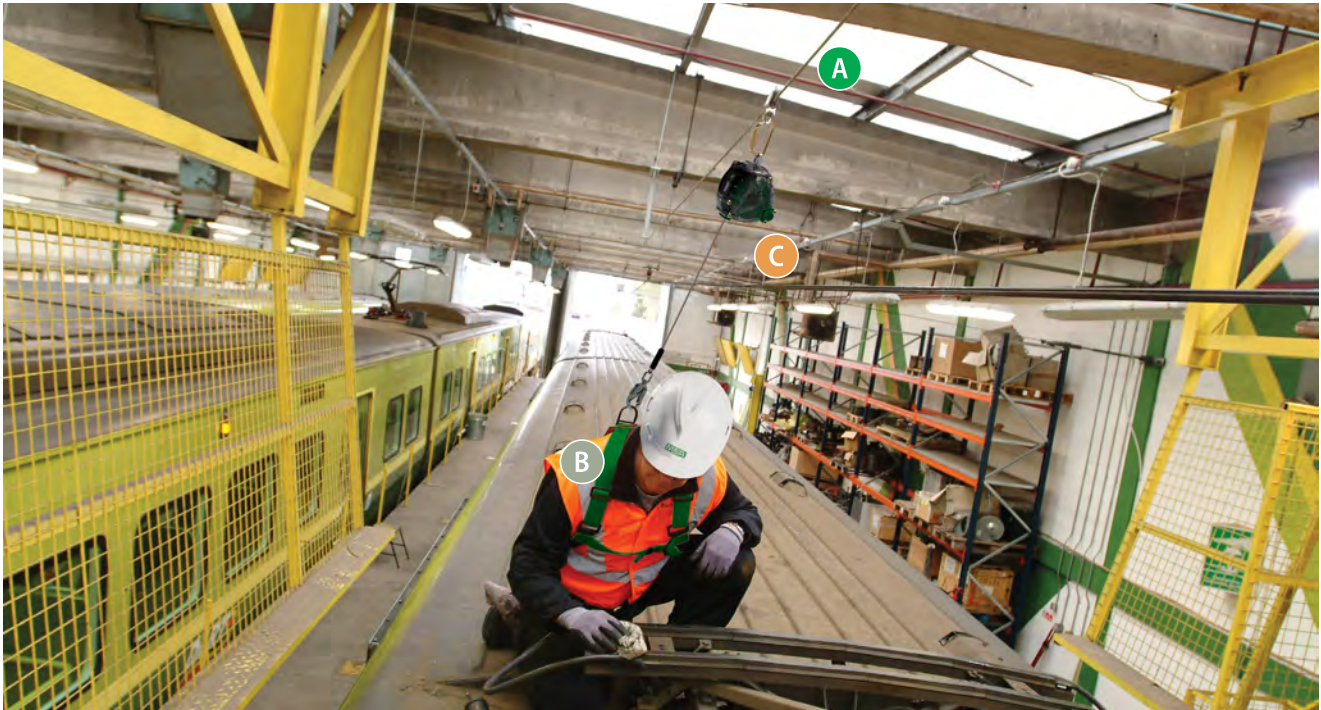

A Anchorage

Anchor points are an important part of any system; they should be suitably positioned for the intended operation and should be unquestionably sound. Anchor points may be provided by Fall Protection Engineered Systems (such as the MSA Latchways® range), or temporary anchor devices.



B Body Harness

Full body or lower body harness, general height work, work positioning/suspension, confined space applications. You must select the harness applicable to your work application.

Note: MSA does not recommend a lower body harness for use in industrial fall protection applications.



C Connecting Device

What is needed between the anchorage and harness? Typically, a lanyard assembly (energy-absorbing lanyard) or self-retracting lanyard.



Did you know?

Suspension trauma can occur in as little as 5 minutes after a person has fallen in a harness. Do not rely on local rescue authorities to be on site within 5 minutes. MSA has a range of simple to use rescue products to assist you in performing a quick, safe and successful rescue.

Categories of Fall Protection

Personal fall protection is divided into the following categories:



Fall Arrest

System that arrest a worker's fall when it occurs, preventing impact at a lower level. Fall arrest systems are required whenever a worker is exposed to a fall hazard.



Restraint

System that restrains a worker from reaching a fall hazard.



Positioning

System that allows the worker to sit back in their harness while performing work with both hands. This type of protection is not designed to be used to arrest a fall, and must be used in conjunction with a fall arrest system.



Access System

Usually used when accessing Confined Spaces, this system provides a worker a safe access by arresting a fall if it occurs, or providing means for rescue.



Suspension or Rope Access

System that is able to lower and support a worker providing for a hands-free work environment. A fall arrest system must be used alongside the suspension system.



Rescue

Otherwise known as a rescue plan, retrieval is a crucial step in the development of a fall protection plan. This system covers the post fall scenario of retrieving a worker who has fallen.

Calculating Total Fall Distance

Knowing how to calculate total fall distance or fall clearance is just as critical as selecting the proper harness, lanyard, anchorage connector, and anchorage point for your specific application. Total fall distance from the anchorage point depends on the length of the lanyard, the extension of the energy absorber, the height of the person to the anchorage point and a safety factor (usually 1m).

However, the total fall distance takes into consideration the position of the person that falls when compared to the position of the anchor point before the fall occurs. This ratio is known as the Fall factor and it can drastically affect the free fall distance (period of acceleration), which leads to define the "severity" of the potential fall.

Typically:

- The higher the fall factor, the higher the total fall distance
- The larger the lanyard, the higher the total fall distance

Instruction manuals usually provide a detailed overview of the required clearance.

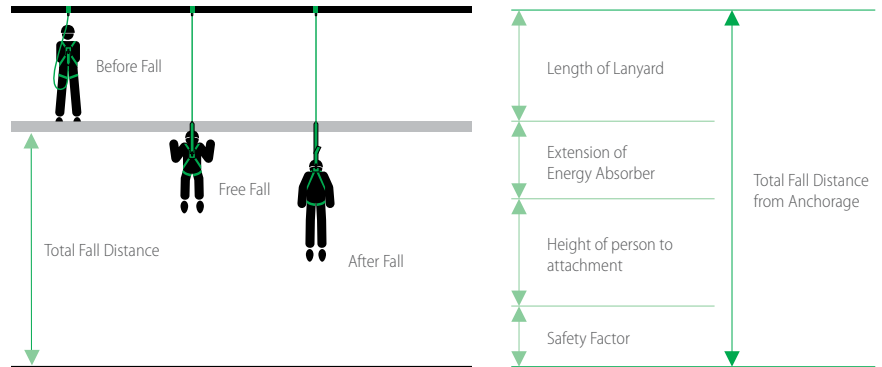

Fall Factor 0

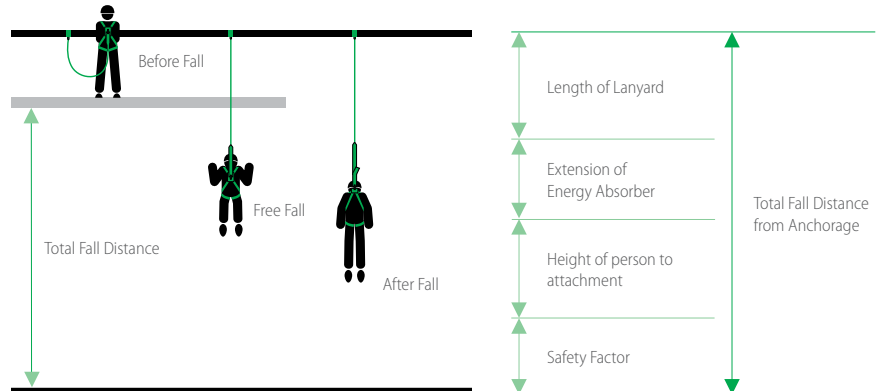

Fall Factor 1

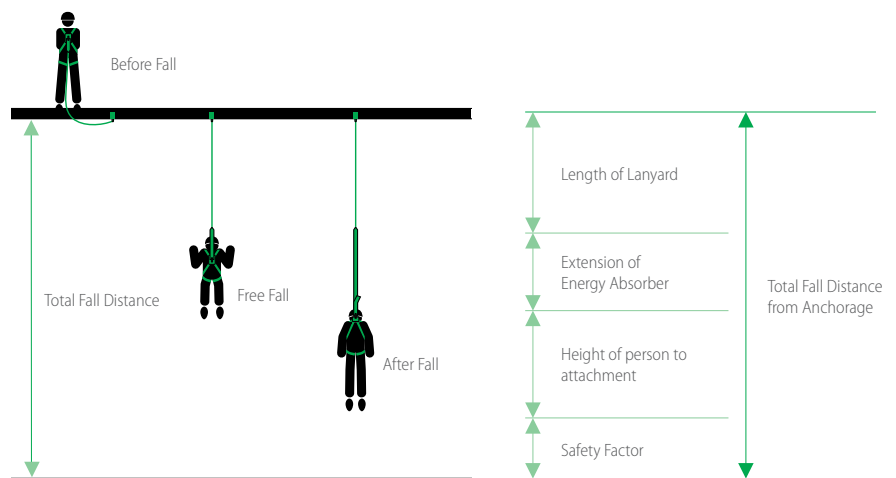

Fall Factor 2

Representation only. NOT TO SCALE.



Did you know?

Always choose a self-retracting lanyard over a shock absorbing lanyard if the fall distance is a concern.

The Weight Limit

In case of a fall, energy absorbers are designed to reduce the forces on a human body to less than 6kN according to the CEN legislation requirements. However, energy absorbers are limited in weight capacity, as the heavier the mass is that falls, the greater the force generated during the fall.

The maximum weight at the time of the fall does not solely include the weight of the worker, but also the weight of any clothing and attached equipment/tools, which always must be taken into consideration. Weight ranges for all fall protection personal protective equipment are specified by the manufacturer, as they are part of the testing procedures and the certification. This information can typically be found on the labels and the instruction manuals.

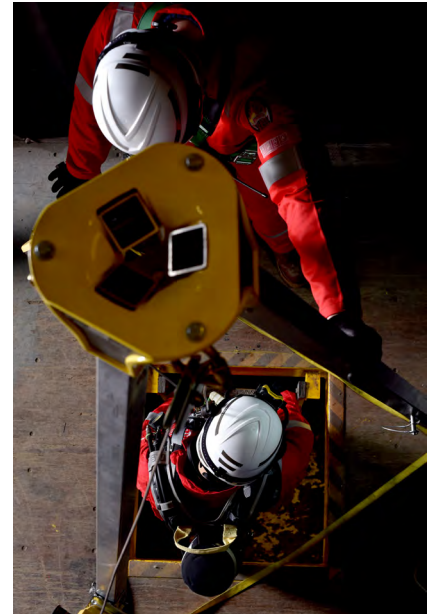

Did you know?

European Standards require as little as 100 kg as standard weight limit. Always check manufacturer's documentation including labels and manuals to verify if your fall protection equipment is certified to higher loads.

The Leading Edge Risk

Leading Edge is an application where in the event of a fall, the lanyard of a Shock Absorbing Lanyard or a Self-Retracting Lifeline may come in contact with an exposed edge.

In many scenarios, leading edge applications occur when the harness wearer is connected to an anchor point below their back D-ring, however it is possible when anchor points are overhead as well. In leading edge applications, the potential for a fall is complicated by an edge. And that means greater risk for the lifeline to be frayed, cut, or severed in the event of a fall.

Swing fall is another hazard associated with leading edge applications. Currently, any lifeline approved for leading edge applications must meet specific standard requirements: the CNB/P/11.060 for self-retracting lanyards, CNB/P/11.074 for shock absorbing lanyards, and CNB/P/11.075 for rope grabs.

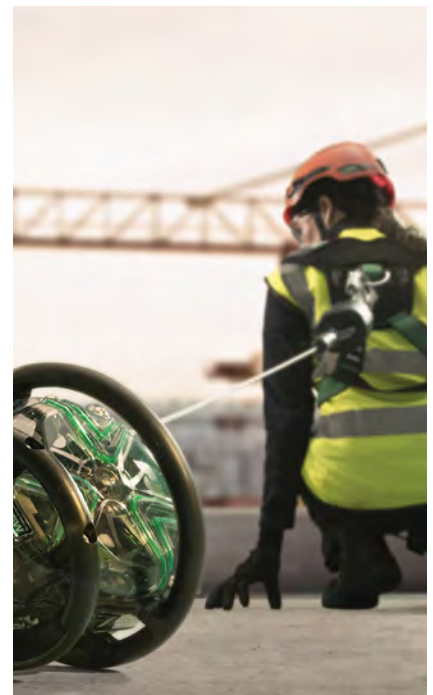
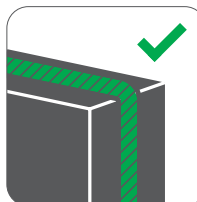

Did you know?

Approvals for fall factor 2 use and leading edge are independent, and the second one is much tougher. Because edge risks are usually present when anchored at foot level, if you need a fall factor 2 approved product for your application, make sure it is also leading edge approved.

The Pendulum Effect or Swing Fall Hazard

A worker who falls while connected to an anchor (unless it is directly overhead) will swing back and forth like a pendulum. Workers can be seriously injured if they strike objects during a swing fall. Installing the anchorage point directly above the work area (i.e. connected to an overhead attachment point with sufficient strength) will help prevent injury.



Did you know?

Severity of swing hazards increases with the height of the anchorage point. Always read instruction manuals or manufacturer documentation to learn more about the safe working zone and the additional clearance that must be considered if not working close to the anchorage point.

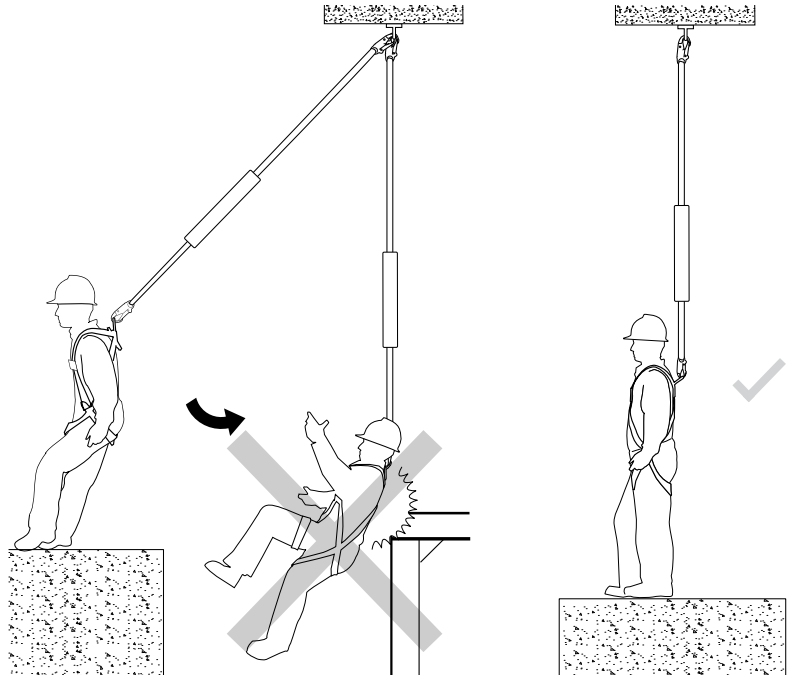

Environmental Conditions

Most fall protection solutions have been designed and approved for use in standard environmental conditions. However, there are specific environments that can seriously affect the performance as well as the durability of any equipment used or exposed.

Those applications exposed to hazards that can immediately affect the performance, such as strong chemicals, sparks, explosion risks, electrical hazards or extreme heat or cold, could require specialty equipment, designed for use in those specific conditions.

Safety of the solutions exposed to environmental conditions affecting durability, such as light chemicals, long outdoor exposure, marine environment, abrasive surfaces, etc. can be controlled through more frequent periodic inspections. For increased durability, seek products built with high quality materials like stainless steel or coated webbing, or solutions designed for specific harsh conditions.



Connectors

Certified to EN 362, connectors are devices that can be opened and used to connect components. This enables a user to assemble a fall protection system and connect themselves directly or indirectly to an anchor.

Gate opening

The maximum gap allowing the passage of a component into the connector, whilst ensuring the correct functioning of the gate-locking feature.

Gate-locking feature

Mechanism that locks the gate when the gate shuts. This mechanism typically depends on the size of the connector. While it is commonly fully automatic for the largest hooks, there is a choice of automatic or manual for carabiners.

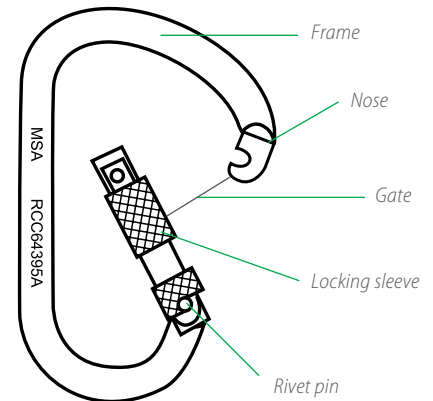

Twist Lock



Step1

Rotate clockwise



Step2

Push inward

Triple Lock



Step1

Push up



Step 2

Rotate clockwise



Step3

Push inward

Snap Hook



Step1

Push



Step2

Push inward

Scaffold Hook



Step1

Push



Step2

Push inward

Screwgate Lock

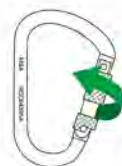

Step1

Rotate clockwise

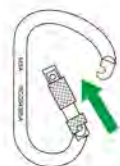

Step 2

Push inward

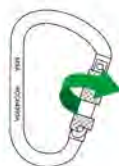

Step3

Rotate anti-clockwise

Connector Strength

While the connectors are fully tested along the major and the minor axis, a connector is designed to always be loaded only along the major axis, near the spine. Primary major-axis strength is marked on the carabiner spine with an up-down arrow symbol, and is given in kilo-Newtons (kN).



Did you know?

The choice of the most suitable connector is typically decided based on the application, which usually requires a larger or a smaller gate. However, sometimes there is also a choice on the locking mechanism. While there are regions where that choice is limited by local regulations, the common agreement is that triple lock mechanisms are the safest and the best to prevent misuse.

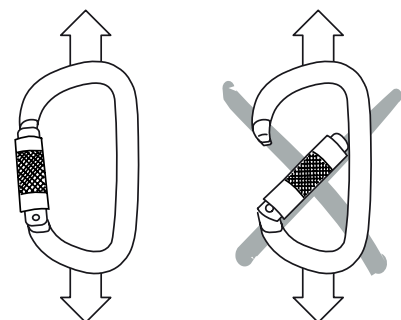



MSA

The Safety Company

Utility Solutions

Confined Spaces

Confined spaces represent a major health and safety risk for many workers when carrying-out tasks in the Sewerage, Telecom and Power Distribution underground infrastructures.

Due to the nature of these spaces, local regulations usually apply. Among the equipment required to work safely in this environment, fall protection equipment by means of access systems and retrieval equipment may be necessary to facilitate both easy entry into and quick exit from confined spaces.

A representative solution:



A - Anchorage Connector	B- Body Harness	C- Connecting Device
Workman Tripod	V-FORM Harness	Workman Rescuer



Did you know?

Accessing vertical confined spaces always require the use of a fall arrest device, usually a self-retracting lanyard anchored on the access system. Rescuing capabilities could be provided by a dedicated winch or through a special device combining a retractable type fall arrester with rescuing capabilities: a rescuer.

Wind Turbines

Wind turbines generally require frequent inspections and preventive maintenance. Any worker accessing the nacelle through the tower internal ladder and performing service tasks is exposed to fall risks.

A representative solution:



A - Anchorage Connector	B- Body Harness	C- Connecting Device
Latchways LadderLatch System	V-FIT Harness	1,8m V-EDGE Mini PFL



Did you know?

The first step in the hierarchy of control is eliminating the risk. Instead of exposing workers to height, the use of drones is becoming popular for the inspection of the blades and the outer structure of wind turbines.

Telecom Tower Works

Maintaining telecom infrastructure means repairing and installing new equipment, as well as keeping towers in good shape. Maintenance teams must be equipped to face working-at-heights risks when performing maintenance repairs on a variety of structures and environments.

A representative solution:



A - Anchorage Connector	B- Body Harness	C- Connecting Device
Latchways LadderLatch System	V-FIT Harness	1,8m V-EDGE Mini PFL



Did you know?

The head of the Occupational Safety and Health Administration (OSHA) once called tower climbing “the most dangerous job” based on the high death toll registered every year.

Power Transmission Works

These works include construction, installation, maintenance, and repair of facilities, devices, and equipment used in high voltage transmission electricity. Workers will face replacements or repairs of old or damaged poles, cross arms, insulators, lightening arrestors, conductors, jumpers and wires, which all require the need to work on high towers.

A representative solution:



A - Anchorage Connector	B- Body Harness	C- Connecting Device
Latchways TowerLatch System	V-FIT Harness	2,4m V-EDGE PFL



Did you know?

Power transmission towers are usually located in windy and harsh weather conditions, meaning workers are exposed to an additional risk factor. This should be taken into account when considering safe access systems and working means.

Electrical Distribution

When performing routine inspections, repairs and tests on the electrical distribution network, workers may face height risks, typically working from truck mounted elevated working platforms.

A representative solution:



B- Body Harness	C- Connecting Device
V-FIT Harness	1,8m V-EDGE Mini PFL

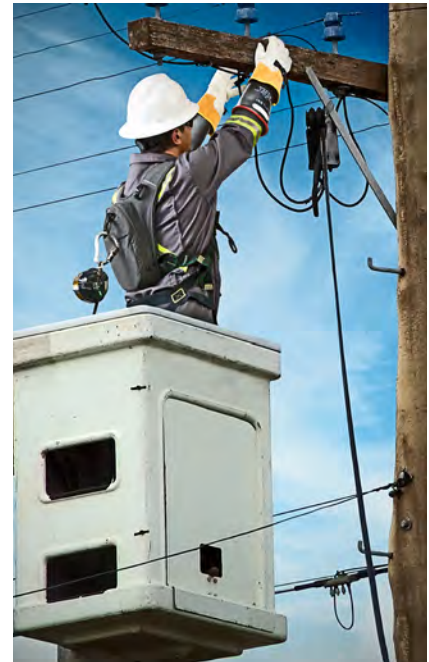

Did you know?

Electrical distribution in highly populated areas could be underground. If so, safe access means should be considered, as well as typical confined space risk scenarios.

Transformers

Being part of the Electrical distribution system, transformers require specific inspection and maintenance routines that requires the access of workers to elevated areas.

A representative solution:



A - Anchorage Connector	B- Body Harness	C- Connecting Device
Latchways Horizontal Lifelines	V-FIT Harness	1,8m V-EDGE Mini PFL

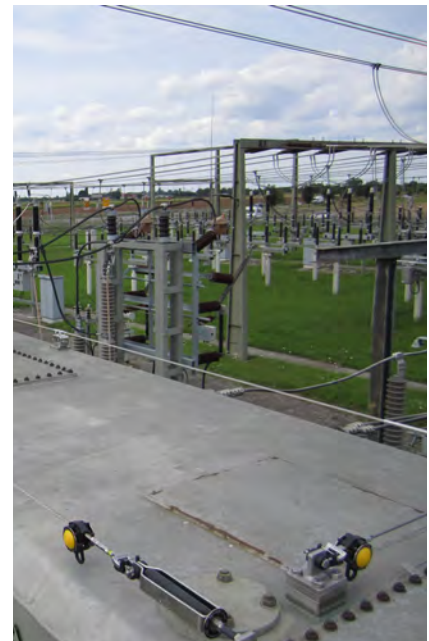

Did you know?

Electrical distribution in highly populated areas could be underground. If so, safe access means should be considered, as well as typical confined space risk scenarios.



MSA
The Safety Company

Construction Solutions

Scaffolding

When erecting, altering or dismantling scaffolding, scaffolders encroach from a scaffolders' safe zone close to an area not protected by guardrails, being exposed to fall risks.

A representative solution:



B- Body Harness	C- Connecting Device
V-FORM Harness V-FIT Harness	Energy absorbing lanyard 1,8m V-EDGE Mini PFL 2,4m V-EDGE PFL



Did you know?

Scaffolders face short fall distances when working close to floor level, usually when starting the erection or dismantling. There are various techniques limiting the exposure to such risk. Small retractable fall arresters, for example, are becoming more popular among scaffolders due to the shorter fall clearance they require, compared to the more traditional shock absorbing lanyards.

Mobile Elevated Working Platforms (MEWPs)

One of the biggest risks when using mobile elevated work platforms (MEWP) is being thrown out of the basket if the boom swings, jolts or tilts away from the machine's center of gravity (this can occur when travelling in a MEWP), or if the operator overreaches (usually by standing on the guard rails). Other risks include: impact from other vehicles, or catching the boom or basket on obstructions.

A representative solution:



B- Body Harness	C- Connecting Device
V-FORM Harness	1,8m V-EDGE Mini PFL



Did you know?

Due to the lack of European regulation, in 2017 Germany pioneered the advances in safety for those operating MEWPs by issuing the first standard specifically focused on this application: the DIN 19427. This standard, which applies to any PFL used on MEWPs is now compulsory for any MEWP operator in Germany and a reference for many other countries.

Roofing

Keeping roofing in good shape, cleaning gutters, accessing air conditioner systems and many other tasks require working on rooftops. When working on rooftops, if no collective fall protection systems are in place, appropriate personal fall protection equipment should be used in conjunction with suitable engineered fall protection systems.

A representative solution:



A - Anchorage Connector	B- Body Harness	C- Connecting Device
Latchways Constant Force® Post Latchways Horizontal Lifelines	V-FORM Harness V-FORM+ Harness	Energy absorbing lanyard V-EDGE SRL

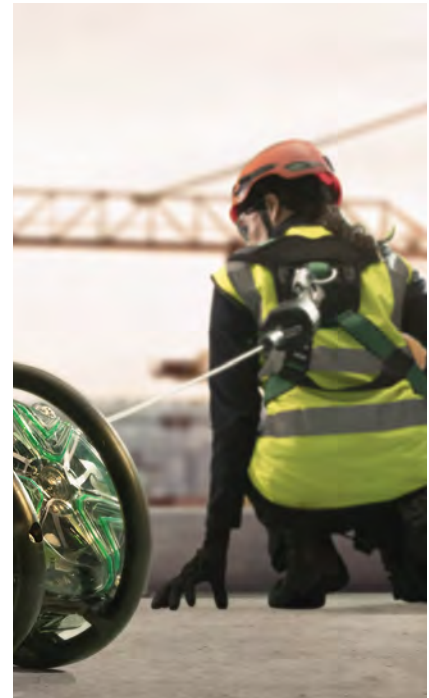

Did you know?

If you are exposed to edges when working on rooftops, any connecting device used must be leading edge approved.

Steel Erection

One of the most dangerous trades in the construction industry is structural steel erection. Usually carried out by specialists, commonly called "ironworkers", any slip or trip in this kind of work most likely would end in a fall.

A representative solution:



A - Anchorage Connector	B- Body Harness	C- Connecting Device
Workman FP Stryder Latchways Overhead System	V-FORM+ Harness V-FIT Harness	2,4m V-EDGE PFL

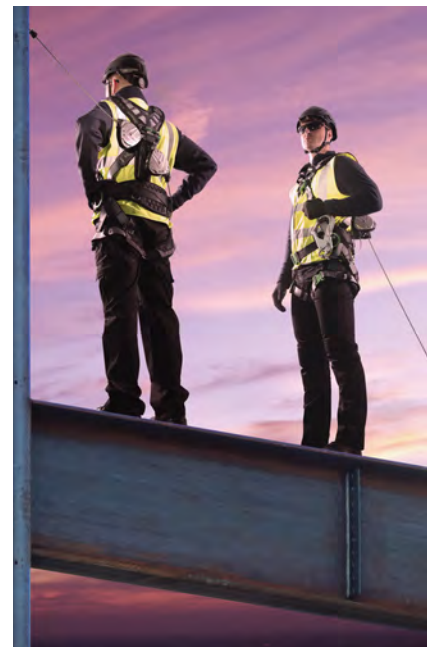

Did you know?

Steel erection is one of the most hazardous jobs in the construction industry with falls being routinely cited as the leading cause of injuries and fatalities.

Confined Spaces

In the Construction industry, pits and other spaces built underground are classified as confined spaces, representing a major safety risk.

Due to the nature of these spaces, local regulations usually apply. Among the equipment required to work safely in this environment, fall protection equipment by means of access systems and retrieval equipment may be necessary to facilitate both easy entry into and quick exit from confined spaces.

A representative solution:



A - Anchorage Connector	B- Body Harness	C- Connecting Device
Workman Tripod	V-FORM Harness	Workman Rescuer



Did you know?

Accessing vertical confined spaces always require the use of a fall arrest device, usually a self-retracting lanyard anchored on the access system. Rescuing capabilities can be provided by a dedicated winch or through a special device combining a retractable type fall arrester with rescuing capabilities: a rescuer.



MSA
The Safety Company

General Industry Solutions

Maintenance at Height

Preventive or corrective maintenance tasks on structures, equipment, machines or facilities often involves reaching roofing and raised sections of plants and machines, which are not properly secured to work safely without fall protection equipment.

A representative solution:



A - Anchorage Connector	B- Body Harness	C- Connecting Device
Anchorage Sling Latchways Overhead System	V-FORM Harness V-FORM+ Harness	1,8m V-EDGE Mini PFL V-TEC SRL



Did you know?

A secure anchor point cannot be achieved by using lifting slings or any other straps without the right certification. Forces generated in a fall event are very high, requiring slings to be tested and approved as personal protective equipment, certified to EN 795.

Crane Tracks

Common risks associated with cranes and lifting equipment include operators falling while accessing the crane or performing maintenance.

A representative solution:



A - Anchorage Connector	B- Body Harness	C- Connecting Device
Latchways Horizontal Lifeline Systems	Latchways Personal Rescue Device®	1,8m V-EDGE Mini PFL



Did you know?

When using a Latchways Personal Rescue Device (PRD), in case of a fall crane workers can lower themselves gently to the ground without involving or endangering other people in the rescue.

Vertical Access through Fixed Ladders

Fixed ladders are extensively used to access higher levels in buildings or industrial structures, such as tanks or chimneys. Since the regulation is not consistent, workers may encounter ladders unprotected, equipped with cages or equipped with a Fall Protection System. In any case, workers using fixed ladders must be aware of the risks and always consider the use of the right safety equipment depending on the situation faced.

A representative solution:



A - Anchorage Connector	B- Body Harness	C- Connecting Device
Latchways LadderLatch Systems	V-FORM Harness V-FORM+ Harness	1,8m V-TEC Mini PFL V-TEC SRL



Did you know?

Though still valid from a legal perspective in many countries, cages in fixed ladders do not stop a fall, but simply funnel it and, in some cases, more injuries can occur from striking the protective barriers on the way down.

Warehouses

In warehouses, accidents typically occur when workers fall from elevated forklift platforms, ladders, items stacked on pallets, elevated walkways, loading docks and mezzanines.

A representative solution:



A - Anchorage Connector	B- Body Harness	C- Connecting Device
Latchways Overhead System Latchways Vertical System	V-FORM Harness Latchways Personal Rescue Device	1,8m V-EDGE Mini PFL V-TEC SRL

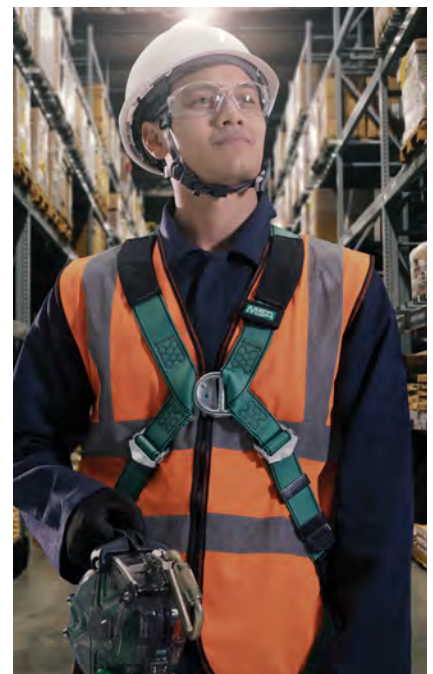

Did you know?

Fall risks in warehouses can be greatly reduced through simple actions like keeping the floor clean and ensuring floors are even.

Loading and Maintenance Bays

There is a danger of people falling off platforms, bays or vehicles in loading and maintenance areas. When fencing is not practical, workers must be correctly secured through proper personal fall protection equipment.

A representative solution:

A - Anchorage Connector	B- Body Harness	C- Connecting Device
Latchways Overhead System WinGrip Vacuum Anchor	V-FORM Harness V-FORM+ Harness	V-TEC SRL

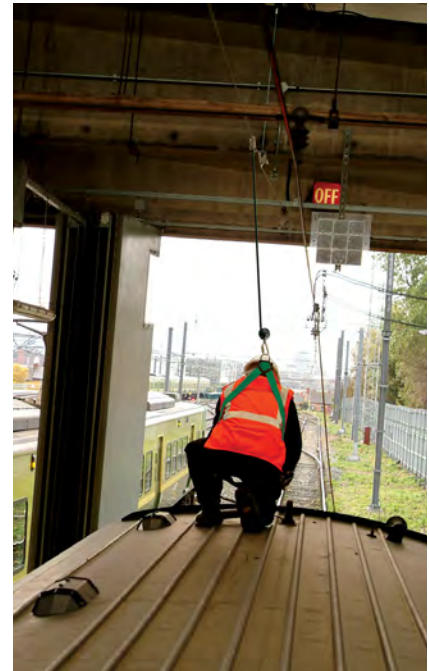

Did you know?

Total Fall Distance when loading and unloading vehicles is usually short, so the use of self-retracting devices anchored overhead is usually recommended.

Assembly Lines

Manufacturing processes sometimes require workers to mount or paint parts at height. While collective fall protection is usually considered for the working stations that are carrying out these tasks, sometimes the size of the objects or the fast moving process does not allow an extensive use of these solutions. In these cases, the use of personal protective equipment must be considered. Since fall clearance is usually limited, typically fall restraint solutions are used.

A representative solution:

A - Anchorage Connector	B- Body Harness	C- Connecting Device
Latchways Overhead System WinGrip Vacuum Anchor	V-FORM Harness	Restraint lanyard V-TEC SRL

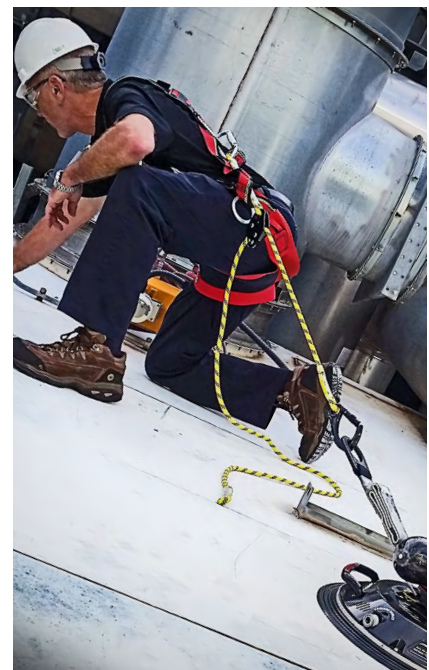

Did you know?

Heavy parts are usually moved with cranes above assembly lines. These cranes can often limit the use of overhead systems, so solutions such as vacuum anchors are sometimes the best choice for this fast moving environment.

Confined Spaces

Industrial processes usually require storage tanks and other confined spaces that require regular maintenance. Due to the nature of these spaces, local regulations usually apply. Among the equipment required to work safely in this environment, fall protection equipment by means of access systems and retrieval equipment may be necessary to facilitate both easy entry into and quick exit from confined spaces.

A representative solution:



A - Anchorage Connector	B- Body Harness	C- Connecting Device
Workman Tripod	V-FORM Harness	Workman Rescuer



Did you know?

Accessing vertical confined spaces always require the use of a fall arrest device, usually a self-retracting lanyard anchored on the access system. Rescuing capabilities could be provided by a dedicated winch or through a special device combining a retractable type fall arrester with rescuing capabilities: a rescuer.



MSA

The Safety Company

Oil and Gas Solutions

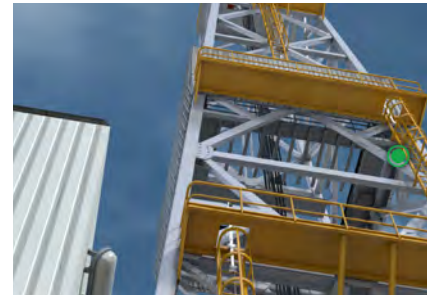

Climbing Derrick Oil Rigs

Climbing a derrick ladder is often necessary to service different areas of the rig, and also for stripping and rig up-and-down operations. As a result, many workers climb the derrick ladder, often in excess of 30 m tall, many times throughout the day. The ladder can be greasy, icy, or extremely narrow, all of which could lead to a fall.

A representative solution:



A - Anchorage Connector	B- Body Harness	C- Connecting Device
Latchways Ladderlatch System	V-FIT Harness	Latchways Sealed SRL



Working on Derrick Oil Rigs

Oil and Gas workers performing work on the monkey or tubing board require specific fall protection equipment. This involves a fall arrest system connected to the harness back D-Ring and special side and back D-Rings for restraint and positioning when leaning forward to assemble drilling pipes.

A representative solution:



B- Body Harness	C- Connecting Device
V-FIT Derrick Harness	Latchways Sealed SRL



Maintenance Operations

Many maintenance tasks such as general rigging, welding, fabrication support and boiler repair occur every day, requiring oil and gas workers to climb various structures in and around the platform. This work is often carried out in rain, wind and snow, increasing fall risks.

A representative solution:



A - Anchorage Connector	B- Body Harness	C- Connecting Device
Latchways Vertical Lifeline System Latchways Horizontal Lifeline Systems	V-FIT Harness V-FLEX Harness	2,4m V-EDGE PFL Latchways Sealed SRL



Confined Spaces

The nature of the oil industry requires the storage of oil and all derivatives along the extraction, transportation and refinement processes. Inspection and maintenance works in those confined spaces are daily tasks for many workers of this industry.

Due to the nature of these spaces, local regulations usually apply. Among the equipment required to work safely in this environment, fall protection equipment by means of access systems and retrieval equipment may be necessary to facilitate both easy entry into and quick exit from confined spaces.

A representative solution:



A - Anchorage Connector	B- Body Harness	C- Connecting Device
Workman Tripod	V-FORM Harness	Workman Rescuer



Did you know?

Accessing vertical confined spaces always require the use of a fall arrest device, usually a self-retracting lanyard anchored on the access system. Rescuing capabilities could be provided by a dedicated winch or through a special device combining a retractable type fall arrester with rescuing capabilities: a rescuer.



MSA
The Safety Company

Body Harness Solutions

Body Harness Types

Full Body Harnesses and Lower Body Harnesses form the two different body harness types available as a component of a fall protection system.

A **full body harness** is primarily for fall arrest purposes, and is a component of a fall arrest system. Full body harnesses comprise straps, fittings, buckles or other elements, suitably arranged and assembled to support the whole body of a person and to restrain the wearer during a fall and after the arrest of a fall. Certified to EN361.

A **waist belt** is designed to enable the wearer to perform his work without undue discomfort in restraint and thus, remain secure against the hazard of a fall from height. Certified to EN358.

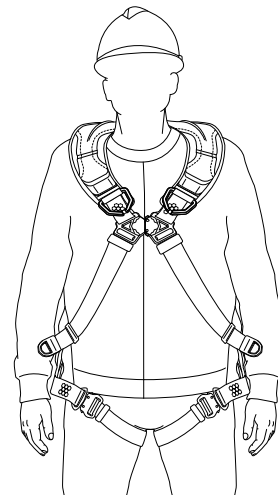
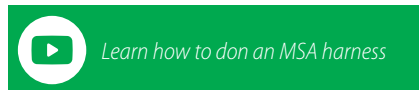

Full Body Harness

Buckles

There are 2 main different types of leg and shoulder strap connections available on a harness:

- **Mating buckles (Qwik-Fit):** These are the traditional buckles. One side of the mating buckle has an opening that allows the other side of the buckle to go through.
- **Quick-Connect Buckles (Bayonet):** These are advanced buckles for easy donning. Both ends interlock through a mechanism and feature a dual-lock release to prevent accidental opening.



Qwik-Fit

Attachment points

Body harnesses have specific points to connect components of the fall protection system. Fall arrest attachments are labelled with "A", but there are others for positioning, descending and ascending.

- 1 **Rear attachment:** Used for fall arrest and can also be used as a rescue attachment.
- 2 **Front attachment:** Used for fall arrest mostly for descent, ladder climbing and rescue.
- 3 **Side/Hip attachment:** Used for work positioning activities that allows the worker to perform hands free work. Typically certified EN 358.
- 4 **Shoulder attachment:** Used for ascending a user out of, or descending a worker into, a working environment. Typically certified EN 1497.
- 5 **Suspension attachment:** Used in rope access applications, these are designed to support a worker while allowing hands-free work. Typically certified EN 813.

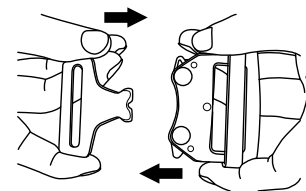

Bayonet

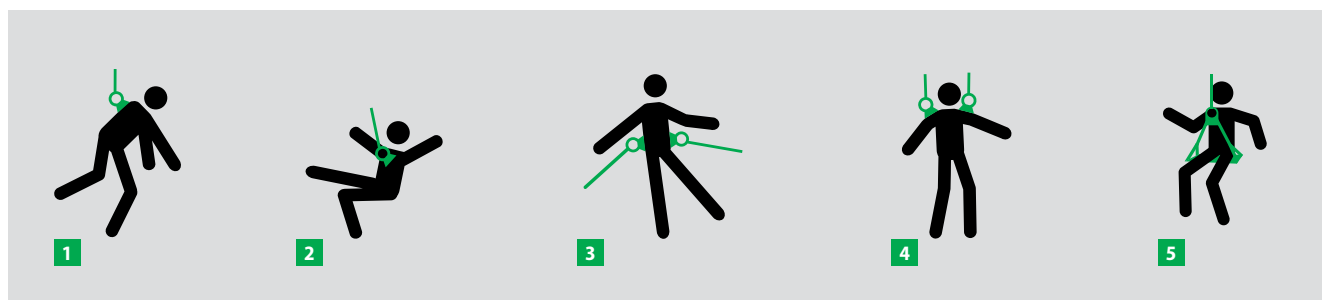

MSA's V-Series™ Harness Range

The Next Generation of Fall Protection

Because the safest fall protection harness is the one you'll actually want to wear, each V-Series harness includes unique features to deliver exceptional comfort – so you can focus on your work, not your harness.

Superior Comfort

Exclusive racing-style buckle allows for a close, comfortable-fitting harness — eliminating the need for bulky chest straps or cumbersome buckles.

Increased Flexibility

Racing-style buckle creates an athletic cut, contouring the harness to the body for improved upper torso movement on the job.

Adjustability

Pull-down adjustment allows you to quickly get the right fit that lasts throughout the work day.

Harness Size Chart

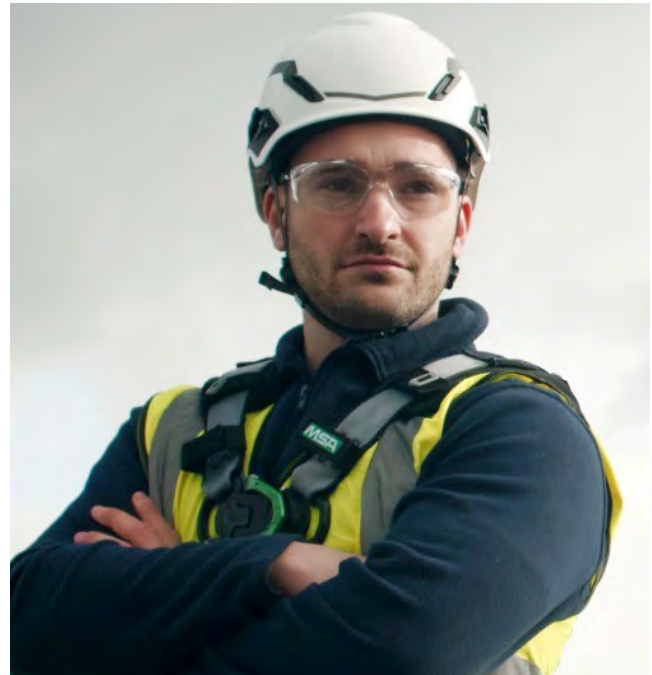
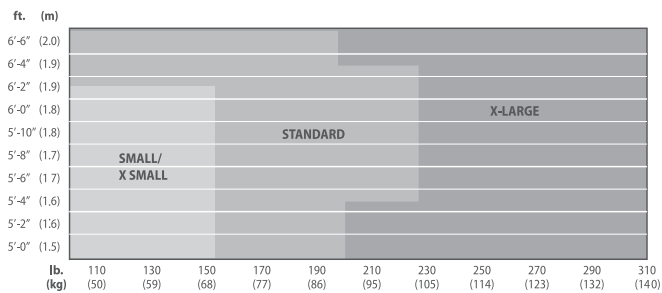

V-FORM™

Setting the Standard

- Racing-style buckle
- Athletic cut
- Pull-down adjustment
- Easy-to-inspect stitch patterns



V-FORM+™

Raising the Standard

Adding to the standard V-FORM™ with...

- Body conforming shoulder pads
- Coated webbing
- Dedicated attachment point for Personal Fall Limiters
- Additional lanyard keepers



V-FIT™

Raising Expectations

All the benefits of the V-FORM+™ and...

- RaceFLEX™ Premium Buckle
- Premium Bayonet style buckles
- Superior shoulder and leg padding
- Horizontal leg straps



V-FLEX™

Changing the Game

All the benefits of the V-FIT™ plus...

- Thermoform shoulder pad designed for cooling
- Leg padding
- Swiveling hip juncture for mobility
- Integrated suspension trauma straps
- Re-settable lanyard keepers

V-FLEX™ Full Body Harness

Superior Comfort



Using a patent-pending RaceFLEX connection, webbing is routed across the chest for a secure and comfortable fit—eliminating the need for bulky chest straps or cumbersome buckles.



Reduce fatigue and heat stress with a breathable, contoured pad material that conforms to the shape of your shoulders for increased comfort.



Patented leg strap design keeps leg straps in place as webbing lays horizontally across the thighs, creating a more natural fit.

Increased Mobility



Using an exclusive racing style design, webbing contours to the torso, reducing the need for adjustments throughout the day and allowing for better mobility on the job.



Featuring a patent-pending hip connection, the harness “flexes” with the worker, reducing fatigue throughout the day.

Style



Inspired from athletic wear design, the V-FLEX not only feels great, it looks good too.



Unique identifiable stitch pattern, along with fewer stitch points, saves time during pre-use inspection process.



140 kg
Load capacity

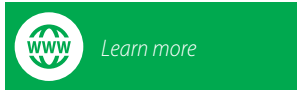

Ordering Information

Part Number	D-Ring Configuration	Size			Leg Buckle Type	Padding			Standards	
		XSM	STD	XLG		Shoulders	Legs	Waist Belt	EN361	EN358
10211350	Back, Chest	■			■	■	■		■	
10211351	Back, Chest		■		■	■	■		■	
10211352	Back, Chest			■	■	■	■		■	
10211353	Back, Chest, Hips	■			■	■	■	■	■	■
10211354	Back, Chest, Hips		■		■	■	■	■	■	■
10211355	Back, Chest, Hips			■	■	■	■	■	■	■

V-FIT™ Full Body Harness

Superior Comfort



Using a patent-pending RaceFLEX™ connection with an integrated D-Ring, webbing is routed across the chest for a secure and comfortable fit—eliminating the need for bulky chest straps or cumbersome buckles.



Shoulder padding responds to your movement to conform to your body, eliminating pressure points and chafing. Shoulder padding is breathable and can be removed for cleaning, extending the life of the harness.



Patented leg strap design keeps leg straps in place as webbing lays horizontally across the thighs, creating a more natural fit.

Increased Flexibility



The RaceFLEX™ Buckle creates an athletic cut contouring the harness to the body and improving upper torso movement on the job.

Adjustability



Pull-down adjustment allows you to quickly and easily get the right fit that lasts throughout the work day.



Dedicated attachment point for Personal Fall Limiters allows for quick and easy attachment, and keeps your back D-ring free for other use.

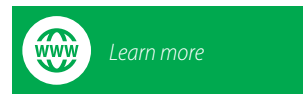

Ordering Information

Part Number	D-Ring Configuration	Size			Leg Buckle Type	Padding			Standards	
		XSM	STD	XLG	Bayonet	Shoulders	Legs	Waist Belt	EN361	EN358
<i>V-FIT Full-Body Harness</i>										
10206533	Back, Chest	■			■	■	■		■	
10206534	Back, Chest		■		■	■	■		■	
10206535	Back, Chest			■	■	■	■		■	
10206545	Back, Chest, Hips	■			■	■	■	■	■	■
10206546	Back, Chest, Hips		■		■	■	■	■	■	■
10206547	Back, Chest, Hips			■	■	■	■	■	■	■
<i>V-FIT Full-Body Harness, non-padded</i>										
10206536	Back, Chest	■			■				■	
10206537	Back, Chest		■		■				■	
10206538	Back, Chest			■	■				■	
10206548	Back, Chest, Hips	■			■			■	■	■
10206549	Back, Chest, Hips		■		■			■	■	■
10206550	Back, Chest, Hips			■	■			■	■	■
<i>V-FIT Full-Body Harness, special versions</i>										
10206542	Back, Chest, Hips, Derrick	■			■	■	■	■	■	■
10206543	Back, Chest, Hips, Derrick		■		■	■	■	■	■	■
10206544	Back, Chest, Hips, Derrick			■	■	■	■	■	■	■

V-FORM+™ Full Body Harness

Superior Comfort



The racing style quick connect buckle allows for a close, comfortable harness fit —eliminating the need for bulky chest straps or cumbersome buckles.



Shoulder padding responds to your movement to conform to your body, eliminating pressure points and chafing.

Increased Flexibility



The racing style quick connect buckle creates an athletic cut, contouring the harness to the body and improving upper torso movement on the job.

Adjustability



Pull-down adjustment allows you to quickly and easily get the right fit that lasts throughout the work day.



Dedicated attachment point for Personal Fall Limiters allows for quick and easy attachment, and keeps your back D-ring free for other use.

Ease of Use



New hex style stitch patterns make finding broken threads easy when inspecting the harness.



140 kg
Load capacity

www.msasafety.com Learn more

Ordering Information

Part Number	D-Ring Configuration	Size			Leg Buckle type	Padding	Standards	
		XSM	STD	XLG			Waist Belt	EN361
10206051	Back, Chest	■			Bayonet		■	
10206052	Back, Chest		■		Bayonet		■	
10206053	Back, Chest			■	Bayonet		■	
10206054	Back, Chest, Hips	■			Bayonet	■	■	■
10206055	Back, Chest, Hips		■		Bayonet	■	■	■
10206056	Back, Chest, Hips			■	Bayonet	■	■	■

V-FORM™ Full Body Harness

Superior Comfort



The racing style quick connect buckle allows for a close, comfortable harness fit —eliminating the need for bulky chest straps or cumbersome buckles.

Increased Flexibility



The racing style quick connect buckle creates an athletic cut, contouring the harness to the body and improving upper torso movement on the job.

Adjustability



Pull-down adjustment allows you to quickly and easily get the right fit that lasts throughout the work day.

Ease of Use



New hex style stitch patterns make finding broken threads easy when inspecting the harness.

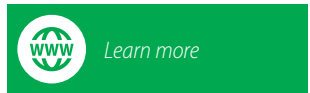

Ordering Information

Part Number	D-Ring Configuration	Size			Leg Buckle Type		Padding	Standards		
		XSM	STD	XLG	Qwik-Fit	Bayonet	Waist Belt	EN361	EN358	EN1497
10205846	Back	■			■			■		
10205847	Back		■		■			■		
10205848	Back			■	■			■		
10205849	Back, Chest	■			■			■		
10205850	Back, Chest		■		■			■		
10206041	Back, Chest			■	■			■		
10206042	Back, Chest	■				■		■		
10206043	Back, Chest		■			■		■		
10206044	Back, Chest			■		■		■		
10206045	Back, Chest, Shoulders	■				■		■		■
10206046	Back, Chest, Shoulders		■			■		■		■
10206047	Back, Chest, Shoulders			■		■		■		■
10206048	Back, Chest, Hips	■			■		■	■	■	
10206049	Back, Chest, Hips		■		■		■	■	■	
10206050	Back, Chest, Hips			■	■		■	■	■	

MSA Latchways Personal Rescue Device® (PRD®)

- Patented integrated safety harness system for self rescue
- Dramatically reduces rescue time
- Lightweight and unobtrusive
- 20 m descent height
- Descent speed: 0.5 – 2 m per second
- Descender device certified to EN 341: 2011 Type 1, Class D
- Extendable Rescue Pole available to activate the PRD® by a third party if necessary. Length 800 to 3400 mm



Harness Size Chart

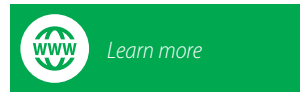
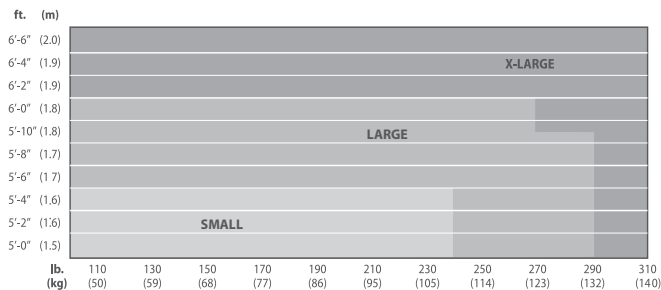

User Instructions

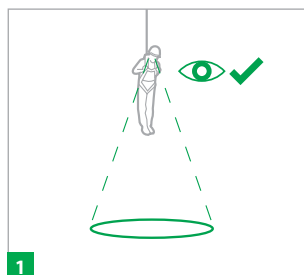

1 Check below to ensure descent path is clear and a safe landing is possible.



2 Open the flap on the right shoulder strap to access the release cord.

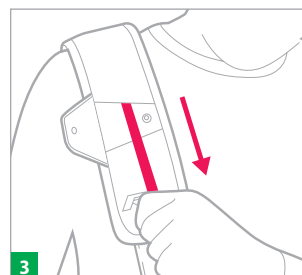

3 Pull down sharply on the release cord.

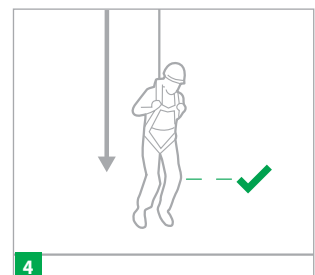

4 Prepare for landing by bending your knees.

Ordering Information

Part Number	D-Ring Configuration	Size			Buckle Type	Padding		Standards		
		S	L	XL	Bayonet	Shoulders	Waist Belt	EN361	EN358	EN341
68202-00S	Back, Chest	■			■	■		■		■
68202-00L	Back, Chest		■		■	■		■		■
68202-00XL	Back, Chest			■	■	■		■		■
68203-00S	Back, Chest, Hips	■			■	■	■	■	■	■
68203-00L	Back, Chest, Hips		■		■	■	■	■	■	■
68203-00XL	Back, Chest, Hips			■	■	■	■	■	■	■

Part Number	Description
68099-00	Rescue Pole



MSA Thermatek Harness

With heat and flame resistant Kevlar/Nomex blend webbing, the Thermatek full body harness is designed to withstand harsh welding environments.

- Webbing and stitching in contrasting colours for easier inspection
- Fully adjustable leg, chest and shoulder straps for a perfect fit
- Certified to 100 Kg load capacity

Harness Size Chart

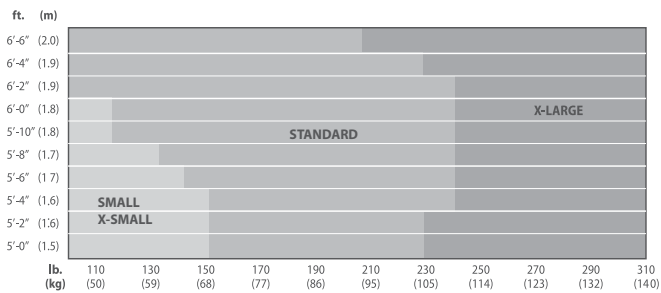

Ordering Information

Part Number	D-Ring Configuration	Size			Buckle Type		Standards
		XSM	STD	XLG	Qwik-Fit	EN361	
10129398	Back	■			■	■	
10129399	Back		■		■	■	
10129400	Back			■	■	■	

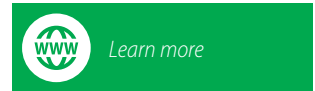



MSA
The Safety Company

Connection Solutions

Connecting Device

There are multiple solutions available to connect the body harness to the anchorage:

Lanyard

A lanyard is a flexible line made of webbing, wire or rope that secures the body harness to an anchorage point.

- Energy absorbing lanyards (1) reduce the energy transmitted to the user's body in the event of a fall. Certified to EN 355.
- Restraint lanyards (2) are meant only to prevent the user from reaching zones where the risk of a fall from a height exists. Certified to EN 354.
- Work positioning lanyards (3) enable the user to work in tension or suspension in such a way that a free fall is prevented. Certified to EN 358.

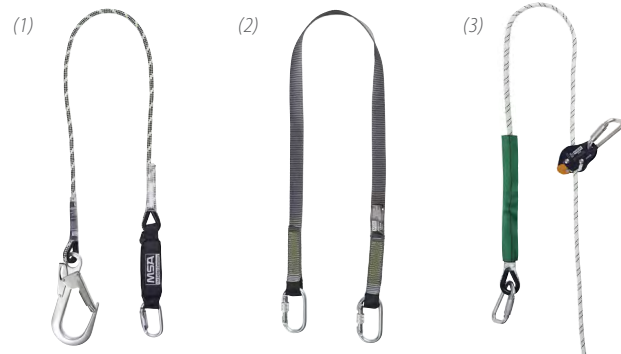

Self-retracting lifeline (SRL)

Consists of a lanyard that retracts and extends in length from within the main housing. It acts in a similar manner to a seatbelt, with an automatic braking system that immediately engages when the lanyard extends at an excessive speed, such as it would if a user was involved in a fall. Self-retracting lanyards that are used always connected to a full body harness are also known as Personal Fall Limiters (PFL). Certified to EN 360.



Rope grab

Consists of a flexible anchor line, a self-locking guided type fall arrester which is attached to the flexible anchor line and a connector or a connected-terminated lanyard. An energy dissipating function may be installed between the fall arrester and the anchor line or an energy absorber may be incorporated in the lanyard or in the anchor line. Certified to EN 353-2.

MSA's V-Series Range of Self-Retracting Lifelines

With premium components and innovative engineering, each V-Series Self-Retracting lifeline offer a smooth operation and prevents hidden costs – so you can benefit from comfort and high productivity without letting you down with unwanted surprises.

V-EDGE™ Mini PFL



Peace of Mind

An Aluminium Triple Lock carabiner provides maximum safety when connected to harness D-Ring.



Assured Durability

Our unique PFL Webbing construction offers industry-leading durability and has been tested to 1 million abrasion cycles



Close comfort connection

Compact design means product sits comfortably on the user's back.



Leading Edge Ready

Ready for high risks: certified for fall factor 2, MEWP (DIN 19427:2017) and leading edge use



Simplified Inspection

A transparent casing allows for easy visual inspection of critical internal components. A yellow indicator thread incorporated into the lanyard webbing means it's easy to see if it is worn.



Conforms to latest standards

Conforms to CNB/P/11.106 which requires swivel connection at the end of the lanyard - preventing the lanyard from twisting during use.



Ease of Use

Lifeline remains extended, allowing the connector to be easily reached.



Superior materials

Components manufactured from Kevlar, high-grade stainless steel and engineered plastics.

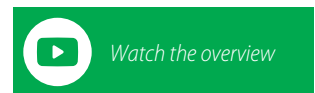
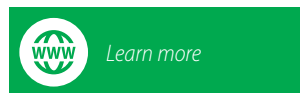

Ordering Information

Part Number	Type		Line Length	Line Type	Anchorage Connection	Harness Connection
	Single-leg	Twin-leg				
63061-00AEU	■		1.8m	Web	Aluminium Swivel Scaffolding Hook	Aluminium Triple-lock Carabiner
63061-00BEU	■		1.8m	Web	Steel Swivel Snaphook	Aluminium Triple-lock Carabiner
63061-00CEU	■		1.8m	Web	Aluminium Swivel Triple-Lock Carabiner	Aluminium Triple-lock Carabiner
63061-00DEU	■		1.8m	Web	Steel Swivel Scaffolding Hook	Aluminium Triple-lock Carabiner
63161-00AEU		■	1.8m	Web	Aluminium Swivel Scaffolding Hook	Aluminium Triple-lock Carabiner
63161-00BEU		■	1.8m	Web	Steel Swivel Snaphook	Aluminium Triple-lock Carabiner
63161-00CEU		■	1.8m	Web	Aluminium Swivel Triple-Lock Carabiner	Aluminium Triple-lock Carabiner
63161-00DEU		■	1.8m	Web	Steel Swivel Scaffolding Hook	Aluminium Triple-lock Carabiner

V-EDGE™ 2.4m PFL

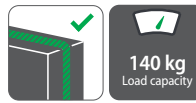

Fully Compliant

Tested to EN 360: 2002;
CNB/P/11.060,
CNB/P/11.062,
CNB/P/11.085



Fits in Tight Spaces

Work comfortably in confined spaces with low-profile housing—just 78 mm (3.1 in.)!



Simplified Selection

The V-EDGE PFL can be used in a variety of applications where edge hazards are a concern, making product selection simple.



Easy to Connect

Get to work faster. Save time and frustration with a sleek and simple locking pin attachment.



Built to Last

Get the most out of your unit in extreme environments with stainless steel casing for enhanced durability.



Increased Comfort

Ensure comfort and reduce fatigue with compact housing that minimizes movement in use.



Reduce Fatigue

Using web for the lifeline, the V-EDGE PFL provides a light-weight option for leading edge applications.

[Learn more \(Cable\)](#)

[Learn more \(Web\)](#)

[Watch the overview](#)

Ordering Information

Part Number	Type		Line Length	Line Type	Anchorage Connection	Harness Connection
	Single-leg	Twin-leg				
10192008	■		2.4 m (8 ft.)	Web	Aluminium Swivel Scaffolding Hook	Locking Pin
10192024	■		2.4 m (8 ft.)	Web	Aluminium Swivel Triple-Lock Carabiner	Locking Pin
10192041	■		2.4 m (8 ft.)	Web	Steel Swivel Snaphook	Locking Pin
10192050	■		2.4 m (8 ft.)	Web	Steel Swivel Scaffolding Hook	Locking Pin
10192011		■	2.4 m (8 ft.)	Web	Aluminium Swivel Scaffolding Hook	Locking Pin
10192027		■	2.4 m (8 ft.)	Web	Aluminium Swivel Triple-Lock Carabiner	Locking Pin
10192044		■	2.4 m (8 ft.)	Web	Steel Swivel Snaphook	Locking Pin
10192053		■	2.4 m (8 ft.)	Web	Steel Swivel Scaffolding Hook	Locking Pin
63062-00JEU	■		2.4 m (8 ft.)	Cable	Aluminium Swivel Scaffolding Hook	Locking Pin
63062-00CEU	■		2.4 m (8 ft.)	Cable	Aluminium Swivel Triple-Lock Carabiner	Locking Pin
63062-00EEU	■		2.4 m (8 ft.)	Cable	Steel Swivel Snaphook	Locking Pin
63062-00IEU	■		2.4 m (8 ft.)	Cable	Steel Swivel Scaffolding Hook	Locking Pin
63162-00JEU		■	2.4 m (8 ft.)	Cable	Aluminium Swivel Scaffolding Hook	Locking Pin
63162-00CEU		■	2.4 m (8 ft.)	Cable	Aluminium Swivel Triple-Lock Carabiner	Locking Pin
63162-00EEU		■	2.4 m (8 ft.)	Cable	Steel Swivel Snaphook	Locking Pin
63162-00IEU		■	2.4 m (8 ft.)	Cable	Steel Swivel Scaffolding Hook	Locking Pin

V-TEC™ Mini PFL



Free range of motion

A fully rotating attachment point for complete flexibility – both 360° and 180°.



Assured Safety

Spiral radial energy-absorbing technology requires zero calibration or adjustment.



Highly durable

A polycarbonate case houses the SRL, and its transparency allows for easy visual inspection of critical internal components.

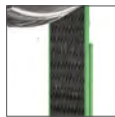

Superior materials

Components manufactured from high-grade stainless steel and engineered plastics.



Ordering Information

Part Number	Type		Line Length	Line Type	Anchorage Connection	Harness Connection
	Single-leg	Twin-leg				
63011-00AEU	■		1.8m	Web	Aluminium Scaffold hook	Steel Twist-Lock Carabiner
63011-00BEU	■		1.8m	Web	Steel Snaphook	Steel Twist-Lock Carabiner
63011-00CEU	■		1.8m	Web	Aluminum Swivel Triple-lock Carabiner	Steel Twist-Lock Carabiner
63011-00DEU	■		1.8m	Web	Aluminium Triple-lock Carabiner	Steel Twist-Lock Carabiner
63011-00FEU	■		1.8m	Web	Steel Scaffold Hook	Steel Twist-Lock Carabiner
63011-00MEU	■		1.8m	Web	Aluminium Scaffold hook	Aluminium Triple-lock Carabiner
63011-00NEU	■		1.8m	Web	Aluminium Triple-lock Carabiner	Aluminium Triple-lock Carabiner
63011-00OEU	■		1.8m	Web	Steel Snaphook	Steel Scaffold Hook
63011-00PEU	■		1.8m	Web	Aluminium Triple-lock Carabiner	Aluminium Scaffold Hook
63011-00SEU	■		1.8m	Web	Aluminium lightweight Scaffold Hook	Steel Twist-Lock Carabiner
63011-00TEU	■		1.8m	Web	Aluminium lightweight Scaffold Hook	Aluminium Triple-lock Carabiner
63011-00VEU	■		1.8m	Web	Aluminium Snaphook	Aluminium Triple-lock Carabiner
63111-00AEU		■	1.8m	Web	Aluminium Scaffold hook	TwinLink connector
63111-00SEU		■	1.8m	Web	Aluminium lightweight Scaffold Hook	TwinLink connector
63013-00AEU	■		3m	Web	Aluminium Scaffold hook	Steel Twist-Lock Carabiner
63013-00BEU	■		3m	Web	Steel Snaphook	Steel Twist-Lock Carabiner
63013-00CEU	■		3m	Web	Aluminum Swivel Triple-lock Carabiner	Steel Twist-Lock Carabiner
63013-00DEU	■		3m	Web	Aluminium Triple-lock Carabiner	Steel Twist-Lock Carabiner
63013-00EEU	■		3m	Web	Steel Swivel Snaphook	Steel Twist-Lock Carabiner
63013-00FEU	■		3m	Web	Steel Scaffold Hook	Steel Twist-Lock Carabiner
63013-00MEU	■		3m	Web	Aluminium Scaffold hook	Aluminium Triple-lock Carabiner
63013-00NEU	■		3m	Web	Aluminium Triple-lock Carabiner	Aluminium Triple-lock Carabiner
63013-00OEU	■		3m	Web	Steel Snaphook	Steel Scaffold Hook
63013-00PEU	■		3m	Web	Aluminium Triple-lock Carabiner	Aluminium Scaffold Hook
63013-00SEU	■		3m	Web	Aluminium lightweight Scaffold Hook	Steel Twist-Lock Carabiner
63013-00TEU	■		3m	Web	Aluminium lightweight Scaffold Hook	Aluminium Triple-lock Carabiner
63013-00VEU	■		3m	Web	Aluminium Snaphook	Aluminium Triple-lock Carabiner
63203-00AEU	■		3m	Cable	Steel Swivel Snaphook	Steel Twist-Lock Carabiner
63203-00BEU	■		3m	Cable	Steel Swivel Scaffold Hook	Steel Twist-Lock Carabiner

 [Learn more \(1,8m\)](#)

 [Learn more \(3m\)](#)

 [Learn about the durability](#)

V-TEC® Standard SRLs

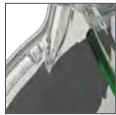

Easy Inspection
Clear outer housing.



Easy Transportation
Carry handle included.



Assured Safety
Spiral radial energy-absorbing technology requires zero calibration or adjustment.



Downtime Minimized
Completely field-serviceable, the cable, energy-absorber, and retraction dampener can all be replaced on site.



Versatile
Galvanized or stainless steel cable.



Durable
Retraction dampening features control the cable speed to 3 m/s (<10 ft./s).



Built to Last
Stainless steel/engineered plastics.



30 m
(100 ft.)



15 m
(50 ft.)



10 m
(30 ft.)



6 m
(20 ft.)

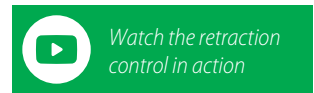
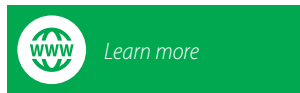

Ordering Information

Part Number	Description
63206-00AEU	V-TEC Standard Cable SRL, 6 m (20 ft.), galvanized cable
63306-00AEU	V-TEC Standard Cable SRL, 6 m (20 ft.), stainless steel cable
63210-00AEU	V-TEC Standard Cable SRL, 10 m (30 ft.), galvanized cable
63310-00AEU	V-TEC Standard Cable SRL, 10 m (30 ft.), stainless steel cable
63215-00AEU	V-TEC Standard Cable SRL, 15 m (50 ft.), galvanized cable
63315-00AEU	V-TEC Standard Cable SRL, 15 m (50 ft.), stainless steel cable
63230-00AEU	V-TEC Standard Cable SRL, 30 m (100 ft.), galvanized cable
63330-00AEU	V-TEC Standard Cable SRL, 30 m (100 ft.), stainless steel cable

V-EDGE® Leading Edge SRLs



Simplify Selection

Use in a variety of applications, from overhead to horizontal tie off points, and where exposed edges are a concern.



Get to Work Faster

Clear outer casing allows for quick visual inspection of internal components



Lower Cost of Ownership

Integrated roll cage protects housing when used in foot-level tie off. Retraction dampening feature controls the life line speed—preventing unwanted damage and maximizing product life.



Reduce Downtime

Internal components like the cable and energy absorber can be replaced on site—reducing repair times.



15 m
(50 ft.)



10 m
(30 ft.)



6 m
(20 ft.)



140 kg
Load capacity

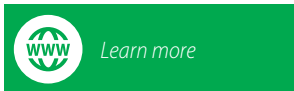

Ordering Information

Part Number	Description
63406-00AEU	V-EDGE Leading-Edge SRL, 6 m (20 ft), galvanized cable
63410-00AEU	V-EDGE Leading-Edge SRL, 10 m (30 ft), galvanized cable
63415-00AEU	V-EDGE Leading-Edge SRL, 15 m (50 ft), galvanized cable

MSA Latchways® Sealed SRLs



- Ingress Protection (IP69K)
- Meets and exceeds global industry standards
- 100% Full Contact™ locking mechanism
- ATEX assessed
- Accelerated corrosion testing
- Completely field serviceable
- Constant Force® frictionless braking mechanism
- Suitable for use in high vibration environments



Smarter



Latchways Sealed SRLs employ patented, frictionless braking technology known as Constant Force. This braking mechanism has no moving parts and will not go out of adjustment or require recalibration for the lifespan of the product.



The Full Contact pawl locking mechanism provides a reliable locking mechanism that won't freeze, hangup or corrode. The advanced pawl technology allows a user to both hear and feel the mechanism working providing reassurance that the system is operating properly.

Stronger



Manufactured from high quality components—following consultation with the Institute of Materials in the UK to ensure material compatibility and durability. Individual components undergo strict quality control procedures prior to assembly.

Better



Internal components are protected by rubber gaskets, ensuring the spring, locking mechanism and absorber are impenetrable to dust and water. The modular design allows for quick and easy recertification with just a few simple tools.

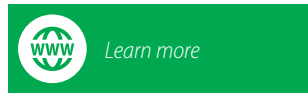









Ordering Information

Part Number	Line Type	Length	Size H x W x D (mm)	Weight	Anchorage
62810-00UK	Ø 5 mm S/S Cable (7 x 19)	9 m	270 x 240 x 180 mm	9.5 kg	Forged/Stainless Steel Snaphook
62816-00UK	Ø 5 mm S/S Cable (7 x 19)	15 m	330 x 280 x 190 mm	12 kg	Forged/Stainless Steel Snaphook
62826-00UK	Ø 5 mm S/S Cable (7 x 19)	25 m	330 x 330 x 200 mm	20 kg	Forged/Stainless Steel Snaphook
62841-00UK	Ø 5 mm S/S Cable (7 x 19)	40 m	380 x 380 x 215 mm	26 kg	Forged/Stainless Steel Snaphook

Energy-Absorbing Lanyards

The MSA range of shock absorbing-lanyards is available in various materials, lengths and with a variety of connectors

Part Number	Lifeline Material	Length	Type		Anchorage Connection	Harness Connection	Load Capacity	Standards	
			Single-leg	Twin-leg					
10185611	Webbing	1,5 m	■		Aluminium Swivel Scaffolding Hook	Steel screwgate carabiner	100 Kg	EN 355:2002	
10185612	Webbing	1,5 m		■	Aluminium Swivel Triple-Lock Carabiner	Steel screwgate carabiner	100 Kg	EN 355:2002	
10185614	Kernmantel rope	1,8 m	■		Steel Swivel Snaphook	Aluminium Twist-Lock carabiner	100 Kg	EN 355:2002 CNB/P/11.074 	
10185615	Kernmantel rope	1,8 m		■	Steel Swivel Scaffolding Hook	Aluminium Twist-Lock carabiner	100 Kg	EN 355:2002 CNB/P/11.074 	
10185616	Kernmantel rope	1,8 m	■		Aluminium Swivel Scaffolding Hook	Aluminium Twist-Lock carabiner	100 Kg	EN 355:2002 CNB/P/11.074 	

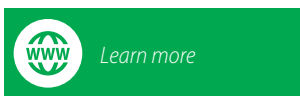

Restraint and Work Positioning Lanyards

The MSA restraint and work positioning lanyards are available in web and kernmantel rope

Part Number	Lifeline Material	Length	Adjustable Length	Single-leg	Connectors	Standards	
10185600	Webbing	1,5 m		■	Steel screwgate carabiner	EN 354:2010	
10115797	Webbing	2 m		■	Steel screwgate carabiner	EN 358:1999	
10185613	Kernmantel rope	1,8 m		■	Aluminium Twist-Lock carabiner	EN 354:2010	
10102692	Cable	1,5 m		■	Steel snaphook	EN 358:1999	
10115799	Webbing	2 m		■	Steel screwgate carabiner	EN 358:1999	
10115800	Webbing	2 m	■	■	Aluminium screwgate carabiner	EN 358:1999	
10115801	Kernmantel rope	2 m	■	■	Aluminium Twist-Lock carabiner	EN 358:1999	
10185620	Kernmantel rope	2 m	■	■	Aluminium Twist-Lock carabiner	EN 358:1999	

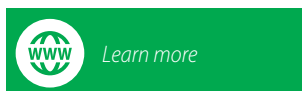

Rope Grab Easy Move

- Provides temporary fall protection on ladders or when climbing
- Can provide a secondary lifeline for suspended positioning
- All-in-one fall arrester: rope adjuster and a guided type fall arrester
- Light weight and compact for comfortable use and easy carrying
- Developed to grip on dirty or icy ropes
- Includes an 11 mm polyamide rope (various lengths available) with sewn eyelets, and a carrying bag. Does not include carabiners
- 100 Kg working load
- Certified to EN 353-2:2002, EN 358:1999, EN 12841:2006

Part Number	Description
10164578	Rope grab Easy Move, 15 m
10164579	Rope grab Easy Move, 20 m
10164580	Rope grab Easy Move, 25 m
10164611	Rope grab Easy Move, 30 m
10177638	15 m Rope, Spare
10177639	20 m Rope, Spare
10177640	25 m Rope, Spare
10177651	30 m Rope, Spare

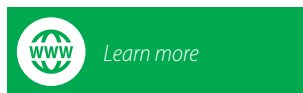

Anthron Descent Device System

- A cam assembly provides friction on the rope to hold or descend at a controlled rate.
- Rope roping/rigging diagrams are clearly indicated on the descender
- The descender can be installed/removed at any point on rope
- Includes a 20 m of 11 mm polyamide rope with sewn eyelets, and a carrying bag
- 136 Kg working load
- Certified to EN 341: 2011

Part Number	Description
10161345	Descender Anthron Kit

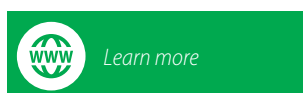



MSA
The Safety Company

Anchorage Solutions

Anchorage

The most obvious anchorage points are existing structures or equipment that are not intended as anchor points but are verified by a competent person as having adequate capacity to serve as anchor points. Examples are rooftop mechanical rooms, structural steel, or reinforced concrete columns.

But many applications require an anchorage point in areas where existing structures are not available. For those cases, there are 5 types of EN795 approved anchor systems used for working at heights:

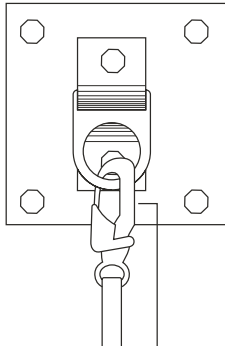

Type A – anchor device with one or more stationary anchor points while in use and with the need for a structural anchor/fixing.

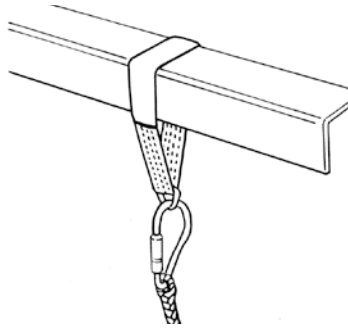

Type B – anchor device with one or more stationary anchor points without the need for a structural anchor/fixing.

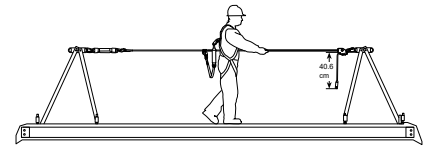

Type C – anchor devices employing a flexible anchor line which deviates from the horizontal not more than 15°.

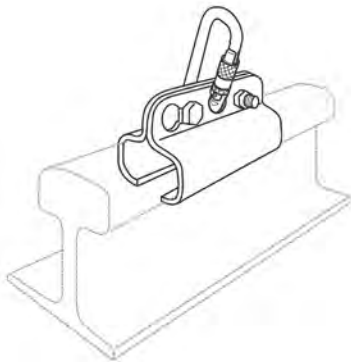

Type D – anchor device employing rigid anchor line which deviates from the horizontal by not more than 15°.

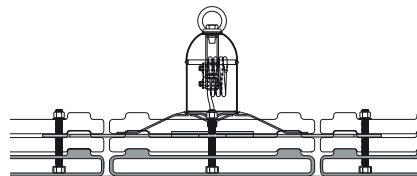

Type E – anchor device for use on surfaces up to 5° from the horizontal, where the performance relies solely on mass and friction between itself and the surface.







Did you know?

MSA has a wide range of Engineered Fall Protection Systems available. See a snapshot of the MSA Latchways range at the end of this catalogue.

EN 795 Type B - Removable Anchorage Connectors

Anchorage Slings

MSA offers several slings for use as a temporary mean of connecting to an anchor point in a variety of applications.

Part Number	Length	Material	
10115802	1,5 m	Polyester	
10115803	2 m	Polyester	
10110162	1,2 m	Vinyl coated Galvanized Cable	
10110163	1,8 m	Vinyl coated Galvanized Cable	



[Learn more](#)

Anchorage Connector Straps

MSA offers several web straps used as removable anchors for connection to an anchorage point.



Part Number	Length	Material	
10103221	1,5 m	Kevlar	
10103222	1,5 m	Polyester	
10103223	1,5 m	Nylon	
10103224	0,9 m	Polyester	



[Learn more](#)

Beam Anchors

Beam Anchors quickly and easily attach to I-beams, providing a safe anchorage point without the need for any tools.

Part Number	Name	Beam Widths	Use	Crossbar Material	Fall Indicator	
10175891	MSA Workman® FP Stryder	10 – 34 cm	Horizontal	Aluminium	■	
10175892	MSA Workman® FP Stryder XL	35 – 60 cm	Horizontal	Steel	■	
10201927	MSA Vertical Beam Clamp	10 – 35 cm	Vertical	Zinc-plated steel		

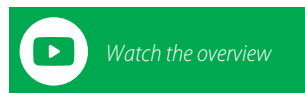
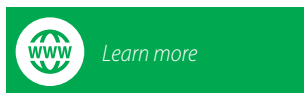

EN 795 Type E – Freestanding anchor points

MSA Latchways Freestanding Constant Force Post

Part Number	Description	Standards
65640-00	300 kg Single point anchor for the attachment of one user	EN795:2012
65643-00	200 kg intermediate anchor for use as part of a Type C horizontal lifeline 1	EN795:2012
65644-00	400 kg End or corner anchor for use as part of a Type C horizontal lifeline 2	EN795:2012
65724-00	500 kg Single point anchor for the attachment of one user	EN795:2012



Upgrade Kit	
65641-00	100 kg Upgrade kit (Upgrade 65640-00 to 65644-00)
65725-00	200 kg Upgrade Kit (Upgrade 65640-00 to 65724-00)

Accessories	
60031-00	MSA Latchways Constant Force 6 – 25 m adjustable EN 795 Type C temporary rope system

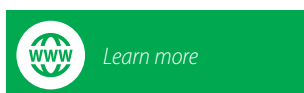



MSA
The Safety Company

Engineered Fall Protection Solutions

Collective Fall Protection Solutions

Collective Fall Protection Solutions don't require any action to be taken by the worker once installed. Guardrails and netting are perfect examples of just such protection— helping to minimise risk by providing a barrier to the hazard while protecting more than one worker at a time. Other scenarios where passive fall protection comes into play include areas where workers have frequent and regular access to locations, environments where tasks may take longer, and situations where workers aren't required to participate in personal protection equipment training.

MSA Latchways VersiRail® Guardrail

On Guard for Fall Hazards For flat surfaces up to a 10° slope, the MSA range of Latchways VersiRail guardrail systems offer collective protection designed to safeguard against falls. It's available in two different forms: as a freestanding system that requires no penetration, or as a fixed system that can be permanently attached to parapet walls or roof decks.

Made of durable Aluminium and corrosion-resistant construction, these lightweight, fully weatherproof systems are quick and easy to install— not to mention versatile enough to be designed for any roof with up to 10° pitch. They're also built with your aesthetic eye in mind. VersiRail systems are available in straight, curved or inclined styles, and they can be delivered with a polished finish or powder coated in a large array of colors.

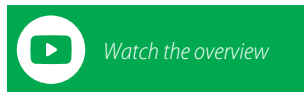
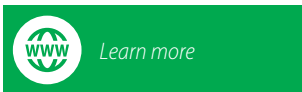

MSA Latchways Walksafe® Walkways and Skylight Covers

WalkSafe walkway systems attach to rooftops to create a level, anti-slip surface that keeps workers protected against potential fall hazards. In addition to offering ease of access up sloped or pitched roofs, WalkSafe's leveled walkways help provide workers a defined route that guides them away from hazards. Wherever in-plane or raised skylights are installed, WalkSafe Skylight Covers work to keep employees from falling through them. As skylights often vary in shape and size, WalkSafe solutions can be customised to fit your particular needs.

Manufactured from recycled PVCu, WalkSafe systems are designed to distribute the load evenly on the roof, reducing wear and tear on the roofing system itself. This is particularly useful in instances where regular access is required, for example in plant inspection, rooflight cleaning or air quality monitoring. Versatile in its applications for easy customisation, WalkSafe systems work on all major roof systems—from standing-seam to corrugated metal to single-ply membrane.

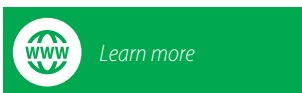

MSA Latchways Horizontal Lifelines (HLL)



Latchways horizontal lifelines are known worldwide for their versatility and ease of use, making them the ideal choice for protecting workers as they go about day-to-day activities like maintenance, cleaning, inspection and more.

Constant Force® Post Technology Explained

The principles of fall arrest are based on effective load control, meaning that a system must be able to withstand the force of a person's fall while absorbing the energy it generates. In the past, this was achieved by attaching the system to the structure of the building with the anchor point absorbing the load. This inherently caused difficulties for designers and installers, since the system location was determined by the structural elements of the building. System installation, meanwhile, was time consuming because anchors had to be fixed above and below, often creating issues regarding warranties, leakage and cold bridging.

The MSA Solution

Latchways Constant Force post (CFP) does not need to be fixed to the building structure but instead top-fixes to the roof, therefore simplifying installation, saving time and protecting structures from compromise. With Constant Force technology as its governing principle, the load generated in the event of a fall is absorbed through the Latchways system, minimising loads placed on the roof structure.

Specifications:

- Top fix pre-engineered system
- Multi-user and directional
- 500+ full scale roofs tested
- EN 795:2012 + CEN TS 16415:2013
- Approved for major roofing systems globally

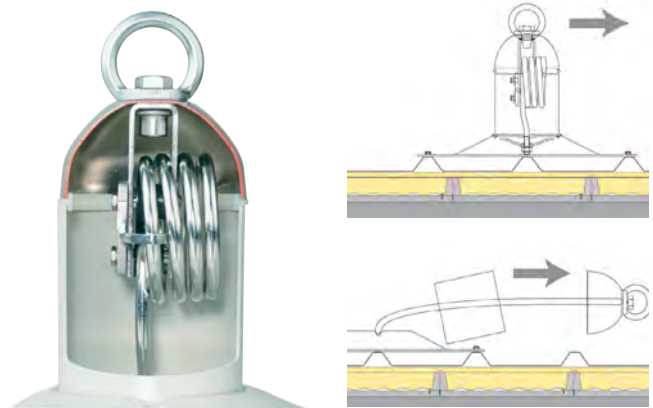

The Constant Force coil controls the load when a fall occurs, limiting the impact to the roof construction.

Latchways Transfastener™

The user, wearing a full-body harness and energy-absorbing lanyard, is continuously attached to the system with a Transfastener, MSA's innovative device that can rotate its way through the intermediate cable supports. For systems with no entry terminal, a Removable Transfastener can be used.

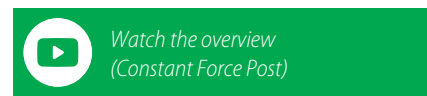
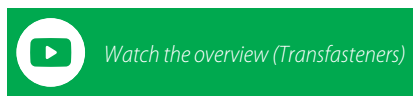
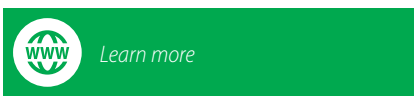

MSA Latchways Overhead System

Combining MSA's unique knowledge of fall protection with innovative Constant Force technology, our overhead systems deliver maximum accessibility and hands-free mobility—not to mention ease of use and simple installation.

The MSA Latchways range of overhead systems house Constant Force technology in an in-line energy absorber, so if a worker connected to the system should fall, the Constant Force energy absorber controls the load back to the structure. Simply put, it's a smartly designed system precisely engineered to react lightning quick.

Ideal for industrial environments and in applications such as warehouses, loading bays and airplane hangars, the MSA Latchways overhead system is heads above when it comes to fall protection safety.

Specifications:

- EN 795:2012 Typ C + CEN/TS 16415:2013 + abZ Z-14.9-788
- Single-Span system: single spans up to 60 m
- Multi-Span long distance systems
- Number of users: up to 10 users
- Max. load transferred to the structure: 18kN
- Permanent & Removable trolley options available



Mobile Anchorage

Allows an SRL to be connected to the overhead system. Anchorage can travel over intermediate brackets without disconnection.



Did you know?

For systems up to 60m, intermediate brackets are not necessary with the MSA Latchways overhead system, as they remove the need for structural elements and intermediate bracket fittings to be installed.



[Learn more](#)

Crane Tracks



Loading Bays



Maintenance Bays

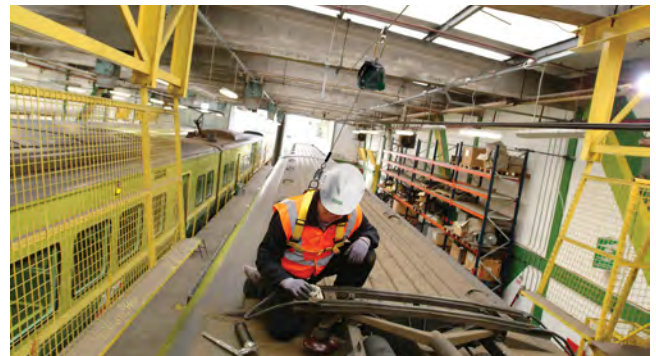

Pipe Racks

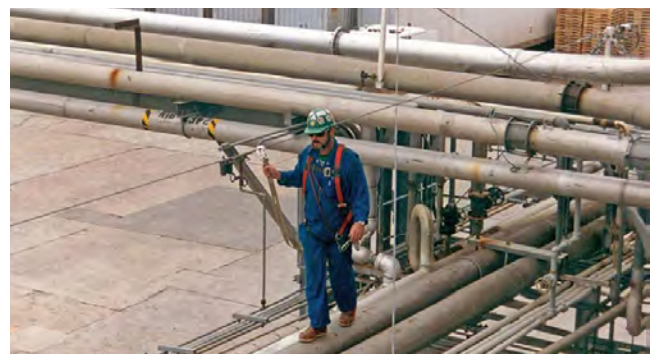

MSA Latchways Vertical Lifelines (VLL)

Featuring the brilliantly engineered TowerLatch® and LadderLatch® systems the MSA Latchways system options offer outstanding personal safety for those working at height, particularly in the telecom and wind energy industries. Both TowerLatch and LadderLatch can be configured for a wide variety of applications, including ladders, towers, masts, monopoles and other structures specific to these industries.

Dedicated to Safety

- **Reliable security:** Our VLLs incorporate a fluorescent red indicator that appears in the event of a fall
- **Flexible freedom:** Each systems' universal attachment device rotates freely through intermediate cable guides for continuous hands-free protection
- **Load control:** In the event of a fall, the load applied to the worker is limited to a maximum of 6kN (1349 lbs) by either a Constant Force® absorber at the top of the system or a webbing energy absorber on the device
- **Inspection:** TowerLatch and LadderLatch systems are regarded as part of the tower structure, and inspected accordingly
- **Trusted quality:** Both systems meet the new EN 353-1:2018 up to 150 Kg per user
- **Extra security:** A webbing strop can be incorporated into the systems' attachment device to facilitate rescue as needed



Fixed ladder systems use the LadderLatch attachment device.



TowerLatch systems for overhead towers use the TowerLatch or TowerLatch SP attachment devices.

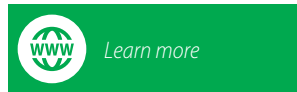

Fixed Ladder Systems



With its simple design concept built for optimal flexibility and superior protection, MSA TowerLatch and LadderLatch systems can be installed to follow the contours of any structure, maximizing the system's safety value in a working environment.

Networks and Telecoms



MSA's mission is to make sure every customer gets the solution they need. Whether the systems you require are for greenfield sites or rooftops sites, new build or retrofit, network roll-out programs or upgrading of antennas, MSA offers tailor-made service with maximum support.

Wind Turbines



When ascending a ladder within a new build or retrofit turbine, rely on MSA Latchways TowerLatch to deliver the ideal hands-free solution, securing the climber to the cable via the chest D-ring on their full-body harness.

Transmission Towers



Flexible enough to accommodate every safety need for working at height, Latchways vertical systems are ideal for personnel accessing high-voltage transmission towers or transformers in substations.

MSA Latchways Inclined Systems

The comprehensive range of MSA Latchways system components can be configured to provide a tailored cable lifeline suited to structures that slope.

Our two main components, the BridgeLatch™ and ClimbLatch™ devices, are built to bring optimal security, flexibility and mobility to the at-height, on-incline workplace.

BridgeLatch

For inclined lifelines running between 0° and 70°, the MSA Latchways BridgeLatch device secures the user to the cable via a fixed-length lanyard connecting to the D-ring attachment point of a full-body harness.



ClimbLatch

Designed to protect the user from a sliding fall on a sloped surface, the ClimbLatch™ device was created for use on an inclined system between 15° and 40°—though it can also be used on a system that moves from horizontal to vertical orientation.

Compatibility among components ensures your customised system—whether vertical, horizontal or inclined—delivers smooth, continuous transitions.



[Learn more](#)



[Watch the overview](#)

Bridges



Leisure and Stadiums



Conveyors



Inclined Ladders

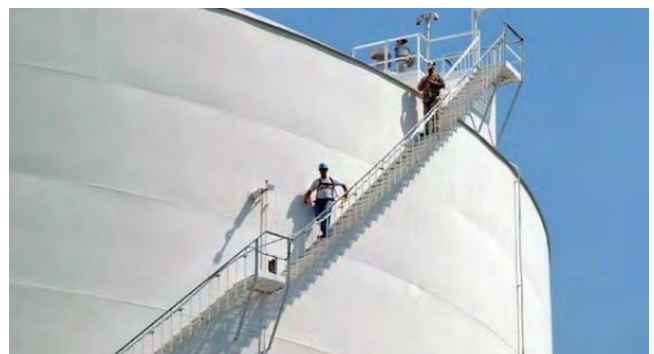

MSA WinGrip® Vacuum Anchor

The MSA WinGrip is a vacuum anchor fall protection system used in the maintenance and manufacturing of aircraft, among other applications. The system is quick to install, easy to use and suitable for work inside the hangar, or outside, on the apron. Single-user systems give the industry a time saving, cost-cutting lift by delivering fall protection in a radius around the anchor, in virtually any location on the aircraft—and they're still being used today. In fact, WinGrip is so ubiquitous, you'll find it in the aircraft maintenance manuals of both Boeing and Airbus. MSA WinGrip aerospace line consists of four different products—each with its own unique benefits that accommodate ever-evolving customer needs and legislative requirements.

WinGrip at a Glance

- Lightweight and portable anchors weigh less than 5.9 kg (13 lbs).
- Suitable for wet or dry surfaces, inside hangars, or on the apron
- Intrinsically safe, even with fuel tanks open—runs on compressed air or nitrogen; no electrical requirements
- Approved and used by all major aircraft manufacturers
- Easy to install and simple hands-free operation
- Independently tested to meet all relevant international standards
- Absence of metal-on-metal contact protects surfaces and eliminates risk of sparking
- Single- or multiple-user cable-based systems are available
- Suitable for heavy and light maintenance environments
- Should air supply fail, an alarm will sound and workers have at least 20 minutes to reach safety

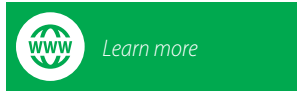

WinGrip Single-User System

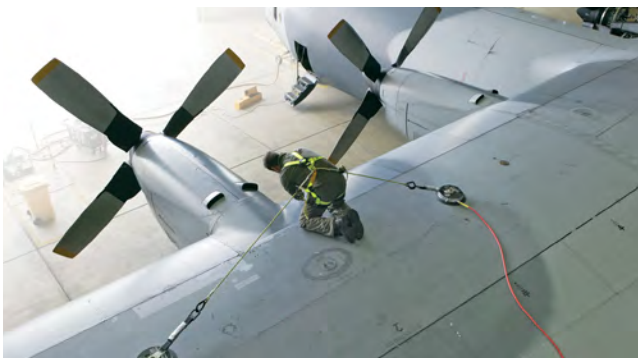

WinGrip Barrier System

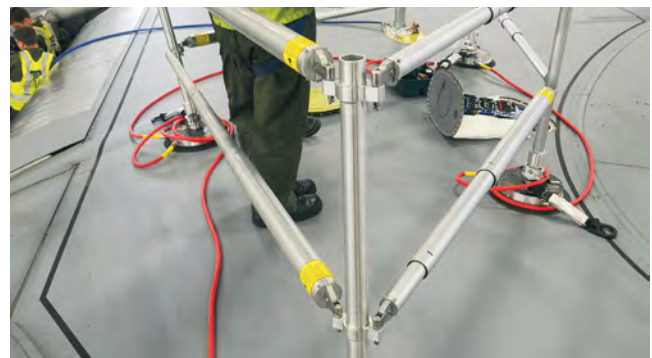

WinGrip Lifeline System



WinGrip AIO





MSA
The Safety Company

Confined Space Entry Solutions

A confined space is a place which is substantially enclosed (though not always entirely), and where serious injury can occur from hazardous substances or conditions within the space or nearby.

Among the many risks involving confined spaces, falls have to be considered, especially if the space is accessed vertically through a hatch or a manhole.

Confined space entry products have two main functions. One is to protect the worker while descending into the space. Another function of this system is to rescue or retrieve the worker in case they become trapped in a dangerous environment, injured or overcome while in the confined space.

The confined space entry system is usually made up of the following components:

- A tripod/davit arm, that provides an approved EN795 anchorage point (1)
- A self-retracting lifeline anchored at the tripod/davit arm that provides an approved EN360 connecting device. Self-retracting lifelines with retrievable mode, commonly named rescuers are very popular due to the additional rescuing capabilities (2)
- A winch that allows ascending or descending the worker if no ladder can be used, and that also allows rescuing the worker if necessary. The winch is usually mounted on the tripod and requires a pulley and a carabiner. (3)

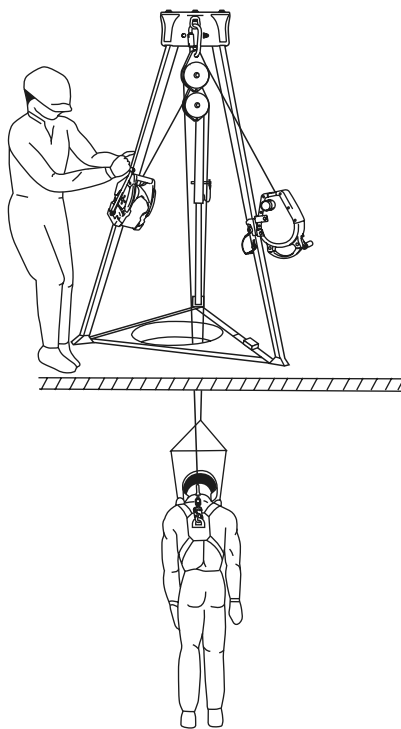

Did you know?

Workers near the opening of a confined space, like those preparing to conduct atmospheric monitoring, inadvertently may become overwhelmed by fumes when the cover is removed, which could result in loss of consciousness, and fall through the opening. The first fall protection consideration when working near or preparing to enter a confined space relates to the access area itself. As soon as a manhole is removed, the opening immediately should be guarded with a handrail or temporary cover to prevent a fall. All workers close to a non-guarded opening should use fall protection equipment and using either a restraint lanyard, preventing them from reaching the edge of the opening, or an arrest lanyard or lifeline, to stop a fall in progress.

MSA Workman® Tripod system

Various accessories available make the system customizable for specific applications and needs:

- The complete system is certified to Machinery Directive 2006/42/EC
- Legs automatically lock in the open position for added safety
- A maximum height indicator provides quick and easy identification of the maximum leg extension length
- No need for a separate bracket assembly, which makes accessories attachment easier and faster to any leg
- Telescoping legs (up to 2.45 m high) do not tangle when the unit is collapsed
- Certified to EN 795: 2012

Part Number	Description
10116521	MSA Workman Tripod
10129888	Steel autolock carabiner, 25mm
506222	Pulley
10169369	Carrying bag for Workman tripod
10129891	Replacement leg strap

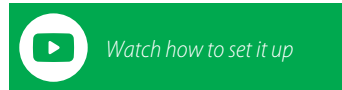
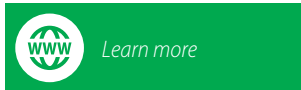

10116521



10129888



506222



10169369



10129891

MSA Workman® Spreader Bar

- Used in conjunction with the V-Series harnesses for raising and lowering a person during rescue.
- The attached web loops can be used to secure an incapacitated victim's arms when lifting or lowering.
- Certified to EN354:2010

Part Number	Description
10115550	MSA Workman Spreader Bar, steel snaphook
10115551	MSA Workman Spreader Bar, aluminium snaphook

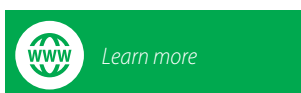

MSA Workman® Winch

- Designed for lifting, lowering, and positioning of personnel and materials.
- Level wind mechanism keeps cable evenly spooled on hub
- Built-in clutch prevents injury if worker becomes snagged
- Double braking system provides secondary protection
- Built-in energy absorber keeps forces below 6 kN
- RFID-enabled
- Integral, ergonomic carrying grip and unique, foldable handle for simple storage
- Certified to Machinery Directive 2006/42/EC, testing based on EN ISO 12100:2010, EN 1496:2006 Class B



Length	Part Number Cable Material	
	Stainless-Steel	Galvanized
10 m	10147566	10153828
15 m	10147567	10153829
20 m	10147296	10153830
25 m	10154687	10154689
30 m	10154688	10154690

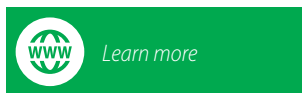

MSA Workman® Rescuer

- Provides fast, easy and intuitive fall protection with integral bidirectional retrieval capability, allowing the user to ascend or descend to a safe location
- Colour-coded switch for retrieval mechanism activation
- Built-in shock absorber
- Robust aluminium housing with thermoplastic bumpers
- Ergonomic, stainless steel carrying handle can also be used as anchorage connection point
- Self-locking swivel snaphook with load indicator
- Stowable, foldable crank handle
- RFID-enabled
- Certified to EN 360:2002, EN 1496:2006 Class B



Part Number	Description
10158192	MSA Workman Rescuer, stainless steel cable, 15 m

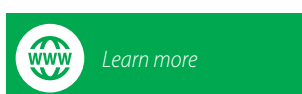



MSA

The Safety Company

Accessories

V-Gard® H1 Safety Helmet

- Fas-Trac® III Pivot Ratchet Suspension for superior comfort, adjustability, and range of motion.
- Non-contact foam liner maximizes air flow and breathability for optimal cooling and hygiene.
- Non-vented option for use in electrical applications.
- Vented option for optimal air flow and cooling.
- Field replaceable 4-point chinstraps with multiple adjustment points for customized fit and comfort.
- Premium moisture wicking headband with breathable foam and hook and loop attachment for easy field replacement.
- Patent-pending “push-button” accessory attachment rail and universal clips for head lamps enables quick installation and removal, with no need for an additional carrier.
- Low profile design, even with a visor or spectacles attached.
- Convenient rescue whistle integrated into the chin strap buckle.
- Matte finish shell.
- Standard reflective stickers.
- Optional logo customisation in up to 3 locations.



V-Gard H1 Novent Safety Helmet



V-Gard H1 Trivent Safety Helmet

Shell Material Styles HDPE (high-density polyethylene)
Styles Trivent, Novent
Colors
Size 52–64 cm head circumference

Color	Trivent EN 12492:2012	Novent EN 397:2012
WHITE	10194783	10194791
RED	10194784	10194792
BLUE	10194785	10194793
GREEN	10194786	10194794
YELLOW	10194787	10194795
HI-VIZ YELLOW GREEN	10194788	10194796
ORANGE	10194789	10194797
BLACK	10194790	10194798
GRAY	10204346	10204347



All V-Gard H1 Safety Helmet Trivent and Novent models include a Fas-Trac III Pivot Ratchet Suspension, reflective stickers and a chinstrap.

Accessories			
PART NO.	10194818	10194819	10194820
NAME	V-Gard H1 Clear Face Shield	V-Gard H1 Mesh/Forestry Face Shield	V-Gard H1 Spectacles
COLOR	Clear	Mesh	Clear



10194818







10194819

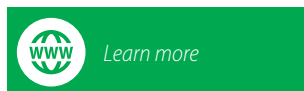

10194820



Carabiners

Part Number	Description	Weight	Internal Length	Gate	Material	MBL	
10144125	Steel screwgate carabiner, 17 mm gate	0,16 kg	87 mm	17 mm	Steel	22 kN	
10144126	Aluminium screwgate carabiner, 19 mm gate	0,08 kg	86 mm	19 mm	Aluminium	22 kN	
10129888	Steel autolock carabiner, 25 mm gate	0,32 kg	109 mm	25 mm	Steel	35 kN	
10157585	Steel triple lock carabiner, 25 mm gate	0,30 kg	109 mm	25 mm	Steel	35 kN	

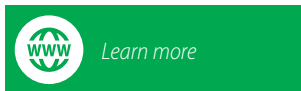

D-Ring Extender

The D-Ring Extender allows easier access to the dorsal D-ring without any external help.

- 60 cm D-ring extension with a webbing loop at one end, steel D-ring at other end
- Abrasion resistant polyester webbing
- Certified to EN 354:2010

Part Number	Description
10180209	D-Ring Extender, EN

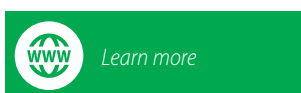

Harness Accessories

Accessories to replace wearable parts and complement harnesses with new features.

Part Number	Description
10113240	Lanyard Keeper, Velcro version, all harnesses. Pack of 2
10207094	Lanyard Keeper, Rigid version, all harnesses, Kit
10205837	Lanyard Keeper, replacement for V-FLEX
10203504	V-FIT Shoulder pad, replacement
10211645	V-FIT Leg pads, replacement

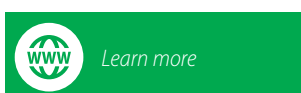

10207094

Suspension Trauma Safety Step

The Suspension Trauma Safety Step is designed to help workers in a post-fall suspension position avoid the effects of suspension trauma. Workers can use a single Safety Step or two Safety Steps (one for each leg) to provide additional support, balance, and comfort.

- Compact, lightweight, versatile
- Multiple attachment point options
- Fast, easy installation and deployment
- Attaches to any harness
- Multiple loop design accommodates all heights and sizes

Part Number	Description
10143346	Suspension Trauma Safety Step with carabiner
10143347	Suspension Trauma Safety Step without carabiner

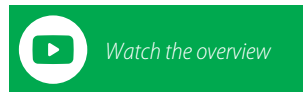
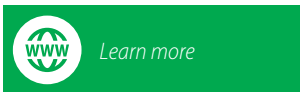

Other Accessories

The practical cell phone holder comes with Velcro attachments for fitting to the harness. With the tool lanyard you can securely carry or stow tools when working.

Part Number	Description
10117271	Cell phone holder
10110670	Tool lanyard

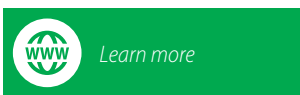



MSA
The Safety Company

Training Solutions

Introduction

As we are all very much aware, falling from heights is still a significant cause of serious workplace-related injuries or fatalities. Whether you are 60+ meters up on a telecommunications tower or four rungs up an access ladder, potential for injury without proper training and equipment remains very real.

MSA is pleased to offer both training and necessary products to increase worker knowledge and practical skills to reduce the risk of injury and enhance the safety of those who work at heights.

Training builds individual situational awareness and selfconfidence by completing workplace scenario-based practical exercises and gaining knowledge of how to work safely at height. And, equally important, training is a legal requirement.



Fall Protection Awareness Training

The must have course for all worker's requiring to work in areas, or access areas, where there is the potential for them to fall and injure themselves. The course is suitable for all industries being a mixture of theory and practical, the practical element being based on your work place environment and day to day work activities.

Module information

Duration:
½ - 1 day dependent on the location and on the practical requirements

Location:
The course can be delivered remotely, on site, or at one of our MSA training venues

Delegate Numbers:
Minimum 4, maximum 8 delegates to 1 instructor



Competent Persons Inspection Course for Personal Fall Protection Equipment (PFPE)

This course is designed to meet the moral and legal obligation of the employer regarding the detailed examination of fall protection equipment in the work place. Successful completion of this training will qualify an individual as 'competent' to inspect work place personal fall protection equipment as the companies 'Competent Person'. The basic course focuses on soft goods, harnesses, lanyards, ropes and anchor strops. Modules can be added for self- retracting lifelines (SRL's), man riding winches and rescue systems (manufacturer dependent).

Module information

Duration:
6 – 8 hours' dependent on modules required

Location:
The course can be delivered remotely, on site, or at one of our MSA training venues

Delegate Numbers:
Minimum 4, maximum 8 delegates to 1 instructor



Bespoke

A course tailored to specific risks and hazards you are facing in your facilities. In addition, specific rescue set up can be used, which delegates can bring with them, or used if training is delivered on site.

Module information

Duration:

1 day

Location:

The course can be delivered on site, providing minimum theory and practical facilities are available or at an MSA training venue

Delegate Numbers:

Minimum of 4 delegates, maximum 6 to 1 instructor



Do you want a truly hands-on safety experience?
Get in touch!



Learn more about the MSA Demonstration Truck

MSA – The Safety Company

Our business is safety. We've been the world's leading manufacturer of high-quality safety products since 1914. MSA products may be simple to use and maintain, but they're also highly-sophisticated devices and protective gear – the result of countless R&D hours, relentless testing and an unwavering commitment to quality that saves lives and protects thousands of men and women each and every day. Many of our most popular products integrate multiple combinations of electronics, mechanical systems and advanced materials to help ensure that users around the world remain protected in even the most hazardous of situations.

Our Mission

MSA's mission is to see to it that men and women may work in safety and that they, their families and their communities may live in health throughout the world.

MSA: We Know What's at Stake.

Note: This Bulletin contains only a general description of the products shown. While product uses and performance capabilities are generally described, the products shall not, under any circumstances, be used by untrained or unqualified individuals. The products shall not be used until the product instructions/user manual, which contains detailed information concerning the proper use and care of the products, including any warnings or cautions, have been thoroughly read and understood. Specifications are subject to change without prior notice.

MSA operates in over 40 countries worldwide. To find an MSA office near you, please visit ***MSAsafety.com/offices***.