

ACS550

efesotomasyon.com

User's Manual

ACS550-02 Drives (132...355 kW)

ACS550-U2 Drives (250...550 hp)



efesotomasyon.com

ABB

ACS550-02/U2 Drive Manuals

GENERAL MANUALS

ACS550-02/U2 User's Manual (132...355 kW) / (250...550 hp)

3AFE64804626 (English)

- Safety
- Planning electrical installation
- Installation
- Start-up, control with I/O and ID Run
- Control panels
- Application macros
- Parameters
- Embedded fieldbus
- Fieldbus adapter
- Diagnostics
- Maintenance
- Technical data

ACS550-U2 Installation Supplement

3AUA0000004067 (English)

OPTION MANUALS

(delivered with optional equipment)

OHDI-01 115/230 V Digital Input Module User's Manual

3AUA0000003101 (English)

OREL-01 Relay Output Extension Module User's Manual

3AUA0000001935 (English)

OTAC-01 User's Manual Pulse Encoder Interface Module User's Manual

3AUA0000001938 (English).

RCAN-01 CANopen Adapter User's Manual

3AFE64504231 (English)

RCNA-01 ControlNet Adapter User's Manual

3AFE64506005 (English)

RDNA-01 DeviceNet Adapter User's Manual

3AFE64504223 (English)

RETA-01 Ethernet Adapter User's Manual

3AFE64539736 (English)

RETA-02 Ethernet Adapter User's Manual

3AFE68895383 (English)

RLON-01 LonWorks Adapter Module User's Manual

3AFE64798693 (English)

RPBA-01 PROFIBUS-DP Adapter User's Manual

3AFE64504215 (English)

Typical contents

- Safety
- Installation
- Programming/Start-up
- Diagnostics
- Technical data

MAINTENANCE MANUALS

Guide for Capacitor Reforming in ACS50, ACS55, ACS150, ACS350, ACS550 and ACH550

3AFE68735190 (English)

The Industrial^{IT} wordmark and Product names in the form Drive^{IT} are registered or pending trademarks of ABB. CANopen is a registered trademark of CAN in Automation e.V. ControlNet is a registered trademark of ControlNet International. DeviceNet is a registered trademark of Open DeviceNet Vendor Association. Ethernet/IP is a registered trademark of Open DeviceNet Vendor Association. DRIVECOM is a registered trademark of DRIVECOM User Organization. Interbus is a registered trademark of Interbus Club. LonWorks is a registered trademark of Echelon Corp. Metasys is a registered trademark of Johnson Controls Inc. Modbus, Modbus Plus and Modbus/TCP are registered trademarks of Schneider Automation Inc. PROFIBUS is a registered trademark of Profibus Trade Org. PROFIBUS-DP is a registered trademark of Siemens AG.

ACS550-02/U2 Drives
132...355 kW
250...550 hp

User's Manual

3AFE64804626 Rev C
EN
EFFECTIVE: 17.09.2007

Safety

Use of warnings and notes

There are two types of safety instructions throughout this manual:

- Notes draw attention to a particular condition or fact, or give information on a subject.
- Warnings caution you about conditions which can result in serious injury or death and/or damage to the equipment. They also tell you how to avoid the danger. The warning symbols are used as follows:



Dangerous voltage warning warns of high voltage which can cause physical injury and/or damage to the equipment.



General warning warns about conditions, other than those caused by electricity, which can result in physical injury and/or damage to the equipment.



WARNING! The ACS550 adjustable speed AC drive should ONLY be installed by a qualified electrician.



WARNING! Even when the motor is stopped, dangerous voltage is present at the power circuit terminals U1, V1, W1 and U2, V2, W2 and UDC+, UDC-.



WARNING! Dangerous voltage is present when input power is connected. After disconnecting the supply, wait at least 5 minutes (to let the intermediate circuit capacitors discharge) before removing the cover.



WARNING! Even when power is switched off from the input terminals of the ACS550, there may be dangerous voltage (from external sources) on the terminals of the relay outputs RO1...RO3 and, if the relay extension board is included in the installation, RO4...RO6, as well as terminals X1:19...X1:27 on the control board.





WARNING! When the control terminals of two or more drives are connected in parallel, the auxiliary voltage for these control connections must be taken from a single source which can either be one of the drives or an external supply.



WARNING! Disconnect the EMC filter (frame size R7) and the varistor network (frame sizes R7 and R8) when installing the drive on an IT system [an ungrounded power system or a high resistance-grounded (over 30 ohm) power system], otherwise the system will be connected to earth potential through the EMC filter capacitors or varistor network. This may cause danger or damage the drive.

Disconnect the EMC filter (frame size R7) and the varistor network (frame sizes R7 and R8) when installing the drive on a corner grounded TN system, otherwise the drive will be damaged.



WARNING! Do not control the motor with the disconnecting device (disconnecting means); instead, use the control panel start and stop keys  and , or commands via the I/O board of the drive. The maximum allowed number of charging cycles of the DC capacitors (i.e. power-ups by applying power) is five in ten minutes.



WARNING! The ACS550-02/U2 is a field repairable drive. In case of service or repair of malfunctioning drive, contact your local Authorized Service Centre for service.



WARNING! The ACS550 will start up automatically after an input voltage interruption if the external run command is on.



WARNING! The heat sink will reach a high temperature. See chapter [Technical data](#) on page [293](#).



WARNING! The drive is heavy. Lift the drive by the lifting lugs only. Do not tilt the drive. The drive will overturn from a tilt of about 6 degrees. Use extreme caution when manoeuvring a drive that runs on wheels. **An overturning drive can cause physical injury.**

Do not tilt!



Note: For more technical information, contact the factory or your local ABB representative.

Table of contents

| | |
|----------------------------------|---|
| ACS550-02/U2 Drive Manuals | 2 |
|----------------------------------|---|

Safety

| | |
|---------------------------------|---|
| Use of warnings and notes | 5 |
|---------------------------------|---|

Table of contents

Installation and commissioning flowchart

Planning the electrical installation

| | |
|---|----|
| Checking the compatibility of the motor | 15 |
| Supply connection | 18 |
| Thermal overload and short-circuit protection | 19 |
| Ground fault protection | 20 |
| Emergency stop devices | 21 |
| Selecting the power cables | 21 |
| Power factor compensation capacitors | 23 |
| Equipment connected to the motor cable | 24 |
| Selecting the control cables | 26 |
| Connection of a motor temperature sensor to the drive I/O | 27 |
| Routing the cables | 27 |

Installation

| | |
|---|----|
| Moving the drive | 29 |
| Before installation | 31 |
| Checking the insulation of the installation | 35 |
| Power cable connection diagram | 36 |
| Installation procedure | 37 |
| Installation checklist | 59 |

Start-up, control with I/O and ID Run

| | |
|--|----|
| How to start up the drive | 61 |
| How to control the drive through the I/O interface | 68 |
| How to perform the ID Run | 69 |

Control panels

| | |
|-------------------------------|----|
| About control panels | 71 |
| Compatibility | 71 |
| Assistant Control Panel | 72 |

| | |
|--|-----|
| Basic Control Panel | 92 |
| Application macros | |
| ABB Standard macro | 102 |
| 3-wire macro | 103 |
| Alternate macro | 104 |
| Motor Potentiometer macro | 105 |
| Hand-Auto macro | 106 |
| PID Control macro | 107 |
| PFC macro | 108 |
| Torque Control macro | 109 |
| Connection example of a two-wire sensor | 110 |
| User parameter sets | 111 |
| Macro default values for parameters | 112 |
| Parameters | |
| Complete parameter list | 115 |
| Complete parameter descriptions | 128 |
| Embedded fieldbus | |
| Overview | 219 |
| Planning | 220 |
| Mechanical and electrical installation – EFB | 220 |
| Communication set-up – EFB | 221 |
| Activate drive control functions – EFB | 223 |
| Feedback from the drive – EFB | 227 |
| Diagnostics – EFB | 228 |
| Modbus protocol technical data | 231 |
| ABB control profiles technical data | 239 |
| Fieldbus adapter | |
| Overview | 251 |
| Planning | 253 |
| Mechanical and electrical installation – FBA | 254 |
| Communication set-up – FBA | 255 |
| Activate drive control functions – FBA | 255 |
| Feedback from the drive – FBA | 258 |
| Diagnostics – FBA | 259 |
| ABB Drives profile technical data | 262 |
| Generic profile technical data | 270 |
| Diagnostics | |
| Diagnostic displays | 273 |
| Correcting faults | 274 |

| | |
|-------------------------|-----|
| Correcting alarms | 280 |
|-------------------------|-----|

Maintenance

| | |
|-----------------------------|-----|
| Maintenance intervals | 285 |
| Heatsink | 286 |
| Fan | 286 |
| Capacitors | 289 |
| LEDs | 291 |
| Control panel | 291 |

Technical data

| | |
|---|-----|
| Ratings | 293 |
| Fuses and circuit breakers | 295 |
| Cable types | 297 |
| Cable entries | 299 |
| Input power (mains) connection | 299 |
| Motor connection | 300 |
| Control connections | 301 |
| Efficiency | 301 |
| Cooling | 302 |
| Dimensions, weights and noise | 302 |
| Degrees of protection | 302 |
| Ambient conditions | 303 |
| Materials | 304 |
| Applicable standards | 304 |
| CE marking | 305 |
| C-Tick marking | 305 |
| UL markings | 305 |
| IEC/EN 61800-3 (2004) Definitions | 306 |
| Compliance with the IEC/EN 61800-3 (2004) | 306 |
| Equipment warranty and liability | 307 |
| Product protection in the USA | 308 |
| Dimension drawings | 308 |

Contact ABB

| | |
|--|-----|
| Product and service inquiries | 311 |
| Product training | 311 |
| Providing feedback on ABB Drives manuals | 311 |

Installation and commissioning flowchart

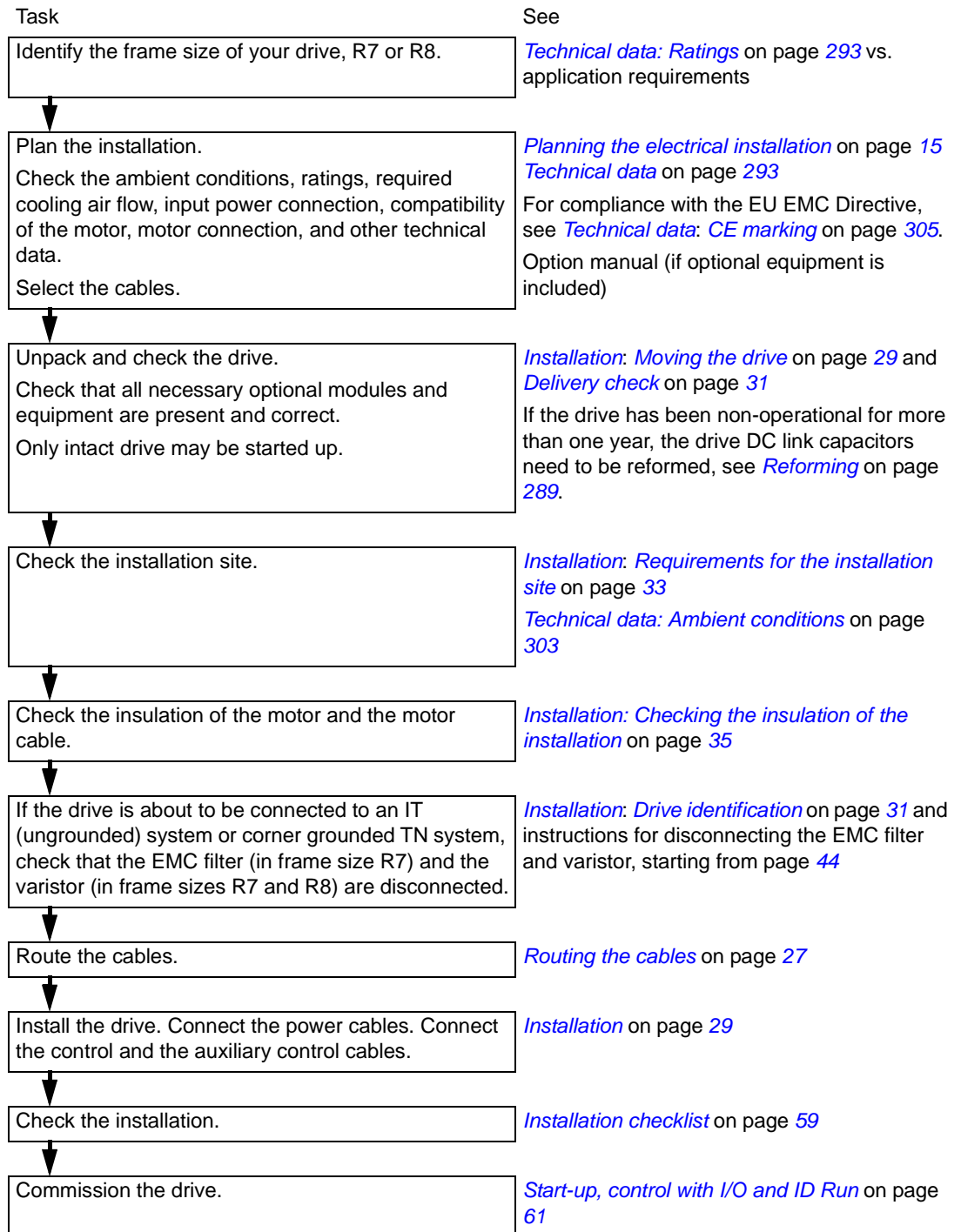

Planning the electrical installation

Note: The installation must always be designed and made according to applicable local laws and regulations. ABB does not assume any liability whatsoever for any installation which breaches the local laws and/or other regulations. Furthermore, if the recommendations given by ABB are not followed, the drive may experience problems that the warranty does not cover.

Note: *ACS550-U2 Installation Supplement* [3AUA0000004067 (English)] provides more information about the installation of ACS550-U2 drives.

Checking the compatibility of the motor

1. Select the motor according to the needs of the application.
2. Select the drive according to the rating tables in chapter [Technical data on page 293](#). Use the DriveSize PC tool if the default load cycles are not applicable.
3. Check that the motor ratings lie within the allowed ranges of the drive control program:
 - motor nominal voltage is $1/2 \dots 2 \cdot U_N$ of the drive
 - motor nominal current is $1/6 \dots 2 \cdot I_{2hd}$ of the drive in vector control and $0 \dots 2 \cdot I_{2hd}$ in scalar control. The control mode is selected by parameter 9904 MOTOR CTRL MODE.
4. Consult the motor manufacturer before using a motor in a drive system where the motor nominal voltage differs from the AC power source voltage.
5. Ensure that the motor insulation system withstands the maximum peak voltage in the motor terminals. See section [Requirements table on page 16](#) for the required motor insulation system and drive filtering.

Example 1: When the supply voltage is 440 V, the maximum peak voltage in the motor terminals can be approximated as follows: $440 \text{ V} \cdot 1.35 \cdot 2 = 1190 \text{ V}$. Check that the motor insulation system withstands this voltage.

Protecting the motor winding and bearings

The output of the drive comprises – regardless of output frequency – pulses of approximately 1.35 times the mains network voltage with a very short rise time. This is the case with all drives employing modern IGBT inverter technology.

The voltage of the pulses can be almost double at the motor terminals, depending on the motor cable properties. This in turn can cause additional stress on the motor insulation.

Modern variable speed drives with their fast rising voltage pulses and high switching frequencies can cause current pulses through the motor bearings which can gradually erode the bearing races.

To avoid damage to motor bearings, insulated N-end (non-drive end) bearings are recommended according to the following table. In addition, the cables must be selected and installed according to the instructions given in this manual.

ACS550-02/U2 devices are equipped with a common mode filter (CMF) which is adequate to prevent bearing currents at voltages less than 500 V.

The common mode filter is composed of toroidal cores installed onto the output busbars inside the drive at the factory.

Requirements table

The following table shows how to select the motor insulation system and when external du/dt limitation and insulated N-end (non-drive end) motor bearings are required. The motor manufacturer should be consulted regarding the construction of the motor insulation and additional requirements for explosion-safe (Ex) motors. Failure of the motor to fulfill the following requirements or improper installation may shorten motor life or damage the motor bearings. ACS550-02/U2 devices have common mode filters as standard accessories.

| Random wound ABB motors and generators of series M2_ and M3_ | | | | |
|--|--|--|---|---|
| Random wound standard motors (non-Ex) and generators | $U_N \leq 500 \text{ V}$ | $P_N < 100 \text{ kW}$ | $P_N \geq 100 \text{ kW}$ or IEC 315 \leq frame size \leq IEC 355 | $P_N \geq 350 \text{ kW}$ or IEC 400 \leq frame size \leq IEC 450 |
| | | Standard motor | Standard motor + insulated N-bearing | Standard motor + insulated N-bearing + common mode filter * |
| Random wound high-output motors and other non-harmonized designs | $U_N \leq 500 \text{ V}$ | $P_N < 55 \text{ kW}$ | $P_N \geq 55 \text{ kW}$ | $P_N \geq 200 \text{ kW}$ |
| | | Standard motor | Standard motor + insulated N-bearing | Standard motor + insulated N-bearing + common mode filter * |
| Random wound motors for hazardous environments (Ex-motors) | $U_N \leq 500 \text{ V}$ | \leq IEC 250 | \geq IEC 280 | \geq IEC 355 |
| | | Standard motor | Standard motor + insulated N-bearing | Standard motor + insulated N-bearing + common mode filter * |
| Random wound ABB motors and generators of series HX_ and AM_ | | | | |
| | $0 < U_N < 500 \text{ V}$ | Winding type | | Protective measures |
| | | Enamelled wire with fibre glass taping | | + insulated N-bearing |
| Form wound low voltage ABB motors of series AM_ and HX_ | | | | |
| | | Protective measures | | |
| | | <ul style="list-style-type: none"> insulated bearing construction common mode filter (CMF) | | |
| Non-ABB motors, random wound and form wound windings | | | | |
| Insulation level | | Protective measures | | |
| | | $P_N < 100 \text{ kW}$ | $100 \text{ kW} < P_N < 350 \text{ kW}$ | $P_N > 350 \text{ kW}$ |
| Standard $\hat{U}_{LL} = 1300 \text{ V}$ | $0 < U_N \leq 420 \text{ V}$ | - | + insulated N-bearing | + insulated N-bearing |
| Standard $\hat{U}_{LL} = 1300 \text{ V}$ | $420 \text{ V} < U_N \leq 500 \text{ V}$ | + du/dt | + du/dt | + du/dt + insulated N-bearing |
| Reinforced 0.2 V/us | $420 \text{ V} < U_N \leq 500 \text{ V}$ | - | - | + insulated N-bearing |

The abbreviations used in the table are defined below.

| Abbreviation | Definition |
|----------------|--|
| U_N | nominal voltage of the supply network |
| \hat{U}_{LL} | peak line-to-line voltage at motor terminals which the motor insulation must withstand |
| P_N | motor nominal power |
| du/dt | du/dt filter at the output of the drive or internal du/dt limitation. Contact ABB. |
| N | N-end bearing: insulated motor non-drive end bearing |

* Common mode filter (CMF) is included in ACS550-02/U2 as standard.

Supply connection

Disconnecting device (means)

Install a hand-operated input disconnecting device between the AC power source (MCC) and the drive. The disconnecting device must be of a type that can be locked to the open position for installation and maintenance work.

EU

To meet the European Union Directives, according to standard EN 60204-1, Safety of Machinery, the disconnecting device must be one of the following types:

- a switch-disconnector of utilization category AC-23B (EN 60947-3)
- a disconnector that has an auxiliary contact that in all cases causes switching devices to break the load circuit before the opening of the main contacts of the disconnector (EN 60947-3)
- a circuit breaker suitable for isolation in accordance with EN 60947-2.

US

The disconnecting means must conform to the applicable safety regulations.

Fuses

See section [Fuses and circuit breakers](#) on page [295](#).

Thermal overload and short-circuit protection

Thermal overload protection of the drive and the input and motor cables

The drive protects itself and the input and motor cables against thermal overload when the cables are dimensioned according to the nominal current of the drive. No additional thermal protection devices are needed.



WARNING! If the drive is connected to multiple motors, a separate thermal overload switch or a circuit breaker must be used for protecting each cable and motor. These devices may require a separate fuse to cut off the short-circuit current.

Thermal overload protection of the motor

According to regulations, the motor must be protected against thermal overload and the current must be switched off when overload is detected. The drive includes a motor thermal protection function that protects the motor and switches off the current when necessary. Depending on a drive parameter value, the function either monitors a calculated temperature value (based on a motor thermal model) or an actual temperature indication given by motor temperature sensors. The user can tune the thermal model further by feeding in additional motor and load data.

The most common temperature sensors are:

- motor sizes IEC180...225: thermal switch (e.g. Klixon)
- motor sizes IEC200...250 and larger: PTC or Pt100.

See [Group 30: FAULT FUNCTIONS](#) on page 170 for more information on the motor thermal protection by the software and [Group 35: MOTOR TEMP MEAS](#) on page 180 for the connection and use of the temperature sensors.

Protection against short-circuit in the motor and motor cable

The drive protects the motor cable and motor in a short-circuit situation when the motor cable is dimensioned according to the nominal current of the drive. No additional protection devices are needed.

Protection against short-circuit inside the drive or in the supply cable

Arrange the protection according to the following guidelines.

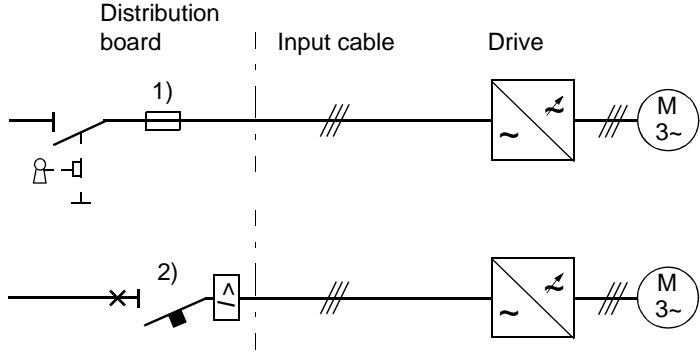
| Circuit diagram | Short-circuit protection |
|--|--|
|  <p>The diagram illustrates two protection configurations. The top configuration shows a distribution board on the left with a switch and a fuse labeled '1)'. A vertical dashed line separates this from the 'Input cable' section. The bottom configuration shows a distribution board on the left with a switch and a circuit breaker labeled '2)'. A vertical dashed line separates this from the 'Input cable' section. Both configurations show the 'Drive' connected to a 3-phase motor (M 3~).</p> | <p>Protect the drive and input cable with fuses or a circuit breaker. See footnotes 1) and 2).</p> |

- 1) Size the fuses according to instructions given in section [Fuses and circuit breakers](#) on page 295. The fuses will protect the input cable in short-circuit situations, restrict drive damage and prevent damage to adjoining equipment in case of a short-circuit inside the drive.
- 2) Circuit breakers which have been tested by ABB with the ACS550 can be used. Fuses must be used with other circuit breakers. See section [Fuses and circuit breakers](#) on page 295.

The protective characteristics of circuit breakers depend on the type, construction and settings of the breakers. There are also limitations pertaining to the short-circuit capacity of the supply network.



WARNING! Due to the inherent operating principle and construction of circuit breakers, independent of the manufacturer, hot ionized gases may escape from the breaker enclosure in case of a short-circuit. To ensure safe use, special attention must be paid to the installation and placement of the breakers. Follow the manufacturer's instructions.

Note: Circuit breakers must not be used without fuses in the USA.

Ground fault protection

The drive is equipped with an internal ground fault protective function to protect the drive against ground faults in the motor and the motor cable. This is not a personal safety or a fire protection feature. The ground fault protective function can be disabled with parameter 3017 EARTH FAULT.

The EMC filter of the drive includes capacitors connected between the main circuit and the frame. These capacitors and long motor cables increase the ground leakage current and may cause fault current circuit breakers to function.

Emergency stop devices

For safety reasons, install the emergency stop devices at each operator control station and at other operating stations where emergency stop may be needed.

Note: Pressing the stop key () on the control panel of the drive does not generate an emergency stop of the motor or separate the drive from dangerous potential.

Selecting the power cables

General rules

Dimension the mains (input power) and motor cables **according to local regulations:**

- The cable must be able to carry the drive load current. See section [Ratings](#) on page [293](#) for the rated currents.
- The cable must be rated for at least 70 °C maximum permissible temperature of conductor in continuous use. For US, see [Additional US requirements](#) on page [22](#).
- The inductance and impedance of the PE conductor/cable (grounding wire) must be rated according to permissible touch voltage appearing under fault conditions (so that the fault point voltage will not rise excessively when a ground fault occurs).
- 600 V AC cable is accepted for up to 500 V AC covering the whole ACS550 range.

Symmetrical shielded cables must be used for the input and motor cables (see the figure below). A four-conductor system cannot be used.

Compared to a four-conductor system, the use of symmetrical shielded cable reduces electromagnetic emission of the whole drive system as well as the stress on motor insulation, bearing currents and wear.

The motor cable and its PE pigtail (twisted shield) should be kept as short as possible in order to reduce electromagnetic emission (see details in section [Power cable connection diagram](#) on page [36](#)).

Motor cable shield

To effectively suppress radiated and conducted radio-frequency emissions, the shield conductivity must be at least 1/10 of the phase conductor conductivity. The requirements are easily met with a copper or aluminium shield. The minimum requirement of the motor cable shield of the drive is shown below. It consists of a

concentric layer of copper wires. The better and tighter the shield, the lower the emission level and bearing current.

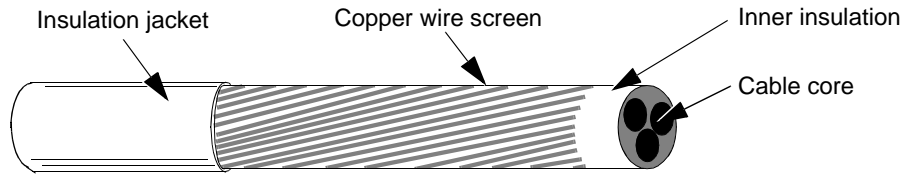

Additional US requirements

Type MC continuous corrugated aluminum armor cable with symmetrical grounds or shielded power cable must be used for the motor cables if metallic conduit is not used. For the North American market, 600 V AC cable is accepted for up to 500 V AC. For drives rated over 100 amperes, the power cables must be rated for 75 °C (167 °F).

Conduit

Where conduits must be coupled together, bridge the joint with a ground conductor bonded to the conduit on each side of the joint. Bond the conduits also to the drive enclosure. Use separate conduits for input power, motor and control wiring. Do not run motor wiring from more than one drive in the same conduit.

Armored cable / shielded power cable

The motor cables can be run in the same cable tray as other 460 V power wiring. Control and signal cables must not be run in the same tray as power cables. Six conductor (3 phases and 3 ground) type MC continuous corrugated aluminum armor cable with symmetrical grounds is available from the following suppliers (trade names in parentheses):

- Anixter Wire & Cable (Philsheath)
- BICC General Corp (Philsheath)
- Rockbestos Co. (Gardex)
- Oaknite (CLX).

Shielded power cables are available from Belden, Lapp Kabel (ÖLFLEX) and Pirelli.

Power factor compensation capacitors

Power factor compensation is not needed with AC drives. However, if a drive is to be connected in a system with compensation capacitors installed, note the following restrictions.



WARNING! Do not connect power factor compensation capacitors or surge absorbers to the motor cables (between the drive and the motor). They are not meant to be used with AC drives and can cause permanent damage to the drive or themselves.

If there are power factor compensation capacitors in parallel with the three phase input of the drive:

1. Do not connect a high-power capacitor to the power line while the drive is connected. The connection will cause voltage transients that may trip or even damage the drive.
2. If capacitor load is increased/decreased step by step when the AC drive is connected to the power line: Ensure that the connection steps are low enough not to cause voltage transients that would trip the drive.
3. Check that the power factor compensation unit is suitable for use in systems with AC drives, i.e. harmonic generating loads. In such systems, the compensation unit should typically be equipped with a blocking reactor or harmonic filter.

Equipment connected to the motor cable

Installation of safety switches, contactors, connection boxes, etc.

To minimize the emission level when safety switches, contactors, connection boxes or similar equipment are installed in the motor cable (i.e. between the drive and the motor):

- EU: Install the equipment in a metal enclosure with 360 degrees grounding for the screens of both the incoming and outgoing cable, or connect the screens of the cables otherwise together.
- US: Install the equipment in a metal enclosure in a way that the conduit or motor cable shielding runs consistently without breaks from the drive to the motor.

Bypass connection



WARNING! Never connect the supply power to the drive output terminals U2, V2 and W2. If frequent bypassing is required, employ mechanically connected switches or contactors. Mains (line) voltage applied to the output can result in permanent damage to the drive.

Before opening a contactor, sensorless vector control (SVC) mode selected

If an output isolator or contactor is used, supply either stop signal or RUN ENABLE (see parameter 1601) signal from an auxiliary contact of the isolator to the drive, in order to make sure that the drive will coast to stop immediately when the isolator opens. Improper use of the isolator may damage the drive and the isolator itself.

Protecting the relay output contacts and attenuating disturbances in case of inductive loads

Inductive loads (relays, contactors, motors) cause voltage transients when switched off.

It is highly recommended to equip inductive loads with noise attenuating circuits [varistors, RC filters (AC) or diodes (DC)] in order to minimize the EMC emission at switch-off. If not suppressed, the disturbances may connect capacitively or inductively to other conductors in the control cable and form a risk of malfunction in other parts of the system.

Install the protective component as close to the inductive load as possible. Do not install protective components at the control board terminal block.

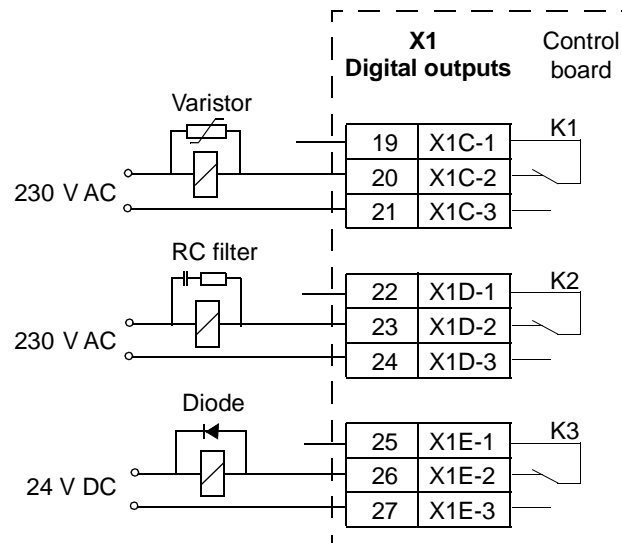

Selecting the control cables

All control cables must be shielded.

Use a double-shielded twisted pair cable (Figure a, e.g. JAMAK by Draka NK Cables) for analog signals. This type of cable is recommended for the pulse encoder signals also. Employ one individually shielded pair for each signal. Do not use common return for different analog signals.

A double-shielded cable is the best alternative for low-voltage digital signals but single-shielded twisted multipair cable (Figure b) is also usable.

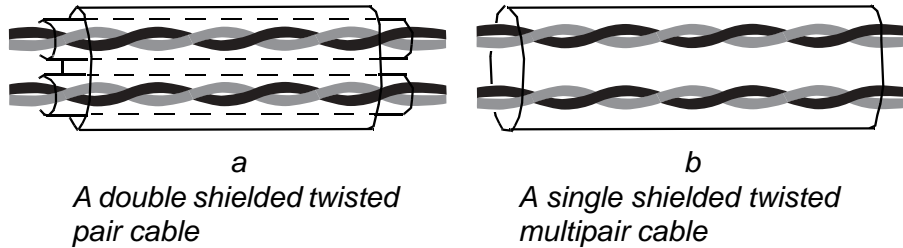

Run analog and digital signals in separate, shielded cables.

Relay-controlled signals, providing their voltage does not exceed 48 V, can be run in the same cables as digital input signals. It is recommended that the relay-controlled signals be run as twisted pairs.

Note: Never mix 24 V DC and 115 / 230 V AC signals in the same cable.

Note: Never ground control cables at both ends.

Relay cable

The cable type with braided metallic screen (e.g. ÖLFLEX by Lapp Kabel) has been tested and approved by ABB.

Control panel cable

In remote use, the cable connecting the control panel to the drive must not exceed 3 metres (10 ft). The cable type tested and approved by ABB is used in control panel option kits.

Connection of a motor temperature sensor to the drive I/O



WARNING! IEC 60664 requires double or reinforced insulation between live parts and the surface of accessible parts of electrical equipment which are either non-conductive or conductive but not connected to the protective earth.

To fulfill this requirement, the connection of a thermistor (and other similar components) to the digital inputs of the drive can be implemented in three alternate ways:

1. There is double or reinforced insulation between the thermistor and live parts of the motor.
2. Circuits connected to all digital and analog inputs of the drive are protected against contact and insulated with basic insulation (the same voltage level as the drive main circuit) from other low voltage circuits.
3. An external thermistor relay is used. The insulation of the relay from measuring circuit to output contact must be rated for the same voltage level as the main circuit of the drive.

Routing the cables

Route the motor cable away from other cable routes. Motor cables of several drives can be run in parallel installed next to each other. It is recommended that the motor cable, input power cable and control cables be installed on separate trays. Avoid long parallel runs of motor cables with other cables in order to decrease electromagnetic interference caused by the rapid changes in the drive output voltage.

Where control cables must cross power cables make sure they are arranged at an angle as near to 90 degrees as possible.

The cable trays must have good electrical bonding to each other and to the grounding electrodes. Aluminium tray systems can be used to improve local equalizing of potential.

A diagram of the cable routing is below.

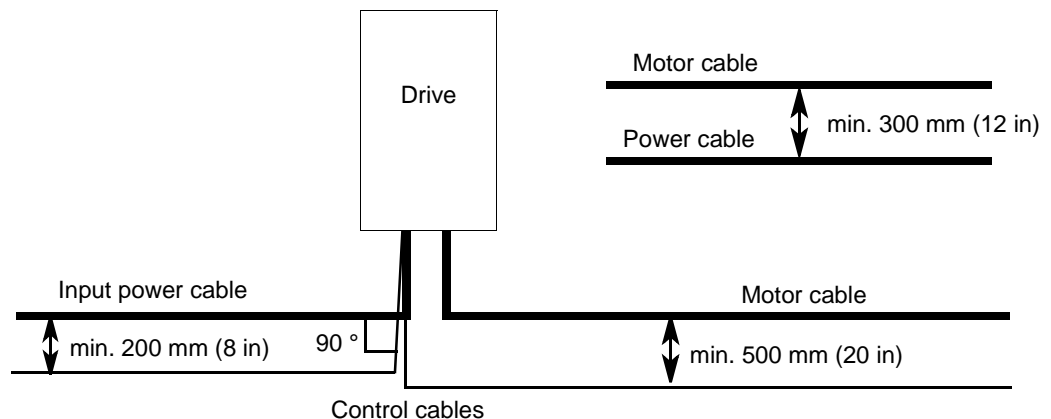

Installation



WARNING! Only qualified electricians are allowed to carry out the work described in this chapter. Follow the instructions in chapter [Safety](#) on page 5. Ignoring the safety instructions can cause injury or death.

Note: *ACS550-U2 Installation Supplement* [3AUA0000004067 (English)] provides more information about the installation of ACS550-U2 drives.

Moving the drive

Move the transport package by pallet truck to the installation site. Unpack the package as shown below.



Lifting when the enclosure extension is included

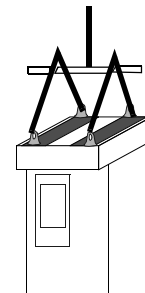



WARNING! The drive is heavy [frame size R7: 115 kg (254 lb), frame size R8: 230 kg (507 lb)]. Lift the drive by the upper part only using the lifting lugs attached to the top of the drive. The lower part will be deformed if used for lifting. Do not remove the pedestal before lifting.

Do not tilt the drive. The centre of gravity of the drive is high. The drive will overturn from a tilt of about 6 degrees. Frame size R8 drives are equipped with support legs to prevent tilting. They must be locked to the open position during the installation and always when wheeling the drive.

Do not wheel the drive except for installation (the front direction is preferable because the front wheels are steadier). The drive frame may be deformed if wheeled when the pedestal is removed. If the drive is moved over long distances, place it on its back on a pallet and move it by fork-lift.

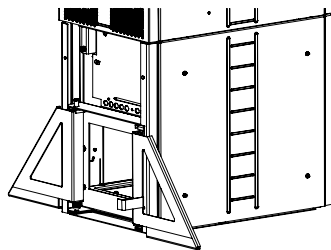
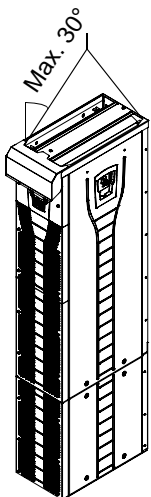
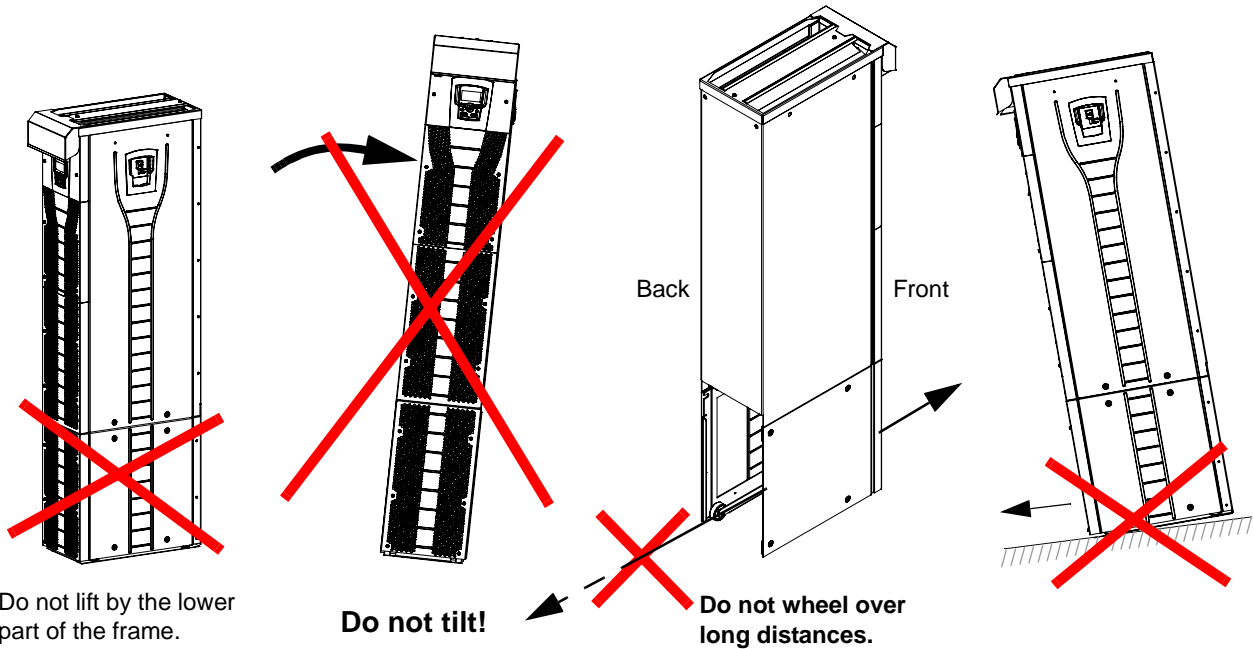

Frame size R8:
Log the support legs open during the installation and always when wheeling the drive.

Before installation

Delivery check

The drive is delivered in a box that also contains:

- appropriate user's manual
- optional module manuals
- delivery documents.

Check that there are no signs of damage. Before attempting installation and operation, check the information on the type designation label of the drive to verify that the drive is of the correct type.

Drive identification

Drive labels

To determine the type of drive you are installing, refer to either:

- serial number label attached inside the drive, or



- type code label attached under the front visor.



Type code

Use the following chart to interpret the type code found on both the type code and the serial number label.

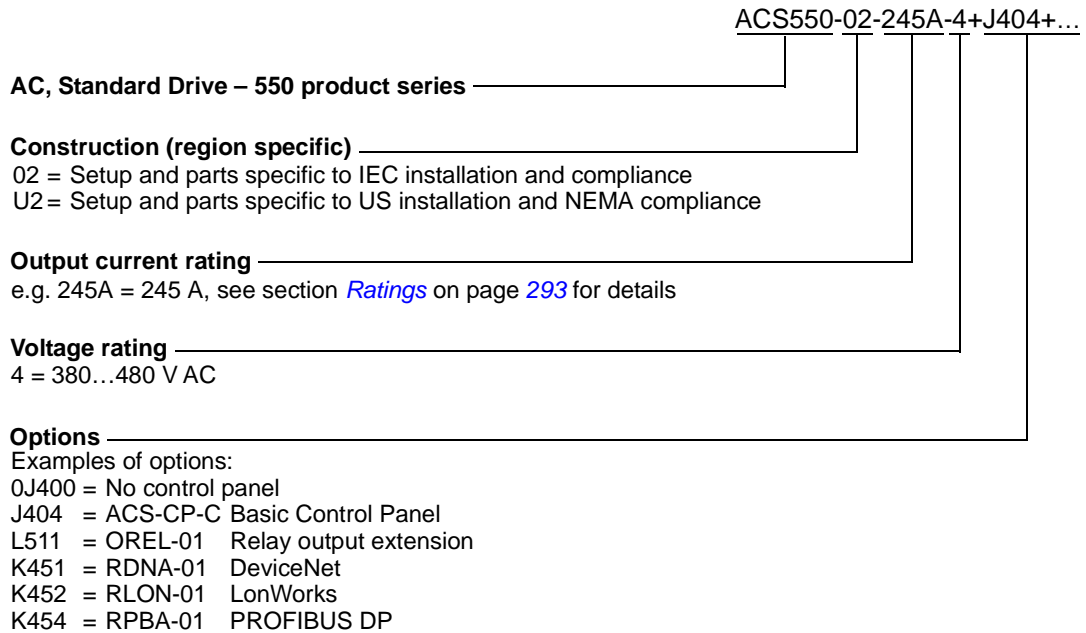

Ratings and frame size

The chart in section [Ratings](#) on page 293 lists technical specifications and identifies the drive's frame size – significant, since some instructions in this document vary, depending on the drive's frame size. To read the ratings table, you need the “Output current rating” entry from the type code. Also, when using the ratings table, note that the table is broken into sections based on the drive's “Construction”(02 or U2).

Serial number

The format of the drive serial number shown on the labels is described below.

Serial number is of format CYYWWXXXXX, where

C: Country of manufacture

YY: Year of manufacture

WW: Week of manufacture; 01, 02, 03, ... for week 1, week 2, week 3, ...

XXXXX: Integer starting every week from 0001.

Requirements for the installation site

The drive must be installed in an upright position on the floor (or wall). Check the installation site according to the requirements below. Refer to section [Dimension drawings](#) on page 308 for frame details. See section [Ambient conditions](#) on page 303 for the allowed operation conditions of the drive.

Floor

The floor/material below the drive must be non-flammable. The floor must be horizontal.

Wall

The wall/material near the drive must be non-flammable. Check that there is nothing on the wall to inhibit the installation.

If the drive is mounted on the wall, the wall must be as close to vertical as possible, and strong enough to carry the weight of the drive. The drive must not be installed without the pedestal on the wall.

Free space around the drive

See section [Choose the mounting orientation \(a, b, or c\)](#) on page 37.

Cooling air flow

Provide the drive with the amount of fresh cooling air given in section [Ratings](#) on page 293.

The cooling air will enter the drive from the front air grating and flow upwards inside the drive. Recirculating cooling air into the drive is not allowed.

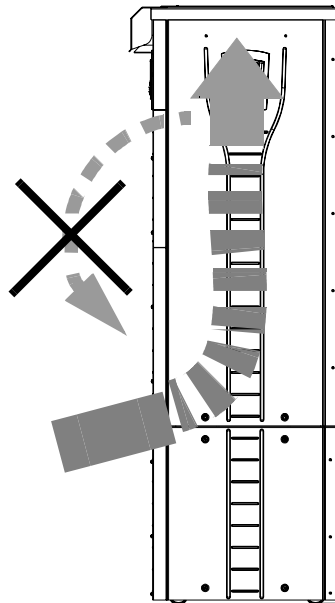

IT (ungrounded) systems

The drive is suitable for IT (ungrounded) systems, but you have to disconnect the EMC filter (frame size R7) and varistor (frame sizes R7 and R8) before connecting the drive to an IT system. See the following sections for how to do this.

- [Disconnecting the EMC filter on IT \(ungrounded\) and corner grounded TN systems \(frame size R7 only\)](#) on page 44
- [Disconnecting the varistor on IT \(ungrounded\) and corner grounded TN systems \(frame size R7\)](#) on page 45
- [Disconnecting the varistor on IT \(ungrounded\) and corner grounded TN systems \(frame size R8\)](#) on page 46



WARNING! If a drive with its EMC filter (frame size R7) or varistor (frame sizes R7 and R8) connected is installed on an IT system [an ungrounded power system or a high resistance-grounded (over 30 ohm) power system], the system will be connected to earth potential through the EMC filter capacitors or varistor. This may cause danger or damage the drive.

Required tools

- set of screw drivers
- torque wrench with 500 mm (20 in) or 2 x 250 mm (2 x 10 in) extension bar
- 19 mm (3/4 in) socket
for frame size R7: 13 mm (1/2 in) magnetic end socket
for frame size R8: 17 mm (11/16 in) magnetic end socket.

Checking the insulation of the installation

Drive

Do not make any voltage tolerance or insulation resistance tests (e.g. hi-pot or megger) on any part of the drive as testing can damage the drive. Every drive has been tested for insulation between the main circuit and the chassis at the factory. Also, there are voltage-limiting circuits inside the drive which cut down the testing voltage automatically.

Input cable

Check the insulation of the input cable according to local regulations before connecting it to the drive.

Motor and motor cable

Check the insulation of the motor and motor cable as follows:

1. Check that the motor cable is connected to the motor, and disconnected from the drive output terminals U2, V2 and W2.
2. Measure the insulation resistance between each phase conductor and the Protective Earth conductor using a measuring voltage of 500 V DC. The insulation resistance of an ABB motor must exceed 10 Mohm (reference value at 25 °C or 77 °F). For the insulation resistance of other motors, please consult the manufacturer's instructions.

Note: Moisture inside the motor casing will reduce the insulation resistance. If moisture is suspected, dry the motor and repeat the measurement.

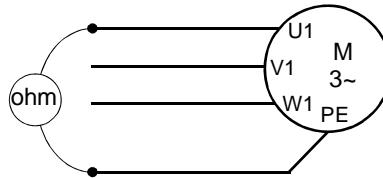

Power cable connection diagram

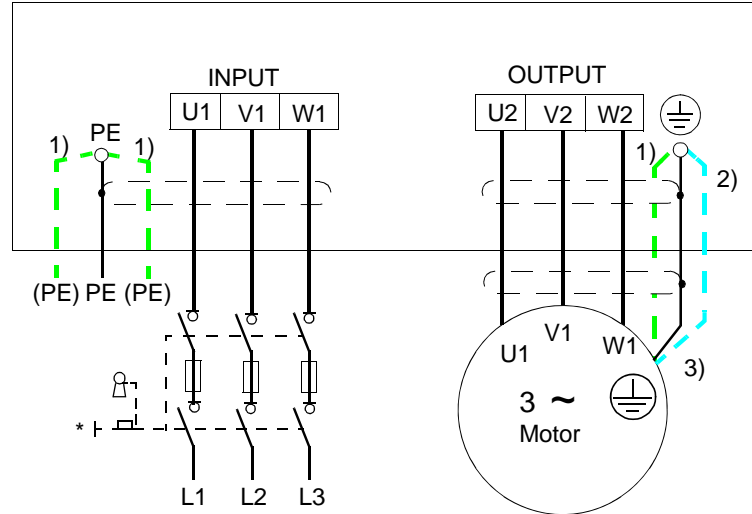

Ground the other end of the input cable shield / PE conductor at the distribution board.

- 1) An alternative to the grounding of the drive and the motor through the cable shield or armour
Note: Connecting the fourth conductor of the motor cable at the motor end increases bearing currents and causes extra wear.
- 2) Used if the conductivity of the cable shield is $< 50\%$ of the conductivity of the phase conductor.
- 3) For minimum radio frequency interference at the motor end:
 - ground the cable shield 360 degrees at the lead-through of the motor terminal box

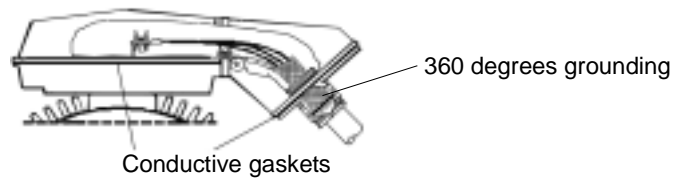

- or ground the cable by twisting the shield as follows: flattened width $\geq 1/5 \cdot$ length. In the figure below, $b \geq 1/5 \cdot a$.

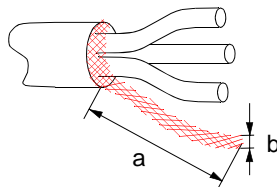

Installation procedure

Choose the mounting orientation (a, b, or c)

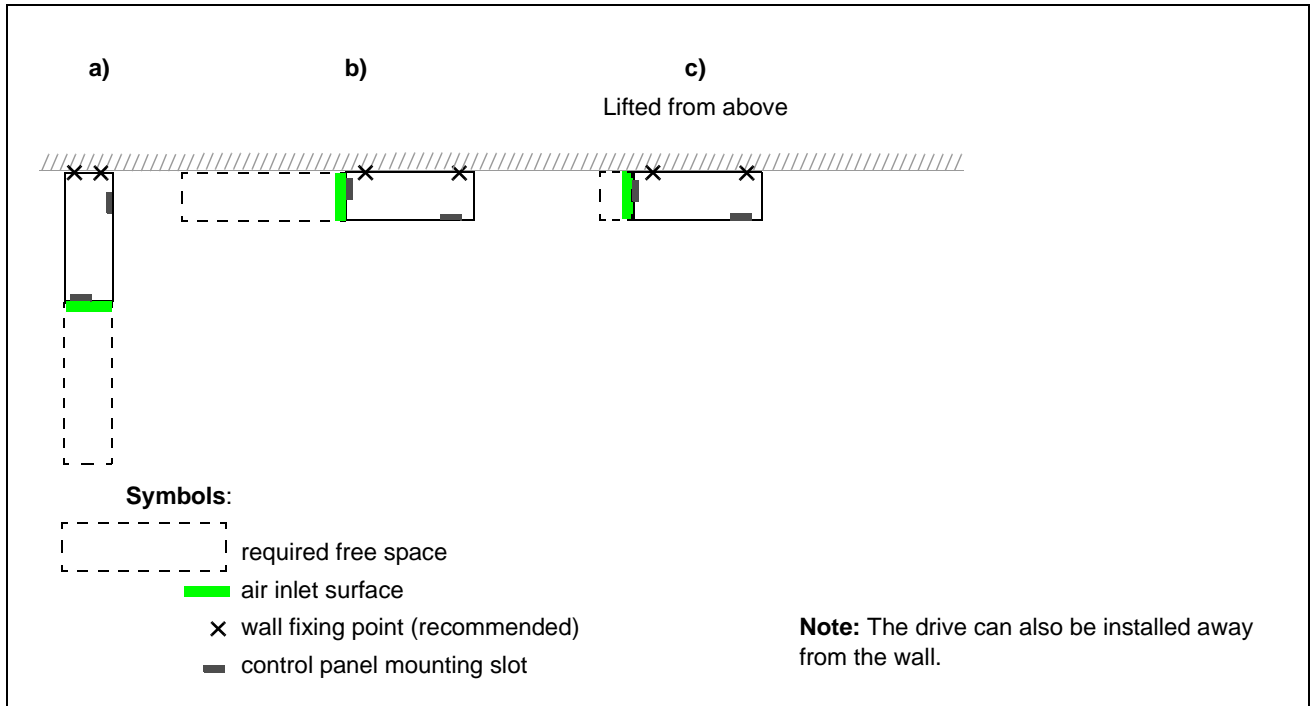

| Frame size | Mounting orientation | Required free space around the drive for mounting, maintenance, service and cooling * | | | | | |
|------------|----------------------|---|----|-------|-------|---------------|---------------|
| | | Front | | Side | | Above | |
| | | mm | in | mm | in | mm | in |
| R7 | a | 500 | 20 | - | - | 200 | 7.9 |
| | b | - | - | 500 | 20 | 200 | 7.9 |
| | c | - | - | 200** | 7.9** | lifting space | lifting space |
| R8 | a | 600 | 24 | - | - | 300 | 12 |
| | b | - | - | 600 | 24 | 300 | 12 |
| | c | - | - | 300** | 12** | lifting space | lifting space |

* space for the installer not included

** space for fan and capacitor replacement not included

Preparing the mounting location on concrete floor

Bare (concrete) floor where cables come through openings made on the floor below the drive. The floor or floor material of the installation place should not be flammable.

1. Lift the drive against the wall into the mounting place.
2. Mark the locations for the two fixing points in the wall.
3. Mark the bottom edges of the drive to the floor.

Preparing the mounting location on a cable channel

In this case there are various ways how to fix the drive onto the channel.

1. Check that there is a place for the fixing holes.
2. Check that there is space under the lead-through plate for the cables.

Preparing the mounting location on a raised floor

This method is used in cases when several drives are located in the same space close to each other. The pedestal is constructed normally on-site.

1. Check that there is a place for the fixing holes.
2. Check that the route is free for the main cables.

Preparing the mounting location against a wall

Because of its weight it is not recommended to mount the drive on a wall but it can be fastened on a wall for additional support.

1. Lift the drive against the wall into the mounting place.
2. Check that the cable openings through the floor are in an appropriate place.
3. Mark the bottom edges of the drive to the floor.
4. Mark the locations of the two fixing points on the wall.

Installation, orientation a or b

Removing the pedestal (frame size R7)

1. Remove the lower front covers by undoing the fixing screws.
2. Undo the red screws that fix the pedestal to the frame from front.
3. Undo the red M8 combi screws (6 pcs) that connect the busbars of the pedestal to the upper frame. Use a torque wrench with an extension bar.
4. Wheel the frame out by using the handle.

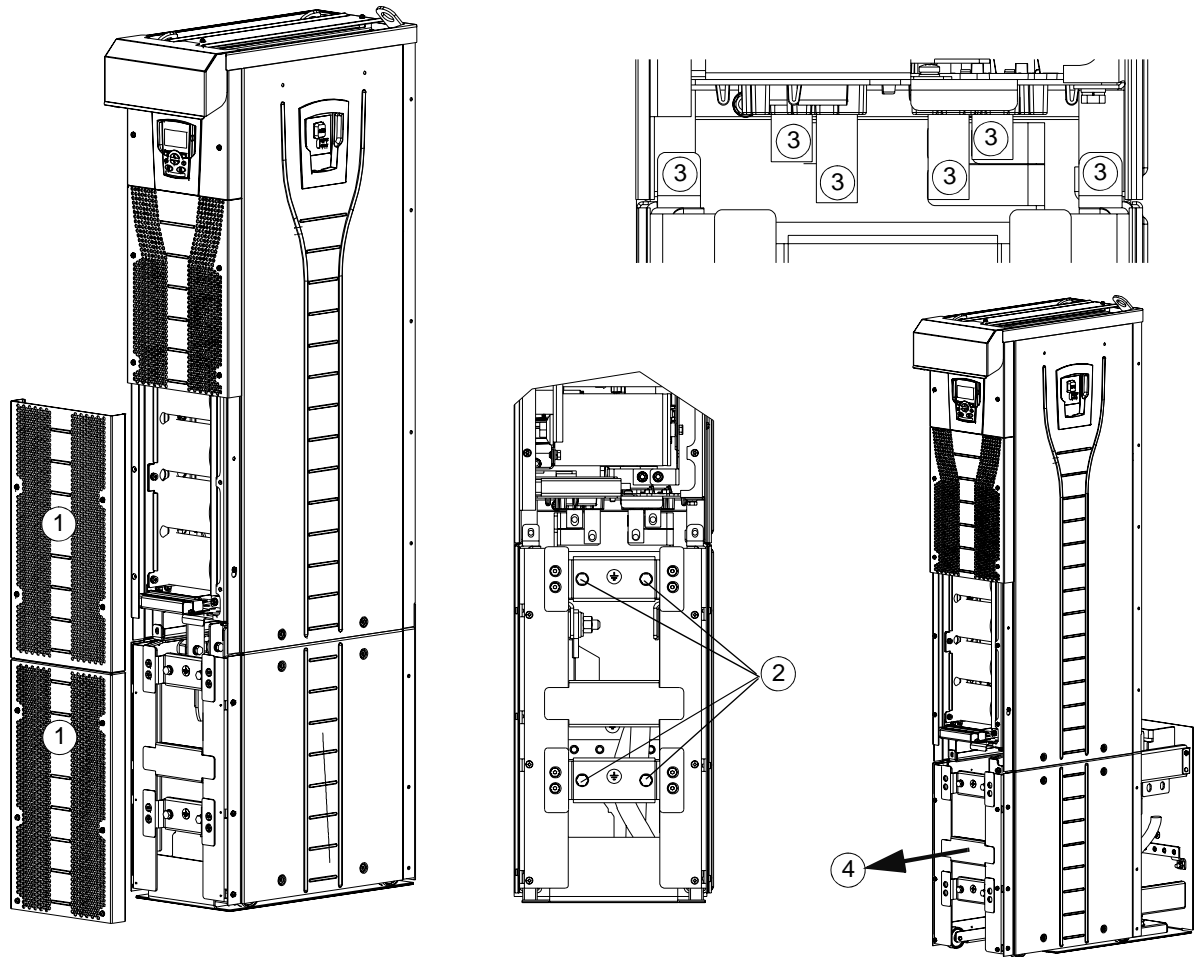

Wheeling the frame out

Removing the pedestal (frame size R8)

1. Remove the lower front covers by undoing the fixing screws.
2. Press the left support leg a little down and turn it left. Let it lock down. Turn the right leg aside in the same way. The legs will prevent the drive from falling down during the installation.
3. Undo the screws that fix the pedestal to the frame from front.
4. Undo the screws that connect the busbars of the pedestal to the upper frame. Use a torque wrench with an extension (see the figure on page 41).
5. Wheel the drive frame out by using the handle (see the figure on page 41).

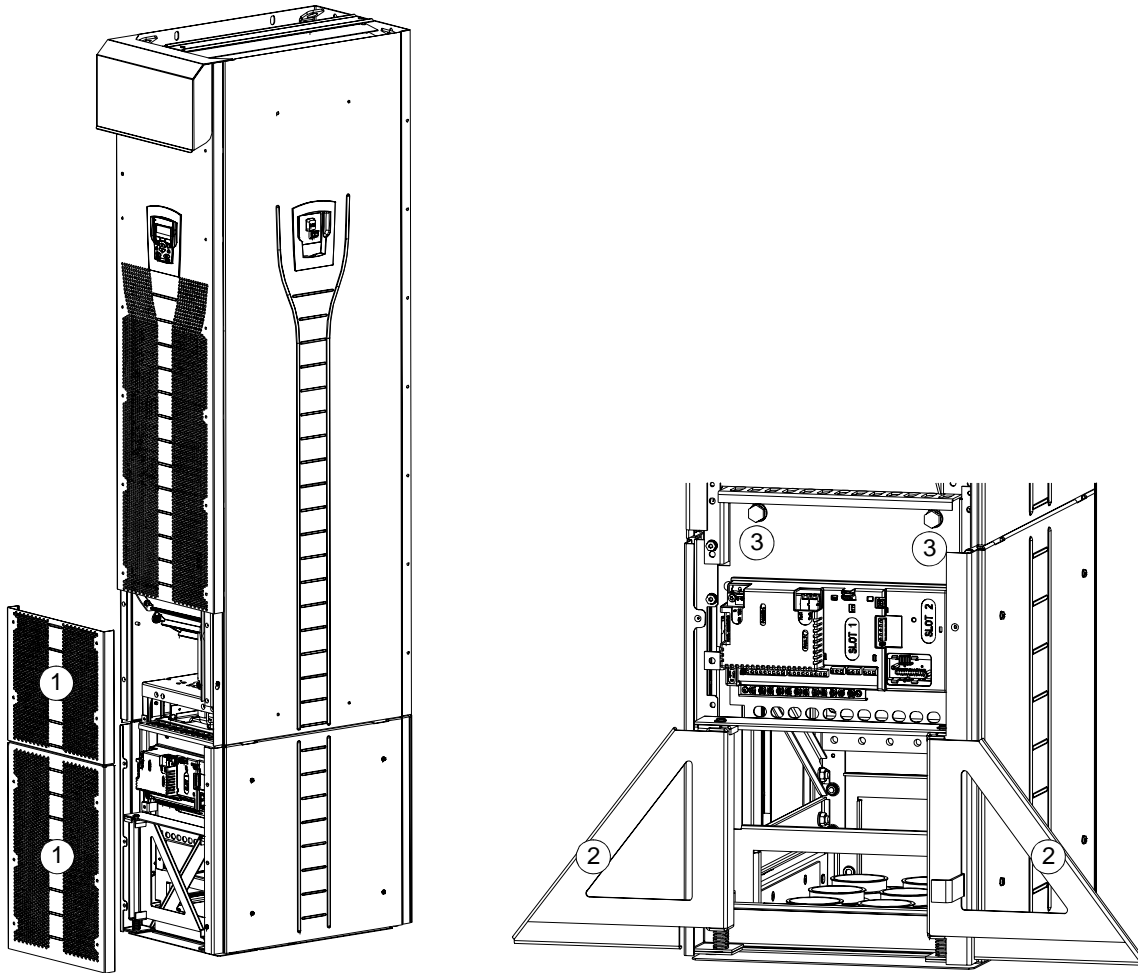

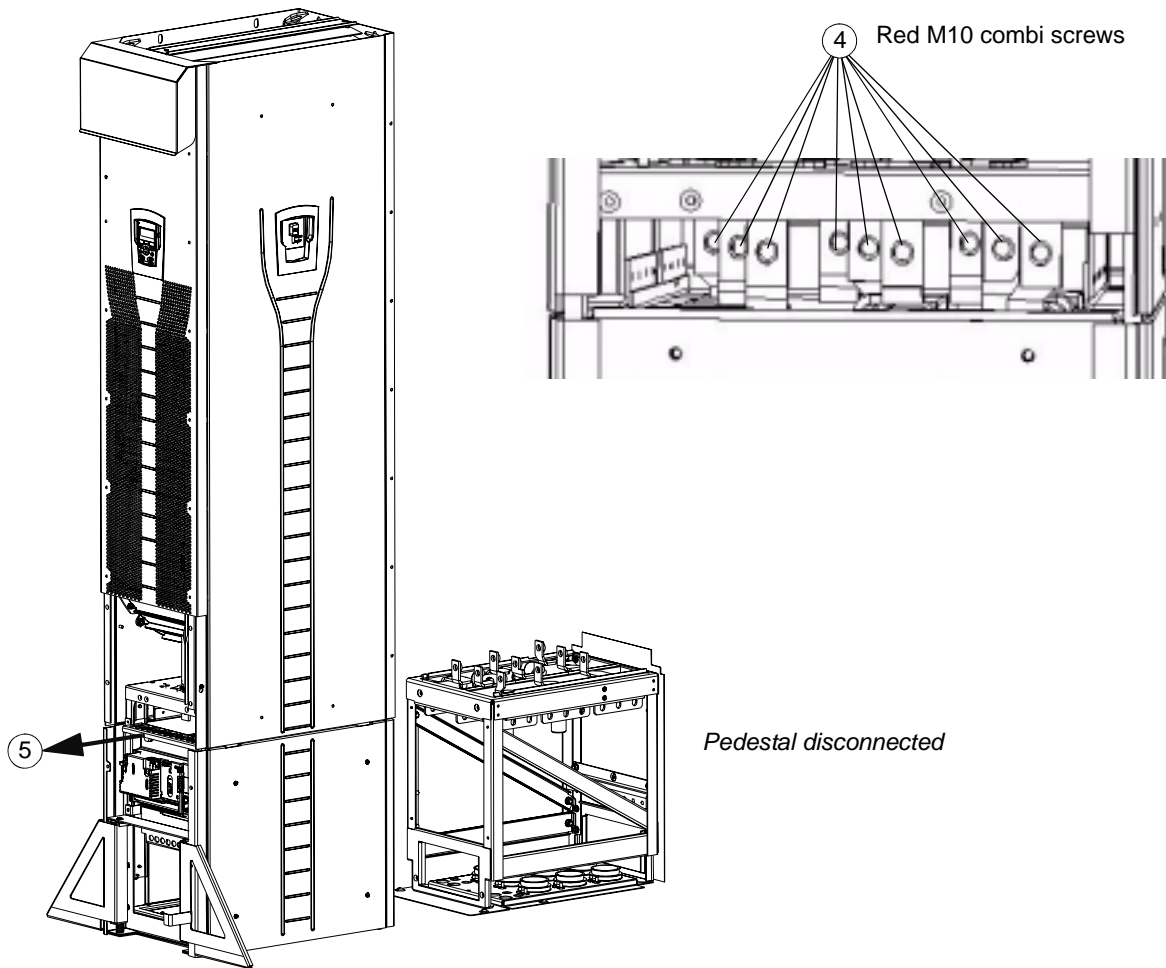

Fixing the lead-through plate to the floor

1. Make a hole in the floor or cable conduit cover below the lead-through. See section [Dimension drawings](#) on page 308
2. Check that the floor is horizontal with a spirit level.
3. Fasten the lead-through plate to the floor with screws or bolts. You can also lead the cables through the plate first (see steps [Leading the power \(input and motor\) cables through the lead-through plate](#) on page 47 and [Leading the control cables through the lead-through plate](#) on page 49) and fasten the plate to the floor after that, if the cabling procedure is more convenient in that way.

Note: These screws/bolts are also used to fix the pedestal to the lead-through plate, so you will have to remove and refasten them later on when the pedestal is fixed.

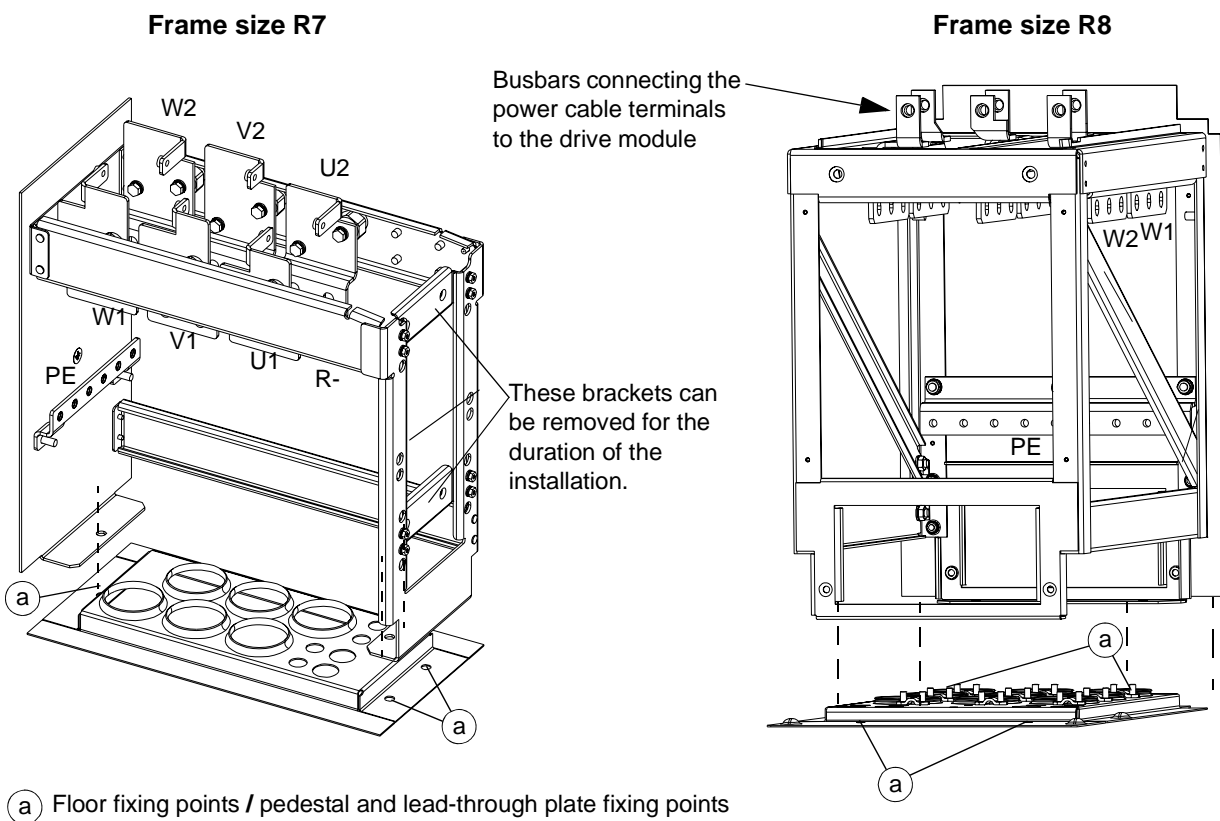

Removing the EMC screen from the pedestal (frame size R7 only)

1. Remove the EMC screen by undoing the five fastening screws.

Note: The screen must be replaced when the cables have been connected. Tightening torque of the fastening screws is 5 N·m (3.7 lbf·ft).

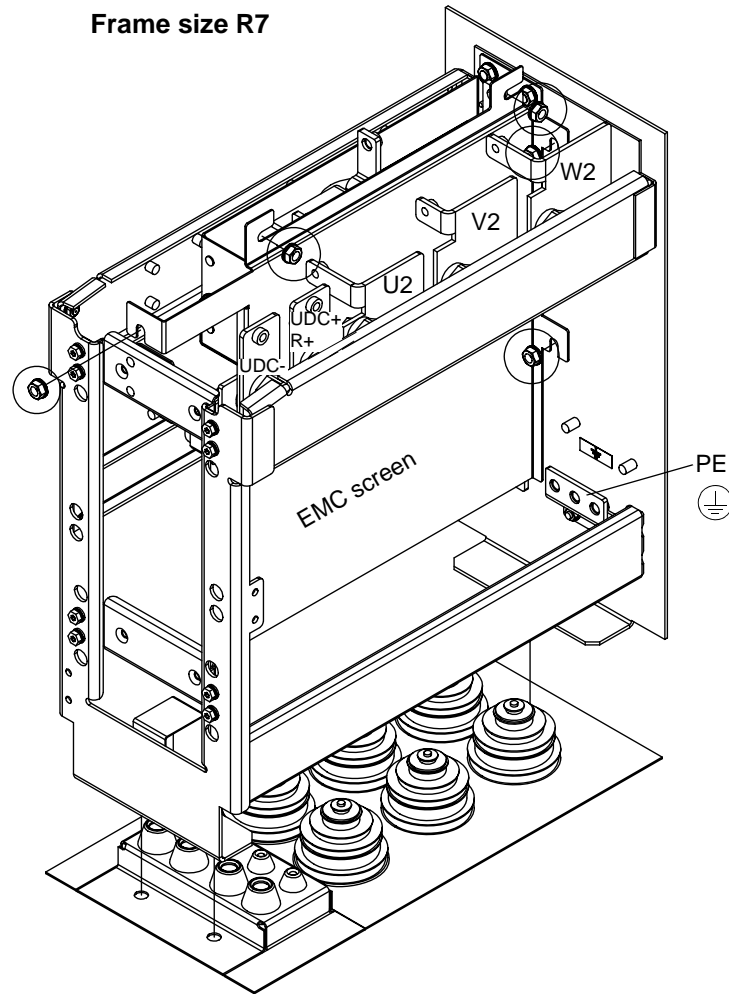

*Disconnecting the EMC filter on IT (ungrounded) and corner grounded TN systems
(frame size R7 only)*



WARNING! If a drive with its EMC filter connected is installed on an IT system [an ungrounded power system or a high resistance-grounded (over 30 ohm) power system], the system will be connected to earth potential through the EMC filter capacitors. This may cause danger or damage the drive.

If a drive with its EMC filter connected is installed on a corner grounded TN system, the drive will be damaged.

Only frame size R7 drives have an EMC filter.

1. Disconnect the EMC filter by removing the two screws shown in the figure below.

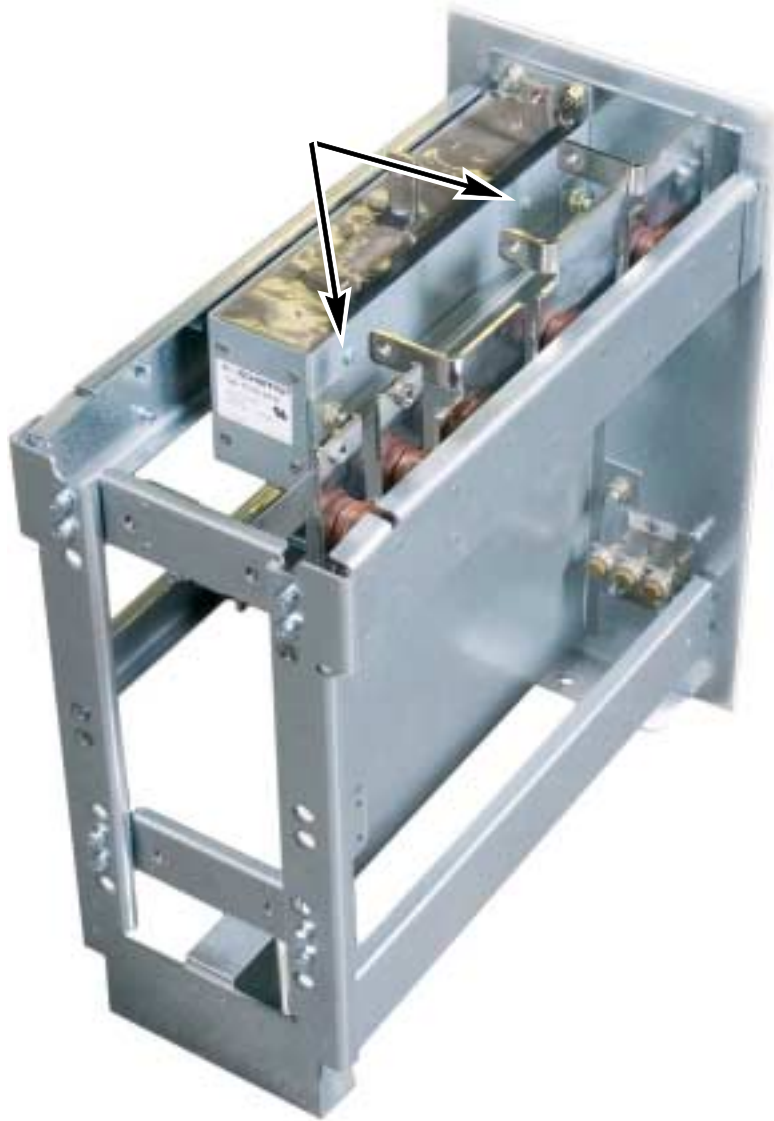

Disconnecting the varistor on IT (ungrounded) and corner grounded TN systems (frame size R7)



WARNING! If a drive with its varistor connected is installed on an IT system [an ungrounded power system or a high resistance-grounded (over 30 ohm) power system], the system will be connected to earth potential through the varistor. This may cause danger or damage the drive.

If a drive with its varistor connected is installed on a corner grounded TN system, the drive will be damaged.

1. Ensure that the power is removed from the drive.
2. Remove the upper front cover by undoing the screws.
3. Disconnect the varistor cable.

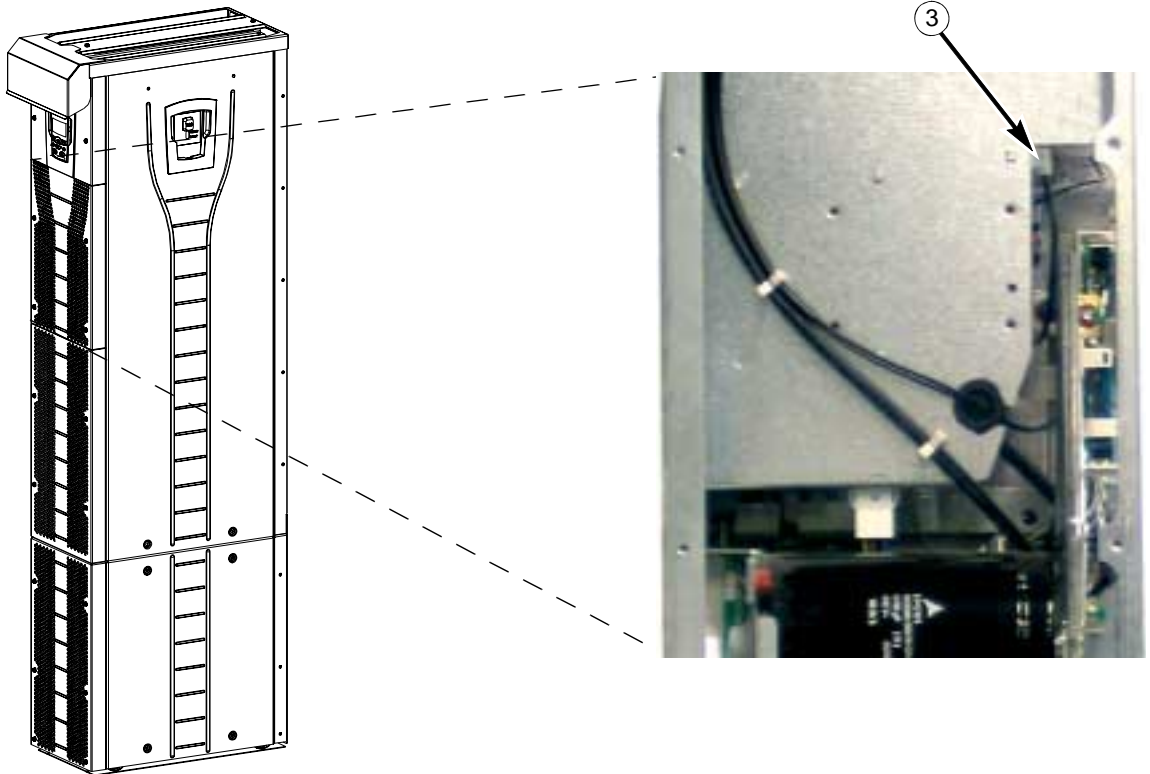

4. Fasten the front cover.

Disconnecting the varistor on IT (ungrounded) and corner grounded TN systems (frame size R8)



WARNING! If a drive with its varistor connected is installed on an IT system [an ungrounded power system or a high resistance-grounded (over 30 ohm) power system], the system will be connected to earth potential through the varistor. This may cause danger or damage the drive.

If a drive with its varistor connected is installed on a corner grounded TN system, the drive will be damaged.

1. Ensure that the power is removed from the drive.
2. Remove the upper front cover by undoing the screws.
3. Disconnect the varistor cable from the board.
4. Disconnect the other end of the varistor cable.

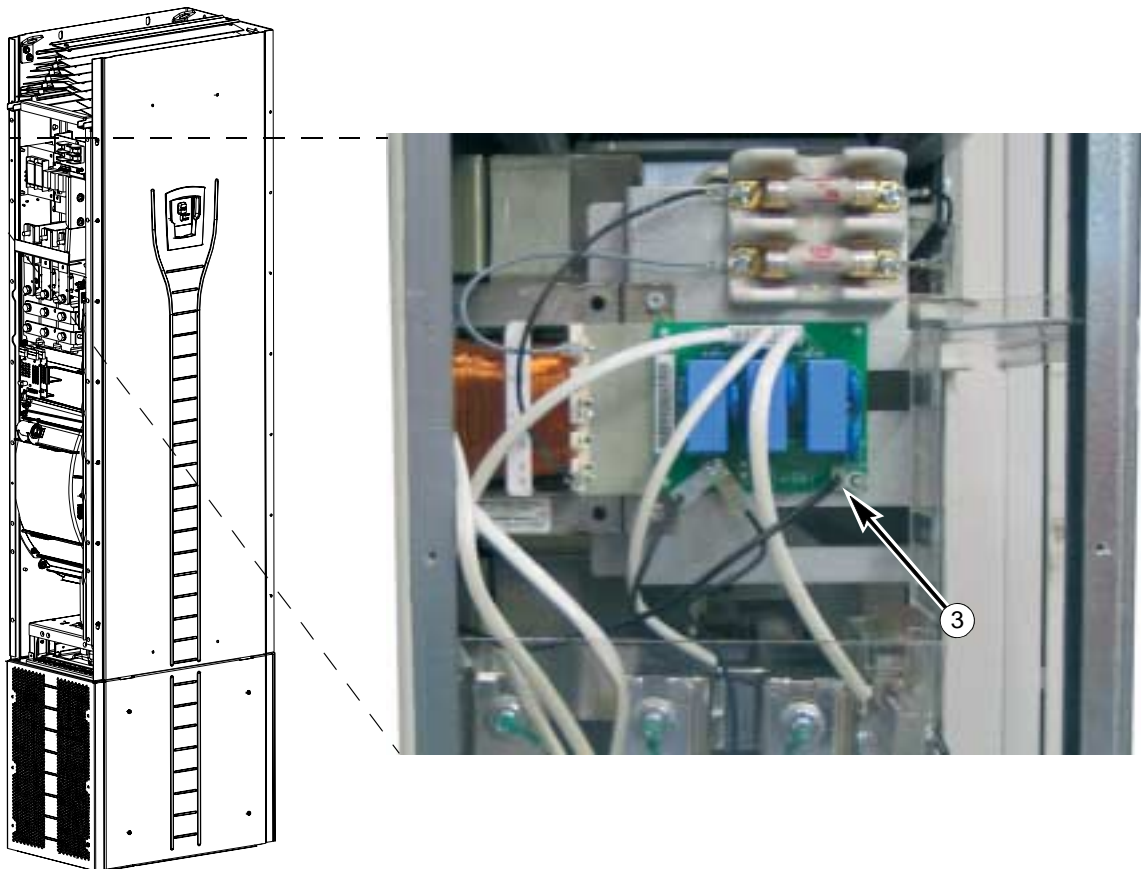

5. Fasten the front cover.

Leading the power (input and motor) cables through the lead-through plate

1. Make adequate holes in the grommets to fit them tightly on the cables.
2. Lead the cables through the holes (all three conductors of a three-phase cable through the same hole) and slide the grommets onto the cables.

Preparing the power cables

1. Strip the cables.
2. Twist the shield wires.
3. Bend the conductors to the terminals.



4. Cut the conductors to adequate length. Put the pedestal onto the lead-through plate and check the length of the conductors. Remove the pedestal.
5. Crimp or screw cable lugs onto the conductors.



WARNING! The maximum allowed width of the cable lug is 38 mm (1.5 in). Wider cable lugs may cause a short-circuit.

6. Connect the twisted shields of the cables to the PE terminal (frame size R7), or to the grounding clamps or PE terminal (frame size R8).

Note: 360 degrees grounding is not needed at the cable entry. The short twisted shield provides, in addition to the protective grounding, also sufficient disturbance suppression.

Frame size R7

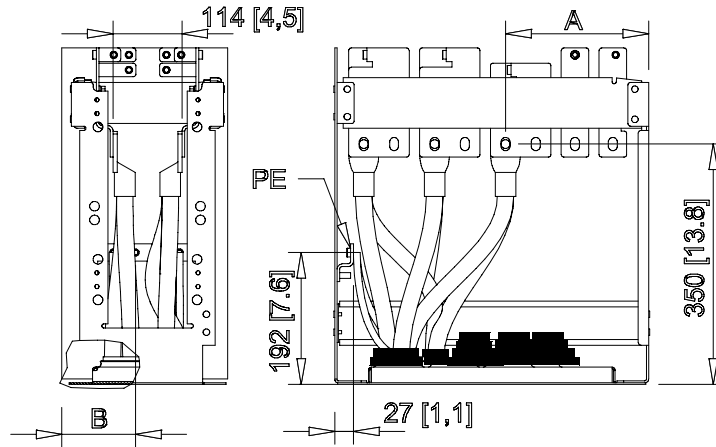

| Terminal | U1, U2 | V1, V2 | W1, W2 |
|----------------------|-----------|------------|------------|
| A (hole 1) / mm [in] | 159 [6.3] | 262 [10.3] | 365 [14.4] |
| A (hole 2) / mm [in] | 115 [4.5] | 218 [8.5] | 321 [12.6] |

| PE terminal hole | 1 | 2 | 3 | 4 | 5 | 6 |
|------------------|----------|----------|-----------|-----------|-----------|-----------|
| B / mm [in] | 43 [1.7] | 75 [3.0] | 107 [4.2] | 139 [5.5] | 171 [6.7] | 203 [8.0] |

Frame size R8

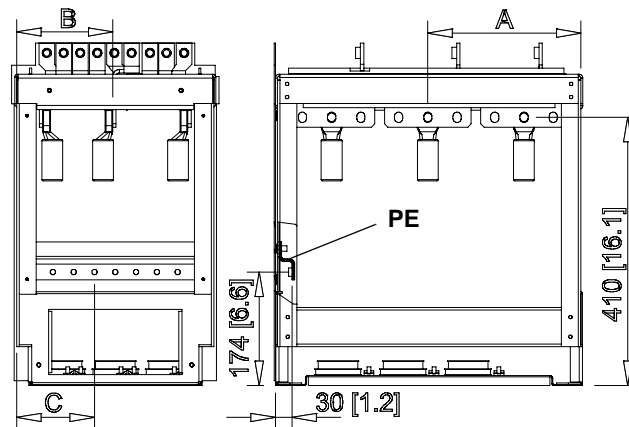

| Terminal | A | | | B | A | | | B |
|----------------------|--------|--------|--------|-----|--------|--------|--------|------|
| | Hole 1 | Hole 2 | Hole 3 | | Hole 1 | Hole 2 | Hole 3 | |
| | mm | mm | mm | | in | in | in | |
| Frame size R8 | | | | | | | | |
| U1 | 432 | 387 | 342 | 40 | 17.0 | 15.2 | 13.5 | 1.6 |
| V1 | | | | 148 | | | | 5.8 |
| W1 | | | | 264 | | | | 10.4 |
| U2 | 284 | 239 | 194 | 40 | 11.2 | 9.4 | 7.6 | 1.6 |
| V2 | | | | 148 | | | | 5.8 |
| W2 | | | | 264 | | | | 10.4 |

| PE terminal hole | 1 | 2 | 3 | 4 | 5 | 6 | 7 | 8 | 9 |
|------------------|----------|----------|----------|-----------|-----------|-----------|-----------|-----------|------------|
| C / mm [in] | 24 [0.9] | 56 [2.2] | 88 [3.5] | 120 [4.7] | 152 [6.0] | 184 [7.2] | 216 [8.5] | 248 [9.8] | 280 [11.0] |

Leading the control cables through the lead-through plate

1. Cut holes in the grommets to fit them tightly onto the control cables.
2. Lead the control cables through the lead-through plate and slide the grommets onto the cables.

Connecting the cable lugs to the pedestal

1. If the lead-through plate is fixed to the floor, undo the fixing screws.
2. Place the pedestal onto the lead-through plate.
3. Fasten the pedestal and the lead-through plate to the floor with the screws through the same holes.
4. Connect the cable lugs to the pedestal (U1, V1, W1, U2, V2, W2 and PE).
5. Tighten the connections
6. **Frame size R7:** Fasten the EMC screen between the input and motor cables as shown in the figure on page 43.

Frame size R7

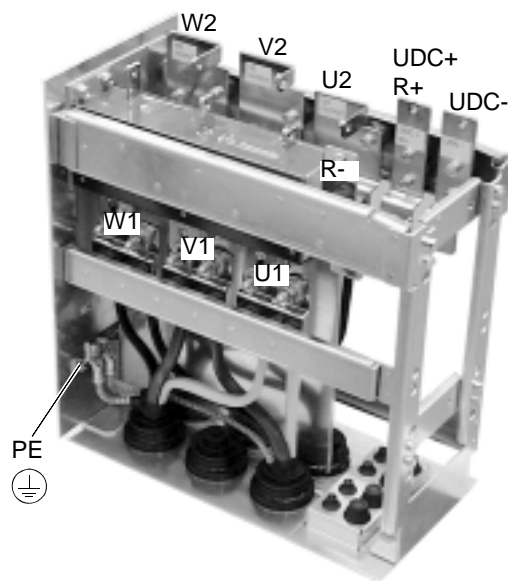

Frame sizes R7 and R8:
 M12 (1/2 in) bolt
 Tightening torque: 50...75 N·m
 (37...55 lbf·ft)

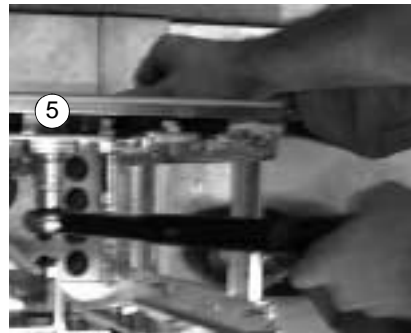
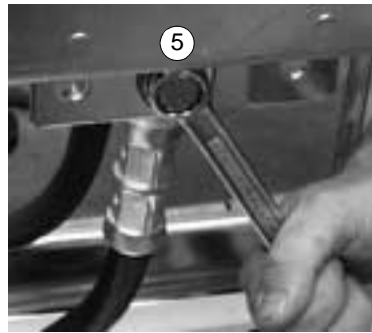

WARNING! It is not allowed to connect the cables directly to the drive module terminals. The lead-through insulation material is not strong enough to carry the mechanical stress exerted by the cables. The cable connections must be performed in the pedestal.

7. Wheel the drive frame back on the pedestal.

Fixing the pedestal to the drive frame

1. Fix the fastening screws.



WARNING! The fixing is important because the screws are required for the grounding of the drive.

2. Connect the terminals at the top of the pedestal to the terminals at the bottom of the upper part of the drive frame.



WARNING! Be careful not to drop screws inside the pedestal. Loose metal pieces inside the drive may cause damage.

3. Tighten the connections.

View of frame size R7

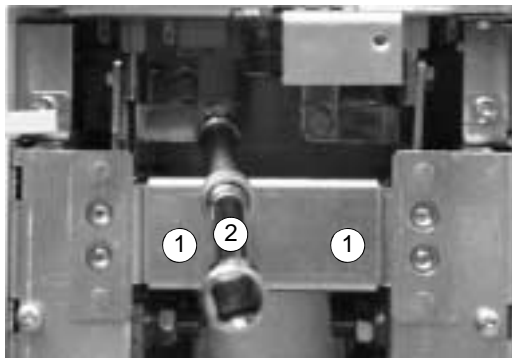
Terminal connection screws

R7: M8 (5/16 in) combi screws

Tightening torque: 15...22 N·m (11...16 lbf·ft)

R8: M10 (3/8 in) combi screws

Tightening torque: 30...44 N·m (22...32 lbf·ft)

4. Fasten the drive with screws or bolts to the holes in the wall.

Note: In mounting orientation **a** (see page 37), do not fasten the drive to a wall if it is subjected to sideways vibration.

5. Connect the control cables as described in section [Connecting the control cables](#) on page 54.

Fastening the covers

1. Connect the control panel cables.
2. Fasten the upper front cover.
3. Fasten the lower front covers.

Installation, orientation c (lifting from above)

Make the installation otherwise as described in [Installation, orientation a or b](#) on page [39](#) but leave the pedestal connected to the frame.

- Remove the lead-through plate and the lower front and side plates.
- Lift the drive frame onto the lead-through plate from above.
- Fasten the drive to the floor.
- Connect the cable lugs to the terminals.
- Fasten the lower front and side plates.
- Fasten the drive by top to the wall (recommended).

Routing the control/signal cables inside the cubicle

Frame size R7

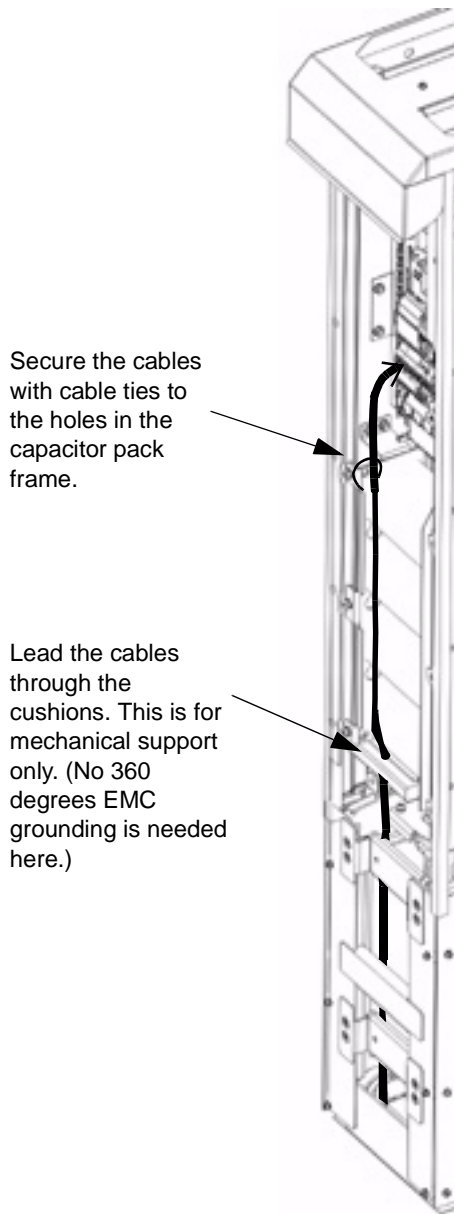

Frame size R8

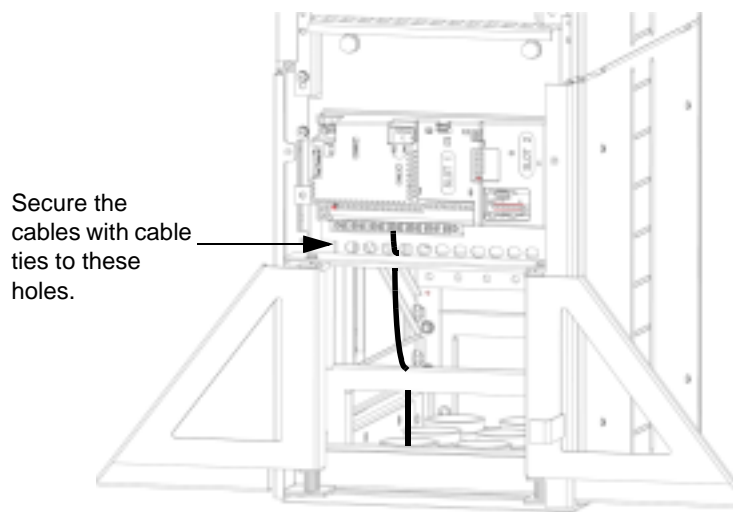











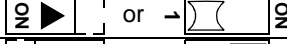



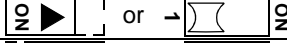

Connecting the control cables

Connect the control cables as described below. Connect the conductors to the appropriate terminals of the control board. Tighten the screws to secure the connection. Use 0.4 N·m (0.3 lbf·ft) torque for both frame sizes.

Control connections

To complete the control connections, use:

- Cable recommendations in section [Power factor compensation capacitors](#) on page [23](#)
- Table [Hardware description](#) on page [55](#)
- [ABB Standard macro](#) on page [102](#)
- [Complete parameter descriptions](#) on page [128](#)
- Embedded fieldbus: [Mechanical and electrical installation – EFB](#) on page [220](#).

| | X1 | Hardware description | |
|-----------------------------|--|---|--|
| Analog I/O | 1 | SCR Terminal for signal cable screen. (Connected internally to chassis ground.) | |
| | 2 | AI1 Analog input channel 1, programmable. Default ² = frequency reference. Resolution 0.1%, accuracy ±1%. J1:AI1 OFF: 0...10 V (R _i = 312 kΩ)  or  NO | |
| | | J1:AI1 ON: 0...20 mA (R _i = 100 Ω)  or  NO | |
| | | 3 | AGND Analog input circuit common. (Connected internally to chassis gnd. through 1 MΩ.) |
| | 4 | +10 V 10 V / 10 mA reference voltage output for analog input potentiometer (1...10 kohm), accuracy ±2%. | |
| | 5 | AI2 Analog input channel 2, programmable. Default ² = not used. Resolution 0.1%, accuracy ±1%. J1:AI1 OFF: 0...10 V (R _i = 312 kΩ)  or  NO | |
| | | J1:AI1 ON: 0...20 mA (R _i = 100 Ω)  or  NO | |
| | | 6 | AGND Analog input circuit common. (Connected internally to chassis gnd. through 1 MΩ.) |
| | 7 | AO1 Analog output, programmable. Default ² = frequency. 0...20 mA (load < 500 Ω). | |
| 8 | AO2 Analog output, programmable. Default ² = current. 0...20 mA (load < 500 Ω). | | |
| 9 | AGND Analog output circuit common (Connected internally to chassis gnd. through 1 MΩ.) | | |
| Digital Inputs ¹ | 10 | +24V Auxiliary voltage output 24 V DC / 250 mA (reference to GND). Short circuit protected. | |
| | 11 | GND Auxiliary voltage output common. (Connected internally as floating.) | |
| | 12 | DCOM Digital input common. To activate a digital input, there must be ≥+10 V (or ≤-10 V) between that input and DCOM. The 24 V may be provided by the ACS550 (X1-10) or by an external 12...24 V source of either polarity. | |
| | 13 | DI1 Digital input 1, programmable. Default ² = start/stop. | |
| | 14 | DI2 Digital input 2, programmable. Default ² = fwd/rev. | |
| | 15 | DI3 Digital input 3, programmable. Default ² = constant speed sel (code). | |
| | 16 | DI4 Digital input 4, programmable. Default ² = constant speed sel (code). | |
| | 17 | DI5 Digital input 5, programmable. Default ² = ramp pair selection (code). | |
| 18 | DI6 Digital input 6, programmable. Default ² = not used. | | |
| Relay outputs | 19 | RO1C  Relay output 1, programmable. Default ² = Ready. Maximum: 250 V AC / 30 V DC, 2 A Minimum: 500 mW (12 V, 10 mA) | |
| | 20 | | RO1A  |
| | 21 | | RO1B  |
| | 22 | RO2C  Relay output 2, programmable. Default ² = Running. Maximum: 250 V AC / 30 V DC, 2 A Minimum: 500 mW (12 V, 10 mA) | |
| | 23 | | RO2A  |
| | 24 | | RO2B  |
| | 25 | RO3C  Relay output 3, programmable. Default ² = Fault. Maximum: 250 V AC / 30 V DC, 2 A Minimum: 500 mW (12 V, 10 mA) | |
| 26 | RO3A  | | |
| 27 | RO3B  | | |

¹ Digital input impedance 1.5 kohm. Maximum voltage for digital inputs is 30 V.

² Default values depend on the macro used. Values specified are for the default macro. See chapter [Application macros](#) on page 101.

Note: Terminals 3, 6, and 9 are at the same potential.

Note: For safety reasons the fault relay signals a “fault” when the drive is powered down.



WARNING! All ELV (Extra Low Voltage) circuits connected to the drive must be used within a zone of equipotential bonding, i.e. within a zone where all simultaneously accessible conductive parts are electrically connected to prevent hazardous voltages appearing between them. This is accomplished by a proper factory grounding.

The terminals on the control board as well as on the optional modules attachable to the board fulfill the Protective Extra Low Voltage (PELV) requirements stated in EN 50178, provided that the external circuits connected to the terminals also fulfill the requirements and the installation site is below 2000 m (6562 ft).

You can wire the digital input terminals in either a PNP or NPN configuration.

PNP connection (source)

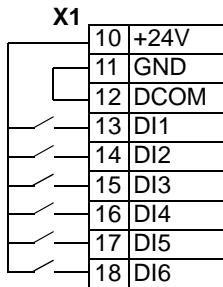

NPN connection (sink)

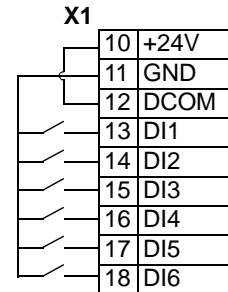

Connecting the shield wires at the control board

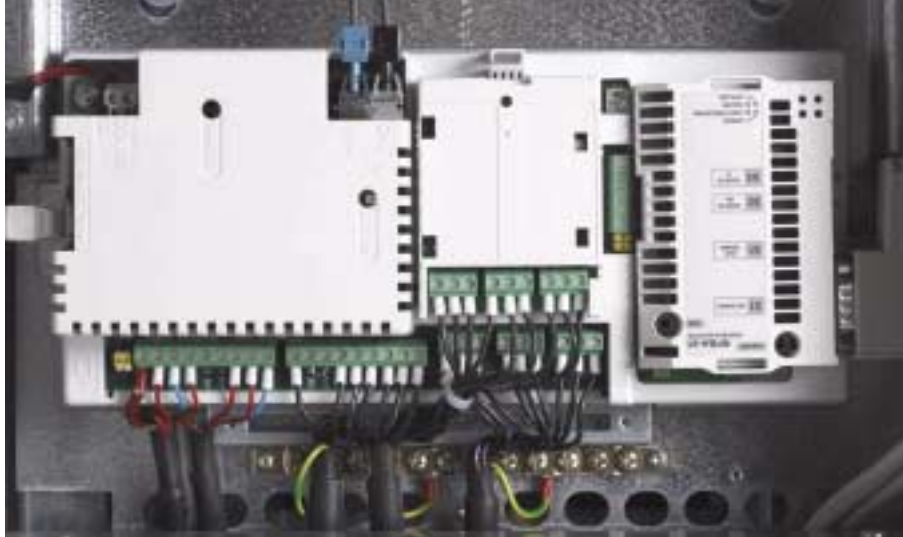

Single shielded cables: Twist the grounding wires of the outer shield and connect them to the grounding busbar below the X1 terminals.

Double shielded cables: Connect the inner shields and the grounding wires of the outer shield to the grounding busbar below the X1 terminals.

Do not connect shields of different cables to the same grounding clamp.

Leave the other end of the shield unconnected or ground it indirectly via a few nanofarads high-frequency, high-voltage capacitor (e.g. 3.3 nF / 3000 V). The shield can also be grounded directly at both ends if they are **in the same ground line** with no significant voltage drop between the end points.

Keep the signal wire pairs twisted as close to the terminals as possible. Twisting the wire with its return wire reduces disturbances caused by inductive coupling.

Securing the control cables mechanically

Fasten the control cables together and to the drive frame with cable ties as shown in section [Routing the control/signal cables inside the cubicle](#) on page 53.

Settings of the cooling fan transformer

The voltage transformer of the cooling fan is located at the top right-hand corner of the drive.

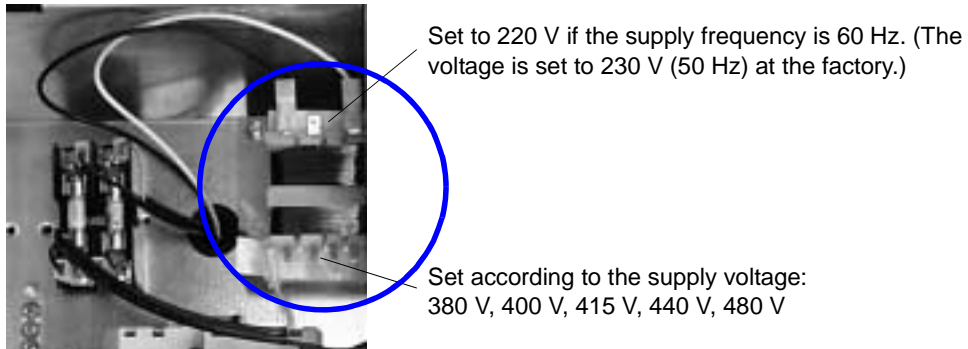

Installation of optional modules

The optional module (fieldbus adapter, relay output extension module) is inserted in the optional module slot of the control board. See the appropriate optional module manual for cable connections.

Cabling of I/O and fieldbus modules

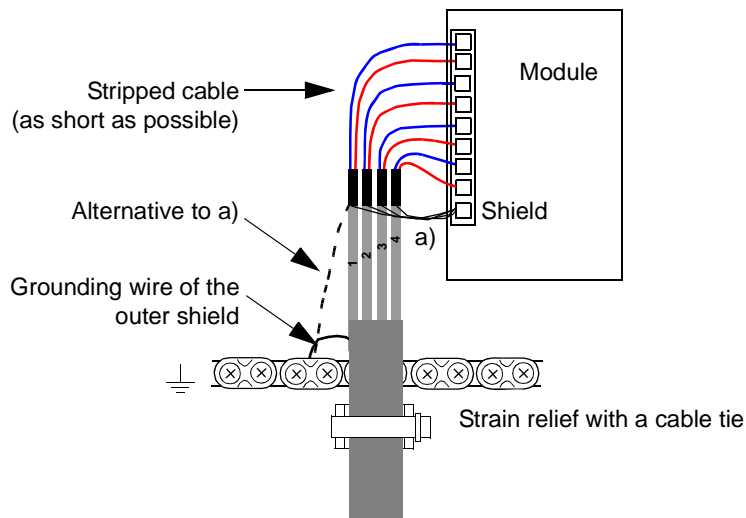

Installation checklist

Check the mechanical and electrical installation of the drive before start-up. Go through the checklist below together with another person. Read chapter [Safety](#) on page [5](#) before you work on the drive.

| Check | |
|---|--------------------------|
| MECHANICAL INSTALLATION | |
| The ambient operating conditions are allowed. See Installation on page 29 , Technical data: Ratings on page 293 , Ambient conditions on page 303 . | <input type="checkbox"/> |
| The drive is fixed properly on the floor and a vertical non-flammable wall. See Installation on page 29 . | <input type="checkbox"/> |
| The cooling air will flow freely. | <input type="checkbox"/> |
| ELECTRICAL INSTALLATION See Planning the electrical installation on page 15 and Installation on page 29 . | |
| The motor and the driven equipment are ready for start. See Planning the electrical installation: Checking the compatibility of the motor on page 15 , Technical data: Motor connection on page 300 . | <input type="checkbox"/> |
| EMC filter capacitors and varistor are disconnected if the drive is connected to an IT (ungrounded) or corner grounded TN system. See <ul style="list-style-type: none"> • Disconnecting the EMC filter on IT (ungrounded) and corner grounded TN systems (frame size R7 only) on page 44 • Disconnecting the varistor on IT (ungrounded) and corner grounded TN systems (frame size R7) on page 45 • Disconnecting the varistor on IT (ungrounded) and corner grounded TN systems (frame size R8) on page 46. | <input type="checkbox"/> |
| The capacitors are reformed if stored over one year. See Reforming on page 289 . | <input type="checkbox"/> |
| The drive is grounded properly. | <input type="checkbox"/> |
| The input power voltage matches the drive nominal input voltage. | <input type="checkbox"/> |
| The input power connections at U1, V1 and W1 and their tightening torques are OK. | <input type="checkbox"/> |
| Appropriate input power fuses and disconnectors are installed. | <input type="checkbox"/> |
| The motor connections at U2, V2 and W2 and their tightening torques are OK. | <input type="checkbox"/> |
| The motor cable is routed away from other cables. | <input type="checkbox"/> |
| Setting of the fan voltage transformer | <input type="checkbox"/> |
| Setting of the auxiliary voltage transformer. | <input type="checkbox"/> |
| There are no power factor compensation capacitors in the motor cable. | <input type="checkbox"/> |
| The external control connections inside the drive are OK. | <input type="checkbox"/> |
| There are no tools, foreign objects or dust from drilling inside the drive. | <input type="checkbox"/> |
| The input power voltage cannot be applied to the output of the drive (especially with bypass connection). | <input type="checkbox"/> |
| Drive, motor connection box and other covers are in place. | <input type="checkbox"/> |

Start-up, control with I/O and ID Run

The chapter instructs how to:

- perform the start-up
- start, stop, change the direction of rotation and adjust the speed of the motor through the I/O interface
- perform an Identification Run for the drive.

Using the control panel to do these tasks is explained briefly in this chapter. For details on how to use the control panel, refer to chapter [Control panels](#) starting on page [71](#).

How to start up the drive

How you start up the drive depends on the control panel you have.

- **If you have an Assistant Control Panel**, you can either run the Start-up Assistant (see section [How to perform the guided start-up](#) on page [66](#)) or perform a limited start-up (see section [How to perform the limited start-up](#) on page [61](#)).

The Start-up Assistant, which is included in the Assistant Control Panel only, guides you through all essential settings to be done. In the limited start-up, the drive gives no guidance; you go through the very basic settings by following the instructions given in the manual.

- **If you have a Basic Control Panel**, follow the instructions given in section [How to perform the limited start-up](#) on page [61](#).

How to perform the limited start-up

For the limited start-up, you can use the Basic Control Panel or the Assistant Control Panel. The instructions below are valid for both control panels, but the displays shown are the Basic Control Panel displays, unless the instruction applies to the Assistant Control Panel only.

Before you start, ensure that you have the motor nameplate data on hand.

SAFETY



The start-up may only be carried out by a qualified electrician.

The safety instructions given in chapter [Safety](#) must be followed during the start-up procedure.



The drive will start up automatically at power up, if the external run command is on.

- Check the installation. See the checklist in chapter [Installation](#), page [59](#).

- Check that the starting of the motor does not cause any danger. **De-couple the driven machine** if:
 - there is a risk of damage in case of incorrect direction of rotation, or
 - an ID Run needs to be performed during the drive start-up. ID Run is essential only in applications that require the ultimate in motor control accuracy.

POWER-UP

- Apply input power.
The Basic Control Panel powers up into the Output mode.

The Assistant Control Panel asks if you want to run the Start-up Assistant. If you press , the Start-up Assistant is not run, and you can continue with manual start-up in a similar manner as described below for the Basic Control Panel.

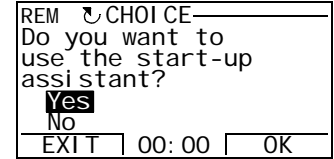















MANUAL ENTRY OF START-UP DATA (Group 99: START-UP DATA)

- If you have an Assistant Control Panel, select the language (the Basic Control Panel does not support languages). See parameter [9901](#) for the values of the available language alternatives. You find parameter descriptions in section [Complete parameter descriptions](#) starting on page [128](#).

The general parameter setting procedure is described below for the Basic Control Panel. You find more detailed instructions for the Basic Control Panel on page [97](#). Instructions for the Assistant Control Panel are on page [79](#).

The general parameter setting procedure:

1. To go to the Main menu, press  if the bottom line shows OUTPUT; otherwise press  repeatedly until you see MENU at the bottom.
2. Press keys / until you see "PAR" and press .
3. Find the appropriate parameter group with keys / and press .
4. Find the appropriate parameter in the group with keys /.
5. Press and hold  for about two seconds until the parameter value is shown with **SET** under the value.
6. Change the value with keys /. The value changes faster while you keep the key pressed down.
7. Save the parameter value by pressing .



- Select the application macro (parameter 9902). The general parameter setting procedure is given above.
The default value 1 (ABB STANDARD) is suitable in most cases.
- Select the motor control mode (parameter 9904).
1 (VECTOR:SPEED) is suitable in most cases. 2 (VECTOR:TORQ) is suitable for torque control applications. 3 (SCALAR:FREQ) is recommended
 - for multimotor drives when the number of the motors connected to the drive is variable
 - when the nominal current of the motor is less than 20% of the nominal current of the drive
 - when the drive is used for test purposes with no motor connected.
- Enter the motor data from the motor nameplate:

| ABB Motors CE | | | | | | | | | |
|----------------------------|----|----------------|-------|------|---------|--------------------------------|-------------------|--|--|
| 3 ~ motor | | M2AA 200 MLA 4 | | | | | | | |
| IEC 200 ML 55 | | | | | | | | | |
| No | | | | | | | | | |
| | | | | | Ins.cl. | F | IP 55 | | |
| V | Hz | kW | r/min | A | cos φ | I _A /I _N | t _E /s | | |
| 690 Y | 50 | 30 | 1475 | 32.5 | 0.83 | | | | |
| 400 D | 50 | 30 | 1475 | 56 | 0.83 | | | | |
| 660 Y | 50 | 30 | 1470 | 34 | 0.83 | | | | |
| 380 D | 50 | 30 | 1470 | 59 | 0.83 | | | | |
| 415 D | 50 | 30 | 1475 | 54 | 0.83 | | | | |
| 440 D | 60 | 35 | 1770 | 59 | 0.83 | | | | |
| Cat. no 3GAA 202 001 - ADA | | | | | | | | | |
| 6312/C3 | | 6210/C3 | | | 180 kg | | | | |
| IEC 34-1 | | | | | | | | | |

380 V
supply
voltage

- motor nominal voltage (parameter 9905)
- motor nominal current (parameter 9906)
Allowed range: 0.2...2.0 · I_{2hd} A
- motor nominal frequency (parameter 9907)
- motor nominal speed (parameter 9908)
- motor nominal power (parameter 9909)

REM 9902
PAR FWD

REM 9904
PAR FWD

Note: Set the motor data to exactly the same value as on the motor nameplate. For example, if the motor nominal speed is 1470 rpm on the nameplate, setting the value of parameter 9908 MOTOR NOM SPEED to 1500 rpm results in the wrong operation of the drive.

REM 9905
PAR FWD

REM 9906
PAR FWD

REM 9907
PAR FWD

REM 9908
PAR FWD

REM 9909
PAR FWD

- Select the motor identification method (parameter [9910](#)).
- The default value 0 (OFF/IDMAGN) using the identification magnetization is suitable for most applications. It is applied in this basic start-up procedure. Note however that this requires that:

- parameter [9904](#) is set to 1 (VECTOR:SPEED) or 2 (VECTOR:TORQ), or
- parameter [9904](#) is set to 3 (SCALAR:FREQ) and parameter [2101](#) is set to 3 (SCALAR FLYST) or 5 (FLY + BOOST).

If your selection is 0 (OFF/IDMAGN), move to the next step.

Value 1 (ON), which performs a separate ID Run, should be selected if:

- vector control mode is used [parameter [9904](#) = 1 (VECTOR:SPEED) or 2 (VECTOR:TORQ)], and/or
- the operation point is near zero speed, and/or
- operation at torque range above the motor nominal torque over a wide speed range and without any measured speed feedback is required.

If you decide to do the ID Run [value 1 (ON)], continue by following the separate instructions given on page [69](#) in section [How to perform the ID Run](#) and then return to step [DIRECTION OF THE MOTOR ROTATION](#) on page [64](#).









IDENTIFICATION MAGNETIZATION WITH ID RUN SELECTION 0 (OFF/IDMAGN)

- As stated above, the identification magnetization is performed only if:
- parameter [9904](#) is set to 1 (VECTOR:SPEED) or 2 (VECTOR:TORQ), or
 - parameter [9904](#) is set to 3 (SCALAR:FREQ) and parameter [2101](#) is set to 3 (SCALAR FLYST) or 5 (FLY + BOOST).

Press key  to switch to local control (LOC shown on the left).

Press  to start the drive. The motor model is now calculated by magnetizing the motor for 10 to 15 s at zero speed (motor not rotating).

DIRECTION OF THE MOTOR ROTATION

- Check the direction of the motor rotation.
- If the drive is in remote control (REM shown on the left), switch to local control by pressing .
 - To go to the Main menu, press  if the bottom line shows OUTPUT; otherwise press  repeatedly until you see MENU at the bottom.
 - Press keys / until you see "rEF" and press .
 - Increase the frequency reference from zero to a small value with key .
 - Press  to start the motor.
 - Check that the actual direction of the motor is the same as indicated on the display (FWD means forward and REV reverse).
 - Press  to stop the motor.

| | |
|-----|----------------|
| LOC | XXX Hz |
| | SET FWD |

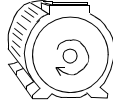
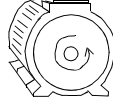
| | |
|--|--|
| <p>To change the direction of the motor rotation:</p> <ul style="list-style-type: none"> • Disconnect input power from the drive, and wait 5 minutes for the intermediate circuit capacitors to discharge. Measure the voltage between each input terminal (U1, V1 and W1) and earth with a multimeter to ensure that the drive is discharged. • Exchange the position of two motor cable phase conductors at the drive output terminals or at the motor connection box. • Verify your work by applying input power and repeating the check as described above. |  forward direction  reverse direction |
|--|--|

SPEED LIMITS AND ACCELERATION/DECELERATION TIMES

| | |
|---|----------------------------|
| <input type="checkbox"/> Set the minimum speed (parameter 2001). | LOC 2001 PAR FWD |
| <input type="checkbox"/> Set the maximum speed (parameter 2002). | LOC 2002 PAR FWD |
| <input type="checkbox"/> Set the acceleration time 1 (parameter 2202). Note: Check also acceleration time 2 (parameter 2205) if two acceleration times will be used in the application. | LOC 2202 PAR FWD |
| <input type="checkbox"/> Set the deceleration time 1 (parameter 2203). Note: Set also deceleration time 2 (parameter 2206) if two deceleration times will be used in the application. | LOC 2203 PAR FWD |

SAVING A USER PARAMETER SET AND FINAL CHECK

| | |
|---|----------------------------|
| <input type="checkbox"/> The start-up is now completed. However, it might be useful at this stage to set the parameters required by your application and save the settings as a user parameter set as instructed in section User parameter sets on page 111 . | LOC 9902 PAR FWD |
| <input type="checkbox"/> Check that the drive state is OK. Basic Control Panel: Check that there are no faults or alarms shown on the display. If you want to check the LEDs on the front of the drive, switch first to remote control (otherwise a fault is generated) before removing the panel and verifying that the red LED is not lit and the green LED is lit but not blinking. Assistant Control Panel: Check that there are no faults or alarms shown on the display and that the panel LED is green and does not blink. | |

The drive is now ready for use.

How to perform the guided start-up

To be able to perform the guided start-up, you need the Assistant Control Panel. Before you start, ensure that you have the motor nameplate data on hand.

SAFETY



The start-up may only be carried out by a qualified electrician.

The safety instructions given in chapter [Safety](#) must be followed during the start-up procedure.



The drive will start up automatically at power up, if the external run command is on.

- Check the installation. See the checklist in chapter [Installation](#), page 59.
- Check that the starting of the motor does not cause any danger.

De-couple the driven machine if:

 - there is a risk of damage in case of incorrect direction of rotation, or
 - an ID Run needs to be performed during the drive start-up. ID Run is essential only in applications that require the ultimate in motor control accuracy.

POWER-UP

- Apply input power. The control panel first asks if you want to use the Start-up Assistant.
 - Press (when **Yes** is highlighted) to run the Start-up Assistant.
 - Press if you do not want to run the Start-up Assistant.
 - Press key to highlight **No** and then press if you want to make the panel ask (or not ask) the question about running the Start-up Assistant again the next time you switch on the power to the drive.

```

REM  CHOICE
Do you want to
use the start-up
assistant?
Yes
No
EXIT | 00:00 | OK
  
```

```

REM  CHOICE
Show start-up
assistant on
next boot?
Yes
No
EXIT | 00:00 | OK
  
```

SELECTING THE LANGUAGE

- If you decided to run the Start-up Assistant, the display then asks you to select the language. Scroll to the desired language with keys / and press to accept. If you press , the Start-up Assistant is stopped.

```

REM  PAR EDIT
9901 LANGUAGE
ENGLISH
[0]
EXIT | 00:00 | SAVE
  
```





STARTING THE GUIDED SET-UP

- The Start-up Assistant now guides you through the set-up tasks, starting with the motor set-up. Set the motor data to exactly the same value as on the motor nameplate. Scroll to the desired parameter value with keys / and press to accept and continue with the Start-up Assistant.

Note: At any time, if you press , the Start-up Assistant is stopped and the display goes to the Output mode.

```

REM  PAR EDIT
9905 MOTOR NOM VOLT
220 V
EXIT | 00:00 | SAVE
  
```

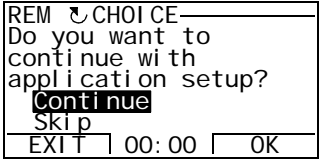
| | | |
|--|---|---|
| <input type="checkbox"/> | <p>After completing a set-up task, the Start-up Assistant suggests the next one.</p> <ul style="list-style-type: none"> • Press  (when Continue is highlighted) to continue with the suggested task. • Press key  to highlight Skip and then press  to move to the following task without doing the suggested task. • Press  to stop the Start-up Assistant. |  |
| SAVING A USER PARAMETER SET AND FINAL CHECK | | |
| <input type="checkbox"/> <input type="checkbox"/> | <p>The start-up is now completed. However, it might be useful at this stage to set the parameters required by your application and save the settings as a user parameter set as instructed in section <i>User parameter sets</i> on page 111.</p> <p>After the whole set-up is completed, check there are no faults or alarms shown on the display and the panel LED is green and does not blink.</p> | |
| The drive is now ready for use. | | |

How to control the drive through the I/O interface

The table below instructs how to operate the drive through the digital and analog inputs when:

- the motor start-up is performed, and
- the default (standard) parameter settings are valid.

Displays of the Basic Control Panel are shown as an example.

| PRELIMINARY SETTINGS | |
|--|--|
| <p>If you need to change the direction of rotation, check that parameter 1003 is set to 3 (REQUEST).</p> <p>Ensure that the control connections are wired according to the connection diagram given for the ABB Standard macro.</p> <p>Ensure that the drive is in remote control. Press key  to switch between remote and local control.</p> | <p>See section ABB Standard macro on page 102.</p> <p>In remote control, the panel display shows text REM.</p> |
| STARTING AND CONTROLLING THE SPEED OF THE MOTOR | |
| <p>Start by switching digital input DI1 on.</p> <p>Assistant Control Panel: The arrow starts rotating. It is dotted until the setpoint is reached.</p> <p>Basic Control Panel: Text FWD starts flashing fast and stops after the setpoint is reached</p> <p>Regulate the drive output frequency (motor speed) by adjusting the voltage of analog input AI1.</p> | <div style="border: 1px solid black; padding: 5px; margin-bottom: 10px;"> <p>REM 00 Hz</p> <p>OUTPUT FWD</p> </div> <div style="border: 1px solid black; padding: 5px;"> <p>REM 500 Hz</p> <p>OUTPUT FWD</p> </div> |
| CHANGING THE DIRECTION OF ROTATION OF THE MOTOR | |
| <p>Reverse direction: Switch digital input DI2 on.</p> <p>Forward direction: Switch digital input DI2 off.</p> | <div style="border: 1px solid black; padding: 5px; margin-bottom: 10px;"> <p>REM 500 Hz</p> <p>OUTPUT REV</p> </div> <div style="border: 1px solid black; padding: 5px;"> <p>REM 500 Hz</p> <p>OUTPUT FWD</p> </div> |
| STOPPING THE MOTOR | |
| <p>Switch digital input DI1 off. The motor stops.</p> <p>Assistant Control Panel: The arrow stops rotating.</p> <p>Basic Control Panel: Text FWD starts flashing slowly.</p> | <div style="border: 1px solid black; padding: 5px;"> <p>REM 00 Hz</p> <p>OUTPUT FWD</p> </div> |

How to perform the ID Run

The drive estimates motor characteristics automatically using identification magnetization when the drive is started for the first time and after any motor parameter (*Group 99: START-UP DATA*) is changed. This is valid when parameter **9910** ID RUN has value 0 (OFF/IDMAGN), and

- parameter **9904** = 1 (VECTOR:SPEED) or 2 (VECTOR:TORQ), or
- parameter **9904** = 3 (SCALAR:FREQ) and parameter **2101** = 3 (SCALAR FLYST) or 5 (FLY + BOOST).

In most applications there is no need to perform a separate ID Run [**9910** ID RUN = 1 (ON)]. The ID Run should be selected if:

- vector control mode is used [parameter **9904** = 1 (VECTOR:SPEED) or 2 (VECTOR:TORQ)], and/or
- the operation point is near zero speed, and/or
- operation at torque range above the motor nominal torque over a wide speed range and without any measured speed feedback is required.

Note: If motor parameters (*Group 99: START-UP DATA*) are changed after the ID Run, it must be repeated.

ID Run procedure

The general parameter setting procedure is not repeated here. For Assistant Control Panel see page [79](#) and for Basic Control Panel page [97](#) in chapter *Control panels*.





PRE-CHECK



WARNING! The motor will run at up to approximately 50...80% of the nominal speed during the ID Run. The motor will rotate in the forward direction. **Ensure that it is safe to run the motor before performing the ID Run!**



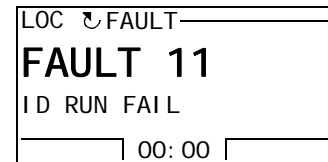
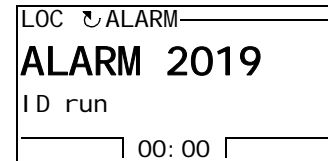
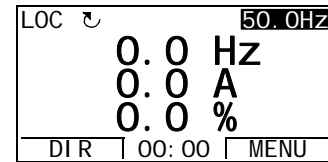
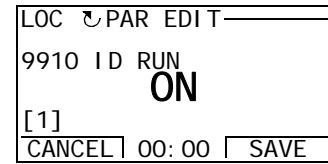

- De-couple the motor from the driven equipment.
- Check that the values of the motor data parameters **9905...9909** are equivalent to those on the motor nameplate, as shown in the steps on page [63](#).
- If parameter values (*Group 01: OPERATING DATA* to *Group 98: OPTIONS*) are changed before the ID Run, check that the new settings meet the following conditions:
 - 2001** MINIMUM SPEED ≤ 0 rpm
 - 2002** MAXIMUM SPEED $> 80\%$ of the motor rated speed
 - 2003** MAXIMUM CURRENT $\geq I_{2hd}$
 - 2017** MAX TORQUE 1 $> 50\%$ or **2018** MAX TORQUE 2 $> 50\%$, depending on which limit is in use according to parameter **2014** MAX TORQUE SEL.
- Check that the Run Enable signal is on (parameter **1601**).
- Ensure that the panel is in local control (LOC shown on the left / at the top). Press key  to switch between local and remote control.

ID RUN WITH THE ASSISTANT CONTROL PANEL

- Change parameter **9910** ID RUN to 1 (ON). Save the new setting by pressing .
 - If you want to monitor actual values during the ID Run, go to the Output mode by pressing  repeatedly until you get there.
 - Press  to start the ID Run. The panel keeps switching between the display that was shown when you started the ID Run and the alarm display presented on the right.
In general, it is recommended not to press any control panel keys during the ID Run. However, you can stop the ID Run at any time by pressing .
- After the ID Run is completed, the alarm display is not shown any more.
If the ID Run fails, the fault display presented on the right is shown.



ID RUN WITH THE BASIC CONTROL PANEL

- Change parameter **9910** ID RUN to 1 (ON). Save the new setting by pressing .
 - If you want to monitor actual values during the ID Run, go to the Output mode by pressing  repeatedly until you get there.
 - Press  to start the ID Run. The panel keeps switching between the display that was shown when you started the ID Run and the alarm display presented on the right.
In general, it is recommended not to press any control panel keys during the ID Run. However, you can stop the ID Run at any time by pressing .
- After the ID Run is completed, the alarm display is not shown any more.
If the ID Run fails, the fault display presented on the right is shown.

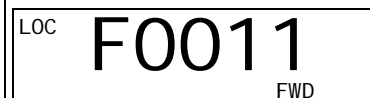
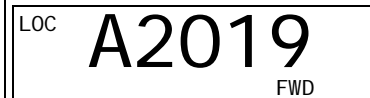
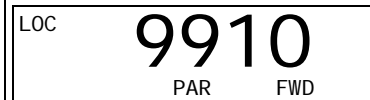

Control panels

About control panels

Use a control panel to control the drive, read status data and adjust parameters. The drive works with either of two different control panel types:

- Basic Control Panel – This panel (described in section [Basic Control Panel](#) on page 92) provides basic tools for manual entry of parameter values.
- Assistant Control Panel – This panel (described below) includes pre-programmed assistants to automate the most common parameter setups. The panel provides language support. It is available with different language sets.

Compatibility

The manual is compatible with the following panel versions:

- Basic Control Panel: ACS-CP-C Rev. K
- Assistant Control Panel (Area 1): ACS-CP-A Rev. Y
- Assistant Control Panel (Area 2): ACS-CP-L Rev. E
- Assistant Control Panel (Asia): ACS-CP-D Rev. M

See page 75 for how to find out the version of your Assistant Control Panel. See parameter 9901 LANGUAGE to see the languages supported by the different Assistant Control Panels.

Assistant Control Panel

Features

The Assistant Control Panel features:

- alphanumeric control panel with an LCD display
- language selection for the display
- Start-up Assistant to ease drive commissioning
- copy function – parameters can be copied to the control panel memory for later transfer to other drives or for backup of a particular system.
- context sensitive help
- real time clock.

Overview

The following table summarizes the key functions and displays on the Assistant Control Panel.

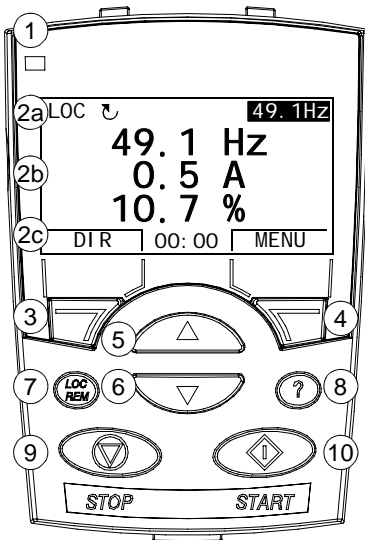

| No. | Use |
|-----|---|
| 1 | Status LED – Green for normal operation. If LED is flashing, or red, see section Diagnostic displays on page 273. |
| 2 | LCD display – Divided into three main areas: <ol style="list-style-type: none"> Status line – variable, depending on the mode of operation, see section Status line on page 73. Center – variable; in general, shows signal and parameter values, menus or lists. Shows also faults and alarms. Bottom line – shows current functions of the two soft keys and, if enabled, the clock display. |
| 3 | Soft key 1 – Function depends on the context. The text in the lower left corner of the LCD display indicates the function. |
| 4 | Soft key 2 – Function depends on the context. The text in the lower right corner of the LCD display indicates the function. |
| 5 | Up – <ul style="list-style-type: none"> • Scrolls up through a menu or list displayed in the center of the LCD display. • Increments a value if a parameter is selected. • Increments the reference value if the upper right corner is highlighted. Holding the key down changes the value faster. |
| 6 | Down – <ul style="list-style-type: none"> • Scrolls down through a menu or list displayed in the center of the LCD display. • Decrements a value if a parameter is selected. • Decrements the reference value if the upper right corner is highlighted. Holding the key down changes the value faster. |
| 7 | LOC/REM – Changes between local and remote control of the drive. |
| 8 | Help – Displays context sensitive information when the key is pressed. The information displayed describes the item currently highlighted in the center of the display. |
| 9 | STOP – Stops the drive in local control. |
| 10 | START – Starts the drive in local control. |

Status line

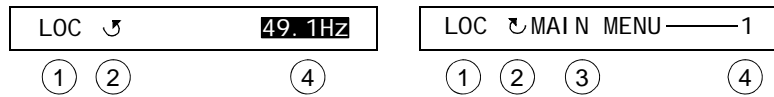

The top line of the LCD display shows the basic status information of the drive.



| No. | Field | Alternatives | Significance |
|-----|--|-------------------------|---|
| 1 | Control location | LOC | Drive control is local, that is, from the control panel. |
| | | REM | Drive control is remote, such as the drive I/O or fieldbus. |
| 2 | State | ↻ | Forward shaft direction |
| | | ↺ | Reverse shaft direction |
| | | Rotating arrow | Drive is running at setpoint. |
| | | Dotted rotating arrow | Drive is running but not at setpoint. |
| | | Stationary arrow | Drive is stopped. |
| | | Dotted stationary arrow | Start command is present, but the motor is not running, e.g. because start enable is missing. |
| 3 | Panel operation mode | | <ul style="list-style-type: none"> Name of the current mode Name of the list or menu shown Name of the operation state, e.g. PAR EDIT. |
| 4 | Reference value or number of the selected item | | <ul style="list-style-type: none"> Reference value in the Output mode Number of the highlighted item, e.g. mode, parameter group or fault. |

Operation

You operate the control panel with menus and keys. The keys include two context-sensitive soft keys, whose current function is indicated by the text shown in the display above each key.

You select an option, e.g. operation mode or parameter, by scrolling the  and  arrow keys until the option is highlighted (in reverse video) and then pressing the relevant soft key. With the right soft key you usually enter a mode, accept an option or save the changes. The left soft key is used to cancel the made changes and return to the previous operation level.

The Assistant Control Panel has nine panel modes: Output, Parameters, Assistants, Changed Parameters, Fault Logger, Time and Date, Parameter Backup, I/O Settings and Fault. The operation in the first eight modes is described in this chapter. When a fault or alarm occurs, the panel goes automatically to the Fault mode showing the fault or alarm. You can reset it in the Output or Fault mode (see chapter [Diagnostics](#)).

Initially, the panel is in the Output mode, where you can start, stop, change the direction, switch between local and remote control, modify the reference value and monitor up to three actual values. To do other tasks, go first to the Main menu and select the appropriate mode on the menu. The status line (see section [Status line](#) on page 73) shows the name of the current menu, mode, item or state.

| | | |
|--------------------|---------|---------|
| LOC ↻ | 49.1 Hz | 49.1 Hz |
| | 0.5 A | |
| | 10.7 % | |
| DIR | 00:00 | MENU |
| LOC ↻ MAIN MENU | 1 | |
| PARAMETERS | | |
| ASSISTANTS | | |
| CHANGED PAR | | |
| EXIT | 00:00 | ENTER |

How to do common tasks

The table below lists common tasks, the mode in which you can perform them and the page number where the steps to do the task are described in detail.

| Task | Mode | Page |
|---|--------------------|---------------------|
| How to get help | Any | 75 |
| How to find out the panel version | At power up | 75 |
| How to adjust the display contrast | Output | 78 |
| How to switch between local and remote control | Any | 76 |
| How to start and stop the drive | Any | 76 |
| How to change the direction of the motor rotation | Output | 77 |
| How to set the speed, frequency or torque reference | Output | 78 |
| How to change the value of a parameter | Parameters | 79 |
| How to select the monitored signals | Parameters | 80 |
| How to do guided tasks (specification of related parameter sets) with assistants | Assistants | 81 |
| How to view and edit changed parameters | Changed Parameters | 84 |
| How to view faults | Fault Logger | 85 |
| How to reset faults and alarms | Output, Fault | 279 |
| How to show/hide the clock, change date and time formats, set the clock and enable/disable automatic clock transitions according to the daylight saving changes | Time and Date | 86 |
| How to copy parameters from the drive to the control panel | Parameter Backup | 89 |
| How to restore parameters from the control panel to the drive | Parameter Backup | 89 |
| How to view backup information | Parameter Backup | 90 |
| How to edit and change parameter settings related to I/O terminals | I/O Settings | 91 |

How to get help









| Step | Action | Display |
|------|---|---|
| 1. | Press (?) to read the context-sensitive help text for the item that is highlighted. If help text exists for the item, it is shown on the display. | <pre> LOC ↵ PAR GROUPS — 10 01 OPERATING DATA 03 FB ACTUAL SIGNALS 04 FAULT HISTORY 10 START/STOP/DIR 11 REFERENCE SELECT EXIT 00:00 SEL </pre> <pre> LOC ↵ HELP This group defines external sources (EXT1 and EXT2) for commands that enable start, stop and EXIT 00:00 </pre> |
| 2. | If the whole text is not visible, scroll the lines with keys ▲ and ▼ . | <pre> LOC ↵ HELP external sources (EXT1 and EXT2) for commands that enable start, stop and directi on changes. EXIT 00:00 </pre> |
| 3. | After reading the text, return to the previous display by pressing EXIT  . | <pre> LOC ↵ PAR GROUPS — 10 01 OPERATING DATA 03 FB ACTUAL SIGNALS 04 FAULT HISTORY 10 START/STOP/DIR 11 REFERENCE SELECT EXIT 00:00 SEL </pre> |

How to find out the panel version

| Step | Action | Display |
|------|--|--|
| 1. | If the power is switched on, switch it off. | |
| 2. | Keep key (?) pressed down while you switch on the power and read the information. The display shows the following panel information: Panel FW: panel firmware version ROM CRC: panel ROM check sum Flash Rev: flash content version Flash content comment. When you release the (?) key, the panel goes to the Output mode. | <pre> PANEL VERSION INFO Panel FW: x.xx ROM CRC: xxxxxxxxxx Flash Rev: x.xx xxxxxxxxxxxxxxxxxxxxxxxx </pre> |

How to start, stop and switch between local and remote control

You can start, stop and switch between local and remote control in any mode. To be able to start or stop the drive, the drive must be in local control.

| Step | Action | Display |
|------|---|--|
| 1. | <ul style="list-style-type: none"> To switch between remote control (REM shown on the status line) and local control (LOC shown on the status line), press . <p>Note: Switching to local control can be disabled with parameter 1606 LOCAL LOCK.</p> <p>The very first time the drive is powered up, it is in remote control (REM) and controlled through the drive I/O terminals. To switch to local control (LOC) and control the drive using the control panel, press . The result depends on how long you press the key:</p> <ul style="list-style-type: none"> If you release the key immediately (the display flashes “Switching to the local control mode”), the drive stops. Set the local control reference as instructed on page 78. If you press the key for about two seconds, the drive continues as before. The drive copies the current remote values for the run/stop status and the reference, and uses them as the initial local control settings. <ul style="list-style-type: none"> To stop the drive in local control, press . To start the drive in local control, press . | <div data-bbox="1098 367 1420 529" style="border: 1px solid black; padding: 5px;"> <p>LOC  MESSAGE</p> <p>Switching to the local control mode.</p> <hr/> <p style="text-align: center;">00: 00</p> </div> <p>The arrow ( or ) on the status line stops rotating.</p> <p>The arrow ( or ) on the status line starts rotating. It is dotted until the drive reaches the setpoint.</p> |

Output mode

In the Output mode, you can:



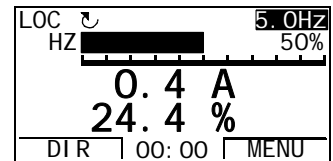
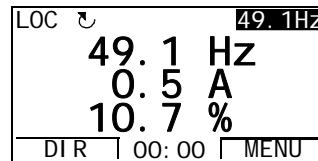

- monitor actual values of up to three signals in *Group 01: OPERATING DATA*
- change the direction of the motor rotation
- set the speed, frequency or torque reference
- adjust the display contrast
- start, stop, change the direction and switch between local and remote control.

You get to the Output mode by pressing  repeatedly.





The top right corner of the display shows the reference value. The center can be configured to show up to three signal values or bar graphs; see page 80 for instructions on selecting and modifying the monitored signals.





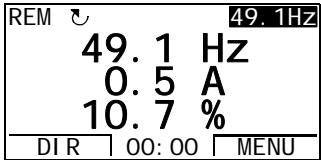

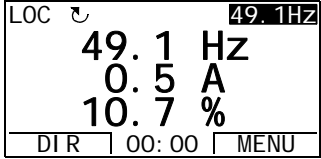
How to change the direction of the motor rotation

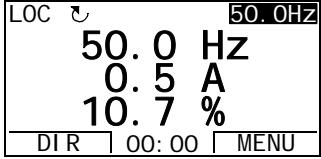
| Step | Action | Display | | | | | | | | | | | | | | | |
|---------|--|---|-----|---|---------|---------|--|--|-------|--|--|--------|--|--|-----|--|--------------|
| 1. | If you are not in the Output mode, press  repeatedly until you get there. | <table border="1"> <tr> <td>REM</td> <td>↺</td> <td>49.1 Hz</td> </tr> <tr> <td colspan="3" style="text-align: center;">49.1 Hz</td> </tr> <tr> <td colspan="3" style="text-align: center;">0.5 A</td> </tr> <tr> <td colspan="3" style="text-align: center;">10.7 %</td> </tr> <tr> <td>DIR</td> <td> </td> <td>00:00 MENU</td> </tr> </table> | REM | ↺ | 49.1 Hz | 49.1 Hz | | | 0.5 A | | | 10.7 % | | | DIR | | 00:00 MENU |
| REM | ↺ | 49.1 Hz | | | | | | | | | | | | | | | |
| 49.1 Hz | | | | | | | | | | | | | | | | | |
| 0.5 A | | | | | | | | | | | | | | | | | |
| 10.7 % | | | | | | | | | | | | | | | | | |
| DIR | | 00:00 MENU | | | | | | | | | | | | | | | |
| 2. | If the drive is in remote control (REM shown on the status line), switch to local control by pressing  . The display briefly shows a message about changing the mode and then returns to the Output mode. | <table border="1"> <tr> <td>LOC</td> <td>↺</td> <td>49.1 Hz</td> </tr> <tr> <td colspan="3" style="text-align: center;">49.1 Hz</td> </tr> <tr> <td colspan="3" style="text-align: center;">0.5 A</td> </tr> <tr> <td colspan="3" style="text-align: center;">10.7 %</td> </tr> <tr> <td>DIR</td> <td> </td> <td>00:00 MENU</td> </tr> </table> | LOC | ↺ | 49.1 Hz | 49.1 Hz | | | 0.5 A | | | 10.7 % | | | DIR | | 00:00 MENU |
| LOC | ↺ | 49.1 Hz | | | | | | | | | | | | | | | |
| 49.1 Hz | | | | | | | | | | | | | | | | | |
| 0.5 A | | | | | | | | | | | | | | | | | |
| 10.7 % | | | | | | | | | | | | | | | | | |
| DIR | | 00:00 MENU | | | | | | | | | | | | | | | |
| 3. | To change the direction from forward ( shown on the status line) to reverse ( shown on the status line), or vice versa, press  . Note: Parameter 1003 DIRECTION must be set to 3 (REQUEST). | <table border="1"> <tr> <td>LOC</td> <td>↻</td> <td>49.1 Hz</td> </tr> <tr> <td colspan="3" style="text-align: center;">49.1 Hz</td> </tr> <tr> <td colspan="3" style="text-align: center;">0.5 A</td> </tr> <tr> <td colspan="3" style="text-align: center;">10.7 %</td> </tr> <tr> <td>DIR</td> <td> </td> <td>00:00 MENU</td> </tr> </table> | LOC | ↻ | 49.1 Hz | 49.1 Hz | | | 0.5 A | | | 10.7 % | | | DIR | | 00:00 MENU |
| LOC | ↻ | 49.1 Hz | | | | | | | | | | | | | | | |
| 49.1 Hz | | | | | | | | | | | | | | | | | |
| 0.5 A | | | | | | | | | | | | | | | | | |
| 10.7 % | | | | | | | | | | | | | | | | | |
| DIR | | 00:00 MENU | | | | | | | | | | | | | | | |

How to set the speed, frequency or torque reference

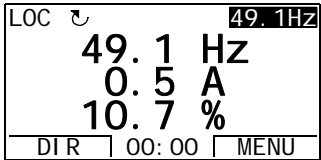
| Step | Action | Display |
|------|--|---|
| 1. | If you are not in the Output mode, press  repeatedly until you get there. |  |
| 2. | If the drive is in remote control (REM shown on the status line), switch to local control by pressing  . The display briefly shows a message about changing the mode and then returns to the Output mode. Note: With Group 11: REFERENCE SELECT , you can allow the reference modification in remote control. |  |
| 3. | <ul style="list-style-type: none"> To increase the highlighted reference value shown in the top right corner of the display, press . The value changes immediately. It is stored in the drive permanent memory and restored automatically after power switch-off. To decrease the value, press . |  |

How to adjust the display contrast

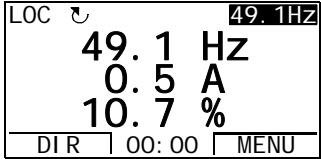













| Step | Action | Display |
|------|--|---|
| 1. | If you are not in the Output mode, press  repeatedly until you get there. |  |
| 2. | <ul style="list-style-type: none"> To increase the contrast, press keys  and  simultaneously. To decrease the contrast, press keys  and  simultaneously. |  |

Parameters mode

In the Parameters mode, you can:

- view and change parameter values
- start, stop, change the direction and switch between local and remote control.

How to select a parameter and change its value

| Step | Action | Display |
|------|---|--|
| 1. | Go to the Main menu by pressing  if you are in the Output mode, otherwise by pressing  repeatedly until you get to the Main menu. | <pre> LOC MAIN MENU 1 PARAMETERS ASSTANTS CHANGED PAR EXIT 00:00 ENTER </pre> |
| 2. | Go to the Parameters mode by selecting PARAMETERS on the menu with keys  and  , and pressing  . | <pre> LOC PAR GROUPS 01 01 OPERATING DATA 03 FB ACTUAL SIGNALS 04 FAULT HISTORY 10 START/STOP/DIR 11 REFERENCE SELECT EXIT 00:00 SEL </pre> |
| 3. | Select the appropriate parameter group with keys  and  . Press  . | <pre> LOC PAR GROUPS 99 99 START-UP DATA 01 OPERATING DATA 03 FB ACTUAL SIGNALS 04 FAULT HISTORY 10 START/STOP/DIR EXIT 00:00 SEL </pre> <pre> LOC PARAMETERS 9901 LANGUAGE ENGLISH 9902 APPLIC MACRO 9904 MOTOR CTRL MODE 9905 MOTOR NOM VOLT EXIT 00:00 EDIT </pre> |
| 4. | Select the appropriate parameter with keys  and  . The current value of the parameter is shown below the selected parameter. Press  . | <pre> LOC PARAMETERS 9901 LANGUAGE 9902 APPLIC MACRO ABB STANDARD 9904 MOTOR CTRL MODE 9905 MOTOR NOM VOLT EXIT 00:00 EDIT </pre> <pre> LOC PAR EDIT 9902 APPLIC MACRO ABB STANDARD [1] CANCEL 00:00 SAVE </pre> |
| 5. | Specify a new value for the parameter with keys  and  . Pressing the key once increments or decrements the value. Holding the key down changes the value faster. Pressing the keys simultaneously replaces the displayed value with the default value. | <pre> LOC PAR EDIT 9902 APPLIC MACRO 3-WIRE [2] CANCEL 00:00 SAVE </pre> |
| 6. | <ul style="list-style-type: none"> • To save the new value, press . • To cancel the new value and keep the original, press . | <pre> LOC PARAMETERS 9901 LANGUAGE 9902 APPLIC MACRO 3-WIRE 9904 MOTOR CTRL MODE 9905 MOTOR NOM VOLT EXIT 00:00 EDIT </pre> |

How to select the monitored signals

| Step | Action | Display |
|------|--|---|
| 1. | <p>You can select which signals are monitored in the Output mode and how they are displayed with Group 34: PANEL DISPLAY parameters. See page 79 for detailed instructions on changing parameter values.</p> <p>By default, the display shows three signals. The particular default signals depend on the value of parameter 9902 APPLIC MACRO: For macros whose default value of parameter 9904 MOTOR CTRL MODE is 1 (VECTOR:SPEED), the default for signal 1 is 0102 SPEED, otherwise 0103 OUTPUT FREQ. The defaults for signals 2 and 3 are always 0104 CURRENT and 0105 TORQUE, respectively.</p> <p>To change the default signals, select up to three signals from Group 01: OPERATING DATA to be shown.</p> <p>Signal 1: Change the value of parameter 3401 SIGNAL1 PARAM to the index of the signal parameter in Group 01: OPERATING DATA (= number of the parameter without the leading zero), e.g. 105 means parameter 0105 TORQUE. Value 100 means that no signal is displayed.</p> <p>Repeat for signals 2 (3408 SIGNAL2 PARAM) and 3 (3415 SIGNAL3 PARAM).</p> | <div style="border: 1px solid black; padding: 2px;"> LOC <input type="checkbox"/> PAR EDIT <input type="checkbox"/> 3401 SIGNAL1 PARAM OUTPUT FREQ [103] CANCEL 00:00 SAVE </div> <div style="border: 1px solid black; padding: 2px;"> LOC <input type="checkbox"/> PAR EDIT <input type="checkbox"/> 3408 SIGNAL2 PARAM CURRENT [104] CANCEL 00:00 SAVE </div> <div style="border: 1px solid black; padding: 2px;"> LOC <input type="checkbox"/> PAR EDIT <input type="checkbox"/> 3415 SIGNAL3 PARAM TORQUE [105] CANCEL 00:00 SAVE </div> |
| 2. | <p>Select how you want the signals to be displayed: as a decimal number or a bar graph. For decimal numbers, you can specify the decimal point location, or use the decimal point location and unit of the source signal [setting (9 (DIRECT))]. For details, see parameter 3404.</p> <p>Signal 1: parameter 3404 OUTPUT1 DSP FORM Signal 2: parameter 3411 OUTPUT2 DSP FORM Signal 3: parameter 3418 OUTPUT3 DSP FORM.</p> | <div style="border: 1px solid black; padding: 2px;"> LOC <input type="checkbox"/> PAR EDIT <input type="checkbox"/> 3404 OUTPUT1 DSP FORM DIRECT [9] CANCEL 00:00 SAVE </div> |
| 3. | <p>Select the units to be displayed for the signals. This has no effect if parameter 3404/3411/3418 is set to 9 (DIRECT). For details, see parameter 3405.</p> <p>Signal 1: parameter 3405 OUTPUT1 UNIT Signal 2: parameter 3412 OUTPUT2 UNIT Signal 3: parameter 3419 OUTPUT3 UNIT.</p> | <div style="border: 1px solid black; padding: 2px;"> LOC <input type="checkbox"/> PAR EDIT <input type="checkbox"/> 3405 OUTPUT1 UNIT Hz [3] CANCEL 00:00 SAVE </div> |
| 4. | <p>Select the scalings for the signals by specifying the minimum and maximum display values. This has no effect if parameter 3404/3411/3418 is set to 9 (DIRECT). For details, see parameters 3406 and 3407.</p> <p>Signal 1: parameters 3406 OUTPUT1 MIN and 3407 OUTPUT1 MAX Signal 2: parameters 3413 OUTPUT2 MIN and 3414 OUTPUT2 MAX Signal 3: parameters 3420 OUTPUT3 MIN and 3421 OUTPUT3 MAX.</p> | <div style="border: 1px solid black; padding: 2px;"> LOC <input type="checkbox"/> PAR EDIT <input type="checkbox"/> 3406 OUTPUT1 MIN 0.0 Hz CANCEL 00:00 SAVE </div> <div style="border: 1px solid black; padding: 2px;"> LOC <input type="checkbox"/> PAR EDIT <input type="checkbox"/> 3407 OUTPUT1 MAX 500.0 Hz CANCEL 00:00 SAVE </div> |

Assistants mode

















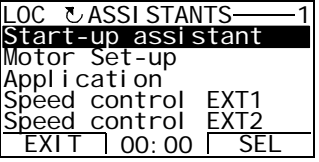

When the drive is first powered up, the Start-up Assistant guides you through the setup of the basic parameters. The Start-up Assistant is divided into assistants, each of which guides you through the task of specifying a related parameter set, for example Motor Set-up or PID Control. You can activate the assistants one after the other as the Start-up Assistant suggests, or independently. The tasks of the assistants are listed in the table on page 82.

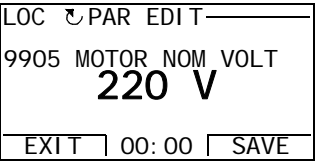
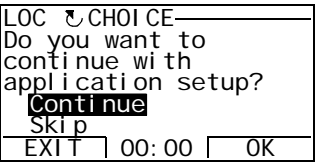

In the Assistants mode, you can:

- use assistants to guide you through the specification of a set of basic parameters
- start, stop, change the direction and switch between local and remote control.

How to use an assistant

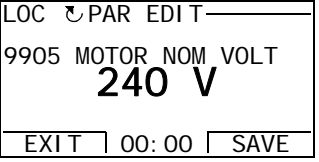
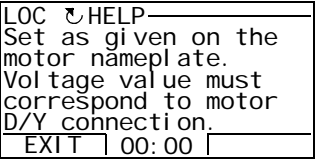
The table below shows the basic operation sequence which leads you through assistants. The Motor Set-up Assistant is used as an example.

| Step | Action | Display |
|------|---|--|
| 1. | Go to the Main menu by pressing  if you are in the Output mode, otherwise by pressing  repeatedly until you get to the Main menu. |  |
| 2. | Go to the Assistants mode by selecting ASSISTANTS on the menu with keys  and  , and pressing  . |  |
| 3. | Select the assistant with keys  and  , and press  . If you select any other assistant than the Start-up Assistant, it guides you through the task of specification of its parameter set as shown in steps 4. and 5. below. After that you can select another assistant on the Assistants menu or exit the Assistants mode. The Motor Set-up Assistant is used here as an example. If you select the Start-up Assistant, it activates the first assistant, which guides you through the task of specification of its parameter set as shown in steps 4. and 5. below. The Start-up Assistant then asks if you want to continue with the next assistant or skip it – select the appropriate answer with keys  and  , and press  . If you choose to skip, the Start-up Assistant asks the same question about the next assistant, and so on. |   |
| 4. | <ul style="list-style-type: none"> • To specify a new value, press keys  and . • To ask for information on the requested parameter, press key . Scroll the help text with keys  and . Close the help by pressing . |   |

| Step | Action | Display |
|------|--|--|
| 5. | <ul style="list-style-type: none"> To accept the new value and continue to the setting of the next parameter, press . To stop the assistant, press . | <pre> LOC ↻ PAR EDIT 9906 MOTOR NOM CURR 1.2 A EXIT 00:00 SAVE </pre> |

The table below lists the tasks of the assistants and the relevant drive parameters. Depending on the selection made in the Application task (parameter [9902](#) APPLIC MACRO), the Start-up Assistant decides, which consequent tasks it suggests.

| Name | Description | Set parameters |
|---------------------------|---|--|
| Language select | Selecting the language | 9901 |
| Motor set-up | Setting the motor data Performing the motor identification. (If the speed limits are not in the allowed range: Setting the limits.) | 9904...9909 9910 |
| Application | Selecting the application macro | 9902 , parameters associated to the macro |
| Option modules | Activating the option modules | Group 35: MOTOR TEMP MEAS Group 52: PANEL COMM 9802 |
| Speed control EXT1 | Selecting the source for the speed reference (If AI1 is used: Setting analog input AI1 limits, scale, inversion) Setting the reference limits Setting the speed (frequency) limits Setting the acceleration and deceleration times | 1103 (1301...1303 , 3001) 1104 , 1105 2001 , 2002 , (2007 , 2008) 2202 , 2203 |
| Speed control EXT2 | Selecting the source for the speed reference (If AI1 is used: Setting analog input AI1 limits, scale, inversion) Setting the reference limits | 1106 (1301...1303 , 3001) 1107 , 1108 |
| Torque control | Selecting the source for the torque reference (If AI1 is used: Setting analog input AI1 limits, scale, inversion) Setting the reference limits Setting the torque ramp up and ramp down times | 1106 (1301...1303 , 3001) 1107 , 1108 2401 , 2402 |
| PID control | Selecting the source for the process reference (If AI1 is used: Setting analog input AI1 limits, scale, inversion) Setting the reference limits Setting the speed (reference) limits Setting the source and limits for the process actual value | 1106 (1301...1303 , 3001) 1107 , 1108 2001 , 2002 , (2007 , 2008) 4016 , 4018 , 4019 |
| Start/Stop control | Selecting the source for start and stop signals of the two external control locations, EXT1 and EXT2 Selecting between EXT1 and EXT2 Defining the direction control Defining the start and stop modes Selecting the use of Run Enable signal | 1001 , 1002 1102 1003 2101...2103 1601 |
| Timed functions | Setting the timed functions Selecting the timed start/stop control for external control locations EXT1 and EXT2 Selecting timed EXT1/EXT2 control Activation of timed constant speed 1 | Group 36: TIMED FUNCTIONS 1001 , 1002 1102 1201 |













| Name | Description | Set parameters |
|-----------------------|--|---|
| | Selecting timed function status indicated through relay output RO Selecting timed PID1 parameter set 1/2 control | 1401 4027 |
| Protections | Setting the current and torque limits | 2003, 2017 |
| Output signals | Selecting the signals indicated through relay output RO Selecting the signals indicated through analog output AO Setting the minimum, maximum, scaling and inversion | Group 14: RELAY OUTPUTS Group 15: ANALOG OUTPUTS |

Changed Parameters mode

In the Changed Parameters mode, you can:

- view a list of all parameters that have been changed from the macro default values
- change these parameters
- start, stop, change the direction and switch between local and remote control.

How to view and edit changed parameters













| Step | Action | Display |
|------|---|--|
| 1. | Go to the Main menu by pressing  if you are in the Output mode, otherwise by pressing  repeatedly until you get to the Main menu. | <pre> LOC MAIN MENU 1 PARAMETERS ASSISTANTS CHANGED PAR EXIT 00:00 ENTER </pre> |
| 2. | Go to the Changed Parameters mode by selecting CHANGED PAR on the menu with keys  and  , and pressing  . | <pre> LOC CHANGED PAR 1202 CONST SPEED 1 10.0 Hz 1203 CONST SPEED 2 1204 CONST SPEED 3 9902 APPLIC MACRO EXIT 00:00 EDIT </pre> |
| 3. | Select the changed parameter on the list with keys  and  . The value of the selected parameter is shown below it. Press  to modify the value. | <pre> LOC PAR EDIT 1202 CONST SPEED 1 10.0 Hz CANCEL 00:00 SAVE </pre> |
| 4. | Specify a new value for the parameter with keys  and  . Pressing the key once increments or decrements the value. Holding the key down changes the value faster. Pressing the keys simultaneously replaces the displayed value with the default value. | <pre> LOC PAR EDIT 1202 CONST SPEED 1 15.0 Hz CANCEL 00:00 SAVE </pre> |
| 5. | <ul style="list-style-type: none"> • To accept the new value, press . If the new value is the default value, the parameter is removed from the list of changed parameters. • To cancel the new value and keep the original, press . | <pre> LOC CHANGED PAR 1202 CONST SPEED 1 15.0 Hz 1203 CONST SPEED 2 1204 CONST SPEED 3 9902 APPLIC MACRO EXIT 00:00 EDIT </pre> |

Fault Logger mode

In the Fault Logger mode, you can:

- view the drive fault history of maximum ten faults (after a power off, only the three latest faults are kept in the memory)
- see the details of the three latest faults (after a power off, the details of only the most recent fault is kept in the memory)
- read the help text for the fault
- start, stop, change the direction and switch between local and remote control.

How to view faults

| Step | Action | Display |
|------|--|--|
| 1. | Go to the Main menu by pressing  if you are in the Output mode, otherwise by pressing  repeatedly until you get to the Main menu. | <pre> LOC MAIN MENU 1 PARAMETERS ASSTANTS CHANGED PAR EXIT 00:00 ENTER </pre> |
| 2. | Go to the Fault Logger mode by selecting FAULT LOGGER on the menu with keys  and  , and pressing  . The display shows the fault log starting with the latest fault. The number on the row is the fault code according to which the causes and corrective actions are listed in chapter Diagnostics . | <pre> LOC FAULT LOG 10: PANEL LOSS 19.03.05 13:04:57 6: DC UNDERVOLT 6: AI 1 LOSS EXIT 00:00 DETAIL </pre> |
| 3. | To see the details of a fault, select it with keys  and  , and press  . | <pre> LOC PANEL LOSS FAULT 10 FAULT TIME 1 13:04:57 FAULT TIME 2 EXIT 00:00 DIAG </pre> |
| 4. | To show the help text, press  . Scroll the help text with keys  and  . After reading the help, press  to return to the previous display. | <pre> LOC DIAGNOSTICS Check: Comm lines and connections, parameter 3002, parameters in groups 10 and 11. EXIT 00:00 OK </pre> |

















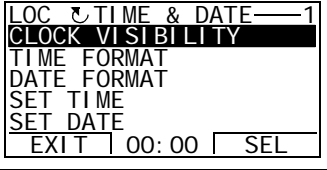





Time and Date mode









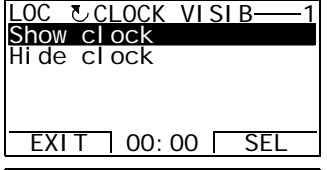
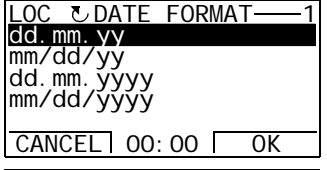
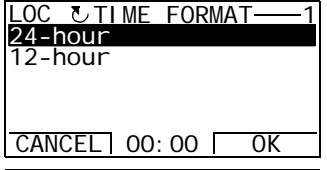
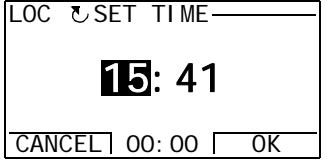



In the Time and Date mode, you can:

- show or hide the clock
- change date and time display formats
- set the date and time
- enable or disable automatic clock transitions according to the daylight saving changes
- start, stop, change the direction and switch between local and remote control.

The Assistant Control Panel contains a battery to ensure the function of the clock when the panel is not powered by the drive.

How to show or hide the clock, change display formats, set the date and time and enable or disable clock transitions due to daylight saving changes

| Step | Action | Display |
|------|--|--|
| 1. | Go to the Main menu by pressing  if you are in the Output mode, otherwise by pressing  repeatedly until you get to the Main menu. |  |
| 2. | Go to the Time and Date mode by selecting TIME & DATE on the menu with keys  and  , and pressing  . |  |
| 3. | <ul style="list-style-type: none"> • To show (hide) the clock, select CLOCK VISIBILITY on the menu, press , select Show clock (Hide clock) and press , or, if you want to return to the previous display without making changes, press . • To specify the date format, select DATE FORMAT on the menu, press  and select a suitable format. Press  to save or  to cancel your changes. • To specify the time format, select TIME FORMAT on the menu, press  and select a suitable format. Press  to save or  to cancel your changes. • To set the time, select SET TIME on the menu and press . Specify the hours with keys  and , and press . Then specify the minutes. Press  to save or  to cancel your changes. |     |

| Step | Action | Display |
|------|--|--|
| | <ul style="list-style-type: none"> To set the date, select SET DATE on the menu and press . Specify the first part of the date (day or month depending on the selected date format) with keys  and , and press . Repeat for the second part. After specifying the year, press . To cancel your changes, press . To enable or disable the automatic clock transitions according to the daylight saving changes, select DAYLIGHT SAVING on the menu and press . Pressing  opens the help that shows the beginning and end dates of the period during which daylight saving time is used in each country or area whose daylight saving changes you can select to be followed. To disable automatic clock transitions according to the daylight saving changes, select Off and press . To enable automatic clock transitions, select the country or area whose daylight saving changes are followed and press . To return to the previous display without making changes, press . | <div data-bbox="1152 235 1473 394"> <p>LOC  SET DATE</p> <p>19. 03. 05</p> <p>CANCEL 00: 00 OK</p> </div> <div data-bbox="1152 403 1473 562"> <p>LOC DAYLIGHT SAV—1</p> <p>Off</p> <p>EU</p> <p>US</p> <p>Austral ia1: NSW, Vi ct. .</p> <p>Austral ia2: Tasmani a. .</p> <p>EXIT 00: 00 SEL</p> </div> <div data-bbox="1152 571 1473 730"> <p>LOC HELP</p> <p>EU:</p> <p>On: Mar 1st Sunday</p> <p>Off: Oct 1st Sunday</p> <p>US:</p> <p>EXIT 00: 00 </p> </div> |

Parameter Backup mode

The Parameter Backup mode is used to export parameters from one drive to another or to make a backup of the drive parameters. Uploading to the panel stores all drive parameters, including up to two user sets, to the Assistant Control Panel. The full set, partial parameter set (application) and user sets can then be downloaded from the control panel to another drive or the same drive.

The control panel memory is non-volatile and does not depend on the panel battery.

In the Parameter Backup mode, you can:

- copy all parameters from the drive to the control panel (UPLOAD TO PANEL). This includes all defined user sets of parameters and internal (not adjustable by the user) parameters such as those created by the ID Run.
- view the information about the backup stored to the control panel with UPLOAD TO PANEL (BACKUP INFO). This includes e.g. the type and rating of the drive where the backup was made. It is useful to check this information when you are going to copy the parameters to another drive with DOWNLOAD FULL SET to ensure that the drives match.
- restore the full parameter set from the control panel to the drive (DOWNLOAD FULL SET). This writes all parameters, including the internal non-user-adjustable motor parameters, to the drive. It does not include the user sets of parameters.

Note: Only use this function to restore a drive from a backup or to transfer parameters to systems that are identical to the original system.

- copy a partial parameter set (part of the full set) from the control panel to a drive (DOWNLOAD APPLICATION). The partial set does not include user sets, internal motor parameters, parameters [9905...9909](#), [1605](#), [1607](#), [5201](#), nor any [Group 51: EXT COMM MODULE](#) and [Group 53: EFB PROTOCOL](#) parameters.

The source and target drives and their motor sizes do not need to be the same.















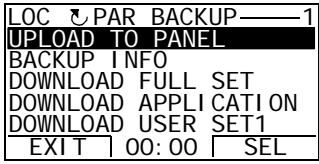

- copy USER S1 parameters from the control panel to the drive (DOWNLOAD USER SET1). A user set includes [Group 99: START-UP DATA](#) parameters and the internal motor parameters.

The function is only shown on the menu when User Set 1 has been first saved using parameter [9902](#) APPLIC MACRO (see section [User parameter sets](#) on page [111](#)) and then uploaded to the control panel with UPLOAD TO PANEL.







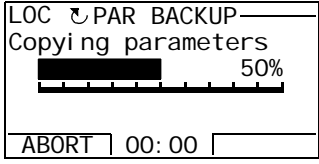
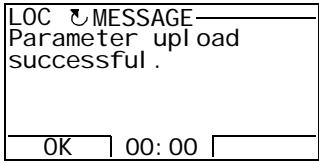
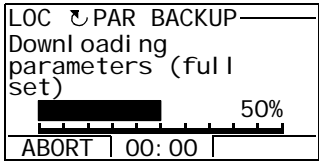
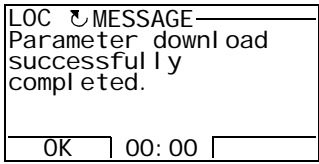



- copy USER S2 parameters from the control panel to the drive (DOWNLOAD USER SET2). As DOWNLOAD USER SET1 above.
- start, stop, change the direction and switch between local and remote control.

How to upload and download parameters

For the upload and download functions available, see above.

| Step | Action | Display |
|------|--|---|
| 1. | Go to the Main menu by pressing  if you are in the Output mode, otherwise by pressing  repeatedly until you get to the Main menu. |  |
| 2. | Go to the Par Backup mode by selecting PAR BACKUP on the menu with keys  and  , and pressing  . |  |
| 3. | <p>• To copy all parameters (including user sets and internal parameters) from the drive to the control panel, select UPLOAD TO PANEL on the Par Backup menu with keys  and , and press . During the transfer, the display shows the transfer status as a percentage of completion. Press  if you want to stop the operation.</p> <p>After the upload is completed, the display shows a message about the completion. Press  to return to the Par Backup menu.</p> <p>• To perform downloads, select the appropriate operation (here DOWNLOAD FULL SET is used as an example) on the Par Backup menu with keys  and , and press . The display shows the transfer status as a percentage of completion. Press  if you want stop the operation.</p> <p>After the download is completed, the display shows a message about the completion. Press  to return to the Par Backup menu.</p> |     |

How to view information about the backup















| Step | Action | Display |
|------|---|---|
| 1. | Go to the Main menu by pressing  if you are in the Output mode, otherwise by pressing  repeatedly until you get to the Main menu. | <pre> LOC MAIN MENU-----1 PARAMETERS ASSISTANTS CHANGED PAR EXIT 00:00 ENTER </pre> |
| 2. | Go to the Par Backup mode by selecting PAR BACKUP on the menu with keys  and  , and pressing  . | <pre> LOC PAR BACKUP-----1 UPLOAD TO PANEL BACKUP INFO DOWNLOAD FULL SET DOWNLOAD APPLI CATION DOWNLOAD USER SET1 EXIT 00:00 SEL </pre> |
| 3. | <p>Select BACKUP INFO on the Par Backup menu with keys  and , and press . The display shows the following information about the drive where the backup was made:</p> <p>DRIVE TYPE: type of the drive</p> <p>DRIVE RATING: rating of the drive in format XXXYZ, where</p> <p> XXX: nominal current rating. If present, an "A" indicates</p> <p> a decimal point, e.g. 4A6 means 4.6 A.</p> <p> Y: 2 = 200 V</p> <p> 4 = 400 V</p> <p> 6 = 600 V</p> <p> Z: i = European loading package</p> <p> n = US loading package</p> <p>FIRMWARE: firmware version of the drive.</p> <p>You can scroll the information with keys  and .</p> | <pre> LOC BACKUP INFO----- DRIVE TYPE ACS550 3304 DRIVE RATING 4A62i 3301 FIRMWARE EXIT 00:00 </pre> <pre> LOC BACKUP INFO----- ACS550 3304 DRIVE RATING 4A62i 3301 FIRMWARE 300F hex EXIT 00:00 </pre> |
| 4. | Press  to return to the Par Backup menu. | <pre> LOC PAR BACKUP-----1 UPLOAD TO PANEL BACKUP INFO DOWNLOAD FULL SET DOWNLOAD APPLI CATION DOWNLOAD USER SET1 EXIT 00:00 SEL </pre> |

I/O Settings mode

In the I/O Settings mode, you can:

- check the parameter settings related to any I/O terminal
- edit the parameter setting. For example, if “1103: REF1” is listed under Ain1 (Analog input 1), that is, parameter **1103** REF1 SELECT has value AI1, you can change its value to e.g. AI2. You cannot, however, set the value of parameter **1106** REF2 SELECT to AI1.
- start, stop, change the direction and switch between local and remote control.

How to edit and change parameter settings related to I/O terminals

| Step | Action | Display |
|------|--|---|
| 1. | Go to the Main menu by pressing  if you are in the Output mode, otherwise by pressing  repeatedly until you get to the Main menu. | <pre> LOC MAIN MENU —1 PARAMETERS ASST STANTS CHANGED PAR EXIT 00:00 ENTER </pre> |
| 2. | Go the I/O Settings mode by selecting I/O SETTINGS on the menu with keys  and  , and pressing  . | <pre> LOC I/O SETTINGS—1 DIGITAL INPUTS (DI) ANALOG INPUTS (AI) RELAY OUTPUTS (ROUT) ANALOG OUTPUTS (AOUT) PANEL EXIT 00:00 SEL </pre> |
| 3. | Select the I/O group, e.g. DIGITAL INPUTS, with keys  and  , and press  . After a brief pause, the display shows the current settings for the selection. | <pre> LOC I/O SETTINGS— -DI 1— 1001: START/STOP (E1) -DI 2— — -DI 3— EXIT 00:00 </pre> |
| 4. | Select the setting (line with a parameter number) with keys  and  , and press  . | <pre> LOC PAR EDIT— 1001 EXT1 COMMANDS DI 1 [1] CANCEL 00:00 SAVE </pre> |
| 5. | Specify a new value for the setting with keys  and  . Pressing the key once increments or decrements the value. Holding the key down changes the value faster. Pressing the keys simultaneously replaces the displayed value with the default value. | <pre> LOC PAR EDIT— 1001 EXT1 COMMANDS DI 1, 2 [2] CANCEL 00:00 SAVE </pre> |
| 6. | <ul style="list-style-type: none"> • To save the new value, press . • To cancel the new value and keep the original, press . | <pre> LOC I/O SETTINGS— -DI 1— 1001: START/STOP (E1) -DI 2— 1001: DIR (E1) -DI 3— EXIT 00:00 </pre> |

Basic Control Panel

Features

The Basic Control Panel features:

- numeric control panel with an LCD display
- copy function – parameters can be copied to the control panel memory for later transfer to other drives or for backup of a particular system.

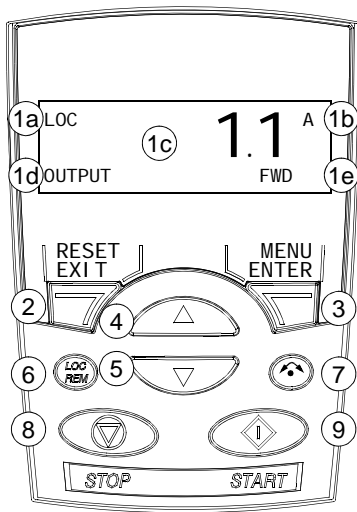

Overview

The following table summarizes the key functions and displays on the Basic Control Panel.



| No. | Use |
|-----|---|
| 1 | <p>LCD display – Divided into five areas:</p> <p>a. Upper left – Control location: LOC: drive control is local, that is, from the control panel REM: drive control is remote, such as the drive I/O or fieldbus.</p> <p>b. Upper right – Unit of the displayed value.</p> <p>c. Center – Variable; in general, shows parameter and signal values, menus or lists. Shows also fault and alarm codes.</p> <p>d. Lower left and center – Panel operation state: OUTPUT: Output mode PAR: Parameter mode MENU: Main menu FAULT: Fault mode.</p> <p>e. Lower right – Indicators: FWD (forward) / REV (reverse): direction of the motor rotation Flashing slowly: stopped Flashing rapidly: running, not at setpoint Steady: running, at setpoint SET: Displayed value can be modified (in the Parameter and Reference modes).</p> |
| 2 | RESET/EXIT – Exits to the next higher menu level without saving changed values. Resets faults in the Output and Fault modes. |
| 3 | MENU/ENTER – Enters deeper into menu level. In the Parameter mode, saves the displayed value as the new setting. |
| 4 | Up – <ul style="list-style-type: none"> • Scrolls up through a menu or list. • Increases a value if a parameter is selected. • Increases the reference value in the Reference mode. Holding the key down changes the value faster. |
| 5 | Down – <ul style="list-style-type: none"> • Scrolls down through a menu or list. • Decreases a value if a parameter is selected. • Decreases the reference value in the Reference mode. Holding the key down changes the value faster. |
| 6 | LOC/REM – Changes between local and remote control of the drive. |
| 7 | DIR – Changes the direction of the motor rotation. |
| 8 | STOP – Stops the drive in local control. |
| 9 | START – Starts the drive in local control. |

Operation

You operate the control panel with menus and keys. You select an option, e.g. operation mode or parameter, by scrolling the  and  arrow keys until the option is visible in the display and then pressing the  key.

With the  key, you return to the previous operation level without saving the made changes.

The Basic Control Panel has five panel modes: Output, Reference, Parameter, Copy and Fault. The operation in the first four modes is described in this chapter. When a fault or alarm occurs, the panel goes automatically to the Fault mode showing the fault or alarm code. You can reset the fault or alarm in the Output or Fault mode (see chapter [Diagnostics](#)).

After the power is switched on, the panel is in the Output mode, where you can start, stop, change the direction, switch between local and remote control and monitor up to three actual values (one at a time). To do other tasks, go first to the Main menu and select the appropriate mode.

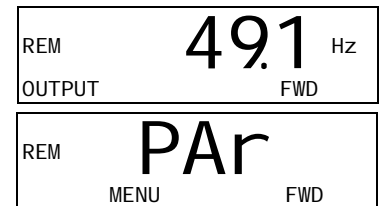





How to do common tasks

The table below lists common tasks, the mode in which you can perform them and the page number where the steps to do the task are described in detail.

| Task | Mode | Page |
|---|---------------|---------------------|
| How to switch between local and remote control | Any | 94 |
| How to start and stop the drive | Any | 94 |
| How to change the direction of the motor rotation | Any | 94 |
| How to browse the monitored signals | Output | 95 |
| How to set the speed, frequency or torque reference | Reference | 96 |
| How to change the value of a parameter | Parameter | 97 |
| How to select the monitored signals | Parameter | 98 |
| How to reset faults and alarms | Output, Fault | 279 |
| How to copy parameters from the drive to the control panel | Copy | 100 |
| How to restore parameters from the control panel to the drive | Copy | 100 |



How to start, stop and switch between local and remote control

You can start, stop and switch between local and remote control in any mode. To be able to start or stop the drive, the drive must be in local control.

| Step | Action | Display |
|------|---|---|
| 1. | <ul style="list-style-type: none"> To switch between remote control (REM shown on the left) and local control (LOC shown on the left), press . Note: Switching to local control can be disabled with parameter 1606 LOCAL LOCK. <p>After pressing the key, the display briefly shows message "LoC" or "rE", as appropriate, before returning to the previous display.</p> <p>The very first time the drive is powered up, it is in remote control (REM) and controlled through the drive I/O terminals. To switch to local control (LOC) and control the drive using the control panel, press . The result depends on how long you press the key:</p> <ul style="list-style-type: none"> If you release the key immediately (the display flashes "LoC"), the drive stops. Set the local control reference as instructed on page 96. If you press the key for about two seconds (release when the display changes from "LoC" to "LoC r"), the drive continues as before. The drive copies the current remote values for the run/stop status and the reference, and uses them as the initial local control settings. <ul style="list-style-type: none"> To stop the drive in local control, press . To start the drive in local control, press . | <div style="border: 1px solid black; padding: 5px; margin-bottom: 10px;"> LOC 49.1 Hz OUTPUT FWD </div> <div style="border: 1px solid black; padding: 5px;"> LOC LoC FWD </div> <p>Text FWD or REV on the bottom line starts flashing slowly.</p> <p>Text FWD or REV on the bottom line starts flashing rapidly. It stops flashing when the drive reaches the setpoint.</p> |

How to change the direction of the motor rotation

You can change the direction of the motor rotation in any mode.

| Step | Action | Display |
|------|---|---|
| 1. | <p>If the drive is in remote control (REM shown on the left), switch to local control by pressing . The display briefly shows message "LoC" before returning to the previous display.</p> | <div style="border: 1px solid black; padding: 5px;"> LOC 49.1 Hz OUTPUT FWD </div> |
| 2. | <p>To change the direction from forward (FWD shown at the bottom) to reverse (REV shown at the bottom), or vice versa, press .</p> <p>Note: Parameter 1003 DIRECTION must be set to 3 (REQUEST).</p> | <div style="border: 1px solid black; padding: 5px;"> LOC 49.1 Hz OUTPUT REV </div> |

Output mode

In the Output mode, you can:



- monitor actual values of up to three *Group 01: OPERATING DATA* signals, one signal at a time
- start, stop, change the direction and switch between local and remote control.

You get to the Output mode by pressing  until the display shows text OUTPUT at the bottom.

The display shows the value of one *Group 01: OPERATING DATA* signal. The unit is shown on the right. Page 98 tells how to select up to three signals to be monitored in the Output mode. The table below shows how to view them one at a time.

| | |
|--------|----------------|
| REM | 49.1 Hz |
| OUTPUT | FWD |

How to browse the monitored signals













| Step | Action | Display | | | | | | | | | | | | |
|--------|--|--|-----|----------------|--------|-----|-----|-------------|--------|-----|-----|--------------|--------|-----|
| 1. | <p>If more than one signals have been selected to be monitored (see page 98), you can browse them in the Output mode.</p> <p>To browse the signals forward, press key  repeatedly. To browse them backward, press key  repeatedly.</p> | <table border="1"> <tr> <td>REM</td> <td style="text-align: center;">49.1 Hz</td> </tr> <tr> <td>OUTPUT</td> <td style="text-align: center;">FWD</td> </tr> </table> <table border="1"> <tr> <td>REM</td> <td style="text-align: center;">05 A</td> </tr> <tr> <td>OUTPUT</td> <td style="text-align: center;">FWD</td> </tr> </table> <table border="1"> <tr> <td>REM</td> <td style="text-align: center;">107 %</td> </tr> <tr> <td>OUTPUT</td> <td style="text-align: center;">FWD</td> </tr> </table> | REM | 49.1 Hz | OUTPUT | FWD | REM | 05 A | OUTPUT | FWD | REM | 107 % | OUTPUT | FWD |
| REM | 49.1 Hz | | | | | | | | | | | | | |
| OUTPUT | FWD | | | | | | | | | | | | | |
| REM | 05 A | | | | | | | | | | | | | |
| OUTPUT | FWD | | | | | | | | | | | | | |
| REM | 107 % | | | | | | | | | | | | | |
| OUTPUT | FWD | | | | | | | | | | | | | |

Reference mode

In the Reference mode, you can:

- set the speed, frequency or torque reference
- start, stop, change the direction and switch between local and remote control.

How to set the speed, frequency or torque reference

















| Step | Action | Display |
|------|---|--|
| 1. | Go to the Main menu by pressing  if you are in the Output mode, otherwise by pressing  repeatedly until you see MENU at the bottom. |  |
| 2. | If the drive is in remote control (REM shown on the left), switch to local control by pressing  . The display briefly shows "LoC" before switching to local control. Note: With Group 11: REFERENCE SELECT , you can allow the reference modification in remote control (REM). |  |
| 3. | If the panel is not in the Reference mode ("rEF" not visible), press key  or  until you see "rEF" and then press  . Now the display shows the current reference value with SET under the value. |   |
| 4. | <ul style="list-style-type: none"> • To increase the reference value, press . • To decrease the reference value, press . The value changes immediately when you press the key. It is stored in the drive permanent memory and restored automatically after power switch-off. |  |

Parameter mode

In the Parameter mode, you can:

- view and change parameter values
- select and modify the signals shown in the Output mode
- start, stop, change the direction and switch between local and remote control.

How to select a parameter and change its value

| Step | Action | Display |
|------|--|---|
| 1. | Go to the Main menu by pressing  if you are in the Output mode, otherwise by pressing  repeatedly until you see MENU at the bottom. | <div style="border: 1px solid black; padding: 5px;"> LOC <div style="text-align: center; font-size: 2em; font-weight: bold;">rEF</div> <div style="display: flex; justify-content: space-between; font-size: 0.8em;"> MENU FWD </div> </div> |
| 2. | If the panel is not in the Parameter mode ("PAR" not visible), press key  or  until you see "PAR" and then press  . The display shows the number of one of the parameter groups. | <div style="border: 1px solid black; padding: 5px;"> LOC <div style="text-align: center; font-size: 2em; font-weight: bold;">PAR</div> <div style="display: flex; justify-content: space-between; font-size: 0.8em;"> MENU FWD </div> </div> <div style="border: 1px solid black; padding: 5px; margin-top: 5px;"> LOC <div style="text-align: center; font-size: 2em; font-weight: bold;">-01-</div> <div style="display: flex; justify-content: space-between; font-size: 0.8em;"> PAR FWD </div> </div> |
| 3. | Use keys  and  to find the desired parameter group. | <div style="border: 1px solid black; padding: 5px;"> LOC <div style="text-align: center; font-size: 2em; font-weight: bold;">-11-</div> <div style="display: flex; justify-content: space-between; font-size: 0.8em;"> PAR FWD </div> </div> |
| 4. | Press  . The display shows one of the parameters in the selected group. | <div style="border: 1px solid black; padding: 5px;"> LOC <div style="text-align: center; font-size: 2em; font-weight: bold;">1101</div> <div style="display: flex; justify-content: space-between; font-size: 0.8em;"> PAR FWD </div> </div> |
| 5. | Use keys  and  to find the desired parameter. | <div style="border: 1px solid black; padding: 5px;"> LOC <div style="text-align: center; font-size: 2em; font-weight: bold;">1103</div> <div style="display: flex; justify-content: space-between; font-size: 0.8em;"> PAR FWD </div> </div> |
| 6. | Press and hold  for about two seconds until the display shows the value of the parameter with SET underneath indicating that changing of the value is now possible. Note: When SET is visible, pressing keys  and  simultaneously changes the displayed value to the default value of the parameter. | <div style="border: 1px solid black; padding: 5px;"> LOC <div style="text-align: center; font-size: 2em; font-weight: bold;">1</div> <div style="display: flex; justify-content: space-between; font-size: 0.8em;"> PAR SET FWD </div> </div> |
| 7. | Use keys  and  to select the parameter value. When you have changed the parameter value, SET starts flashing. <ul style="list-style-type: none"> • To save the displayed parameter value, press . • To cancel the new value and keep the original, press . | <div style="border: 1px solid black; padding: 5px;"> LOC <div style="text-align: center; font-size: 2em; font-weight: bold;">2</div> <div style="display: flex; justify-content: space-between; font-size: 0.8em;"> PAR SET FWD </div> </div> <div style="border: 1px solid black; padding: 5px; margin-top: 5px;"> LOC <div style="text-align: center; font-size: 2em; font-weight: bold;">1103</div> <div style="display: flex; justify-content: space-between; font-size: 0.8em;"> PAR FWD </div> </div> |

How to select the monitored signals

| Step | Action | Display |
|------|--|--|
| 1. | <p>You can select which signals are monitored in the Output mode and how they are displayed with Group 34: PANEL DISPLAY parameters. See page 79 for detailed instructions on changing parameter values.</p> <p>By default, you can monitor three signals by browsing (see page 95). The particular default signals depend on the value of parameter 9902 APPLIC MACRO: For macros whose default value of parameter 9904 MOTOR CTRL MODE is 1 (VECTOR:SPEED), the default for signal 1 is 0102 SPEED, otherwise 0103 OUTPUT FREQ. The defaults for signals 2 and 3 are always 0104 CURRENT and 0105 TORQUE, respectively.</p> <p>To change the default signals, select from Group 01: OPERATING DATA up to three signals to be browsed.</p> <p>Signal 1: Change the value of parameter 3401 SIGNAL1 PARAM to the index of the signal parameter in Group 01: OPERATING DATA (= number of the parameter without the leading zero), e.g. 105 means parameter 0105 TORQUE. Value 100 means that no signal is displayed.</p> <p>Repeat for signals 2 (3408 SIGNAL2 PARAM) and 3 (3415 SIGNAL3 PARAM). For example, if 3401 = 0 and 3415 = 0, browsing is disabled and only the signal specified by 3408 appears in the display. If all three parameters are set to 0, i.e. no signals are selected for monitoring, the panel displays text "n.A".</p> | <div style="border: 1px solid black; padding: 5px; margin-bottom: 5px;">LOC 103 PAR SET FWD</div> <div style="border: 1px solid black; padding: 5px; margin-bottom: 5px;">LOC 104 PAR SET FWD</div> <div style="border: 1px solid black; padding: 5px;">LOC 105 PAR SET FWD</div> |
| 2. | <p>Specify the decimal point location, or use the decimal point location and unit of the source signal [setting 9 (DIRECT)]. Bar graphs are not available for Basic Operation Panel. For details, see parameter 3404.</p> <p>Signal 1: parameter 3404 OUTPUT1 DSP FORM Signal 2: parameter 3411 OUTPUT2 DSP FORM Signal 3: parameter 3418 OUTPUT3 DSP FORM.</p> | <div style="border: 1px solid black; padding: 5px;">LOC 9 PAR SET FWD</div> |
| 3. | <p>Select the units to be displayed for the signals. This has no effect if parameter 3404/3411/3418 is set to 9 (DIRECT). For details, see parameter 3405.</p> <p>Signal 1: parameter 3405 OUTPUT1 UNIT Signal 2: parameter 3412 OUTPUT2 UNIT Signal 3: parameter 3419 OUTPUT3 UNIT.</p> | <div style="border: 1px solid black; padding: 5px;">LOC 3 PAR SET FWD</div> |
| 4. | <p>Select the scalings for the signals by specifying the minimum and maximum display values. This has no effect if parameter 3404/3411/3418 is set to 9 (DIRECT). For details, see parameters 3406 and 3407.</p> <p>Signal 1: parameters 3406 OUTPUT1 MIN and 3407 OUTPUT1 MAX Signal 2: parameters 3413 OUTPUT2 MIN and 3414 OUTPUT2 MAX Signal 3: parameters 3420 OUTPUT3 MIN and 3421 OUTPUT3 MAX.</p> | <div style="border: 1px solid black; padding: 5px; margin-bottom: 5px;">LOC 00 Hz PAR SET FWD</div> <div style="border: 1px solid black; padding: 5px;">LOC 5000 Hz PAR SET FWD</div> |

Copy mode

The Basic Control Panel can store a full set of drive parameters and up to two user sets of drive parameters to the control panel. The control panel memory is non-volatile.

In the Copy mode, you can:

- copy all parameters from the drive to the control panel (uL – Upload). This includes all defined user sets of parameters and internal (not adjustable by the user) parameters such as those created by the ID Run.
- restore the full parameter set from the control panel to the drive (dL A – Download All). This writes all parameters, including the internal non-user-adjustable motor parameters, to the drive. It does not include the user sets of parameters.

Note: Only use this function to restore a drive, or to transfer parameters to systems that are identical to the original system.

- copy a partial parameter set from the control panel to a drive (dL P – Download Partial). The partial set does not include user sets, internal motor parameters, parameters [9905...9909](#), [1605](#), [1607](#), [5201](#), nor any [Group 51: EXT COMM MODULE](#) and [Group 53: EFB PROTOCOL](#) parameters.

The source and target drives and their motor sizes do not need to be the same.











- copy USER S1 parameters from the control panel to the drive (dL u1 – Download User Set 1). A user set includes [Group 99: START-UP DATA](#) parameters and the internal motor parameters.

The function is only shown on the menu when User Set 1 has been first saved using parameter [9902](#) APPLIC MACRO (see section [User parameter sets](#) on page [111](#)) and then uploaded to panel.

- copy USER S2 parameters from the control panel to the drive (dL u2 – Download User Set 2). As dL u1 – Download User Set 1 above.
- start, stop, change the direction and switch between local and remote control.

How to upload and download parameters

For the upload and download functions available, see above.

| Step | Action | Display |
|------|---|--|
| 1. | Go to the Main menu by pressing  if you are in the Output mode, otherwise by pressing  repeatedly until you see MENU at the bottom. | <div style="border: 1px solid black; padding: 5px;"> LOC PAr MENU FWD </div> |
| 2. | If the panel is not in the Copy mode ("CoPY" not visible), press key  or  until you see "CoPY". | <div style="border: 1px solid black; padding: 5px;"> LOC CoPY MENU FWD </div> |
| | Press  . | <div style="border: 1px solid black; padding: 5px;"> LOC dL u1 MENU FWD </div> |
| 3. | <ul style="list-style-type: none"> To upload all parameters (including user sets) from the drive to the control panel, step to "uL" with keys  and . | <div style="border: 1px solid black; padding: 5px;"> LOC uL MENU FWD </div> |
| | Press  . During the transfer, the display shows the transfer status as a percentage of completion. | <div style="border: 1px solid black; padding: 5px;"> LOC uL 50 % MENU FWD </div> |
| | <ul style="list-style-type: none"> To perform downloads, step to the appropriate operation (here "dL A", Download All, is used as an example) with keys  and . | <div style="border: 1px solid black; padding: 5px;"> LOC dL A MENU FWD </div> |
| | Press  . During the transfer, the display shows the transfer status as a percentage of completion. | <div style="border: 1px solid black; padding: 5px;"> LOC dL 50 % MENU FWD </div> |

Basic Control Panel alarm codes

In addition to the faults and alarms generated by the drive (see chapter [Diagnostics](#)), the Basic Control Panel indicates control panel alarms with a code of form A5xxx. See section [Alarm codes \(Basic Control Panel\)](#) on page 283 for a list of the alarm codes and descriptions.

Application macros

Macros change a group of parameters to new, predefined values. Use macros to minimize the need for manual editing of parameters. Selecting a macro sets all other parameters to their default values, except:

- [Group 99: START-UP DATA](#) parameters (except parameter [9904](#))
- [1602](#) PARAMETER LOCK
- [1607](#) PARAM SAVE
- [3018](#) COMM FAULT FUNC and [3019](#) COMM FAULT TIME
- [9802](#) COMM PROT SEL
- [Group 50: ENCODER](#) ... [Group 53: EFB PROTOCOL](#) parameters
- [Group 29: MAINTENANCE TRIG](#) parameters.

After selecting a macro, you can make additional parameter changes manually with the control panel.

You enable application macros by setting the value for parameter [9902](#) APPLIC MACRO. By default, 1, ABB STANDARD, is the enabled macro.

The following sections describe each of the application macros and provide a connection example for each macro.

The last section in this chapter, [Macro default values for parameters](#), lists the parameters that the macros change and the default values established by each macro.

ABB Standard macro

This is the default macro. It provides a general purpose, 2-wire I/O configuration, with three (3) constant speeds. Parameter values are the default values defined in section [Complete parameter list](#) on page 115.

Connection example:

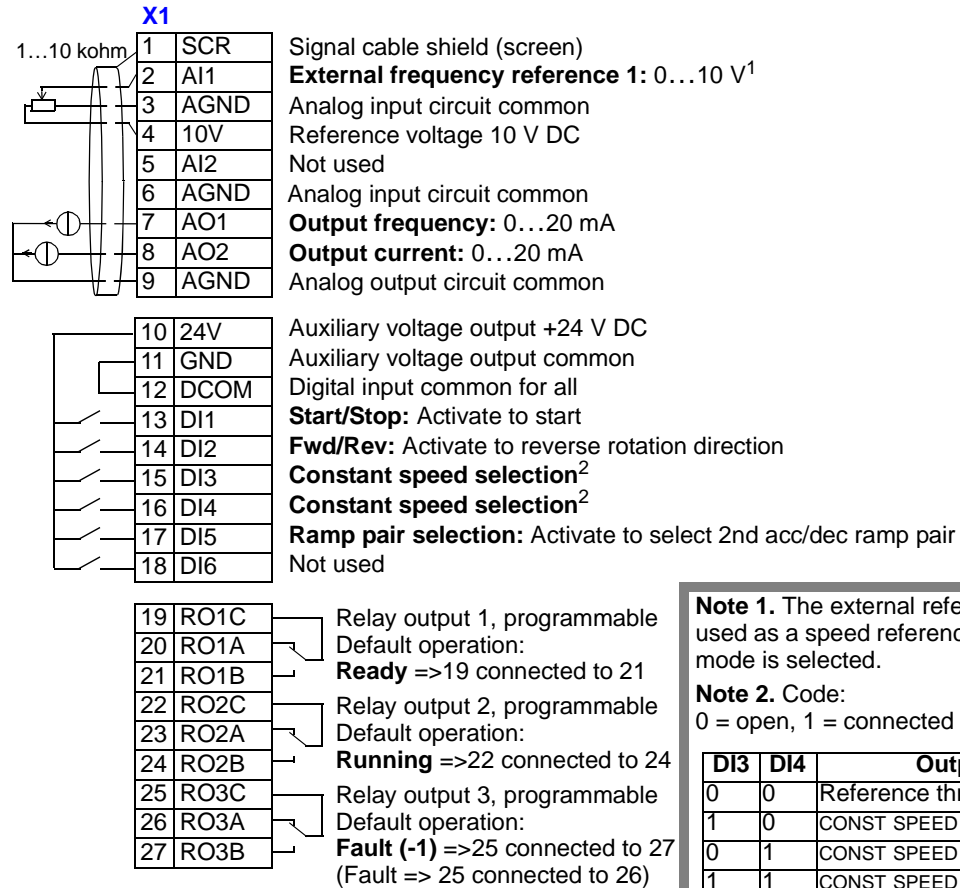

Note 1. The external reference is used as a speed reference if a vector mode is selected.

Note 2. Code:
0 = open, 1 = connected

| DI3 | DI4 | Output |
|-----|-----|-----------------------|
| 0 | 0 | Reference through AI1 |
| 1 | 0 | CONST SPEED 1 (1202) |
| 0 | 1 | CONST SPEED 2 (1203) |
| 1 | 1 | CONST SPEED 3 (1204) |

- | | | |
|---|---|--|
| <p>Input signals</p> <ul style="list-style-type: none"> • Analog reference (AI1) • Start, stop and direction (DI1,2) • Constant speed selection (DI3,4) • Ramp pair (1 of 2) selection (DI5) | <p>Output signals</p> <ul style="list-style-type: none"> • Analog output AO1: Frequency • Analog output AO2: Current • Relay output 1: Ready • Relay output 2: Running • Relay output 3: Fault (-1) | <p>Jumper setting</p> <p>J1 AI1: 0...10 V AI2: 0(4)...20 mA or J1 AI1: 0...10 V AI2: 0(4)...20 mA</p> |
|---|---|--|

3-wire macro

This macro is used when the drive is controlled using momentary push-buttons. It provides three (3) constant speeds. To enable, set the value of parameter 9902 to 2 (3-WIRE).

Note: When the stop input (DI2) is deactivated (no input), the control panel start/stop buttons are disabled.

Connection example:

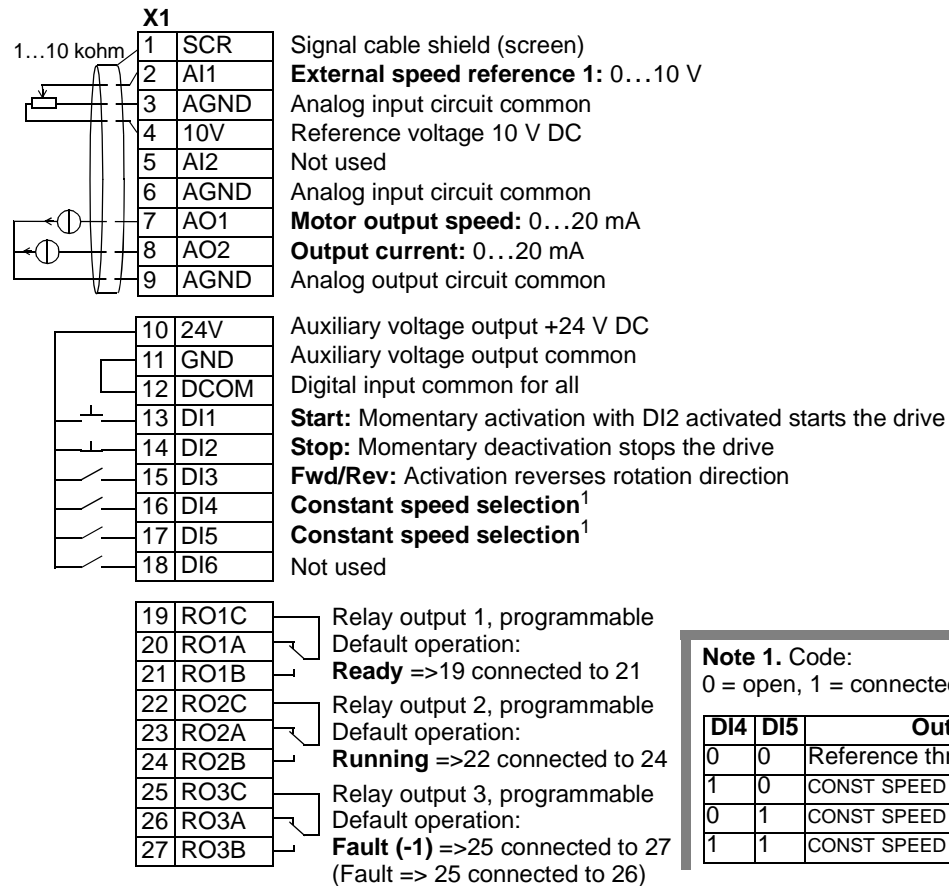

Note 1. Code:
0 = open, 1 = connected

Input signals

- Analog reference (AI1)
- Start, stop and direction (DI1,2,3)
- Constant speed selection (DI4,5)

Output signals

- Analog output AO1: Speed
- Analog output AO2: Current
- Relay output 1: Ready
- Relay output 2: Running
- Relay output 3: Fault (-1)

Jumper setting

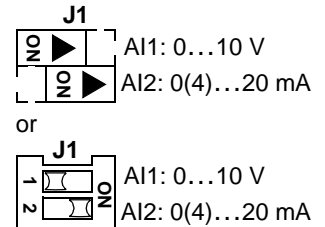

Alternate macro

This macro provides an I/O configuration adopted to a sequence of DI control signals used when alternating the rotation direction of the motor. To enable, set the value of parameter 9902 to 3 (ALTERNATE).

Connection example:

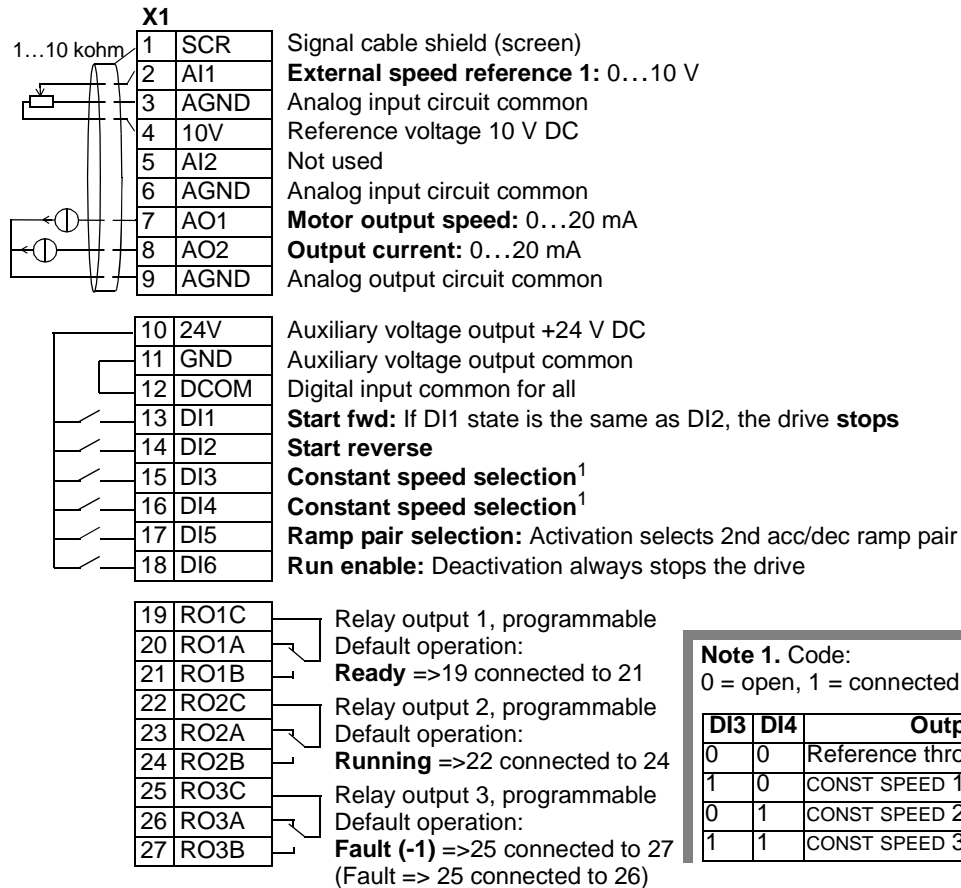

Note 1. Code:
0 = open, 1 = connected

| DI3 | DI4 | Output |
|-----|-----|-----------------------|
| 0 | 0 | Reference through AI1 |
| 1 | 0 | CONST SPEED 1 (1202) |
| 0 | 1 | CONST SPEED 2 (1203) |
| 1 | 1 | CONST SPEED 3 (1204) |

Input signals

- Analog reference (AI1)
- Start, stop and direction (DI1,2)
- Constant speed selection (DI3,4)
- Ramp pair 1/2 selection (DI5)
- Run enable (DI6)

Output signals

- Analog output AO1: Speed
- Analog output AO2: Current
- Relay output 1: Ready
- Relay output 2: Running
- Relay output 3: Fault (-1)

Jumper setting

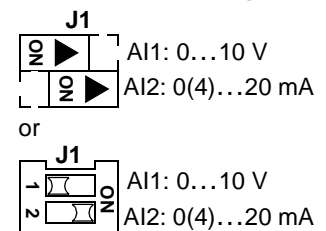

Motor Potentiometer macro

This macro provides a cost-effective interface for PLCs that vary the speed of the motor using only digital signals. To enable, set the value of parameter 9902 to 4 (MOTOR POT).

Connection example:

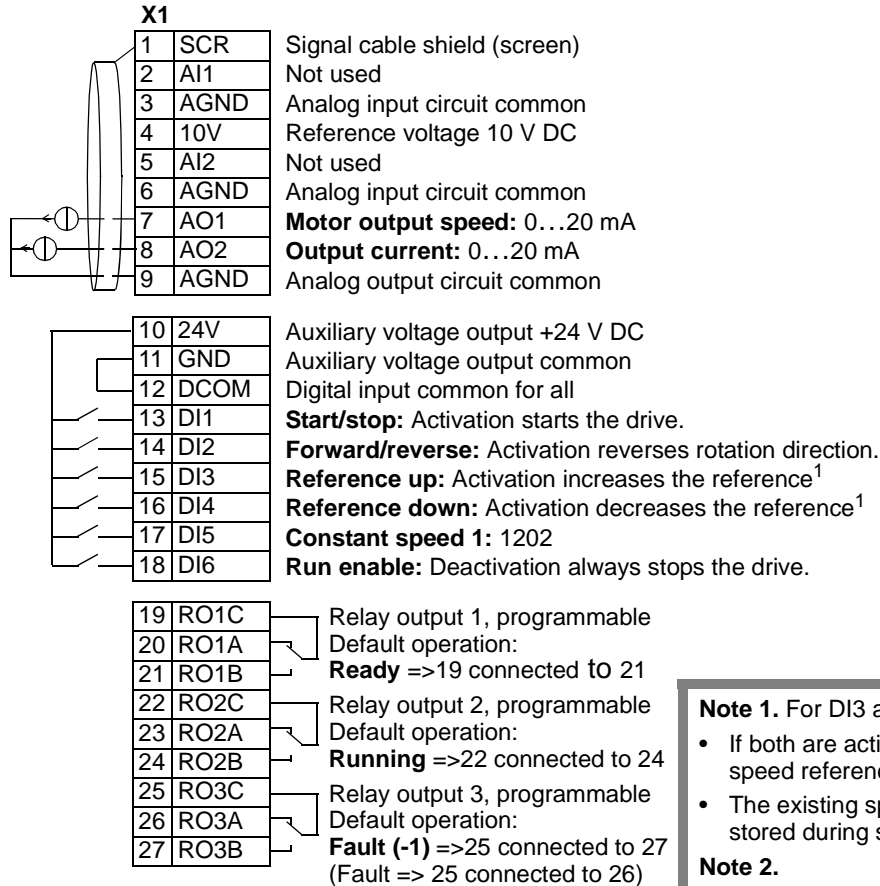

Note 1. For DI3 and DI4:

- If both are active or inactive the speed reference is unchanged.
- The existing speed reference is stored during stop or power down.

Note 2.

- Settings of the ramp times with acceleration and deceleration time 2 (parameters 2205 and 2206).

- Input signals**
- Start, stop and direction (DI1,2)
 - Reference up/down (DI3,4)
 - Constant speed selection (DI5)
 - Run enable (DI6)

- Output signals**
- Analog output AO1: Speed
 - Analog output AO2: Current
 - Relay output 1: Ready
 - Relay output 2: Running
 - Relay output 3: Fault (-1)

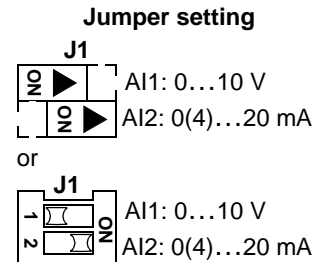

Hand-Auto macro

This macro provides an I/O configuration that is typically used in HVAC applications. To enable, set the value of parameter 9902 to 5 (HAND/AUTO).

Note: Parameter 2108 START INHIBIT must remain in the default setting, 0 (OFF).

Connection example:

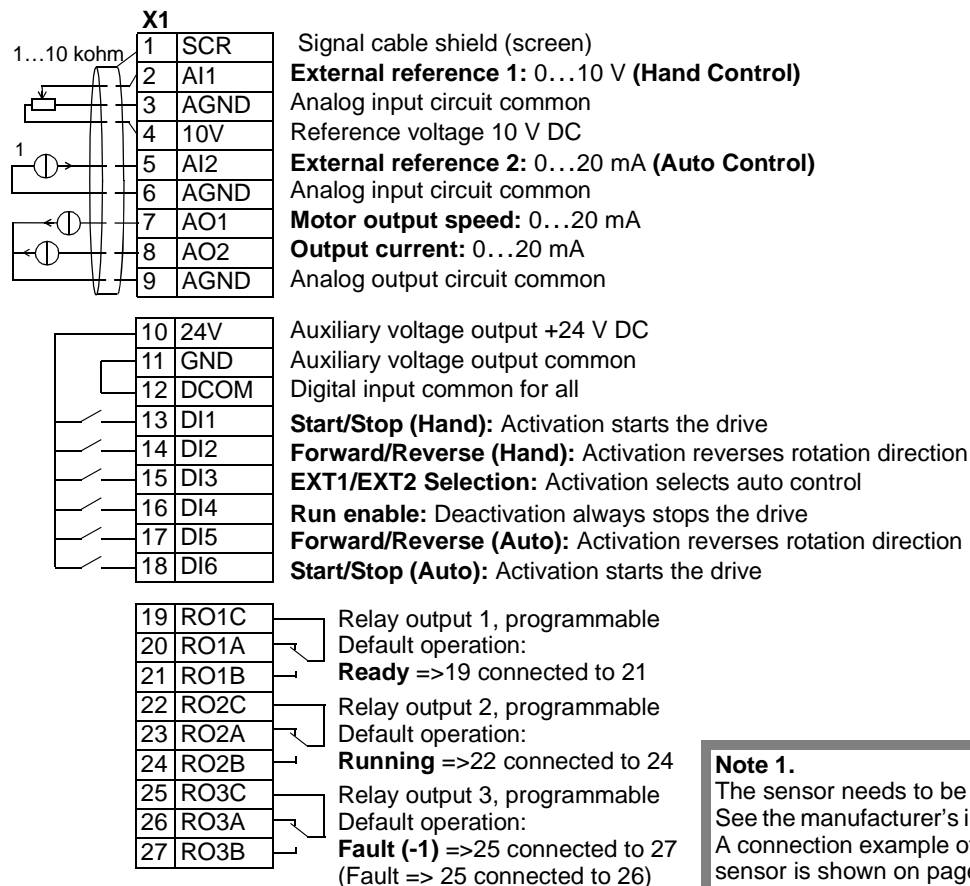

Note 1.
The sensor needs to be powered. See the manufacturer's instructions. A connection example of a two-wire sensor is shown on page 110.

- | Input signals | Output signals |
|------------------------------------|------------------------------|
| • Two analog references (AI1, 2) | • Analog output AO1: Speed |
| • Start/stop – hand/auto (DI1, 6) | • Analog output AO2: Current |
| • Direction – hand/auto (DI2, 5) | • Relay output 1: Ready |
| • Control location selection (DI3) | • Relay output 2: Running |
| • Run enable (DI4) | • Relay output 3: Fault (-1) |

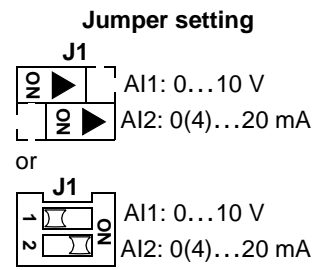

PID Control macro

This macro provides parameter settings for closed-loop control systems such as pressure control, flow control, etc. To enable, set the value of parameter 9902 to 6 (PID CONTROL).

Note: Parameter 2108 START INHIBIT must remain in the default setting, 0 (OFF).

Connection example:

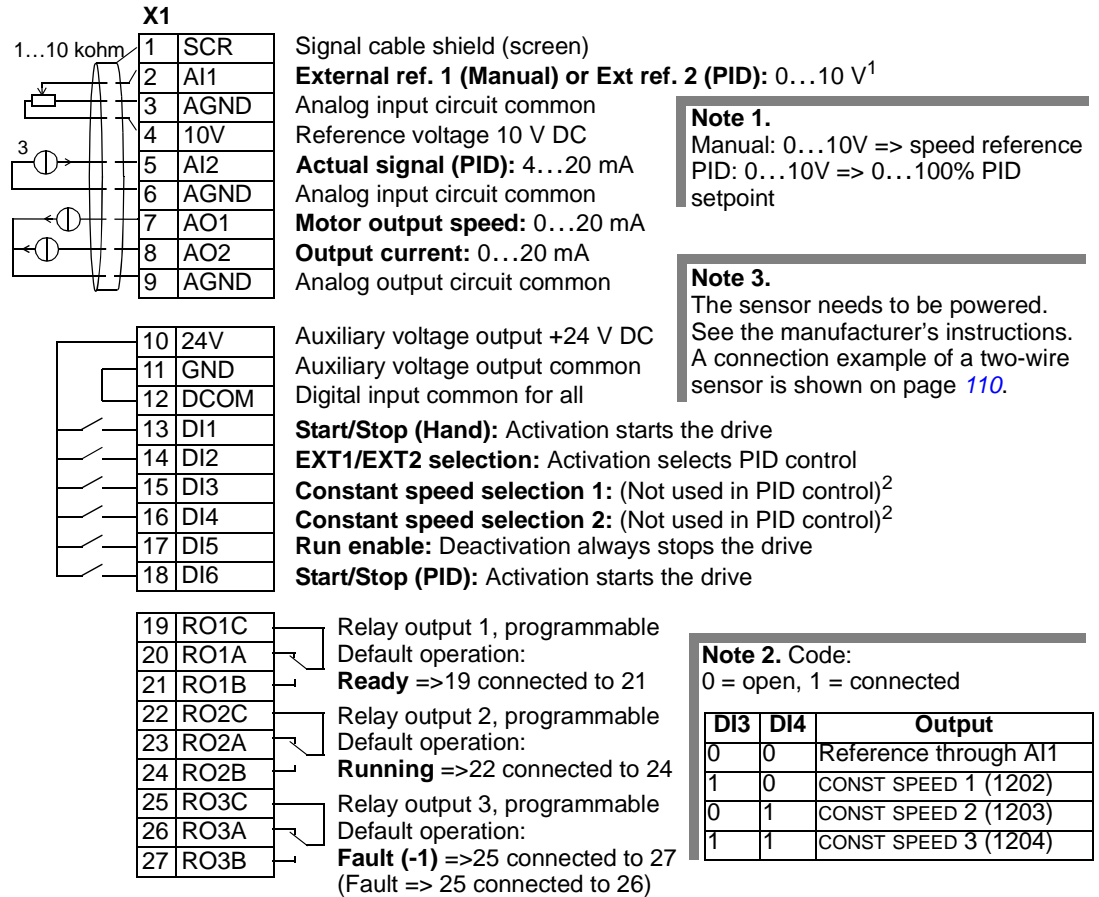

Input signals

- Analog reference (AI1)
- Actual value (AI2)
- Start/stop – hand/PID (DI1, 6)
- EXT1/EXT2 selection (DI2)
- Constant speed selection (DI3, 4)
- Run enable (DI5)

Output signals

- Analog output AO1: Speed
- Analog output AO2: Current
- Relay output 1: Ready
- Relay output 2: Running
- Relay output 3: Fault (-1)

Jumper setting

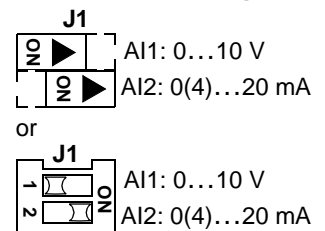

Note: Use the following switch-on order:

1. EXT1/EXT2
2. Run Enable
3. Start.

PFC macro

This macro provides parameter settings for pump and fan control (PFC) applications. To enable, set the value of parameter 9902 to 7 (PFC CONTROL).

Note: Parameter 2108 START INHIBIT must remain in the default setting, 0 (OFF).

Connection example:

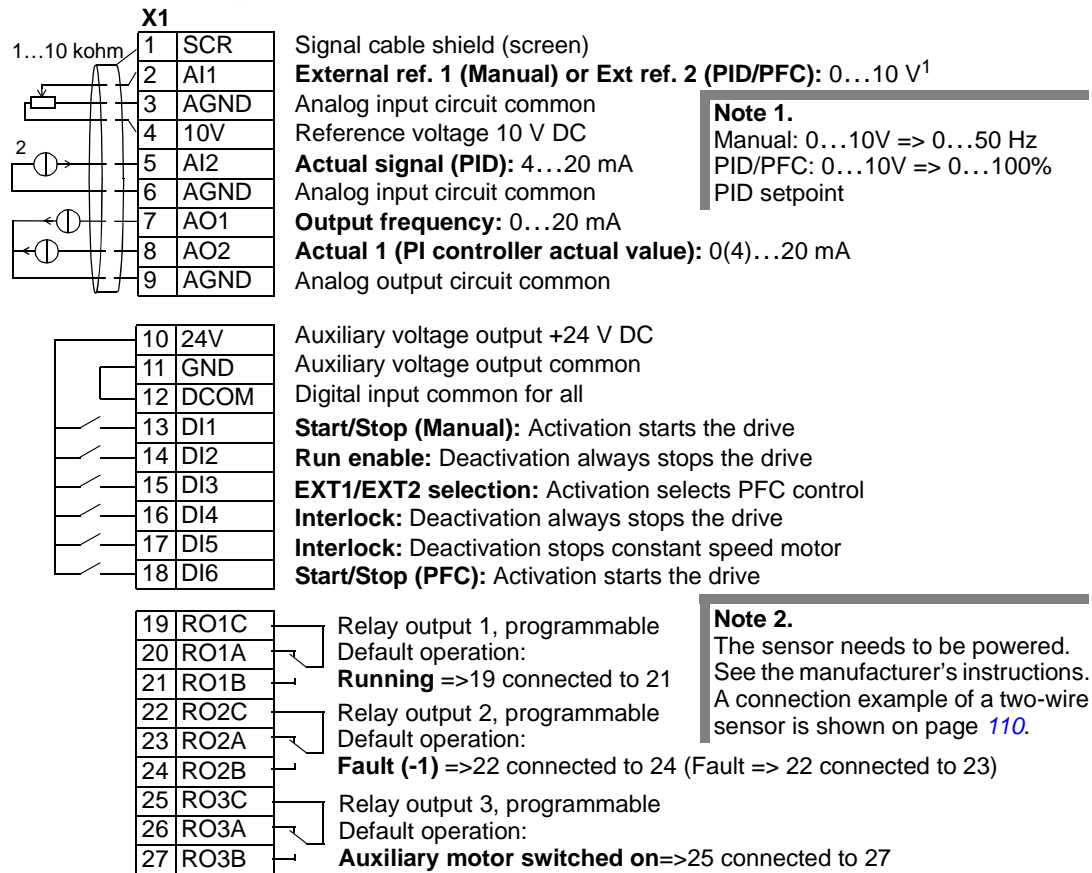

Note 1.
 Manual: 0...10V => 0...50 Hz
 PID/PFC: 0...10V => 0...100%
 PID setpoint

Note 2.
 The sensor needs to be powered.
 See the manufacturer's instructions.
 A connection example of a two-wire sensor is shown on page 110.

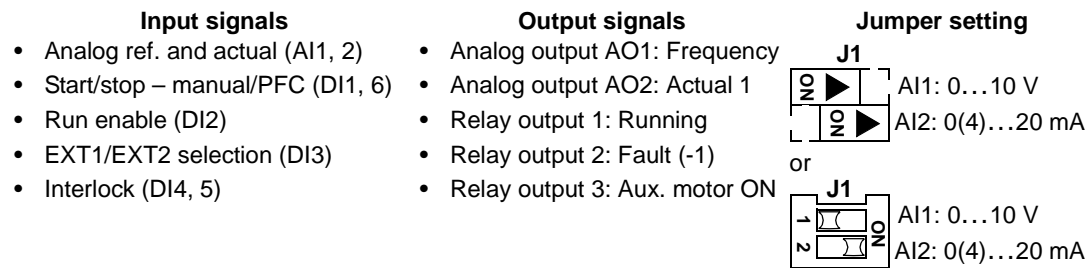

Note: Use the following switch-on order:

- EXT1/EXT2
- Run Enable
- Start.

Torque Control macro

This macro provides parameter settings for applications that require torque control of the motor. Control can also be switched to speed control. To enable, set the value of parameter 9902 to 8 (TORQUE CTRL).

Connection example:

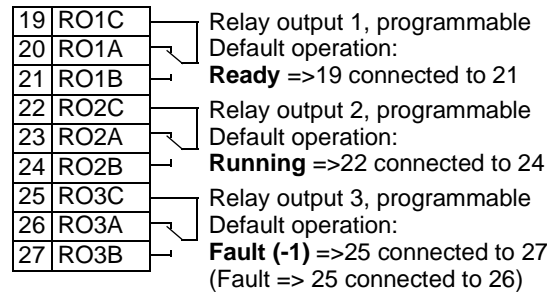
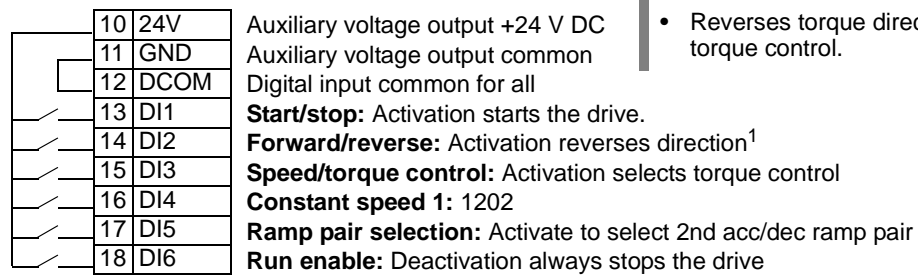
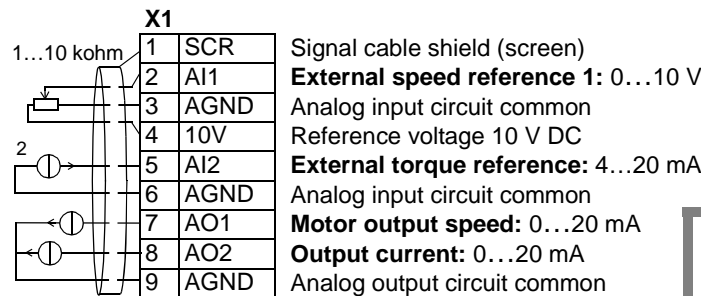

Note 1.

- Reverses rotation direction in speed control.
- Reverses torque direction in torque control.

Note 2.

The sensor needs to be powered. See the manufacturer's instructions. A connection example of a two-wire sensor is shown on page 110.

Input signals

- Two analog references (AI1, 2)
- Start/stop and direction (DI1, 2)
- Speed/torque control (DI3)
- Constant speed selection (DI4)
- Ramp pair 1/2 selection (DI5)
- Run enable (DI6)

Output signals

- Analog output AO1: Speed
- Analog output AO2: Current
- Relay output 1: Ready
- Relay output 2: Running
- Relay output 3: Fault (-1)

Jumper setting

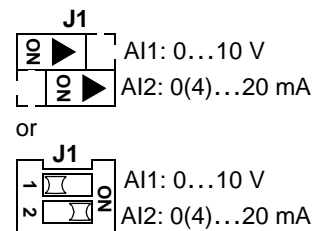

Connection example of a two-wire sensor

Many applications use process PI(D) and need a feedback signal from the process. The feedback signal is typically connected to analog input 2 (AI2). The macro wiring diagrams in this chapter show the connection when a separately powered sensor is used. The figure below gives an example of a connection using a two-wire sensor.

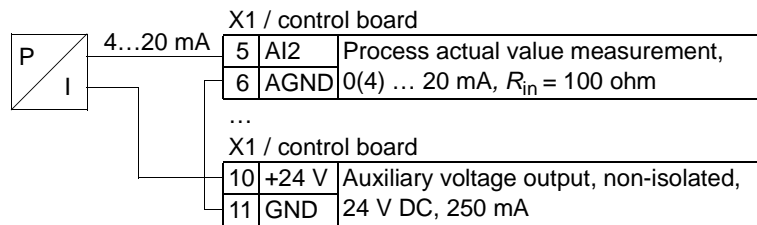



Note: The sensor is supplied through its current output. Thus the output signal must be 4...20 mA, not 0...20 mA.

User parameter sets



In addition to the standard application macros, it is possible to save two user parameter sets into the permanent memory and load them at a later time. A user parameter set consists of the user parameter settings, including [Group 99: START-UP DATA](#), and the results of the motor identification. The panel reference is also saved if the user parameter set is saved and loaded in local control. The remote control setting is saved into the user parameter set, but the local control setting is not.

The steps below show how to save and load User Parameter Set 1. The procedure for User Parameter Set 2 is identical, only the parameter [9902](#) values are different.

To save User Parameter Set 1:

- Adjust the parameters. Perform the motor identification if it is needed in the application but it is not done yet.
- Save the parameter settings and the results of the motor identification to the permanent memory by changing parameter [9902](#) to -1 (USER S1 SAVE).
- Press  (Assistant Control Panel) or  (Basic Control Panel).

To load User Parameter Set 1:

- Change parameter [9902](#) to 0 (USER S1 LOAD).
- Press  (Assistant Control Panel) or  (Basic Control Panel) to load.

The user parameter set can also be switched through digital inputs (see parameter [1605](#)).

Note: Loading the user parameter set restores the parameter settings including [Group 99: START-UP DATA](#) and the results of the motor identification. Check that the settings correspond to the motor used.

Hint: The user can for example switch the drive between two motors without having to adjust the motor parameters and to repeat the motor identification every time the motor is changed. The user needs only to adjust the settings and perform the motor identification once for each motor and then to save the data as two user parameter sets. When the motor is changed, only the corresponding user parameter set needs to be loaded, and the drive is ready to operate.

Macro default values for parameters

Parameter default values are listed in section [Complete parameter list](#) on page 115. Changing from the default macro (ABB Standard), that is, editing the value of parameter 9902, changes the parameter default values as defined in the following tables.

Note: There are two sets of values because the defaults are configured for 50 Hz/ IEC compliance (ACS550-02) and 60 Hz/NEMA compliance (ACS550-U2).

ACS550-02

| Parameter | ABB Standard | 3-wire | Alternate | Motor Potentiometer | Hand-auto | PID Control | PFC Control | Torque Control | |
|-----------|------------------|--------|-----------|---------------------|-----------|-------------|-------------|----------------|-----|
| 9902 | APPLIC MACRO | 1 | 2 | 3 | 4 | 5 | 6 | 7 | 8 |
| 9904 | MOTOR CTRL MODE | 3 | 1 | 1 | 1 | 1 | 1 | 3 | 2 |
| 1001 | EXT1 COMMANDS | 2 | 4 | 9 | 2 | 2 | 1 | 1 | 2 |
| 1002 | EXT2 COMMANDS | 0 | 0 | 0 | 0 | 7 | 6 | 6 | 2 |
| 1003 | DIRECTION | 3 | 3 | 3 | 3 | 3 | 1 | 1 | 3 |
| 1102 | EXT1/EXT2 SEL | 0 | 0 | 0 | 0 | 3 | 2 | 3 | 3 |
| 1103 | REF1 SELECT | 1 | 1 | 1 | 12 | 1 | 1 | 1 | 1 |
| 1106 | REF2 SELECT | 2 | 2 | 2 | 2 | 2 | 19 | 19 | 2 |
| 1201 | CONST SPEED SEL | 9 | 10 | 9 | 5 | 0 | 9 | 0 | 4 |
| 1304 | MINIMUM Ai2 | 0 | 0 | 0 | 0 | 20 | 20 | 20 | 20 |
| 1401 | RELAY OUTPUT 1 | 1 | 1 | 1 | 1 | 1 | 1 | 2 | 1 |
| 1402 | RELAY OUTPUT 2 | 2 | 2 | 2 | 2 | 2 | 2 | 3 | 2 |
| 1403 | RELAY OUTPUT 3 | 3 | 3 | 3 | 3 | 3 | 3 | 31 | 3 |
| 1501 | AO1 CONTENT SEL | 103 | 102 | 102 | 102 | 102 | 102 | 103 | 102 |
| 1503 | AO1 CONTENT MAX | 50 | 50 | 50 | 50 | 50 | 50 | 52 | 50 |
| 1507 | AO2 CONTENT SEL | 104 | 104 | 104 | 104 | 104 | 104 | 130 | 104 |
| 1510 | MINIMUM AO2 | 0 | 0 | 0 | 0 | 0 | 0 | 4 | 0 |
| 1601 | RUN ENABLE | 0 | 0 | 6 | 6 | 4 | 5 | 2 | 6 |
| 2008 | MAXIMUM FREQ | 50 | 50 | 50 | 50 | 50 | 50 | 52 | 50 |
| 2201 | ACC/DEC 1/2 SEL | 5 | 0 | 5 | 0 | 0 | 0 | 0 | 5 |
| 3201 | SUPERV 1 PARAM | 103 | 102 | 102 | 102 | 102 | 102 | 103 | 102 |
| 3401 | SIGNAL1 PARAM | 103 | 102 | 102 | 102 | 102 | 102 | 103 | 102 |
| 4001 | GAIN | 10 | 10 | 10 | 10 | 10 | 10 | 25 | 10 |
| 4002 | INTEGRATION TIME | 60 | 60 | 60 | 60 | 60 | 60 | 3 | 60 |
| 4101 | GAIN | 1 | 1 | 1 | 1 | 1 | 1 | 2,5 | 1 |
| 4102 | INTEGRATION TIME | 60 | 60 | 60 | 60 | 60 | 60 | 3 | 60 |
| 8123 | PFC ENABLE | 0 | 0 | 0 | 0 | 0 | 0 | 1 | 0 |

ACS550-U2

| Parameter | | ABB Standard | 3-wire | Alternate | Motor Potentiometer | Hand-auto | PID Control | PFC Control | Torque Control |
|-----------|------------------|--------------|--------|-----------|---------------------|-----------|-------------|-------------|----------------|
| 9902 | APPLIC MACRO | 1 | 2 | 3 | 4 | 5 | 6 | 7 | 8 |
| 9904 | MOTOR CTRL MODE | 3 | 1 | 1 | 1 | 1 | 1 | 3 | 2 |
| 1001 | EXT1 COMMANDS | 2 | 4 | 9 | 2 | 2 | 1 | 1 | 2 |
| 1002 | EXT2 COMMANDS | 0 | 0 | 0 | 0 | 7 | 6 | 6 | 2 |
| 1003 | DIRECTION | 3 | 3 | 3 | 3 | 3 | 1 | 1 | 3 |
| 1102 | EXT1/EXT2 SEL | 0 | 0 | 0 | 0 | 3 | 2 | 3 | 3 |
| 1103 | REF1 SELECT | 1 | 1 | 1 | 12 | 1 | 1 | 1 | 1 |
| 1106 | REF2 SELECT | 2 | 2 | 2 | 2 | 2 | 19 | 19 | 2 |
| 1201 | CONST SPEED SEL | 9 | 10 | 9 | 5 | 0 | 9 | 0 | 4 |
| 1304 | MINIMUM AI2 | 0 | 0 | 0 | 0 | 20 | 20 | 20 | 20 |
| 1401 | RELAY OUTPUT 1 | 1 | 1 | 1 | 1 | 1 | 1 | 2 | 1 |
| 1402 | RELAY OUTPUT 2 | 2 | 2 | 2 | 2 | 2 | 2 | 3 | 2 |
| 1403 | RELAY OUTPUT 3 | 3 | 3 | 3 | 3 | 3 | 3 | 31 | 3 |
| 1501 | AO1 CONTENT SEL | 103 | 102 | 102 | 102 | 102 | 102 | 103 | 102 |
| 1503 | AO1 CONTENT MAX | 60 | 60 | 60 | 60 | 60 | 60 | 62 | 60 |
| 1507 | AO2 CONTENT SEL | 104 | 104 | 104 | 104 | 104 | 104 | 130 | 104 |
| 1510 | MINIMUM AO2 | 0 | 0 | 0 | 0 | 0 | 0 | 4 | 0 |
| 1601 | RUN ENABLE | 0 | 0 | 6 | 6 | 4 | 5 | 2 | 6 |
| 2008 | MAXIMUM FREQ | 60 | 60 | 60 | 60 | 60 | 60 | 62 | 60 |
| 2201 | ACC/DEC 1/2 SEL | 5 | 0 | 5 | 0 | 0 | 0 | 0 | 5 |
| 3201 | SUPERV 1 PARAM | 103 | 102 | 102 | 102 | 102 | 102 | 103 | 102 |
| 3401 | SIGNAL1 PARAM | 103 | 102 | 102 | 102 | 102 | 102 | 103 | 102 |
| 4001 | GAIN | 10 | 10 | 10 | 10 | 10 | 10 | 25 | 10 |
| 4002 | INTEGRATION TIME | 60 | 60 | 60 | 60 | 60 | 60 | 3 | 60 |
| 4101 | GAIN | 1 | 1 | 1 | 1 | 1 | 1 | 2,5 | 1 |
| 4102 | INTEGRATION TIME | 60 | 60 | 60 | 60 | 60 | 60 | 3 | 60 |
| 8123 | PFC ENABLE | 0 | 0 | 0 | 0 | 0 | 0 | 1 | 0 |

Parameters

Complete parameter list

The following table lists all parameters. Table header abbreviations are:

- S = Parameters can be modified only when the drive is stopped.
- User = Space to enter desired parameter values.

Some values depend on the “construction” as indicated in the table by “02:” or “U2:”. Refer to the type code on the drive, for example ACS550-02-245A-4.

| Code | Name | Range | Resolution | Default | User | S |
|---------------------------------|-----------------|--|----------------------------|------------------------------|------|---|
| Group 99: START-UP DATA | | | | | | |
| 9901 | LANGUAGE | 0...15 / 0...3 | 1 | 0 (ENGLISH) | | |
| 9902 | APPLIC MACRO | -3...8 | 1 | 1 (ABB STANDARD) | | ✓ |
| 9904 | MOTOR CTRL MODE | 1 = VECTOR:SPEED, 2 = VECTOR:TORQUE, 3 = SCALAR:FREQ | 1 | 3 (SCALAR:FREQ) | | ✓ |
| 9905 | MOTOR NOM VOLT | 02: 200...600 V / U2: 230...690 V | 1 V | 02: 400 V / U2: 460 V | | ✓ |
| 9906 | MOTOR NOM CURR | $0.2 \cdot I_{2hd} \dots 2.0 \cdot I_{2hd}$ | 0.1 A | $1.0 \cdot I_{2hd}$ | | ✓ |
| 9907 | MOTOR NOM FREQ | 10.0.0...500.0 Hz | 0.1 Hz | 02: 50.0 Hz / U2: 60.0 Hz | | ✓ |
| 9908 | MOTOR NOM SPEED | 50...30000 rpm | 1 rpm | Size dependent | | ✓ |
| 9909 | MOTOR NOM POWER | $0.2 \dots 3.0 \cdot P_{hd}$ | 02: 0.1 kW / U2: 0.1 hp | $1.0 \cdot P_{hd}$ | | ✓ |
| 9910 | ID RUN | 0 = OFF/IDMAGN, 1 = ON | 1 | 0 (OFF/IDMAGN) | | ✓ |
| Group 01: OPERATING DATA | | | | | | |
| 0101 | SPEED & DIR | -30000...30000 rpm | 1 rpm | - | | |
| 0102 | SPEED | 0...30000 rpm | 1 rpm | - | | |
| 0103 | OUTPUT FREQ | 0.0...500.0 Hz | 0.1 Hz | - | | |
| 0104 | CURRENT | $0.0 \dots 2.0 \cdot I_{2hd}$ | 0.1 A | - | | |
| 0105 | TORQUE | -200.0...200.0% | 0.1% | - | | |
| 0106 | POWER | $-2.0 \dots 2.0 \cdot P_{hd}$ | 0.1 kW | - | | |
| 0107 | DC BUS VOLTAGE | $0 \dots 2.5 \cdot V_{dN}$ | 1 V | - | | |
| 0109 | OUTPUT VOLTAGE | $0 \dots 2.0 \cdot V_{dN}$ | 1 V | - | | |
| 0110 | DRIVE TEMP | 0.0...150.0 °C | 0.1 °C | - | | |
| 0111 | EXTERNAL REF 1 | 0...30000 rpm / 0.0...500.0 Hz | 1 rpm / 0.1 Hz | - | | |
| 0112 | EXTERNAL REF 2 | 0.0...100.0% (0.0...600.0% for torque) | 0.1% | - | | |
| 0113 | CTRL LOCATION | 0 = LOCAL, 1 = EXT1, 2 = EXT2 | 1 | - | | |
| 0114 | RUN TIME (R) | 0...9999 h | 1 h | 0 h | | |
| 0115 | KWH COUNTER (R) | 0...9999 kWh | 1 kWh | - | | |
| 0116 | APPL BLK OUTPUT | 0.0...100.0% (0.0...600.0% for torque) | 0.1% | - | | |
| 0118 | DI 1-3 STATUS | 000...111 (0...7 decimal) | 1 | - | | |
| 0119 | DI 4-6 STATUS | 000...111 (0...7 decimal) | 1 | - | | |
| 0120 | AI 1 | 0.0...100.0% | 0.1% | - | | |

| Code | Name | Range | Resolution | Default | User | S |
|------------------------------------|------------------|--|--------------|---------|------|---|
| 0121 | AI 2 | 0.0...100.0% | 0.1% | - | | |
| 0122 | RO 1-3 STATUS | 000...111 (0...7 decimal) | 1 | - | | |
| 0123 | RO 4-6 STATUS | 000...111 (0...7 decimal) | 1 | - | | |
| 0124 | AO 1 | 0.0...20.0 mA | 0.1 mA | - | | |
| 0125 | AO 2 | 0.0...20.0 mA | 0.1 mA | - | | |
| 0126 | PID 1 OUTPUT | -1000.0...1000.0% | 0.1% | - | | |
| 0127 | PID 2 OUTPUT | -100.0...100.0% | 0.1% | - | | |
| 0128 | PID 1 SETPNT | Unit and scale defined by par. 4006/ 4106 and 4007/4107 | - | - | | |
| 0129 | PID 2 SETPNT | Unit and scale defined by par. 4206 and 4207 | - | - | | |
| 0130 | PID 1 FBK | Unit and scale defined by par. 4006/ 4106 and 4007/4107 | - | - | | |
| 0131 | PID 2 FBK | Unit and scale defined by par. 4206 and 4207 | - | - | | |
| 0132 | PID 1 DEVIATION | Unit and scale defined by par. 4006/ 4106 and 4007/4107 | - | - | | |
| 0133 | PID 2 DEVIATION | Unit and scale defined by par. 4206 and 4207 | - | - | | |
| 0134 | COMM RO WORD | 0...65535 | 1 | 0 | | |
| 0135 | COMM VALUE 1 | -32768...+32767 | 1 | 0 | | |
| 0136 | COMM VALUE 2 | -32768...+32767 | 1 | 0 | | |
| 0137 | PROCESS VAR 1 | - | 1 | | | |
| 0138 | PROCESS VAR 2 | - | 1 | | | |
| 0139 | PROCESS VAR 3 | - | 1 | | | |
| 0140 | RUN TIME | 0.00...499.99 kh | 0.01 kh | 0.00 kh | | |
| 0141 | MWH COUNTER | 0...9999 MWh | 1 MWh | - | | |
| 0142 | REVOLUTION CNTR | 0...65535 Mrev | 1 Mrev | 0 | | |
| 0143 | DRIVE ON TIME HI | 0...65535 days | 1 day | 0 | | |
| 0144 | DRIVE ON TIME LO | 00:00:00...23:59:58 | 1 = 2 s | 0 | | |
| 0145 | MOTOR TEMP | Par. 3501 = 1...3: -10...200 °C Par. 3501 = 4: 0...5000 ohm Par. 3501 = 5...6: 0...1 | 1 | - | | |
| 0146 | MECH ANGLE | 0...32768 | 1 | - | | |
| 0147 | MECH REVS | -32768 ...+32767 | 1 | - | | |
| 0148 | Z PLS DETECTED | 0 = NOT DETECTED, 1 = DETECTED | 1 (DETECTED) | - | | |
| 0150 | CB TEMP | -20.0...150.0 °C | 1.0 °C | - | | |
| 0151 | INPUT KWH (R) | 0.0...999.9 kWh | 1.0 kWh | - | | |
| 0152 | INPUT MWH | 0...9999 MWh | 1 MWh | - | | |
| 0158 | PID COMM VALUE 1 | -32768 ...+32767 | 1 | - | | |
| 0159 | PID COMM VALUE 2 | -32768 ...+32767 | 1 | - | | |
| Group 03: FB ACTUAL SIGNALS | | | | | | |
| 0301 | FB CMD WORD 1 | - | - | - | | |
| 0302 | FB CMD WORD 2 | - | - | - | | |
| 0303 | FB STS WORD 1 | - | - | - | | |
| 0304 | FB STS WORD 2 | - | 1 | 0 | | |
| 0305 | FAULT WORD 1 | - | 1 | 0 | | |

| Code | Name | Range | Resolution | Default | User | S |
|-----------------------------------|------------------|--|----------------|--|------|---|
| 0306 | FAULT WORD 2 | - | 1 | 0 | | |
| 0307 | FAULT WORD 3 | - | 1 | 0 | | |
| 0308 | ALARM WORD 1 | - | 1 | 0 | | |
| 0309 | ALARM WORD 2 | - | 1 | 0 | | |
| Group 04: FAULT HISTORY | | | | | | |
| 0401 | LAST FAULT | Fault codes (panel displays as text) | 1 | 0 | | |
| 0402 | FAULT TIME 1 | Date dd.mm.yy / power-on time in days | 1 day | 0 | | |
| 0403 | FAULT TIME 2 | Time hh.mm.ss | 2 s | 0 | | |
| 0404 | SPEED AT FLT | -32768...+32767 | 1 rpm | 0 | | |
| 0405 | FREQ AT FLT | -3276.8...+3276.7 | 0.1 Hz | 0 | | |
| 0406 | VOLTAGE AT FLT | 0.0...6553.5 | 0.1 V | 0 | | |
| 0407 | CURRENT AT FLT | 0.0...6553.5 | 0.1 A | 0 | | |
| 0408 | TORQUE AT FLT | -3276.8...+3276.7 | 0.1% | 0 | | |
| 0409 | STATUS AT FLT | 0...0xFFFF (hex) | 1 | 0 | | |
| 0410 | DI 1-3 AT FLT | 000...111 (0...7 decimal) | 1 | 0 | | |
| 0411 | DI 4-6 AT FLT | 000...111 (0...7 decimal) | 1 | 0 | | |
| 0412 | PREVIOUS FAULT 1 | As par. 0401 | 1 | 0 | | |
| 0413 | PREVIOUS FAULT 2 | As par. 0401 | 1 | 0 | | |
| Group 10: START/STOP/DIR | | | | | | |
| 1001 | EXT1 COMMANDS | 0...14 | 1 | 2 (DI1,2) | | ✓ |
| 1002 | EXT2 COMMANDS | 0...14 | 1 | 0 (NOT SEL) | | ✓ |
| 1003 | DIRECTION | 1 = FORWARD, 2 = REVERSE, 3 = REQUEST | 1 | 3 (REQUEST) | | ✓ |
| 1004 | JOGGING SEL | -6...6 | 1 | 0 (NOT SEL) | | ✓ |
| Group 11: REFERENCE SELECT | | | | | | |
| 1101 | KEYPAD REF SEL | 1 = REF1(Hz/rpm), 2 = REF2(%) | 1 | 1 [REF1(Hz/rpm)] | | |
| 1102 | EXT1/EXT2 SEL | -6...12 | 1 | 0 (EXT1) | | ✓ |
| 1103 | REF1 SELECT | 0...17, 20...21 | 1 | 1 (KEYPAD) | | ✓ |
| 1104 | REF1 MIN | 0.0...500.0 Hz / 0...30000 rpm | 0.1 Hz / 1 rpm | 0.0 Hz / 0 rpm | | |
| 1105 | REF1 MAX | 0.0...500.0 Hz / 0...30000 rpm | 0.1 Hz / 1 rpm | 02: 50.0 Hz / 1500 rpm U2: 60.0 Hz / 1800 rpm | | |
| 1106 | REF2 SELECT | 0...17, 19...21 | 1 | 2 (AI2) | | ✓ |
| 1107 | REF2 MIN | 0.0...100.0% (0.0...600.0% for torque) | 0.1% | 0.0% | | |
| 1108 | REF2 MAX | 0.0...100.0% (0.0...600.0% for torque) | 0.1% | 100.0% | | |
| Group 12: CONSTANT SPEEDS | | | | | | |
| 1201 | CONST SPEED SEL | -14 ...19 | 1 | 9 (DI3,4) | | ✓ |
| 1202 | CONST SPEED 1 | 0...30000 rpm / 0.0...500.0 Hz | 1 rpm / 0.1 Hz | 02: 300 rpm / 5.0 Hz U2: 360 rpm / 6.0 Hz | | |
| 1203 | CONST SPEED 2 | 0...30000 rpm / 0.0...500.0 Hz | 1 rpm / 0.1 Hz | 02: 600 rpm / 10.0 Hz U2: 720 rpm / 12.0 Hz | | |
| 1204 | CONST SPEED 3 | 0...30000 rpm / 0.0...500.0 Hz | 1 rpm / 0.1 Hz | 02: 900 rpm / 15.0 Hz U2: 1080 rpm / 18.0 Hz | | |
| 1205 | CONST SPEED 4 | 0...30000 rpm / 0.0...500.0 Hz | 1 rpm / 0.1 Hz | 02: 1200 rpm / 20.0 Hz U2: 1440 rpm / 24.0 Hz | | |
| 1206 | CONST SPEED 5 | 0...30000 rpm / 0.0...500.0 Hz | 1 rpm / 0.1 Hz | 02: 1500 rpm / 25.0 Hz U2: 1800 rpm / 30.0 Hz | | |

| Code | Name | Range | Resolution | Default | User | S |
|---------------------------------|-----------------|--------------------------------|----------------|--|------|---|
| 1207 | CONST SPEED 6 | 0...30000 rpm / 0.0...500.0 Hz | 1 rpm / 0.1 Hz | 02: 2400 rpm / 40.0 Hz U2: 2880 rpm / 48.0 Hz | | |
| 1208 | CONST SPEED 7 | 0...30000 rpm / 0.0...500.0 Hz | 1 rpm / 0.1 Hz | 02: 3000 rpm / 50.0 Hz U2: 3600 rpm / 60.0 Hz | | |
| 1209 | TIMED MODE SEL | 1 = EXT/CS1/2/3, 2 = CS1/2/3/4 | 1 | 2 (cs1/2/3/4) | | ✓ |
| Group 13: ANALOG INPUTS | | | | | | |
| 1301 | MINIMUM AI1 | 0.0...100.0% | 0.1% | 0.0% | | |
| 1302 | MAXIMUM AI1 | 0.0...100.0% | 0.1% | 100.0% | | |
| 1303 | FILTER AI1 | 0.0...10.0 s | 0.1 s | 0.1 s | | |
| 1304 | MINIMUM AI2 | 0.0...100.0% | 0.1% | 0.0% | | |
| 1305 | MAXIMUM AI2 | 0.0...100.0% | 0.1% | 100.0% | | |
| 1306 | FILTER AI2 | 0.0...10.0 s | 0.1 s | 0.1 s | | |
| Group 14: RELAY OUTPUTS | | | | | | |
| 1401 | RELAY OUTPUT 1 | 0...47, 52 | 1 | 1 (READY) | | |
| 1402 | RELAY OUTPUT 2 | 0...47, 52 | 1 | 2 (RUN) | | |
| 1403 | RELAY OUTPUT 3 | 0...47, 52 | 1 | 3 [FAULT(-1)] | | |
| 1404 | RO 1 ON DELAY | 0.0...3600.0 s | 0.1 s | 0.0 s | | |
| 1405 | RO 1 OFF DELAY | 0.0...3600.0 s | 0.1 s | 0.0 s | | |
| 1406 | RO 2 ON DELAY | 0.0...3600.0 s | 0.1 s | 0.0 s | | |
| 1407 | RO 2 OFF DELAY | 0.0...3600.0 s | 0.1 s | 0.0 s | | |
| 1408 | RO 3 ON DELAY | 0.0...3600.0 s | 0.1 s | 0.0 s | | |
| 1409 | RO 3 OFF DELAY | 0.0...3600.0 s | 0.1 s | 0.0 s | | |
| 1410 | RELAY OUTPUT 4 | 0...46, 52 | 1 | 0 (NOT SEL) | | |
| 1411 | RELAY OUTPUT 5 | 0...46, 52 | 1 | 0 (NOT SEL) | | |
| 1412 | RELAY OUTPUT 6 | 0...46, 52 | 1 | 0 (NOT SEL) | | |
| 1413 | RO 4 ON DELAY | 0.0...3600.0 s | 0.1 s | 0.0 s | | |
| 1414 | RO 4 OFF DELAY | 0.0...3600.0 s | 0.1 s | 0.0 s | | |
| 1415 | RO 5 ON DELAY | 0.0...3600.0 s | 0.1 s | 0.0 s | | |
| 1416 | RO 5 OFF DELAY | 0.0...3600.0 s | 0.1 s | 0.0 s | | |
| 1417 | RO 6 ON DELAY | 0.0...3600.0 s | 0.1 s | 0.0 s | | |
| 1418 | RO 6 OFF DELAY | 0.0...3600.0 s | 0.1 s | 0.0 s | | |
| Group 15: ANALOG OUTPUTS | | | | | | |
| 1501 | AO1 CONTENT SEL | 99...159 | 1 | 103 (parameter 0103 OUTPUT FREQ) | | |
| 1502 | AO1 CONTENT MIN | - | - | Defined by par. 0103 | | |
| 1503 | AO1 CONTENT MAX | - | - | Defined by par. 0103 | | |
| 1504 | MINIMUM AO1 | 0.0...20.0 mA | 0.1 mA | 0.0 mA | | |
| 1505 | MAXIMUM AO1 | 0.0...20.0 mA | 0.1 mA | 20.0 mA | | |
| 1506 | FILTER AO1 | 0.0...10.0 s | 0.1 s | 0.1 s | | |
| 1507 | AO2 CONTENT SEL | 99...159 | 1 | 104 (parameter 0104 CURRENT) | | |
| 1508 | AO2 CONTENT MIN | - | - | Defined by par. 0104 | | |
| 1509 | AO2 CONTENT MAX | - | - | Defined by par. 0104 | | |
| 1510 | MINIMUM AO2 | 0.0...20.0 mA | 0.1 mA | 0.0 mA | | |
| 1511 | MAXIMUM AO2 | 0.0...20.0 mA | 0.1 mA | 20.0 mA | | |
| 1512 | FILTER AO2 | 0.0...10.0 s | 0.1 s | 0.1 s | | |

| Code | Name | Range | Resolution | Default | User | S |
|----------------------------------|------------------|--|------------|--------------------------------|------|---|
| Group 16: SYSTEM CONTROLS | | | | | | |
| 1601 | RUN ENABLE | -6...7 | 1 | 0 (NOT SEL) | | ✓ |
| 1602 | PARAMETER LOCK | 0 = LOCKED, 1 = OPEN, 2 = NOT SAVED | 1 | 1 (OPEN) | | |
| 1603 | PASS CODE | 0...65535 | 1 | 0 | | |
| 1604 | FAULT RESET SEL | -6...8 | 1 | 0 (KEYPAD) | | |
| 1605 | USER PAR SET CHG | -6...6 | 1 | 0 (NOT SEL) | | |
| 1606 | LOCAL LOCK | -6...8 | 1 | 0 (NOT SEL) | | |
| 1607 | PARAM SAVE | 0 = DONE, 1 = SAVE... | 1 | 0 (DONE) | | |
| 1608 | START ENABLE 1 | -6...7 | 1 | 0 (NOT SEL) | | ✓ |
| 1609 | START ENABLE 2 | -6...7 | 1 | 0 (NOT SEL) | | ✓ |
| 1610 | DISPLAY ALARMS | 0 = NO, 1 = YES | 1 | 0 (NO) | | |
| Group 20: LIMITS | | | | | | |
| 2001 | MINIMUM SPEED | -30000...30000 rpm | 1 rpm | 0 rpm | | ✓ |
| 2002 | MAXIMUM SPEED | 0...30000 rpm | 1 rpm | 02: 1500 rpm / U2: 1800 rpm | | ✓ |
| 2003 | MAX CURRENT | 0... $1.8 \cdot I_{2hd}$ | 0.1 A | $1.8 \cdot I_{2hd}$ | | ✓ |
| 2005 | OVERVOLT CTRL | 0 = DISABLE, 1 = ENABLE | 1 | 1 (ENABLE) | | |
| 2006 | UNDERVOLT CTRL | 0 = DISABLE, 1 = ENABLE(TIME), 2 = ENABLE | 1 | 1 [ENABLE(TIME)] | | |
| 2007 | MINIMUM FREQ | -500.0...500.0 Hz | 0.1 Hz | 0.0 Hz | | ✓ |
| 2008 | MAXIMUM FREQ | 0.0...500.0 Hz | 0.1 Hz | 02: 50.0 Hz / U2: 60.0 Hz | | ✓ |
| 2013 | MIN TORQUE SEL | -6...7 | 1 | 0 (MIN TORQUE 1) | | |
| 2014 | MAX TORQUE SEL | -6...7 | 1 | 0 (MAX TORQUE 1) | | |
| 2015 | MIN TORQUE 1 | -600.0...0.0% | 0.1% | -300.0% | | |
| 2016 | MIN TORQUE 2 | -600.0...0.0% | 0.1% | -300.0% | | |
| 2017 | MAX TORQUE 1 | 0.0...600.0% | 0.1% | 300.0% | | |
| 2018 | MAX TORQUE 2 | 0.0...600.0% | 0.1% | 300.0% | | |
| Group 21: START/STOP | | | | | | |
| 2101 | START FUNCTION | Vector control modes: 1, 2, 8 Scalar control mode: 1...5, 8 | 1 | 8 (RAMP) | | ✓ |
| 2102 | STOP FUNCTION | 1 = COAST, 2 = RAMP | 1 | 1 (COAST) | | |
| 2103 | DC MAGN TIME | 0.00...10.00 s | 0.01 s | 0.30 s | | |
| 2104 | DC HOLD CTL | 0 = NOT SEL, 1 = DC HOLD, 2 = DC BRAKING | 1 | 0 (NOT SEL) | | ✓ |
| 2105 | DC HOLD SPEED | 0...360 rpm | 1 rpm | 5 rpm | | |
| 2106 | DC CURR REF | 0...100% | 1% | 30% | | |
| 2107 | DC BRAKE TIME | 0.0...250.0 s | 0.1 s | 0.0 s | | |
| 2108 | START INHIBIT | 0 = OFF, 1 = ON | 1 | 0 (OFF) | | |
| 2109 | EMERG STOP SEL | -6...6 | 1 | 0 (NOT SEL) | | |
| 2110 | TORQ BOOST CURR | 15...300% | 1% | 100% | | |
| 2112 | ZERO SPEED DELAY | 0.0 = NOT SEL, 0.1...60.0 s | 0.1 s | 0.0 s (NOT SEL) | | |
| 2113 | START DELAY | 0.00...60.00 s | 0.01 s | 0.00 s | | |

| Code | Name | Range | Resolution | Default | User | S |
|-----------------------------------|------------------|--------------------------------|----------------|----------------|------|---|
| Group 22: ACCEL/DECEL | | | | | | |
| 2201 | ACC/DEC 1/2 SEL | -6...7 | 1 | 5 (DI5) | | |
| 2202 | ACCELER TIME 1 | 0.0...1800.0 s | 0.1 s | 5.0 s | | |
| 2203 | DECELER TIME 1 | 0.0...1800.0 s | 0.1 s | 5.0 s | | |
| 2204 | RAMP SHAPE 1 | 0.0 = LINEAR, 0.1...1000.0 s | 0.1 s | 0.0 s | | |
| 2205 | ACCELER TIME 2 | 0.0...1800.0 s | 0.1 s | 60.0 s | | |
| 2206 | DECELER TIME 2 | 0.0...1800.0 s | 0.1 s | 60.0 s | | |
| 2207 | RAMP SHAPE 2 | 0.0 = LINEAR, 0.1...1000.0 s | 0.1 s | 0.0 s | | |
| 2208 | EMERG DEC TIME | 0.0...1800.0 s | 0.1 s | 1.0 s | | |
| 2209 | RAMP INPUT 0 | -6...7 | 1 | 0 (NOT SEL) | | |
| Group 23: SPEED CONTROL | | | | | | |
| 2301 | PROP GAIN | 0.00...200.00 | 0.01 | 10.00 | | |
| 2302 | INTEGRATION TIME | 0.00...600.00 s | 0.01 s | 2.50 s | | |
| 2303 | DERIVATION TIME | 0...10000 ms | 1 ms | 0 ms | | |
| 2304 | ACC COMPENSATION | 0.00...600.00 s | 0.01 s | 0.00 s | | |
| 2305 | AUTOTUNE RUN | 0 = OFF, 1 = ON | 1 | 0 (OFF) | | |
| Group 24: TORQUE CONTROL | | | | | | |
| 2401 | TORQ RAMP UP | 0.00...120.00 s | 0.01 s | 0.00 s | | |
| 2402 | TORQ RAMP DOWN | 0.00...120.00 s | 0.01 s | 0.00 s | | |
| Group 25: CRITICAL SPEEDS | | | | | | |
| 2501 | CRIT SPEED SEL | 0 = OFF, 1 = ON | 1 | 0 (OFF) | | |
| 2502 | CRIT SPEED 1 LO | 0...30000 rpm / 0.0...500.0 Hz | 1 rpm / 0.1 Hz | 0 rpm / 0.0 Hz | | |
| 2503 | CRIT SPEED 1 HI | 0...30000 rpm / 0.0...500.0 Hz | 1 rpm / 0.1 Hz | 0 rpm / 0.0 Hz | | |
| 2504 | CRIT SPEED 2 LO | 0...30000 rpm / 0.0...500.0 Hz | 1 rpm / 0.1 Hz | 0 rpm / 0.0 Hz | | |
| 2505 | CRIT SPEED 2 HI | 0...30000 rpm / 0.0...500.0 Hz | 1 rpm / 0.1 Hz | 0 rpm / 0.0 Hz | | |
| 2506 | CRIT SPEED 3 LO | 0...30000 rpm / 0.0...500.0 Hz | 1 rpm / 0.1 Hz | 0 rpm / 0.0 Hz | | |
| 2507 | CRIT SPEED 3 HI | 0...30000 rpm / 0.0...500.0 Hz | 1 rpm / 0.1 Hz | 0 rpm / 0.0 Hz | | |
| Group 26: MOTOR CONTROL | | | | | | |
| 2601 | FLUX OPT ENABLE | 0 = OFF, 1 = ON | 1 | 0 (OFF) | | |
| 2602 | FLUX BRAKING | 0 = OFF, 1 = ON | 1 | 0 (OFF) | | |
| 2603 | IR COMP VOLT | 0.0...100.0 V | 0.1 V | Size dependent | | |
| 2604 | IR COMP FREQ | 0...100% | 1% | 80% | | |
| 2605 | U/F RATIO | 1 = LINEAR, 2 = SQUARED | 1 | 1 (LINEAR) | | |
| 2606 | SWITCHING FREQ | 1, 4 kHz | - | 4 kHz | | |
| 2607 | SWITCH FREQ CTRL | 0 = OFF, 1 = ON | 1 | 1 (ON) | | |
| 2608 | SLIP COMP RATIO | 0...200% | 1% | 0 | | |
| 2609 | NOISE SMOOTHING | 0 = DISABLE, 1 = ENABLE | 1 | 0 (DISABLE) | | |
| 2619 | DC STABILIZER | 0 = DISABLE, 1 = ENABLE | 1 | 0 (DISABLE) | | |
| Group 29: MAINTENANCE TRIG | | | | | | |
| 2901 | COOLING FAN TRIG | 0.0...6553.5 kh, 0.0 disables | 0.1 kh | 0.0 kh | | |
| 2902 | COOLING FAN ACT | 0.0...6553.5 kh | 0.1 kh | 0.0 kh | | |
| 2903 | REVOLUTION TRIG | 0...65535 Mrev, 0 disables | 1 Mrev | 0 Mrev | | |
| 2904 | REVOLUTION ACT | 0...65535 Mrev | 1 Mrev | 0 Mrev | | |
| 2905 | RUN TIME TRIG | 0.0...6553.5 kh, 0.0 disables | 0.1 kh | 0.0 kh | | |
| 2906 | RUN TIME ACT | 0.0...6553.5 kh | 0.1 kh | 0.0 kh | | |

| Code | Name | Range | Resolution | Default | User | S |
|----------------------------------|------------------|--|------------|----------------------------------|------|---|
| 2907 | USER MWh TRIG | 0.0...6553.5 MWh, 0.0 disables | 0.1 MWh | 0.0 MWh | | |
| 2908 | USER MWh ACT | 0.0...6553.5 MWh | 0.1 MWh | 0.0 MWh | | |
| Group 30: FAULT FUNCTIONS | | | | | | |
| 3001 | AI<MIN FUNCTION | 0...3 | 1 | 0 (NOT SEL) | | |
| 3002 | PANEL COMM ERR | 1...3 | 1 | 1 (FAULT) | | |
| 3003 | EXTERNAL FAULT 1 | -6...6 | 1 | 0 (NOT SEL) | | |
| 3004 | EXTERNAL FAULT 2 | -6...6 | 1 | 0 (NOT SEL) | | |
| 3005 | MOT THERM PROT | 0 = NOT SEL, 1 = FAULT, 2 = ALARM | 1 | 1 (FAULT) | | |
| 3006 | MOT THERM TIME | 256...9999 s | 1 | 500 s | | |
| 3007 | MOT LOAD CURVE | 50...150% | 1 | 100% | | |
| 3008 | ZERO SPEED LOAD | 25...150% | 1 | 70% | | |
| 3009 | BREAK POINT FREQ | 1...250 Hz | 1 | 35 Hz | | |
| 3010 | STALL FUNCTION | 0 = NOT SEL, 1 = FAULT, 2 = ALARM | 1 | 0 (NOT SEL) | | |
| 3011 | STALL FREQUENCY | 0.5...50 Hz | 0.1 Hz | 20 Hz | | |
| 3012 | STALL TIME | 10...400 s | 1 s | 20 s | | |
| 3017 | EARTH FAULT | 0 = DISABLE, 1 = ENABLE | 1 | 1 (ENABLE) | | ✓ |
| 3018 | COMM FAULT FUNC | 0 = NOT SEL, 1 = FAULT, 2 = CONST SP 7, 3 = LAST SPEED | 1 | 0 (NOT SEL) | | |
| 3019 | COMM FAULT TIME | 0...60.0 s | 0.1 s | 3.0 s | | |
| 3021 | AI1 FAULT LIMIT | 0...100% | 0.1% | 0% | | |
| 3022 | AI2 FAULT LIMIT | 0...100% | 0.1% | 0% | | |
| 3023 | WIRING FAULT | 0 = DISABLE, 1 = ENABLE | 1 | 1 (ENABLE) | | ✓ |
| 3024 | CB TEMP FAULT | 0 = DISABLE, 1 = ENABLE | 1 | 1 (ENABLE) | | |
| Group 31: AUTOMATIC RESET | | | | | | |
| 3101 | NUMBER OF TRIALS | 0...5 | 1 | 0 | | |
| 3102 | TRIAL TIME | 1.0...600.0 s | 0.1 s | 30 s | | |
| 3103 | DELAY TIME | 0.0...120.0 s | 0.1 s | 0 s | | |
| 3104 | AR OVERCURRENT | 0 = DISABLE, 1 = ENABLE | 1 | 0 (DISABLE) | | |
| 3105 | AR OVERVOLTAGE | 0 = DISABLE, 1 = ENABLE | 1 | 0 (DISABLE) | | |
| 3106 | AR UNDERVOLTAGE | 0 = DISABLE, 1 = ENABLE | 1 | 0 (DISABLE) | | |
| 3107 | AR AI<MIN | 0 = DISABLE, 1 = ENABLE | 1 | 0 (DISABLE) | | |
| 3108 | AR EXTERNAL FLT | 0 = DISABLE, 1 = ENABLE | 1 | 0 (DISABLE) | | |
| Group 32: SUPERVISION | | | | | | |
| 3201 | SUPERV 1 PARAM | 100 = NOT SELECTED, 101...159 | 1 | 103 (parameter 0103 OUTPUT FREQ) | | |
| 3202 | SUPERV 1 LIM LO | - | - | 0 | | |
| 3203 | SUPERV 1 LIM HI | - | - | 0 | | |
| 3204 | SUPERV 2 PARAM | 100 = NOT SELECTED, 101...159 | 1 | 104 (parameter 0104 CURRENT) | | |
| 3205 | SUPERV 2 LIM LO | - | - | 0 | | |
| 3206 | SUPERV 2 LIM HI | - | - | 0 | | |
| 3207 | SUPERV 3 PARAM | 100 = NOT SELECTED, 101...159 | 1 | 105 (parameter 0105 TORQUE) | | |
| 3208 | SUPERV 3 LIM LO | - | - | 0 | | |
| 3209 | SUPERV 3 LIM HI | - | - | 0 | | |

| Code | Name | Range | Resolution | Default | User | S |
|----------------------------------|------------------|--|------------|----------------------------------|------|---|
| Group 33: INFORMATION | | | | | | |
| 3301 | FIRMWARE | 0000...FFFF hex | 1 | Firmware version | | |
| 3302 | LOADING PACKAGE | 0000...FFFF hex | 1 | 0 | | |
| 3303 | TEST DATE | yy.ww | 1 | 0 | | |
| 3304 | DRIVE RATING | - | - | - | | |
| 3305 | PARAMETER TABLE | 0000...FFFF hex | 1 | Par. table version | | |
| Group 34: PANEL DISPLAY | | | | | | |
| 3401 | SIGNAL1 PARAM | 100 = NOT SELECTED, 101...159 | 1 | 103 (parameter 0103 OUTPUT FREQ) | | |
| 3402 | SIGNAL1 MIN | - | 1 | - | | |
| 3403 | SIGNAL1 MAX | - | 1 | - | | |
| 3404 | OUTPUT1 DSP FORM | 0...9 | 1 | 9 (DIRECT) | | |
| 3405 | OUTPUT1 UNIT | 0...127 | 1 | - | | |
| 3406 | OUTPUT1 MIN | - | 1 | - | | |
| 3407 | OUTPUT1 MAX | - | 1 | - | | |
| 3408 | SIGNAL2 PARAM | 100 = NOT SELECTED, 101...159 | 1 | 104 (parameter 0104 CURRENT) | | |
| 3409 | SIGNAL2 MIN | - | 1 | - | | |
| 3410 | SIGNAL2 MAX | - | 1 | - | | |
| 3411 | OUTPUT2 DSP FORM | 0...9 | 1 | 9 (DIRECT) | | |
| 3412 | OUTPUT2 UNIT | 0...127 | 1 | - | | |
| 3413 | OUTPUT2 MIN | - | 1 | - | | |
| 3414 | OUTPUT2 MAX | - | 1 | - | | |
| 3415 | SIGNAL3 PARAM | 100 = NOT SELECTED, 101...159 | 1 | 105 (parameter 0105 TORQUE) | | |
| 3416 | SIGNAL3 MIN | - | 1 | - | | |
| 3417 | SIGNAL3 MAX | - | 1 | - | | |
| 3418 | OUTPUT3 DSP FORM | 0...9 | 1 | 9 (DIRECT) | | |
| 3419 | OUTPUT3 UNIT | 0...127 | 1 | - | | |
| 3420 | OUTPUT3 MIN | - | 1 | - | | |
| 3421 | OUTPUT3 MAX | - | 1 | - | | |
| Group 35: MOTOR TEMP MEAS | | | | | | |
| 3501 | SENSOR TYPE | 0...6 | 1 | 0 (NONE) | | |
| 3502 | INPUT SELECTION | 1...8 | 1 | 1 (AI1) | | |
| 3503 | ALARM LIMIT | Par. 3501 = 1...3: -10...200 °C Par. 3501 = 4: 0...5000 ohm Par. 3501 = 5...6: 0...1 | 1 | 110 °C / 1500 ohm / 0 | | |
| 3504 | FAULT LIMIT | Par. 3501 = 1...3: -10...200 °C Par. 3501 = 4: 0...5000 ohm Par. 3501 = 5...6: 0...1 | 1 | 130 °C / 4000 ohm / 0 | | |
| Group 36: TIMED FUNCTIONS | | | | | | |
| 3601 | TIMERS ENABLE | -6...7 | 1 | 0 (NOT SEL) | | |
| 3602 | START TIME 1 | 00:00:00...23:59:58 | 2 s | 00:00:00 | | |
| 3603 | STOP TIME 1 | 00:00:00...23:59:58 | 2 s | 00:00:00 | | |
| 3604 | START DAY 1 | 1...7 | 1 | 1 (MONDAY) | | |
| 3605 | STOP DAY 1 | 1...7 | 1 | 1 (MONDAY) | | |
| 3606 | START TIME 2 | 00:00:00...23:59:58 | 2 s | 00:00:00 | | |

| Code | Name | Range | Resolution | Default | User | S |
|------------------------------------|----------------------|--|------------|-------------|------|---|
| 3607 | STOP TIME 2 | 00:00:00...23:59:58 | 2 s | 00:00:00 | | |
| 3608 | START DAY 2 | 1...7 | 1 | 1 (MONDAY) | | |
| 3609 | STOP DAY 2 | 1...7 | 1 | 1 (MONDAY) | | |
| 3610 | START TIME 3 | 00:00:00...23:59:58 | 2 s | 00:00:00 | | |
| 3611 | STOP TIME 3 | 00:00:00...23:59:58 | 2 s | 00:00:00 | | |
| 3612 | START DAY 3 | 1...7 | 1 | 1 (MONDAY) | | |
| 3613 | STOP DAY 3 | 1...7 | 1 | 1 (MONDAY) | | |
| 3614 | START TIME 4 | 00:00:00...23:59:58 | 2 s | 00:00:00 | | |
| 3615 | STOP TIME 4 | 00:00:00...23:59:58 | 2 s | 00:00:00 | | |
| 3616 | START DAY 4 | 1...7 | 1 | 1 (MONDAY) | | |
| 3617 | STOP DAY 4 | 1...7 | 1 | 1 (MONDAY) | | |
| 3622 | BOOSTER SEL | -6...6 | 1 | 0 (NOT SEL) | | |
| 3623 | BOOSTER TIME | 00:00:00...23:59:58 | 2 s | 00:00:00 | | |
| 3626 | TIMED FUNC 1...4 SRC | 0...31 | 1 | 0 (NOT SEL) | | |
| ... | | | | | | |
| 3629 | | | | | | |
| Group 37: USER LOAD CURVE | | | | | | |
| 3701 | USER LOAD C MODE | 0...3 | 1 | 0 (NOT SEL) | | |
| 3702 | USER LOAD C FUNC | 1 = FAULT, 2 = ALARM | 1 | 1 (FAULT) | | |
| 3703 | USER LOAD C TIME | 10...400 s | 1 s | 20 s | | |
| 3704 | LOAD FREQ 1 | 0...500 Hz | 1 Hz | 5 Hz | | |
| 3705 | LOAD TORQ LOW 1 | 0...600% | 1% | 10% | | |
| 3706 | LOAD TORQ HIGH 1 | 0...600% | 1% | 300% | | |
| 3707 | LOAD FREQ 2 | 0...500 Hz | 1 Hz | 25 Hz | | |
| 3708 | LOAD TORQ LOW 2 | 0...600% | 1% | 15% | | |
| 3709 | LOAD TORQ HIGH 2 | 0...600% | 1% | 300% | | |
| 3710 | LOAD FREQ 3 | 0...500 Hz | 1 Hz | 43 Hz | | |
| 3711 | LOAD TORQ LOW 3 | 0...600% | 1% | 25% | | |
| 3712 | LOAD TORQ HIGH 3 | 0...600% | 1% | 300% | | |
| 3713 | LOAD FREQ 4 | 0...500 Hz | 1 Hz | 50 Hz | | |
| 3714 | LOAD TORQ LOW 4 | 0...600% | 1% | 30% | | |
| 3715 | LOAD TORQ HIGH 4 | 0...600% | 1% | 300% | | |
| 3716 | LOAD FREQ 5 | 0...500 Hz | 1 Hz | 500 Hz | | |
| 3717 | LOAD TORQ LOW 5 | 0...600% | 1% | 30% | | |
| 3718 | LOAD TORQ HIGH 5 | 0...600% | 1% | 300% | | |
| Group 40: PROCESS PID SET 1 | | | | | | |
| 4001 | GAIN | 0.1...100.0 | 0.1 | 1.0 | | |
| 4002 | INTEGRATION TIME | 0.0 = NOT SEL, 0.1...3600.0 s | 0.1 s | 60.0 s | | |
| 4003 | DERIVATION TIME | 0.0...10.0 s | 0.1 s | 0.0 s | | |
| 4004 | PID DERIV FILTER | 0.0...10.0 s | 0.1 s | 1.0 s | | |
| 4005 | ERROR VALUE INV | 0 = NO, 1 = YES | 1 | 0 (NO) | | |
| 4006 | UNITS | 0...127 | 1 | 4 (%) | | |
| 4007 | UNIT SCALE | 0...4 | 1 | 1 | | |
| 4008 | 0% VALUE | Unit and scale defined by par. 4006 and 4007 | - | 0.0% | | |

| Code | Name | Range | Resolution | Default | User | S |
|------------------------------------|------------------|--|----------------|-----------------|------|---|
| 4009 | 100% VALUE | Unit and scale defined by par. 4006 and 4007 | - | 100.0% | | |
| 4010 | SET POINT SEL | 0...2, 8...17, 19...20 | 1 | 1 (AI1) | | ✓ |
| 4011 | INTERNAL SETPNT | Unit and scale defined by par. 4006 and 4007 | - | 40.0% | | |
| 4012 | SETPOINT MIN | -500.0...500.0% | 0.1% | 0.0% | | |
| 4013 | SETPOINT MAX | -500.0...500.0% | 0.1% | 100.0% | | |
| 4014 | FBK SEL | 1...13 | 1 | 1 (ACT1) | | |
| 4015 | FBK MULTIPLIER | 0.000 = NOT SEL, -32.768...32.767 | 0.001 | 0.000 (NOT SEL) | | |
| 4016 | ACT1 INPUT | 1...7 | 1 | 2 (AI2) | | ✓ |
| 4017 | ACT2 INPUT | 1...7 | 1 | 2 (AI2) | | ✓ |
| 4018 | ACT1 MINIMUM | -1000...1000% | 1% | 0% | | |
| 4019 | ACT1 MAXIMUM | -1000...1000% | 1% | 100% | | |
| 4020 | ACT2 MINIMUM | -1000...1000% | 1% | 0% | | |
| 4021 | ACT2 MAXIMUM | -1000...1000% | 1% | 100% | | |
| 4022 | SLEEP SELECTION | -6...7 | 1 | 0 (NOT SEL) | | |
| 4023 | PID SLEEP LEVEL | 0...30000 rpm / 0.0...500.0 Hz | 1 rpm / 0.1 Hz | 0 rpm / 0.0 Hz | | |
| 4024 | PID SLEEP DELAY | 0.0...3600.0 s | 0.1 s | 60.0 s | | |
| 4025 | WAKE-UP DEV | Unit and scale defined by par. 4006 and 4007 | - | 0.0% | | |
| 4026 | WAKE-UP DELAY | 0.00...60.00 s | 0.01 s | 0.50 s | | |
| 4027 | PID 1 PARAM SET | -6...14 | 1 | 0 (SET 1) | | |
| Group 41: PROCESS PID SET 2 | | | | | | |
| 4101 | GAIN | 0.1...100.0 | 0.1 | 1.0 | | |
| 4102 | INTEGRATION TIME | 0.0 = NOT SEL, 0.1...3600.0 s | 0.1 s | 60.0 s | | |
| 4103 | DERIVATION TIME | 0.0...10.0 s | 0.1 s | 0.0 s | | |
| 4104 | PID DERIV FILTER | 0.0...10.0 s | 0.1 s | 1.0 s | | |
| 4105 | ERROR VALUE INV | 0 = NO, 1 = YES | 1 | 0 (NO) | | |
| 4106 | UNITS | 0...127 | 1 | 4 (%) | | |
| 4107 | UNIT SCALE | 0...4 | 1 | 1 | | |
| 4108 | 0% VALUE | Unit and scale defined by par. 4106 and 4107 | - | 0.0% | | |
| 4109 | 100% VALUE | Unit and scale defined by par. 4106 and 4107 | - | 100.0% | | |
| 4110 | SET POINT SEL | 0...2, 8...17, 19...20 | 1 | 1 (AI1) | | ✓ |
| 4111 | INTERNAL SETPNT | Unit and scale defined by par. 4106 and 4107 | - | 40.0% | | |
| 4112 | SETPOINT MIN | -500.0...500.0% | 0.1% | 0.0% | | |
| 4113 | SETPOINT MAX | -500.0...500.0% | 0.1% | 100.0% | | |
| 4114 | FBK SEL | 1...13 | 1 | 1 (ACT1) | | |
| 4115 | FBK MULTIPLIER | 0.000 = NOT SEL, -32.768...32.767 | 0.001 | 0.000 (NOT SEL) | | |
| 4116 | ACT1 INPUT | 1...7 | 1 | 2 (AI2) | | ✓ |
| 4117 | ACT2 INPUT | 1...7 | 1 | 2 (AI2) | | ✓ |
| 4118 | ACT1 MINIMUM | -1000...1000% | 1% | 0% | | |
| 4119 | ACT1 MAXIMUM | -1000...1000% | 1% | 100% | | |
| 4120 | ACT2 MINIMUM | -1000...1000% | 1% | 0% | | |
| 4121 | ACT2 MAXIMUM | -1000...1000% | 1% | 100% | | |

| Code | Name | Range | Resolution | Default | User | S |
|----------------------------------|------------------|--|----------------|-----------------|------|---|
| 4122 | SLEEP SELECTION | -6...7 | 1 | 0 (NOT SEL) | | |
| 4123 | PID SLEEP LEVEL | 0...30000 rpm / 0.0...500.0 Hz | 1 rpm / 0.1 Hz | 0 rpm / 0.0 Hz | | |
| 4124 | PID SLEEP DELAY | 0.0...3600.0 s | 0.1 s | 60.0 s | | |
| 4125 | WAKE-UP DEV | Unit and scale defined by par. 4106 and 4107 | - | 0.0% | | |
| 4126 | WAKE-UP DELAY | 0.00...60.00 s | 0.01 s | 0.50 s | | |
| Group 42: EXT / TRIM PID | | | | | | |
| 4201 | GAIN | 0.1...100.0 | 0.1 | 1.0 | | |
| 4202 | INTEGRATION TIME | 0.0 = NOT SEL, 0.1...3600.0 s | 0.1 s | 60 s | | |
| 4203 | DERIVATION TIME | 0.0...10.0 s | 0.1 s | 0.0 s | | |
| 4204 | PID DERIV FILTER | 0.0...10.0 s | 0.1 s | 1.0 s | | |
| 4205 | ERROR VALUE INV | 0 = NO, 1 = YES | 1 | 0 (NO) | | |
| 4206 | UNITS | 0...127 | 1 | 4 (%) | | |
| 4207 | UNIT SCALE | 0...4 | 1 | 1 | | |
| 4208 | 0% VALUE | Unit and scale defined by par. 4206 and 4207 | - | 0.0% | | |
| 4209 | 100% VALUE | Unit and scale defined by par. 4206 and 4207 | - | 100.0% | | |
| 4210 | SET POINT SEL | 0...2, 8...17, 19...20 | 1 | 1 (AI1) | | ✓ |
| 4211 | INTERNAL SETPNT | Unit and scale defined by par. 4206 and 4207 | - | 40.0% | | |
| 4212 | SETPOINT MIN | -500.0...500.0% | 0.1% | 0.0% | | |
| 4213 | SETPOINT MAX | -500.0...500.0% | 0.1% | 100.0% | | |
| 4214 | FBK SEL | 1...13 | 1 | 1 (ACT1) | | |
| 4215 | FBK MULTIPLIER | 0.000 = NOT SEL, -32.768...32.767 | 0.001 | 0.000 (NOT SEL) | | |
| 4216 | ACT1 INPUT | 1...7 | 1 | 2 (AI2) | | ✓ |
| 4217 | ACT2 INPUT | 1...7 | 1 | 2 (AI2) | | ✓ |
| 4218 | ACT1 MINIMUM | -1000...1000% | 1% | 0% | | |
| 4219 | ACT1 MAXIMUM | -1000...1000% | 1% | 100% | | |
| 4220 | ACT2 MINIMUM | -1000...1000% | 1% | 0% | | |
| 4221 | ACT2 MAXIMUM | -1000...1000% | 1% | 100% | | |
| 4228 | ACTIVATE | -6...12 | 1 | 0 (NOT SEL) | | |
| 4229 | OFFSET | 0.0...100.0% | 0.1% | 0.0% | | |
| 4230 | TRIM MODE | 0 = NOT SEL, 1 = PROPORTIONAL, 3 = DIRECT | 1 | 0 (NOT SEL) | | |
| 4231 | TRIM SCALE | -100.0...100.0% | 0.1% | 0.0% | | |
| 4232 | CORRECTION SRC | 1 = PID2REF, 2 = PID2OUTPUT | 1 | 1 (PID2REF) | | |
| Group 50: ENCODER | | | | | | |
| 5001 | PULSE NR | 50...16384 | 1 | 1024 | | ✓ |
| 5002 | ENCODER ENABLE | 0 = DISABLE, 1 = ENABLE | 1 | 0 (DISABLE) | | ✓ |
| 5003 | ENCODER FAULT | 1 = FAULT, 2 = ALARM | 1 | 1 (FAULT) | | ✓ |
| 5010 | Z PLS ENABLE | 0 = DISABLE, 1 = ENABLE | 1 | 0 (DISABLE) | | ✓ |
| 5011 | POSITION RESET | 0 = DISABLE, 1 = ENABLE | 1 | 0 (DISABLE) | | |
| Group 51: EXT COMM MODULE | | | | | | |
| 5101 | FBA TYPE | - | - | 0 (NOT DEFINED) | | |
| 5102... 5126 | FB PAR 2...26 | 0...65535 | 1 | 0 | | |

| Code | Name | Range | Resolution | Default | User | S |
|-------------------------------|------------------|--|------------|-----------------|------|---|
| 5127 | FBA PAR REFRESH | 0 = DONE, 1 = REFRESH | 1 | 0 (DONE) | | ✓ |
| 5128 | FILE CPI FW REV | 0...0xFFFF (hex) | 1 | 0 | | |
| 5129 | FILE CONFIG ID | 0...0xFFFF (hex) | 1 | 0 | | |
| 5130 | FILE CONFIG REV | 0...0xFFFF (hex) | 1 | 0 | | |
| 5131 | FBA STATUS | 0...6 | 1 | 0 (IDLE) | | |
| 5132 | FBA CPI FW REV | 0...0xFFFF (hex) | 1 | 0 | | |
| 5133 | FBA APPL FW REV | 0...0xFFFF (hex) | 1 | 0 | | |
| Group 52: PANEL COMM | | | | | | |
| 5201 | STATION ID | 1...247 | 1 | 1 | | |
| 5202 | BAUD RATE | 9.6, 19.2, 38.4, 57.6, 115.2 kbits/s | - | 9.6 kbits/s | | |
| 5203 | PARITY | 0 = 8 NONE 1, 1 = 8 NONE 2, 2 = 8 EVEN 1, 3 = 8 ODD 1 | 1 | 0 (8 NONE 1) | | |
| 5204 | OK MESSAGES | 0...65535 | 1 | - | | |
| 5205 | PARITY ERRORS | 0...65535 | 1 | - | | |
| 5206 | FRAME ERRORS | 0...65535 | 1 | - | | |
| 5207 | BUFFER OVERRUNS | 0...65535 | 1 | - | | |
| 5208 | CRC ERRORS | 0...65535 | 1 | - | | |
| Group 53: EFB PROTOCOL | | | | | | |
| 5301 | EFB PROTOCOL ID | 0...0xFFFF | 1 | 0 | | |
| 5302 | EFB STATION ID | 0...65535 | 1 | 1 | | ✓ |
| 5303 | EFB BAUD RATE | 1.2, 2.4, 4.8, 9.6, 19.2, 38.4, 57.6, 76.8 kbits/s | - | 9.6 kbits/s | | |
| 5304 | EFB PARITY | 0 = 8 NONE 1, 1 = 8 NONE 2, 2 = 8 EVEN 1, 3 = 8 ODD 1 | | 0 (8 NONE 1) | | |
| 5305 | EFB CTRL PROFILE | 0 = ABB DRV LIM, 1 = DCU PROFILE, 2 = ABB DRV FULL | 1 | 0 (ABB DRV LIM) | | |
| 5306 | EFB OK MESSAGES | 0...65535 | 1 | 0 | | |
| 5307 | EFB CRC ERRORS | 0...65535 | 1 | 0 | | |
| 5308 | EFB UART ERRORS | 0...65535 | 1 | 0 | | |
| 5309 | EFB STATUS | 0...7 | 1 | 0 (IDLE) | | |
| 5310 | EFB PAR 10 | 0...65535 | 1 | 0 (NOT SEL) | | |
| 5311 | EFB PAR 11 | 0...65535 | 1 | 0 (NOT SEL) | | |
| 5312 | EFB PAR 12 | 0...65535 | 1 | 0 (NOT SEL) | | |
| 5313 | EFB PAR 13 | 0...65535 | 1 | 0 (NOT SEL) | | |
| 5314 | EFB PAR 14 | 0...65535 | 1 | 0 (NOT SEL) | | |
| 5315 | EFB PAR 15 | 0...65535 | 1 | 0 (NOT SEL) | | |
| 5316 | EFB PAR 16 | 0...65535 | 1 | 0 (NOT SEL) | | |
| 5317 | EFB PAR 17 | 0...65535 | 1 | 0 (NOT SEL) | | |
| 5318 | EFB PAR 18 | 0...65535 | 1 | 0 | | |
| 5319 | EFB PAR 19 | 0...0xFFFF (hex) | 1 | 0 | | |
| 5320 | EFB PAR 20 | 0...0xFFFF (hex) | 1 | 0 | | |
| Group 81: PFC CONTROL | | | | | | |
| 8103 | REFERENCE STEP 1 | 0.0...100.0% | 0.1% | 0.0% | | |
| 8104 | REFERENCE STEP 2 | 0.0...100.0% | 0.1% | 0.0% | | |
| 8105 | REFERENCE STEP 3 | 0.0...100.0% | 0.1% | 0.0% | | |

| Code | Name | Range | Resolution | Default | User | S |
|--------------------------|------------------|---|------------|------------------------------|------|---|
| 8109 | START FREQ 1 | 0.0...500.0 Hz | 0.1 Hz | 02: 50.0 Hz / U2: 0.0 Hz | | |
| 8110 | START FREQ 2 | 0.0...500.0 Hz | 0.1 Hz | 02: 50.0 Hz / U2: 0.0 Hz | | |
| 8111 | START FREQ 3 | 0.0...500.0 Hz | 0.1 Hz | 02: 50.0 Hz / U2: 0.0 Hz | | |
| 8112 | LOW FREQ 1 | 0.0...500.0 Hz | 0.1 Hz | 02: 25.0 Hz / U2: 30.0 Hz | | |
| 8113 | LOW FREQ 2 | 0.0...500.0 Hz | 0.1 Hz | 02: 25.0 Hz / U2: 30.0 Hz | | |
| 8114 | LOW FREQ 3 | 0.0...500.0 Hz | 0.1 Hz | 02: 25.0 Hz / U2: 30.0 Hz | | |
| 8115 | AUX MOT START D | 0.0...3600.0 s | 0.1 s | 5.0 s | | |
| 8116 | AUX MOT STOP D | 0.0...3600.0 s | 0.1 s | 3.0 s | | |
| 8117 | NR OF AUX MOT | 0...4 | 1 | 1 | | ✓ |
| 8118 | AUTOCHNG INTERV | -0.1 = TEST MODE, 0.0 = NOT SEL, 0.1...336 h | 0.1 h | 0.0 h (NOT SEL) | | ✓ |
| 8119 | AUTOCHNG LEVEL | 0.0...100.0% | 0.1% | 50% | | |
| 8120 | INTERLOCKS | 0...6 | 1 | 4 (DI4) | | ✓ |
| 8121 | REG BYPASS CTRL | 0 = NO, 1 = YES | 1 | 0 (NO) | | |
| 8122 | PFC START DELAY | 0.00...10.00 s | 0.01 s | 0.50 s | | |
| 8123 | PFC ENABLE | 0 = NOT SEL, 1 = ACTIVE | 1 | 0 (NOT SEL) | | ✓ |
| 8124 | ACC IN AUX STOP | 0.0 = NOT SEL, 0.1...1800.0 s | 0.1 s | 0.0 s (NOT SEL) | | |
| 8125 | DEC IN AUX START | 0.0 = NOT SEL, 0.1...1800.0 s | 0.1 s | 0.0 s (NOT SEL) | | |
| 8126 | TMED AUTOCHNG | 0...4 | 1 | 0 (NOT SEL) | | |
| 8127 | MOTORS | 1...7 | 1 | 2 | | ✓ |
| 8128 | AUX START ORDER | 1 = EVEN RUNTIME, 2 = RELAY ORDER | 1 | 1 (EVEN RUNTIME) | | ✓ |
| Group 98: OPTIONS | | | | | | |
| 9802 | COMM PROT SEL | 0 = NOT SEL, 1 = STD MODBUS, 4 = EXT FBA | 1 | 0 (NOT SEL) | | ✓ |

Complete parameter descriptions



This section describes the actual signals and parameters for ACS550.

Group 99: START-UP DATA

This group defines special start-up data required to:

- set up the drive
- enter motor information.

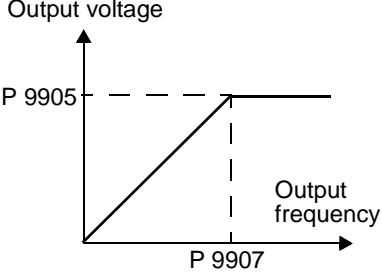
| Code | Description | | | | | | | | | | | | | | | | | | | | | | | | |
|------------------|--|-------------------|-------------------|---------------|---------------|---------------|-----------------|-----------------|-----------------|-----------|-----------|------------------|-------------------|-------------------|-------------------|------------|-------------|--|--|--|--|-------------|-------------|------------|--------------|
| 9901 | <p>LANGUAGE</p> <p>Selects the display language. There are two different Assistant Control Panels, each supporting a different language set. (Panel ACS-CP-L supporting languages 0, 2, 11...15 has been integrated into ACS-CP-A.)</p> <p>Assistant Control Panel ACS-CP-A:</p> <table> <tr> <td>0 = ENGLISH</td> <td>1 = ENGLISH (AM)</td> <td>2 = DEUTSCH</td> <td>3 = ITALIANO</td> <td>4 = ESPAÑOL</td> </tr> <tr> <td>5 = PORTUGUES</td> <td>6 = NEDERLANDS</td> <td>7 = FRANÇAIS</td> <td>8 = DANSK</td> <td>9 = SUOMI</td> </tr> <tr> <td>10 = SVENSKA</td> <td>11 = RUSSKI</td> <td>12 = POLSKI</td> <td>13 = TÜRKÇE</td> <td>14 = CZECH</td> </tr> <tr> <td>15 = MAGYAR</td> <td></td> <td></td> <td></td> <td></td> </tr> </table> <p>Assistant Control Panel ACS-CP-D (Asia):</p> <table> <tr> <td>0 = ENGLISH</td> <td>1 = CHINESE</td> <td>2 = KOREAN</td> <td>3 = JAPANESE</td> </tr> </table> | 0 = ENGLISH | 1 = ENGLISH (AM) | 2 = DEUTSCH | 3 = ITALIANO | 4 = ESPAÑOL | 5 = PORTUGUES | 6 = NEDERLANDS | 7 = FRANÇAIS | 8 = DANSK | 9 = SUOMI | 10 = SVENSKA | 11 = RUSSKI | 12 = POLSKI | 13 = TÜRKÇE | 14 = CZECH | 15 = MAGYAR | | | | | 0 = ENGLISH | 1 = CHINESE | 2 = KOREAN | 3 = JAPANESE |
| 0 = ENGLISH | 1 = ENGLISH (AM) | 2 = DEUTSCH | 3 = ITALIANO | 4 = ESPAÑOL | | | | | | | | | | | | | | | | | | | | | |
| 5 = PORTUGUES | 6 = NEDERLANDS | 7 = FRANÇAIS | 8 = DANSK | 9 = SUOMI | | | | | | | | | | | | | | | | | | | | | |
| 10 = SVENSKA | 11 = RUSSKI | 12 = POLSKI | 13 = TÜRKÇE | 14 = CZECH | | | | | | | | | | | | | | | | | | | | | |
| 15 = MAGYAR | | | | | | | | | | | | | | | | | | | | | | | | | |
| 0 = ENGLISH | 1 = CHINESE | 2 = KOREAN | 3 = JAPANESE | | | | | | | | | | | | | | | | | | | | | | |
| 9902 | <p>APPLIC MACRO</p> <p>Selects an application macro. Application macros automatically edit parameters to configure the ACS550 for a particular application.</p> <table> <tr> <td>1 = ABB STANDARD</td> <td>2 = 3-WIRE</td> <td>3 = ALTERNATE</td> <td>4 = MOTOR POT</td> <td>5 = HAND/AUTO</td> </tr> <tr> <td>6 = PID CONTROL</td> <td>7 = PFC CONTROL</td> <td>8 = TORQUE CTRL</td> <td></td> <td></td> </tr> <tr> <td>0 = USER S1 LOAD</td> <td>-1 = USER S1 SAVE</td> <td>-2 = USER S2 LOAD</td> <td>-3 = USER S2 SAVE</td> <td></td> </tr> </table> <p>-1 = USER S1 SAVE, -3 = USER S2 SAVE – With these it is possible to save two different user parameter sets into the drive permanent memory for later use. Each set contains parameter settings, including Group 99: START-UP DATA, and the results of the motor identification run.</p> <p>0 = USER S1 LOAD, -2 = USER S2 LOAD – With these the user parameter sets can be taken back in use.</p> | 1 = ABB STANDARD | 2 = 3-WIRE | 3 = ALTERNATE | 4 = MOTOR POT | 5 = HAND/AUTO | 6 = PID CONTROL | 7 = PFC CONTROL | 8 = TORQUE CTRL | | | 0 = USER S1 LOAD | -1 = USER S1 SAVE | -2 = USER S2 LOAD | -3 = USER S2 SAVE | | | | | | | | | | |
| 1 = ABB STANDARD | 2 = 3-WIRE | 3 = ALTERNATE | 4 = MOTOR POT | 5 = HAND/AUTO | | | | | | | | | | | | | | | | | | | | | |
| 6 = PID CONTROL | 7 = PFC CONTROL | 8 = TORQUE CTRL | | | | | | | | | | | | | | | | | | | | | | | |
| 0 = USER S1 LOAD | -1 = USER S1 SAVE | -2 = USER S2 LOAD | -3 = USER S2 SAVE | | | | | | | | | | | | | | | | | | | | | | |
| 9904 | <p>MOTOR CTRL MODE</p> <p>Selects the motor control mode.</p> <p>1 = VECTOR:SPEED – sensorless vector control mode.</p> <ul style="list-style-type: none"> • Reference 1 is speed reference in rpm. • Reference 2 is speed reference in % (100% is absolute maximum speed, equal to the value of parameter 2002 MAXIMUM SPEED, or 2001 MINIMUM SPEED if the absolute value of the minimum speed is greater than the maximum speed). <p>2 = VECTOR:TORQ.</p> <ul style="list-style-type: none"> • Reference 1 is speed reference in rpm. • Reference 2 is torque reference in % (100% is nominal torque.) <p>3 = SCALAR:FREQ – scalar control mode.</p> <ul style="list-style-type: none"> • Reference 1 is frequency reference in Hz. • Reference 2 is frequency reference in % (100% is absolute maximum frequency, equal to the value of parameter 2008 MAXIMUM FREQ, or 2007 MINIMUM FREQ if the absolute value of the minimum speed is greater than the maximum speed). | | | | | | | | | | | | | | | | | | | | | | | | |

| Code | Description | |
|------|--|---|
| 9905 | MOTOR NOM VOLT Defines the nominal motor voltage. <ul style="list-style-type: none"> • Must equal the value on the motor rating plate. • The ACS550 cannot supply the motor with a voltage greater than the input power (mains) voltage. |  |
| 9906 | MOTOR NOM CURR Defines the nominal motor current. <ul style="list-style-type: none"> • Must equal the value on the motor rating plate. • Range allowed: $0.2 \dots 2.0 \cdot I_{2hd}$ (where I_{2hd} is drive current). | |
| 9907 | MOTOR NOM FREQ Defines the nominal motor frequency. <ul style="list-style-type: none"> • Range: 10...500 Hz (typically 50 or 60 Hz) • Sets the frequency at which output voltage equals the MOTOR NOM VOLT. • Field weakening point = Nom Freq · Supply Volt / Mot Nom Volt | |
| 9908 | MOTOR NOM SPEED Defines the nominal motor speed. <ul style="list-style-type: none"> • Must equal the value on the motor rating plate. | |
| 9909 | MOTOR NOM POWER Defines the nominal motor power. <ul style="list-style-type: none"> • Must equal the value on the motor rating plate. | |
| 9910 | ID RUN This parameter controls a self-calibration process called the Motor ID Run. During this process, the drive operates the motor (motor rotating) and makes measurements in order to identify motor characteristics and create a model used for internal calculations. An ID Run is especially effective when: <ul style="list-style-type: none"> • vector control mode is used [parameter 9904 = 1 (VECTOR:SPEED) or 2 (VECTOR:TORQ)], and/or • operation point is near zero speed, and/or • operation requires a torque range above the motor nominal torque, over a wide speed range, and without any measured speed feedback (i.e. without a pulse encoder). 0 = OFF/IDMAGN – The Motor ID Run process is not run. Identification magnetization is performed, depending on parameter 9904 and 2101 settings. In identification magnetization, the motor model is calculated at first start by magnetizing the motor for 10 to 15 s at zero speed (motor not rotating). The model is recalculated always at start after motor parameter changes. <ul style="list-style-type: none"> • Parameter 9904 = 1 (VECTOR:SPEED) or 2 (VECTOR:TORQ): Identification magnetization is performed. • Parameter 9904 = 3 (SCALAR:FREQ) and parameter 2101 = 3 (SCALAR FLYST) or 5 (FLY + BOOST): Identification magnetization is performed. • Parameter 9904 = 3 (SCALAR:FREQ) and parameter 2101 has other value than 3 (SCALAR FLYST) or 5 (FLY + BOOST): Identification magnetization is not performed. 1 = ON – Enables the Motor ID Run, during which the motor is rotating, at the next start command. After run completion, this value automatically changes to 0. <p>Note: The motor must be de-coupled from the driven equipment.</p> <p>Note: If motor parameters are changed after ID Run, repeat the ID Run.</p> <p> WARNING! The motor will run at up to approximately 50...80% of the nominal speed during the ID Run. The motor will rotate in the forward direction.</p> <p>Ensure that it is safe to run the motor before performing the ID Run!</p> <p>See also section How to perform the ID Run on page 69.</p> | |

Group 01: OPERATING DATA

This group contains drive operating data, including actual signals. The drive sets the values for actual signals, based on measurements or calculations. You cannot set these values.

| Code | Description |
|------|---|
| 0101 | SPEED & DIR The calculated signed speed of the motor (rpm). The absolute value of 0101 SPEED & DIR is the same as the value of 0102 SPEED. <ul style="list-style-type: none"> • The value of 0101 SPEED & DIR is positive if the motor runs in the forward direction. • The value of 0101 SPEED & DIR is negative if the motor runs in the reverse direction. |
| 0102 | SPEED The calculated speed of the motor (rpm). (Parameter 0102 or 0103 is shown by default in the control panel Output mode.) |
| 0103 | OUTPUT FREQ The frequency (Hz) applied to the motor. (Parameter 0102 or 0103 is shown by default in the control panel Output mode.) |
| 0104 | CURRENT The motor current, as measured by the ACS550. (Shown by default in the control panel Output mode.) |
| 0105 | TORQUE Output torque. Calculated value of torque on motor shaft in % of motor nominal torque. (Shown by default in the control panel Output mode.) |
| 0106 | POWER The measured motor power in kW. |
| 0107 | DC BUS VOLTAGE The DC bus voltage in V DC, as measured by the ACS550. |
| 0109 | OUTPUT VOLTAGE The voltage applied to the motor. |
| 0110 | DRIVE TEMP The temperature of the drive power transistors in degrees Celsius. |
| 0111 | EXTERNAL REF 1 External reference, REF1, in rpm or Hz – units determined by parameter 9904. |
| 0112 | EXTERNAL REF 2 External reference, REF2, in %. |
| 0113 | CTRL LOCATION Active control location. Alternatives are: 0 = LOCAL 1 = EXT1 2 = EXT2 |
| 0114 | RUN TIME (R) The drive's accumulated running time in hours (h). <ul style="list-style-type: none"> • Can be reset by pressing UP and DOWN keys simultaneously when the control panel is in the Parameters mode. |
| 0115 | KWH COUNTER (R) The drive's accumulated power consumption in kilowatt hours. <ul style="list-style-type: none"> • Can be reset by pressing UP and DOWN keys simultaneously when the control panel is in the Parameters mode. |
| 0116 | APPL BLK OUTPUT Application block output signal. Value is from either: <ul style="list-style-type: none"> • PFC control, if PFC Control is active, or • Parameter 0112 EXTERNAL REF 2. |

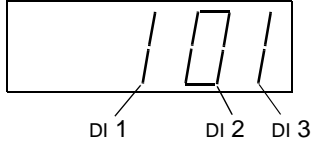
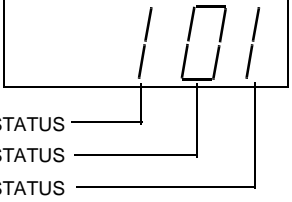
| Code | Description | |
|------|---|---|
| 0118 | DI 1-3 STATUS Status of the three digital inputs. <ul style="list-style-type: none"> • Status is displayed as a binary number. • 1 indicates that the input is activated. • 0 indicates that the input is deactivated. |  |
| 0119 | DI 4-6 STATUS Status of the three digital inputs. <ul style="list-style-type: none"> • See parameter 0118 DI 1-3 STATUS. | |
| 0120 | AI 1 The relative value of analog input 1 in %. | |
| 0121 | AI 2 The relative value of analog input 2 in %. | |
| 0122 | RO 1-3 STATUS Status of the three relay outputs. <ul style="list-style-type: none"> • 1 indicates that the relay is energized. • 0 indicates that the relay is de-energized. |  |
| 0123 | RO 4-6 STATUS Status of the three relay outputs. <ul style="list-style-type: none"> • See parameter 0122. | |
| 0124 | AO 1 The analog output 1 value in milliamperes. | |
| 0125 | AO 2 The analog output 2 value in milliamperes. | |
| 0126 | PID 1 OUTPUT The PID controller 1 output value in %. | |
| 0127 | PID 2 OUTPUT The PID controller 2 output value in %. | |
| 0128 | PID 1 SETPNT The PID 1 controller setpoint signal. <ul style="list-style-type: none"> • Units and scale defined by PID parameters. | |
| 0129 | PID 2 SETPNT The PID 2 controller setpoint signal. <ul style="list-style-type: none"> • Units and scale defined by PID parameters. | |
| 0130 | PID 1 FBK The PID 1 controller feedback signal. <ul style="list-style-type: none"> • Units and scale defined by PID parameters. | |
| 0131 | PID 2 FBK The PID 2 controller feedback signal. <ul style="list-style-type: none"> • Units and scale defined by PID parameters. | |
| 0132 | PID 1 DEVIATION The difference between the PID 1 controller reference value and actual value. <ul style="list-style-type: none"> • Units and scale defined by PID parameters. | |
| 0133 | PID 2 DEVIATION The difference between the PID 2 controller reference value and actual value. <ul style="list-style-type: none"> • Units and scale defined by PID parameters. | |
| 0134 | COMM RO WORD Free data location that can be written from serial link. <ul style="list-style-type: none"> • Used for relay output control. • See parameter 1401. | |
| 0135 | COMM VALUE 1 Free data location that can be written from serial link. | |

| Code | Description |
|------|---|
| 0136 | COMM VALUE 2 Free data location that can be written from serial link. |
| 0137 | PROCESS VAR 1 Process variable 1 <ul style="list-style-type: none"> Defined by parameters in Group 34: PANEL DISPLAY. |
| 0138 | PROCESS VAR 2 Process variable 2 <ul style="list-style-type: none"> Defined by parameters in Group 34: PANEL DISPLAY. |
| 0139 | PROCESS VAR 3 Process variable 3 <ul style="list-style-type: none"> Defined by parameters in Group 34: PANEL DISPLAY. |
| 0140 | RUN TIME The drive's accumulated running time in thousands of hours (kh). <ul style="list-style-type: none"> Cannot be reset. |
| 0141 | MWH COUNTER The drive's accumulated power consumption in megawatt hours. <ul style="list-style-type: none"> Cannot be reset. |
| 0142 | REVOLUTION CNTR The motor's accumulated revolutions in millions of revolutions. <ul style="list-style-type: none"> Can be reset by pressing UP and DOWN keys simultaneously when the control panel is in the Parameters mode. |
| 0143 | DRIVE ON TIME HI The drive's accumulated power-on time in days. <ul style="list-style-type: none"> Cannot be reset. |
| 0144 | DRIVE ON TIME LO The drive's accumulated power-on time in 2 second ticks (30 ticks = 60 seconds). <ul style="list-style-type: none"> Shown in format hh.mm.ss. Cannot be reset. |
| 0145 | MOTOR TEMP Motor temperature in degrees Celsius / PTC resistance in ohms. <ul style="list-style-type: none"> Applies only if motor temperature sensor is set up. See parameter 3501. |
| 0146 | MECH ANGLE Defines the motor shaft's angular position to about 0.01° (32,768 divisions for 360°). The position is defined as 0 at power up. During operation the zero position can be set by: <ul style="list-style-type: none"> a Z-pulse input, if parameter 5010 Z PLS ENABLE = 1 (ENABLE) parameter 5011 POSITION RESET, if parameter 5010 Z PLS ENABLE = 2 (DISABLE) any status change of parameter 5002 ENCODER ENABLE. |
| 0147 | MECH REVS A signed integer that counts full revolutions of the motor shaft. The value: <ul style="list-style-type: none"> increments when parameter 0146 MECH ANGLE changes from 32767 to 0 decrements when parameter 0146 MECH ANGLE changes from 0 to 32767. |
| 0148 | Z PLS DETECTED Encoder zero pulse detector. When a Z-pulse defines the zero position, the shaft must pass through the zero position to trigger a Z-pulse. Until then, the shaft position is unknown (the drive uses the shaft position at power up as zero). This parameter signals when parameter 0146 MECH ANGLE is valid. The parameter starts at 0 = NOT DETECTED on power-up and changes to 1 = DETECTED only if: <ul style="list-style-type: none"> parameter 5010 Z PLS ENABLE = 1 (ENABLE) and an encoder Z-pulse has been detected. |
| 0150 | CB TEMP Temperature of the drive control board in degrees Celsius. Note: Some drives have a control board (OMIO) that does not support this feature. These drives always show the constant value of 25.0 °C. |

| Code | Description |
|-------------|---|
| 0151 | INPUT KWH (R) Calculated actual intake energy in kWh. |
| 0152 | INPUT MWH Calculated actual intake energy in MWh. |
| 0158 | PID COMM VALUE 1 Data received from fieldbus for PID control (PID1 and PID2). |
| 0159 | PID COMM VALUE 2 Data received from fieldbus for PID control (PID1 and PID2). |

Group 03: FB ACTUAL SIGNALS

This group monitors fieldbus communications.

| Code | Description | | | | | | | | | | | | | | | | | | | | | | | | | | | | | | | | | | | | | | | | | | | | | | | | | | | | | | |
|------|---|---|---|--|---------------------|---------------------|---------------------|-------------|-------|-------|-------------|---------|---------|----------------|---------|---------|----------------|---------|-----------|----------|------------|----------|----------|------------|-------------|----------|------------|-----------|----------|-------------|------------|----------|-------|-----------|----------|-------------|----------|----------|---------|------------|-----------|---------|-----------|---------|-------------|-----------|---------|----------------|---------------|--------------|----------|--------------|---------------|-------|--------------|
| 0301 | FB CMD WORD 1 Read-only copy of the Fieldbus Command Word 1. <ul style="list-style-type: none"> The fieldbus command is the principal means for controlling the drive from a fieldbus controller. The command consists of two Command Words. Bit-coded instructions in the Command Words switch the drive between states. To control the drive, using the Command Words, an external location (EXT1 or EXT2) must be active and set to COMM. (See parameters 1001 and 1002.) The control panel displays the word in hex. For example, all zeros and a 1 in Bit 0 displays as 0001. All zeros and a 1 in Bit 15 displays as 8000. | <table border="1"> <thead> <tr> <th>Bit #</th> <th>0301, FB CMD WORD 1</th> <th>0302, FB CMD WORD 2</th> </tr> </thead> <tbody> <tr><td>0</td><td>STOP</td><td>FBLOCAL_CTL</td></tr> <tr><td>1</td><td>START</td><td>FBLOCAL_REF</td></tr> <tr><td>2</td><td>REVERSE</td><td>START_DISABLE1</td></tr> <tr><td>3</td><td>LOCAL</td><td>START_DISABLE2</td></tr> <tr><td>4</td><td>RESET</td><td>Reserved</td></tr> <tr><td>5</td><td>EXT2</td><td>Reserved</td></tr> <tr><td>6</td><td>RUN_DISABLE</td><td>Reserved</td></tr> <tr><td>7</td><td>STPMODE_R</td><td>Reserved</td></tr> <tr><td>8</td><td>STPMODE_EM</td><td>Reserved</td></tr> <tr><td>9</td><td>STPMODE_C</td><td>Reserved</td></tr> <tr><td>10</td><td>RAMP_2</td><td>Reserved</td></tr> <tr><td>11</td><td>RAMP_OUT_0</td><td>REF_CONST</td></tr> <tr><td>12</td><td>RAMP_HOLD</td><td>REF_AVE</td></tr> <tr><td>13</td><td>RAMP_IN_0</td><td>LINK_ON</td></tr> <tr><td>14</td><td>RREQ_LOCALLOC</td><td>REQ_STARTINH</td></tr> <tr><td>15</td><td>TORQLIM2</td><td>OFF_INTERLOCK</td></tr> </tbody> </table> | Bit # | 0301, FB CMD WORD 1 | 0302, FB CMD WORD 2 | 0 | STOP | FBLOCAL_CTL | 1 | START | FBLOCAL_REF | 2 | REVERSE | START_DISABLE1 | 3 | LOCAL | START_DISABLE2 | 4 | RESET | Reserved | 5 | EXT2 | Reserved | 6 | RUN_DISABLE | Reserved | 7 | STPMODE_R | Reserved | 8 | STPMODE_EM | Reserved | 9 | STPMODE_C | Reserved | 10 | RAMP_2 | Reserved | 11 | RAMP_OUT_0 | REF_CONST | 12 | RAMP_HOLD | REF_AVE | 13 | RAMP_IN_0 | LINK_ON | 14 | RREQ_LOCALLOC | REQ_STARTINH | 15 | TORQLIM2 | OFF_INTERLOCK | | |
| | | Bit # | 0301, FB CMD WORD 1 | 0302, FB CMD WORD 2 | | | | | | | | | | | | | | | | | | | | | | | | | | | | | | | | | | | | | | | | | | | | | | | | | | | |
| | | 0 | STOP | FBLOCAL_CTL | | | | | | | | | | | | | | | | | | | | | | | | | | | | | | | | | | | | | | | | | | | | | | | | | | | |
| | | 1 | START | FBLOCAL_REF | | | | | | | | | | | | | | | | | | | | | | | | | | | | | | | | | | | | | | | | | | | | | | | | | | | |
| | | 2 | REVERSE | START_DISABLE1 | | | | | | | | | | | | | | | | | | | | | | | | | | | | | | | | | | | | | | | | | | | | | | | | | | | |
| | | 3 | LOCAL | START_DISABLE2 | | | | | | | | | | | | | | | | | | | | | | | | | | | | | | | | | | | | | | | | | | | | | | | | | | | |
| | | 4 | RESET | Reserved | | | | | | | | | | | | | | | | | | | | | | | | | | | | | | | | | | | | | | | | | | | | | | | | | | | |
| | | 5 | EXT2 | Reserved | | | | | | | | | | | | | | | | | | | | | | | | | | | | | | | | | | | | | | | | | | | | | | | | | | | |
| | | 6 | RUN_DISABLE | Reserved | | | | | | | | | | | | | | | | | | | | | | | | | | | | | | | | | | | | | | | | | | | | | | | | | | | |
| | | 7 | STPMODE_R | Reserved | | | | | | | | | | | | | | | | | | | | | | | | | | | | | | | | | | | | | | | | | | | | | | | | | | | |
| | | 8 | STPMODE_EM | Reserved | | | | | | | | | | | | | | | | | | | | | | | | | | | | | | | | | | | | | | | | | | | | | | | | | | | |
| | | 9 | STPMODE_C | Reserved | | | | | | | | | | | | | | | | | | | | | | | | | | | | | | | | | | | | | | | | | | | | | | | | | | | |
| | | 10 | RAMP_2 | Reserved | | | | | | | | | | | | | | | | | | | | | | | | | | | | | | | | | | | | | | | | | | | | | | | | | | | |
| | | 11 | RAMP_OUT_0 | REF_CONST | | | | | | | | | | | | | | | | | | | | | | | | | | | | | | | | | | | | | | | | | | | | | | | | | | | |
| | | 12 | RAMP_HOLD | REF_AVE | | | | | | | | | | | | | | | | | | | | | | | | | | | | | | | | | | | | | | | | | | | | | | | | | | | |
| 13 | RAMP_IN_0 | LINK_ON | | | | | | | | | | | | | | | | | | | | | | | | | | | | | | | | | | | | | | | | | | | | | | | | | | | | | |
| 14 | RREQ_LOCALLOC | REQ_STARTINH | | | | | | | | | | | | | | | | | | | | | | | | | | | | | | | | | | | | | | | | | | | | | | | | | | | | | |
| 15 | TORQLIM2 | OFF_INTERLOCK | | | | | | | | | | | | | | | | | | | | | | | | | | | | | | | | | | | | | | | | | | | | | | | | | | | | | |
| 0302 | FB CMD WORD 2 Read-only copy of the Fieldbus Command Word 2. <ul style="list-style-type: none"> See parameter 0301. | | | | | | | | | | | | | | | | | | | | | | | | | | | | | | | | | | | | | | | | | | | | | | | | | | | | | | |
| | | 0303 | FB STS WORD 1 Read-only copy of the Status Word 1. <ul style="list-style-type: none"> The drive sends status information to the fieldbus controller. The status consists of two Status Words. The control panel displays the word in hex. For example, all zeros and a 1 in Bit 0 displays as 0001. All zeros and a 1 in Bit 15 displays as 8000. | <table border="1"> <thead> <tr> <th>Bit #</th> <th>0303, FB STS WORD 1</th> <th>0304, FB STS WORD 2</th> </tr> </thead> <tbody> <tr><td>0</td><td>READY</td><td>ALARM</td></tr> <tr><td>1</td><td>ENABLED</td><td>NOTICE</td></tr> <tr><td>2</td><td>STARTED</td><td>DIRLOCK</td></tr> <tr><td>3</td><td>RUNNING</td><td>LOCALLOCK</td></tr> <tr><td>4</td><td>ZERO_SPEED</td><td>CTL_MODE</td></tr> <tr><td>5</td><td>ACCELERATE</td><td>Reserved</td></tr> <tr><td>6</td><td>DECELERATE</td><td>Reserved</td></tr> <tr><td>7</td><td>AT_SETPOINT</td><td>CPY_CTL</td></tr> <tr><td>8</td><td>LIMIT</td><td>CPY_REF1</td></tr> <tr><td>9</td><td>SUPERVISION</td><td>CPY_REF2</td></tr> <tr><td>10</td><td>REV_REF</td><td>REQ_CTL</td></tr> <tr><td>11</td><td>REV_ACT</td><td>REQ_REF1</td></tr> <tr><td>12</td><td>PANEL_LOCAL</td><td>REQ_REF2</td></tr> <tr><td>13</td><td>FIELDBUS_LOCAL</td><td>REQ_REF2EXT</td></tr> <tr><td>14</td><td>EXT2_ACT</td><td>ACK_STARTINH</td></tr> <tr><td>15</td><td>FAULT</td><td>ACK_OFF_ILCK</td></tr> </tbody> </table> | Bit # | 0303, FB STS WORD 1 | 0304, FB STS WORD 2 | 0 | READY | ALARM | 1 | ENABLED | NOTICE | 2 | STARTED | DIRLOCK | 3 | RUNNING | LOCALLOCK | 4 | ZERO_SPEED | CTL_MODE | 5 | ACCELERATE | Reserved | 6 | DECELERATE | Reserved | 7 | AT_SETPOINT | CPY_CTL | 8 | LIMIT | CPY_REF1 | 9 | SUPERVISION | CPY_REF2 | 10 | REV_REF | REQ_CTL | 11 | REV_ACT | REQ_REF1 | 12 | PANEL_LOCAL | REQ_REF2 | 13 | FIELDBUS_LOCAL | REQ_REF2EXT | 14 | EXT2_ACT | ACK_STARTINH | 15 | FAULT | ACK_OFF_ILCK |
| | | | | Bit # | 0303, FB STS WORD 1 | 0304, FB STS WORD 2 | | | | | | | | | | | | | | | | | | | | | | | | | | | | | | | | | | | | | | | | | | | | | | | | | |
| | | | | 0 | READY | ALARM | | | | | | | | | | | | | | | | | | | | | | | | | | | | | | | | | | | | | | | | | | | | | | | | | |
| | | | | 1 | ENABLED | NOTICE | | | | | | | | | | | | | | | | | | | | | | | | | | | | | | | | | | | | | | | | | | | | | | | | | |
| | | | | 2 | STARTED | DIRLOCK | | | | | | | | | | | | | | | | | | | | | | | | | | | | | | | | | | | | | | | | | | | | | | | | | |
| | | | | 3 | RUNNING | LOCALLOCK | | | | | | | | | | | | | | | | | | | | | | | | | | | | | | | | | | | | | | | | | | | | | | | | | |
| | | | | 4 | ZERO_SPEED | CTL_MODE | | | | | | | | | | | | | | | | | | | | | | | | | | | | | | | | | | | | | | | | | | | | | | | | | |
| | | | | 5 | ACCELERATE | Reserved | | | | | | | | | | | | | | | | | | | | | | | | | | | | | | | | | | | | | | | | | | | | | | | | | |
| | | | | 6 | DECELERATE | Reserved | | | | | | | | | | | | | | | | | | | | | | | | | | | | | | | | | | | | | | | | | | | | | | | | | |
| | | | | 7 | AT_SETPOINT | CPY_CTL | | | | | | | | | | | | | | | | | | | | | | | | | | | | | | | | | | | | | | | | | | | | | | | | | |
| | | | | 8 | LIMIT | CPY_REF1 | | | | | | | | | | | | | | | | | | | | | | | | | | | | | | | | | | | | | | | | | | | | | | | | | |
| | | | | 9 | SUPERVISION | CPY_REF2 | | | | | | | | | | | | | | | | | | | | | | | | | | | | | | | | | | | | | | | | | | | | | | | | | |
| | | | | 10 | REV_REF | REQ_CTL | | | | | | | | | | | | | | | | | | | | | | | | | | | | | | | | | | | | | | | | | | | | | | | | | |
| | | | | 11 | REV_ACT | REQ_REF1 | | | | | | | | | | | | | | | | | | | | | | | | | | | | | | | | | | | | | | | | | | | | | | | | | |
| 12 | PANEL_LOCAL | | | REQ_REF2 | | | | | | | | | | | | | | | | | | | | | | | | | | | | | | | | | | | | | | | | | | | | | | | | | | | |
| 13 | FIELDBUS_LOCAL | REQ_REF2EXT | | | | | | | | | | | | | | | | | | | | | | | | | | | | | | | | | | | | | | | | | | | | | | | | | | | | | |
| 14 | EXT2_ACT | ACK_STARTINH | | | | | | | | | | | | | | | | | | | | | | | | | | | | | | | | | | | | | | | | | | | | | | | | | | | | | |
| 15 | FAULT | ACK_OFF_ILCK | | | | | | | | | | | | | | | | | | | | | | | | | | | | | | | | | | | | | | | | | | | | | | | | | | | | | |
| 0304 | FB STS WORD 2 Read-only copy of the Status Word 2. <ul style="list-style-type: none"> See parameter 0303. | | | | | | | | | | | | | | | | | | | | | | | | | | | | | | | | | | | | | | | | | | | | | | | | | | | | | | |

| Code | Description | | | | | | |
|------|---|--------------|--|---------------------------|---------------------------|-----------------|--------------|
| 0305 | FAULT WORD 1 Read-only copy of the Fault Word 1. <ul style="list-style-type: none"> When a fault is active, the corresponding bit for the active fault is set in the Fault Words. Each fault has a dedicated bit allocated within Fault Words. See section Fault listing on page 274 for a description of the faults. The control panel displays the word in hex. For example, all zeros and a 1 in Bit 0 displays as 0001. All zeros and a 1 in Bit 15 displays as 8000. | Bit # | 0305, FAULT WORD 1 | 0306, FAULT WORD 2 | 0307, FAULT WORD 3 | | |
| | | 0 | OVERCURRENT | Obsolete | EFB 1 | | |
| | | 1 | DC OVERVOLT | THERM FAIL | EFB 2 | | |
| | | 2 | DEV OVERTEMP | OPEX LINK | EFB 3 | | |
| | | 3 | SHORT CIRC | OPEX PWR | INCOMPATIBLE SW | | |
| | | 4 | Reserved | CURR MEAS | USER LOAD CURVE | | |
| | | 5 | DC UNDERVOLT | SUPPLY PHASE | Reserved | | |
| | | 6 | AI1 LOSS | ENCODER ERR | Reserved | | |
| | | 7 | AI2 LOSS | OVERSPEED | Reserved | | |
| | | 0306 | FAULT WORD 2 Read-only copy of the Fault Word 2. <ul style="list-style-type: none"> See parameter 0305. | 8 | MOT OVERTEMP | Reserved | Reserved |
| | | | | 9 | PANEL LOSS | DRIVE ID | Reserved |
| | | 0307 | FAULT WORD 3 Read-only copy of the Fault Word 3. <ul style="list-style-type: none"> See parameter 0305. | 10 | ID RUN FAIL | CONFIG FILE | System error |
| | | | | 11 | MOTOR STALL | SERIAL 1 ERR | System error |
| | | | | 12 | CB OVERTEMP | EFB CON FILE | System error |
| | | | | 13 | EXT FAULT 1 | FORCE TRIP | System error |
| | | | | 14 | EXT FAULT 2 | MOTOR PHASE | System error |
| 15 | EARTH FAULT | | | OUTP WIRING | Param. setting fault | | |
| 0308 | ALARM WORD 1 <ul style="list-style-type: none"> When an alarm is active, the corresponding bit for the active alarm is set in the Alarm Words. Each alarm has a dedicated bit allocated within Alarm Words. Bits remain set until the whole alarm word is reset. (Reset by writing zero to the word.) The control panel displays the word in hex. For example, all zeros and a 1 in Bit 0 displays as 0001. All zeros and a 1 in Bit 15 displays as 8000. | Bit # | 0308, ALARM WORD 1 | 0309, ALARM WORD 2 | | | |
| | | 0 | OVERCURRENT | Reserved | | | |
| | | 1 | OVERVOLTAGE | PID SLEEP | | | |
| | | 2 | UNDERVOLTAGE | ID RUN | | | |
| | | 3 | DIR LOCK | Reserved | | | |
| | | 4 | IO COMM | START ENABLE 1 MISSING | | | |
| | | 5 | AI1 LOSS | START ENABLE 2 MISSING | | | |
| | | 6 | AI2 LOSS | EMERGENCY STOP | | | |
| | | 7 | PANEL LOSS | ENCODER ERROR | | | |
| | | 0309 | ALARM WORD 2 See parameter 0308. | 8 | DEVICE OVERTEMP | FIRST START | |
| | | | | 9 | MOTOR TEMP | Reserved | |
| | | | | 10 | Reserved | USER LOAD CURVE | |
| | | | | 11 | MOTOR STALL | START DELAY | |
| | | | | 12 | AUTORESET | Reserved | |
| | | | | 13 | AUTOCHANGE | Reserved | |
| | | | | 14 | PFC I LOCK | Reserved | |
| 15 | Reserved | | | Reserved | | | |

Group 04: FAULT HISTORY

This group stores a recent history of the faults reported by the drive.

| Code | Description |
|------|---|
| 0401 | LAST FAULT 0 – Clear the fault history (on panel = NO RECORD). n – Fault code of the last recorded fault. The fault code is displayed as a name. See section Fault listing on page 274 for the fault codes and names. The fault name shown for this parameter may be shorter than the corresponding name in the fault listing, which shows the names as they are shown in the fault display. |
| 0402 | FAULT TIME 1 The day on which the last fault occurred. Either as: <ul style="list-style-type: none"> • A date – if real time clock is operating. • The number of days after power on – if real time clock is not used, or was not set. |
| 0403 | FAULT TIME 2 The time at which the last fault occurred. Either as: <ul style="list-style-type: none"> • Real time, in format hh:mm:ss – if real time clock is operating. • The time since power on (minus the whole days reported in 0402), in format hh:mm:ss – if real time clock is not used, or was not set. • Format on the Basic Control Panel: The time since power on in 2-second ticks (minus the whole days reported in 0402). 30 ticks = 60 seconds. E.g. Value 514 equals 17 minutes and 8 seconds (= 514/30). |
| 0404 | SPEED AT FLT The motor speed (rpm) at the time the last fault occurred. |
| 0405 | FREQ AT FLT The frequency (Hz) at the time the last fault occurred. |
| 0406 | VOLTAGE AT FLT The DC bus voltage (V) at the time the last fault occurred. |
| 0407 | CURRENT AT FLT The motor current (A) at the time the last fault occurred. |
| 0408 | TORQUE AT FLT The motor torque (%) at the time the last fault occurred. |
| 0409 | STATUS AT FLT The drive status (hex code word) at the time the last fault occurred. |
| 0410 | DI 1-3 AT FLT The status of digital inputs 1...3 at the time the last fault occurred. |
| 0411 | DI 4-6 AT FLT The status of digital inputs 4...6 at the time the last fault occurred. |
| 0412 | PREVIOUS FAULT 1 Fault code of the second last fault. Read-only. |
| 0413 | PREVIOUS FAULT 2 Fault code of the third last fault. Read-only. |

Group 10: START/STOP/DIR

This group:

- defines external sources (EXT1 and EXT2) for commands that enable start, stop and direction changes
- locks direction or enables direction control.

To select between the two external locations use the next group (parameter 1102).

| Code | Description |
|------|--|
| 1001 | <p>EXT1 COMMANDS</p> <p>Defines external control location 1 (EXT1) – the configuration of start, stop and direction commands. 0 = NOT SEL – No external start, stop and direction command source.</p> <p>1 = DI1 – Two-wire Start/Stop.</p> <ul style="list-style-type: none"> • Start/Stop is through digital input DI1 (DI1 activated = Start; DI1 de-activated = Stop). • Parameter 1003 defines the direction. Selecting 1003 = 3 (REQUEST) is the same as 1003 = 1 (FORWARD). <p>2 = DI1,2 – Two-wire Start/Stop, Direction.</p> <ul style="list-style-type: none"> • Start/Stop is through digital input DI1 (DI1 activated = Start; DI1 de-activated = Stop). • Direction control [requires parameter 1003 = 3 (REQUEST)] is through digital input DI2 (DI2 activated = Reverse; de-activated = Forward). <p>3 = DI1P,2P – Three-wire Start/Stop.</p> <ul style="list-style-type: none"> • Start/Stop commands are through momentary push-buttons (the P stands for “pulse”). • Start is through a normally open push-button connected to digital input DI1. In order to start the drive, the digital input DI2 must be activated prior to the pulse in DI1. • Connect multiple Start push-buttons in parallel. • Stop is through a normally closed push-button connected to digital input DI2. • Connect multiple Stop push-buttons in series. • Parameter 1003 defines the direction. Selecting 1003 = 3 (REQUEST) is the same as 1003 = 1 (FORWARD). <p>4 = DI1P,2P,3 – Three-wire Start/Stop, Direction.</p> <ul style="list-style-type: none"> • Start/Stop commands are through momentary push-buttons, as described for DI1P,2P. • Direction control [requires parameter 1003 = 3 (REQUEST)] is through digital input DI3 (DI3 activated = Reverse; de-activated = Forward). <p>5 = DI1P,2P,3P – Start Forward, Start Reverse and Stop.</p> <ul style="list-style-type: none"> • Start and Direction commands are given simultaneously with two separate momentary push-buttons (the P stands for “pulse”). • Start Forward command is through a normally open push-button connected to digital input DI1. In order to start the drive, the digital input DI3 must be activated prior to the pulse in DI1. • Start Reverse command is through a normally open push-button connected to digital input DI2. In order to start the drive, the digital input DI3 must be activated during the pulse in DI2. • Connect multiple Start push-buttons in parallel. • Stop is through a normally closed push-button connected to digital input DI3. • Connect multiple Stop push-buttons in series. • Requires parameter 1003 = 3 (REQUEST). <p>6 = DI6 – Two-wire Start/Stop.</p> <ul style="list-style-type: none"> • Start/Stop is through digital input DI6 (DI6 activated = Start; DI6 de-activated = Stop). • Parameter 1003 defines the direction. Selecting 1003 = 3 (REQUEST) is the same as 1003 = 1 (FORWARD). <p>7 = DI6,5 – Two-wire Start/Stop/Direction.</p> <ul style="list-style-type: none"> • Start/Stop is through digital input DI6 (DI6 activated = Start; DI6 de-activated = Stop). • Direction control [requires parameter 1003 = 3 (REQUEST)] is through digital input DI5. (DI5 activated = Reverse; de-activated = Forward). <p>8 = KEYPAD – Control Panel.</p> <ul style="list-style-type: none"> • Start/Stop and Direction commands are through the control panel when EXT1 is active. • Direction control requires parameter 1003 = 3 (REQUEST). <p>9 = DI1F,2R – Start/Stop/Direction commands through DI1 and DI2 combinations.</p> <ul style="list-style-type: none"> • Start forward = DI1 activated and DI2 de-activated. • Start reverse = DI1 de-activated and DI2 activated. • Stop = both DI1 and DI2 activated, or both de-activated. • Requires parameter 1003 = 3 (REQUEST). <p>10 = COMM – Assigns the fieldbus Command Word as the source for the start/stop and direction commands.</p> <ul style="list-style-type: none"> • Bits 0,1, 2 of Command Word 1 (parameter 0301) activates the start/stop and direction commands. • See Fieldbus user's manual for detailed instructions. |

| Code | Description |
|------|--|
| | 11 = TIMED FUNC 1. – Assigns Start/Stop control to Timed Function 1 (Timed Function activated = START; Timed Function de-activated = STOP). See Group 36: TIMED FUNCTIONS . 12...14 = TIMED FUNC 2...4 – Assigns Start/Stop control to Timed Function 2...4. See TIMED FUNC 1 above. |
| 1002 | EXT2 COMMANDS Defines external control location 2 (EXT2) – the configuration of start, stop and direction commands. • See parameter 1001 EXT1 COMMANDS above. |
| 1003 | DIRECTION Defines the control of motor rotation direction. 1 = FORWARD – Rotation is fixed in the forward direction. 2 = REVERSE – Rotation is fixed in the reverse direction. 3 = REQUEST – Rotation direction can be changed on command. |
| 1004 | JOGGING SEL Defines the signal that activates the jogging function. Jogging uses Constant Speed 7 (parameter 1208) for speed reference and ramp pair 2 (parameters 2205 and 2206) for accelerating and decelerating. When the jogging activation signal is lost, the drive uses ramp stop to decelerate to zero speed, even if coast stop is used in normal operation (parameter 2102). The jogging status can be parameterized to relay outputs (parameter 1401). The jogging status is also seen in DCU Profile status bit 21. 0 = NOT SEL – Disables the jogging function. 1 = DI1 – Activates/de-activates jogging based on the state of DI1 (DI1 activated = jogging active; DI1 de-activated = jogging inactive). 2...6 = DI2...DI6 – Activates jogging based on the state of the selected digital input. See DI1 above. -1 = DI1(INV) – Activates jogging based on the state of DI1 (DI1 activated = jogging inactive; DI1 de-activated = jogging active). -2...-6 = DI2(INV)...DI6(INV) – Activates jogging based on the state of the selected digital input. See DI1(INV) above. |

Group 11: REFERENCE SELECT

This group defines:

- how the drive selects between command sources
- characteristics and sources for REF1 and REF2.

| Code | Description |
|------|---|
| 1101 | <p>KEYPAD REF SEL</p> <p>Selects the reference controlled in local control mode.</p> <p>1 = REF1(Hz/rpm) – Reference type depends on parameter 9904 MOTOR CTRL MODE.</p> <ul style="list-style-type: none"> • Speed reference (rpm) if 9904 = 1 (VECTOR:SPEED) or 2 (VECTOR:TORQ). • Frequency reference (Hz) if 9904 = 3 (SCALAR:FREQ). <p>2 = REF2(%)</p> |
| 1102 | <p>EXT1/EXT2 SEL</p> <p>Defines the source for selecting between the two external control locations EXT1 or EXT2. Thus, defines the source for Start/Stop/Direction commands and reference signals.</p> <p>0 = EXT1 – Selects external control location 1 (EXT1).</p> <ul style="list-style-type: none"> • See parameter 1001 EXT1 COMMANDS for EXT1's Start/Stop/Dir definitions. • See parameter 1103 REF1 SELECT for EXT1's reference definitions. <p>1 = DI1 – Assigns control to EXT1 or EXT2 based on the state of DI1 (DI1 activated = EXT2; DI1 de-activated = EXT1).</p> <p>2...6 = DI2...DI6 – Assigns control to EXT1 or EXT2 based on the state of the selected digital input. See DI1 above.</p> <p>7 = EXT2 – Selects external control location 2 (EXT2).</p> <ul style="list-style-type: none"> • See parameter 1002 EXT2 COMMANDS for EXT2's Start/Stop/Dir definitions. • See parameter 1106 REF2 SELECT for EXT2's reference definitions. <p>8 = COMM – Assigns control of the drive via external control location EXT1 or EXT2 based on the fieldbus control word.</p> <ul style="list-style-type: none"> • Bit 5 of the Command Word 1 (parameter 0301) defines the active external control location (EXT1 or EXT2). • See Fieldbus user's manual for detailed instructions. <p>9 = TIMED FUNC 1 – Assigns control to EXT1 or EXT2 based on the state of the Timed Function (Timed Function activated = EXT2; Timed Function de-activated = EXT1). See Group 36: TIMED FUNCTIONS.</p> <p>10...12 = TIMED FUNC 2...4 – Assigns control to EXT1 or EXT2 based on the state of the Timed Function. See TIMED FUNC 1 above.</p> <p>-1 = DI1(INV) – Assigns control to EXT1 or EXT2 based on the state of DI1 (DI1 activated = EXT1; DI1 de-activated = EXT2).</p> <p>-2...-6 = DI2(INV)...DI6(INV) – Assigns control to EXT1 or EXT2 based on the state of the selected digital input. See DI1(INV) above.</p> |
| 1103 | <p>REF1 SELECT</p> <p>Selects the signal source for external reference REF1.</p> <p>0 = KEYPAD – Defines the control panel as the reference source.</p> <p>1 = AI1 – Defines analog input 1 (AI1) as the reference source.</p> <p>2 = AI2 – Defines analog input 2 (AI2) as the reference source.</p> <p>3 = AI1/JOYST – Defines analog input 1 (AI1), configured for joystick operation, as the reference source.</p> <ul style="list-style-type: none"> • The minimum input signal runs the drive at the maximum reference in the reverse direction. Define the minimum using parameter 1104. • The maximum input signal runs the drive at maximum reference in the forward direction. Define the maximum using parameter 1105. • Requires parameter 1003 = 3 (REQUEST). <p>⚠ WARNING! Because the low end of the reference range commands full reverse operation, do not use 0 V as the lower end of the reference range. Doing so means that if the control signal is lost (which is a 0 V input) the result is full reverse operation. Instead, use the following set-up so that loss of the analog input triggers a fault, stopping the drive:</p> <ul style="list-style-type: none"> • Set parameter 1301 MINIMUM AI1 (1304 MINIMUM AI2) at 20% (2 V or 4 mA). • Set parameter 3021 AI1 FAULT LIMIT to a value 5% or higher. • Set parameter 3001 AI<MIN FUNCTION to 1 (FAULT). <p>4 = AI2/JOYST – Defines analog input 2 (AI2), configured for joystick operation, as the reference source.</p> <ul style="list-style-type: none"> • See above (AI1/JOYST) description. |

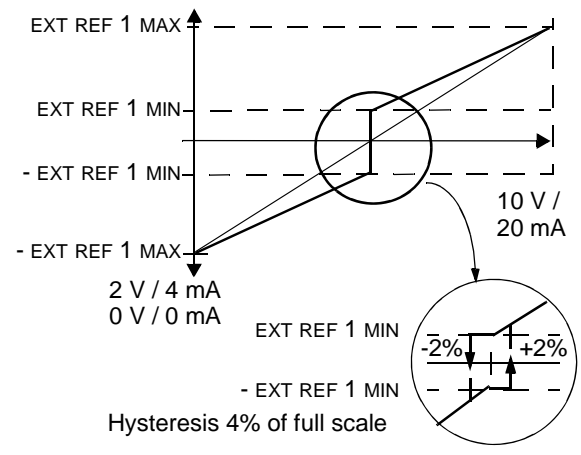

| Code | Description | | | | | | | | | | |
|---------------|---|---------------|---------------------------------|-------|--|-------|--|-------|--|-------|--|
| | <p>5 = DI3U,4D(R) – Defines digital inputs as the speed reference source (motor potentiometer control).</p> <ul style="list-style-type: none"> • Digital input DI3 increases the speed (the U stands for “up”). • Digital input DI4 decreases the speed (the D stands for “down”). • A Stop command resets the reference to zero (the R stands for “reset”). • Parameter 2205 ACCELER TIME 2 controls the reference signal's rate of change. <p>6 = DI3U,4D – Same as above (DI3U,4D(R)), except:</p> <ul style="list-style-type: none"> • A Stop command does not reset the reference to zero. The reference is stored. • When the drive restarts, the motor ramps up (at the selected acceleration rate) to the stored reference. <p>7 = DI5U,6D – Same as above (DI3U,4D), except that DI5 and DI6 are the digital inputs used.</p> <p>8 = COMM – Defines the fieldbus as the reference source.</p> <p>9 = COMM+AI1 – Defines a fieldbus and analog input 1 (AI1) combination as the reference source. See Analog input reference correction below.</p> <p>10 = COMM*AI1 – Defines a fieldbus and analog input 1 (AI1) combination as the reference source. See Analog input reference correction below.</p> <p>11 = DI3U,4D(RNC) – Same as DI3U,4D(R) above, except that:</p> <ul style="list-style-type: none"> • Changing the control source (EXT1 to EXT2, EXT2 to EXT1, LOC to REM) does not copy the reference. <p>12 = DI3U,4D(NC) – Same as DI3U,4D above, except that:</p> <ul style="list-style-type: none"> • Changing the control source (EXT1 to EXT2, EXT2 to EXT1, LOC to REM) does not copy the reference. <p>13 = DI5U,6D(NC) – Same as DI5U,6D above, except that:</p> <ul style="list-style-type: none"> • Changing the control source (EXT1 to EXT2, EXT2 to EXT1, LOC to REM) does not copy the reference. <p>14 = AI1+AI2 – Defines an analog input 1 (AI1) and analog input 2 (AI2) combination as the reference source. See Analog input reference correction below.</p> <p>15 = AI1*AI2 – Defines an analog input 1 (AI1) and analog input 2 (AI2) combination as the reference source. See Analog input reference correction below.</p> <p>16 = AI1-AI2 – Defines an analog input 1 (AI1) and analog input 2 (AI2) combination as the reference source. See Analog input reference correction below.</p> <p>17 = AI1/AI2 – Defines an analog input 1 (AI1) and analog input 2 (AI2) combination as the reference source. See Analog input reference correction below.</p> <p>20 = KEYPAD(RNC) – Defines the control panel as the reference source.</p> <ul style="list-style-type: none"> • A Stop command resets the reference to zero (the R stands for reset.). • Changing the control source (EXT1 to EXT2, EXT2 to EXT1) does not copy the reference. <p>21 = KEYPAD(NC) – Defines the control panel as the reference source.</p> <ul style="list-style-type: none"> • A Stop command does not reset the reference to zero. The reference is stored. • Changing the control source (EXT1 to EXT2, EXT2 to EXT1) does not copy the reference. | | | | | | | | | | |
| | <p>Analog input reference correction Parameter values 9, 10 and 14...17 use the formula in the following table.</p> <table border="1" style="width: 100%; border-collapse: collapse;"> <thead> <tr> <th style="background-color: #e0e0e0;">Value setting</th> <th style="background-color: #e0e0e0;">Calculation of the AI reference</th> </tr> </thead> <tbody> <tr> <td>C + B</td> <td>C value + (B value - 50% of reference value)</td> </tr> <tr> <td>C * B</td> <td>C value * (B value / 50% of reference value)</td> </tr> <tr> <td>C - B</td> <td>(C value + 50% of reference value) - B value</td> </tr> <tr> <td>C / B</td> <td>(C value * 50% of reference value) / B value</td> </tr> </tbody> </table> <p>Where:</p> <ul style="list-style-type: none"> • C = Main reference value (= COMM for values 9, 10 and = AI1 for values 14...17). • B = Correcting reference (= AI1 for values 9, 10 and = AI2 for values 14...17). <p>Example: The figure shows the reference source curves for value settings 9, 10 and 14...17, where:</p> <ul style="list-style-type: none"> • C = 25%. • P 4012 SETPOINT MIN = 0. • P 4013 SETPOINT MAX = 0. • B varies along the horizontal axis. | Value setting | Calculation of the AI reference | C + B | C value + (B value - 50% of reference value) | C * B | C value * (B value / 50% of reference value) | C - B | (C value + 50% of reference value) - B value | C / B | (C value * 50% of reference value) / B value |
| Value setting | Calculation of the AI reference | | | | | | | | | | |
| C + B | C value + (B value - 50% of reference value) | | | | | | | | | | |
| C * B | C value * (B value / 50% of reference value) | | | | | | | | | | |
| C - B | (C value + 50% of reference value) - B value | | | | | | | | | | |
| C / B | (C value * 50% of reference value) / B value | | | | | | | | | | |
| | | | | | | | | | | | |

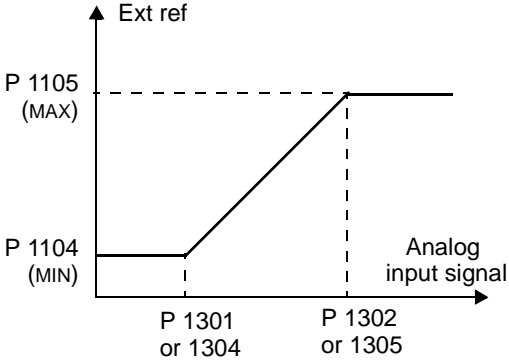
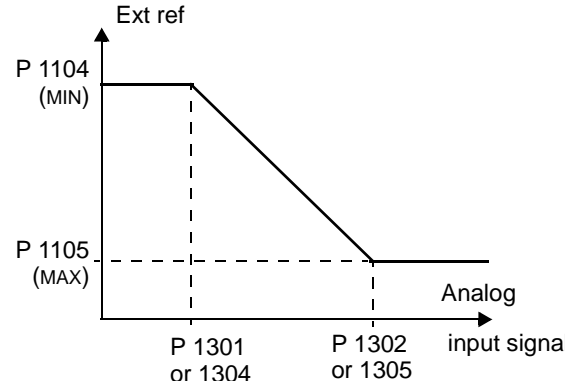
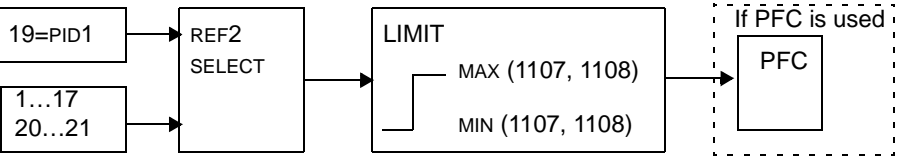
| Code | Description | |
|------|---|--|
| 1104 | <p>REF1 MIN</p> <p>Sets the minimum for external reference 1.</p> <ul style="list-style-type: none"> The minimum analog input signal (as a percent of the full signal in volts or amperes) corresponds to REF1 MIN in Hz/rpm. Parameter 1301 MINIMUM AI1 or 1304 MINIMUM AI2 sets the minimum analog input signal. These parameters (reference and analog min. and max. settings) provide scale and offset adjustment for the reference. |  |
| 1105 | <p>REF1 MAX</p> <p>Sets the maximum for external reference 1.</p> <ul style="list-style-type: none"> The maximum analog input signal (as a percent of full the signal in volts or amperes) corresponds to REF1 MAX in Hz/rpm. Parameter 1302 MAXIMUM AI1 or 1305 MAXIMUM AI2 sets the maximum analog input signal. |  |
| 1106 | <p>REF2 SELECT</p> <p>Selects the signal source for external reference REF2.</p> <p>0...17 – Same as for parameter 1103 REF1 SELECT.</p> <p>19 = PID1OUT – The reference is taken from the PID1 output. See Group 40: PROCESS PID SET 1 and Group 41: PROCESS PID SET 2.</p> <p>20...21 – Same as for parameter 1103 REF1 SELECT.</p> |  |
| 1107 | <p>REF2 MIN</p> <p>Sets the minimum for external reference 2.</p> <ul style="list-style-type: none"> The minimum analog input signal (in volts or amperes) corresponds to REF2 MIN in %. Parameter 1301 MINIMUM AI1 or 1304 MINIMUM AI2 sets the minimum analog input signal. This parameter sets the minimum frequency reference. The value is a percentage of the: <ul style="list-style-type: none"> – maximum frequency or speed – maximum process reference – nominal torque. | |
| 1108 | <p>REF2 MAX</p> <p>Sets the maximum for external reference 2.</p> <ul style="list-style-type: none"> The maximum analog input signal (in volts or amperes) corresponds to REF2 MAX in %. Parameter 1302 MAXIMUM AI1 or 1305 MAXIMUM AI2 sets the maximum analog input signal. This parameter sets the maximum frequency reference. The value is a percentage of the: <ul style="list-style-type: none"> – maximum frequency or speed – maximum process reference – nominal torque. | |

Group 12: CONSTANT SPEEDS

This group defines a set of constant speeds. In general:

- You can program up to 7 constant speeds, ranging from 0...500 Hz or 0...30000 rpm.
- Values must be positive (No negative speed values for constant speeds).
- Constant speed selections are ignored if:
 - the torque control is active, or
 - the process PID reference is followed, or
 - the drive is in local control mode, or
 - PFC (Pump-Fan Control) is active.

Note: Parameter 1208 CONST SPEED 7 acts also as a so-called fault speed which may be activated if the control signal is lost. For example, see parameters 3001 AI<MIN FUNCTION, 3002 PANEL COMM ERR and 3018 COMM FAULT FUNC.

| Code | Description | | | | | | | | | | | | | | | | | | | | | | | | | | | | | | | | | | | | | | | | | | | | | | | | | | | |
|------|--|-------------------------|-------------------------|----------|---|---|-------------------|---|---|-------------------------|---|---|-------------------------|---|---|-------------------------|-----|-----|-----|----------|---|---|---|-------------------|---|---|---|-------------------------|---|---|---|-------------------------|---|---|---|-------------------------|---|---|---|-------------------------|---|---|---|-------------------------|---|---|---|-------------------------|---|---|---|-------------------------|
| 1201 | <p>CONST SPEED SEL Defines the digital inputs used to select Constant Speeds. See general comments in introduction. 0 = NOT SEL – Disables the constant speed function. 1 = DI1 – Selects Constant Speed 1 with digital input DI1. • Digital input activated = Constant Speed 1 activated. 2...6 = DI2...DI6 – Selects Constant Speed 1 with digital input DI2...DI6. See above. 7 = DI1,2 – Selects one of three Constant Speeds (1...3) using DI1 and DI2. • Uses two digital inputs, as defined below (0 = DI de-activated, 1 = DI activated):</p> <table border="1"> <thead> <tr> <th>DI1</th> <th>DI2</th> <th>Function</th> </tr> </thead> <tbody> <tr> <td>0</td> <td>0</td> <td>No constant speed</td> </tr> <tr> <td>1</td> <td>0</td> <td>Constant speed 1 (1202)</td> </tr> <tr> <td>0</td> <td>1</td> <td>Constant speed 2 (1203)</td> </tr> <tr> <td>1</td> <td>1</td> <td>Constant speed 3 (1204)</td> </tr> </tbody> </table> <p>• Can be set up as a so-called fault speed, which is activated if the control signal is lost. Refer to parameter 3001 AI<MIN function and parameter 3002 PANEL COMM ERR. 8 = DI2,3 – Selects one of three Constant Speeds (1...3) using DI2 and DI3. • See above (DI1,2) for code. 9 = DI3,4 – Selects one of three Constant Speeds (1...3) using DI3 and DI4. • See above (DI1,2) for code. 10 = DI4,5 – Selects one of three Constant Speeds (1...3) using DI4 and DI5. • See above (DI1,2) for code. 11 = DI5,6 – Selects one of three Constant Speeds (1...3) using DI5 and DI6. • See above (DI1,2) for code. 12 = DI1,2,3 – Selects one of seven Constant Speeds (1...7) using DI1, DI2 and DI3. • Uses three digital inputs, as defined below (0 = DI de-activated, 1 = DI activated):</p> <table border="1"> <thead> <tr> <th>DI1</th> <th>DI2</th> <th>DI3</th> <th>Function</th> </tr> </thead> <tbody> <tr> <td>0</td> <td>0</td> <td>0</td> <td>No constant speed</td> </tr> <tr> <td>1</td> <td>0</td> <td>0</td> <td>Constant speed 1 (1202)</td> </tr> <tr> <td>0</td> <td>1</td> <td>0</td> <td>Constant speed 2 (1203)</td> </tr> <tr> <td>1</td> <td>1</td> <td>0</td> <td>Constant speed 3 (1204)</td> </tr> <tr> <td>0</td> <td>0</td> <td>1</td> <td>Constant speed 4 (1205)</td> </tr> <tr> <td>1</td> <td>0</td> <td>1</td> <td>Constant speed 5 (1206)</td> </tr> <tr> <td>0</td> <td>1</td> <td>1</td> <td>Constant speed 6 (1207)</td> </tr> <tr> <td>1</td> <td>1</td> <td>1</td> <td>Constant speed 7 (1208)</td> </tr> </tbody> </table> | DI1 | DI2 | Function | 0 | 0 | No constant speed | 1 | 0 | Constant speed 1 (1202) | 0 | 1 | Constant speed 2 (1203) | 1 | 1 | Constant speed 3 (1204) | DI1 | DI2 | DI3 | Function | 0 | 0 | 0 | No constant speed | 1 | 0 | 0 | Constant speed 1 (1202) | 0 | 1 | 0 | Constant speed 2 (1203) | 1 | 1 | 0 | Constant speed 3 (1204) | 0 | 0 | 1 | Constant speed 4 (1205) | 1 | 0 | 1 | Constant speed 5 (1206) | 0 | 1 | 1 | Constant speed 6 (1207) | 1 | 1 | 1 | Constant speed 7 (1208) |
| DI1 | DI2 | Function | | | | | | | | | | | | | | | | | | | | | | | | | | | | | | | | | | | | | | | | | | | | | | | | | | |
| 0 | 0 | No constant speed | | | | | | | | | | | | | | | | | | | | | | | | | | | | | | | | | | | | | | | | | | | | | | | | | | |
| 1 | 0 | Constant speed 1 (1202) | | | | | | | | | | | | | | | | | | | | | | | | | | | | | | | | | | | | | | | | | | | | | | | | | | |
| 0 | 1 | Constant speed 2 (1203) | | | | | | | | | | | | | | | | | | | | | | | | | | | | | | | | | | | | | | | | | | | | | | | | | | |
| 1 | 1 | Constant speed 3 (1204) | | | | | | | | | | | | | | | | | | | | | | | | | | | | | | | | | | | | | | | | | | | | | | | | | | |
| DI1 | DI2 | DI3 | Function | | | | | | | | | | | | | | | | | | | | | | | | | | | | | | | | | | | | | | | | | | | | | | | | | |
| 0 | 0 | 0 | No constant speed | | | | | | | | | | | | | | | | | | | | | | | | | | | | | | | | | | | | | | | | | | | | | | | | | |
| 1 | 0 | 0 | Constant speed 1 (1202) | | | | | | | | | | | | | | | | | | | | | | | | | | | | | | | | | | | | | | | | | | | | | | | | | |
| 0 | 1 | 0 | Constant speed 2 (1203) | | | | | | | | | | | | | | | | | | | | | | | | | | | | | | | | | | | | | | | | | | | | | | | | | |
| 1 | 1 | 0 | Constant speed 3 (1204) | | | | | | | | | | | | | | | | | | | | | | | | | | | | | | | | | | | | | | | | | | | | | | | | | |
| 0 | 0 | 1 | Constant speed 4 (1205) | | | | | | | | | | | | | | | | | | | | | | | | | | | | | | | | | | | | | | | | | | | | | | | | | |
| 1 | 0 | 1 | Constant speed 5 (1206) | | | | | | | | | | | | | | | | | | | | | | | | | | | | | | | | | | | | | | | | | | | | | | | | | |
| 0 | 1 | 1 | Constant speed 6 (1207) | | | | | | | | | | | | | | | | | | | | | | | | | | | | | | | | | | | | | | | | | | | | | | | | | |
| 1 | 1 | 1 | Constant speed 7 (1208) | | | | | | | | | | | | | | | | | | | | | | | | | | | | | | | | | | | | | | | | | | | | | | | | | |

| Code | Description | | | | | | | | | | | | | | | | | | | | | | | | | | | | | | | | | | | | | | | | | | | | | | | | | | | |
|------|---|-------------------------|-------------------------|----------|---|---|-------------------|---|---|-------------------------|---|---|-------------------------|---|---|-------------------------|-----|-----|-----|----------|---|---|---|-------------------|---|---|---|-------------------------|---|---|---|-------------------------|---|---|---|-------------------------|---|---|---|-------------------------|---|---|---|-------------------------|---|---|---|-------------------------|---|---|---|-------------------------|
| | <p>13 = DI3,4,5 – Selects one of seven Constant Speeds (1...7) using DI3, DI4 and DI5. <ul style="list-style-type: none"> • See above (DI1,2,3) for code. </p> <p>14 = DI4,5,6 – Selects one of seven Constant Speeds (1...7) using DI4, DI5 and DI6. <ul style="list-style-type: none"> • See above (DI1,2,3) for code. </p> <p>15...18 = TIMED FUNC 1...4 – Selects Constant Speed 1 when Timed Function is active. See Group 36: TIMED FUNCTIONS.</p> <p>19 = TIMED FUN1&2 – Selects a constant speed depending on the state of Timed Functions 1 & 2. See parameter 1209.</p> <p>-1 = DI1(INV) – Selects Constant Speed 1 with digital input DI1. <ul style="list-style-type: none"> • Inverse operation: Digital input de-activated = Constant Speed 1 activated. </p> <p>-2...-6 = DI2(INV)...DI6(INV) – Selects Constant Speed 1 with digital input. See above.</p> <p>-7 = DI1,2(INV) – Selects one of three Constant Speeds (1...3) using DI1 and DI2. <ul style="list-style-type: none"> • Inverse operation uses two digital inputs, as defined below (0 = DI de-activated, 1 = DI activated): <table border="1" data-bbox="277 583 686 737"> <thead> <tr> <th>DI1</th> <th>DI2</th> <th>Function</th> </tr> </thead> <tbody> <tr> <td>1</td> <td>1</td> <td>No constant speed</td> </tr> <tr> <td>0</td> <td>1</td> <td>Constant speed 1 (1202)</td> </tr> <tr> <td>1</td> <td>0</td> <td>Constant speed 2 (1203)</td> </tr> <tr> <td>0</td> <td>0</td> <td>Constant speed 3 (1204)</td> </tr> </tbody> </table> </p> <p>-8 = DI2,3(INV) – Selects one of three Constant Speeds (1...3) using DI2 and DI3. <ul style="list-style-type: none"> • See above (DI1,2(INV)) for code. </p> <p>-9 = DI3,4(INV) – Selects one of three Constant Speeds (1...3) using DI3 and DI4. <ul style="list-style-type: none"> • See above (DI1,2(INV)) for code. </p> <p>-10 = DI4,5(INV) – Selects one of three Constant Speeds (1...3) using DI4 and DI5. <ul style="list-style-type: none"> • See above (DI1,2(INV)) for code. </p> <p>-11 = DI5,6(INV) – Selects one of three Constant Speeds (1...3) using DI5 and DI6. <ul style="list-style-type: none"> • See above (DI1,2(INV)) for code. </p> <p>-12 = DI1,2,3(INV) – Selects one of seven Constant Speeds (1...7) using DI1, DI2 and DI3. <ul style="list-style-type: none"> • Inverse operation uses three digital inputs, as defined below (0 = DI de-activated, 1 = DI activated): <table border="1" data-bbox="277 1035 734 1310"> <thead> <tr> <th>DI1</th> <th>DI2</th> <th>DI3</th> <th>Function</th> </tr> </thead> <tbody> <tr> <td>1</td> <td>1</td> <td>1</td> <td>No constant speed</td> </tr> <tr> <td>0</td> <td>1</td> <td>1</td> <td>Constant speed 1 (1202)</td> </tr> <tr> <td>1</td> <td>0</td> <td>1</td> <td>Constant speed 2 (1203)</td> </tr> <tr> <td>0</td> <td>0</td> <td>1</td> <td>Constant speed 3 (1204)</td> </tr> <tr> <td>1</td> <td>1</td> <td>0</td> <td>Constant speed 4 (1205)</td> </tr> <tr> <td>0</td> <td>1</td> <td>0</td> <td>Constant speed 5 (1206)</td> </tr> <tr> <td>1</td> <td>0</td> <td>0</td> <td>Constant speed 6 (1207)</td> </tr> <tr> <td>0</td> <td>0</td> <td>0</td> <td>Constant speed 7 (1208)</td> </tr> </tbody> </table> </p> <p>-13 = DI3,4,5(INV) – Selects one of seven Constant Speeds (1...7) using DI3, DI4 and DI5. <ul style="list-style-type: none"> • See above (DI1,2,3(INV)) for code. </p> <p>-14 = DI4,5,6(INV) – Selects one of seven Constant Speeds (1...7) using DI4, DI5 and DI6. <ul style="list-style-type: none"> • See above (DI1,2,3(INV)) for code. </p> | DI1 | DI2 | Function | 1 | 1 | No constant speed | 0 | 1 | Constant speed 1 (1202) | 1 | 0 | Constant speed 2 (1203) | 0 | 0 | Constant speed 3 (1204) | DI1 | DI2 | DI3 | Function | 1 | 1 | 1 | No constant speed | 0 | 1 | 1 | Constant speed 1 (1202) | 1 | 0 | 1 | Constant speed 2 (1203) | 0 | 0 | 1 | Constant speed 3 (1204) | 1 | 1 | 0 | Constant speed 4 (1205) | 0 | 1 | 0 | Constant speed 5 (1206) | 1 | 0 | 0 | Constant speed 6 (1207) | 0 | 0 | 0 | Constant speed 7 (1208) |
| DI1 | DI2 | Function | | | | | | | | | | | | | | | | | | | | | | | | | | | | | | | | | | | | | | | | | | | | | | | | | | |
| 1 | 1 | No constant speed | | | | | | | | | | | | | | | | | | | | | | | | | | | | | | | | | | | | | | | | | | | | | | | | | | |
| 0 | 1 | Constant speed 1 (1202) | | | | | | | | | | | | | | | | | | | | | | | | | | | | | | | | | | | | | | | | | | | | | | | | | | |
| 1 | 0 | Constant speed 2 (1203) | | | | | | | | | | | | | | | | | | | | | | | | | | | | | | | | | | | | | | | | | | | | | | | | | | |
| 0 | 0 | Constant speed 3 (1204) | | | | | | | | | | | | | | | | | | | | | | | | | | | | | | | | | | | | | | | | | | | | | | | | | | |
| DI1 | DI2 | DI3 | Function | | | | | | | | | | | | | | | | | | | | | | | | | | | | | | | | | | | | | | | | | | | | | | | | | |
| 1 | 1 | 1 | No constant speed | | | | | | | | | | | | | | | | | | | | | | | | | | | | | | | | | | | | | | | | | | | | | | | | | |
| 0 | 1 | 1 | Constant speed 1 (1202) | | | | | | | | | | | | | | | | | | | | | | | | | | | | | | | | | | | | | | | | | | | | | | | | | |
| 1 | 0 | 1 | Constant speed 2 (1203) | | | | | | | | | | | | | | | | | | | | | | | | | | | | | | | | | | | | | | | | | | | | | | | | | |
| 0 | 0 | 1 | Constant speed 3 (1204) | | | | | | | | | | | | | | | | | | | | | | | | | | | | | | | | | | | | | | | | | | | | | | | | | |
| 1 | 1 | 0 | Constant speed 4 (1205) | | | | | | | | | | | | | | | | | | | | | | | | | | | | | | | | | | | | | | | | | | | | | | | | | |
| 0 | 1 | 0 | Constant speed 5 (1206) | | | | | | | | | | | | | | | | | | | | | | | | | | | | | | | | | | | | | | | | | | | | | | | | | |
| 1 | 0 | 0 | Constant speed 6 (1207) | | | | | | | | | | | | | | | | | | | | | | | | | | | | | | | | | | | | | | | | | | | | | | | | | |
| 0 | 0 | 0 | Constant speed 7 (1208) | | | | | | | | | | | | | | | | | | | | | | | | | | | | | | | | | | | | | | | | | | | | | | | | | |
| 1202 | <p>CONST SPEED 1 Sets value for Constant Speed 1. <ul style="list-style-type: none"> • The range and units depend on parameter 9904 MOTOR CTRL MODE. • Range: 0...30000 rpm when 9904 = 1 (VECTOR:SPEED) or 2 (VECTOR:TORQ). • Range: 0...500 Hz when 9904 = 3 (SCALAR:FREQ). </p> | | | | | | | | | | | | | | | | | | | | | | | | | | | | | | | | | | | | | | | | | | | | | | | | | | | |
| 1203 | <p>CONST SPEED 2...CONST SPEED 7 Each sets a value for a Constant Speed. See CONST SPEED 1 above.</p> | | | | | | | | | | | | | | | | | | | | | | | | | | | | | | | | | | | | | | | | | | | | | | | | | | | |
| 1208 | <p>Constant Speed 7 is used also as jogging speed. See parameter 1004 JOGGING SEL.</p> | | | | | | | | | | | | | | | | | | | | | | | | | | | | | | | | | | | | | | | | | | | | | | | | | | | |

| Code | Description | | | | | | | | | | | | | | | | | | | | | | | | | | | | | | |
|--------|---|-------------------------|--------|----------|---|---|--------------------|---|---|-------------------------|---|---|-------------------------|---|---|-------------------------|--------|--------|----------|---|---|-------------------------|---|---|-------------------------|---|---|-------------------------|---|---|-------------------------|
| 1209 | <p>TIMED MODE SEL</p> <p>Defines timed function activated, constant speed mode. Timed function can be used to change between external reference and a maximum of three constant speeds, or to change between a maximum of 4 selectable speeds, i.e. constant speeds 1, 2, 3 and 4.</p> <p>1 = EXT/CS1/2/3 – Selects an external speed when no timed function is active, selects Constant speed 1 when only Timed function 1 is active, Selects Constant speed 2 when only Timed function 2 is active and selects Constant speed 3 when both Timed functions 1 and 2 are active.</p> <table border="1"> <thead> <tr> <th>TIMER1</th> <th>TIMER2</th> <th>Function</th> </tr> </thead> <tbody> <tr> <td>0</td> <td>0</td> <td>External reference</td> </tr> <tr> <td>1</td> <td>0</td> <td>Constant speed 1 (1202)</td> </tr> <tr> <td>0</td> <td>1</td> <td>Constant speed 2 (1203)</td> </tr> <tr> <td>1</td> <td>1</td> <td>Constant speed 3 (1204)</td> </tr> </tbody> </table> <p>2 = cs1/2/3/4 – Selects Constant speed 1 when no timer is active, selects Constant speed 2 when only Timed function 1 is active, selects Constant speed 3 when only Timed function 2 is active, selects Constant speed 4 when both Timed functions are active.</p> <table border="1"> <thead> <tr> <th>TIMER1</th> <th>TIMER2</th> <th>Function</th> </tr> </thead> <tbody> <tr> <td>0</td> <td>0</td> <td>Constant speed 1 (1202)</td> </tr> <tr> <td>1</td> <td>0</td> <td>Constant speed 2 (1203)</td> </tr> <tr> <td>0</td> <td>1</td> <td>Constant speed 3 (1204)</td> </tr> <tr> <td>1</td> <td>1</td> <td>Constant speed 4 (1205)</td> </tr> </tbody> </table> | TIMER1 | TIMER2 | Function | 0 | 0 | External reference | 1 | 0 | Constant speed 1 (1202) | 0 | 1 | Constant speed 2 (1203) | 1 | 1 | Constant speed 3 (1204) | TIMER1 | TIMER2 | Function | 0 | 0 | Constant speed 1 (1202) | 1 | 0 | Constant speed 2 (1203) | 0 | 1 | Constant speed 3 (1204) | 1 | 1 | Constant speed 4 (1205) |
| TIMER1 | TIMER2 | Function | | | | | | | | | | | | | | | | | | | | | | | | | | | | | |
| 0 | 0 | External reference | | | | | | | | | | | | | | | | | | | | | | | | | | | | | |
| 1 | 0 | Constant speed 1 (1202) | | | | | | | | | | | | | | | | | | | | | | | | | | | | | |
| 0 | 1 | Constant speed 2 (1203) | | | | | | | | | | | | | | | | | | | | | | | | | | | | | |
| 1 | 1 | Constant speed 3 (1204) | | | | | | | | | | | | | | | | | | | | | | | | | | | | | |
| TIMER1 | TIMER2 | Function | | | | | | | | | | | | | | | | | | | | | | | | | | | | | |
| 0 | 0 | Constant speed 1 (1202) | | | | | | | | | | | | | | | | | | | | | | | | | | | | | |
| 1 | 0 | Constant speed 2 (1203) | | | | | | | | | | | | | | | | | | | | | | | | | | | | | |
| 0 | 1 | Constant speed 3 (1204) | | | | | | | | | | | | | | | | | | | | | | | | | | | | | |
| 1 | 1 | Constant speed 4 (1205) | | | | | | | | | | | | | | | | | | | | | | | | | | | | | |

Group 13: ANALOG INPUTS

This group defines the limits and the filtering for analog inputs.

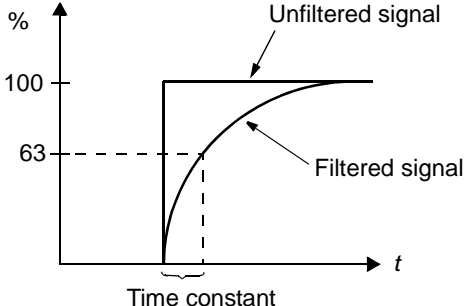
| Code | Description |
|------|---|
| 1301 | <p>MINIMUM AI1</p> <p>Defines the minimum value of the analog input.</p> <ul style="list-style-type: none"> Define value as a percent of the full analog signal range. See example below. The minimum analog input signal corresponds to 1104 REF1 MIN or 1107 REF2 MIN. MINIMUM AI cannot be greater than MAXIMUM AI. These parameters (reference and analog min. and max. settings) provide scale and offset adjustment for the reference. See the figure at parameter 1104. <p>Example. To set the minimum analog input value to 4 mA:</p> <ul style="list-style-type: none"> Configure the analog input for 0...20 mA current signal. Calculate the minimum (4 mA) as a percent of full range (20 mA) = $4 \text{ mA} / 20 \text{ mA} \cdot 100\% = 20\%$ |
| 1302 | <p>MAXIMUM AI1</p> <p>Defines the maximum value of the analog input.</p> <ul style="list-style-type: none"> Define value as a percent of the full analog signal range. The maximum analog input signal corresponds to 1105 REF1 MAX or 1108 REF2 MAX. See the figure at parameter 1104. |
| 1303 | <p>FILTER AI1</p> <p>Defines the filter time constant for analog input 1 (AI1).</p> <ul style="list-style-type: none"> The filtered signal reaches 63% of a step change within the time specified.  |
| 1304 | <p>MINIMUM AI2</p> <p>Defines the minimum value of the analog input.</p> <ul style="list-style-type: none"> See MINIMUM AI1 above. |
| 1305 | <p>MAXIMUM AI2</p> <p>Defines the maximum value of the analog input.</p> <ul style="list-style-type: none"> See MAXIMUM AI1 above. |
| 1306 | <p>FILTER AI2</p> <p>Defines the filter time constant for analog input 2 (AI2).</p> <ul style="list-style-type: none"> See FILTER AI1 above. |

Group 14: RELAY OUTPUTS

This group defines the condition that activates each of the relay outputs.

| Code | Description |
|------|--|
| 1401 | <p>RELAY OUTPUT 1</p> <p>Defines the event or condition that activates relay 1 – what relay output 1 means.</p> <p>0 = NOT SEL – Relay is not used and is de-energized.</p> <p>1 = READY – Energize relay when drive is ready to function. Requires:</p> <ul style="list-style-type: none"> • Run enable signal present. • No faults exist. • Supply voltage is within range. • Emergency Stop command is not on. <p>2 = RUN – Energize relay when the drive is running.</p> <p>3 = FAULT(-1) – Energize relay when power is applied. De-energizes when a fault occurs.</p> <p>4 = FAULT – Energize relay when a fault is active.</p> <p>5 = ALARM – Energize relay when an alarm is active.</p> <p>6 = REVERSED – Energize relay when motor rotates in reverse direction.</p> <p>7 = STARTED – Energize relay when drive receives a start command (even if Run Enable signal is not present). De-energized relay when drive receives a stop command or a fault occurs.</p> <p>8 = SUPRV1 OVER – Energize relay when first supervised parameter (3201) exceeds the limit (3203).</p> <ul style="list-style-type: none"> • See Group 32: SUPERVISION starting on page 174. <p>9 = SUPRV1 UNDER – Energize relay when first supervised parameter (3201) drops below the limit (3202).</p> <ul style="list-style-type: none"> • See Group 32: SUPERVISION starting on page 174. <p>10 = SUPRV2 OVER – Energize relay when second supervised parameter (3204) exceeds the limit (3206).</p> <ul style="list-style-type: none"> • See Group 32: SUPERVISION starting on page 174. <p>11 = SUPRV2 UNDER – Energize relay when second supervised parameter (3204) drops below the limit (3205).</p> <ul style="list-style-type: none"> • See Group 32: SUPERVISION starting on page 174. <p>12 = SUPRV3 OVER – Energize relay when third supervised parameter (3207) exceeds the limit (3209).</p> <ul style="list-style-type: none"> • See Group 32: SUPERVISION starting on page 174. <p>13 = SUPRV3 UNDER – Energize relay when third supervised parameter (3207) drops below the limit (3208).</p> <ul style="list-style-type: none"> • See Group 32: SUPERVISION starting on page 174. <p>14 = AT SET POINT – Energize relay when the output frequency is equal to the reference frequency.</p> <p>15 = FAULT(RST) – Energize relay when the drive is in a fault condition and will reset after the programmed auto-reset delay.</p> <ul style="list-style-type: none"> • See parameter 3103 DELAY TIME. <p>16 = FLT/ALARM – Energize relay when fault or alarm occurs.</p> <p>17 = EXT CTRL – Energize relay when external control is selected.</p> <p>18 = REF 2 SEL – Energize relay when EXT2 is selected.</p> <p>19 = CONST FREQ – Energize relay when a constant speed is selected.</p> <p>20 = REF LOSS – Energize relay when reference or active control place is lost.</p> <p>21 = OVERCURRENT – Energize relay when an overcurrent alarm or fault occurs.</p> <p>22 = OVERVOLTAGE – Energize relay when an overvoltage alarm or fault occurs.</p> <p>23 = DRIVE TEMP – Energize relay when a drive or control board overtemperature alarm or fault occurs.</p> <p>24 = UNDERVOLTAGE – Energize relay when an undervoltage alarm or fault occurs.</p> <p>25 = AI1 LOSS – Energize relay when AI1 signal is lost.</p> <p>26 = AI2 LOSS – Energize relay when AI2 signal is lost.</p> <p>27 = MOTOR TEMP – Energize relay when a motor overtemperature alarm or fault occurs.</p> <p>28 = STALL – Energize relay when a stall alarm or fault exists.</p> <p>30 = PID SLEEP – Energize relay when the PID sleep function is active.</p> <p>31 = PFC – Use relay to start/stop motor in PFC control (See Group 81: PFC CONTROL).</p> <ul style="list-style-type: none"> • Use this option only when PFC control is used. • Selection activated / deactivated when drive is not running. <p>32 = AUTOCHANGE – Energize relay when PFC autochange operation is performed.</p> <ul style="list-style-type: none"> • Use this option only when PFC control is used. <p>33 = FLUX READY – Energize relay when the motor is magnetized and able to supply nominal torque (motor has reached nominal magnetizing).</p> <p>34 = USER MACRO 2 – Energize relay when User Parameter Set 2 is active.</p> |

| Code | Description | | | | | | | | | | | | | | | | | | | | | | | | | | | | | | | | | | | | | | | | | | | | | | | | | | | | | | | | | | | | | | | | | | | | | | | | | | | | | | | | | | | | | | | | | | | | | | | | | | | | | | | | | | | | | | | | | | | | | | | | | | | | | | | | |
|-----------|---|-----------|--------|-----|-----|-----|-----|-----|-----|---|--------|---|---|---|---|---|---|---|--------|---|---|---|---|---|---|---|--------|---|---|---|---|---|---|---|--------|---|---|---|---|---|---|---|--------|---|---|---|---|---|---|--------|-----|-----|-----|-----|-----|-----|-----|----|--------|---|---|---|---|---|---|-----------|--------|-----|-----|-----|-----|-----|-----|---|--------|---|---|---|---|---|---|---|--------|---|---|---|---|---|---|---|--------|---|---|---|---|---|---|---|--------|---|---|---|---|---|---|---|--------|---|---|---|---|---|---|--------|-----|-----|-----|-----|-----|-----|-----|----|--------|---|---|---|---|---|---|
| | <p>35 = COMM – Energize relay based on input from fieldbus communication.</p> <ul style="list-style-type: none"> Fieldbus writes binary code in parameter 0134 that can energize relay 1...relay 6 according to the following: <table border="1"> <thead> <tr> <th>Par. 0134</th> <th>Binary</th> <th>RO6</th> <th>RO5</th> <th>RO4</th> <th>RO3</th> <th>RO2</th> <th>RO1</th> </tr> </thead> <tbody> <tr> <td>0</td> <td>000000</td> <td>0</td> <td>0</td> <td>0</td> <td>0</td> <td>0</td> <td>0</td> </tr> <tr> <td>1</td> <td>000001</td> <td>0</td> <td>0</td> <td>0</td> <td>0</td> <td>0</td> <td>1</td> </tr> <tr> <td>2</td> <td>000010</td> <td>0</td> <td>0</td> <td>0</td> <td>0</td> <td>1</td> <td>0</td> </tr> <tr> <td>3</td> <td>000011</td> <td>0</td> <td>0</td> <td>0</td> <td>0</td> <td>1</td> <td>1</td> </tr> <tr> <td>4</td> <td>000100</td> <td>0</td> <td>0</td> <td>0</td> <td>1</td> <td>0</td> <td>0</td> </tr> <tr> <td>5...62</td> <td>...</td> <td>...</td> <td>...</td> <td>...</td> <td>...</td> <td>...</td> <td>...</td> </tr> <tr> <td>63</td> <td>111111</td> <td>1</td> <td>1</td> <td>1</td> <td>1</td> <td>1</td> <td>1</td> </tr> </tbody> </table> <ul style="list-style-type: none"> 0 = De-energize relay, 1 = Energize relay. <p>36 = COMM(-1) – Energize relay based on input from fieldbus communication.</p> <ul style="list-style-type: none"> Fieldbus writes binary code in parameter 0134 that can energize relay 1...relay 6 according to the following: <table border="1"> <thead> <tr> <th>Par. 0134</th> <th>Binary</th> <th>RO6</th> <th>RO5</th> <th>RO4</th> <th>RO3</th> <th>RO2</th> <th>RO1</th> </tr> </thead> <tbody> <tr> <td>0</td> <td>000000</td> <td>1</td> <td>1</td> <td>1</td> <td>1</td> <td>1</td> <td>1</td> </tr> <tr> <td>1</td> <td>000001</td> <td>1</td> <td>1</td> <td>1</td> <td>1</td> <td>1</td> <td>0</td> </tr> <tr> <td>2</td> <td>000010</td> <td>1</td> <td>1</td> <td>1</td> <td>1</td> <td>0</td> <td>1</td> </tr> <tr> <td>3</td> <td>000011</td> <td>1</td> <td>1</td> <td>1</td> <td>1</td> <td>0</td> <td>0</td> </tr> <tr> <td>4</td> <td>000100</td> <td>1</td> <td>1</td> <td>1</td> <td>0</td> <td>1</td> <td>1</td> </tr> <tr> <td>5...62</td> <td>...</td> <td>...</td> <td>...</td> <td>...</td> <td>...</td> <td>...</td> <td>...</td> </tr> <tr> <td>63</td> <td>111111</td> <td>0</td> <td>0</td> <td>0</td> <td>0</td> <td>0</td> <td>0</td> </tr> </tbody> </table> <ul style="list-style-type: none"> 0 = De-energize relay, 1 = Energize relay. <p>37 = TIMED FUNC 1 – Energize relay when Timed Function 1 is active. See Group 36: TIMED FUNCTIONS.</p> <p>38...40 = TIMED FUNC 2...4 – Energize relay when Timed Function 2...4 is active. See TIMED FUNC 1 above.</p> <p>41 = MNT TRIG FAN – Energize relay when cooling fan counter is triggered. See Group 29: MAINTENANCE TRIG.</p> <p>42 = MNT TRIG REV – Energize relay when revolutions counter is triggered. See Group 29: MAINTENANCE TRIG.</p> <p>43 = MNT TRIG RUN – Energize relay when run time counter is triggered. See Group 29: MAINTENANCE TRIG.</p> <p>44 = MNT TRIG MWH – Energize relay when MWh counter is triggered. See Group 29: MAINTENANCE TRIG.</p> <p>46 = START DELAY – Energize relay when a start delay is active.</p> <p>47 = USER LOAD C – Energize relay when a user load curve fault or alarm occurs.</p> <p>52 = JOG ACTIVE – Energize relay when the jogging function is active.</p> | Par. 0134 | Binary | RO6 | RO5 | RO4 | RO3 | RO2 | RO1 | 0 | 000000 | 0 | 0 | 0 | 0 | 0 | 0 | 1 | 000001 | 0 | 0 | 0 | 0 | 0 | 1 | 2 | 000010 | 0 | 0 | 0 | 0 | 1 | 0 | 3 | 000011 | 0 | 0 | 0 | 0 | 1 | 1 | 4 | 000100 | 0 | 0 | 0 | 1 | 0 | 0 | 5...62 | ... | ... | ... | ... | ... | ... | ... | 63 | 111111 | 1 | 1 | 1 | 1 | 1 | 1 | Par. 0134 | Binary | RO6 | RO5 | RO4 | RO3 | RO2 | RO1 | 0 | 000000 | 1 | 1 | 1 | 1 | 1 | 1 | 1 | 000001 | 1 | 1 | 1 | 1 | 1 | 0 | 2 | 000010 | 1 | 1 | 1 | 1 | 0 | 1 | 3 | 000011 | 1 | 1 | 1 | 1 | 0 | 0 | 4 | 000100 | 1 | 1 | 1 | 0 | 1 | 1 | 5...62 | ... | ... | ... | ... | ... | ... | ... | 63 | 111111 | 0 | 0 | 0 | 0 | 0 | 0 |
| Par. 0134 | Binary | RO6 | RO5 | RO4 | RO3 | RO2 | RO1 | | | | | | | | | | | | | | | | | | | | | | | | | | | | | | | | | | | | | | | | | | | | | | | | | | | | | | | | | | | | | | | | | | | | | | | | | | | | | | | | | | | | | | | | | | | | | | | | | | | | | | | | | | | | | | | | | | | | | | | | | | |
| 0 | 000000 | 0 | 0 | 0 | 0 | 0 | 0 | | | | | | | | | | | | | | | | | | | | | | | | | | | | | | | | | | | | | | | | | | | | | | | | | | | | | | | | | | | | | | | | | | | | | | | | | | | | | | | | | | | | | | | | | | | | | | | | | | | | | | | | | | | | | | | | | | | | | | | | | | |
| 1 | 000001 | 0 | 0 | 0 | 0 | 0 | 1 | | | | | | | | | | | | | | | | | | | | | | | | | | | | | | | | | | | | | | | | | | | | | | | | | | | | | | | | | | | | | | | | | | | | | | | | | | | | | | | | | | | | | | | | | | | | | | | | | | | | | | | | | | | | | | | | | | | | | | | | | | |
| 2 | 000010 | 0 | 0 | 0 | 0 | 1 | 0 | | | | | | | | | | | | | | | | | | | | | | | | | | | | | | | | | | | | | | | | | | | | | | | | | | | | | | | | | | | | | | | | | | | | | | | | | | | | | | | | | | | | | | | | | | | | | | | | | | | | | | | | | | | | | | | | | | | | | | | | | | |
| 3 | 000011 | 0 | 0 | 0 | 0 | 1 | 1 | | | | | | | | | | | | | | | | | | | | | | | | | | | | | | | | | | | | | | | | | | | | | | | | | | | | | | | | | | | | | | | | | | | | | | | | | | | | | | | | | | | | | | | | | | | | | | | | | | | | | | | | | | | | | | | | | | | | | | | | | | |
| 4 | 000100 | 0 | 0 | 0 | 1 | 0 | 0 | | | | | | | | | | | | | | | | | | | | | | | | | | | | | | | | | | | | | | | | | | | | | | | | | | | | | | | | | | | | | | | | | | | | | | | | | | | | | | | | | | | | | | | | | | | | | | | | | | | | | | | | | | | | | | | | | | | | | | | | | | |
| 5...62 | ... | ... | ... | ... | ... | ... | ... | | | | | | | | | | | | | | | | | | | | | | | | | | | | | | | | | | | | | | | | | | | | | | | | | | | | | | | | | | | | | | | | | | | | | | | | | | | | | | | | | | | | | | | | | | | | | | | | | | | | | | | | | | | | | | | | | | | | | | | | | | |
| 63 | 111111 | 1 | 1 | 1 | 1 | 1 | 1 | | | | | | | | | | | | | | | | | | | | | | | | | | | | | | | | | | | | | | | | | | | | | | | | | | | | | | | | | | | | | | | | | | | | | | | | | | | | | | | | | | | | | | | | | | | | | | | | | | | | | | | | | | | | | | | | | | | | | | | | | | |
| Par. 0134 | Binary | RO6 | RO5 | RO4 | RO3 | RO2 | RO1 | | | | | | | | | | | | | | | | | | | | | | | | | | | | | | | | | | | | | | | | | | | | | | | | | | | | | | | | | | | | | | | | | | | | | | | | | | | | | | | | | | | | | | | | | | | | | | | | | | | | | | | | | | | | | | | | | | | | | | | | | | |
| 0 | 000000 | 1 | 1 | 1 | 1 | 1 | 1 | | | | | | | | | | | | | | | | | | | | | | | | | | | | | | | | | | | | | | | | | | | | | | | | | | | | | | | | | | | | | | | | | | | | | | | | | | | | | | | | | | | | | | | | | | | | | | | | | | | | | | | | | | | | | | | | | | | | | | | | | | |
| 1 | 000001 | 1 | 1 | 1 | 1 | 1 | 0 | | | | | | | | | | | | | | | | | | | | | | | | | | | | | | | | | | | | | | | | | | | | | | | | | | | | | | | | | | | | | | | | | | | | | | | | | | | | | | | | | | | | | | | | | | | | | | | | | | | | | | | | | | | | | | | | | | | | | | | | | | |
| 2 | 000010 | 1 | 1 | 1 | 1 | 0 | 1 | | | | | | | | | | | | | | | | | | | | | | | | | | | | | | | | | | | | | | | | | | | | | | | | | | | | | | | | | | | | | | | | | | | | | | | | | | | | | | | | | | | | | | | | | | | | | | | | | | | | | | | | | | | | | | | | | | | | | | | | | | |
| 3 | 000011 | 1 | 1 | 1 | 1 | 0 | 0 | | | | | | | | | | | | | | | | | | | | | | | | | | | | | | | | | | | | | | | | | | | | | | | | | | | | | | | | | | | | | | | | | | | | | | | | | | | | | | | | | | | | | | | | | | | | | | | | | | | | | | | | | | | | | | | | | | | | | | | | | | |
| 4 | 000100 | 1 | 1 | 1 | 0 | 1 | 1 | | | | | | | | | | | | | | | | | | | | | | | | | | | | | | | | | | | | | | | | | | | | | | | | | | | | | | | | | | | | | | | | | | | | | | | | | | | | | | | | | | | | | | | | | | | | | | | | | | | | | | | | | | | | | | | | | | | | | | | | | | |
| 5...62 | ... | ... | ... | ... | ... | ... | ... | | | | | | | | | | | | | | | | | | | | | | | | | | | | | | | | | | | | | | | | | | | | | | | | | | | | | | | | | | | | | | | | | | | | | | | | | | | | | | | | | | | | | | | | | | | | | | | | | | | | | | | | | | | | | | | | | | | | | | | | | | |
| 63 | 111111 | 0 | 0 | 0 | 0 | 0 | 0 | | | | | | | | | | | | | | | | | | | | | | | | | | | | | | | | | | | | | | | | | | | | | | | | | | | | | | | | | | | | | | | | | | | | | | | | | | | | | | | | | | | | | | | | | | | | | | | | | | | | | | | | | | | | | | | | | | | | | | | | | | |
| 1402 | <p>RELAY OUTPUT 2</p> <p>Defines the event or condition that activates relay 2 – what relay output 2 means.</p> <ul style="list-style-type: none"> See 1401 RELAY OUTPUT 1. | | | | | | | | | | | | | | | | | | | | | | | | | | | | | | | | | | | | | | | | | | | | | | | | | | | | | | | | | | | | | | | | | | | | | | | | | | | | | | | | | | | | | | | | | | | | | | | | | | | | | | | | | | | | | | | | | | | | | | | | | | | | | | | | |
| 1403 | <p>RELAY OUTPUT 3</p> <p>Defines the event or condition that activates relay 3 – what relay output 3 means.</p> <ul style="list-style-type: none"> See 1401 RELAY OUTPUT 1. | | | | | | | | | | | | | | | | | | | | | | | | | | | | | | | | | | | | | | | | | | | | | | | | | | | | | | | | | | | | | | | | | | | | | | | | | | | | | | | | | | | | | | | | | | | | | | | | | | | | | | | | | | | | | | | | | | | | | | | | | | | | | | | | |
| 1404 | <p>RO 1 ON DELAY</p> <p>Defines the switch-on delay for relay 1.</p> <ul style="list-style-type: none"> On / off delays are ignored when relay output 1401 is set to PFC. | | | | | | | | | | | | | | | | | | | | | | | | | | | | | | | | | | | | | | | | | | | | | | | | | | | | | | | | | | | | | | | | | | | | | | | | | | | | | | | | | | | | | | | | | | | | | | | | | | | | | | | | | | | | | | | | | | | | | | | | | | | | | | | | |
| 1405 | <p>RO 1 OFF DELAY</p> <p>Defines the switch-off delay for relay 1.</p> <ul style="list-style-type: none"> On / off delays are ignored when relay output 1401 is set to PFC. | | | | | | | | | | | | | | | | | | | | | | | | | | | | | | | | | | | | | | | | | | | | | | | | | | | | | | | | | | | | | | | | | | | | | | | | | | | | | | | | | | | | | | | | | | | | | | | | | | | | | | | | | | | | | | | | | | | | | | | | | | | | | | | | |
| | | | | | | | | | | | | | | | | | | | | | | | | | | | | | | | | | | | | | | | | | | | | | | | | | | | | | | | | | | | | | | | | | | | | | | | | | | | | | | | | | | | | | | | | | | | | | | | | | | | | | | | | | | | | | | | | | | | | | | | | | | | | | | | | | |
| 1406 | <p>RO 2 ON DELAY</p> <p>Defines the switch-on delay for relay 2.</p> <ul style="list-style-type: none"> See RO 1 ON DELAY. | | | | | | | | | | | | | | | | | | | | | | | | | | | | | | | | | | | | | | | | | | | | | | | | | | | | | | | | | | | | | | | | | | | | | | | | | | | | | | | | | | | | | | | | | | | | | | | | | | | | | | | | | | | | | | | | | | | | | | | | | | | | | | | | |
| 1407 | <p>RO 2 OFF DELAY</p> <p>Defines the switch-off delay for relay 2.</p> <ul style="list-style-type: none"> See RO 1 OFF DELAY. | | | | | | | | | | | | | | | | | | | | | | | | | | | | | | | | | | | | | | | | | | | | | | | | | | | | | | | | | | | | | | | | | | | | | | | | | | | | | | | | | | | | | | | | | | | | | | | | | | | | | | | | | | | | | | | | | | | | | | | | | | | | | | | | |
| 1408 | <p>RO 3 ON DELAY</p> <p>Defines the switch-on delay for relay 3.</p> <ul style="list-style-type: none"> See RO 1 ON DELAY. | | | | | | | | | | | | | | | | | | | | | | | | | | | | | | | | | | | | | | | | | | | | | | | | | | | | | | | | | | | | | | | | | | | | | | | | | | | | | | | | | | | | | | | | | | | | | | | | | | | | | | | | | | | | | | | | | | | | | | | | | | | | | | | | |

| Code | Description |
|------|---|
| 1409 | RO 3 OFF DELAY Switch-off delay for relay 3. • See RO 1 OFF DELAY. |
| 1410 | RELAY OUTPUT 4...6 Defines the event or condition that activates relay 4...6 – what relay output 4...6 means. • See 1401 RELAY OUTPUT 1. |
| 1412 | |
| 1413 | RO 4 ON DELAY Defines the switch-on delay for relay 4. • See RO 1 ON DELAY. |
| 1414 | RO 4 OFF DELAY Defines the switch-off delay for relay 4. • See RO 1 OFF DELAY. |
| 1415 | RO 5 ON DELAY Defines the switch-on delay for relay 5. • See RO 1 ON DELAY. |
| 1416 | RO 5 OFF DELAY Defines the switch-off delay for relay 5. • See RO 1 OFF DELAY. |
| 1417 | RO 6 ON DELAY Defines the switch-on delay for relay 6. • See RO 1 ON DELAY. |
| 1418 | RO 6 OFF DELAY Defines the switch-off delay for relay 6. • See RO 1 OFF DELAY. |

Group 15: ANALOG OUTPUTS

This group defines the drive's analog (current signal) outputs. The drive's analog outputs can be:

- any parameter in [Group 01: OPERATING DATA](#)
- limited to programmable minimum and maximum values of output current
- scaled (and/or inverted) by defining the minimum and maximum values of the source parameter (or content). Defining an maximum value (parameter 1503 or 1509) that is less than the content minimum value (parameter 1502 or 1508) results in an inverted output.
- filtered.

| Code | Description |
|------|---|
| 1501 | <p>AO1 CONTENT SEL Defines the content for analog output AO1. 99 = EXCITE PTC – Provides a current source for sensor type PTC. Output = 1.6 mA. See Group 35: MOTOR TEMP MEAS. 100 = EXCITE PT100 – Provides a current source for sensor type PT100. Output = 9.1 mA. See Group 35: MOTOR TEMP MEAS. 101...159 – Output corresponds to a parameter in Group 01: OPERATING DATA. • Parameter defined by value (value 102 = parameter 0102)</p> |
| 1502 | <p>AO1 CONTENT MIN Sets the minimum content value. • Content is the parameter selected by parameter 1501. • Minimum value refers to the minimum content value that will be converted to an analog output. • These parameters (content and current min. and max. settings) provide scale and offset adjustment for the output. See the figure.</p> |
| 1503 | <p>AO1 CONTENT MAX Sets the maximum content value • Content is the parameter selected by parameter 1501. • Maximum value refers to the maximum content value that will be converted to an analog output.</p> |
| 1504 | <p>MINIMUM AO1 Sets the minimum output current.</p> |
| 1505 | <p>MAXIMUM AO1 Sets the maximum output current.</p> |
| 1506 | <p>FILTER AO1 Defines the filter time constant for AO1. • The filtered signal reaches 63% of a step change within the time specified. • See the figure in parameter 1303.</p> |
| 1507 | <p>AO2 CONTENT SEL Defines the content for analog output AO2. See AO1 CONTENT SEL above.</p> |
| 1508 | <p>AO2 CONTENT MIN Sets the minimum content value. See AO1 CONTENT MIN above.</p> |
| 1509 | <p>AO2 CONTENT MAX Sets the maximum content value. See AO1 CONTENT MAX above.</p> |
| 1510 | <p>MINIMUM AO2 Sets the minimum output current. See MINIMUM AO1 above.</p> |

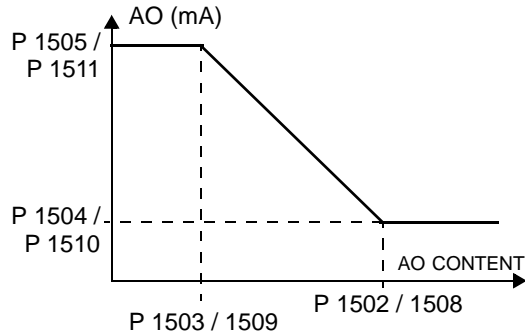
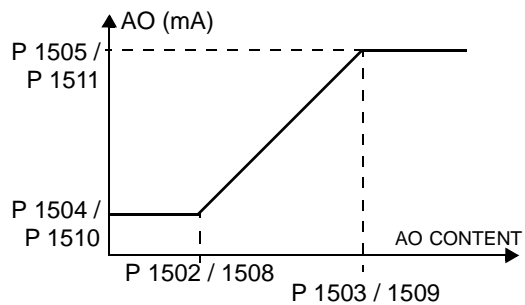

| Code | Description |
|------|--|
| 1511 | MAXIMUM AO2 Sets the maximum output current. See MAXIMUM AO1 above. |
| 1512 | FILTER AO2 Defines the filter time constant for AO2. See FILTER AO1 above. |

Group 16: SYSTEM CONTROLS

This group defines a variety of system level locks, resets and enables.

| Code | Description |
|------|--|
| 1601 | <p>RUN ENABLE</p> <p>Selects the source of the run enable signal.</p> <p>0 = NOT SEL – Allows the drive to start without an external run enable signal.</p> <p>1 = DI1 – Defines digital input DI1 as the run enable signal.</p> <ul style="list-style-type: none"> This digital input must be activated for run enable. If the voltage drops and de-activates this digital input, the drive will coast to stop and not start until the run enable signal resumes. <p>2...6 = DI2...DI6 – Defines digital input DI2...DI6 as the run enable signal.</p> <ul style="list-style-type: none"> See DI1 above. <p>7 = COMM – Assigns the fieldbus Command Word as the source for the run enable signal.</p> <ul style="list-style-type: none"> Bit 6 of the Command Word 1 (parameter 0301) activates the run disable signal. See fieldbus user's manual for detailed instructions. <p>-1 = DI1(INV) – Defines an inverted digital input DI1 as the run enable signal.</p> <ul style="list-style-type: none"> This digital input must be de-activated for run enable. If this digital input activates, the drive will coast to stop and not start until the run enable signal resumes. <p>-2...-6 = DI2(INV)...DI6(INV) – Defines an inverted digital input DI2...DI6 as the run enable signal.</p> <ul style="list-style-type: none"> See DI1(INV) above. |
| 1602 | <p>PARAMETER LOCK</p> <p>Determines if the control panel can change parameter values.</p> <ul style="list-style-type: none"> This lock does not limit parameter changes made by macros. This lock does not limit parameter changes written by fieldbus inputs. This parameter value can be changed only if the correct pass code is entered. See parameter 1603 PASS CODE. <p>0 = LOCKED – You cannot use the control panel to change parameter values.</p> <ul style="list-style-type: none"> The lock can be opened by entering the valid pass code to parameter 1603. <p>1 = OPEN – You can use the control panel to change parameter values.</p> <p>2 = NOT SAVED – You can use the control panel to change parameter values, but they are not stored in permanent memory.</p> <ul style="list-style-type: none"> Set parameter 1607 PARAM SAVE to 1 (SAVE) to store changed parameter values to memory. |
| 1603 | <p>PASS CODE</p> <p>Entering the correct pass code allows you to change the parameter lock.</p> <ul style="list-style-type: none"> See parameter 1602 above. The code 358 allows you to change the value of the parameter 1602 once. This entry reverts back to 0 automatically. |
| 1604 | <p>FAULT RESET SEL</p> <p>Selects the source for the fault reset signal. The signal resets the drive after a fault trip if the cause of the fault no longer exists.</p> <p>0 = KEYPAD – Defines the control panel as the only fault reset source.</p> <ul style="list-style-type: none"> Fault reset is always possible with control panel. <p>1 = DI1 – Defines digital input DI1 as a fault reset source.</p> <ul style="list-style-type: none"> Activating the digital input resets the drive. <p>2...6 = DI2...DI6 – Defines digital input DI2...DI6 as a fault reset source.</p> <ul style="list-style-type: none"> See DI1 above. <p>7 = START/STOP – Defines the Stop command as a fault reset source.</p> <ul style="list-style-type: none"> Do not use this option when fieldbus communication provides the start, stop and direction commands. <p>8 = COMM – Defines the fieldbus as a fault reset source.</p> <ul style="list-style-type: none"> The Command Word is supplied through fieldbus communication. The bit 4 of the Command Word 1 (parameter 0301) resets the drive. <p>-1 = DI1(INV) – Defines an inverted digital input DI1 as a fault reset source.</p> <ul style="list-style-type: none"> De-activating the digital input resets the drive. <p>-2...-6 = DI2(INV)...DI6(INV) – Defines an inverted digital input DI2...DI6 as a fault reset source.</p> <ul style="list-style-type: none"> See DI1(INV) above. |

| Code | Description |
|------|--|
| 1605 | <p>USER PAR SET CHG</p> <p>Defines control for changing the user parameter set.</p> <ul style="list-style-type: none"> • See parameter 9902 APPLIC MACRO. • The drive must be stopped to change User Parameter Sets. • During a change, the drive will not start. <p>Note: Always save the User Parameter Set after changing any parameter settings, or performing a motor identification.</p> <ul style="list-style-type: none"> • Whenever the power is cycled, or parameter 9902 APPLIC MACRO is changed, the drive loads the last settings saved. Any unsaved changes to a user parameter set are lost. <p>Note: The value of this parameter (1605) is not included in the User Parameter Sets, and it does not change if User Parameter Sets change.</p> <p>Note: You can use a relay output to supervise the selection of User Parameter Set 2.</p> <ul style="list-style-type: none"> • See parameter 1401. <p>0 = NOT SEL – Defines the control panel (using parameter 9902) as the only control for changing User Parameter Sets.</p> <p>1 = DI1 – Defines digital input DI1 as a control for changing User Parameter Sets.</p> <ul style="list-style-type: none"> • The drive loads User Parameter Set 1 on the falling edge of the digital input. • The drive loads User Parameter Set 2 on the rising edge of the digital input. • The User Parameter Set changes only when the drive is stopped. <p>2...6 = DI2...DI6 – Defines digital input DI2...DI6 as a control for changing User Parameter Sets.</p> <ul style="list-style-type: none"> • See DI1 above. <p>-1 = DI1(INV) – Defines an inverted digital input DI1 as a control for changing User Parameter Sets.</p> <ul style="list-style-type: none"> • The drive loads User Parameter Set 1 on the rising edge of the digital input. • The drive loads User Parameter Set 2 on the falling edge of the digital input. • The User Parameter Set changes only when the drive is stopped. <p>-2...-6 = DI2(INV)...DI6(INV) – Defines an inverted digital input DI2...DI6 as a control for changing User Parameter Sets.</p> <ul style="list-style-type: none"> • See DI1(INV) above. |
| 1606 | <p>LOCAL LOCK</p> <p>Defines control for the use of the LOC mode. The LOC mode allows drive control from the control panel.</p> <ul style="list-style-type: none"> • When LOCAL LOCK is active, the control panel cannot change to LOC mode. <p>0 = NOT SEL – Disables the lock. The control panel can select LOC and control the drive.</p> <p>1 = DI1 – Defines digital input DI1 as the control for setting the local lock.</p> <ul style="list-style-type: none"> • Activating the digital input locks out local control. • De-activating the digital input enable the LOC selection. <p>2...6 = DI2...DI6 – Defines digital input DI2...DI6 as the control for setting the local lock.</p> <ul style="list-style-type: none"> • See DI1 above. <p>7 = ON – Sets the lock. The control panel cannot select LOC and cannot control the drive.</p> <p>8 = COMM – Defines bit 14 of the Command Word 1 as the control for setting the local lock.</p> <ul style="list-style-type: none"> • The Command Word is supplied through fieldbus communication. • The Command Word is 0301. <p>-1 = DI1(INV) – Defines an inverted digital input DI1 as the control for setting the local lock.</p> <ul style="list-style-type: none"> • De-activating the digital input locks out local control. • Activating the digital input enable the LOC selection. <p>-2...-6 = DI2(INV)...DI6(INV) – Defines an inverted digital input DI2...DI6 as the control for setting the local lock.</p> <ul style="list-style-type: none"> • See DI1(INV) above. |
| 1607 | <p>PARAM SAVE</p> <p>Saves all altered parameters to permanent memory.</p> <ul style="list-style-type: none"> • Parameters altered through a fieldbus are not automatically saved to permanent memory. To save, you must use this parameter. • If 1602 PARAMETER LOCK = 2 (NOT SAVED), parameters altered from the control panel are not saved. To save, you must use this parameter. • If 1602 PARAMETER LOCK = 1 (OPEN), parameters altered from the control panel are stored immediately to permanent memory. <p>0 = DONE – Value changes automatically when all parameters are saved.</p> <p>1 = SAVE... – Saves altered parameters to permanent memory.</p> |

| Code | Description |
|------|--|
| 1608 | <p>START ENABLE 1 Selects the source of the start enable 1 signal.</p> <p>Note: Start enable functionality differs from the run enable functionality.</p> <p>0 = NOT SEL – Allows the drive to start without an external start enable signal.</p> <p>1 = DI1 – Defines digital input DI1 as the start enable 1 signal.</p> <ul style="list-style-type: none"> This digital input must be activated for start enable 1 signal. If the voltage drops and de-activates this digital input, the drive will coast to stop and show alarm 2021 on the panel display. The drive will not start until start enable 1 signal resumes. <p>2...6 = DI2...DI6 – Defines digital input DI2...DI6 as the start enable 1 signal.</p> <ul style="list-style-type: none"> See DI1 above. <p>7 = COMM – Assigns the fieldbus Command Word as the source for the start enable 1 signal.</p> <ul style="list-style-type: none"> Bit 2 of the Command word 2 (parameter 0302) activates the start disable 1 signal. See fieldbus user's manual for detailed instructions. <p>-1 = DI1(INV) – Defines an inverted digital input DI1 as the start enable 1 signal.</p> <p>-2...-6 = DI2 (INV)...DI6(INV) – Defines an inverted digital input DI2...DI6 as the start enable 1 signal.</p> <ul style="list-style-type: none"> See DI1 (INV) above. |

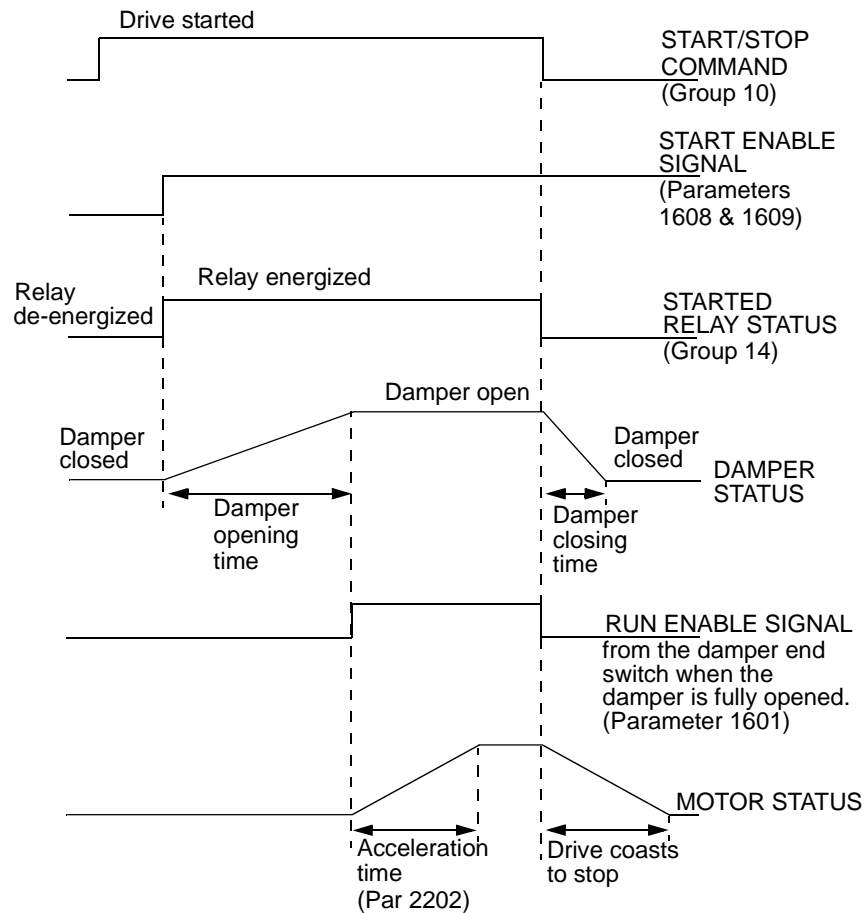

| Code | Description |
|------|--|
| 1609 | <p>START ENABLE 2</p> <p>Selects the source of the start enable 2 signal.</p> <p>Note: Start enable functionality differs from the run enable functionality.</p> <p>0 = NOT SEL – Allows the drive to start without an external start enable signal.</p> <p>1 = DI1 – Defines digital input DI1 as the start enable 2 signal.</p> <ul style="list-style-type: none"> • This digital input must be activated for start enable 2 signal. • If the voltage drops and de-activates this digital input, the drive will coast to stop and show alarm 2022 on the panel display. The drive will not start until start enable 2 signal resumes. <p>2...6 = DI2...DI6 – Defines digital input DI2...DI6 as the start enable 2 signal.</p> <ul style="list-style-type: none"> • See DI1 above. <p>7 = COMM – Assigns the fieldbus Command Word as the source for the start enable 2 signal. Bit 3 of the Command word 2 (parameter 0302) activates the start disable 2 signal.</p> <ul style="list-style-type: none"> • See fieldbus user's manual for detailed instructions. <p>-1 = DI1(INV) – Defines an inverted digital input DI1 as the start enable 2 signal.</p> <p>-2...-6 = DI2(INV)...DI6(INV) – Defines an inverted digital input DI2...DI6 as the start enable 2 signal.</p> <ul style="list-style-type: none"> • See DI1 (INV) above. |
| 1610 | <p>DISPLAY ALARMS</p> <p>Controls the visibility of the following alarms:</p> <ul style="list-style-type: none"> • 2001, Overcurrent alarm • 2002, Overvoltage alarm • 2003, Undervoltage alarm • 2009, Device overtemperature alarm. <p>For more information, see section Alarm listing on page 280.</p> <p>0 = NO – The above alarms are suppressed.</p> <p>1 = YES – All of the above alarms are enabled.</p> |

Group 20: LIMITS

This group defines minimum and maximum limits to follow in driving the motor – speed, frequency, current, torque, etc.

| Code | Description |
|------|---|
| 2001 | <p>MINIMUM SPEED Defines the minimum speed (rpm) allowed.</p> <ul style="list-style-type: none"> • A positive (or zero) minimum speed value defines two ranges, one positive and one negative. • A negative minimum speed value defines one speed range. • See the figure. |
| 2002 | <p>MAXIMUM SPEED Defines the maximum speed (rpm) allowed.</p> |
| 2003 | <p>MAX CURRENT Defines the maximum output current (A) supplied by the drive to the motor.</p> |
| 2005 | <p>OVERVOLT CTRL Sets the DC overvoltage controller on or off.</p> <ul style="list-style-type: none"> • Fast braking of a high inertia load causes the DC bus voltage to rise to the overvoltage control limit. To prevent the DC voltage from exceeding the trip limit, the overvoltage controller automatically decreases the braking torque by increasing output frequency. <p>0 = DISABLE – Disables controller. 1 = ENABLE – Enables controller</p> <p>Note: If a braking chopper or a braking resistor is connected to the drive, this parameter value must be set to 0 (DISABLE) to ensure proper operation of the chopper.</p> |
| 2006 | <p>UNDERVOLT CTRL Sets the DC undervoltage controller on or off. When on:</p> <ul style="list-style-type: none"> • If the DC bus voltage drops due to loss of input power, the undervoltage controller decreases the motor speed in order to keep the DC bus voltage above the lower limit. • When the motor speed decreases, the inertia of the load causes regeneration back into the drive, keeping the DC bus charged and preventing an undervoltage trip. • The DC undervoltage controller increases power loss ride-through on systems with a high inertia, such as a centrifuge or a fan. <p>0 = DISABLE – Disables controller. 1 = ENABLE(TIME) – Enables controller with 500 ms time limit for operation. 2 = ENABLE – Enables controller without maximum time limit for operation.</p> |

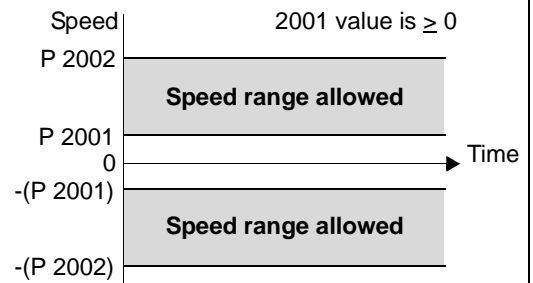
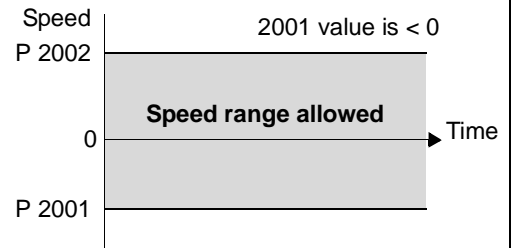

| Code | Description | |
|------|---|--|
| 2007 | <p>MINIMUM FREQ</p> <p>Defines the minimum limit for the drive output frequency.</p> <ul style="list-style-type: none"> • A positive or zero minimum frequency value defines two ranges, one positive and one negative. • A negative minimum frequency value defines one speed range. <p>See the figure.</p> <p>Note: Keep MINIMUM FREQ ≤ MAXIMUM FREQ.</p> | |
| 2008 | <p>MAXIMUM FREQ</p> <p>Defines the maximum limit for the drive output frequency.</p> | |
| 2013 | <p>MIN TORQUE SEL</p> <p>Defines control of the selection between two minimum torque limits (2015 MIN TORQUE 1 and 2016 MIN TORQUE 2).</p> <p>0 = MIN TORQUE 1 – Selects 2015 MIN TORQUE 1 as the minimum limit used.</p> <p>1 = DI1 – Defines digital input DI1 as the control for selecting the minimum limit used.</p> <ul style="list-style-type: none"> • Activating the digital input selects MIN TORQUE 2 value. • De-activating the digital input selects MIN TORQUE 1 value. <p>2...6 = DI2...DI6 – Defines digital input DI2...DI6 as the control for selecting the minimum limit used.</p> <ul style="list-style-type: none"> • See DI1 above. <p>7 = COMM – Defines bit 15 of the Command Word 1 as the control for selecting the minimum limit used.</p> <ul style="list-style-type: none"> • The Command Word is supplied through fieldbus communication. • The Command Word is parameter 0301. <p>-1 = DI1(INV) – Defines an inverted digital input DI1 as the control for selecting the minimum limit used.</p> <ul style="list-style-type: none"> • Activating the digital input selects MIN TORQUE 1 value. • De-activating the digital input selects MIN TORQUE 2 value. <p>-2...-6 = DI2(INV)...DI6(INV) – Defines an inverted digital input DI2...DI6 as the control for selecting the minimum limit used.</p> <ul style="list-style-type: none"> • See DI1(INV) above. | |
| 2014 | <p>MAX TORQUE SEL</p> <p>Defines control of the selection between two maximum torque limits (2017 MAX TORQUE 1 and 2018 MAX TORQUE 2).</p> <p>0 = MAX TORQUE 1 – Selects 2017 MAX TORQUE 1 as the maximum limit used.</p> <p>1 = DI1 – Defines digital input DI1 as the control for selecting the maximum limit used.</p> <ul style="list-style-type: none"> • Activating the digital input selects MAX TORQUE 2 value. • De-activating the digital input selects MAX TORQUE 1 value. <p>2...6 = DI2...DI6 – Defines digital input DI2...DI6 as the control for selecting the maximum limit used.</p> <ul style="list-style-type: none"> • See DI1 above. <p>7 = COMM – Defines bit 15 of the Command Word 1 as the control for selecting the maximum limit used.</p> <ul style="list-style-type: none"> • The Command Word is supplied through fieldbus communication. • The Command Word is parameter 0301. <p>-1 = DI1(INV) – Defines an inverted digital input di1 as the control for selecting the maximum limit used.</p> <ul style="list-style-type: none"> • Activating the digital input selects MAX TORQUE 1 value. • De-activating the digital input selects MAX TORQUE 2 value. <p>-2...-6 = DI2(INV)...DI6(INV) – Defines an inverted digital input DI2...DI6 as the control for selecting the maximum limit used.</p> <ul style="list-style-type: none"> • See DI1(INV) above. | |
| 2015 | <p>MIN TORQUE 1</p> <p>Sets the first minimum limit for torque (%). Value is a percent of the motor nominal torque.</p> | |
| 2016 | <p>MIN TORQUE 2</p> <p>Sets the second minimum limit for torque (%). Value is a percent of the motor nominal torque.</p> | |

| Code | Description |
|------|--|
| 2017 | MAX TORQUE 1 Sets the first maximum limit for torque (%). Value is a percent of the motor nominal torque. |
| 2018 | MAX TORQUE 2 Sets the second maximum limit for torque (%). Value is a percent of the motor nominal torque. |

Group 21: START/STOP

This group defines how the motor starts and stops. The ACS550 supports several start and stop modes.

| Code | Description |
|------|---|
| 2101 | <p>START FUNCTION</p> <p>Selects the motor start method. The valid options depend on the value of parameter 9904 MOTOR CTRL MODE.</p> <p>1 = AUTO – Selects the automatic start mode.</p> <ul style="list-style-type: none"> • Vector control modes: Optimal start in most cases. The drive automatically selects the correct output frequency to start a rotating motor. • SCALAR:FREQ mode: Immediate start from zero frequency. <p>2 = DC MAGN – Selects the DC Magnetizing start mode.</p> <p>Note: The DC Magnetizing start mode cannot start a rotating motor.</p> <p>Note: The drive starts when the set pre-magnetizing time (parameter 2103 DC MAGN TIME) has passed, even if motor magnetization is not complete.</p> <ul style="list-style-type: none"> • Vector control modes: Magnetizes the motor within the time determined by the parameter 2103 DC MAGN TIME using DC current. The normal control is released exactly after the magnetizing time. This selection guarantees the highest possible break-away torque. • SCALAR:FREQ mode: Magnetizes the motor within the time determined by the parameter 2103 DC MAGN TIME using DC current. The normal control is released exactly after the magnetizing time. <p>3 = SCALAR FLYST – Selects the flying start mode.</p> <ul style="list-style-type: none"> • Vector control modes: Not applicable. • SCALAR:FREQ mode: The drive automatically selects the correct output frequency to start a rotating motor – useful if the motor is already rotating and if the drive will start smoothly at the current frequency. <p>4 = TORQ BOOST – Selects the automatic torque boost mode (SCALAR:FREQ mode only).</p> <ul style="list-style-type: none"> • May be necessary in drives with high starting torque. • Torque boost is only applied at start, ending when output frequency exceeds 20 Hz or when output frequency is equal to reference. • In the beginning the motor magnetizes within the time determined by the parameter 2103 DC MAGN TIME using DC current. • See parameter 2110 TORQ BOOST CURR. <p>5 = FLY + BOOST – Selects both the flying start and the torque boost mode (SCALAR:FREQ mode only).</p> <ul style="list-style-type: none"> • Flying start routine is performed first and the motor is magnetized. If the speed is found to be zero, the torque boost is done. <p>8 = RAMP – Immediate start from zero frequency.</p> |
| 2102 | <p>STOP FUNCTION</p> <p>Selects the motor stop method.</p> <p>1 = COAST – Selects cutting off the motor power as the stop method. The motor coasts to stop.</p> <p>2 = RAMP – Selects using a deceleration ramp.</p> <ul style="list-style-type: none"> • Deceleration ramp is defined by 2203 DECELER TIME 1 or 2206 DECELER TIME 2 (whichever is active). |
| 2103 | <p>DC MAGN TIME</p> <p>Defines the pre-magnetizing time for the DC Magnetizing start mode.</p> <ul style="list-style-type: none"> • Use parameter 2101 to select the start mode. • After the start command, the drive pre-magnetizes the motor for the time defined here and then starts the motor. • Set the pre-magnetizing time just long enough to allow full motor magnetization. Too long a time heats the motor excessively. |
| 2104 | <p>DC HOLD CTL</p> <p>Selects whether DC current is used for braking or DC Hold.</p> <p>0 = NOT SEL – Disables the DC current operation.</p> <p>1 = DC HOLD – Enables the DC Hold function. See the diagram.</p> <ul style="list-style-type: none"> • Requires parameter 9904 MOTOR CTRL MODE = 1 (VECTOR:SPEED) • Stops generating sinusoidal current and injects DC into the motor when both the reference and the motor speed drop below the value of parameter 2105. • When the reference rises above the level of parameter 2105 the drive resumes normal operation. <p>2 = DC BRAKING – Enables the DC Injection Braking after modulation has stopped.</p> <ul style="list-style-type: none"> • If parameter 2102 STOP FUNCTION is 1 (COAST), braking is applied after start is removed. • If parameter 2102 STOP FUNCTION is 2 (RAMP), braking is applied after ramp. |

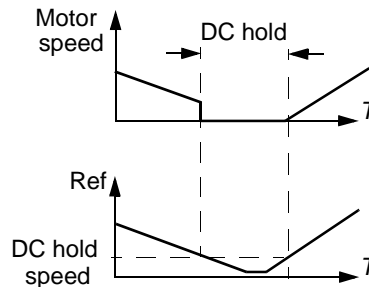

| Code | Description |
|------|---|
| 2105 | <p>DC HOLD SPEED</p> <p>Sets the speed for DC Hold. Requires that parameter 2104 DC HOLD CTL = 1 (DC HOLD).</p> |
| 2106 | <p>DC CURR REF</p> <p>Defines the DC current control reference as a percentage of parameter 9906 MOTOR NOM CURR.</p> |
| 2107 | <p>DC BRAKE TIME</p> <p>Defines the DC brake time after modulation has stopped, if parameter 2104 is 2 (DC BRAKING).</p> |
| 2108 | <p>START INHIBIT</p> <p>Sets the Start inhibit function on or off. The Start inhibit function ignores a pending start command in any of the following situations (a new start command is required):</p> <ul style="list-style-type: none"> • A fault is reset. • Run Enable (parameter 1601) activates while start command is active. • Mode changes from local to remote. • Control switches from EXT1 to EXT2. • Control switches from EXT2 to EXT1. <p>0 = OFF – Disables the Start inhibit function. 1 = ON – Enables the Start inhibit function.</p> |
| 2109 | <p>EMERG STOP SEL</p> <p>Defines control of the Emergency stop command. When activated:</p> <ul style="list-style-type: none"> • Emergency stop decelerates the motor using the emergency stop ramp (parameter 2208 EMERG DEC TIME). • Requires an external stop command and removal of the emergency stop command before drive can restart. <p>0 = NOT SEL – Disables the Emergency stop function through digital inputs. 1 = DI1 – Defines digital input DI1 as the control for Emergency stop command.</p> <ul style="list-style-type: none"> • Activating the digital input issues an Emergency stop command. • De-activating the digital input removes the Emergency stop command. <p>2...6 = DI2...DI6 – Defines digital input DI2...DI6 as the control for Emergency stop command.</p> <ul style="list-style-type: none"> • See DI1 above. <p>-1 = DI1(INV) – Defines an inverted digital input DI1 as the control for Emergency stop command.</p> <ul style="list-style-type: none"> • De-activating the digital input issues an Emergency stop command. • Activating the digital input removes the Emergency stop command. <p>-2...-6 = DI2(INV)...DI6(INV) – Defines an inverted digital input DI2...DI6 as the control for Emergency stop command.</p> <ul style="list-style-type: none"> • See DI1(INV) above. |
| 2110 | <p>TORQ BOOST CURR</p> <p>Sets the maximum supplied current during torque boost.</p> <ul style="list-style-type: none"> • See parameter 2101 START FUNCTION. |

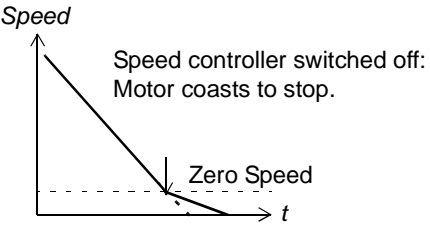
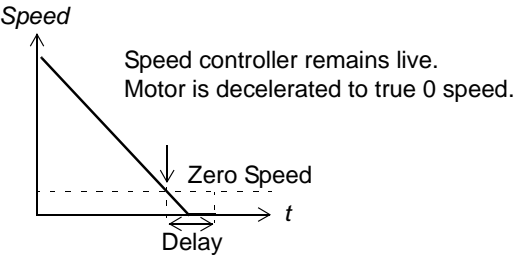
| Code | Description |
|------|--|
| 2112 | <p>ZERO SPEED DELAY</p> <p>Defines the delay for the Zero Speed Delay function. If parameter value is set to zero, the Zero Speed Delay function is disabled.</p> <p>The function is useful in applications where a smooth and quick restarting is essential. During the delay the drive knows accurately the rotor position.</p> <div style="display: flex; justify-content: space-around;"> <div data-bbox="263 373 694 640"> <p>No Zero Speed Delay</p>  </div> <div data-bbox="805 373 1324 661"> <p>With Zero Speed Delay</p>  </div> </div> <p>Zero speed delay can be used e.g. with jogging function or mechanical brake.</p> <p>No Zero Speed Delay</p> <p>The drive receives a stop command and decelerates along a ramp. When the motor actual speed falls below an internal limit (called Zero Speed), the speed controller is switched off. The drive modulation is stopped and the motor coasts to standstill.</p> <p>With Zero Speed Delay</p> <p>The drive receives a stop command and decelerates along a ramp. When the motor actual speed falls below an internal limit (called Zero Speed), the zero speed delay function activates. During the delay the functions keeps the speed controller live: The drive modulates, motor is magnetized and drive is ready for a quick restart.</p> <p>Note: Parameter 2102 STOP FUNCTION must be 2 = RAMP for zero speed delay to operate. 0.0 = NOT SEL – Disables the Zero Speed Delay function.</p> |
| 2113 | <p>START DELAY</p> <p>Defines the Start delay. After the conditions for start have been fulfilled, the drive waits until the delay has elapsed and then starts the motor. Start delay can be used with all start modes.</p> <ul style="list-style-type: none"> • If START DELAY = zero, the delay is disabled. • During the Start delay, alarm 2028 START DELAY is shown. |

Group 22: ACCEL/DECEL

This group defines ramps that control the rate of acceleration and deceleration. You define these ramps as a pair, one for acceleration and one for deceleration. You can define two pairs of ramps and use a digital input to select one or the other pair.

| Code | Description |
|------|--|
| 2201 | <p>ACC/DEC 1/2 SEL</p> <p>Defines control for selection of acceleration/deceleration ramps.</p> <ul style="list-style-type: none"> Ramps are defined in pairs, one each for acceleration and deceleration. See below for the ramp definition parameters. <p>0 = NOT SEL – Disables selection, the first ramp pair is used.</p> <p>1 = DI1 – Defines digital input DI1 as the control for ramp pair selection.</p> <ul style="list-style-type: none"> Activating the digital input selects ramp pair 2. De-activating the digital input selects ramp pair 1. <p>2...6 = DI2...DI6 – Defines digital input DI2...DI6 as the control for ramp pair selection.</p> <ul style="list-style-type: none"> See DI1 above. <p>7 = COMM – Defines bit 10 of the Command Word 1 as the control for ramp pair selection.</p> <ul style="list-style-type: none"> The Command Word is supplied through fieldbus communication. The Command Word is parameter 0301. <p>-1 = DI1(INV) – Defines an inverted digital input DI1 as the control for ramp pair selection.</p> <ul style="list-style-type: none"> De-activating the digital input selects ramp pair 2 Activating the digital input selects ramp pair 1. <p>-2...-6 = DI2(INV)...DI6(INV) – Defines an inverted digital input DI2...DI6 as the control for ramp pair selection.</p> <ul style="list-style-type: none"> See DI1(INV) above. |
| 2202 | <p>ACCELER TIME 1</p> <p>Sets the acceleration time for zero to maximum frequency for ramp pair 1. See A in the figure.</p> <ul style="list-style-type: none"> Actual acceleration time also depends on 2204 RAMP SHAPE 1. See 2008 MAXIMUM FREQ. |
| 2203 | <p>DECELER TIME 1</p> <p>Sets the deceleration time for maximum frequency to zero for ramp pair 1.</p> <ul style="list-style-type: none"> Actual deceleration time also depends on 2204 RAMP SHAPE 1. See 2008 MAXIMUM FREQ. |
| 2204 | <p>RAMP SHAPE 1</p> <p>Selects the shape of the acceleration/deceleration ramp for ramp pair 1. See B in the figure.</p> <ul style="list-style-type: none"> Shape is defined as a ramp, unless additional time is specified here to reach the maximum frequency. A longer time provides a softer transition at each end of the slope. The shape becomes an s-curve. Rule of thumb: 1/5 is a suitable relation between the ramp shape time and the acceleration ramp time. <p>0.0 = LINEAR – Specifies linear acceleration/deceleration ramps for ramp pair 1.</p> <p>0.1...1000.0 = S-CURVE – Specifies s-curve acceleration/deceleration ramps for ramp pair 1.</p> |
| 2205 | <p>ACCELER TIME 2</p> <p>Sets the acceleration time for zero to maximum frequency for ramp pair 2.</p> <ul style="list-style-type: none"> See 2202 ACCELER TIME 1. Used also as jogging acceleration time. See 1004 JOGGING SEL. |
| 2206 | <p>DECELER TIME 2</p> <p>Sets the deceleration time for maximum frequency to zero for ramp pair 2.</p> <ul style="list-style-type: none"> See 2203 DECELER TIME 1. Used also as jogging deceleration time. See 1004 JOGGING SEL. |
| 2207 | <p>RAMP SHAPE 2</p> <p>Selects the shape of the acceleration/deceleration ramp for ramp pair 2.</p> <ul style="list-style-type: none"> See 2204 RAMP SHAPE 1. |

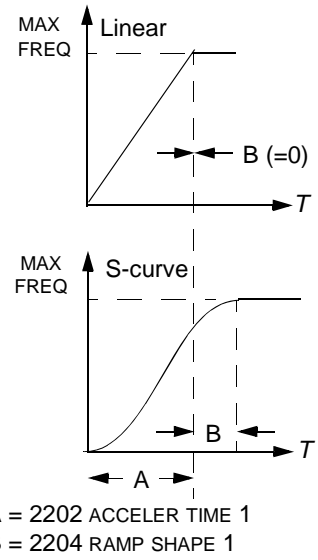

| Code | Description |
|------|---|
| 2208 | <p>EMERG DEC TIME</p> <p>Sets the deceleration time for maximum frequency to zero for an emergency.</p> <ul style="list-style-type: none"> • See parameter 2109 EMERG STOP SEL. • Ramp is linear. |
| 2209 | <p>RAMP INPUT 0</p> <p>Defines control for forcing the ramp input to 0.</p> <p>0 = NOT SEL – Not selected.</p> <p>1 = DI1 – Defines digital input DI1 as the control for forcing the ramp input to 0.</p> <ul style="list-style-type: none"> • Activating the digital input forces ramp input to 0. Ramp output will ramp to 0 according to the currently used ramp time, after which it will stay at 0. • De-activating the digital input: ramp resumes normal operation. <p>2...6 = DI2...DI6 – Defines digital input DI2...DI6 as the control for forcing the ramp input to 0.</p> <ul style="list-style-type: none"> • See DI1 above. <p>7 = COMM – Defines bit 13 of the Command Word 1 as the control for forcing the ramp input to 0.</p> <ul style="list-style-type: none"> • The Command Word is supplied through fieldbus communication. • The Command Word is parameter 0301. <p>-1 = DI1(INV) – Defines an inverted digital input DI1 as the control for forcing the ramp input to 0.</p> <ul style="list-style-type: none"> • De-activating the digital input forces ramp input to 0. • Activating the digital input: ramp resumes normal operation. <p>-2...-6 = DI2(INV)...DI6(INV) – Defines an inverted digital input DI2...DI6 as the control for forcing the ramp function generator input to 0.</p> <ul style="list-style-type: none"> • See DI1(INV) above. |

Group 23: SPEED CONTROL

This group defines variables used for speed control operation.

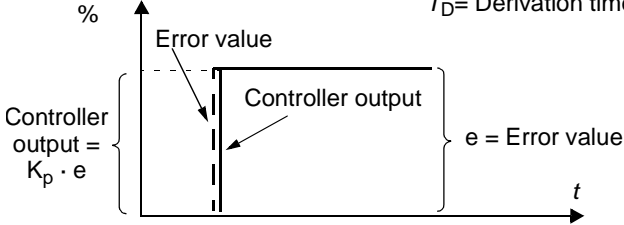
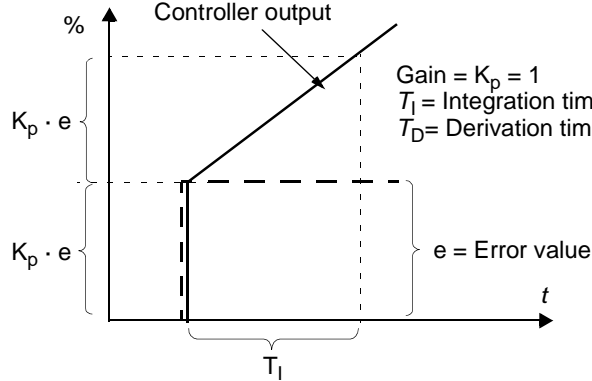
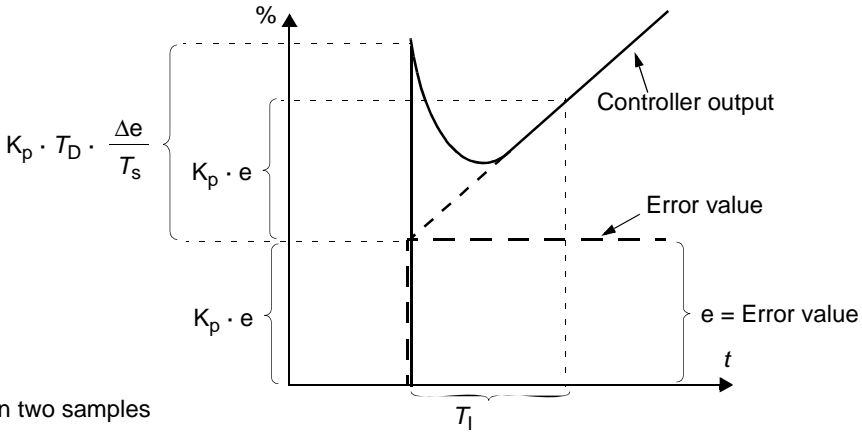
| Code | Description |
|------|---|
| 2301 | <p>PROP GAIN</p> <p>Sets the relative gain for the speed controller.</p> <ul style="list-style-type: none"> • Larger values may cause speed oscillation. • The figure shows the speed controller output after an error step (error remains constant). <p>Note: You can use parameter 2305 AUTOTUNE RUN to automatically set the proportional gain.</p> <div style="text-align: right;"> <p>Gain = $K_p = 1$ $T_I =$ Integration time = 0 $T_D =$ Derivation time = 0</p> </div>  |
| 2302 | <p>INTEGRATION TIME</p> <p>Sets the integration time for the speed controller.</p> <ul style="list-style-type: none"> • The integration time defines the rate at which the controller output changes for a constant error value. • Shorter integration times correct continuous errors faster. • Control becomes unstable if the integration time is too short. • The figure shows the speed controller output after an error step (error remains constant). <p>Note: You can use parameter 2305 AUTOTUNE RUN to automatically set the integration time.</p> <div style="text-align: right;"> <p>Gain = $K_p = 1$ $T_I =$ Integration time > 0 $T_D =$ Derivation time = 0</p> </div>  |
| 2303 | <p>DERIVATION TIME</p> <p>Sets the derivation time for the speed controller.</p> <ul style="list-style-type: none"> • Derivative action makes the control more responsive to error value changes. • The longer the derivation time, the more the speed controller output is boosted during the change. • If the derivation time is set to zero, the controller works as a PI controller, otherwise as a PID controller. <p>The figure below shows the speed controller output after an error step when the error remains constant.</p> <div style="text-align: right;"> <p>Gain = $K_p = 1$ $T_I =$ Integration time > 0 $T_D =$ Derivation time > 0 $T_s =$ Sample time period = 2 ms $\Delta e =$ Error value change between two samples</p> </div>  |

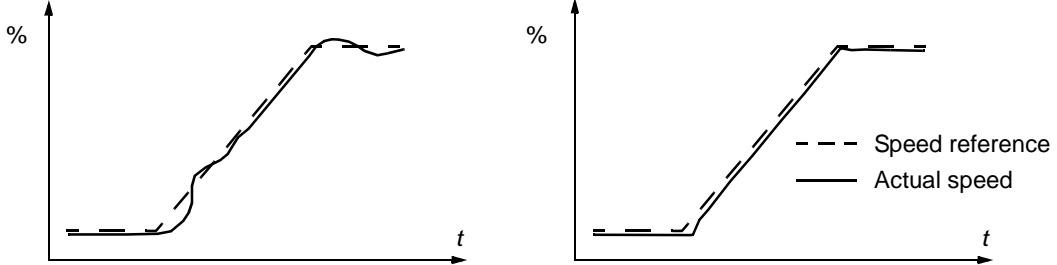
| Code | Description |
|------|---|
| 2304 | <p>ACC COMPENSATION</p> <p>Sets the derivation time for acceleration compensation.</p> <ul style="list-style-type: none"> • Adding a derivative of the reference to the output of the speed controller compensates for inertia during acceleration. • 2303 DERIVATION TIME describes the principle of derivative action. • Rule of thumb: Set this parameter between 50 and 100% of the sum of the mechanical time constants for the motor and the driven machine. • The figure shows the speed responses when a high inertia load is accelerated along a ramp. <p>* No acceleration compensation Acceleration compensation</p>  <p>*Note: You can use parameter 2305 AUTOTUNE RUN to automatically set acceleration compensation.</p> |
| 2305 | <p>AUTOTUNE RUN</p> <p>Starts automatic tuning of the speed controller.</p> <p>0 = OFF – Disables the Autotune creation process. (Does not disable the operation of Autotune settings.)</p> <p>1 = ON – Activates speed controller autotuning. Automatically reverts to OFF.</p> <p>Procedure:</p> <p>Note: The motor load must be connected.</p> <ul style="list-style-type: none"> • Run the motor at a constant speed of 20 to 40% of the rated speed. • Change the autotuning parameter 2305 to ON. <p>The drive:</p> <ul style="list-style-type: none"> • Accelerates the motor. • Calculates values for proportional gain, integration time and acceleration compensation. • Changes parameters 2301, 2302 and 2304 to these values. • Resets 2305 to OFF. |

Group 24: TORQUE CONTROL

This group defines variables used for torque control operation.

| Code | Description |
|-------------|--|
| 2401 | TORQ RAMP UP Defines the torque reference ramp up time – The minimum time for the reference to increase from zero to the nominal motor torque. |
| 2402 | TORQ RAMP DOWN Defines the torque reference ramp down time – The minimum time for the reference to decrease from the nominal motor torque to zero. |

Group 25: CRITICAL SPEEDS

This group defines up to three critical speeds or ranges of speeds that are to be avoided due, for example, to mechanical resonance problems at certain speeds.

| Code | Description |
|------|---|
| 2501 | <p>CRIT SPEED SEL</p> <p>Sets the critical speeds function on or off. The critical speed function avoids specific speed ranges.</p> <p>0 = OFF – Disables the critical speeds function. 1 = ON – Enables the critical speeds function.</p> <p>Example: To avoid speeds at which a fan system vibrates badly:</p> <ul style="list-style-type: none"> • Determine problem speed ranges. Assume they are found to be: 18...23 Hz and 46...52 Hz. • Set 2501 CRIT SPEED SEL = 1. • Set 2502 CRIT SPEED 1 LO = 18 Hz. • Set 2503 CRIT SPEED 1 HI = 23 Hz. • Set 2504 CRIT SPEED 2 LO = 46 Hz. • Set 2505 CRIT SPEED 2 HI = 52 Hz. |
| 2502 | <p>CRIT SPEED 1 LO</p> <p>Sets the minimum limit for critical speed range 1.</p> <ul style="list-style-type: none"> • The value must be less than or equal to 2503 CRIT SPEED 1 HI. • Units are rpm, unless 9904 MOTOR CTRL MODE = 3 (SCALAR:FREQ), then units are Hz. |
| 2503 | <p>CRIT SPEED 1 HI</p> <p>Sets the maximum limit for critical speed range 1.</p> <ul style="list-style-type: none"> • The value must be greater than or equal to 2502 CRIT SPEED 1 LO. • Units are rpm, unless 9904 MOTOR CTRL MODE = 3 (SCALAR:FREQ), then units are Hz. |
| 2504 | <p>CRIT SPEED 2 LO</p> <p>Sets the minimum limit for critical speed range 2.</p> <ul style="list-style-type: none"> • See parameter 2502. |
| 2505 | <p>CRIT SPEED 2 HI</p> <p>Sets the maximum limit for critical speed range 2.</p> <ul style="list-style-type: none"> • See parameter 2503. |
| 2506 | <p>CRIT SPEED 3 LO</p> <p>Sets the minimum limit for critical speed range 3.</p> <ul style="list-style-type: none"> • See parameter 2502. |
| 2507 | <p>CRIT SPEED 3 HI</p> <p>Sets the maximum limit for critical speed range 3.</p> <ul style="list-style-type: none"> • See parameter 2503. |

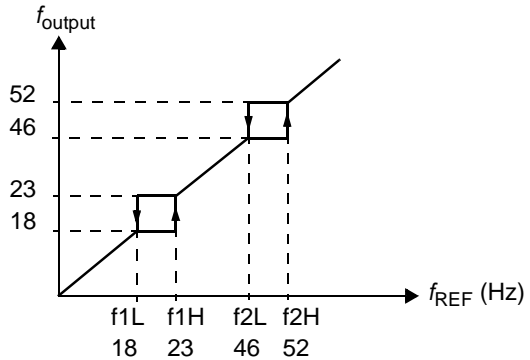

Group 26: MOTOR CONTROL

This group defines variables used for motor control.

| Code | Description | | | | | | | | | | | | | | | | | | | |
|--------------------|--|---|----|----|-----|--|--|------------|---|-----|----|----|-----|-------------|----|----|----|---|---|---|
| 2601 | <p>FLUX OPT ENABLE</p> <p>Changes the magnitude of the flux depending on the actual load. Flux Optimization can reduce the total energy consumption and noise, and it should be enabled for drives that usually operate below nominal load.</p> <p>0 = OFF – Disables the feature. 1 = ON – Enables the feature.</p> | | | | | | | | | | | | | | | | | | | |
| 2602 | <p>FLUX BRAKING</p> <p>Provides faster deceleration by raising the level of magnetization in the motor when needed, instead of limiting the deceleration ramp. By increasing the flux in the motor, the energy of the mechanical system is changed to thermal energy in the motor.</p> <ul style="list-style-type: none"> Requires parameter 9904 MOTOR CTRL MODE = 1 (VECTOR:SPEED) OR 2 (VECTOR:TORQ). <p>0 = OFF – Disables the feature. 1 = ON – Enables the feature.</p> <div style="display: flex; justify-content: space-between;"> <div style="width: 45%;"> </div> <div style="width: 45%;"> <p>Rated motor power</p> <ul style="list-style-type: none"> ① 2.2 kW ② 15 kW ③ 37 kW ④ 75 kW ⑤ 250 kW </div> </div> | | | | | | | | | | | | | | | | | | | |
| 2603 | <p>IR COMP VOLT</p> <p>Sets the IR compensation voltage used for 0 Hz.</p> <ul style="list-style-type: none"> Requires parameter 9904 MOTOR CTRL MODE = 3 (SCALAR:FREQ). Keep IR compensation as low as possible to prevent overheating. Typical IR compensation values are: <table border="1" style="width: 100%; text-align: center;"> <thead> <tr> <th colspan="6">380...480 V drives</th> </tr> <tr> <th>P_N (kW)</th> <td>3</td> <td>7.5</td> <td>15</td> <td>37</td> <td>132</td> </tr> <tr> <th>IR comp (V)</th> <td>18</td> <td>15</td> <td>12</td> <td>8</td> <td>3</td> </tr> </thead> </table> | 380...480 V drives | | | | | | P_N (kW) | 3 | 7.5 | 15 | 37 | 132 | IR comp (V) | 18 | 15 | 12 | 8 | 3 | <p>IR compensation</p> <ul style="list-style-type: none"> When enabled, IR compensation provides an extra voltage boost to the motor at low speeds. Use IR compensation, for example, in applications that require a high breakaway torque. <div style="text-align: center;"> <p>A = IR compensated B = No compensation</p> </div> |
| 380...480 V drives | | | | | | | | | | | | | | | | | | | | |
| P_N (kW) | 3 | 7.5 | 15 | 37 | 132 | | | | | | | | | | | | | | | |
| IR comp (V) | 18 | 15 | 12 | 8 | 3 | | | | | | | | | | | | | | | |
| 2604 | <p>IR COMP FREQ</p> <p>Sets the frequency at which IR compensation is 0 V (in % of motor frequency).</p> | <p style="text-align: center;">P 2604</p> | | | | | | | | | | | | | | | | | | |
| 2605 | <p>U/F RATIO</p> <p>Selects the form for the U/f (voltage to frequency) ratio below field weakening point.</p> <p>1 = LINEAR – Preferred for constant torque applications. 2 = SQUARED – Preferred for centrifugal pump and fan applications. (SQUARED is more silent for most operating frequencies.)</p> | | | | | | | | | | | | | | | | | | | |
| 2606 | <p>SWITCHING FREQ</p> <p>Sets the switching frequency for the drive. Also see parameter 2607 SWITCH FREQ CTRL.</p> <ul style="list-style-type: none"> Higher switching frequencies mean less noise. Available switching frequencies 1 and 4 kHz. | | | | | | | | | | | | | | | | | | | |

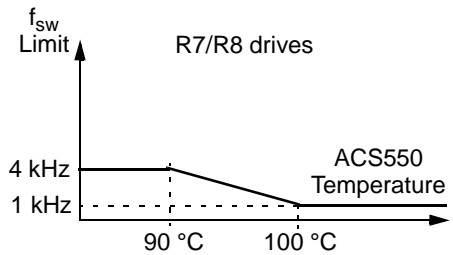
| Code | Description |
|------|---|
| 2607 | <p>SWITCH FREQ CTRL</p> <p>The switching frequency may be reduced if the ACS550 internal temperature rises above a limit. See the figure. This function allows the highest possible switching frequency to be used based on operating conditions. Higher switching frequency results in lower acoustic noise.</p> <p>0 = OFF – The function is disabled. 1 = ON – The switching frequency is limited according to the figure.</p>  |
| 2608 | <p>SLIP COMP RATIO</p> <p>Sets gain for slip compensation (in %).</p> <ul style="list-style-type: none"> • A squirrel-cage motor slips under load. Increasing the frequency as the motor torque increases compensates for the slip. • Requires parameter 9904 MOTOR CTRL MODE = 3 (SCALAR:FREQ). <p>0 – No slip compensation. 1...200 – Increasing slip compensation. 100% means full slip compensation.</p> |
| 2609 | <p>NOISE SMOOTHING</p> <p>This parameter introduces a random component to the switching frequency. Noise smoothing distributes the acoustic motor noise over a range of frequencies instead of a single tonal frequency resulting in lower peak noise intensity. The random component has an average of 0 Hz. It is added to the switching frequency set by parameter 2606 SWITCHING FREQ.</p> <p>0 = DISABLE 1 = ENABLE.</p> |
| 2619 | <p>DC STABILIZER</p> <p>Enables or disables the DC voltage stabilizer. The DC stabilizer is used in scalar control mode to prevent possible voltage oscillations in the drive DC bus caused by motor load or weak supply network. In case of voltage variation the drive tunes the frequency reference to stabilize the DC bus voltage and therefore the load torque oscillation.</p> <p>0 = DISABLE – Disables DC stabilizer. 1 = ENABLE – Enables DC stabilizer.</p> |



Group 29: MAINTENANCE TRIG

This group contains usage levels and trigger points. When usage reaches the set trigger point, a notice displayed on the control panel signals that maintenance is due.

| Code | Description |
|-------------|--|
| 2901 | <p>COOLING FAN TRIG</p> <p>Sets the trigger point for the drive's cooling fan counter.</p> <ul style="list-style-type: none"> Value is compared to parameter 2902 value. <p>0.0 – Disables the trigger.</p> |
| 2902 | <p>COOLING FAN ACT</p> <p>Defines the actual value of the drive's cooling fan counter.</p> <ul style="list-style-type: none"> When parameter 2901 has been set to a non-zero value, the counter starts. When the actual value of the counter exceeds the value defined by parameter 2901, a maintenance notice is displayed on the panel. <p>0.0 – Resets the parameter.</p> |
| 2903 | <p>REVOLUTION TRIG</p> <p>Sets the trigger point for the motor's accumulated revolutions counter.</p> <ul style="list-style-type: none"> Value is compared to parameter 2904 value. <p>0 – Disables the trigger.</p> |
| 2904 | <p>REVOLUTION ACT</p> <p>Defines the actual value of the motor's accumulated revolutions counter.</p> <ul style="list-style-type: none"> When parameter 2903 has been set to a non-zero value, the counter starts. When the actual value of the counter exceeds the value defined by parameter 2903, a maintenance notice is displayed on the panel. <p>0 – Resets the parameter.</p> |
| 2905 | <p>RUN TIME TRIG</p> <p>Sets the trigger point for the drive's run time counter.</p> <ul style="list-style-type: none"> Value is compared to parameter 2906 value. <p>0.0 – Disables the trigger.</p> |
| 2906 | <p>RUN TIME ACT</p> <p>Defines the actual value of the drive's run time counter.</p> <ul style="list-style-type: none"> When parameter 2905 has been set to a non-zero value, the counter starts. When the actual value of the counter exceeds the value defined by parameter 2905, a maintenance notice is displayed on the panel. <p>0.0 – Resets the parameter.</p> |
| 2907 | <p>USER MWh TRIG</p> <p>Sets the trigger point for the drive's accumulated power consumption (in megawatt hours) counter.</p> <ul style="list-style-type: none"> Value is compared to parameter 2908 value. <p>0.0 – Disables the trigger.</p> |
| 2908 | <p>USER MWh ACT</p> <p>Defines the actual value of the drive's accumulated power consumption (in megawatt hours) counter.</p> <ul style="list-style-type: none"> When parameter 2907 has been set to a non-zero value, the counter starts. When the actual value of the counter exceeds the value defined by parameter 2907, a maintenance notice is displayed on the panel. <p>0.0 – Resets the parameter.</p> |

Group 30: FAULT FUNCTIONS

This group defines situations that the drive should recognize as potential faults and defines how the drive should respond if the fault is detected.

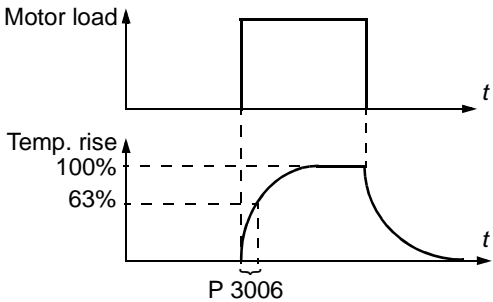
| Code | Description |
|------|--|
| 3001 | <p>AI<MIN FUNCTION</p> <p>Defines the drive response if the analog input (AI) signal drops below the fault limits and AI is used in reference chain.</p> <ul style="list-style-type: none"> • 3021 AI1 FAULT LIMIT and 3022 AI2 FAULT LIMIT set the fault limits <p>0 = NOT SEL – No response. 1 = FAULT – Displays a fault (7, AI1 LOSS or 8, AI2 LOSS) and the drive coasts to stop. 2 = CONST SP 7 – Displays an alarm (2006, AI1 LOSS or 2007, AI2 LOSS) and sets speed using 1208 CONST SPEED 7. 3 = LAST SPEED – Displays an alarm (2006, AI1 LOSS or 2007, AI2 LOSS) and sets speed using the last operating level. This value is the average speed over the last 10 seconds.</p> <p> WARNING! If you select CONST SP 7 or LAST SPEED, make sure that continued operation is safe when the analog input signal is lost.</p> |
| 3002 | <p>PANEL COMM ERR</p> <p>Defines the drive response to a control panel communication error.</p> <p>1 = FAULT – Displays a fault (10, PANEL LOSS) and the drive coasts to stop. 2 = CONST SP 7 – Displays an alarm (2008, PANEL LOSS) and sets speed using 1208 CONST SPEED 7. 3 = LAST SPEED – Displays an alarm (2008, PANEL LOSS) and sets speed using the last operating level. This value is the average speed over the last 10 seconds.</p> <p> WARNING! If you select CONST SP 7 or LAST SPEED, make sure that continued operation is safe when the control panel communication is lost.</p> |
| 3003 | <p>EXTERNAL FAULT 1</p> <p>Defines the External Fault 1 signal input and the drive response to an external fault.</p> <p>0 = NOT SEL – External fault signal is not used. 1 = DI1 – Defines digital input DI1 as the external fault input. <ul style="list-style-type: none"> • Activating the digital input indicates a fault. The drive displays a fault (14, EXT FAULT 1) and the drive coasts to stop. 2...6 = DI2...DI6 – Defines digital input DI2...DI6 as the external fault input. <ul style="list-style-type: none"> • See DI1 above. -1 = DI1(INV) – Defines an inverted digital input DI1 as the external fault input. <ul style="list-style-type: none"> • De-activating the digital input indicates a fault. The drive displays a fault (14, EXT FAULT 1) and the drive coasts to stop. -2...-6 = DI2(INV)...DI6(INV) – Defines an inverted digital input DI2...DI6 as the external fault input. <ul style="list-style-type: none"> • See DI1(INV) above. </p> |
| 3004 | <p>EXTERNAL FAULT 2</p> <p>Defines the External Fault 2 signal input and the drive response to an external fault.</p> <ul style="list-style-type: none"> • See parameter 3003 above. |
| 3005 | <p>MOT THERM PROT</p> <p>Defines the drive response to motor overheating.</p> <p>0 = NOT SEL – No response and/or motor thermal protection not set up. 1 = FAULT – When the calculated motor temperature exceeds 90 °C, displays an alarm (2010, MOTOR TEMP). When the calculated motor temperature exceeds 110 °C, displays a fault (9, MOT OVERTEMP) and the drive coasts to stop. 2 = ALARM – When the calculated motor temperature exceeds 90 °C, displays an alarm (2010, MOTOR TEMP).</p> |
| 3006 | <p>MOT THERM TIME</p> <p>Sets the motor thermal time constant for the motor temperature model.</p> <ul style="list-style-type: none"> • This is the time required for the motor to reach 63% of the final temperature with steady load. • For thermal protection according to UL requirements for NEMA class motors, use the rule of thumb: MOTOR THERM TIME equals 35 times t_6, where t_6 (in seconds) is specified by the motor manufacturer as the time that the motor can safely operate at six times its rated current. • The thermal time for a Class 10 trip curve is 350 s, for a Class 20 trip curve 700 s, and for a Class 30 trip curve 1050 s. <div style="text-align: right;">  </div> |

| Code | Description | |
|---|---|---|
| 3007 | <p>MOT LOAD CURVE</p> <p>Sets the maximum allowable operating load of the motor.</p> <ul style="list-style-type: none"> When set to 100%, the maximum allowable load is equal to the value of parameter 9906 MOTOR NOM CURR. Adjust the load curve level if the ambient temperature differs from nominal. | |
| 3008 | <p>ZERO SPEED LOAD</p> <p>Sets the maximum allowable current at zero speed.</p> <ul style="list-style-type: none"> Value is relative to 9906 MOTOR NOM CURR. | |
| 3009 | <p>BREAK POINT FREQ</p> <p>Sets the break point frequency for the motor load curve.</p> | |
| <p>Example: Thermal protection trip times when parameters 3006 MOT THERM TIME, 3007 MOT LOAD CURVE and 3008 ZERO SPEED LOAD have default values.</p> | | |
| | | <p>I_O = Output current I_N = Nominal motor current f_O = Output frequency f_{BRK} = Break point frequency A = Trip time</p> |
| 3010 | <p>STALL FUNCTION</p> <p>This parameter defines the operation of the Stall function. This protection is active if the drive operates in the stall region (see the figure) for the time defined by 3012 STALL TIME. The "User Limit" is defined in Group 20: LIMITS by 2017 MAX TORQUE 1, 2018 MAX TORQUE 2, or the limit on the COMM input.</p> <p>0 = NOT SEL – Stall protection is not used. 1 = FAULT – When the drive operates in the stall region for the time set by 3012 STALL TIME:</p> <ul style="list-style-type: none"> The drive coasts to stop. A fault indication is displayed. <p>2 = ALARM – When the drive operates in the stall region for the time set by 3012 STALL TIME:</p> <ul style="list-style-type: none"> An alarm indication is displayed. The alarm disappears when the drive is out of the stall region for half the time set by parameter 3012 STALL TIME. | |
| 3011 | <p>STALL FREQUENCY</p> <p>This parameter sets the frequency value for the Stall function. Refer to the figure.</p> | |
| 3012 | <p>STALL TIME</p> <p>This parameter sets the time value for the Stall function.</p> | |
| 3017 | <p>EARTH FAULT</p> <p>Defines the drive response if the drive detects a ground fault in the motor or motor cables. The drive monitors for ground faults while the drive is running, and while the drive is not running. Also see parameter 3023 WIRING FAULT.</p> <p>0 = DISABLE – No drive response to ground faults. 1 = ENABLE – Ground faults display fault 16 (EARTH FAULT), and (if running) the drive coasts to stop.</p> | |

| Code | Description |
|------|---|
| 3018 | <p>COMM FAULT FUNC</p> <p>Defines the drive response if the fieldbus communication is lost.</p> <p>0 = NOT SEL – No response.</p> <p>1 = FAULT – Displays a fault (28, SERIAL 1 ERR) and the drive coasts to stop.</p> <p>2 = CONST SP 7 – Displays an alarm (2005, I/O COMM) and sets speed using 1208 CONST SPEED 7. This “alarm speed” remains active until the fieldbus writes a new reference value.</p> <p>3 = LAST SPEED – Displays an alarm (2005, I/O COMM) and sets speed using the last operating level. This value is the average speed over the last 10 seconds. This “alarm speed” remains active until the fieldbus writes a new reference value.</p> <p> WARNING! If you select CONST SP 7, or LAST SPEED, make sure that continued operation is safe when fieldbus communication is lost.</p> |
| 3019 | <p>COMM FAULT TIME</p> <p>Sets the communication fault time used with 3018 COMM FAULT FUNC.</p> <ul style="list-style-type: none"> Brief interruptions in the fieldbus communication are not treated as faults if they are less than the COMM FAULT TIME value. |
| 3021 | <p>AI1 FAULT LIMIT</p> <p>Sets a fault level for analog input 1.</p> <ul style="list-style-type: none"> See 3001 AI<MIN FUNCTION. |
| 3022 | <p>AI2 FAULT LIMIT</p> <p>Sets a fault level for analog input 2.</p> <ul style="list-style-type: none"> See 3001 AI<MIN FUNCTION. |
| 3023 | <p>WIRING FAULT</p> <p>Defines the drive response to cross wiring faults and to ground faults detected when the drive is NOT running. When the drive is not running it monitors for:</p> <ul style="list-style-type: none"> Improper connections of input power to the drive output (the drive can display fault 35, OUTPUT WIRING if improper connections are detected). Ground faults (the drive can display fault 16, EARTH FAULT if a ground fault is detected). Also, see parameter 3017 EARTH FAULT. <p>0 = DISABLE – No drive response to either of the above monitoring results.</p> <p>1 = ENABLE – The drive displays faults when this monitoring detects problems.</p> |
| 3024 | <p>CB TEMP FAULT</p> <p>Defines the drive response to control board overheating. Not for drives with an OMIO control board.</p> <p>0 = DISABLE – No response.</p> <p>1 = ENABLE – Displays fault 37 (CB OVERTEMP) and the drive coasts to stop.</p> |

Group 31: AUTOMATIC RESET

This group defines conditions for automatic resets. An automatic reset occurs after a particular fault is detected. The drive holds for a set delay time, then automatically restarts. You can limit the number of resets in a specified time period and set up automatic resets for a variety of faults.

| Code | Description | |
|------|---|---|
| 3101 | <p>NUMBER OF TRIALS</p> <p>Sets the number of allowed automatic resets within a trial period defined by 3102 TRIAL TIME.</p> <ul style="list-style-type: none"> If the number of automatic resets exceeds this limit (within the trial time), the drive prevents additional automatic resets and remains stopped. Starting then requires a successful reset performed from the control panel or from a source selected by 1604 FAULT RESET SEL. | <p>Example: Three faults have occurred in the trial time. The last is reset only if the value for 3101 NUMBER OF TRIALS is 3 or more.</p> <p>x = Automatic reset</p> |
| 3102 | <p>TRIAL TIME</p> <p>Sets the time period used for counting and limiting the number of resets.</p> <ul style="list-style-type: none"> See 3101 NUMBER OF TRIALS. | |
| 3103 | <p>DELAY TIME</p> <p>Sets the delay time between a fault detection and attempted drive restart.</p> <ul style="list-style-type: none"> If DELAY TIME = zero, the drive resets immediately. | |
| 3104 | <p>AR OVERCURRENT</p> <p>Sets the automatic reset for the overcurrent function on or off.</p> <p>0 = DISABLE – Disables automatic reset. 1 = ENABLE – Enables automatic reset.</p> <ul style="list-style-type: none"> Automatically resets the fault (OVERCURRENT) after the delay set by 3103 DELAY TIME, and the drive resumes normal operation. | |
| 3105 | <p>AR OVERVOLTAGE</p> <p>Sets the automatic reset for the overvoltage function on or off.</p> <p>0 = DISABLE – Disables automatic reset. 1 = ENABLE – Enables automatic reset.</p> <ul style="list-style-type: none"> Automatically resets the fault (DC OVERVOLT) after the delay set by 3103 DELAY TIME, and the drive resumes normal operation. | |
| 3106 | <p>AR UNDERVOLTAGE</p> <p>Sets the automatic reset for the undervoltage function on or off.</p> <p>0 = DISABLE – Disables automatic reset. 1 = ENABLE – Enables automatic reset.</p> <ul style="list-style-type: none"> Automatically resets the fault (DC UNDERVOLT) after the delay set by 3103 DELAY TIME, and the drive resumes normal operation. | |
| 3107 | <p>AR AI<MIN</p> <p>Sets the automatic reset for the analog input less than minimum value function on or off.</p> <p>0 = DISABLE – Disables automatic reset. 1 = ENABLE – Enables automatic reset.</p> <ul style="list-style-type: none"> Automatically resets the fault (AI<MIN) after the delay set by 3103 DELAY TIME, and the drive resumes normal operation. <p> WARNING! When the analog input signal is restored, the drive may restart, even after a long stop. Make sure that automatic, long delayed starts will not cause physical injury and/or damage equipment.</p> | |
| 3108 | <p>AR EXTERNAL FLT</p> <p>Sets the automatic reset for external faults function on or off.</p> <p>0 = DISABLE – Disables automatic reset. 1 = ENABLE – Enables automatic reset.</p> <ul style="list-style-type: none"> Automatically resets the fault (EXT FAULT 1 or EXT FAULT 2) after the delay set by 3103 DELAY TIME, and the drive resumes normal operation. | |

Group 32: SUPERVISION

This group defines supervision for up to three signals from *Group 01: OPERATING DATA*. Supervision monitors a specified parameter and energizes a relay output if the parameter passes a defined limit. Use *Group 14: RELAY OUTPUTS* to define the relay and whether the relay activates when the signal is too low or too high.

| Code | Description |
|------|---|
| 3201 | <p>SUPERV 1 PARAM</p> <p>Selects the first supervised parameter.</p> <ul style="list-style-type: none"> Must be a parameter number from <i>Group 01: OPERATING DATA</i>. 100 = NOT SELECTED – No parameter selected. 101...159 – Selects parameter 0101...0159. If the supervised parameter passes a limit, a relay output is energized. The supervision limits are defined in this group. The relay outputs are defined in <i>Group 14: RELAY OUTPUTS</i> (definition also specifies which supervision limit is monitored). <p>LO ≤ HI</p> <p>Operating data supervision using relay outputs, when LO ≤ HI.</p> <ul style="list-style-type: none"> Case A = Parameter 1401 RELAY OUTPUT 1 (or 1402 RELAY OUTPUT 2, etc.) value is SUPRV1 OVER or SUPRV2 OVER. Use for monitoring when/if the supervised signal exceeds a given limit. The relay remains active until the supervised value drops below the low limit. Case B = Parameter 1401 RELAY OUTPUT 1 (or 1402 RELAY OUTPUT 2, etc.) value is SUPRV1 UNDER or SUPRV2 UNDER. Use for monitoring when/if the supervised signal falls below a given limit. The relay remains active until the supervised value rises above the high limit. <p>LO > HI</p> <p>Operating data supervision using relay outputs, when LO > HI. The lowest limit (HI 3203) is active initially and remains active until the supervised parameter goes above the highest limit (LO 3202), making that limit the active limit. That limit remains active until the supervised parameter goes below the lowest limit (HI 3203), making that limit active.</p> <ul style="list-style-type: none"> Case A = Parameter 1401 RELAY OUTPUT 1 (or 1402 RELAY OUTPUT 2, etc.) value is SUPRV1 OVER or SUPRV2 OVER. Initially the relay is de-energized. It is energized whenever the supervised parameter goes above the active limit. Case B = Parameter 1401 RELAY OUTPUT 1 (or 1402 RELAY OUTPUT 2, etc.) value is SUPRV1 UNDER or SUPRV2 UNDER. Initially the relay is energized. It is de-energized whenever the supervised parameter goes below the active limit. |
| 3202 | <p>SUPERV 1 LIM LO</p> <p>Sets the low limit for the first supervised parameter. See 3201 SUPERV 1 PARAM above.</p> |
| 3203 | <p>SUPERV 1 LIM HI</p> <p>Sets the high limit for the first supervised parameter. See 3201 SUPERV 1 PARAM above.</p> |
| 3204 | <p>SUPERV 2 PARAM</p> <p>Selects the second supervised parameter. See 3201 SUPERV 1 PARAM above.</p> |
| 3205 | <p>SUPERV 2 LIM LO</p> <p>Sets the low limit for the second supervised parameter. See 3204 SUPERV 2 PARAM above.</p> |
| 3206 | <p>SUPERV 2 LIM HI</p> <p>Sets the high limit for the second supervised parameter. See 3204 SUPERV 2 PARAM above.</p> |

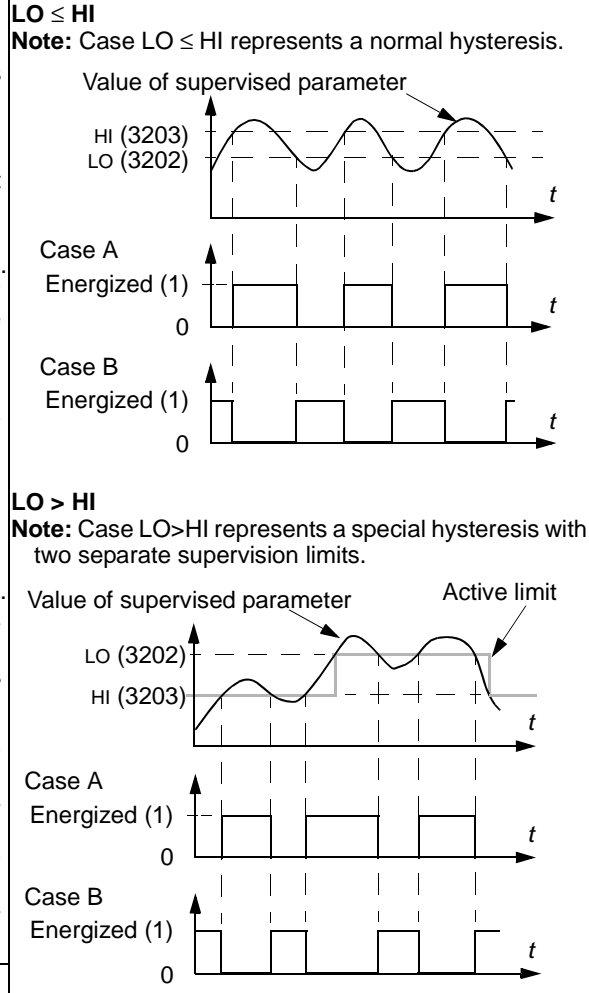

| Code | Description |
|-------------|--|
| 3207 | SUPERV 3 PARAM Selects the third supervised parameter. See 3201 SUPERV 1 PARAM above. |
| 3208 | SUPERV 3 LIM LO Sets the low limit for the third supervised parameter. See 3207 SUPERV 3 PARAM above. |
| 3209 | SUPERV 3 LIM HI Sets the high limit for the third supervised parameter. See 3207 SUPERV 3 PARAM above. |

Group 33: INFORMATION

This group provides access to information about the drive's current programs: versions and test date.

| Code | Description |
|------|---|
| 3301 | FIRMWARE Contains the version of the drive's firmware. |
| 3302 | LOADING PACKAGE Contains the version of the loading package. |
| 3303 | TEST DATE Contains the test date (yy.ww). |
| 3304 | DRIVE RATING Indicates the drive's current and voltage rating. The format is XXXY, where: <ul style="list-style-type: none"> • XXX = The nominal current rating of the drive in amperes. If present, an "A" indicates a decimal point in the rating for the current. For example XXX = 8A8 indicates a nominal current rating of 8.8 A. • Y = The voltage rating of the drive, where Y = : <ul style="list-style-type: none"> • 2 indicates a 208...240 V rating. • 4 indicates a 380...480 V rating. • 6 indicates a 500...600 V rating. |
| 3305 | PARAMETER TABLE Contains the version of the parameter table used in the drive. |

Group 34: PANEL DISPLAY

This group defines the content for control panel display (middle area), when the control panel is in the Output mode.

| Code | Description | | | | | | | | | | | | | | | | | | | | | | | | | | | | |
|------------|--|-----------------------------|---------|-------|---|-----|-----------------------------|---|-------|---|--------|---|---------|-------------------------|---|---|---|-----|---|------|---|-------|--|---|----------------------|--|---|--|--|
| 3401 | <p>SIGNAL1 PARAM</p> <p>Selects the first parameter (by number) displayed on the control panel.</p> <ul style="list-style-type: none"> Definitions in this group define display content when the control panel is in the control mode. Any parameter number in <i>Group 01: OPERATING DATA</i> can be selected. Using the following parameters, the display value can be scaled, converted to convenient units and/or displayed as a bar graph. The figure identifies selections made by parameters in this group. <p>100 = NOT SELECTED – First parameter not displayed. 101...159 – Displays parameter 0101...0159. If parameter does not exist, the display shows "n.a."</p> | | | | | | | | | | | | | | | | | | | | | | | | | | | | |
| 3402 | <p>SIGNAL1 MIN</p> <p>Defines the minimum expected value for the first display parameter. Use parameters 3402, 3403, 3406 and 3407, for example to convert a <i>Group 01: OPERATING DATA</i> parameter, such as 0102 SPEED (in rpm) to the speed of a conveyor driven by the motor (in ft/min). For such a conversion, the source values in the figure are the min. and max. motor speed, and the display values are the corresponding min. and max. conveyor speed. Use parameter 3405 to select the proper units for the display.</p> <p>Note: Selecting units does not convert values. Parameter is not effective if parameter 3404 OUTPUT1 DSP FORM = 9 (DIRECT).</p> | | | | | | | | | | | | | | | | | | | | | | | | | | | | |
| 3403 | <p>SIGNAL1 MAX</p> <p>Defines the maximum expected value for the first display parameter.</p> <p>Note: Parameter is not effective if parameter 3404 OUTPUT1 DSP FORM = 9 (DIRECT).</p> | | | | | | | | | | | | | | | | | | | | | | | | | | | | |
| 3404 | <p>OUTPUT1 DSP FORM</p> <p>Defines the decimal point location for the first display parameter. 0...7 – Defines the decimal point location.</p> <ul style="list-style-type: none"> Enter the number of digits desired to the right of the decimal point. See the table for an example using pi (3.14159). <p>8 = BAR METER – Specifies a bar meter display. 9 = DIRECT – Decimal point location and units of measure are identical to the source signal. See <i>Group 01: OPERATING DATA</i> parameter listing in section <i>Complete parameter list</i> on page 115 for resolution (which indicates the decimal point location) and the units of measure.</p> <table border="1"> <thead> <tr> <th>3404 value</th> <th>Display</th> <th>Range</th> </tr> </thead> <tbody> <tr> <td>0</td> <td>+ 3</td> <td rowspan="3">-32768...+32767 (Signed)</td> </tr> <tr> <td>1</td> <td>+ 3.1</td> </tr> <tr> <td>2</td> <td>+ 3.14</td> </tr> <tr> <td>3</td> <td>+ 3.142</td> <td rowspan="4">0...65535 (Unsigned)</td> </tr> <tr> <td>4</td> <td>3</td> </tr> <tr> <td>5</td> <td>3.1</td> </tr> <tr> <td>6</td> <td>3.14</td> </tr> <tr> <td>7</td> <td>3.142</td> <td></td> </tr> <tr> <td>8</td> <td colspan="2">Bar meter displayed.</td> </tr> <tr> <td>9</td> <td colspan="2">Decimal point location and units as for the source signal.</td> </tr> </tbody> </table> | 3404 value | Display | Range | 0 | + 3 | -32768...+32767 (Signed) | 1 | + 3.1 | 2 | + 3.14 | 3 | + 3.142 | 0...65535 (Unsigned) | 4 | 3 | 5 | 3.1 | 6 | 3.14 | 7 | 3.142 | | 8 | Bar meter displayed. | | 9 | Decimal point location and units as for the source signal. | |
| 3404 value | Display | Range | | | | | | | | | | | | | | | | | | | | | | | | | | | |
| 0 | + 3 | -32768...+32767 (Signed) | | | | | | | | | | | | | | | | | | | | | | | | | | | |
| 1 | + 3.1 | | | | | | | | | | | | | | | | | | | | | | | | | | | | |
| 2 | + 3.14 | | | | | | | | | | | | | | | | | | | | | | | | | | | | |
| 3 | + 3.142 | 0...65535 (Unsigned) | | | | | | | | | | | | | | | | | | | | | | | | | | | |
| 4 | 3 | | | | | | | | | | | | | | | | | | | | | | | | | | | | |
| 5 | 3.1 | | | | | | | | | | | | | | | | | | | | | | | | | | | | |
| 6 | 3.14 | | | | | | | | | | | | | | | | | | | | | | | | | | | | |
| 7 | 3.142 | | | | | | | | | | | | | | | | | | | | | | | | | | | | |
| 8 | Bar meter displayed. | | | | | | | | | | | | | | | | | | | | | | | | | | | | |
| 9 | Decimal point location and units as for the source signal. | | | | | | | | | | | | | | | | | | | | | | | | | | | | |

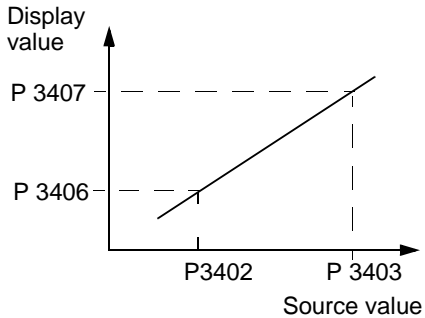
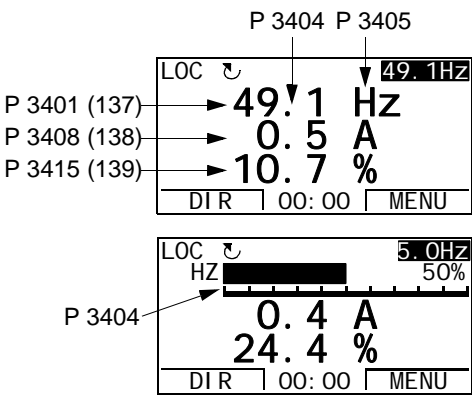

| Code | Description | | | | | | | | | | | | | | | | | | | | | | | | | | | | | | | | | | | | | | | | | | | | | | | | | | | | | | | | | | | | | | | | | | | | | | | | | | | | | | | | | | | | |
|-------------|---|-------------------------|------------|------------------------|-------------------------|-------------------------|------------|-----------|-----------|-------|------------|----------|----------|------------|----------|-----------|--------|-------|---------|------------------------|-----------|----------|------------|----------|-----------|--------|---------|-------------------------|----------|------------------------|------------|-----------|------------|-------|---------|----------|-----------|------------------------|------------|-------------------------|---------|-------|--------|----------|----------|-----------|-------------------------|------------|--|-------|----------|----------|----------|-----------|-------------------------|------------|--|---------|---------|----------|----------|-----------|-------------------------|-----------|--|--------|---------|----------|----------|-----------|-----------|---------|--|------------|------------|------------|------------|------------|-----------|------------|------------|------------|------------|------------|--|
| 3405 | <p>OUTPUT1 UNIT Selects the units used with the first display parameter. Note: Parameter is not effective if parameter 3404 OUTPUT1 DSP FORM = 9 (DIRECT).</p> <table border="0"> <tr> <td>0 = NO UNIT</td> <td>9 = °C</td> <td>18 = MWh</td> <td>27 = ft</td> <td>36 = l/s</td> <td>45 = Pa</td> <td>54 = lb/m</td> <td>63 = Mrev</td> </tr> <tr> <td>1 = A</td> <td>10 = lb ft</td> <td>19 = m/s</td> <td>28 = MGD</td> <td>37 = l/min</td> <td>46 = GPS</td> <td>55 = lb/h</td> <td>64 = d</td> </tr> <tr> <td>2 = V</td> <td>11 = mA</td> <td>20 = m³/h</td> <td>29 = inHg</td> <td>38 = l/h</td> <td>47 = gal/s</td> <td>56 = FPS</td> <td>65 = inWC</td> </tr> <tr> <td>3 = Hz</td> <td>12 = mV</td> <td>21 = dm³/s</td> <td>30 = FPM</td> <td>39 = m³/s</td> <td>48 = gal/m</td> <td>57 = ft/s</td> <td>66 = m/min</td> </tr> <tr> <td>4 = %</td> <td>13 = kW</td> <td>22 = bar</td> <td>31 = kb/s</td> <td>40 = m³/m</td> <td>49 = gal/h</td> <td>58 = inH₂O</td> <td>67 = Nm</td> </tr> <tr> <td>5 = s</td> <td>14 = W</td> <td>23 = kPa</td> <td>32 = kHz</td> <td>41 = kg/s</td> <td>50 = ft³/s</td> <td>59 = in wg</td> <td></td> </tr> <tr> <td>6 = h</td> <td>15 = kWh</td> <td>24 = GPM</td> <td>33 = ohm</td> <td>42 = kg/m</td> <td>51 = ft³/m</td> <td>60 = ft wg</td> <td></td> </tr> <tr> <td>7 = rpm</td> <td>16 = °F</td> <td>25 = PSI</td> <td>34 = ppm</td> <td>43 = kg/h</td> <td>52 = ft³/h</td> <td>61 = lbsi</td> <td></td> </tr> <tr> <td>8 = kh</td> <td>17 = hp</td> <td>26 = CFM</td> <td>35 = pps</td> <td>44 = mbar</td> <td>53 = lb/s</td> <td>62 = ms</td> <td></td> </tr> </table> <p>The following units are useful for the bar display.</p> <table border="0"> <tr> <td>117 = %ref</td> <td>119 = %dev</td> <td>121 = % SP</td> <td>123 = Iout</td> <td>125 = Fout</td> <td>127 = Vdc</td> </tr> <tr> <td>118 = %act</td> <td>120 = % LD</td> <td>122 = %FBK</td> <td>124 = Vout</td> <td>126 = Tout</td> <td></td> </tr> </table> | 0 = NO UNIT | 9 = °C | 18 = MWh | 27 = ft | 36 = l/s | 45 = Pa | 54 = lb/m | 63 = Mrev | 1 = A | 10 = lb ft | 19 = m/s | 28 = MGD | 37 = l/min | 46 = GPS | 55 = lb/h | 64 = d | 2 = V | 11 = mA | 20 = m ³ /h | 29 = inHg | 38 = l/h | 47 = gal/s | 56 = FPS | 65 = inWC | 3 = Hz | 12 = mV | 21 = dm ³ /s | 30 = FPM | 39 = m ³ /s | 48 = gal/m | 57 = ft/s | 66 = m/min | 4 = % | 13 = kW | 22 = bar | 31 = kb/s | 40 = m ³ /m | 49 = gal/h | 58 = inH ₂ O | 67 = Nm | 5 = s | 14 = W | 23 = kPa | 32 = kHz | 41 = kg/s | 50 = ft ³ /s | 59 = in wg | | 6 = h | 15 = kWh | 24 = GPM | 33 = ohm | 42 = kg/m | 51 = ft ³ /m | 60 = ft wg | | 7 = rpm | 16 = °F | 25 = PSI | 34 = ppm | 43 = kg/h | 52 = ft ³ /h | 61 = lbsi | | 8 = kh | 17 = hp | 26 = CFM | 35 = pps | 44 = mbar | 53 = lb/s | 62 = ms | | 117 = %ref | 119 = %dev | 121 = % SP | 123 = Iout | 125 = Fout | 127 = Vdc | 118 = %act | 120 = % LD | 122 = %FBK | 124 = Vout | 126 = Tout | |
| 0 = NO UNIT | 9 = °C | 18 = MWh | 27 = ft | 36 = l/s | 45 = Pa | 54 = lb/m | 63 = Mrev | | | | | | | | | | | | | | | | | | | | | | | | | | | | | | | | | | | | | | | | | | | | | | | | | | | | | | | | | | | | | | | | | | | | | | | | | | | | | | |
| 1 = A | 10 = lb ft | 19 = m/s | 28 = MGD | 37 = l/min | 46 = GPS | 55 = lb/h | 64 = d | | | | | | | | | | | | | | | | | | | | | | | | | | | | | | | | | | | | | | | | | | | | | | | | | | | | | | | | | | | | | | | | | | | | | | | | | | | | | | |
| 2 = V | 11 = mA | 20 = m ³ /h | 29 = inHg | 38 = l/h | 47 = gal/s | 56 = FPS | 65 = inWC | | | | | | | | | | | | | | | | | | | | | | | | | | | | | | | | | | | | | | | | | | | | | | | | | | | | | | | | | | | | | | | | | | | | | | | | | | | | | | |
| 3 = Hz | 12 = mV | 21 = dm ³ /s | 30 = FPM | 39 = m ³ /s | 48 = gal/m | 57 = ft/s | 66 = m/min | | | | | | | | | | | | | | | | | | | | | | | | | | | | | | | | | | | | | | | | | | | | | | | | | | | | | | | | | | | | | | | | | | | | | | | | | | | | | | |
| 4 = % | 13 = kW | 22 = bar | 31 = kb/s | 40 = m ³ /m | 49 = gal/h | 58 = inH ₂ O | 67 = Nm | | | | | | | | | | | | | | | | | | | | | | | | | | | | | | | | | | | | | | | | | | | | | | | | | | | | | | | | | | | | | | | | | | | | | | | | | | | | | | |
| 5 = s | 14 = W | 23 = kPa | 32 = kHz | 41 = kg/s | 50 = ft ³ /s | 59 = in wg | | | | | | | | | | | | | | | | | | | | | | | | | | | | | | | | | | | | | | | | | | | | | | | | | | | | | | | | | | | | | | | | | | | | | | | | | | | | | | | |
| 6 = h | 15 = kWh | 24 = GPM | 33 = ohm | 42 = kg/m | 51 = ft ³ /m | 60 = ft wg | | | | | | | | | | | | | | | | | | | | | | | | | | | | | | | | | | | | | | | | | | | | | | | | | | | | | | | | | | | | | | | | | | | | | | | | | | | | | | | |
| 7 = rpm | 16 = °F | 25 = PSI | 34 = ppm | 43 = kg/h | 52 = ft ³ /h | 61 = lbsi | | | | | | | | | | | | | | | | | | | | | | | | | | | | | | | | | | | | | | | | | | | | | | | | | | | | | | | | | | | | | | | | | | | | | | | | | | | | | | | |
| 8 = kh | 17 = hp | 26 = CFM | 35 = pps | 44 = mbar | 53 = lb/s | 62 = ms | | | | | | | | | | | | | | | | | | | | | | | | | | | | | | | | | | | | | | | | | | | | | | | | | | | | | | | | | | | | | | | | | | | | | | | | | | | | | | | |
| 117 = %ref | 119 = %dev | 121 = % SP | 123 = Iout | 125 = Fout | 127 = Vdc | | | | | | | | | | | | | | | | | | | | | | | | | | | | | | | | | | | | | | | | | | | | | | | | | | | | | | | | | | | | | | | | | | | | | | | | | | | | | | | | |
| 118 = %act | 120 = % LD | 122 = %FBK | 124 = Vout | 126 = Tout | | | | | | | | | | | | | | | | | | | | | | | | | | | | | | | | | | | | | | | | | | | | | | | | | | | | | | | | | | | | | | | | | | | | | | | | | | | | | | | | | |
| 3406 | <p>OUTPUT1 MIN Sets the minimum value displayed for the first display parameter. Note: Parameter is not effective if parameter 3404 OUTPUT1 DSP FORM = 9 (DIRECT).</p> | | | | | | | | | | | | | | | | | | | | | | | | | | | | | | | | | | | | | | | | | | | | | | | | | | | | | | | | | | | | | | | | | | | | | | | | | | | | | | | | | | | | |
| 3407 | <p>OUTPUT1 MAX Sets the maximum value displayed for the first display parameter. Note: Parameter is not effective if parameter 3404 OUTPUT1 DSP FORM = 9 (DIRECT).</p> | | | | | | | | | | | | | | | | | | | | | | | | | | | | | | | | | | | | | | | | | | | | | | | | | | | | | | | | | | | | | | | | | | | | | | | | | | | | | | | | | | | | |
| 3408 | <p>SIGNAL2 PARAM Selects the second parameter (by number) displayed on the control panel. See parameter 3401.</p> | | | | | | | | | | | | | | | | | | | | | | | | | | | | | | | | | | | | | | | | | | | | | | | | | | | | | | | | | | | | | | | | | | | | | | | | | | | | | | | | | | | | |
| 3409 | <p>SIGNAL2 MIN Defines the minimum expected value for the second display parameter. See parameter 3402.</p> | | | | | | | | | | | | | | | | | | | | | | | | | | | | | | | | | | | | | | | | | | | | | | | | | | | | | | | | | | | | | | | | | | | | | | | | | | | | | | | | | | | | |
| 3410 | <p>SIGNAL2 MAX Defines the maximum expected value for the second display parameter. See parameter 3403.</p> | | | | | | | | | | | | | | | | | | | | | | | | | | | | | | | | | | | | | | | | | | | | | | | | | | | | | | | | | | | | | | | | | | | | | | | | | | | | | | | | | | | | |
| 3411 | <p>OUTPUT2 DSP FORM Defines the decimal point location for the second display parameter. See parameter 3404.</p> | | | | | | | | | | | | | | | | | | | | | | | | | | | | | | | | | | | | | | | | | | | | | | | | | | | | | | | | | | | | | | | | | | | | | | | | | | | | | | | | | | | | |
| 3412 | <p>OUTPUT2 UNIT Selects the units used with the second display parameter. See parameter 3405.</p> | | | | | | | | | | | | | | | | | | | | | | | | | | | | | | | | | | | | | | | | | | | | | | | | | | | | | | | | | | | | | | | | | | | | | | | | | | | | | | | | | | | | |
| 3413 | <p>OUTPUT2 MIN Sets the minimum value displayed for the second display parameter. See parameter 3406.</p> | | | | | | | | | | | | | | | | | | | | | | | | | | | | | | | | | | | | | | | | | | | | | | | | | | | | | | | | | | | | | | | | | | | | | | | | | | | | | | | | | | | | |
| 3414 | <p>OUTPUT2 MAX Sets the maximum value displayed for the second display parameter. See parameter 3407.</p> | | | | | | | | | | | | | | | | | | | | | | | | | | | | | | | | | | | | | | | | | | | | | | | | | | | | | | | | | | | | | | | | | | | | | | | | | | | | | | | | | | | | |
| 3415 | <p>SIGNAL3 PARAM Selects the third parameter (by number) displayed on the control panel. See parameter 3401.</p> | | | | | | | | | | | | | | | | | | | | | | | | | | | | | | | | | | | | | | | | | | | | | | | | | | | | | | | | | | | | | | | | | | | | | | | | | | | | | | | | | | | | |
| 3416 | <p>SIGNAL3 MIN Defines the minimum expected value for the third display parameter. See parameter 3402.</p> | | | | | | | | | | | | | | | | | | | | | | | | | | | | | | | | | | | | | | | | | | | | | | | | | | | | | | | | | | | | | | | | | | | | | | | | | | | | | | | | | | | | |
| 3417 | <p>SIGNAL3 MAX Defines the maximum expected value for the third display parameter. See parameter 3403.</p> | | | | | | | | | | | | | | | | | | | | | | | | | | | | | | | | | | | | | | | | | | | | | | | | | | | | | | | | | | | | | | | | | | | | | | | | | | | | | | | | | | | | |
| 3418 | <p>OUTPUT3 DSP FORM Defines the decimal point location for the third display parameter. See parameter 3404.</p> | | | | | | | | | | | | | | | | | | | | | | | | | | | | | | | | | | | | | | | | | | | | | | | | | | | | | | | | | | | | | | | | | | | | | | | | | | | | | | | | | | | | |
| 3419 | <p>OUTPUT3 UNIT Selects the units used with the third display parameter. See parameter 3405.</p> | | | | | | | | | | | | | | | | | | | | | | | | | | | | | | | | | | | | | | | | | | | | | | | | | | | | | | | | | | | | | | | | | | | | | | | | | | | | | | | | | | | | |
| 3420 | <p>OUTPUT3 MIN Sets the minimum value displayed for the third display parameter. See parameter 3406.</p> | | | | | | | | | | | | | | | | | | | | | | | | | | | | | | | | | | | | | | | | | | | | | | | | | | | | | | | | | | | | | | | | | | | | | | | | | | | | | | | | | | | | |

| Code | Description |
|------|---|
| 3421 | OUTPUT3 MAX Sets the maximum value displayed for the third display parameter. See parameter 3407. |

Group 35: MOTOR TEMP MEAS

This group defines the detection and reporting for a particular potential fault – motor overheating, as detected by a temperature sensor. Typical connections are shown below.

One sensor

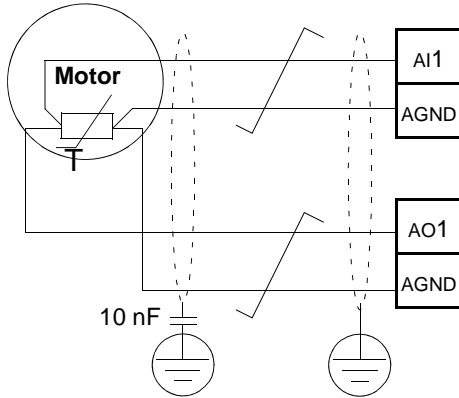

Three sensors

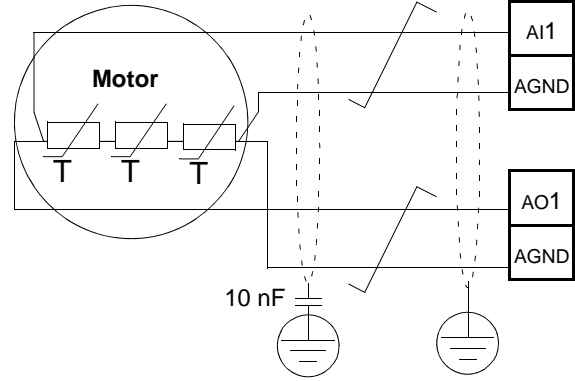

WARNING! IEC 60664 requires double or reinforced insulation between live parts and the surface of accessible parts of electrical equipment which are either non-conductive or conductive but not connected to the protective earth.

To fulfill this requirement, connect a thermistor (and other similar components) to the drive's control terminals using any of these alternatives:

- Separate the thermistor from live parts of the motor with double reinforced insulation.
- Protect all circuits connected to the drive's digital and analog inputs. Protect against contact, and insulate from other low voltage circuits with basic insulation (rated for the same voltage level as the drive's main circuit).
- Use an external thermistor relay. The relay insulation must be rated for the same voltage level as the drive's main circuit.

The figure below shows thermistor relay and PTC sensor connections using a digital input. At the motor end, the cable shield should be earthed through a 10 nF capacitor. If this is not possible, leave the shield unconnected.

Thermistor relay

3501 SENSOR TYPE = 5 (THERM(0)) or 6 (THERM(1))

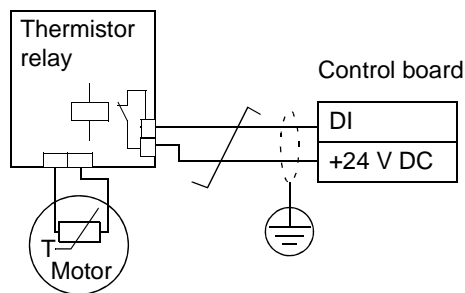

PTC sensor

3501 SENSOR TYPE = 5 (THERM(0))

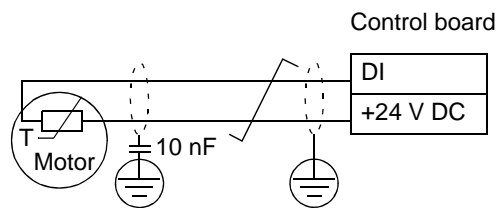

For other faults, or for anticipating motor overheating using a model, see [Group 30: FAULT FUNCTIONS](#).

| Code | Description | | | | | | | | | | | | |
|-------------|---|-------------|------------|--------|------------|-----------|----------|-------------|------------|--------|----------|-----------|-----------|
| 3501 | <p>SENSOR TYPE</p> <p>Identifies the type of the motor temperature sensor used, PT100 (°C), PTC (ohm) or thermistor. See parameters 1501 AO1 CONTENT SEL and 1507 AO2 CONTENT SEL.</p> <p>0 = NONE</p> <p>1 = 1 x PT100 – Sensor configuration uses one PT100 sensor.</p> <ul style="list-style-type: none"> Analog output AO1 or AO2 feeds constant current through the sensor. The sensor resistance increases as the motor temperature rises, as does the voltage over the sensor. The temperature measurement function reads the voltage through analog input AI1 or AI2 and converts it to degrees Celsius. <p>2 = 2 x PT100 – Sensor configuration uses two PT100 sensors.</p> <ul style="list-style-type: none"> Operation is the same as for above 1 x PT100. <p>3 = 3 x PT100 – Sensor configuration uses three PT100 sensors.</p> <ul style="list-style-type: none"> Operation is the same as for above 1 x PT100. <p>4 = PTC – Sensor configuration uses one PTC.</p> <ul style="list-style-type: none"> The analog output feeds a constant current through the sensor. The resistance of the sensor increases sharply as the motor temperature rises over the PTC reference temperature (T_{ref}), as does the voltage over the resistor. The temperature measurement function reads the voltage through analog input AI1 and converts it into ohms. The table below and the graph show typical PTC sensor resistance as a function of the motor operating temperature. <table border="1"> <thead> <tr> <th>Temperature</th> <th>Resistance</th> </tr> </thead> <tbody> <tr> <td>Normal</td> <td>< 1.5 kohm</td> </tr> <tr> <td>Excessive</td> <td>> 4 kohm</td> </tr> </tbody> </table> <p>5 = THERM(0) – Sensor configuration uses a thermistor.</p> <ul style="list-style-type: none"> Motor thermal protection is activated through a digital input. Connect either a PTC sensor or a normally closed thermistor relay to a digital input. When the digital input is '0', the motor is overheated. See the connection figure on page 180. The table below and the graph show the resistance requirements for a PTC sensor connected between 24 V and digital input as a function of the motor operating temperature. <table border="1"> <thead> <tr> <th>Temperature</th> <th>Resistance</th> </tr> </thead> <tbody> <tr> <td>Normal</td> <td>< 3 kohm</td> </tr> <tr> <td>Excessive</td> <td>> 28 kohm</td> </tr> </tbody> </table> <ul style="list-style-type: none"> 6 = THERM(1) – Sensor configuration uses a thermistor. Motor thermal protection is activated through a digital input. Connect a normally open thermistor relay to a digital input. When the digital input is '1', the motor is overheated. See the connection figure on page 180. | Temperature | Resistance | Normal | < 1.5 kohm | Excessive | > 4 kohm | Temperature | Resistance | Normal | < 3 kohm | Excessive | > 28 kohm |
| Temperature | Resistance | | | | | | | | | | | | |
| Normal | < 1.5 kohm | | | | | | | | | | | | |
| Excessive | > 4 kohm | | | | | | | | | | | | |
| Temperature | Resistance | | | | | | | | | | | | |
| Normal | < 3 kohm | | | | | | | | | | | | |
| Excessive | > 28 kohm | | | | | | | | | | | | |
| 3502 | <p>INPUT SELECTION</p> <p>Defines the input used for the temperature sensor.</p> <p>1 = AI1 – PT100 and PTC.</p> <p>2 = AI2 – PT100 and PTC.</p> <p>3...8 = DI1...DI6 – Thermistor and PTC</p> | | | | | | | | | | | | |
| 3503 | <p>ALARM LIMIT</p> <p>Defines the alarm limit for the motor temperature measurement.</p> <ul style="list-style-type: none"> At motor temperatures above this limit, the drive displays an alarm (2010, MOTOR TEMP) <p>For thermistors or PTC connected to digital input:</p> <p>0 – de-activated</p> <p>1 – activated</p> | | | | | | | | | | | | |

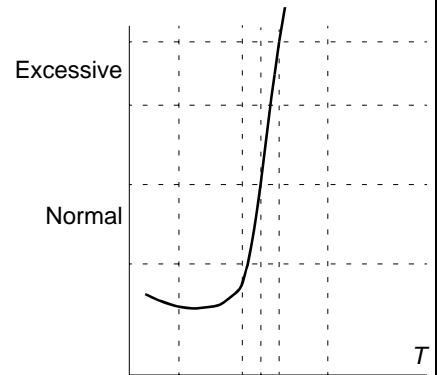

| Code | Description |
|------|--|
| 3504 | FAULT LIMIT Defines the fault limit for motor temperature measurement. <ul style="list-style-type: none">• At motor temperatures above this limit, the drive displays a fault (9, MOT OVERTEMP) and stops the drive. For thermistors or PTC connected to digital input: 0 – de-activated 1 – activated |

Group 36: TIMED FUNCTIONS

This group defines the timed functions. The timed functions include:

- four daily start and stop times
- four weekly start, stop and boost times
- four timers for collecting selected periods together.

A timer can be connected to multiple time periods and a time period can be in multiple timers.

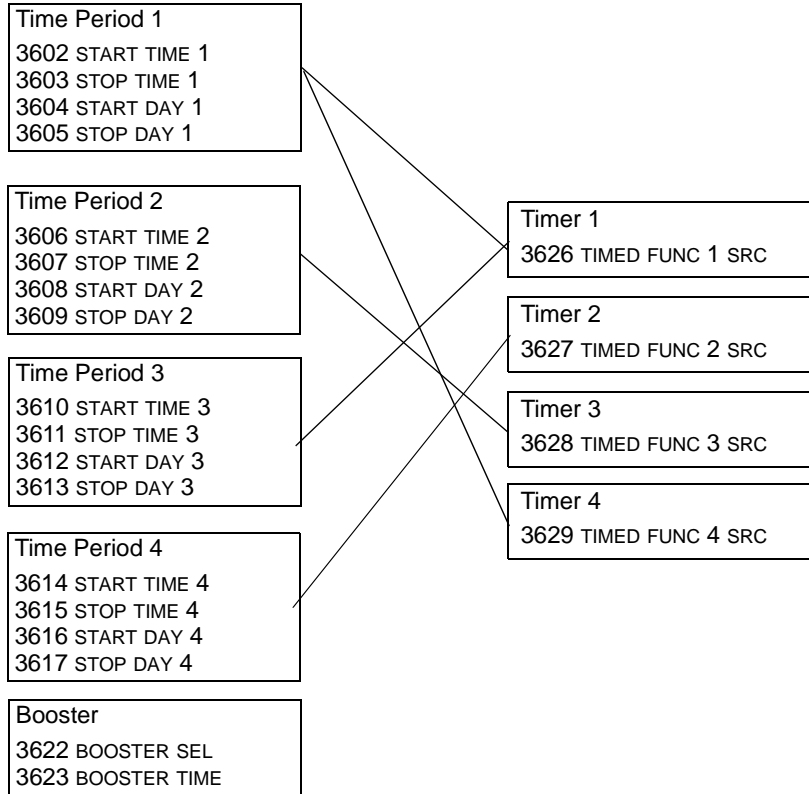

A parameter can be connected to only one timer.

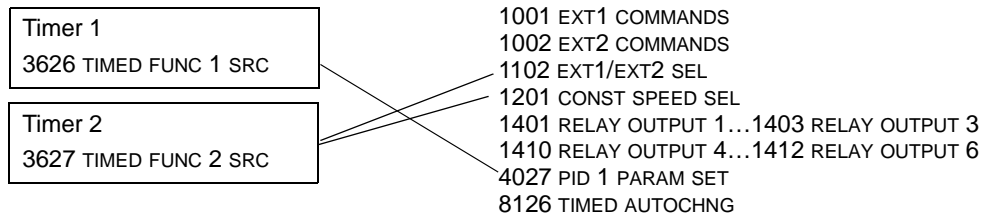

| Code | Description |
|------|--|
| 3601 | <p>TIMERS ENABLE</p> <p>Selects the source for the timer enable signal.</p> <p>0 = NOT SEL – Timed functions are disabled.</p> <p>1 = DI1 – Defines digital input DI1 as the timed function enable signal.</p> <ul style="list-style-type: none"> The digital input must be activated to enable the timed function. <p>2...6 = DI2...DI6 – Defines digital input DI2...DI6 as the timed function enable signal.</p> <p>7 = ACTIVE – Timed functions are enabled.</p> <p>-1 = DI1(INV) – Defines an inverted digital input DI1 as the timed function enable signal.</p> <ul style="list-style-type: none"> This digital input must be de-activated to enable the timed function. -2...-6 = DI2(INV)...DI6(INV) – Defines an inverted digital input DI2...DI6 as the timed function enable signal. |
| 3602 | <p>START TIME 1</p> <p>Defines the daily start time. 20:30:00</p> <ul style="list-style-type: none"> The time can be changed in steps of 2 seconds. If parameter value is 07:00:00, the timer is activated at 7 a.m. The figure shows multiple timers on different weekdays. <p>17:00:00</p> <p>15:00:00</p> <p>13:00:00</p> <p>12:00:00</p> <p>10:30:00</p> <p>09:00:00</p> <p>00:00:00</p> <p>Mon Tue Wed Thu Fri Sat Sun</p> |
| 3603 | <p>STOP TIME 1</p> <p>Defines the daily stop time.</p> <ul style="list-style-type: none"> The time can be changed in steps of 2 seconds. If the parameter value is 09:00:00, the timer is deactivated at 9 a.m. |
| 3604 | <p>START DAY 1</p> <p>Defines the weekly start day.</p> <p>1 = MONDAY...7 = SUNDAY</p> <ul style="list-style-type: none"> If parameter value is 1, timer 1 weekly is active from Monday midnight (00:00:00). |
| 3605 | <p>STOP DAY 1</p> <p>Defines weekly stop day.</p> <p>1 = MONDAY...7 = SUNDAY</p> <ul style="list-style-type: none"> If parameter value is 5, timer 1 weekly is deactivated on Friday midnight (23:59:58). |
| 3606 | <p>START TIME 2</p> <p>Defines timer2 daily start time.</p> <ul style="list-style-type: none"> See parameter 3602. |
| 3607 | <p>STOP TIME 2</p> <p>Defines timer 2 daily stop time.</p> <ul style="list-style-type: none"> See parameter 3603. |
| 3608 | <p>START DAY 2</p> <p>Defines timer 2 weekly start day.</p> <ul style="list-style-type: none"> See parameter 3604. |
| 3609 | <p>STOP DAY 2</p> <p>Defines timer 2 weekly stop day.</p> <ul style="list-style-type: none"> See parameter 3605. |
| 3610 | <p>START TIME 3</p> <p>Defines timer 3 daily start time.</p> <ul style="list-style-type: none"> See parameter 3602. |
| 3611 | <p>STOP TIME 3</p> <p>Defines timer 3 daily stop time.</p> <ul style="list-style-type: none"> See parameter 3603. |

| Code | Description |
|------|--|
| 3612 | <p>START DAY 3 Defines timer 3 weekly start day. • See parameter 3604.</p> |
| 3613 | <p>STOP DAY 3 Defines timer 3 weekly stop day. • See parameter 3605.</p> |
| 3614 | <p>START TIME 4 Defines timer 4 daily start time. • See parameter 3602.</p> |
| 3615 | <p>STOP TIME 4 Defines timer 4 daily stop time. • See parameter 3603.</p> |
| 3616 | <p>START DAY 4 Defines timer 4 weekly start day. • See parameter 3604.</p> |
| 3617 | <p>STOP DAY 4 Defines timer 4 weekly stop day. • See parameter 3605.</p> |
| 3622 | <p>BOOSTER SEL Selects the source for the booster signal. 0 = NOT SEL – Booster signal is disabled. 1 = DI1 – Defines DI1 as the booster signal. 2...6 = DI2...DI6 – Defines DI2...DI6 as the booster signal. -1 = DI1(INV) – Defines an inverted digital input DI1 as the booster signal. -2...-6 = DI2(INV)...DI6(INV) – Defines an inverted digital input DI2...DI6 as the booster signal.</p> |
| 3623 | <p>BOOSTER TIME Defines the booster ON time. Time is started when booster sel signal is released. If parameter value is 01:30:00, booster is active for 1 hour and 30 minutes after activation DI is released.</p> |
| 3626 | <p>TIMED FUNC 1 SRC Defines the time periods used by the timer. 0 = NOT SEL – No time periods have been selected. 1 = T1 – Time Period 1 selected in the timer. 2 = T2 – Time Period 2 selected in the timer. 3 = T1+T2 – Time Periods 1 and 2 selected in the timer. 4 = T3 – Time Period 3 selected in the timer. 5 = T1+T3 – Time Periods 1 and 3 selected in the timer. 6 = T2+T3 – Time Periods 2 and 3 selected in the timer. 7 = T1+T2+T3 – Time Periods 1, 2 and 3 selected in the timer. 8 = T4 – Time Period 4 selected in the timer. 9 = T1+T4 – Time Periods 1 and 4 selected in the timer. 10 = T2+T4 – Time Periods 2 and 4 selected in the timer. 11 = T1+T2+T4 – Time Periods 1, 2 and 4 selected in the timer. 12 = T3+T4 – Time Periods 3 and 4 selected in the timer. 13 = T1+T3+T4 – Time Periods 1, 3 and 4 selected in the timer. 14 = T2+T3+T4 – Time Periods 2, 3 and 4 selected in the timer. 15 = T1+T2+T3+T4 – Time Periods 1, 2, 3 and 4 selected in the timer. 16 = BOOSTER – Booster selected in the timer. 17 = T1+B – Booster and Time Period 1 selected in the timer. 18 = T2+B – Booster and Time Period 2 selected in the timer. 19 = T1+T2+B – Booster and Time Periods 1 and 2 selected in the timer. 20 = T3+B – Booster and Time Period 3 selected in the timer.</p> |

| Code | Description |
|------|---|
| | 21 = T1+T3+B – Booster and Time Periods 1 and 3 selected in the timer. 22 = T2+T3+B – Booster and Time Periods 2 and 3 selected in the timer. 23 = T1+T2+T3+B – Booster and Time Periods 1, 2 and 3 selected in the timer. 24 = T4+B – Booster and Time Period 4 selected in the timer. 25 = T1+T4+B – Booster and Time Periods 1 and 4 selected in the timer. 26 = T2+T4+B – Booster and Time Periods 2 and 4 selected in the timer. 27 = T1+T2+T4+B – Booster and Time Periods 1, 2 and 4 selected in the timer. 28 = T3+T4+B – Booster and Time Periods 3 and 4 selected in the timer. 29 = T1+T3+T4+B – Booster and Time Periods 1, 3 and 4 selected in the timer. 30 = T2+T3+T4+B – Booster and Time Periods 2, 3 and 4 selected in the timer. 31 = T1+2+3+4+B – Booster and Time Periods 1, 2, 3 and 4 selected in the timer. |
| 3627 | TIMED FUNC 2 SRC • See parameter 3626. |
| 3628 | TIMED FUNC 3 SRC • See parameter 3626. |
| 3629 | TIMED FUNC 4 SRC • See parameter 3626. |

Group 37: USER LOAD CURVE

This group defines supervision of user adjustable load curves (motor torque as a function of frequency). The curve is defined by five points.

| Code | Description |
|------|---|
| 3701 | <p>USER LOAD C MODE Supervision mode for the user adjustable load curves.</p> <p>This functionality replaces the former underload supervision in Group 30: FAULT FUNCTIONS. To emulate it, see section Correspondence with the obsolete underload supervision on page 188.</p> <p>0 = NOT SEL – Supervision is not active. 1 = UNDERLOAD – Supervision for the torque dropping below the underload curve. 2 = OVERLOAD – Supervision for the torque exceeding the overload curve. 3 = BOTH – Supervision for the torque dropping below the underload curve or exceeding the overload curve.</p> |
| | |
| 3702 | <p>USER LOAD C FUNC Action wanted during load supervision.</p> <p>1 = FAULT – A fault is generated when the condition defined by 3701 USER LOAD C MODE has been valid longer than the time set by 3703 USER LOAD C TIME. 2 = ALARM – An alarm is generated when the condition defined by 3701 USER LOAD C MODE has been valid longer than half of the time defined by 3703 USER LOAD C TIME.</p> |
| 3703 | <p>USER LOAD C TIME Defines the time limit for generating a fault.</p> <ul style="list-style-type: none"> • Half of this time is used as the limit for generating an alarm. |
| 3704 | <p>LOAD FREQ 1 Defines the frequency value of the first load curve definition point.</p> <ul style="list-style-type: none"> • Must be smaller than 3707 LOAD FREQ 2. |
| 3705 | <p>LOAD TORQ LOW 1 Defines the torque value of the first underload curve definition point.</p> <ul style="list-style-type: none"> • Must be smaller than 3706 LOAD TORQ HIGH 1. |
| 3706 | <p>LOAD TORQ HIGH 1 Defines the torque value of the first overload curve definition point.</p> |
| 3707 | <p>LOAD FREQ 2 Defines the frequency value of the second load curve definition point.</p> <ul style="list-style-type: none"> • Must be smaller than 3710 LOAD FREQ 3. |
| 3708 | <p>LOAD TORQ LOW 2 Defines the torque value of the second underload curve definition point.</p> <ul style="list-style-type: none"> • Must be smaller than 3709 LOAD TORQ HIGH 2. |
| 3709 | <p>LOAD TORQ HIGH 2 Defines the torque value of the second overload curve definition point.</p> |
| 3710 | <p>LOAD FREQ 3 Defines the frequency value of the third load curve definition point.</p> <ul style="list-style-type: none"> • Must be smaller than 3713 LOAD FREQ 4. |
| 3711 | <p>LOAD TORQ LOW 3 Defines the torque value of the third underload curve definition point.</p> <ul style="list-style-type: none"> • Must be smaller than 3712 LOAD TORQ HIGH 3. |
| 3712 | <p>LOAD TORQ HIGH 3 Defines the torque value of the third overload curve definition point.</p> |

| Code | Description |
|------|---|
| 3713 | LOAD FREQ 4 Defines the frequency value of the fourth load curve definition point. • Must be smaller than 3716 LOAD FREQ 5 |
| 3714 | LOAD TORQ LOW 4 Defines the torque value of the fourth underload curve definition point. • Must be smaller than 3715 LOAD TORQ HIGH 4. |
| 3715 | LOAD TORQ HIGH 4 Defines the torque value of the fourth overload curve definition point. |
| 3716 | LOAD FREQ 5 Defines the frequency value of fifth load curve definition point. |
| 3717 | LOAD TORQ LOW 5 Defines the torque value of the fifth underload curve definition point. • Must be smaller than 3718 LOAD TORQ HIGH 5. |
| 3718 | LOAD TORQ HIGH 5 Defines the torque value of the fifth overload curve definition point. |

Correspondence with the obsolete underload supervision

The now obsolete parameter 3015 UNDERLOAD CURVE provided five selectable curves shown in the figure. The parameter characteristics were as described below.

- If the load drops below the set curve for longer than the time set by parameter 3014 UNDERLOAD TIME (obsolete), the underload protection is activated.
- Curves 1...3 reach maximum at the motor rated frequency set by parameter 9907 MOTOR NOM FREQ.
- T_M = nominal torque of the motor.
- f_N = nominal frequency of the motor.

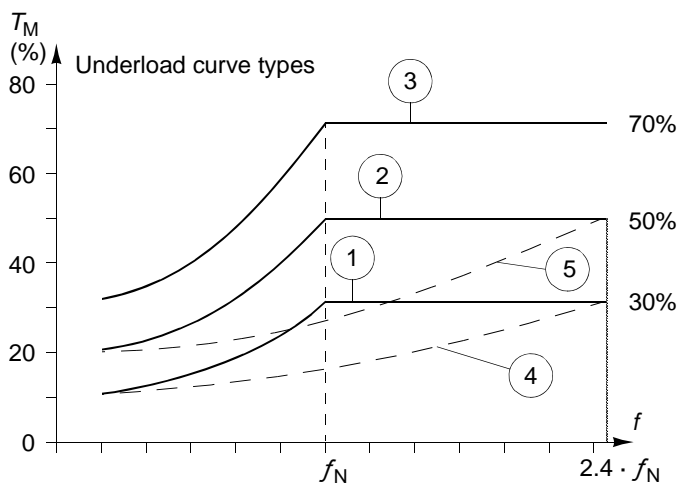

If you want to emulate the behavior of an old underload curve with parameters as in the shaded columns, set the new parameters as in the white columns in the two tables below:

| Underload supervision with parameters 3013...3015 (obsolete) | Obsolete parameters | | New parameters | | |
|--|-------------------------|---------------------|-----------------------|-----------------------|-----------------------|
| | 3013 UNDERLOAD FUNCTION | 3014 UNDERLOAD TIME | 3701 USER LOAD C MODE | 3702 USER LOAD C FUNC | 3703 USER LOAD C TIME |
| No underload functionality | 0 | - | 0 | - | - |
| Underload curve, fault generated | 1 | t | 1 | 1 | t |
| Underload curve, alarm generated | 2 | t | 1 | 2 | 2 · t |

| Obs. par. | New parameters | | | | | | | | | | | | | | |
|--------------|------------------------------------|----|--|------------------------------------|----|--|------------------------------------|-----|--|------------------------------------|-----|--|------------------------------------|-----|--|
| | 3704 LOAD FREQ 1 (Hz) | | 3705 LOAD TORQ LOW 1 (%) | 3707 LOAD FREQ 2 (Hz) | | 3708 LOAD TORQ LOW 2 (%) | 3710 LOAD FREQ 3 (Hz) | | 3711 LOAD TORQ LOW 3 (%) | 3713 LOAD FREQ 4 (Hz) | | 3714 LOAD TORQ LOW 4 (%) | 3716 LOAD FREQ 5 (Hz) | | 3717 LOAD TORQ LOW 5 (%) |
| | EU | US | | EU | US | | EU | US | | EU | US | | EU | US | |
| 1 | 5 | 6 | 10 | 32 | 38 | 17 | 41 | 50 | 23 | 50 | 60 | 30 | 500 | 500 | 30 |
| 2 | 5 | 6 | 20 | 31 | 37 | 30 | 42 | 50 | 40 | 50 | 60 | 50 | 500 | 500 | 50 |
| 3 | 5 | 6 | 30 | 31 | 37 | 43 | 42 | 50 | 57 | 50 | 60 | 70 | 500 | 500 | 70 |
| 4 | 5 | 6 | 10 | 73 | 88 | 17 | 98 | 117 | 23 | 120 | 144 | 30 | 500 | 500 | 30 |
| 5 | 5 | 6 | 20 | 71 | 86 | 30 | 99 | 119 | 40 | 120 | 144 | 50 | 500 | 500 | 50 |

Group 40: PROCESS PID SET 1

This group defines a set of parameters used with the Process PID (PID1) controller.

Typically only parameters in this group are needed.

PID controller – Basic set-up

In PID control mode, the drive compares a reference signal (setpoint) to an actual signal (feedback) and automatically adjusts the speed of the drive to match the two signals. The difference between the two signals is the error value.

Typically PID control mode is used, when the speed of a motor needs to be controlled based on pressure, flow or temperature. In most cases – when there is only 1 transducer signal wired to the ACS550 – only parameter group 40 is needed.

The following is a schematic of setpoint/feedback signal flow using parameter group 40.

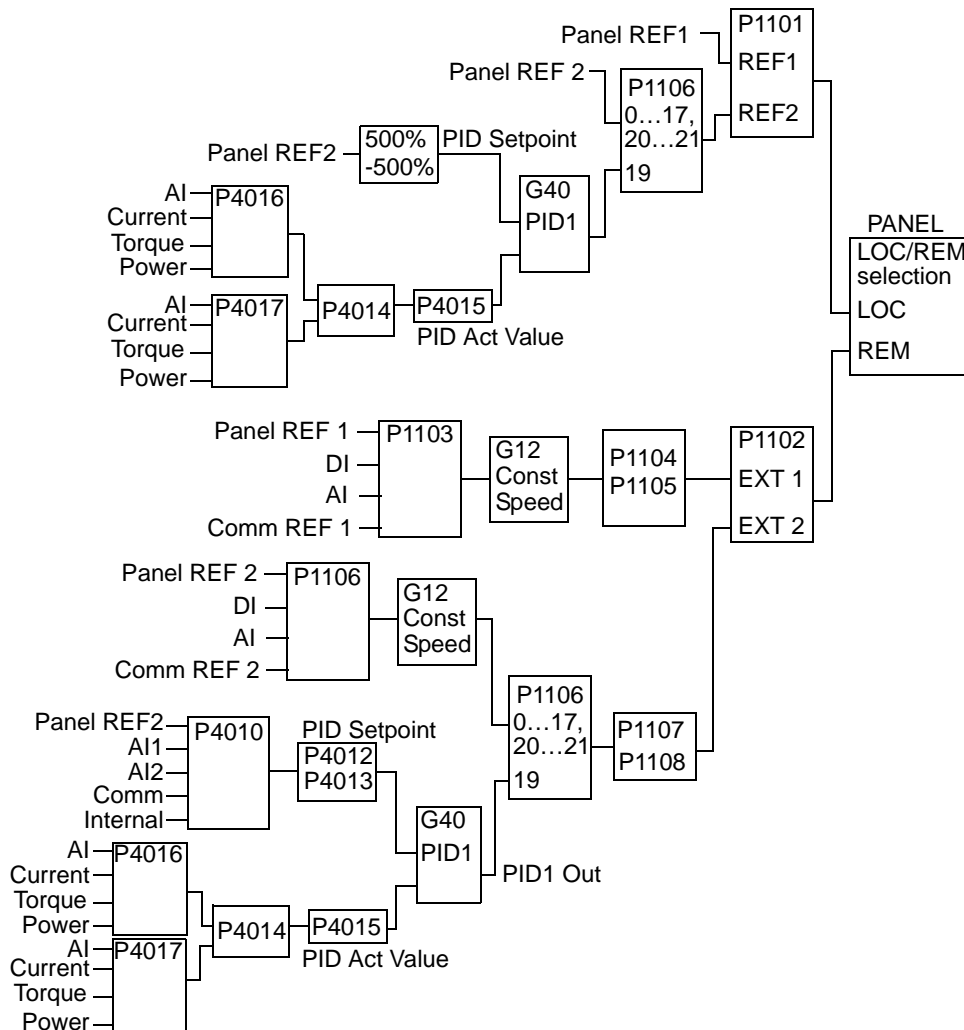

Note: In order to activate and use the PID controller, parameter 1106 must be set to value 19.

PID controller – Advanced

The ACS550 has two separate PID controllers:

- Process PID (PID1) and
- External PID (PID2)

Process PID (PID1) has 2 separate sets of parameters:

- Process PID (PID1) SET1, defined in [Group 40: PROCESS PID SET 1](#) and
- Process PID (PID1) SET2, defined in [Group 41: PROCESS PID SET 2](#)

You can select between the two different sets by using parameter 4027.

Typically two different PID controller sets are used when the load of the motor changes considerably from one situation to another.

You can use External PID (PID2), defined in [Group 42: EXT / TRIM PID](#), in two different ways:

- Instead of using additional PID controller hardware, you can set outputs of the ACS550 to control a field instrument like a damper or a valve. In this case, set parameter 4230 to value 0. (0 is the default value.)
- You can use External PID (PID2) to trim or fine-tune the speed of the ACS550.

| Code | Description |
|------|---|
| 4001 | <p>GAIN</p> <p>Defines the PID controller's gain.</p> <ul style="list-style-type: none"> • The setting range is 0.1... 100. • At 0.1, the PID controller output changes one-tenth as much as the error value. • At 100, the PID controller output changes one hundred times as much as the error value. <p>Use the proportional gain and integration time values to adjust the responsiveness of the system.</p> <ul style="list-style-type: none"> • A low value for proportional gain and a high value for integral time ensures stable operation, but provides sluggish response. <p>If the proportional gain value is too large or the integral time too short, the system can become unstable.</p> <p>Procedure:</p> <ul style="list-style-type: none"> • Initially, set: <ul style="list-style-type: none"> • 4001 GAIN = 0.1. • 4002 INTEGRATION TIME = 20 seconds. • Start the system and see if it reaches the setpoint quickly while maintaining stable operation. If not, increase GAIN (4001) until the actual signal (or drive speed) oscillates constantly. It may be necessary to start and stop the drive to induce this oscillation. • Reduce GAIN (4001) until the oscillation stops. • Set GAIN (4001) to 0.4 to 0.6 times the above value. • Decrease the INTEGRATION TIME (4002) until the feedback signal (or drive speed) oscillates constantly. It may be necessary to start and stop the drive to induce this oscillation. • Increase INTEGRATION TIME (4002) until the oscillation stops. • Set INTEGRATION TIME (4002) to 1.15 to 1.5 times the above value. • If the feedback signal contains high frequency noise, increase the value of parameter 1303 FILTER AI1 or 1306 FILTER AI2 until the noise is filtered from the signal. |

| Code | Description | | | | | | | | | | | | | | | |
|------------|---|------------|-------|---------|---|------|---|---|------|-----|---|------|------|---|------|-------|
| 4002 | <p>INTEGRATION TIME</p> <p>Defines the PID controller's integration time.</p> <p>Integration time is, by definition, the time required to increase the output by the error value:</p> <ul style="list-style-type: none"> • Error value is constant and 100%. • Gain = 1. • Integration time of 1 second denotes that a 100% change is achieved in 1 second. <p>0.0 = NOT SEL – Disables integration (I-part of controller). 0.1...3600.0 – Integration time (seconds).</p> <ul style="list-style-type: none"> • See 4001 for adjustment procedure. | | | | | | | | | | | | | | | |
| | <p>A = Error B = Error value step C = Controller output with Gain = 1 D = Controller output with Gain = 10</p> | | | | | | | | | | | | | | | |
| 4003 | <p>DERIVATION TIME</p> <p>Defines the PID controller's derivation time.</p> <ul style="list-style-type: none"> • You can add the derivative of the error to the PID controller output. The derivative is the error value's rate of change. For example, if the process error value changes linearly, the derivative is a constant added to the PID controller output. • The error-derivative is filtered with a 1-pole filter. The time constant of the filter is defined by parameter 4004 PID DERIV FILTER. <p>0.0...10.0 – Derivation time (seconds).</p> | | | | | | | | | | | | | | | |
| | <p>Process error value</p> <p>PID output</p> <p>Gain_ P 4001</p> <p>D-part of controller output</p> <p>P 4003</p> | | | | | | | | | | | | | | | |
| 4004 | <p>PID DERIV FILTER</p> <p>Defines the filter time constant for the error-derivative part of the PID controller output.</p> <ul style="list-style-type: none"> • Before being added to the PID controller output, the error-derivative is filtered with a 1-pole filter. • Increasing the filter time smooths the error-derivative, reducing noise. <p>0.0...10.0 – Filter time constant (seconds).</p> | | | | | | | | | | | | | | | |
| 4005 | <p>ERROR VALUE INV</p> <p>Selects either a normal or inverted relationship between the feedback signal and the drive speed.</p> <p>0 = NO – Normal, a decrease in feedback signal increases drive speed. Error = Ref - Fbk 1 = YES – Inverted, a decrease in feedback signal decreases drive speed. Error = Fbk - Ref</p> | | | | | | | | | | | | | | | |
| 4006 | <p>UNITS</p> <p>Selects the unit for the PID controller actual values. (PID1 parameters 0128, 0130 and 0132).</p> <ul style="list-style-type: none"> • See parameter 3405 for list of available units. | | | | | | | | | | | | | | | |
| 4007 | <p>UNIT SCALE</p> <p>Defines the decimal point location in PID controller actual values.</p> <ul style="list-style-type: none"> • Enter the decimal point location counting in from the right of the entry. • See the table for example using pi (3.14159). <table border="1" style="margin-left: auto; margin-right: auto;"> <thead> <tr> <th>4007 value</th> <th>Entry</th> <th>Display</th> </tr> </thead> <tbody> <tr> <td>0</td> <td>0003</td> <td>3</td> </tr> <tr> <td>1</td> <td>0031</td> <td>3.1</td> </tr> <tr> <td>2</td> <td>0314</td> <td>3.14</td> </tr> <tr> <td>3</td> <td>3142</td> <td>3.142</td> </tr> </tbody> </table> | 4007 value | Entry | Display | 0 | 0003 | 3 | 1 | 0031 | 3.1 | 2 | 0314 | 3.14 | 3 | 3142 | 3.142 |
| 4007 value | Entry | Display | | | | | | | | | | | | | | |
| 0 | 0003 | 3 | | | | | | | | | | | | | | |
| 1 | 0031 | 3.1 | | | | | | | | | | | | | | |
| 2 | 0314 | 3.14 | | | | | | | | | | | | | | |
| 3 | 3142 | 3.142 | | | | | | | | | | | | | | |

| Code | Description | |
|------|---|--|
| 4008 | <p>0% VALUE</p> <p>Defines (together with the next parameter) the scaling applied to the PID controller's actual values (PID1 parameters 0128, 0130 and 0132).</p> <ul style="list-style-type: none"> Units and scale are defined by parameters 4006 and 4007. | |
| 4009 | <p>100% VALUE</p> <p>Defines (together with the previous parameter) the scaling applied to the PID controller's actual values.</p> <ul style="list-style-type: none"> Units and scale are defined by parameters 4006 and 4007. | |
| 4010 | <p>SET POINT SEL</p> <p>Defines the reference signal source for the PID controller.</p> <ul style="list-style-type: none"> Parameter has no significance when the PID regulator is by-passed (see 8121 REG BYPASS CTRL). <p>0 = KEYPAD – Control panel provides reference.</p> <p>1 = AI1 – Analog input 1 provides reference.</p> <p>2 = AI2 – Analog input 2 provides reference.</p> <p>8 = COMM – Fieldbus provides reference.</p> <p>9 = COMM+AI1 – Defines a fieldbus and analog input 1 (AI1) combination as the reference source. See Analog input reference correction below.</p> <p>10 = COMM*AI1 – Defines a fieldbus and analog input 1 (AI1) combination as the reference source. See Analog input reference correction below.</p> <p>11 = DI3U,4D(RNC) – Digital inputs, acting as a motor potentiometer control, provide reference.</p> <ul style="list-style-type: none"> DI3 increases the speed (the U stands for “up”) DI4 decreases the reference (the D stands for “down”). Parameter 2205 ACCELER TIME 2 controls the reference signal's rate of change. R = Stop command resets the reference to zero. NC = Reference value is not copied. <p>12 = DI3U,4D(NC) – Same as DI3U,4D(RNC) above, except:</p> <ul style="list-style-type: none"> Stop command does not reset reference to zero. At restart the motor ramps up, at the selected acceleration rate, to the stored reference. <p>13 = DI5U,6D(NC) – Same as DI3U,4D(NC) above, except:</p> <ul style="list-style-type: none"> Uses digital inputs DI5 and DI6. <p>14 = AI1+AI2 – Defines an analog input 1 (AI1) and analog input 2 (AI2) combination as the reference source. See Analog input reference correction below.</p> <p>15 = AI1*AI2 – Defines an analog input 1 (AI1) and analog input 2 (AI2) combination as the reference source. See Analog input reference correction below.</p> <p>16 = AI1-AI2 – Defines an analog input 1 (AI1) and analog input 2 (AI2) combination as the reference source. See Analog input reference correction below.</p> <p>17 = AI1/AI2 – Defines an analog input 1 (AI1) and analog input 2 (AI2) combination as the reference source. See Analog input reference correction below.</p> <p>19 = INTERNAL – A constant value set using parameter 4011 provides reference.</p> <p>20 = PID2OUT – Defines PID controller 2 output (parameter 0127 PID 2 OUTPUT) as the reference source.</p> | |

| Code | Description | | | | | | | | | | |
|---------------|---|---------------|---------------------------------|-------|--|-------|--|-------|--|-------|--|
| | <p>Analog input reference correction Parameter values 9, 10 and 14...17 use the formula in the following table.</p> <table border="1"> <thead> <tr> <th>Value setting</th> <th>Calculation of the AI reference</th> </tr> </thead> <tbody> <tr> <td>C + B</td> <td>C value + (B value - 50% of reference value)</td> </tr> <tr> <td>C * B</td> <td>C value * (B value / 50% of reference value)</td> </tr> <tr> <td>C - B</td> <td>((C value + 50% of reference value) - B value)</td> </tr> <tr> <td>C / B</td> <td>((C value * 50% of reference value) / B value)</td> </tr> </tbody> </table> <p>Where:</p> <ul style="list-style-type: none"> C = Main reference value (= COMM for values 9, 10 and = AI1 for values 14...17) B = Correcting reference (= AI1 for values 9, 10 and = AI2 for values 14...17). <p>Example: The figure shows the reference source curves for value settings 9, 10 and 14...17, where:</p> <ul style="list-style-type: none"> C = 25%. P 4012 SETPOINT MIN = 0. P 4013 SETPOINT MAX = 0. B varies along the horizontal axis. | Value setting | Calculation of the AI reference | C + B | C value + (B value - 50% of reference value) | C * B | C value * (B value / 50% of reference value) | C - B | ((C value + 50% of reference value) - B value) | C / B | ((C value * 50% of reference value) / B value) |
| Value setting | Calculation of the AI reference | | | | | | | | | | |
| C + B | C value + (B value - 50% of reference value) | | | | | | | | | | |
| C * B | C value * (B value / 50% of reference value) | | | | | | | | | | |
| C - B | ((C value + 50% of reference value) - B value) | | | | | | | | | | |
| C / B | ((C value * 50% of reference value) / B value) | | | | | | | | | | |
| 4011 | <p>INTERNAL SETPNT Sets a constant value used for the process reference. • Units and scale are defined by parameters 4006 and 4007.</p> | | | | | | | | | | |
| 4012 | <p>SETPOINT MIN Sets the minimum value for the reference signal source. • See parameter 4010.</p> | | | | | | | | | | |
| 4013 | <p>SETPOINT MAX Sets the maximum value for the reference signal source. • See parameter 4010.</p> | | | | | | | | | | |
| 4014 | <p>FBK SEL Defines the PID controller feedback (actual signal). • You can define a combination of two actual values (ACT1 and ACT2) as the feedback signal. • Use parameter 4016 to define the source for actual value 1 (ACT1). • Use parameter 4017 to define the source for actual value 2 (ACT2). 1 = ACT1 – Actual value 1 (ACT1) provides the feedback signal. 2 = ACT1-ACT2 – ACT1 minus ACT2 provides the feedback signal. 3 = ACT1+ACT2 – ACT1 plus ACT2 provides the feedback signal. 4 = ACT1*ACT2 – ACT1 times ACT2 provides the feedback signal. 5 = ACT1/ACT2 – ACT1 divided by ACT2 provides the feedback signal. 6 = MIN(ACT1,2) – The smaller of ACT1 or ACT2 provides the feedback signal. 7 = MAX(ACT1,2) – The greater of ACT1 or ACT2 provides the feedback signal. 8 = sqrt(ACT1-2) – Square root of the value for ACT1 minus ACT2 provides the feedback signal. 9 = sqrt(ACT1)+sqrt(ACT2) – Square root of ACT1 plus the square root of ACT2 provides the feedback signal. 10 = sqrt(ACT1) – Square root of ACT1 provides the feedback signal. 11 = COMM FBK 1 – Signal 0158 PID COMM VALUE 1 provides the feedback signal. 12 = COMM FBK 2 – Signal 0159 PID COMM VALUE 2 provides the feedback signal. 13 = AVE(ACT1,2) – The average of ACT1 and ACT2 provides the feedback signal.</p> | | | | | | | | | | |
| 4015 | <p>FBK MULTIPLIER Defines an extra multiplier for the PID feedback value FBK defined by parameter 4014. • Used mainly in applications where the flow is calculated from the pressure difference. 0.000 = NOT SEL – The parameter has no effect (1.000 used as the multiplier). -32.768...32.767 – Multiplier applied to the signal defined by parameter 4014 FBK SEL.</p> <p>Example: FBK = Multiplier × √A1 - A2</p> | | | | | | | | | | |

| Code | Description | | | | | | | | | | | | | | | | | | | | | | | | |
|----------|---|---------------------|---------------------|-------------|-------------|---|----------------|------------------|------------------|---|----------------|------------------|------------------|---|---------|---|---------------------|---|--------|---------------------|--------------------|---|-------|--------------------|-------------------|
| 4016 | <p>ACT1 INPUT</p> <p>Defines the source for actual value 1 (ACT1). See also parameter 4018 ACT1 MINIMUM.</p> <p>1 = AI1 – Uses analog input 1 for ACT1. 2 = AI2 – Uses analog input 2 for ACT1. 3 = CURRENT – Uses current for ACT1. 4 = TORQUE – Uses torque for ACT1. 5 = POWER – Uses power for ACT1. 6 = COMM ACT 1 – Uses value of signal 0158 PID COMM VALUE 1 for ACT1. 7 = COMM ACT 2 – Uses value of signal 0159 PID COMM VALUE 2 for ACT1.</p> | | | | | | | | | | | | | | | | | | | | | | | | |
| 4017 | <p>ACT2 INPUT</p> <p>Defines the source for actual value 2 (ACT2). See also parameter 4020 ACT2 MINIMUM.</p> <p>1 = AI1 – Uses analog input 1 for ACT2. 2 = AI2 – Uses analog input 2 for ACT2. 3 = CURRENT – Uses current for ACT2. 4 = TORQUE – Uses torque for ACT2. 5 = POWER – Uses power for ACT2. 6 = COMM ACT 1 – Uses value of signal 0158 PID COMM VALUE 1 for ACT2. 7 = COMM ACT 2 – Uses value of signal 0159 PID COMM VALUE 2 for ACT2.</p> | | | | | | | | | | | | | | | | | | | | | | | | |
| 4018 | <p>ACT1 MINIMUM</p> <p>Sets the minimum value for ACT1.</p> <ul style="list-style-type: none"> • Scales the source signal used as the actual value ACT1 (defined by parameter 4016 ACT1 INPUT). For parameter 4016 values 6 (COMM ACT 1) and 7 (COMM ACT 2) scaling is not done. <table border="1"> <thead> <tr> <th>Par 4016</th> <th>Source</th> <th>Source min.</th> <th>Source max.</th> </tr> </thead> <tbody> <tr> <td>1</td> <td>Analog input 1</td> <td>1301 MINIMUM AI1</td> <td>1302 MAXIMUM AI1</td> </tr> <tr> <td>2</td> <td>Analog input 2</td> <td>1304 MINIMUM AI2</td> <td>1305 MAXIMUM AI2</td> </tr> <tr> <td>3</td> <td>Current</td> <td>0</td> <td>2 · nominal current</td> </tr> <tr> <td>4</td> <td>Torque</td> <td>-2 · nominal torque</td> <td>2 · nominal torque</td> </tr> <tr> <td>5</td> <td>Power</td> <td>-2 · nominal power</td> <td>2 · nominal power</td> </tr> </tbody> </table> <ul style="list-style-type: none"> • See the figure: A= Normal; B = Inversion (ACT1 MINIMUM > ACT1 MAXIMUM) | Par 4016 | Source | Source min. | Source max. | 1 | Analog input 1 | 1301 MINIMUM AI1 | 1302 MAXIMUM AI1 | 2 | Analog input 2 | 1304 MINIMUM AI2 | 1305 MAXIMUM AI2 | 3 | Current | 0 | 2 · nominal current | 4 | Torque | -2 · nominal torque | 2 · nominal torque | 5 | Power | -2 · nominal power | 2 · nominal power |
| Par 4016 | Source | Source min. | Source max. | | | | | | | | | | | | | | | | | | | | | | |
| 1 | Analog input 1 | 1301 MINIMUM AI1 | 1302 MAXIMUM AI1 | | | | | | | | | | | | | | | | | | | | | | |
| 2 | Analog input 2 | 1304 MINIMUM AI2 | 1305 MAXIMUM AI2 | | | | | | | | | | | | | | | | | | | | | | |
| 3 | Current | 0 | 2 · nominal current | | | | | | | | | | | | | | | | | | | | | | |
| 4 | Torque | -2 · nominal torque | 2 · nominal torque | | | | | | | | | | | | | | | | | | | | | | |
| 5 | Power | -2 · nominal power | 2 · nominal power | | | | | | | | | | | | | | | | | | | | | | |
| 4019 | <p>ACT1 MAXIMUM</p> <p>Sets the maximum value for ACT1.</p> <ul style="list-style-type: none"> • See 4018 ACT1 MINIMUM. | | | | | | | | | | | | | | | | | | | | | | | | |
| 4020 | <p>ACT2 MINIMUM</p> <p>Sets the minimum value for ACT2.</p> <ul style="list-style-type: none"> • See 4018 ACT1 MINIMUM. | | | | | | | | | | | | | | | | | | | | | | | | |
| 4021 | <p>ACT2 MAXIMUM</p> <p>Sets the maximum value for ACT2.</p> <ul style="list-style-type: none"> • See 4018 ACT1 MINIMUM. | | | | | | | | | | | | | | | | | | | | | | | | |
| 4022 | <p>SLEEP SELECTION</p> <p>Defines the control for the PID sleep function.</p> <p>0 = NOT SEL– Disables the PID sleep control function.</p> <p>1 = DI1 – Defines digital input DI1 as the control for the PID sleep function.</p> <ul style="list-style-type: none"> • Activating the digital input activates the sleep function. • De-activating the digital input restores PID control. <p>2...6 = DI2...DI6 – Defines digital input DI2...DI6 as the control for the PID sleep function.</p> <ul style="list-style-type: none"> • See DI1 above. <p>7 = INTERNAL – Defines the output rpm/frequency, process reference and process actual value as the control for the PID sleep function. Refer to parameters 4025 WAKE-UP DEV and 4023 PID SLEEP LEVEL.</p> <p>-1 = DI1(INV) – Defines an inverted digital input DI1 as the control for the PID sleep function.</p> <ul style="list-style-type: none"> • De-activating the digital input activates the sleep function. • Activating the digital input restores PID control. <p>-2...-6 = DI2(INV)...DI6(INV) – Defines an inverted digital input DI2...DI6 as the control for the PID sleep function.</p> <ul style="list-style-type: none"> • See DI1(INV) above. | | | | | | | | | | | | | | | | | | | | | | | | |

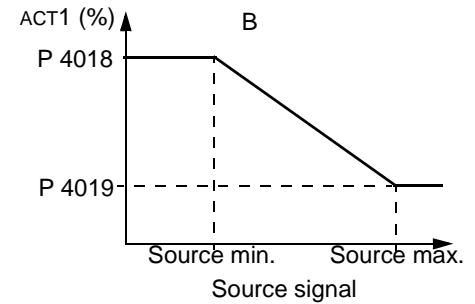
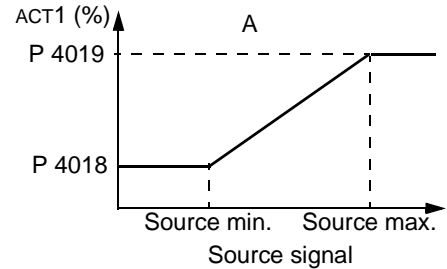

| Code | Description | |
|------|---|--|
| 4023 | <p>PID SLEEP LEVEL</p> <p>Sets the motor speed / frequency that enables the PID sleep function – a motor speed / frequency below this level, for at least the time period 4024 PID SLEEP DELAY enables the PID sleep function (stopping the drive).</p> <ul style="list-style-type: none"> • Requires 4022 = 7 (INTERNAL). • See the figure: A = PID output level; B = PID process feedback. | |
| 4024 | <p>PID SLEEP DELAY</p> <p>Sets the time delay for the PID sleep function – a motor speed / frequency below 4023 PID SLEEP LEVEL for at least this time period enables the PID sleep function (stopping the drive).</p> <ul style="list-style-type: none"> • See 4023 PID SLEEP LEVEL above. | |
| 4025 | <p>WAKE-UP DEV</p> <p>Defines the wake-up deviation – a deviation from the setpoint greater than this value, for at least the time period 4026 WAKE-UP DELAY, re-starts the PID controller.</p> <ul style="list-style-type: none"> • Parameters 4006 and 4007 define the units and scale. • Parameter 4005 = 0, Wake-up level = Setpoint - Wake-up deviation. • Parameter 4005 = 1, Wake-up level = Setpoint + Wake-up deviation. • Wake-up level can be above or below setpoint. <p>See the figures:</p> <ul style="list-style-type: none"> • C = Wake-up level when parameter 4005 = 1 • D = Wake-up level when parameter 4005 = 0 • E = Feedback is above wake-up level and lasts longer than 4026 WAKE-UP DELAY – PID function wakes up. • F = Feedback is below wake-up level and lasts longer than 4026 WAKE-UP DELAY – PID function wakes up. | |
| 4026 | <p>WAKE-UP DELAY</p> <p>Defines the wake-up delay – a deviation from the setpoint greater than 4025 WAKE-UP DEV, for at least this time period, re-starts the PID controller.</p> | |

| Code | Description |
|------|---|
| 4027 | <p>PID 1 PARAM SET</p> <p>Process PID (PID1) has two separate sets of parameters, PID set 1 and PID set 2.</p> <ul style="list-style-type: none"> • PID set 1 uses parameters 4001...4026. • PID set 2 uses parameters 4101...4126. <p>PID 1 PARAM SET defines which set is selected.</p> <p>0 = SET 1 – PID Set 1 (parameters 4001...4026) is active.</p> <p>1 = DI1 – Defines digital input DI1 as the control for PID Set selection.</p> <ul style="list-style-type: none"> • Activating the digital input selects PID Set 2. • De-activating the digital input selects PID Set 1. <p>2...6 = DI2...DI6 – Defines digital input DI2...DI6 as the control for PID Set selection.</p> <ul style="list-style-type: none"> • See DI1 above. <p>7 = SET 2 – PID Set 2 (parameters 4101...4126) is active.</p> <p>8...11 = TIMED FUNC 1...4 – Defines the Timed function as the control for the PID Set selection (Timed function de-activated = PID Set 1; Timed function activated = PID Set 2)</p> <ul style="list-style-type: none"> • See Group 36: TIMED FUNCTIONS. <p>12 = 2-ZONE MIN – The drive calculates the difference between setpoint 1 and feedback 1 as well as setpoint 2 and feedback 2. The drive will control the zone (and select the set) that has a larger difference.</p> <ul style="list-style-type: none"> • A positive difference (a setpoint higher than the feedback) is always larger than a negative difference. This keeps feedback values at or above the setpoint. • Controller does not react to the situation of feedback above setpoint if another zone's feedback is closer to its setpoint. <p>13 = 2-ZONE MAX – The drive calculates the difference between setpoint 1 and feedback 1 as well as setpoint 2 and feedback 2. The drive will control the zone (and select the set) that has a smaller difference.</p> <ul style="list-style-type: none"> • A negative difference (a setpoint lower than the feedback) is always smaller than a positive difference. This keeps feedback values at or below the setpoint. • Controller does not react to the situation of feedback below setpoint if another zone's feedback is closer to its setpoint. <p>14 = 2-ZONE AVE – The drive calculates the difference between setpoint 1 and feedback 1 as well as setpoint 2 and feedback 2. In addition, it calculates the average of the deviations and uses it to control zone 1. Therefore one feedback is kept above its setpoint and another is kept as much below its setpoint.</p> <p>-1 = DI1(INV) – Defines an inverted digital input DI1 as the control for PID Set selection.</p> <ul style="list-style-type: none"> • Activating the digital input selects PID Set 1. • De-activating the digital input selects PID Set 2. <p>-2...-6 = DI2(INV)...DI6(INV) – Defines an inverted digital input DI2...DI6 as the control for PID Set selection.</p> <ul style="list-style-type: none"> • See DI1(INV) above. |

Group 41: PROCESS PID SET 2

Parameters of this group belong to PID parameter set 2. The operation of parameters 4101...4126 is analogous with set 1 parameters 4001...4026.

PID parameter set 2 can be selected by parameter 4027 PID 1 PARAM SET.

| Code | Description |
|---------------------|------------------|
| 4101 ... 4126 | See 4001 ...4026 |

Group 42: EXT / TRIM PID

This group defines the parameters used for the second PID controller (PID2), which is used for the External / Trimming PID.

The operation of parameters 4201...4221 is analogous with Process PID set 1 (PID1) parameters 4001...4021.

| Code | Description |
|---------------------|--|
| 4201 ... 4221 | See 4001 ...4021 |
| 4228 | <p>ACTIVATE</p> <p>Defines the source for enabling the external PID function.</p> <ul style="list-style-type: none"> Requires 4230 TRIM MODE = 0 (NOT SEL). <p>0 = NOT SEL – Disables external PID control.</p> <p>1 = DI1 – Defines digital input DI1 as the control for enabling external PID control.</p> <ul style="list-style-type: none"> Activating the digital input enables external PID control. De-activating the digital input disables external PID control. <p>2...6 = DI2...DI6 – Defines digital input DI2...DI6 as the control for enabling external PID control.</p> <ul style="list-style-type: none"> See DI1 above. <p>7 = DRIVE RUN – Defines the start command as the control for enabling external PID control.</p> <ul style="list-style-type: none"> Activating the start command (drive is running) enables external PID control. <p>8 = ON – Defines the power-on as the control for enabling external PID control.</p> <ul style="list-style-type: none"> Activating power to the drive enables external PID control. <p>9...12 = TIMED FUNC 1...4 – Defines the Timed function as the control for enabling external PID control (Timed function active enables external PID control).</p> <ul style="list-style-type: none"> See Group 36: TIMED FUNCTIONS. <p>-1 = DI1(INV) – Defines an inverted digital input DI1 as the control for enabling external PID control.</p> <ul style="list-style-type: none"> Activating the digital input disables external PID control. De-activating the digital input enables external PID control. <p>-2...-6 = DI2(INV)...DI6(INV) – Defines an inverted digital input DI2...DI6 as the control for enabling external PID control.</p> <ul style="list-style-type: none"> See DI1(INV) above. |
| 4229 | <p>OFFSET</p> <p>Defines the offset for the PID output.</p> <ul style="list-style-type: none"> When PID is activated, output starts from this value. When PID is deactivated, output resets to this value. Parameter is active when 4230 TRIM MODE = 0 (trim mode is not active). |
| 4230 | <p>TRIM MODE</p> <p>Selects the type of trim, if any. Using the trim it is possible to combine a corrective factor to the drive reference.</p> <p>0 = NOT SEL – Disables the trim function.</p> <p>1 = PROPORTIONAL – Adds a trim factor that is proportional to the rpm/Hz reference.</p> <p>2 = DIRECT – Adds a trim factor based on the control loop's maximum limit.</p> |
| 4231 | <p>TRIM SCALE</p> <p>Defines the multiplier (as a percent, plus or minus) used in the trim mode.</p> |

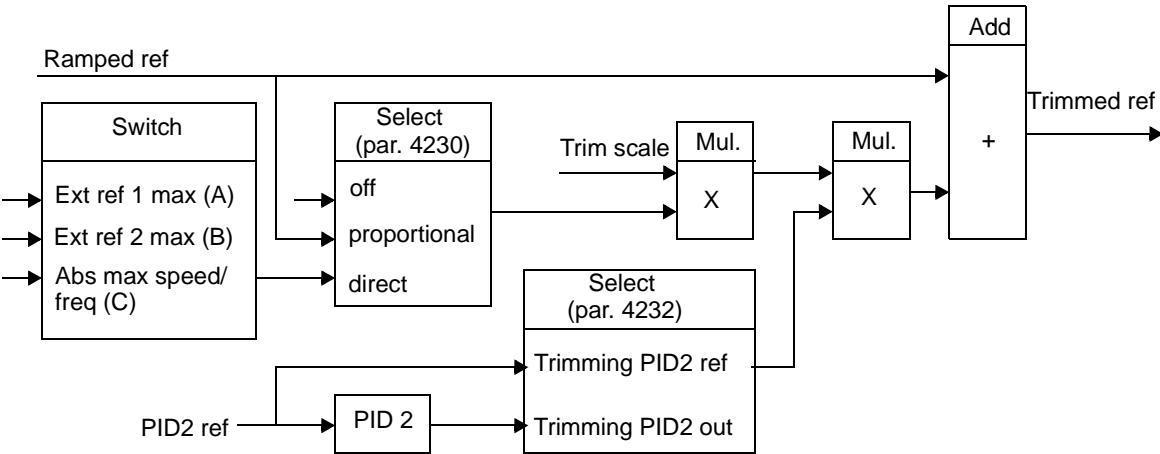
| Code | Description |
|------|---|
| 4232 | <p>CORRECTION SRC</p> <p>Defines the trimming reference for the correction source.</p> <p>1 = PID2REF – Uses appropriate REF MAX (SWITCH A OR B):</p> <ul style="list-style-type: none"> • 1105 REF1 MAX when REF1 is active (A). • 1108 REF2 MAX when REF2 is active (B). <p>2 = PID2OUTPUT – Uses the absolute maximum speed or frequency (Switch C):</p> <ul style="list-style-type: none"> • 2002 MAXIMUM SPEED if 9904 MOTOR CTRL MODE = 1 (VECTOR:SPEED) or 2 (VECTOR:TORQ). • 2008 MAXIMUM FREQ if 9904 MOTOR CTRL MODE = 3 (SCALAR:FREQ).  |

Group 50: ENCODER

This group defines the setup for encoder use:

- Sets the number of encoder pulses per shaft revolution.
- Enables the encoder operation.
- Defines how mechanical angle and revolution data is reset.

See also *User's Manual for Pulse Encoder Interface Module OTAC-01* [3AUA0000001938 (English)].

| Code | Description |
|------|---|
| 5001 | <p>PULSE NR</p> <p>Sets the number of pulses provided by an optional encoder for each full motor shaft revolution (ppr).</p> |
| 5002 | <p>ENCODER ENABLE</p> <p>Enables/disables an optional encoder.</p> <p>0 = DISABLE – Drive uses speed feedback derived from the internal motor model (applies for any setting of parameter 9904 MOTOR CTRL MODE).</p> <p>1 = ENABLE – Drive uses feedback from an optional encoder. This function requires the Pulse Encoder Interface Module (OTAC-01) and an encoder. Operation depends on the setting of parameter 9904 MOTOR CTRL MODE:</p> <ul style="list-style-type: none"> • 9904 = 1 (VECTOR:SPEED): The encoder provides improved speed feedback and improved low speed torque accuracy. • 9904 = 2 (VECTOR:TORQ): The encoder provides improved speed feedback and improved low speed torque accuracy. • 9904 = 3 (SCALAR:SPEED): The encoder provides speed feedback. (This is not closed loop speed regulation. However, using parameter 2608 SLIP COMP RATIO and an encoder improves steady state speed accuracy.) |
| 5003 | <p>ENCODER FAULT</p> <p>Defines the drive operation if a failure is detected in communication between the encoder and the encoder interface module, or between the module and the drive.</p> <p>1 = FAULT – The drive generates fault ENCODER ERR, and the motor coasts to a stop.</p> <p>2 = ALARM – The drive generates alarm ENCODER ERR and operates as if parameter 5002 ENCODER ENABLE = 0 (DISABLE), that is, speed feedback is derived from the internal motor model.</p> |
| 5010 | <p>Z PLS ENABLE</p> <p>Enables/disables the use of an encoder's Z-pulse to define the motor shaft's zero position. When enabled, a Z-pulse input resets parameter 0146 MECH ANGLE to zero to define the shaft's zero position. This function requires an encoder that provides Z-pulse signals.</p> <p>0 = DISABLE – Z-pulse input is not present or ignored if present.</p> <p>1 = ENABLE – A Z-pulse input resets parameter 0146 MECH ANGLE to zero.</p> |
| 5011 | <p>POSITION RESET</p> <p>Resets the encoder's position feedback. This parameter is self-clearing.</p> <p>0 = DISABLE – Inactive.</p> <p>1 = ENABLE – Resets the encoder position feedback. Parameters reset depends on the state of parameter 5010 Z PLS ENABLE:</p> <ul style="list-style-type: none"> • 5010 = 0 (DISABLE) – Reset applies to parameters 0147 MECH REVS and 0146 MECH ANGLE. • 5010 = 1 (ENABLE) – Reset applies only to parameter 0147 MECH REVS. |

Group 51: EXT COMM MODULE

This group defines set-up variables for a fieldbus adapter (FBA) communication module. For more information on these parameters, refer to the user's manual supplied with the FBA module.

| Code | Description |
|---------------------|--|
| 5101 | <p>FBA TYPE</p> <p>Displays the type of the connected fieldbus adapter module.</p> <p>0 = NOT DEFINED – Module not found, or not properly connected, or parameter 9802 is not set to 4 (EXT FBA).</p> <p>1 = PROFIBUS-DP</p> <p>16 = INTERBUS</p> <p>21 = LONWORKS</p> <p>32 = CANopen</p> <p>37 = DEVICENET</p> <p>64 = MODBUS PLUS</p> <p>101 = CONTROLNET</p> <p>128 = ETHERNET</p> |
| 5102 ... 5126 | <p>FB PAR 2...FB PAR 26</p> <p>Refer to communication module documentation for more information on these parameters.</p> |
| 5127 | <p>FBA PAR REFRESH</p> <p>Validates any changed fieldbus parameter settings.</p> <p>0 = DONE – Refreshing done.</p> <p>1 = REFRESH – Refreshing.</p> <ul style="list-style-type: none"> • After refreshing, the value reverts automatically to DONE. |
| 5128 | <p>FILE CPI FW REV</p> <p>Displays the CPI firmware revision of the drive's fieldbus adapter configuration file. Format is xyz where:</p> <ul style="list-style-type: none"> • x = major revision number • y = minor revision number • z = correction number <p>Example: 107 = revision 1.07</p> |
| 5129 | <p>FILE CONFIG ID</p> <p>Displays the revision of the drive's fieldbus adapter module's configuration file identification.</p> <ul style="list-style-type: none"> • File configuration information is drive application program-dependent. |
| 5130 | <p>FILE CONFIG REV</p> <p>Contains the revision of the drive's fieldbus adapter module configuration file.</p> <p>Example: 1 = revision 1</p> |
| 5131 | <p>FBA STATUS</p> <p>Contains the status of the adapter module.</p> <p>0 = IDLE – Adapter not configured.</p> <p>1 = EXECUT INIT – Adapter is initializing.</p> <p>2 = TIME OUT – A timeout has occurred in the communication between the adapter and the drive.</p> <p>3 = CONFIG ERROR – Adapter configuration error.</p> <ul style="list-style-type: none"> • The revision code of the adapter's CPI firmware revision is older than required CPI firmware version defined in the drive's configuration file (parameter 5132 < 5128). <p>4 = OFF-LINE – Adapter is off-line.</p> <p>5 = ON-LINE – Adapter is on-line.</p> <p>6 = RESET – Adapter is performing a hardware reset.</p> |
| 5132 | <p>FBA CPI FW REV</p> <p>Contains the revision of the module's CPI program. Format is xyz where:</p> <ul style="list-style-type: none"> • x = major revision number • y = minor revision number • z = correction number <p>Example: 107 = revision 1.07</p> |
| 5133 | <p>FBA APPL FW REV</p> <p>Contains the revision of the module's application program. Format is xyz (see parameter 5132).</p> |

Group 52: PANEL COMM

This group defines the communication settings for the control panel port on the drive. Normally, when using the supplied control panel, there is no need to change settings in this group.

In this group, parameter modifications take effect on the next power-up.

| Code | Description |
|------|--|
| 5201 | STATION ID Defines the address of the drive. <ul style="list-style-type: none"> • Two units with the same address are not allowed on-line. • Range: 1...247 |
| 5202 | BAUD RATE Defines the communication speed of the drive in kbits per second (kb/s). 9.6 kb/s 19.2 kb/s 38.4 kb/s 57.6 kb/s 115.2 kb/s |
| 5203 | PARITY Sets the character format to be used with the panel communication. 0 = 8 NONE 1 – 8 data bits, no parity, one stop bit. 1 = 8 NONE 2 – 8 data bits, no parity, two stop bits. 2 = 8 EVEN 1 – 8 data bits, even parity, one stop bit. 3 = 8 ODD 1 – 8 data bits, odd parity, one stop bit. |
| 5204 | OK MESSAGES Contains a count of valid Modbus messages received by the drive. <ul style="list-style-type: none"> • During normal operation, this counter is increasing constantly. |
| 5205 | PARITY ERRORS Contains a count of the characters with a parity error that is received from the bus. For high counts, check: <ul style="list-style-type: none"> • Parity settings of devices connected on the bus – they must not differ. • Ambient electro-magnetic noise levels – high noise levels generate errors. |
| 5206 | FRAME ERRORS Contains a count of the characters with a framing error that the bus receives. For high counts, check: <ul style="list-style-type: none"> • Communication speed settings of devices connected on the bus – they must not differ. • Ambient electro-magnetic noise levels – high noise levels generate errors. |
| 5207 | BUFFER OVERRUNS Contains a count of the characters received that cannot be placed in the buffer. <ul style="list-style-type: none"> • Longest possible message length for the drive is 128 bytes. • Received messages exceeding 128 bytes overflow the buffer. The excess characters are counted. |
| 5208 | CRC ERRORS Contains a count of the messages with a CRC error that the drive receives. For high counts, check: <ul style="list-style-type: none"> • Ambient electro-magnetic noise levels – high noise levels generate errors. • CRC calculations for possible errors. |

Group 53: EFB PROTOCOL

This group defines set-up variables used for an embedded fieldbus (EFB) communication protocol. The standard EFB protocol in the ACS550 is Modbus. See chapter [Embedded fieldbus](#) page 219.

| Code | Description |
|------|--|
| 5301 | EFB PROTOCOL ID Contains the identification and program revision of the protocol. <ul style="list-style-type: none"> • Format: XYY, where xx = protocol ID, and YY = program revision. |
| 5302 | EFB STATION ID Defines the node address of the RS485 link. <ul style="list-style-type: none"> • The node address on each unit must be unique. |
| 5303 | EFB BAUD RATE Defines the communication speed of the RS485 link in kbits per second (kb/s). 1.2 kb/s 2.4 kb/s 4.8 kb/s 9.6 kb/s 19.2 kb/s 38.4 kb/s 57.6 kb/s 76.8 kb/s |
| 5304 | EFB PARITY Defines the data length, parity and stop bits to be used with the RS485 link communication. <ul style="list-style-type: none"> • The same settings must be used in all on-line stations. 0 = 8 NONE 1 – 8 data bits, no parity, one stop bit. 1 = 8 NONE 2 – 8 data bits, no parity, two stop bits. 2 = 8 EVEN 1 – 8 data bits, even parity, one stop bit. 3 = 8 ODD 1 – 8 data bits, odd parity, one stop bit. |
| 5305 | EFB CTRL PROFILE Selects the communication profile used by the EFB protocol. 0 = ABB DRV LIM – Operation of Control/Status Words conforms to ABB Drives Profile, as used in ACS400. 1 = DCU PROFILE – Operation of Control/Status Words conforms to 32-bit DCU Profile. 2 = ABB DRV FULL – Operation of Control/Status Words conforms to ABB Drives Profile, as used in ACS600/800. |
| 5306 | EFB OK MESSAGES Contains a count of valid messages received by the drive. <ul style="list-style-type: none"> • During normal operation, this counter is increasing constantly. |
| 5307 | EFB CRC ERRORS Contains a count of the messages with a CRC error received by the drive. For high counts, check: <ul style="list-style-type: none"> • Ambient electro-magnetic noise levels – high noise levels generate errors. • CRC calculations for possible errors. |
| 5308 | EFB UART ERRORS Contains a count of the messages with a character error received by the drive. |
| 5309 | EFB STATUS Contains the status of the EFB protocol. 0 = IDLE – EFB protocol is configured, but not receiving any messages. 1 = EXECUT INIT – EFB protocol is initializing. 2 = TIME OUT – A timeout has occurred in the communication between the network master and the EFB protocol. 3 = CONFIG ERROR – EFB protocol has a configuration error. 4 = OFF-LINE – EFB protocol is receiving messages that are NOT addressed to this drive. 5 = ON-LINE – EFB protocol is receiving messages that are addressed to this drive. 6 = RESET – EFB protocol is performing a hardware reset. 7 = LISTEN ONLY – EFB protocol is in listen-only mode. |
| 5310 | EFB PAR 10 Specifies the parameter mapped to Modbus Register 40005. |

| Code | Description |
|-------------|--|
| 5311 | EFB PAR 11 Specifies the parameter mapped to Modbus Register 40006. |
| 5312 | EFB PAR 12 Specifies the parameter mapped to Modbus Register 40007. |
| 5313 | EFB PAR 13 Specifies the parameter mapped to Modbus Register 40008. |
| 5314 | EFB PAR 14 Specifies the parameter mapped to Modbus Register 40009. |
| 5315 | EFB PAR 15 Specifies the parameter mapped to Modbus Register 40010. |
| 5316 | EFB PAR 16 Specifies the parameter mapped to Modbus Register 40011. |
| 5317 | EFB PAR 17 Specifies the parameter mapped to Modbus Register 40012. |
| 5318 | EFB PAR 18 For Modbus: Sets additional delay in milliseconds before the ACS550 begins transmitting response to the master request. |
| 5319 | EFB PAR 19 ABB Drives profile (ABB DRV LIM or ABB DRV FULL) Control Word. Read only copy of the Fieldbus Control Word. |
| 5320 | EFB PAR 20 ABB Drives profile (ABB DRV LIM or ABB DRV FULL) Status Word. Read only copy of the Fieldbus Status Word. |

Group 81: PFC CONTROL

This group defines a Pump-Fan Control (PFC) mode of operation. The major features of PFC control are:

- The ACS550 controls the motor of pump no. 1, varying the motor speed to control the pump capacity. This motor is the speed regulated motor.
- Direct line connections power the motor of pump no. 2 and pump no.3, etc. The ACS550 switches pump no. 2 (and then pump no. 3, etc.) on and off as needed. These motors are auxiliary motors.
- The ACS550 PID control uses two signals: a process reference and an actual value feedback. The PID controller adjusts the speed (frequency) of the first pump such that the actual value follows the process reference.
- When demand (defined by the process reference) exceeds the first motor's capacity (user defined as a frequency limit), the PFC control automatically starts an auxiliary pump. The PFC also reduces the speed of the first pump to account for the auxiliary pump's addition to total output. Then, as before, the PID controller adjusts the speed (frequency) of the first pump such that the actual value follows the process reference. If demand continues to increase, PFC adds additional auxiliary pumps, using the same process.
- When demand drops, such that the first pump speed falls below a minimum limit (user defined by a frequency limit), the PFC control automatically stops an auxiliary pump. The PFC also increases the speed of the first pump to account for the auxiliary pump's missing output.
- An Interlock function (when enabled) identifies off-line (out of service) motors, and the PFC control skips to the next available motor in the sequence.
- An Autochange function (when enabled and with the appropriate switchgear) equalizes duty time between the pump motors. Autochange periodically increments the position of each motor in the rotation – the speed regulated motor becomes the last auxiliary motor, the first auxiliary motor becomes the speed regulated motor, etc.

| Code | Description |
|------|--|
| 8103 | <p>REFERENCE STEP 1</p> <p>Sets a percentage value that is added to the process reference.</p> <ul style="list-style-type: none"> • Applies only when <u>at least one</u> auxiliary (constant speed) motor is running. • Default value is 0%. <p>Example: An ACS550 operates three parallel pumps that maintain water pressure in a pipe.</p> <ul style="list-style-type: none"> • 4011 INTERNAL SETPNT sets a constant pressure reference that controls the pressure in the pipe. • The speed regulated pump operates alone at low water consumption levels. • As water consumption increases, first one constant speed pump operates, then, the second. • As flow increases, the pressure at the output end of the pipe drops relative to the pressure measured at the input end. As auxiliary motors step in to increase the flow, the adjustments below correct the reference to more closely match the output pressure. • When the first auxiliary pump operates, increase the reference with parameter 8103 REFERENCE STEP 1. • When two auxiliary pumps operate, increase the reference with parameter 8103 REFERENCE STEP 1 + parameter 8104 REFERENCE STEP 2. • When three auxiliary pumps operate, increase the reference with parameter 8103 REFERENCE STEP 1 + parameter 8104 REFERENCE STEP 2 + parameter 8105 REFERENCE STEP 3. |

| Code | Description |
|------|---|
| 8104 | <p>REFERENCE STEP 2</p> <p>Sets a percentage value that is added to the process reference.</p> <ul style="list-style-type: none"> • Applies only when <u>at least two</u> auxiliary (constant speed) motors are running. • See parameter 8103 REFERENCE STEP 1. |
| 8105 | <p>REFERENCE STEP 3</p> <p>Sets a percentage value that is added to the process reference.</p> <ul style="list-style-type: none"> • Applies only when <u>at least three</u> auxiliary (constant speed) motors are running. • See parameter 8103 REFERENCE STEP 1. |
| 8109 | <p>START FREQ 1</p> <p>Sets the frequency limit used to start the first auxiliary motor. The first auxiliary motor starts if:</p> <ul style="list-style-type: none"> • No auxiliary motors are running. • ACS550 output frequency exceeds the limit: 8109 + 1 Hz. • Output frequency stays above a relaxed limit (8109 - 1 Hz) for at least the time: 8115 AUX MOT START D. <p>After the first auxiliary motor starts:</p> <ul style="list-style-type: none"> • Output frequency decreases by the value = (8109 START FREQ 1) - (8112 LOW FREQ 1). • In effect, the output of the speed regulated motor drops to compensate for the input from the auxiliary motor. <p>See the figure, where:</p> <ul style="list-style-type: none"> • A = (8109 START FREQ 1) - (8112 LOW FREQ 1) • B = Output frequency increase during the start delay. • C = Diagram showing auxiliary motor's run status as frequency increases (1 = On). <p>Note: 8109 START FREQ 1 value must be between:</p> <ul style="list-style-type: none"> • 8112 LOW FREQ 1 • (2008 MAXIMUM FREQ) -1. |
| 8110 | <p>START FREQ 2</p> <p>Sets the frequency limit used to start the second auxiliary motor.</p> <ul style="list-style-type: none"> • See 8109 START FREQ 1 for a complete description of the operation. <p>The second auxiliary motor starts if:</p> <ul style="list-style-type: none"> • One auxiliary motor is running. • ACS550 output frequency exceeds the limit: 8110 + 1. • Output frequency stays above the relaxed limit (8110 - 1 Hz) for at least the time: 8115 AUX MOT START D. |
| 8111 | <p>START FREQ 3</p> <p>Sets the frequency limit used to start the third auxiliary motor.</p> <ul style="list-style-type: none"> • See 8109 START FREQ 1 for a complete description of the operation. <p>The third auxiliary motor starts if:</p> <ul style="list-style-type: none"> • Two auxiliary motors are running. • ACS550 output frequency exceeds the limit: 8111 + 1 Hz. • Output frequency stays above the relaxed limit (8111 - 1 Hz) for at least the time: 8115 AUX MOT START D. |

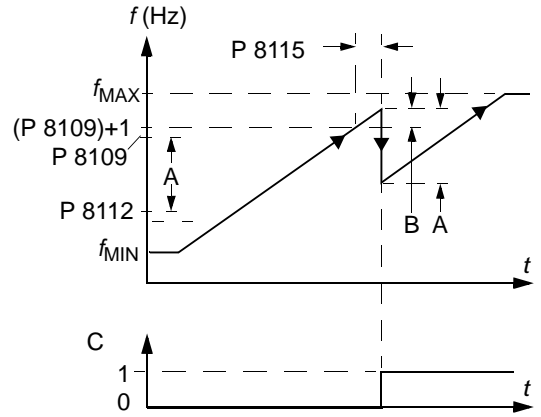

| Code | Description |
|------|---|
| 8112 | <p>LOW FREQ 1</p> <p>Sets the frequency limit used to stop the first auxiliary motor. The first auxiliary motor stops if:</p> <ul style="list-style-type: none"> • Only one (the first) auxiliary motor is running. • ACS550 output frequency drops below the limit: 8112 - 1. • Output frequency stays below the relaxed limit (8112 + 1 Hz) for at least the time: 8116 AUX MOT STOP D. <p>After the first auxiliary motor stops:</p> <ul style="list-style-type: none"> • Output frequency increases by the value = (8109 START FREQ 1) - (8112 LOW FREQ 1). • In effect, the output of the speed regulated motor increases to compensate for the loss of the auxiliary motor. <p>See the figure, where:</p> <ul style="list-style-type: none"> • A = (8109 START FREQ 1) - (8112 LOW FREQ 1) • B = Output frequency decrease during the stop delay. • C = Diagram showing auxiliary motor's run status as frequency decreases (1 = On). • Grey path = Shows hysteresis – if time is reversed, the path backwards is not the same. For details on the path for starting, see the diagram at 8109 START FREQ 1. <p>Note: 8112 LOW FREQ 1 value must be between:</p> <ul style="list-style-type: none"> • (2007 MINIMUM FREQ) +1. • 8109 START FREQ 1 |
| 8113 | <p>LOW FREQ 2</p> <p>Sets the frequency limit used to stop the second auxiliary motor.</p> <ul style="list-style-type: none"> • See 8112 LOW FREQ 1 for a complete description of the operation. <p>The second auxiliary motor stops if:</p> <ul style="list-style-type: none"> • Two auxiliary motors are running. • ACS550 output frequency drops below the limit: 8113 - 1. • Output frequency stays below the relaxed limit (8113 + 1 Hz) for at least the time: 8116 AUX MOT STOP D. |
| 8114 | <p>LOW FREQ 3</p> <p>Sets the frequency limit used to stop the third auxiliary motor.</p> <ul style="list-style-type: none"> • See 8112 LOW FREQ 1 for a complete description of the operation. <p>The third auxiliary motor stops if:</p> <ul style="list-style-type: none"> • Three auxiliary motors are running. • ACS550 output frequency drops below the limit: 8114 - 1. • Output frequency stays below the relaxed limit (8114 + 1 Hz) for at least the time: 8116 AUX MOT STOP D. |
| 8115 | <p>AUX MOT START D</p> <p>Sets the Start Delay for the auxiliary motors.</p> <ul style="list-style-type: none"> • The output frequency must remain above the start frequency limit (parameter 8109, 8110, or 8111) for this time period before the auxiliary motor starts. • See 8109 START FREQ 1 for a complete description of the operation. |
| 8116 | <p>AUX MOT STOP D</p> <p>Sets the Stop Delay for the auxiliary motors.</p> <ul style="list-style-type: none"> • The output frequency must remain below the low frequency limit (parameter 8112, 8113, or 8114) for this time period before the auxiliary motor stops. • See 8112 LOW FREQ 1 for a complete description of the operation. |

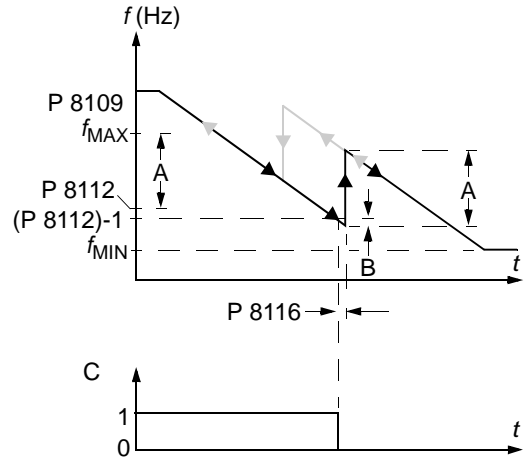

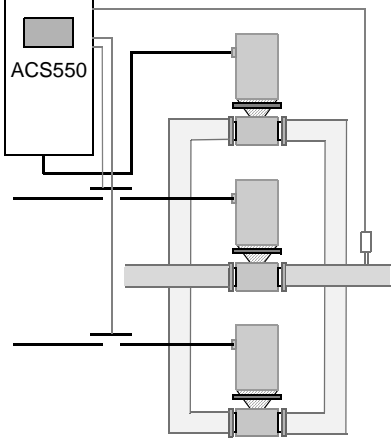
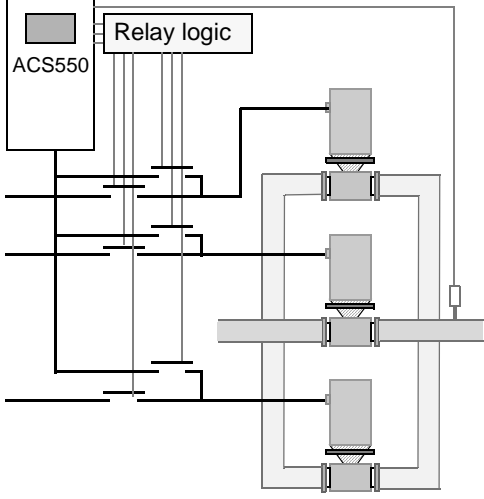
| Code | Description |
|------|--|
| 8117 | <p>NR OF AUX MOT</p> <p>Sets the number of auxiliary motors.</p> <ul style="list-style-type: none"> • Each auxiliary motor requires a relay output, which the drive uses to send start/stop signals. • The Autochange function, if used, requires an additional relay output for the speed regulated motor. • The following describes the set-up of the required relay outputs. <p>Relay outputs</p> <p>As noted above, each auxiliary motor requires a relay output, which the drive uses to send start/stop signals. The following describes how the drive keeps track of motors and relays.</p> <ul style="list-style-type: none"> • The ACS550 provides relay outputs RO1...RO3. • An external digital output module can be added to provide relay outputs RO4...RO6. • Parameters 1401...1403 and 1410...1412 define, respectively, how relays RO1...RO6 are used – the parameter value 31 PFC defines the relay as used for PFC. • The ACS550 assigns auxiliary motors to relays in ascending order. If the Autochange function is disabled, the first auxiliary motor is the one connected to the first relay with a parameter setting = 31 PFC, and so on. If the Autochange function is used, the assignments rotate. Initially, the speed regulated motor is the one connected to the first relay with a parameter setting = 31 PFC, the first auxiliary motor is the one connected to the second relay with a parameter setting = 31 PFC, and so on. <div style="display: flex; justify-content: space-around; align-items: flex-start;"> <div style="text-align: center;">  <p>Standard PFC mode</p> </div> <div style="text-align: center;">  <p>PFC with Autochange mode</p> </div> </div> <ul style="list-style-type: none"> • The fourth auxiliary motor uses the same reference step, low frequency and start frequency values as the third auxiliary motor. |

Code **Description**

• The table below shows the ACS550 PFC motor assignments for some typical settings in the Relay Output parameters (1401...1403 and 1410...1412), where the settings are either =31 (PFC), or =X (anything but 31), and where the Autochange function is disabled (8118 AUTOCHNG INTERV = 0).

| Parameter setting | | | | | | | ACS550 Relay assignment | | | | | |
|-------------------|----|----|----|---|----|----|-------------------------|------|------|------|-----|------|
| 1 | 4 | 0 | 1 | 1 | 1 | 8 | Autochange disabled | | | | | |
| 1 | 2 | 3 | 0 | 1 | 2 | 7 | RO1 | RO2 | RO3 | RO4 | RO5 | RO6 |
| 31 | X | X | X | X | X | 1 | Aux. | X | X | X | X | X |
| 31 | 31 | X | X | X | X | 2 | Aux. | Aux. | X | X | X | X |
| 31 | 31 | 31 | X | X | X | 3 | Aux. | Aux. | Aux. | X | X | X |
| X | 31 | 31 | X | X | X | 2 | X | Aux. | Aux. | X | X | X |
| X | X | X | 31 | X | 31 | 2 | X | X | X | Aux. | X | Aux. |
| 31 | 31 | X | X | X | X | 1* | Aux. | Aux. | X | X | X | X |

* = One additional relay output for the PFC that is in use. One motor is in "sleep" when the other is rotating.

• The table below shows the ACS550 PFC motor assignments for some typical settings in the Relay Output parameters (1401...1403 and 1410...1412), where the settings are either =31 (PFC), or =X (anything but 31), and where the Autochange function is enabled (8118 AUTOCHNG INTERV = value > 0).

| Parameter setting | | | | | | | ACS550 Relay assignment | | | | | |
|-------------------|----|----|----|---|----|-----|-------------------------|-----|-----|-----|-----|-----|
| 1 | 4 | 0 | 1 | 1 | 1 | 8 | Autochange enabled | | | | | |
| 1 | 2 | 3 | 0 | 1 | 2 | 7 | RO1 | RO2 | RO3 | RO4 | RO5 | RO6 |
| 31 | 31 | X | X | X | X | 1 | PFC | PFC | X | X | X | X |
| 31 | 31 | 31 | X | X | X | 2 | PFC | PFC | PFC | X | X | X |
| X | 31 | 31 | X | X | X | 1 | X | PFC | PFC | X | X | X |
| X | X | X | 31 | X | 31 | 1 | X | X | X | PFC | X | PFC |
| 31 | 31 | X | X | X | X | 0** | PFC | PFC | X | X | X | X |

** = No auxiliary motors, but the autochange function is in use. Working as a standard PID-control.

8118 AUTOCHNG INTERV

Controls operation of the Autochange function and sets the interval between changes.

- The Autochange time interval only applies to the time when the speed regulated motor is running.
 - See parameter 8119 AUTOCHNG LEVEL for an overview of the Autochange function.
 - The drive always coasts to stop when autochange is performed.
 - Autochange enabled requires parameter 8120 INTERLOCKS = value > 0.
- 0.1 = TEST MODE – Forces the interval to value 36...48 s.
 0.0 = NOT SEL – Disables the Autochange function.
 0.1...336 – The operating time interval (the time when the start signal is on) between automatic motor changes.

⚠ WARNING! When enabled, the Autochange function requires the interlocks (8120 INTERLOCKS = value > 0) enabled. During autochange the power output is interrupted and the drive coasts to stop, preventing damage to the contacts.

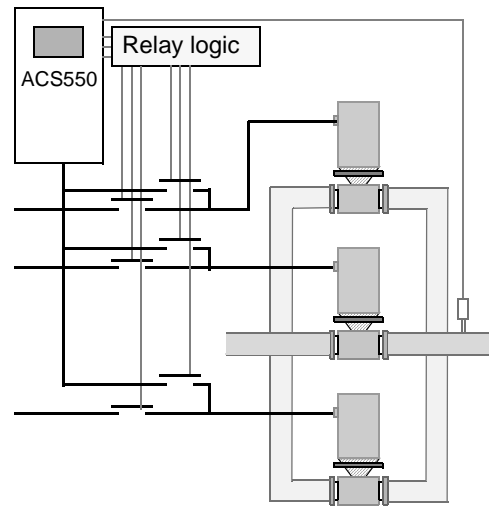

PFC with Autochange mode

| Code | Description |
|------|---|
| 8119 | <p>AUTOCHNG LEVEL</p> <p>Sets an upper limit, as a percent of output capacity, for the autochange logic. When the output from the PID/PFC control block exceeds this limit, autochange is prevented. For example, use this parameter to deny autochange when the Pump-Fan system is operating near maximum capacity.</p> <p>Autochange overview</p> <p>The purpose of the autochange operation is to equalize duty time between multiple motors used in a system. At each autochange operation:</p> <ul style="list-style-type: none"> • A different motor takes a turn connected to the ACS550 output – the speed regulated motor. • The starting order of the other motors rotates. <p>The Autochange function requires:</p> <ul style="list-style-type: none"> • External switchgear for changing the drive's output power connections. • Parameter 8120 INTERLOCKS = value > 0. <p>Autochange is performed when:</p> <ul style="list-style-type: none"> • The running time since the previous autochange reaches the time set by 8118 AUTOCHNG INTERV. • The PFC input is below the level set by this parameter, 8119 AUTOCHNG LEVEL. <p>Note: The ACS550 always coasts to stop when autochange is performed.</p> <p>In an autochange, the Autochange function does all of the following (see the figure):</p> <ul style="list-style-type: none"> • Initiates a change when the running time, since the last autochange, reaches 8118 AUTOCHNG INTERV, and PFC input is below limit 8119 AUTOCHNG LEVEL. • Stops the speed regulated motor. • Switches off the contactor of the speed regulated motor. • Increments the starting order counter, to change the starting order for the motors. • Identifies the next motor in line to be the speed regulated motor. • Switches off the above motor's contactor, if the motor was running. Any other running motors are not interrupted. • Switches on the contactor of the new speed regulated motor. The autochange switchgear connects this motor to the ACS550 power output. • Delays motor start for the time 8122 PFC START DELAY. • Starts the speed regulated motor. • Identifies the next constant speed motor in the rotation. • Switches the above motor on, but only if the new speed regulated motor had been running (as a constant speed motor) – This step keeps an equal number of motors running before and after autochange. • Continues with normal PFC operation. <p>Starting order counter</p> <p>The operation of the starting-order counter:</p> <ul style="list-style-type: none"> • The relay output parameter definitions (1401...1403 and 1410...1412) establish the initial motor sequence. (The lowest parameter number with a value 31 (PFC) identifies the relay connected to 1PFC, the first motor, and so on.) • Initially, 1PFC = speed regulated motor, 2PFC = 1st auxiliary motor, etc. • The first autochange shifts the sequence to: 2PFC = speed regulated motor, 3PFC = 1st auxiliary motor, ..., 1PFC = last auxiliary motor. • The next autochange shifts the sequence again, and so on. • If the autochange cannot start a needed motor because all inactive motors are interlocked, the drive displays an alarm (2015, PFC I LOCK). • When ACS550 power supply is switched off, the counter preserves the current Autochange rotation positions in permanent memory. When power is restored, the Autochange rotation starts at the position stored in memory. • If the PFC relay configuration is changed (or if the PFC enable value is changed), the rotation is reset. (See the first bullet above.) |

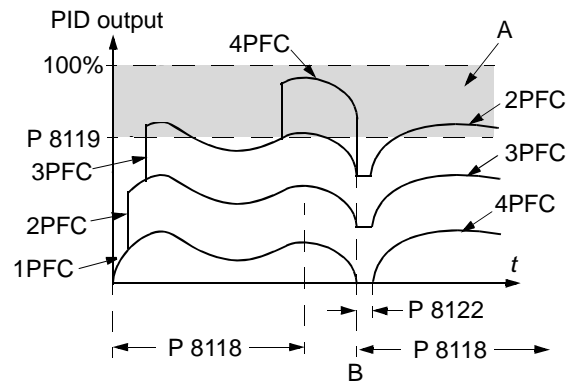

A = Area above 8119 AUTOCHNG LEVEL – autochange not allowed.
 B = Autochange occurs.
 1PFC, etc. = PID output associated with each motor.

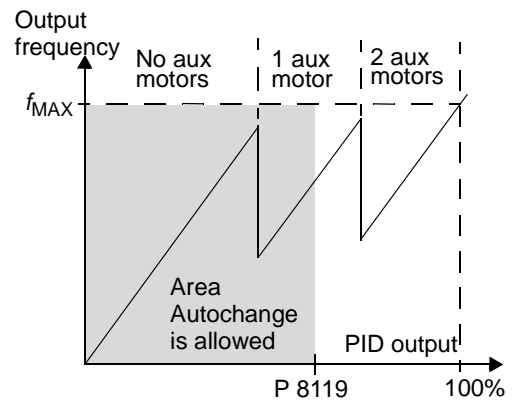

| Code | Description | | | | | | | | | | | | | | | | | | | | | | | | |
|----------------|--|--|------------------------------|-----------------------------|---|---|-------------|---|---|---|---|--|--|---|--|--|---|---|---|---|--|---|---|-------------|--|
| 8120 | <p>INTERLOCKS</p> <p>Defines operation of the Interlock function. When the Interlock function is enabled:</p> <ul style="list-style-type: none"> • An interlock is active when its command signal is absent. • An interlock is inactive when its command signal is present. • The ACS550 will not start if a start command occurs when the speed regulated motor's interlock is active – the control panel displays an alarm (2015, PFC I LOCK). <p>Wire each Interlock circuit as follows:</p> <ul style="list-style-type: none"> • Wire a contact of the motor's On/Off switch to the Interlock circuit – the drive's PFC logic can then recognize that the motor is switched off and start the next available motor. • Wire a contact of the motor thermal relay (or other protective device in the motor circuit) to the Interlock input – the drive's PFC logic can then recognize that a motor fault is activated and stop the motor. <p>0 = NOT SEL – Disables the Interlock function. All digital inputs are available for other purposes.</p> <ul style="list-style-type: none"> • Requires 8118 AUTOCHNG INTERV = 0 (The Autochange function must be disabled if Interlock function is disabled.) <p>1 = DI1 – Enables the Interlock function and assigns a digital input (starting with DI1) to the interlock signal for each PFC relay. These assignments are defined in the following table and depend on:</p> <ul style="list-style-type: none"> • the number of PFC relays [number of parameters 1401...1403 and 1410...1412 with value = 31 (PFC)] • the Autochange function status (disabled if 8118 AUTOCHNG INTERV = 0, and otherwise enabled). <table border="1" data-bbox="236 705 1019 1638"> <thead> <tr> <th data-bbox="236 705 363 758">No. PFC relays</th> <th data-bbox="363 705 687 758">Autochange disabled (P 8118)</th> <th data-bbox="687 705 1019 758">Autochange enabled (P 8118)</th> </tr> </thead> <tbody> <tr> <td data-bbox="236 758 363 821">0</td> <td data-bbox="363 758 687 821">DI1: Speed Reg Motor DI2...DI6: Free</td> <td data-bbox="687 758 1019 821">Not allowed</td> </tr> <tr> <td data-bbox="236 821 363 898">1</td> <td data-bbox="363 821 687 898">DI1: Speed Reg Motor DI2: First PFC Relay DI3...DI6: Free</td> <td data-bbox="687 821 1019 898">DI1: First PFC Relay DI2...DI6: Free</td> </tr> <tr> <td data-bbox="236 898 363 1010">2</td> <td data-bbox="363 898 687 1010">DI1: Speed Reg Motor DI2: First PFC Relay DI3: Second PFC Relay DI4...DI6: Free</td> <td data-bbox="687 898 1019 1010">DI1: First PFC Relay DI2: Second PFC Relay DI3...DI6: Free</td> </tr> <tr> <td data-bbox="236 1010 363 1150">3</td> <td data-bbox="363 1010 687 1150">DI1: Speed Reg Motor DI2: First PFC Relay DI3: Second PFC Relay DI4: Third PFC Relay DI5...DI6: Free</td> <td data-bbox="687 1010 1019 1150">DI1: First PFC Relay DI2: Second PFC Relay DI3: Third PFC Relay DI4...DI6: Free</td> </tr> <tr> <td data-bbox="236 1150 363 1312">4</td> <td data-bbox="363 1150 687 1312">DI1: Speed Reg Motor DI2: First PFC Relay DI3: Second PFC Relay DI4: Third PFC Relay DI5: Fourth PFC Relay DI6: Free</td> <td data-bbox="687 1150 1019 1312">DI1: First PFC Relay DI2: Second PFC Relay DI3: Third PFC Relay DI4: Fourth PFC Relay DI5...DI6: Free</td> </tr> <tr> <td data-bbox="236 1312 363 1474">5</td> <td data-bbox="363 1312 687 1474">DI1: Speed Reg Motor DI2: First PFC Relay DI3: Second PFC Relay DI4: Third PFC Relay DI5: Fourth PFC Relay DI6: Fifth PFC Relay</td> <td data-bbox="687 1312 1019 1474">DI1: First PFC Relay DI2: Second PFC Relay DI3: Third PFC Relay DI4: Fourth PFC Relay DI5: Fifth PFC Relay DI6: Free</td> </tr> <tr> <td data-bbox="236 1474 363 1638">6</td> <td data-bbox="363 1474 687 1638">Not allowed</td> <td data-bbox="687 1474 1019 1638">DI1: First PFC Relay DI2: Second PFC Relay DI3: Third PFC Relay DI4: Fourth PFC Relay DI5: Fifth PFC Relay DI6: Sixth PFC Relay</td> </tr> </tbody> </table> | No. PFC relays | Autochange disabled (P 8118) | Autochange enabled (P 8118) | 0 | DI1: Speed Reg Motor DI2...DI6: Free | Not allowed | 1 | DI1: Speed Reg Motor DI2: First PFC Relay DI3...DI6: Free | DI1: First PFC Relay DI2...DI6: Free | 2 | DI1: Speed Reg Motor DI2: First PFC Relay DI3: Second PFC Relay DI4...DI6: Free | DI1: First PFC Relay DI2: Second PFC Relay DI3...DI6: Free | 3 | DI1: Speed Reg Motor DI2: First PFC Relay DI3: Second PFC Relay DI4: Third PFC Relay DI5...DI6: Free | DI1: First PFC Relay DI2: Second PFC Relay DI3: Third PFC Relay DI4...DI6: Free | 4 | DI1: Speed Reg Motor DI2: First PFC Relay DI3: Second PFC Relay DI4: Third PFC Relay DI5: Fourth PFC Relay DI6: Free | DI1: First PFC Relay DI2: Second PFC Relay DI3: Third PFC Relay DI4: Fourth PFC Relay DI5...DI6: Free | 5 | DI1: Speed Reg Motor DI2: First PFC Relay DI3: Second PFC Relay DI4: Third PFC Relay DI5: Fourth PFC Relay DI6: Fifth PFC Relay | DI1: First PFC Relay DI2: Second PFC Relay DI3: Third PFC Relay DI4: Fourth PFC Relay DI5: Fifth PFC Relay DI6: Free | 6 | Not allowed | DI1: First PFC Relay DI2: Second PFC Relay DI3: Third PFC Relay DI4: Fourth PFC Relay DI5: Fifth PFC Relay DI6: Sixth PFC Relay |
| No. PFC relays | Autochange disabled (P 8118) | Autochange enabled (P 8118) | | | | | | | | | | | | | | | | | | | | | | | |
| 0 | DI1: Speed Reg Motor DI2...DI6: Free | Not allowed | | | | | | | | | | | | | | | | | | | | | | | |
| 1 | DI1: Speed Reg Motor DI2: First PFC Relay DI3...DI6: Free | DI1: First PFC Relay DI2...DI6: Free | | | | | | | | | | | | | | | | | | | | | | | |
| 2 | DI1: Speed Reg Motor DI2: First PFC Relay DI3: Second PFC Relay DI4...DI6: Free | DI1: First PFC Relay DI2: Second PFC Relay DI3...DI6: Free | | | | | | | | | | | | | | | | | | | | | | | |
| 3 | DI1: Speed Reg Motor DI2: First PFC Relay DI3: Second PFC Relay DI4: Third PFC Relay DI5...DI6: Free | DI1: First PFC Relay DI2: Second PFC Relay DI3: Third PFC Relay DI4...DI6: Free | | | | | | | | | | | | | | | | | | | | | | | |
| 4 | DI1: Speed Reg Motor DI2: First PFC Relay DI3: Second PFC Relay DI4: Third PFC Relay DI5: Fourth PFC Relay DI6: Free | DI1: First PFC Relay DI2: Second PFC Relay DI3: Third PFC Relay DI4: Fourth PFC Relay DI5...DI6: Free | | | | | | | | | | | | | | | | | | | | | | | |
| 5 | DI1: Speed Reg Motor DI2: First PFC Relay DI3: Second PFC Relay DI4: Third PFC Relay DI5: Fourth PFC Relay DI6: Fifth PFC Relay | DI1: First PFC Relay DI2: Second PFC Relay DI3: Third PFC Relay DI4: Fourth PFC Relay DI5: Fifth PFC Relay DI6: Free | | | | | | | | | | | | | | | | | | | | | | | |
| 6 | Not allowed | DI1: First PFC Relay DI2: Second PFC Relay DI3: Third PFC Relay DI4: Fourth PFC Relay DI5: Fifth PFC Relay DI6: Sixth PFC Relay | | | | | | | | | | | | | | | | | | | | | | | |

| Code | Description | | | | | | | | | | | | | | | | | | | | | | | | |
|----------------|--|---|------------------------------|-----------------------------|---|--|-------------|---|--|--|---|---|---|---|---|---|---|---|--|---|-------------|---|---|-------------|-------------|
| | <p>2 = DI2 – Enables the Interlock function and assigns a digital input (starting with DI2) to the interlock signal for each PFC relay. These assignments are defined in the following table and depend on:</p> <ul style="list-style-type: none"> • the number of PFC relays [number of parameters 1401...1403 and 1410...1412 with value = 31 (PFC)] • the Autochange function status (disabled if 8118 AUTOCHNG INTERV = 0, and otherwise enabled). <table border="1"> <thead> <tr> <th>No. PFC relays</th> <th>Autochange disabled (P 8118)</th> <th>Autochange enabled (P 8118)</th> </tr> </thead> <tbody> <tr> <td>0</td> <td>DI1: Free DI2: Speed Reg Motor DI3...DI6: Free</td> <td>Not allowed</td> </tr> <tr> <td>1</td> <td>DI1: Free DI2: Speed Reg Motor DI3: First PFC Relay DI4...DI6: Free</td> <td>DI1: Free DI2: First PFC Relay DI3...DI6: Free</td> </tr> <tr> <td>2</td> <td>DI1: Free DI2: Speed Reg Motor DI3: First PFC Relay DI4: Second PFC Relay DI5...DI6: Free</td> <td>DI1: Free DI2: First PFC Relay DI3: Second PFC Relay DI4...DI6: Free</td> </tr> <tr> <td>3</td> <td>DI1: Free DI2: Speed Reg Motor DI3: First PFC Relay DI4: Second PFC Relay DI5: Third PFC Relay DI6: Free</td> <td>DI1: Free DI2: First PFC Relay DI3: Second PFC Relay DI4: Third PFC Relay DI5...DI6: Free</td> </tr> <tr> <td>4</td> <td>DI1: Free DI2: Speed Reg Motor DI3: First PFC Relay DI4: Second PFC Relay DI5: Third PFC Relay DI6: Fourth PFC Relay</td> <td>DI1: Free DI2: First PFC Relay DI3: Second PFC Relay DI4: Third PFC Relay DI5: Fourth PFC Relay DI6: Free</td> </tr> <tr> <td>5</td> <td>Not allowed</td> <td>DI1: Free DI2: First PFC Relay DI3: Second PFC Relay DI4: Third PFC Relay DI5: Fourth PFC Relay DI6: Fifth PFC Relay</td> </tr> <tr> <td>6</td> <td>Not allowed</td> <td>Not allowed</td> </tr> </tbody> </table> | No. PFC relays | Autochange disabled (P 8118) | Autochange enabled (P 8118) | 0 | DI1: Free DI2: Speed Reg Motor DI3...DI6: Free | Not allowed | 1 | DI1: Free DI2: Speed Reg Motor DI3: First PFC Relay DI4...DI6: Free | DI1: Free DI2: First PFC Relay DI3...DI6: Free | 2 | DI1: Free DI2: Speed Reg Motor DI3: First PFC Relay DI4: Second PFC Relay DI5...DI6: Free | DI1: Free DI2: First PFC Relay DI3: Second PFC Relay DI4...DI6: Free | 3 | DI1: Free DI2: Speed Reg Motor DI3: First PFC Relay DI4: Second PFC Relay DI5: Third PFC Relay DI6: Free | DI1: Free DI2: First PFC Relay DI3: Second PFC Relay DI4: Third PFC Relay DI5...DI6: Free | 4 | DI1: Free DI2: Speed Reg Motor DI3: First PFC Relay DI4: Second PFC Relay DI5: Third PFC Relay DI6: Fourth PFC Relay | DI1: Free DI2: First PFC Relay DI3: Second PFC Relay DI4: Third PFC Relay DI5: Fourth PFC Relay DI6: Free | 5 | Not allowed | DI1: Free DI2: First PFC Relay DI3: Second PFC Relay DI4: Third PFC Relay DI5: Fourth PFC Relay DI6: Fifth PFC Relay | 6 | Not allowed | Not allowed |
| No. PFC relays | Autochange disabled (P 8118) | Autochange enabled (P 8118) | | | | | | | | | | | | | | | | | | | | | | | |
| 0 | DI1: Free DI2: Speed Reg Motor DI3...DI6: Free | Not allowed | | | | | | | | | | | | | | | | | | | | | | | |
| 1 | DI1: Free DI2: Speed Reg Motor DI3: First PFC Relay DI4...DI6: Free | DI1: Free DI2: First PFC Relay DI3...DI6: Free | | | | | | | | | | | | | | | | | | | | | | | |
| 2 | DI1: Free DI2: Speed Reg Motor DI3: First PFC Relay DI4: Second PFC Relay DI5...DI6: Free | DI1: Free DI2: First PFC Relay DI3: Second PFC Relay DI4...DI6: Free | | | | | | | | | | | | | | | | | | | | | | | |
| 3 | DI1: Free DI2: Speed Reg Motor DI3: First PFC Relay DI4: Second PFC Relay DI5: Third PFC Relay DI6: Free | DI1: Free DI2: First PFC Relay DI3: Second PFC Relay DI4: Third PFC Relay DI5...DI6: Free | | | | | | | | | | | | | | | | | | | | | | | |
| 4 | DI1: Free DI2: Speed Reg Motor DI3: First PFC Relay DI4: Second PFC Relay DI5: Third PFC Relay DI6: Fourth PFC Relay | DI1: Free DI2: First PFC Relay DI3: Second PFC Relay DI4: Third PFC Relay DI5: Fourth PFC Relay DI6: Free | | | | | | | | | | | | | | | | | | | | | | | |
| 5 | Not allowed | DI1: Free DI2: First PFC Relay DI3: Second PFC Relay DI4: Third PFC Relay DI5: Fourth PFC Relay DI6: Fifth PFC Relay | | | | | | | | | | | | | | | | | | | | | | | |
| 6 | Not allowed | Not allowed | | | | | | | | | | | | | | | | | | | | | | | |

| Code | Description | | | | | | | | | | | | | | | | | | | | | | | | | | | | | | | | | | | | | | | |
|----------------|---|---|------------------------------|-----------------------------|---|--|-------------|---|--|--|---|---|---|---|--|---|---|-------------|---|-------|-------------|-------------|----------------|------------------------------|-----------------------------|---|--|-------------|---|--|--|---|--|---|---|-------------|--|-------|-------------|-------------|
| | <p>3 = DI3 – Enables the Interlocks function and assigns a digital input (starting with DI3) to the interlock signal for each PFC relay. These assignments are defined in the following table and depend on:</p> <ul style="list-style-type: none"> • the number of PFC relays [number of parameters 1401...1403 and 1410...1412 with value = 31 (PFC)] • the Autochange function status (disabled if 8118 AUTOCHNG INTERV = 0, and otherwise enabled). <table border="1"> <thead> <tr> <th>No. PFC relays</th> <th>Autochange disabled (P 8118)</th> <th>Autochange enabled (P 8118)</th> </tr> </thead> <tbody> <tr> <td>0</td> <td>DI1...DI2: Free DI3: Speed Reg Motor DI4...DI6: Free</td> <td>Not allowed</td> </tr> <tr> <td>1</td> <td>DI1...DI2: Free DI3: Speed Reg Motor DI4: First PFC Relay DI5...DI6: Free</td> <td>DI1...DI2: Free DI3: First PFC Relay DI4...DI6: Free</td> </tr> <tr> <td>2</td> <td>DI1...DI2: Free DI3: Speed Reg Motor DI4: First PFC Relay DI5: Second PFC Relay DI6: Free</td> <td>DI1...DI2: Free DI3: First PFC Relay DI4: Second PFC Relay DI5...DI6: Free</td> </tr> <tr> <td>3</td> <td>DI1...DI2: Free DI3: Speed Reg Motor DI4: First PFC Relay DI5: Second PFC Relay DI6: Third PFC Relay</td> <td>DI1...DI2: Free DI3: First PFC Relay DI4: Second PFC Relay DI5: Third PFC Relay DI6: Free</td> </tr> <tr> <td>4</td> <td>Not allowed</td> <td>DI1...DI2: Free DI3: First PFC Relay DI4: Second PFC Relay DI5: Third PFC Relay DI6: Fourth PFC Relay</td> </tr> <tr> <td>5...6</td> <td>Not allowed</td> <td>Not allowed</td> </tr> </tbody> </table> <p>4 = DI4 – Enables the Interlock function and assigns a digital input (starting with DI4) to the interlock signal for each PFC relay. These assignments are defined in the following table and depend on:</p> <ul style="list-style-type: none"> • the number of PFC relays [number of parameters 1401...1403 and 1410...1412 with value = 31 (PFC)] • the Autochange function status (disabled if 8118 AUTOCHNG INTERV = 0, and otherwise enabled). <table border="1"> <thead> <tr> <th>No. PFC relays</th> <th>Autochange disabled (P 8118)</th> <th>Autochange enabled (P 8118)</th> </tr> </thead> <tbody> <tr> <td>0</td> <td>DI1...DI3: Free DI4: Speed Reg Motor DI5...DI6: Free</td> <td>Not allowed</td> </tr> <tr> <td>1</td> <td>DI1...DI3: Free DI4: Speed Reg Motor DI5: First PFC Relay DI6: Free</td> <td>DI1...DI3: Free DI4: First PFC Relay DI5...DI6: Free</td> </tr> <tr> <td>2</td> <td>DI1...DI3: Free DI4: Speed Reg Motor DI5: First PFC Relay DI6: Second PFC Relay</td> <td>DI1...DI3: Free DI4: First PFC Relay DI5: Second PFC Relay DI6: Free</td> </tr> <tr> <td>3</td> <td>Not allowed</td> <td>DI1...DI3: Free DI4: First PFC Relay DI5: Second PFC Relay DI6: Third PFC Relay</td> </tr> <tr> <td>4...6</td> <td>Not allowed</td> <td>Not allowed</td> </tr> </tbody> </table> | No. PFC relays | Autochange disabled (P 8118) | Autochange enabled (P 8118) | 0 | DI1...DI2: Free DI3: Speed Reg Motor DI4...DI6: Free | Not allowed | 1 | DI1...DI2: Free DI3: Speed Reg Motor DI4: First PFC Relay DI5...DI6: Free | DI1...DI2: Free DI3: First PFC Relay DI4...DI6: Free | 2 | DI1...DI2: Free DI3: Speed Reg Motor DI4: First PFC Relay DI5: Second PFC Relay DI6: Free | DI1...DI2: Free DI3: First PFC Relay DI4: Second PFC Relay DI5...DI6: Free | 3 | DI1...DI2: Free DI3: Speed Reg Motor DI4: First PFC Relay DI5: Second PFC Relay DI6: Third PFC Relay | DI1...DI2: Free DI3: First PFC Relay DI4: Second PFC Relay DI5: Third PFC Relay DI6: Free | 4 | Not allowed | DI1...DI2: Free DI3: First PFC Relay DI4: Second PFC Relay DI5: Third PFC Relay DI6: Fourth PFC Relay | 5...6 | Not allowed | Not allowed | No. PFC relays | Autochange disabled (P 8118) | Autochange enabled (P 8118) | 0 | DI1...DI3: Free DI4: Speed Reg Motor DI5...DI6: Free | Not allowed | 1 | DI1...DI3: Free DI4: Speed Reg Motor DI5: First PFC Relay DI6: Free | DI1...DI3: Free DI4: First PFC Relay DI5...DI6: Free | 2 | DI1...DI3: Free DI4: Speed Reg Motor DI5: First PFC Relay DI6: Second PFC Relay | DI1...DI3: Free DI4: First PFC Relay DI5: Second PFC Relay DI6: Free | 3 | Not allowed | DI1...DI3: Free DI4: First PFC Relay DI5: Second PFC Relay DI6: Third PFC Relay | 4...6 | Not allowed | Not allowed |
| No. PFC relays | Autochange disabled (P 8118) | Autochange enabled (P 8118) | | | | | | | | | | | | | | | | | | | | | | | | | | | | | | | | | | | | | | |
| 0 | DI1...DI2: Free DI3: Speed Reg Motor DI4...DI6: Free | Not allowed | | | | | | | | | | | | | | | | | | | | | | | | | | | | | | | | | | | | | | |
| 1 | DI1...DI2: Free DI3: Speed Reg Motor DI4: First PFC Relay DI5...DI6: Free | DI1...DI2: Free DI3: First PFC Relay DI4...DI6: Free | | | | | | | | | | | | | | | | | | | | | | | | | | | | | | | | | | | | | | |
| 2 | DI1...DI2: Free DI3: Speed Reg Motor DI4: First PFC Relay DI5: Second PFC Relay DI6: Free | DI1...DI2: Free DI3: First PFC Relay DI4: Second PFC Relay DI5...DI6: Free | | | | | | | | | | | | | | | | | | | | | | | | | | | | | | | | | | | | | | |
| 3 | DI1...DI2: Free DI3: Speed Reg Motor DI4: First PFC Relay DI5: Second PFC Relay DI6: Third PFC Relay | DI1...DI2: Free DI3: First PFC Relay DI4: Second PFC Relay DI5: Third PFC Relay DI6: Free | | | | | | | | | | | | | | | | | | | | | | | | | | | | | | | | | | | | | | |
| 4 | Not allowed | DI1...DI2: Free DI3: First PFC Relay DI4: Second PFC Relay DI5: Third PFC Relay DI6: Fourth PFC Relay | | | | | | | | | | | | | | | | | | | | | | | | | | | | | | | | | | | | | | |
| 5...6 | Not allowed | Not allowed | | | | | | | | | | | | | | | | | | | | | | | | | | | | | | | | | | | | | | |
| No. PFC relays | Autochange disabled (P 8118) | Autochange enabled (P 8118) | | | | | | | | | | | | | | | | | | | | | | | | | | | | | | | | | | | | | | |
| 0 | DI1...DI3: Free DI4: Speed Reg Motor DI5...DI6: Free | Not allowed | | | | | | | | | | | | | | | | | | | | | | | | | | | | | | | | | | | | | | |
| 1 | DI1...DI3: Free DI4: Speed Reg Motor DI5: First PFC Relay DI6: Free | DI1...DI3: Free DI4: First PFC Relay DI5...DI6: Free | | | | | | | | | | | | | | | | | | | | | | | | | | | | | | | | | | | | | | |
| 2 | DI1...DI3: Free DI4: Speed Reg Motor DI5: First PFC Relay DI6: Second PFC Relay | DI1...DI3: Free DI4: First PFC Relay DI5: Second PFC Relay DI6: Free | | | | | | | | | | | | | | | | | | | | | | | | | | | | | | | | | | | | | | |
| 3 | Not allowed | DI1...DI3: Free DI4: First PFC Relay DI5: Second PFC Relay DI6: Third PFC Relay | | | | | | | | | | | | | | | | | | | | | | | | | | | | | | | | | | | | | | |
| 4...6 | Not allowed | Not allowed | | | | | | | | | | | | | | | | | | | | | | | | | | | | | | | | | | | | | | |

| Code | Description | | | | | | | | | | | | | | | | | | | | | | | | | | | |
|----------------|---|--|------------------------------|-----------------------------|---|--|-------------|---|---|--|---|-------------|--|-------|-------------|-------------|----------------|---------------------|--------------------|---|---|-------------|---|-------------|---|-------|-------------|-------------|
| | <p>5 = DI5 – Enables the Interlock function and assigns a digital input (starting with DI5) to the interlock signal for each PFC relay. These assignments are defined in the following table and depend on:</p> <ul style="list-style-type: none"> the number of PFC relays [number of parameters 1401...1403 and 1410...1412 with value = 31 (PFC)] the Autochange function status (disabled if 8118 AUTOCHNG INTERV = 0, and otherwise enabled). <table border="1"> <thead> <tr> <th>No. PFC relays</th> <th>Autochange disabled (P 8118)</th> <th>Autochange enabled (P 8118)</th> </tr> </thead> <tbody> <tr> <td>0</td> <td>DI1...DI4: Free DI5: Speed Reg Motor DI6: Free</td> <td>Not allowed</td> </tr> <tr> <td>1</td> <td>DI1...DI4: Free DI5: Speed Reg Motor DI6: First PFC Relay</td> <td>DI1...DI4: Free DI5: First PFC Relay DI6: Free</td> </tr> <tr> <td>2</td> <td>Not allowed</td> <td>DI1...DI4: Free DI5: First PFC Relay DI6: Second PFC Relay</td> </tr> <tr> <td>3...6</td> <td>Not allowed</td> <td>Not allowed</td> </tr> </tbody> </table> <p>6 = DI6 – Enables the Interlock function and assigns digital input DI6 to the interlock signal for the speed regulated motor.</p> <ul style="list-style-type: none"> Requires 8118 AUTOCHNG INTERV = 0. <table border="1"> <thead> <tr> <th>No. PFC relays</th> <th>Autochange disabled</th> <th>Autochange enabled</th> </tr> </thead> <tbody> <tr> <td>0</td> <td>DI1...DI5: Free DI6: Speed Reg Motor</td> <td>Not allowed</td> </tr> <tr> <td>1</td> <td>Not allowed</td> <td>DI1...DI5: Free DI6: First PFC Relay</td> </tr> <tr> <td>2...6</td> <td>Not allowed</td> <td>Not allowed</td> </tr> </tbody> </table> | No. PFC relays | Autochange disabled (P 8118) | Autochange enabled (P 8118) | 0 | DI1...DI4: Free DI5: Speed Reg Motor DI6: Free | Not allowed | 1 | DI1...DI4: Free DI5: Speed Reg Motor DI6: First PFC Relay | DI1...DI4: Free DI5: First PFC Relay DI6: Free | 2 | Not allowed | DI1...DI4: Free DI5: First PFC Relay DI6: Second PFC Relay | 3...6 | Not allowed | Not allowed | No. PFC relays | Autochange disabled | Autochange enabled | 0 | DI1...DI5: Free DI6: Speed Reg Motor | Not allowed | 1 | Not allowed | DI1...DI5: Free DI6: First PFC Relay | 2...6 | Not allowed | Not allowed |
| No. PFC relays | Autochange disabled (P 8118) | Autochange enabled (P 8118) | | | | | | | | | | | | | | | | | | | | | | | | | | |
| 0 | DI1...DI4: Free DI5: Speed Reg Motor DI6: Free | Not allowed | | | | | | | | | | | | | | | | | | | | | | | | | | |
| 1 | DI1...DI4: Free DI5: Speed Reg Motor DI6: First PFC Relay | DI1...DI4: Free DI5: First PFC Relay DI6: Free | | | | | | | | | | | | | | | | | | | | | | | | | | |
| 2 | Not allowed | DI1...DI4: Free DI5: First PFC Relay DI6: Second PFC Relay | | | | | | | | | | | | | | | | | | | | | | | | | | |
| 3...6 | Not allowed | Not allowed | | | | | | | | | | | | | | | | | | | | | | | | | | |
| No. PFC relays | Autochange disabled | Autochange enabled | | | | | | | | | | | | | | | | | | | | | | | | | | |
| 0 | DI1...DI5: Free DI6: Speed Reg Motor | Not allowed | | | | | | | | | | | | | | | | | | | | | | | | | | |
| 1 | Not allowed | DI1...DI5: Free DI6: First PFC Relay | | | | | | | | | | | | | | | | | | | | | | | | | | |
| 2...6 | Not allowed | Not allowed | | | | | | | | | | | | | | | | | | | | | | | | | | |

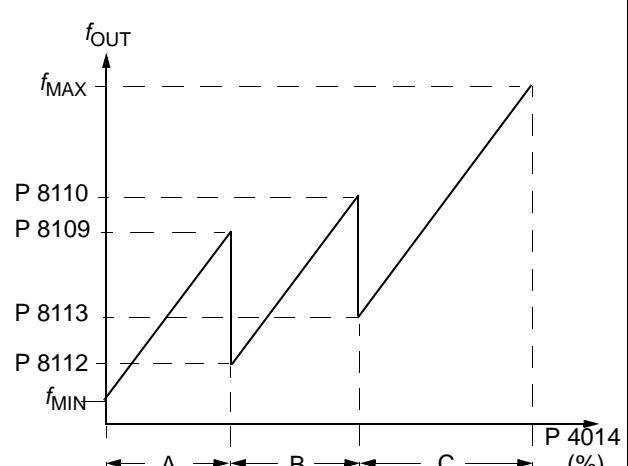
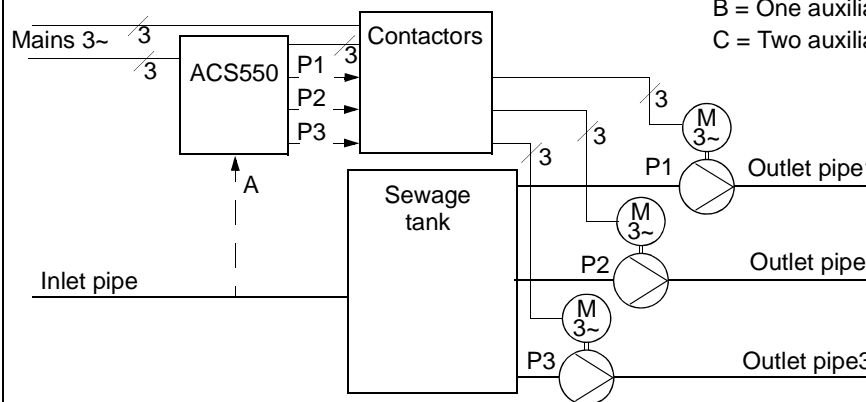
| Code | Description |
|------|--|
| 8121 | <p>REG BYPASS CTRL</p> <p>Selects Regulator by-pass control. When enabled, Regulator by-pass control provides a simple control mechanism without a PID regulator.</p> <ul style="list-style-type: none"> Use Regulator by-pass control only in special applications. <p>0 = NO – Disables Regulator by-pass control. The drive uses the normal PFC reference: 1106 REF2 SELECT.</p> <p>1 = YES – Enables Regulator by-pass control.</p> <ul style="list-style-type: none"> The process PID regulator is bypassed. Actual value of PID is used as the PFC reference (input). Normally EXT REF2 is used as the PFC reference. The drive uses the feedback signal defined by 4014 FBK SEL (or 4114) for the PFC frequency reference. The figure shows the relation between the control signal 4014 FBK SEL (OR 4114) and the speed regulated motor's frequency in a three-motor system. <p>Example: In the diagram below, the pumping station's outlet flow is controlled by the measured inlet flow (A).</p>  <p>A = No auxiliary motors running B = One auxiliary motor running C = Two auxiliary motors running</p>  |
| 8122 | <p>PFC START DELAY</p> <p>Sets the start delay for speed regulated motors in the system. Using the delay, the drive works as follows:</p> <ul style="list-style-type: none"> Switches on the contactor of the speed regulated motor – connecting the motor to the ACS550 power output. Delays motor start for the time 8122 PFC START DELAY. Starts the speed regulated motor. Starts auxiliary motors. See parameter 8115 for delay. <p>⚠ WARNING! Motors equipped with star-delta starters require a PFC Start Delay.</p> <ul style="list-style-type: none"> After the ACS550 relay output switches a motor on, the star-delta starter must switch to the star-connection and then back to the delta-connection before the drive applies power. So, the PFC Start Delay must be longer than the time setting of the star-delta starter. |
| 8123 | <p>PFC ENABLE</p> <p>Selects PFC control. When enabled, PFC control:</p> <ul style="list-style-type: none"> Switches in, or out, auxiliary constant speed motors as output demand increases or decreases. Parameters 8109 START FREQ 1 to 8114 LOW FREQ 3 define the switch points in terms of the drive output frequency. Adjusts the speed regulated motor output down, as auxiliary motors are added, and adjusts the speed regulated motor output up, as auxiliary motors are taken off line. Provides Interlock functions, if enabled. Requires 9904 MOTOR CTRL MODE = 3 (SCALAR:FREQ). <p>0 = NOT SEL – Disables PFC control.</p> <p>1 = ACTIVE – Enables PFC control.</p> |

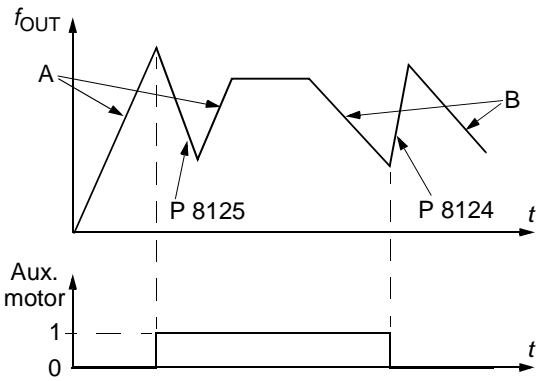
| Code | Description | |
|------|--|---|
| 8124 | <p>ACC IN AUX STOP</p> <p>Sets the PFC acceleration time for a zero-to-maximum frequency ramp. This PFC acceleration ramp:</p> <ul style="list-style-type: none"> • Applies to the speed regulated motor, when an auxiliary motor is switched off. • Replaces the acceleration ramp defined in Group 22: ACCEL/DECCEL. • Applies only until the output of the regulated motor increases by an amount equal to the output of the switched off auxiliary motor. Then the acceleration ramp defined in Group 22: ACCEL/DECCEL applies. <p>0 = NOT SEL. 0.1...1800 – Activates this function using the value entered as the acceleration time.</p> |  <ul style="list-style-type: none"> • A = speed regulated motor accelerating using Group 22: ACCEL/DECCEL parameters (2202 or 2205). • B = speed regulated motor decelerating using Group 22: ACCEL/DECCEL parameters (2203 or 2206). • At aux. motor start, speed regulated motor decelerates using 8125 DEC IN AUX START. • At aux. motor stop, speed regulated motor accelerates using 8124 ACC IN AUX STOP. |
| 8125 | <p>DEC IN AUX START</p> <p>Sets the PFC deceleration time for a maximum-to-zero frequency ramp. This PFC deceleration ramp:</p> <ul style="list-style-type: none"> • Applies to the speed regulated motor, when an auxiliary motor is switched on. • Replaces the deceleration ramp defined in Group 22: ACCEL/DECCEL. • Applies only until the output of the regulated motor decreases by an amount equal to the output of the auxiliary motor. Then the deceleration ramp defined in Group 22: ACCEL/DECCEL applies. <p>0 = NOT SEL. 0.1...1800 – Activates this function using the value entered as the deceleration time.</p> | |
| 8126 | <p>TIMED AUTOCHNG</p> <p>Sets the autochange using a Timed function. See parameter 8119 AUTOCHNG LEVEL.</p> <p>0 = NOT SEL. 1 = TIMED FUNC 1 – Enables autochange when Timed function 1 is active. 2...4 = TIMED FUNC 2...4 – Enables autochange when Timed function 2...4 is active.</p> | |
| 8127 | <p>MOTORS</p> <p>Sets the actual number of PFC controlled motors (maximum 7 motors, 1 speed regulated, 3 connected direct-on-line and 3 spare motors).</p> <ul style="list-style-type: none"> • This value includes also the speed regulated motor. • This value must be compatible with the number of relays allocated to PFC if the Autochange function is used. • If Autochange function is not used, the speed regulated motor does not need to have a relay output allocated to PFC but it needs to be included in this value. | |
| 8128 | <p>AUX START ORDER</p> <p>Sets the start order of the auxiliary motors.</p> <p>1 = EVEN RUNTIME – Time sharing is active. The start order depends on the run times. 2 = RELAY ORDER – The start order is fixed to be the order of the relays.</p> | |

Group 98: OPTIONS

This group configures for options, in particular, enabling serial communication with the drive.

| Code | Description |
|------|---|
| 9802 | COMM PROT SEL Selects the communication protocol. 0 = NOT SEL – No communication protocol selected. 1 = STD MODBUS – The drive communicates with Modbus via the RS485 channel (X1-communications, terminal). <ul style="list-style-type: none">• See also Group 53: EFB PROTOCOL. 4 = EXT FBA – The drive communicates via a fieldbus adapter module in option slot 2 of the drive. <ul style="list-style-type: none">• See also Group 51: EXT COMM MODULE. |

Embedded fieldbus

Overview

The ACS550 can be set up to accept control from an external system using standard serial communication protocols. When using serial communication, the ACS550 can either:

- receive all of its control information from the fieldbus, or
- be controlled from some combination of fieldbus control and other available control locations, such as digital or analog inputs and the control panel.

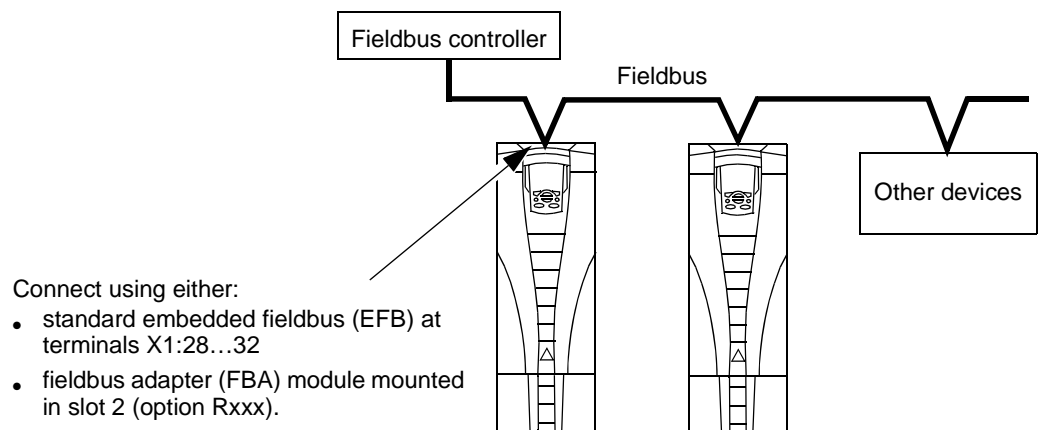

Two basic serial communications configurations are available:

- embedded fieldbus (EFB) – Using the RS485 interface at terminals X1:28...32 on the control board, a control system can communicate with the drive using the Modbus® protocol. (For protocol and profile descriptions, see sections [Modbus protocol technical data](#) and [ABB control profiles technical data](#) later in this chapter.)
- fieldbus adapter (FBA) – See chapter [Fieldbus adapter](#) on page 251.

Control interface

In general, the basic control interface between Modbus and the drive consists of:

- Output words
 - Control Word
 - Reference1
 - Reference2
- Input words
 - Status Word
 - Actual value 1
 - Actual value 2

- Actual value 3
- Actual value 4
- Actual value 5
- Actual value 6
- Actual value 7
- Actual value 8

The content of these words is defined by profiles. For details on the profiles used, see section [ABB control profiles technical data](#) on page 239.

Note: The words “output” and “input” are used as seen from the fieldbus controller point of view. For example an output describes data flow from the fieldbus controller to the drive and appears as an input from the drive point of view.

Planning

Network planning should address the following questions:

- What types and quantities of devices must be connected to the network?
- What control information must be sent down to the drives?
- What feedback information must be sent from the drives to the controlling system?

Mechanical and electrical installation – EFB



WARNING! Connections should be made only while the drive is disconnected from the power source.

Drive terminals 28...32 are for RS485 communications.

- Use Belden 9842 or equivalent. Belden 9842 is a dual twisted, shielded pair cable with a wave impedance of 120 ohm.
- Use one of these twisted shielded pairs for the RS485 link. Use this pair to connect all A (-) terminals together and all B (+) terminals together.
- Use one of the wires in the other pair for the logical ground (terminal 31), leaving one wire unused.
- Do not directly ground the RS485 network at any point. Ground all devices on the network using their corresponding earthing terminals.
- As always, the grounding wires should not form any closed loops, and all the devices should be earthed to a common ground.
- Connect the RS485 link in a daisy-chained bus, without dropout lines.

- To reduce noise on the network, terminate the RS485 network using 120 Ω resistors at both ends of the network. Use the DIP switch to connect or disconnect the termination resistors. See following diagram and table.



| X1 | Identification | Hardware description | |
|----|----------------|---------------------------------|--|
| 28 | Screen | RS485 Multidrop application | |
| 29 | B (Positive +) | | |
| 30 | A (Negative -) | | |
| 31 | AGND | | |
| 32 | Screen | | |
| | | RS485 interface | |

- Connect the shield at each end of the cable to a drive. On one end, connect the shield to terminal 28, and on the other end connect to terminal 32. Do not connect the incoming and outgoing cable shields to the same terminals, as that would make the shielding continuous.
- For configuration information see the following sections:
 - [Communication set-up – EFB](#) on page 221
 - [Activate drive control functions – EFB](#) on page 223
 - The appropriate EFB protocol specific technical data. For example, [Modbus protocol technical data](#) on page 231.

Communication set-up – EFB

Serial communication selection

To activate the serial communication, set parameter 9802 COMM PROT SEL = 1 (STD MODBUS).

Note: If you cannot see the desired selection on the panel, your drive does not have that protocol software in the application memory.

Serial communication configuration

Setting 9802 automatically sets the appropriate default values in parameters that define the communication process. These parameters and descriptions are defined below. In particular, note that the station Id may require adjustment.

| Code | Description | Protocol reference | | | | | | | | |
|----------|--|--|-----------|----------|-----------|----------|-----------|----------|-----------|--|
| | | Modbus | | | | | | | | |
| 5301 | <p>EFB PROTOCOL ID</p> <p>Contains the identification and program revision of the protocol.</p> | Do not edit. Any non-zero value entered for parameter 9802 COMM PROT SEL, sets this parameter automatically. The format is: XXYY, where XX = protocol ID, and YY = program revision. | | | | | | | | |
| 5302 | <p>EFB STATION ID</p> <p>Defines the node address of the RS485 link.</p> <p>Note: For a new address to take affect, the drive power must be cycled or 5302 must first be set to 0 before selecting a new address. Leaving 5302 = 0 places the RS485 channel in reset, disabling communication.</p> | <p>Set each drive on the network with a unique value for this parameter.</p> <p>When this protocol is selected, the default value for this parameter is: 1</p> | | | | | | | | |
| 5303 | <p>EFB BAUD RATE</p> <p>Defines the communication speed of the RS485 link in kbits per second (kbits/s).</p> <table> <tr> <td>1.2 kb/s</td> <td>19.2 kb/s</td> </tr> <tr> <td>2.4 kb/s</td> <td>38.4 kb/s</td> </tr> <tr> <td>4.8 kb/s</td> <td>57.6 kb/s</td> </tr> <tr> <td>9.6 kb/s</td> <td>76.8 kb/s</td> </tr> </table> | 1.2 kb/s | 19.2 kb/s | 2.4 kb/s | 38.4 kb/s | 4.8 kb/s | 57.6 kb/s | 9.6 kb/s | 76.8 kb/s | When this protocol is selected, the default value for this parameter is: 9.6 |
| 1.2 kb/s | 19.2 kb/s | | | | | | | | | |
| 2.4 kb/s | 38.4 kb/s | | | | | | | | | |
| 4.8 kb/s | 57.6 kb/s | | | | | | | | | |
| 9.6 kb/s | 76.8 kb/s | | | | | | | | | |
| 5304 | <p>EFB PARITY</p> <p>Defines the data length, parity and stop bits to be used with the RS485 communication.</p> <ul style="list-style-type: none"> The same settings must be used in all on-line stations. <p>0 = 8 NONE 1 – 8 data bits, no parity, one stop bit. 1 = 8 NONE 2 – 8 data bits, no parity, two stop bits. 2 = 8 EVEN 1 – 8 data bits, even parity, one stop bit. 3 = 8 ODD 1 – 8 data bits, odd parity, one stop bit.</p> | When this protocol is selected, the default value for this parameter is: 1 | | | | | | | | |
| 5305 | <p>EFB CTRL PROFILE</p> <p>Selects the communication profile used by the EFB protocol.</p> <p>0 = ABB DRV LIM – Operation of Control/Status Words conforms to ABB Drives Profile, as used in ACS400. 1 = DCU PROFILE – Operation of Control/Status Words conforms to 32-bit DCU Profile. 2 = ABB DRV FULL – Operation of Control/Status Words conforms to ABB Drives Profile, as used in ACS600/800.</p> | When this protocol is selected, the default value for this parameter is: 0 | | | | | | | | |

Note: After any changes to the communication settings, the protocol must be reactivated by either cycling the drive power, or by clearing and then restoring the station Id (5302).

Activate drive control functions – EFB

Controlling the drive

Fieldbus control of various drive functions requires configuration to:

- tell the drive to accept fieldbus control of the function
- define as a fieldbus input, any drive data required for control
- define as a fieldbus output, any control data required by the drive.

The following sections describe, at a general level, the configuration required for each control function. For the protocol-specific details, see the document supplied with the FBA module.

Start/Stop Direction control

Using the fieldbus for start/stop/direction control of the drive requires:

- drive parameter values set as defined below
- fieldbus controller supplied command(s) in the appropriate location. (The location is defined by the Protocol Reference, which is protocol dependent.)

| Drive parameter | | Value | Description | Modbus ¹ protocol reference | |
|-----------------|---------------|-------------|--|--|-----------------|
| | | | | ABB DRV | DCU PROFILE |
| 1001 | EXT1 COMMANDS | 10 (COMM) | Start/Stop by fieldbus with Ext1 selected. | 40001 bits 0...3 | 40031 bits 0, 1 |
| 1002 | EXT2 COMMANDS | 10 (COMM) | Start/Stop by fieldbus with Ext2 selected. | 40001 bits 0...3 | 40031 bits 0, 1 |
| 1003 | DIRECTION | 3 (REQUEST) | Direction by fieldbus. | 4002/4003 ² | 40031 bit 3 |

¹ For Modbus, the protocol reference can depend on the profile used, hence two columns in these tables. One column refers to the ABB Drives profile, selected when parameter 5305 = 0 (ABB DRV LIM) or 5305 = 2 (ABB DRV FULL). The other column refers to the DCU profile selected when parameter 5305 = 1 (DCU PROFILE). See section [ABB control profiles technical data](#) on page 239.

² The reference provides direction control – a negative reference provides reverse rotation.

Input reference select

Using the fieldbus to provide input references to the drive requires:

- drive parameter values set as defined below
- fieldbus controller supplied reference word(s) in the appropriate location. (The location is defined by the Protocol Reference, which is protocol dependent.)

| Drive parameter | | Value | Description | Modbus protocol reference | |
|-----------------|---------------|----------|--------------------------------------|---------------------------|-------------|
| | | | | ABB DRV | DCU PROFILE |
| 1102 | EXT1/EXT2 SEL | 8 (COMM) | Reference set selection by fieldbus. | 40001 bit 11 | 40031 bit 5 |
| 1103 | REF1 SELECT | 8 (COMM) | Input reference 1 by fieldbus. | 40002 | |
| 1106 | REF2 SELECT | 8 (COMM) | Input reference 2 by fieldbus. | 40003 | |

Reference Scaling

Where required, REFERENCES can be scaled. See the following, as appropriate:

- Modbus Register [40002](#) in section [Modbus protocol technical data](#) on page [231](#)
- [Reference scaling](#) in section [ABB control profiles technical data](#) on page [239](#).

Miscellaneous drive control

Using the fieldbus for miscellaneous drive control requires:

- drive parameter values set as defined below
- fieldbus controller supplied command(s) in the appropriate location. (The location is defined by the Protocol Reference, which is protocol dependent.)

| Drive parameter | | Value | Description | Modbus protocol reference | |
|-----------------|-----------------|----------|---|---------------------------|------------------------|
| | | | | ABB DRV | DCU PROFILE |
| 1601 | RUN ENABLE | 7 (COMM) | Run enable by fieldbus. | 40001 bit 3 | 40031 bit 6 (inverted) |
| 1604 | FAULT RESET SEL | 8 (COMM) | Fault reset by fieldbus. | 40001 bit 7 | 40031 bit 4 |
| 1606 | LOCAL LOCK | 8 (COMM) | Source for local lock selection is the fieldbus. | Does not apply | 40031 bit 14 |
| 1607 | PARAM SAVE | 1 (SAVE) | Saves altered parameters to memory (then value returns to 0). | 41607 | |
| 1608 | START ENABLE 1 | 7 (COMM) | Source for start enable 1 is the fieldbus Command word. | Does not apply. | 40032 bit 2 |
| 1609 | START ENABLE 2 | 7 (COMM) | Source for start enable 2 is the fieldbus Command word. | | 40032 bit 3 |
| 2013 | MIN TORQUE SEL | 7 (COMM) | Source for minimum torque selection is the fieldbus. | | 40031 bit 15 |
| 2014 | MAX TORQUE SEL | 7 (COMM) | Source for maximum torque selection is the fieldbus. | | |
| 2201 | ACC/DEC 1/2 SEL | 7 (COMM) | Source for ramp pair selection is the fieldbus. | | 40031 bit 10 |

Relay output control

Using the fieldbus for relay output control requires:

- drive parameter values set as defined below
- fieldbus controller supplied, binary coded, relay command(s) in the appropriate location. (The location is defined by the Protocol Reference, which is protocol dependent.)

| Drive parameter | | Value | Description | Modbus protocol reference | |
|-------------------|----------------|-----------|--|---------------------------|-------------|
| | | | | ABB DRV | DCU PROFILE |
| 1401 | RELAY OUTPUT 1 | 35 (COMM) | Relay Output 1 controlled by fieldbus. | 40134 bit 0 or 00033 | |
| 1402 | RELAY OUTPUT 2 | 35 (COMM) | Relay Output 2 controlled by fieldbus. | 40134 bit 1 or 00034 | |
| 1403 | RELAY OUTPUT 3 | 35 (COMM) | Relay Output 3 controlled by fieldbus. | 40134 bit 2 or 00035 | |
| 1410 ¹ | RELAY OUTPUT 4 | 35 (COMM) | Relay Output 4 controlled by fieldbus. | 40134 bit 3 or 00036 | |
| 1411 ¹ | RELAY OUTPUT 5 | 35 (COMM) | Relay Output 5 controlled by fieldbus. | 40134 bit 4 or 00037 | |
| 1412 ¹ | RELAY OUTPUT 6 | 35 (COMM) | Relay Output 6 controlled by fieldbus. | 40134 bit 5 or 00038 | |

¹ More than 3 relays requires the addition of a relay extension module.

Note: Relay status feedback occurs without configuration as defined below.

| Drive parameter | | Description | Modbus protocol reference | |
|-----------------|---------------|---------------------|---------------------------|-------------|
| | | | ABB DRV | DCU PROFILE |
| 0122 | RO 1-3 STATUS | Relay 1...3 status. | 40122 | |
| 0123 | RO 4-6 STATUS | Relay 4...6 status. | 40123 | |

Analog output control

Using the fieldbus for analog output control (e.g. PID setpoint) requires:

- drive parameter values set as defined below
- fieldbus controller supplied analog value(s) in the appropriate location. (The location is defined by the Protocol Reference, which is protocol dependent.)

| Drive parameter | | Value | Description | Modbus protocol reference | |
|-----------------|-----------------|--------------------|--|---------------------------|-------------|
| | | | | ABB DRV | DCU PROFILE |
| 1501 | AO1 CONTENT SEL | 135 (COMM VALUE 1) | Analog Output 1 controlled by writing to parameter 0135. | – | |
| 0135 | COMM VALUE 1 | – | | 40135 | |
| 1507 | AO2 CONTENT SEL | 136 (COMM VALUE 2) | Analog Output 2 controlled by writing to parameter 0136. | – | |
| 0136 | COMM VALUE 2 | – | | 40136 | |

PID control setpoint source

Using the following settings to select the fieldbus as the setpoint source for PID loops:

| Drive parameter | | Value | Description | Modbus protocol reference | |
|-----------------|--------------------------|---|---|---------------------------|-------------|
| | | | | ABB DRV | DCU PROFILE |
| 4010 | SET POINT SEL (Set 1) | 8 (COMM VALUE 1) 9 (COMM+A11) 10 (COMM*A11) | Setpoint is input reference 2 (+/-/* A11) | 40003 | |
| 4110 | SET POINT SEL (Set 2) | | | | |
| 4210 | SET POINT SEL (Ext/Trim) | | | | |

Communication fault

When using fieldbus control, specify the drive's action if serial communication is lost.

| Drive parameter | | Value | Description |
|-----------------|-----------------|---|-------------------------------------|
| 3018 | COMM FAULT FUNC | 0 (NOT SEL) 1 (FAULT) 2 (CONST SP7) 3 (LAST SPEED) | Set for appropriate drive response. |
| 3019 | COMM FAULT TIME | Set time delay before acting on a communication loss. | |

Feedback from the drive – EFB

Pre-defined feedback

Inputs to the controller (drive outputs) have pre-defined meanings established by the protocol. This feedback does not require drive configuration. The following table lists a sample of feedback data. For a complete listing, see input word/point/object listings in the technical data for the appropriate protocol starting on page [231](#).

| Drive parameter | | Modbus protocol reference | |
|-----------------|------------------------------|---------------------------|-------------|
| | | ABB DRV | DCU PROFILE |
| 0102 | SPEED | 40102 | |
| 0103 | OUTPUT FREQ | 40103 | |
| 0104 | CURRENT | 40104 | |
| 0105 | TORQUE | 40105 | |
| 0106 | POWER | 40106 | |
| 0107 | DC BUS VOLTAGE | 40107 | |
| 0109 | OUTPUT VOLTAGE | 40109 | |
| 0301 | FB CMD WORD1 – bit 0 (STOP) | 40301 bit 0 | |
| 0301 | FB CMD WORD1 1 – bit 2 (REV) | 40301 bit 2 | |
| 0118 | DI 1-3 STATUS – bit 0 (DI3) | 40118 | |

Note: With Modbus, any parameter can be accessed using the format: “4” followed by the parameter number.

Actual value scaling

The scaling of actual values can be protocol dependent. In general, for Actual Values, scale the feedback integer using the parameter's resolution. (See section [Complete parameter list](#) on page [115](#) for parameter resolutions.) For example:

| Feedback integer | Parameter resolution | (Feedback integer) · (Parameter resolution) = Scaled value |
|------------------|----------------------|--|
| 1 | 0.1 mA | 1 · 0.1 mA = 0.1 mA |
| 10 | 0.1% | 10 · 0.1% = 1% |

Where parameters are in percent, the [Complete parameter descriptions](#) section specifies what parameter corresponds to 100%. In such cases, to convert from percent to engineering units, multiply by the value of the parameter that defines 100% and divide by 100%.

For example:

| Feedback integer | Parameter resolution | Value of the parameter that defines 100% | (Feedback integer) · (Parameter resolution) · (Value of 100% ref.) / 100% = Scaled value |
|------------------|----------------------|--|--|
| 10 | 0.1% | 1500 rpm ¹ | $10 \cdot 0.1\% \cdot 1500 \text{ RPM} / 100\% = 15 \text{ rpm}$ |
| 100 | 0.1% | 500 Hz ² | $100 \cdot 0.1\% \cdot 500 \text{ Hz} / 100\% = 50 \text{ Hz}$ |

¹ Assuming, for the sake of this example, that the Actual Value uses parameter 9908 MOT NOM SPEED as the 100% reference and that 9908 = 1500 rpm.

² Assuming, for the sake of this example, that the Actual Value uses parameter 9907 MOT NOM FREQ as the 100% reference and that 9907 = 500 Hz.

Diagnostics – EFB

Fault queue for drive diagnostics

For general ACS550 diagnostics information, see chapter [Diagnostics](#) on page 273. The three most recent ACS550 faults are reported to the fieldbus as defined below.

| Drive parameter | | Modbus protocol reference | |
|-----------------|------------------|---------------------------|-------------|
| | | ABB DRV | DCU PROFILE |
| 0401 | LAST FAULT | 40401 | |
| 0412 | PREVIOUS FAULT 1 | 40412 | |
| 0413 | PREVIOUS FAULT 2 | 40413 | |

Serial communication diagnostics

Network problems can be caused by multiple sources. Some of these sources are:

- loose connections
- incorrect wiring (including swapped wires)
- bad grounding
- duplicate station numbers
- incorrect setup of drives or other devices on the network.

The major diagnostic features for fault tracing on an EFB network include [Group 53: EFB PROTOCOL](#) parameters 5306...5309. Section [Complete parameter descriptions](#) on page 128 describes these parameters in detail.

Diagnostic situations

The sub-sections below describe various diagnostic situations – the problem symptoms and corrective actions.

Normal operation

During normal network operation, 5306...5309 parameter values act as follows at each drive:

- 5306 EFB OK MESSAGES advances (advances for each message properly received and addressed to this drive).
- 5307 EFB CRC ERRORS does not advance at all (advances when an invalid message CRC is received).
- 5308 EFB UART ERRORS does not advance at all (advances when character format errors are detected, such as parity or framing errors).
- 5309 EFB STATUS value varies depending on network traffic.

Loss of communication

The ACS550 behavior, if communication is lost, was configured earlier in section [Communication fault](#) on page 226. The parameters are 3018 COMM FAULT FUNC and 3019 COMM FAULT TIME. Section [Complete parameter descriptions](#) on page 128 describes these parameters in detail.

No master station on line

If no master station is on line: Neither the EFB OK MESSAGES nor the errors (5307 EFB CRC ERRORS and 5308 EFB UART ERRORS) increase on any of the stations.

To correct:

- Check that a network master is connected and properly programmed on the network.
- Verify that the cable is connected and that it is not cut or short circuited.

Duplicate stations

If two or more stations have duplicate numbers:

- Two or more drives cannot be addressed.
- Every time there is a read or write to one particular station, the value for 5307 EFB CRC ERRORS or 5308 EFB UART ERRORS advances.

To correct: Verify the station numbers of all stations. Change conflicting station numbers.

Swapped wires

If the communication wires are swapped (terminal A on one drive is connected to terminal B on another):

- The value of 5306 EFB OK MESSAGES does not advance.
- The values of 5307 EFB CRC ERRORS and 5308 EFB UART ERRORS are advancing.

To correct: Check that the RS-485 lines are not swapped.

Fault 28 – Serial 1 Err

If the drive's control panel shows fault code 28, SERIAL 1 ERR, check for either of the following:

- The master system is down. To correct, resolve problem with master system.
- The communication connection is bad. To correct, check communication connection at the drive.
- The time-out selection for the drive is too short for the given installation. The master is not polling the drive within the specified time-out delay. To correct, increase the time set by parameter 3019 COMM FAULT TIME.

Faults 31...33 – EFB1...EFB3

The three EFB fault codes listed for the drive in chapter [Diagnostics](#) on page [273](#) (fault codes 31...33) are not used.

Intermittent off-line occurrences

The problems described above are the most common problems encountered with ACS550 serial communication. Intermittent problems might also be caused by:

- marginally loose connections
- wear on wires caused by equipment vibrations
- insufficient grounding and shielding on both the devices and on the communication cables.

Modbus protocol technical data

Overview

The Modbus® protocol was introduced by Modicon, Inc. for use in control environments featuring Modicon programmable controllers. Due to its ease of use and implementation, this common PLC language was quickly adopted as a de-facto standard for integration of a wide variety of master controllers and slave devices.

Modbus is a serial, asynchronous protocol. Transactions are half-duplex, featuring a single Master controlling one or more Slaves. While RS232 can be used for point-to-point communication between a single Master and a single Slave, a more common implementation features a multi-drop RS485 network with a single Master controlling multiple Slaves. The ACS550 features RS485 for its Modbus physical interface.

RTU

The Modbus specification defines two distinct transmission modes: ASCII and RTU. The ACS550 supports RTU only.

Feature summary

The following Modbus function codes are supported by the ACS550.

| Function | Code (Hex) | Description |
|---------------------------------------|------------|--|
| Read Coil Status | 0x01 | Read discrete output status. For the ACS550, the individual bits of the control word are mapped to Coils 1...16. Relay outputs are mapped sequentially beginning with Coil 33 (e.g. RO1=Coil 33). |
| Read Discrete Input Status | 0x02 | Read discrete inputs status. For the ACS550, the individual bits of the status word are mapped to Inputs 1...16 or 1...32, depending on the active profile. Terminal inputs are mapped sequentially beginning with Input 33 (e.g. DI1=Input 33). |
| Read Multiple Holding Registers | 0x03 | Read multiple holding registers. For the ACS550, the entire parameter set is mapped as holding registers, as well as command, status and reference values. |
| Read Multiple Input Registers | 0x04 | Read multiple input registers. For the ACS550, the 2 analog input channels are mapped as input registers 1 & 2. |
| Force Single Coil | 0x05 | Write a single discrete output. For the ACS550, the individual bits of the control word are mapped to Coils 1...16. Relay outputs are mapped sequentially beginning with Coil 33 (e.g. RO1=Coil 33). |
| Write Single Holding Register | 0x06 | Write single holding register. For the ACS550, the entire parameter set is mapped as holding registers, as well as command, status and reference values. |
| Diagnostics | 0x08 | Perform Modbus diagnostics. Subcodes for Query (0x00), Restart (0x01) & Listen Only (0x04) are supported. |
| Force Multiple Coils | 0x0F | Write multiple discrete outputs. For the ACS550, the individual bits of the control word are mapped to Coils 1...16. Relay outputs are mapped sequentially beginning with Coil 33 (e.g. RO1=Coil 33). |
| Write Multiple Holding Registers | 0x10 | Write multiple holding registers. For the ACS550, the entire parameter set is mapped as holding registers, as well as command, status and reference values. |
| Read/Write Multiple Holding Registers | 0x17 | This function combines functions 0x03 and 0x10 into a single command. |

Mapping summary

The following table summarizes the mapping between the ACS550 (parameters and I/O) and Modbus reference space. For details, see [Modbus addressing](#) below.

| ACS550 | Modbus reference | Supported function codes |
|--|--------------------------|---|
| <ul style="list-style-type: none"> Control Bits Relay Outputs | Coils(0xxxx) | <ul style="list-style-type: none"> 01 – Read Coil Status 05 – Force Single Coil 15 – Force Multiple Coils |
| <ul style="list-style-type: none"> Status Bits Discrete Inputs | Discrete Inputs(1xxxx) | <ul style="list-style-type: none"> 02 – Read Input Status |
| <ul style="list-style-type: none"> Analog Inputs | Input Registers(3xxxxx) | <ul style="list-style-type: none"> 04 – Read Input Registers |
| <ul style="list-style-type: none"> Parameters Control/Status Words References | Holding Registers(4xxxx) | <ul style="list-style-type: none"> 03 – Read 4X Registers 06 – Preset Single 4X Register 16 – Preset Multiple 4X Registers 23 – Read/Write 4X Registers |

Communication profiles

When communicating by Modbus, the ACS550 supports multiple profiles for control and status information. Parameter 5305 EFB CTRL PROFILE selects the profile used.

- ABB DRV LIM – The primary (and default) profile is the ABB DRV LIM profile. This implementation of the ABB Drives profile standardizes the control interface with ACS400 drives. The ABB Drives profile is based on the PROFIBUS interface. It is discussed in detail in the following sections.
- DCU PROFILE – The DCU PROFILE profile extends the control and status interface to 32 bits. It is the internal interface between the main drive application and the embedded fieldbus environment.
- ABB DRV FULL – ABB DRV FULL is the implementation of the ABB Drives profile that standardizes the control interface with ACS600 and ACS800 drives. This implementation supports two control word bits not supported by the ABB DRV LIM implementation.

Modbus addressing

With Modbus, each function code implies access to a specific Modbus reference set. Thus, the leading digit is not included in the address field of a Modbus message.

Note: The ACS550 supports the zero-based addressing of the Modbus specification. Holding register 40002 is addressed as 0001 in a Modbus message. Similarly, coil 33 is addressed as 0032 in a Modbus message.

Refer again to the [Mapping summary](#) above. The following sections describe, in detail, the mapping to each Modbus reference set.

0xxxx Mapping – Modbus coils. The drive maps the following information to the 0xxxx Modbus set called Modbus Coils:

- bit-wise map of the CONTROL WORD (selected using parameter 5305 EFB CTRL PROFILE). The first 32 coils are reserved for this purpose.

- relay output states, numbered sequentially beginning with coil 00033.

The following table summarizes the 0xxxx reference set:

| Modbus ref. | Internal location (all profiles) | ABB DRV LIM (5305 = 0) | DCU PROFILE (5305 = 1) | ABB DRV FULL (5305 = 2) |
|-------------------|----------------------------------|---------------------------|------------------------|----------------------------|
| 00001 | CONTROL WORD – Bit 0 | OFF1 ¹ | STOP | OFF1 ¹ |
| 00002 | CONTROL WORD – Bit 1 | OFF2 ¹ | START | OFF2 ¹ |
| 00003 | CONTROL WORD – Bit 2 | OFF3 ¹ | REVERSE | OFF3 ¹ |
| 00004 | CONTROL WORD – Bit 3 | START | LOCAL | START |
| 00005 | CONTROL WORD – Bit 4 | N/A | RESET | RAMP_OUT_ZERO ¹ |
| 00006 | CONTROL WORD – Bit 5 | RAMP_HOLD ¹ | EXT2 | RAMP_HOLD ¹ |
| 00007 | CONTROL WORD – Bit 6 | RAMP_IN_ZERO ¹ | RUN_DISABLE | RAMP_IN_ZERO ¹ |
| 00008 | CONTROL WORD – Bit 7 | RESET | STPMODE_R | RESET |
| 00009 | CONTROL WORD – Bit 8 | N/A | STPMODE_EM | N/A |
| 00010 | CONTROL WORD – Bit 9 | N/A | STPMODE_C | N/A |
| 00011 | CONTROL WORD – Bit 10 | N/A | RAMP_2 | REMOTE_CMD ¹ |
| 00012 | CONTROL WORD – Bit 11 | EXT2 | RAMP_OUT_0 | EXT2 |
| 00013 | CONTROL WORD – Bit 12 | N/A | RAMP_HOLD | N/A |
| 00014 | CONTROL WORD – Bit 13 | N/A | RAMP_IN_0 | N/A |
| 00015 | CONTROL WORD – Bit 14 | N/A | REQ_LOCALLOCK | N/A |
| 00016 | CONTROL WORD – Bit 15 | N/A | TORQLIM2 | N/A |
| 00017 | CONTROL WORD – Bit 16 | Does not apply | FBLOCAL_CTL | Does not apply |
| 00018 | CONTROL WORD – Bit 17 | | FBLOCAL_REF | |
| 00019 | CONTROL WORD – Bit 18 | | START_DISABLE1 | |
| 00020 | CONTROL WORD – Bit 19 | | START_DISABLE2 | |
| 00021... 00032 | Reserved | Reserved | Reserved | Reserved |
| 00033 | RELAY OUTPUT 1 | Relay Output 1 | Relay Output 1 | Relay Output 1 |
| 00034 | RELAY OUTPUT 2 | Relay Output 2 | Relay Output 2 | Relay Output 2 |
| 00035 | RELAY OUTPUT 3 | Relay Output 3 | Relay Output 3 | Relay Output 3 |
| 00036 | RELAY OUTPUT 4 | Relay Output 4 | Relay Output 4 | Relay Output 4 |
| 00037 | RELAY OUTPUT 5 | Relay Output 5 | Relay Output 5 | Relay Output 5 |
| 00038 | RELAY OUTPUT 6 | Relay Output 6 | Relay Output 6 | Relay Output 6 |

¹ = Active low

For the 0xxxx registers:

- Status is always readable.
- Forcing is allowed by user configuration of the drive for fieldbus control.
- Additional relay outputs are added sequentially.

The ACS550 supports the following Modbus function codes for coils:

| Function code | Description |
|---------------|----------------------|
| 01 | Read coil status |
| 05 | Force single coil |
| 15 (0x0F Hex) | Force multiple coils |

1xxxx Mapping – Modbus discrete inputs. The drive maps the following information to the 1xxxx Modbus set called Modbus Discrete Inputs:

- bit-wise map of the STATUS WORD (selected using parameter 5305 EFB CTRL PROFILE). The first 32 inputs are reserved for this purpose.
- discrete hardware inputs, numbered sequentially beginning with input 33.

The following table summarizes the 1xxxx reference set:

| Modbus ref. | Internal location (all profiles) | ABB DRV (5305 = 0 OR 2) | DCU PROFILE (5305 = 1) |
|-------------|----------------------------------|-------------------------|------------------------|
| 10001 | STATUS WORD – Bit 0 | RDY_ON | READY |
| 10002 | STATUS WORD – Bit 1 | RDY_RUN | ENABLED |
| 10003 | STATUS WORD – Bit 2 | RDY_REF | STARTED |
| 10004 | STATUS WORD – Bit 3 | TRIPPED | RUNNING |
| 10005 | STATUS WORD – Bit 4 | OFF_2_STA ¹ | ZERO_SPEED |
| 10006 | STATUS WORD – Bit 5 | OFF_3_STA ¹ | ACCELERATE |
| 10007 | STATUS WORD – Bit 6 | SWC_ON_INHIB | DECELERATE |
| 10008 | STATUS WORD – Bit 7 | ALARM | AT_SETPOINT |
| 10009 | STATUS WORD – Bit 8 | AT_SETPOINT | LIMIT |
| 10010 | STATUS WORD – Bit 9 | REMOTE | SUPERVISION |
| 10011 | STATUS WORD – Bit 10 | ABOVE_LIMIT | REV_REF |
| 10012 | STATUS WORD – Bit 11 | EXT2 | REV_ACT |
| 10013 | STATUS WORD – Bit 12 | RUN_ENABLE | PANEL_LOCAL |
| 10014 | STATUS WORD – Bit 13 | N/A | FIELD BUS_LOCAL |
| 10015 | STATUS WORD – Bit 14 | N/A | EXT2_ACT |
| 10016 | STATUS WORD – Bit 15 | N/A | FAULT |
| 10017 | STATUS WORD – Bit 16 | Reserved | ALARM |
| 10018 | STATUS WORD – Bit 17 | Reserved | REQ_MAINT |
| 10019 | STATUS WORD – Bit 18 | Reserved | DIRLOCK |
| 10020 | STATUS WORD – Bit 19 | Reserved | LOCALLOCK |
| 10021 | STATUS WORD – Bit 20 | Reserved | CTL_MODE |
| 10022 | STATUS WORD – Bit 21 | Reserved | Reserved |
| 10023 | STATUS WORD – Bit 22 | Reserved | Reserved |
| 10024 | STATUS WORD – Bit 23 | Reserved | Reserved |
| 10025 | STATUS WORD – Bit 24 | Reserved | Reserved |
| 10026 | STATUS WORD – Bit 25 | Reserved | Reserved |
| 10027 | STATUS WORD – Bit 26 | Reserved | REQ_CTL |

| Modbus ref. | Internal location (all profiles) | ABB DRV (5305 = 0 OR 2) | DCU PROFILE (5305 = 1) |
|-------------|----------------------------------|-------------------------|------------------------|
| 10028 | STATUS WORD – Bit 27 | Reserved | REQ_REF1 |
| 10029 | STATUS WORD – Bit 28 | Reserved | REQ_REF2 |
| 10030 | STATUS WORD – Bit 29 | Reserved | REQ_REF2EXT |
| 10031 | STATUS WORD – Bit 30 | Reserved | ACK_STARTINH |
| 10032 | STATUS WORD – Bit 31 | Reserved | ACK_OFF_ILCK |
| 10033 | DI1 | DI1 | DI1 |
| 10034 | DI2 | DI2 | DI2 |
| 10035 | DI3 | DI3 | DI3 |
| 10036 | DI4 | DI4 | DI4 |
| 10037 | DI5 | DI5 | DI5 |
| 10038 | DI6 | DI6 | DI6 |

¹ = Active low

For the 1xxxx registers:

- Additional discrete inputs are added sequentially.

The ACS550 supports the following Modbus function codes for discrete inputs:

| Function code | Description |
|---------------|-------------------|
| 02 | Read input status |

3xxxx Mapping – Modbus inputs. The drive maps the following information to the 3xxxx Modbus addresses called Modbus input registers:

- any user defined analog inputs.

The following table summarizes the input registers:

| Modbus reference | ACS550 all profiles | Remarks |
|------------------|---------------------|--|
| 30001 | AI1 | This register shall report the level of Analog Input 1 (0...100%). |
| 30002 | AI2 | This register shall report the level of Analog Input 2 (0...100%). |

The ACS550 supports the following Modbus function codes for 3xxxx registers:

| Function code | Description |
|---------------|-------------------------|
| 04 | Read 3xxxx input status |

4xxxx Register mapping. The drive maps its parameters and other data to the 4xxxx holding registers as follows:

- 40001...40099 map to drive control and actual values. These registers are described in the table below.
- 40101...49999 map to drive parameters 0101...9999. Register addresses that do not correspond to drive parameters are invalid. If there is an attempt to read or write outside the parameter addresses, the Modbus interface returns an exception code to the controller.

The following table summarizes the 4xxxx drive control registers 40001...40099 (for 4xxxx registers above 40099, see the drive parameter list, e.g. 40102 is parameter 0102):

| Modbus register | | Access | Remarks |
|-----------------|---------------------------------|--------|---|
| 40001 | CONTROL WORD | R/W | Maps directly to the profile's CONTROL WORD. Supported only if 5305 = 0 or 2 (ABB Drives profile). Parameter 5319 holds a copy in hex format. |
| 40002 | Reference 1 | R/W | Range = 0...+20000 (scaled to 0...1105 REF1 MAX), or -20000...0 (scaled to 1105 REF1 MAX...0). |
| 40003 | Reference 2 | R/W | Range = 0...+10000 (scaled to 0...1108 REF2 MAX), or -10000...0 (scaled to 1108 REF2 MAX...0). |
| 40004 | STATUS WORD | R | Maps directly to the profile's STATUS WORD. Supported only if 5305 = 0 or 2 (ABB Drives profile). Parameter 5320 holds a copy in hex format. |
| 40005 | Actual 1 (select using 5310) | R | By default, stores a copy of 0103 OUTPUT FREQ. Use parameter 5310 to select a different actual value for this register. |
| 40006 | Actual 2 (select using 5311) | R | By default, stores a copy of 0104 CURRENT. Use parameter 5311 to select a different actual value for this register. |
| 40007 | Actual 3 (select using 5312) | R | By default, stores nothing. Use parameter 5312 to select an actual value for this register. |
| 40008 | Actual 4 (select using 5313) | R | By default, stores nothing. Use parameter 5313 to select an actual value for this register. |
| 40009 | Actual 5 (select using 5314) | R | By default, stores nothing. Use parameter 5314 to select an actual value for this register. |
| 40010 | Actual 6 (select using 5315) | R | By default, stores nothing. Use parameter 5315 to select an actual value for this register. |
| 40011 | Actual 7 (select using 5316) | R | By default, stores nothing. Use parameter 5316 to select an actual value for this register. |
| 40012 | Actual 8 (select using 5317) | R | By default, stores nothing. Use parameter 5317 to select an actual value for this register. |
| 40031 | ACS550 CONTROL WORD LSW | R/W | Maps directly to the Least Significant Word of the DCU profile's CONTROL WORD. Supported only if 5305 = 1. See parameter 0301. |
| 40032 | ACS550 CONTROL WORD MSW | R | Maps directly to the Most Significant Word of the DCU profile's CONTROL WORD. Supported only if 5305 = 1. See parameter 0302. |
| 40033 | ACS550 STATUS WORD LSW | R | Maps directly to the Least Significant Word of the DCU profile's STATUS WORD. Supported only if 5305 = 1. See parameter 0303. |
| 40034 | ACS550 STATUS WORD MSW | R | Maps directly to the Most Significant Word of the DCU profile's STATUS WORD. Supported only if 5305 = 1. See parameter 0304. |

For the Modbus protocol, drive parameters in [Group 53: EFB PROTOCOL](#) report the parameter mapping to 4xxxx Registers.

| Code | Description |
|------|---|
| 5310 | EFB PAR 10 Specifies the parameter mapped to Modbus register 40005. |
| 5311 | EFB PAR 11 Specifies the parameter mapped to Modbus register 40006. |
| 5312 | EFB PAR 12 Specifies the parameter mapped to Modbus register 40007. |
| 5313 | EFB PAR 13 Specifies the parameter mapped to Modbus register 40008. |
| 5314 | EFB PAR 14 Specifies the parameter mapped to Modbus register 40009. |
| 5315 | EFB PAR 15 Specifies the parameter mapped to Modbus register 40010. |
| 5316 | EFB PAR 16 Specifies the parameter mapped to Modbus register 40011. |
| 5317 | EFB PAR 17 Specifies the parameter mapped to Modbus register 40012. |
| 5318 | EFB PAR 18 Sets additional delay in milliseconds before the ACS550 begins transmitting response to the master request. |
| 5319 | EFB PAR 19 Holds a copy (in hex) of the CONTROL WORD, Modbus register 40001. |
| 5320 | EFB PAR 20 Holds a copy (in hex) of the STATUS WORD, Modbus register 40004. |

Except where restricted by the drive, all parameters are available for both reading and writing. The parameter writes are verified for the correct value and for a valid register addresses.

Note: Parameter writes through standard Modbus are always volatile i.e. modified values are not automatically stored to permanent memory. Use parameter 1607 PARAM SAVE to save all altered values.

The ACS550 supports the following Modbus function codes for 4xxxx registers:

| Function code | Description |
|---------------|---------------------------------|
| 03 | Read holding 4xxxx registers |
| 06 | Preset single 4xxxx register |
| 16 (0x10 Hex) | Preset multiple 4xxxx registers |
| 23 (0x17 Hex) | Read/write 4xxxx registers |

Actual values

The contents of the register addresses 40005...40012 are ACTUAL VALUES and are:

- specified using parameters 5310...5317
- Read-only values containing information on the operation of the drive
- 16-bit words containing a sign bit and a 15-bit integer
- when negative values, written as the two's complement of the corresponding positive value
- scaled as described earlier in section [Actual value scaling](#) on page 227.

Exception codes

Exception codes are serial communication responses from the drive. The ACS550 supports the standard Modbus exception codes defined below.

| Exception code | Name | Meaning |
|----------------|----------------------|---|
| 01 | ILLEGAL FUNCTION | Unsupported Command |
| 02 | ILLEGAL DATA ADDRESS | The data address received in the query is not allowable. It is not a defined parameter/group. |
| 03 | ILLEGAL DATA VALUE | A value contained in the query data field is not an allowable value for the ACS550, because it is one of the following: <ul style="list-style-type: none"> • Outside min. or max. limits. • Parameter is read-only. • Message is too long. • Parameter write not allowed when start is active. • Parameter write not allowed when factory macro is selected. |

ABB control profiles technical data

Overview

ABB Drives profile

The ABB Drives profile provides a standard profile that can be used on multiple protocols, including Modbus and the protocols available on the FBA module. Two implementations of the ABB Drives profile are available:

- ABB DRV FULL – This implementation standardizes the control interface with ACS600 and ACS800 drives.
- ABB DRV LIM – This implementation standardizes the control interface with ACS400 drives. This implementation does not support two control word bits supported by ABB DRV FULL.

Except as noted, the following “ABB Drives Profile” descriptions apply to both implementations.

DCU profile

The DCU profile extends the control and status interface to 32 bits. It is the internal interface between the main drive application and the embedded fieldbus environment.

Control Word

The CONTROL WORD is the principal means for controlling the drive from a fieldbus system. The fieldbus master station sends the CONTROL WORD to the drive. The drive switches between states according to the bit-coded instructions in the CONTROL WORD. Using the CONTROL WORD requires that:

- The drive is in remote (REM) control.
- The serial communication channel is defined as the source for controlling commands (set using parameters such as 1001 EXT1 COMMANDS, 1002 EXT2 COMMANDS and 1102 EXT1/EXT2 SEL).
- The serial communication channel used is configured to use an ABB control profile. For example, to use the control profile ABB DRV FULL requires both parameter 9802 COMM PROT SEL = 1 (STD MODBUS) and parameter 5305 EFB CTRL PROFILE = 2 (ABB DRV FULL).

ABB Drives profile

The following table and the state diagram later in this sub-section describe the CONTROL WORD content for the ABB Drives profile.

| ABB Drives profile CONTROL WORD (See parameter 5319) | | | | |
|--|------------------------------|-------|---------------------|---|
| Bit | Name | Value | Commanded state | Comments |
| 0 | OFF1 CONTROL | 1 | READY TO OPERATE | Enter READY TO OPERATE |
| | | 0 | EMERGENCY OFF | Drive ramps to stop according to currently active deceleration ramp (2203 or 2205) Normal command sequence: <ul style="list-style-type: none"> • Enter OFF1 ACTIVE • Proceed to READY TO SWITCH ON, unless other interlocks (OFF2, OFF3) are active. |
| 1 | OFF2 CONTROL | 1 | OPERATING | Continue operation (OFF2 inactive) |
| | | 0 | EMERGENCY OFF | Drive coasts to stop. Normal command sequence: <ul style="list-style-type: none"> • Enter OFF2 ACTIVE • Proceed to SWITCHON INHIBITED |
| 2 | OFF3 CONTROL | 1 | OPERATING | Continue operation (OFF3 inactive) |
| | | 0 | EMERGENCY STOP | Drive stops within time specified by parameter 2208. Normal command sequence: <ul style="list-style-type: none"> • Enter OFF3 ACTIVE • Proceed to SWITCH ON INHIBITED  WARNING! Be sure motor and driven equipment can be stopped using this mode. |
| 3 | INHIBIT OPERATION | 1 | OPERATION ENABLED | Enter OPERATION ENABLED (Note the Run enable signal must be active. See 1601. If 1601 is set to COMM, this bit also activates the Run Enable signal.) |
| | | 0 | OPERATION INHIBITED | Inhibit operation. Enter OPERATION INHIBITED |
| 4 | Unused (ABB DRV LIM) | | | |
| | RAMP_OUT_ZERO (ABB DRV FULL) | 1 | NORMAL OPERATION | Enter RAMP FUNCTION GENERATOR: ACCELERATION ENABLED |
| | | 0 | RFG OUT ZERO | Force ramp function generator output to Zero. Drive ramps to stop (current and DC voltage limits in force). |
| 5 | RAMP_HOLD | 1 | RFG OUT ENABLED | Enable ramp function. Enter RAMP FUNCTION GENERATOR: ACCELERATOR ENABLED |
| | | 0 | RFG OUT HOLD | Halt ramping (Ramp Function Generator output held) |
| 6 | RAMP_IN_ZERO | 1 | RFG INPUT ENABLED | Normal operation. Enter OPERATING |
| | | 0 | RFG INPUT ZERO | Force Ramp Function Generator input to zero. |

| ABB Drives profile CONTROL WORD (See parameter 5319) | | | | |
|--|---------------------------|-------|-----------------|---|
| Bit | Name | Value | Commanded state | Comments |
| 7 | RESET | 0=>1 | RESET | Fault reset if an active fault exists (Enter SWITCH-ON INHIBITED). Effective if 1604 = COMM. |
| | | 0 | OPERATING | Continue normal operation |
| 8...9 | Unused | | | |
| 10 | Unused (ABB DRV LIM) | | | |
| | REMOTE_CMD (ABB DRV FULL) | 1 | | Fieldbus control enabled. |
| | | 0 | | <ul style="list-style-type: none"> CW ≠ 0 or Ref ≠ 0: Retain last CW and Ref. CW = 0 and Ref = 0: Fieldbus control enabled. Ref and deceleration/acceleration ramp are locked. |
| 11 | EXT CTRL LOC | 1 | EXT2 SELECT | Select external control location 2 (EXT2). Effective if 1102 = COMM. |
| | | 0 | EXT1 SELECT | Select external control location 1 (EXT1). Effective if 1102 = COMM. |
| 12...15 | Unused | | | |

DCU Profile

The following tables describe the CONTROL WORD content for the DCU profile.

| DCU profile CONTROL WORD (See parameter 0301) | | | | |
|---|-------------|-------|-----------------------|--|
| Bit | Name | Value | Command/Req. | Comments |
| 0 | STOP | 1 | Stop | Stops according to either the stop mode parameter or the stop mode requests (bits 7 and 8). |
| | | 0 | (no op) | |
| 1 | START | 1 | Start | Simultaneous STOP and START commands result in a stop command. |
| | | 0 | (no op) | |
| 2 | REVERSE | 1 | Reverse direction | This bit XOR'd with the sign of the reference defines direction. |
| | | 0 | Forward direction | |
| 3 | LOCAL | 1 | Local mode | When the fieldbus sets this bit, it steals control and the drive moves to fieldbus local control mode. |
| | | 0 | External mode | |
| 4 | RESET | -> 1 | Reset | Edge sensitive. |
| | | other | (no op) | |
| 5 | EXT2 | 1 | Switch to EXT2 | |
| | | 0 | Switch to EXT1 | |
| 6 | RUN_DISABLE | 1 | Run disable | Inverted run enable. |
| | | 0 | Run enable on | |
| 7 | STPMODE_R | 1 | Normal ramp stop mode | |
| | | 0 | (no op) | |

| DCU profile CONTROL WORD (See parameter 0301) | | | | |
|---|----------------|-------|--------------------------|---|
| Bit | Name | Value | Command/Req. | Comments |
| 8 | STPMODE_EM | 1 | Emergency ramp stop mode | |
| | | 0 | (no op) | |
| 9 | STPMODE_C | 1 | Coast stop mode | |
| | | 0 | (no op) | |
| 10 | RAMP_2 | 1 | Ramp pair 2 | |
| | | 0 | Ramp pair 1 | |
| 11 | RAMP_OUT_0 | 1 | Ramp output to 0 | |
| | | 0 | (no op) | |
| 12 | RAMP_HOLD | 1 | Ramp freeze | |
| | | 0 | (no op) | |
| 13 | RAMP_IN_0 | 1 | Ramp input to 0 | |
| | | 0 | (no op) | |
| 14 | RREQ_LOCALL OC | 1 | Local mode lock | In lock, drive will not switch to local mode. |
| | | 0 | (no op) | |
| 15 | TORQLIM2 | 1 | Torque limit pair 2 | |
| | | 0 | Torque limit pair 1 | |

| DCU profile CONTROL WORD (See parameter 0302) | | | | |
|---|---------------|-------|----------------------------------|--|
| Bit | Name | Value | Function | Comments |
| 16...26 | Reserved | | | |
| 27 | REF_CONST | 1 | Constant speed ref. | These bits are only for supervision purposes. |
| | | 0 | (no op) | |
| 28 | REF_AVE | 1 | Average speed ref. | |
| | | 0 | (no op) | |
| 29 | LINK_ON | 1 | Master is detected in link | |
| | | 0 | Link is down | |
| 30 | REQ_STARTINH | 1 | Start inhibit request is pending | |
| | | 0 | Start inhibit request is OFF | |
| 31 | OFF_INTERLOCK | 1 | Panel OFF button pressed | For the control panel (or PC tool) this is the OFF button interlock. |
| | | 0 | (no op) | |

Status Word

The contents of the STATUS WORD is status information, sent by the drive to the master station.

ABB Drives profile

The following table and the state diagram later in this sub-section describe the STATUS WORD content for the ABB Drives profile.

| ABB Drives profile (EFB) STATUS WORD (See parameter 5320) | | | |
|---|----------------|-------|---|
| Bit | Name | Value | Description (Correspond to states/boxes in the state diagram) |
| 0 | RDY_ON | 1 | READY TO SWITCH ON |
| | | 0 | NOT READY TO SWITCH ON |
| 1 | RDY_RUN | 1 | READY TO OPERATE |
| | | 0 | OFF1 ACTIVE |
| 2 | RDY_REF | 1 | OPERATION ENABLED |
| | | 0 | OPERATION INHIBITED |
| 3 | TRIPPED | 0...1 | FAULT |
| | | 0 | No fault |
| 4 | OFF_2_STA | 1 | OFF2 INACTIVE |
| | | 0 | OFF2 ACTIVE |
| 5 | OFF_3_STA | 1 | OFF3 INACTIVE |
| | | 0 | OFF3 ACTIVE |
| 6 | SWC_ON_INHIB | 1 | SWITCH-ON INHIBIT ACTIVE |
| | | 0 | SWITCH-ON INHIBIT NOT ACTIVE |
| 7 | ALARM | 1 | Alarm (See section Alarm listing on page 280 for details on alarms.) |
| | | 0 | No alarm |
| 8 | AT_SETPOINT | 1 | OPERATING. Actual value equals (within tolerance limits) the reference value. |
| | | 0 | Actual value is outside tolerance limits (not equal to reference value). |
| 9 | REMOTE | 1 | Drive control location: REMOTE (EXT1 or EXT2) |
| | | 0 | Drive control location: LOCAL |
| 10 | ABOVE_LIMIT | 1 | Supervised parameter's value \geq supervision high limit. Bit remains "1" until supervised parameter's value < supervision low limit. See Group 32: SUPERVISION . |
| | | 0 | Supervised parameter's value < supervision low limit. Bit remains "0" until supervised parameter's value > supervision high limit. See Group 32: SUPERVISION . |
| 11 | EXT CTRL LOC | 1 | External control location 2 (EXT2) selected |
| | | 0 | External control location 1 (EXT1) selected |
| 12 | EXT RUN ENABLE | 1 | External Run Enable signal received |
| | | 0 | No External Run Enable signal received |
| 13... 15 | Unused | | |

DCU profile

The following tables describe the STATUS WORD content for the DCU profile.

| DCU profile STATUS WORD (See parameter 0303) | | | |
|--|----------------|-------|--|
| Bit | Name | Value | Status |
| 0 | READY | 1 | Drive is ready to receive start command. |
| | | 0 | Drive is not ready. |
| 1 | ENABLED | 1 | External run enable signal received. |
| | | 0 | No external run enable signal received. |
| 2 | STARTED | 1 | Drive has received start command. |
| | | 0 | Drive has not received start command. |
| 3 | RUNNING | 1 | Drive is modulating. |
| | | 0 | Drive is not modulating. |
| 4 | ZERO_SPEED | 1 | Drive is at zero speed. |
| | | 0 | Drive has not reached zero speed. |
| 5 | ACCELERATE | 1 | Drive is accelerating. |
| | | 0 | Drive is not accelerating. |
| 6 | DECELERATE | 1 | Drive is decelerating. |
| | | 0 | Drive is not decelerating. |
| 7 | AT_SETPOINT | 1 | Drive is at setpoint. |
| | | 0 | Drive has not reached setpoint. |
| 8 | LIMIT | 1 | Operation is limited. Reference cannot be followed. |
| | | 0 | Operation is not limited. |
| 9 | SUPERVISION | 1 | A supervised parameter (<i>Group 32: SUPERVISION</i>) is outside its limits. |
| | | 0 | All supervised parameters are within limits. |
| 10 | REV_REF | 1 | Drive reference is in reverse direction. |
| | | 0 | Drive reference is in forward direction. |
| 11 | REV_ACT | 1 | Drive is running in reverse direction. |
| | | 0 | Drive is running in forward direction. |
| 12 | PANEL_LOCAL | 1 | Control is in control panel (or PC tool) local mode. |
| | | 0 | Control is not in control panel local mode. |
| 13 | FIELDBUS_LOCAL | 1 | Control is in fieldbus local mode (steals control panel local). |
| | | 0 | Control is not in fieldbus local mode. |
| 14 | EXT2_ACT | 1 | Control is in EXT2 mode. |
| | | 0 | Control is in EXT1 mode. |
| 15 | FAULT | 1 | Drive is in a fault state. |
| | | 0 | Drive is not in a fault state. |

| DCU profile STATUS WORD (See parameter 0304) | | | |
|---|--------------|--------------|--|
| Bit | Name | Value | Status |
| 16 | ALARM | 1 | An alarm is on. |
| | | 0 | No alarms are on. |
| 17 | REQ_MAINT | 1 | A maintenance request is pending. |
| | | 0 | No maintenance request is pending. |
| 18 | DIRLOCK | 1 | Direction lock is ON. (Direction change is locked out.) |
| | | 0 | Direction lock is OFF. |
| 19 | LOCALLOCK | 1 | Local mode lock is ON. (Local mode is locked out.) |
| | | 0 | Local mode lock is OFF. |
| 20 | CTL_MODE | 1 | Drive is in vector control mode. |
| | | 0 | Drive is in scalar control mode. |
| 21...25 | Reserved | | |
| 26 | REQ_CTL | 1 | Copy the control word |
| | | 0 | (no op) |
| 27 | REQ_REF1 | 1 | Reference 1 requested in this channel. |
| | | 0 | Reference 1 is not requested in this channel. |
| 28 | REQ_REF2 | 1 | Reference 2 requested in this channel. |
| | | 0 | Reference 2 is not requested in this channel. |
| 29 | REQ_REF2EXT | 1 | External PID reference 2 requested in this channel. |
| | | 0 | External PID reference 2 is not requested in this channel. |
| 30 | ACK_STARTINH | 1 | A start inhibit from this channel is granted. |
| | | 0 | A start inhibit from this channel is not granted. |
| 31 | ACK_OFF_ILCK | 1 | Start inhibit due to OFF button |
| | | 0 | Normal operation |

State diagram

ABB Drives profile

To illustrate the operation of the state diagram, the following example (ABB DRV LIM implementation of the ABB Drives profile) uses the control word to start the drive:

- First, the requirements for using the CONTROL WORD must be met. See above.
- When the power is first connected, the state of the drive is not ready to switch on. See dotted lined path (---) in the state diagram below.
- Use the CONTROL WORD to step through the state machine states until the OPERATING state is reached, meaning that the drive is running and follows the given reference. See the table below.

| Step | CONTROL WORD Value | Description |
|------|---|---|
| 1 | CW = 0000 0000 0000 0110 bit 15 bit 0 | This CW value changes the drive state to READY TO SWITCH ON. |
| 2 | | Wait at least 100 ms before proceeding. |
| 3 | CW = 0000 0000 0000 0111 | This CW value changes the drive state to READY TO OPERATE. |
| 4 | CW = 0000 0000 0000 1111 | This CW value changes the drive state to OPERATION ENABLED. The drive starts, but will not accelerate. |
| 5 | CW = 0000 0000 0010 1111 | This CW value releases the ramp function generator (RFG) output and changes the drive state to RFG: ACCELERATOR ENABLED. |
| 6 | CW = 0000 0000 0110 1111 | This CW value releases the ramp function generator (RFG) output and changes the drive state to OPERATING. The drive accelerates to the given reference and follows the reference. |

The state diagram below describes the start-stop function of CONTROL WORD (CW) and STATUS WORD (SW) bits for the ABB Drives profile.

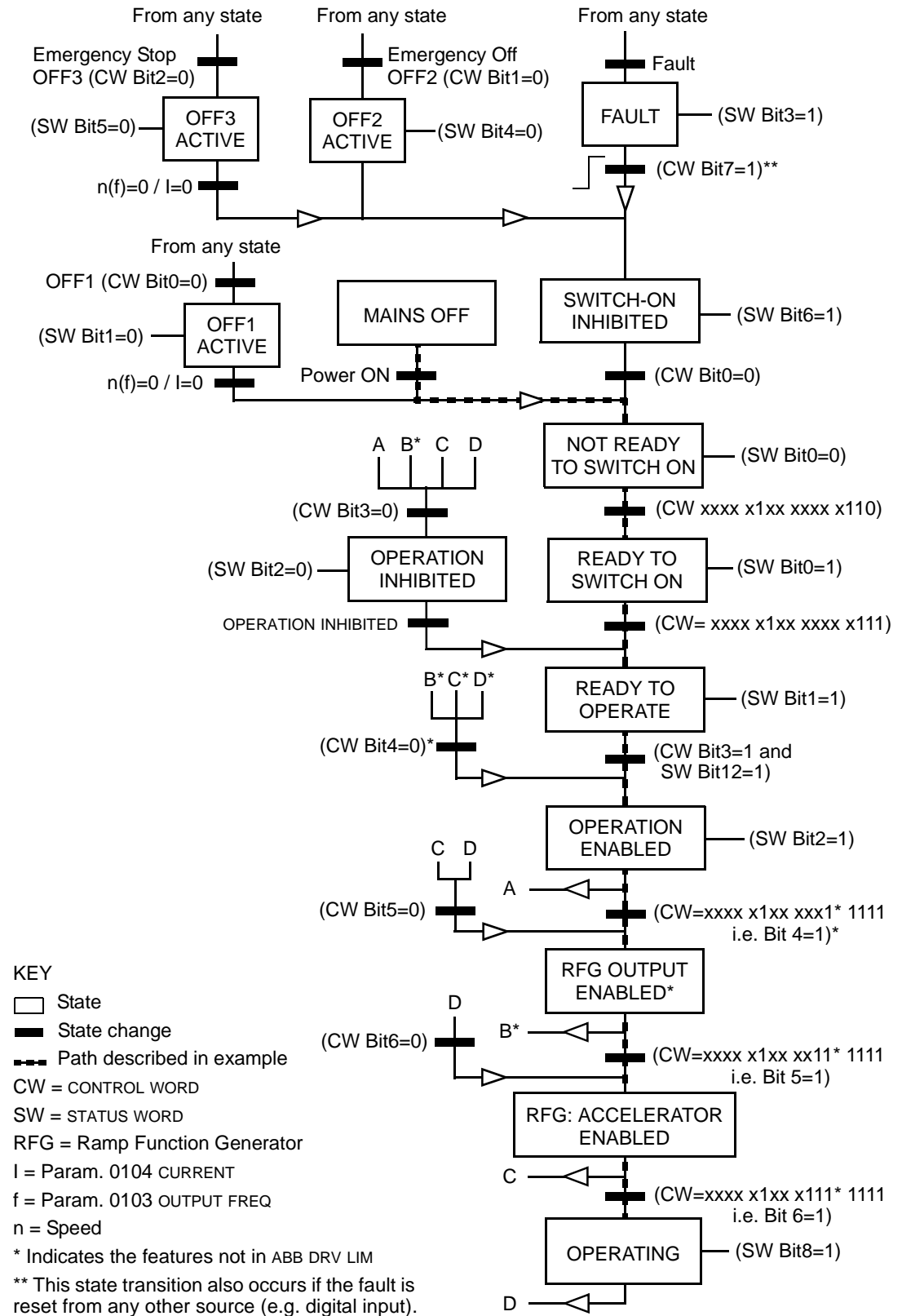

Reference scaling

ABB Drives and DCU profiles

The following table describes REFERENCE scaling for the ABB Drives and DCU profiles.

| ABB Drives and DCU profiles | | | | |
|-----------------------------|-------------------------|--------------------|---|---|
| Reference | Range | Reference type | Scaling | Remarks |
| REF1 | -32767 ... +32767 | Speed or frequency | -20000 = -(par. 1105) 0 = 0 +20000 = (par. 1105) (20000 corresponds to 100%) | Final reference limited by 1104/1105. Actual motor speed limited by 2001/2002 (speed) or 2007/2008 (frequency). |
| REF2 | -32767 ... +32767 | Speed or frequency | -10000 = -(par. 1108) 0 = 0 +10000 = (par. 1108) (10000 corresponds to 100%) | Final reference limited by 1107/1108. Actual motor speed limited by 2001/2002 (speed) or 2007/2008 (frequency). |
| | | Torque | -10000 = -(par. 1108) 0 = 0 +10000 = (par. 1108) (10000 corresponds to 100%) | Final reference limited by 2015/2017 (torque1) or 2016/2018 (torque2). |
| | | PID Reference | -10000 = -(par. 1108) 0 = 0 +10000 = (par. 1108) (10000 corresponds to 100%) | Final reference limited by 4012/4013 (PID set1) or 4112/4113 (PID set2). |

Note: The setting of parameter 1104 REF1 MIN and 1107 REF2 MIN has no effect on the scaling of references.

When parameter 1103 REF1 SELECT or 1106 REF2 SELECT is set to COMM+AI1 or COMM*AI1, the reference is scaled as follows:

| ABB Drives and DCU profiles | | |
|-----------------------------|---------------|--|
| Reference | Value setting | AI reference scaling |
| REF1 | COMM+AI1 | $\text{COMM (\%)} + (\text{AI (\%)} - 0.5 \cdot \text{REF1 MAX (\%)})$ |

| ABB Drives and DCU profiles | | |
|-----------------------------|---------------|--|
| Reference | Value setting | AI reference scaling |
| REF1 | COMM*AI1 | $\text{COMM (\%)} \cdot (\text{AI (\%)} / 0.5 \cdot \text{REF1 MAX (\%)})$ <p>Fieldbus reference correction coefficient</p> <p>200%</p> <p>100%</p> <p>0%</p> <p>0% 50% 100%</p> <p>AI1 input signal</p> <p>$(100 - 0.5 \cdot (\text{par. 1105}))\%$</p> |
| REF2 | COMM+AI1 | $\text{COMM (\%)} + (\text{AI (\%)} - 0.5 \cdot \text{REF2 MAX (\%)})$ <p>Fieldbus reference correction coefficient</p> <p>$(100 + 0.5 \cdot (\text{Par. 1108}))\%$</p> <p>100%</p> <p>0%</p> <p>0% 50% 100%</p> <p>AI1 input signal</p> <p>$(100 - 0.5 \cdot (\text{par. 1108}))\%$</p> |
| REF2 | COMM*AI1 | $\text{COMM (\%)} \cdot (\text{AI (\%)} / 0.5 \cdot \text{REF2 MAX (\%)})$ <p>Fieldbus reference correction coefficient</p> <p>200%</p> <p>100%</p> <p>0%</p> <p>0% 50% 100%</p> <p>AI1 input signal</p> |

Reference handling

Use *Group 10: START/STOP/DIR* parameters to configure for control of rotation direction for each control location (EXT1 and EXT2). The following diagrams illustrate how group 10 parameters and the sign of the fieldbus reference interact to produce REFERENCE values (REF1 and REF2). Note, fieldbus references are bipolar, that is they can be positive or negative.

| ABB Drives profile | | |
|--------------------|---------------|---|
| Parameter | Value setting | AI reference scaling |
| 1003 DIRECTION | 1 (FORWARD) | <p>Max. ref</p> <p>Fieldbus reference</p> <p>-163% -100%</p> <p>100% 163%</p> <p>-(Max. ref.)</p> <p>Resultant ref.</p> |
| 1003 DIRECTION | 2 (REVERSE) | <p>Max. ref</p> <p>Fieldbus reference</p> <p>-163% -100%</p> <p>100% 163%</p> <p>-(Max. ref.)</p> <p>Resultant ref.</p> |
| 1003 DIRECTION | 3 (REQUEST) | <p>Max. ref</p> <p>Fieldbus reference</p> <p>-163% -100%</p> <p>100% 163%</p> <p>-(Max. ref.)</p> <p>Resultant ref.</p> |

Fieldbus adapter

Overview

The ACS550 can be set up to accept control from an external system using standard serial communication protocols. When using serial communication, the ACS550 can either:

- receive all of its control information from the fieldbus, or
- be controlled from some combination of fieldbus control and other available control locations, such as digital or analog inputs and the control panel.

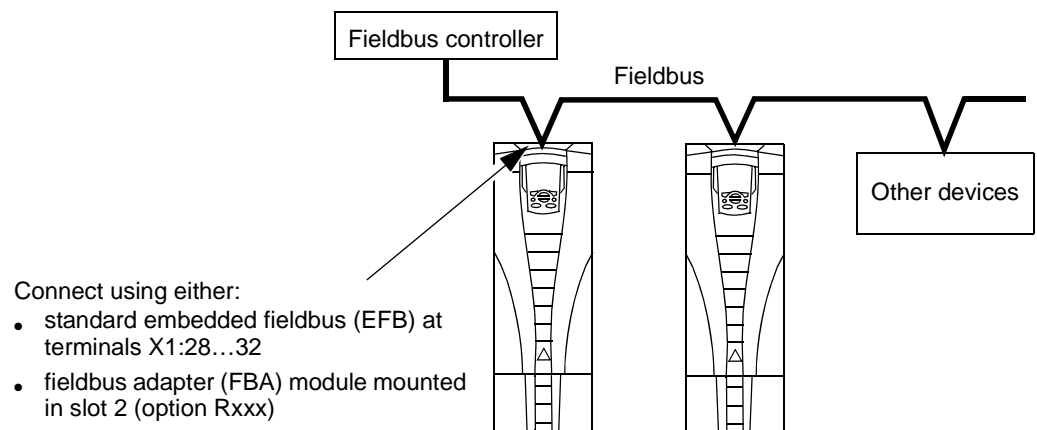

Two basic serial communications configurations are available:

- embedded fieldbus (EFB) – See chapter [Embedded fieldbus](#) on page 219.
- fieldbus adapter (FBA) – With one of the optional FBA modules in the drive's expansion slot 2, the drive can communicate to a control system using one of the following protocols:
 - PROFIBUS DP®
 - LonWorks®
 - Ethernet (Modbus/TCP®, Ethernet/IP®)
 - CANopen®
 - DeviceNet®
 - ControlNet®.

The ACS550 detects automatically which communication protocol is used by the plug-in fieldbus adapter. The default settings for each protocol assume that the profile used is the protocol's industry-standard drive profile (e.g. PROFIdrive for PROFIBUS, AC/DC Drive for DeviceNet). All of the FBA protocols can also be configured for the ABB Drives profile.

Configuration details depend on the protocol and profile used. These details are provided in a user's manual supplied with the FBA module.

Details for the ABB Drives profile (which apply for all protocols) are provided in section [ABB Drives profile technical data](#) on page 262.

Control interface

In general, the basic control interface between the fieldbus system and the drive consists of:

- Output Words:
 - CONTROL WORD
 - REFERENCE (speed or frequency)
 - Others: The drive supports a maximum of 15 output words. Protocols limits may further restrict the total.
- Input Words:
 - STATUS WORD
 - Actual Value (speed or frequency)
 - Others: The drive supports a maximum of 15 input words. Protocols limits may further restrict the total.

Note: The words “output” and “input” are used as seen from the fieldbus controller point of view. For example an output describes data flow from the fieldbus controller to the drive and appears as an input from the drive point of view.

The meanings of the controller interface words are not restricted by the ACS550. However, the profile used may set particular meanings.

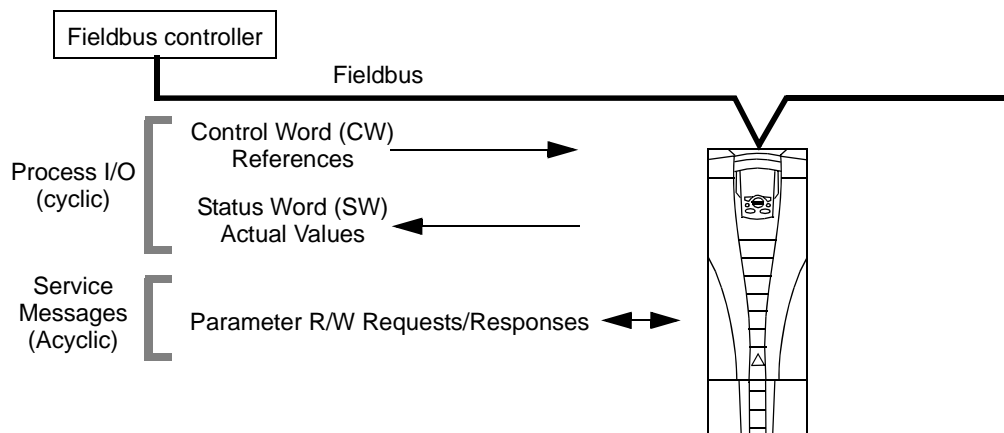

Control Word

The CONTROL WORD is the principal means for controlling the drive from a fieldbus system. The fieldbus controller sends the CONTROL WORD to the drive. The drive switches between states according to the bit-coded instructions in the CONTROL WORD. Using the CONTROL WORD requires that:

- The drive is in remote (REM) control.

- The serial communication channel is defined as the source for controlling commands from EXT1 (set using parameters 1001 EXT1 COMMANDS and 1102 EXT1/EXT2 SEL).
- The external plug-in fieldbus adapter is activated:
 - Parameter 9802 COMM PROT SEL = 4 (EXT FBA).
 - The external plug-in fieldbus adapter is configured to use the drive profile mode or drive profile objects.

The content of the CONTROL WORD depends on the protocol/profile used. See the user's manual provided with the FBA module and/or section [ABB Drives profile technical data](#) on page 262.

Status Word

The STATUS WORD is a 16-bit word containing status information, sent by the drive to the fieldbus controller. The content of the STATUS WORD depends on the protocol/profile used. See the user's manual provided with the FBA module and/or section [ABB Drives profile technical data](#) on page 262.

Reference

The contents of each REFERENCE word:

- can be used, as speed or frequency reference
- is a 16-bit word comprised of a sign bit and a 15-bit integer
- Negative references (indicating reversed rotation direction) are indicated by the two's complement of the corresponding positive reference value.

The use of a second reference (REF2) is supported only when a protocol is configured for the ABB Drives profile.

Reference scaling is fieldbus type specific. See the user's manual provided with the FBA module and/or the following sections as appropriate:

- [Reference scaling](#) on page 266 ([ABB Drives profile technical data](#))
- [Reference scaling](#) on page 270 ([Generic profile technical data](#)).

Actual Values

Actual Values are 16-bit words containing information on selected operations of the drive. Drive Actual Values (for example, [Group 10: START/STOP/DIR](#) parameters) can be mapped to Input Words using [Group 51: EXT COMM MODULE](#) parameters (protocol-dependent, but typically parameters 5104...5126).

Planning

Network planning should address the following questions:

- What types and quantities of devices must be connected to the network?
- What control information must be sent down to the drives?
- What feedback information must be sent from the drives to the controlling system?

Mechanical and electrical installation – FBA



WARNING! Connections should be made only while the drive is disconnected from the power source.

Overview

The FBA (fieldbus adapter) is a plug-in module that fits in the drive's expansion slot 2. The module is held in place with plastic retaining clips and two screws. The screws also ground the shield for the module cable and connect the module GND signals to the drive control board.

On installation of the module, electrical connection to the drive is automatically established through the 34-pin connector.

Mounting procedure

Note: Install the input power and motor cables first.

1. Insert the module carefully into the drive expansion slot 2 until the retaining clips lock the module into position.
2. Fasten the two screws (included) to the stand-offs.

Note: Correct installation of the screws is essential for fulfilling the EMC requirements and for proper operation of the module.

3. Open the appropriate knockout in the conduit box and install the cable clamp for the network cable.
4. Route the network cable through the cable clamp.
5. Connect the network cable to the module's network connector.
6. Tighten the cable clamp.
7. Install the conduit box cover (1 screw).
8. For configuration information see the following:
 - section [Communication set-up – FBA](#) on page 255
 - section [Activate drive control functions – FBA](#) on page 255
 - The protocol specific documentation provided with the module.

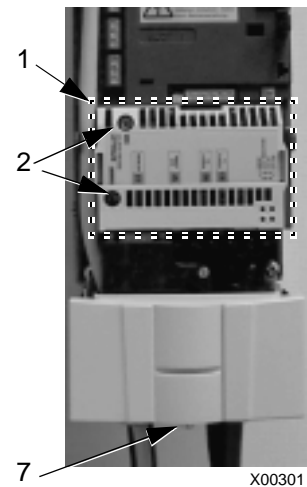

X00301

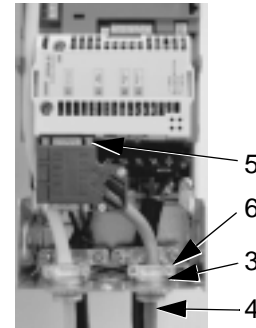

X00302

Communication set-up – FBA

Serial communication selection

To activate the serial communication, use parameter 9802 COMM PROT SEL. Set 9802 = 4 (EXT FBA).

Serial communication configuration

Setting 9802, together with mounting a particular FBA module, automatically sets the appropriate default values in parameters that define the communication process. These parameters and descriptions are defined in the user's manual supplied with the FBA module.

- Parameter 5101 is automatically configured.
- Parameters 5102...5126 are protocol-dependent and define, for example, the profile used and additional I/O words. These parameters are referred to as the fieldbus configuration parameters. See the user's manual provided with the FBA module for details on the fieldbus configuration parameters.
- Parameter 5127 forces the validation of changes to parameters 5102...5126. If parameter 5127 is not used, changes to parameters 5102...5126 take affect only after the drive power is cycled.
- Parameters 5128...5133 provide data about the FBA module currently installed (e.g. component versions and status).

See [Group 51: EXT COMM MODULE](#) for parameter descriptions.

Activate drive control functions – FBA

Fieldbus control of various drive functions requires configuration to:

- tell the drive to accept fieldbus control of the function
- define as a fieldbus input, any drive data required for control
- define as a fieldbus output, any control data required by the drive.

The following sections describe, at a general level, the configuration required for each control function. The last column in each table below is deliberately blank. See the user's manual supplied with the FBA module for the appropriate entry.

Start/Stop Direction control

Using the fieldbus for start/stop/direction control of the drive requires:

- drive parameter values set as defined below
- fieldbus controller supplied command(s) in the appropriate location. (The location is defined by the Protocol Reference, which is protocol dependent.)

| Drive parameter | | Value | Description | Protocol reference |
|-----------------|------------------|-----------|---|--------------------|
| 1001 | EXT1 COMMANDS | 10 (COMM) | Start/Stop controlled by fieldbus with Ext1 selected. | |

| Drive parameter | | Value | Description | Protocol reference |
|-----------------|---------------|-------------|---|--------------------|
| 1002 | EXT2 COMMANDS | 10 (COMM) | Start/Stop by controlled fieldbus with Ext2 selected. | |
| 1003 | DIRECTION | 3 (REQUEST) | Direction controlled by fieldbus. | |

Input reference select

Using the fieldbus to provide input reference to the drive requires:

- drive parameter value set as defined below
- fieldbus controller supplied reference word(s) in the appropriate location. (The location is defined by the Protocol Reference, which is protocol dependent.)

| Drive parameter | | Value | Description | Protocol reference |
|-----------------|---------------|---|--|--------------------|
| 1102 | EXT1/EXT2 SEL | 8 (COMM) | Ref. selected by fieldbus. (Required only if 2 references used.) | |
| 1103 | REF1 SELECT | 8 (COMM) 9 (COMM+AI1) 10 (COMM*AI1) | Input reference 1 supplied by fieldbus. | |
| 1106 | REF2 SELECT | 8 (COMM) 9 (COMM+AI) 10 (COMM*AI) | Input reference 2 supplied by fieldbus. (Required only if 2 references used.) | |

Note: Multiple references are supported only when using the ABB Drives profile.

Scaling

Where required, REFERENCES can be scaled. See the following sections, as appropriate:

- [Reference scaling](#) on page 266 (*ABB Drives profile technical data*)
- [Reference scaling](#) on page 270 (*Generic profile technical data*).

System control

Using the fieldbus for miscellaneous drive control requires:

- drive parameter values set as defined below
- fieldbus controller command(s) in the appropriate location. (The location is defined by the Protocol Reference, which is protocol dependent.)

| Drive parameter | | Value | Description | Protocol reference |
|-----------------|-----------------|----------|---|--------------------|
| 1601 | RUN ENABLE | 7 (COMM) | Run enable by fieldbus. | |
| 1604 | FAULT RESET SEL | 8 (COMM) | Fault reset by fieldbus. | |
| 1607 | PARAM SAVE | 1 (SAVE) | Saves altered parameters to memory (then value returns to 0). | |

Relay output control

Using the fieldbus for relay output control requires:

- drive parameter values set as defined below
- fieldbus controller supplied, binary coded, relay command(s) in the appropriate location. (The location is defined by the Protocol Reference, which is protocol dependent.)

| Drive parameter | | Value | Description | Protocol reference |
|-------------------|----------------|---------------|--|--------------------|
| 1401 | RELAY OUTPUT 1 | 35 (COMM) | Relay Output 1 controlled by fieldbus. | |
| 1402 | RELAY OUTPUT 2 | 36 (COMM(-1)) | Relay Output 2 controlled by fieldbus. | |
| 1403 | RELAY OUTPUT 3 | | Relay Output 3 controlled by fieldbus. | |
| 1410 ¹ | RELAY OUTPUT 4 | | Relay Output 4 controlled by fieldbus. | |
| 1411 ¹ | RELAY OUTPUT 5 | | Relay Output 5 controlled by fieldbus. | |
| 1412 ¹ | RELAY OUTPUT 6 | | Relay Output 6 controlled by fieldbus. | |

¹ More than 3 relays requires the addition of a relay extension module.

Note: Relay status feedback occurs without configuration as defined below.

| Drive parameter | | Value | Protocol reference |
|-----------------|---------------|---------------------|--------------------|
| 0122 | RO 1-3 STATUS | Relay 1...3 status. | |
| 0123 | RO 4-6 STATUS | Relay 4...6 status. | |

Analog output control

Using the fieldbus for analog output control (e.g. PID setpoint) requires:

- drive parameter values set as defined below
- fieldbus controller supplied analog value(s) in the appropriate location. (The location is defined by the Protocol Reference, which is protocol dependent.)

| Drive parameter | | Value | Description | Protocol reference |
|---------------------|---------------------------------------|-------------------------|--|--------------------|
| 1501 | AO1 CONTENT SEL | 135 (COMM VALUE 1) | Analog Output 1 controlled by writing to parameter 0135. | – |
| 0135 | COMM VALUE 1 | – | | |
| 1502 ... 1505 | AO1 CONTENT MIN ... MAXIMUM AO1 | Set appropriate values. | Used for scaling | – |
| 1506 | FILTER AO1 | | Filter time constant for AO1. | |
| 1507 | AO2 CONTENT SEL | | 136 (COMM VALUE 2) | |
| 0136 | COMM VALUE 2 | – | | |
| 1508 ... 1511 | AO2 CONTENT MIN ... MAXIMUM AO2 | Set appropriate values. | Used for scaling | – |
| 1512 | FILTER AO2 | | Filter time constant for AO2. | |

PID Control setpoint source

Using the following settings to select the fieldbus as the setpoint source for PID loops:

| Drive parameter | | Value | Setting | Protocol reference |
|-----------------|--------------------------|------------------|---|--------------------|
| 4010 | SET POINT SEL (Set 1) | 8 (COMM VALUE 1) | Setpoint is input reference 2 (+/-/* AI1) | |
| 4110 | SET POINT SEL (Set 2) | 9 (COMM+AI1) | | |
| 4210 | SET POINT SEL (Ext/Trim) | 10 (COMM*AI1) | | |

Communication fault

When using fieldbus control, specify the drive's action if serial communication is lost.

| Drive parameter | | Value | Description |
|-----------------|-----------------|---|-------------------------------------|
| 3018 | COMM FAULT FUNC | 0 (NOT SEL) 1 (FAULT) 2 (CONST SP7) 3 (LAST SPEED) | Set for appropriate drive response. |
| 3019 | COMM FAULT TIME | Set time delay before acting on a communication loss. | |

Feedback from the drive – FBA

Inputs to the controller (drive outputs) have pre-defined meanings established by the protocol. This feedback does not require drive configuration. The following table lists a sample of feedback data. For a complete listing, see all parameters listed in section [Complete parameter descriptions](#) on page 128.

| Drive parameter | | Protocol reference |
|-----------------|------------------------------|--------------------|
| 0102 | SPEED | |
| 0103 | OUTPUT FREQ | |
| 0104 | CURRENT | |
| 0105 | TORQUE | |
| 0106 | POWER | |
| 0107 | DC BUS VOLTAGE | |
| 0109 | OUTPUT VOLTAGE | |
| 0301 | FB CMD WORD 1 – bit 0 (STOP) | |
| 0301 | FB CMD WORD 1 – bit 2 (REV) | |
| 0118 | DI 1-3 STATUS – bit 0 (DI3) | |

Scaling

To scale the drive parameter values see the following sections, as appropriate:

- [Actual Value scaling](#) on page 269 (*ABB Drives profile technical data*)
- [Actual Value scaling](#) on page 271 (*Generic profile technical data*).

Diagnostics – FBA

Fault handling

The ACS550 provides fault information as follows:

- The control panel display shows a fault code and text. See chapter [Diagnostics](#) on page 273 for a complete description.
- Parameters 0401 LAST FAULT, 0412 PREVIOUS FAULT1 and 0413 PREVIOUS FAULT2 store the most recent faults.
- For fieldbus access, the drive reports faults as a hexadecimal value, assigned and coded according to the DRIVECOM specification. See the table below. Not all profiles support requesting fault codes using this specification. For profiles that support this specification, the profile documentation defines the proper fault request process.

| Drive fault code | | Fieldbus fault code (DRIVECOM specification) |
|------------------|--------------|--|
| 1 | OVERCURRENT | 2310h |
| 2 | DC OVERVOLT | 3210h |
| 3 | DEV OVERTEMP | 4210h |
| 4 | SHORT CIRC | 2340h |
| 5 | Reserved | FF6Bh |
| 6 | DC UNDERVOLT | 3220h |
| 7 | AI1 LOSS | 8110h |
| 8 | AI2 LOSS | 8110h |
| 9 | MOT OVERTEMP | 4310h |
| 10 | PANEL LOSS | 5300h |
| 11 | ID RUN FAIL | FF84h |
| 12 | MOTOR STALL | 7121h |
| 14 | EXT FAULT 1 | 9000h |
| 15 | EXT FAULT 2 | 9001h |
| 16 | EARTH FAULT | 2330h |
| 17 | Obsolete | FF6Ah |
| 18 | THERM FAIL | 5210h |
| 19 | OPEX LINK | 7500h |
| 20 | OPEX PWR | 5414h |
| 21 | CURR MEAS | 2211h |
| 22 | SUPPLY PHASE | 3130h |
| 23 | ENCODER ERR | 7301h |
| 24 | OVERSPEED | 7310h |
| 25 | Reserved | FF80h |
| 26 | DRIVE ID | 5400h |

| Drive fault code | | Fieldbus fault code (DRIVECOM specification) |
|------------------|----------------------|--|
| 27 | CONFIG FILE | 630Fh |
| 28 | SERIAL 1 ERR | 7510h |
| 29 | EFB CON FILE | 6306h |
| 30 | FORCE TRIP | FF90h |
| 31 | EFB 1 | FF92h |
| 32 | EFB 2 | FF93h |
| 33 | EFB 3 | FF94h |
| 34 | MOTOR PHASE | FF56h |
| 35 | OUTP WIRING | FF95h |
| 36 | INCOMPATIBLE SW | 630Fh |
| 37 | CB OVERTEMP | 4110h |
| 38 | USER LOAD CURVE | FF6Bh |
| 101 | SERF CORRUPT | FF55h |
| 102 | Reserved | FF55h |
| 103 | SERF MACRO | FF55h |
| 104 | Reserved | FF55h |
| 105 | Reserved | FF55h |
| 201 | DSP T1 OVERLOAD | 6100h |
| 202 | DSP T2 OVERLOAD | 6100h |
| 203 | DSP T3 OVERLOAD | 6100h |
| 204 | DSP STACK ERROR | 6100h |
| 205 | Reserved (obsolete) | 5000h |
| 206 | CB ID ERROR | 5000h |
| 207 | EFB LOAD ERROR | 6100h |
| 1000 | PAR HZRPM | 6320h |
| 1001 | PAR PFC REF NEG | 6320h |
| 1002 | Reserved (obsolete) | 6320h |
| 1003 | PAR AI SCALE | 6320h |
| 1004 | PAR AO SCALE | 6320h |
| 1005 | PAR PCU 2 | 6320h |
| 1006 | PAR EXT RO | 6320h |
| 1007 | PAR FIELDBUS MISSING | 6320h |
| 1008 | PAR PFC MODE | 6320h |
| 1009 | PAR PCU 1 | 6320h |
| 1012 | PAR PFC IO 1 | 6320h |
| 1013 | PAR PFC IO 2 | 6320h |
| 1014 | PAR PFC IO 3 | 6320h |
| 1016 | PAR USER LOAD C | 6320h |

Serial communication diagnostics

Besides the drive fault codes, the FBA module has diagnostic tools. Refer to the user's manual supplied with the FBA module.

ABB Drives profile technical data

Overview

The ABB Drives profile provides a standard profile that can be used on multiple protocols, including protocols available on the FBA module. This section describes the ABB Drives profile implemented for FBA modules.

Control Word

As described earlier in section [Control interface](#) on page 252, the CONTROL WORD is the principal means for controlling the drive from a fieldbus system.

The following table and the state diagram later in this sub-section describe the CONTROL WORD content for the ABB Drives profile.

| ABB Drives profile (FBA) CONTROL WORD | | | | |
|---------------------------------------|-------------------|-------|---------------------|---|
| Bit | Name | Value | Commanded state | Comments |
| 0 | OFF1 CONTROL | 1 | READY TO OPERATE | Enter READY TO OPERATE |
| | | 0 | EMERGENCY OFF | Drive ramps to stop according to currently active deceleration ramp (2203 or 2205) Normal command sequence: <ul style="list-style-type: none"> • Enter OFF1 ACTIVE • Proceed to READY TO SWITCH ON, unless other interlocks (OFF2, OFF3) are active. |
| 1 | OFF2 CONTROL | 1 | OPERATING | Continue operation (OFF2 inactive) |
| | | 0 | EMERGENCY OFF | Drive coasts to stop. Normal command sequence: <ul style="list-style-type: none"> • Enter OFF2 ACTIVE • Proceed to SWITCHON INHIBITED |
| 2 | OFF3 CONTROL | 1 | OPERATING | Continue operation (OFF3 inactive) |
| | | 0 | EMERGENCY STOP | Drive stops within in time specified by parameter 2208. Normal command sequence: <ul style="list-style-type: none"> • Enter OFF3 ACTIVE • Proceed to SWITCH ON INHIBITED  WARNING! Be sure motor and driven equipment can be stopped using this mode. |
| 3 | INHIBIT OPERATION | 1 | OPERATION ENABLED | Enter OPERATION ENABLED (Note the Run enable signal must be active. See 1601. If 1601 is set to COMM, this bit also activates the Run Enable signal.) |
| | | 0 | OPERATION INHIBITED | Inhibit operation. Enter OPERATION INHIBITED |
| 4 | RAMP_OUT_ZERO | 1 | NORMAL OPERATION | Enter RAMP FUNCTION GENERATOR: ACCELERATION ENABLED |
| | | 0 | RFG OUT ZERO | Force ramp function generator output to Zero. Drive ramps to stop (current and DC voltage limits in force). |

| ABB Drives profile (FBA) CONTROL WORD | | | | |
|---------------------------------------|--------------|-------|-------------------|---|
| Bit | Name | Value | Commanded state | Comments |
| 5 | RAMP_HOLD | 1 | RFG OUT ENABLED | Enable ramp function. Enter RAMP FUNCTION GENERATOR: ACCELERATOR ENABLED |
| | | 0 | RFG OUT HOLD | Halt ramping (Ramp Function Generator output held) |
| 6 | RAMP_IN_ZERO | 1 | RFG INPUT ENABLED | Normal operation. Enter OPERATING |
| | | 0 | RFG INPUT ZERO | Force Ramp Function Generator input to zero. |
| 7 | RESET | 0=>1 | RESET | Fault reset if an active fault exists (Enter SWITCH-ON INHIBITED). Effective if 1604 = COMM. |
| | | 0 | OPERATING | Continue normal operation |
| 8...9 | Unused | | | |
| 10 | REMOTE_CMD | 1 | | Fieldbus control enabled |
| | | 0 | | <ul style="list-style-type: none"> CW ≠ 0 or Ref ≠ 0: Retain last CW and Ref. CW = 0 and Ref = 0: Fieldbus control enabled. Ref and deceleration/acceleration ramp are locked. |
| 11 | EXT CTRL LOC | 1 | EXT2 SELECT | Select external control location 2 (EXT2). Effective if 1102 = COMM. |
| | | 0 | EXT1 SELECT | Select external control location 1 (EXT1). Effective if 1102 = COMM. |
| 12...15 | Unused | | | |

Status Word

As described earlier in section [Control interface](#) on page 252, the contents of the STATUS WORD is status information, sent by the drive to the master station. The following table and the state diagram later in this sub-section describe the status word content.

| ABB Drives profile (FBA) STATUS WORD | | | |
|--------------------------------------|---------|-------|--|
| Bit | Name | Value | Description (Correspond to states/boxes in the state diagram) |
| 0 | RDY_ON | 1 | READY TO SWITCH ON |
| | | 0 | NOT READY TO SWITCH ON |
| 1 | RDY_RUN | 1 | READY TO OPERATE |
| | | 0 | OFF1 ACTIVE |
| 2 | RDY_REF | 1 | OPERATION ENABLED |
| | | 0 | OPERATION INHIBITED |
| 3 | TRIPPED | 0...1 | FAULT |
| | | 0 | No fault |

| ABB Drives profile (FBA) STATUS WORD | | | |
|--------------------------------------|----------------|-------|--|
| Bit | Name | Value | Description (Correspond to states/boxes in the state diagram) |
| 4 | OFF_2_STA | 1 | OFF2 inactive |
| | | 0 | OFF2 ACTIVE |
| 5 | OFF_3_STA | 1 | OFF3 inactive |
| | | 0 | OFF3 ACTIVE |
| 6 | SWC_ON_INHIB | 1 | SWITCH-ON INHIBIT ACTIVE |
| | | 0 | SWITCH-ON INHIBIT NOT ACTIVE |
| 7 | ALARM | 1 | Alarm (See section Alarm listing on page 280 for details on alarms.) |
| | | 0 | No alarm |
| 8 | AT_SETPOINT | 1 | OPERATING. Actual value equals (within tolerance limits) the reference value. |
| | | 0 | Actual value is outside tolerance limits (not equal to reference value). |
| 9 | REMOTE | 1 | Drive control location: REMOTE (EXT1 or EXT2) |
| | | 0 | Drive control location: LOCAL |
| 10 | ABOVE_LIMIT | 1 | Supervised parameter's value \geq supervision high limit. Bit remains "1" until supervised parameter's value < supervision low limit. See Group 32: SUPERVISION . |
| | | 0 | Supervised parameter's value < supervision low limit. Bit remains "0" until supervised parameter's value > supervision high limit. See Group 32: SUPERVISION . |
| 11 | EXT CTRL LOC | 1 | External control location 2 (EXT2) selected |
| | | 0 | External control location 1 (EXT1) selected |
| 12 | EXT RUN ENABLE | 1 | External Run Enable signal received |
| | | 0 | No External Run Enable signal received |
| 13... 15 | Unused | | |

The state diagram below describes the start-stop function of CONTROL WORD (CW) and STATUS WORD (SW) bits.

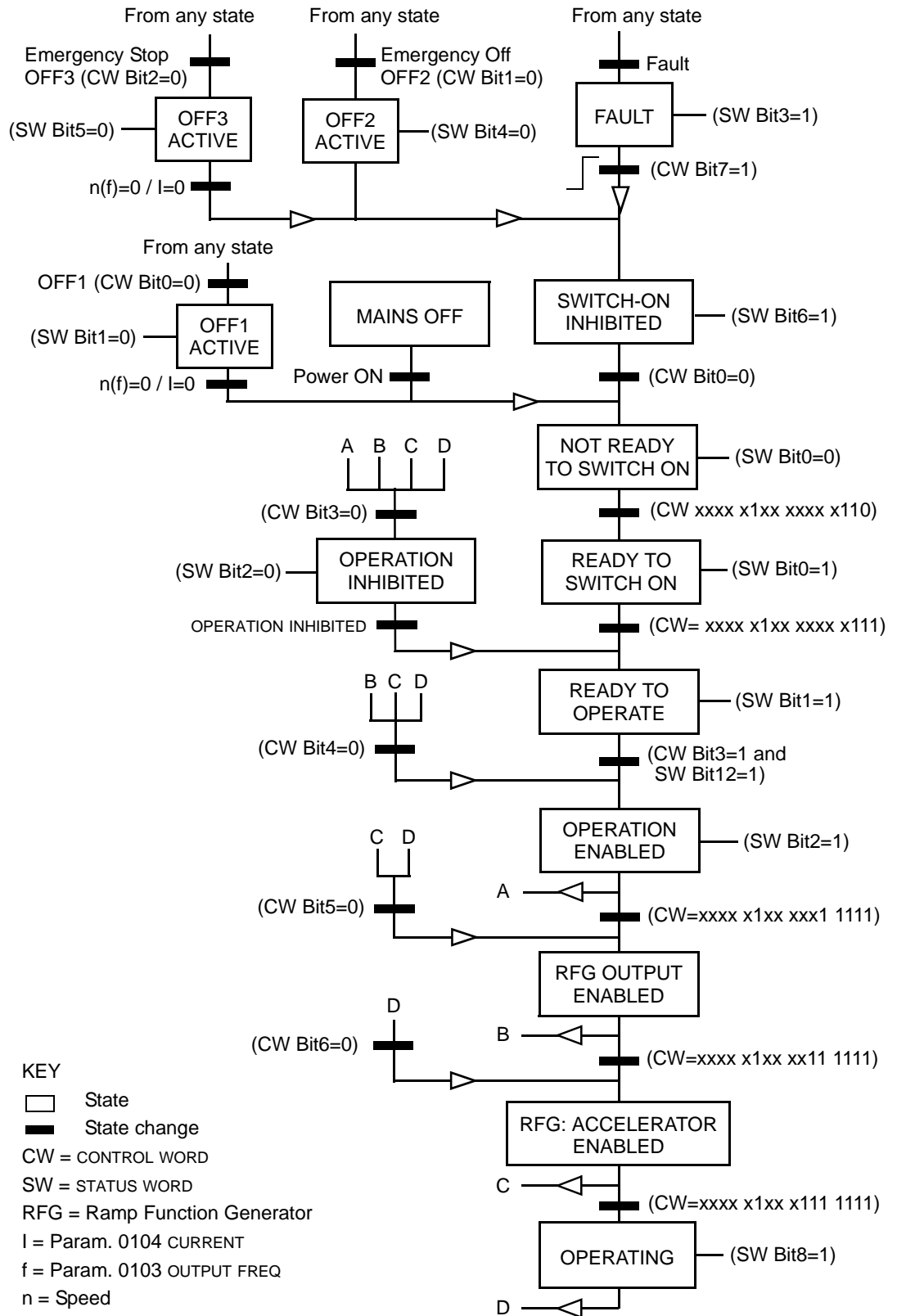

Reference

As described earlier in section *Control interface* on page 252, the REFERENCE word is a speed or frequency reference.

Reference scaling

The following table describes REFERENCE scaling for the ABB Drives profile.

| ABB Drives Profile (FBA) | | | | |
|--------------------------|---------------------|--------------------|---|---|
| Reference | Range | Reference type | Scaling | Remarks |
| REF1 | -32767... +32767 | Speed or frequency | -20000 = -(par. 1105) 0 = 0 +20000 = (par. 1105) (20000 corresponds to 100%) | Final reference limited by 1104/1105. Actual motor speed limited by 2001/2002 (speed) or 2007/2008 (frequency). |
| REF2 | -32767... +32767 | Speed or frequency | -10000 = -(par. 1108) 0 = 0 +10000 = (par. 1108) (10000 corresponds to 100%) | Final reference limited by 1107/1108. Actual motor speed limited by 2001/2002 (speed) or 2007/2008 (frequency). |
| | | Torque | -10000 = -(par. 1108) 0 = 0 +10000 = (par. 1108) (10000 corresponds to 100%) | Final reference limited by 2015/2017 (torque1) or 2016/2018 (torque2). |
| | | PID Reference | -10000 = -(par. 1108) 0 = 0 +10000 = (par. 1108) (10000 corresponds to 100%) | Final reference limited by 4012/4013 (PID set1) or 4112/4113 (PID set2). |

Note: The setting of parameter 1104 REF1 MIN and 1107 REF2 MIN has no effect on the scaling of references.

When parameter 1103 REF1 SELECT or 1106 REF2 SELECT is set to COMM+AI1 or COMM*AI1, the reference is scaled as follows:

| ABB Drives profile (FBA) | | |
|--------------------------|---------------|--|
| Reference | Value setting | AI reference scaling |
| REF1 | COMM+AI1 | $\text{COMM (\%)} + (\text{AI (\%)} - 0.5 \cdot \text{REF1 MAX (\%)})$ |

| ABB Drives profile (FBA) | | |
|--------------------------|---------------|--|
| Reference | Value setting | AI reference scaling |
| REF1 | COMM+AI1 | $\text{COMM (\%)} \cdot (\text{AI (\%)} / 0.5 \cdot \text{REF1 MAX (\%)})$ |
| REF2 | COMM+AI1 | $\text{COMM (\%)} + (\text{AI (\%)} - 0.5 \cdot \text{REF2 MAX (\%)})$ |
| REF2 | COMM*AI1 | $\text{COMM (\%)} \cdot (\text{AI (\%)} / 0.5 \cdot \text{REF2 MAX (\%)})$ |

Reference handling

Use [Group 10: START/STOP/DIR](#) parameters to configure for control of rotation direction for each control location (EXT1 and EXT2). The following diagrams illustrate how group 10 parameters and the sign of the fieldbus reference interact to produce REFERENCE values (REF1 and REF2). Note, fieldbus references are bipolar, that is they can be positive or negative.

| ABB Drives profile | | |
|--------------------|---------------|----------------------|
| Parameter | Value setting | AI reference scaling |
| 1003 DIRECTION | 1 (FORWARD) | |
| 1003 DIRECTION | 2 (REVERSE) | |
| 1003 DIRECTION | 3 (REQUEST) | |

Actual Value

As described earlier in section [Control interface](#) on page 252, Actual Values are words containing drive values.

Actual Value scaling

The scaling of the integers sent to the fieldbus as Actual Values depends on the resolution of the selected drive parameter. Except as noted for ACT1 and ACT2 below, scale the feedback integer using the resolution listed for the parameter in section [Complete parameter list](#) on page 115. For example:

| Feedback integer | Parameter resolution | Scaled Value |
|------------------|----------------------|---|
| 1 | 0.1 mA | $1 \cdot 0.1 \text{ mA} = 0.1 \text{ mA}$ |
| 10 | 0.1% | $10 \cdot 0.1\% = 1\%$ |

Data words 5 and 6 are scaled as follows:

| ABB Drives profile | | |
|--------------------|--------------|---|
| | Contents | Scaling |
| ACT1 | ACTUAL SPEED | $-20000 \dots +20000 = -(\text{par. 1105}) \dots +(\text{par. 1105})$ |
| ACT2 | TORQUE | $-10000 \dots +10000 = -100\% \dots +100\%$ |

Virtual addresses of the drive control

The virtual address area of the drive control is allocated as follows:

| | |
|---|-----------------------|
| 1 | Control Word |
| 2 | Reference 1 (REF1) |
| 3 | Reference 2 (REF2) |
| 4 | Status Word |
| 5 | Actual Value 1 (ACT1) |
| 6 | Actual Value 2 (ACT2) |

Generic profile technical data

Overview

The generic profile aims to fulfill the industry-standard drive profile for each protocol (e.g. PROFIdrive for PROFIBUS, AC/DC Drive for DeviceNet).

Control Word

As described earlier in section [Control interface](#) on page 252, the CONTROL WORD is the principal means for controlling the drive from a fieldbus system. For specific CONTROL WORD content, see the user's manual provided with the FBA module.

Status Word

As described earlier in section [Control interface](#) on page 252, the contents of the STATUS WORD is status information, sent by the drive to the master station. For specific STATUS WORD content, see the user's manual provided with the FBA module.

Reference

As described earlier in section [Control interface](#) on page 252, the REFERENCE word is a speed or frequency reference.

Note: REF2 is not supported by the Generic Drive profiles.

Reference scaling

REFERENCE scaling is fieldbus type specific. However, at the drive, the meaning of a 100% REFERENCE value is fixed as described in the table below. For a detailed description on the range and scaling of the REFERENCE, see the user's manual supplied with the FBA module.

| Generic profile | | | | |
|-----------------|-------------------|----------------|---|---|
| Reference | Range | Reference type | Scaling | Remarks |
| REF | Fieldbus specific | Speed | -100% = -(par. 9908) 0 = 0 +100 = (par. 9908) | Final reference limited by 1104/1105. Actual motor speed limited by 2001/2002 (speed). |
| | | Frequency | -100% = -(par. 9907) 0 = 0 +100 = (par. 9907) | Final reference limited by 1104/1105. Actual motor speed limited by 2007/2008 (frequency). |

Actual Values

As described earlier in section [Control interface](#) on page 252, Actual Values are words containing drive values.

Actual Value scaling

For Actual Values, scale the feedback integer using the parameter's resolution. (See section [Complete parameter list](#) on page 115 for parameter resolutions.) For example:

| Feedback integer | Parameter resolution | (Feedback integer) · (Parameter resolution) = Scaled Value |
|------------------|----------------------|--|
| 1 | 0.1 mA | 1 · 0.1 mA = 0.1 mA |
| 10 | 0.1% | 10 · 0.1% = 1% |

Where parameters are in percent, the [Complete parameter list](#) section specifies what parameter corresponds to 100%. In such cases, to convert from percent to engineering units, multiply by the value of the parameter that defines 100% and divide by 100%. For example:

| Feedback integer | Parameter resolution | Value of the parameter that defines 100% | (Feedback integer) · (Parameter resolution) · (Value of 100% ref.) / 100% = Scaled Value |
|------------------|----------------------|--|--|
| 10 | 0.1% | 1500 rpm ¹ | 10 · 0.1% · 1500 RPM / 100% = 15 rpm |
| 100 | 0.1% | 500 Hz ² | 100 · 0.1% · 500 Hz / 100% = 50 Hz |

¹ Assuming, for the sake of this example, that the Actual Value uses parameter 9908 MOT NOM SPEED as the 100% reference and that 9908 = 1500 rpm.

² Assuming, for the sake of this example, that the Actual Value uses parameter 9907 MOT NOM FREQ as the 100% reference and that 9907 = 500 Hz.

Actual Value mapping

See the user's manual supplied with the FBA module.

Diagnosics



WARNING! Do not attempt any measurement, parts replacement or other service procedure not described in this manual. Such action will void the warranty, may endanger correct operation and increase downtime and expense.



WARNING! All electrical installation and maintenance work described in this chapter should only be undertaken by qualified service personnel. The safety instructions in chapter [Safety](#) on page [5](#) must be followed.

Diagnostic displays

The drive detects error situations and reports them using:

- the green and red LED on the body of the drive
- the status LED on the control panel (if an Assistant Control Panel is attached to the drive)
- the control panel display (if a control panel is attached to the drive)
- the Fault Word and Alarm Word parameter bits (parameters 0305 to 0309). See [Group 03: FB ACTUAL SIGNALS](#) on page [134](#) for the bit definitions.

The form of the display depends on the severity of the error. You can specify the severity for many errors by directing the drive to:

- ignore the error situation
- report the situation as an alarm
- report the situation as a fault.

Red – Faults

The drive signals that it has detected a severe error, or fault, by:

- enabling the red LED on the drive (LED is either steady on or blinking)
- showing the steady red status LED on the control panel (if attached to the drive)
- setting an appropriate bit in a Fault Word parameter (0305 to 0307)
- overriding the control panel display with the display of a fault code in the Fault mode (figures on the right)
- stopping the motor (if it was on).

The fault code on the control panel display is temporary. Pressing any of the following keys removes the fault message: MENU, ENTER, UP, or DOWN key.

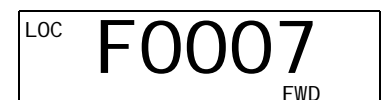
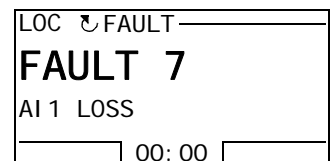

The message reappears after a few seconds if the control panel is not touched and the fault is still active.

Flashing green – Alarms

For less severe errors, called alarms, the diagnostic display is advisory. For these situations, the drive is simply reporting that it had detected something “unusual.” In these situations, the drive:

- flashes the green LED on the drive (does not apply to alarms that arise from control panel operation errors)
- flashes the green LED on the control panel (if attached to the drive)
- sets an appropriate bit in an Alarm Word parameter (0308 or 0309). See [Group 03: FB ACTUAL SIGNALS](#) on page 134 for the bit definitions
- overrides the control panel display with the display of an alarm code and/or name in the Fault mode (figures on the right).

Alarm messages disappear from the control panel display after a few seconds. The message returns periodically as long as the alarm condition exists.

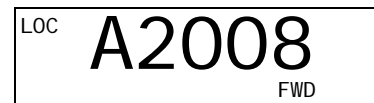
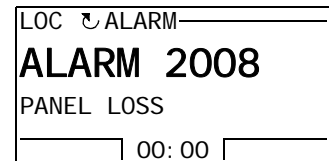

Correcting faults

The recommended corrective action for faults is:

- Use the table in section [Fault listing](#) below to find and address the root cause of the problem.
- Reset the drive. See section [Fault resetting](#) on page 279.

Fault listing

The following table lists the faults by code number and describes each. The fault name is the long form shown in the Fault mode of the Assistant Control Panel when the fault occurs. The fault names shown (for Assistant Control Panel only) in the Fault Logger mode (see page 85) and the fault names for parameter 0401 LAST FAULT may be shorter.

| Fault code | Fault name in panel | Description and recommended corrective action |
|------------|---------------------|---|
| 1 | OVERCURRENT | Output current is excessive. Check for and correct: <ul style="list-style-type: none"> • Excessive motor load. • Insufficient acceleration time (parameters 2202 ACCELER TIME 1 and 2205 ACCELER TIME 2). • Faulty motor, motor cables or connections. |

| Fault code | Fault name in panel | Description and recommended corrective action |
|------------|---------------------|---|
| 2 | DC OVERVOLT | Intermediate circuit DC voltage is excessive. Check for and correct: <ul style="list-style-type: none"> • Static or transient overvoltages in the input power supply. • Insufficient deceleration time (parameters 2203 DECELER TIME 1 and 2206 DECELER TIME 2). • Undersized brake chopper (if present). • Verify that overvoltage controller is ON (using parameter 2005). |
| 3 | DEV OVERTEMP | Drive heatsink is overheated. Temperature is at or above limit. R7 and R8: 115 °C (239 °F) Check for and correct: <ul style="list-style-type: none"> • Fan failure. • Obstructions in the air flow. • Dirt or dust coating on the heat sink. • Excessive ambient temperature. • Excessive motor load. |
| 4 | SHORT CIRC | Fault current. Check for and correct: <ul style="list-style-type: none"> • A short-circuit in the motor cable(s) or motor. • Supply disturbances. |
| 5 | RESERVED | Not used. |
| 6 | DC UNDERVOLT | Intermediate circuit DC voltage is not sufficient. Check for and correct: <ul style="list-style-type: none"> • Missing phase in the input power supply. • Blown fuse. • Undervoltage on mains. |
| 7 | AI1 LOSS | Analog input 1 loss. Analog input value is less than AI1 FAULT LIMIT (3021). Check for and correct: <ul style="list-style-type: none"> • Source and connection for analog input. • Parameter settings for AI1 FAULT LIMIT (3021) and 3001 AI<MIN FUNCTION. |
| 8 | AI2 LOSS | Analog input 2 loss. Analog input value is less than AI2 FAULT LIMIT (3022). Check for and correct: <ul style="list-style-type: none"> • Source and connection for analog input. • Parameter settings for AI2 FAULT LIMIT (3022) and 3001 AI<MIN FUNCTION. |
| 9 | MOT OVERTEMP | Motor is too hot, based on either the drive's estimate or on temperature feedback. <ul style="list-style-type: none"> • Check for overloaded motor. • Adjust the parameters used for the estimate (3005...3009). • Check the temperature sensors and Group 35: MOTOR TEMP MEAS parameters. |
| 10 | PANEL LOSS | Panel communication is lost and either: <ul style="list-style-type: none"> • Drive is in local control mode (the control panel displays LOC), or • Drive is in remote control mode (REM) and is parameterized to accept start/stop, direction or reference from the control panel. To correct check: <ul style="list-style-type: none"> • Communication lines and connections. • Parameter 3002 PANEL COMM ERR. • Parameters in Group 10: START/STOP/DIR and Group 11: REFERENCE SELECT (if drive operation is REM). |

| Fault code | Fault name in panel | Description and recommended corrective action |
|------------|---------------------|---|
| 11 | ID RUN FAIL | The Motor ID Run was not completed successfully. Check for and correct: <ul style="list-style-type: none"> • Motor connections. • Motor parameters 9905...9909. |
| 12 | MOTOR STALL | Motor or process stall. Motor is operating in the stall region. Check for and correct: <ul style="list-style-type: none"> • Excessive load. • Insufficient motor power. • Parameters 3010...3012. |
| 13 | RESERVED | Not used. |
| 14 | EXT FAULT 1 | Digital input defined to report first external fault is active. See parameter 3003 EXTERNAL FAULT 1. |
| 15 | EXT FAULT 2 | Digital input defined to report second external fault is active. See parameter 3004 EXTERNAL FAULT 2. |
| 16 | EARTH FAULT | Possible ground fault detected in the motor or motor cables. The drive monitors for ground faults while the drive is running and while the drive is not running. Detection is more sensitive when the drive is not running and can produce false positives. Possible corrections: <ul style="list-style-type: none"> • Check for/correct faults in the input wiring. • Verify that motor cable does not exceed maximum specified length. • A delta grounded input power supply and motor cables with high capacitance may result in erroneous error reports during non-running tests. To disable response to fault monitoring when the drive is not running, use parameter 3023 WIRING FAULT. To disable response to all ground fault monitoring, use parameter 3017 EARTH FAULT. |
| 17 | OBSOLETE | Not used. |
| 18 | THERM FAIL | Internal fault. The thermistor measuring the internal temperature of the drive is open or shorted. Contact your local ABB representative. |
| 19 | OPEX LINK | Internal fault. A communication-related problem has been detected on the fiber optic link between the control and OINT boards. Contact your local ABB representative. |
| 20 | OPEX PWR | Internal fault. Low voltage condition detected on OINT power supply. Contact your local ABB representative. |
| 21 | CURR MEAS | Internal fault. Current measurement is out of range. Contact your local ABB representative. |
| 22 | SUPPLY PHASE | Ripple voltage in the DC link is too high. Check for and correct: <ul style="list-style-type: none"> • Missing mains phase. • Blown fuse. |
| 23 | ENCODER ERR | The drive is not detecting a valid encoder signal. Check for and correct: <ul style="list-style-type: none"> • Encoder presence and proper connection (reverse wired, loose connection or short circuit). • Voltage logic levels are outside of the specified range. • A working and properly connected Pulse Encoder Interface Module, OTAC-01. • Wrong value entered in parameter 5001 PULSE NR. A wrong value will only be detected if the error is such that the calculated slip is greater than 4 times the rated slip of the motor. • Encoder is not being used, but parameter 5002 ENCODER ENABLE = 1 (ENABLE). |

| Fault code | Fault name in panel | Description and recommended corrective action |
|------------|---------------------|---|
| 24 | OVERSPEED | Motor speed is greater than 120% of the larger (in magnitude) of 2001 MINIMUM SPEED or 2002 MAXIMUM SPEED. Check for and correct: <ul style="list-style-type: none"> • Parameter settings for 2001 and 2002. • Adequacy of motor braking torque. • Applicability of torque control. • Brake chopper and resistor. |
| 25 | RESERVED | Not used. |
| 26 | DRIVE ID | Internal fault. Configuration Block Drive ID is not valid. Contact your local ABB representative. |
| 27 | CONFIG FILE | Internal configuration file has an error. Contact your local ABB representative. |
| 28 | SERIAL 1 ERR | Fieldbus communication has timed out. Check for and correct: <ul style="list-style-type: none"> • Fault setup (3018 COMM FAULT FUNC and 3019 COMM FAULT TIME). • Communication settings (Group 51: EXT COMM MODULE or Group 53: EFB PROTOCOL as appropriate). • Poor connections and/or noise on line. |
| 29 | EFB CON FILE | Error in reading the configuration file for the embedded fieldbus. |
| 30 | FORCE TRIP | Fault trip forced by the fieldbus. See the fieldbus User's Manual. |
| 31 | EFB 1 | Fault code reserved for the embedded fieldbus (EFB) protocol application. The meaning is protocol dependent. |
| 32 | EFB 2 | |
| 33 | EFB 3 | |
| 34 | MOTOR PHASE | |
| 35 | OUTP WIRING | Possible power wiring error detected. When the drive is not running it monitors for an improper connection between the drive input power and the drive output. Check for and correct: <ul style="list-style-type: none"> • Proper input wiring – line voltage is NOT connected to drive output. • The fault can be erroneously declared if the input power is a delta grounded system and motor cable capacitance is large. This fault can be disabled using parameter 3023 WIRING FAULT. |
| 36 | INCOMPATIBLE SW | The drive cannot use the software. <ul style="list-style-type: none"> • Internal fault. • The loaded software is not compatible with the drive. • Call support representative. |
| 37 | CB OVERTEMP | Drive control board is overheated. The fault trip limit is 88 °C. Check for and correct: <ul style="list-style-type: none"> • Excessive ambient temperature. • Fan failure. • Obstructions in the air flow. Not for drives with an OMIO control board. |
| 38 | USER LOAD CURVE | Condition defined by parameter 3701 USER LOAD C MODE has been valid longer than the time defined by 3703 USER LOAD C TIME. |

| Fault code | Fault name in panel | Description and recommended corrective action |
|---------------|--|---|
| 101... 199 | SYSTEM ERROR | Error internal to the drive. Contact your local ABB representative and report the error number. |
| 201... 299 | SYSTEM ERROR | Error in the system. Contact your local ABB representative and report the error number. |
| - | UNKNOWN DRIVE TYPE: ACS550 SUPPORTED DRIVES: X | Wrong type of panel, i.e. panel that supports drive X but not the ACS550, has been connected to the ACS550. |

Faults that indicate conflicts in the parameter settings are listed below.

| Fault code | Fault name in panel | Description and recommended corrective action |
|------------|-----------------------|---|
| 1000 | PAR HZRPM | Parameter values are inconsistent. Check for any of the following: <ul style="list-style-type: none"> • 2001 MINIMUM SPEED > 2002 MAXIMUM SPEED. • 2007 MINIMUM FREQ > 2008 MAXIMUM FREQ. • 2001 MINIMUM SPEED / 9908 MOTOR NOM SPEED is outside proper range (> 50). • 2002 MAXIMUM SPEED / 9908 MOTOR NOM SPEED is outside proper range (> 50). • 2007 MINIMUM FREQ / 9907 MOTOR NOM FREQ is outside proper range (> 50). • 2008 MAXIMUM FREQ / 9907 MOTOR NOM FREQ is outside proper range (> 50). |
| 1001 | PAR PFC REF NEG | Parameter values are inconsistent. Check for the following: <ul style="list-style-type: none"> • 2007 MINIMUM FREQ is negative, when 8123 PFC ENABLE is active. |
| 1002 | RESERVED | Not used. |
| 1003 | PAR AI SCALE | Parameter values are inconsistent. Check for any of the following: <ul style="list-style-type: none"> • 1301 MINIMUM AI1 > 1302 MAXIMUM AI1. • 1304 MINIMUM AI2 > 1305 MAXIMUM AI2. |
| 1004 | PAR AO SCALE | Parameter values are inconsistent. Check for any of the following: <ul style="list-style-type: none"> • 1504 MINIMUM AO1 > 1505 MAXIMUM AO1. • 1510 MINIMUM AO2 > 1511 MAXIMUM AO2. |
| 1005 | PAR PCU 2 | Parameter values for power control are inconsistent: Improper motor nominal kVA or motor nominal power. Check for the following: <ul style="list-style-type: none"> • $1.1 \leq (9906 \text{ MOTOR NOM CURR} \cdot 9905 \text{ MOTOR NOM VOLT} \cdot 1.73 / P_N) \leq 3.0$ where: $P_N = 1000 \cdot 9909 \text{ MOTOR NOM POWER}$ (if units are kW) or $P_N = 746 \cdot 9909 \text{ MOTOR NOM POWER}$ (if units are hp, e.g. in US) |
| 1006 | PAR EXT RO | Parameter values are inconsistent. Check for the following: <ul style="list-style-type: none"> • Extension relay module not connected and • 1410...1412 RELAY OUTPUTS 4...6 have non-zero values. |
| 1007 | PAR FIELD BUS MISSING | Parameter values are inconsistent. Check for and correct: <ul style="list-style-type: none"> • A parameter is set for fieldbus control (e.g. 1001 EXT1 COMMANDS = 10 (COMM)), but 9802 COMM PROT SEL = 0. |
| 1008 | PAR PFC MODE | Parameter values are inconsistent – 9904 MOTOR CTRL MODE must be = 3 (SCALAR:FREQ), when 8123 PFC ENABLE is activated. |

| Fault code | Fault name in panel | Description and recommended corrective action |
|---------------|---------------------|--|
| 1009 | PAR PCU 1 | Parameter values for power control are inconsistent: Improper motor nominal frequency or speed. Check for both of the following: <ul style="list-style-type: none"> $1 \leq (60 \cdot 9907 \text{ MOTOR NOM FREQ} / 9908 \text{ MOTOR NOM SPEED}) \leq 16$ $0.8 \leq 9908 \text{ MOTOR NOM SPEED} / (120 \cdot 9907 \text{ MOTOR NOM FREQ} / \text{Motor Poles}) \leq 0.992$ |
| 1010/ 1011 | RESERVED | Not used. |
| 1012 | PAR PFC IO 1 | IO configuration is not complete – not enough relays are parameterized to PFC. Or, a conflict exists between Group 14: RELAY OUTPUTS , parameter 8117 NR OF AUX MOT and parameter 8118 AUTOCHNG INTERV. |
| 1013 | PAR PFC IO 2 | IO configuration is not complete – the actual number of PFC motors (parameter 8127, MOTORS) does not match the PFC motors in Group 14: RELAY OUTPUTS and parameter 8118 AUTOCHNG INTERV. |
| 1014 | PAR PFC IO 3 | IO configuration is not complete – the drive is unable to allocate a digital input (interlock) for each PFC motor (parameters 8120 INTERLOCKS and 8127 MOTORS). |
| 1015 | RESERVED | Not used. |
| 1016 | PAR USER LOAD C | Parameter values for the user load curve are inconsistent. Check that the following conditions are met: <ul style="list-style-type: none"> $3704 \text{ LOAD FREQ } 1 \leq 3707 \text{ LOAD FREQ } 2 \leq 3710 \text{ LOAD FREQ } 3 \leq 3713 \text{ LOAD FREQ } 4 \leq 3716 \text{ LOAD FREQ } 5$. $3705 \text{ LOAD TORQ LOW } 1 \leq 3706 \text{ LOAD TORQ HIGH } 1$. $3708 \text{ LOAD TORQ LOW } 2 \leq 3709 \text{ LOAD TORQ HIGH } 2$. $3711 \text{ LOAD TORQ LOW } 3 \leq 3712 \text{ LOAD TORQ HIGH } 3$. $3714 \text{ LOAD TORQ LOW } 4 \leq 3715 \text{ LOAD TORQ HIGH } 4$. $3717 \text{ LOAD TORQ LOW } 5 \leq 3718 \text{ LOAD TORQ HIGH } 5$. |

Fault resetting

The ACS550 can be configured to automatically reset certain faults. Refer to parameter [Group 31: AUTOMATIC RESET](#).



WARNING! If an external source for start command is selected and it is active, the ACS550 may start immediately after fault reset.

Flashing red LED

To reset the drive for faults indicated by a flashing red LED:

- Turn the power off for 5 minutes.

Red LED

To reset the drive for faults indicated by a red LED (on, not flashing), correct the problem and do one of the following:

- Press RESET from the control panel.
- Turn the power off for 5 minutes.

Depending on the value of 1604 FAULT RESET SEL, the following could also be used to reset the drive:

- digital input
- serial communication.

When the fault has been corrected, the motor can be started.

History

For reference, the last three fault codes are stored into parameters 0401, 0412, 0413. For the most recent fault (identified by parameter 0401), the drive stores additional data (in parameters 0402...0411) to aid in troubleshooting a problem. For example, parameter 0404 stores the motor speed at the time of the fault.

The Assistant Control Panel provides additional information about the fault history. See section [Fault Logger mode](#) on page 85 for more information.

To clear the fault history (all of the [Group 04: FAULT HISTORY](#) parameters):

1. Using the control panel in the Parameters mode, select parameter 0401.
2. Press EDIT (or ENTER on the Basic Control Panel).
3. Press UP and DOWN at the same time.
4. Press SAVE.

Correcting alarms

The recommended corrective action for alarms is:

- Determine if the alarm requires any corrective action (action is not always required).
- Use the table in section [Alarm listing](#) below to find and address the root cause of the problem.

Alarm listing

The following table lists the alarms by code number and describes each.

| Alarm code | Display | Description |
|------------|--------------|---|
| 2001 | OVERCURRENT | Current limiting controller is active. Check for and correct: <ul style="list-style-type: none"> • Excessive motor load. • Insufficient acceleration time (parameters 2202 ACCELER TIME 1 and 2205 ACCELER TIME 2). • Faulty motor, motor cables or connections. |
| 2002 | OVERVOLTAGE | Overvoltage controller is active. Check for and correct: <ul style="list-style-type: none"> • Static or transient overvoltages in the input power supply. • Insufficient deceleration time (parameters 2203 DECELER TIME 1 and 2206 DECELER TIME 2). |
| 2003 | UNDERVOLTAGE | Undervoltage controller is active. Check for and correct: <ul style="list-style-type: none"> • Undervoltage on mains. |

| Alarm code | Display | Description |
|------------|-----------------|---|
| 2004 | DIR LOCK | The change in direction being attempted is not allowed. Either: <ul style="list-style-type: none"> Do not attempt to change the direction of motor rotation, or Change parameter 1003 DIRECTION to allow direction change (if reverse operation is safe). |
| 2005 | IO COMM | Fieldbus communication has timed out. Check for and correct: <ul style="list-style-type: none"> Fault setup (3018 COMM FAULT FUNC and 3019 COMM FAULT TIME). Communication settings (Group 51: EXT COMM MODULE or Group 53: EFB PROTOCOL as appropriate). Poor connections and/or noise on line. |
| 2006 | AI1 LOSS | Analog input 1 is lost, or value is less than the minimum setting. Check: <ul style="list-style-type: none"> Input source and connections. Parameter that sets the minimum (3021). Parameter that sets the alarm/fault operation (3001), |
| 2007 | AI2 LOSS | Analog input 2 is lost, or value is less than the minimum setting. Check: <ul style="list-style-type: none"> Input source and connections. Parameter that sets the minimum (3022). Parameter that sets the alarm/fault operation (3001). |
| 2008 | PANEL LOSS | Panel communication is lost and either: <ul style="list-style-type: none"> Drive is in local control mode (the control panel displays LOC), or Drive is in remote control mode (REM) and is parameterized to accept start/stop, direction or reference from the control panel. To correct check: <ul style="list-style-type: none"> Communication lines and connections. Parameter 3002 PANEL COMM ERR. Parameters in Group 10: START/STOP/DIR and Group 11: REFERENCE SELECT (if drive operation is REM). |
| 2009 | DEVICE OVERTEMP | Drive heatsink is hot. This alarm warns that a DEVICE OVERTEMP fault may be near. R7 and R8: 100 °C (212 °F) Check for and correct: <ul style="list-style-type: none"> Fan failure. Obstructions in the air flow. Dirt or dust coating on the heat sink. Excessive ambient temperature. Excessive motor load. |
| 2010 | MOTOR TEMP | Motor is hot, based on either the drive's estimate or on temperature feedback. This alarm warns that a MOT OVERTEMP fault trip may be near. Check: <ul style="list-style-type: none"> Check for overloaded motor. Adjust the parameters used for the estimate (3005...3009). Check the temperature sensors and Group 35: MOTOR TEMP MEAS. |
| 2011 | RESERVED | Not used. |
| 2012 | MOTOR STALL | Motor is operating in the stall region. This alarm warns that a MOTOR STALL fault trip may be near. |

| Alarm code | Display | Description |
|------------------|---------------------------|--|
| 2013 (Note 1) | AUTORESET | This alarm warns that the drive is about to perform an automatic fault reset, which may start the motor. <ul style="list-style-type: none"> To control automatic reset, use Group 31: AUTOMATIC RESET. |
| 2014 (Note 1) | AUTOCHANGE | This alarm warns that the PFC autochange function is active. <ul style="list-style-type: none"> To control PFC, use Group 81: PFC CONTROL and the PFC macro on page 108. |
| 2015 | PFC I LOCK | This alarm warns that the PFC interlocks are active, which means that the drive cannot start the following: <ul style="list-style-type: none"> Any motor (when Autochange is used). The speed regulated motor (when Autochange is not used). |
| 2016/ 2017 | RESERVED | Not used. |
| 2018 (Note 1) | PID SLEEP | This alarm warns that the PID sleep function is active, which means that the motor could accelerate when the PID sleep function ends. <ul style="list-style-type: none"> To control PID sleep, use parameters 4022...4026 or 4122...4126. |
| 2019 | ID RUN | Performing ID Run. |
| 2020 | RESERVED | Not used. |
| 2021 | START ENABLE 1 MISSING | This alarm warns that the Start Enable 1 signal is missing. <ul style="list-style-type: none"> To control Start Enable 1 function, use parameter 1608. To correct, check: <ul style="list-style-type: none"> Digital input configuration. Communication settings. |
| 2022 | START ENABLE 2 MISSING | This alarm warns that the Start Enable 2 signal is missing. <ul style="list-style-type: none"> To control Start Enable 2 function, use parameter 1609. To correct, check: <ul style="list-style-type: none"> Digital input configuration. Communication settings. |
| 2023 | EMERGENCY STOP | Emergency stop activated. |
| 2024 | ENCODER ERROR | The drive is not detecting a valid encoder signal. Check for and correct: <ul style="list-style-type: none"> Encoder presence and proper connection (reverse wired, loose connection, or short circuit). Voltage logic levels are outside of the specified range. A working and properly connected Pulse Encoder Interface Module, OTAC-01. Wrong value entered in parameter 5001 PULSE NR. A wrong value will only be detected if the error is such that the calculated slip is greater than 4 times the rated slip of the motor. Encoder is not being used, but parameter 5002 ENCODER ENABLE = 1 (ENABLE). |
| 2025 | FIRST START | Signals that a the drive is performing a First Start evaluation of motor characteristics. This is normal the first time the motor is run after motor parameters are entered or changed. See parameter 9910 ID RUN for a description of motor models. |
| 2026 | RESERVED | Not used. |

| Alarm code | Display | Description |
|------------|-----------------|--|
| 2027 | USER LOAD CURVE | This alarm warns that the condition defined by parameter 3701 USER LOAD C MODE has been valid longer than half of the time defined by 3703 USER LOAD C TIME. |
| 2028 | START DELAY | Shown during the Start delay. See parameter 2113 START DELAY. |

Note 1. Even when the relay output is configured to indicate alarm conditions (e.g. parameter 1401 RELAY OUTPUT 1 = 5 (ALARM) or 16 (FLT/ALARM)), this alarm is not indicated by a relay output.

Alarm codes (Basic Control Panel)

The Basic Control Panel indicates control panel alarms with a code, A5xxx. The following table lists the alarm codes and descriptions.

| Code | Description |
|------|--|
| 5001 | Drive is not responding. |
| 5002 | The communication profile is incompatible with the drive. |
| 5010 | The panel's parameter backup file is corrupted. |
| 5011 | Drive is controlled from another source. |
| 5012 | Rotation direction is locked. |
| 5013 | Button is disabled, because start is inhibited. |
| 5014 | Button is disabled, because drive is faulted. |
| 5015 | Button is disabled, because local mode lock is on. |
| 5018 | Parameter default value can't be found. |
| 5019 | Writing a non-zero value is prohibited (can only write a zero value). |
| 5020 | Group or parameter does not exist or parameter value is inconsistent. |
| 5021 | Group or parameter is hidden. |
| 5022 | Group or parameter is write protected. |
| 5023 | Modification is not allowed while the drive is running. |
| 5024 | Drive is busy, try again. |
| 5025 | Write is not allowed while upload or download is in progress. |
| 5026 | Value is at or below low limit. |
| 5027 | Value is at or above high limit. |
| 5028 | Value is invalid – doesn't match any values in the discrete values list. |
| 5029 | Memory is not ready, try again. |
| 5030 | Request is invalid. |
| 5031 | Drive is not ready, e.g due to low DC voltage. |
| 5032 | Parameter error was detected. |
| 5040 | Selected parameter set can't be found in the current parameter backup. |
| 5041 | Parameter backup doesn't fit into memory. |
| 5042 | Selected parameter set can't be found in the current parameter backup. |
| 5043 | No start inhibit was granted. |
| 5044 | Parameter backup versions do not match. |

| Code | Description |
|-------------|---|
| 5050 | Parameter upload was aborted. |
| 5051 | File error was detected. |
| 5052 | Parameter upload attempt has failed. |
| 5060 | Parameter download was aborted. |
| 5062 | Parameter download attempt has failed. |
| 5070 | Panel backup memory write error was detected. |
| 5071 | Panel backup memory read error was detected. |
| 5080 | Operation is not allowed, because the drive is not in local mode. |
| 5081 | Operation is not allowed, because a fault is active. |
| 5083 | Operation is not allowed, because parameter lock is not open. |
| 5084 | Operation is not allowed, because drive is busy, try again. |
| 5085 | Download is not allowed, because drive types are incompatible. |
| 5086 | Download is not allowed, because drive models are incompatible. |
| 5087 | Download is not allowed, because parameter sets do not match. |
| 5088 | Operation failed, because a drive memory error was detected. |
| 5089 | Download failed, because a CRC error was detected. |
| 5090 | Download failed, because a data processing error was detected. |
| 5091 | Operation failed, because a parameter error was detected. |
| 5092 | Download failed, because parameter sets do not match. |

Maintenance

Safety



WARNING! Read chapter [Safety](#) on page [5](#) before performing any maintenance on the equipment. Ignoring the safety instructions can cause injury or death.

Note: There are parts carrying dangerous voltages near the control board when the drive is powered.

Note: *ACS550-U2 Installation Supplement* [3AUA0000004067 (English)] provides more information about the maintenance of ACS550-U2 drives.

Maintenance intervals

If installed in an appropriate environment, the drive requires very little maintenance. This table lists the routine maintenance intervals recommended by ABB.

| Interval | Maintenance | Instruction |
|---|---|---|
| Every year when stored | Capacitor reforming | See Reforming on page 289 . |
| Every 6 to 12 months (depending on the dustiness of the environment) | Heatsink temperature check and cleaning | See Heatsink on page 286 . |
| Every 6 years | Cooling fan replacement | See Fan on page 286 . |
| Every 9 to 10 years | Capacitor replacement | See Capacitors on page 289 . |
| Every 10 years | Assistant Control Panel battery replacement | See Control panel on page 291 |

Heatsink

The heatsink fins pick up dust from the cooling air. The drive runs into overtemperature alarms and faults if the heatsink is not clean. In a “normal” environment (not dusty, not clean) the heatsink should be checked annually, in a dusty environment more often.

Clean the heatsink as follows (when necessary):

1. Remove the cooling fan (see section [Fan](#)).
2. Blow dry clean compressed air from bottom to top and simultaneously use a vacuum cleaner at the air outlet to trap the dust. **Note:** Prevent dust from entering adjoining equipment.
3. Replace the cooling fan.

Fan

The life span of the cooling fan of the drive is about 50 000 (R7) and 60 000 (R8) hours. The actual life span depends on the running time of the fan, ambient temperature and dust concentration.

When the Assistant Control Panel is in use, the Notice Handler Assistant informs when the definable value of the operating hour counter is reached (see parameter 2901). This information can also be passed to the relay output (see parameter 1401) regardless of the used panel type.

Replacement fans are available from ABB. Do not use other than ABB specified spare parts.

Replacing the fan (R7)

1. Remove power from the drive.
2. Remove the upper front cover and disconnect the control panel cables.
3. Disconnect the discharging resistor wire.
4. Remove the DC capacitor pack by undoing the black fixing screws.
5. Disconnect the fan supply wires (detachable terminal).
6. Disconnect the fan capacitor wires.
7. Undo the black fixing screws of the fan cassette.
8. Press the snap-on holders to release the side cover.
9. Lift from the handle and pull the fan cassette out.

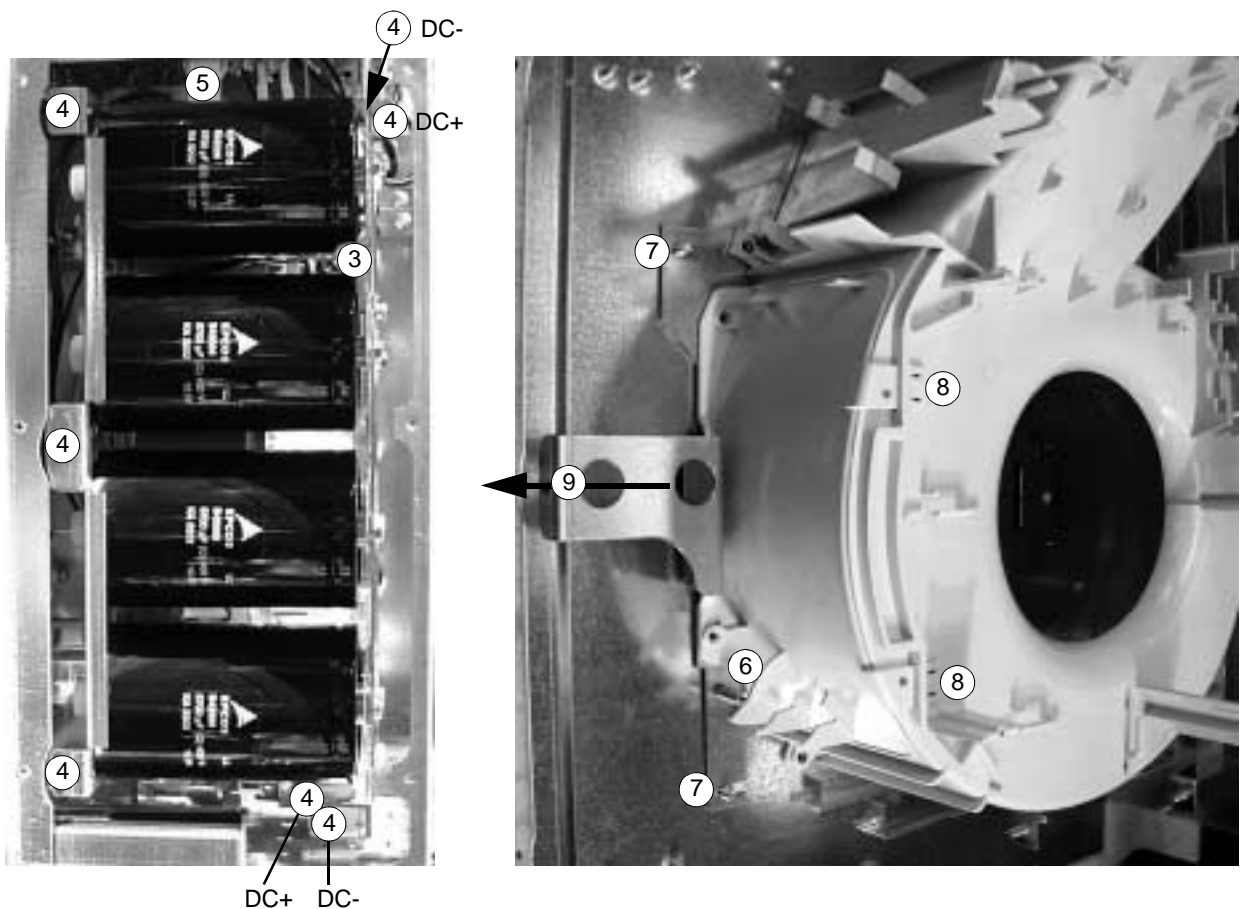

10. Install the fan in reverse order to the above and replace the fan capacitor.
11. Restore power.

Replacing the fan (R8)

1. Remove power from the drive.
2. Remove the upper front cover.
3. Disconnect the fan capacitor and power supply wires. Replace the starting capacitor.
4. Undo the black fastening screws of the plastic side cover of the fan and lift the cover off.
5. Undo the black fastening screws of the fan.
6. Lift the fan out of the cabinet.

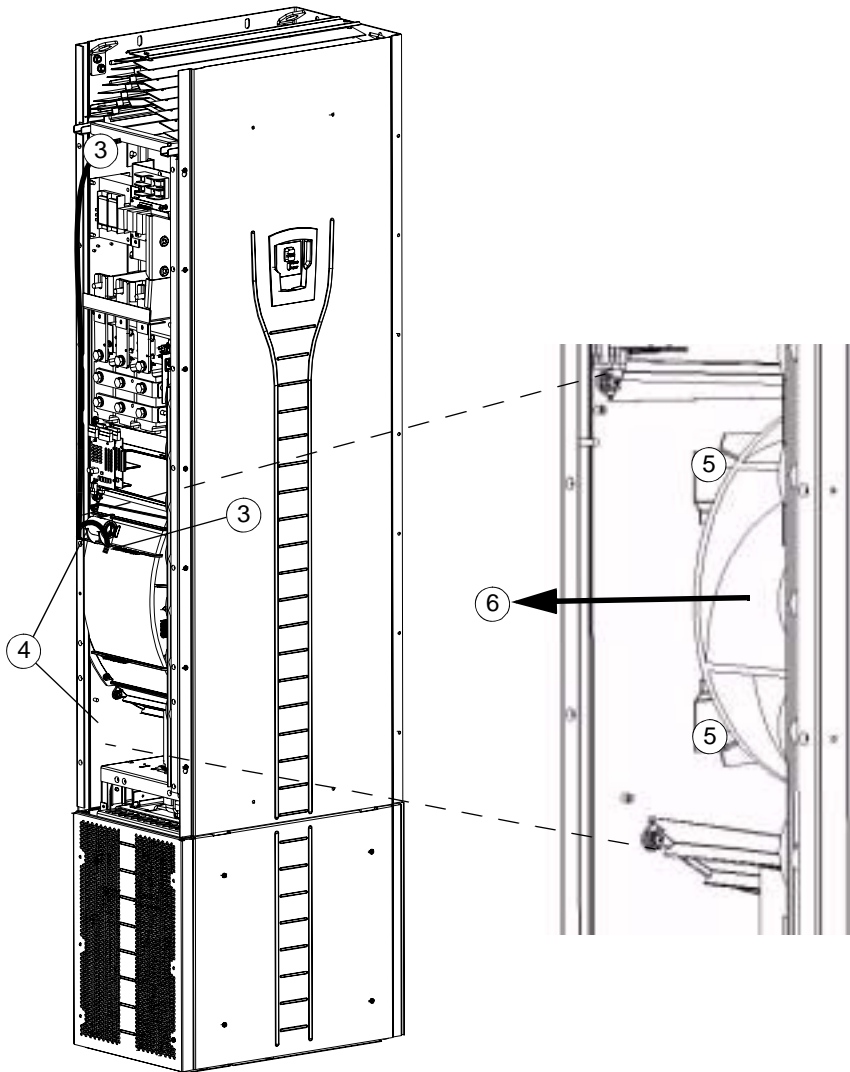

7. Install the fan in reverse order to the above.
8. Restore power.

Capacitors

The drive intermediate circuit employs several electrolytic capacitors. Their life span is at least 90 000 hours depending on the operating time of the drive, loading and ambient temperature. Capacitor life can be prolonged by lowering the ambient temperature.

It is not possible to predict a capacitor failure. Capacitor failure is usually followed by damage to the drive and an input cable fuse failure, or a fault trip. Contact ABB if capacitor failure is suspected. Replacements are available from ABB. Do not use other than ABB specified spare parts.

Reforming

Reform (re-age) spare part capacitors once a year according to *Guide for Capacitor Reforming in ACS50, ACS55, ACS150, ACS350, ACS550 and ACH550* [3AFE68735190 (English)], available on the Internet (go to www.abb.com and enter the code in the Search field).

Replacing the capacitor pack (R7)

Replace the capacitor pack as described in section [Replacing the fan \(R7\)](#) on page [287](#).

Replacing the capacitor pack (R8)

1. Remove power from the drive.
2. Remove the upper front cover and the side plate equipped with control panel mounting slot.
3. Disconnect the discharging resistor wire.
4. Undo the fastening screws.
5. Lift the capacitor pack out.

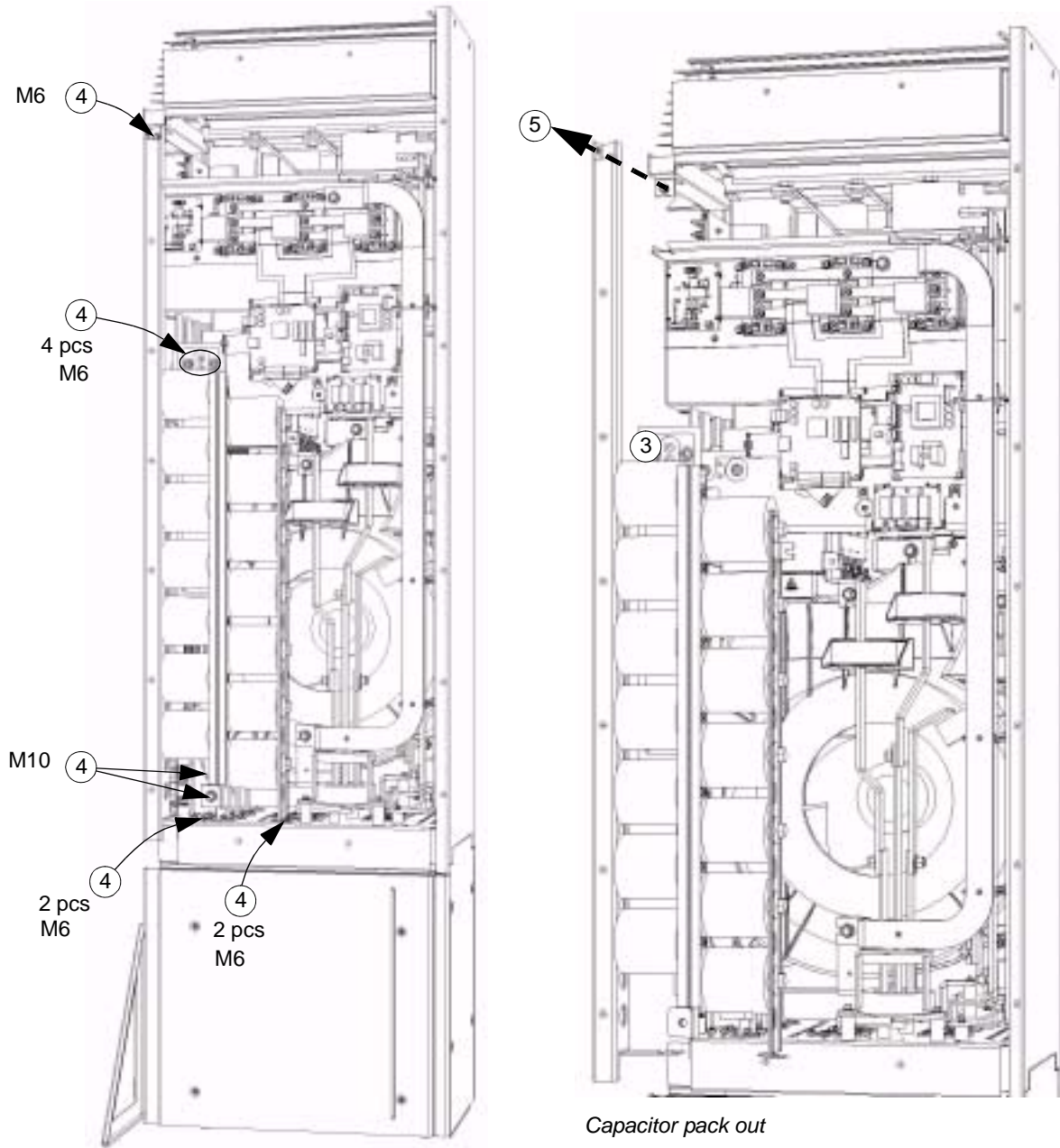

6. Install the capacitor pack in reverse order to the above.
7. Restore power.

LEDs

This table describes LEDs of the drive.

| Where | LED | When the LED is lit |
|---------------------------------|----------------|---|
| Control board | Red (blinking) | Drive in fault state |
| | Green | The power supply on the board is OK. |
| Control panel mounting platform | Red | Drive in fault state |
| | Green | The main + 24 V power supply for the control panel and the control board is OK. |
| OITF board | V204 (green) | +5 V voltage of the board is OK. |
| | V309 (red) | Prevention of unexpected start is ON. |
| | V310 (green) | IGBT control signal transmission to the gate driver control boards is enabled. |

Control panel

Cleaning

Use a soft damp cloth to clean the control panel. Avoid harsh cleaners which could scratch the display window.

Battery

A battery is only used in Assistant Control Panels that have the clock function available and enabled. The battery keeps the clock operating in memory during power interruptions.

The expected life for the battery is greater than ten years. To remove the battery, use a coin to rotate the battery holder on the back of the control panel. Replace the battery with type CR2032.

Technical data

Ratings

By type code, the table below provides ratings for the ACS550 adjustable speed AC drive, including:

- IEC ratings
- NEMA ratings (shaded columns)
- frame size
- drive cabinet heat dissipation and air flow.

IEC ratings

| Type code ACS550-02 | Ratings (380...480 V AC supply) | | | | | | Frame size |
|------------------------|---------------------------------|-------------|----------------|----------------|------------------|-------------------|------------|
| | Normal use | | Heavy-duty use | | Heat dissipation | Air flow | |
| | I_{2N} A | P_N kW | I_{2hd} A | P_{hd} kW | W | m ³ /h | |
| -245A-4 | 245 | 132 | 192 | 110 | 3850 | 540 | R7 |
| -289A-4 | 289 | 160 | 224 | 132 | 4550 | 540 | R7 |
| -368A-4 | 368 | 200 | 302 | 160 | 6850 | 1220 | R8 |
| -486A-4 | 486 | 250 | 414 | 200 | 7850 | 1220 | R8 |
| -526A-4 | 526 | 280 | 477 | 250 | 7600 | 1220 | R8 |
| -602A-4 | 602 | 315 | 515 | 280 | 8100 | 1220 | R8 |
| -645A-4 | 645 | 355 | 590 | 315 | 9100 | 1220 | R8 |

00467918.xls B

NEMA ratings

| Type code ACS550-U2 UL Type 1 (NEMA 1) | Ratings (380...480 V AC supply) | | | | | | Frame size |
|---|---------------------------------|-------------|----------------|----------------|------------------|----------------------|------------|
| | Normal use | | Heavy-duty use | | Heat dissipation | Air flow | |
| | I_{2N} A | P_N hp | I_{2hd} A | P_{hd} hp | BTU/hr | ft ³ /min | |
| -196A-4 ¹ | 196 | 150 | 162 | 125 | 10416 | 318 | R7 |
| -245A-4 ¹ | 245 | 200 | 192 | 150 | 13148 | 318 | R7 |
| -316A-4 | 316 | 250 | 240 | 200 | 23394 | 718 | R8 |
| -368A-4 | 368 | 300 | 302 | 250 | 23394 | 718 | R8 |
| -414A-4 | 414 | 350 | 368 | 300 | 26809 | 718 | R8 |
| -486A-4 | 486 | 400 | 414 | 350 | 26809 | 718 | R8 |
| -526A-4 | 526 | 450 | 477 | 400 | 25955 | 718 | R8 |
| -602A-4 | 602 | 500 | 515 | 450 | 27663 | 718 | R8 |
| -645A-4 | 645 | 550 | 590 | 500 | 31078 | 718 | R8 |

00467918.xls B

1. ACS550-U2-196A-4 and ACS550-U2-245A-4 will be discontinued. Consult US factory.

Symbols

Typical ratings:

Normal use (10% overload capability)

I_{2N} continuous rms current. 10% overload is allowed for one minute in ten minutes.

P_N typical motor power. The power ratings apply to most IEC 34, or NEMA 4-pole motors at the nominal voltage, 400 V or 460 V.

Heavy-duty use (50% overload capability)

I_{2hd} continuous rms current. 50% overload is allowed for one minute in ten minutes.

P_{hd} typical motor power. The power ratings apply to most IEC 34, or NEMA 4-pole motors at the nominal voltage, 400 V or 460 V.

Sizing

The current ratings are the same regardless of the supply voltage within one voltage range. To achieve the rated motor power given in the table, the rated current of the drive must be higher than or equal to the rated motor current.

Note 1: The maximum allowed motor shaft power is limited to $1.5 \cdot P_{hd}$. If the limit is exceeded, motor torque and current are automatically restricted. The function protects the input bridge of the drive against overload.

Note 2: The ratings apply in ambient temperature of 40 °C (104 °F).

Derating

The load capacity (current and power) decreases if the installation site altitude exceeds 1000 meters (3300 ft) or if the ambient temperature exceeds 40 °C (104 °F).

Temperature derating

In the temperature range +40 °C...50 °C (+104 °F...122 °F), the rated output current is decreased 1% for every 1 °C (1.8 °F) above +40 °C (+104 °F). Calculate the output current by multiplying the current given in the rating table by the derating factor.

Example If the ambient temperature is 50 °C (+122 °F), the derating factor is $100\% - 1\%/^{\circ}\text{C} \cdot 10\text{ }^{\circ}\text{C} = 90\%$ or 0.90.

The output current is then $0.90 \cdot I_{2N}$ or $0.90 \cdot I_{2hd}$.

Altitude derating

In altitudes from 1000...4000 m (3300...13,200 ft) above sea level, the derating is 1% for every 100 m (330 ft). If the installation site is higher than 2000 m (6600 ft) above sea level, please contact your local ABB distributor or office for further information.

Fuses and circuit breakers

Fuses

Branch circuit protection must be provided by the end-user, sized per national and local electric codes. Recommendations for fuses for short-circuit protection on the input cable and the drive are below.

Verify that the fuse operates rapidly enough by **checking that the short-circuit current of the installation is at least the minimum short-circuit current given in the table below**. The short-circuit current of the installation can be calculated as follows:

$$I_{k2-ph} = \frac{U}{2 \cdot \sqrt{R_c^2 + (Z_k + X_c)^2}}$$

where

I_{k2-ph} = short-circuit current in symmetrical two-phase short-circuit (A)

U = network line-to-line voltage (V)

R_c = cable resistance (ohm)

$Z_k = z_k \cdot U_N^2 / S_N$ = transformer impedance (ohm)

z_k = transformer impedance (%)

U_N = transformer rated voltage (V)

S_N = nominal apparent power of the transformer (kVA)

X_c = cable reactance (ohm).

If the calculated short-circuit current of the installation is smaller than the minimum short-circuit current given in the table below, the fuse does not operate rapidly enough to protect the drive in 0.1 s. Select a faster fuse to ensure that the required 0.1 s operation time is met.

| Type code ACS550-02 ACS550-U2 | Input current A | Fuses | | | | |
|-------------------------------------|---------------------------|------------------------------------|----------------------|---------------------|-----------------|------------------|
| | | Min. short-circuit current A | IEC 60269 gG A | ABB Control type | UL Class T A | Bussmann type |
| -196A-4 | 196 | 3820 | 250 | OFAF1H250 | 250 | JJS-250 |
| -245A-4 | 245 | 4510 | 250 | OFAF2H315 | 400 | JJS-300 |
| -289A-4 | 289 | 4510 | 315 | OFAF2H315 | 400 | JJS-400 |
| -316A-A | 316 | | 400 | | 400 | JJS-500 |
| -368A-4 | 368 | 6180 | 400 | OFAF3H400 | 400 | JJS-500 |
| -414A-A | 414 | | 500 | | 600 | JJS-500 |
| -486A-4 | 486 | 10200 | 500 | OFAF3H630 | 600 | JJS-600 |
| -526A-4 | 526 | 10200 | 630 | OFAF3H630 | 800 | JJS-800 |
| -602A-4 | 602 | 10200 | 630 | OFAF3H630 | 800 | JJS-800 |
| -645A-4 | 645 | 13500 | 800 | OFAF3H800 | 800 | JJS-800 |

00467918.xls B

Circuit breakers

Use of fuses is preferable, but ABB MCCB circuit breakers listed in the table below can also be used.

| Type code ACS550-02 ACS550-U2 | Input current | ABB Tmax moulded case circuit breaker (MCCB) | | | |
|-------------------------------------|---------------|--|-------------|--------------------|-----------------------------------|
| | | Tmax frame | Tmax rating | Electronic release | Prospective short-circuit current |
| | A | | A | A | kA |
| -196A-4 | 196 | T4 | 250 | 250 | 65 |
| -245A-4 | 245 | T4 | 320 | 320 | 65 |
| -289A-4 | 289 | T4 | 320 | 320 | 65 |
| -316A-4 | 316 | T5 | 630 | 630 | 65 |
| -368A-4 | 368 | T5 | 630 | 630 | 65 |
| -414A-4 | 414 | T5 | 630 | 630 | 65 |
| -486A-4 | 486 | T5 | 630 | 630 | 65 |
| -526A-4 | 526 | T5 | 630 | 630 | 65 |
| -602A-4 | 602 | T5 | 630 | 630 | 65 |
| -645A-4 | 645 | - | - | - | - |

00577998.xls A

Cable types

IEC

The table below gives copper and aluminium cable types for different load currents. Cable sizing is based on max. 9 cables laid on a cable ladder side by side, ambient temperature 30 °C, PVC insulation, surface temperature 70 °C (EN 60204-1 and IEC 60364-5-52/2001). For other conditions, size the cables according to local safety regulations, appropriate input voltage and the load current of the drive.

In any case, the cable must be between the minimum limit defined in this table and the maximum limit defined by the terminal size (see [Cable entries](#) on page 299).

| Copper cables with concentric copper shield | | Aluminium cables with concentric copper shield | |
|---|-------------------------------|--|-------------------------------|
| Max. load current A | Cable type mm ² | Max. load current A | Cable type mm ² |
| 56 | 3x16 | 69 | 3x35 |
| 71 | 3x25 | 83 | 3x50 |
| 88 | 3x35 | 107 | 3x70 |
| 107 | 3x50 | 130 | 3x95 |
| 137 | 3x70 | 151 | 3x120 |
| 167 | 3x95 | 174 | 3x150 |
| 193 | 3x120 | 199 | 3x185 |
| 223 | 3x150 | 235 | 3x240 |
| 255 | 3x185 | 214 | 2 x (3x70) |
| 301 | 3x240 | 260 | 2 x (3x95) |
| 274 | 2 x (3x70) | 302 | 2 x (3x120) |
| 334 | 2 x (3x95) | 348 | 2 x (3x150) |
| 386 | 2 x (3x120) | 398 | 2 x (3x185) |
| 446 | 2 x (3x150) | 470 | 2 x (3x240) |
| 510 | 2 x (3x185) | 522 | 3 x (3x150) |
| 602 | 2 x (3x240) | 597 | 3 x (3x185) |
| 579 | 3 x (3x120) | 705 | 3 x (3x240) |
| 669 | 3 x (3x150) | | |
| 765 | 3 x (3x185) | | |
| 903 | 3 x (3x240) | | |

3BFA01051905 C

NEMA

Cable sizing is based on NEC Table 310-16 for copper wires, 75 °C (167 °F) wire insulation at 40 °C (104 °F) ambient temperature. Not more than three current-carrying conductors in raceway or cable or earth (directly buried). For other conditions, dimension the cables according to local safety regulations, appropriate input voltage and the load current of the drive.

In any case, the cable must be between the minimum limit defined in this table and the maximum limit defined by the terminal size (see [Cable entries](#) on page 299).

| Copper cables with concentric copper shield | |
|--|-------------------------------|
| Max. load current A | Cable type AWG/kcmil |
| 57 | 6 |
| 75 | 4 |
| 88 | 3 |
| 101 | 2 |
| 114 | 1 |
| 132 | 1/0 |
| 154 | 2/0 |
| 176 | 3/0 |
| 202 | 4/0 |
| 224 | 250 MCM or 2 × 1 |
| 251 | 300 MCM or 2 × 1/0 |
| 273 | 350 MCM or 2 × 2/0 |
| 295 | 400 MCM or 2 × 2/0 |
| 334 | 500 MCM or 2 × 3/0 |
| 370 | 600 MCM or 2 × 4/0 or 3 × 1/0 |
| 405 | 700 MCM or 2 × 4/0 or 3 × 2/0 |
| 449 | 2 × 250 MCM or 3 × 2/0 |
| 502 | 2 × 300 MCM or 3 × 3/0 |
| 546 | 2 × 350 MCM or 3 × 4/0 |
| 590 | 2 × 400 MCM or 3 × 4/0 |
| 669 | 2 × 500 MCM or 3 × 250 MCM |
| 739 | 2 × 600 MCM or 3 × 300 MCM |
| 810 | 2 × 700 MCM or 3 × 350 MCM |
| 884 | 3 × 400 MCM or 4 × 250 MCM |
| 1003 | 3 × 500 MCM or 4 × 300 MCM |
| 1109 | 3 × 600 MCM or 4 × 400 MCM |
| 1214 | 3 × 700 MCM or 4 × 500 MCM |

Cable entries

Mains and motor cable maximum sizes (per phase) accepted at the cable terminals, and the tightening torques are listed below.

| Frame size | U1, V1, W1, U2, V2, W2 | | | | | | Earthing PE | | |
|------------|--|---------------------|------|-----------|-------------------|---------|-------------|-------------------|---------|
| | Number of cable lead-through holes per phase | Max. cable diameter | | Bolt size | Tightening torque | | Bolt size | Tightening torque | |
| | | mm | in | | N-m | lbf-ft | | N-m | lbf-ft |
| R7 | 2 | 58 | 2.28 | M12 | 50...75 | 35...55 | M8 | 15...22 | 10...16 |
| R8 | 3 | 58 | 2.28 | M12 | 50...75 | 35...55 | M8 | 15...22 | 10...16 |

00467918.xls B

Input power (mains) connection

| Input power (mains) connection specifications | | | | | |
|--|--|------------------------|----------|-------|--------|
| Voltage (U_1) | 400/415/440/460/480 V AC 3-phase +10% -15% for 400 V AC drives | | | | |
| Short-circuit withstand strength (IEC 60439-1) | <p>Maximum allowable prospective short-circuit current when protected by IEC fuses given in the fuse table on page 295 is</p> <p>for O2 drives: 65 kA (I_{cc})</p> <p>for U2 drives (with enclosure extension):</p> <table border="1" style="margin-left: 20px;"> <thead> <tr> <th>$I_{cw} / 1 \text{ s}$</th> <th>I_{pk}</th> </tr> </thead> <tbody> <tr> <td>50 kA</td> <td>105 kA</td> </tr> </tbody> </table> | $I_{cw} / 1 \text{ s}$ | I_{pk} | 50 kA | 105 kA |
| $I_{cw} / 1 \text{ s}$ | I_{pk} | | | | |
| 50 kA | 105 kA | | | | |
| Short-circuit current protection (UL 508) | US and Canada: According to UL 508, the drive is suitable for use in a circuit capable of delivering not more than 100 kA symmetrical amperes (rms) at 600 V maximum when protected by UL fuses given in the fuse table on page 295. | | | | |
| Frequency | 48...63 Hz | | | | |
| Imbalance | Max. \pm 3% of nominal phase to phase input voltage | | | | |
| Fundamental power factor ($\cos \phi_1$) | 0.98 (at nominal load) | | | | |
| Cable temperature rating | 70 °C (158 °F) rating minimum | | | | |

Motor connection

| Motor connection specifications | |
|-----------------------------------|--|
| Voltage (U_2) | 0... U_1 , 3-phase symmetrical, U_{max} at the field weakening point |
| Frequency | 0...500 Hz |
| Frequency resolution | 0.01 Hz |
| Current | See section Ratings on page 293. |
| Power limit | $1.5 \cdot P_{hd}$ |
| Field weakening point | 10...500 Hz |
| Switching frequency | Selectable: 1, 4 kHz |
| Cable temperature rating | 70 °C (158 °F) rating minimum. |
| Maximum motor cable length | See section Motor cable length below. |

Motor cable length

The table below shows the maximum motor cable lengths for 1 or 4 kHz switching frequencies. Examples for using the table are also given

| Frame size | EMC limits | | | | Operational limits | | | |
|------------|---|-----|--|-----|--------------------|-----|-----------------------|-----|
| | IEC/EN 61800-3 Second environment (category C3 ¹) | | IEC/EN 61800-3 First environment (category C2 ¹) | | Basic limits | | With du/dt filters | |
| | m | ft | m | ft | m | ft | m | ft |
| R7 | 100 | 330 | 100 | 330 | 300 | 980 | 300 | 980 |
| R8 | 100 | 330 | - | - | 300 | 980 | 300 | 980 |

¹ See the new terms in section [IEC/EN 61800-3 \(2004\) Definitions](#) on page 306.

00577999.xls A

Sine filters further extend the cable lengths.

Under heading “Operational limits”, the “Basic unit” columns define the cable lengths with which the basic drive unit works without problems within the drive specification, without installing any further options. Column “With du/dt filters” defines the cable lengths when an external du/dt filter is used.

The columns under heading “EMC limits” show the maximum cable lengths with which the units have been tested for EMC emissions. The factory guarantees that these cable lengths meet the EMC standard requirements.

If external sine filters are installed, longer cable lengths can be used. With sine filters the limiting factors are the voltage drop of the cable, which has to be taken into account in engineering, as well as the EMC limits (where applicable).



WARNING! Using a motor cable longer than specified in the table above may cause permanent damage to the drive.

Examples for using the table:

| Requirements | Checking and conclusions |
|--|--|
| R7 frame size, Category C2, 100 m (330 ft) cable | Check operational limits for R7 -> for a 100 m (330 ft) cable the basic unit is sufficient. Check EMC limits -> EMC requirements for Category C2 are met with a 100 m (330 ft) cable. |
| R7 frame size, Category C3, 150 m (490 ft) cable | Check operational limits for R7 -> for a 150 m (490 ft) cable the basic unit is sufficient. Check EMC limits -> EMC requirements for Category C3 cannot be met with a 150 m (490 ft) cable. The installation configuration is not possible. An EMC plan is recommended to overcome the situation. |
| R8 frame size, EMC limits not applicable, 300 m (980 ft) cable | Check operational limits for R8 -> for a 300 m (980 ft) cable the basic unit is sufficient. EMC limits do not need to be checked as there are no EMC requirements. |

Control connections

| Control connection specifications | |
|-----------------------------------|---|
| Analog inputs and outputs | See the Hardware description table on page 55 . |
| Digital inputs | Digital input impedance 1.5 kΩ. Maximum voltage for digital inputs is 30 V. |
| Relays (Digital outputs) | <ul style="list-style-type: none"> Max. contact voltage: 30 V DC, 250 V AC Max. contact current / power: 6 A, 30 V DC; 1500 VA, 250 V AC Max. continuous current: 2 A rms ($\cos \varphi = 1$), 1 A rms ($\cos \varphi = 0.4$) Minimum load: 500 mW (12 V, 10 mA) Contact material: Silver-nickel (AgN) Isolation between relay digital outputs, test voltage: 2.5 kV rms, 1 minute |
| Cable specifications | See section Power factor compensation capacitors on page 23 . |

| Frame size | Control terminals | | | |
|------------|--------------------------------|-----|--------|--------|
| | Maximum wire size ¹ | | Torque | |
| | mm ² | AWG | N-m | lbf-ft |
| R7, R8 | 1.5 | 16 | 0.4 | 0.3 |

¹ Values given for solid wires.
For stranded wires the maximum size is 1 mm².

Efficiency

Approximately 98% at nominal power level.

Cooling

| Cooling Specifications | |
|------------------------------------|--|
| Method | Internal fan, flow direction from front to top. |
| Free space around the drive | See the table on page 29 for required free space around the drive. |

Dimensions, weights and noise

The dimensions and mass for the ACS550 depend on the frame size and enclosure type, refer to section [Dimension drawings](#) on page 308.

| Frame size | H | | W | | D | | Weight | | Noise |
|------------|------|-------|-----|-------|-----|-------|--------|-----|-------|
| | mm | in | mm | in | mm | in | kg | lb | dB |
| R7 | 1507 | 59.33 | 250 | 9.84 | 520 | 20.47 | 115 | 254 | 71 |
| R8 | 2024 | 79.68 | 347 | 13.66 | 617 | 24.29 | 230 | 507 | 72 |

00467918.xls B

Degrees of protection

Available enclosures:

- IP21 / UL type 1 enclosure. The site must be free of airborne dust, corrosive gases or liquids, and conductive contaminants such as condensation, carbon dust, and metallic particles

Ambient conditions

The following table lists the ACS550 environmental requirements.



| Ambient environment requirements | | |
|---|---|--|
| | Installation site | Storage and transportation in the protective package |
| Altitude | <ul style="list-style-type: none"> 0...1000 m (0...3 300 ft) 1000...2000 m (3 300...6 600 ft) if P_N and I_{2N} derated 1% every 100 m above 1000 m (300 ft above 3 300 ft) | |
| Ambient temperature | <ul style="list-style-type: none"> -15...40 °C (5...104 °F), no frost allowed Max. 50 °C (122 °F) if P_N and I_{2N} derated to 90% | -40...70 °C (-40...158 °F) |
| Relative humidity | < 95% (non-condensing) | |
| Contamination levels (IEC 721-3-3) | <ul style="list-style-type: none"> No conductive dust allowed. The drive should be installed in clean air according to enclosure classification. Cooling air must be clean, free from corrosive materials and free from electrically conductive dust. Chemical gases: Class 3C2 Solid particles: Class 3S2 | Storage <ul style="list-style-type: none"> No conductive dust allowed. chemical gases: Class 1C2 solid particles: Class 1S2 Transportation <ul style="list-style-type: none"> No conductive dust allowed. Chemical gases: Class 2C2 Solid particles: Class 2S2 |
| Sinusoidal vibration (IEC 60068-2-6) | <ul style="list-style-type: none"> Mechanical conditions: Class 3M4 (IEC 60721-3-3) 2...9 Hz 3.0 mm (0.12 in) 9...200 Hz 10 m/s² (33 ft/s²) | Storage <ul style="list-style-type: none"> Max. 1 mm (0.04 in) (5 to 13.2 Hz), max. 7 m/s² (23 ft/s²) (13.2 to 100 Hz) sinusoidal Transportation <ul style="list-style-type: none"> Max. 3.5 mm (0.14 in.) (2 to 9 Hz), max. 15 m/s² (49 ft/s²) (9 to 200 Hz) sinusoidal |
| Shock (IEC 68-2-29) | Not allowed | max. 100 m/s ² (330 ft/s ²), 11ms |
| Free fall | Not allowed | 100 mm (4 in) for weight over 100 kg (220 lb) |

Materials

| Materials specifications | |
|--------------------------|---|
| Drive enclosure | <ul style="list-style-type: none"> • PC/ABS 2.5 mm, color NCS 1502-Y (RAL 90021/PMS 420 C) • Hot-dip zinc coated steel sheet 1.5...2 mm, thickness of coating 100 micrometers • Extruded aluminum AISi |
| Package | Plywood box (drives and option modules), expanded polystyrene. Plastic covering of the package PE-LD, bands PP or steel. |
| Disposal | <p>The drive contains raw materials that should be recycled to preserve energy and natural resources. The package materials are environmentally compatible and recyclable. All metal parts can be recycled. The plastic parts can either be recycled or burned under controlled circumstances, according to local regulations. Most recyclable parts are marked with recycling marks.</p> <p>If recycling is not feasible, all parts excluding electrolytic capacitors and printed circuit boards can be landfilled. Plywood box has to be burned in high temperature. The DC capacitors contain electrolyte and the printed circuit boards contain lead, both of which are classified as hazardous waste within the EU. They must be removed and handled according to local regulations.</p> <p>For further information on environmental aspects and more detailed recycling instructions, please contact your local ABB representative.</p> |

Applicable standards

Drive compliance with the following standards is identified by the standard “marks” on the type code label. The compliance with the European Low Voltage Directive is verified according to standards EN 50178 and EN 60204-1.

| Mark | Applicable standards | |
|---|-------------------------|---|
|  | EN 50178 (1997) | Electronic equipment for use in power installations |
| | IEC/EN 60204-1 (2005) | Safety of machinery. Electrical equipment of machines. Part 1: General requirements. <i>Provisions for compliance:</i> The final assembler of the machine is responsible for installing: <ul style="list-style-type: none"> • an emergency-stop device • a supply disconnecting device. |
| | IEC/EN 60529 (2004) | Degrees of protection provided by enclosures (IP code) |
| | IEC 60664-1 (2002) | Insulation coordination for equipment within low-voltage systems. Part 1: Principles, requirements and tests |
| | IEC/EN 61800-5-1 (2003) | Adjustable speed electrical power drive systems. Part 5-1: Safety requirements. Electrical, thermal and energy |
| | IEC/EN 61800-3 (2004) | Adjustable speed electrical power drive systems. Part 3: EMC requirements and specific test methods |
|  | IEC/EN 61800-3 (2004) | Adjustable speed electrical power drive systems. Part 3: EMC requirements and specific test methods |
|  | UL 508C | UL Standard for Safety, Power Conversion Equipment, third edition |

CE marking

 A CE mark is attached to the drive to verify that the drive follows the provisions of the European Low Voltage and EMC Directives (Directive 73/23/EEC, as amended by 93/68/EEC, and Directive 89/336/EEC, as amended by 93/68/EEC).

Compliance with the EMC Directive

The Directive defines the requirements for immunity and emissions of electrical equipment used within the European Union. The EMC product standard [IEC/EN 61800-3 (2004)] covers requirements stated for drives.

Compliance with IEC/EN 61800-3 (2004)

See page [306](#).

C-Tick marking

 The drive carries C-Tick marking.
C-Tick marking is required in Australia and New Zealand. A C-Tick mark is attached to the drive to verify compliance with the relevant standard (IEC 61800-3 (2004) – Adjustable speed electrical power drive systems – Part 3: EMC product standard including specific test methods), mandated by the Trans-Tasman Electromagnetic Compatibility Scheme.

The Trans-Tasman Electromagnetic Compatibility Scheme (EMCS) was introduced by the Australian Communication Authority (ACA) and the Radio Spectrum Management Group (RSM) of the New Zealand Ministry of Economic Development (NZMED) in November 2001. The aim of the scheme is to protect the radio frequency spectrum by introducing technical limits for emission from electrical/electronic products.

Compliance with IEC/EN 61800-3 (2004)

See page [306](#).

UL markings



An UL mark is attached to ACS550 drives to verify that the drive follows the provisions of UL 508C.

The ACS550 is suitable for use on a circuit capable of delivering not more than 100 kA rms symmetrical amperes, 480 V maximum. The ampere rating is based on tests done according to UL 508.

Branch circuit protection must be provided in accordance with local codes.

The ACS550 has an electronic motor protection feature that complies with the requirements of UL 508C. When this feature is selected and properly adjusted, additional overload protection is not required unless more than one motor is connected to the drive or unless additional protection is required by applicable safety regulations. See parameters 3005 (MOT THERM PROT) and 3006 (MOT THERM RATE).

The drives are to be used in a controlled environment. See section [Ambient conditions](#) on page [303](#) for specific limits.

IEC/EN 61800-3 (2004) Definitions

EMC stands for **E**lectromagnetic **C**ompatibility. It is the ability of electrical/electronic equipment to operate without problems within an electromagnetic environment. Likewise, the equipment must not disturb or interfere with any other product or system within its locality.

First environment includes establishments connected to a low-voltage network which supplies buildings used for domestic purposes.

Second environment includes establishments connected to a network not directly supplying domestic premises.

Drive of category C2: drive of rated voltage less than 1000 V and intended to be installed and commissioned only by a professional when used in the first environment.

Note: A professional is a person or organization having necessary skills in installing and/or commissioning power drive systems, including their EMC aspects.

Category C2 has the same EMC emission limits as the earlier class first environment restricted distribution. EMC standard IEC/EN 61800-3 does not any more restrict the distribution of the drive, but the using, installation and commissioning are defined.

Drive of category C3: drive of rated voltage less than 1000 V, intended for use in the second environment and not intended for use in the first environment.

Category C3 has the same EMC emission limits as the earlier class second environment unrestricted distribution.

Compliance with the IEC/EN 61800-3 (2004)

The immunity performance of the drive complies with the demands of IEC/EN 61800-3, category C2 (see page [306](#) for IEC/EN 61800-3 definitions). The emission limits of IEC/EN 61800-3 are complied with the provisions described below.

First environment (drives of category C2)

1. Frame size R7 drives: The internal EMC filter is connected and the EMC screen is installed.

Frame size R8 drives do not comply with the demands of category C2.

2. The motor and control cables are selected as specified in this manual.
3. The drive is installed according to the instructions given in this manual.
4. The maximum motor cable length is 100 m (330 ft).

WARNING! In a domestic environment, this product may cause radio interference, in which case supplementary mitigation measures may be required.

Second environment (drives of category C3)

1. Frame size R7 drives: The internal EMC filter is connected and the EMC screen is installed.
Frame size R8 drives comply with the demands of category C3.
2. The motor and control cables are selected as specified in this manual.
3. The drive is installed according to the instructions given in this manual.
4. The maximum motor cable length is 100 m (330 ft).

WARNING! A drive of category C3 is not intended to be used on a low-voltage public network which supplies domestic premises. Radio frequency interference is expected if the drive is used on such a network.

Note: It is not allowed to install a frame size R7 drive with the internal EMC filter connected on IT (ungrounded) systems. The supply network becomes connected to ground potential through the EMC filter capacitors, which may cause danger or damage the drive.

Note: It is not allowed to install a frame size R7 drive with the internal EMC filter connected to a corner grounded TN system as this would damage the drive.

Equipment warranty and liability

The manufacturer is not responsible for:

- Any costs resulting from a failure if the installation, commissioning, repair, alteration, or ambient conditions of the drive do not fulfill the requirements specified in the documentation delivered with the unit and other relevant documentation.
- Units subjected to misuse, negligence or accident.
- Units comprised of materials provided or designs stipulated by the purchaser.

In no event shall the manufacturer, its suppliers or subcontractors be liable for special, indirect, incidental or consequential damages, losses or penalties.

This is the sole and exclusive warranty given by the manufacturer with respect to the equipment and is in lieu of and excludes all other warranties, express or implied, arising by operation of law or otherwise, including, but not limited to, any implied warranties of merchantability or fitness for a particular purpose.

If you have any questions concerning your ABB drive, please contact the local distributor or ABB office. The technical data, information and specifications are valid at the time of printing. The manufacturer reserves the right to make modifications without prior notice.

Product protection in the USA

This product is protected by one or more of the following US patents:

| | | | | | |
|-----------|-----------|-----------|-----------|-----------|-----------|
| 4,920,306 | 5,301,085 | 5,463,302 | 5,521,483 | 5,532,568 | 5,589,754 |
| 5,612,604 | 5,654,624 | 5,799,805 | 5,940,286 | 5,942,874 | 5,952,613 |
| 6,094,364 | 6,147,887 | 6,175,256 | 6,184,740 | 6,195,274 | 6,229,356 |
| 6,252,436 | 6,265,724 | 6,305,464 | 6,313,599 | 6,316,896 | 6,335,607 |
| 6,370,049 | 6,396,236 | 6,448,735 | 6,498,452 | 6,552,510 | 6,597,148 |
| 6,600,290 | 6,741,059 | 6,774,758 | 6,844,794 | 6,856,502 | 6,859,374 |
| 6,922,883 | 6,940,253 | 6,934,169 | 6,956,352 | 6,958,923 | 6,967,453 |
| 6,972,976 | 6,977,449 | 6,984,958 | 6,985,371 | 6,992,908 | 6,999,329 |
| 7,023,160 | 7,034,510 | 7,036,223 | 7,045,987 | 7,057,908 | 7,059,390 |
| 7,067,997 | 7,082,374 | 7,084,604 | 7,098,623 | 7,102,325 | 7,109,780 |
| 7,164,562 | 7,176,779 | 7,190,599 | 7,215,099 | 7,221,152 | 7,227,325 |
| 7,245,197 | 7,262,577 | D503,931 | D510,319 | D510,320 | D511,137 |
| D511,150 | D512,026 | D512,696 | D521,466 | D541,743S | D541,744S |
| D541,745S | D548,182 | D548,183 | | | |

Other patents pending.

Dimension drawings

The dimensions are given in millimetres and [inches].

Frame size R7

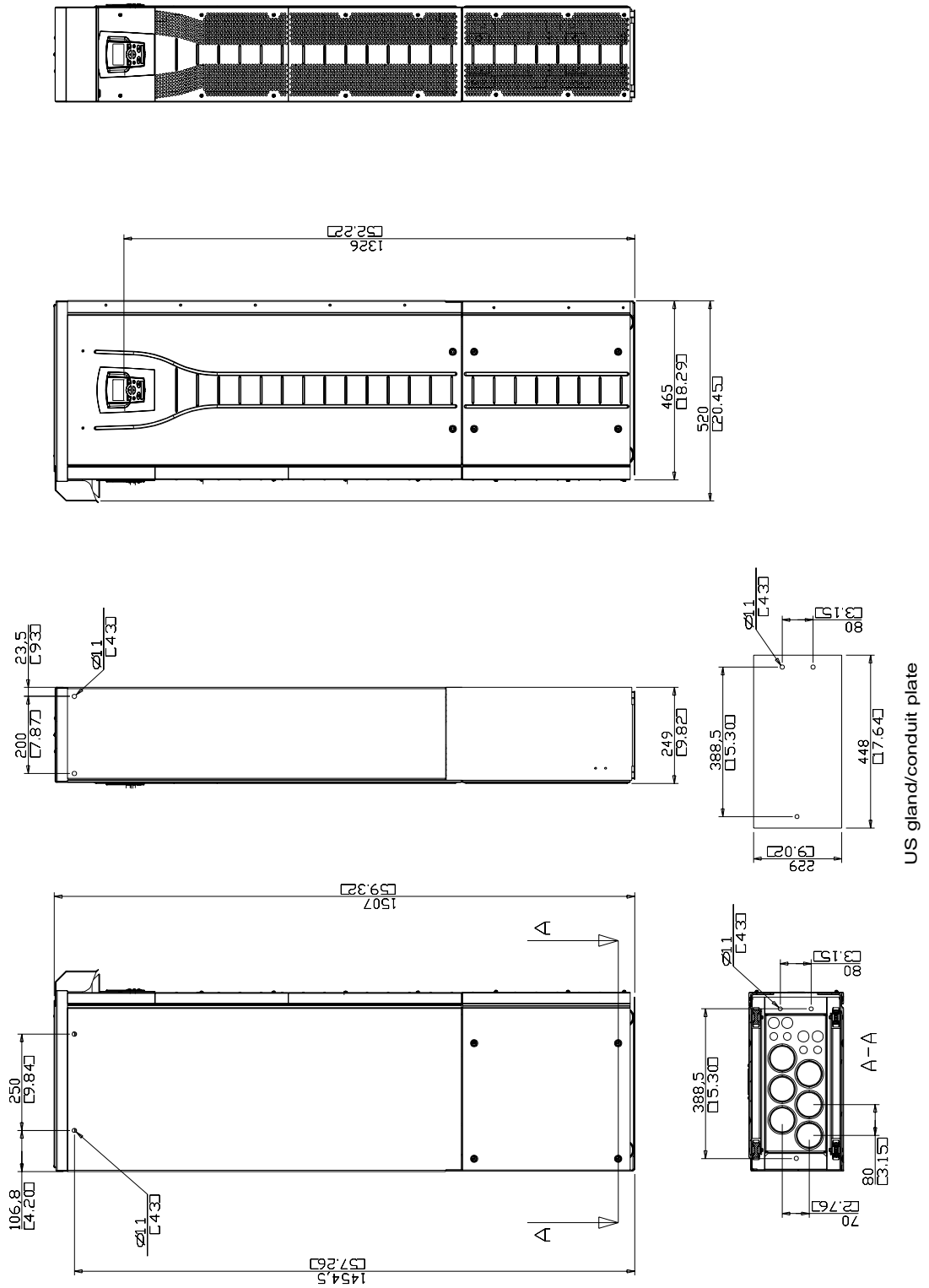

Frame size R8

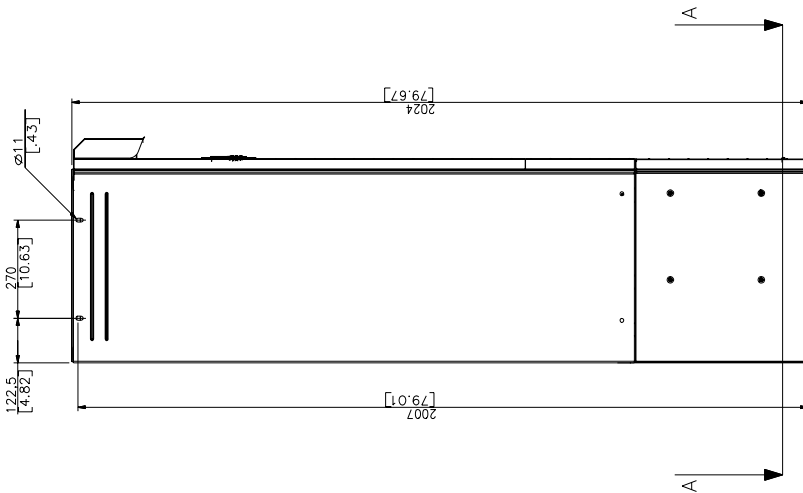
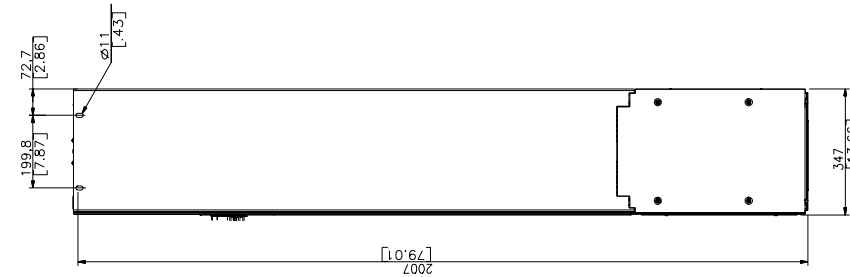
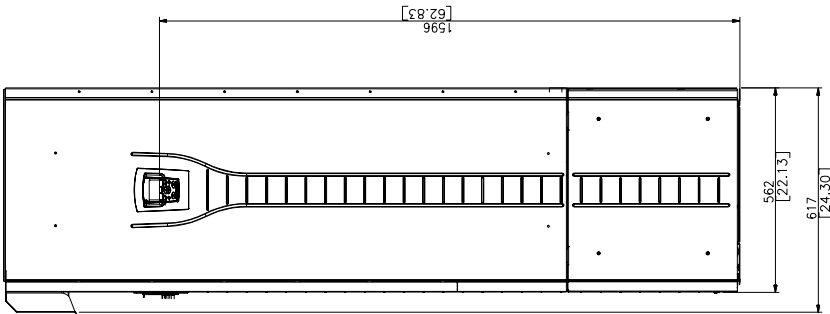
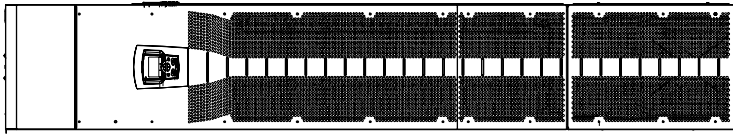

US gland/conduit plate

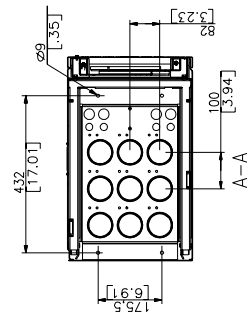
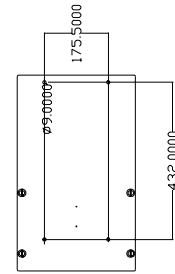

Contact ABB

Product and service inquiries

Address any inquiries about the product to your local ABB representative, quoting the type code and serial number of the drive in question. A listing of ABB sales, support and service contacts can be found by navigating to www.abb.com/drives and selecting *World wide service contacts*.

Product training

For information on ABB product training, navigate to www.abb.com/drives and select *Training courses*.

Providing feedback on ABB Drives manuals

Your comments on our manuals are welcome. Go to www.abb.com/drives and select *Document Library – Manuals feedback form (LV AC drives)*.



ABB Oy
AC Drives
P.O. Box 184
FI-00381 HELSINKI
FINLAND
Telephone +358 10 22 11
Fax +358 10 22 22681
Internet www.abb.com

ABB Inc.
Automation Technologies
Drives & Motors
16250 West Glendale Drive
New Berlin, WI 53151
USA
Telephone +1 262 785-3200
+1 800-HELP-365
Fax +1 262 780-5135

3AFE64804626 Rev C EN
EFFECTIVE: 17.09.2007