

# Lightning Protection for Your Repeater System

You've invested considerable time and money in your repeater system, and we all want it to continue working forever. It probably will, if you keep "Old Man Lightning" away.

We'll look at what lightning is, how it can enter a repeater system and how to keep it out, some approaches to minimizing damage, and insurance policies which can cover the cost of damage that can't be avoided.

The extent of protection you provide should be based on the amount of investment in your equipment, the frequency of thunderstorm activity in your area, and the level of reliability you want to achieve from your system. But in any case, protection for your equipment will pay in the long run!

## Lightning - Free Electricity

Lightning is a cloud-to-cloud, cloud-to-ground, or even ground-to-cloud electrical discharge. Frontal type thunderstorms result in larger strokes, and more strokes to ground, than convection thunderstorms. The southeastern U.S. and portions of the midwest have the greatest incidence of destructive storms. But virtually every area of the country is susceptible to thunderstorms, and being at a high elevation (i.e., at a repeater site) obviously increases the odds of damage.

The actual stroke, or discharge to ground, is equivalent to a current source of magnitude up to a hundred thousand amperes. The current pulse has a typical rise time of 2 microseconds and a decay time of around 40 us. The fast rate of rise of the pulse contributes to its destructive power, since even just a small portion of the stroke traveling through a small inductance can generate large voltage potentials. But its speed also helps make it easier to tame.

Direct hits are rare - the greatest likelihood for damage are near misses and surges induced in power and telephone lines.

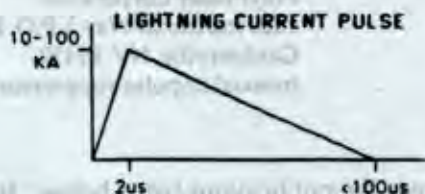

## Keep Out

The first goal is to *keep destructive lightning current out* of your equipment. The second goal is to make it *easy to exit* if it does enter.

The likely entry points into your system include (most obviously) the antenna, the phone line, and the ac power line. Attention should be paid to each of these potential entry points, but the key to any form of protection is grounding.

# QCC

advanced  
computer  
controls, inc.

## Lightning Protection

2356 Walsh Avenue, Santa Clara, California 95051  
(408) 727-3330



## Protection Inside ACC Controllers

ACC's RC-850 and RC-85 Repeater Controllers include built-in protection from transients due to lightning. As we've seen, this built-in protection should be considered as a last resort safeguard only and should not be viewed as a substitute for following the principles discussed above.

Each controller has at least one TransZorb protector across the twelve volt power supply input. This device protects against relatively low energy surges reaching the controller from the power supply.

The RC-85 controller and the RC-850 controller with the TP-3 Telephone Interface Board include a three terminal gas-discharge tube installed across the phone line. The RC-85 controller returns the tube's third terminal to the power connector ground. The RC-850 controller TP-3 board takes the third terminal to a separate terminal block connector - it should be wired directly to the main ground system.

## Insurance

Assuming reasonable precautions are taken to prevent damage, insurance is a viable option to protect against unavoidable damage. Some homeowner's policies cover the cost of repair or replacement of equipment damaged by lightning - check your policy.

The best value appears to be available to ARRL Members, with the "All-Risk" Ham Radio Equipment Insurance Program. At a cost of only 1% of the equipment value per year (plus a \$5 administrative fee), the insurance covers virtually all forms of loss, including lightning damage. For \$5000 worth of repeater equipment, that's just \$55 per year. If you're not an ARRL member, their insurance program is a good reason to join.

## Bottom Line

For a high level of protection we'd suggest the LEA TET-200-100 device on the phone line, the LEA SE-115-10-BF on the ac power line, and a PolyPhaser coaxial impulse suppressor appropriate to your frequency and power level. Devices from the manufacturers listed below, and others, may also provide effective levels of protection.

## Sources for Protection Equipment

Lightning Elimination Associates

12516 Lakeland Road

Sante Fe Springs, CA 90670

(213) 944-0916

(power line and phone line protectors)

Joslyn Electric Systems

P.O. Box 817

Goleta, CA 93116

(3 terminal gas tube phone line protectors)

Decibel Products, Inc.

3184 Quebec

Dallas, TX 75247

(214) 631-0310

(coaxial impulse suppressors)

PolyPhaser Corporation

1420 Industrial Way \ P.O. Box 1237

Gardnerville, NV 89410

(coaxial impulse suppressors)

## References

This writeup is based on information condensed from the publications listed below. It is intended as an introduction to the subject. We encourage you to write the companies for the literature mentioned below. We also thank Doug Zastrow, WBØUPJ and John Williams, K8JW for their ideas and suggestions.

"About Lightning", Decibel Products, Inc.

"Impulse Protection", PolyPhaser Corporation

"Protection Requirements and Concepts for Data and Control Lines", Lightning Elimination Associates

"Lightning" Newsletter, Quintron Corp., 13 B Commercial Dr., Quincy, IL 62301



## Power Supply

Another entry point for damaging transients is through the power line. ACC's controllers operate from an external twelve volt supply. Because the available supply is regulated, you may feel that it's regulated from transients on the ac line. *It is not!* A typical supply will pass high frequency components of an impulse from the ac line.

A site may be otherwise well engineered, but if your site neighbors protect their equipment from line surges and you don't, you may be the only one to suffer damage.

The MOS large scale integrated circuits used in modern computer based equipment, such as our controllers, are more susceptible to damage from transients than rugged rf transistors in your transmitter and receiver. The best protection is a transient protector which mounts at the fuse box. A variety of surge protectors which plug into the wall are available which are intended for use with small computers and will provide some level of protection. A transient suppressor may be added at the DC output of the power supply to help limit relatively low energy pulses.

## Protection Devices

A variety of technologies are available, ranging from semiconductors, to gas discharge tubes, to simple inductance. Zener diodes can offer a low level of protection, limited by their turnon speed and energy absorbing capability. A better device is the TransZorb (General Semiconductor) which is similar to a Zener but optimized for surge protection.

MOVs (metal oxide varistors) are effective for higher voltages, but are slower and allow a high peak voltage to result, relative to their rated clamp voltage. Gas discharge devices are also effective for high voltage applications (such as telephone line protection), and can handle very high transient currents. They're particularly effective for phone line use since they provide both excellent common mode and differential mode protection.

None of these devices *by themselves* offer complete protection for sensitive components at a typical repeater site. A well-engineered protector combines several technologies and must be applied properly in the system.

## Important Guidelines

The protector should be separated from the protected. Keep the transient energy *away* from the sensitive circuits. Provide the protection well away from the equipment being protected – not inside it.

Separate the exposed wires from the protected wires. Run the input and output lines from the protector with as much separation as possible, and preferably at right angles.

A "series" protector will provide considerably greater protection than a "parallel" protector. A protection device installed across the equipment (like a TransZorb) will obviously only *share* the transient with the equipment. A series protector will prevent the transient from *reaching* the equipment.

SEPARATE THE PROTECTOR FROM THE PROTECTED

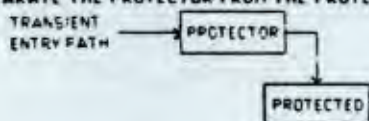

SERIES VS PARALLEL PROTECTION

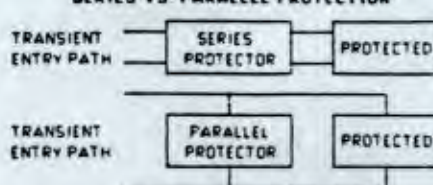



## Ground It Out

A good ground must be low resistance, and because of the lightning stroke's fast rise time, must be *low inductance*. The good ground is the essential first step, since it provides a non-destructive discharge path for lightning currents that we intend to keep out of our equipment.

The extent of the grounding system needed depends on the resistivity of the soil, and generally more than one ground rod is required to achieve a "good" ground. Several shorter rods, interconnected with bare buried wire, will have a lower impedance than one longer rod. Radials can reduce the impedance further in rocky or sandy earth.

Your earth ground, equipment ground, telephone company, and power company grounds *must* be interconnected properly to prevent large differential voltages from appearing between them due to ground surge currents. Each ground may be connected by a separate line to every other ground, or a "ring" closed loop may surround the installation. The interconnections should be large (#8) solid wire – not braid or stranded wire. The strands eventually oxidize and corrode, and with their many twists become highly inductive. Metals should be similar – copper should never touch steel.

With a good ground system, we can proceed to keeping the lightning current out of the equipment.

## The Antenna – The Unwanted Lightning Rod

Since the antenna is the highest point at the installation, it's the most likely entry path. Grounded towers, DC grounded antennas bonded to the tower, and lightning rods are important. The transmission line should run along the tower to the base, then loop before entering the building.

A coaxial impulse suppressor should be mounted at the grounded tower leg or grounded bulkhead panel – not at the equipment. The feedline should wind its way with as many bends as possible to the transmitter.

## The Phone Line

The telephone lines are subject to direct hits, as well as induced transients from nearby lightning activity. Although the telephone company usually installs some form of lightning protection, it should not be relied upon.

The best form of protection is a three terminal gas tube which limits differential voltages (between the two conductors) as well as voltage to ground. When the gas ionizes, it provides a simultaneous path to ground for both conductors. Other types of protectors, such as a pair of MOVs to ground, aren't as effective. Since each MOV has a slightly different turnon time, a common mode transient will appear as a full differential signal for a period of time, which can cause *more* damage than if no MOVs were installed.

The telephone cord from the protector to the equipment can be coiled or tied in knots to increase its inductance and help impede the transient.







**RC-850 REPEATER CONTROLLER** with Version 3 Firmware

		<b>List Price</b>	<b>Discount Price*</b>
<input type="checkbox"/>	<b>RC-850 Repeater Controller in 19" rack mount cabinet</b> (includes Telephone Interface and Voice Response Telemetry)		
<input type="checkbox"/>	with Plain Front Panel	\$2800.00	\$2400.00
<input type="checkbox"/>	with Front Panel Display	2900.00	2700.00
<input type="checkbox"/>	<b>CIB/VEO Computer Interface Option (V3.5) with Vocabulary Expansion Option</b>	525.00	450.00*
<input type="checkbox"/>	<b>PS Nspector™ Programming Sheet Software**</b>	115.00	95.00
	Runs on IBM PC or 100% compatible. DOS 3.0 or higher required. Custom Programming Sheet Header _____ (Must be completed. Example: "NU6P Repeater Group")		
<input type="checkbox"/>	<b>FC-900 Interface for IC-900/901 FM Mobile band units**</b>	260.00	225.00
<input type="checkbox"/>	<b>ENC FC-900 CTCSS Encoder Option</b>	35.00	25.00
<input type="checkbox"/>	<b>CTCSS Subaudible Tone Decoder</b>		
<input type="checkbox"/>	Installed	120.00	100.00
<input type="checkbox"/>	Not installed	70.00	60.00
<input type="checkbox"/>	<b>MC48 Local Microphone</b>	100.00	85.00
<input type="checkbox"/>	<b>FC-1 Frequency Control Board</b>	60.00	55.00
<input type="checkbox"/>	<b>M850 Manual Only (included in purchase)</b>	45.00	35.00

\* CIB/VEO discount price is \$350.00 when ordered with either rack mount RC-850 Controller.

\*\* Requires CIB/VEO Option.

RC-850, TP-3 Telephone Interface, and VR-2 Voice Response Telemetry are also available in board-only configurations. Please call the factory for pricing.

**RC-96 REPEATER CONTROLLER** with Version 4 Firmware

		<b>List Price</b>	<b>Discount Price*</b>
<input type="checkbox"/>	<b>RC-96 Repeater Controller with one DIN cable</b>	\$1550.00	\$1365.00
<input type="checkbox"/>	<b>TNP CTCSS Tone Panel Option with one tone installed</b>	200.00	175.00
<input type="checkbox"/>	<b>EAT Each additional Tone (up to 7 additional)</b>	45.00	35.00
<input type="checkbox"/>	<b>AD-2 Audio Delay Line Board Kit</b>	185.00	160.00
<input type="checkbox"/>	<b>FC-900 Interface for IC-900 Super Multi-Bander System units</b>	260.00	225.00
<input type="checkbox"/>	<b>ENC FC-900 Interface CTCSS Encoder Option</b>	35.00	25.00
<input type="checkbox"/>	<b>FC-1 Frequency Control Board</b>	65.00	55.00
<input type="checkbox"/>	<b>CB Additional DIN Cable (one supplied with controller)</b>	35.00	25.00
<input type="checkbox"/>	<b>CN Additional DIN Connector only</b>	15.00	10.00
<input type="checkbox"/>	<b>M96 Manual Only (included in purchase)</b>	25.00	15.00



## RC-85 REPEATER CONTROLLER with Version 4 Firmware

		List Price	Discount Price*
<input type="checkbox"/>	RC-85B Repeater Controller Board	\$ 1050.00	\$ 895.00
<input type="checkbox"/>	RC-85RM Repeater Controller in 19" rack mount cabinet	1165.00	995.00
<input type="checkbox"/>	CTCSS Subaudible Tone Decoder		
	<input type="checkbox"/> Installed	120.00	100.00
	<input type="checkbox"/> Not installed	70.00	60.00
<input type="checkbox"/>	AD-2 Audio Delay Line Board Kit	185.00	160.00
<input type="checkbox"/>	FC-900 Interface for IC-900 Super Multi-Bander System units	260.00	225.00
<input type="checkbox"/>	ENC FC-900 Interface CTCSS Encoder Option	35.00	25.00
<input type="checkbox"/>	FC-1 Frequency Control Board	65.00	55.00
<input type="checkbox"/>	M85 Manual Only (included in purchase)	25.00	15.00

## DIGITAL VOICE RECORDER

		List Price	Discount Price*
<input type="checkbox"/>	Digital Voice Recorder (one channel, one block 64K byte memories)		
	<input type="checkbox"/> Assembled and tested board only	\$ 1150.00	\$ 950.00
	<input type="checkbox"/> In 19" rack mount cabinet	1350.00	1150.00
<input type="checkbox"/>	MX-3 256K byte memory block (up to four blocks total)†	125.00	100.00
<input type="checkbox"/>	CH-2 Second record/playback channel††	250.00	200.00
<input type="checkbox"/>	CH-3 Third record/playback channel††	250.00	200.00
<input type="checkbox"/>	MDVR Manual Only (included in purchase)	15.00	10.00

† Memory may be expanded by the user in the field. Dynamic RAM required for operation. Either 4164 (64K bit) or 41256 (256K bit), 200 ns or faster (150 ns, 120 ns, etc.). Up to four blocks of 8 devices (32 total). Check current product flier for details.

†† Factory upgradeable only.

The cost of a previously purchased manual is applicable as a credit toward your new equipment. Owner's supplements are shipped when controllers are ordered.

\* To qualify for **Discount Price**, order may be accompanied by a deposit with balance due prior to shipment, or payable via COD certified funds, or VISA or Mastercard charge. Orders placed on company purchase orders requiring credit terms do not qualify for Discount Price.

### Warranty periods are:

RC-850 Repeater Controller - 2 years  
 RC-96 Repeater Controller - 2 years  
 RC-85 Repeater Controller - 2 years  
 Digital Voice Recorder - 1 year

Limited Warranty - Advanced Computer Controls, Inc. warrants that the products manufactured by ACC will be free from defects in material and workmanship for the warranty period from the date of shipment. The liability of ACC is limited to replacing or repairing, at ACC's option, any defective products which are returned to ACC, Santa Clara, California. In no case are products to be returned without first obtaining permission from ACC. The foregoing warranty shall not be valid: (i) if the products or parts have been subjected to misuse, accident, alteration, neglect, unauthorized repair or installation; (ii) for expendable items with the products; (iii) for custom equipment or products produced to Buyer's specifications. ACC shall make the final determination as to the existence to any alleged defect.

EXCEPT AS HEREINABOVE PROVIDED, ACC MAKES NO WARRANTIES, EXPRESS OR IMPLIED, INCLUDING ANY WARRANTY OF MERCHANTABILITY OR FITNESS FOR A PARTICULAR PURPOSE, AND SHALL NOT BE LIABLE FOR INCIDENTAL OR CONSEQUENTIAL DAMAGES. All implied warranties are limited in duration to the above stated warranty period. Some states do not allow the exclusion or limitation of incidental or consequential damages or on how long an implied warranty lasts.

PRICES - All prices are subject to change without notice. Prices do not include any taxes. Prices include packing suitable for domestic shipping. Export packing and freight are extra.

CANCELLATION AND DEFERRAL - Cancellation of or changes to acknowledged orders are accepted only on terms that protect ACC against loss.

TITLE AND SHIPMENT - All shipments are F.O.B. ACC, Santa Clara, California. Title to the products and risk of loss shall pass to Buyer upon ACC's delivery to the carrier, regardless of any provisions for payment of freight or insurance or form of shipping documents. The method of shipping and packaging shall be in accordance with ACC's then current standards. Shipping dates provided by ACC are approximate only. ACC shall not be liable for any loss, damage, or expense (consequential or otherwise) incurred by Buyer if ACC fails to meet specified delivery dates.

LIMITATION OF LIABILITY - ACC'S LIABILITY UNDER OR FOR BREACH OF THIS AGREEMENT SHALL BE LIMITED TO REFUND OF THE PURCHASE PRICE. IN NO EVENT SHALL ACC BE LIABLE FOR COSTS OF PROCUREMENT OF SUBSTITUTE GOODS, LOSS OF PROFITS, OR FOR ANY SPECIAL, CONSEQUENTIAL OR INCIDENTAL DAMAGES, HOWEVER CAUSED, WHETHER FOR BREACH OF WARRANTY, BREACH OF CONTRACT, REPUDIATION OF CONTRACT, NEGLIGENCE, OR OTHERWISE.

SOFTWARE PRODUCTS RESTRICTIONS - No title to or ownership of any Software or any parts thereof is transferred to Buyer by any delivery of Software to the Buyer hereunder. All Software provided by ACC is subject to a separate license agreement between Buyer and ACC.



Date: \_\_\_\_\_

Name: \_\_\_\_\_

Call Sign: \_\_\_\_\_

Repeater Group or Company: \_\_\_\_\_

Repeater Call: \_\_\_\_\_

Mailing Address: \_\_\_\_\_  
\_\_\_\_\_  
\_\_\_\_\_

Shipping Address (not a P.O. Box): \_\_\_\_\_  
\_\_\_\_\_  
\_\_\_\_\_

Day phone #: \_\_\_\_\_  
☎ \_\_\_\_\_

Alternate #: \_\_\_\_\_  
☎ \_\_\_\_\_

Comments: \_\_\_\_\_

**To speed processing of your order, please . . .**

- ✓ Provide both a mailing and shipping address
- ✓ Provide both day and evening phone numbers where you can be reached
- ✓ Shipping address cannot be a P.O. Box (UPS does not deliver to P.O. Boxes)

① Subtotal \$ \_\_\_\_\_

② Credit for previously purchased manual - \$ \_\_\_\_\_

③ New subtotal \$ \_\_\_\_\_

④ California residents add sales tax  
(line 3 times 6.25, 6.75, or 7.25%) \$ \_\_\_\_\_  
(name of county : \_\_\_\_\_)

⑤ Shipping and insurance  
(UPS second day air):  
RC-850 - \$24.00 DVR - \$20.00  
RC-96 - 15.00 RC-85RM - 13.00  
RC-85B - 10.00 CIB or FC-900 - \$8.00  
Accessories - 5.00  
Manuals - no charge  
International - call for quote \$ \_\_\_\_\_

⑥ C.O.D. fee (\$4 if applicable) \$ \_\_\_\_\_

⑦ TOTAL DUE \$ \_\_\_\_\_

⑧ Deposit enclosed - \$ \_\_\_\_\_

⑨ BALANCE DUE \$ \_\_\_\_\_

**METHOD OF PAYMENT**

(Please indicate one)

- Check enclosed for total amount due
- Deposit encl. w/ balance due prior to shipment
- Deposit encl. w/balance due COD Cert. Funds
- Charge to a VISA / Mastercard
- Company p. o. - subject to credit approval

P.O. # \_\_\_\_\_  
(Hard copy required prior to shipment)

Credit card #: \_\_\_\_\_

Expiration date: \_\_\_\_\_

Name on card: \_\_\_\_\_

address: \_\_\_\_\_  
\_\_\_\_\_

Signature: \_\_\_\_\_



**Thank you for your order!**



# Glossary

<b>abort</b>	Message Editor command to terminate editing session without writing message.
<b>activity timer</b>	Patch timer which resets at start and end of each transmission.
<b>Anxious ID</b>	ID attempted between user transmissions because it's getting late in the ID cycle.
<b>alarm</b>	Over the air indication of activated Alarm logic input.
<b>autodialer</b>	Speed dial patch where phone numbers are stored in memory.
<b>Autopatch</b>	Patch where user enters phone number of part of the command because the number isn't in an autodial location.
<b>BCD</b>	Binary Coded Decimal. Logic data format for control of remote base transceiver frequency synthesizer.
<b>bulletin board</b>	Synthesized speech or Morse code messages stored in memory by repeater owner which can be retrieved by users.
<b>click</b>	Short transmission by user to initiate dialing of Autopatch and User Loadable Autodialer.
<b>command</b>	Touch-Tone sequence which instructs controller to perform a function.
<b>command channel</b>	Audio source for Touch-Tone decoder, including repeater receiver, phone line, and control receiver.
<b>configurable</b>	Remotely changable by repeater owner using Touch-Tone commands.
<b>controller</b>	Device which supervises operation of the repeater system.
<b>Control Operator</b>	Class of person having access to Control Operator commands.
<b>Control Operator commands</b>	Touch-Tone commands available to the repeater's Control Operators.
<b>control receiver</b>	RF receiver having highest priority of Touch-Tone control.
<b>COR</b>	Carrier-operated-relay. Device which indicates signal present at receiver.
<b>COS</b>	Carrier-operated-switch. Same as COR.
<b>courtesy tone</b>	Indication to user that previous user has finished his transmission.
<b>CPU</b>	Central processing unit. The heart of the microcomputer.
<b>CTCSS</b>	Continuous tone-controlled squelch system - also known as subaudible tone or PL (Private Line).



<b>custom hangup code</b>	User definable hangup code which prevents malicious hangup of patch by jammer.
<b>Digital Voice Recorder</b>	ACC product which allows remote recording of voice messages with solid-state storage.
<b>DIP switch</b>	Dual-inline-package switch. Switch array accessible from rear panel which allows selection of certain options.
<b>DVR</b>	Digital Voice Recorder.
<b>Emergency Autodialer</b>	Autodialer which contains 10 emergency service phone numbers and response messages.
<b>enter key</b>	Touch-Tone key which instructs controller that the entire command has been entered. Optional over the air, required over the phone.
<b>EPROM</b>	Erasable-programmable-read-only-memory. Semiconductor memory device for storage of program and data.
<b>E<sup>2</sup>PROM</b>	Electrically-erasable programmable read-only-memory. In-system reprogrammable non-volatile memory.
<b>external device busy</b>	Logic input from external tape playback system.
<b>firmware</b>	Computer program stored in EPROM.
<b>five/six tone sequential</b>	Paging tone signalling format consisting of five or six tones.
<b>Forced CW ID</b>	ID message attempted when controller cannot generate a synthesized speech ID because a user is talking.
<b>frequency synthesizer</b>	Device in remote base transceiver which determines transmit and receive frequency of transceiver.
<b>group call</b>	Paging tone signalling format consisting of eight second continuous tone, for alerting a group of pagers with common "B" tone.
<b>hang time</b>	Period that repeater transmitter stays on after input signal goes away.
<b>high true</b>	Logic output where high state indicates active function.
<b>Initial ID</b>	ID message attempted when a new repeater user appears after a period of inactivity.
<b>interdigit timer</b>	Timer which disqualifies a command sequence if too long a period between individual digits occurs.
<b>Kerchunker filtering</b>	Algorithm which discourages brief unidentified transmissions.
<b>link</b>	Hard wired connection to another repeater or to transceiver.



<b>lock</b>	User Loadable Autodialer state which prohibits entry or erasing of phone numbers. Also state of controller where Programming command may not be entered.
<b>low true</b>	Logic output where low state indicates active function.
<b>message editor</b>	Portion of controller command set which allows repeater owner to construct Morse code and synthesized speech messages from the available character set and vocabulary.
<b>offhook</b>	State of telephone circuit where call is in progress.
<b>onhook</b>	State of telephone circuit where call is not presently in progress.
<b>open collector</b>	Logic output consisting of solid state contact closure to ground without capability of sourcing current.
<b>pad test</b>	Command procedure which permits users to test their Touch-Tone pads for proper operation.
<b>paging</b>	Selective calling technique involving tone signalling.
<b>patch</b>	General term for phone patch, covering Autopatch, User Loadable Autodialer, Emergency Autodialer, and reverse patch.
<b>Pending ID</b>	ID message attempted when no repeater activity is in progress or when the repeater carrier is allowed to drop.
<b>prefix</b>	Portion of a Touch-Tone command which precedes the root portion.
<b>program</b>	Computer instructions stored in memory. Also the act of remotely configuring the controller.
<b>Programming commands</b>	Touch-Tone commands which enable repeater owner to remotely program repeater characteristics.
<b>PTT</b>	Push-to-talk. Logic output from the controller which tells the transmitter to transmit.
<b>QSO</b>	Exchange of transmissions between users.
<b>RAM</b>	Random-access-memory. Semiconductor memory used for temporary storage by the controller.
<b>readback</b>	Synthesized speech or Morse code acknowledgement by the controller.
<b>regenerated Touch-Tone</b>	Touch-Tone audio synthesized by the controller into the phone line for improved patch reliability.
<b>remote base</b>	Remotely controlled Amateur radio station. Generally tied to repeater to allow shared access.
<b>remote programming</b>	The ability to remotely change various characteristics of the controller.
<b>repeater owner</b>	A person with access to Programming commands.



<b>reset</b>	Act of computer starting execution of its program from the beginning. Results from pushing Reset button, entering the Reset Control Operator command, or protective circuitry.
<b>reverse patch</b>	Phone patch initiated from the phone line.
<b>root</b>	Portion of command following prefix.
<b>site alarm</b>	Same as alarm.
<b>spare audio input</b>	Audio input to the controller which may be selected by users for monitoring. May be used for weather radio or similar audio source. Same hardware input as Link Receiver.
<b>Special ID</b>	ID message attempted at Pending ID time when selected by Control Operator.
<b>speech synthesizer</b>	Electronic device which generates audio closely resembling human speech.
<b>squelch tail</b>	Noise burst from FM receiver when input signal goes away.
<b>subaudible tone</b>	Same as CTCSS.
<b>tail</b>	Period after user unkeys when repeater transmitter is still up.
<b>tail message</b>	Synthesized speech or Morse code message generated just before repeater transmitter drops off.
<b>timeout timer</b>	Timer which disables repeater transmitter if a continuous signal appears at repeater receiver for too long a period.
<b>to end of transmission timer</b>	Timer which disqualifies a Touch-Tone command if too long a period elapses from the last Touch-Tone key to the end of the user's transmission.
<b>Tone Panel</b>	Remotely programmable multi-tone CTCSS decoder/encoder
<b>Touch-Tone Access Mode</b>	Access mode which may be activated with user Touch-Tone commands.
<b>two-tone sequential</b>	Paging tone signalling format consisting of a one-second and three-second tone sequence.
<b>unlock</b>	State of user Loadable Autodialer which permits entry and erasure of telephone numbers from memory. Also the state of the controller when Programming commands are accepted.
<b>unlock code</b>	Touch-Tone command sequence which places the controller in the state where Programming commands are accepted.
<b>User commands</b>	Class of Touch-Tone commands available to general repeater users.
<b>User Function Logic Outputs</b>	Logic outputs from the controller which may be remotely controlled with Touch-Tone commands for remote control of various equipment at the repeater site.



**User Loadable Autodialer** Autodialer which contains 190 phone numbers which may be loaded and erased by users remotely users. Persons with access to User commands.

**write** The act of storing Programming information into memory using Programming commands.



## Appendix II

## Connectors, Switches and Adjustments

## DIP SWITCH DEFINITIONS

	DESCRIPTION	ON	OFF
SW1	REPEATER RCVR COS	HIGH TRUE	LOW TRUE
SW2	REPEATER TX PTT	HIGH TRUE	LOW TRUE
SW3	CONTROL RCVR COS	HIGH TRUE	LOW TRUE
SW4	R/C MODE	EXPANDED/FC900	DIRECT
SW5	NOT USED (OFF)		
SW6			
SW7	FC-900 MODE	YES	NO
SW8	UNLOCK CMD DEFINE	DEFINE UL CODE	NORMAL

## RC-96

## Adjustments

R101	Telephone level (rear panel - PHONE)
R102	Receiver level (rear panel - RX)
R103	Link receiver level (rear panel - LRX)
R104	Transmitter level (rear panel - TX)
R105	Phone line drive level (rear panel - PH DRV)
R106	Speech synthesizer level
R107	Tone level
R108	Hybrid balance
R109	Speech pitch
R110	Speaker volume (front panel)



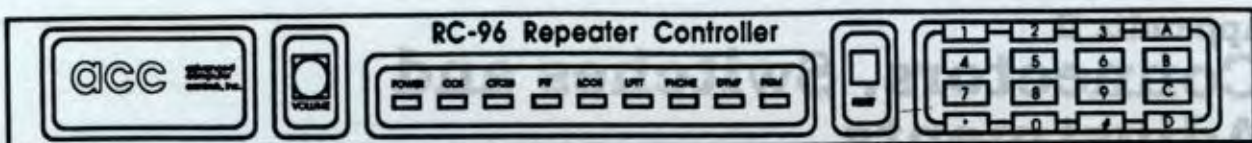

RC-96 CONNECTOR PINOUTS						
Color	PIN #	I/O	DVR	Cntl Rx	Link	Rptr
Black	1	Alarm	TX Audio Mixer Input	COS CR	COSL	COS
Brown	2	AG	AG	AG	AG	AG
Red	3	CX1	RX Audio	-	CX1	SMET
Orange	4	CX3	Serial Data	-	PTTL	PTT
Yellow	5	CX2	Phone Out	-	CX2	CTCSS
Green	6	Ph. Busy	Phone Spare In	-	TX Audio	TX Audio
Blue	7	CT Sel	Busy	CR RX Audio	Link RX Audio	RX Audio
White	8	DG	COS	DG	DG	DG
Tin	shield	DG	DG	DG	DG	DG

### DIN CONNECTOR PINOUT

#### REAR VIEW

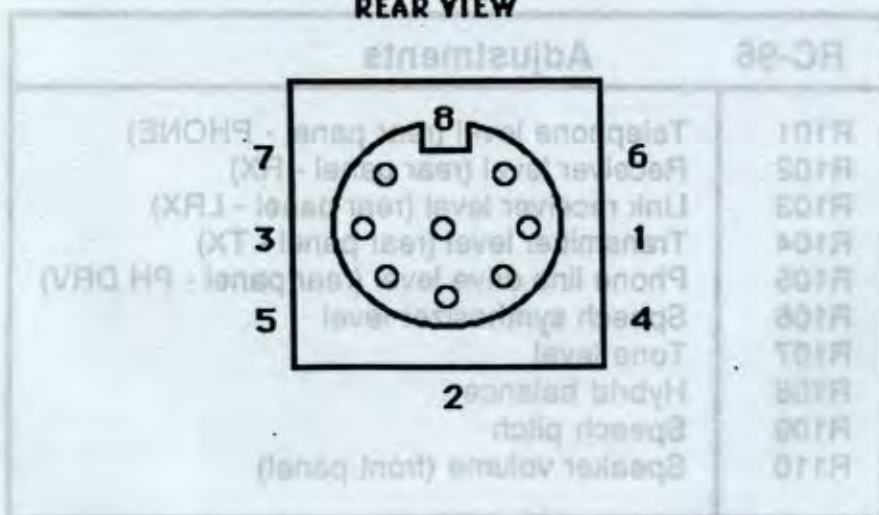



# Appendix III Schematic

MODEL	TYPE	MANUFACTURER	PART NUMBER
74181	IC	INTEGRATED CIRCUITS	74181
74182	IC	INTEGRATED CIRCUITS	74182
74183	IC	INTEGRATED CIRCUITS	74183
74184	IC	INTEGRATED CIRCUITS	74184
74185	IC	INTEGRATED CIRCUITS	74185
74186	IC	INTEGRATED CIRCUITS	74186
74187	IC	INTEGRATED CIRCUITS	74187
74188	IC	INTEGRATED CIRCUITS	74188
74189	IC	INTEGRATED CIRCUITS	74189
74190	IC	INTEGRATED CIRCUITS	74190
74191	IC	INTEGRATED CIRCUITS	74191
74192	IC	INTEGRATED CIRCUITS	74192
74193	IC	INTEGRATED CIRCUITS	74193
74194	IC	INTEGRATED CIRCUITS	74194
74195	IC	INTEGRATED CIRCUITS	74195
74196	IC	INTEGRATED CIRCUITS	74196
74197	IC	INTEGRATED CIRCUITS	74197
74198	IC	INTEGRATED CIRCUITS	74198
74199	IC	INTEGRATED CIRCUITS	74199

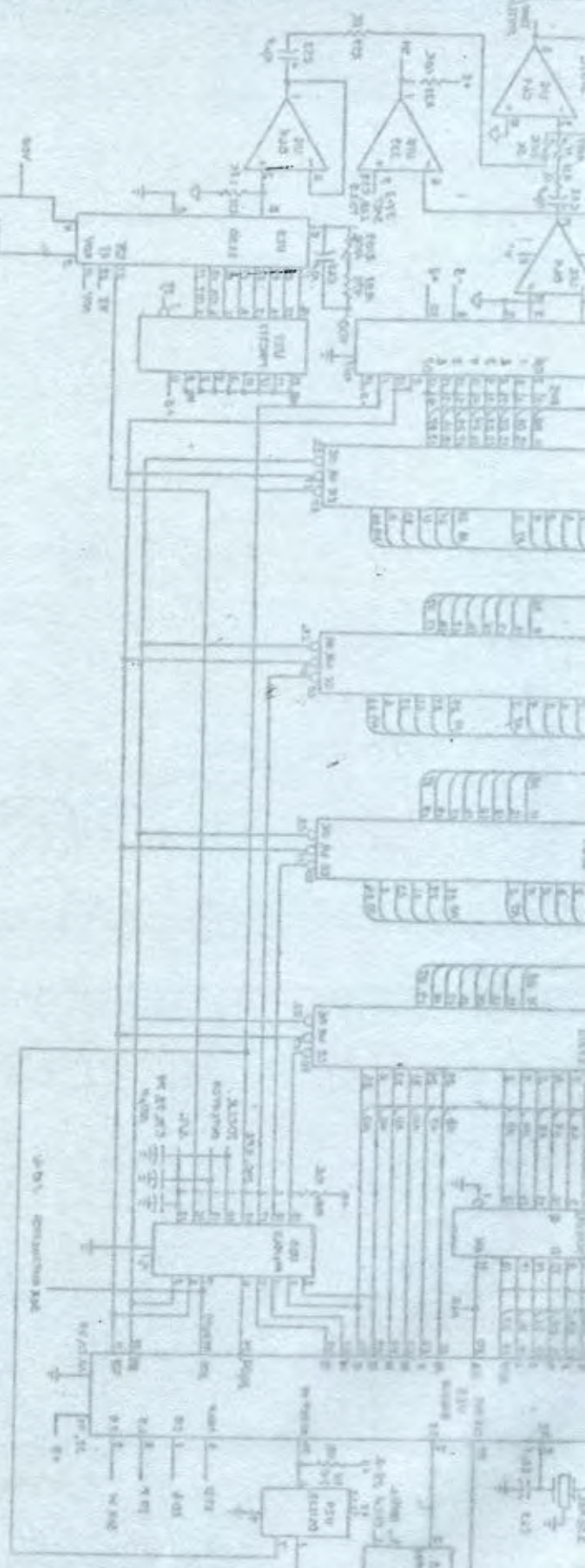
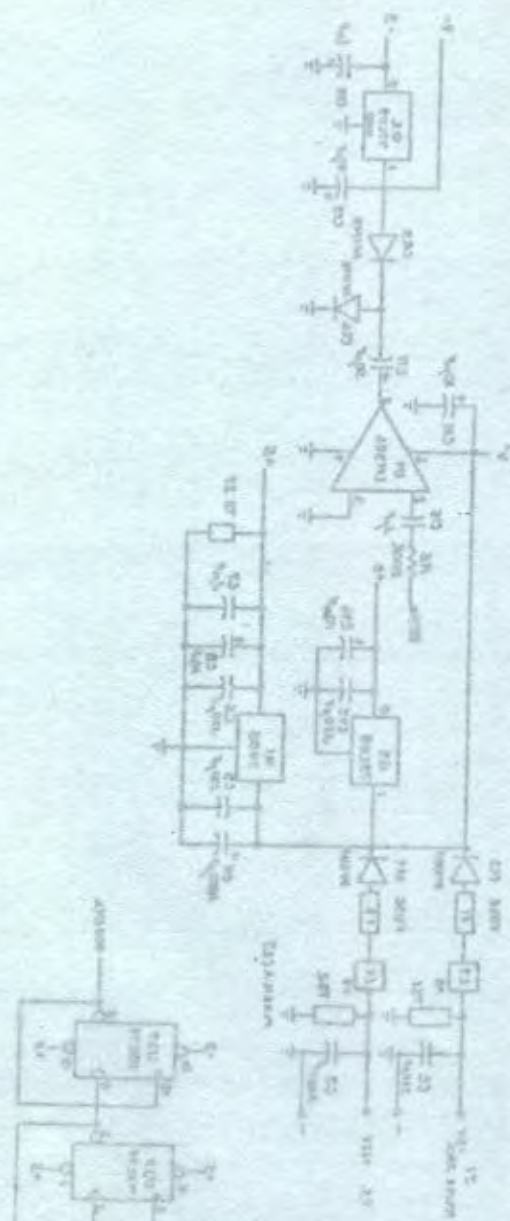



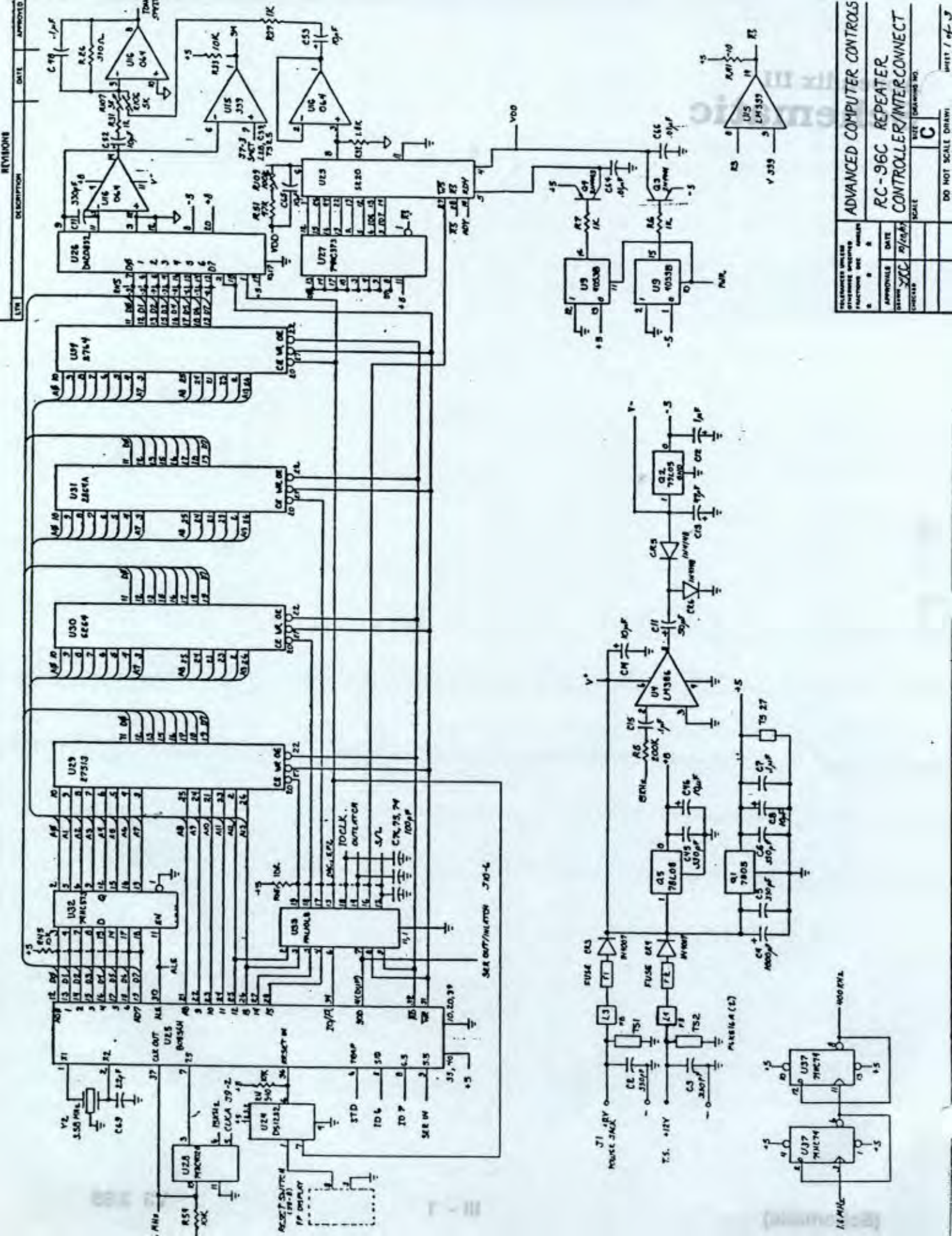

REV	DESCRIPTION	DATE	APPROVED

ADVANCED COMPUTER CONTROLS			
RC-96C REPEATER CONTROLLER/INTERCONNECT			
DESIGNED BY	DATE	SCALE	SHEET NO.
XXX	2/10/75	C	1 of 3
CHECKED BY			
APPROVED BY			

DO NOT SCALE DRAWING















# Index

- access 3-3, 5-16, 6-3
- adjustments 2-6, Appendix II
- alarm
  - interface 8-4
  - commands 6-7
  - message 7-7
  - site alarm 8-4
- audio
  - input characteristics 2-2
  - level adjustments 2-4, Appendix II
  - output characteristics 2-4, 2-6
  - receiver interface 2-4
  - transmitter interface 2-4
- Autodialer
  - see "User Loadable Autodialer" and "Emergency Autodialer"
- Autopatch
  - command codes 6-4, 7-10
  - cover tone 5-5, 6-4, 6-5
  - operation 5-2, 6-4
  - timers 5-6, 6-4, 7-9
  - toll restrict 5-3, 6-4
  - hangup 5-4
  - see also:
    - Emergency Autodialer patch
    - reverse patch
    - User Loadable Autodialer
- battery 2-2
- bulletin board
  - programming 7-7, 7-8
  - selection 5-12
- command codes 7-10, Appendix I
- command channels 3-2, 4-3, 4-4
- command evaluation 4-4
- connectors
  - audio 2-4, Appendix II
  - logic 2-5, Appendix II
  - phone line 2-5, Appendix II
  - power 2-2, Appendix II
- Control Operator commands 3-2, 4-1, 4-2, Chapter 6, 7-10, 7-11
- control receiver
  - command channel 3-2
  - interface 8-3
- COR
  - see "COS"
- COS
  - interface 2-2
  - levels 2-3
- courtesy tone
  - commands 7-8
  - operation 3-5, 7-8
  - selection 7-8
  - telemetry 3-5, 7-9
- CTCSS 3-3, 6-3
- custom hangup 5-4
- demo messages 5-12, 7-10
- Digital Voice Recorder 7-8, 8-9
- DIP switches 2-5, Appendix II
- D-key 4-4
- editor
  - see "Message Editor"
- Emergency Autodialer
  - commands 5-9, 6-5, 7-10
  - loading numbers 7-10
  - loading messages 7-7
  - operation 5-9
- external tape player 7-8, 8-9
- full-duplex
  - selection 5-5
  - commands 6-6
- glossary Glossary
- ground 2-2, 10-2, Appendix II
- hang time 3-3, 3-5, 7-9
- ID
  - commands 6-6
  - editing 7-6
  - previewing 5-12
  - selection 3-4, 6-6
  - timing 3-4
- initialization 6-8
- interfacing
  - alarm 8-4
  - control receiver 8-3
  - COS 2-2
  - CTCSS decoder 8-1
  - Digital Voice Recorder 8-9
  - external tape player 8-9
  - levels, audio 2-4, 2-6
  - levels, logic 2-2, 8-5
  - link 8-7
  - phone line 2-5, Appendix II
  - power 2-4, Appendix II
  - PTT 2-3
  - receiver audio 2-4
  - remote base 8-7
  - remote control outputs 8-5
  - S-meter 8-2
  - site alarm 8-4
  - spare audio 8-8
  - transmitter audio 2-4
- Kerchunker filtering 3-7
- link
  - see "Remote Base"
- lock
  - configuration 7-1
  - User Loadable Autodialer 6-5
- macro sets 4-3, 6-2, 7-11
- message editor 7-2, 7-6
- microprocessor reset 6-8
- Morse code
  - character codes 7-3
  - editing messages 7-3, 7-6
  - pitch 7-8
  - speed 7-8
- noise filtering 3-7
- pad test 5-1
- paging tones 5-14, 5-15, 7-12



- patch
  - activity timer 5-6, 6-4, 7-9
  - custom hangup code 5-4
  - dialing prefix 7-7, 7-8
  - hangup 7-7, 7-10
  - redial 5-4
  - timer extend 5-6
  - utility prefix 5-4, 5-11, 7-10
  - see also:
    - Autopatch
    - Emergency Autodial
    - telephone line
    - User Loadable Autodial
    - reverse patch
- PBX
  - see "patch: dialing prefix"
- phone line
  - see "Telephone line"
- pocket pagers 5-14, 7-10
- power 2-2, 10-2, Appendix II
- powerup state
  - see "Macro Sets"
- programming
  - commands 4-1, 4-3, Chapter 7
  - lock 4-3, 7-1
  - unlock 4-3, 7-1
- push-to-talk (PTT) 2-3
- Questions and Answers 10-3
- remote base
  - commands 5-13, 6-4, 7-10
  - interfacing 8-7
  - operation 5-13
- remote control outputs
  - see "User Function Outputs"
- reset 6-8
- reverse patch
  - commands 5-10, 6-6, 7-10
  - operation 3-2, 5-10, 5-11
- signal strength
  - see "S-Meter test"
- site alarm
  - see "Alarm"
- S-Meter test 5-12, 7-10, 8-2
- spare audio
  - command 5-16
  - interface 8-8
  - operation 5-16
- speech synthesizer
  - commands 6-7, 7-7
  - message editor 7-2
  - pitch adjustment Appendix II
  - vocabulary 7-4
- squelch gate
  - see "COS"
- subaudible tone
  - see "CTCSS"
- switches
  - control receiver COS Appendix II
  - link PTT/out 3 select Appendix II
  - repeater rcvr COS 2-2, Appendix II
  - repeater tx PTT 2-3, Appendix II
- tail messages
  - commands 6-7
  - operation 3-5, 6-7
  - programming 3-5, 7-7
  - selection 3-5, 6-7
  - timing 3-5, 3-6
- telephone line
  - control 3-2
  - interface 2-5
  - sharing 8-10
  - signalling type 7-11
  - timer extend 7-10
- timers
  - activity (patch) 6-6
  - Autopatch 5-3, 5-6, 6-4, 7-9
  - changing 6-2, 7-9
  - command codes 6-3
  - Emergency Autodial 7-9
  - interdigit 4-5
  - phone answer delay 7-9
  - tail message 3-5, 7-9
  - telephone 7-10
  - to end of transmission 4-5
  - timeout 3-6, 7-9
  - User Loadable Autodial 7-9
- Touch-Tone
  - access mode 5-16, 7-9, 7-10
  - cover tone 5-5, 6-5, 7-8
  - decoder
    - see "command channels"
  - muting 3-6, 4-4, 5-14
  - pad test 5-1
- troubleshooting 10-2, 10-3
- unlock
  - configuration 7-2
  - User Loadable Autodialer 6-4
- unmute Touch-Tone 4-4, 5-14
- User commands 4-1, 4-2, Chapter 5
  - commands 6-4, Appendix I
- User Function Outputs
  - commands 5-17, 7-10, 7-11
  - description 5-17
  - interfacing 8-5, 8-10
- User Loadable Autodialer
  - commands 5-7, 6-5, 7-10
  - erasing 5-7, 7-10
  - loading 5-7, 7-10
  - operation 5-8, 6-4
  - see also:
    - Autopatch
    - Emergency Autodial
    - patch
    - reverse patch
- vocabulary 7-4
- zero hang time 6-8



## Appendix IV

# AD-2 Audio Delay Board Kit

### Description

The AD-2 audio delay board delays the repeater receiver audio by 75 ms before reaching the repeater (and remote base) transmitter. The delay gives the '96 audio circuitry an opportunity to fully mute Touch-Tone (instead of passing "blips") and to fully mute squelch tails less than 75 ms in duration. The benefit of squelch tail muting is pleasant listening - no crash, chunk, or click is heard at the end of users' transmissions - just the courtesy tone. Touch-Tone blip muting has a variety of benefits, including pleasant listening, improved security, and elimination of sending tone blips through the remote base transmitter which could affect the linked repeater's control system.

The 75 ms delay is long enough to mute squelch tails in most receivers. Those receivers designed for a longer squelch tail may be modified in many cases by reducing a capacitor in the squelch circuit to reduce the tail duration.

Installation of the AD-2 board preserves the outstanding audio characteristics of the '96. Although low pass filtering is required on the board because of the sampled data nature of the delay line, flat frequency response is maintained to nearly 6 kHz.

The AD-2 board mounts in an existing IC socket on the '96 board. Three additional signals are picked up by the J-9 connector. These three wires are connectorized on the AD-2 board for easy removal if necessary.

### Installation

The board is supplied with mounting hardware for the '96. In addition, two Molex connectors and wire are supplied for connections to J-9 on the '96.

1. Cut the supplied wires to the following lengths. Strip about 1/8" insulation from one end, and about 1/4" insulation from the other end of each wire and tin each end.

orange - 10.25"                      green - 10.25"                      red - 10.25"

2. Crimp a Molex pin on both ends (the 1/4" stripped end) of each wire.

3. Install the Molex pins in the two white connector housings. Be sure that when the Molex connector plugs into the mating connector on the AD-2 board, the wires go to the pin labeled on the board as follows:

orange - pin 1                      green - pin 2                      red - pin 3



Be sure that when the Molex connector plugs into J-9, the wires, from left to right, are as follows:

red - pin 1

orange - pin 2

green - pin 3

4. Power down the RC-96 repeater controller.
5. Remove IC U9 (4053B) from the RC-96 board, and plug it into U5 of the AD-2 board. Be sure to plug it in so that pin 1 is oriented properly.
6. If your repeater receiver's COS signal is *low true*, remove the jumper wire at JU1.
7. Plug the 16 pin DIP plug on the bottom of the AD-2 board into a single 16 pin socket as a spacer. (Three 16 pin sockets will be left over.) Unscrew the 4-40 screw near the center of the board next to U23. Screw in the short standoff extender (see the assembly drawing on the following page). Mount the two short plastic spacers in the holes on the two diagonal corners of the AD-2 board using 4-40 screws. These will serve as supporting feet. Be sure that the socket spacer pins are straight, then carefully plug the AD-2 board into socket U9 on the RC-96 board. Screw a 4-40 screw into the standoff extender.

### Adjustments

No adjustments to R12 and R13 on the AD-2 board should be necessary. The pots set the DC bias and null point for the MN3005 chip.

If there is audio clipping, chances are that level coming into the board is too high. Back off R102 on the '96 board. Only if there is asymmetrical clipping should the R101 and R102 pots be adjusted, *and then only using an oscilloscope*. Adjust pot R101 so that very high level audio clips symmetrically at pin 4 of U5, and pot R102 at pin 4 of U4.



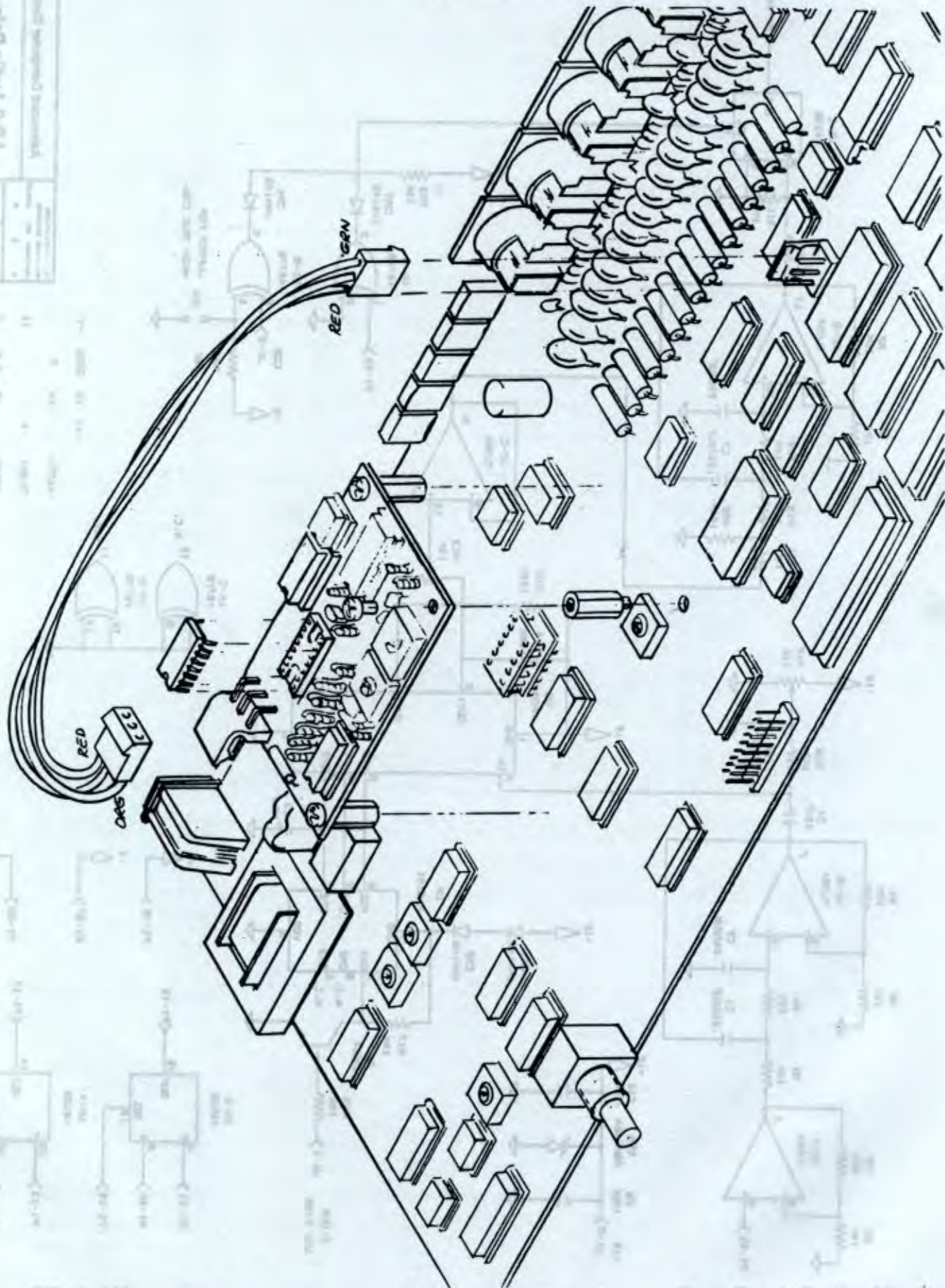



### Macro Set 1

RE RD	UE UD	T1 T2 T3 TF
TE TD	AU AL	RE AD
TL TS	UU UH	SE SD
CA PC PU FL	EE ED	SI SO
ME MD	NC XC NR	KE KD
CE CD	PT PX	TM TU
TE TD	TD TE TA	ZD ZE
LE LD	XE XD	FD AD
PE PD	RO R1 R2	CT ___
LE LD	P1 P2 P3 SP RP RS	

UF 1 2 3 4 5 6 7 8  
LINK OFF RCY XMT FREQ \_\_\_\_\_

### Macro Set 2

RE RD	UE UD	T1 T2 T3 TF
TE TD	AU AL	RE AD
TL TS	UU UH	SE SD
CA PC PU PL	EE ED	SI SO
ME MD	NC XC NR	KE KD
CE CD	PT PX	TM TU
TE TD	TD TE TA	ZD ZE
LE LD	XE XD	FD AD
PE PD	RO R1 R2	CT ___
LE LD	P1 P2 P3 SP RP RS	

UF 1 2 3 4 5 6 7 8  
LINK OFF RCY XMT FREQ \_\_\_\_\_



### Macro Set 3

RE RD	UE UD	T1 T2 T3 TF
TE TD	AU AL	RE AD
TL TS	UU UH	SE SD
CA PC PU PL	EE ED	SI SO
ME MD	NC XC NR	KE KD
CE CD	PT PX	TM TU
TE TD	TD TE TA	ZD ZE
LE LD	XE XD	FD AD
PE PD	RO R1 R2	CT _____
LE LD	P1 P2 P3 SP RP RS	

UF 1 2 3 4 5 6 7 8  
LINK OFF RCY XMT FREQ \_\_\_\_\_

### Macro Set 4

RE RD	UE UD	T1 T2 T3 TF
TE TD	AU AL	RE AD
TL TS	UU UH	SE SD
CA PC PU PL	EE ED	SI SO
ME MD	NC XC NR	KE KD
CE CD	PT PX	TM TU
TE TD	TD TE TA	ZD ZE
LE LD	XE XD	FD AD
PE PD	RO R1 R2	CT _____
LE LD	P1 P2 P3 SP RP RS	

UF 1 2 3 4 5 6 7 8  
LINK OFF RCY XMT FREQ \_\_\_\_\_





advanced  
computer  
controls, inc.

2356 Walsh Avenue, Santa Clara, California 95051  
(408) 727-3330

# RC-96 REPEATER CONTROLLER

**Owner's Manual**

**Firmware Version 3  
with Version 4 Updates and  
Command Code Summary**



## Chapter 10

# In Case of Difficulty

### Contents

- 10-1 **Maintenance**
- 10-1 **Servicing**
- 10-2 **General Checklist**
- 10-2 **Trouble-shooting Chart**
- 10-3 **Most Often Asked Questions, and Answers**

### Maintenance

The RC-96 controller is designed conservatively with high quality, reliable components, and it is very unlikely that a component failure will take the controller out of service. No periodic maintenance is necessary to ensure long life. Internal transient suppressors on each I/O lead and a three terminal gas discharge tube across the phone line minimize impact of lightning on all equipment in the system. Follow common sense in installing the controller, such as avoiding locating it in extremely hot or dirty areas. You should expect your RC-96 controller to run virtually forever.

### Servicing

However, since Zap, the Lightning God, has been known to visit repeater sites, it's possible that it may become necessary to repair the controller at some time in its service life. Even though the RC-96 controller includes transient protection to minimize the possibility of damage, this protection should be supplemented with sound site engineering to minimize impact of lightning on all equipment in the system.

Of course, the controller may be returned to the factory for repair, but it would be desirable to attempt to diagnose and repair failures at the site when possible to minimize repeater down time. While all potential failure modes can't be anticipated, the guidelines will help isolate the problem to a particular component or area.

In general, hardware failures can be classified into two broad categories – those where the computer executes its program correctly, and those where it executes garbage or nothing at all. If the computer is executing its program correctly, as evidenced by partial operation of the controller, the failure is probably a peripheral or interface circuit. Otherwise, the problem is probably the CPU, memory, or decoding circuitry.



**GENERAL CHECKLIST**

- ICs firmly seated in sockets?
- Cable connectors properly inserted?
- +12 volt and ground connected properly?
- DIP switches set correctly and firmly?
- Any components hot? (careful!)

**TROUBLE****PROBABLE CAUSE****REMEDY**

Computer Dead

+12 volt supply not present  
 Defective supply  
 Defective power wiring  
 +5 volt supply not present  
 Defective 7805 regulator  
 Defective IC overloading regulator

Repair supply  
 Repair wiring

Replace regulator  
 Locate and replace  
 defective IC  
 Replace xtal Y2

No audio

Oscillator not running  
 -9 volt supply not present

Trace "V-"

Distorted Audio

Excessive input level  
 Excessive deviation

Reduce input level  
 Reduce deviation control  
 in transmitter

Logic Inputs  
Not Sensed

Defective input buffer

Replace U5

Logic Outputs  
Not Operating

Need pullup resistor to define  
 high level  
 Defective output port  
 Defective output buffer

Add pullup resistor  
 Replace 74HC595  
 Replace IRFD113 transistor

Touch-Tone Decode  
Unreliable

Audio clipping  
 Excessive twist

Reduce level  
 throughout system  
 Flatten system  
 frequency response



## Most Often Asked Questions (and Answers)

### **The controller doesn't mute Touch-Tone and doesn't decode any commands.**

Check DIP switch 3 - this selects the control receiver COS logic sense. If you don't have a control receiver, switch 3 should be ON. If not, the controller thinks that the control receiver is active, and the Touch-Tone decoder is monitoring the control receiver audio input - not the repeater receiver.

### **Touch-Tone doesn't always decode. Why not?**

The dynamic range of the Touch-Tone decoder is very wide so that if the receiver audio to the controller is between a few hundred millivolts and 2.5 volts p-p, it should decode. But some mobile and portable rigs transmit tone levels very hot, which causes clipping of the tones in the user's transmitter. If the level is hot enough to distort, the only solution is to reduce the tone level in the user's rig so that it transmits clean Touch-Tone. Other possibilities are non-flat frequency response somewhere between the user's transmitter and the controller, which causes the two tones of the Touch-Tone to be greatly different in level.

There are several other things to check. If you have a control receiver, be sure that its squelch isn't opening when you don't suspect it is. Perhaps someone is calling the repeater on the phone, grabbing the Touch-Tone decoder. Be careful about who you give out your repeater number to.

### **The patch won't dial the phone number - it just reads back the number and beeps.**

Don't forget that you need to click your mike during the pause to initiate dialing, unless you select the Control Op mode "Dial without click" or "No Phone Number Readback".

### **Why won't the controller accept commands from the phone?**

Don't forget to terminate all Touch-Tone commands over the phone with a #. The # tells the controller to evaluate the command - without it, it'll just sit there.

### **Do I need to store a Control Op Macro Set whenever I make a change?**

Only if you want changes in the Control Op setup to be stored for powerup or macro selection.

### **I don't measure anything on the logic outputs. Why not?**

The logic outputs are open collector transistors. The transistor is either on, so that there's a path to ground, or it's an open circuit. To see a logic voltage level, you need to add a pullup resistor to define the logic high when the transistor is off. It's very tricky to try to measure resistance of the transistor output with an ohmmeter - don't try it. Just connect a pullup and look for a voltage.



### **I can't enter commands for a while after the controller hangs up the phone. What's going on?**

When the controller hangs up, the phone company sometimes reverses the battery ("winks"), and this can be seen by the controller as a ring, so it picks up the phone again. Set the Phone Answer Delay timer longer than about 10 seconds. Just before the controller answers the phone, it looks back in time eight seconds to see if the phone was still ringing in that period. With a longer answer delay time, it will reject the "wink" as a ring.

### **How do I change the Patch Hangup code back to #?**

Enter the Command Code Prefix Configuration command with an "empty" prefix, i.e., \*5011 with nothing following. This tells the controller to look for a # for hangup.

### **Do I need to enter \*0 to actually write programming information into E<sup>2</sup>PROM?**

No. The \*0 command applies only to the message editor, so use it to write an edited message, but nothing else.

### **What information is stored in the E<sup>2</sup>PROM?**

All Configuration commands result in storage of information in the E<sup>2</sup>PROM. Messages are stored after entering the \*0. Control Op setup information is written into the E<sup>2</sup>PROM only when storing a Control Op Macro Set with the Configuration command. All User Loadable Autodial Load/Erase commands also write to the E<sup>2</sup>PROM.

### **When I programmed something with a Programming command, the controller said, "E R, Write". What's wrong?**

The "E R" message indicates that there was a problem writing into the E<sup>2</sup>PROM. If you get this message, contact the factory to help determine the nature of the failure.

### **How many digits can be in the autodial numbers?**

All 200 autodial locations (10 Emergency and 190 User Loadable) may contain up to 11 digit phone numbers.

### **Why does the voice response wait up to a few seconds when I enter a Programming command?**

It's programming the E<sup>2</sup>PROM which takes about 100 ms per byte. The Special ID, as an example, will take almost 5 seconds to program - it's normal.

### **If the Touch-Tone Access Mode is enabled but down, will a reverse patch come through?**

Yes. A reverse patch will bring up the TT Access Mode and load the TTAM timer. Assuming the timer is non-zero, it will time itself back down if there's no activity.



**Sometimes when entering the Link Receive Only command, the controller reads back the frequency and other times it reads back "Remote Base R". What is the rule?**

If the frequency is set to all zeros, it says, "Remote Base R". Otherwise it reads back the frequency.

**When making a patch, there's a slightly longer delay until it starts to dial. Why?**

To avoid falsing the phone company's Touch-Tone decoder, the controller waits until it's finished "talking" before going offhook. Then it waits 1.5 seconds before starting to dial.

**The controller doesn't always ID when the Touch-Tone Access Mode goes down. How come?**

Generally it will ID when going down only when it's necessary, i.e., there has been some activity since the last ID. For example, if the TTAM timer is set to 20 minutes, if no activity causes it to time out, it won't generally be necessary to ID because it would have completed the ID cycle several minutes earlier.

**What's the patch Activity Timer for?**

The activity timer causes a patch to be terminated if the mobile drives out of range or otherwise goes away. The timer resets at the beginning and end of each transmission. If it's allowed to time out (no carrier or stuck carrier), there's a warning warble, and if there's still no "activity" within 10 seconds, it will hang up. The patch activity timer can be used along with, or instead of, the overall patch timers.



## Chapter 1

# Introduction and Specifications

The RC-96 Repeater Controller is a complete control system for two-way radio repeater stations. It provides everything needed between the repeater's transmitter and receiver. The controller serves the traditional repeater control requirements and adds a host of additional capabilities which make your repeater more useful. It introduces the concept of remote programming, which permits changing the repeater's characteristics from anywhere using a Touch-Tone command set.

For example, programming an IDer previously involved constructing a diode-matrix read-only memory to form the dits and dahs of Morse code. The RC-96 controller, on the other hand, allows you to edit ID messages with your Touch-Tone pad and store them in the board's non-volatile memory. But that's just part of the story - your repeater can talk to you! The IDs may be in natural-sounding synthesized speech so your users don't have to be CW buffs to understand what the repeater is saying. Add to that the RC-96 controller's custom repeater-oriented speech vocabulary of nearly 500 words, and you can easily construct informative ID messages for your repeater's users.

If there's a net tonight at 8 o'clock, one of the IDs can say, "Net tonight at 8, on WA6AXX, Repeater". Or on Fridays say, "TGIF, from WA6AXX, Repeater". Or change the ID messages for special events using any of the words in its large vocabulary, in seconds, from home, using your Touch-Tone pad.

The autopatch built into the RC-96 controller is second in capability only to ACC's RC-850 controller. Gone are the days of wrong numbers because of a fluttery signal or marginal decoding. No more fumbling to enter an access code, then the phone number, while you're trying to drive down the freeway. The RC-96 controller's built-in autodialer lets you dial stored numbers with simple two digit commands. Just tell it what autodial location you want, then the controller goes offhook, waits for dial tone, and dials the number for you in Touch-Tone or dial pulse. If the number you want isn't in one of the autodialer's 200 slots, enter the number as part of the patch command and it will be read back to you (in voice) to make sure you've entered it correctly before it dials!

The controller's support of synthesized remote base operation allows linking your repeater to other repeaters accessible from your site, extending the usable range of your system and making your radio equipment more valuable. PL access and control and a Touch-Tone access mode provide security and interference immunity. Two-tone and five-tone paging offer selective calling through your repeater to standard pocket pagers, which means users don't have to be listening to be available.



## Standard Features

- Complete standalone repeater controller**
- Remotely programmable with Touch-Tone commands**
  - Messages – over 25 (ID's, tails, Bulletin Boards, etc.).  
May include CW, synthesized speech, and DVR tracks (w/Digital Voice Recorder)
  - Morse code parameters – Speed – 12-30 WPM; Pitch – dc-3000 Hz
  - Control Op and user command codes (19 prefix groups, up to 7 digits each)
  - Courtesy tone selection (from 10 predefined sets)
  - Timers – 10 sets, 0-30 minute with 1 second resolution
  - Autodialer numbers (200)
  - Pager memories (1000)
  - Non-volatile E<sup>2</sup>PROM storage (no batteries)
- Natural sounding speech synthesizer** for effective user/repeater interface
  - Custom ham/repeater/public service vocabulary of nearly 500 words
  - Letters, numbers, phoenetic alphabet
  - Amateur radio terms – club, net, meeting, hamfest, amateur, etc.
  - Days of the week, months of the year
  - Weather, emergency, and public service words
  - Easy to use interactive message editor
- Autopatch / Autodial**
  - FCC registered telephone interface
  - Store/forward, DTMF or rotary
  - Full or half-duplex
  - Optional phone number readback for confirmation before dialing
  - User Loadable Autodial (190 numbers)
  - Emergency Autodial (10 numbers) with message readback
  - Toll restrict – leading 1/0 and digit count
  - Cover tone for semi-private patches
  - Programmable overall timer and activity timer with warning warble
  - Paging, ringout, control from the telephone line
  - Three terminal gas discharge tube for effective lightning protection
- Reverse patch**
- Talking S-Meter** for user signal strength readings from the repeater
- Paging** – two-tone sequential, five-tone sequential; 1000 pager memories
- Remote base** transceiver control – commandable frequency and mode (BCD type “thumbwheel” transceivers)
- CTCSS access and control modes** (with Tone Panel option or external CTCSS decoder)
- Touch-Tone access mode** with programmable timeout
- Remote control logic outputs** – 3 expandable to 8
- Low distortion computer synthesized tone generation**
- Courtesy Tones** – 10 selectable sets
- Noise and kerchunker filtering**
- Touch-Tone muting**
- Control receiver provisions**
- Site alarm logic input**
- Intelligent ID algorithm** – automatically selects from up to 7 programmable ID's
- Tail messages** – 3, programmable repetition rate
- Command acknowledgement** with unique messages
- Low power, single supply operation** with built-in battery backup circuitry
- Attractive 19" rack mount enclosure** with adjustable mounting ears
- Front panel keypad and display**, rear speaker jack for easy local programming
- Proven reliability** designed in, with watchdog timer, voltage monitoring circuitry, extensive lightning protection, conservative design
- Compatible with ACC's Digital Voice Recorder**
- Manual and free telephone technical support**



## Options

- CTCSS Tone Panel (Encoder/Decoder)** - up to 8 remotely selected tones from EIA standard 37 plus 97.4 Hz
- AD-1 Audio Delay "Piggyback Board Kit"** - to *fully* mute Touch-Tone and squelch tails through the repeater
- FC-1 Frequency Control Board** - for frequency control of BCD remote base transceivers and remote control output expansion



**Warning:** This equipment generates, uses, and can radiate radio frequency energy and if not installed and used in accordance with the instruction manual, may cause interference to radio communications. It has been tested and found to comply with the limits for a Class A computing device pursuant to Subpart J of Part 15 of FCC Rules, which are designed to provide reasonable protection against such interference when operated in a commercial environment. Operation of this equipment in a residential area is likely to cause interference in which case the user at his own expense will be required to correct the interference.

**Got a question? Be sure and check "Most Often Asked Questions and Answers" in Chapter 10.**

Touch-Tone is a registered trademark of American Telephone and Telegraph company.

HamVention is a registered trademark of Dayton Amateur Radio Association.

ShackMaster is a trademark of Advanced Computer Controls, Inc.

Copyright © 1988 Advanced Computer Controls, Inc.

All rights reserved

Printed in U.S.A.

Specifications subject to change without notice

RC-96 Controller Software Copyright © 1988 ACC

RC-96 Controller Command Codes Copyright © 1988 ACC



## Chapter 2

# Hookup to Your Repeater

### Contents

- 2-1 Introduction
- 2-2 Power
- 2-2 Trying it Out
- 2-2 Carrier-Operated-Switch
- 2-3 Push-to-Talk
- 2-4 Receiver Audio
- 2-4 Transmitter Audio
- 2-5 Telephone Line
- 2-5 Setting DIP Switch Options
- 2-6 Setting Audio Levels

## Introduction

The RC-96 controller is the new "brain" of your repeater, but to have its orders carried out it needs a few connections. It needs to know when there's a signal at the receiver's input, and it needs to be able to tell the transmitter when to turn on and off. The controller must be able to listen to audio from the receiver, both to hear Touch-Tone command codes you're sending it, and also because it passes receiver audio on to the transmitter. And finally, since the controller board has final say on what audio goes to the transmitter, it needs to connect to the transmitter's audio input.

Since all the control functions are handled internally by the RC-96 controller, the only connections absolutely necessary to the rest of the system are these four basic signals plus power. Connecting a phone line to the board lets you use the patch, reverse patch, telephone access paging and control from the phone capabilities. Other inputs and outputs from the controller allow you to build a "Super System" with a control receiver, remote base or crossband link, CTCSS operation, site alarm, Digital Voice Recorder, and remote control outputs. We'll go into these in Chapter 8, but for now let's just cover the basics.

## Interface Signals Required

- Power** - "POWER" jack or terminal block "+12V" and "GND"
- Carrier-Operated-Switch (COS)** - "REPEATER" DIN connector pin 1
- Push-to-Talk (PTT)** - "REPEATER" DIN connector pin 4
- Receiver Audio** - "REPEATER" DIN connector pin 7
- Transmitter Audio** - "REPEATER" DIN connector pin 6
- Phone Line** - modular jack and cord (supplied)



## Power

The RC-96 controller will operate from a supply voltage of 11.5 to 15 volts DC at a current of 250mA. Low power, single supply operation means it's easy to battery back up, along with the rest of your repeater, to keep it available in case the primary supply goes away. It also means that primary power can be borrowed from the existing system 12 volt supply. Good system design suggests avoiding unnecessary duplication of power supplies in the repeater system, so it shouldn't be necessary to dedicate a supply to the controller.

Inputs for your primary supply and an optional backup battery are provided at the "POWER" connector and at the terminal block "+12V" and "GND" terminals. The primary supply and optional battery may connect to either power input. The power inputs are diode isolated so that the battery is normally isolated from the load through a back biased diode until the primary supply goes away, at which time the battery instantly begins supplying the power. The battery is only necessary to continue operation of the controller - remotely programmed information is stored in non-volatile memory and *does not require battery backup*. The controller does not provide trickle charging to the battery.

## Trying it Out

Before you hook up the RC-96 controller to your repeater, you may want to program the ID's, tail messages, Bulletin Boards, and other features. Using the external speaker jack on the rear panel, plug in an 8Ω speaker and supply 12 volts to the unit (see "Power" above). The '96 will "wake up" and all the front panel LEDs will light up momentarily. The "Power" indicator will stay lit and the '96 will say, "This is the Advanced Computer Controls RC-96 Repeater Controller, Vx.x." While the '96 is talking, adjust the volume to a comfortable listening level using the volume control knob. Before you begin programming, do a Touch-Tone pad test by pressing

5 (any sequence of keys) #

The 5 is the Touch-Tone pad test prefix and the # key acts as an enter key. The "DTMF" indicator will light up to verify that the tones are being decoded. The controller will respond with the sequence of keys you entered. If the '96 does not respond with the numbers you entered, double check the power and speaker connections. Once you have verified that the Touch-Tone pad works, you may begin programming. See Chapter 7 - "Programming the Controller", for further details. Or you may wait until the controller is installed in your repeater and program the controller remotely.

## Carrier-Operated-Switch

The output from the receiver which indicates that a signal is present is called COS, or carrier-operated-switch. It's a logic signal which is at a particular logic state when a signal is at the receiver's input, or the squelch is open, and at the opposite state when the squelch is closed. Most receivers designed for repeater service have such a logic output, called



receivers designed for repeater service have such a logic output, called "COS", "COR", "squelch gate", or something similar. With other receivers, such as transceivers put into repeater service, it's necessary to find a usable logic signal for COS. Look after the FM detector, following the noise amplifier and rectifier in the squelch circuit, for a usable signal. Contact the receiver's manufacturer if you need help with your particular receiver.

Since signals from different receivers can vary in characteristics, the RC-96 controller is designed to accept a variety of logic levels and to accept "high true" and "low true" signals. The only requirements are that a logic low be less than .8 volts and a logic high be greater than 2.4 volts (up to about 15 volts). The COS input high impedance is approximately 10K ohms so that it won't load down the circuitry providing the COS signal. A DIP switch accessible from the rear allows selection of high or low true, based on what your receiver provides. For a high true COS, set DIP switch 1 ON; for low true COS, set it OFF.

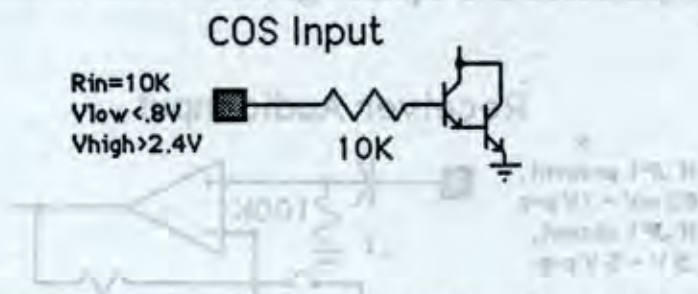

### Push-to-Talk

The PTT (push-to-talk) signal is just as easy to interface to the transmitter. The controller provides a solid-state switch closure to ground capable of sinking up to 500 mA from a positive source. Most any transmitter has a keying line (PTT), so if a contact closure to ground normally keys the transmitter, you're in business. If a logic high keys your transmitter, the controller board also allows PTT high true operation, so that a pullup resistor on the output can define a logic one level to the keying logic. High or low true operation is selected by a DIP switch option. For a high true PTT, set DIP switch 2 ON; for low true PTT, set it OFF.

If your transmitter has *negative* voltage on the keying line, it's necessary to buffer PTT with a relay or other transistor circuitry. The PTT transistor switch is capable of keying positive voltages only and may be damaged if connected to a negative voltage.

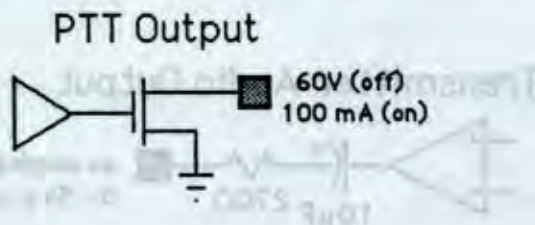



## Receiver Audio

Audio from the receiver needs to be supplied to the controller. The receiver audio is mixed with other audio sources before being sent along to the transmitter.

The receiver audio input circuitry to the RC-96 controller allows for a variety of signal levels and impedances. The audio input is capacitively coupled, which means that a DC level may be present on the signal supplied. The level is internally adjustable so that a fairly wide range of input levels is acceptable, but for best results the input audio should be greater than approximately 1 volt peak-to-peak. If the level available is less than approximately 1 volt peak-to-peak, add jumper JP1 to increase the input sensitivity (to 100mV).

The input impedance for receiver audio is 100K ohms so that audio may be picked off from anywhere inside the receiver without loading problems. No impedance matching is necessary. Find a point past the FM detector where the audio is de-emphasized and squelch gated to route to the controller.

### Receiver Audio Input

If JP1 present,  
80 mV - 1V p-p  
If JP1 absent,  
.5 V - 5 V p-p

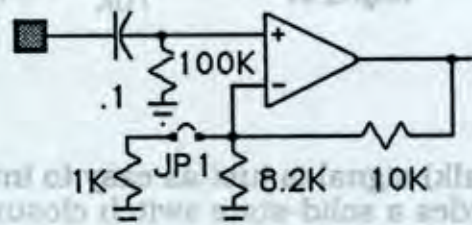

## Transmitter Audio

Audio is supplied by the controller to the transmitter. Any existing internal audio paths in the repeater should be disabled.

The audio consists of receiver, speech synthesizer, tone, link, and phone patch audio, switched and mixed under the control of the computer in the RC-96 controller. The audio out of the controller is adjustable level and low source impedance so it's easy to find a good place to inject it into the transmitter. If the transmitter audio input is very sensitive, it may be best to reduce the gain of its audio input stage by changing a resistor value.

### Transmitter Audio Output

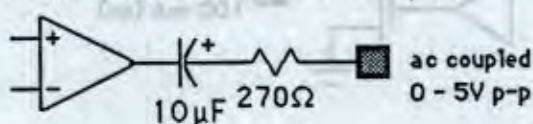



## Telephone Line

The RC-96 controller may connect directly to the telephone line through the supplied modular cord which plugs into the modular jack. Since all the autopatch, autodial, reverse patch, and control over the phone line functions are handled by the controller, connection to the phone line enables all these capabilities. The "EG" (earth ground) terminal of the block should be run through a separate wire directly to the grounding system. This terminal is connected to the third pin of a gas discharge tube across the phone jack, and connection to a good ground will help protect the controller from lightning.

## FCC Notice To User

1. UPON REQUEST ONLY, you must provide the following data to your telephone utility company (telco):
  - (a) Notice of intention to install or permanently remove an FCC Part 68-registered device or system, and the FCC Registration Number\*.
  - (b) The Ringer Equivalence (R.E.N.) Number\*. Note that if several devices are connected to the same line, the R.E.N.'s must not add up to more than 5.0. This R.E.N. figure is important to your telco.
  - (c) The USOC jack type to be provided by the telco - RJ11C.

\* See equipment FCC Compliance label.
2. This device may not be used on telco-operated coin phone lines. Party lines and privately owned coin-phones are subject to local State regulatory policies, and possible additional State special requirements.
3. The telco has the right to make changes to their network which may affect the operation of your equipment, provided you are given adequate advance written notice to permit correct operation.
4. In case of operational problems, disconnect your unit by removing the modular plug from the telco's jack. If your regular phone still works properly, your RC-96 controller has a problem and must remain disconnected and (officially) serviced or returned for repairs. If upon the above disconnection your regular phone still has problems, notify your telco that they may have a problem. Request prompt service at no cost to you the user. If a problem is found in premises wiring not telco-installed, you are subject to a service charge. If a fault is in telco-installed wiring, you may be subject to a service call charge.
5. Unless otherwise noted in the Owner's Manual (eg: fuses, etc.), user may not under any circumstances (in or out of warranty) attempt any service, adjustments or repairs on this unit. It must be returned to the factory for all such work. The location of the factory is listed in this Owner's Manual.
6. Special FCC rules apply to equipment connected behind a PBX or KTS.

## Setting DIP Switch Options

Switch settings on the RC-96 controller board select high or low true sense for the COS and PTT signals (see below). It's now necessary to set the switches correctly to properly control the repeater. Switch 1 selects COS sense and switch 2 selects PTT sense. Assuming you don't have a control receiver connected yet, switch 3 must be set ON so that the controller doesn't think that a control receiver is active, therefore grabbing the Touch-Tone decoder. The other switches should be left off for now.



INITIAL DIP SWITCH SETTINGS			
DESCRIPTION		ON	OFF
SW1	REPEATER RCVR COS	HIGH TRUE	LOW TRUE
SW2	REPEATER TX PTT	HIGH TRUE	LOW TRUE
SW3		ON	
SW4-8		OFF	

See Chapter 8 and Appendix II for additional details.

### Setting Audio Levels

Several of the audio levels to the transmitter and phone may be adjusted with a small screwdriver using pots accessible from the rear panel. The levels of the speech synthesizer and tone generator may be adjusted, if necessary, with p.c. board mounted pots accessible with the cover removed. The receiver audio levels (repeater and link receivers, "RX" and "LRX") should be adjusted to match the preset speech synthesizer level. The overall audio level to the transmitter may be adjusted with pot "TX".

The audio level from the phone ("PHONE") should be adjusted during a phone patch. The audio drive level into the telephone may be adjusted with pot "PH DRV".

Remember that the RC-96 controller is an audio source to the transmitter, and its various audio levels should be balanced relative to each other. First, balance the audio levels from the various sources to the controller, including your receivers, at the controller's output, using the preset speech synthesizer and tone generator as a reference. An oscilloscope viewing the transmit audio is ideal for monitoring these levels. Then, with the controller connected to the transmitter, use the TX pot as a transmit audio level adjustment. Adjust the controller's TX pot and transmitter deviation control using a deviation meter. Certain high frequency audio peaks may be allowed to clip in the transmitter's peak limiter.

**This completes** the basic installation of the RC-96 Repeater Controller into your system. You're now ready to put it on the air!



# RC-96 Repeater Controller Version 4

## New Features ... Not in the V3 Manual!

### User's Features

#### IC-900 Support

The new software supports IC-900 band units as remote base transceivers, interfaced via the FC-900. Refer to the FC-900 Manual for details.

#### Reverse Patch Answer Acknowledgement

When the reverse patch is answered over the air, a "beep-beep" acknowledgement is sent over the air to confirm connection.

#### Touch-Tone Access Up Message

When a user brings Touch-Tone Access up, the controller acknowledges with "up".

### Control Operator

The following new Control Operator level commands are available. They are included in the command summary at the end of this section.

#### Macro Set Selection Commands

A fifth macro set is available. It is selected with the following Control Op command.

<b>5</b>	<b>M5</b>	<b>Macro Set 5 Select</b>	Selects Control Op Macro Set #5
----------	-----------	---------------------------	---------------------------------

#### Disable Autopatch Phone Number and Autodial Location Readback

<b>68</b>	<b>NR</b>	<b>Disable Autopatch Phone Number and Autodial Location Readback</b> (and dial without click)
-----------	-----------	---

This new command is mutually exclusive with the existing commands:

<b>60</b>	<b>NC</b>	Dial Needing Click
<b>59</b>	<b>XC</b>	Dial Without Click

### Programming the Controller

#### Timers

*4014(period)	TK	Talkout Timer	Reverse Patch Mode 3 Talkout period limit. If not "answered" from over the air during this period, the controller will hang up.
*4015(period)	AL	Alarm Timer	Limits the period that the alarm message will be generated over the air.

#### Command Code Prefixes

*5019(prefix)	Touch-Tone Pad Test Prefix
---------------	----------------------------



## Chapter 3 General Operation

### Contents

- 3-1 Introduction
- 3-2 Command Channels
- 3-2 Control Over the Telephone Line
- 3-3 Access
- 3-4 ID Timing and Selection
- 3-5 Courtesy Tone
- 3-5 Tail Messages
- 3-6 Timeout Timer
- 3-6 Touch-Tone Muting
- 3-7 Noise and Kerchunker Filtering

### Introduction

The RC-96 Repeater Controller brings your repeater to life by automatically controlling the operation of the system and by responding to Touch-Tone commands from its users. A system block diagram is shown below, illustrating how the controller fits into a typical repeater system.

### REPEATER BLOCK DIAGRAM

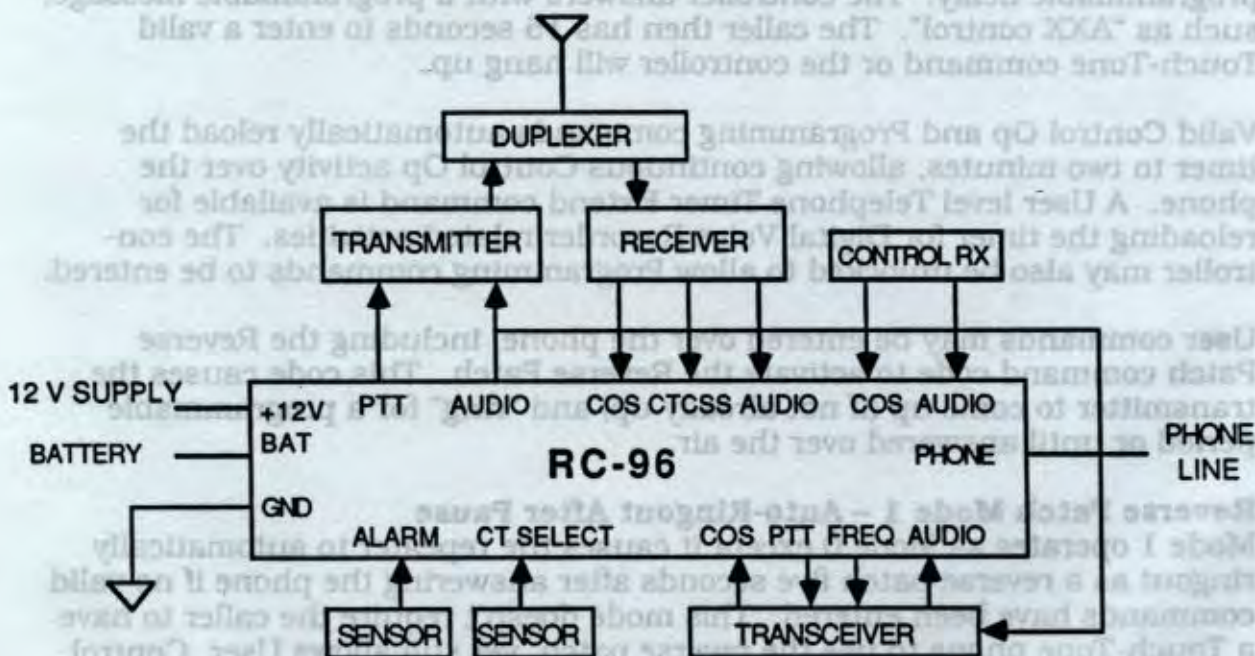



The controller's command decoder and command structure are described in detail in the next chapter. We'll describe here the command channels, along with access modes, ID, courtesy tone, tail messages, and other aspects of the controller's operation.

## Command Channels

Commands may be entered from the front panel keypad, over the repeater receiver, the telephone, or through the control receiver. The Touch-Tone decoder is always connected to one channel based on its priority.

Priority for Selection by Decoder	
Front Panel Keypad	(highest)
Control Receiver	
Telephone	
Repeater Receiver	(lowest)

## Control Over the Telephone Line

The Reverse Patch Mode is selectable with Control Operator commands and may be enabled or disabled as well.

### Reverse Patch Mode 0 – Normal Control Mode

Calls into the repeater's phone line are answered by the controller after a programmable delay. The controller answers with a programmable message, such as "AXX control". The caller then has 15 seconds to enter a valid Touch-Tone command or the controller will hang up.

Valid Control Op and Programming commands automatically reload the timer to two minutes, allowing continuous Control Op activity over the phone. A User level Telephone Timer Extend command is available for reloading the timer for Digital Voice Recorder related activities. The controller may also be unlocked to allow Programming commands to be entered.

User commands may be entered over the phone, including the Reverse Patch command code to activate the Reverse Patch. This code causes the transmitter to come up (if not already up) and "ring" for a programmable period or until answered over the air.

### Reverse Patch Mode 1 – Auto-Ringout After Pause

Mode 1 operates as Mode 0 except it causes the repeater to automatically ringout as a reverse patch five seconds after answering the phone if no valid commands have been entered. This mode doesn't require the caller to have a Touch-Tone phone to use the reverse patch, yet still allows User, Control Op, and Programming control over the phone.



**Reverse Patch Mode 2 – Ringout Without Answering**

Mode 2 causes a ringout over the air without answering the phone for a programmable period or until the reverse patch is answered over the repeater. If Mode 2 is selected, no control functions may be accomplished over the phone.

**Reverse Patch Mode 3 – Telephone Access Paging / Control**

Mode 3 is similar to Mode 0 except that it is optimized for talkback paging applications. Upon answering the phone, the controller expects a three-digit pager code. The paging sequence is activated over the repeater transmitter, after which the caller is placed on the air for a programmable talkout period. The call may be answered from the repeater and will then proceed as a reverse patch. Otherwise, the controller will hang up after the programmable talkout period.

Instead of entering the pager code, however, the caller may enter Touch-Tone #, which restores control to Mode 0 for the remainder of the call. Callers wishing to initiate a page simply enter three digits. A caller requiring further control enters #, then proceeds. For example, a caller wishing to go directly on the air may enter # followed by the Control Op "Offhook" command.

**Access**

A high degree of flexibility is provided in access to the repeater and its command structure over the repeater receiver.

**Carrier/CTCSS**

The optional built-in CTCSS tone panel encoder/decoder, or an external CTCSS logic signal, in conjunction with Control Op commands, allows

- 1) Carrier access and carrier control
- 2) Carrier access and User command control, but CTCSS required for Control Operator and Programming control
- 3) Carrier access, but CTCSS required for User Command, Control Operator, and Programming control
- 4) CTCSS access and CTCSS control

**Touch-Tone**

A Touch-Tone Access Mode allows users to bring the repeater up and down with Touch-Tone commands. The Touch-Tone Access Mode offers security, interference immunity, and allows co-sharing a channel with another repeater.

When enabled by the Control Op, the mode may be brought up and down by users with commands, and when brought up, may automatically go back down after a period of inactivity. The Touch-Tone Access Mode timer may be set for any period up to half an hour, or the timer may be disabled (by setting it to zero).



## **CTCSS /Touch-Tone**

The Touch-Tone Access Mode can be used in conjunction with CTCSS access as well. When in CTCSS access, the Touch-Tone Access mode selectively allows non-CTCSS users to access the repeater.

## **ID Timing and Selection**

Amateur repeaters in the U.S. are required to ID at least every 10 minutes when in use. The RC-96 controller offers an intelligent ID algorithm which selects one of seven remotely programmable Morse code and synthesized speech ID messages based on the circumstances.

The ease of remotely programming the ID messages and the custom repeater oriented speech vocabulary allow the repeater owner to include informational messages as part of the ID. Messages such as, "Meeting tonight at 8. This is WA6AXX, Repeater", can be entered in a minute or two.

If the repeater has not been in use for the Pending ID period (normally six minutes), and a new user comes up, the controller will ID after he unkeys with the "Initial ID Message". This message could say "Hi", or "Welcome", etc., followed by the call sign. If the new user holds his carrier up for a period greater than ten seconds, preventing generation of the Initial ID, the controller will send the "Forced CW ID Message" on top of him so that the repeater is ID'd.

After the Initial ID or Forced CW ID, the Pending ID Timer (programmable, nominally six minutes) starts to run. When it times out, the controller looks for no repeater activity or for users to let the repeater carrier drop. If they do, the controller sends a "Pending ID Message" at the end of the repeater hang time. The Pending ID can rotate between three ID messages for variety. In addition, a "Special ID Message" can be added to the rotation for special events. The Pending and Special IDs can conveniently contain informational messages, as they occur, without interfering with conversations on the repeater.

If the repeater carrier is not allowed to drop during the Pending ID period (such as if a conversation is in progress), the controller looks for a break between user's transmissions for a period of three minutes to work in the "Anxious ID Message". The Anxious ID could typically be a straight call sign Morse code ID or brief synthesized speech ID to minimize distraction to users.

Finally, if the controller isn't given the opportunity to ID between user's transmissions, it forces a "Forced CW ID Message" over the conversation in progress following timeout of the sixty second Forced CW ID Timer. The cycle then repeats and continues as long as there is repeater activity following an ID.

The suggested value of the Pending ID timer is six minutes (360 seconds) for the amateur service, eleven minutes (660 seconds) for commercial services, and twenty-four minutes (1440 seconds) for Public Safety services.



## ID TIMING

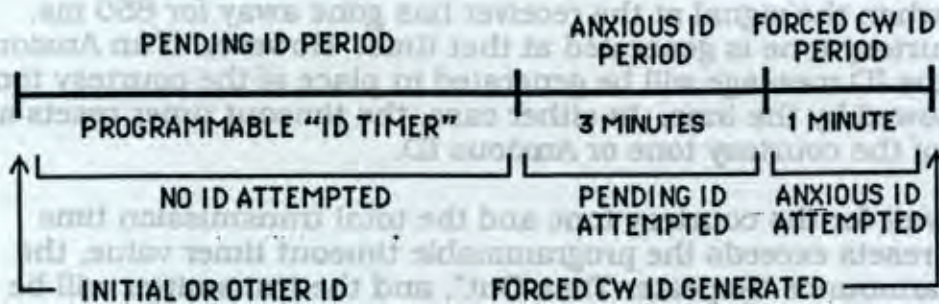

## Courtesy Tone

Following each user's transmission, the repeater transmitter remains on for a programmable period (hang time) with a courtesy tone provided to indicate that the other user may transmit. The delay to the tone allows other stations to break into the conversation. The fact that the repeater carrier may stay up continuously during a conversation eliminates the "second squelch tail" in the user's receiver, replaced instead by a pleasant, selectable courtesy tone.

Ten different courtesy tone "sets" including "no tone" may be chosen for use on the repeater with Control Op commands. A Courtesy Tone Select logic input to the controller chooses between the Control Op selected set and a second selectable set, allowing the courtesy tone to convey information (high/low power, emergency power, etc.). A third selectable tone set indicates a signal received on the link or remote base receiver, differentiating link signals from repeater signals.

## Tail Messages

Up to three different tail messages may be programmed with Programming commands and selected for use by the Control Operator. These messages are sent at the end of the hang time, just prior to dropping the transmitter carrier and can remind users of status of the machine or an approaching net or meeting. Some examples of tail messages which could be useful are "Net tonight", or "Weather alert!", or "CTCSS". Tail messages may be composed of any words in the controller's vocabulary or any Morse code characters.

Tail messages are generated when users allow the repeater carrier to drop (at the end of the hang time) so that they don't interrupt a conversation in progress. They also will occur no more frequently than defined by the Tail Message Timer to keep them from becoming annoying. For example, if the Tail Message Timer is set to five minutes, tail messages will not occur more frequently than every five minutes.



## Timeout Timer

The repeater's timeout timer is available to limit transmission duration in case of a continuous carrier at the repeater's receiver. The timer resets automatically when the signal at the receiver has gone away for 650 ms. Normally, a courtesy tone is generated at that time. However, if an Anxious ID is waiting, the ID message will be generated in place of the courtesy tone and will be followed by the tone. In either case, the timeout timer resets at the beginning of the courtesy tone or Anxious ID.

If users don't wait for the courtesy tone and the total transmission time between timer resets exceeds the programmable timeout timer value, the controller will announce "Repeater Time Out", and the transmitter will be shut off. When the signal at the input goes away for at least 650 ms, the transmitter will be re-enabled and will announce "Repeater Time Out Cancel".

The Control Op may disable the timeout timer and may reset it if it has timed out or is about to time out and the signal is still present at the receiver.

## TAIL TIMING EXAMPLES

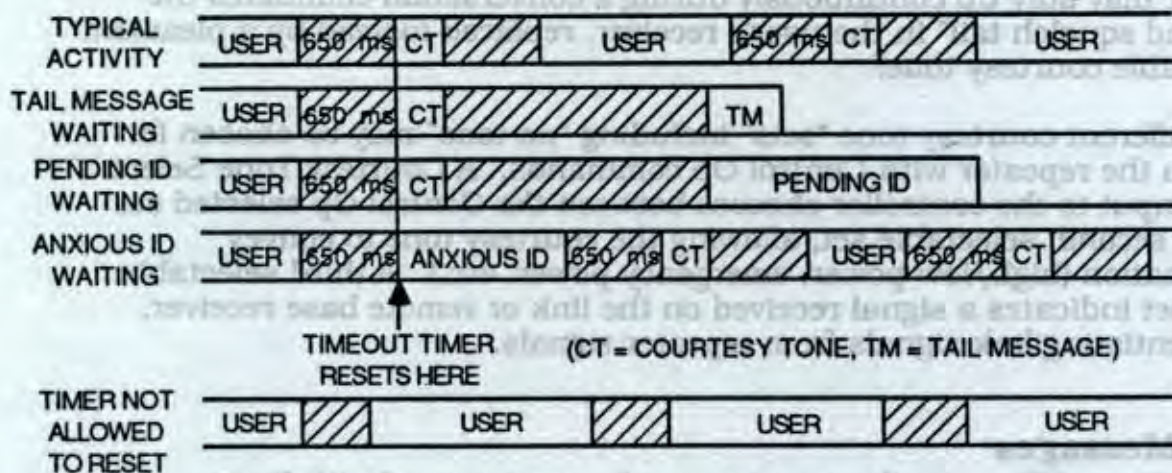

## Touch-Tone Muting

Touch-Tone commands through the repeater are normally muted by the controller, both for security and so that users don't have to listen to the tones. Since about 50 ms are required by the controller to detect that tones are present, a short "blip" will be heard on the first and second tones. Following the second tone, the muting overlaps to subsequent tones so that no further blips are heard. (The AD-1 Audio Delay board eliminates these Touch-Tone "blips".) The controller inserts a cover tone on the transmitter audio to indicate to users that someone is entering a Touch-Tone command. The pitch of the cover tone is programmable.

Users may defeat the controller's Touch-Tone muting to send tones directly through to a linked repeater or to the telephone line if necessary.



The Control Op may disable Touch-Tone muting so that *all* tones pass through the repeater.

### Noise and Kerchunker Filtering

The RC-96 controller provides filtering against noise and kerchunking on the repeater receiver. An algorithm filters against spurious noise on the receiver COS logic input, preventing static crashes and random noise bursts from bringing up the repeater. Kerchunker filtering prevents short transmissions from holding up the repeater transmitter, frustrating the kerchunker into making a "real" transmission to see if the repeater is up. The Kerchunker filter may be enabled or disabled with Control Op level commands.

In the Control Op selectable "Zero Hang Time Mode" neither the noise nor kerchunker filtering apply.

#### NOISE REJECTION

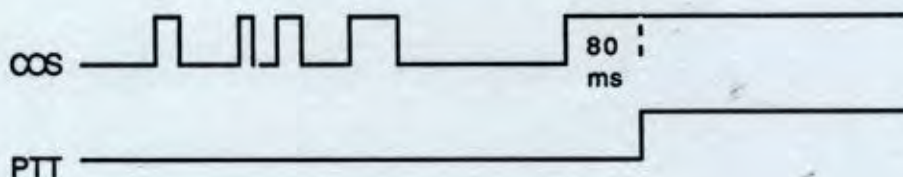

#### KERCHUNKER FILTERING

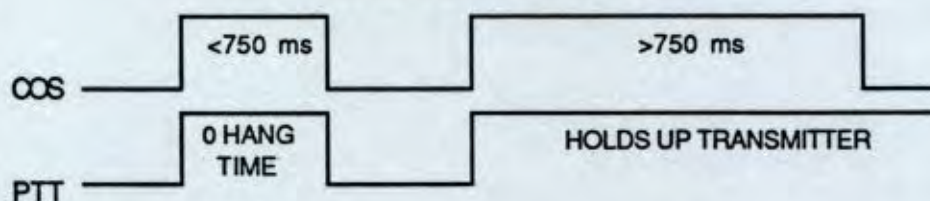



## **Avoiding Command Code Conflicts**

Previously, each command code needed to have a prefix programmed. To avoid a potential conflict, it was recommended to program an "out of the way" prefix. Now it is possible to disable the command code by programming it empty. For example, if you will not use the Touch-Tone Pad Test, simply program (with the controller unlocked) \*5019.



## Chapter 4

# Command Code Structure

## Contents

- 4-1 Introduction
- 4-2 User Commands
- 4-2 Control Operator Commands
- 4-3 Programming Commands
- 4-4 Command Evaluation
- 4-4 Special Keys
- 4-5 Command Decoder Timers

## Introduction

You speak to your new controller in a simple Touch-Tone command language. Your controller speaks back to you in voice. Commands can be entered from the front panel keypad, over the repeater, phone, or control receiver. The responses are in synthesized speech.

There are several levels of Touch-Tone commands which control the RC-96 controller. Your repeater group probably consists of three types of individuals - the repeater owner or technical group, the Control Operators, and the general users. Therefore, there are three levels of commands in the controller.

**User commands** are those that would typically be made available to the general users for activating the autopatch, remote base, bulletin board, and other user type functions. The user command level is the lowest level of command classification.

**Control Operator commands** are those which allow enabling and disabling the various functions of the repeater and selection from various operating modes. For example, the Control Op may select between carrier and CTCSS access or enable and disable the autopatch or autodialers.

**Programming commands** change parameters of the repeater such as content of the ID and tail messages, timer values, emergency autodial telephone numbers, and command codes. Programming commands are the most secure type and require that the repeater be placed in a special mode to execute them (unlocked). Typically, details on Programming commands would be reserved for the repeater owner or the repeater's technical group.

Note that all User and Control Op command codes (except Touch-Tone Pad Test) can be changed remotely with Touch-Tone Programming commands.



## User Commands

There are 19 classes of User commands, each with its own independent command code. User command codes consist of a prefix immediately followed by a command root. The prefix may be remotely programmed by the repeater owner using Programming commands, while the command roots contain information related to the action desired. For example, if the User Loadable Autodial prefix is \*, dialing autodial location 45 is done by entering the command \*45. The \* is the prefix, and is remotely changeable, while 45 is the root, which specifies the autodial location being called.

The User command code classifications include:

- Touch-Tone Pad Test**
- Autopatch**
- User Loadable Autodial (2 banks)**
- Emergency Autodial**
- Patch Utilities (Cover Tone, Full Duplex, Custom Hangup, Timer Extend, Reverse Patch Answer, Redial)**
- Patch Hangup**
- User Loadable Autodial Load / Erase (2 banks)**
- Reverse Patch**
- S-Meter Readback**
- Demonstration / Bulletin Board Messages**
- Link / Remote Base**
- Paging**
- Touch-Tone Access Mode Up / Down**
- Spare Audio Select**
- User Function Remote Control Outputs**
- Telephone Timer Extend**

Each User command classification may have an independent command code prefix, and codes may be changed at any time remotely by the repeater owner.

The operation of each of the user commandable functions is described in the next chapter of the manual.

## Control Operator Commands

Control Operator commands, those that enable and disable various repeater functions, and select operational modes consist of a command prefix which may be programmed by the repeater owner remotely with Programming commands followed by a one or two digit root code. The command prefix may consist of between 1 and 7 digits so that Control Op commands may be made as secure as is necessary in your system. Control Op commands may be between 2 and 9 digits long - easy or secure, it's up to you.

Control Operator selections may be grouped into four "Macro Sets". That is, most of the enable/disable and mode selections can be grouped together and stored in the controller's non-volatile memory using a Programming command. The Control Op Macro Sets make it easy to select a special mode, like night operation, or net mode. One easy to remember Control Op macrocommand can, in effect, perform many command functions.



One of the macro sets defines how the controller powers up. The repeater owner can specify what features are enabled and disabled and what modes are selected in a stored macro set.

The function of the various Control Op commands is described in the next chapter, and the command groups include:

- Macro Set Selection**
- Repeater Enable/Disable**
- Repeater Timer**
- Access/Control**
- User Command Enable/Disable**
- Link Enable/Disable**
- Autopatch/Autodial**
- Reverse Patch**
- ID**
- Tail Message**
- Alarm Enable/Disable**
- Speech Synthesizer**
- Kerchunker Filter Enable/Disable**
- Touch-Tone Mute/Unmute**
- Zero Hang Time Mode Enable/Disable**
- Low Courtesy Tone Select**
- Initialize**

## Programming Commands

Programming commands are the super-secure commands which allow you to remotely change User and Control Op codes, ID and other messages, Morse code characteristics, courtesy tone selection, timer values, and Emergency Autodial numbers. Since Programming commands need to be very secure to prevent tampering, they are accessible only when the controller is "unlocked". Unlocking the controller accesses the programming commands. When the controller is locked in normal operation, any Programming commands entered are ignored. The controller is unlocked by entering a long Touch-Tone "unlock" command. The actual command is field programmable by the repeater owner among ten billion possible codes and is unique to each controller.

While unlocked, the various ID and response messages in the controller may be edited, timer values may be changed, Emergency Autodial numbers may be reprogrammed, and command codes may be modified. After you've finished a session of programming, you "lock" up the controller so that it's secure from tampering. If you forget to lock it, the controller will lock itself after one minute of no commands.

The classes of Programming commands include:

- Messages**
- Tone Parameters**
- Courtesy Tone Selection**
- Timers**
- Command Code Prefixes**
- Emergency Autodial Numbers**
- Misc. Selections**



## Command Evaluation

The controller evaluates Touch-Tone commands to determine the function requested. Commands may be entered from the front panel keypad, over the repeater receiver, the phone line, or the command receiver. When entered over either receiver, the controller examines the sequence of Touch-Tone digits sent during the transmission **after the carrier drops** (after the user unkeys his PTT). The controller examines the length of the command, as well as the digits present, and checks for a perfect match to valid commands before acting on the command received.

## Special Keys

There are several special keys that affect operation of the command decoder.

### Telephone and Front Panel Enter Key

**Over the phone and from the front panel**, since the controller doesn't know when you've finished entering your command (since there's no carrier to drop), the controller looks for a special **enter key - the # key**. For example, to enter the command "123" over the phone or from the front panel, it should actually be entered as "123#", where the # indicates the completion of the command sequence. This applies to User, Control Op, and Programming commands entered from the front panel or over the phone.

### Over-the-Air Enter Key

On rare occasions, it is desirable to force a command evaluation when a command is entered over the air. For example, if a weak carrier is present at the receiver input, the controller won't detect a carrier drop which would normally cause a command evaluation. **Over the air, the D key serves as an optional enter key**. If a weak carrier is present at the receiver input, and the Control Op wants to disable the repeater timer, and the Repeater Timer Disable command is 3A45, he may enter "3A45D" and the command will be accepted by the controller even though the carrier has not dropped.

### Over-the-Air Cancel Key

When sending a command to the controller over the air, if you make a mistake part way through the sequence, a **# key will cancel the digits sent to that point** during the transmission, and the correct command may immediately follow the #. For example, if the desired command is 3A45, and you mistakenly enter 33, you may enter a # followed by 3A45, i.e., 33#3A45 entered over the air is interpreted by the controller as 3A45.

### Unmute Touch-Tone Key

The # key sent as the first key of a sequence **unmutes Touch-Tone** for the remainder of the transmission and causes the controller to ignore the sequence. Touch-Tone unmute is useful for entering telephone credit card numbers and passing tones through the remote base to other repeaters.



**Summary**

- # Command terminator for commands from the phone or front panel
- D** Optional enter key for commands entered over the air
- # In middle of a sequence cancels preceding keys
- # As first key of a sequence unmutes Touch-Tone for remainder of sequence, controller ignores sequence

**Command Decoder Timers**

Two timers relating to command entry totally eliminate the effects of rare but unavoidable Touch-Tone decoder falsing on voice. A four second **inter-digit timer** cancels a sequence where any digit occurs more than four seconds after the last digit. An eight second "**to end of transmission timer**" cancels any sequence where the last digit was received greater than eight seconds before the end of the transmission.

These timers help the controller discriminate between valid command sequences and the rare occasional false decode on voice.

These timers impose two simple but important requirements on command entry:

- 1) **Command sequences may not be entered v-e-r-y s-l-o-w-l-y**, because if more than four seconds elapses between digits, the controller will disqualify the command.
- 2) **Command sequences may not be entered at the beginning of a long transmission**, because if more than eight seconds elapses from the last digit to the end of the transmission, the sequence will be disqualified. A Touch-Tone command followed by the Gettysburg Address will not be accepted.



# About this Manual . . .

Congratulations on owning an RC-96 Repeater Controller. This manual provides a description of the function, operation, and interface of the unit.

**Chapter 1** provides a brief introduction to the RC-96 controller and its capabilities in general terms, followed by its specifications and features.

**Chapter 2** describes the basic installation of the controller into your repeater system, covering interface to the repeater transmitter and receiver, the phone line, and the power supply.

**Chapter 3** provides an overview of the operation of the controller, including a description of command channels, access, ID algorithms, courtesy tones, etc.

**Chapter 4** explains the structure of the RC-96 controller commands and describes the operation of the command decoder.

**Chapter 5** describes how to activate the features available to system users.

**Chapter 6** details the capabilities available to Control Operators.

**Chapter 7** explains how to remotely program the RC-96 controller using Touch-Tone Programming commands.

**Chapter 8** describes in detail the interface of the controller to other equipment in advanced installations, including CTCSS, control receiver, talking S-meter, remote base, alarm, remote control logic output functions, and more.

**Chapter 9** provides an overview of the theory of operation of the controller.

**Chapter 10** offers troubleshooting hints in case of operational or installation difficulty, or component failure in the controller. It also includes many of the most often asked questions and answers.

**Appendix I** provides a summary of the Touch-Tone command codes.

**Appendix II** defines the connector location and pinouts, DIP switch option selections, and adjustments.

**Appendix III** provides the controller's hardware schematic.

**Appendix IV** provides the installation instructions and information on the operation of the optional AD-1 Audio Delay Board Kit.

**Appendix V** provides the installation instructions and information on the operation of the optional CTCSS Tone Panel.

The **Glossary** defines various terms used in the manual, while the **Index** provides a quick guide to location of various information alphabetized by subject.



## Chapter 5

# How to Command the User's Features

### Contents

- 5-1 Introduction
- 5-1 Testing Your Touch-Tone Pad
- 5-2 Activating the Autopatch
- 5-3 Hanging Up the Patch
- 5-4 Patch Redial
- 5-4 Defining Your Own Custom Hangup Code
- 5-5 Selecting the Cover Tone for Semi-Private Patch
- 5-5 Selecting Full Duplex
- 5-6 Extending the Patch Timer
- 5-7 Loading and Erasing the User Loadable Autodialer
- 5-8 Activating the User Loadable Autodialer
- 5-9 Activating the Emergency Autodialer
- 5-10 Bringing Up the Reverse Patch From the Phone
- 5-11 Answering the Reverse Patch Over the Air
- 5-11 Extending the Telephone Timer
- 5-12 Reading Back Your Signal Strength
- 5-12 Commanding the Demo Messages and Bulletin Board
- 5-13 Bringing Up the Link / Remote Base
- 5-14 Unmuting Touch-Tone
- 5-14 Activating Pocket Pagers and Selective Call Decoders
- 5-15 Two-Tone Paging
- 5-16 Taking the Touch-Tone Access Mode Up and Down
- 5-16 Activating the Spare Audio Function
- 5-17 Commanding the Remote Control Output Functions

### Introduction

This chapter guides you step by step through the procedures for operating the user features of the RC-96 controller. Detailed examples are provided which you may try on your repeater as you read them.

Remember - you can't break your controller with Touch-Tone commands so feel free to play!

### Testing Your Touch-Tone Pad

Since your Touch-Tone pad is used for entry of all commands to the controller, it may be a good idea to "check it out". The controller allows you to easily and thoroughly test your pad by letting you enter a sequence of keys, and it reads the sequence back to you in voice.



**Hint:** It isn't necessary to click your mike to initiate dialing. One and three digit numbers can only be dialed from the User Loadable or Emergency Autodialers.

**Related Commands:**

<b>Program</b>	Autodial Service Messages, Emergency Autodial Timer, Patch Activity Timer, Patch Timer Extend Timer, Emergency Autodial Command Prefix, Emergency Autodial Numbers, Touch-Tone / Dial-pulse signalling
<b>Control Op</b>	Emergency Autodialer E/D, Patch Timer E/D, Cover Tone E/D/Always
<b>User</b>	Patch Cover Tone, Full-Duplex, Patch Timer Extend, Patch Hangup, Patch Custom Hangup, Patch Redial

**Bringing Up the Reverse Patch From the Phone**

The reverse patch may be activated by calling the controller on the phone. Three Control Op selectable modes are available.

Mode 0 operates as follows. The caller dials the repeater's phone number and the call is auto-answered with a programmable message such as "WA6AXX Repeater, control". So far, the transmitter has not been affected, and users over the air are not aware of the call, except that they no longer have access to the Touch-Tone decoder (it's listening on the phone instead). The caller may then enter the reverse patch command, and the transmitter will activate with a "ring" signal to alert users that a call is waiting. The Touch-Tone decoder switches back to the receiver to await a user answering the reverse patch.

Mode 1 answers as in mode 0, but automatically starts to ring out after 5 seconds if no Touch-Tone command has been received. This mode allows callers without Touch-Tone phones to use the reverse patch while still allowing commands to be entered over the telephone.

Mode 2 causes the controller to ring out when a phone ring is detected, but the line is not answered until a repeater user enters the Reverse Patch Answer command over the air.

Mode 3 is similar to Mode 0 except that it is optimized for talkback paging applications. Upon answering the phone, the controller expects a three digit paging code. The paging sequence is activated over the repeater transmitter, and the caller is placed on the air. The call may be answered from the repeater and will then proceed as a reverse patch.

The following command is relevant only in Modes 0 and 3.

**Command: (Reverse Patch Command)**

**Example:** Reverse Patch Command = 1  
 Caller on the phone enters 1# (# required as "enter key" on the phone). Controller activates transmitter and "rings" for one minute or until answered with Reverse Patch Answer command.



- Hints:** After the Reverse Patch Command is entered, the Touch-Tone decoder switches to the repeater receiver, so that the caller cannot enter additional Touch-Tone commands.  
If you don't want to answer the reverse patch, the Patch Hangup command from over the air will terminate the ringout early.

**Related Commands:**

<b>Program</b>	Phone Answer Message, Phone Answer Delay Timer, Autopatch Timer, Patch Activity Timer, Patch Timer Extend Timer, Reverse Patch Command Code (Patch Utilities Command Prefix), Patch Hangup Command Prefix
<b>Control Op</b>	Reverse Patch Enable/Disable, Patch Timer Enable/Disable, Cover Tone Disable/Enable/Always On, Reverse Patch Mode
<b>User</b>	Hangup, Custom Hangup, Cover Tone, Full-Duplex, Patch Timer Extend

### Answering the Reverse Patch Over the Air

Repeater users over the air may answer a reverse patch call by entering the Reverse Patch Answer Command (which is simply the Patch Utility Command Prefix). After entering the command, the user must unkey in order to let the controller evaluate the command and connect the caller to the repeater.

**Command:** (Patch Utility Prefix)

**Example:** Patch Utility Prefix = \*

User sends "\*" while reverse patch is ringing.  
Controller connects caller to the radio.

- Hints:** After entering the command, unkey and listen for telephone noise to be sure the patch is connected.  
When answering the reverse patch, identify yourself to the caller so that they will not be confused.

**Related Commands:**

<b>Program</b>	Patch Utility Command Prefix, Autopatch Timer, Patch Activity Timer, Patch Timer Extend Timer
<b>Control Op</b>	Reverse Patch E/D, Patch Timer E/D
<b>User</b>	Hangup, Custom Hangup, Cover Tone, Full-Duplex, Patch Timer Extend

### Extending the Telephone Timer

When calling the repeater on the phone, the user may extend the telephone timer (from 15 seconds) to two minutes. The command is effective only from the telephone (nothing happens if entered over the air). This capability is useful when calling to record or play back mail from the Digital Voice Recorder.



**Command: (Telephone Timer Extend Command)****Example:** Telephone Timer Extend Command = 0

User calls the repeater on the phone to load voice mail into the Digital Voice Recorder. Controller answers the phone. User enters "0#" to extend the controller's timer. Controller says, "Two minutes". User may then activate the DVR mailbox. This command may be entered more than once if needed.

**Reading Back Your Signal Strength**

Assuming that an S-meter signal voltage is connected to the RC-96 controller, users may interrogate their signal strength into the repeater. The controller always measures the S-meter one-half second into each new transmission and stores the reading. If the user happens to request his signal strength, the stored reading is spoken in synthesized speech. The meter is calibrated in S units and db from S0 to S9 plus 60.

**Command: (S-Meter Command)****Example:** S-Meter Command = 8

User's signal strength into the repeater is S9+20

User keys down at least one half second and sends "8".

Controller says, "S9 plus twenty".

**Hint:** Be sure to key down at least 1/2 second when entering the command.

**Related Command:**

**Prog** S-Meter Command Code

**Commanding the Demo Messages and Bulletin Board**

Users may call up several messages which may be programmed by the repeater owner to include information of interest to the users. They may also activate the various ID messages contained in the controller.

The response to the Bulletin Board 1 command would be the message stored in Bulletin Board 1, such as "Club meeting tomorrow at 8. See you at the meeting".

**Command: (Demo Prefix) (0-8, \*)**

**0 = Initial ID Message**

**1 = Forced CW ID Message**

**2 = Anxious ID Message**

**3 = Pending ID Message 1**

**4 = Pending ID Message 2**

**5 = Pending ID Message 3**

**6 = Special ID Message**

**7 = Bulletin Board Message 1**

**8 = Bulletin Board Message 2**

**\* = Firmware Revision Announcement**



**Example:** Demo Prefix = 3  
 User sends "3 \*".  
 Controller says, "This is the Advanced Computer Controls  
 RC-96 Repeater Controller, V3.0".

#### Related Commands:

**Program** Demo Command Code Prefix  
**Control Op** User Command E/D

### Bringing Up the Link / Remote Base

You may activate a link or remote base transceiver connected to the controller, allowing you to tie your repeater to other frequencies. The link may be activated in the listen only mode (repeater users monitor the link receiver but don't activate its transmitter), receive/transmit mode (users monitor its receiver and activate its transmitter when they talk into the repeater), and may be turned off.

In addition, users may change the frequency of the remote base transceiver with Touch-Tone commands so that they may link the repeater to any frequency.

The Link On Receive Only command brings up the link or remote in listen only mode. Signals received over the link transceiver bring up the repeater transmitter and are retransmitted over the repeater. Users may talk on the repeater, however, without interfering with the stations on the link frequency. Repeater users' audio overrides link audio to allow a conversation to take place in this mode.

The user may activate the link transmitter. Now repeater users are retransmitted over the link frequency and appear to listeners on the link frequency as any other user on that frequency. The link may be to other repeaters or to simplex frequencies.

Users may change the frequency of the transceiver by entering the desired frequency in a format similar to that of keyboard entry HT's, including provisions for selecting the transmit offset.

The Link Off command turns off receive and transmit capabilities of the link or remote base.

#### Commands:

(Link Prefix) 1	Link On Receive Only
(Link Prefix) 2	Link On Receive/Transmit
(Link Prefix) 3	Link Off
(Link Prefix) (mhtof)	Link Frequency (Mhz, hundreds kHz, tens kHz, ones kHz, xmit offset 1/minus, 2/simplex, 3/plus)



**Examples:** Link Prefix = 7

User sends "7 1". Controller responds with current frequency and goes to receive only mode.

User sends "7 69401". Controller responds with, "Six point nine four, minus" and programs remote base transceiver to 6.940 with minus transmit offset.

User sends "7 2". Controller responds with, "Remote Base TX" and goes to transmit mode.

User sends "7 3". Controller responds with, "Remote Base Off" and turns remote base off.

**Related Commands:**

**Program** Link / Remote Base Command Code Prefix

**Control Op** User Command E/D

**Unmuting Touch-Tone**

At times it is desirable to pass Touch-Tone sequences through the repeater or through to the phone line unmuted, without them being decoded by the RC-96 controller. For example, bringing up an autopatch on a repeater accessed through the remote base would require passing tones through the controller to the linked repeater. Another application would be passing a credit card number through to the phone line.

**Command:** # (sequence)

**Example:** Pass MCI code and long distance phone number through to the phone line after an autopatch to the local MCI number. User sends "# 54321 408 555 1234" all during one transmission. Controller unmutes after the # and allows the MCI code and phone number to pass unmuted, while ignoring the sequence.

**Hint:** Be sure to send the # at the beginning of *each transmission* that you want unmuted.

If you would like *all* Touch-Tones to be unmuted and would like the controller to decode the commands, use the Control Op selectable "Touch-Tone Unmute" mode.

**Activating Pocket Pagers and Selective Call Decoders**

The controller can generate various paging tones in response to Touch-Tone commands entered from over the air or phone. These tones can activate pocket pagers and selective call decoders installed in mobile and handheld transceivers.

A pager may be activated by entering the paging prefix followed by the three digit pager ID code. Up to 1000 pagers may be defined in the controller's reprogrammable memory (see Chapter 7, "Pager Memories"). In Reverse Patch Mode 3, the caller may simply enter the three digit pager ID code over the phone without the paging prefix or terminator.



**Command: (Memory Paging Prefix)(3 digit pager code)**

**Example:** Memory Paging prefix = 2

User sends 2165 over the air.

Controller sending paging sequence to the pager type and address stored in pager memory 165.

**Command: (3 digit pager code)**

**Example:** Reverse Patch Mode 3

User calls on the phone and enters 165.

Controller sends paging sequence to the pager type and address stored in memory 165. The controller acknowledges with, "Wait for ready..." and waits for a break in a conversation over the air before sending the tones stored in pager memory 165. After sending the tones, the controller prompts the caller with "Ready". The caller may talk out over the air for a programmable period, and a user over the air may enter the Reverse Patch Answer command to make the conversation two way.

#### Related Commands:

<b>Prog</b>	Memory Paging Command Code Prefix, Pager Memories
<b>Control Op</b>	User Command E/D

#### Two-Tone Paging

For backward compatibility to the RC-85 controller, and for additional flexibility in two-tone paging, an additional paging command is available which allows the user to directly specify the tones to be generated. One second / three second two-tone and eight second group call tones can be generated.

The paging command consists of the paging prefix followed by the group number and tone number of each of the two sequential tones.

**Commands: (Two-Tone Paging Prefix)(A Group #)(A Tone #)  
(B Group #)(B Tone #)**

**(Two-Tone Paging Prefix)(Group #)(Tone #) [group call]**

**Examples:** Two-Tone Paging Prefix = 2

User sends 22315.

Controller sends two tone sequential tones, A tone Group #2 Tone #3 (669.9 Hz), B tone Group #1 Tone #5 (433.7 Hz).

User sends 236.

Controller sends eight second group call Group #3 Tone #6 (979.9 Hz).



**Hints:** When sent from the phone, the controller acknowledges with, "PAGE" and waits for a break in a conversation over the air before sending the tones.

**Related Commands:**

**Program** Two-Tone Paging Command Code Prefix  
**Control Op** User Command E/D

### Taking the Touch-Tone Access Mode Up and Down

When the Touch-Tone Access Mode is enabled by the Control Op, users may bring the repeater up and down with the Touch-Tone Access command. Touch-Tone Access is intended as an alternative to the need for CTCSS.

**Command:** (Touch-Tone Access Mode Prefix) 0 [down]  
 (Touch-Tone Access Mode Prefix) 1 [up]

**Examples:** Touch-Tone Access Mode Prefix = 741

User sends "7410".

Repeater "goes to sleep" - i.e., TT Access down.

Repeater is effectively off.

User sends "7411".

Repeater "wakes up".

**Hints:** The controller sends the Forced CW ID Message when going down, if necessary, to properly ID at the end of an exchange of transmissions.

When taken up, the Touch-Tone Access Mode Timer will take the repeater back down after a period of inactivity.

If in the Control Op selected PL Access Mode, Touch-Tone Access Up allows carrier access to the repeater. Touch-Tone Access Down or Disabled restores the need for CTCSS to access the repeater.

**Related Commands:**

**Program** Touch-Tone Access Mode Timer, Touch-Tone Access Mode Command Code prefix  
**Control Op** Touch-Tone Access Mode E/D, PL Access

### Activating the Spare Audio Function

Users may bring up an auxiliary audio source, such as a scanner, weather radio, etc. Entering the Spare Audio command causes the Spare Audio input to connect to the transmitter audio mixer and holds up the repeater transmitter PTT. The Spare Audio source may be shut off with #. A programmable timer is available to automatically shut down the Spare Audio function if a user forgets to turn it off.

**Command:** (Spare Audio Command)



**Example:** Spare Audio Command = 666  
 User sends "666".  
 Controller holds up transmitter and connects Spare/Link audio input to transmitter (turns off with #).

**Hint:** Avoid a single digit access command, because occasional Touch-Tone falsing could bring up the Spare Audio function.

**Related Commands:**

<b>Program</b>	Spare Audio Command Code Prefix, Spare Audio Timer
<b>Control Op</b>	User Command E/D
<b>User</b>	# Knockdown

### Commanding the Remote Control Output Functions

Users may activate or interrogate up to eight remote control logic outputs (User Functions) from the controller. These outputs may be wired to various equipment in the repeater system for controlling high/low power, antenna selection, remote base band select, etc. In response to the command entry, the controller provides a high or low beep tone to indicate the current state of the output.

Certain of the UF outputs take on dedicated functions when various options are selected. For example, UF 3 becomes a Phone Line Busy output when in the Phone Line Shared mode. UF commands to dedicated outputs are ignored by the controller.

**Commands:** (UF Prefix) (Output #1-8) (1 = on (low), 0 = off (high))  
 (UF Prefix) (Output #1-8) [interrogate]

**Examples:** UF Prefix = 9  
 User sends "9 3 0".  
 Controller sends low tone and output #3 turns off.  
 User sends "9 2 1".  
 Controller sends high tone and output #2 turns on.  
 User sends "9 3".  
 Controller sends low tone confirming off state.

**Hints:** See Chapter 8 for details of remote control logic output function. Commands to UF 3 would be ignored when the Phone Line Shared mode is selected.  
 The UF output logic sense may be inverted with the UF Logic Sense Programming command - i.e., high beep / "1" = output on or low.

**Related Commands:**

<b>Program</b>	User Function Logic Output Command Prefix, UF Logic Sense
<b>Control Op</b>	User Command E/D



The first key of the sequence, which tells the controller that you're testing your pad, is "5", and then you can enter any sequence of up to 32 digits for readback. So to test your entire pad, for example, you can enter, all in one transmission:

5 123456789\*0#ABCD

The controller responds by reading back everything after the "5" (\* as Sierra, # as P). If a key doesn't decode, it won't be read back. To check a key for intermittent operation, you can press it several times:

5 3333

The controller should read back "3" four times if it decoded each time.

**Command: 5 (sequence of up to 32 keys)**

**Example:** User sends "5 123456".  
Controller says, "One two three four five six".

#### **Related Commands:**

**Control Op** Pad Test Enable/Disable, User Command Enable/Disable

#### **Activating the Autopatch**

Now that you know that your tones decode properly, you can make a patch. The Autopatch command consists of the Autopatch prefix followed immediately by the phone number, all as one command. Try

(prefix) 7273330

The controller will say, "Autopatch", pause, then read back the phone number for verification and pause again. During either pause, if you want the controller to dial the number, click your rig's PTT briefly. By clicking your mike at the *first* pause, you prevent phone number readback. Waiting until the second pause lets you verify that the proper number was entered.

You can hear the controller dial the tones, although, for security, the actual tones heard over the air are not the phone number Touch-Tones. Optional phone number readback and Touch-Tone or dial pulse regeneration mean NO WRONG NUMBERS! If your phone line won't accept Touch-Tone, we'll show how to make it pulse dial in Chapter 7 (Miscellaneous Selections). Again, if you don't want the phone number read back, "click" your mike briefly after it says, "Autopatch", and it will dial the number immediately.

**Command: (Autopatch Prefix) (telephone number)**

**Example:** Autopatch Prefix = \*  
User sends "\* 7273330".  
Controller says, "Autopatch (pause) seven two seven three three three zero (pause)". User clicks his mike at either pause and controller dials the number.



## Patch Redial

The phone number dialed is stored in a redial memory and is available for easy redial without the need to enter the entire phone number again. The redial memory is erased fifteen minutes after the attempted patch so that it doesn't remain indefinitely. Redial is useful in the case of a busy signal or other need to call back the same number.

**Command: (Patch Utility Prefix) \***

**Example:** Patch Utility Prefix = \*

User made a patch within the last 15 minutes, and the line was busy. He can redial by sending "\*\* \*\*".

The controller says, "Repeat dial" and dials the number.

## Defining Your Own Hangup Code

In case of malicious patch hangup during a call, you may define your own three digit hangup code prior to making your call again. The Custom Hangup Code permits you to define the hangup code which inhibits the Patch Hangup command from hanging up the patch.

To define a custom hangup code, enter the command within 15 seconds of initiating the patch. The hangup code is returned to the normal code after completing the current patch or if the patch isn't initiated within 15 seconds.

**Command: (Patch Utility Prefix) (any 3 keys except # or D, and may not begin with 1 or 5)**

**Example:** Patch Utility Prefix = \*

User sends "\* 3A7" within 15 sec. of starting the patch.

Controller responds with, "Cancel" and redefines the patch hangup code to 3A7.

**Hints:** If you forget the custom code you define, the Control Op can hang up the patch with the Phone Onhook Control Op command.

If you start to enter a patch command and unkey and hear the controller say, "Cancel", wait 15 seconds to let the accidental Custom Hangup Code clear before retrying.

Avoiding "1" as a leading digit of the Custom Hangup Code lets us allow the repeater owner to define User Loadable Auto-dialer Command Prefix with \*, Extended User Loadable Autodialer Command Prefix with \*1, and Patch Utility Prefix with \*, without conflict. (Otherwise \*121 could be Custom Hangup or Extended Autodial.)

### Related Commands:

<b>Program</b>	Patch Utility Command Prefix
<b>Control Op</b>	Control Op Onhook



## Selecting the Cover Tone for Semi-private Patch

The controller offers a "cover tone" available during patches which results in muting of the mobile audio through the repeater replaced by the cover tone. The cover tone offers a degree of privacy by allowing only one side of the conversation to be heard on the air (the telephone side). The cover tone may be selected by the Control Operator to be always on, to be user selectable, or to be disabled.

To activate the cover tone if in the user selectable mode, enter the Cover Tone Command before or during a patch. The cover tone selection is cancelled at the end of the patch and may be selected again for the next patch.

**Command:** (Patch Utility Prefix) \*2

**Example:** Patch Utility Prefix = \*, and User Selectable

User enters "\*\* \*2" before or during a patch.

Controller responds with "C", and the cover tone is activated for the next/current patch.

### Related Commands:

**Program** Cover Tone Pitch, Morse Code Speed, Patch Utility

Command Prefix

**Control Op** Cover Tone E/D/Always On

**User** Patch Hangup (cancels cover when "Cover Tone Enable" mode)

## Selecting Full Duplex

Telephone audio during a patch is normally muted at the repeater transmitter while the user is transmitting (half-duplex). This allows the user to immediately block inappropriate remarks made by the party on the phone by simply keying his microphone.

In the full-duplex mode, phone audio is not muted while the user transmits. This allows users with a full-duplex transceiver or a pair of ordinary transceivers to make patches allowing them to talk and listen at the same time.

In the full-duplex mode, inappropriate remarks made by the party on the phone can only be blocked by terminating the patch.

The Control Operator may select full-duplex mode as "user selectable" or "always on".

In the *user selectable mode*, the patch operates half-duplex unless the user specifies full-duplex by entering the duplex command before or during a patch. The full-duplex selection is cancelled at the end of the patch and may be selected again for the next patch.

If full-duplex is Control Op selected as *always on*, then all patches proceed in Full-Duplex. The user may specify half-duplex for a particular call by



entering the duplex command. He may also enter the cover tone command to activate the cover tone and operate the patch half-duplex.

The activity timer is disabled during full-duplex patches.

#### **Command: (Patch Utility Prefix)\*1**

**Example:** Patch Utility P prefix = \*, full-duplex user selectable

User enters "\*\*\*1" before or during a patch.

Controller says, "D" and prepares for full-duplex patch.

Patch Utility P prefix = \*, full-duplex always on

User wants this patch only to be half-duplex.

User enters "\*\*\*1" before or during the patch.

Controller says, "D" and prepares for half-duplex patch.

#### **Related Commands**

**Control Op** Full-duplex User Selectable/Always On

### **Extending the Patch Timer**

When the user is notified by the controller that he has "30 seconds left", he may extend the patch timer with the Timer Extend command. Entering the Timer Extend command reloads the patch timer with the value defined by the repeater owner, allowing indefinite extension of the patch.

#### **Command: (Patch Utility Prefix) \*3**

**Example:** Patch Utility Prefix = \*

User sends "\*\* \*3" during patch after the controller informed him that "30 seconds left", i.e., that the timer has almost expired.

Controller says, "Timer X" and reloads patch timer with the Patch Timer Extend value.

**Hints:** The controller waits until the mobile is listening before saying, "30 seconds left" to be sure he has an opportunity to extend the timer.

Since the controller waits until the mobile is listening before the warning, the actual patch duration may end up being somewhat longer than the programmed patch timer *plus* 30 seconds.

The timer may be extended over and over, but no warning is given before it times out again.

#### **Related Commands:**

**Program** Patch Timer Extend Timer, Patch Utility Command Prefix

**Control Op** Patch Timer E/D



## Loading and Erasing the User Loadable Autodialer

The Autopatch is convenient and reliable, but punching in all the numbers can be tricky while you're zooming down the freeway. The autodialers allow quick, easy access to frequently called numbers with just a few keys, instead of the eight or more needed with the Autopatch. And the autodial numbers can be loaded and changed remotely, so it's easy to keep up with new members and users that move or want to add or delete numbers.

There are two banks of User Loadable Autodialer numbers - the first bank (Bank 0) holds locations 10-99, and the second bank (Bank 1) contains 100-199. Each bank has its own load/erase command code prefix.

The phone number can be secured from readback when activating the autodialer for security. The security option is selected when loading the number into memory.

Even though the User Loadable Autodialer comes empty from the factory, first ERASE a location, then LOAD a number into it. To erase a number, enter the load/erase prefix followed by the location. To erase location 10, which is in the first bank of numbers, the command is:

(prefix) 10

The controller responds with, "Autodial Cancel", and the location is erased.

To load location 10 (first bank of autodial numbers) with the phone number 727-3414, the command is:

(prefix) 10 7273414

The controller responds to the command with, "Autodial write". From now on, you can call location 10 with the User Loadable Autodial activate command.

**Command:** (User Loadable Autodial Load/Erase Prefix) (location)

**Example:** Autodial Bank 0 Load/Erase Prefix = 456

User sends "456 40".

Controller says, "Autodial Cancel" and erases location 40.

**Command:** (User Autodial L/E Prefix) (Location) (Phone Number)  
or (User Autodial L/E Prefix) \* (Location) (Phone Number)

[phone number secured from readback]

**Example:** Autodial Bank 0 Load/Erase Prefix = 456

User sends "456 40 7273414".

Controller says, "Autodial Write" and loads location 40 with the phone number 727-3414. Activating User Loadable Autodialer allows phone number readback.



**Example:** Autodial Bank 1 Load/Erase Prefix = 457

User sends "457 \* 20 7273330".

Controller says, "Autodial Write" and loads location 120 with the phone number 727-3330. Activating User Loadable Autodialer does not allow phone number readback.

**Hints:** If you don't want users to be able to erase and change autodial numbers, either keep the autodialer locked with the Control Op command, or keep the L/E command code prefix secret. If an autodial location is secured from readback, the Control Op can bypass security option with User Autodialer Unhide mode.

Write down what numbers are stored where so that you won't lose track of what's in the controller.

#### **Related Commands:**

<b>Program</b>	User Loadable Autodial L/E Command Code Prefix, Extended User Loadable Autodial L/E Command Code Prefix
<b>Control Op</b>	User Autodial Unlock/Lock, User Autodial Hide/Unhide
<b>User</b>	User Loadable Autodialer Activate

### **Activating the User Loadable Autodialer**

Phone numbers stored in the User Loadable Autodialer may be dialed by entering the User Loadable Autodial command prefix followed by the autodial location. To call location 10 (which is in Bank 0), enter:

(prefix) 10

The controller responds with, "Autodial 10", pause, the phone number "7273414", and pause. As with the Autopatch, briefly keying the mike at either pause commands the controller to dial the number into the phone. If the Control Op "Dial without click" mode is selected, the number will be dialed after the second pause without needing to key the mike.

You can inhibit the phone number readback by clicking the mike at the first pause. Waiting until the second pause allows you to verify the contents of the autodial memory. You can also prevent phone number readback of an autodial slot by having selected the "security" option when loading the number into the User Loadable Autodialer. The Control Operator can bypass the security mode to allow verification of the numbers stored, if necessary, with the Unhide command.

If you've made a mistake entering the autodial command, you can cancel the request by entering any Touch-Tone during either pause, or by not clicking the mike if required.

**Command:** (User Loadable Autodial Prefix) (Location)



**Example:** User Loadable Autodial Prefix = \*  
 User sends "\*\* 40".  
 Controller says, "Autodial 40 (pause) seven two seven three four one four", user clicks his mike at either pause and controller dials the number.

**Hints:** If you don't want your users to have to "click" their mikes to start dialing, select the Control Operator "Dial without click" mode.  
 The Long Distance E/D Control Operator selection does not apply to the User Loadable Autodialer.  
 One and three digit numbers can only be dialed from the User Loadable or Emergency Autodialers  
 The User Loadable Autodialer and Extended User Loadable Autodialer prefixes are totally independent. For example, they could be \* and 9, or \* and \*1, or 94 and 95, or 3 and 697, etc.

### Related Commands:

<b>Program</b>	User Loadable Autodialer Timer, Patch Activity Timer, Patch Timer Extend Timer, User Loadable Autodialer Command Prefix, Extended User Loadable Autodialer Command Prefix, Touch-Tone/Dial-pulse signalling
<b>Control Op</b>	User Loadable Autodial E/D, Patch Timer E/D, Cover Tone E/D/Always, Dial Needing/Without Click/No Phone Number Readback, User Loadable Autodial Hide/Unhide
<b>User</b>	Patch Cover Tone, Full-Duplex, Patch Timer Extend, Patch Hangup, Patch Custom Hangup, Patch Redial

### Activating the Emergency Autodialer

One hundred and ninety of the autodial numbers (locations 10-199) are accessed with their prefix (Bank 0 or Bank 1) plus their two digit location number. But locations 0-9 are accessed with the Emergency Autodial Prefix followed by the location number. These autodial locations function somewhat differently in that the responses by the controller are not the locations and phone numbers, but are programmable messages, like "Operator", "Fire", "Police", etc. These ten numbers are intended for emergency public service agencies, and the response indicates selection of the correct agency. The Emergency Autodialer does not require that the user click his mike to initiate telephone dialing. The patch is terminated just like the Autopatch and User Loadable Autodialer.

**Command:** (Emergency Autodial Prefix) (Location)

**Example:** Emergency Autodial Prefix = \*  
 Emergency Autodial Location 1 Message= "Fire"  
 User sends "\*\* 1".  
 Controller says, "Fire", then dials the phone number stored in Emergency Autodial location 1. The user does not need to click his mike to emergency autodial.



## Chapter 6

## How to Be a Control Operator

## Contents

- 6-1 Introduction
- 6-1 Control Operator Commands
- 6-2 Macro Set Selection
- 6-2 Repeater Enable / Disable
- 6-2 Repeater Timer
- 6-3 Access / Control
- 6-4 User Command Enable / Disable
- 6-4 Link Enable / Disable
- 6-4 Autopatch / Autodial
- 6-6 Reverse Patch
- 6-6 ID
- 6-7 Tail Message
- 6-7 Alarm Enable / Disable
- 6-7 Speech Synthesizer
- 6-8 Kerchunker Filter Enable/Disable
- 6-8 Touch-Tone Mute/Unmute
- 6-8 Zero Hang Time Mode Enable/Disable
- 6-8 Low Courtesy Tone Select
- 6-8 Initialize

## Introduction

This chapter describes the Touch-Tone commands available to the repeater's Control Operators.

## Control Operator Commands

The Control Op commands permit enabling and disabling the various functions and selection of operating modes. The Control Op command codes consist of a **prefix** which is remotely programmable by the repeater owner (Control Op Command Code Prefix), followed by a one or two digit **root code** defined below and summarized in Appendix I. The prefix may be defined to be one to seven digits, so that the Control Op commands may be two to nine digits. The entire command is entered as one sequence, i.e., prefix-root as one transmission over the air, or prefix-root-# over the phone (# is required as the command evaluation key over the phone).

The controller responds to each Control Op command with a unique response message so that the Control Op knows for sure that he entered the correct command. The format used for command description is as follows:

**root code** response message **command name(t)** command description



The † which follows many of the command names indicates that the command selection is stored in the Control Op Macro Sets.

### Macro Set Selection Commands

Two commands allow "macro" selection of Control Op Command Macro Set 1, 2, 3 or 4. Each macro set stores the entire array of Control Op selections designated below with the †. The macro sets are stored by the repeater owner using the Store Macro Set Configuration commands. The macro sets also store the user selected state of the link/remote base, and the states of the eight User Function remote control logic outputs.

1	M1	<b>Macro Set 1 Select</b>	Selects Control Op Macro Set #1.
2	M2	<b>Macro Set 2 Select</b>	Selects Control Op Macro Set #2.
3	M3	<b>Macro Set 3 Select</b>	Selects Control Op Macro Set #3.
4	M4	<b>Macro Set 4 Select</b>	Selects Control Op Macro Set #4.

**Example:** Control Op Prefix = 123.  
Enter "123 2" to select Macro Set 2

**Hints:** The controller powers up and resets to Macro Set #1.  
Macro sets simplify the work of the Control Op by requiring only a single command to carry out many routine Control Op chores.

### Repeater Enable / Disable Commands

Two commands allow the Control Op to enable or disable the repeater's transmitter.

00	RE	<b>Repeater Enable†</b>	Enables repeater transmitter.
01	RD	<b>Repeater Disable†</b>	Disables repeater transmitter.

**Example:** Control Op Prefix = 3749101  
Enter 3749101 01 to disable the repeater.

**Hints:** These commands are the repeater's "Big Switch".  
While disabled, user commands are not recognized, but Control Op and Programming commands are.

### Repeater Timer Commands

Five commands affect the repeater's timeout timer, or "alligator". The Control Op may enable or disable the timeout timer and select one of two different timeout periods previously defined by the repeater owner with Programming commands. Finally, the Control Op may clear the timer, either in anticipation of a station timing out the repeater, or after the repeater has been timed out. The timeout timer automatically clears after the signal timing it out goes away.



<b>02</b>	<b>TE</b>	<b>Repeater Timer Enable†</b>	Enables repeater timeout timer.
<b>03</b>	<b>TD</b>	<b>Repeater Timer Disable†</b>	Disables repeater timeout timer.
<b>04</b>	<b>TL</b>	<b>Repeater Timer Long†</b>	Selects long timeout timer.
<b>05</b>	<b>TS</b>	<b>Repeater Timer Short†</b>	Selects short timeout timer.
<b>06</b>	<b>TC</b>	<b>Clear Repeater Timer</b>	Cancels existing timeout condition, clears timeout timer.

**Hint:** If a carrier times out the repeater and remains present, the Control Op can clear the repeater timer if he can capture the other signal, but he must terminate the command with the "D" key to force a command evaluation over the air.

### Access / Control Commands

The Control Op may select from four different carrier/CTCSS operation modes and a Touch-Tone access mode. CTCSS operation relies on an active high logic signal from an external CTCSS decoder indicating to the controller that subaudible tone is present on a signal at the receiver or the optional internal Tone Panel board.

The "Carrier Access/Control" mode allows full access and control without the need for CTCSS. "CTCSS Control Op Command" mode allows carrier access to the repeater, and carrier only for operating User commands, but requires CTCSS for activation of Control Op (and Programming) commands. "CTCSS Control Op/User Command" mode requires CTCSS for activation of User, Control Op, or Programming commands, but allows carrier access to the repeater. Finally, "CTCSS Access" requires CTCSS for any level of control and for access to the repeater.

Touch-Tone access is brought up or down by the Touch-Tone Access User commands, and the Touch-Tone Access timer may automatically take the repeater down after a period of inactivity. When the mode is disabled by the Control Op, the Touch-Tone Access User commands have no effect.

<b>07</b>	<b>CA</b>	<b>Carrier Access/Control†</b>	Enables carrier access and control.
<b>08</b>	<b>PC</b>	<b>CTCSS Control Op Command†</b>	Enables carrier access, CTCSS required for Control Operator Touch-Tone commands.
<b>09</b>	<b>PU</b>	<b>CTCSS Control Op/User Cmd†</b>	Enables carrier access, CTCSS required for Control Op and User commands.
<b>10</b>	<b>CT</b>	<b>CTCSS Access†</b>	CTCSS required for access and control.
<b>52</b>	<b>ME</b>	<b>TT Access Mode Enable†</b>	Enables Touch-Tone Access Mode.
<b>53</b>	<b>MD</b>	<b>TT Access Mode Disable†</b>	Disables Touch-Tone Access Mode.



- Hints:** CA, PC, PU and CTCSS are mutually exclusive.  
 ME and MD are mutually exclusive, but Touch-Tone Access may be enabled (ME) along with CA/PC/PU/CTCSS condition.  
 When in CTCSS Access, Touch-Tone Access overrides the need for CTCSS for access, and is an optional alternative to the need for CTCSS.

### User Command Enable / Disable Commands

The Control Op may enable or disable the User Command level. The disable command disables all User Commands *except the Emergency Autodialer*, which may be left enabled while all other User Commands are disabled. The Pad Test Disable command allows just the Touch-Tone pad test to be off.

- |    |    |                       |                                    |
|----|----|-----------------------|------------------------------------|
| 11 | CE | User Command Enable†  | Enables User Touch-Tone commands.  |
| 12 | CD | User Command Disable† | Disables User Touch-Tone commands. |
| 41 | TE | Pad Test Enable†      | Enables Touch-Tone Pad Test.       |
| 42 | TD | Pad Test Disable†     | Disables Touch-Tone Pad Test.      |

**Hint:** Disable the Emergency Autodialer as well as User Commands to shut off all User level commands.

### Link Enable / Disable Commands

The Control Op may enable or disable the link or remote base with these commands. When disabled, the Link User commands have no effect.

- |    |    |               |                              |
|----|----|---------------|------------------------------|
| 13 | LE | Link Enable†  | Enables link / remote base.  |
| 14 | LD | Link Disable† | Disables link / remote base. |

**Hint:** The Link frequency and mode, which are User command functions, are also stored in the Macro Sets so that selecting a Macro Set can enable the link and bring it up on a certain frequency in receive only or receive/transmit.

### Autopatch / Autodial Commands

The Control Op may enable or disable independently the Autopatch, User Loadable Autodialer, and Emergency Autodialer. When disabled, the related user command codes are ignored by the controller. Long distance may be enabled or disabled. When disabled, phone numbers with a leading zero or one, or longer than seven digits are not permitted by the Autopatch. The User Loadable Autodialer may be locked, which prevents erasing or loading phone numbers.

The patch timer, which includes the overall timer and the activity timer, may be enabled or disabled. (Separate overall timer values are permitted for the Autopatch and each Autodialer, and for the activity timer.) The patch Cover Tone may be selected for all calls, may be shut off, or may be left user selectable (with the Patch Cover Tone User Command) on a call by call basis.



Full-duplex may be selected for all calls, or may be left user selectable (with the Full-Duplex User Command) on a call by call basis.

The user may be required to click his mike to initiate Autopatch and User Loadable Autodial calls, or the controller may be set to "Dial Without Click". Further, all phone number readback may be disabled as well as not requiring the click to dial with the "No Phone Number Readback command". User Loadable Autodial phone number readback may be enabled by the Control Op even for phone numbers loaded with the security option - i.e., the numbers may be "unhidden".

The Control Op Offhook command performs one of two functions.

(1) When entered over the air, it activates the patch without regenerating signalling into the phone. The Control Op may then send tones directly into the phone.

(2) Entered over the phone after calling into the repeater, this command places the Control Op on the air. The Control Op keeps the Touch-Tone decoder on the phone and is responsible for hanging up. The patch timers protect against forgetting to enter the Hangup command.

The Control Op Onhook command may be used to hang up after calling the controller on the phone for a command session, or following the Offhook command. The Patch Hangup User Command (followed by a # over the phone) will also place the phone back on hook. The Onhook command may be used over the air to hang up the patch in case a user has defined a custom hangup code and forgotten the code he defined.

<b>19 PE Autopatch Enable†</b>	Enables Autopatch.
<b>20 PD Autopatch Disable†</b>	Disables Autopatch.
<b>27 LE Long Distance Enable†</b>	Enables Autopatch long distance.
<b>28 LD Long Distance Disable†</b>	Disables Autopatch long distance.
<b>21 UE User Autodial Enable†</b>	Enables User Loadable Autodialer.
<b>22 UD User Autodial Disable†</b>	Disables User Loadable Autodialer.
<b>47 AU User Autodial Unlock†</b>	Unlocks User Loadable Autodialer.
<b>48 AL User Autodial Lock†</b>	Locks User Loadable Autodialer.
<b>57 UU User Autodial Unhide†</b>	Allows numbers loaded with security option to be read back.
<b>58 UH User Autodial Hide†</b>	Allows numbers loaded with security option to remain hidden.
<b>23 EE Emergency Autodial Enable†</b>	Enables Emergency Autodialer.
<b>24 ED Emergency Autodial Disable†</b>	Disables Emergency Autodialer.
<b>60 NC Dial Needing Click†</b>	Requires user click to initiate dialing.
<b>59 XC Dial Without Click†</b>	Enables dialing without user click.
<b>68 NR No Phone Number Readback†</b>	Disables phone number readback and enables dialing without user click.
<b>25 PT Patch Timer Enable†</b>	Enables patch overall and activity timers.
<b>26 PX Patch Timer Disable†</b>	Disables patch timers.
<b>49 TD Cover Tone Disable†</b>	Disables patch cover tone.
<b>50 TE Cover Tone Enable†</b>	Enables patch cover tone - user selected.



- 51 TA Cover Tone Always On†** Selects patch cover tone for all patches.
- 80 FD Full-Duplex User Selectable†** Patches are half-duplex unless user selected to be full-duplex.
- 81 FA Full-Duplex Always†** All patches are full-duplex.
- 43 -- Control Op Offhook** "Manually" takes phone offhook.
- 44 -- Control Op Onhook** Places phone onhook (hangup).

**Hints:** When controlling from the phone, hang up with Control Op Onhook. If someone forgets his custom hangup code, hang up with Control Op Onhook.

Emergency Autodial never requires user to click his mike to initiate dialing.

NC, XC, and NR are mutually exclusive.

Disabling all patch timers can be *dangerous*.

## Reverse Patch Commands

These commands allow the Control Op to enable or disable the Reverse Patch. He may also select from one of four Reverse Patch modes.

- 45 XE Reverse Patch Enable†** Enables Reverse Patch.
- 46 XD Reverse Patch Disable†** Disables Reverse Patch.
- 54 R0 Reverse Patch Mode 0†** Selects phone line control /reverse patch.
- 55 R1 Reverse Patch Mode 1†** Selects auto-ringout after 5 seconds.
- 56 R2 Reverse Patch Mode 2†** Selects auto-ringout without answering.
- 67 R3 Reverse Patch Mode 3†** Selects telephone access paging/phone line control

**Warning:** One or more Reverse Patch modes may not be legal in the Amateur service.

## ID Commands

The Control Op may select which ID messages are generated at Pending ID times. Any of the Pending ID messages or the Special ID message may be generated at each Pending ID time, or the controller may rotate between the three Pending ID messages, or between the three Pending ID and the Special ID messages.

- 29 P1 Pending ID 1†** Selects Pending ID 1.
- 30 P2 Pending ID 2†** Selects Pending ID 2.
- 31 P3 Pending ID 3†** Selects Pending ID 3.
- 32 SP Special ID†** Selects Special ID.
- 33 RP Rotate Pending IDs†** Rotates Pending ID 1-2-3
- 34 RS Rotate Pending-Special IDs†** Rotates Pending ID 1-2-3 - Special ID

**Hint:** These commands are mutually exclusive - only one is in effect at a time.



## Tail Message Commands

The Control Op may select from three remotely programmable tail messages to be generated occasionally just before the repeater carrier is allowed to drop. He may also disable the tail message function. Tail messages are useful as reminders of events to users, or to indicate repeater status or emergency conditions.

<b>35</b>	<b>T1</b>	<b>Tail Message 1†</b>	Selects Tail Message 1.
<b>36</b>	<b>T2</b>	<b>Tail Message 2†</b>	Selects Tail Message 2.
<b>37</b>	<b>T3</b>	<b>Tail Message 3†</b>	Selects Tail Message 3.
<b>38</b>	<b>TF</b>	<b>Tail Message Off†</b>	Disables Tail Messages.

**Hint:** These commands are mutually exclusive – only one is in effect at a time.

## Alarm Enable / Disable Commands

The Alarm Enable command arms the site alarm. Disabling the alarm clears an alarm condition latched into the controller and prevents further alarm activation until reenabled.

<b>00</b>	<b>RE</b>	<b>Alarm Enable†</b>	Enables site alarm.
<b>15</b>	<b>AD</b>	<b>Alarm Disable†</b>	Disables site alarm.

**Hint:** The Alarm Enable is the same as the Repeater Enable command.

## Speech Synthesizer Commands

The Control Op may enable or disable the speech synthesizer. The Speech Enable command may reenable the synthesizer after a hardware fault or programming error which results in automatic disabling of the synthesizer. The Speech Disable command is available if the Control Op would like to temporarily shut off speech and revert to Morse code exclusively.

Normally, speech responses are interrupted by a signal at the receiver.

<b>16</b>	<b>SE</b>	<b>Speech Enable†</b>	Enables speech synthesizer.
<b>17</b>	<b>SD</b>	<b>Speech Disable†</b>	Disables (turns off) speech synthesizer.
<b>39</b>	<b>SI</b>	<b>Allow Speech Interrupt†</b>	Speech halted by user signal.
<b>40</b>	<b>SO</b>	<b>Force Speech Talkover†</b>	Speech overrides user signal.

**Note:** When speech is disabled, the Forced CW ID is generated in place of the other ID messages. Other command responses may not completely convert from speech to Morse, so operation in Speech Disable mode should be limited to special circumstances.



**Kerchunker Filter Enable/Disable**

The Kerchunker filter may be enabled or disabled.

- 61 KE **Kerchunker Filter Enable**† Enables kerchunker filter.  
 62 KD **Kerchunker Filter Disable**† Disables kerchunker filter.

**Touch-Tone Mute/Unmute**

The Control Op may cause Touch-Tone to be normally unmuted, although the keys will be evaluated by the command decoder. Unmuting Touch-Tone can be useful to hear tones being sent, to pass tones through to other control systems listening on channel (such as ShackMaster), etc.

- 63 TM **Touch-Tone Mute**† Touch-Tone normally muted  
 64 TU **Touch-Tone Unmute**† Touch-Tone unmuted

**Zero Hang Time Mode Enable/Disable**

A user transmission is normally followed by a Courtesy Tone and a programmable hang time. The hang time may be forced to zero so that the repeater transmitter directly follows the received signal. This mode can be useful for operating a ShackMaster station located at someone's home and for other purposes.

- 65 ZD **Zero Hang Time Disable**† Disables zero hang time.  
 66 ZE **Zero Hang Time Enable**† Enables zero hang time.

**Low Courtesy Tone Select**

The courtesy tone generated when the Courtesy Tone Select logic input is in the low state may be Control Op selected. (The logic input is internally pulled low so that if nothing is connected, it is in the low state.) This makes it possible for the Courtesy Tone to indicate which Macro Set is selected while allowing a hardware override to the CT input high tone.

- 70-79 CT **Courtesy Tone Low Select**† Selects CT0-9 for the CT logic input low state.

**Initialize Command**

The Initialize command causes the computer to perform a "soft restart" and is generally equivalent to pressing the reset button. The command initializes the state of the board and loads Control Op Macro Set #1.

- 18 -- **Reset** † Initializes microprocessor.



## Chapter 7

# Programming the Controller

### Contents

- 7-1 Introduction
- 7-1 Programming Commands
- 7-1 Unlocking and Locking
- 7-2 Programming the Unlock Code
- 7-2 Messages
- 7-8 Tone Parameters
- 7-8 Courtesy Tone Selection
- 7-9 Timers
- 7-10 Command Code Prefixes
- 7-10 Emergency Autodial Numbers
- 7-11 Miscellaneous Selections
- 7-11 Store Macro Sets

### Introduction

This chapter describes how the RC-96 repeater controller is remotely programmed by the repeater owner to customize many of its characteristics. The controller is programmed with Programming commands which may be entered when the controller is unlocked. These commands cause information to be stored in the controller's non-volatile memory so that the information isn't lost if power fails. The various types of Programming commands are described with examples shown.

### Programming Commands

Programming commands allow remote Touch-Tone programming of the controller. They are accessed by placing the controller into a special "unlocked" mode where only Programming commands are recognized. Unlocking the controller requires an "unlock command" unique to the controller, providing security against tampering. When entry of a series of Programming commands is completed, the controller is "locked" up again for normal operation so that it's secure from unintended changes.

### Unlocking and Locking

The controller normally operates in the "locked" mode where Programming commands are protected and not accessible. To access the Programming commands to make remote changes to the messages, timers, command codes, etc., the controller must be unlocked.



**Hint:** Because of the ID algorithm, the maximum period between ID's is the ID timer period plus four minutes. In the Amateur Radio service, set the ID timer to six minutes or less.

## Command Code Prefixes

Command code prefixes for Control Operator commands and the various classes of User commands may be changed remotely. The command prefix desired is entered directly as part of the Command Code Prefix Programming commands.

*5000(prefix)	Control Operator Command	CMD
*5001(prefix)	User Function Logic Output	CMD
*5002(prefix)	Emergency Autodial	CMD
*5003(prefix)	User Loadable Autodial	CMD
*5004(prefix)	Autopatch	CMD
*5005(prefix)	Link / Remote Base	CMD
*5006(prefix)	User Autodial Load / Erase	CMD
*5007(prefix)	Demo / Bulletin Board	CMD
*5008(command)	Reverse Patch (from phone only)	CMD
*5009(command)	Spare Audio (user cancels with #)	CMD
*5010(prefix)	Patch Utilities	CMD
*5011(command)	Patch Hangup (load empty command to restore #)	CMD
*5012(prefix)	Two-Tone Paging	CMD
*5013(prefix)	Touch-Tone Access Mode Up / Down	CMD
*5014(command)	S-Meter Readback	CMD
*5015(prefix)	Extended User Autodial (Bank 1)	CMD
*5016(prefix)	Extended User Autodial Load/Erase	CMD
*5017(command)	Telephone Timer Extend	CMD
*5018(prefix)	Memory Paging	CMD

**Hint:** To define the Patch Hangup command to be #, load an empty command, i.e., "\*5011".

All patch related prefixes may be identical, i.e., \*.

## Emergency Autodial Numbers

The ten Emergency Autodialer telephone numbers are loaded or changed with these commands.

\*520x(telephone number) (x = autodial location 0-9)

**Hints:** A location may be erased and left empty by entering nothing for the phone number. For example, to erase slot 3, enter "\*5203". The Emergency Autodial response messages are defined with the Message Editor.

## Miscellaneous Selections

Various controller operating modes may be selected with the following Programming commands. Either Touch-Tone or dial-pulse (rotary) signalling into the phone may be selected for patch operation. Control



Operator and Programming control may be permitted or not permitted through the repeater receiver (may be prohibited for overall security). The controller may be set up for shared or unshared use of the phone line (see Chapter 8 - Sharing the Phone Line). Finally, the logic sense of the User Function remote control logic outputs may be selected to be low true or high true.

<b>*5400</b>	<b>Touch-Tone patch signalling</b>	TT
<b>*5401</b>	<b>Dial Pulse signalling</b>	DP
<b>*5402</b>	<b>Enable control over repeater receiver</b>	EC
<b>*5403</b>	<b>Disable control over repeater receiver</b>	DC
<b>*5404</b>	<b>Phone line not shared</b>	PLU
<b>*5405</b>	<b>Phone line shared</b>	PLS
<b>*5406</b>	<b>UF Low True</b>	FL
<b>*5407</b>	<b>UF High True</b>	FH

**Hints:** The commands are mutually exclusive in pairs, i.e., you may select TT or DP, EC or DC, PLU or PLS, and FL or FH.  
The EC and DC commands may not be entered through the repeater receiver.

### Store Macro Sets

The currently active Control Operator enable/disable and mode selections may be stored in one of two "Macro Sets" which may later be selected by the Control Operator with simple commands. One macro select Control Op command in effect performs may Control Op command functions. The macro sets also store the user state of the link/remote base and the UF remote control logic output states.

To store a macro set, set up the repeater as you wish to have it stored. The Store Macro Set commands take a "snapshot" of the current setup of the controller and stores it in the non-volatile memory in set 1, 2, 3 or 4.

<b>*5911</b>	<b>Store Macro Set #1</b>	MACRO
<b>*5912</b>	<b>Store Macro Set #2</b>	MACRO
<b>*5913</b>	<b>Store Macro Set #3</b>	MACRO
<b>*5914</b>	<b>Store Macro Set #4</b>	MACRO

### Pager Memories

The format and address of one thousand pagers may be stored in the controller's memory. Several forms of two-tone sequential, and 5/6 tone sequential are supported.

- \*29 xxx f aaaa(aa)** PAGE
- xxx** = three digit memory number (000 - 999)  
**f** = pager format
- 0 = 1 second / 3 second two-tone
  - 1 = 2.7 second / .8 second two-tone
  - 2 = .4 second / .8 second two-tone
  - 3 = 8 second group call



- 5 = five tone sequential  
 6 = six tone sequential  
 aaaa(aa) = pager address  
 two-tone - A group, A tone, B group, B tone  
 two-tone group call - A group, A tone, A group, A tone  
 5/6 tone - wakeup tone, tones 1-5 (six digits)  
 (for no wakeup tone, insert \* as first digit)

## 2-TONE SEQUENTIAL MOTOROLA TONE FREQUENCIES

STONE	GROUP 1 CODE FREQ	GROUP 2 CODE FREQ	GROUP 3 CODE FREQ	GROUP 4 CODE FREQ	GROUP 5 CODE FREQ	GROUP 6 CODE FREQ
1	111 349.0	121 600.9	138 288.5	141 339.6	151 584.8	191 1153.4
2	112 368.5	122 634.5	108 296.5	142 358.6	152 617.4	192 1185.2
3	113 389.0	123 669.9	139 304.7	143 378.6	153 651.9	193 1217.8
4	114 410.8	124 707.3	109 313.0	144 399.8	154 688.3	194 1251.4
5	115 433.7	125 746.8	160 953.7	145 422.1	155 726.8	195 1285.8
6	116 457.9	126 788.5	130 979.9	146 445.7	156 767.4	196 1321.2
7	117 483.5	127 832.5	161 1006.9	147 470.5	157 810.2	197 1357.6
8	118 510.5	128 879.0	131 1034.7	148 496.8	158 855.5	198 1395.0
9	119 539.0	129 928.1	162 1063.2	149 524.6	159 903.2	199 1433.4
0	110 330.5	120 569.1	189 1092.4	140 321.7	150 553.9	190 1122.5

## GE TYPE 99 TONE FREQUENCIES

STONE	GROUP 7 FREQ "A"	GROUP 8 FREQ "B"	GROUP 9 FREQ "C"
1	592.5	607.5	712.5
2	757.5	787.5	772.5
3	802.5	832.5	817.5
4	847.5	877.5	862.5
5	892.5	922.5	907.5
6	937.5	967.5	952.5
7	547.5	517.5	532.5
8	727.5	562.5	577.5
9	637.5	697.5	622.5
0	682.5	652.5	667.5

## 5/6 TONE SEQUENTIAL

STONE	FREQUENCY
0	600
1	741
2	882
3	1023
4	1164
5	1305
6	1446
7	1587
8	1728
9	1869
X	2010
R	459



## TWO-TONE SEQUENTIAL TIMINGS

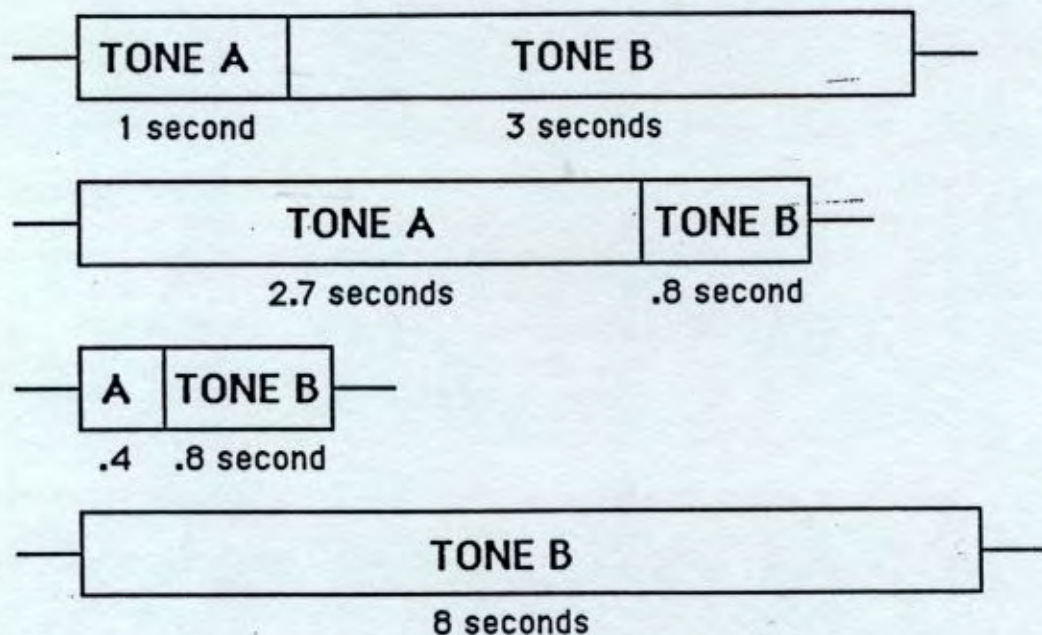

## 5/6 TONE SEQUENTIAL TIMING

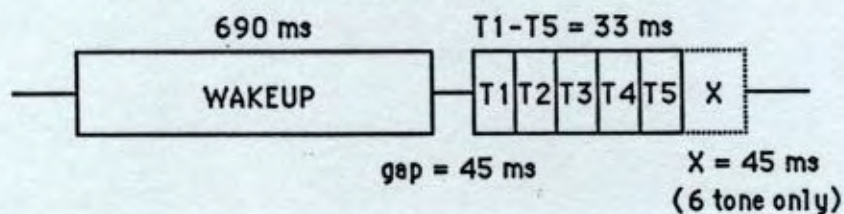



The "unlock code" is programmed by the repeater owner and can start with any key except 5, #, or D. The remainder of the code can contain any keys except # or D. If it becomes necessary to change the unlock code for security, it may be changed whenever necessary to any ten digit code, but it must be done at the site.

While the controller is unlocked, the "UL" prompt indicates that it is waiting for valid Programming commands. Each entry of a valid command reloads the one minute unlock timer. If the timer times out, the controller automatically locks back up.

The controller is normally locked back up after a series of Programming commands with the # key (## over the phone or from the keypad).

### Programming the Unlock Code

The repeater owner may program his favorite ten digit sequence as the controller's unlock code. Simply flip DIP switch 8 "ON" and enter the desired ten digit Touch-Tone unlock code over any of the command channels. The controller writes the code into its non-volatile memory and responds by saying, "UL PGM". DIP switch 8 should be turned "OFF", and from then on the controller may be unlocked by entering the specified ten digit code (followed by # over the phone or from the keypad).

The ten digit code should not begin with 5 (Touch-Tone Pad Test prefix) and should not contain # or D.

*Be sure to turn off DIP switch 8 after entering the desired unlock code.*

### Messages

Most of the Morse code and synthesized speech messages are remotely programmable, including IDs, tail messages, Emergency Autodial responses, telephone answer and hangup messages, alarm message, and two Bulletin Board messages.

Messages may only be entered or changed while the controller is unlocked. The message to be edited is selected with the appropriate Touch-Tone Programming command. Then the message is entered based on Morse code character or speech vocabulary Touch-Tone representation, shown below.

Codes for Morse code and speech letters and numbers are based on their position on a telephone keypad. The first digit of the code indicates what button the letter appears on, and the second digit indicates whether it's the first, second, or third letter on the key. The letters Q and Z are represented by 70 and 90. Numbers are represented by 00 through 09. This logical layout makes it easy to enter letters and numbers with the Message Editor without having to look up the codes.



The additional synthesized speech vocabulary and Morse code punctuation characters are assigned two and four digit codes shown in the tables below.

## Message Editor Commands

(see Chapter 7 - "Programming the Controller", for details)

<b>Store Message in Memory</b>	<b>*0</b>	(after completed editing a message)
<b>Delete Last Character</b>	<b>*1</b>	(to erase a mistaken character)
<b>Read Back Message</b>	<b>*2</b>	(to check what you've entered so far)
<b>Abort Message Editor</b>	<b>*4</b>	(to return to "UL" level without storing the message in memory)

## Morse Code Character Codes

<b>A</b>	<b>21</b>	<b>N</b>	<b>62</b>	<b>0</b>	<b>00</b>	<b>-</b>	<b>10</b>
<b>B</b>	<b>22</b>	<b>O</b>	<b>63</b>	<b>1</b>	<b>01</b>	<b>word space</b>	<b>11</b>
<b>C</b>	<b>23</b>	<b>P</b>	<b>71</b>	<b>2</b>	<b>02</b>	<b>/</b>	<b>12</b>
<b>D</b>	<b>31</b>	<b>Q</b>	<b>70</b>	<b>3</b>	<b>03</b>	<b>AR</b>	<b>13</b>
<b>E</b>	<b>32</b>	<b>R</b>	<b>72</b>	<b>4</b>	<b>04</b>	<b>:</b>	<b>14</b>
<b>F</b>	<b>33</b>	<b>S</b>	<b>73</b>	<b>5</b>	<b>05</b>	<b>?</b>	<b>20</b>
<b>G</b>	<b>41</b>	<b>T</b>	<b>81</b>	<b>6</b>	<b>06</b>	<b>;</b>	<b>24</b>
<b>H</b>	<b>42</b>	<b>U</b>	<b>82</b>	<b>7</b>	<b>07</b>	<b>,</b>	<b>30</b>
<b>I</b>	<b>43</b>	<b>V</b>	<b>83</b>	<b>8</b>	<b>08</b>	<b>.</b>	<b>40</b>
<b>J</b>	<b>51</b>	<b>W</b>	<b>91</b>	<b>9</b>	<b>09</b>	<b>(</b>	<b>50</b>
<b>K</b>	<b>52</b>	<b>X</b>	<b>92</b>			<b>SK</b>	<b>60</b>
<b>L</b>	<b>53</b>	<b>Y</b>	<b>93</b>				
<b>M</b>	<b>61</b>	<b>Z</b>	<b>90</b>				

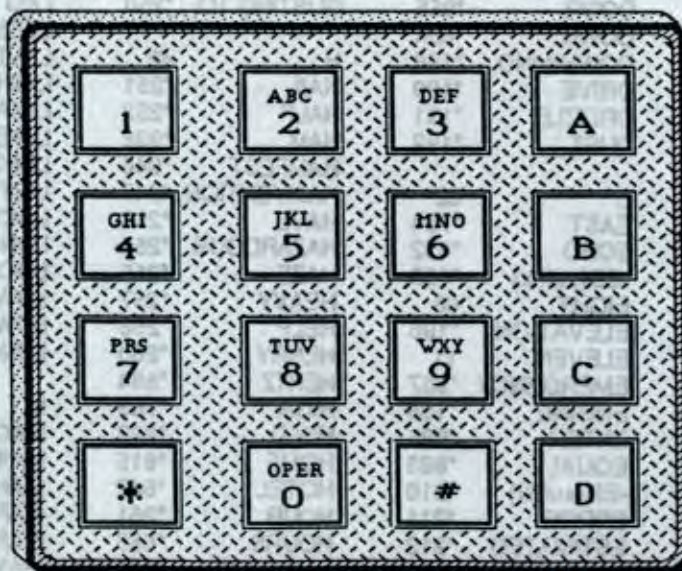

Examples: **W = 91**  
**3 = 03**



## Speech Synthesizer Vocabulary Codes

A	21	CHARLIE	*623	F	33	ICING	*263
A.M.	*110	CHECK	*865	FAIL	*755	IDENTIFY	*264
ABORT	*992	CIRCUIT	*720	FAILURE	*216	IGNITE	*266
ABOUT	*855	CLEAR	*163	FARENHEIT	*217	IGNITION	*267
ABOVE	*112	CLIMB	*165	FAST	*925	IMMEDIATELY	*268
ACKNOWLEDGE	*114	CLOCK	*945	FEBRUARY	*218	IN	*270
ACTION	*115	CLOSED	*166	FEET	15	INBOUND	*271
ADJUST	*944	CLUB	*926	FIF-	50	INCH	*964
ADVANCED	*916	CODE	75	FILED	*223	INCREASE	*272
ADVISE	*116	COME	*167	FINAL	*224	INCREASING TO	*274
AERIAL	*117	COMPLETE	*721	FIRE	*634	INDIA	*643
AFFIRMATIVE	*118	COMPUTER	*927	FIRST	*225	INDICATED	*275
AIR	*120	CONDITION	*168	FIVE	05	INFLIGHT	*276
AIRPORT	*122	CONGRATULATIONS		FLAPS	*227	INFORMATION	*996
ALERT	40		*170	FLIGHT	*228	-ING(suffix)	*948
ALL	*685	CONNECT	*940	FLOW	*960	INNER	*277
ALOFT	*124	CONTACT	*171	FOG	*230	INSPECTOR	*785
ALPHA	*621	CONTROL	*624	FOR	*231	INTRUDER	*764
ALTERNATE	*125	CONVERGING	*172	FOUR	04	IS	*733
ALTITUDE	*127	COUNT	*173	FOURTH	*234	IT	*281
AMATEUR	*917	COURSE	*174	FOXTROT	*633		
AMPS	*831	CROSSWIND	*175	FREEDOM	*235	J	51
AND	74	CURRENT	*177	FREEZING	*236	JANUARY	*282
ANSWER	*128	CYCLE	*951	FREQUENCY	*610	JULIET	*651
APRIL	*131			FRIDAY	*237	JULY	*283
AREA	*713	D	31	FROM	64	JUNE	*284
ARRIVAL	*132	DANGER	*712	FRONT	*238		
AS	*133	DAYS	*952	FULL	*241	K	52
AT	*742	DAYTON	*928			KEY	*285
AUGUST	*135	DECEMBER	*181	G	41	KILO	*652
AUTO	*918	DECREASE	*182	GALLONS	*991	KNOTS	*286
AUTOMATIC	*741	DECREASING	*183	GATE	*845		
AUTOPILOT	*136	DEGREES	*722	GEAR	*244	L	53
AUXILIARY	*137	DELTA	*631	GET	*962	LAND	*287
		DEPARTURE	*185	GLIDE	*245	LANDING	*288
B	22	DIAL	*936	GO	*895	LATE	*956
BAND	*138	DINNER	*186	GOLF	*641	LAUNCH	*291
BANK	*140	DIRECTION	*752	GREEN	*762	LEAN	*292
BASE	*141	DISPLAY	*954	GROUND	*248	LEFT	*770
BATTERY	*142	DOOR	*955	GUSTING TO	*250	LEG	*293
BELOW	*143	DOWN	*654			LESS THAN	*294
BETWEEN	*660	DOWNWIND	*188	H	42	LEVEL	*295
BLOWING	*144	DRIVE	*190	HAIL	*251	LIGHT	*934
BOARD	*145	DRIZZLE	*191	HALF	*252	LIMA	*653
BOOST	*146	DUST	*192	HAM	*938	LINE	*942
BOZO	*147			HAMFEST	*946	LINK	*998
BRAKE	*148	E	32	HAMVENTION	*947	LIST	*296
BRAVO	*622	EAST	*754	HAVE	*253	LOCK	*297
BREAK	*743	ECHO	*632	HAZARDOUS	*254	LONG	*298
BROKEN	*151	-ED(suffix)	*193	HAZE	*255	LOOK	*957
BUTTON	*993	EIGHT	08	HEAVY	*257	LOW	*771
BY	*152	ELEVATION	*196	HELP	*258	LOWER	*310
		ELEVEN	11	HENRY	*260	LUNCH	*311
C	23	EMERGENCY	*937	HERTZ	*684		
CABIN	*153	ENGINE	*198	HIGH	*763	M	61
CALIBRATE	*735	ENTER	*995	HOLD	*963	MACHINE	84
CALL	*751	EQUAL	*893	HOME	*615	MAINTAIN	*312
CALLING	*155	-ER(suffix)	*210	HOTEL	*642	MANUAL	*965
CALM	*156	ERROR	*211	HOUR	*261	MARCH	*313
CANCEL	*864	ESTIMATED	*212	HOURS	*655	MARKER	*314
CAUTION	*711	EVACUATE	*213	HUNDRED	*640	MAY	*315
CEILING	*158	EVACUATION	*214			MAYDAY	*316
CENTER	*161	EXIT	*761	I	43	ME	*920
CHANGE	*875	EXPECT	*215	ICE	*262	MEAN	*317



MEASURE	*970	PERCENT	*675	SHOWERS	*416	TURN	*990
MEETING	35	PHONE	*914	SHUT	*765	TWELVE	12
MEGA	*680	PLEASE	*967	SIDE	*417	TWENTY	20
MESSAGES	*625	PLUS	*611	SIERRA	*673	TWO	02
METER	*620	POINT	*674	SIGHT	*418	-TY(suffix)	60
MIKE	*661	POLICE	*968	SIX	06	U	82
MILES	*322	POSITION	*780	SLEET	*423	UNDER	*775
MILLI	*825	POWER	*714	SLOPE	*424	UNIFORM	*682
MILLION	*323	PRACTICE	85	SLOW	*983	UNIT	*715
MINUS	*612	PRESS	*781	SMOKE	*795	UNLIMITED	*467
MINUTES	*645	PRESSURE	*935	SNOW	*425	UNTIL	*468
MIST	*324	PRIVATE	*366	SOUTH	*790	UP	*650
MOBILE	*958	PROBE	*975	SPEED	*984	USE(noun)	*470
MODERATE	*326	PROGRAMMING	*367	SPRAY	*427	USE(verb)	*471
MONDAY	*327	PULL	*980	SQUAWK	*428	V	83
MONTH	*328	PUSH	*977	STALL	*431	VALLEY	*986
MORE THAN	*330	Q	70	START	*730	VARIABLE	*473
MOTOR	*972	QUEBEC	*670	STOP	*731	VERIFY	*475
MOVE	*973	R	72	STORM	*433	VICTOR	*683
MUCH	*332	RADIO	*976	SUNDAY	*434	VISIBILITY	*476
N	62	RAIN	*374	SWITCH	*725	VOLTS	*750
NEAR	*333	RAISE	*375	SYSTEM	*997	W	91
NEGATIVE	*334	RANGE	*981	T	81	WAIT	54
NET	25	RATE	*376	TANGO	*681	WAKE	*477
NEW	*335	READY	*783	TANK	*435	WAKE UP	*478
NEXT	*336	REAR	*377	TARGET	*436	WARNING	*480
NIGHT	*337	RECEIVE	*378	TAXI	*437	WATCH	*481
NINE	09	RED	*744	-TEEN(suffix)	14	WATTS	*815
NO	*342	RELEASE	*381	TELEPHONE	*438	WAY	*482
NORTH	*772	REMARK	*382	TEMPERATURE	*724	WEATHER	95
NOT	*695	REMOTE	*910	TEN	10	WEDNESDAY	*484
NOVEMBER	*662	REPAIR	*745	TERMINAL	*440	WELCOME	*913
NUMBER	*734	REPEAT	*982	TEST	*792	WEST	*793
O	63	REPEATER	80	-TH(suffix)	*441	WHISKEY	*691
OBSCURED	*344	RICH	*383	THANK YOU	*978	WILL	*912
OCLOCK	*345	RIG	*384	THAT	*442	WIND	*487
OCTOBER	*346	RIGHT	*665	THE	24	WITH	*490
OF	*694	ROAD	*385	THE(long e)	*443	WRONG	*491
OFF	*614	ROGER	*386	THE(short e)	*444	X	92
OHIO	*348	ROMEO	*672	THIR-	13 or 30	X-RAY	*692
OHMS	*933	ROUTE	*388	THIRD	*447	Y	93
OIL	*350	RUNWAY	*390	THIRTEEN	*448	YANKEE	*693
ON	*613	S	73	THIS	*451	YELLOW	*794
ONE	01	-S(suffix)	*915	THIS IS	65	YESTERDAY	*492
OPEN	94	SAFE	*784	THOUSAND	*644	YOU	*493
OPERATION	*352	SAND	*391	THREE	03	YOUR	*987
OPERATOR	*630	SANTA CLARA	*392	THUNDERSTORMS	*452	Z	90
OSCAR	*663	SATURDAY	*393	THURSDAY	*453	ZED	*988
OTHER	*353	SCATTERED	*394	TIME	44	ZERO	00
OUT	*740	SECOND	*395	TIMER	*732	ZONE	*494
OUTER	*355	SECONDS	*635	TO	*455	ZULU	*690
OVER	*773	SECURITY	*396	TODAY	*456		
OVERCAST	*356	SELECT	*397	TOMORROW	55		
P	71	SEPTEMBER	*398	TONIGHT	45		
P.M.	*358	SEQUENCE	*410	TOOL	*985		
PAPA	*671	SERVICE	*723	TORNADO	*457		
PARTIALLY	*361	SET	*885	TOUCHDOWN	*458		
PASS	*774	SEVEN	07	TOWER	*460		
PATCH	*966	SEVERE	*413	TRAFFIC	*461		
PATH	*362	SEXY	*414	TRANSMIT	*462		
PER	*364	SHORT	*415	TRIM	*463		
				TUESDAY	*464		
				TURBULANCE	*465		



Several Message Editor **commands** control its operation:

**Store Message in Memory - \*0** When you've completed editing the message and it's correct, it may be stored in the controller's non-volatile memory by entering \*0 (\*0# over the phone). There will be a brief delay as it's programming the E<sup>2</sup>PROM, then the controller will announce, "Write, UL", indicating a successful write operation and that it's ready for the next Programming command.

**Delete Last Character - \*1** If you make a mistake in entering a word or character, the last character entered can be deleted (i.e., backspace or rubout) with \*1 (\*1# over the phone). The deleted character is read back for confirmation. One character at a time can be deleted.

**Read Back Message - \*2** At any time while editing a message, you can read back what's been entered so far with \*2 (\*2# over the phone). With long messages, it's a good idea to enter a few characters at a time and occasionally read back the entire message to verify that what you intended is what you've entered.

**Abort Message Editor - \*4** At any time while editing a message, you can abort the operation without storing the message with \*4 (\*4# over the phone) and return to the "UL" prompt, ready to accept additional Programming commands or to lock up the controller.

To illustrate, here are two editing examples - a Morse code ID for the Forced CW ID Message, and a speech Bulletin Board message. First, if the controller is not already unlocked, enter the unlock command. Then select the message to be edited with the command \*1001 (\*1001# over the phone). The controller responds by saying, "FI" to confirm selection of the Forced CW ID Message. Now you can enter the message you wish with Touch-Tone digits representing the characters you want. When you've entered the message, you can command it to be written into memory, and you're ready for the next Programming command.

**Example:** Forced CW ID Message = "WA6AXX/R"

ENTER	RESPONSE	COMMENT
(unlock code)	UL	Unlock the controller
*1001	FI	Select Forced CW ID Message
912106	WA6 (cw)	Enter a few characters at a time
219292	AXX (cw)	
1271	/P (cw)	Woe! Error
*1	P (cw)	Delete last character
72	R (cw)	Enter correct character
*2	WA6AXX/R (cw)	Read back message
*0	Write	Store message in memory
	UL	Ready for next Programming command



The next example is a synthesized speech message. You'll load the Bulletin Board Message #1 with "See you at the meeting tonight. Call AXX for INFO. 73's."

ENTER	RESPONSE	COMMENT
(unlock code)	UL	Unlock the controller
*1123	B1	Select Bulletin Board #1 Message
2382*74224	See you at the	Enter a few characters at a time
354534	meeting tonight (pause)	
*75021929204	Call AXX for	
43623363	INFO	
34076003	(pause) 73.	
*2	See you at the meeting tonight.	
	Call AXX for INFO. 73.	
*0	Write	Store message in memory
	UL	Ready for next Prog. command

Note that the \*1 Delete Last Character command causes the last character entered to be deleted after it is read back to acknowledge. The \*2 Read Back Message command may be used at any time to read back what has been entered so far. The \*4 Abort command would return you to the unlock command level, allowing you to quit without storing the message that you're editing.

Command		Message Name	Response	Max # of Characters
Morse	Speech			
*1000	*1100	Initial ID	II	20
*1001	---	Forced CW ID	FI	12
*1002	*1102	Anxious ID	AI	12
*1003	*1103	Pending ID 1	P1	24
*1004	*1104	Pending ID 2	P2	24
*1005	*1105	Pending ID 3	P3	24
*1006	*1106	Special ID	SI	48
*1007	*1107	Tail Message 1	T1	8
*1008	*1108	Tail Message 2	T2	8
*1009	*1109	Tail Message 3	T3	8
*1010	*1110	Autodial 0 Service	E0	6
*1011	*1111	Autodial 1 Service	E1	6
*1012	*1112	Autodial 2 Service	E2	6
*1013	*1113	Autodial 3 Service	E3	6
*1014	*1114	Autodial 4 Service	E4	6
*1015	*1115	Autodial 5 Service	E5	6
*1016	*1116	Autodial 6 Service	E6	6
*1017	*1117	Autodial 7 Service	E7	6
*1018	*1118	Autodial 8 Service	E8	6
*1019	*1119	Autodial 9 Service	E9	6
*1020	*1120	Phone Answer	PH	16
*1021	*1121	Phone Hangup	HG	8
*1022	*1122	Alarm	AL	8
*1023	*1123	Bulletin Board #1	B1	32
*1024	*1124	Bulletin Board #2	B2	32
---	*1125	Patch Dialing Prefix	DX	6

(Each message may be either Morse or speech - there is one storage location per message.)



- Hints:** Most vocabulary words occupy one character slot. Words beginning with \*1, \*2, \*3, \*4, or \*9 occupy *two* character slots. The Patch Dialing Prefix is not a message per se, but is the telephone dialing string that may precede all phone patches. For example, if the controller is connected to a PBX, it may be necessary to dial "9 pause" before all calls. Load speech "9 (pause)" into this message.
- An *external tape player* may be addressed from any programmable message by selecting the message with the command "**\*13xx**" and loading the message with the speech letter "X". For example, to have Bulletin Board #2 address the external tape player, enter the command "**\*1324**" and load the character "X" (92), then write the message into memory. See Chapter 8 for details of interfacing the external tape player.
- Digital Voice Recorder* tracks may be addressed from any programmable message. See Chapter 8 and the DVR manual for details.

## Tone Parameters

The Morse code speed and pitch and the Cover Tone pitch may be changed using these commands; speed is entered directly in words per minute and pitch is entered in Hertz. The Cover Tone level is 6 dB below Morse level, and the Cover Tone can be made inaudible if desired by setting a very low pitch.

<b>*2000(speed)</b>	<b>Morse Code Speed</b>	speed = 12 - 30 wpm
<b>*2010(pitch)</b>	<b>Morse Code Pitch</b>	pitch = 1 - 3000 Hz
<b>*2020(pitch)</b>	<b>Cover Tone Pitch</b>	pitch = 1 - 3000 Hz

**Example:** Set the Cover Tone Pitch to 440 Hz.  
Unlock the controller. Enter "**\*\*2020440**" (or "**\*\*2020440\*\***" over the phone). Controller responds with Forced CW ID message at the selected pitch.

## Courtesy Tone Selection

Ten different predefined courtesy tone sets are stored in the controller's firmware and may be selected for use. Two courtesy tones are available for normal repeater use, based on the state of the Courtesy Tone Select logic input. The logic input low state tone is selected with a Control Op level command so that it can be stored in a Macro Set (to indicate which macro is selected, among other reasons). The logic input high state tone is selected by the Programming command below and is intended to indicate a special hardware condition. A third configurable tone applies to signals received through the remote base, and it differentiates remote base signals from those on the repeater frequency.



The ten courtesy tone sets are described below – but you really have to hear them for yourself!

CT Set #	Description	CT Set #	Description
0	(no tone)	5	"Stardust"
1	"Bumble Bee"	6	"Duncecap"
2	"Yellow Jacket"	7	"Piano Chord"
3	"Shooting Star"	8	"Boop"
4	"Comet"	9	"Beep"

*3001(ct)	CT SEL Logic High Tone	ct = 0-9	CT
*3002(ct)	Link Tone	ct = 0-9	CT

**Hint:** If the "no tone" set is selected, users must still wait about 650 ms between transmissions to allow the timeout timer to reset.

## Timers

Several of the repeater's timers may be modified, including the hang timer, timeout timers, patch related timers, and tail message timer. The timer value is entered directly in seconds, or in milliseconds for repeater hang time.

Certain of the timers may be disabled by setting their value to zero. Those that may safely be disabled are marked with °. For example, it may be desirable to disable the Emergency Autodial Timer, relying on the activity timer for emergency calls. However, disabling the Tail Message Timer will cause tail messages to be generated at every tail. Disabling the Phone Answer Delay timer will cause the phone never to answer! Be careful!

*4000(period)	Repeater Timeout Long°	(≈30-1799 sec)	TL
*4001(period)	Repeater Timeout Short°	(≈15-1799 sec)	TS
*4002(period)	Phone Answer Delay	(≈10-≈60 sec)	PA
*4003(period)	Autopatch Timer°	(0, ≈60-1799 sec)	AP
*4004(period)	User Autodial Timer°	(0, ≈60-1799 sec)	AU
*4005(period)	Emergency Autodial Timer°	(0, ≈60-1799 sec)	AE
*4006(period)	Patch Activity Timer°	(0, ≈30-1799 sec)	AA
*4007(period)	Patch Timer Extend Timer°	(0, ≈30-1799 sec)	TX
*4008(period)	Tail Message Timer	(≈60-1799 sec)	TM
*4009(period)	Touch-Tone Access Timer°	(0, ≈30-1799 sec)	TA
*4010(period)	Hang Timer	(≈750-≈5000 ms)	HT
*4011(period)	Spare Audio Timer	(0, ≈15-1799 sec)	SP
*4012(period)	ID Timer	(360,660,1440 sec)	ID
*4013(period)	Reverse Patch Ringout	(≈5-60 sec)	RO

**Examples:** Load the Patch Activity Timer with 45 seconds. While unlocked, enter "\*\*4006 45" all as one transmission, or "\*\*4006 45 #" over the phone.  
Load the Hang Timer to 3-1/2 seconds (3500 ms). Enter "\*\*4010 3500".



## Chapter 8 Interfacing to Other Equipment

### Contents

- 8-1 Introduction
- 8-1 CTCSS Decoder
- 8-3 Talking S-Meter
- 8-3 Control Receiver
- 8-4 Site Alarm
- 8-5 Remote Control Outputs
- 8-5 Expanded Remote Control Outputs
- 8-7 Link / Remote Base
- 8-8 Spare Audio Source
- 8-9 External Tape Player
- 8-9 Digital Voice Recorder
- 8-10 Sharing the Phone Line

### Introduction

The basic hookup of the RC-96 controller to the repeater system was described in detail in Chapter 2. There are many additional features of the controller which may optionally be used in your repeater. This chapter describes interfacing of those additional features to your repeater system.

### CTCSS Decoder

An optional external CTCSS decoder may be connected to the RC-96 controller to permit CTCSS access and/or control. (An internal remotely programmable tone panel is also available as a built-in option, instead.) Any decoder with an active high logic output may connect to the CTCSS Logic Input on the Repeater connector pin 5. A logic low must be less than .8 volts, and a logic high greater than 2.4 volts. If the decoder's output is "open-collector", tie a pullup resistor, approximately 10K, from the output to the 12 volt supply.

A popular tone decoder is the Communications Specialists TS-32. The diagram below shows how the TS-32 may interface with the repeater receiver and the RC-96 controller (it is shown for CTCSS *decode* only - the encode section may be used as you wish). The active high logic output (OUT-2) may drive the controller CTCSS logic input (Repeater connector pin 5) with a 10K pullup resistor to +12 volts. **It's necessary to ground the hang-up pin on the TS-32 to enable decoding.**



## DIGITAL VOICE RECORDER INTERFACE

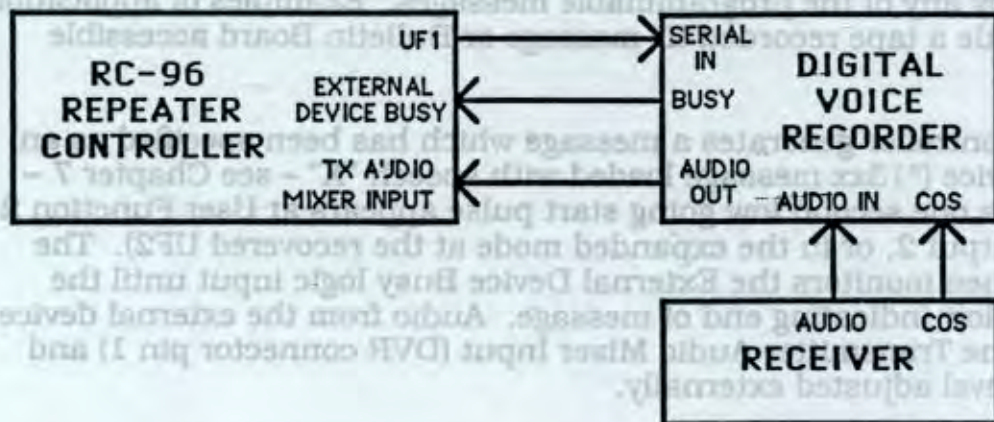

### Sharing the Phone Line

Several controllers at a common repeater site can share one phone line with handshaking among controllers to indicate when the phone line is in use. When the "Phone Line Shared" mode is selected with a Programming command, User Function 3 becomes a low true phone line busy output, which may be or-tied with other controller busy outputs. The signals are also connected to all the controllers' Phone Line Busy inputs. When a user attempts to bring up the patch, and the phone line is in use by another controller, the RC-96 controller responds by saying, "Busy". If the phone line is not in use, the patch proceeds, and the RC-96 controller pulls the busy output low to indicate to other controllers that the phone line is now in use.

### MULTIPLE CONTROLLERS SHARING A COMMON PHONE LINE

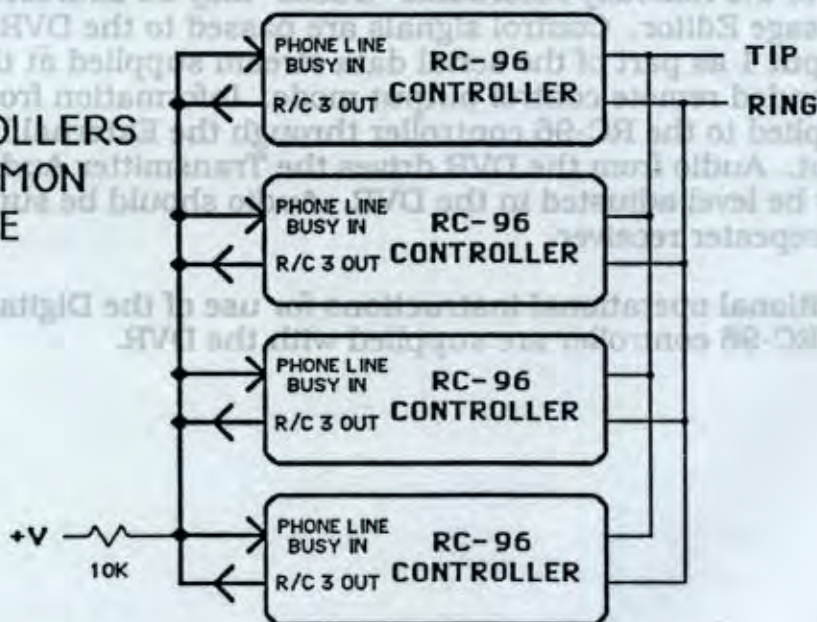



Audio into the TS-32 Tone Input should come from a point in the receiver where sub-audible tones have not been filtered out – the proper point is receiver dependent and in some cases audio must be taken directly from the discriminator. Other receivers have wide frequency response, and sub-audible tone is present at later points throughout the receiver.

The TS-32 includes a high pass filter which may be wired in-line with the receiver audio to the controller. The high pass filter removes the sub-audible tone components from the received signal so that they are not retransmitted. Use of the high pass filter in your installation is optional. Some systems are designed to allow user CTCSS to pass unaffected, others filter out CTCSS, and still others regenerate CTCSS on the repeater transmitter.

### COMM-SPEC TS-32 SUBAUDIBLE TONE DECODER INTERFACE

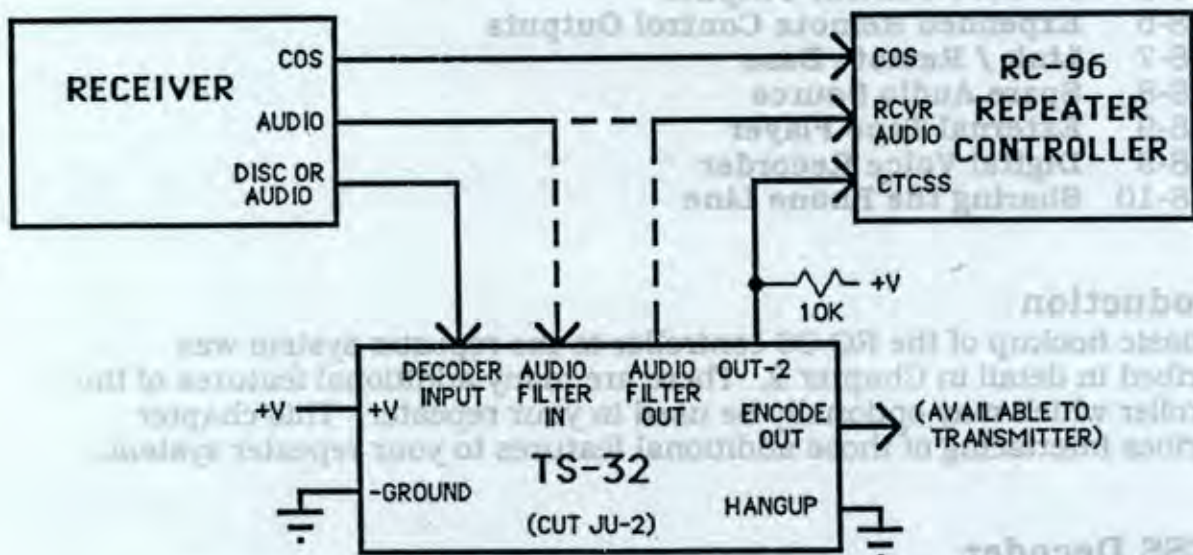

### Talking S-Meter

The controller is capable of measuring a 0-5 volt S-meter signal and reading back the measurement to the user in synthesized speech on command. The signal should be conditioned if necessary to range from zero volts (S0) to approximately four volts (S9 plus 60) and should drive the Repeater connector pin 3. The signal may range between zero and twelve volts without damaging the controller.

As an example, the diagram below shows connection of a Spectrum Communications SCR-200 S-meter signal output to the RC-96 controller. The meter should be disconnected and a 10K resistor placed from the signal output to ground. The signal may drive the controller directly. The resistor divides down the S-meter signal to an approximately zero to five volt range and also provides a discharge path for the emitter follower transistor in the receiver's S-meter circuit.



## S-METER (S-UNITS, DB OVER S9)



## APPLICATIONS:

REPEATER RECEIVER S-METER

REMOTE BASE RECEIVER S-METER

## S-METER INTERFACE TO SPECTRUM SCR-200

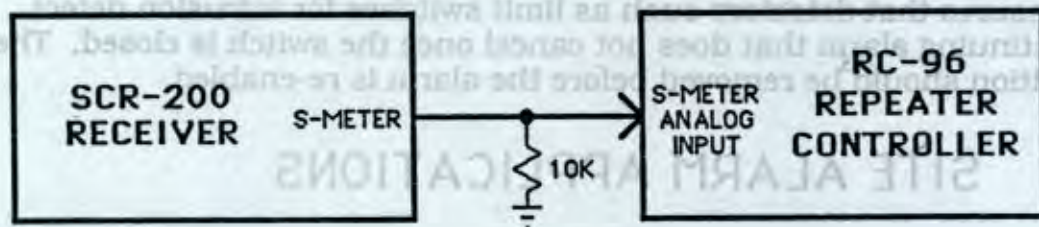

## Control Receiver

An independent receiver may function as a control receiver and have command priority over other command channels in the system (repeater receiver and phone). The control receiver audio may connect to the Control Receiver connector pin 7 and should be in the range of .5 to 2.5 volts peak-to-peak.

The COS signal should connect to the Control Receiver connector pin 1. The COS may be high true or low true. DIP switch 3 should be set based on its logic sense - ON for high true, OFF for low true. If a control receiver is not connected, DIP switch 3 *must* be ON.

For greater security, a CTCSS decode signal from the control receiver can replace the COS signal. CTCSS would need to be transmitted on the control channel to activate the control receiver function.

## CONTROL RECEIVER INTERFACE

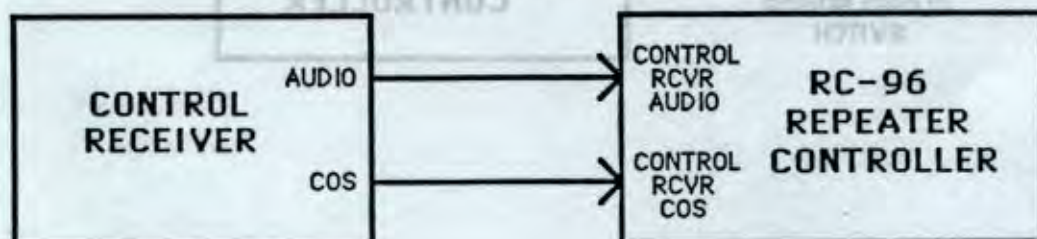



## Site Alarm

The Site Alarm logic input to the controller provides an over-the-air alarm announcement when the alarm logic input is taken high. The alarm message is programmed with the Alarm Message Programming command. The site alarm may be used as an indication of intrusion, over-temperature, water on the floor, or even as a weather radio storm alert or aviation ELT warning.

The alarm is activated by applying a high logic signal (2.4 - 15 volts) to the Alarm Input at I/O connector pin 1. The alarm signal can be derived from other circuitry, such as a temperature sensor, or from a normally open switch which applies a voltage to the Alarm input when closed. Alternatively, for more security in intrusion detection applications, a pull-up resistor on the board can normally be grounded by a normally closed switch, and if the switch is opened or if wires are cut, the alarm will be activated.

Activation of the site alarm causes the alarm message to be announced over the repeater transmitter at 15 second intervals, until cleared by a Control Op. The alarm condition is latching - meaning that once the logic input is taken high, the alarm condition continues even if the logic input is returned low. This insures that detectors such as limit switches for intrusion detect cause a continuing alarm that does not cancel once the switch is closed. The alarm condition should be removed before the alarm is re-enabled.

## SITE ALARM APPLICATIONS

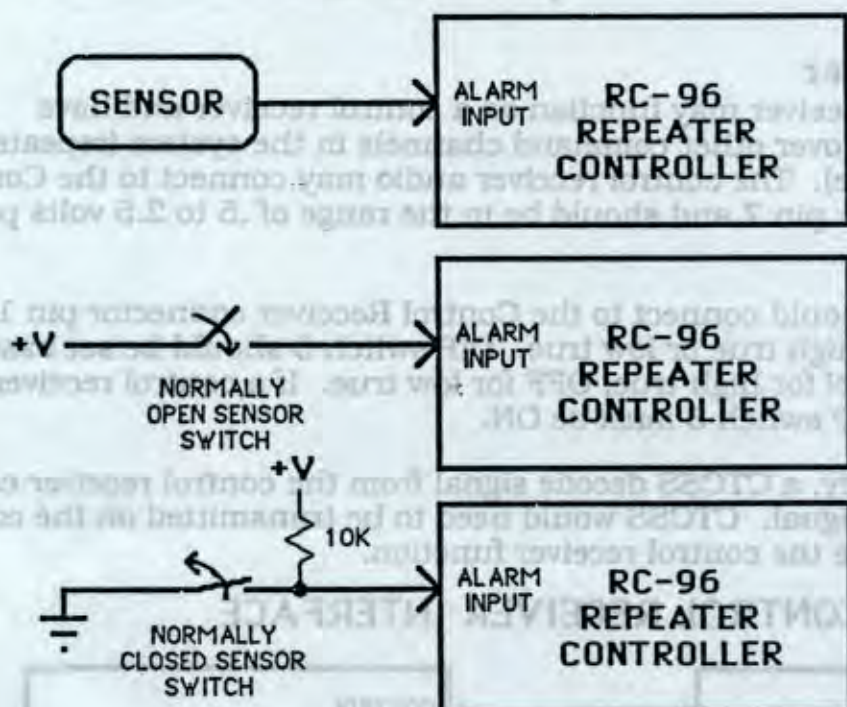



## Remote Control Outputs

The RC-96 controller provides three open collector high voltage, high current remote control logic output functions which may be controlled by Touch-Tone commands. The remote control logic outputs may be used for such functions as high/low power select, antenna select, or control of other equipment at the repeater site.

The three outputs are commanded with the User Function user commands and may be forced on or off, and may be interrogated. When any output is interrogated, a short (2ms) pulse is generated on that output - that is, the output toggles to the opposite state and back. The pulse is too short to disturb equipment being controlled, but long enough to trigger a one-shot or 555 timer to stretch to any duration required.

Two logic outputs may have dedicated functions when certain options are selected. If commanded to the "Phone Line Shared" mode with a Programming command, Control Output 3 (UF 3) becomes an active low Phone Line In-Use output, which may be or-tied with other controllers at the site to indicate that another controller is currently using the phone line. See "Sharing the Phone Line" later in this chapter.

An external cartridge tape player may be interfaced to the controller to play ID, tail, or Bulletin Board messages. The activation of these messages when loaded properly with the Message Editor may cause a one second pulse to be generated at Control Output 2 (UF 2) to start the external device. The controller then monitors the External Device Busy logic input for indication of completion of the recorded message. See "External Tape Player" later in this chapter for details.

## Expanded Remote Control Outputs

An alternative mode (DIP switch selectable) uses the outputs to serially shift out eight remote control logic functions plus remote base frequency information (see next section) - a total of 24 bits. The eight remote control output functions permit more extensive remote control of equipment at the site at the expense of several external IC's required to capture the data. The FC-1 Frequency Control Board is available from ACC for this purpose.

In the expanded mode, the User Function outputs appear at the shift register outputs, just as they appeared directly at the control outputs in the direct mode. The logic sense of the UF outputs may be inverted with a Programming command, which may be useful when buffering the recovered outputs with open collector transistors, as in the FC-1 Frequency Control Board.



**CONTROL OUTPUT MODE SELECTIONS**

<b>MODE OUTPUT</b>	<b>DIRECT UF OUTPUT</b>	<b>SYNTHESIZED LINK/REMOTE AND EXPANDED UF OUTPUTS</b>
<b>CX1</b>	UF 1	SERIAL DATA
<b>CX2</b>	UF 2	SERIAL CLOCK
<b>CX3</b>	UF 3	SERIAL TRANSFER
<b>DIP SW SETTINGS</b>	SW4 OFF	SW4 ON

**SERIAL TIMING AND DATA BIT DEFINITIONS**

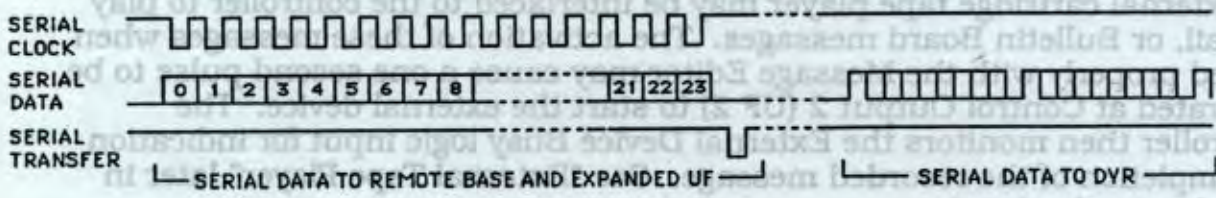

<b>SERIAL DATA BIT DEFINITIONS</b>			
0	UF1	8	MHz D0
1	UF2	9	MHz D1
2	UF3	10	MHz D2
3	UF4	11	MHz D3
4	UF5	12	PLUS/MINUS
5	UF6	13	SIMPLX/DUPLX
6	UF7	14	5/0 KHz
7	UF8	15	LINK ON/OFF
16	10's KHz D0	16	10's KHz D0
17	10's KHz D1	17	10's KHz D1
18	10's KHz D2	18	10's KHz D2
19	10's KHz D3	19	10's KHz D3
20	100's KHz D0	20	100's KHz D0
21	100's KHz D1	21	100's KHz D1
22	100's KHz D2	22	100's KHz D2
23	100's KHz D3	23	100's KHz D3

USER FUNCTIONS

LINK / REMOTE BASE



## RECOVERING UF OUTPUTS AND REMOTE BASE FREQUENCY INFORMATION

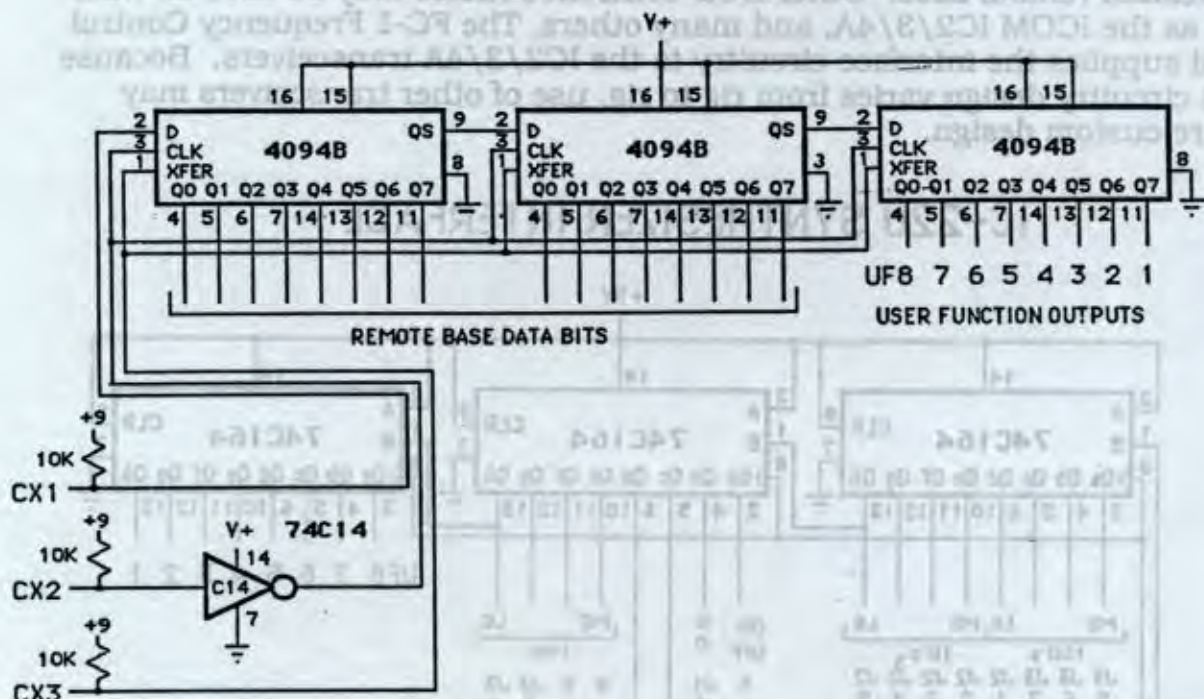

### Link / Remote Base

Touch-Tone user commands allow control of a transceiver which may tie the repeater to other frequencies. When the link is activated, a signal at the repeater receiver keys the link PTT, and a received signal on the link transceiver keys the repeater PTT.

In addition to activating the link function with Touch-Tone commands, the frequency of the link transceiver may be commanded. The hardware interfaces allow remote control of the remote base frequency. Synthesized speech readback of the frequency verifies command entry.

A fixed frequency link or remote base transceiver may be controlled by the RC-96 controller by connecting link PTT, link COS, link receiver audio, and by driving the link transmitter with repeater transmitter audio.

### BCD Frequency Interface

External shift register ICs capture the data shifted out of the controller and at the same time may perform any level translation required in interfacing to a particular radio. The format of the BCD frequency data is compatible with the ACC RC-850 Repeater Controller (Link 1), the RC-85 Repeater Controller, and the ITC-32 Intelligent Touch-Tone Control Board.



Shown below is circuitry suitable for capturing the serial frequency information for interface to an ICOM IC-22U two meter transceiver as a synthesized remote base. Other BCD controlled radios may be used as well, such as the ICOM IC2/3/4A, and many others. The FC-1 Frequency Control Board supplies the interface circuitry to the IC2/3/4A transceivers. Because offset circuitry design varies from rig to rig, use of other transceivers may require custom design.

### IC-22U SYNTHESIZER INTERFACE

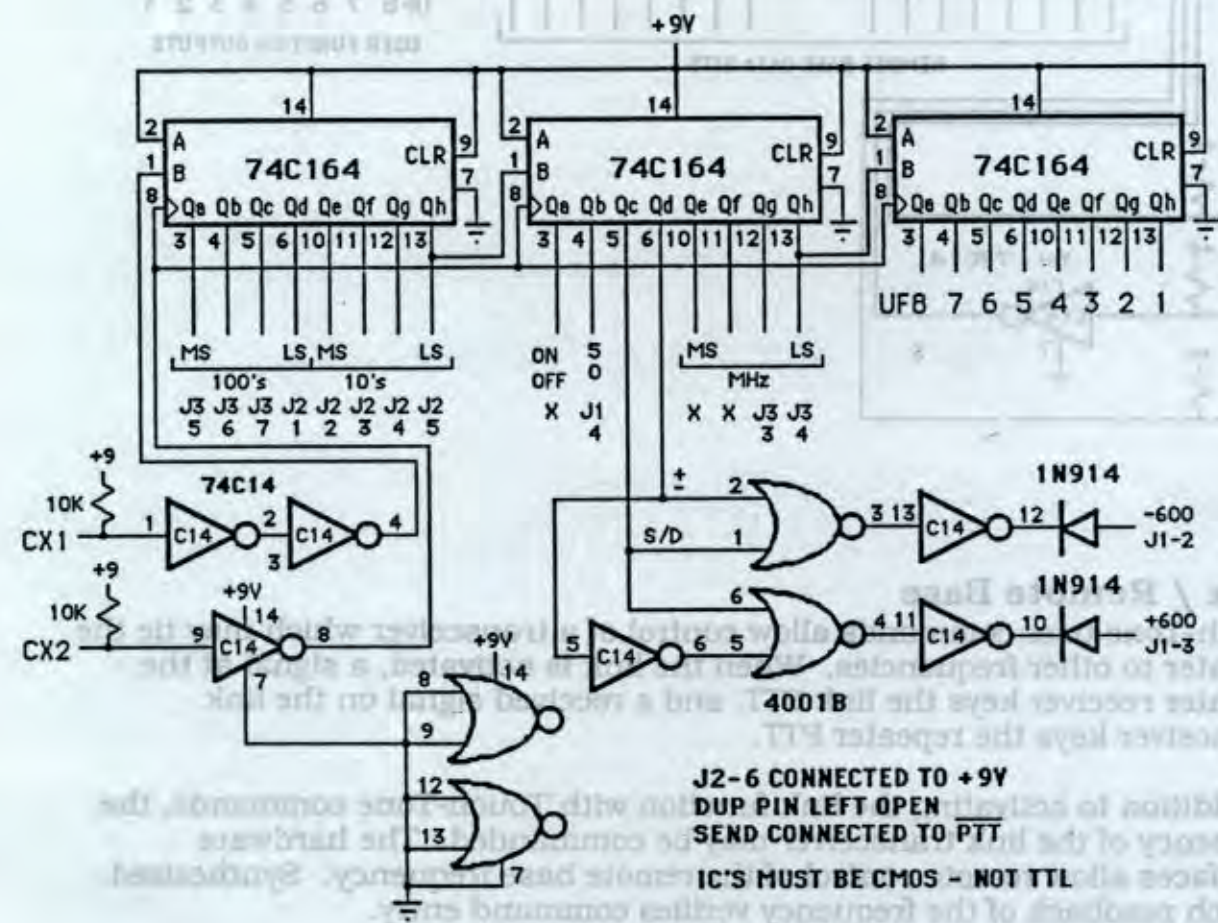

### Spare Audio

User commands may allow selections of a weather radio, scanner, or other audio source. The audio input shares the Link / Remote Base receiver input and is available if the link function is not used. The audio is gated to the transmitter under computer control in response to the user commands, and the transmitter PTT is held active. The audio may be continuously present at the controller's audio input and no control signals to or from the audio source are required.

**Note:** Retransmission of another radio service through the Amateur service may not be legal.



## External Tape Player

An external tape playback unit may be interfaced to the controller and addressed by any of the programmable messages. Examples of applications would include a tape recorded ID message or Bulletin Board accessible message.

When the controller generates a message which has been specified as an external device (\*13xx message loaded with speech "X" - see Chapter 7 - Messages), a one second low going start pulse appears at User Function 2 (Control Output 2, or in the expanded mode at the recovered UF2). The controller then monitors the External Device Busy logic input until the signal goes low indicating end of message. Audio from the external device may drive the Transmitter Audio Mixer Input (DVR connector pin 1) and should be level adjusted externally.

## EXTERNAL TAPE PLAYER INTERFACE

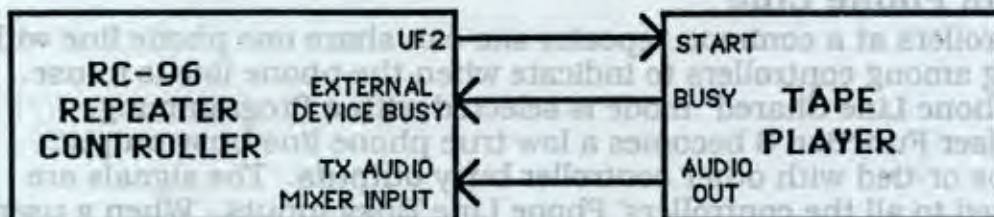

## Digital Voice Recorder

ACC's Digital Voice Recorder may interface to the RC-96 controller so that any of the remotely recordable "tracks" may be addressed through the Message Editor. Control signals are passed to the DVR through Control Output 1 as part of the serial data stream supplied at that output in the expanded remote control output mode. Information from the DVR is supplied to the RC-96 controller through the External Device Busy logic input. Audio from the DVR drives the Transmitter Audio Mixer input and may be level adjusted in the DVR. Audio should be supplied to the DVR from the repeater receiver.

Additional operational instructions for use of the Digital Voice Recorder with the RC-96 controller are supplied with the DVR.

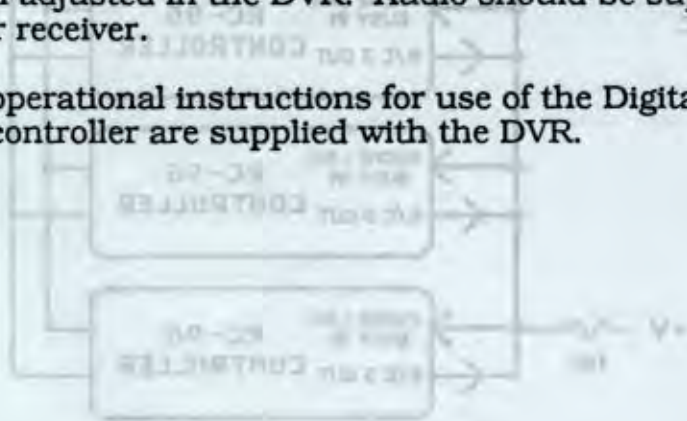



## Chapter 9

# How it Works

The RC-96 Repeater Controller is centered around a microcomputer with a software program contained in EPROM memory. Program stored in EPROM means that the controller is ready to go as soon as it's powered up. The microcomputer detects the logic inputs to the system and the Touch-Tone decoder information and controls the logic outputs, audio switching and mixing, speech synthesizer, and other circuits. More importantly, the computer directs operation of the various operational features of the controller, such as remote programming, autopatch, remote base linking, etc.

A block diagram of the RC-96 controller is shown below. The major functional blocks include the microcomputer, audio switching and mixing circuits, buffered I/O, speech synthesizer, tone generator, Touch-Tone decoder, and telephone interface. In addition, various protective circuits ensure reliable long term operation with automatic error recovery.

The microcomputer consists of an 8085 microprocessor with 80K bytes or more of EPROM program memory, 8K of E<sup>2</sup>PROM re-programmable non-volatile memory, 8K of RAM, and various I/O circuits. Remotely programmed information is stored in the write protected E<sup>2</sup>PROM.

The CPU is automatically reset on powerup and will be reset whenever the voltage for the CPU drops below its specification. The 8085 multiplexed address/data bus is demultiplexed by the 74HC373 octal latch, and its address space is decoded by the PAL10L8 decoder.

The audio switching and mixing circuits consist of two active mixers, one for audio driving the repeater transmitter, and one for audio to the phone line. Selection of active sources into each mixer is supervised by the computer program in response to normal repeater operation and user commands.

The logic outputs from the board, for transmitter PTT and general remote control functions, are output ports buffered by high voltage/high current (60 V, 500 mA) VMOS FET transistors. The logic inputs are buffered by an integrated transistor array which provides a universal logic level compatibility.

The speech synthesizer interfaces to the CPU through I/O ports and is controlled by the microcomputer program. The pot R109 adjustment sets the synthesizer clock frequency, setting the pitch of the voice.

The tone generator creates Morse code, courtesy tone, and Touch-Tone audio under control of the computer program.

The Touch-Tone receiver may connect to any of the audio input channels under control of the computer program. The receiver detects Touch-Tone audio and sends the information to the microcomputer to permit command evaluation.



The telephone interface provides the protective coupling between the op amp audio signals and logic control signals and the telephone line. It includes ring detect, off-hook control, impedance matching, and isolation.

## RC-96 BLOCK DIAGRAM

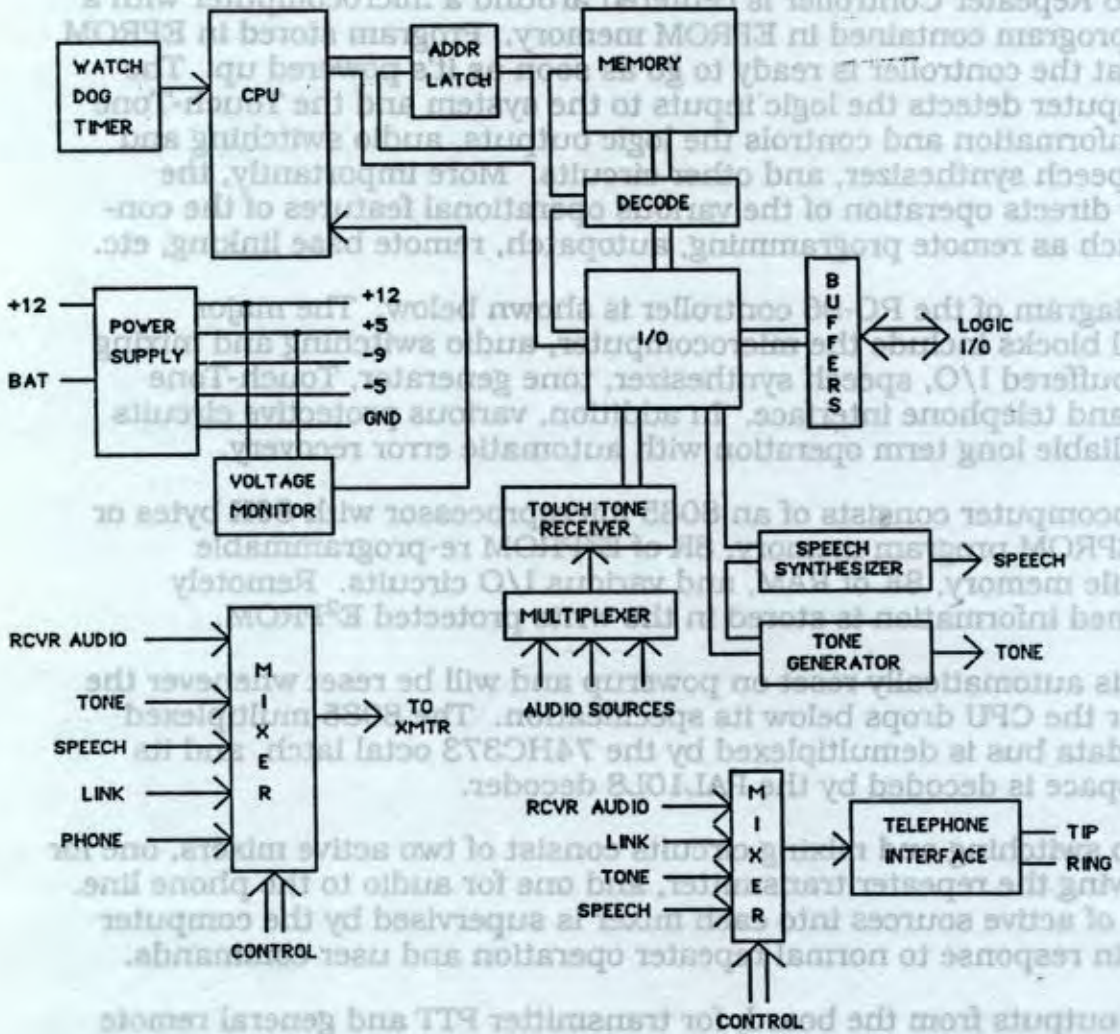



# RC-96 Programming Sheet

## Messages

II \_\_\_\_\_  
F1 HI \_\_\_\_\_  
A1 \_\_\_\_\_  
P1 \_\_\_\_\_  
P2 \_\_\_\_\_  
P3 \_\_\_\_\_  
S1 \_\_\_\_\_  
T1 WELCOME TO THE REPEATER  
T2 SEVEN-TY THREE  
T3 WEATHER ALERT  
PH REPEATER CONTROL  
HG CALL COMPLETE  
AL INTRUDER ALERT  
B1 GRU  
B2 \_\_\_\_\_

## Tone Parameters

Morse Code Speed 15  
Morse Code Pitch 880  
Cover Tone Pitch 440

## Timers

Timeout Long 180  
Timeout Short 45  
Phone Answer 15  
Autopatch 180  
User Autodial 180  
Emergency Autodial 600  
Patch Activity 60  
Patch Timer Extend 45  
Tail Message 300  
Touch-Tone Access 900  
Hang Time (ms) 4000  
Spare Audio 90  
ID 360  
Ringout 60

## Emergency Autodial Numbers

	Message	Phone Number
0	OPERATOR	0
1	_____	_____
2	_____	_____
3	_____	_____
4	_____	_____
5	_____	_____
6	_____	_____
7	_____	_____
8	_____	_____
9	NINE ONE ONE	911

## Command Code Prefixes

Control Op <u>123</u>	Reverse Patch <u>1</u>
R/C Logic <u>9</u>	Patch Utilities <u>*</u>
Emer. Autodial <u>*</u>	Patch Hangup <u>*</u>
User Autodial <u>*</u>	2-Tone Paging <u>2</u>
Autopatch <u>*</u>	TT Access <u>741</u>
Link <u>7</u>	S-Meter <u>8</u>
User Autodial L/E <u>456</u>	Ext. User Autodial <u>*1</u>
BB <u>3</u>	Ext. User Autodial L/E <u>457</u>
Spare Audio <u>666</u>	Telephone Timer Ext. <u>0</u>
Unlock <u>1234567890</u>	Memory Paging <u>2</u>

## Courtesy Tone Selection

CT Logic High STARDUST  
Link Tone PIANO CHORD

## Misc. Selections

Patch signalling  DP  
Control over receiver  DC  
Phone line share  PLS  
UF high/low true  FL  
Patch Dialing Prefix EMPTY



## User Loadable Autodial Numbers

10	40	70	100	130	165
11	41	71	101	131	166
12	42	72	102	132	167
13	43	73	103	133	168
14	44	74	104	134	169
15	45	75	105	135	170
16	46	76	106	136	171
17	47	77	107	137	172
18	48	78	108	138	173
19	49	79	109	139	174
20	50	80	110	140	175
21	51	81	111	141	176
22	52	82	112	142	177
23	53	83	113	143	178
24	54	84	114	144	179
25	55	85	115	145	180
26	56	86	116	146	181
27	57	87	117	147	182
28	58	88	118	148	183
29	59	89	119	149	184
30	60	90	120	150	185
31	61	91	121	151	186
32	62	92	122	152	187
33	63	93	123	153	188
34	64	94	124	154	189
35	65	95	125	155	190
36	66	96	126	156	191
37	67	97	127	157	192
38	68	98	128	158	193
39	69	99	129	159	194
				160	195
				161	196
				162	197
				163	198
				164	199

## Macro Sets 1, 2, 3, and 4

(RE) RD	(UE) UD	T1 T2 T3 (TF)
(TE) TD	(AU) AL	(RE) AD
(TL) TS	UU (UH)	(SE) SD
(CA) PC PU PL	(EE) ED	(SI) SO
ME (MD)	(NC) XC NR	(KE) KD
(CE) CD	(PT) PX	(TM) TU
(TE) TD	TD (TE) TA	(ZD) ZE
(LE) LD	(XE) XD	(FD) AD
(PE) PD	(RO) R1 R2	CT 1
(LE) LD	P1 P2 P3 SP (RP) RS	
	UF 1 2 3 4 5 6 7 8	
	LINK (OFF) RCY XMT	FREQ 6.520 S



# RC-96 Programming Sheet

## Messages

II \_\_\_\_\_  
 FI \_\_\_\_\_  
 AI \_\_\_\_\_  
 P1 \_\_\_\_\_  
 P2 \_\_\_\_\_  
 P3 \_\_\_\_\_  
 SI \_\_\_\_\_  
 T1 \_\_\_\_\_  
 T2 \_\_\_\_\_  
 T3 \_\_\_\_\_  
 PH \_\_\_\_\_  
 HG \_\_\_\_\_  
 AL \_\_\_\_\_  
 B1 \_\_\_\_\_  
 B2 \_\_\_\_\_

## Tone Parameters

Morse Code Speed \_\_\_\_\_  
 Morse Code Pitch \_\_\_\_\_  
 Cover Tone Pitch \_\_\_\_\_

## Timers

Timeout Long \_\_\_\_\_  
 Timeout Short \_\_\_\_\_  
 Phone Answer \_\_\_\_\_  
 Autopatch \_\_\_\_\_  
 User Autodial \_\_\_\_\_  
 Emergency Autodial \_\_\_\_\_  
 Patch Activity \_\_\_\_\_  
 Patch Timer Extend \_\_\_\_\_  
 Tail Message \_\_\_\_\_  
 Touch-Tone Access \_\_\_\_\_  
 Hang Time (ms) \_\_\_\_\_  
 Spare Audio \_\_\_\_\_  
 ID \_\_\_\_\_  
 Ringout \_\_\_\_\_

## Emergency Autodial Numbers

Message Phone Number

0	_____	_____
1	_____	_____
2	_____	_____
3	_____	_____
4	_____	_____
5	_____	_____
6	_____	_____
7	_____	_____
8	_____	_____
9	_____	_____

## Command Code Prefixes

Control Op _____	Reverse Patch _____
R/C Logic _____	Patch Utilities _____
Emer. Autodial _____	Patch Hangup _____
User Autodial _____	2-Tone Paging _____
Autopatch _____	TT Access _____
Link _____	S-Meter _____
User Autodial L/E _____	Ext. User Autodial _____
BB _____	Ext. User Autodial L/E _____
Spare Audio _____	Telephone Timer Ext. _____
Unlock _____	Memory Paging _____

## Courtesy Tone Selection

CT Logic High \_\_\_\_\_  
 Link Tone \_\_\_\_\_

## Misc. Selections

Patch signalling	TT DP
Control over receiver	EC DC
Phone line share	PLU PLS
UF high/low true	FH FL
Patch Dialing Prefix	_____



# User Loadable Autodial Numbers

10	40	70	100	130	165
11	41	71	101	131	166
12	42	72	102	132	167
13	43	73	103	133	168
14	44	74	104	134	169
15	45	75	105	135	170
16	46	76	106	136	171
17	47	77	107	137	172
18	48	78	108	138	173
19	49	79	109	139	174
20	50	80	110	140	175
21	51	81	111	141	176
22	52	82	112	142	177
23	53	83	113	143	178
24	54	84	114	144	179
25	55	85	115	145	180
26	56	86	116	146	181
27	57	87	117	147	182
28	58	88	118	148	183
29	59	89	119	149	184
30	60	90	120	150	185
31	61	91	121	151	186
32	62	92	122	152	187
33	63	93	123	153	188
34	64	94	124	154	189
35	65	95	125	155	190
36	66	96	126	156	191
37	67	97	127	157	192
38	68	98	128	158	193
39	69	99	129	159	194
				160	195
				161	196
				162	197
				163	198
				164	199







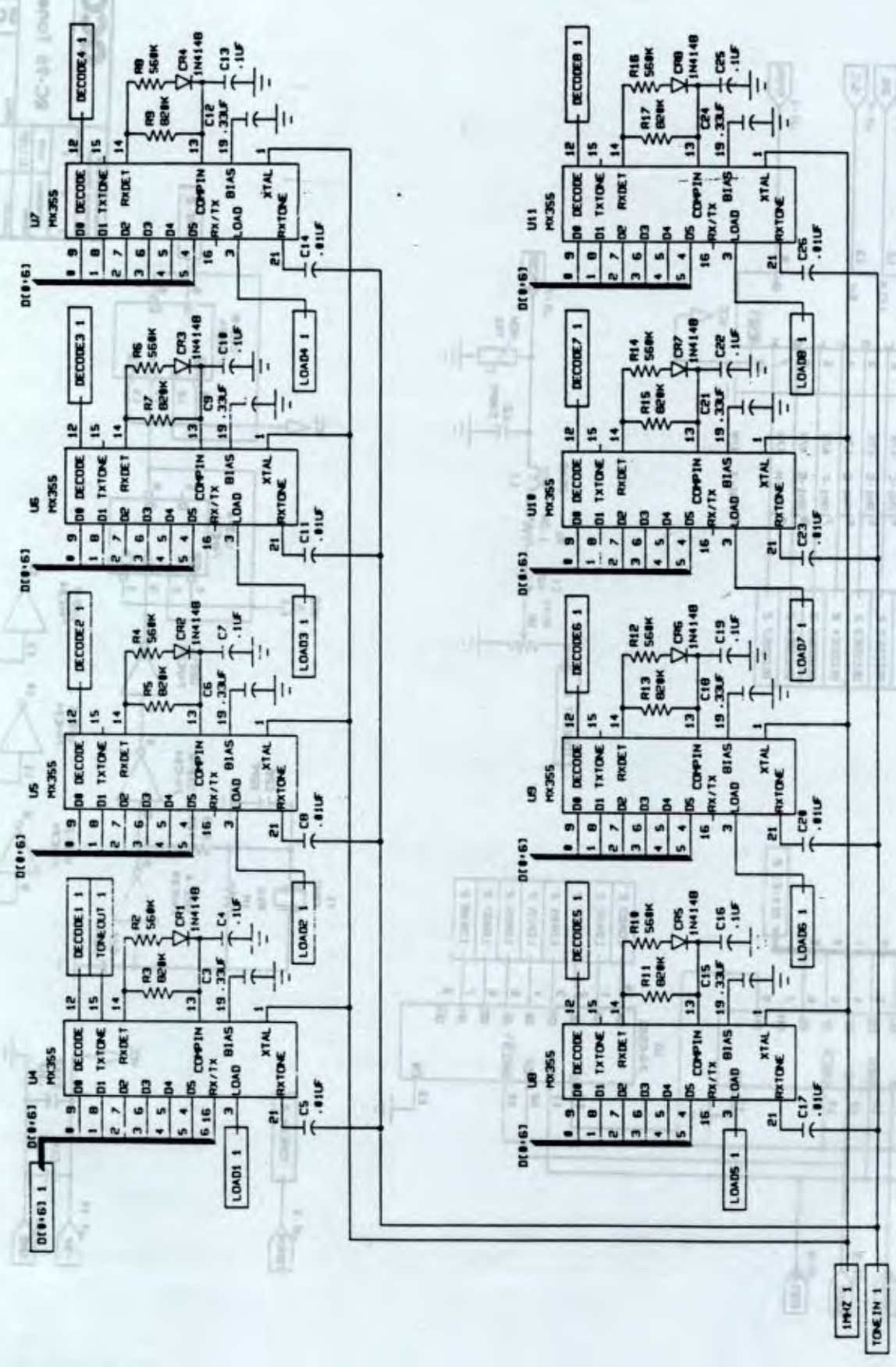



## Appendix V CTCSS Tone Panel

### Introduction

The Tone Panel option provides one remotely programmable CTCSS encode, and up to eight programmable CTCSS decode frequencies. The board is supplied standard with provisions for one tone (encode or decode), and can accommodate up to seven additional decode tones by adding chips.

The '96 controller provides Control Op selectable CTCSS modes, requiring tone encoding on signals to access the repeater or to access different levels of commands (see Chapter 6 - Access / Control Commands). With the tone panel, the repeater can recognize one or more programmable tone frequencies. Each tone can be enabled or disabled independently with Control Op commands, and the enable/disable status of each tone is stored in macro sets.

Tone #1 can be selected for decode or encode. If selected for encode, the programmed tone signal is available for injection into the repeater transmitter. Tones #2-8 are decode only.

### Installation

The Tone Panel board installs easily into the RC-96 controller, with the four provided #4-40 screws and a 10-pin ribbon cable connecting J10 on the main board to J1 on the Tone Panel board. Of course, install the board with power off!

CTCSS tone from the receiver discriminator should be applied to Pin 5 of the REPEATER DIN connector. Lift Pin 4 of integrated circuit U5 on the large controller board (ULN2804A) to eliminate loading on your CTCSS signal by the logic IC input. Pull out U5 and bend the lead up, or cut it off, so that it does not make contact to the socket pin. (This is necessary because this connector signal input may instead be used for a CTCSS *logic* signal if an external decoder, such as a TS-32, is used in place of the Tone Panel option.)

Encoded CTCSS tone output is available at the REPEATER DIN connector, Pin 8. The encode level is adjustable with pot R101 on the tone board. If CTCSS is expected to be present on user's signals, the receiver audio should be high-pass filtered externally before being applied to the controller's receiver audio input, or receiver audio should be taken from a point in the receiver where CTCSS has been filtered out. This will prevent repeated CTCSS from interfering with the internally generated encode tone.



## Programming

The frequency of each tone may be set with Programming commands. Tone #1 may be selected for encode or decode. Tones #2-8 are decode only.

**\*5100x**      **Tone #1 ENCODE or DECODE**  
**(x=1 ENCODE; x=0 DECODE)**

**TONE**

**\*510T FF**      **Tone #T Frequency**  
**(T=1-8; FF from table below)**

**TONE**

**The controller must then be reset for these commands to take effect. Enter (COP prefix)18 after locking the controller.**

CTCSS FREQUENCIES							
01	67.0	11	-	21	136.5	31	192.8
02	71.9	12	100.0	22	141.3	32	203.5
03	74.4	13	103.5	23	146.2	33	210.7
04	77.0	14	107.2	24	151.4	34	218.1
05	79.7	15	110.9	25	156.7	35	225.7
06	82.5	16	114.8	26	162.2	36	233.6
07	85.4	17	118.8	27	167.9	37	241.8
08	88.5	18	123.0	28	173.8	38	250.3
09	91.5	19	127.3	29	179.9		
10	94.8	20	131.8	30	186.2		

## Control Operator Selection

The Control Op may enable or disable controller recognition of each of the decode tones. When any of the enabled tones are detected, the controller permits access or command of the repeater as selected by Access / Control commands. The selection information is stored in macro sets for easy change of setup.

**81-88**      **Enable Tone #1-8**      1E-8E

**91-98**      **Disable Tone #1-8**      1D-8D



REV	DESCRIPTION	DATE	APPROVED

RC-8 Repeater Controller Owner's Manual

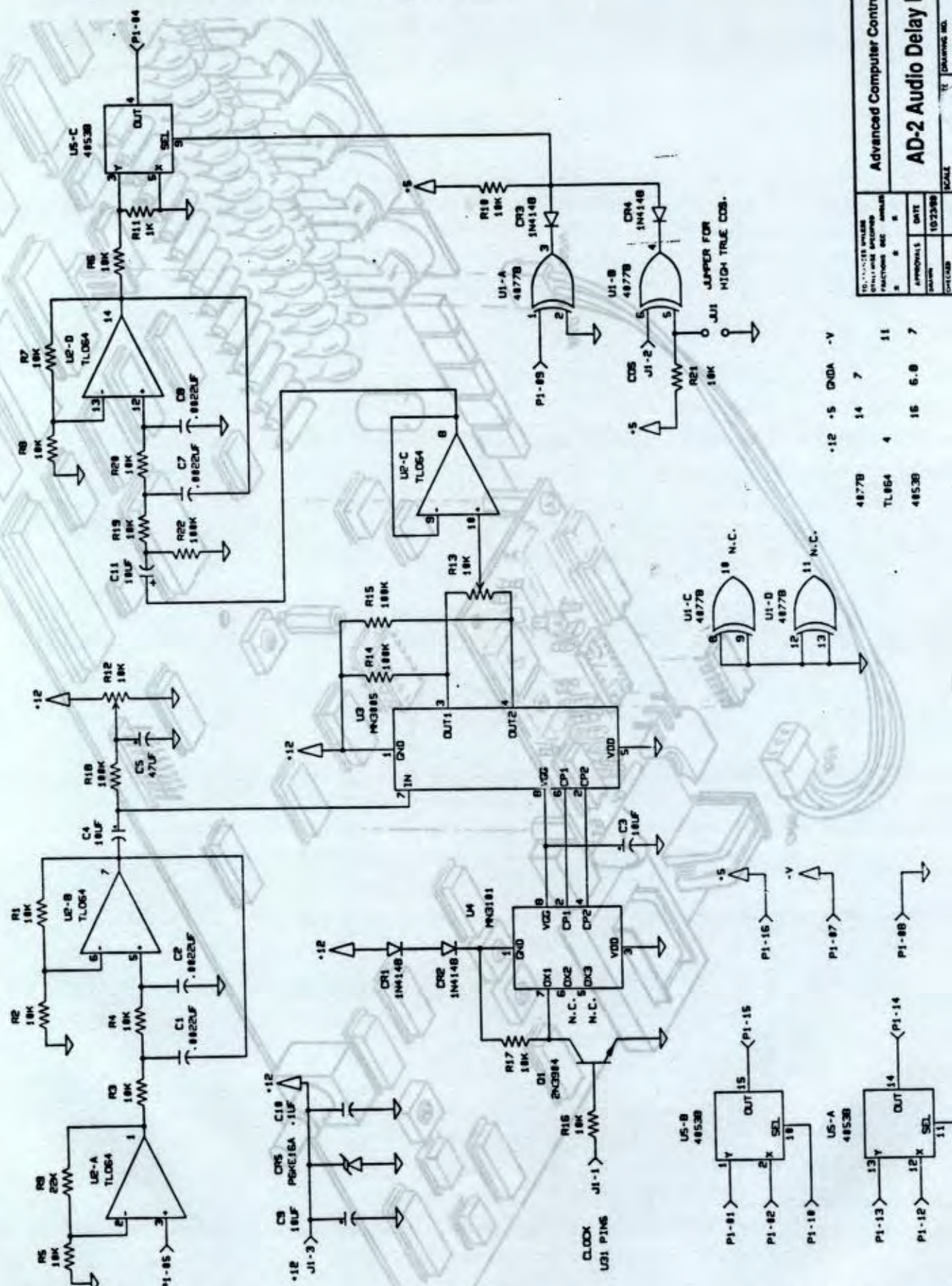

48778	14	7	
TL064	4	11	
48538	15	5, 8	7

-12 +5 GND -V

TO: OWNER WHEN DELIVERED INCLUDE FUNCTIONS SEE AMPLIF		DATE	SCALE
APPROVALS	DATE	10/23/89	
DESIGNER	SCALE		
DO NOT SCALE DRAWING		DRWING NO.	SHEET 1 OF 1

(Audio Delay Board)



## Appendix I

**Command Code Summary****User Commands****Touch-Tone Pad Test**

(Pad Test Prefix) (sequence of up to 32 keys)

**Autopatch**

(Autopatch Prefix) (telephone number)

**User Loadable Autodial Load**

or (Autodial Load/Erase Prefix)(Location)(Phone Number)  
 (Autodial Load/Erase Prefix)\*(Location)(Phone Number)  
 [phone number secured from readback]

**User Loadable Autodial Erase**

(Autodial Load/Erase Prefix) (Location)

**User Loadable Autodial**

(User Loadable Autodial Prefix) (Location)

**Emergency Autodial**

(Emergency Autodial Prefix) (Location)

**Reverse Patch Activate (from phone only)**

(Reverse Patch Command)#

**Reverse Patch Answer**

(Patch Utility Prefix)

**Extending the Telephone Timer (from phone only)**

(Telephone Timer Extend Command)#

**Patch Hangup**

(Patch Hangup Command)

**Patch Custom Hangup Code**

(Patch Utility Prefix) (any 3 keys except # or D)

**Patch Redial**

(Patch Utility Prefix) \*

**Patch Full-Duplex**

(Patch Utility Prefix) \*1

**Patch Cover Tone**

(Patch Utility Prefix) \*2

**Patch Timer Extend**

(Patch Utility Prefix) \*3



**BCD or Fixed Frequency Link / Remote Base**

(Link Prefix) 1	Link On Receive Only
(Link Prefix) 2	Link On Receive/Transmit
(Link Prefix) 3	Link Off
(Link Prefix) (mhtof)	Link Frequency
(Link Prefix) (m*htof)	Link Frequency

**FC-900 Link / Remote Base**

(Link Prefix) 1	Link 1 On Receive Only
(Link Prefix) 2	Link 1 Receive/Transmit
(Link Prefix) 3	Link 1 Off
(Link Prefix) 4	Link 2 On Receive Only
(Link Prefix) 6	Link 2 Off
(Link Prefix) *	Swap Link 1 / Link 2 Bands
(Link Prefix) 1 x	Link 1 Band Select
(Link Prefix) 4 x	Link 2 Band Select
x = 0 1240	7 420
1 10 meter	8 1280
2 2 meter	9 1290
3 220	A 1270 ( $\pm 20$ MHz)
4 440	B 1270 ( $\pm 12$ MHz)
5 430	C 1250
6 6 meter	
(Link Prefix) (mhtof)	Link 1 Frequency
(Link Prefix) (m*htof)	Link 1 Frequency
(Link Prefix) 1 (m*htof)	Link 1 Frequency
(Link Prefix) 4 (m*htof)	Link 2 Frequency
(Link Prefix) 1 *	Link 1 Power Interrogate
(Link Prefix) 1 * 1	Link 1 High Power
(Link Prefix) 1 * 0	Link 1 Low Power
(Link Prefix) 7 xx	CTCSS Select (00=off, 01-38=on)

**S-Meter Readback**

(S-Meter Command)

**Demonstration / Bulletin Board**

(Demo Prefix) (0 - 8, \*)

- (0 = Initial ID Message)
- (1 = Forced ID Message)
- (2 = Anxious ID Message)
- (3 = Pending ID Message 1)
- (4 = Pending ID Message 2)
- (5 = Pending ID Message 3)
- (6 = Special ID Message)
- (7 = Bulletin Board Message 1)
- (8 = Bulletin Board Message 2)
- (\* = Firmware Revision Announcement)

**Unmuting Touch-Tone**

# (sequence)

**Two-Tone Paging**

(2-Tone Paging Prefix)(A Group number)(A Tone number)(B Group number)  
(B Tone number)  
(2-Tone Paging Prefix)(Group number)(Tone number) [group call]



**Memory Paging**

(Memory Paging Prefix) xxx  
xxx = 000 - 999

**Touch-Tone Access**

(TT Access Mode Prefix) 0 [down]  
(TT Access Mode Prefix) 1 [up]

**Spare Audio Select**

(Spare Audio Command)  
# knock down

**User Function (Remote Control) Output Force and Interrogate**

(UF Prefix) (Output #1-8) (1 = on, 0 = off)  
(UF Prefix) (Output #1-8) Interrogate

**Control Operator Commands**

Macro Set Selection Commands	
M1	Macro Set 1 Select
M2	Macro Set 2 Select
M3	Macro Set 3 Select
M4	Macro Set 4 Select
M5	Macro Set 5 Select

Repeater Enable / Disable Commands	
RE	Repeater Enable
RD	Repeater Disable

**Repeater Timer Commands**

TE	Repeater Timer Enable
TD	Repeater Timer Disable
TL	Repeater Timer Long
TS	Repeater Timer Short
TC	Clear Repeater Timer
ZD	Zero Hang Time Disable
ZE	Zero Hang Time Enable

**Access / Control Commands**

CA	Carrier Access / Control
PC	CTCSS Control Op Command
PU	CTCSS Control Op/User Cmd
PA	CTCSS Access
ME	TT Access Mode Enable
MD	TT Access Mode Disable
KE	Kerchunker Filter Enable
KD	Kerchunker Filter Disable

**User Command Enable / Disable Commands**

CE	User Command Enable
CD	User Command Disable
TE	Pad Test Enable
TD	Pad Test Disable
TM	Touch-Tone Mute
TU	Touch-Tone Unmute

**Link Enable / Disable Commands**

LE	Link Enable
LD	Link Disable

**Autopatch / Autodial Commands**

RE	Autopatch Enable
RD	Autopatch Disable
LE	Long Distance Enable
LD	Long Distance Disable
UE	User Autodial Enable
UD	User Autodial Disable
AU	User Autodial Unlock



# Control Operator Commands

## Macro Set Selection Commands

1	M1	Macro Set 1 Select	Selects Control Op Macro Set #1.
2	M2	Macro Set 2 Select	Selects Control Op Macro Set #2.
3	M3	Macro Set 3 Select	Selects Control Op Macro Set #3.
4	M4	Macro Set 4 Select	Selects Control Op Macro Set #4.
5	M5	Macro Set 5 Select	Selects Control Op Macro Set #5.

## Repeater Enable / Disable Commands

00	RE	Repeater Enable	Enables repeater transmitter.
01	RD	Repeater Disable	Disables repeater transmitter.

## Repeater Timer Commands

02	TE	Repeater Timer Enable	Enables repeater timeout timer.
03	TD	Repeater Timer Disable	Disables repeater timeout timer.
04	TL	Repeater Timer Long	Selects long timeout timer.
05	TS	Repeater Timer Short	Selects short timeout timer.
06	TC	Clear Repeater Timer	Cancel timeout condition, clears timer.
65	ZD	Zero Hang Time Disable	Disables zero hang time.
66	ZE	Zero Hang Time Enable	Enable zero hang time.

## Access / Control Commands

07	CA	Carrier Access / Control	Enables carrier access and control.
08	PC	CTCSS Control Op Command	Enables carrier access, CTCSS required for Control Operator Touch-Tone commands.
09	PU	CTCSS Control Op/User Cmd	Enables carrier access, CTCSS required for Control Op and User commands.
10	PL	CTCSS Access	CTCSS required for access and control.
52	ME	TT Access Mode Enable	Enables Touch-Tone Access Mode.
53	MD	TT Access Mode Disable	Disables Touch-Tone Access Mode.
61	KE	Kerchunker Filter Enable	Enables kerchunker filter.
62	KD	Kerchunker Filter Disable	Disables kerchunker filter.

## User Command Enable / Disable Commands

11	CE	User Command Enable	Enables User Touch-Tone commands.
12	CD	User Command Disable	Disables User Touch-Tone commands.
41	TE	Pad Test Enable	Enables Touch-Tone Pad Test.
42	TD	Pad Test Disable	Disables Touch-Tone Pad Test.
63	TM	Touch-Tone Mute	Mutes Touch-Tone through the repeater.
64	TU	Touch-Tone Unmute	Unmutes Touch-Tone through the repeater.

## Link Enable / Disable Commands

13	LE	Link Enable	Enables link / remote base.
14	LD	Link Disable	Disables link / remote base.

## Autopatch / Autodial Commands

19	PE	Autopatch Enable	Enables Autopatch.
20	PD	Autopatch Disable	Disables Autopatch.
27	LE	Long Distance Enable	Enables Autopatch long distance.
28	LD	Long Distance Disable	Disables Autopatch long distance.
21	UE	User Autodial Enable	Enables User Loadable Autodialer.
22	UD	User Autodial Disable	Disables User Loadable Autodialer.
47	AU	User Autodial Unlock	Unlocks User Loadable Autodialer.



48	AL	User Autodial Lock	Locks User Loadable Autodialer.
57	UU	User Autodial Unhide	Allows secured numbers to be read back.
58	UH	User Autodial Hide	Secures autodial numbers loaded w/option
23	EE	Emergency Autodial Enable	Enables Emergency Autodialer.
24	ED	Emergency Autodial Disable	Disables Emergency Autodialer.
60	NC	Dial Needing Click	Requires user click to initiate dialing.
59	XC	Dial Without Click	Enables dialing without user click.
68	NR	No Phone Number Readback	Disables phone number readback and disables autodial location readback and enables dialing without user click.
25	PT	Patch Timer Enable	Enables patch timers.
26	PX	Patch Timer Disable	Disables patch timers.
49	TD	Cover Tone Disable	Disables patch cover tone.
50	TE	Cover Tone Enable	Enables patch cover tone - user selected.
51	TA	Cover Tone Always On	Enables patch cover tone for all patches.
69	FD	Full-Duplex User Selectable	Patches are half-duplex unless user selected to be full-duplex.
80	FA	Full-Duplex Always	All patches are full-duplex.
43	-	Control Op Offhook	"Manually" takes phone offhook.
44	-	Control Op Onhook	Places phone onhook (hangup).

**Reverse Patch Commands**

45	XE	Reverse Patch Enable	Enables Reverse Patch.
46	XD	Reverse Patch Disable	Disables Reverse Patch.
54	R0	Reverse Patch Mode 0	Selects phone line control mode.
55	R1	Reverse Patch Mode 1	Selects automatic ringout after 5 sec.
56	R2	Reverse Patch Mode 2	Selects auto. ringout w/out answering.
67	R3	Reverse Patch Mode 3	Selects telephone access paging/phone line control.

**ID Commands**

29	P1	Pending ID 1	Selects Pending ID 1.
30	P2	Pending ID 2	Selects Pending ID 2.
31	P3	Pending ID 3	Selects Pending ID 3.
32	SP	Special ID	Selects Special ID.
33	RP	Rotate Pending IDs	Rotates Pending ID 1-2-3.
34	RS	Rotate Pending-Special IDs	Rotates Pending ID 1-2-3 - Special ID.

**Tail Message Commands**

35	T1	Tail Message 1	Selects Tail Message 1.
36	T2	Tail Message 2	Selects Tail Message 2.
37	T3	Tail Message 3	Selects Tail Message 3.
38	TF	Tail Message Off	Disables Tail Messages.

**Alarm Enable / Disable Commands**

00	RE	Alarm Enable	Enables site alarm.
15	AD	Alarm Disable	Disables site alarm.

**Speech Synthesizer Commands**

16	SE	Speech Enable	Enables speech synthesizer.
17	SD	Speech Disable	Disables (turns off) speech synthesizer.
39	SI	Allow Speech Interrupt	Speech halted by user signal.
40	SO	Force Speech Talkover	Speech overrides user signal.



**Tone Panel Commands (requires Tone Panel Option)**

81-88	1E-8E	<b>Tone 1-8 Enable</b>	Enables CTCSS tone 1-8
91-98	1D-8D	<b>Tone 1-8 Disable</b>	Disables CTCSS tone 1-8

**Logic Low Courtesy Tone Select**

70	CT	<b>Select Courtesy Tone 0</b>	No tone
71	CT	<b>Select Courtesy Tone 1</b>	Bumblebee
72	CT	<b>Select Courtesy Tone 2</b>	Yellow Jacket
73	CT	<b>Select Courtesy Tone 3</b>	Shooting Star
74	CT	<b>Select Courtesy Tone 4</b>	Comet
75	CT	<b>Select Courtesy Tone 5</b>	Stardust
76	CT	<b>Select Courtesy Tone 6</b>	Dunce Cap
77	CT	<b>Select Courtesy Tone 7</b>	Piano Chord
78	CT	<b>Select Courtesy Tone 8</b>	Boop
79	CT	<b>Select Courtesy Tone 9</b>	Beep

**Initialize Command**

18	-	<b>Reset</b>	Initializes controller, loads Macro Set 1.
----	---	--------------	--

Enables Reverse Patch.  
 Disables Reverse Patch.  
 Selects phone line control mode.  
 Selects automatic hangout after 5 sec.  
 Selects auto hangout w/out answering.  
 Selects telphone access paging/phone line control.

**ID Commands**

29	P1	Pending ID 1
30	P2	Pending ID 2
31	P3	Pending ID 3
32	SP	Special ID
33	RP	Rotate Pending ID
34	RS	Rotate Pending-Special ID

**Tail Message Commands**

26	T1	Tail Message 1
27	T2	Tail Message 2
28	T3	Tail Message 3
29	T4	Tail Message Off

**Alarm Enable/Disable Commands**

40	FE	Alarm Enable
41	FD	Alarm Disable

**Speech Synthesizer Commands**

42	SE	Speech Enable
43	SD	Speech Disable
44	SI	Allow Speech Interrupt
45	SO	Force Speech Takeover



# Programming Commands

Morse	Speech			
*1000	*1100	Initial ID	II	20
*1001	—	Forced CW ID	FI	12
*1002	*1102	Anxious ID	AI	12
*1003	*1103	Pending ID 1	P1	24
*1004	*1104	Pending ID 2	P2	24
*1005	*1105	Pending ID 3	P3	24
*1006	*1106	Special ID	SI	48
*1007	*1107	Tail Message 1	T1	8
*1008	*1108	Tail Message 2	T2	8
*1009	*1109	Tail Message 3	T3	8
*1010-9	*1110-9	Autodial 0-9 Service	E0-E9	6
*1020	*1120	Phone Answer	PH	16
*1021	*1121	Phone Hangup	HG	8
*1022	*1122	Alarm	AL	8
*1023	*1123	Bulletin Board #1	B1	32
*1024	*1124	Bulletin Board #2	B2	32
—	*1125	Patch Dialing Prefix	DX	6

## Tone Parameters

*2000(speed)	Morse Code Speed	speed = 12-30 wpm
*2010(pitch)	Morse Code Pitch	pitch = 0-3000 Hz
*2020(pltch)	Cover Tone Pitch	pitch = 0-3000 Hz

## Courtesy Tone Selection

*3001(ct)	CT SEL Logic High Tone	ct = 0-9	CT
*3002(ct)	Link Tone	ct = 0-9	CT

## Timers

*4000(period)	Repeater Timeout Long	(~30-1799 sec)	TL
*4001(period)	Repeater Timeout Short	(~15-1799 sec)	TS
*4002(period)	Phone Answer Delay	(~10-~60 sec)	PA
*4003(period)	Autopatch Timer	(0, ~60-1799 sec)	AP
*4004(period)	User Autodial Timer	(0, ~60-1799 sec)	AU
*4005(period)	Emergency Autodial Timer	(0, ~60-1799 sec)	AE
*4006(period)	Patch Activity Timer	(0, ~30-1799 sec)	AA
*4007(period)	Patch Timer Extend Timer	(0, ~30-1799 sec)	TX
*4008(period)	Tail Message Timer	(~60-1799 sec)	TM
*4009(period)	Touch-Tone Access Timer	(0, ~30-1799 sec)	TA
*4010(period)	Hang Timer	(~750-~5000 ms)	HT
*4011(period)	Spare Audio Timer	(0, ~30-~1799 sec)	SP
*4012(period)	ID Timer	(amateur - 360 sec, commercial - 540 or 1140 sec)	ID
*4013(period)	Ringout Timer	(~10 - 120 sec)	RO
*4014(period)	Mode 3 Paging Talkout Timer	(~10 - 60 sec)	TK
*4015(period)	Alarm Timer	(0, ~10 - 1799 sec)	AL

## Tone Panel Frequency Selection (requires Tone Panel Option)

*5100 x	Tone #1 Encode (x=1) or Decode (x=0)	TONE
*510T FF	Tone (T) 1-8 Frequency Selection (FF)	TONE



**Command Code Prefixes**

*5000(prefix)	Control Operator Command	CMD
*5001(prefix)	User Function Logic Output	CMD
*5002(prefix)	Emergency Autodial	CMD
*5003(prefix)	User Loadable Autodial	CMD
*5004(prefix)	Autopatch	CMD
*5005(prefix)	Link / Remote Base	CMD
*5006(prefix)	User Autodial Load / Erase	CMD
*5007(prefix)	Demo / Bulletin Board	CMD
*5008(command)	Reverse Patch (from phone only)	CMD
*5009(command)	Spare Audio	CMD
*5010(prefix)	Patch Utilities	CMD
*5011(command)	Patch Hangup	CMD
*5012(prefix)	Two-Tone Paging	CMD
*5013(prefix)	Touch-Tone Access Mode Up/Down	CMD
*5014(command)	S-Meter Readback	CMD
*5015(prefix)	Extended User Autodial (Bank 1)	CMD
*5016(prefix)	Extended User Autodial Load/Erase	CMD
*5017(command)	Telephone Timer Extend Command	CMD
*5018(prefix)	Memory Paging	CMD
*5019(prefix)	Touch-Tone Pad Test	CMD

**Emergency Autodial Numbers**

\*520x(telephone number)      x = location 0 - 9      Phone number

**Misc. Selections**

*5400	Touch-Tone patch signalling	TT
*5401	Dial Pulse signalling	DP
*5402	Enable control over repeater receiver	EC
*5403	Disable control over repeater receiver	DC
*5404	Phone line not shared	PLU
*5405	Phone line shared	PLS
*5406	UF Low True	FL
*5407	UF High True	FH

**Store Macro Sets**

*5911	Store Macro Set #1	MACRO
*5912	Store Macro Set #2	MACRO
*5913	Store Macro Set #3	MACRO
*5914	Store Macro Set #4	MACRO
*5915	Store Macro Set #5	MACRO

**Pager Memories**

\*29 xxx f aaaa(aa)      PAGE

xxx = three digit memory number (000-999)

f = pager format

- |                                     |                          |
|-------------------------------------|--------------------------|
| 0 = 1 second / 3 second two-tone    | 4 = DTMF                 |
| 1 = 2.7 second / .8 second two-tone | 5 = five tone sequential |
| 2 = .4 seconds / .8 second two-tone | 6 = six tone sequential  |
| 3 = 8 second group call             |                          |

aaaa(aa) = pager address

two-tone - A group, A tone, B group, B tone

two-tone group call - A group, A tone, A group, A tone

DTMF - 4 or 6 digits (0-9, \*, A, B, C), fill unused digits with D keys

5/6 tone - wakeup tone, tones 1-5 (six digits) [for no wakeup tone, insert \* as first digit]



MEASURE	*970	PERCENT	*675	SHOWERS	*416	TURN	*990
MEETING	35	PHONE	*914	SHUT	*765	TWELVE	12
MEGA	*680	PLEASE	*967	SIDE	*417	TWENTY	20
MESSAGES	*625	PLUS	*611	SIERRA	*673	TWO	02
METER	*620	POINT	*674	SIGHT	*418	-TY(suffix)	60
MIKE	*661	POLICE	*968	SIX	06	U	82
MILES	*322	POSITION	*780	SLEET	*423	UNDER	*775
MILLI	*825	POWER	*714	SLOPE	*424	UNIFORM	*682
MILLION	*323	PRACTICE	85	SLOW	*983	UNIT	*715
MINUS	*612	PRESS	*781	SMOKE	*795	UNLIMITED	*467
MINUTES	*645	PRESSURE	*935	SNOW	*425	UNTIL	*468
MIST	*324	PRIVATE	*366	SOUTH	*790	UP	*650
MOBILE	*958	PROBE	*975	SPEED	*984	USE(noun)	*470
MODERATE	*326	PROGRAMMING	*367	SPRAY	*427	USE(verb)	*471
MODERATELY	*327	PULL	*980	SQUAWK	*428	V	83
MONTH	*328	PUSH	*977	STALL	*431	VALLEY	*986
MORE THAN	*330	Q	70	START	*730	VARIABLE	*473
MOTOR	*972	QUEBEC	*670	STOP	*731	VERIFY	*475
MOVE	*973	R	72	STORM	*433	VICTOR	*683
MUCH	*332	RADIO	*976	SUNDAY	*434	VISIBILITY	*476
N	62	RAIN	*374	SWITCH	*725	VOLTS	*750
NEAR	*333	RAISE	*375	SYSTEM	*997	W	91
NEGATIVE	*334	RANGE	*981	T	81	WAIT	54
NET	25	RATE	*376	TANGO	*681	WAKE	*477
NEW	*335	READY	*783	TANK	*435	WAKE UP	*478
NEXT	*336	REAR	*377	TARGET	*436	WARNING	*480
NIGHT	*337	RECEIVE	*378	TAXI	*437	WATCH	*481
NINE	09	RED	*744	-TEEN(suffix)	14	WATTS	*815
NO	*342	RELEASE	*381	TELEPHONE	*438	WAY	*482
NORTH	*772	REMARK	*382	TEMPERATURE	*724	WEATHER	95
NOT	*695	REMOTE	*910	TEN	10	WEDNESDAY	*484
NOVEMBER	*662	REPAIR	*745	TERMINAL	*440	WELCOME	*913
NUMBER	*734	REPEAT	*982	TEST	*792	WEST	*793
O	63	REPEATER	80	-TH(suffix)	*441	WHISKEY	*691
OBSCURED	*344	RICH	*383	THANK YOU	*978	WILL	*912
OCLOCK	*345	RIG	*384	THAT	*442	WIND	*487
OCTOBER	*346	RIGHT	*665	THE	24	WITH	*490
OF	*694	ROAD	*385	THE(long e)	*443	WRONG	*491
OFF	*614	ROGER	*386	THE(short e)	*444	X	92
OHIO	*348	ROMEO	*672	THIR-	13 or 30	X-RAY	*692
OHMS	*933	ROUTE	*388	THIRD	*447	Y	93
OIL	*350	RUNWAY	*390	THIRTEEN	*448	YANKEE	*693
ON	*613	S	73	THIS	*451	YELLOW	*794
ONE	01	-S(suffix)	*915	THIS IS	65	YESTERDAY	*492
OPEN	94	SAFE	*784	THOUSAND	*644	YOU	*493
OPERATION	*352	SAND	*391	THREE	03	YOUR	*987
OPERATOR	*630	SANTA CLARA	*392	THUNDERSTORMS	*452	Z	90
OSCAR	*663	SATURDAY	*393	THURSDAY	*453	ZED	*988
OTHER	*353	SCATTERED	*394	TIME	44	ZERO	00
OUT	*740	SECOND	*395	TIMER	*732	ZONE	*494
OUTER	*355	SECONDS	*635	TO	*455	ZULU	*690
OVER	*773	SECURITY	*396	TODAY	*456		
OVERCAST	*356	SELECT	*397	TOMORROW	55		
P	71	SEPTEMBER	*398	TONIGHT	45		
P.M.	*358	SEQUENCE	*410	TOOL	*985		
PAPA	*671	SERVICE	*723	TORNADO	*457		
PARTIALLY	*361	SET	*885	TOUCHDOWN	*458		
PASS	*774	SEVEN	07	TOWER	*460		
PATCH	*966	SEVERE	*413	TRAFFIC	*461		
PATH	*362	SEXY	*414	TRANSMIT	*462		
PER	*364	SHORT	*415	TRIM	*463		
				TUESDAY	*464		
				TURBULANCE	*465		



Remote programming is the key to the flexibility and power of the RC-96 controller. Its Touch-Tone command set allows remote reprogramming of messages, autodial numbers, command codes, and more. The remotely programmed information is stored in a reliable E<sup>2</sup>PROM, which combines the data integrity of a PROM with the flexibility of in-system reprogramming. And it isn't necessary to reprogram your controller when you upgrade the software.

The RC-96 controller is fully compatible with ACC's Digital Voice Recorder. The DVR lets you remotely record the various programmable messages in your '96. It also provides voice mailbox capability for your users, from over the air and over the phone. The '96 and DVR make an unbeatable pair!

This is just a sampling of the capability of the RC-96 Repeater Controller - read on to find out the whole story.

## Specifications

**Microprocessor** 8085AH

**Memory** Total 96K byte  
 EPROM - 80K byte  
 E<sup>2</sup>PROM - 8K byte  
 RAM - 8K byte

**Logic Inputs** Low 0 to .8 volts  
 High 2.4 to 15 volts  
 COS, Link COS, Control Receiver COS,  
 CTCSS, Courtesy Tone select,  
 Site Alarm, Phone Line Busy

**Logic Outputs** Open collector, 60V, 500mA  
 PTT, Link PTT, Control Outputs  
 (3, expandable to 8), Serial Output

**Audio Inputs** Receiver, Link Receiver,  
 Control Receiver, Spare (adjustable levels)

**Audio Outputs** Transmitter Audio (adjustable level)

**Operating Temperature** -15 to +55°C

**Power** 11.5 to 15V, 250 mA

**Cabinet Size** 19" rack mount, 1.75" high, 7" deep,  
 adjustable mounting ears



# **Table of Contents**

- 1 Introduction and Specifications**
- 2 Hookup to Your Repeater**
- 3 General Operation**
- 4 Command Code Structure**
- 5 How to Command the User's Features**
- 6 How to Be A Control Operator**
- 7 Programming the Controller**
- 8 Hookup to Other Equipment**
- 9 How It Works**
- 10 In Case of Difficulty**
- I Command Code Summary**
- II Connectors, Switches, and Adjustments**
- III Schematic**
- IV AD-1 Audio Delay Board Kit Option**
- V CTCSS Tone Panel Option**
- Glossary**
- Index**





advanced  
computer  
controls, inc.

2356 Walsh Avenue, Santa Clara, California 95051  
(408) 727-3330

## PROBLEM REPORT FORM

### SUBMITTED BY

Name: \_\_\_\_\_ Phone: \_\_\_\_\_

Organization: \_\_\_\_\_

Address: \_\_\_\_\_

City/State/Zip: \_\_\_\_\_

### PROBLEM

I wish to  Report an Error  Submit a Suggestion/Comment

In the area of  Hardware  Software  Manual  Schematic

### OPERATING ENVIRONMENT

RC-850  TP-3  FP-2  VR-2

RC-96  AD-1  FC-1

RC-85  AD-1  FC-1

ShackMaster 100  RCB-2  FC-1

DVR  CH-1  CH-2  CH-3

ITC-32  TP-3  FC-1

OTHER: \_\_\_\_\_

SOFTWARE VERSION: \_\_\_\_\_

### PROBLEM DESCRIPTION/COMMENTS



# Version 5!

## For the '96 and '85

### Introduction

The new Version 5 firmware for your RC-96 or RC-85 Repeater Controller adds the following exciting features:

- **Time of day clock and calendar**
- **Scheduler**
- **Expanded vocabulary – FEMALE and sound effects**
- **Support for an HF remote base**
- **Miscellaneous additions and improvements**

These features are easily added to your existing Version 3 or Version 4 controller by simply plugging them in!

### Description

The **time of day clock and calendar** is set with Touch-Tone programming commands, and is battery backed up to keep it running even if your controller loses power. You can choose 12 hour a.m./p.m. or 24 hour military format. Several time and date "run time variables" are like synthesized speech vocabulary, but instead of being fixed words, these variables say the time, date, a.m. or p.m., the day of the week, and morning/afternoon/evening when programmed into messages. These run time variables can be included in any messages (IDs, tail messages, bulletin boards, etc.) using the message editor.

The **scheduler** works in conjunction with the time of day clock and your existing macro sets. It relieves you of the chore of repetitively manually selecting different macro sets at different times of the day and days of the week. It's like an automatic control operator. With programming commands, you select the time and days (every day, weekends only, etc.) for automatic changeover of macro sets to automatically control everything from Control Op settings to remote bases and user function outputs.

We've added a new voice to your controller to announce the time – and *she'll* really perk up your repeater. She often goes by the name Juliet, and she joins Romeo in her new duties. Technically, Juliet is the **female synthesized speech** vocabulary, and along with some sound effects we've added, she brings the total vocabulary size of your controller to 535.



## Installation of the HF Remote Base

In addition to your RC-85 or RC-96 Repeater Controller, you need:

### From Kenwood:

Kenwood TS-440S

IC-10 IC kit (Intel or equivalent 8251A, RCA or equivalent CD4040B)

You do not need the IF-232C level translator.

### From ACC:

For the RC-96 only, Serial Port Board (available from ACC)

## Connections

The interconnections between the controller and the TS-440S include transmit audio, receive audio, push-to-talk (RC-96 only), and serial port for control. A COS or squelch signal may be used but is not readily accessible from the radio.

Be sure to install the '96 Serial Port Board as indicated in the instructions supplied with it to generate the Serial Out signal.

<u>'85</u>	<u>'96</u>	<u>TS-440S</u>
Tx Audio (J4-8)	Tx Audio (LINK-6, green)	AFSK IN
Link Rx Audio (J4-6)	Link Rx Audio (LINK-7, blue)	AFSK OUT or speaker jack
-	PTTL (LINK-4, orange)	PTT (ACC2 jack pin 13 or REMOTE "From standby switch")
CX3 (J3-11)	Serial Out (CNTL RX-6, green)	Serial Input (ACC1 jack pin 3, bottom pin)

With the controller unlocked, program an HF command prefix (\*5020 prefix). Assuming you are not using a COS, program the Link COS Logic Sense to "low true" (\*5410). Enable the HF remote base with the Control Op command (prefix) 107.

With the HF remote turned on (see User Command summary), set link receive level on the controller ('96 = LRX, '85 = R2), and the mic gain on the TS-440 for HF transmit level.



## Miscellaneous Improvements

The following changes have been made in V5 firmware.

- VHF/UHF remote base frequency readback can be inhibited when \* is left out as a decimal point.
- Loading autodial locations from the phone automatically extends the telephone timer so the controller won't hang up.
- Band units not present in your IC-900 "stack" can be locked out from selection to avoid potential confusion. See Appendix C, *Programming Commands*.
- When using the FC-900, Link 2 can be disabled if you have only one band unit to avoid confusion. See Appendix C, *Programming Commands*.
- Bands can be swapped without Link 2 unit needing to be on.
- A band unit cannot be selected for both Link 1 and Link 2.
- If Control Receiver COS becomes active while someone is controlling on the phone, control is returned properly to the phone after COS becomes inactive.
- The cover tone is automatically disabled if a user manually selects full duplex.
- Spare audio is properly muted by a signal on the repeater receiver.
- The unlock timer has been changed from one minute to two minutes.
- The speech letter "S" can be included in the Patch Dialing Prefix to generate Touch-Tone "\*\*".



Many people have asked for the ability to hook up an HF remote base transceiver to their repeater so they could work HF from their handhelds. Now you can! The '85 and '96 controllers each have one link or remote base port, and now an HF radio can be connected to that port. (If you're already using your link port for a fixed frequency, BCD, or FC-900 remote, the HF function is not available). With the '96 controller you'll need to add a low cost serial port board available from ACC. The '85 controller will connect to the HF radio as-is.

We selected the Kenwood TS-440S HF transceiver because of its clean interface and its popularity. You'll have a basic subset of control functions – frequency, mode, memory recall, and scan (not loading memories, operating the antenna tuner, controlling a rotor, etc.). The TS-440S is the **only** radio that we plan to support – if you like ICOM or Yaesu, try Kenwood! (We like all three! – we just don't support the other HF radios.) And if you have another in Kenwood's series, you may want to try it, but we've done all our testing with the TS-440S.

Finally, as our controller firmware continues to evolve, we've made a number of **miscellaneous additions and improvements** based on feedback from owners and users. The details are outlined at the end of this note.

**WARNING:** The field installation of the upgrade involves **some risk** – if you don't follow the instructions precisely, or if there is a mechanical problem such as a bent pin, it may be necessary to return the controller to ACC for repair. We've done everything possible to make the upgrade easy to install. ACC offers to perform the installation at no charge (except return shipping). If you would like us to perform the upgrade, return your controller and the upgrade kit to ACC *before attempting installation*. If you choose to perform the installation in the field, please recognize the small but finite risk.

**WARNING:** Version 5 firmware **requires 8Kx8 of E<sup>2</sup>PROM**. All RC-96 controllers are equipped with the necessary 8Kx8. *Very old RC-85 controllers* (shipped approximately before February, 1987, S/N 696) may have only 2Kx8 of E<sup>2</sup>PROM. If your old '85 contains a 2815, 2816, or 2817A at socket U27, then you need to upgrade the E<sup>2</sup>PROM to a 28C64. Contact the factory for availability before attempting the installation.

**WARNING:** If you connect your controller to a Kenwood TS-440S transceiver, we strongly recommend lightning protection for your repeater and site to avoid damage to the expensive HF radio.

**WARNING:** If you connect your controller to a Kenwood TS-440S transceiver and plan to operate ten meters, be aware that RF emissions from the RC-85 controller may require additional shielding and filtering for effective operation. See Chapter 10 of the RC-85 Manual for suggestions.

**WARNING:** Do not tamper with the label on either supplied module.  
***Tampering with the labels will void all warranties.***



## **Installation**

The Version 5 upgrade consists of two modules which plug into existing sockets on your controller. They include the new EPROM program memory which contains the Version 5 firmware, and a time of day clock and calendar with its built-in lithium backup battery.

### **RC-96 Repeater Controller**

1. Remove power from the controller. Be sure that any backup battery is also removed from the controller before performing the following steps. Remove the top cover by removing the six side screws.
2. CAREFULLY, with the supplied IC extractor, remove the integrated circuit at location U29. Replace it with the U29 chip supplied with the upgrade (oriented so that the pin 1 notch on the chip matches the notch on the pc board).
3. CAREFULLY remove the integrated circuit at location U34. This chip will no longer be needed, and the socket at U34 will be left empty.
4. CAREFULLY remove the integrated circuit at location U31 – save it for later use in this step. Replace it with the clock module supplied with the upgrade. Now plug in the chip you just removed into the socket on the top of the clock module.
5. You should now have left over the original U29 and U34 chips from your controller. Go back over the last steps FOR THE '96 CONTROLLER, and be sure that the chips are plugged into their sockets in the proper orientation and with no bent pins.
6. Power up the controller – it should sign on with the V5.x message. Proceed to program the new functions of the controller as described in the next sections.

### **RC-85 Repeater Controller**

**CAUTION:** You must either have an 8Kx8 E<sup>2</sup>PROM at location U27 or have obtained an 8Kx8 E<sup>2</sup>PROM from ACC before performing the installation. If the chip at U27 is a 9864 or 28C64A or other part number ending with 64, then you may proceed. If the chip is a 2815, 2816, or 2817A (not ending in 64) then you must purchase an E<sup>2</sup>PROM upgrade from ACC before attempting the installation. Call the factory to order the part.

1. Remove power from the controller. Be sure that any backup battery is also removed from the controller before performing the following steps. Remove the top cover of the '85 enclosure or otherwise gain access to the top of the printed circuit board.
2. CAREFULLY, with the supplied IC extractor, remove the integrated circuit at location U28. Replace it with the U28 chip supplied with the upgrade.



3. **CAREFULLY** remove the integrated circuit at location U27 – save it for possible later use in this step. Replace it with the clock module supplied with the upgrade.

Now, if the chip that you just removed is a 9864 or 2864 or something else 64, then plug it back into the socket on the top of the clock module. If the chip that you removed is a 2815, 2816, or 2817A, then plug in your new 28C64A obtained separately into the socket of the clock module.

4. You should now have left over the original U28 chip from your controller, and possibly the 2815/16/17 chip. Go back over the last steps **FOR THE '85 CONTROLLER**, and be sure that the chips are plugged into their sockets in the proper orientation and with no bent pins.

5. Power up the controller – it should sign on with the V5.x message. Proceed to program the new functions of the controller as described in the next sections.

## **Initial Selections and Programming**

After powering up the controller with Version 5 firmware, be sure to do the following programming and selection steps to avoid unexpected difficulties. See the appendices for command summaries.

### **Control Op**

Disable the scheduler until you program the setpoints that you want – 102.

If you have an FC-900 Interface connected to your controller, enable Link 2 if you have more than one band unit – 105. Otherwise, disable Link 2 – 106.

Disable the HF Remote Base until and unless you connect a TS-440S to your controller – 108.

Re-select your Reverse Patch Mode 0-4 – 54, 55, 56, 67, or 109 (new).

### **Programming**

Program your Control Op setup in macro sets so that what you've selected above isn't undone when you select a new macro set – \*5911-\*5915.

Program Link COS to be high true (previous fixed condition) – \*5411.

If you have an FC-900 Interface connected to your controller, indicate which band units are present and which are absent – \*530B P.

If you have not connected a TS-440S HF transceiver to your controller, program an empty HF Command Prefix – \*5020.

Program the five Permitted Area Codes as empty messages except for the ones you intend to use (i.e. 1-800, 1-408, etc.) – \*1126-\*1130.

When programming setpoints for the first time, zero out all unused setpoints by loading all zeros – \*420S 0 0 0 00 00 0.



## Operation

This section describes the operation of the various new features in Version 5. The new command codes (programming, control operator, and user) are also summarized later.

### Clock / Calendar

The clock and calendar serves several purposes – the time can be played on request by entering a Demo user command; the time, date, and day of week can be included in any programmable message using the message editor; the time and day of week drive the scheduler which automatically selects macro sets.

Decide if you want your clock to operate in 12 hour format (a.m. and p.m.) or 24 hour format (military time). Set the time using *one* of the following two **programming commands** (entered with the controller *unlocked*). The command you chose will determine the format. It will also be necessary to load the scheduler setpoints below using the *same* format.

**Set Time (12 hr mode)** \*4100 AP H10 H1 M10 M1

**Set Time (24 hr mode)** \*4100 H10 H1 M10 M1

AP: 1 = p.m., 0 = a.m. (12 hour mode only)

H10: tens hours, H1: ones hours, M10: tens minutes, M1: ones minutes

**Example:** It's 2:53:05 p.m. To set the clock using 12 hour mode, wait until nearly 2:54 and enter the command (with the controller unlocked) \*4100 1 0254 and unkey. Time your command entry so that you unkey at 2:54:00 if you want to set the clock precisely.

**Set Date** \*4101 M10 M1 D10 D1 Y10 Y1

M10: tens month, M1: ones month, D10: tens day, D1: ones day, Y10: tens year, Y1: ones year

**Example:** The date is April 1, 1991. To set the calendar, enter the command (with the controller unlocked) \*4101 04 01 91.

**Set Day of Week** \*4102 DOW

DOW (day of week):

0 = Sunday

4 = Thursday

1 = Monday

5 = Friday

2 = Tuesday

6 = Saturday

3 = Wednesday

**Example:** It's Friday (thank goodness). To set the day of week to Friday, enter the command (with the controller unlocked) \*4102 5.

The current time of day can be played by users with the demo user command below.

**Say Time of Day** [Demo Prefix] 9



## Scheduler

The scheduler works with your existing five macro sets, the new clock / calendar, and "setpoints" which you can program to tell the controller when to change over to a new macro set. The automatic selection of macro sets by the scheduler is identical to your manual selection using the Macro Set Select Control Operator command.

You've programmed the clock above, and this section gives programming information for setpoints.

There is room for ten setpoints which you can fill in as needed to arrange your "schedule". Each setpoint specifies certain information relating to the changeover. The day of the week can be a specific day (Monday, etc.), weekends (Saturday, Sunday), all weekdays (Monday through Friday), or every day of the week. You can also optionally specify an nth day of the month - i.e. third Monday of each month. The time for the changeover is defined by hours and minutes. Finally, the macro set to be loaded at the changeover is specified in the programming command shown below. Use the **programming command** below based on the 12 or 24 hour mode you selected when setting the clock.

**Define setpoint (12 hr mode)**     \*420 S Nth DOW AP H10 H1 M10 M1 M#

**Define setpoint (24 hr mode)**     \*420 S Nth DOW            H10 H1 M10 M1 M#

S: Setpoint 0-9. Ten setpoints can be programmed. To erase a setpoint, enter all zeros.

Nth: The 1st, 2nd, 3rd, 4th, or ANY day of week of the month.

0 = ANY            1 = first            2 = second            3 = third            4 = fourth

DOW (day of week):

0 = Sunday	5 = Friday
1 = Monday	6 = Saturday
2 = Tuesday	7 = everyday
3 = Wednesday	8 = weekdays
4 = Thursday	9 = weekends

AP: 1 = p.m., 0 = a.m. (12 hour mode only)

H10: tens hours, H1: ones hours, M10: tens minutes, M1: ones minutes

M#: Macro set # 1-5

**Example:** Select macro set #3 every weeknight at 11:00 p.m. Use setpoint #5. The clock is in 12 hour mode. Enter the command (with the controller unlocked) \*420 5 0 9 1 11 00.

Be sure you have selected the format you want to use (12 or 24 hour) using the Time command. You must define setpoints using the same format as selected for the time.

The following new Control Operator commands relate to the scheduler. The currently selected macro set number can be read back. The scheduler can be turned on and off, and the on/off status of the scheduler can be read back.

100	1-5	Interrogate Current Macro Set
101	S on	Scheduler Ont
102	S off	Scheduler Offt
103	on/off	Interrogate Scheduler On/Off



## Female and Sound Effects Synthesized Speech

Thirty-two female words, 10 male words, and 8 sound effects are added to the vocabulary list. In addition, five "run-time variables" can be programmed into messages to play time and date related information as part of the messages. The vocabulary additions along with their message editor codes are shown below and in the programming summary.

### Female

oh	*800	twelve	*812	good	*834
one	*801	thirteen	*813	morning	*841
two	*802	fourteen	*814	afternoon	*842
three	*803	fifteen	*854	evening	*843
four	*804	sixteen	*864	the	*821
five	*805	seventeen	*874	time	*822
six	*806	eighteen	*884	is	*823
seven	*807	nineteen	*894	o'clock	*824
eight	*808	twenty	*820		
nine	*809	thirty	*830		
ten	*810	forty	*840		
eleven	*811	fifty	*850		

### Male

crane	*950	gauge	*961	pico	*932
device	*953	micro	*931	valve	*941
electrician	*943	mill	*971		
farad	*930	passed	*974		

### Sound Effects

crowd	*892	tic	*860
explosion	*891	toc	*870
laser	*873	train	*883
phaser	*882	whistle	*881

### Run-Time Variables

morning/afternoon/evening	*844 (female)
current time	*872 (female)
current a.m./p.m.	*832 (female)
current date	*833 (male month, female day)
current day of week	*871 (male)



## HF Remote Base

A Kenwood TS-440S HF transceiver can be connected to the controller and can be operated remotely through the repeater. Installation instructions for the transceiver are shown later in this note. This section describes the commands which relate to operation of the HF remote.

The HF remote base gets its own user command code prefix. The **programming command** for selecting the user level HF Prefix is:

\*5020 (prefix)

**Example:** Select HF remote base prefix as 1. Enter the command (while unlocked) \*50201.

The **Control Op** can enable and disable the HF remote base:

107	HF Remote Base Enabled†	HE
108	HF Remote Base Disabled†	HD

The HF remote can be put into Receive Only, Receive/Transmit, and can be turned Off by users. In addition, frequency, mode, and memories can be selected. The **user commands** for these functions are:

Receive Only	[HF Prefix] 1
Receive/Transmit	[HF Prefix] 2
Off	[HF Prefix] 3
Frequency Interrogate	[HF Prefix] 8
Frequency Enter	[HF Prefix] (10M)M*HT(O(h(t)))

Examples (assuming HF Prefix = factory default value of 1):

14.23 MHz = 1 14*23	3.89551 MHz = 1 3*89551
7.255 MHz = 1 7*255	21.3 MHz = 1 21*30

Bump Up 100 Hz	[HF Prefix] 6
Bump Down 100 Hz	[HF Prefix] 4
Bump Up 500 Hz	[HF Prefix] 9
Bump Down 500 Hz	[HF Prefix] 7
Bump Up 20 Hz	[HF Prefix] A
Bump Down 20 Hz	[HF Prefix] B

Example (assuming HF Prefix = factory default value of 1): Bump HF frequency up 100 Hz: 1 6

Scan Down Slow	[HF Prefix] 7 1
Scan Up Slow	[HF Prefix] 7 3
Scan Down Medium	[HF Prefix] 7 4
Scan Up Medium	[HF Prefix] 7 6
Scan Down Fast	[HF Prefix] 7 7
Scan Up Fast	[HF Prefix] 7 9
Scan Stop	Carrier (key down VHF/UHF radio)

Example (assuming HF Prefix = factory default value of 1):

Scan up medium: 1 7 6. Stop scanning: key your radio.



Mode [HF Prefix] 1 (mode 1-4)

Mode: 1=USB, 2=LSB, 3=AM, 4=FM

Examples (assuming HF Prefix = factory default value of 1):

USB = 1 1      LSB = 1 2

Memory [HF Prefix] 5 (00-99)

Note: Memories must be *preprogrammed* into the HF transceiver.

VFO A [HF Prefix] 5

Example (assuming HF Prefix = factory default value of 1):

Select memory 54 which has been preprogrammed into the radio. Enter 1 5 54. To return the HF radio to VFO A, enter 1 5.

### Tone Panel CTCSS Regeneration ('96 Only)

The existing Tone Panel programming commands are expanded to provide for several modes of regeneration of the incoming tone. Previously, only a fixed tone could be encoded. As a reminder, tone #1 must be programmed as encode (unlocked, \*5100 1) in order to regenerate.

- \*5101 39      Regenerate incoming tone – only while present
- \*5101 40      Regenerate incoming tone – until repeater carrier drops
- \*5101 41      Regenerate incoming tone – lockout others until repeater carrier drops

**Example:** We have four decode tones installed in positions 2-5. Encoder at position 1 should regenerate the incoming tone, and the controller should not respond to other incoming tones until the repeater carrier is allowed to drop. Enter the command (with the controller unlocked) \*5101 41.

### Autopatch Toll Restrict Enhancement

In order to better accommodate densely populated locations where area codes are being split, five "Permitted Area Codes" have been added. These are entered as *messages* (either Morse or speech), i.e. "1415", "301", "1800".

In addition, "local calls" can be defined as maximum seven or eight digit (permitting "1"+7 digit calls while preserving 10 and 11 digit toll call protection). The 7 or 8 is programmed as a one character *message*.

See the message list in Appendix C, *Programming Commands*.

### Don't Answer Telephone For Two Minutes

A new Control Op command – "Don't answer for 2 minutes" – makes it more convenient to share the '85/'96 phone line with an '850 and modem. See Appendix B, *Control Operator Commands*.

### Interrogating Autodial Numbers

Telephone numbers stored in Autodial locations can be read out without dialing the number, including from the phone. See Appendix A, *User Commands*.



# User Commands

## Touch-Tone-Pad Test

(Pad Test Prefix) (sequence of up to 32 keys)

## Autopatch

(Autopatch Prefix) (telephone number)

## User Loadable Autodial Load

(Autodial Load/Erase Prefix)(Location)(Phone Number) or  
(Autodial Load/Erase Prefix)\*(Location)(Phone Number)  
[phone number secured from readback]

## User Loadable Autodial Erase

(Autodial Load/Erase Prefix) (Location)

## User Loadable Autodial Readback

(Autodial Load/Erase Prefix)\*(Location)

## User Loadable Autodial

(User Loadable Autodial Prefix) (Location)

## Emergency Autodial

(Emergency Autodial Prefix) (Location)

## Reverse Patch Activate (from phone only)

(Reverse Patch Command)#

## Reverse Patch Answer

(Patch Utility Prefix)

## Extending the Telephone Timer (from phone only)

(Telephone Timer Extend Command)#



**Patch Hangup**

(Patch Hangup Command)

**Patch Custom Hangup Code**

(Patch Utility Prefix) (any 3 keys except # or D)

**Patch Redial**

(Patch Utility Prefix) \*

**Patch Full-Duplex**

(Patch Utility Prefix) \*1

**Patch Cover Tone**

(Patch Utility Prefix) \*2

**Patch Timer Extend**

(Patch Utility Prefix) \*3

**BCD or Fixed Frequency Link / Remote Base**

(Link Prefix) 1	Link On Receive Only
(Link Prefix) 2	Link On Receive/Transmit
(Link Prefix) 3	Link Off
(Link Prefix) (mhtof)	Link Frequency
(Link Prefix) (m*htof)	Link Frequency

**EC-900 Link / Remote Base**

(Link Prefix) 1	Link 1 On Receive Only
(Link Prefix) 2	Link 1 Receive/Transmit
(Link Prefix) 3	Link 1 Off
(Link Prefix) 4	Link 2 On Receive Only
(Link Prefix) 6	Link 2 Off
(Link Prefix) *	Swap Link 1 / Link 2 Bands
(Link Prefix) 1 x	Link 1 Band Select
(Link Prefix) 4 x	Link 2 Band Select
x = 0	1240
1	10 meter
2	2 meter
3	220
4	440
5	430
6	6 meter
(Link Prefix) (mhtof)	Link 1 Frequency
(Link Prefix) (m*htof)	Link 1 Frequency
(Link Prefix) 1 (m*htof)	Link 1 Frequency
(Link Prefix) 4 (m*htof)	Link 2 Frequency
(Link Prefix) 1 *	Link 1 Power, Interrogate
(Link Prefix) 1 * 1	Link 1 High Power
(Link Prefix) 1 * 0	Link 1 Low Power
(Link Prefix) 7 xx	CTCSS Select (00=off, 01-38=on)



V5

**HF Remote Base**

(HF Prefix) 1	Receive Only
(HF Prefix) 2	Receive/Transmit
(HF Prefix) 3	Off
(HF Prefix) 8	Frequency Interrogate
(HF Prefix) (10M)M*HT(O(h(t)))	Frequency Enter
(HF Prefix) 6	Bump Up 100 Hz
(HF Prefix) 4	Bump Down 100 Hz
(HF Prefix) 9	Bump Up 500 Hz
(HF Prefix) 7	Bump Down 500 Hz
(HF Prefix) A	Bump Up 20 Hz
(HF Prefix) B	Bump Down 20 Hz
(HF Prefix) 7 1	Scan Down Slow
(HF Prefix) 7 3	Scan Up Slow
(HF Prefix) 7 4	Scan Down Medium
(HF Prefix) 7 6	Scan Up Medium
(HF Prefix) 7 7	Scan Down Fast
(HF Prefix) 7 9	Scan Up Fast
Carrier	Stop Scan
(HF Prefix) 1 (mode)	Mode (1=USB, 2=LSB, 3=AM, 4=FM)
(HF Prefix) 5 (00-99)	Memory
(HF Prefix) 5	Return to VFO A

**S-Meter Readback**

(S-Meter Command)

**Demonstration / Bulletin Board**

(Demo Prefix) (0 - 8, \*)

- (0 = Initial ID Message)
- (1 = Forced ID Message)
- (2 = Anxious ID Message)
- (3 = Pending ID Message 1)
- (4 = Pending ID Message 2)
- (5 = Pending ID Message 3)
- (6 = Special ID Message)
- (7 = Bulletin Board Message 1)
- (8 = Bulletin Board Message 2)
- (9 = Time of Day Announcement)
- (\* = Firmware Revision Announcement)

V5

**Unmuting Touch-Tone**

# (sequence)



**Two-Tone Paging**

(2-Tone Paging Prefix)(A Group number)(A Tone number)(B Group number)(B Tone number)

(2-Tone Paging Prefix)(Group number)(Tone number)[group call]

**Memory Paging**

(Memory Paging Prefix) xxx  
xxx = 000 - 999

**Touch-Tone Access**

(TT Access Mode Prefix) 0 [down]

(TT Access Mode Prefix) 1 [up]

**Spare Audio Select**

(Spare Audio Command)

# knock down

**User Function (Remote Control) Output Force & Interrogate**

(UF Prefix) (Output #1-8) (1 = on, 0 = off)

(UF Prefix) (Output #1-8) Interrogate

2-Meter Readback  
(2-Meter Command)

**Demonstration / Bulletin Board**

(Demo Prefix) (0 - 8, \*)

(0 = Initial ID Message)

(1 = Forced ID Message)

(2 = Anxious ID Message)

(3 = Pending ID Message 1)

(4 = Pending ID Message 2)

(5 = Pending ID Message 3)

(6 = Special ID Message)

(7 = Bulletin Board Message 1)

(8 = Bulletin Board Message 2)

(9 = Time of Day Announcement)

(\* = Firmware Revision Announcement)

Limiting Touch-Tone

(# sequence)



## Appendix B

# Control Operator Commands

### Macro Set Selection Commands

	1	M1	Macro Set 1 Select	Selects Control Op Macro Set #1.
	2	M2	Macro Set 2 Select	Selects Control Op Macro Set #2.
	3	M3	Macro Set 3 Select	Selects Control Op Macro Set #3.
	4	M4	Macro Set 4 Select	Selects Control Op Macro Set #4.
	5	M5	Macro Set 5 Select	Selects Control Op Macro Set #5.
V5	100	1-5	Interrogate Currently Selected Macro Set	
V5	101	S on	Scheduler On	Enables scheduler.
V5	102	S off	Scheduler Off	Disables scheduler.
V5	103	on/off	Interrogate Scheduler On / Off	

### Repeater Enable / Disable Commands

	00	RE	Repeater Enable	Enables repeater transmitter.
	01	RD	Repeater Disable	Disables repeater transmitter.

### Repeater Timer Commands

	02	TE	Repeater Timer Enable	Enables repeater timeout timer.
	03	TD	Repeater Timer Disable	Disables repeater timeout timer.
	04	TL	Repeater Timer Long	Selects long timeout timer.
	05	TS	Repeater Timer Short	Selects short timeout timer.
	06	TC	Clear Repeater Timer	Cancels timeout condition, clears timer.
	65	ZD	Zero Hang Time Disable	Disables zero hang time.
	66	ZE	Zero Hang Time Enable	Enable zero hang time.

### Access / Control Commands

	07	CA	Carrier Access / Control	Enables carrier access and control.
--	----	----	--------------------------	-------------------------------------



<b>08</b>	<b>PC CTCSS COP Command</b>	Enables carrier access, CTCSS required for Control Op Touch-Tone commands.
<b>09</b>	<b>PU CTCSS COP/User Cmd</b>	Enables carrier access, CTCSS required for Control Op and User commands.
<b>10</b>	<b>PL CTCSS Access</b>	CTCSS required for access and control.
<b>52</b>	<b>ME TT Access Mode Enable</b>	Enables Touch-Tone Access Mode.
<b>53</b>	<b>MD TT Access Mode Disable</b>	Disables Touch-Tone Access Mode.
<b>61</b>	<b>KE Kerchunker Filter Enable</b>	Enables kerchunker filter.
<b>62</b>	<b>KD Kerchunker Filter Disable</b>	Disables kerchunker filter.

#### User Command Enable / Disable Commands

<b>11</b>	<b>CE User Command Enable</b>	Enables User Touch-Tone commands.
<b>12</b>	<b>CD User Command Disable</b>	Disables User Touch-Tone commands.
<b>41</b>	<b>TE Pad Test Enable</b>	Enables Touch-Tone Pad Test.
<b>42</b>	<b>TD Pad Test Disable</b>	Disables Touch-Tone Pad Test.
<b>63</b>	<b>TM Touch-Tone Mute</b>	Mutes Touch-Tone through the repeater.
<b>64</b>	<b>TU Touch-Tone Unmute</b>	Unmutes Touch-Tone through the repeater.

#### Link Enable / Disable Commands

	<b>13</b>	<b>LE Link Enable</b>	Enables link / remote base.
	<b>14</b>	<b>LD Link Disable</b>	Disables link / remote base.
<b>V5</b>	<b>105</b>	<b>2E FC-900 Link 2 Enable</b>	Enables FC-900 Link 2.
<b>V5</b>	<b>106</b>	<b>2D FC-900 Link 2 Disable</b>	Disables FC-900 Link 2.
<b>V5</b>	<b>107</b>	<b>HE HF Remote Base Enable</b>	Enables HF remote.
<b>V5</b>	<b>108</b>	<b>HD HF Remote Base Disable</b>	Disables HF remote.

#### Autopatch / Autodial Commands

	<b>19</b>	<b>PE Autopatch Enable</b>	Enables Autopatch.
	<b>20</b>	<b>PD Autopatch Disable</b>	Disables Autopatch.
	<b>27</b>	<b>LE Long Distance Enable</b>	Enables Autopatch long distance.
	<b>28</b>	<b>LD Long Distance Disable</b>	Disables Autopatch long distance.
	<b>21</b>	<b>UE User Autodial Enable</b>	Enables User Loadable Autodialer.
	<b>22</b>	<b>UD User Autodial Disable</b>	Disables User Loadable Autodialer.



	<b>47 AU User Autodial Unlock</b>	Unlocks User Loadable Autodialer.
	<b>48 AL User Autodial Lock</b>	Locks User Loadable Autodialer.
	<b>57 UU User Autodial Unhide</b>	Allows secured numbers to be read back.
	<b>58 UH User Autodial Hide</b>	Secures autodial numbers loaded w/option.
	<b>23 EE Emergency Autodial Enable</b>	Enables Emergency Autodialer.
	<b>24 ED Emergency Autodial Disable</b>	Disables Emergency Autodialer.
	<b>60 NC Dial Needing Click</b>	Requires user click to initiate dialing.
	<b>59 XC Dial Without Click</b>	Enables dialing without user click.
	<b>68 NR No Phone Number Readback</b>	Disables phone number readback and disables autodial location read-back and enables dialing without user click.
	<b>25 PT Patch Timer Enable</b>	Enables patch timers.
	<b>26 PX Patch Timer Disable</b>	Disables patch timers.
	<b>49 TD Cover Tone Disable</b>	Disables patch cover tone.
	<b>50 TE Cover Tone Enable</b>	Enables patch cover tone - user selected.
	<b>51 TA Cover Tone Always On</b>	Enables patch cover tone for all patches.
	<b>69 FD Full-Duplex User Selectable ('96 only)</b>	Patches are half-duplex unless user selected to be full-duplex.
	<b>80 FA Full-Duplex Always ('96)</b>	All patches are full-duplex.
	<b>43 — Control Op Offhook</b>	“Manually” takes phone offhook.
	<b>44 — Control Op Onhook</b>	Places phone onhook (hangup).
	<b><u>Reverse Patch Commands</u></b>	
	<b>45 XE Reverse Patch Enable</b>	Enables Reverse Patch.
	<b>46 XD Reverse Patch Disable</b>	Disables Reverse Patch.
	<b>54 R0 Reverse Patch Mode 0</b>	Selects phone control mode.
	<b>55 R1 Reverse Patch Mode 1</b>	Selects automatic ringout after 5 sec.
	<b>56 R2 Reverse Patch Mode 2</b>	Selects auto. ringout w/out answering.
	<b>67 R3 Reverse Patch Mode 3</b>	Selects telephone access paging/phone line control.
<b>V5</b>	<b>109 R3 Reverse Patch Mode 4</b>	Places caller directly on air.
<b>V5</b>	<b>104 NA Don't Answer Phone For 2 Minutes</b>	



**ID Commands**

29 P1	Pending ID 1	Selects Pending ID 1.
30 P2	Pending ID 2	Selects Pending ID 2.
31 P3	Pending ID 3	Selects Pending ID 3.
32 SP	Special ID	Selects Special ID.
33 RP	Rotate Pending IDs	Rotates Pending ID 1-2-3.
34 RS	Rotate Pending-Special IDs	Rotates Pending ID 1-2-3 - Special ID.

**Tail Message Commands**

35 T1	Tail Message 1	Selects Tail Message 1.
36 T2	Tail Message 2	Selects Tail Message 2.
37 T3	Tail Message 3	Selects Tail Message 3.
38 TF	Tail Message Off	Disables Tail Messages.

**Alarm Enable / Disable Commands**

00 RE	Alarm Enable	Enables site alarm.
15 AD	Alarm Disable	Disables site alarm.

**Speech Synthesizer Commands**

16 SE	Speech Enable	Enables speech synthesizer.
17 SD	Speech Disable	Disables (turns off) speech synthesizer.
39 SI	Allow Speech Interrupt	Speech halted by user signal.
40 SO	Force Speech Talkover	Speech overrides user signal.

**Tone Panel Commands** ('96 only, requires Tone Panel Option)

81-88	1E-8E	Tone 1-8 Enable	Enables CTCSS tone 1-8.
91-98	1D-8D	Tone 1-8 Disable	Disables CTCSS tone 1-8.

**Logic Low Courtesy Tone Select**

70 CT	Select Courtesy Tone 0	No tone
71 CT	Select Courtesy Tone 1	Bumblebee
72 CT	Select Courtesy Tone 2	Yellow Jacket
73 CT	Select Courtesy Tone 3	Shooting Star
74 CT	Select Courtesy Tone 4	Comet
75 CT	Select Courtesy Tone 5	Stardust
76 CT	Select Courtesy Tone 6	Dunce Cap
77 CT	Select Courtesy Tone 7	Piano Chord
78 CT	Select Courtesy Tone 8	Boop
79 CT	Select Courtesy Tone 9	Beep

**Initialize Command**

18 —	Reset	Initializes controller, loads Macro Set 1.
------	-------	--



## Appendix C

# Programming Commands

<u>Morse</u>	<u>Speech</u>			
*1000	*1100	Initial ID	II	20
*1001	—	Forced CW ID	FI	12
*1002	*1102	Anxious ID	AI	12
*1003	*1103	Pending ID 1	P1	24
*1004	*1104	Pending ID 2	P2	24
*1005	*1105	Pending ID 3	P3	24
*1006	*1106	Special ID	SI	48
*1007	*1107	Tail Message 1	T1	8
*1008	*1108	Tail Message 2	T2	8
*1009	*1109	Tail Message 3	T3	8
*1010-9	*1110-9	Autodial 0-9 Service	E0-E9	6
*1020	*1120	Phone Answer	PH	16
*1021	*1121	Phone Hangup	HG	8
*1022	*1122	Alarm	AL	8
*1023	*1123	Bulletin Board #1	B1	32
*1024	*1124	Bulletin Board #2	B2	32
—	*1125	Patch Dialing Prefix	DX	6
V5	—	*1126 Permitted Area Code 1	P1	4
V5	—	*1127 Permitted Area Code 2	P2	4
V5	—	*1128 Permitted Area Code 3	P3	4
V5	—	*1129 Permitted Area Code 4	P4	4
V5	—	*1130 Permitted Area Code 5	P5	4
V5	—	*1131 Max. # "Local" Digits (7 or 8)	LD	1
<u>Tone Parameters</u>				
*2000(speed)	Morse Code Speed	speed = 12-30 wpm		
*2010(pitch)	Morse Code Pitch	pitch = 0-3000 Hz		
*2020(pitch)	Cover Tone Pitch	pitch = 0-3000 Hz		
<u>Courtesy Tone Selection</u>				
*3001(ct)	CT SEL Logic High Tone	ct = 0-9	CT	
*3002(ct)	Link Tone	ct = 0-9	CT	



44	TIME	W	91	<u>NUMBERS (MALE)</u>	
558*	TIME†	WAIT	54	NUMBER	*734
732*	TIMER	WAKE	*477	ZERO	00
752*	TO	WAKE UP	*478	OH	63
756*	TODAY	WARNING	*480	ONE	01
88	TOMORROW	WATCH	*481	TWO	02
82	TONIGHT	WATTS	*815	THREE	03
282*	TOOL	WAY	*482	FOUR	04
757*	TORNADO	WEATHER	95	FIVE	05
488*	TOUCHDOWN	WEDNESDAY	*484	SIX	06
480*	TOWER	WELCOME	*913	SEVEN	07
481*	TRAFFIC	WEST	*793	EIGHT	08
482*	TRANSMIT	WHISKEY	*691	NINE	09
483*	TRIM	WILL	*912	TEN	10
484*	TUESDAY	WIND	*487	ELEVEN	11
485*	TURBULANCE	WITH	*490	TWELVE	12
890*	TURN	WRONG	*491	THIRTEEN	*448
12	TWELVE			THIR-(prefix)	13
872*	TWELVE†	X	92	-TEEN(suffix)	14
50	TWENTY	X-RAY	*692	TWENTY	20
850*	TWENTY†			FIF-(prefix)	50
02	TWO	Y	93	HUNDRED	*640
802*	TWO†	YANKEE	*693	THOUSAND	*644
80	TY(suffix)	YELLOW	*794	MILLION	*323
		YESTERDAY	*492	-TY(suffix)	60
85		YOU	*493	FIRST	*225
772*	UNDER	YOUR	*987	SECOND	*395
882*	UNIFORM			THIRD	*447
712*	UNIT	Z	90	FOURTH	*234
757*	UNLIMITED	ZED	*988		
487*		ZERO	00	<u>NUMBERS (FEMALE)</u>	
488*	UNIT†	ZONE	*494	OH†	*800
820*	UP	ZULU	*690	ONE†	*801
470*	USE (noun)			TWO†	*802
471*	USE (verb)	<u>SOUND EFFECTS</u>		THREE†	*803
		CROWD	*892	FOUR†	*804
83		EXPLOSION	*891	FIVE†	*805
989*	ALLEY	LASER	*873	SIX†	*806
747*	ALIVE	PHASER	*882	SEVEN†	*807
472*	VARIABLE	TIC	*860	EIGHT†	*808
473*	VERIFY	TOC	*870	NINE†	*809
889*	VICTOR	TRAIN	*883	TEN†	*810
474*	VISIBILITY	WHISTLE	*881	ELEVEN†	*811
720*	WOLFS				



TWELVE†	*812	<u>DIRECTIONS</u>	
THIRTEEN†	*813	EAST	*754
FOURTEEN†	*814	NORTH	*772
FIFTEEN†	*854	SOUTH	*790
SIXTEEN†	*864	WEST	*793
SEVENTEEN†	*874		
EIGHTEEN†	*884	<u>NAMES</u>	
NINETEEN†	*894	CHARLIE	*623
TWENTY†	*820	DEE	31
THIRTY†	*830	HENRY	*642
FORTY†	*840	JAY	51
FIFTY†	*850	JULIET	*651
		KAYE	52
<u>DAYS OF THE WEEK</u>		MIKE	*661
DAYS	*952	OSCAR	*663
SUNDAY	*434	PAPA	*671
MONDAY	*327	ROMEO	*672
TUESDAY	*464	VICTOR	*683
WEDNESDAY	*484		
THURSDAY	*453	<u>RUN-TIME VARIABLES</u>	
FRIDAY	*237	M/A/E	*844
SATURDAY	*393	TIME	*872
		AM/PM	*832
<u>MONTHS OF YEAR</u>		DATE	*833
MONTH	*328	DAY OF WEEK	*871
JANUARY	*282		
FEBRUARY	*218		
MARCH	*313		
APRIL	*131		
MAY	*315		
JUNE	*284		
JULY	*283		
AUGUST	*135		
SEPTEMBER	*398		
OCTOBER	*346		
NOVEMBER	*662		
DECEMBER	*181		
<u>COLORS</u>			
GREEN	*762		
RED	*744		
YELLOW	*794		



*754	EAST	*812	TWELVE†
*772	NORTH	*813	THIRTEEN†
*790	SOUTH	*814	FOURTEEN†
*793	WEST	*824	FIFTEEN†
		*864	SIXTEEN†
		*874	SEVENTEEN†
	<u>NAMES</u>	*884	EIGHTEEN†
*623	CHARLIE	*894	NINETEEN†
31	DEE	*820	TWENTY†
*642	HENRY	*830	THIRTY†
51	JAY	*840	FORTY†
*651	JULIE†	*850	FIFTY†
52	KAYE		
*661	MIKE		<u>DAYS OF THE WEEK</u>
*663	OSCAR	*922	DAYS
*671	PAPA	*434	SUNDAY
*672	ROMEO	*327	MONDAY
*683	VICTOR	*484	TUESDAY
		*484	WEDNESDAY
	<u>RUN-TIME VARIABLES</u>	*453	THURSDAY
*844	WAVE	*237	FRIDAY
*872	TIME	*393	SATURDAY
*832	AMPM		
*833	DATE		<u>MONTHS OF YEAR</u>
*871	DAY OF WEEK	*328	MONTH
		*282	JANUARY
		*218	FEBRUARY
		*313	MARCH
		*131	APRIL
		*312	MAY
		*284	JUNE
		*283	JULY
		*132	AUGUST
		*398	SEPTEMBER
		*348	OCTOBER
		*662	NOVEMBER
		*181	DECEMBER
			<u>COLORS</u>
		*762	GREEN
		*744	RED
		*794	YELLOW



**Timers**

*4000(period)	Repeater Timeout Long	(=30-1799 sec)	TL
*4001(period)	Repeater Timeout Short	(=15-1799 sec)	TS
*4002(period)	Phone Answer Delay	(=10-60 sec)	-PA
*4003(period)	Autopatch Timer	(0, =60-1799 sec)	AP
*4004(period)	User Autodial Timer	(0, =60-1799 sec)	AU
*4005(period)	Emerg. Autodial Timer	(0, =60-1799 sec)	AE
*4006(period)	Patch Activity Timer	(0, =30-1799 sec)	AA
*4007(period)	Patch Timer Extend Timer	(0, =30-1799 sec)	TX
*4008(period)	Tail Message Timer	(=60-1799 sec)	TM
*4009(period)	Touch-Tone Access Timer	(0, =30-1799 sec)	TA
*4010(period)	Hang Timer	(=750-5000 ms)	HT
*4011(period)	Spare Audio Timer	(0, =30-1799 sec)	SP
*4012(period)	ID Timer	(amateur - 360 sec, commercial - 540 or 1140 sec)	ID
*4013(period)	Ringout Timer	(=10 - 120 sec)	RO
*4014(period)	Mode 3 Paging Talkout Timer	(=10 - 60 sec)	TK
*4015(period)	Alarm Timer	(0, =10 - 1799 sec)	AL

V5

**Clock Calendar and Scheduler**

*4100 AP H10 H1 M10 M1	Set Time (12 hr mode)	time
*4100 H10 H1 M10 M1	Set Time (24 hr mode)	time
*4101 M10 M1 D10 D1 Y10 Y1	Set Date	DATE
*4102 DOW	Set Day of Week	DOW
*420S Nth DOW AP H10 H1 M10 M1 M#	Define Setpoint (12 hr mode)	SETPT
*420S Nth DOW H10 H1 M10 M1 M#	Define Setpoint (24 hr mode)	SETPT

**Tone Panel Frequency Selection** (requires Tone Panel Option)

*5100 x	Tone #1 Encode (x=1) or Decode (x=0)	TONE
*510T FF	Tone (T) 1-8 Frequency Selection (FF)	TONE
	[Tone #1/FF - 39=Regenerate when mobile present, 40=Regenerate continuous, 41=lockout mode]	

V5

**Command Code Prefixes**

*5000(prefix)	Control Operator Command	CMD
*5001(prefix)	User Function Logic Output	CMD
*5002(prefix)	Emergency Autodial	CMD
*5003(prefix)	User Loadable Autodial	CMD
*5004(prefix)	Autopatch	CMD
*5005(prefix)	Link / Remote Base	CMD
*5006(prefix)	User Autodial Load / Erase	CMD
*5007(prefix)	Demo / Bulletin Board	CMD
*5008(command)	Reverse Patch (from phone only)	CMD
*5009(command)	Spare Audio	CMD
*5010(prefix)	Patch Utilities	CMD
*5011(command)	Patch Hangup	CMD
*5012(prefix)	Two-Tone Paging	CMD



	*5013(prefix)	Touch-Tone Access Mode Up/Down	CMD
	*5014(command)	S-Meter Readback	CMD
	*5015(prefix)	Extended User Autodial (Bank 1)	CMD
	*5016(prefix)	Extended User Autodial Load/Erase	CMD
	*5017(command)	Telephone Timer Extend Command	CMD
	*5018(prefix)	Memory Paging	CMD
	*5019(prefix)	Touch-Tone Pad Test	CMD
V5	*5020(prefix)	HF Remote Base	CMD

**Emergency Autodial Numbers**

\*520x(telephone number) x = location 0 - 9 Phone number

**V5 EC-900 Band Unit Configuration**

\*530B P Band Unit Present / Absent FCBU  
 B: band unit (1=10M,2=6M,3=2M,4=220,5=440,6=1200)  
 P: present / absent (1=present, 0=absent)

**Misc. Selections**

*5400	Touch-Tone patch signalling	TT	
*5401	Dial Pulse signalling	DP	
*5402	Enable control over repeater receiver	EC	
*5403	Disable control over repeater receiver	DC	
*5404	Phone line not shared	PLU	
*5405	Phone line shared	PLS	
*5406	UF Low True	FL	
*5407	UF High True	FH	
*5408	UF Strobe High True ('85 only)	STH	
*5409	UF Strobe Low True ('85 only)	STL	
V5	*5410	Link COS Low True	LL
V5	*5411	Link COS High True	LH

**Store Macro Sets 1-5**

\*5911-\*5915 Store Macro Set #1 - #5 MACRO

**Pager Memories ('96 only)**

\*29 xxx f aaaa(aa) PAGE  
 xxx = three digit memory number (000-999)  
 f = pager format  
 0 = 1 second/3 second 2-tone 4 = DTMF  
 1 = 2.7 second/.8 second 2-tone 5 = five tone sequential  
 2 = .4 second/.8 second 2-tone 6 = six tone sequential  
 3 = 8 second group call  
 aaaa(aa) = pager address  
 two-tone - A group, A tone, B group, B tone  
 two-tone group call - A group, A tone, A group, A tone  
 DTMF - 4 or 6 digits (0-9, \*, A, B, C), fill unused digits  
 with D keys  
 5/6 tone - wakeup tone, tones 1-5 (six digits) [for no  
 wakeup tone, insert \* as first digit]



## Vocabulary

(PAUSE)	34	BELOW	*143
A	21	BETWEEN	*660
A.M.	*110	BLOWING	*144
ABORT	*992	BOARD	*145
ABOUT	*855	BOOST	*146
ABOVE	*112	BOZO	*147
ACKNOWLEDGE	*114	BRAKE	*148
ACTION	*115	BRAVO	*622
ADJUST	*944	BREAK	*743
ADVANCED	*916	BROKEN	*151
ADVISE	*116	BUTTON	*993
AERIAL	*117	BY	*152
AFFIRMATIVE	*118	C	23
AFTERNOON†	*842	CABIN	*153
AIR	*120	CALIBRATE	*735
AIRPORT	*122	CALL	*751
ALERT	40	CALLING	*155
ALL	*685	CALM	*156
ALOFT	*124	CANCEL	*664
ALPHA	*621	CAUTION	*711
ALTERNATE	*125	CEILING	*158
ALTITUDE	*127	CENTER	*161
AMATEUR	*917	CHANGE	*875
AMPS	*831	CHARLIE	*623
AND	74	CHECK	*865
ANSWER	*128	CIRCUIT	*720
APRIL	*131	CLEAR	*163
AREA	*713	CLIMB	*165
ARRIVAL	*132	CLOCK	*945
AS	*133	CLOSED	*166
AT	*742	CLUB	*926
AUGUST	*135	CODE	75
AUTO	*918	COME	*167
AUTOMATIC	*741	COMPLETE	*721
AUTOPILOT	*136	COMPUTER	*927
AUXILIARY	*137	CONDITION	*168
B	22	CONGRATULATIONS	*170
BAND	*138	CONNECT	*940
BANK	*140	CONTACT	*171
BASE	*141	CONTROL	*624
BATTERY	*142	CONVERGING	*172



COUNT	*173	EQUAL	*893
COURSE	*174	-ER(suffix)	*210
CRANE	*950	ERROR	*211
CROSSWIND	*175	ESTIMATED	*212
CURRENT	*177	EVACUATE	*213
CYCLE	*951	EVACUATION	*214
		EVENING†	*843
D	31	EXIT	*761
DANGER	*712	EXPECT	*215
DAYS	*952		
DAYTON	*928	F	33
DECEMBER	*181	FAIL	*755
DECREASE	*182	FAILURE	*216
DECREASING	*183	FARAD	*930
DEGREES	*722	FARENHEIT	*217
DELTA	*631	FAST	*925
DEPARTURE	*185	FEBRUARY	*218
DEVICE	*953	FEET	15
DIAL	*936	FIF-(prefix)	50
DINNER	*186	FIFTEEN†	*854
DIRECTION	*752	FIFTY†	*850
DISPLAY	*954	FILED	*223
DOOR	*955	FINAL	*224
DOWN	*654	FIRE	*634
DOWNWIND	*188	FIRST	*225
DRIVE	*190	FIVE	05
DRIZZLE	*191	FIVE†	*805
DUST	*192	FLAPS	*227
		FLIGHT	*228
E	32	FLOW	*960
EAST	*754	FOG	*230
ECHO	*632	FOR	*231
-ED(suffix)	*193	FORTY†	*840
EIGHT	08	FOUR	04
EIGHT†	*808	FOUR†	*804
EIGHTEEN†	*884	FOURTEEN†	*814
ELECTRICIAN	*943	FOURTH	*234
ELEVATION	*196	FOXTROT	*633
ELEVEN	11	FREEDOM	*235
ELEVEN†	*811	FREEZING	*236
EMERGENCY	*937	FREQUENCY	*610
ENGINE	*198	FRIDAY	*237
ENTER	*995	FROM	64







LINK	*998	N	62
LIST	*296	NEAR	*333
LOCK	*297	NEGATIVE	*334
LONG	*298	NET	25
LOOK	*957	NEW	*335
LOW	*771	NEXT	*336
LOWER	*310	NIGHT	*337
LUNCH	*311	NINE	09
		NINE†	*809
M	61	NINETEEN†	*894
MACHINE	84	NO	*342
MAINTAIN	*312	NORTH	*772
MANUAL	*965	NOT	*695
MARCH	*313	NOVEMBER	*662
MARKER	*314	NUMBER	*734
MAY	*315		
MAYDAY	*316	O	63
ME	*920	OBSCURED	*344
MEAN	*317	OCLOCK	*345
MEASURE	*970	OCLOCK†	*824
MEETING	35	OCTOBER	*346
MEGA	*680	OF	*694
MESSAGES	*625	OFF	*614
METER	*620	OH†	*800
MICRO	*931	OHIO	*348
MIKE	*661	OHMS	*933
MILES	*322	OIL	*350
MILL	*971	ON	*613
MILLI	*825	ONE	01
MILLION	*323	ONE†	*801
MINUS	*612	OPEN	94
MINUTES	*645	OPERATION	*352
MIST	*324	OPERATOR	*630
MOBILE	*958	OSCAR	*663
MODERATE	*326	OTHER	*353
MONDAY	*327	OUT	*740
MONTH	*328	OUTER	*355
MORE THAN	*330	OVER	*773
MORNING†	*841	OVERCAST	*356
MOTOR	*972		
MOVE	*973	P	71
MUCH	*332	P.M.	*358
		PAPA	*671



	PARTIALLY	*361	RICH	*383
	PASS	*774	RIG	*384
	PASSED	*974	RIGHT	*665
	PATCH	*966	ROAD	*385
	PATH	*362	ROGER	*386
	PER	*364	ROMEO	*672
	PERCENT	*675	ROUTE	*388
	PHONE	*914	RUNWAY	*390
	PICO	*932		
	PLEASE	*967	S	73
	PLUS	*611	-S(suffix)	*915
	POINT	*674	SAFE	*784
	POLICE	*968	SAND	*391
	POSITION	*780	SANTA CLARA	*392
	POWER	*714	SATURDAY	*393
	PRACTICE	85	SCATTERED	*394
	PRESS	*781	SECOND	*395
	PRESSURE	*935	SECONDS	*635
	PRIVATE	*366	SECURITY	*396
	PROBE	*975	SELECT	*397
	PROGRAMMING	*367	SEPTEMBER	*398
	PULL	*980	SEQUENCE	*410
	PUSH	*977	SERVICE	*723
			SET	*885
	Q	70	SEVEN	07
	QUEBEC	*670	SEVEN†	*807
			SEVENTEEN†	*874
	R	72	SEVERE	*413
	RADIO	*976	SEXY	*414
	RAIN	*374	SHORT	*415
	RAISE	*375	SHOWERS	*416
	RANGE	*981	SHUT	*765
	RATE	*376	SIDE	*417
	READY	*783	SIERRA	*673
	REAR	*377	SIGHT	*418
	RECEIVE	*378	SIX	06
	RED	*744	SIX†	*806
	RELEASE	*381	SIXTEEN†	*864
	REMARK	*382	SLEET	*423
	REMOTE	*910	SLOPE	*424
	REPAIR	*745	SLOW	*983
	REPEAT	*982	SMOKE	*795
	REPEATER	80	SNOW	*425



SOUTH	*790	TIME	44
SPEED	*984	TIME†	*822
SPRAY	*427	TIMER	*732
SQUAWK	*428	TO	*455
STALL	*431	TODAY	*456
START	*730	TOMORROW	55
STOP	*731	TONIGHT	45
STORM	*433	TOOL	*985
SUNDAY	*434	TORNADO	*457
SWITCH	*725	TOUCHDOWN	*458
SYSTEM	*997	TOWER	*460
T	81	TRAFFIC	*461
TANGO	*681	TRANSMIT	*462
TANK	*435	TRIM	*463
TARGET	*436	TUESDAY	*464
TAXI	*437	TURBULANCE	*465
-TEEN(suffix)	14	TURN	*990
TELEPHONE	*438	TWELVE	12
TEMPERATURE	*724	TWELVE†	*812
TEN	10	TWENTY	20
TEN†	*810	TWENTY†	*820
TERMINAL	*440	TWO	02
TEST	*792	TWO†	*802
-TH(suffix)	*441	-TY(suffix)	60
THANK YOU	*978	U	82
THAT	*442	UNDER	*775
THE	24	UNIFORM	*682
THE(long e)	*443	UNIT	*715
THE(short e)	*444	UNLIMITED	*467
THE†	*821	UNTIL	*468
THIR-(prefix)	13 or 30	UP	*650
THIRD	*447	USE(noun)	*470
THIRTEEN	*448	USE(verb)	*471
THIRTEEN†	*813	V	83
THIRTY†	*830	VALLEY	*986
THIS	*451	VALVE	*941
THIS IS	65	VARIABLE	*473
THOUSAND	*644	VERIFY	*475
THREE	03	VICTOR	*683
THREE†	*803	VISIBILITY	*476
THUNDERSTORMS	*452	VOLTS	*750
THURSDAY	*453		