

Digital Design

Computers • Peripherals • Systems

Thin Film Heads Invade 5.25" Micro-Winchesters

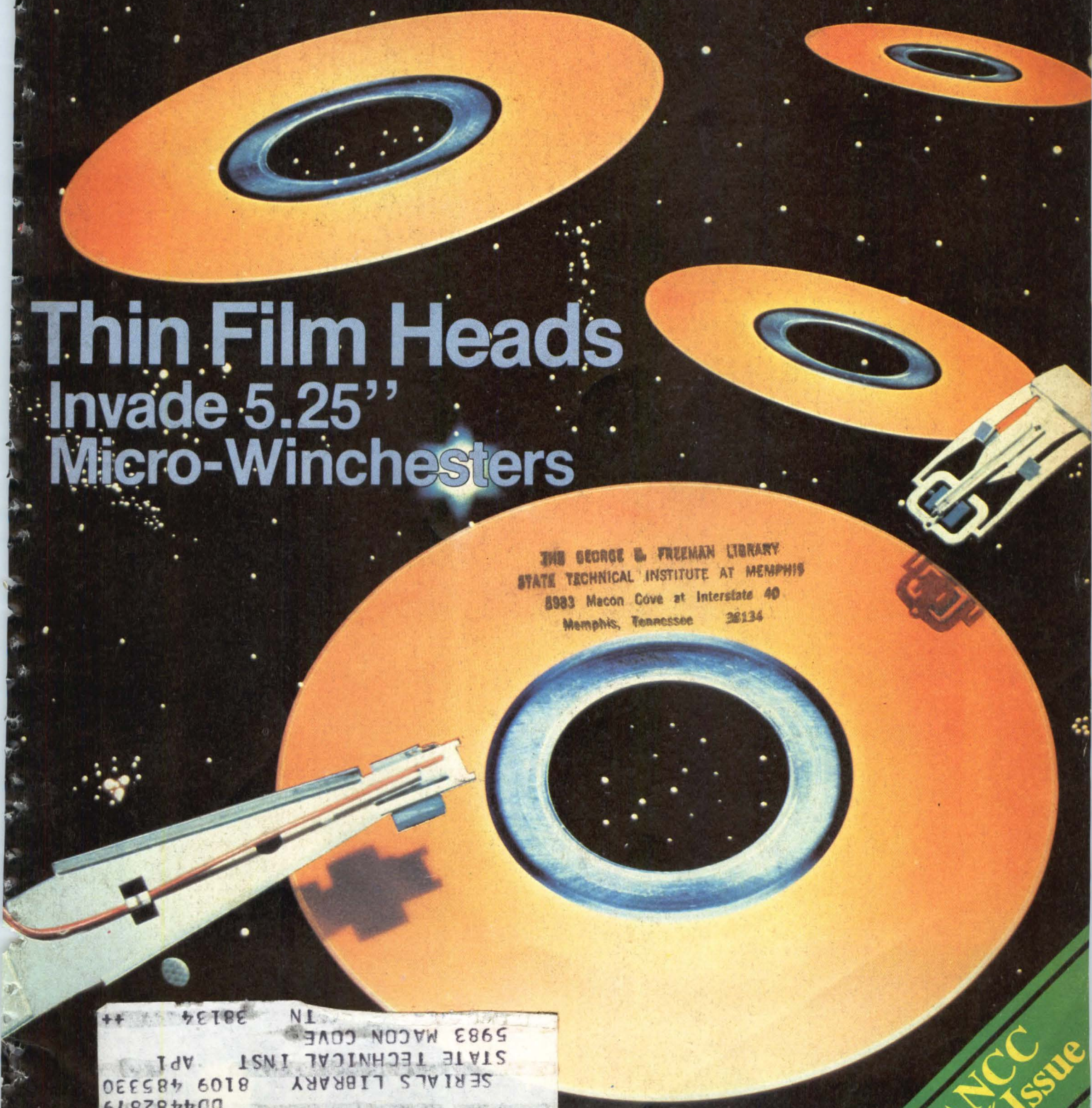

DD4482879
SERIALS LIBRARY 8109 485330
STATE TECHNICAL INST APT
5983 MACON COVE
TN 38134 **

NCC
Issue

AND NOW SAMUX III!

Distributed I/O Control for the
80's from Opto 22
64 I/O Stations Per Host
Computer
192 I/O Points Per Station
Simple Twisted Pair Communica-
tion To The Host and Station-to-
Station
Digital and Analog I/O Modules
Efficient Protocol
Versatile Command Set
Watchdog Timer
Latched Inputs and Time Delays
Extensive Communication
Attachments
Isn't it what you expected from
Opto 22?

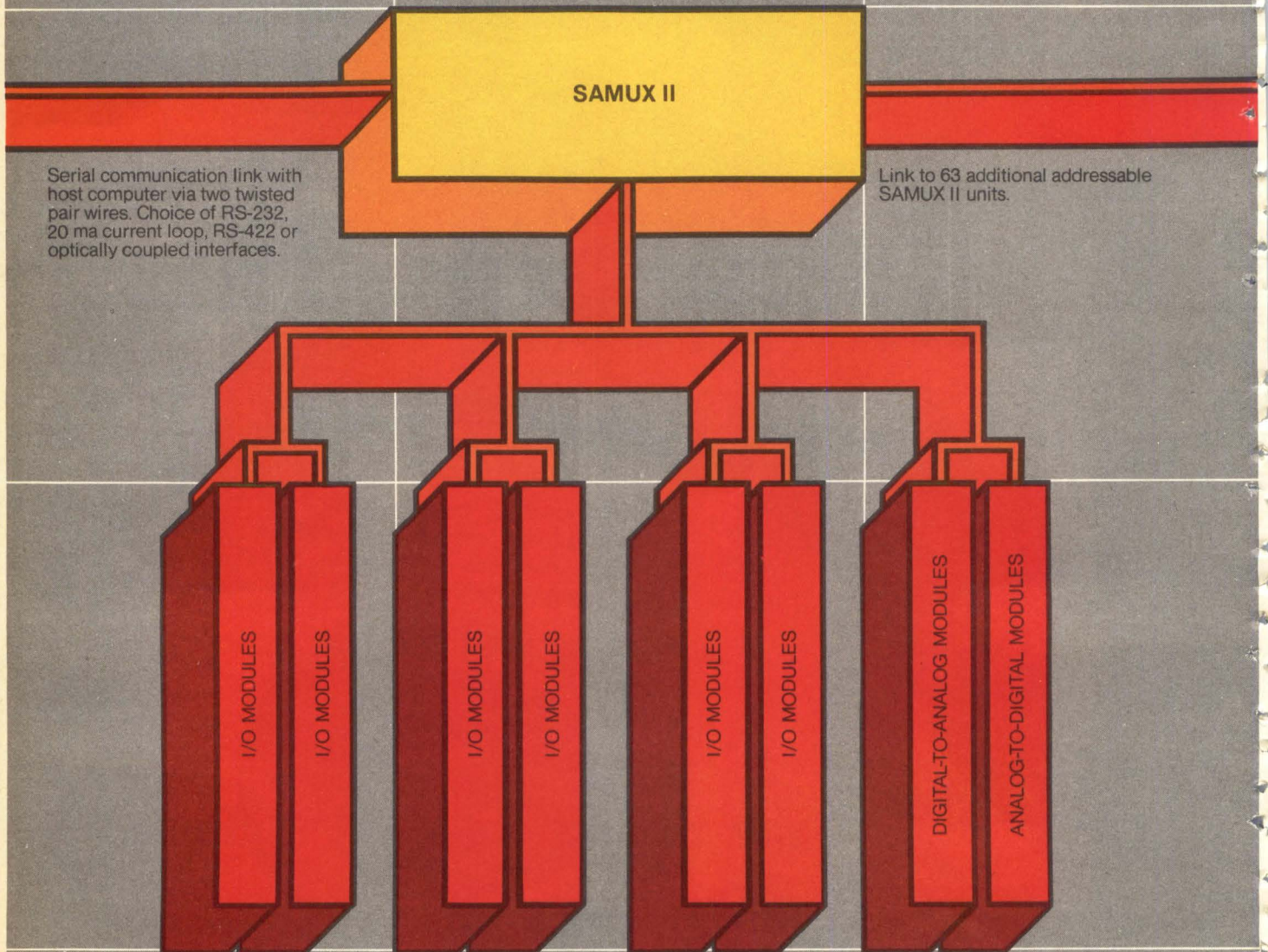

15461 Springdale St.
Huntington Beach,
CA 92649
(714) 891-5861
(800) 854-8851
Telex: 692386

Modules per station range from
96 digital power I/O plus 48
analog to digital plus 8 digital
to analog or up to 192 digital
power I/O.

opto 22

Distributed by Hamilton/Avnet

What Makes Archive Streamers The Intelligent Backup Choice?

For one thing, they're the only intelligent 1/4" streaming tape drives available today.

But there are plenty of other smart reasons for choosing Archive Sidewinder streamers over other types of Winchester backup.

Such as greater capacity and faster transfer rates. You can store up to 20 megabytes of formatted data on one standard cartridge in just over 4 minutes.

That's about 5 times as fast (and one third the media cost) as using 8" floppy disks, for example.

And speaking of floppy disks, the Sidewinder just happens to be the same package size as an 8" floppy.

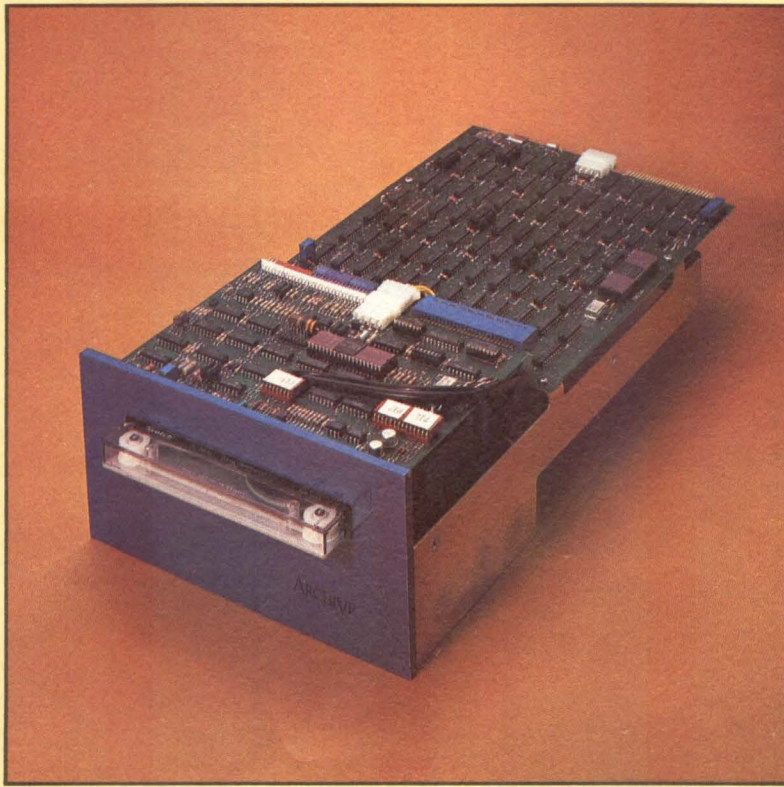

THE GEORGE E. FREEMAN LIBRARY.
STATE TECHNICAL INSTITUTE AT MEMPH
5983 Macon Cove at Interstate 40
Memphis, Tennessee 38134

The intelligent Sidewinder handles tape formatting, error and file mark processing, tape positioning, automatic read-after-write error correction, block buffering and read

retries without host intervention.

Call today for full information on our easily integrated intelligent Sidewinders.

Archive Corporation, 3540
Cadillac Avenue, Costa
Mesa, California 92626.
(714) 641-0279,
Telex: 683466.

Visit our suite at
The Continental Plaza
during NCC.

Ask The Leader.

ARCHIVE

Circle 3 on Reader Inquiry Card



GET A CLEAR HONEST IMAGE THE HITACHI WAY!

Computer data and graphic displays never looked better, brighter, sharper.

New Hitachi high resolution in-line RGB color monitors utilize wide video bandwidth and a 0.31 mm spacing between triad pairs. The result? A trio-dot density **twice that of conventional monitors!**

Look at these advanced features

Adjustment-free convergence, single PCB configuration, video amplifier bandwidth from 50 Hz to 25 MHz. Flexible frequencies range from 15 to 18 KHz horizontal and 50 to 60 Hz vertical. Monitors

provide high contrast and brightness from black matrix and 85% light transmission tubes. Can any other maker match these advantages?

Variety of Screens

You can select from a wide

choice of screens to meet your specific application needs: Normal phosphor; long persistence phosphor to virtually eliminate flickering, or medium resolution versions for most ambient light situations.

Unsurpassed performance

Long time convergence stability is assured due to self convergent in-line guns and **single PCB reliability**. Operator controls include power on/off, degauss, brightness, contrast.

Call or write for more information.

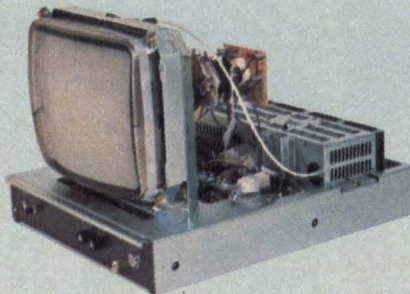

Hitachi America, Ltd. 100 California Street, San Francisco, Calif. 94111 Tel: (415) 981-7871

Crown Electronics, Tualatin, OR (503) 638-7561; **Quadrep, Inc.**, San Jose, CA (408) 946-4000; **Bestronics, Inc.**, Culver City, CA (213) 870-9191, Irvine, CA (714) 979-9910, San Diego, CA (714) 452-5500; **Comstrand, Inc.**, Minneapolis, MN (612) 788-9234; **Sumer, Inc.**, Rolling Meadows, IL (312) 991-8500, Brookfield, WI (414) 784-6641; **Bear Marketing**, Richfield, OH (216) 659-3131; **Robert Electronic Sales**, Catonsville, MD (301) 788-2380, Lansdale, PA (215) 855-3962, Richmond, VA (804) 276-3979; **Technology Sales, Inc.**, Lexington, MA (617) 862-1306.

SEE US AT NCC BOOTH 5412

Circle 61 on Reader Inquiry Card

Digital Design

Computers • Peripherals • Systems

Copyright © 1981 Benwill Publishing Corporation, a Morgan-Grampian company

Publication Number: USPS 407-010

Features

22 Magnetic Bubble Memory Systems Software Interfacing to μ Ps

Commonality must not be overlooked.

25 Single-Chip Video Timer/Controller Eases Video Terminal Design

Video display systems are easily constructed using TM 990 family 16-bit μ Cs.

28 Expanding Markets For Winchester Disks

Winchester disks are now being produced in increasing quantity.

32 Thin-Film Head Increases Micro-Winchester Capacity

Thin film head technology is taking off in 5.25" rigid disk drives.

38 Consider Applications When Specifying Winchester Disk Drives

Examine reliability, interfacing and capacity.

50 1/4" Streaming Tape Cartridge Backs Up Winchester Drives

The more software overhead in controller firmware, the better.

53 Half-Inch Streaming Drives

Multiple speeds permit half-inch streaming drive use as a start/stop device in addition to backup.

59 Use μ P-Controlled Stepper Motors To Improve Peripherals

Stepper- μ Ps are disk head positioning, tape drives, X-Y plotters, optical disks and chart recorders.

64 NCC/81 Paints Industry Portrait

NCC/81 comes to Chicago this year to provide attendees a fresh portrait of the computer industry's present, and a look into the industry's future.

67 1979-1980 Index of Articles

Departments

6 Letters

8 Speakout:

Computer-Compatible Directory

10 Technology Trends

- RM80 Disk Modularity Improves Reliability and Servicability
- 400% Growth For Peripherals
- Will Teleprinters Break \$1,500?
- ADA Seminars
- German Computers In World War II

16 Remote Terminals

72 Innovative Design

- Architecture Shuffling Distinguishes Image Processor
- Bubble Memories On Cassette
- Blade Technology Makes Quiet Impact

74 New Products

76 Product Index

94 Designers' Notebook

- Up/Down Display Counter Counts Over Pos/Neg Range
- ROM Breakpoint Debugging Via Logic Analyzer

96 Advertisers' Index

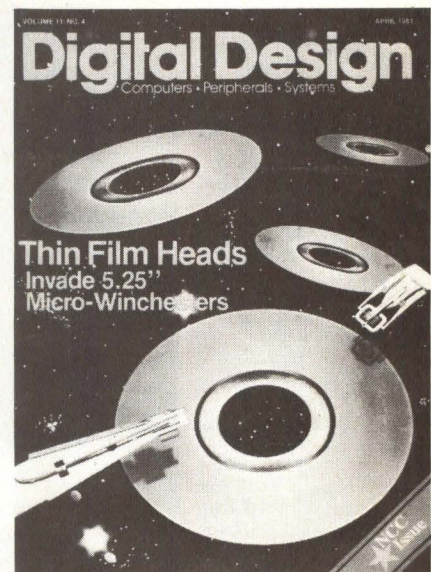

Thin film technology and 5.25" hard disk drives provide higher capacity drives.

Photo courtesy of Seagate Technology
Cover designed by Josh Randall

Clifton brushless dc motors work hard for more precise control in Winchester drives.

**Special
15-slot
configuration**
for low
cogging

**8 Ceramic
magnets**
for
dependable service

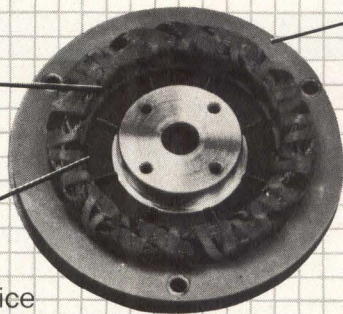

Compact size
Easier
packaging;
better air
flow

Low cost
Inexpensive
to buy
and use

Plus, you get:

- Better speed control
- Fewer moving parts for better reliability
- No arcing—no brush dust
- Optional control electronics package
- Performance customized to meet your needs

To review your requirements, call Carey Walter today at (215) 622-1000.



CLIFTON PRECISION®

Marple at Broadway
Clifton Heights, PA 19018

... We make it happen with motors

CP1055A

Circle 4 on Reader Inquiry Card

Our new, slower, cheaper array processor.

Our new MSP-3X is only about half as fast as our MSP-3. But at \$4950 its price is also less than half that of any other array processor on the market.

"Slower," of course, is relative: MSP-3X lets your PDP-11 computer perform arithmetic and signal analyses 20 to 50 times faster than it can alone. A 1024-point real Fast Fourier Transform in 14.3 milliseconds, for example.

That's plenty of speed for most analyses of vibration, sonar, communications, radar, medical image, and dozens of other kinds of data.

And you needn't sacrifice convenience, either. Operation is simple and reliable, based on straightforward execution of an extensive library of functions, accessed through Fortran calls. And MSP-3X's two hex boards simply plug into your PDP-11.

All in all, MSP-3X is a most intelligent trade-off. Write us for detailed specifications.

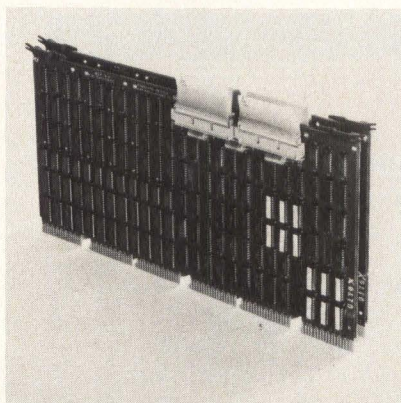

MSP-3X array processor

**Computer Design
& Applications, Inc.**

377 Elliot Street
Newton, MA 02164 (617) 964-4320

Circle 5 on Reader Inquiry Card

Digital Design
Computers • Peripherals • Systems

Group Publisher: Main Office
Harold G. Buchbinder (617) 232-5470

Editorial Director: Western Office
George King (714) 789-6688

Editor: Main Office
Paul Snigier (617) 232-5470

Managing Editor Harry Shershow
Book Review Editor William Belt
Assistant Editor Bob Hirshon
Editorial Assistant Martha Hawkins
Art Director Richard D. Sarno
Staff Artists Jacky Brill, Stephen Fisher
Laurie R. Guptill, Josh Randall
Donni Richman
Production Jon Buchbinder
Florence L. Daniels, Erik W. Slickman
Research Director Jackson Parker
Marketing Services Manager C. King
Circulation Hiro Irie
Sarah Binder, Regina Harrington
Composition M. Yva Doricent
Robert Hildebrand, Claudia Majetch
Harvey Sweat
General Administration Joan Carey
Lisa Finichel, Mal Rankin
Heather Ryan, Esther Shershow

SUBSCRIPTION POLICY

DIGITAL DESIGN is circulated only to qualified research, development and design engineers in all branches of industry, government institutions and universities. To obtain a complimentary subscription, request (on company letterhead) a qualification card from Circulation Director. For change of address, attach old address label from recent issue to new company letterhead or note. Send this plus request for new qualification card to:

Circulation Department
DIGITAL DESIGN
1050 Commonwealth Ave.
Boston, MA 02215

Subscription rates: non-qualified subscribers (US and Canada) — \$35/yr.; non-qualified foreign — surface mail — \$45; air mail — \$70.

DIGITAL DESIGN solicits editorial material and articles from engineers and scientists. Contributors should submit duplicate manuscripts typed with two spaces between lines. All illustrations should be clear; components on all schematics and line drawings should be labeled. The editors assume no responsibility for the safety or return of any unsolicited manuscripts.



Published monthly by Benwill Publishing Corporation, a Morgan-Grampian Company, Harold G. Buchbinder, Chief Executive Officer; George Palken, President; Domenic A. Mucchetti, Treasurer; Executive, Editorial and Subscription Offices, 1050 Commonwealth Ave., Boston, MA 02215. Telephone: (617) 232-5470.

Morgan-Grampian also publishes American City & County • Circuits Manufacturing • Contractor • Design Engineering • Electronics Test • Government Buyer • Industrial Distribution • Industrial Product Bulletin • Mart • Municipal Index

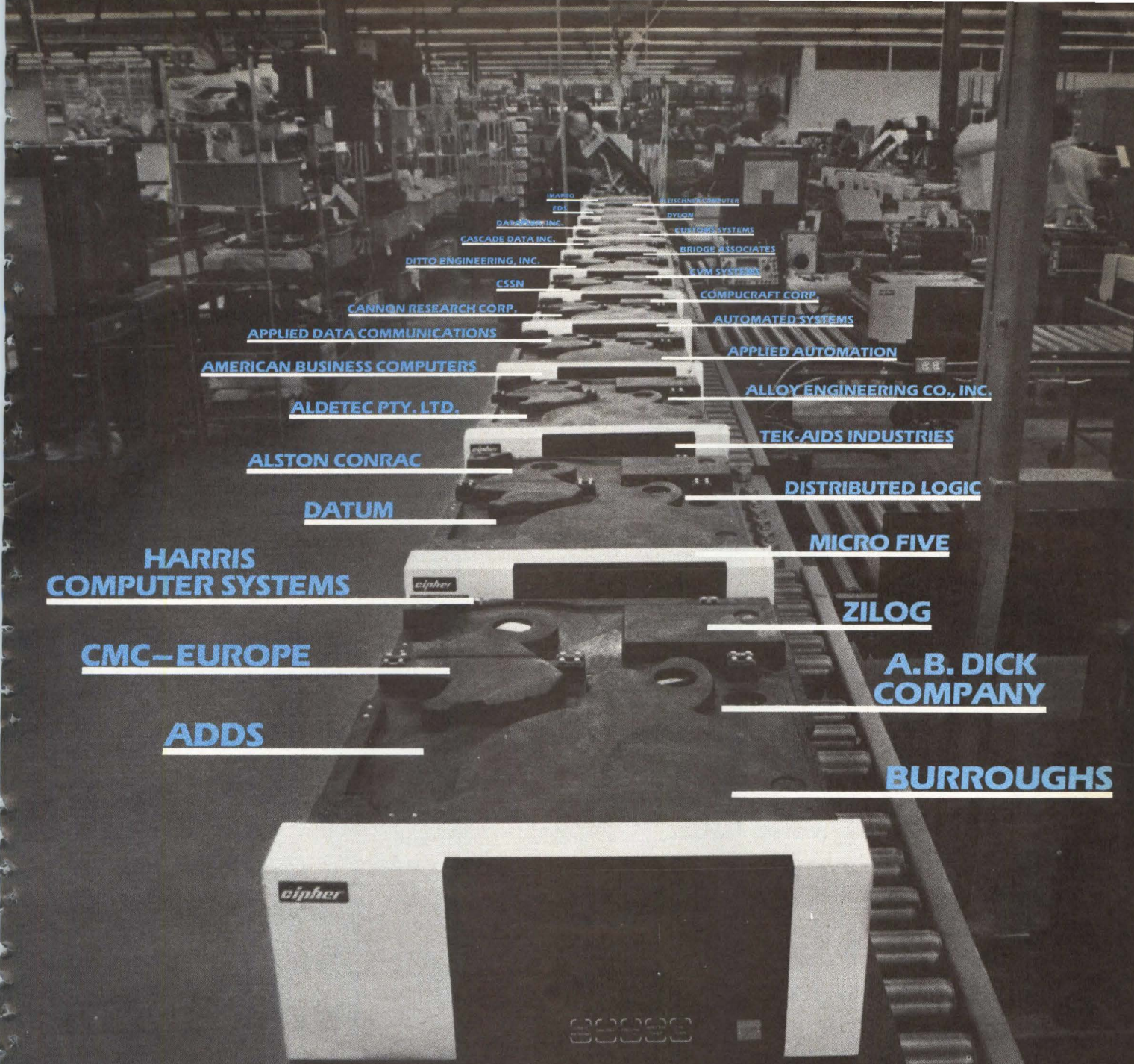

IMAPRO
EDS

HEISENBERG COMPUTER
DYSON

DATACORP INC.

ELECTRONIC SYSTEMS

CASCADE DATA INC.

BRIDGE ASSOCIATES

DITTO ENGINEERING, INC.

EVM SYSTEMS

CSSN

COMPUCRAFT CORP.

CANNON RESEARCH CORP.

AUTOMATED SYSTEMS

APPLIED DATA COMMUNICATIONS

APPLIED AUTOMATION

AMERICAN BUSINESS COMPUTERS

ALLOY ENGINEERING CO., INC.

ALDETEC PTY. LTD.

TEK-AIDS INDUSTRIES

ALSTON CONRAC

DISTRIBUTED LOGIC

DATUM

MICRO FIVE

HARRIS
COMPUTER SYSTEMS

ZILOG

CMC-EUROPE

A.B. DICK
COMPANY

ADDS

BURROUGHS

Way out front in backup!

“We can dump a 33 megabyte disk in 3.5 minutes and what’s more we have instituted a verify in reverse read...” states John Jacobs—Director of Advanced Systems Development for Applied Digital Data (ADDS). Nearly 200 other companies feel they also have found the solution and have taken deliveries of our Microstreamer™. If your company isn’t among these good names—check the list. Your competition may be. Want to know why we have 1,000 units out in the field already, while others are still looking for the solution?

Call the Leader today (714) 578-9100. Or write for our free product brochure—10225 Willow Creek Road, San Diego, CA 92131.



See us at NCC Booth 311
Circle 6 on Reader Inquiry Card

Letters

IBM not first

Dear Editor:

I enjoyed your article "Minicomputers" in the December, 1980, issue. I agree with several of your observations, including the idea that the definition of what is a mini is changing. Let's discard these terms and talk about "functional size", as in large data-base computers, small business computers, personal computers, dedicated controllers, etc. You state that virtual memory was "first used on the IBM 370 in 1974". Burroughs was delivering a multiprogramming, multiprocessing, virtual memory system (B-5500) in 1964. The Burroughs approach was superior, since it used variable-sized segments which follow the structure of the program, rather than fixed-size pages. This makes program performance in a multiprogrammed virtual memory environment far more dependent on good programming practice — not on random chance.

Joseph W. Werner
Systems Consultant
1732 Cambria Drive A-1
East Lansing MI

likes DEC compatible issue

Dear Editor:

Your DEC Compatible issue is great! To make it even greater, a keyword index would add 500% to the utility. Thanks.

Richard E. Reeves
Vice President
General Digital Industries, Inc.
Huntsville, AL

a needed reference

Dear Editor:

I found your DEC-compatible directory immensely useful. Within the week I received it, I referred to it three times to satisfy the needs of my job and customers. I have long felt the need for such a directory, and have often considered developing one from the vast quantities of material available in the advertising in magazines like yours.

Only the problem of getting the data into the machine has held me back.

Mark Pearson
New York, NY

do aliens lower EE salaries?

Dear Editor:

Recent comments in your "Speakout" in favor of aliens and "pruning" should not go without challenge. Irwin Feerst raised the flag on the many aliens here at school and work. Alien engineers are happy to take whatever employment they can obtain, and thereby affect salaries paid to "working" engineers. This hurts the engineering profession. Obsolescence is due to short-range goals of management, who exploit technologists before throwing them away onto the scrap heap. "Working" engineers need some organized group to help them protect their interests since the IEEE does not represent our best interests, as noted by Irwin Feerst. IEEE is controlled by professors and upper management who find it difficult to work for the benefit of "working" engineers.

John Norman
RT 1 Bos 222
Montrose, MN

what's coming?

Dear Editor:

In the December editorial, "Computers Kill Jobs," your solution is worksharing with reduced workweeks. Obviously this solution is not permanent. With continuing trends, the majority of workers seem destined to be displaced by computers. Who will be left to buy the products produced in automated factories if no one has money? Should everyone share industry ownership or have subsidies paid by the wealthy to the unemployed majority? Also, since most workers will no longer be spending their time working, what will they do instead? Significant shifts in perfunctory and social activities are in the offing.

Fred Nidal
San Diego, CA

DEC-compatibility

Dear Editor:

I just finished the configuration of an LSI-11/23-based design and development system. This task was complicated by the need to attach several devices via UNIBUS interface. I found your January issue *The World of DEC Compatibility* of enormous help. Thank you very much for providing this service to your readers.

Jeffrey W. Smith, PE
Raleigh, NC

Writing a new product release?

If you have a new product and want to improve its chances of being accepted for our New Products section, follow these simple rules.

First — and most important of all — tell us your product's "claim to fame." Why is it better? Place this in the head and mention it at the start of your release; don't bury it in the verbiage. A new product editor screens incoming releases with care; what his magazine prints represents the cream of the crop and only one product in ten is selected.

Should you include prices? Yes! Do your product a favor: specify both prices and availability; none of our readers likes priceless ads, and our experience indicates that priceless ads draw 20-30 less response.

Avoid "retreads." By issuing a second "new" product release several months after the first, some firms hope that the product editor has forgotten and will run it again.

High resolution, dot addressable graphics with vertical resolution of 72 dots per inch and up to 82 dots per inch horizontal resolution.

"Q.T." cover reduces noise to an office comfort level. This is an optional feature to our standard sound deadening case.

Single sheet feeder is very simple to use. The only front load feeder available on the market today.*

1K standard buffer permits the 88G to print while receiving data. The optional 2K buffer allows a 1920 character dump to the printer freeing the CRT.

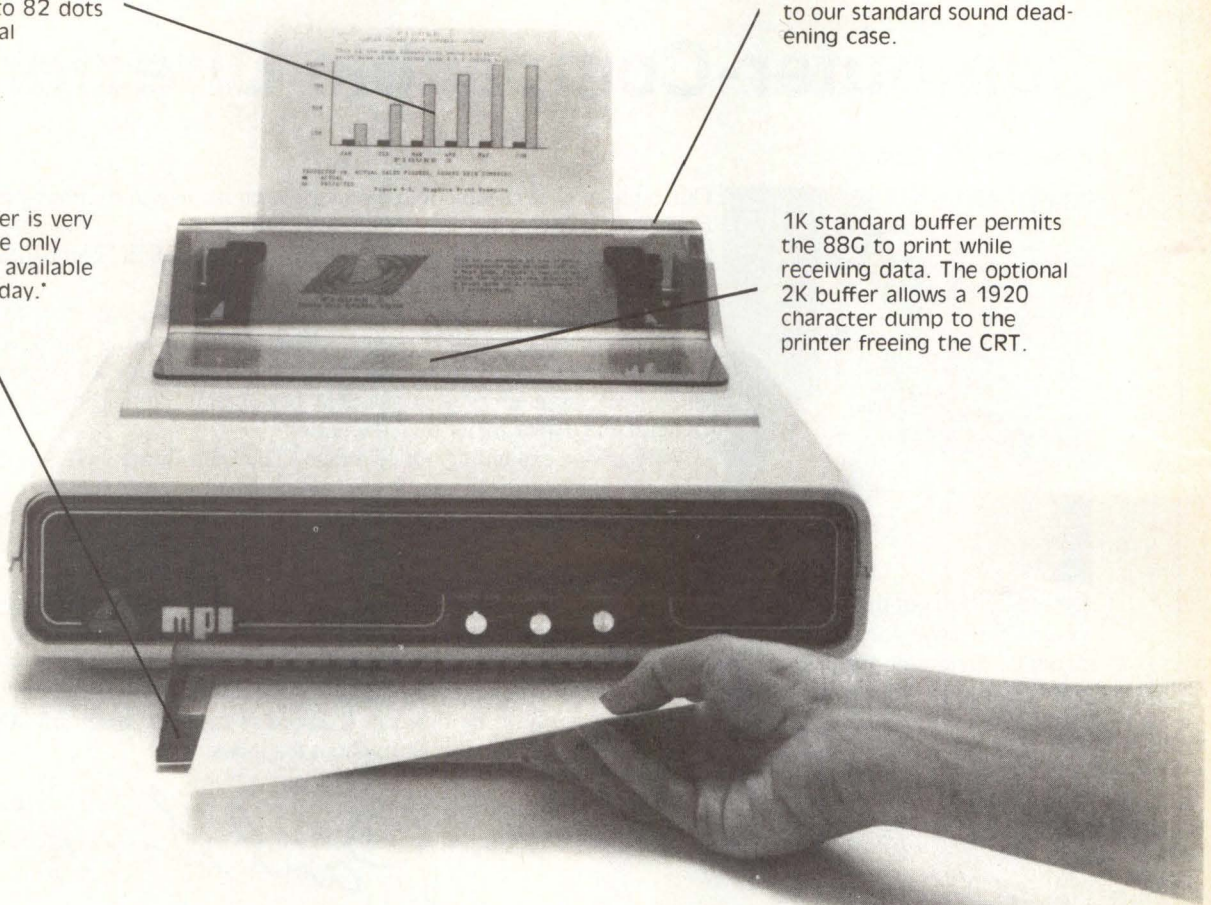

The Features Leader

Integrated Paper Handling System

Dual tractor/friction feed allows use of pin feed, roll or single sheet paper.

Versatile Interface

Data input from most computers can be supported by the 88G. RS232C serial and Centronics® type parallel is standard. Options can be added for current loop, IEEE 488 and high speed serial inputs.

Letter Quality Capability

The 88G provides a selectable 11 x 7 serif style dot matrix for correspondence printing.

Cost Effective

The 88G has more features than any other impact printer in its price class. First compare the quality of the 88G, then compare the price—the 88G wins! Single unit price is less than \$800.

*Optional



Micro Peripherals, Inc. 4426 South Century Drive Salt Lake City, Utah 84107 (801) 263-3081
The Printer People

California VITEK (714) 744-8305 Colorado PLS Associates (303) 773-1218 Florida GMI Distributors (305) 894-3354 Illinois Coombs & Associates (312) 298-4830 Massachusetts Eastmark (617) 449-0050 Minnesota Bohlig & Associates (612) 922-7011 New Jersey Hansen & Hughes (201) 652-7055 Oregon Microwave (503) 620-8150 Utah PLS Associates (801) 466-8729 Type-A-Line (801) 521-5310 International England Russet Instruments, Ltd. (0734) 868147 Telex: 849721 Phoenix Sigma International (602) 994-3435 Telex: 165-745 Sigma France IER Tel. 333.67.81 Telex: 620-289 Canada Norango (416) 449-2761

Circle 7 on Reader Inquiry Card

Speakout

Computer-Compatible Directory

Paul Snigier, Editor

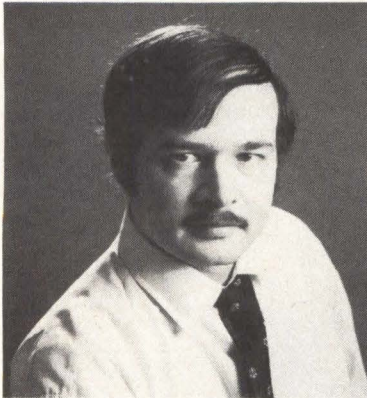

Our January DEC-compatible directory is on its way to becoming a classic issue. An industry first, it will be referred to for the next 12 months or more by OEM system integrators and builders looking for DEC-compatible products. We will extend our coverage to other PCMs.

This August we are publishing a computer-compatible directory to include those computer-compatible products that missed entering the directory or that came out since then. We are expanding it to include **all** minicomputer and microcomputer plug-compatible peripherals and products for Data General and **other** major manufacturers.

Why are we expanding our coverage? The Data General plug-compatible market, which just ten months ago languished, is showing a resurgence which promises to turn into an upsurge. So, if your firm is manufacturing — or about to introduce — such plug-compatible products, let us and our readers know, so that we may include your products in this August's

Directory. Fill out this questionnaire. Use photocopied forms for each product. Don't take the easy way out and write: "See spec sheet." (We cannot reprint spec sheets.) Include in your mail-back, press releases, photos, manuals, literature, articles, etc. Also, let us know whom to contact for more information.

Remember, if your firm manufactures computer-compatible products in the industrial, scientific, engineering (nonbusiness) areas, this is an excellent opportunity to be listed in a directory that will reach 65,000 direct (173,000 total) readers — leading computer system integrators throughout the industry. **D**

Paul Snigier

If your firm manufactures, buys, sells, trades, writes software for DEC-, Data General- and other mini- & micro-compatible memories, peripherals or equipment, then let our 65,000 direct (173,000 total) readers know. Send us all the product literature you've got. Please place one product per page (make photocopies as desired). See *Speakout* above for more directions.

Category (for this product)

- | | | | |
|--|---|---|---|
| <input type="checkbox"/> Flexible Disk Drive | <input type="checkbox"/> Controllers | <input type="checkbox"/> VT-52,100 Emulator | <input type="checkbox"/> Services |
| <input type="checkbox"/> Rigid Disk Drive | <input type="checkbox"/> Add-In/Add-On Memory | <input type="checkbox"/> Matrix Impact Printer | <input type="checkbox"/> Software |
| <input type="checkbox"/> Special I/Os | <input type="checkbox"/> Communications | <input type="checkbox"/> Other Printers | <input type="checkbox"/> Other (describe) |
| <input type="checkbox"/> Streaming Tape Drives | <input type="checkbox"/> Array Processor | <input type="checkbox"/> Test Equipment/Instrumentation | |
| <input type="checkbox"/> Cartridge | <input type="checkbox"/> CRT Terminal | <input type="checkbox"/> Packaging, Hardware, | |
| <input type="checkbox"/> Cassette | <input type="checkbox"/> Graphic Terminal | Backplanes, Enclosures | |

Product Name/Model No. _____

Description/specs _____

Are you a manufacturer? wholesaler? retailer? service? other? describe _____

Is vendor maintenance available? _____

Number of your field offices: _____ FO, Name of 3rd party service: _____

No vendor maintenance: _____

Price(s) _____

Company contact (sales) _____

Company Name/Division _____

Street/box # _____ City _____ State/Zip _____ Phone () _____

Whom should our editors contact? _____

Mail this form to Directory Editor, *Digital Design*, 1050 Commonwealth Ave., Boston, MA 02215 (617) 232-5470.

Plessey's Versatile PM-DC1102 Disc Controller for the PDP-11*

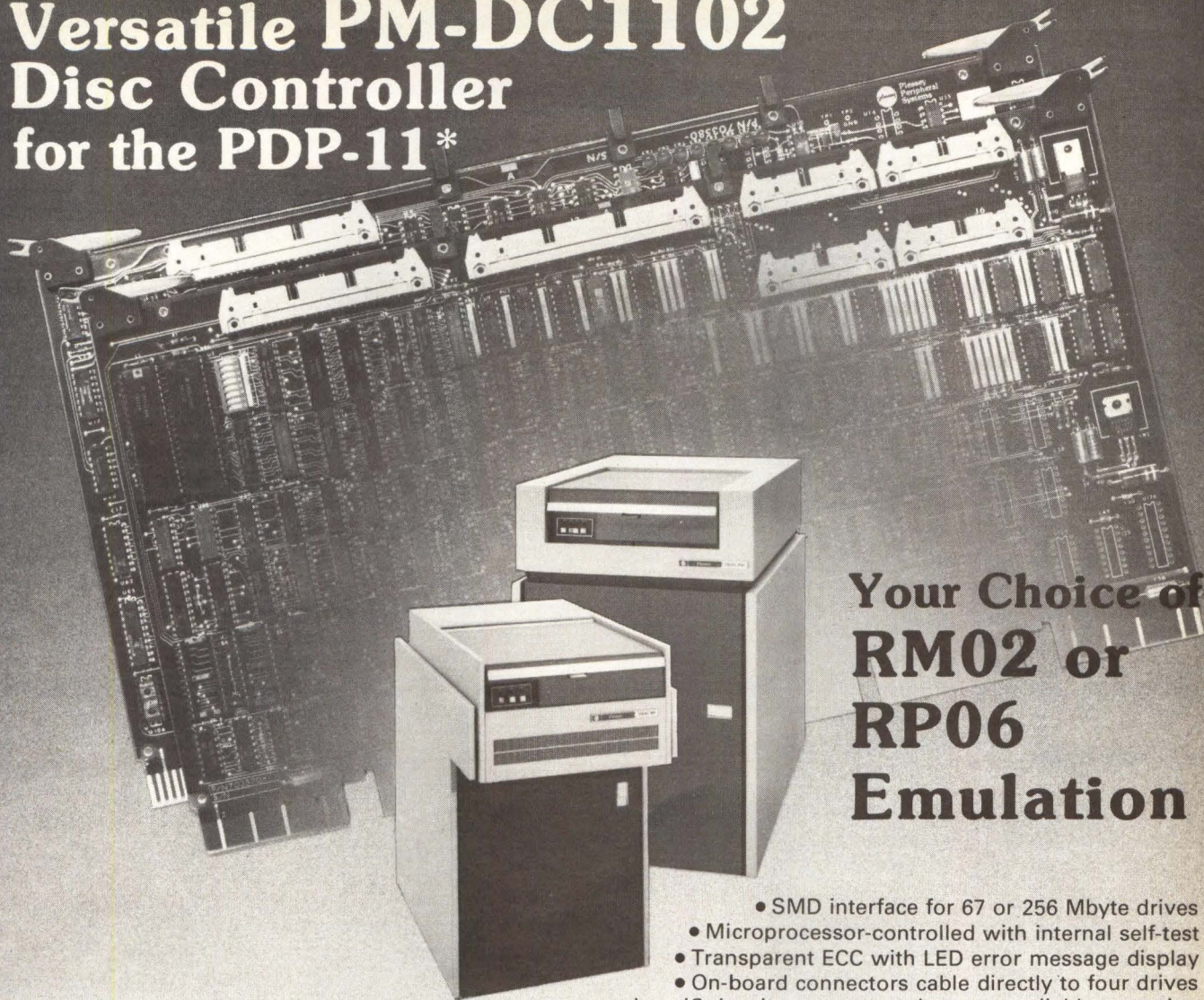

Your Choice of RM02 or RP06 Emulation

- SMD interface for 67 or 256 Mbyte drives
- Microprocessor-controlled with internal self-test
- Transparent ECC with LED error message display
- On-board connectors cable directly to four drives
- Low IC density ensures cooler, more reliable operation
- Easily installed in any two PDP-11 SPC backplane slots for full DEC* compatibility
- Cost savings of 50% compared to RM02 or RP06 when configured into disc subsystem

PM-DS02D (RM02 emulation)



Plessey's PM-DS02D disc subsystem consists of the PM-DC1102 controller and one 67 Mbyte PM-DD11/80 SMD drive that has a proven history of reliability and data integrity. The PM-DS02D subsystem provides complete software and media compatibility with DEC's RH11/RM02 subsystem. The PM-DC1102, in this configuration, can directly support four 67 Mbyte disc drives for a total system capacity of 268 Mbytes. Disc pack files created on either the PM-DS02D or the DEC RM02 can be used interchangeably.

of 268 Mbytes. Disc pack files created on either the PM-DS02D or the DEC RM02 can be used interchangeably.

PM-DS06E (RP06 emulation)

The PM-DS06E consists of the PM-DC1102 disc controller and one 256 Mbyte PM-DD11/300 SMD disc pack drive with cables. The PM-DS06E provides for expanded capacity RP06 emulation (256 instead of 176 Mbytes) and, by use of minor software patches, is compatible with RSTS*/RSX11M* system software and diagnostics for DEC's RP06 disc subsystem. Up to four 256 Mbyte PM-DD11/300 disc drives may be cabled directly to the controller for a maximum system capacity in excess of 1000 Mbytes.



*Trademark of Digital Equipment Corporation

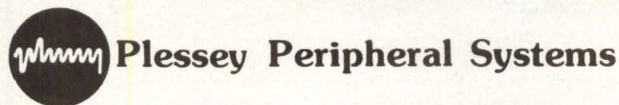

Plessey Peripheral Systems

1691 Browning Avenue
Irvine, CA. 92714

Toll Free Tele: 1-800-854-3581
In Calif: 1-800-422-4217

Please send me further information on Plessey's:

PM-DC1102 PM-DS02D PM-DS06E

Name _____ Title _____
Company _____ Tele: () _____
Street _____ City _____ State _____ Zip _____

Plessey Peripheral Systems, Attn: Marketing Department, 1691 Browning, Irvine, CA 92714

DD4/81

See Us at NCC Booths 256-259
Circle 8 on Reader Inquiry Card

RM80 disk modularity improves reliability and serviceability

Serviceability and reliability improvements this decade will be key factors in Winchester drives. These two factors will sell systems in the 1980s. With this in mind, the RM80, DEC's first mass storage disk drive employs Winchester technology. For use with the VAX-11, RM80 is an example of this trend.

The RM80 doubles the storage capacity of DEC's current RM03 disks and at a lower price. The new disk is a mid-range storage unit with a capacity of 124 MB. The RM80 is designed to interface with Digital's high-speed data bus, the MASSBUS, has a data transfer rate of 1.2 megabytes per second, and has an average access time of 33.3 ms. Its head/disk assembly (HDA) contains four platters with seven data recording surfaces and one surface for servo information. Asked for an in-depth report of behind-the-scenes factors leading up to the recently-introduced RM80, John Read, Carolyn Finch and James Coffee provided the following account.

modularity key to design

Design goals were a cost-effective unit that would provide optimum reliability and serviceability, would be easy to manufacture and would impose the least "ownership responsibility" to system users. This was achieved through design modularity, in electronics and mechanical assemblies.

design modularity

From a manufacturing and service standpoint, modularity proved a reliable design approach; it simplified assembly and aided in troubleshooting. For both manufacturing and servicing, each module was treated as a "black box" by associated modules.

Overall, the RM80 was divided into three major areas: logic chassis, lower chassis, and power supply. These areas were defined by function: the logic chassis was the area in which command and control functions would be concen-

trated; the lower chassis would contain primarily electromechanical components such as the disks and read/write heads; the power supply section was self-explanatory. Isolation of functions simplified both interfacing definitions

and design responsibilities, but resulted in a great deal of care going into the design of each module to ensure that the results remained cost effective.

Design of each module had to consider features of other module ele-

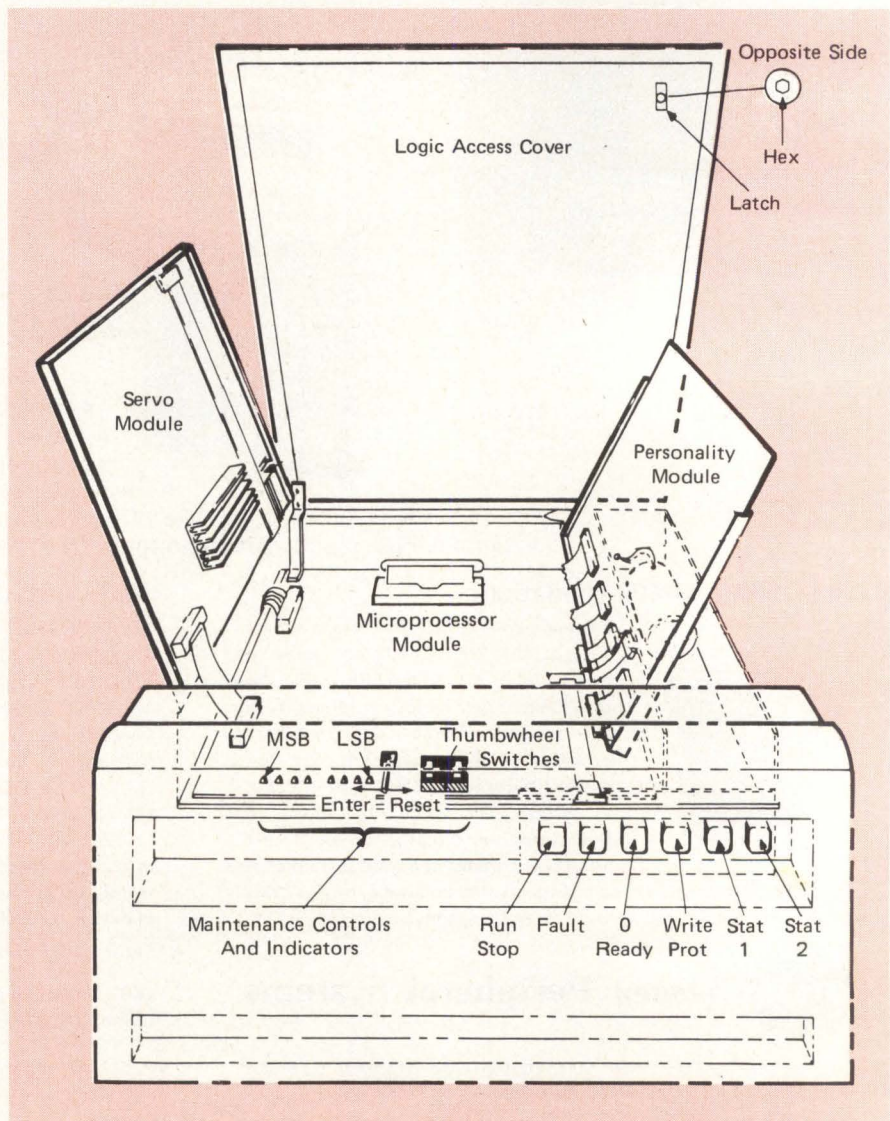

Hinged circuit module arrangement shows RM80 logic. Three main logic modules are accessible by lifting the logic access cover. The hinged module on the left-hand side is the servo module; the one on the right-hand side is the "personality module," used for interfacing to the controller, and the lowest is the microprocessor module. This arrangement enables repair personnel to reach the desired logic element rapidly and with a minimum of tools.

ments. For instance, the level of confidence in hardware had to be assumed as being reasonably high in order to develop a logic arrangement. It was up to the hardware developers to achieve necessary high levels to match requirements of the logic chassis developers.

Packaging of the RM80 was designed to provide access to all chassis elements and modules with use of ordinary, easily available tools. Top fans, the head/disk assembly, power supply, and logic modules were all made field replaceable, minimizing down time. From a modular standpoint ease of field assembly implied ease of manufacturing, since assembly was not difficult in either case.

the head disk assembly

Key modular element in the RM80 was the head/disk assembly, or HDA. Its design goals were to be a minimum size and weight for its capacity, high performance, sufficient modularity of its subassemblies to allow testing prior to assembly, easy removal/installation in the drive, and "service free" filters for the assembly.

The HDA was composed of two modular assemblies of its own: the housing and spindle assembly, and the positioner assembly. The housing assembly, sometimes known as the "clamshell," was fabricated from two identical castings which were machined to produce upper and lower clamshell halves. The machining also made provisions for installation of spindle and positioner assemblies. The result was a symmetrical HDA unit.

By making the HDA symmetrical, immediate benefits were realized. The use of a single casting lowered tooling investment both for casting and for machining. Also, the design resulted in a very stiff platform for the positioner and spindle assemblies. The design produced a RM80 with a center of gravity of major assemblies below base plate. Above-plate design was a condition often found in lower-performance types of disk units.

Design of the spindle also was symmetrical, and had several unique features. Smaller-sized bearings were used both above and below the disks. This resulted in loads becoming nonexistent. Unlike other Winchester-type products, the RM80 spindle design allowed precise two-plane balancing of the spindle after the disks had been assembled. This approach reduced effects of runout on the servo.

By building the main, or recirculating, air filter into the center of the

spindle, we realized a very short air path that provided many air changes per minute. In conventional designs, air is injected at the outside of the disk, resulting in two-way air flow between disks: such an arrangement causes large amounts of turbulence and perturbed the heads. The RM80 air flow arrangement eliminated these problems.

By having the filter in the center of the spindle, the flow-through (unidirectional) air path resulted in another simplification: the disks could be used as the system's air pump. By having the filter incorporated in a short air path with many recirculations per minute, it was possible to get desired filtering action with a filter medium having a lower efficiency than in conventional units: this lowered filter pressure drop for a given pressure, which reduced the size and cost of the filter. In addition, the airflow arrangement with low turbulence reduced the load on the drive motor, which meant that higher reliability could be realized with a lighter motor than would otherwise be necessary.

logic

Just as the HDA was designed as a functional package that could be serviced, and even replaced, easily, so was the logic assembly. The logic modules for the RM80 were organized into four boards: the servo module, the "personality" module, the micro-processor module, and the read/write module. Each represented a subdivision of the overall logical operations along functional lines.

The servo module contained the logic to control the positioning of the heads in the HDA. The personality module controlled interfacing functions for the disk unit. The micro-processor module controlled many basic drive functions as well as the diagnostic operations that ensured proper operation of the RM80. The read/write module was used for the actual recording and sensing of data on the storage medium.

Each of these modules was designed so that its functions could be considered separately. Thus, if there were an interfacing problem for example, a field service check could be made of the personality module. For fast repair, another personality module could be substituted in the field.

The physical packaging of the modules was also designed to make access and repair easy. The servo and personality modules were placed above the logic module. Both were attached

PASCAL + LSI Q-BUS*

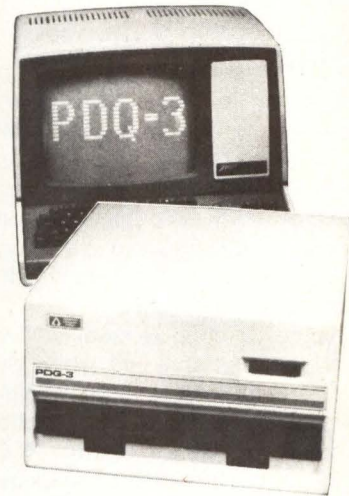

PASCAL PDQ-3

A PDQ-3 computer system consists of PDQ-3 Processor, 64 KB of MOS Memory, Real Time Clock, Interval Timer, CRT/Printer Interface, DMA Floppy Disc Controller, two 8" Floppy Disc Drives, 4 slot 11/23 Q-Bus Backplane and complete UCSD Pascal Software System. Under \$7000. Available with direct addressing to 128 KB, 8-slot backplane, and double density floppies.

ADVANCED
DIGITAL
PRODUCTS

7584 Trade St.
San Diego, CA 92121
(714) 578-9595

*Trademark of Digital Equipment Corporation

Circle 9 on Reader Inquiry Card

by hinges so that access to each lower module was achieved by swinging the upper module(s) out of the way. All replacements could be made without special tools.

protection and diagnostics

The RM80 employs a μ P and logic circuits both to add protection to the operation of the unit and to provide diagnostics for service personnel should troubleshooting and repair prove necessary. The diagnostics aided in the development and manufacture of the RM80 units, and ultimately will aid in any field maintenance.

Diagnostic code is invoked during power-up of the unit, and a drive check is performed. To determine whether a safe spin-up can be performed, checks are made on cable integrity, ROMs, wraps, and status. Also, diagnostics can be invoked by maintenance personnel through use of thumbwheel switches: the settings of the thumbwheel switches are polled by a micro-

processor during its idle loop. If the settings indicate that the diagnostics should be invoked, the microprocessor will check to see whether a momentarily pressed switch (a validation switch) has been activated by maintenance personnel. If so, the microprocessor will shift from functional to diagnostic code. In the diagnostic state, power-up checks can be made, and in addition, such functions such as read/write, servo exerciser, alignment routines, and fault-forcing tests can be performed

400% Growth For Peripherals

More than \$3 billion worth of peripherals for mini and μ C systems were shipped in 1980. In 1990, shipment levels will rise more than fourfold, despite a decline in unit prices of most items. Floppy disk drives, Winchester drives and other mass storage devices will remain the single largest segment of the market, but the 5-1/4" hard discs will reduce the average cost of mass storage per system and will hasten the

trend towards smaller, compact, "desktop" computer systems.

Despite a trend in some sectors towards "paperless" processing techniques, overall printer and paper usage in the future office will increase. However, the trend towards distributed processing will bring a decrease in the line printer average speed. Character printers and teleprinters used in conjunction with minisystems will continue to the 1,200 bps level. Total printer shipments for mini/micro systems will exceed \$1 billion in 1990, compared with some \$500 million in 1980. Half of the 1990 shipment figure will be generated by non-impact printers.

add-on memory bonanza

Adding on additional memory modules will become a "way of life" for many future mini/ μ C owners. Memory prices will decline while labor costs increase, leading to an increased tendency to tolerate memory-inefficient programming. An "increasingly higher proportion" of μ C products will have built-in telecommunications capabilities and will access a variety of new information services and data bases. A 1990 market for mini/micro datacom peripherals will exceed \$1.5 billion, although this includes OEM modems and other "built-in" communications adaptors.

a CRT on every desk?

"Desktop mini/ μ Cs and CRT terminals are currently sitting on about two million desks in the US," estimates Ruth Lipsitz of the IRD's research staff (IRD, Norwalk, CT), who compares this to the 40 million "white collar" workers in the US labor force. "That makes one terminal or μ C for each 20 desks in 1981. But by the end of the decade, the proportion will be one in three," expects Lipsitz. Lipsitz also expects a strong trend towards more data entry devices being coupled to desktop mini/ μ Cs, with a rapid upsurge in the use of speech recognition subsystems for data entry.

supplier shakeout by '85

Over 100 firms are manufacturing mini/micro peripherals. Lipsitz believes that steady price erosion and "fierce" competition will result in a shakeout of more than half of them. "Xerox Corp., which owns floppy-disk leader Shugart and daisywheel printer pioneer Diablo, may emerge as the leading supplier of mini/micro peripherals in the 1980s," comments Lipsitz, who sees Dataproducts and

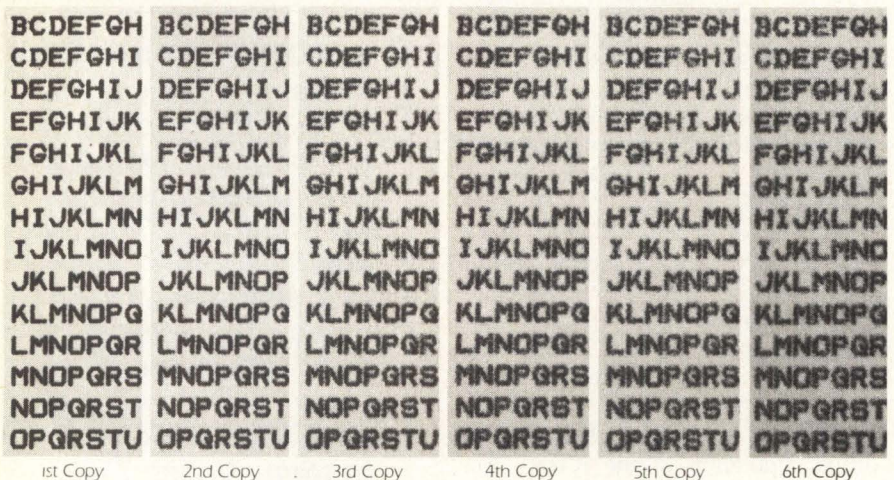

1st Copy 2nd Copy 3rd Copy 4th Copy 5th Copy 6th Copy

Repeat performance.

Printronix printers not only deliver line after line of consistently sharp, readable characters, they produce that same easy-readability through the sixth copy of multiple forms.

Our dot matrix technology provides the high-performance dependability to give you quality alphanumeric printing, OCR and machine-scannable labels, variable-size characters and a wide range of graphics capabilities.

Call us at (714) 549-7700 or write Printronix, 17421 Derian Ave., P.O. Box 19559, Irvine, CA 92713. We'll show you a performer that delivers its lines perfectly every time.



PRINTRONIX
It's simple, to be reliable.

Circle 14 on Reader Inquiry Card

Get the powerful new Intelligent Plotter from Zeta, as advanced as the CAD/CAM systems it is designed to support.

Zeta's new Intelligent Plotter hits speeds up to 50 i.p.s. With 4 g acceleration. And resolution better than .0005". Specifications that meet or exceed anything on the market.

The Zeta edge.

Windowing — the ability to define which part of a plot gets plotted — is a built-in feature of the new Intelligent Plotter, thanks to a pair of 16 bit microprocessors. Other intelligent features include: automatic self-diagnosis circuitry, indi-

vidual pen pressure controls, an LCD plot time display and single vector mode.

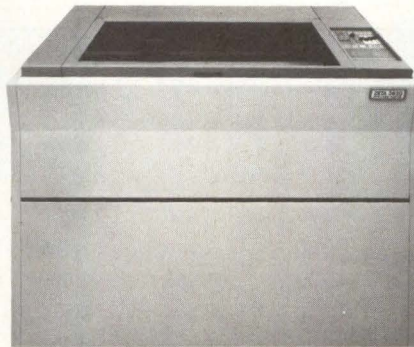

But that's not all.

We've given the Intelligent Plotter one final advantage over the competition. A significant price difference. In your favor. Now, that's really intelligent.

Compatibility? Just plug it in.

We're plug compatible with the competition. And if high performance sounds compatible with your personal standards, write or call today. (415) 671-0600

**PICK THE BEST
CAD/CAM SYSTEM.
THEN, PICK
THE BEST PLOTTER.**

Zeta's new Intelligent Plotter is available in both 36" and 54" models. Zeta manufactures a full line of high performance pen plotters and electrostatic printer/plotters.

ZETA PLOTTERS



NICOLET
ZETA
CORPORATION
A NICOLET INSTRUMENT SUBSIDIARY
2300 Stanwell Drive
Concord, California 94520
TWX 910-481-5951
Tel. 415-671-0600

Plots courtesy of Vitro Laboratories, Division of Automation Industries, Inc., Arragoni Computer Graphics, Inc., and Earth Satellite Corp.

Circle 10 on Reader Inquiry Card

Centronics as potential challengers for the top OEM spot. Asked about IBM, Lipsitz said: "Currently IBM's Information Systems Division is not a factor

in the OEM peripheral market, but there are indications that several important new IBM printers and mass memory devices are going to be announced soon, and these could bring IBM into the OEM market with some excellent products." Other mainframers with significant production capacity for mini/micro peripherals include CDC and DEC. Data General

and Prime are potentially important peripheral vendors "after they have caught up with the demand for peripherals to go into their own minisystems."

The above material was condensed from an IRD report. For full details on the report (#164) contact IRD at 30 High St, Norwalk, CT 06851 (203) 866-6914.

MINI/MICRO PERIPHERAL SHIPMENTS, 1980-1990 (\$ MILLION)				
PERIPHERAL CATEGORY	1980	1982	1985	1990
Data Entry Equipment	240	370	915	1,730
Printers	560	780	1,010	1,185
Memory	300	750	1,150	1,650
Disk/Tape	1,000	1,850	2,565	2,670
G P Terminals	650	1,100	1,650	3,450
Datacomm Equipment	370	665	925	1,915
Sub-Total	3,120	5,515	8,215	12,600
Integral Peripherals	240	260	2,115	17,400
Totals	3,360	5,775	10,330	30,000

(Source: International Resource Development, Inc.)

Will Teleprinters Break \$1,500?

There is no hope that teleprinters will break the \$1,500 price barrier in 1981. Only 9% of all teleprinter models marketed today cost under \$1,500, and no trends indicate a breakthrough. The majority (60%) of teleprinters, are priced between \$1,500 and \$4,000. Most devices priced above \$6,000 are multiterminal cluster systems. Prices have dropped only 20% since 1970 and have a stability unlike most computer product markets. No new technological innovations on the present horizon could contribute to cost reductions.

Want more information? The "GML Teleprinter Supplement" (\$45) contains an overview of the entire teleprinter industry. GML Information Services, 594 Marrett Rd, Lexington, MA 02173. (617) 861-0515.

ADA Seminars

Ada Programming Structures, a 3-day seminar/workshop for engineers, programmers, and technical managers is being presented by Polytechnic Institute of New York and the Institute for Advanced Professional Studies. The course covers the latest developments in the evolution of the Ada language, detailed discussion of its features, rationale for its design, and implications for industry. Application examples, lectures, and informal sessions with the instructor are part of the course.

Seminars will be held on these dates:
 Dallas — June 9, 10, & 11, 1981 — North Park Inn, Dallas, TX;
 Washington, DC — June 17, 18, & 19, 1981 — Holiday Inn, Rosslyn, VA;
 Los Angeles — June 24, 25, & 26, 1981 — Marriott, Los Angeles, CA.
 \$495 Tuition. Contact Prof. Donald D. French at (617) 964-1412 or write Institute for Advanced Professional Studies, One Gateway Center, Newton, MA 02158.

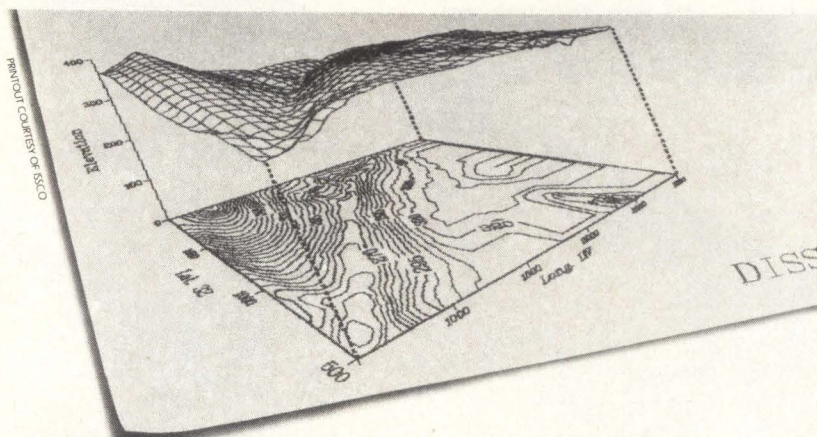

Draw your own comparisons.

Our printers will do anything to illustrate a point. Pie charts, bar charts, maps, 3-dimensional representations — you name it.

Printronix is the only printer in its class that also produces high quality alphanumeric printing, OCR and machine-scannable labels, variable-size characters and multi-part special forms.

For the complete picture on graphics capability, call (714) 549-7700 or write Printronix Inc., 17421 Derian Ave., P.O. Box 19559, Irvine, CA 92713.



PRINTRONIX
It's simple, to be reliable.

Circle 12 on Reader Inquiry Card

Series 630

NEW



*Quite frankly,
when it comes to OEM
terminals, TEC far exceeds competition.*

designed with the OEM in mind

*A must for
your consideration
because the Series 630
starts where other terminals stop.*

The 630 is a smart state-of-the-art ergonomically designed terminal which incorporates quality, reliability, and the flexibility to adapt to your system at a price which helps keep your overall system cost down.

The 630 has many standard features to complement your system. A few of these are detached keyboard with the reliable reed switch technology, non glare screen, full editing capabilities, user programmable auxiliary I/O port and horizontal split screen, six user defined function keys, and upper and lower case characters.

TEC also offers an array of

options to make the 630 even more attractive to you, some of which are tilt/swivel terminal base, 96 character limited graphics set, composite video output, 2, 4, or 8 pages of memory with paging or scrolling.

TEC has been in business for over 23 years. We know how to make OEMs happy, we have built CRT terminals for them for over 15 years. That's a long time and we're proud of it. We believe in providing individual support to all of our customers, especially after the sale has taken place. TEC will also modify or completely redesign its terminals to meet your exact requirement.

For a detailed brochure on the 630 or other TEC terminals, or for applications assistance, contact TEC today.

TEC, Incorporated

DECADES OF SUPPORT

Corporate Headquarters
2727 N. Fairview Ave.
Tucson, Arizona USA 85705 (602) 792-2230
TWX 910-952-1377 Telex 16-5540

- Boston (617) 879-6886
- Chicago (312) 655-1060
- Cincinnati (513) 984-6620
- Los Angeles (714) 848-3111
- Minneapolis (612) 941-1120
- Philadelphia (201) 780-6700
- San Francisco (408) 374-2660
- Washington D.C. (703) 354-1222
- West Palm Beach (305) 684-1604

TEC International, Inc.
European Sales Office
Avenue Louise 148-Box 6
1050 Brussels, Belgium
(02) 649-81 54 Telex 846-63553



Made in U.S.A.

Circle 11 on Reader Inquiry Card
See Us at NCC Booths 542-543

Remote Terminals

Timely items of international interest and suitable for this column should be sent to "From Remote Terminals" c/o DIGITAL DESIGN)

Malaysia. A new company, Montezuma Information Systems of Kuala Lumpur, has been formed to sell, service and support Honeywell Level 6 computers and terminals. Honeywell is one of three major stockholders of the new company ... **India.** Electronics Engineer, V.R. Tatia, of Computer Group Electronics Corp. of India, has written "A Simple Reverse Power Protect Circuit." The informative, technical article will appear in a forthcoming issue of Digital Design ... **Japan.** The world's largest exporting nation is expected to suffer several major headaches in its current position. PREDICASTS, an Ohio-based market-

analysis company, says "Low wages, inexpensive raw materials, favorable exchange rates and other factors responsible for the phenomenal growth in Japanese exports are now gone." ... **Munich.** The 4th International Trade Fair for Electronics ("Productronica '81") takes place at Munich Fairgrounds, Nov. 10 to 14, 1981. Themes for this year's Fair are "Mounting and Interconnection in Device and Equipment Manufacture," and "Measuring, Testing and Analyzing." Active languages will be German and English with simultaneous translations at the technical sessions ... **Brussels.** An international symposium on "Visual Psychophysics and Medical Imaging" begins here July 2, 1981. The symposium is being organized by the faculty of Applied Sciences, Vrije Universiteit of Belgium ... **Washington.** The newly formed

"World Computer Graphics Association, Inc.," is planning joint conferences, in the near future, with member participants: Australia, Canada, Federal Republic of Germany, France, the Scandinavian Nations, Switzerland, the U.K. and the U.S. ... **Norway.** Tanberg Data is producing a new terminal, the TDV 2200. Primary consideration in its design was the comfort of the end user. Muscular strain from a high key board which forces an operator to constantly lift his shoulders is eliminated with the TDV2200 ... **Ontario.** Sonotek Ltd., of Mississauga, has launched a new series of data acquisition and process control computers featuring a CRT with 16x32 characters, optional 256 x 256 pixel graphics, AC operation, and "more elaborate firmware and software with simplified human interfaces and lower prices" ... **The Netherlands.** N.V. Phillips Gloeilampenfabrieken has joined E.I. Dupont de Nemours Co. of Delaware in setting up a joint venture of the development, manufacture and sale of magnetic tape ... **Kenya.** The government is erecting a microwave system to import music and long distance telephone calls ... **Alaska.** Installation of a series of intelligent computer terminals has helped Wien Air Alaska (the territory's major intrastate airline) extend processing and communications services to some of Alaska's farthest and most frigid settlements ... **Hong Kong.** "Electronics '81" runs Oct. 19-23, 1981. "This is your opportunity to meet and sell to the multimillion dollar Hong Kong electronics market," say the sponsors of the International Exhibition ... **Austria.** Siemens has erected a \$25 million plant at Villach, Austria. The new plant, expansion of Siemens' branches in Austria is producing dynamic MOS memories and ICs for microcomputers ... **Monte Carlo.** A three day symposium organized by CII Honeywell Bull discussed the subject of crime. It was estimated that computer crime in Europe is now at the \$3 billion annual level ... **France.** A terrorist bomb attack on Thomson-CSF's Electronics Lab in Toulouse has resulted in \$225 thousand worth of damage.

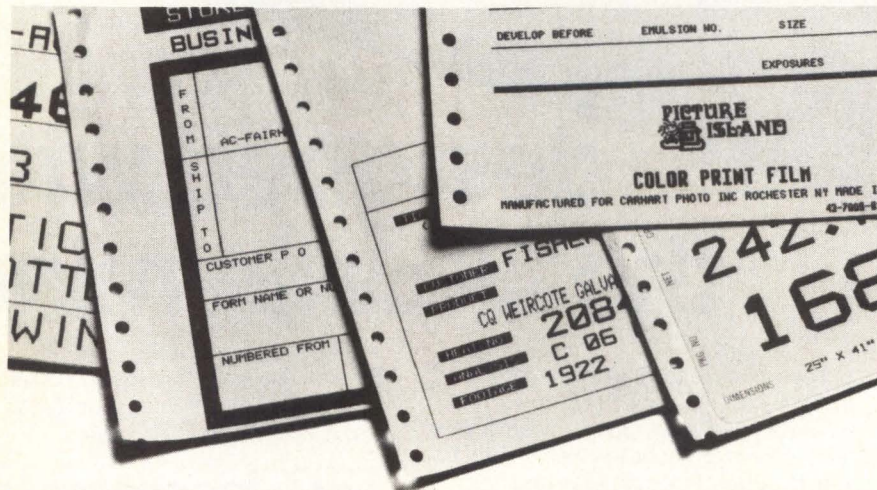

Get your computer output in one form. Or another.

Printronix printers not only print, they prepare forms for everything from invoices to labels.

And our printers finish the job, filling in the blanks as the forms are being printed.

In fact, Printronix printers give you the same high quality in graphics and forms as in classic alphanumeric printing.

To see your output in completed form, call (714) 549-7700, or write Printronix Inc., 17421 Derian Ave., P.O. Box 19559, Irvine, CA 92713.



PRINTRONIX
It's simple, to be reliable.

Circle 15 on Reader Inquiry Card

German Computers in World War II

The recent fourth lecture in DEC's PIONEER SERIES, (sponsored by DIGITAL COMPUTER MUSEUM, in Marlboro, MA) featured Dr. Konrad Zuse, from Germany. Zuse, like other speakers at Digital Equipment's museum, is one of a group of men and women who have been responsible for planning and developing computers. Germany's leading computer scientist, Dr. Zuse built the first fully operational computer in Germany in 1941. "Eniac," (University of Pennsylvania's forerunner of the Sperry Univac) became operational in 1948; MIT's general purpose computer, "Whirlwind," was fully operational in 1951.

At the museum meeting, the internationally known scientist discussed his role in wartime Germany. Unlike the official sponsorship of U.S. Computer research, the German government had little interest in computer development. It looked upon the device as simply an elephantine, sophisticated slide rule. "In fact," says Dr. Zuse, "I was drafted out of my research work and placed in a company of ordinary soldiers. A manufacturer who had been giving me financial help even wrote a letter to my commanding officer asking that I be excused so that I could continue with my research into electronic calculators. The air-force major was astounded. 'I don't understand that request,' he wrote back. 'The German airforce is the best in the world! I don't see any need for his continuation of private research in calculations.' Six months later, however, I was freed from military service. But I was released not to continue computer research but to work as an engineer in the aircraft industry."

Germany's guided missiles in World War II were being manufactured in aircraft factories. These missiles had to fly precise paths to be accurate and these paths were remotely controlled and adjusted from the ground. The V2 rockets, therefore, were sent over a special measurement station located in occupied France where about 100 aerodynamic conditions were remotely read



Dr. Konrad Zuse

and remotely corrected. The data was fed into an S2 computer (one with which Dr. Zuse had been connected) where rapid calculations were made then transmitted back to the overhead missile. This measuring computer, according to Dr. Zuse, was in continuous round-the-clock operation for two years through 1943. The computer station and the missile bases themselves were eventually bombed out of existence.

"Right from the beginning of my research in 1939," said the doctor, "I tried to base computer functions on a new, solid-switching, two-phase technology. Early attempts at producing devices with real binary switching elements, however, did not work well. I decided, then, to stay with the electro-mechanical technology.

"By 1938, I realized that there was no border separating calculations from 'thinking.' It became clear to me that any development in computers would move in the direction of an artificial brain. But nobody then knew much about the human brain and its thinking process. Even today there is no exact knowledge on how the brain functions."

Someone in the audience of about 200 computer engineers, asked Dr. Zuse what he thought about the present state of development of computers.

"When we were working with our special purpose computers in 1940," he responded, "we never thought that the computer would become anything more than that — a special purpose device. We all felt that there was no real future for computers and that they would only become toys — playthings for scientists."

Harry Shershow

PDP/11* Peripherals

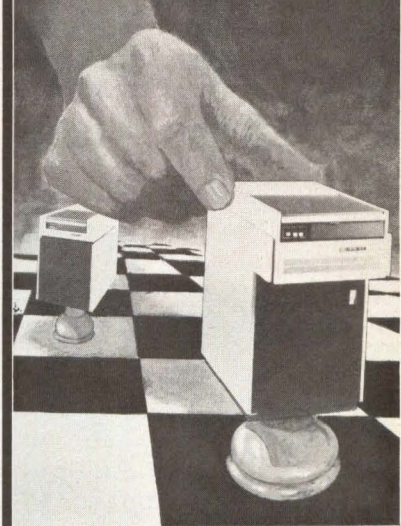

The Winning Strategy in the DEC-Compatible Game

Because ADVANCED DIGITAL PRODUCTS can be your **one-stop shop** for all your DEC add-on needs, upgrading your DEC PDP/11 systems can be much less expensive than you think.

Our Field Engineering specializes in installing DEC add-on equipment and maintaining DEC and mixed vendor systems.

We understand your DEC needs:
We offer low, competitive prices on:

- **CDC Disc/Add-ons**

DM06	(300MB)
DM06/70	(300MB)
DM02	(80MB)
DM02/70	(80MB)
DM-300	(300MB)
DM-80	(80MB)

- **Emulex Controllers**

- **Kennedy Magtapes**

DM-77	(125IPS)
DM-45	(75IPS)

- **Able Communications**

- **Printronix Printers**

- **Zenith Terminals**

**Before you buy, make the
winning move—Call Us!**

**ADVANCED
DIGITAL
PRODUCTS**
A SUBSIDIARY OF COMPUTER SERVICES GROUP, INC.

7584 Trade Street • San Diego, CA 92121
(714) 578-9595

*Trademark Digital Equipment Corporation

Circle 16 on Reader Inquiry Card

THE INDUSTRY STANDARD

BULK CORE BULK SEMI

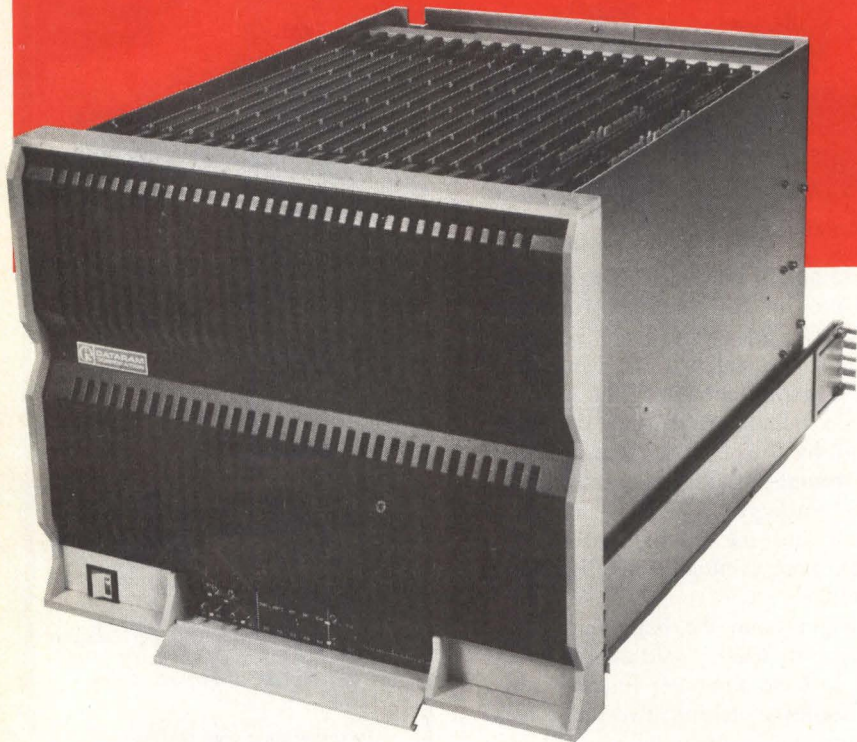

ALSO FROM DATARAM
JUST ANNOUNCED
PDP 11/44
MEMORY

Add a new dimension of speed and reliability to your minicomputer with economical, high-capacity BULK MEMORY from Dataram.

The world leader in minicomputer-compatible disk emulation systems. Dataram's wide range of disk emulations — twice as many minicomputer interfaces as anyone else! — brings the proven performance of BULK MEMORY to your application requirement.

Dataram's BULK CORE and BULK SEMI systems operate at speeds which are orders of magnitude faster than the mechanical disks which they

replace, and do it with the reliability inherent in all-electronic devices. What's more, BULK MEMORY provides up to 8.0 MB in a 15¾" chassis, and offers dual-port capability to enable BULK MEMORY to be shared by two host minicomputers.

If you have a minicomputer and are looking for a way to get more for your storage dollar, Dataram has a BULK CORE or BULK SEMI system ready to work for you. If your minicomputer is not listed below, tell us about it. We'd like to add your name to our growing list of BULK MEMORY users.

MEMORY FROM THE LEADER

DEC, LSI-11, and PDP are registered trademarks of Digital Equipment Corporation. Eclipse and Nova are registered trademarks of Data General Corporation.

DATARAM CORPORATION

Princeton Road
Cranbury, New Jersey 08512
Tel: 609-799-0071 TWX: 510-685-2542

	DEC® PDP®-11	DEC LSI-11®	DEC PDP-15	DATA GENERAL NOVA®	DATA GENERAL ECLIPSE®	ROLM 1602	PERKIN ELMER	MODCOMP	HONEYWELL 316 and 516
BULK CORE	✓	✓	✓	✓	✓	✓	✓	✓	✓
BULK SEMI	✓	✓	✓	✓	✓		✓		
DUAL PORT	✓	✓		✓	✓				

Canada: Ahearn & Soper Ltd., 416-245-4848 • Finland: Systek OY, (80) 73 72 33 • France: YREL, (01) 956 81 42 • Hungary/Poland/Romania: Unironex Corporation, WARSAW 39 6218 • Italy: ESE s.r.l., 02/607 3626 • Netherlands: Technitron b.v., (020) 45 87 55 • Sweden: M. Stenhardt AB, (08) 739 00 50 • Switzerland: ADCOMP AG, 01/730 48 48 • United Kingdom: Sintrom Ellinor Ltd., (0734) 85464 • West Germany: O.E.M.-Elektronik GmbH, 07 11-79 80 47 • Yugoslavia: Institut "Jozef Stefan", 263-261 • Australia/New Zealand: Anderson Digital Equipment, (03) 543-2077 • India: Infosystems Private Limited, 79281 • Israel: Minix Computers & Systems Ltd., 03-298783 • Japan: Matsushita Electric Trading Co., Ltd., 06 (282) 5111

Circle 17 on Reader Inquiry Card

Who will be first with the avionics of the 21st century?

It could be you and Hughes Radar Systems.

We pioneered pulse Doppler radar and built the first operational airborne programmable signal processor. Today, three out of the four front-line U.S. tactical aircraft have Hughes radars. We're leaders in synthetic aperture radar, in-weather reconnaissance and strike radar, high order language, antenna arrays and holographic displays. We're even building the rendezvous radar for the Space Shuttle.

And with computer-aided design, manufacturing, and testing of intelligent radar devices, the future is at Hughes.

In fact, Hughes is one of the nation's largest employers of electronic engineers and a major employer in virtually every other scientific, computer and technical discipline — with 1,500 projects and a backlog of over \$5 billion. Yet we're decentralized to give you the kinds of environments that stimulate innovation and promote recognition of your work.

Who will be first with the avionics of the future? It could be you and Hughes.

At Hughes Radar Systems, we'll introduce you to people, ideas and jobs that could change your world. And maybe ours.

Call (213) 647-4900, collect, or send resume to:

Engineering Employment
Hughes Radar Systems
P.O. Box 92426, Dept. DD-4
Los Angeles, CA 90009

Current openings:

- Software Design/Analysis
- Software Test Engineering
- Systems Integration & Test
- Computer-Aided Design & Manufacturing
- RF/Microwave Design
- Digital Circuits Design & Test
- Radar Systems Design
- Large Scale Integration Design, Development & Test
- Production Process Engineering
- Microprocessor Development/ Applications
- Antenna Systems Design & Test
- Reliability Engineering
- Production Test Engineering
- Industrial Engineering

It could be you and Hughes Radar Systems.

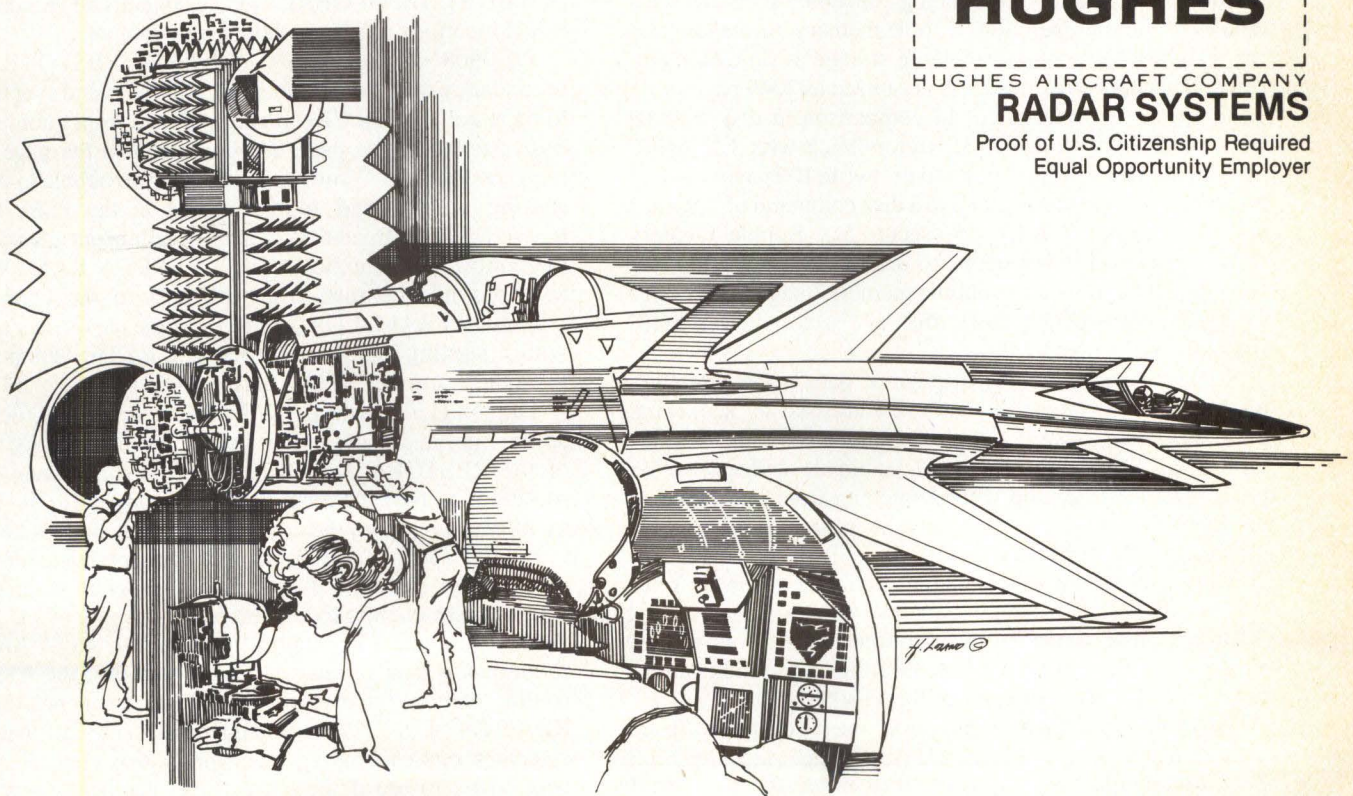

HUGHES

HUGHES AIRCRAFT COMPANY
RADAR SYSTEMS

Proof of U.S. Citizenship Required
Equal Opportunity Employer

Magnetic Bubble Memory Systems: Software Interfacing To μ Ps

Roger Haggard

Software must be written for each magnetic bubble memory application. All applications share the same basic requirements regarding the ability to store and retrieve data from the bubble memory. Bubble memory software in the form of flowcharts and assembly language code is used to initialize the MBM system, to R/W data to/from the host system's RAM and to select different devices in a multiple bubble system. Many of these functions are analogous to those performed in disk memory systems. The device service routine presented here does not fit all CPUs, but because the functions performed are generally common to all applications, the routines can be adapted to meet the specific needs of a particular application.

MBM vs. disks

Let's compare MBM terms and concepts to those of conventional disk technology. The TIB0903 BMC is comparable to a floppy disk controller IC such as the TMS 9909, Western Digital 1791 or Intel 8271. It controls bubble memory subsystem without being concerned with low level details of bubble operation. Bubble memory devices such as the TIB1000 provide non-volatile storage as do disk memories. This particular device is organized as 2049 pages with as many as 34 bytes/page. In comparison, a disk may be organized as 77 tracks of 32 sectors/track with 128 bytes/sector. Thus, a bubble command of "write 100 pages starting at page 450" may correspond to a disk command of "write 3 sectors starting at track 14, sector 5." Bubble memory device selection is analogous to disk drive selection before starting a data transfer. A bubble memory "page buffer full" interrupt corresponds to a disk's "sector buffer full" interrupt to the host CPU.

Some concepts include: a page of data is the minimum accessible unit; pages of data are addressed by sequential page numbers; a single bubble command can either read or write from 1 to 2049 pages; a special bubble device selection algorithm must be used when switching from one MBM to another; each bubble device must be initialized after power up, before transferring any data.

The exact format of commands and data depends on the user's CPU and interfacing hardware between CPU and TIB0903. The device service routine (DSR) was written specifically for a 9900 CPU with a direct communications register unit (CRU) interface to the TIB0903.

There are two primary modes of operation for software

interfacing to the TIB0903: polled I/O and interrupt driven. For simple systems not concerned with efficient use of CPU time, polled I/O mode, presented here, is simple to implement. For systems that are CPU-bound and must maintain a high throughput with many devices, the polled I/O mode wastes too much CPU time waiting for the bubble data transfers. In cases like this, the interface should be interrupt driven so that involvement by the CPU occurs only when bubble data transfers are immediately needed. The device service routine can be adapted for use in the interrupt mode instead of the polled I/O mode.

flow charts

The overall organization or hierarchy of the subroutines in the device service routine would portray the lower level routines including read controller (RDCTLR), write controller (WRCTLR), and check status (CKSTAT) repeated under the higher level routines, which include initialize (INITLZ), switch bubbles (SWITCH), and R/W bubble (RWBUB). The GLOBAL module contains all variables and RAM locations used by bubble driver routines.

TIB0903 commands are as follows. RESTORE: Read redundancy map from bubble into controller and synchronize to page zero. READ: Read pages of data from bubble to the host starting at the page address stored in the page select register. WRITE: Write pages of data from bubble to the host starting at the page address stored in the PSR. READ REDUN RAM: Read the contents of redundancy RAM from the controller to the host. WRITE REDUN RAM: Write a new redundancy map from the host to the controller's redundancy RAM. LOAD PSR: Load the page select register with a starting page number. SHIFT BYTE: Dump a byte from the controller's FIFO during READ.

The INITLZ routine performs the initialization process for all the bubble devices in the system. As indicated by the use of the RESTORE command, one of the functions of this routine is to read the redundancy map data from the bubble memory device into the controller's redundancy RAM. It is important to limit the number of attempts at reading this information correctly to prevent the program from getting caught in an endless loop. This is the purpose of the blocks labeled "set up retry count" and "retry = 0?" After the redundancy data is read into the controller, the CKSTAT routine checks for errors; and if there are none, then the READ REDUN RAM command transfers the data to the host system's main memory. Then the data is checked in two ways: first to see if the correct map has been transferred. There are two halves to each MBM and, consequently, these

The author, formerly with TI, also wrote the two MBM articles in the February 1981 and August 1980 issues.

QUICKLY!

**Who makes
ONE TESTER
that can
test ANY of
the 1-megabit
bubble-memory
devices
available today?**



WATKINS-JOHNSON.

Watkins-Johnson has the **only** tester that is capable of testing **all** commercially available 1-megabit magnetic-bubble-memory devices.

Our computer-controlled test system is designed to provide all testing functions required by rigorous incoming inspection applications.

Our production test fixture allows the fastest, most reliable means of fixturing bubble-memory devices, providing the-highest possible throughput for incoming inspection.

For engineering evaluation applications, our characterization software package allows testing of all bubble-memory devices without additional software development, resulting in substantial cost savings.

Watkins-Johnson has the best solution for bubble-memory testing problems!

For complete specifications and application information, contact your local W-J Field Sales Office, or phone us in Palo Alto, California, at (415) 493-4141, ext 2811.

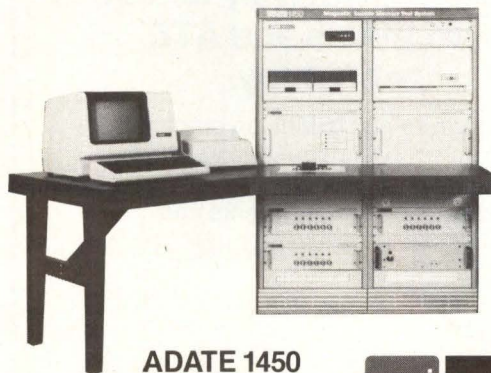

WATKINS-JOHNSON

Watkins-Johnson—U.S.A.: • California, San Jose (408) 262-1411; El Segundo (213) 640-1980 • Georgia, Atlanta (404) 458-9907 • District of Columbia, Gaithersburg, MD (301) 948-7550 • Massachusetts, Lexington (617) 861-1580 • Ohio, Fairborn (513) 426-8303 • Texas, Dallas (214) 234-5396 • United Kingdom: Dedworth Rd., Oakley Green, Windsor, Berkshire SL4 4LH • Tel: Windsor 69241 • Cable: WJUKW-WINDSOR • Telex: 847578 • Germany, Federal Republic of: Manzingeweg 7, 8000 Muenchen 60 • Tel: (089) 836011 • Cable: WJDBM-MUENCHEN • Telex: 529401 • Italy: Piazza G. Marconi, 25 00144 Roma-EUR • Tel: 59 45 54 • Cable: WJROM-I • Telex: 612278

Circle 53 on Reader Inquiry Card

are two different maps. Once these functions have been performed correctly, the page position counter is set to zero and the routine moves to the next bubble device and continues until all devices have been initialized.

The RWBUB routine transfers data to and from the bubble memory system via the RDCTLR and WRCTLR sub-routines. The first part of this routine obtains necessary parameters such as the starting page number and the number of pages to be read or written. These parameters are checked for errors and if none are found, then the page select register (PSR) is loaded with the address of the first page. Then the desired command is issued, either READ or WRITE, and the data transfer begins. Pages of data are transferred until all have been read or written.

The SWITCH routine performs functions necessary for the controller to change from one bubble device to another. Before leaving the old MBM, the program must store the page position in which the bubble memory data has been stopped. This is done by reading and storing the contents of the page position counter (PPC). This same data for the new MBM must then be transferred from the system RAM to the controller. Next the redundancy information is transferred to the controller and finally, the new device is enabled by changing the bubble select lines.

The RDCTLR and WRCTLR routines are similar — except that in the first, data is read from the controller to the host system and in the second, data is written to the controller from the host. In these data transfers, it is important not to cause an overflow or underflow of the controller's FIFO buffer. This is the reason that the number of bytes, N, to be transferred in one pass is calculated at the beginning of the routine. When all bytes have been transferred, the program

returns to the calling routine.

The CKSTAT routine checks for interrupt conditions during reading and writing of data or signals that a timing error has occurred. Status bits can indicate that the FIFO buffer is full, half full, or empty; that a timing error has occurred causing the FIFO buffer to overflow or underflow; that an interrupt condition is present; etc.

assembly language code

An assembly language code is generated for each of the subroutines in the device service routine. Many instructions found in these program listings are similar to those found in instruction sets other than that for the TMS 9900. Some instructions are unique; particularly those associated with the communications register unit (CRU). CRU is a 4096-bit-addressable, synchronous, serial interface over which a single instruction can transfer between one and 16 bits serially. Each of the 4096 bits of the CRU space, which is separate from the main memory, has a unique address and can be read and written to. During multi-bit CRU transfers, the CRU address is incremented at the beginning of each CRU cycle to point to the next consecutive CRU bit. The instructions that control the CRU interface include SBO: set bit to one (output); SBZ: set bit to zero (output); TB: test bit (input); LDCR: load n bits to CRU (output); STCR: receive (store) n bits from CRU (input).

In examining the assembly language code, compare the flow chart with the code. Note that line numbers from the program listings are indicated on the flow charts.

System designers seeking additional information on the TI magnetic bubble memory system and its implementation should contact Texas Instruments in Dallas, TX. **D**

Electronics Test & Measurement Conference



October 5-8, 1981

Hyatt Regency Chicago • Chicago, IL

The only Midwest conference devoted exclusively to test instruments and ATE technology.

Technical program and exhibition emphasize problems in selecting, implementing and managing μ processor-controlled and manual test and measurement instruments and automated test equipment.

For more information, write or call:

Dona Atwood, Registrar
Electronics Test & Measurement Conference
1050 Commonwealth Avenue, Boston, MA 02215
(617) 232-5470

courses in automatic testing technology

ATE: How to Select It — Apply It — Manage It

**Introduction to Digital Testing
Advanced ATE Technology
and Management**

Learn about the latest developments in automatic testing technology by attending any of the above courses taught by industry experts.

Update your testing knowledge and keep abreast of state-of-the-art changes in the field of electronics test and measurement.

June, 1981
Boston

October, 1981
Chicago

November, 1981
Orlando

For more information, write or call:
Dona Atwood, Registrar, **ATE Courses**,
1050 Commonwealth Avenue, Boston, MA 02215
(617) 232-5470.

Single-Chip Video Timer/Controller Eases Video Terminal Design

Engineering Staff
Texas Instruments
Houston, TX

Video display systems for use in computer systems are easily constructed using TM 990 family 16-bit μ Cs. This article describes construction and operation of such a video terminal.

The interface is constructed on a TM 990 prototyping card, allowing it and a TM 990/100M μ C board to be plugged into a TM 990 chassis; video output is connected directly to a video monitor.

scanning and formatting

Using a TMS 9927 single-chip video timer/controller to generate correct timing for scanning and formatting the CRT screen of such video terminals eases their design, reduces component count, improves reliability and cuts costs.

Logic functions to generate *all* timing signals for the display of video data on standard or nonstandard CRT monitors in both interlaced and noninterlaced format are contained in the TMS 9927. All of this logic is on a single N-channel silicon gate chip contained in a standard 40-pin package. All of its inputs and outputs are TTL-compatible. The only display function not on the chip is the dot counter, which cannot be easily implemented with MOS technology because of the high video frequencies.

Using a TMS 9927, some support logic and a dual-port character buffer, a complete video terminal interface can be constructed. Chip count for this interface is typically much less than one constructed using SSI or MSI logic circuits. The interface is completely compatible with TI's 16-bit high performance 990/9900 family of μ Cs and μ Ps. And when the TMS 9927 interface is incorporated into a μ C system containing a TM 990/100M μ C board and an RS-170 video monitor, the result is a complete, high quality, low-cost stand-alone video terminal that is software compatible with the entire 990/9900 family.

functional specs

Specs of this video terminal illustrate the wide range of TMS 9927 capabilities in a typical application.

Video terminal configuration is an 80 character by 24 line format. It has 15 command controls and scroll up and reverse video. Software is comprehensive and includes features you may find unnecessary for some applications. Software routines provide automatic initialization, complete cursor control, clear screen, clear current line, and screen format view

on/off. This wide range of hardware and software features plus the relative ease of including or excluding them lets you design your terminal to fit your own specific requirements. You can design a terminal with minimal features (no cursor, no three-level gray scale and no reverse video), all possible features, or an amount of features lying anywhere in between.

μ C/video controller communications

In most applications, the TMS 9927 will directly interface with the TM 990/100M μ C to load the controller registers, manipulate the cursor, and generate special functions (such as scroll, clear screen, etc). TMS 9927's self-loading feature minimizes μ C dependence by self-loading the formatting registers.

register communications

There are two convenient ways of communicating with the video controller: memory mapping and the Communications Register Unit (CRU).

The TMS 9927 can be memory mapped by applying the least-significant four bits of the address to its select lines, S0-S3. Remaining address bits can be decoded and applied to the Chip Select pin. Data communication is accomplished via Data lines D0-D7. The μ C R/W signals can then be NORed together and presented to the Data Strobe line. Thus, the TMS 9927 will be accessed by the CPU as normal memory, except that some locations will appear as read-only and some as write-only locations.

A second method of communications is through the CRU lines via the TMS 9901 programmable systems interface. In this scheme, TMS 9927 Select lines S0-S3 are connected to P11-P8 and data bus lines D0-D7 are connected to P7-P0 of the TMS 9901. The TMS 9927 is selected by connecting Chip Select to P12. Data is strobed via P13. Software for implementation of the circuit is simple, since the CRU provides proper timing for loading or reading the TMS 9927.

controller/VDT communications

TMS 9927s provide users with three sync signals to produce a variety of methods for presenting sync and video signals to the video monitor.

The device outputs Vertical Sync (VSYN), Horizontal Sync (HSYN) and Composite Sync (CSYN). Actual video signals

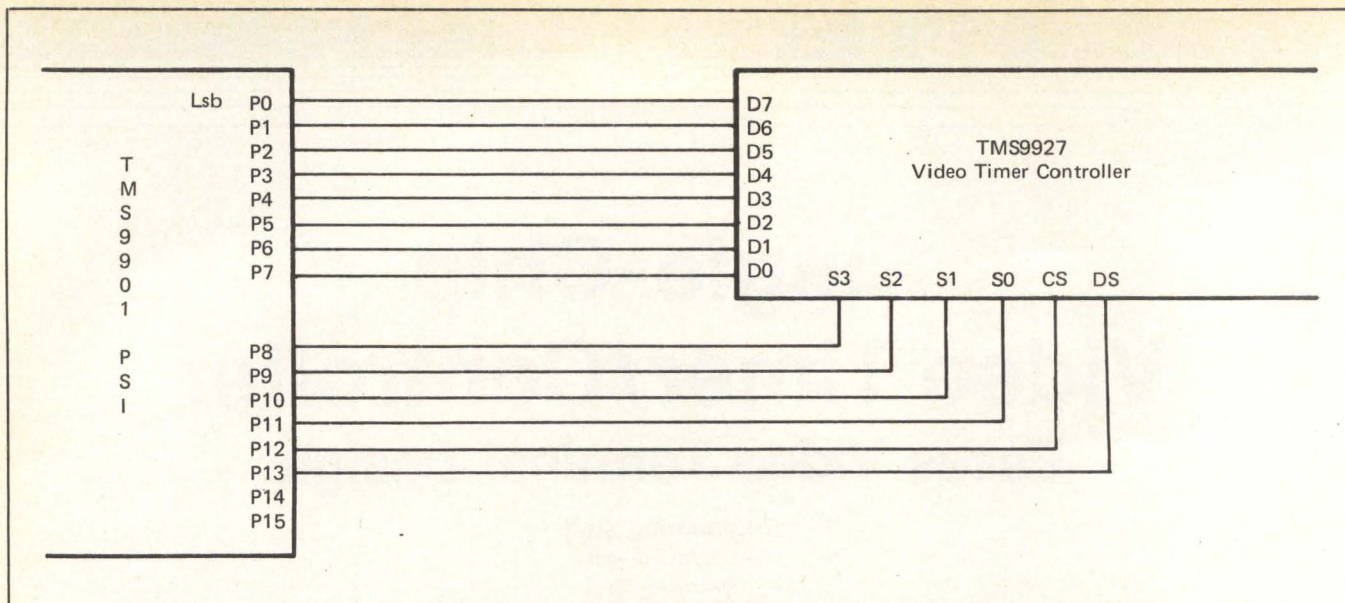

A 9927 signal timer + a 9901 interface + a video monitor = an high quality, stand-alone video terminal.

are generated externally under the control of H0-H7, DR0-DR5, R0-R3, blanking and cursor video from the TMS 9927. From this, designers can implement three types of interface signals to the video monitor: separate sync and video, composite sync and video, and composite video.

Separate sync and video is implemented by buffering HSYN and VSYN and presenting them separately, with the video signal, to the outside world. If these signals are to be transmitted through a long cable, impedance matching is necessary to minimize signal degradation. This degradation of signal appears as alternating dark and light areas within each character which cannot be removed by adjusting the monitor's contrast and intensity controls. If a proper driver is used, no other impedance matching will be necessary.

Composite sync and video are normally implemented the same way separate sync and video are implemented, with one exception: HSYN and VSYN functions are not used; CSYN is used instead. This single sync signal and the video are buffered and presented to the video monitor as two separate signals.

Composite video consists of a combination of composite sync and video discussed in the previous paragraph. Composite sync is mixed with the video and presented to the monitor as a single signal. Many methods can be used to mix the sync and video signals.

interface hardware

Address decode and select logic. Video terminal interface hardware has been designed as minimum support for the software features of the terminal described in this article. The hardware is divided into four main sections. One section is the logic which includes address decode for the video controller chip, hardware control latch, and buffer memory. It also includes logic necessary to select between CPU-generated addresses during buffer memory update and VTC-generated addresses during normal screen refresh. The video timer/controller is transparent to the CPU — that is, the CPU always receives immediate access to the buffer memory. When the CPU is not accessing the buffer, the VTC is allowed to scan it for refresh.

A memory map would show that the interface requires 2 k plus 32 words of memory space. The buffer RAM appears in the top 2 k words of this space. The next 16 words below this

contain the hardware control register. These registers appear in the high byte of all 16 words because of the simplified addressing scheme. The high bytes of the next lower 16 words contain the VTC registers and command addresses. An alternative (trade-off) method is discussed later.

Dual port buffer memory. The second section of the interface hardware is the dual port buffer. It is made with a 1 k by 4-bit static low power RAM with an approximate 300 ns cycle time. If a 12-line format is desired instead of a 24-line format, IC9 and IC10 can be omitted and odd data rows will be blank because the pull-up resistors will force "DELeT" characters (displayed as a blank) to the character generator.

IC6 provides a second level of pipelining for the characters. Each time the Dot Counter Carry (DCC) is updated, the character presently being accessed by the TMS 9927 will be latched into IC6 before the TMS 9927 can respond to the DCC pulse; latching memory data into IC6 occurs simultaneously with the latching of character dot data into the dot shift register.

Video timer/controller. The TMS 9927 video timer/controller is interfaced to the bus via the 8-bit bidirectional data buffer IC20. IC3A/02 ORs bus READ and WRITE signals to provide the proper Data Strobe. IC28 remaps the address from the TMS 9927 to the memory so that an 80-character by 24-line screen format will fit into a 2 kB-character buffer. This logic places the last 16 characters of each row into the otherwise unused buffer space after the 24th row of 64 characters. Another scheme is to use a 128-word by 8-bit PROM to remap the address lines from the VTC to the address selector. In this manner, the addressing scheme can be made linear and the software remap routine can be eliminated (Note that the four least significant address bits do not have to be remapped). This is a hardware/software trade-off which would normally not be made due to ROM expense and the ROM burning process.

Dot generation control. Section four concerns dot generation/control. If the designer decided to utilize the minimum system possible (no cursor, three-level gray scale or reverse video) all logic shown could be eliminated except for IC1, IC12, IC14 and IC19. Such a minimum system would be used in an airline schedule terminal video display, for example. IC12^A and IC12^B generate the dot shift frequency for the Dot Shift Register, IC14. Each time a dot is shifted out

of the dot register, the dot counter is decremented by one. When the dot counter IC13 reaches zero, its Ripple Carry Output goes inactive, thus signifying that eight dots have been shifted out and that a new set of character dots are ready to be loaded into the dot shift register. This same Ripple Carry Output causes the presently accessed memory word to be latched for use by the character generator; simultaneously, the Dot Counter is reloaded with a count of eight dots. DCC input is strobed by a different output of the dot counter to position the cursor symmetrically about the character. IC16 is the Hardware Control Register which contains two hardware flag bits and two unused bits. One can be used to switch in an alternate character or graphic ROM (or EPROM — the TMS 4710 character ROM is pin compatible with the TMS 2708 EPROM). The other bit can be used to switch from normal to reverse video. This was not implemented in this example because reverse video is not normally used with multiple-level gray-scale.

If HW Control bit 5 of IC16 is set, the cursor blink oscillator will be turned off and the cursor will appear solid with the cursor character in reverse video.

If HW Control bit 7 of IC16 is set, a vertical bar one dot in width will appear on the screen to the left of each character column. This feature is provided to allow the user to view protectable and unprotectable areas of the screen. This helps greatly during screen formatting procedures.

Hardware/software tradeoffs. Many hardware/software tradeoffs can be made in this system depending on the economics of production and design effort. For example, a tradeoff was made in the system in this article concerning the memory remap scheme and selected from one of three trade-off possibilities. A decision was made to use simple hardware to remap both VTC-generated addresses and CPU-generated addresses and pay the price of spreading the buffer address space over twice the area. A second possibility is to use a PROM to remap the addresses linearly to reduce software and pay the price of the PROM and the time required to program it. A third possibility is to generate the remapping address in software and pay the price of longer execution time, more CPU independence, and more code.

Another tradeoff consideration concerns whether to overlay the hardware control register and the 16 addresses of the TMS 9927 on the 128 words of unaccessed memory at the high end of the buffer. Overlaying frees memory space taken by the control and VTC registers. However, this increases hardware cost.

Another major tradeoff can be made in hardware by using memory-mapping rather than a Communications Register Unit (CRU) to communicate with the TMS 9927. While using the CRU reduces hardware considerably and essentially breaks-even in software, only the TMS 99XX family of processors offers CRU capability. Typical monitor specs allow the designer to select three monitor parameters: horizontal line frequency, frame rate, and bandwidth. These three parameters allow selection of the rates of X, Y, and Z axes of the monitor. Use these parameters to calculate maximum expectations of the monitor in terms of lines per frame, total character rows and active characters/data per row.

The TMS 9927 video timer/controller can provide you with a way to ease design, improve reliability and cut your video terminal cost. Want more information? An application report, Bulletin MPO24 and data manuals provide additional information about the TMS 9927, TM 990/100M and video terminal applications. Contact Jim Muller, Mag. Bubble Memory Systems, Texas Instruments, Dallas, TX. Tel. (214) 995-4028. **D**

Brand New - Full 90 Day Warranty Brand New - Full 90 Day Warranty

Scherer's Line of New DEC Terminals

"Serving the DEC Community since 1976"

New Special Price VT 100-AA \$1,495 EA.
(with advanced video option)

VT 100-AA	1,375 EA.*
VT 132-AA	1,525 EA.*
LA 34-DA	895 EA.*
LA 34-AA	995 EA.*
LA 38-GA	1,095 EA.*
LA 120-RA	1,795 EA.*
LA 120-AA	1,995 EA.*
LA 120-BA	2,075 EA.*
LA 180-EA	1,750 EA.*

Items are in stock - no limit

★ Quantity 1 cash prices

Call: Sonja at (614) 889-0810

SCHERER'S MINI COMPUTER MART
6145-F Dolan Place Dublin, OH 43017

Warranty Brand New - Full 90 Day Warranty

Circle 48 on Reader Inquiry Card

BUBBLE MEMORY PERFORMANCE AT 1/10th THE COST

That's right. New World's exciting 5¼ and 8 inch Winchester disk drives deliver bubble memory performance at 1/10th the cost. And when compared to standard 5¼ and 8 inch floppies, our performance is unbeatable.

New World's MIKRO-DISCsTM have the entire capacity of a standard floppy under their unique

multiple head assembly at all times and can access this data in an average of 8 milliseconds, as compared to 300 milliseconds for a floppy. A very dramatic 37-fold increase in performance. And, the MIKRO-DISC has up to 16 times the capacity of a standard floppy.

New World's MIKRO-DISCs are small, powerful, low-cost memory systems that fill the gap between conventional drives and main memory. To get the complete MIKRO-DISC story, write or call.



**NEW WORLD
COMPUTER
COMPANY, INC.**

3176 Pullman Street, Unit 120
Costa Mesa, California 92626
(714) 556-9320



5 1/4" MIKRO-DISC V
2.8" x 5.8" x 8"
3.7 lbs.
(\$700 in qty.)

8" MIKRO-DISC VIII
2.0" x 8.5" x 12.0"
6.6 lbs.
(\$900 in qty.)

**See Us at NCC Booth 5509
Circle 49 on Reader Inquiry Card**

Disk Manufacturers and Their Products

Expanding Markets For Winchester Disks

Harry Shershow
Associate Editor

Rigid disk drives have been quietly changing the configuration of all computers. In 1972, for example, only 5% of all minicomputers had disk drives. Today, most minicomputers have such operating systems. A recent marketing report by Strategic Business Services predicts that even personal computers will eventually switch to small-size Winchester. The survey, completed in September, 1980, points out that Winchester disk technology has improved every year since its inception, improved dramatically in 1980, and will continue to improve in the years ahead. This improvement is taking place in both technology and in costs, says the report. In 1980, IBM delivered to the market a 2.35-GB drive at a cost of 79¢/MB. IBM's Winchester technology in 1973 (3340) was one thousand times smaller in capacity (twin storage capacity of 30 MB each) and its cost was almost triple that of today's cost.

The 8" Winchester disks have reached near full production by now, manufacturers claim. All disk sizes will continue to expand their data capacity with every passing year. SBS sees the 5-1/4"-drive moving toward the 40-MB high-water mark; 8" products will be reaching for 400 MB; 14" disks will pass the 2.5-GB threshold and soar into new dimensions.

Magnetic flux at the head-to-surface meeting point prevents current memory capacity from expanding. Helping to overcome this obstacle, however, is the newly developed thin-film-head which eventually will replace the ferrite head. With that barrier out of the way, more data will be squeezed onto more surface tracks and the head will be brought closer

Most of the material in this article was extracted from "Winchester Disks in Emerging Office Systems." That exhaustive, in-depth market survey has nine sections, 258 pages and sells for \$950. Publisher is Strategic Business Services, Inc., (formerly SBS Publishing;) 4320 Stevens Creek Blvd.; Suite 215; San Jose, CA 95129; Tel. (408) 243-8121.

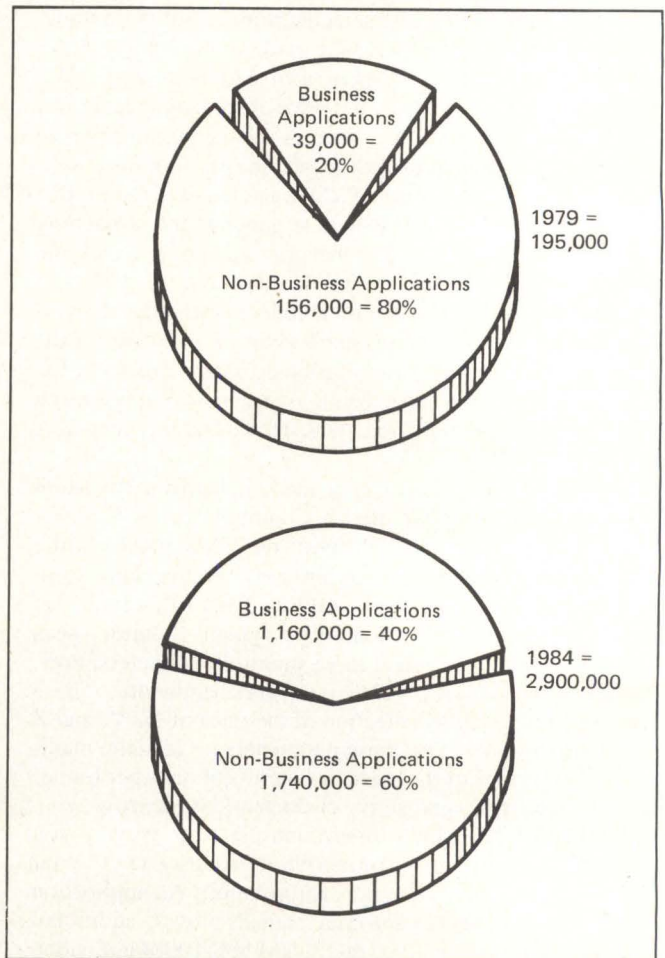

Figure 1: Business-applications units will rise 30 times in next five years; non-business-applications units, in same period, will increase about 10 times.

to the disk for error-free data processing.

Accompanying the improving technology in heads will be similar advances in back-up devices, control electronics and the new technologies of bubble memory, charge coupling and optical disks. SBS names the optical disk as the eventual replacement for the Winchester! Still to be overcome in optical disks, however, are the problems of slow data access speeds and non-eraseability of recorded data. The report says the speed problem will be solved in two years; eraseability, within five years.

The availability factor will have a continuing strong mar-

ket influence. Demand for the 8" drives now far exceeds available supply, due to unexpected development troubles that are now solved. Some large users did choose to go with the available 14" unit rather than wait for the 8" to arrive. A similar sales vacuum also existed in the 5-1/4" Winchester where the demand still is greater than the supply. Some hard-disk customers are remaining with the floppy for the present, and tolerating lower performance; but many will switch in 1981 as production quantities become available. Streaming backup will take longer, and 1982 will be the transition year.

Ultra-High Density, Removable Media Disk Drives: Evolution, Not Revolution

**Tom Beams,
James F. Moore,**
*Ampex Corp.,
El Segundo, CA*

Removable media disk drives over the past 20 years saw increased storage capacity gained by evolution. Several incremental iterations increased track densities and bit packing densities. In addition, improved data encoding and servo position reference techniques resulted from, respectively, the change from 2F codes to the now widely-used miller code (MFM), and the shift from external (to the media) glass grating or induction references to the integrated dedicated "servo" surface on the media, providing both data timing and track position information. The change to miller encoding enabled a more efficient disk surface usage and decreased DC content of the signal written on the disk, improving noise immunity.

The move from external position references to dedicated servo surface on the media itself permitted precision positioning required for higher track densities and permitted write data timing referenced to actual disk rotation (rather than an external reference clock). Utilizing this off-the-media timing reference ensures precise physical placements of write data on the media regardless of dynamic variations in rotation speed. This makes data recovery much easier than with previous techniques.

The removable pack size rapidly grew from 1 platter to 10, providing a resultant multiple of storage capacity by sheer increase in real estate (augmented by capacity increases gained by TPI and BPI increases). Packing densities climbed to 384 TPI and 6038 BPI, so it was possible to develop removable, rack-mountable pack drives having large capacities. The storage module class of drives is an example of this, with a three-platter pack (five data surfaces and one servo position reference and timing surface). Until the recent past, these drives permitted removable storage of up to 82 Mbytes in a 10.5" H x 17.25" W x 30" D unit. Our DM9160 stores 165 Mbytes in a same-sized unit.

evolution, not revolution

The basic 3330 design was quite conservative (over designed) and allowed the move to the 3330-11 with very little "stretching" of technology. Dropping from ten platters to three in the progression from 3330-11 technology to 80 Mbyte SMD likewise resulted in a conservative design. The move to the DM9160 from the 80 Mbyte SMD, like the move of the 3330 to the 3330-11, did not therefore require any extensive "technology stretching."

Through the disk industry, it has become almost an undisputed (albeit unsubstantiated) assumption that a removable media drive of significantly higher track packing densities than the 384 TPI storage module with its 823 tracks/surface could not be reliably produced unless a different approach than the dedicated servo position reference surface was taken. Usually the concept forwarded is that of "embedded servoing" (Enabling positioning detection by the same head as it used to R/W data on the tracks.) In fact, a removable media drive can be made with double the conventional track spacing and operate reliably using the dedicated servo surface approach.

servo electronics design

Crucial to success is the drive's ability to position heads reliably to very close tolerances of the nominal track centers at twice previous track densities. Accurately locating the 750- μ m R/W pole precisely at nominal track centers is equivalent to flying a 747 airplane in concentric circles separated only by 144' or about half a football field. (Since the head is at the outermost track location flying over a surface moving at 136.7 MPH, our 747 would fly at 424 million MPH). Additionally, the servo directed positioner must track circular track eccentricities during each revolution.

Extensive design and testing in linear positioner and servo electronics design optimizes the positioner to meet and exceed tolerances required, creating a tighter response servo electronics package. **D**

Company	14 inch	8 inch	5-1/4 inch
Ampex	9150	W/A*	
Ann Arbor			W/A
BASF	6150	6171/6172	W/A
Ball Computer Products	BFM-90, -160	W/A	
Burroughs	FD214		
Century Data Systems	Marksman M-40		
CII Honeywell Bull	D120, D140, D160		
Computer Peripherie Technik GmbH		HT-40	
Control Data Corporation	9730 Series, 33801 33502	Lark	
DASTEK	4835	2080	
Data General Corp.	6105		
Data Peripherals Inc.		W/A	
Data Recording Equipment Ltd.		3120, 3112, 3144	
Data Technology		W/A	
Datapoint		W/A	
Digital Equipment Corp.		W/A	
Fujitsu America Inc.	FG411, F496, F493, M2284, M2253	2311, 2312	
Hewlett-Packard	7910	W/A	
Hitachi	MFD-135F, DK62-8D	W/A	
IBM	3370	3310	
Int'l Memories Inc.		7710/7720	W/A
ISS/Univac	717, 735, 7350		
Kennedy	5303-70	7000-4, -12, -20	
Memorex	601, 602, 612, 3650/52	101, 102, 201	
Microcomputer Systems Corporation	MSC-5900	MSC-8000	
Microdata	7503	W/A	
Micropolis		1201, 1202, 1203	
Mitsubishi Electric Corporation	M2884-61	W/A	
New World Computer Co.		211 (Mikro-Disc VIII-1TF)	Mini-Micro-Disc V-1TF
Nippon Electric Corp. Information Systems	D1200 Series	D2210, 2220, 2230	
Nippon Peripheral Ltd.	NP24, NP25	NP31	
Okidata	3300	W/A	
Olivetti		W/A	
Ontrax		W/A	
Pertec Computer Corp.		D-8000	
Philips Data Systems BV	X1220		
Priam	DISKOS 3350, 3450, 6650, 5450	2050, 3500	
Remex	Data Warehouse		
Shugart Associates	SA4000, SA4100	SA1002, SA1004	W/A
Shugart Technology			ST506
Siemens Corporation	PS5-8		
SLI Industries		Minifax & Cheyenne	
Storage Technology Corporation	2700, 8350, 8650		
Toshiba	MK300F		
Nyquette			W/A
Quantum		W/A	
Britton & Lee			W/A
Trans Data			W/A

*W/A = Will announce

At the end of 1980 there were only 48 companies manufacturing Winchester drives in one or more of the three sizes. Now, every other week sees a new entrant. Three companies now dominate the Winchester market: IBM, Control Data, Shuggart Associates. IBM still remains the overpowering giant in this field, a position it has held since 1973, when it first introduced the Winchester technology, although CDC is considered by some to be the leading supplier.

As more and more small computers move into small business areas, they will start offering Winchester hard disk storage. However, everyone agrees that the costs of small Winchesters will have to come way down before they can be generally absorbed into cost-frame of all small (and personal) computers. Until the prices decline, most hard disk options will be offered only as add ons.

The leading personal computer manufacturers are either using Winchesters now (Ohio Scientific, North Star) or are evaluating them for future use. Those manufacturers are:

AlphaMicro Systems
 Apple Computers Inc.
 Atari
 Belvedere (formerly Exidy)
 Commodore Business Machines Inc.
 Computhink Computer Corporation
 Cromemco
 Digital Microsystems Inc.
 Dynabyte Inc.
 Heath Company
 Hewlett-Packard
 North Star Computers
 Ohio Scientific
 Radio Shack (Tandy)
 Southwest Technical Products Corporation
 Texas Instruments
 Compucolor
 Mattel Intellivision

Average selling prices for low-cost computers will dip even lower. In 1979, when a small business-computer (Radio Shack) was selling for around \$7,000, DEC's small system was \$58,000. By 1985, SBS predicts, the Radio-Shack-type computer will sell for \$3,276 while DEC's will cost \$26,000. By 1990, this price, if the slide remains consistent, could see prices of \$1,300 and \$16,000 respectively. The small business machine market will have grown by then to a \$50 billion level with three million units being sold annually. **D**

COMTAL brings you image processing for the 80's with their Vision One/20. The system that has been developed to handle your image analysis and interpretation through the 80's. With advanced features that give you a cost-effective real-time image enhancement system.

Hardware options from COMTAL include continuous zoom (COZO), an interactive spatial warping system (MAPPER), multi-megabyte virtual refresh memory (VREFM), and a digital video input processor (DVIP) for high quality film imagery.

Applications for the 80's

Besides the traditional areas of Landsat interpretation and enhancement as major applications for the 80's, there are several new emerging applications that are already taking advantage of digital image processing techniques.

These include:

- Seismic Analysis — Major oil and gas companies are using COMTAL's Vision One/20 for analysis of seismic data.
- Printing/Graphics — New applications are developing for using digital image processing in graphic arts composition and printing.
- LANDSAT/ Meteorology/Oceanography — Interpretation of remote sensing and satellite data to better understand the world around us.
- Medical — Enhancement, even in color, of X-rays and other medical imagery.
- Non-destructive testing — More and more industries are using image processing to better analyze non-destructive testing data.

To find out how COMTAL's Vision One/20 can take your images into the 80's, call or write today.

Real-time image analysis for the 80's



LANDSAT Interpretation



Printing/Graphics

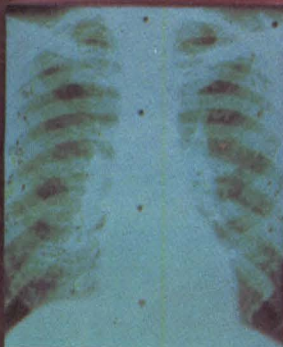

Medical Imagery

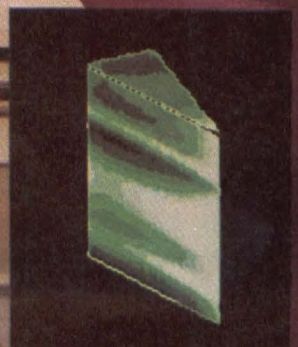

Seismic Analysis
(Oil saturation photo courtesy of Cities Service Company)

Circle 23 on Reader Inquiry Card
See Us at NCC Booth 2504

COMTAL/3M A subsidiary of 3M Corporation

505 W. Woodbury Road, Altadena, CA 91001, (213) 797-1175 TWX 910-588-3256

Thin Film Head Increases Micro-Winchester Capacity

Finis Conner
Seagate Technology
Scotts Valley, CA

The 5-1/4" micro-Winchester disk market is now implementing thin film head technology in this small size drive. What does such head technology mean for this size drive? What does it bode for OEMs?

form factor unchanged

Thin film head technology has been around for at least two years since its debut on the IBM 3370 disk drive system. Thin film heads, in this size Winchester, will begin a growth path upward in capacity, while keeping the same Minifloppy form factor of $5.75 \times 3.25 \times 8.0$ ". Packing larger amounts of data into the same disk area results in a lower price per bit. The latest price/bit reduction has been achieved with higher recording densities and use of thin film heads in the IBM 3370 disk drives. Since this is the first product implementation of thin film heads, one would expect additional price per bit reductions as improvements in the technology become available.

Thin film heads are the forces in micro-Winchester's impressive capacity increase. Time proven semiconductor industry processes are used to miniaturize conventional ferrite recording heads. Performance improvements result, with a vast improvement in consistent manufacturability of recording heads. The heads' smaller size, mass, and better geometric definition improve efficiency from a magnetic and electronic standpoint.

In addition, since head track width is defined by photolithographic processes instead of machining operations, track width can be defined with greater precision as well. This allows a track density of 270 tracks/inch, and remain well below the capability of the technology.

The basic differences between Dastek thin film heads used on the company's own 4835 14" Winchester and the ST512, are in track width and air bearing surface. Track width is greater due to lower track density, and air bearing surface is

greater to allow for a lower disk surface speed.

These specs are nowhere near the capability of thin film heads; with this new technology, 15,000 bpi and 1000 tpi can easily be supported. Thus, while ferrite head products have all but filled their entire useable disk surface, the new disk has plenty of space in which to expand. Then, when two platters have been filled, the third disk can be added to further improve capacity in the same form factor. With thin film heads, it is reasonable to expect capacity of up to 50 Mbytes in the Minifloppy form factor.

Vendors with ferrite head drives using two platters are providing only half capacity. To get near equivalent capacity



Figure 1: ST512s thin film head (left) provides mechanical and electrical characteristics superior to ferrite heads (right). Width of board track is 0.375".

FLOATS LIKE A BUTTERFLY™

Introducing the Butterfly™ switch. The first Key Tronic capacitive keyboard with linear feel. For years our customers have been successfully using tactile feel, however, we've had input from the field that a lot of you like linear feel. Key Tronic now offers both. We want to be your keyboard supplier.

This patented solid-state keyboard uses the same electronics as our proven tactile design. You still get N-key rollover (a must in any medium to high speed data-entry environment) at no extra charge. The same double-shot

molded keytops with over 20,000 legends and over 300 shapes are still available from the leader.

Please call or write for further information. You'll be glad you did.



 **key tronic**
INTERNATIONAL KEYBOARDS

P.O. BOX 14687 — SPOKANE, WASHINGTON 99214 U.S.A. PHONE (509) 928-8000 — TWX 510 773-1885

Never Before Has A Back-up System Been As Intelligent As The System It's Backing Up.

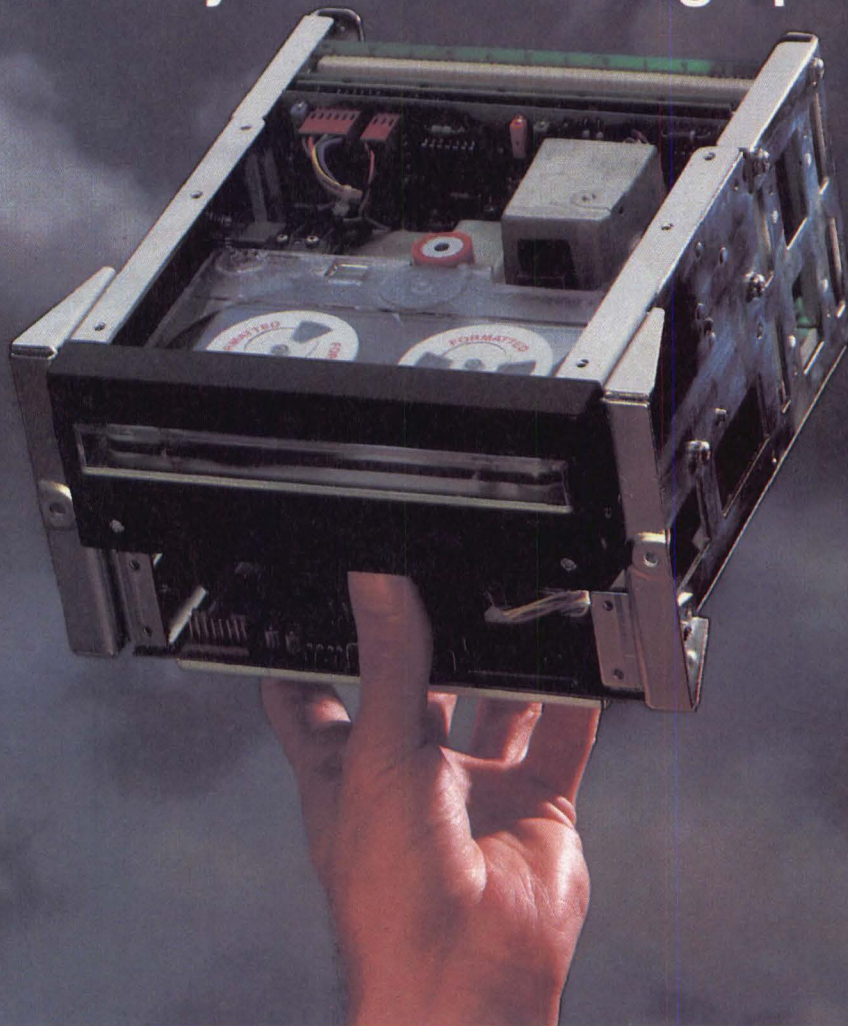

This is 3M's HCD-75 High Capacity Data Cartridge Drive. And the reason it's as intelligent as a computer is because it thinks like one.

You see, unlike other back-up systems, the HCD-75 is interfaced directly with the primary system by means of sophisticated, microprocessor electronics. When the host computer has data to feed, the HCD-75 starts automatically. When the host computer stops, it does too. And since the HCD-75 also positions to any location, it not only saves tape cost, but retrieval time as well.

Of course, the use of microprocessors allows the HCD-75 to perform a number of other time-saving functions, too. Like block replacement, so you can easily correct errors or change files which need updating. And fast random access, which makes it useful both as an I-O device or as a storage unit for low-usage files. All of which relieves the host computer from difficult timing and formatting problems.

What's more, the HCD-75 features state-of-the-art error detection and correction capabilities. Even when

the system is off-line, self-test diagnostic routines monitor its performance. And, combined with each of its \$32.50 high-capacity cartridges, the HCD-75 provides a full 67 megabytes of formatted user information (144 mbytes unformatted). So costly operator interventions are sharply reduced.

If you're looking for a reliable, cost-effective solution to the problem of disk back-up, the HCD-75 High Capacity Data Cartridge Drive is the system you should be thinking about.

Not only has a lot of thinking gone into it. But a lot of thinking comes out of it, too.

For more information, check the listing on the next page for the representative nearest you. Or write: Data Products Division/3M, Bldg. 223-5E/3M Center, St. Paul, MN 55144.

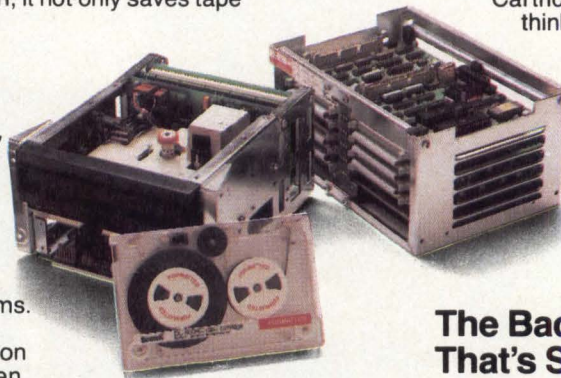

The Back-up System That's Suddenly Way Out Front.

3M Data Products Representatives

Data Products/3M
3M Center, 223-5E
St. Paul, MN 55144
612/733-8892

CANADA

3M Canada, Inc.
P. O. Box 5757
London, Ontario, N6A-4T1

WEST

Hefte Industries, Inc.
Los Gatos, CA
408/264-8319
CTI Data Systems, Inc.
Long Beach, CA
213/426-7375
P.A.R. Associates
Denver, CO
303/355-2363
PSI Systems, Inc.
Albuquerque, NM
505/881-5000

MIDWEST

OASIS Sales Corporation
Elk Grove Village, IL
312/640-1850
Carter, McCormick & Pierce, Inc.
Farmington, MI
313/477-7700
The Cunningham Co.
Houston, TX
713/461-4197
Cahill, Schmitz & Cahill, Inc.
St. Paul, MN 55104
612/646-7212

EAST

J.J. Wild of New England, Inc.
Needham, MA
617/444-2366
Wild & Rutkowski, Inc.
Jericho, Long Island, NY
516/935-6600
COL-INS-CO., Inc.
Orlando, FL
305/423-7615
Technical Sales Associates
Gaithersburg, MD 20760
301/258-9790

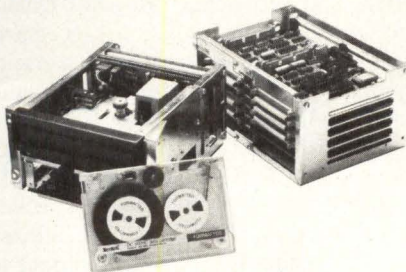

3M Hears You ...

providing only half capacity. To get near equivalent capacity a third disk is required. The big question: How do you increase future capacity by adding more platters while still remaining in the same compact form factor?

eliminating write pre-compensation

Still another thin-film-head advantage is elimination of write pre-compensation — an ever present problem with ferrite head drives. On these older technology

Controller Manufacturers

Alpha Systems Corp.

Joe Wright
711 Chatsworth Pl.
San Jose, CA 95128
408/297-5583
Floppy disk emulator

American Computer & Telecommunications

Tom Allen, Steve Shaffert
11301 Sunset Hills Rd.
Reston, VA 22090
703/471-6288
HEATH/S-100/TRS-80

ANDICOM Technical Products

James Ting
720 Spadina Ave.
Toronto, Ontario
Canada M5S 2T9
416/968-3029
S-100, Apple

Anova Corp.

Dale Williams
760 Longridge Rd.
Oakland, CA 94610
415/836-0800
Multi-bus

Codata Systems

Gary Oates
285 N. Wolfe Rd.
Sunnyvale, CA 94086
408/735-0800

Control Systems

Dave Allen
1317 Central
Kansas City, KS 66102
913/371-6136
Gen. Purpose

Data Technology Corp. (DTC)

Larry Sarisky
2344 A Walsh Ave.
Santa Clara, CA 95051
408/496-0434
Gen. Purpose S-100,
Z80, LSI-11, 6800,
SBC80

Data Management Labs

Dave Scott
2148 Bering Dr.
San Jose, CA 95131
408/946-9424
S-100 Multibus

Distributed Logic Corp. (DILOG)

Glen Salley
12800 G. Garden Grove Blvd.
Garden Grove, CA
92643
714/534-8950
LSI-11/PDP-11

KONAN Corp.

Bruce Wagner
1448 N. 27th Ave.
Phoenix, AZ 85009
602/269-2649
S-100

Lobo Drives

Roger Billings
935 Camino Del Sur
Goleta, CA 93017
805/685-4546
S-100

Microcomputer Systems Corp. (MSC)

John Nosek
432 Lakeside Dr.
Sunnyvale, CA 94086
408/733-4200
IEEE-488, HPIB,
Multibus.

Monitor Dynamics

Gary Clinard
1143 West 9th
Upland, CA 91786
714/982-2216
Custom Des.

Morrow Design

Norm Towson
5221 Central #2
Richmond, CA 94804
415/524-2101
S-100, Single Bd.

Piiceon

Chris Bailey
2350 Bering Dr.
San Jose, CA 95131
408/946-8030
S-100

Progressive Computer Products

Mike Moore
714 Alhambra Blvd.
Sacramento, CA 95816
916/447-7048
TRS-80

Western Digital

Kathy Braun, ext. 241
3125 Red Hill Ave.
Newport Beach, CA
92663
714/557-3550
Gen. Purpose

XCOMP

John Costello
7566 Trade St.
San Diego, CA 92121
Telex 182786
714/271-8730
S-100, Gen. Purpose

NOTE: This does not constitute an endorsement by Seagate Technology of these company's products; companies listed expressed an interest in doing a product compatible with the ST506. Contact them for details on schedule, pricing, etc.

FAST!

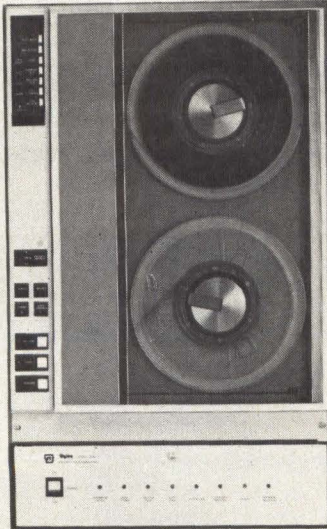

recording solutions for
DEC LSI-11 MINC and
other INSTRUMENTATION
and DATA LOGGING
systems.

IEEE-488 1/2-inch
magnetic tape recording systems

- Dual density, speeds to 75 ips
- World-wide computer data interchange
- Data acquisition, ATE, CAD, disc back-up and more . . .
- IBM and ANSI compatible formats
- Transfer rates to 100,000 bytes/sec.
- Dual buffer to 16,384 bytes
- Over 40 MBytes of storage

Dylon Corporation



10130 Sorrento Valley Rd., San Diego, CA 92121
(714) 455-6102 TWX: 910-335-1524

Circle 39 on Reader Inquiry Card

WANTED: Editors

We're looking for technical editors or good electronics engineers who have thought seriously about becoming editors. If it's creativity and expression you want, we'll give you all you can handle. All we need is your editorial skill and/or engineering expertise, and we'll show you how to be an editor and enjoy it.

You will operate out of our Boston, San Jose or Los Angeles office. Salary is negotiable. Call or write, with resume, to either:

H. G. Buchbinder
Benwill Publishing Corporation
1050 Commonwealth Ave., Boston, MA 02215
(617) 232-5470

C. King
Benwill Publishing Corporation
1901 S. Bascom Ave., Campbell, CA 95008
(408) 371-9620

drives, the problem presented itself in the higher numbered tracks nearer the drive center. Data here is packed more closely together, hence producing higher flux densities.

With this greater flux packing, transitions shift in time, increasing risk of soft errors, in turn leading to a different spacing in time of the transition than was originally recorded. To counteract this shift, pre-compensation was added as needed on the ST512.

In the first case, since the first "1" will tend to move toward the "0", it is written 12 ns late, as this is the optimum pre-compensation to be added for both early and late pulses. In the second case, the second "1" shifts toward the "0", hence is written 12 ns early to compensate. In the third case, adjacent zeros move apart with the clock pulse written for the middle "0" moving toward the last "1"; hence this clock pulse is written 12 ns early.

To effect this pre-compensation, two methods are employed; advancing or delaying the write pulses and causing current applied to the write head to move up or down the saturation curve. This is avoided on the ST512. Without it, the drive still provides a soft error rate of 1-in-10¹⁰ bits read and a hard rate of 1-in-10¹² bits read. In addition, hardware needed to effect the pre-compensation methods is eliminated.

compatible upward migration

With all this larger capacity, does the OEM face the prospect of being forced to redesign the controller he has built for the previous generation drive? No, our interface was established on the first ST506. When the interface was initially designed, the foremost consideration was future capacity growth. Once this was accommodated into the interface, future products could be developed.

While ST512 differs from ST506 in capacity and head technology, it is virtually identical otherwise; its rotational speed, 3600 RPM; transfer rate, 5.0 MHz; and recording format all remain the same. The same rotational speed permits the same transfer rate with capacity increase by keeping the same amount of data on a track while increasing the number of tracks. On the ST512 and ST506, there are 10417 bytes/track, with 32 sectors/track. However, on the newer drive, additional tracks are utilized inward on the disk recording surface to achieve the increased capacity.

With this interface constancy, OEM system builders can offer the next-generation product with a large memory increase — without redesigning this controller.

interface accepted

The interface has good acceptance among 5-1/4" disk suppliers. Tandom Magnetics has standardized its products on the Seagate interface, and both T.I. and Honeywell-Bull have chosen to second-source the drive. While second sourcing is common in the IC industry, these second source agreements on a disk drive are unique in the peripherals business. Finally, there are a number of controller makers providing products for the interface.

Because the interface is common between all our drives, ST512 can easily be incorporated into existing designs, permitting system builders to quickly and economically upgrade their product offering. With ST512, they can, for instance, obtain about eight times the capacity of an 8" floppy for roughly twice the price. The ST512 will find applications in the new generation of systems built with the larger, faster 16-bit and 32-bit μ P chips. This large storage capacity will address a key problem and in these future systems: programmer productivity. Previously, memory space was costly and programs were efficiently written to save memory. Now, with the processor capable of addressing 12 Mbytes or more of main memory, this problem is lessened somewhat. However, this larger main memory meant a need for greater on-line disk memory. Now, programmers can have, in a very compact space, the memory they need to write prompt-driven tutorial programs and other similar programs that can effectively be executed quickly from disk memory.

Thus, greater on-line disk memory will serve in new office systems as an electronic file cabinet; in small business systems, will provide big system storage capacity at a small system price and, in the emerging local area networks, will serve as storage for main nodes in the system.

how the drive works

Inside the drive itself, R/W electronics move data on and off the disks. An actuator places the head over the correct track; and, an air filtration system assures contamination-free operation.

R/W and control electronics reside on two PC boards. Primary board circuits control the following drive functions: index detection, head positioning, R/W operation, drive speed detection, head selection, write fault detection, stepper motor operation, drive selection and track zero detection. The second PCB provides power and speed control to the spindle drive motor.

Providing the central spindle drive is a dc motor which rotates the disks at 3600 rpm. The spindle is driven directly with no belt or pulley. To reduce temperature rise in the sealed chamber containing heads and disks, the motor is thermally isolated from the baseplate. To ensure low vibration, both motor and spindle are dynamically balanced; a brake stops the spindle motor quickly when power is removed. In addition, the baseplate is shock mounted.

Drive R/W heads are mounted on a ball bearing supported carriage and positioned by a band actuator connected to the stepper motor shaft. Heads fly over a lubricated thin magnetic oxide coating on a 130-mm diameter aluminum substrate. The coating formulation of the disk surface, together with low-load-force/low-mass thin film heads, permit reliable contact start/stop operation. Data on each of the four disk surfaces is read by one R/W head, each of which accesses 306 tracks.

Looking for more information and performance specs on the ST512? Contact: Seagate Technology, 340 El Pueblo Rd., Scotts Valley, CA. (408) 438-6550 \square

All other Mag Tape Controllers for PDP-11/VAX-11 just became yesterday's technology.

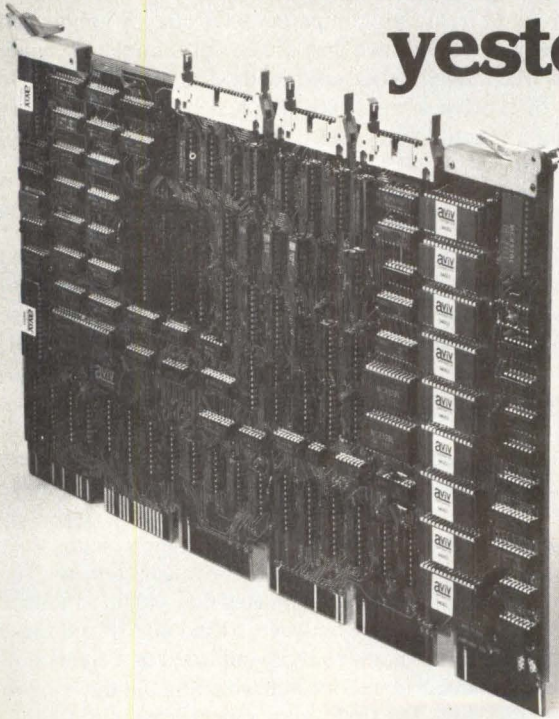

Because Aviv is first again with another major step in minicomputer peripheral technology...the industry's first **dual-density** single-board mag tape controller for PDP-11* and VAX-11* users.

Aviv is the company that introduced the first mag tape controller for LSI-11's... as well as the first GCR mag tape systems for PDP-11/VAX-11 and Nova/ECLIPSE.** Now, Aviv does it again with the new TFC-822... the industry's first **dual density**, mag tape controller on a single hex board for PDP-11/VAX-11 unibus computers.

We didn't take out features...we added them and still designed a smaller and more efficient controller. Features include: bit/slice technology; large FIFO data buffer; burst mode transfer; optional read/write of gapless tape and more.

If you're a DEC user, Aviv's **dual density**, single board mag tape controller will enhance your total system. TFC-822 delivery is 30 days A.R.O. Write or call Aviv for further information.

aviv
CORPORATION

6 Cummings Park
Woburn, Massachusetts 01801
(617) 933-1165

* Digital Equipment Corporation
** Data General Corporation

Circle 52 on Reader Inquiry Card

Consider Applications When Specifying Winchester Disk Drives

C. C. Connell
Corvus Systems, Inc.
San Jose, CA

What should you look for in choosing a Winchester? Each buyer has a set of individual needs set by his market. Basically, there are nine specific qualities for drives. These are: reliability, ease of interfacing, capacity, future expandability, price, availability, backup, access time and physical dimensions.

reliability comes first

Reliability is a prime factor in the disk drive selection. Look for a drive that doesn't require constant service, performs as advertised, and will be in use for the maximum amount of time. The marketplace using these drives is made up of people who are not schooled in computer science. Small, inexpensive systems are not placed in a computer room environment. As a result, look for a drive free of a requirement for periodic maintenance. The ideal drive is maintenance free.

Expect the disk-drive manufacturer to have tested his product before shipping. Give each drive a 48-hour burn-in time as a final check. It is the drive manufacturer's responsibility to have pretested it and exercised QC before it's released. Most manufacturers derive their standards from a statistic based upon a large number of drives built over a given period of time. The manufacturer doesn't guarantee, for example, that every drive in a lot of 1000 will be free from defects; rather he states that *on the average* there will be *n* hours mean time before failure. This figure is an average of a large number of drives tested, or in use, over a long period of time. If the manufacturer has had enough drives in the field to produce such a statistic, then it is a valid criterion. If the manufacturer is new to the Winchester industry — and in today's market this is most often the case — then there is not a large enough number in use for one to make a definitive decision on MTBF.

is interfacing easy?

Next in importance is "ease of interfacing." This is a function of what the drive manufacturer provides. Look for a

manufacturer providing a drive control electronics PC card with functions like data preamplification and clock separation, head select and positioning circuitry, and spindle speed regulation. The number of different input supply voltages required should be kept to a minimum.

Drive capacity is another high priority criterion. Look for large capacity to find the lowest cost.

Track and bit densities increased last year. Once upon a time, you could only expect 10 MB from 8" two-disk drive. Today, in April 1981, it is possible to obtain 40 MB on an 8" five-disk drive.

Newest in this fast changing field is the 5-1/4" Winchester disk drive. At least four companies have already announced availability of a 5-1/4 inch disk drive with a formatted capacity of 5 MB. What about six months from now? A 5-1/4" 20-MB disk drive or an 8" 80-MB Winchester? Perhaps. In choosing a manufacturer, select one who intends to expand drive capacity.

expandability counts

Since 1956, increases in trace and bit densities have been constant. Initial disk drive designs are conservative and use low track and bit densities that can be improved once the product and technology are better understood. Look for this future expansion on the part of the manufacturer; as long as the manufacturer upgrades his product, you can upgrade yours.

Media and head quality, and reliability of data recovery circuitry at higher rates, are areas of concern that make judgment of drive expandability difficult: some designs may not be upgradable — despite the manufacturer's claims.

Availability, or "can he deliver", is a major concern. Ten months ago 14 manufacturers indicated they would announce a new 8" Winchester drive between 10 and 40 MB. Of these 14, five never did. Another survey indicated that eight companies in this same 8" category were shipping. Of these eight, one never did ship. The first figure indicates that almost 36% were not able to produce the Winchester promised; the

THE SMART SET

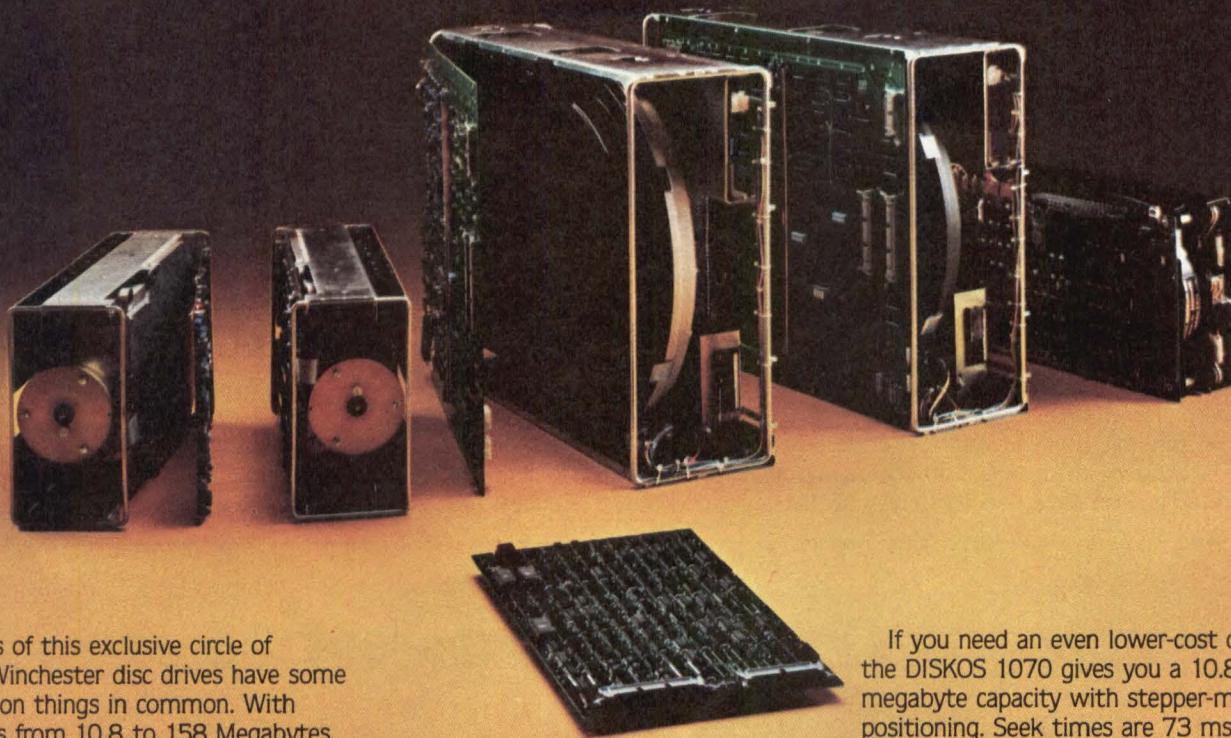

Members of this exclusive circle of PRIAM Winchester disc drives have some uncommon things in common. With capacities from 10.8 to 158 Megabytes, they have the same interface. And they all connect quickly and easily to micro-processor I/O busses through PRIAM's SMART or SMART-E Interface.

With a simple adapter your system can have the remarkable reliability of Winchester disc drives. And PRIAM's DISKOS drives give you the lowest cost-per-megabyte for your system database.

SMART Gets Smarter!

With its own sophisticated pre-programmed microprocessor, PRIAM's SMART Interface gives you comprehensive disc subsystem functions, including:

Control of any combination of one to four PRIAM Winchester disc drives.

Automatic alternate sector assignment for disc-defect transparency to the host processor.

In addition to all SMART functions, PRIAM's new SMART-E Interface provides ECC, streamlined software, sector interleaving, a 2048-byte buffer, and logical-sector addressing. Both the SMART and SMART-E come to you on a single 8" x 14" printed circuit board that is powered from the drive. And it piggybacks on the drive or mounts separately.

Meet The Elite! PRIAM's High-Capacity, Low-Cost 14-Inch Drives

PRIAM's high-technology 14-inch disc drives have capacities of 34, 68, or 158 megabytes, and they all fit in the same 7" x 17" x 20" package, including optional power supply. Fully servoed linear-voice-coil head positioning is reliable and fast—45 ms average for the 34 and 68 megabyte drives and 40 ms for the 158 megabyte version. Track to track is 8 ms.

Brushless DC spindle motors in all PRIAM drives assure mechanical simplicity, precise disc speed control, and operation anywhere in the world without change. No relays, mechanical brakes, brushes, belts, or pulleys. Pure, reliable electronic control. Elegantly simple.

The Talk Of The Town: PRIAM Eight-Inch-Disc Drives!

Debut a Winchester disc drive in place of a floppy disc with PRIAM's DISKOS 3450 and 7050, expanding your database to 35 or 70 megabytes. Thoroughbred performance goes with their linear voice-coil positioners; seek times are only 40 ms average and 8 ms track-to-track.

If you need an even lower-cost drive, the DISKOS 1070 gives you a 10.8-megabyte capacity with stepper-motor positioning. Seek times are 73 ms average and 23 ms track-to-track. And they're just as SMART as other PRIAM drives when used with PRIAM's SMART or SMART-E Interface.

More Basic Interface Options!

To those who have their own controller plans, PRIAM offers lower-cost drive-level interfaces. PRIAM's bit-serial NRZ data interface, similar to the evolving ANSI standard, has an 8-bit bidirectional control bus for easy connection to popular 8 and 16-bit microprocessors. Data separation is included in all PRIAM drives.

And if you have a Storage Module controller, you can use it and your software with PRIAM's SMD Interface to update your system with Winchester drives quickly and inexpensively.

For complete information about the SMART and SMART-E Interfaces and PRIAM's SMART SET of Winchester disc drives, RSVP by telephone or write to:

Visit us at NCC.
Booth #4704 & #4705,
Concourse Level,
McCormick Place.



PRIAM

3096 Orchard Drive San Jose, CA 95134
Telephone (408) 946-4600 TWX 910-338-0293

Circle 25 on Reader Inquiry Card

second, that 12% could not deliver. Seeing is believing. The choice of a manufacturer is crucial to your own credibility, not to mention profitability. Require a manufacturer to produce what he promises.

Find an economical way to back up the data stored on your Winchester drive. Consider providing a backup system for your customers, selecting a disk drive that does this efficiently. Backups available today include floppy, streaming tape and video tape.

minimize interface design

Puts effort into expanding the controller code. Thus you will be able to interface to all computers — not a particular one. If a shared controller is used for both backup device and disk controller, more intelligence is required. In this respect, look for drives easily interfaced to the controller you already use. This minimizes the problem of designing an interface to a new drive in your (hopefully large) controller firmware library, as well as your peripheral family.

Require a fast access time because the drive is a part of our network installation. Seek and latency times make up the access time requirement. Both are crucial. Seek time is time for the head to go from one disk spot to some other spot. Once the head is positioned, it takes finite time (latency period) for

the desired sector to rotate under the head. With multiple μ Cs asking for data from the drive, both seek and latency times must be fast.

While the data transfer rate is important (and you should look for a fast transfer rate), do not place it at the top of your priority list if you produce an intelligent interface that goes between your disk drive and host computer or multiplexer.

Since small packaging is highly desirable, look for small dimensions, minimal weight and quietness. If your drives are placed in offices or classrooms, a noisy motor or fan is annoying.

Drives that require a large amount of dc power need expensive power supplies and larger fans. Look for a physically small drive with low power consumption.

applications dictate priorities

It is difficult to list priorities. Reliability is first from all managers' viewpoints. After that, determine where a trade-off will occur and where the list of priorities can be altered without, in any way, damaging product integrity.

Decide what is most important for your product. After reliability comes ease of interfacing, capacity and future expandability. The next five — price, availability, backup, access time and physical dimensions — are variable. **D**

Winchester-Drive Manufacturers

Ball Computer Products

860 East Arques Ave.
Sunnyvale, CA 94086
(408) 733-6700

BASF Systems

Crosby Dr.
Bedford, MA 01730
(617) 271-4000

Burroughs Corp.

777 Welch Rd., Suite # 158
Palo Alto, CA 94304
(408) 321-5363

Century Data Systems

1270 North Kraemer Blvd.
Anaheim, CA 92806
(714) 632-7500

Control Data Corp.

8100 34th Ave. S.
Minneapolis, MN 55440
(612) 853-8100

Dastek Corp.

141 Albright Way
Los Gatos, CA 95030
(408) 866-0550

Data Peripherals

965 Steard
Sunnyvale, CA 94086
(408) 745-6500

Fujitsu America, Inc.

2945 Oakmead Village Court
Santa Clara, CA 95051
(408) 985-2300

Hitachi America, Ltd.

100 California St.
San Francisco, CA 94111
(415) 981-7871

International Memories, Inc.

10381 Bandlely Dr.
Cupertino, CA 95014
(408) 446-9779

Irwin International

2000 Green Rd.
Ann Arbor, MI 48105
(313) 663-3600

Kennedy Co.

1600 South Shamrock
Monrovia, CA 91046
(213) 357-8831

Memorex Corp.

San Tomas at Central Expwy.
Santa Clara, CA 95052
(408) 987-1000

Microdata Corp.

17481 Red Hill Ave.
Irvine, CA 92713
(714) 540-6730

Micropolis Corp.

21329 Nordhoff St.
Chatsworth, CA 91311
(213) 709-3300

Mitsubishi Electronics America, Inc.

2200 W. Artesia Blvd.
Compton, CA 90220
(213) 979-6055

New World Computer Co., Inc.

3176 Pullman St., Suite 120
Costa Mesa, CA 92626
(714) 556-9320

Ohio Scientific, Inc.

1333 South Chillicothe Rd.
Aurora, OH 44202
(216) 562-5177

Pertec Computer Corp.

Box 2198
Chatsworth, CA 91311
(312) 999-2020

Priam Corp.

3096 Orchard Dr.
San Jose, CA 95134
(408) 946-4600

Seagate Technology

340 El Pueblo Rd.
Scotts Valley, CA 95066
(408) 438-6550

Shugart Associates

475 Oakmead Parkway
Sunnyvale, CA 94086
(408) 733-0100

Storage Technology Corp.

2270 South 88th St.
Louisville, CO 80027
(303) 673-5151

Tandon Magnetics Corp.

9333 Oso Ave.
Chatsworth, CA 91311
(213) 993-6644

You don't get the lion's share of the market by pussyfooting around.

You get it by building the most reliable tape, disc and printer controllers available. Our very first production units built in 1975 are still going strong.

Wespercorp controllers work, right from the moment they're installed, because we thoroughly test and document the performance of each one under actual operating conditions before shipment.

You get it by building one of the best service organizations in the business.

Should you need us anywhere in the world, we'll be there fast. We even fly our

own airplanes, so you won't have to wait.

Wespercorp controllers and cabinets fit DEC (LSI-11, PDP-11) IBM Series I, Data General, and Perkin Elmer computers. Delivery in 30 days ARO – sometimes even faster.

Get the complete story. Call or write us today.

Wespercorp., King of the Jungle, 14321

Myford Rd., Tustin, CA 92680. U.S.A.

Ph. (714) 730-6250.

 **WESPERCORP™**
western peripherals · WESPERLINE · DATASYSTEMS

Number 1 in controllers.

Circle 26 on Reader Inquiry Card
See Us at NCC Booth 2610

BUTER



SOME MODELS & THEIR SPECS

A brief survey of what is currently available was made. Your company name does not appear in the list if there was no response to either our letter or telephone call. It should be pointed out that there is

5^{1/4}-INCH HEADS

Company	MB. Unformatted/ Formatted	No. of Data Surfaces	No. of Disks	Bytes per track	Tracks per inch, Bits per inch	Actuator Type	Data transfer rate K/sec	Interface Type
IMI	7 u	4	2	12095 u	200/8700	Stepper	960 K/sec	SA 1000
Irwin International	12.3 u/10 f	2	1	9135 u	900/8000	Servo positioner	662 K/sec	ANSI STD
New World	1.8 u/1.3 f	1	1	8192 f	200/9000	Stepper	—	Floppy
Seagate Technology	6.38/5.1	4	2	8192 f	254/7690	Stepper	625 K/sec	Floppy
Shugart Assoc.	6.38/5	N/A	N/A	N/A	N/A	N/A	N/A	N/A

14-INCH HEADS

Ampex	16	1	1	20,160	367/6274	Rotary	1,209	SMD/CMD
	48	3	2	20,160	367/6274	Rotary	1,209	SMD/CMD
	80	5	3	20,160	367/6274	Rotary	1,209	SMD/CMD
Century Data	20	2	1	24,000	182/7545	Stepper	960	Marksman
	40	4	2	24,000	182/7545	Stepper	960	Marksman
	80	3	2	24,000	480/7545	N/A	960	Marksman
H-P 300 Series	12.09 f	2	1	—	300/3225	Rotary	409.6	HP
Kennedy	14 u	1	1	20,160	300/6000	Rotary voice coil	1,000	SMD
	42 u	3	2	20,160	300/6000	Rotary voice coil	1,000	SMD
	70 u	5	3	20,160	300/6000	Rotary voice coil	1,000	SMD
Shugart Assoc.	14.5	2	1	15,400	172/5534	Stepper	—	Floppy
	29	4	2	15,400	172/5534	Stepper	—	Floppy
	58	8	4	15,400	172/5534	Stepper	—	Floppy
Ball	90	4	3	20,160	480/6486	Linear Motor	1,200	SMD
	160	7	4	20,160	480/6486	Linear Motor	1,200	SMD
Dastek	203.5 u	3	4	40,960	694/12,772	Linear Voice Coil	1.2 MB	SMD
	339.2 u	5	New units. Information not yet available.					
	407.0 u	6	New units. Information not yet available.					

more disagreement than agreement among manufacturers on what is being defined. For example, how does one define access time, latency time, tracks, bits and bytes per inch? Not everyone agrees on the definitions.

Because not all questions were answered in the

requested form, the survey is brief. In some cases, a manufacturer stated that he was currently shipping a product, but no quantity was listed. This article was prepared in January of 1981, therefore it was not possible to determine how many drives might have been shipped by April.

Spindle Speed (RPM)	Min. access time (ms)	Avg. access time (ms)	Max. access time (ms)	Avg. latency time (ms)	Height, inches	Width, inches	Weight, lbs.	Backup	No. units in field a/o 12/31/80	Began shipping	Drive sold with or without controller	Price per unit
4800	17	110	300	6.25	3.25	9	—	—	—	1/81	opt.	—
4000	5	25	40	7.5	3.25	5.75	5	Integral cartridge	—	2Q/81	—	—
3600	5	8.3	28.3	—	2.8	5.8	3.75	Floppy	10	9/80	with	\$3500
3600	18	90/170	500	8.33	3.25	5.75	4.5	—	1200	8/80	w/o	\$1500
N/A	N/A	N/A	N/A	—	—	—	—	—	—	3Q/81	—	—
3600	6	30	55	8.3	10.3	19	170	Fixed w/cartridge	—	—	—	\$6400
3600	6	30	55	8.3	10.3	19	170	Fixed w/cartridge	1,000	10/79	opt.	\$7300
3600	6	30	55	8.3	10.3	19	170	Fixed w/cartridge	—	—	—	\$8100
2400	20	65	120	125	8.7	16.9	30	—	—	1978	opt.	\$2495
2400	20	65	120	125	8.7	16.9	30	—	—	1978	opt.	\$3090
2400	20	50	100	125	8.7	16.9	40	—	—	1978	opt.	N/A
3000	11	70	100	10	9.3	19	70	Floppy	2400	3/80	with	N/A
3000	10	45	70	10	6.9	19	75	Tape	—	—	w/o	\$3500
3000	10	45	70	10	6.9	19	75	Tape	900	1979	w/o	\$4000
3000	10	45	70	10	6.9	19	75	Tape	—	—	w/o	\$4500
2964	20	65	140	10.1	5.2	16.6	35	Recommend	—	1977	w/o	\$2550
2964	20	65	140	10.1	5.2	16.6	35	1/2" streaming	1000+	1977	w/o	\$3500
2964	20	65	140	10.1	5.2	16.6	35	tape	—	2Q/81	w/o	—
3600	8	30	55	8.4	10.6	17.5	180	—	100	9/80	w/o	\$5800
3600	8	30	55	8.4	10.6	17.5	180	—	—	—	w/o	\$6500
1785	5	25	55	—	10	17 1/2	118	Non recommended	—	12/80	w/o	—

8-INCH HEADS

Company	MB. Unformatted/ Formatted	No. of Data Surfaces	No. of Disks	Bytes per track, KB	Tracks per inch, Bits per inch	Actuator Type	Data transfer rate K/sec.	Interface Type
Control Data	8 fixed	4	2	—	237/10,161	—	1200	SMD
	8 Removable	—	2	—	237/10,161	—	1200	SMD
Burroughs	20	2	1	—	—	—	—	—
Memorex	11.7/10.7	4	2	—	195/6100	Band	596.6K	Shugart SA 4000
BASF System	8.19/7.54	1	1	12,288 f 13,344 u	500/6,542	Linear voice coil	806	SMD; Disk Bus ANSI Std.
	24.57/22.63	3	2	12,288 f 13,344 u	500/6,542	Linear voice coil	806	SMD; Disk Bus
	40.95/37.72	5	3	12,288 f 13,344 u	500/6,542	Linear voice coil	806	ANSI Std.
Data Peripherals	11.02/10.08	2	1	u 13.44K F 12.3K	478/6866	Linear voice coil	874	SA-1000
Fujitsu	11 u	4	2	12,000	195/6100	(Stepper Motor	593	SA-4000
	23 u	8	4	12,000	195/6100	w/band actuator)	593	SA-4000
	48 u	4	3	20,480	720/9550	(Rotary voice	1229	SMD
	84 u	7	4	20,480	720/9550	coil)	1229	SMD
Mitsubishi	21.73	3	2	—	480/7300	Linear Motor	806	SMD, Trident
	50.71	7	4	—	480/7300	Linear Motor	806	SMD, Trident
IMI	11.3 u	3	2	10,800	300/6000	Linear Voice Coil	648	IMI/ANSI
	20.5 u	5	3	10,800	300/6000	Linear Voice Coil	648	IMI/ANSI
	40.0 u	5	3	10,800	600/6000	Linear Voice Coil	648	IMI/ANSI
Pertec	20.13	3	2	—	476/6600	Rotary	864.25	I/O Bus ANSI, 8 Bit Bus
Shugart Assoc.	5.33/5	2	1	10,400	172/6270	Stepper	4.34	Floppy
	10.67/10	4	2	10,400	172/6270	Stepper	4.34	Floppy
Kennedy Co.	4/3.5	1	1	11,520	300/5280	Rotary voice coil	687	Pico Bose
	12/10.7	3	2	11,520	New products available first quarter '81			
	20/17.9	5	3	11,520				
Quantum	10.66/8.40	2	1	—	345/—	Rotary voice coil	4.34	SA-1000
	21.33/16.80	4	2	—	345/—	Rotary voice coil	4.34	SA-1000
	32.00/25.20	6	3	—	345/—	Rotary voice coil	4.34	SA-1000
	42.66/33.60	8	4	—	345/—	Rotary voice coil	4.34	SA-1000
Priam	10.8/8.4	4	—	—	180/7475	—	0.9 MB	NR2
Micropolis	9	1	1	15,364	478/8623	Rotary voice coil	922	Micropolis
	27	3	2	15,364	478/8623	—	—	—
	45	5	3	15,364	478/8623	—	—	—
New World	4.2/3.1	1	1	—	200/9000	Stepper Motor	7.9	Floppy

	Spindle Speed (RPM)	Min. access time (ms)	Avg. access time (ms)	Max. access time (ms)	Avg. latency time (ms)	Height, inches	Width, inches	Weight, lbs.	Backup	No. units in field a/o 12/31/80	Began shipping	Drive sold with or without controller	Price per unit
3510	—	—	—	—	—	—	—	40	Integral cartridge	N/A	—	with	—
3510	—	—	—	—	—	—	—	40	Integral cartridge	N/A	—	with	—
—	—	35	—	—	—	—	—	—	Floppy	N/A	—	with	—
2983	19	70	140	—	4.38	8.55	12	—	Flex Disk or 5¼ tape	N/A	N/A	options	—
3600	8	27	80	8.3	4.6	9	20	—	None	1000	5/80	w/o	\$2900
3600	8	27	80	8.3	4.6	9	20	—	—	1000	5/80	w/o	\$3400
3600	8	27	80	8.3	5.25	9	20.5	—	—	0	4Q/81	w/o	\$4000
3600	15	60	150	8.3	4.62	8.55	15.8	—	—	0	3/81	w/o	\$2600
2964	30	70	140	10.1	4.4	8.5	14	—	None	—	6/80	w/o	—
2964	30	70	140	10.1	4.4	8.5	14	—	None	2000	6/80	w/o	—
3600	5	20	40	8.3	5.1	8.5	20	—	None	—	New	—	—
3600	5	20	40	8.3	5.1	8.5	20	—	None	—	New 1Q/81	—	—
3600	—	—	—	—	5.1	8.5	22	—	Floppy ½" tape	—	—	w/o	—
3600	—	—	—	—	5.1	8.5	22	—	—	—	—	w/o	—
3600	6	35	65	8.3	5.5	8.5	22	—	—	5000	1/79	opt.	\$2730
3600	6	35	65	8.3	5.5	8.5	22	—	—	1000	8/80	opt.	\$3215
3600	6	50	95	8.3	5.5	8.5	22	—	—	—	5/81	opt.	\$3830
3600	10	50	80	—	4.65	8.5	18	—	Floppy	1000	12/79	w	—
3125	19	70	150	9.6	4.62	8.5	17	—	Floppy	10,000+	12/79	w/o	\$1600
3125	19	70	150	9.6	4.62	9.5	17	—	Floppy	—	—	w/o	\$1980
3600	10	50	100	8.3	5.25	8.5	20	—	Cartridge tape	—	—	opt.	\$2500
										—	—	opt.	\$2700
										—	—	opt.	\$3050
3000	15	50	100	10	4.62	8.5	17	—	None	—	9/80	opt.	—
3000	15	55	100	10	4.62	8.5	17	—	None	—	9/80	opt.	—
3000	15	60	100	10	4.62	8.5	17	—	None	—	9/80	opt.	—
3000	15	60	100	10	4.62	8.5	17	—	None	—	9/80	opt.	—
3564	—	—	—	—	4.62	8.5	20	—	—	200	—	—	—
3600	12	42	85	8.3	4.62	8.5	22	—	Floppy	1000	12/79	opt.	\$2130
—	—	—	—	—	—	—	—	—	—	—	—	—	\$2750
—	—	—	—	—	—	—	—	—	—	—	—	—	\$3450
3600	5	—	—	—	—	—	—	—	Floppy	20	7/80	w	\$4500

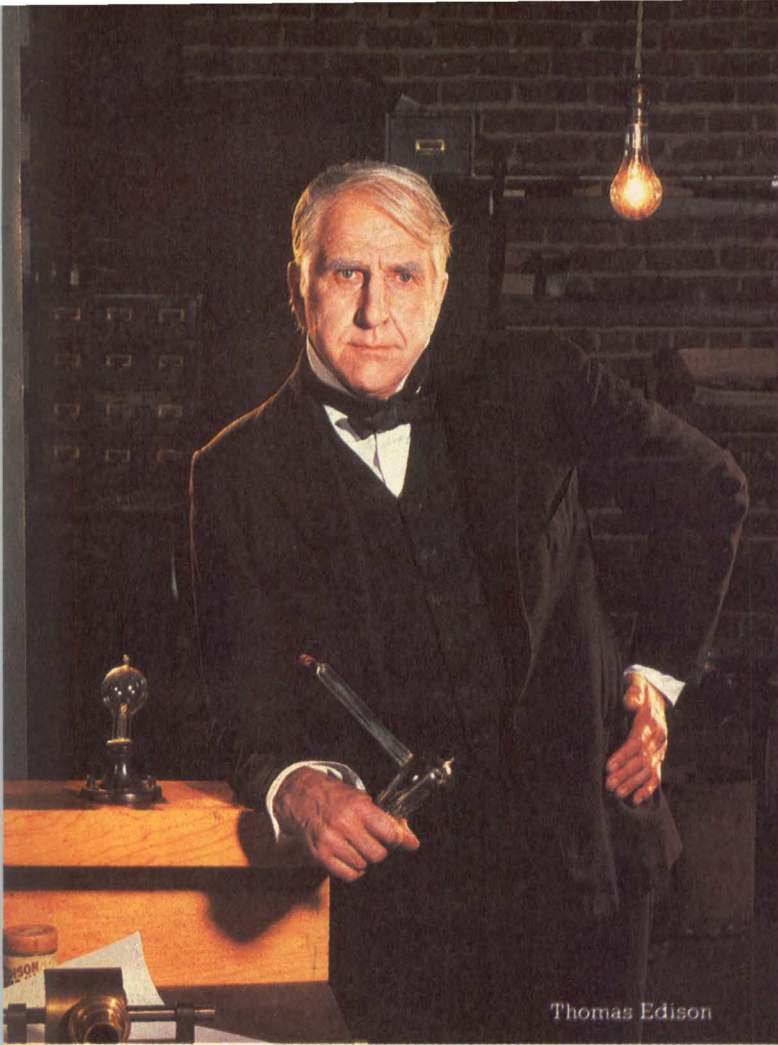

Thomas Edison



Isaac Newton



Leonardo da Vinci

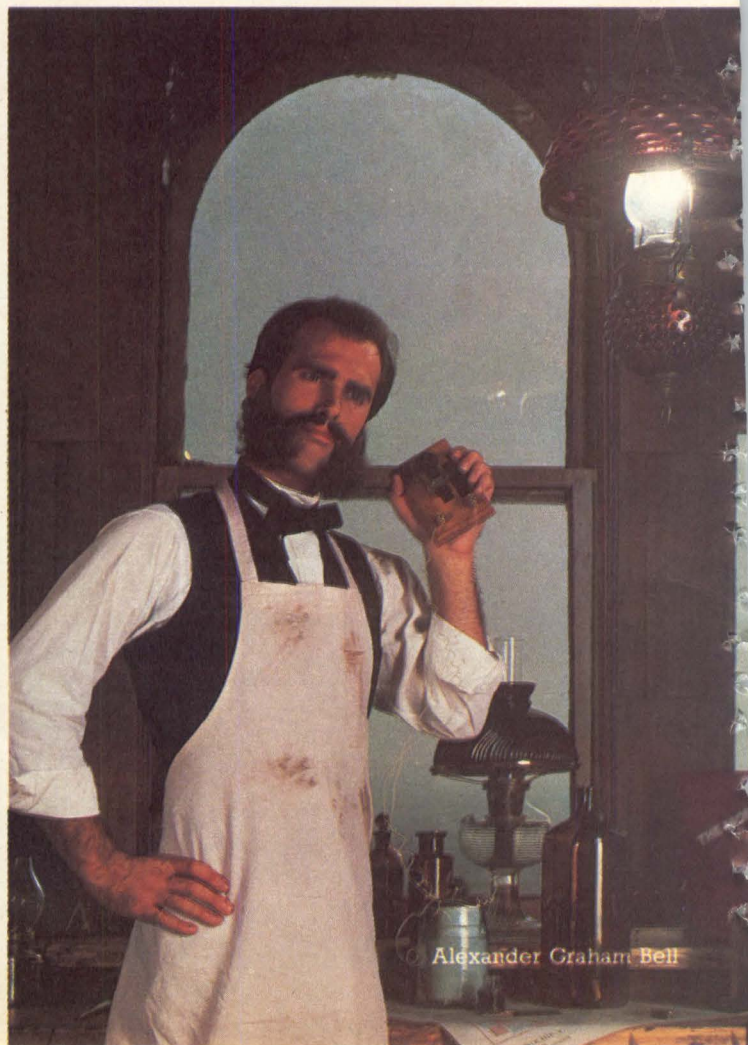

Alexander Graham Bell

Monochips™ give you advantages that some of the greatest inventors never had.

The next great inventor will probably be an electronic design engineer, and it could be you! In fact, with your imagination and Monochip™ semi-custom ICs, you actually have several advantages over the great inventors of the past.

Fast development.

When you have an idea for a great design, you don't have to wait centuries for someone to develop the technology to make it a reality. In fact, with Monochips, you can have prototype ICs in 8 weeks for as little as \$2,800.

Easy development.

Monochips are an extraordinary invention in themselves. Their circuit components—the first five layers—are already in place when you start designing. All you do is connect them to create the circuit you need. Working from your layout, we etch the sixth and final layer, and make the prototypes. After you approve them, we produce from 1,000 to 500,000 parts for you.

The result? You can improve your products immediately—by shrinking their size, increasing their reliability, and making them expensive and difficult to copy.

Simple modification.

Monochips offer you maximum design flexibility. At any time, we can modify your circuit and deliver new prototypes in just four weeks!

Put yourself in the picture NOW.

Your place in history is waiting...so start on your great inventions right away. Our Monochip Design Kits let you develop your own semi-custom IC—linear, CMOS, NMOS, CML, or bipolar—for only \$25 to \$59 per kit. Call us today to order your kit or for more information. Interdesign, 1255 Reamwood Avenue, Sunnyvale, CA 94086. Telephone (408) 734-8666.

This space reserved for you.

Interdesign

1255 Reamwood Avenue
Sunnyvale, CA 94086

- Send me more information on Monochips™.
- Provide me with ordering information on your design kits.

Name _____

Title _____

Company _____

Street _____

City _____

State _____ ZIP _____

Telephone _____ DD

Interdesign

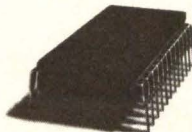

Monochip™
the semi-custom IC.

YOU ARE CORDIALLY INVITED TO

COMPAT '81

COMPATIBLE COMPUTER PRODUCTS EXPOSITION

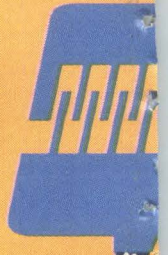

SEPTEMBER 16 & 17, 1981 SAN FRANCISCO HOSPITAL CENTER

COMPAT '81 was conceived to:

- Enhance Computer Capabilities
- Provide Computers with Greater Flexibility
- Assure Availability of Peripherals, Accessories and Software for ALL Branches of the Computer Industry

THE COMPATIBLE COMPUTER EQUIPMENT MANUFACTURERS (CEMs), MEMBERS OF A SPECIALIZED INDUSTRY, WILL SHOW AND TELL ALL ABOUT THEIR PRODUCTS AND SERVICES

LISTEN TO authoritative speakers give you information on how CEMs (Compatible Equipment Manufacturers) help OEMs, systems integrators, turn-key houses and large volume sophisticated end users **SOLVE COMPUTER APPLICATION PROBLEMS**



CIRCLE NO. 69 FOR YOUR EARLY
CIRCLE NO. 99 FOR YOUR

ANOTHER EXPOSITION ORGANIZED BY:

The Benwill Conference Group who also bring you the ATE Seminar/Exhibit, PC '81 — the International Printed Circuits Conference and the Electronics Test and Measurement Conference

THE FIRST NATIONAL EXPOSITION DEDICATED EXCLUSIVELY TO THE EXPANDING WORLD OF COMPATIBLE COMPUTER PRODUCTS

EL (Across the street from WESCON) SAN FRANCISCO, CA

A MARKETING FORUM for CEMs

This exposition is dedicated to the proposition that the unprecedented growth and expansion in the use of computers for all kinds of applications will continue at an exponential rate. No one company can solve everyone's applications problems; no one company can supply everyone's needs for complete systems, add-ons, peripherals and software.

Building around the central processing unit, the OEMs, the systems integrators, the turn-key houses and the sophisticated large volume end users will continue to use compatible computer equipment to devise special systems to solve applications problems with greater versatility and flexibility.

IF YOU ARE a buyer and specifier of plug-in electronics and appropriate software, you have a need to know about currently available products you can design into your systems as well as future trends in the state-of-the-art **THIS EXPOSITION GIVES IT TO YOU.**

THIRD ATTENDEE'S REGISTRATION FORM
EXHIBITOR'S APPLICATION FORM

PRODUCED BY:

Digital Design
Computers • Peripherals • Systems

co-sponsored by Circuits Manufacturing,
Design Engineering and Electronics Test magazines.



1/4" Streaming Tape Cartridge Backs Up Winchester Drives

Engineering Staff Report
Archive Corp.

Microcomputer-based 1/4" streaming cartridge tapes simplify system integration efforts, and an intelligent controller/formatter maximizes system efficiency during Winchester back-up.

As more and more Winchester-type disk drives are designed into both existing and future computer systems, need for an effective yet convenient method of backing up the Winchester device is apparent. Information has been published recently pertaining to functional characteristics of 1/4" streaming cartridge tapes and their advantages when used with Winchester disk drives. The 1/4" streaming cartridge tapes' large formatted data capacity, fast throughput, compact form factor and low cost make it an ideal device for backing up the Winchester disk drive. The ability to use a streaming tape to the fullest requires a sophisticated controller/formatter. A cost-effective controller/formatter alleviates the OEM of this task and reduces the development of systems software to support the streaming device.

As an OEM controller/formatter, the host interface by easy connection to μ Ps and systems buses. The interface consists of two programmed I/O control lines, two programmed I/C status lines, two DMA control lines, an 8-bit bidirectional bus, a bus direction line and a controller reset line. The host software drivers can be designed with as few as two commands: Read, Write. With the software configuration a 20-MB intelligent drive will appear as a 20-MB FIFO in which data is blocked into 512-byte blocks.

For those applications that require more conventional tape formats, the Controller has a total of seven commands. These commands permit drive selection; file mark generation; tape positioning to BOT, Next File, Retension Tape; read diagnostic for hard tape error file reconstruction; read status including error statistics; and R/W.

host/controller communication

Communication between the host and the controller is controlled by four programmed I/O lines, two from the host and two to the host as shown on the Interface Diagram. The two lines from the host are ONLINE and REQUEST. The two lines to the host are READY and EXCEPTION.

ONLINE is asserted by the host prior to issuing read or write commands and is then used by the host to maintain data transfers. In the Write mode, the controller continues to request blocks of data from the host as long as ONLINE is

active. When the host wishes to terminate the Write command, ONLINE must be placed in the inactive (false) state, thus signaling the controller to Write the remaining Write buffers to the tape and terminate the Write command in orderly fashion on a block boundary.

REQUEST is used by the host to initiate command sequences to the controller. REQUEST in conjunction with the READY line from the controller transfer commands and status bytes between host and controller. These two lines form an asynchronous handshaking protocol to transfer command and status bytes across the bidirectional data bus.

READY is a control line from controller to host. The significance of this line is dependent upon the controller's

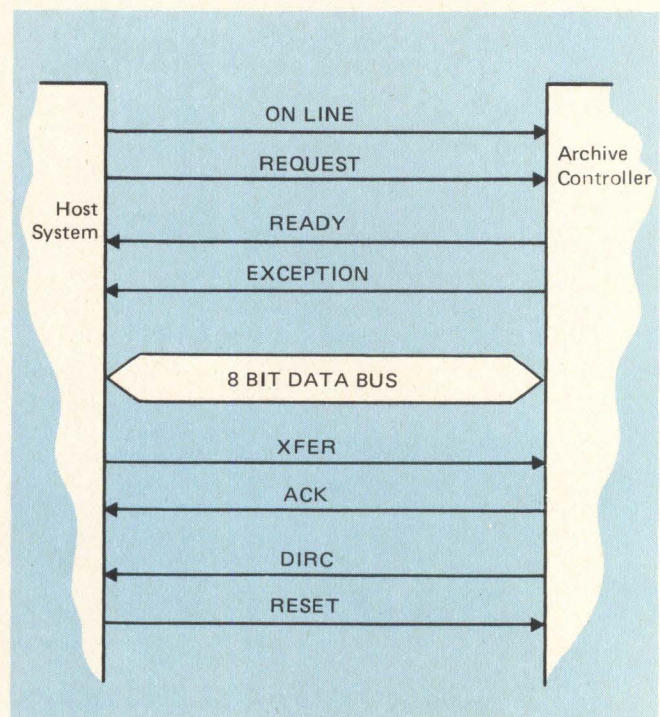

Controller commands for I/O and transfer.

operational mode. When host and controller are in the command mode, the READY line indicates that the controller has read the command byte from the data bus.

EXCEPTION is a control line from controller to host. The controller will activate EXCEPTION when an error condition exists preventing the controller from executing or continuing execution of a command. The only acceptable response by the host to EXCEPTION not accompanied by READY is to issue a Read Status command and transfer all

The quarter-inch streaming cartridge tapes' large formatted data capacity, fast throughput, compact form factor and low cost make it an ideal device for backing up the Winchester disk drive.

status bytes to determine the exact "Exception" condition. Once a data transfer command (Read or Write) has been accepted by the controller, data blocks of 512 bytes each must be transferred between host and controller. Three lines have been provided to control the byte-to-byte transfers across the 8-bit data bus. The RESET line is provided to give the host a means of resetting the controller micro-computer and is equivalent to a power on reset in the controller which

causes all operations to immediately abort and the controller to be placed in a condition to expect a command.

The sequence for transferring the command by the host is as follows: The host places the command byte on the data bus and activates REQUEST. The controller takes the command byte from the data bus and activates READY. The host receives READY and drops REQUEST. The controller drops READY. The host clears the data bus. To read the controller status, the host issues a Read Status command with the same sequence as any other command.

After the controller accepts the Read Status command, it will initiate the following sequence: The controller changes DIRC, the data direction line, places a status byte on the data bus, and activates READY line. The host takes data from the data bus and activates REQUEST. The controller drops READY. The host drops REQUEST. The four preceding steps are repeated until all six status bytes are transferred. The controller restores DIRC.

evaluation criteria

In selecting a streamy cartridge tape drive, be sure the flexibility of the controller design permits you to quickly interface the drive to your CPU for evaluation. At the completion of your evaluation, this same system can be software-upgraded and integrated into your operating system with minimum software effort. Remember, incorporating more software overhead in the controller's firmware offers advantages. These include expedient and thorough evaluation of the device and elimination of significant software coding to integrate the product into the OEM's design. And, since time is money, the actual cost of integrating such a streaming cartridge tape is significantly reduced. **D**

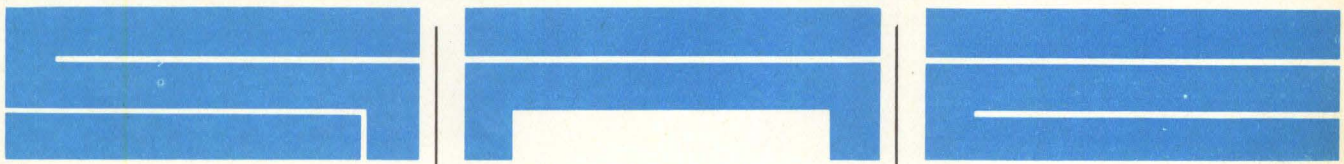

Backplanes

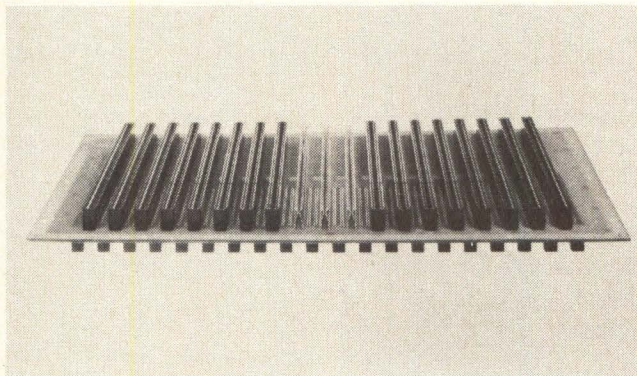

Quality, reliability and performance — that's the SAE interconnection sub-system story.

- Double and multi-layered PC boards.
- Press-fit and discrete backplanes.
- Single and multi-bay card files — all accessories.
- Edgeboard and IDC connectors.
- Wirewrapping services — fast delivery.
- PDQ/DEC-compatible backplanes.

For free catalog on complete Backplanes and Interconnection Sub-systems line, circle Reader Service number, or write:

Stanford Applied Engineering
3520 De La Cruz Boulevard
Santa Clara, California 95050
(408) 988-0700

Circle 27 on Reader Inquiry Card

DEC Compatible

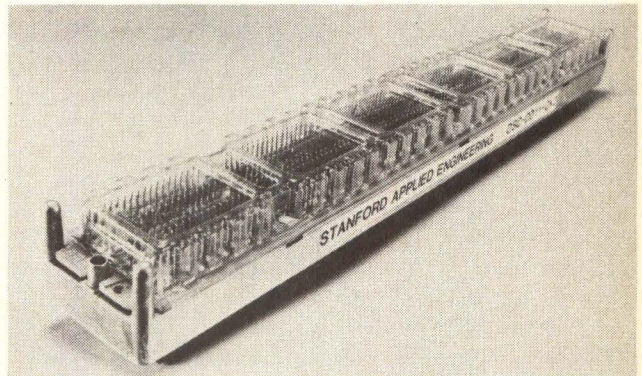

PDQ/DSC DEC compatible press-fit backplane is prewired and pretested.

- 4 and 9 slot systems.
- Easy contact replacement.
- Total groundplane on pin side.
- Die cast aluminum frame.
- Exclusive plastic cover over pins.

For free catalog on PDQ/DSC logics, circle Reader Service number, or write:

Stanford Applied Engineering
3520 De La Cruz Boulevard
Santa Clara, California 95050
(408) 988-0700

Circle 28 on Reader Inquiry Card



VIEWS is changing the way image processing sees the world

In just moments EARTHVIEWS, a new member of the VIEWS family, has enhanced the splendor of San Francisco at the touch of a few keys. And when you're up against a rock and a hard place, quick response counts because you need answers fast.

This ease of interaction helps you to examine vast surfaces or the most minute areas to help rescue our forests from disease, monitor ocean life, assess storm damage, locate precious metals, control pollution, or discover hidden energy resources.

The VIEWS family is a total hardware and software image

analysis and enhancement system able to meet your specific application needs and more. Non-computer people, from many nations, have already produced results after a minimum of training. In fact, VIEWS has set a new standard for "User Friendly" systems.

With our patented IHS hardware system, VIEWS reveals the world to you, as the human mind sees it, as no one else can. VIEWS gives you features that can make your work-world a lot easier to manage. A highly interactive turnkey VIEWS system, which is configured to your requirements, is ready for installation.

Unequaled in today's marketplace, there's no limit to how the proven VIEWS family can help you see image processing at its best. If you would like to know more about our patented IHS system, contact:

LogE/Interpretation Systems Inc.
7001 Loisdale Road
Springfield, Virginia 22150 U.S.A.
(703) 971-1400 Telex: 8-9455

LogE / Interpretation
Systems Incorporated

Circle 29 on Reader Inquiry Card

Half-Inch Streaming Drive

Larry D. Hemmerich
Cipher Data Products

Streaming tape drives were introduced to the world almost two years ago as a solution to the problem of Winchester disk backup. The computer industry, however, has been slow in adopting these devices for backup purposes. Part of the lag is due to the slow introduction of larger capacity (greater than 30 MB) Winchester disks which require half-inch streamers for backup. Another factor: streaming quarter-inch tape cartridges have not been shipped, even though many companies have advertised such products.

Still another concern was pointed out by a spokesman for a major minicomputer manufacturer. When his company recently introduced a 30 ips half-inch streaming tape drive, the spokesman said, "Why buy a Ferrari only to sit in traffic on a freeway? You don't need that kind of speed." This emphasized the problem many users were finding with existing software when trying to use streamers at 100 ips. Dual speed half-inch streamers, however, allow users to resolve that problem.

With all the attention that has been given to the emerging Winchester disk marketplace, (including the scramble to define it and identify suitable backup technologies) the word "streaming" has become synonymous with disk backup. Whether applied to the quarter-inch tape cartridge or to the standard half-inch ANSI compatible tape drive, streaming is now defined simply as reading or writing data on-the-fly. But there is more to the half-inch streaming tape drive story than "streaming."

multiple speed drives

Unlike their quarter-inch cartridge counterparts, these drives offer multiple speeds as well as simplified mechanical elements; and they are just as useful for normal input/output applications as they are for streaming. In fact, in many

applications they offer an improvement in price/performance over standard start/stop tape drives in the 25 inches per second (ips) speed range. Users thus get the streaming capability at either 25 or 100 ips as an added bonus.

Microstreamer streaming tape drives have been optimized to run at 25 ips as well as at 50 and 100 ips. The Microstreamer is capable of offering excellent backup for Winchester disks up to 200 MB in size. The drive can use 50 and 100 ips speeds with packed densities of 3200 and 1600 bpi respectively. The added 25 ips speed can also be used for input/output applications where standard start/stop drives normally are found. For most applications, the streaming drive offers performance that is the same or better than start/stop drives. Moreover, a streaming drive is less than half the cost of a normal start/stop 25 ips tape drive. The streamer's mechanical and electronic designs are simpler, although more sophisticated. New technologies permit these drives to be used in the new ways people are using tape. This means that in most applications a streaming tape drive of 25 ips can be substituted directly for a 25 ips start/stop drive and use all existing software.

Depending on application, performance will remain the same or may even be improved by as much as 17%. In the worst case, throughput may deteriorate by a maximum of 40%. This deterioration can be prevented by proper user planning. Even in the worst case, deterioration might be acceptable to the user were he to consider the improvement in price/performance and reliability as a tradeoff.

In order to better understand streaming tape drives as replacements for standard start/stop drives, users should have a thorough grasp of the fundamentals of the two drives. Once the variables between their operations are identified, users can better judge what tradeoffs they might have to make

between the two. They can also decide if there is a performance difference and, if so, can determine whether the lower cost and higher reliability of the streaming drive offset any potential reduced performance.

In a start/stop drive, after the last data bit is written, tape motion decelerates quickly and the tape stops in the center of the inter-record gap. When motion ceases a command commonly called "BUSY" goes false. This indicates that the drive is ready to receive the next command. Tape motion is initiated again immediately after the "BUSY" signal goes false.

Most software systems and controllers are designed to monitor the busy signal and initiate the next command after it goes false. In actual practice, it is possible to initiate forward motion prior to the tape drive coming to a complete stop. The majority of user applications, however, wait for the drive to come to a complete stop and for "BUSY" to go false. This is advisable because commands must be of the same type and same direction as the last previous command if they are given without waiting for the signal. Problems will result if different commands are used without waiting for the tape to come to a complete stop. That is why, as stated already, the user should have a group of basic fundamental.

deceleration and acceleration times

The mechanical design of a start/stop drive is quite complex, to guarantee that the deceleration and acceleration times are kept to a minimum and that the tape can be "stopped on a dime" within the inter-record gap. This is where high costs are incurred (in the complexity of the mechanical drive elements).

Streaming drives do not stop within the inter-record gap. Their mechanical drive elements are much simpler thus their acceleration and deceleration times are much longer. They actually pass the inter-record gap and must be repositioned in order to read or write ANSI compatible tape.

In repositioning, a period of time exists which is referred to as the "command reinstruct" time. This is the time after reading or writing the last character of the last data block, during which the system can instruct the tape drive to continue or, after reaching Point B, the tape drive will enter the repositioning cycle.

If the command to continue reading or writing is not received by the time the normal tape velocity reaches Point B, the drive automatically decelerates and comes to rest at Point C, reverses its direction to Point D, and comes to rest at Point E. This creates the inter-record gap and, after coming to rest at Point E, the drive waits for the next command to read or write. The interval between Points E and B is referred to as the access time.

There are three primary differences between the tape motion of a start/stop drive and that of a streaming drive. Using a streaming drive: • tape motion does not begin decelerating at the end of the data block, but continues to just prior to the beginning of the next data block; • both acceleration and deceleration times are longer than a start/stop drive; • if the command reinstruct time is missed, then repositioning must occur in order to generate the ANSI compatible inter-record gap. The logical question then is, how can a streaming tape drive perform as well as, or in some applications actually better than, a start/stop drive in terms of throughput?

The answer starts with the fact that streaming drives are microprocessor controlled. The interface command structure is able to accept and execute commands independently from the actual motion of the tape. As for the relationship of the

"BUSY" signal to tape motion in both types of drives, the start/stop drive has to wait until the tape comes to rest in the center of the inter-record gap, a procedure which takes approximately 24 ms. With the streaming drive, the "BUSY" signal goes false almost immediately after the end of the last data block, or in approximately 6 ms, thus the unit can accept the next command more quickly.

formula for throughput

Significance of this timing difference becomes apparent via a simple throughput calculation showing the effect of not having to wait until the tape comes to rest before issuing the next forward command. Using a 4,000 character record — which equals about 3.125" of tape — it is possible to calculate the fundamental throughput of the two drives using the last character of the last data block as a reference. The formula is: inches of tape/time to travel = average tape speed.

In the start/stop drive, effective throughput thus is 21.5 ips to cover the 3.725" of total tape traveled, including 24 ms to ramp down, 24 ms to ramp up and 125 ms to cover the data block.

In comparison, the streaming drive is able to cover the same distance in a shorter period of time because it is still moving the tape when the "BUSY" signal falls, thus its controller can issue the command to continue. The effective throughput is 25 ips, or a 17% increase in throughput.

At the opposite end of the spectrum, consider another example where both tape drives are at rest in the inter-record gap, waiting for a command. In the case of the start/stop drive, the access time is 24 ms plus 125 ms to write the data — an effective throughput of 22.9". The streaming tape access time at 25 ips is 30 ms, therefore its effective throughput is 22.0", or a deterioration in throughput of four percent.

These two examples — one with commands being issued as fast as the drive will accept them and the other where the tape unit is waiting for a command — show two extremes of what may happen when using existing software. These extremes cover the majority of real-life applications. The first is representative of applications such as a disk dump, where successive data is either being read or written. The second is typical of applications such as transactional backup or file updates, where data blocks are written in slower succession.

In practice, however, the start/stop tape drive can be asked to start motion anytime after it comes to rest. Therefore, there is a period of time where the streaming tape drive becomes much more inefficient and that is on those occasions where the request to read or write falls anytime after the command reinstruct period but before the access time.

worst case improvement

In the worst case, where the command to continue is received immediately after the command reinstruct time, the streaming drive must complete its repositioning cycle. This requires an additional 110 ms plus the 30 ms access time. This would give an effective throughput of 14 ips. This still is quite an improvement over a 12.5 ips start/stop drive, however, and even this situation can be prevented by user awareness of this limitation and avoidance of the situation.

One feature of the Microstreamer which helps to offset this worst case performance is use of the 100 ips streaming mode as a search mode. This permits users to search forward or backward through a reel of tape, reading data at a 100 ips speed to find a particular record. The record may then be updated in the 25 ips mode and normal input/output tasks

Reel-to-reel performance in one-sixth the size.



Any way you slice it, the new ECR-40 is a powerful breakthrough in MIL SPEC recorders. Genisco has blended the uncommon ingredients of speed and lightweight design to come up with a digital cartridge recorder that holds its own against reel-to-reel.

Genisco designed the ECR-40 to emulate the full capabilities of 125 ips, 1600 bytes per inch reel-to-reel recorders, at a fraction the size and power consumption. The ECR-40 uses 9-track parallel phase encoded data at 6400 bytes per inch, and offers shuttle speeds up to 240 ips with a capacity of 48M/Bytes on a single cartridge.

ECR-40 SPECIFICATIONS*

- Data Capacity:*
48M/Bytes on 630 ft. of 1/2" tape.
 - Data Transfer Rate:*
200K/Bytes per sec. at 31.25 ips.
 - Start/Stop Time:*
3.0 ± 0.3 m/sec. to 31.25 ips.
 - Power Consumption:*
85 Watts average steady state (incremental mode).
 - Size:*
4.937" (width) x 8.64" (height) x 19.50" (length).
 - Weight:*
35 lbs. without cartridge.
- (*Complete specifications available upon request.)

The ECR-40's quick-loading cartridge and positive locking mecha-

nism saves time and effort, and offers little opportunity for tape contamination. Our fast start/stop time means more data compression on tape, and it sets the ECR-40 apart from other cartridge recorders. Finally, the ECR-40 is as cost-effective a performer as you'll find available anywhere. And it's still smaller than a bread box.

Call or write us today for the whole story. Genisco Systems Division, 18435 Susana Road, Rancho Dominguez, CA 90221 (213) 537-4750.

GENISCO
SYSTEMS DIVISION

Circle 30 on Reader Inquiry Card

may be resumed at 25 ips or another record may be searched for at 100 ips.

In summary, the streaming drive's throughput is 17% better than the start/stop drive during the first 16 ms. Any time after approximately 126 ms the start/stop and streaming drives are, for all practical purposes, equivalent. Should the command come at the in-between period, the throughput of the streaming drive would be reduced. This can be prevented by proper use of the streaming drive, however, thus the price/performance benefits outlined earlier can indeed be realized.

Whether the dual speeds of a streaming drive are useful in a particular application obviously depends on what that application is. A typical example might be a transaction-oriented application where people are writing small amounts of data into the system, followed by a gap in time before the next set of data is written. The time needed for repositioning thus isn't critical to each transaction, yet the writing task is accomplished efficiently each time it occurs. Also, at the end of the day the streaming drive can be used in its 100 ips mode to transfer transactional data to a central processing site more quickly.

Another example might be in a key-to-disk system. The real need here is for collecting data as it becomes available and then interacting with the disk. Using a streaming drive in its 25 ips mode accomplishes this task; also, its 100 ips streaming mode is usable for disk backup as well.

useful applications

The streaming drive is useful in applications such as program load, in which a short burst of data is loaded and then the program performs a computation on it, waits some period of

time and then calls up the next burst of data. Data logging also is a typical intermittent activity example in which the streaming drive is useful. Read-only applications such as computer output microfilm and computer-aided design also are good illustrations. Here, the user is reading data intermittently into slower devices such as plotters or cameras.

In all of the examples, slight repositioning delay has no real effect on throughput because the user's time between blocks of data is fairly long. The repositioning, therefore, is inconsequential to the application.

To decide whether to employ a dual speed streaming drive for an application, a user must consider all the factors that affect his throughput. He must ask how frequently he sends data into the system data; determine the time delay between bursts of data; estimate the average file size; ascertain any unusual timing differences that could affect throughput; determine how many peripheral devices are on the system; and which peripheral devices take priority. All of these factors will affect effective throughput.

The real test is a trial in an actual system environment. As can be seen in these simple illustrations, however, in most applications the throughput of a 25 ips streaming tape drive (such as the Microstreamer or Microstreamer 2) is as good or better than a standard 25 ips start/stop tape drive. These drives can now be used on most types of computers because couplers are available to connect to PDP-11, LSI-11, Nova, Eclipse, Ohio Scientific and General Automation computers, as well as any processor which uses the S-100, Multibus or RS-232 interfaces. When users consider that streaming drives can be purchased for less than half the cost of their start/stop counterparts — offering the streaming mode as an added feature — the value is obvious. **D**

ATE

SEMINAR/EXHIBIT

Automated Testing for Electronics Manufacturing

JANUARY 18 - 22, 1982, PASADENA CENTER, PASADENA, CA

CALL FOR PAPERS

Abstract Deadline: **May 1, 1981**

Send abstracts (200-500 words) and short biographies by May 1, 1981 to Technical Program Coordinator, **ATE/Exhibit**, c/o Benwill Publishing Corp., 1050 Commonwealth Ave., Boston, MA 02215. Or call: (617) 232-5470.

Produced by *Electronics Test* and cosponsored by *Circuits Manufacturing*, *Digital Design* and *Design Engineering* magazines.

We invite technical papers on these subjects for presentation in General Sessions and Workshops

- Field Testing
- Bare-Board Testing
- Loaded Board Functional and In-Circuit Testing
- LSI Board Test
- LSI Component Test
- Digital Diagnostics
- Microprocessor Bus
- Fault Isolation
- Analog Board Test
- Analog Diagnostics
- Bubble Memory Testing
- Burn-In/Temperature Cycling
- Logic Analysis Techniques
- Waveform Analysis
- Electro-Optic Testing
- Test Requirements Analysis
- Interfacing Devices
- Simulation
- Automatic Test Generation
- Systems Support Management
- ATE Management
- ATE Acquisition
- Testability
- Economics of Loaded Board Testing
- ATE System Calibration
- Using IEEE Bus Instruments
- Signature Analysis

Your Smart Choice!

BEEHIVE'S NEW INDUSTRY STANDARD

DM5

\$880 LIST*

- Editing Capability
- Block and Character Transmission
- Mem-Lock (Split Screen)
- Anti-Glare P42 Green CRT
- Line Drawing Capability
- Programmable Status Line

DM5A

EXTENDED FEATURES

- Function Keys
- 12-Key Pad
- Auxiliary Printer Port with Flow Control
- Current Loop
- X-on X-off Printer Control



*Quantity Discounts Available

plus even more!

- Cursor Control Keys
- Upper / Lower Case Characters
- Programmable Baud Rates
- Scrolling
- Line Lock
- Tabbing Capability
- Cursor Addressing & Sensing
- Field Attributes: Half Intensity; Blinking; Reverse Video; Underline; Security; etc.
- Self Test
- Line Monitor Mode
- Keyboard Enable / Disable
- Transmission Cancellation
- Intelligent, Detached Keyboard

CALL TOLL FREE

(800) 453-9454



BEEHIVE INTERNATIONAL

"A proven competitive manufacturer of smart terminals"

CALIFORNIA Costa Mesa (714) 540-8404 • Sunnyvale (408) 738-1560 **FLORIDA** Altamonte Springs (305) 830-4666
ILLINOIS Arlington Heights (312) 593-1565 **MASSACHUSETTS** Woburn (617) 933-0202 **NEW YORK** New York
(212) 682-2760 **TEXAS** Dallas (214) 239-3330 **UTAH** Salt Lake City (801) 355-6000 **WASHINGTON, D.C.** (VA) Falls
Church (703) 356-5133 **EUROPE** The Netherlands Phone 020-451522

Circle 32 on Reader Inquiry Card

Say Ahh...

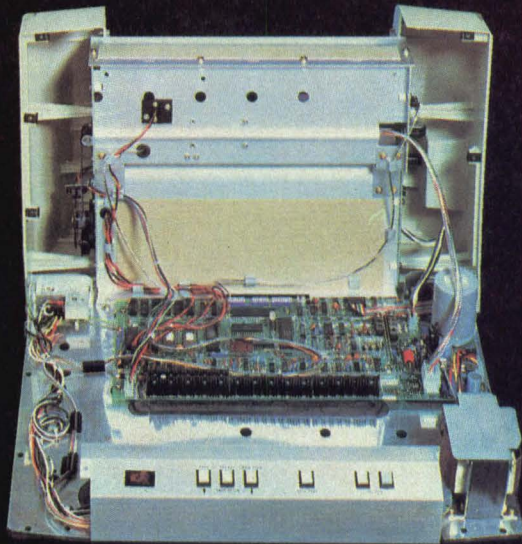

Our New grafixPLUS™ 80-column printer opens wide for easy servicing.

Introducing the newest members of our grafixPLUS™ family—the DP-9000 Series 80/132 column printers—built on the same tradition of quality printout, solid design and low cost of ownership established by our 132/220 column DP-9500 Series.

A Case for Serviceability

Not that it comes up often, but want to get inside? Simple. Just remove a few screws and the clam-shell case swings open exposing all major components. This easy access plus built-in self-test and minimum component count yields an MTTR of one-half hour. The 9-wire print head replacement's even simpler... two screws and it's out. Without opening the case. And without a service call.

Performance Plus

The DP-9000 Series prints the full ASCII 96 character set, including descenders and underlining, bi-directionally, at up to 200 CPS. Number of columns can go up to 80 or 132, depending on character density—switch or data source selectable from 10 to 16.7 characters per inch. And all characters can be printed double width. The print head produces razor-sharp characters and high-density graphics with dot resolutions of 72X75 dots/inch under direct data source control.

Interface Flexibility

The three ASCII compatible interfaces (parallel, RS-232-C and current loop) are standard, so connecting your computer is usually a matter of plug-

it-in and print. Also standard are: a sophisticated communications interface for printer control and full point-to-point communications, DEC PROTOCOL, and a 700 character FIFO buffer. An additional 2K buffer is optional.

When you're ready for a printer (or several thousand), look into the grafixPLUS DP-9000 Series from Anadex—you'll find an open and shut case for quality. Contact us today for details, discounts and demonstrations.

 **Anadex**
...the plus in printers

Circle 46 on Reader Inquiry Card



...close please.

SALES OFFICES: San Jose, CA (408) 247-3933
Fullerton, CA (714) 871-0501 • Wakefield, MA (617) 245-9160 • Austin, TX (512) 327-5250

ANADEx, INC. • 9825 DeSoto Avenue • Chatsworth, California 91311, U.S.A. • Telephone: (213) 998-8010 • TWX 910-494-2761

ANADEx, LTD. • Dorna House, Guildford Road • West End, Woking, Surrey GU24 9PW, England • Tel: Chobham (09905) 6333 • Telex: 858762 ANADEx G

See Us at NCC Booths 2908-2909

Use μ P-Controlled Stepper Motors To Improve Peripherals

Elmer Madsen

AIRPAX/North American Philips Controls Corp.
Cheshire, CT

When μ Ps are teamed up with pulse steppers, they are well-suited for computer peripheral devices requiring a multiplicity of small, precise movements — such as needed in floppy disk head-positioning, tape drives, X-Y plotters, perforated readers, optical disks and chart recorders. They are often substituted for dc servo motors. Stepper advantages include an ever-present holding torque and rotor positioning repeatable without error. They maintain operation speeds independent of load.

μ Ps replace multiple circuit designs

The stepper motor can perform any function a μ P can command. Compensations until now (using complex logic) were made for inertia, resonance, step rates, losses, temperature extremes, voltage transients, pulse forms, inductance delays and time constants of all elements. The μ P can integrate all these functions onto one chip. The same degree of design expertise is required as for logic circuits, but it's a different sort. With μ Ps, once programmed, it's easy to gear up for mass production. Because of the lower cost made possible by μ Ps, new applications have opened up for stepper motors in computer peripherals. You alter the program without rebuilding or adding new components. Thus, for the same amount of money a μ P can handle more functions and is more flexible than systems using discrete elements. μ Ps do not change how stepper motors are used, but change dramatically how they are integrated and controlled.

where to use μ Ps

With stepper motors available that deliver thousands of steps/sec, μ Ps enable peripheral designers to space and time pulses electronically to match load and motor characteristics. A μ P can generate pulses to control step rates up to 10,000 steps/sec. A string of variable space pulses gradually brings the motors (in a fraction of a sec) up to these high step rates while staying synchronized with the steps. To be accurately stepped, however, the motor must be ramped down to normal.

The faster power is put into the stepper motor, the faster it steps. This responsive action often presents overshoot or

resonance problems and may require some kind of damping. Also, the load and motor are a mechanically resonant system that can become unstable despite inherent PM motor damping properties.

These and all related factors are the domain of control design and where μ Ps become effective substitutes for conventional discrete elements. This becomes especially true where there is a need for circuitry changes or adjustments, alterations that are much easier to accomplish with μ Ps.

The μ P spaces and times pulses to match motor and load characteristics, providing the rapid operation necessary for many kinds of high speed equipment. Rapid operation is just as much a function of the controller circuit as are motor torque, speed, and acceleration. An ordinary fixed pulse rate is not enough.

control of damping

A μ P helps control damping where it becomes a factor in stepper motor use by synchronizing stepping pulses electronically with the rotor position relative to the stator and arranges pulses to occur at optimum phases. A form of that technique, "retrotorquing," occurs when a brief pulse of current is injected into a winding to prevent overshoot or undershoot.

With the latest high-powered μ Ps, sine equations of motion (position, velocity, acceleration) can be solved in real time, thus assuring that optimum current and voltage are applied.

In a typical step response, an undamped motor makes several overshoots before it comes to its final rest position. In electronically-controlled damping circuits, after a given delay, a reverse command signal absorbs the power that would have gone into overshoot. Then, a final forward pulse stops the motor with a minimum of overshoot.

Special electronics incorporated into a μ P accomplish this easily so that the last pulse in a train of pulses can always be electronically damped.

A way to do this is to synchronize the stepping pulses with the mechanical position of the rotor by coupling a photo-

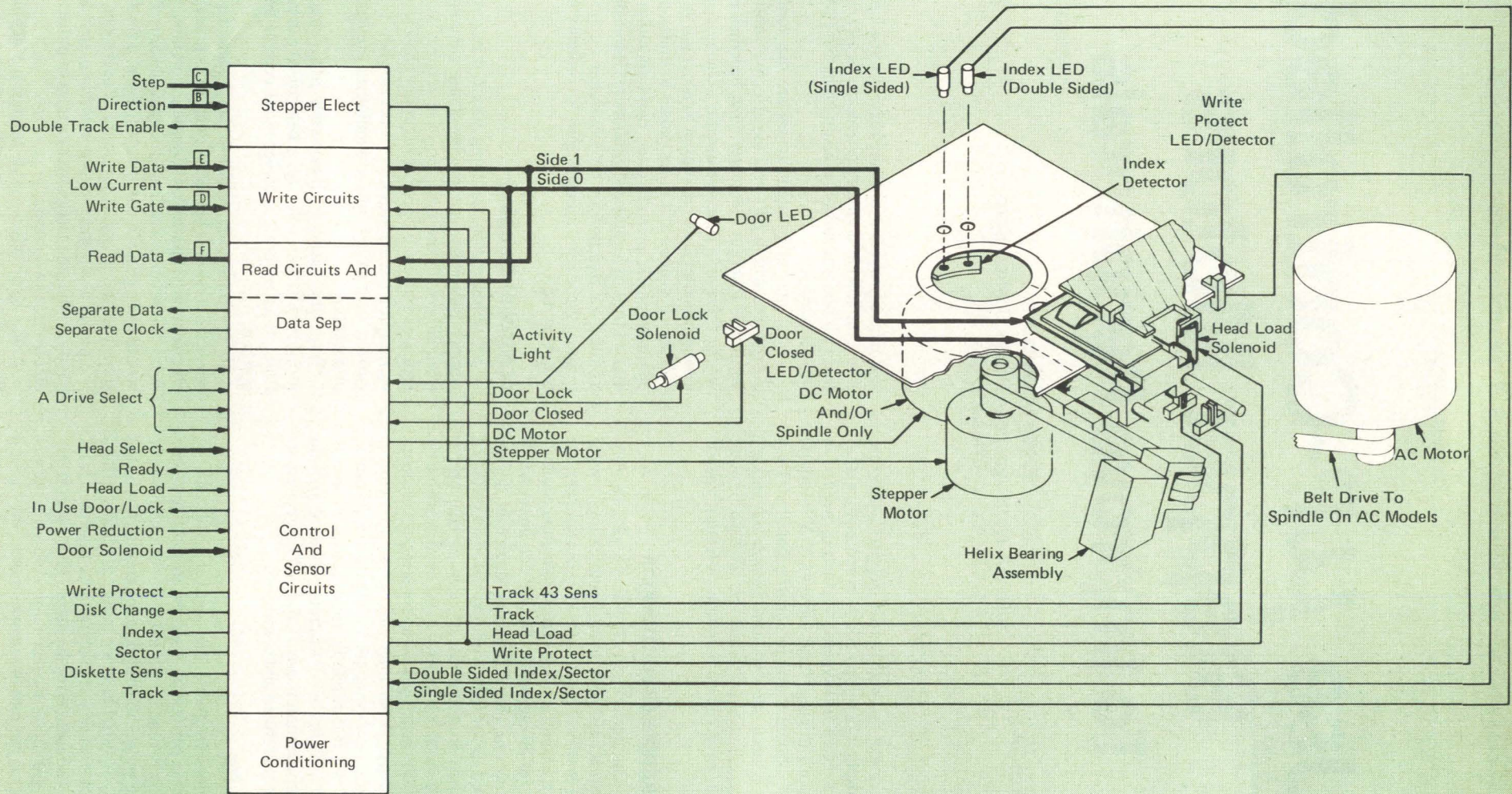

Flexible disk drives, such as MFE's 700 and 500 Series, provide single-sided operation (where maximum capacity is not required) and are just one peripheral that uses μ P-controlled stepper motors.

IT'S RELIABLE... IT'S REMOVABLE.... IT'S SUPERWINCHESTER!

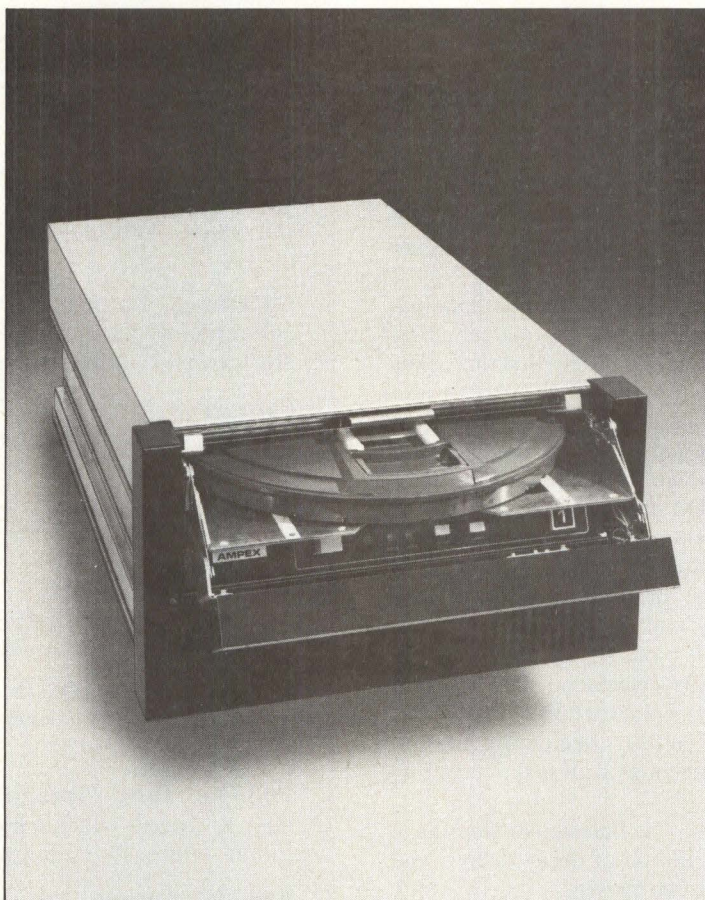

Superwinchester offers fixed disk drive technology plus a built-in, removable 16 megabyte disk cartridge.

Plus 16, 48 or 80 megabytes of fixed Winchester storage.

It's faster than competitive drives. Two, independent head positioners improve access performance by eliminating time consuming seek delays when transferring data between the fixed and removable media.

With the "Independent Seek" option, unique to the Ampex

drive system, throughput is further improved by allowing the head positioners to seek different cylinders simultaneously. The result: A cost-effective solution for optimizing subsystem performance.

But that's not all. There's an industry-standard plug-compatible

SMD/CMD interface that allows for easy daisy-chain expansion of up to 8 drives.

The Ampex Superwinchester

DFR-900 Series provides the features demanded by today's market. It has self-test and status monitoring, remote power sequencing and much, much more.

For the whole incredible story, call Gary Owen at 213/640-0150. Or write to him at Ampex Memory Products, 200 N. Nash Street, El Segundo, CA 90245.

AMPEX

MAKES THE DIFFERENCE.

© 1981 Ampex

Circle 37 on Reader Inquiry Card

optical encoder to it, phased so that pulses generated during the transition between the slots occur halfway between the motor steps. The user can adjust pulses to give various forms of motor control, including acceleration, deceleration, or damping.

A solution to the problem of high speed slewing (unloaded rotation) via μ P control is to close the loop with an optical or magnetic encoder that reinstructs the μ P continuously. Then it is possible to follow any desired pattern of acceleration-deceleration, time lag, or speed cycling.

Though it may not always be the most economical or even the most effective way, μ Ps can also control damping by synchronizing the stepping pulses with the mechanical position of the rotor (relative to the stator) and arrange the pulses to occur at the optimum phase. Retrotorquing is a form of that technique in which a brief pulse of current is injected into a winding to prevent overshoot.

Open-loop and closed-loop systems obviously are the options available when choosing a design in which μ Ps are being considered. The precision and speed of operations along with the possible need for alterations will probably decide which is the most desirable approach.

Open-loop systems need operation verification of the motor. With newer μ Ps, however, some equations of motion (position, velocity and acceleration) can be solved in real time to assure that optimum current and voltage always are applied.

The program steps involve varying degrees of anticipation, delay pulse width (or frequency), and mathematical calculation. The μ P can keep track of the elapsed time, thus anticipating the next step pulse.

Build-up and decay of winding current is known for each condition of operation, and the pulses can be timed accordingly. If the timing should change, the pulses can be automatically retarded or advanced to stay synchronized.

Closed loop systems take maximum advantage of the high reliability of stepper motors. Success stories abound in the areas of desk top calculators, printers, computers, tape readers, chart drives, automatic cameras, and miscellaneous positioning devices such as X-Y plotters.

By careful programming, the calculation time will not interfere with either the instruction time or the feedback time. In the ideal case the chip will be fully used during all transients and can perform other functions such as the recording of data during idle times.

Starting is a special problem. The first step or steps have no prior data for estimating build-up of decay delays, and some average initial values must be chosen.

Deceleration is easier. The delay can be a constant until the motor begins to slow down, then the delay can be set at zero. Deceleration is generally faster than acceleration.

Constant speed can be controlled by calling for pulse rate, measuring the actual motor speed, then gradually (in msec) adjusting the delay time until the actual speed matches the called-for speed (zero error signal). This feedback control is not different in principle from dc servos. The motor load can vary without losing control because the error signal will always compensate.

Damping presents a more complex problem, if the stepping rate is too close to motor resonance. A more complex equation and algorithm is needed to sense and correct for hunting, friction variations, slewing, and other variables.

μ Ps bring to design engineers a new generation of potential applications. There are problems to be solved, but the future holds virtually unlimited uses for the μ P-controlled stepper. **D**

Stepper Motor Terminology

Detent Torque: The maximum torque that can be applied to the shaft of an unexcited motor without causing continuous rotation. Unit: gcm, oz in.

Deviation: The change in shaft position from the unloaded holding position when a certain torque is applied to the shaft of an excited motor. Unit: degrees.

Holding Torque: The maximum steady torque that can be externally applied to the shaft of an excited motor without causing continuous rotation. Unit: gcm, oz in.

Maximum Pull-In Rate (Speed): The maximum switching rate (speed) at which an unloaded motor can start without losing steps. Unit: steps/s (rev/min).

Maximum Pull-Out Rate (Speed): The maximum switching rate (speed) which the unloaded motor can follow without losing steps. Unit: steps/s (rev/min).

Overshoot: The maximum amplitude of the oscillation around the final holding position of the rotor after cessation of the switching pulses. Unit: degrees.

Permanent Overshoot: The number of steps the rotor moves after cessation of the switching pulses. Unit: steps.

Phase: Each winding connected across supply voltage.

Pull-In Rate (Speed): The maximum switching rate (speed) at which a frictionally loaded motor can start without losing steps. Unit: steps/s (rev/min).

Pull-In Torque: The maximum torque that can be applied to a motor shaft when starting at the pull-in rate. Unit: gcm, oz in.

Pull-Out Rate (Speed): The maximum switching rate (speed) which a frictionally loaded motor can follow without losing steps. Unit: steps/s (rev/min).

Pull-Out Torque: The maximum torque that can be applied to a motor shaft when running at the pull-out rate. Unit: gcm, oz in.

Start Range: The range of switching rates within which a motor can start without losing steps.

Step Angle: The nominal angle that the motor shaft will turn for each input pulse. Unit: degrees.

Stepping Rate: The number of step positions passed by a fixed point on the rotor per second. Unit: step/s.

Slew Range: The range of switching rates within which a motor can run unidirectionally and follow the switching rate (within a certain maximum acceleration) without losing steps, but cannot start, stop or reverse. **D**

Data Electronics delivers high density, microprocessor-controlled 1/4" streaming cartridge tape drives for Winchester disk back-up. In quantity. On time. Without excuses.

Because our new assembly line has raised high technology production to the next level: high output.

Now with our hard tooling in place, up to 10,000 reliable 10 and 20 MByte drives can roll out the door each month. Headed for

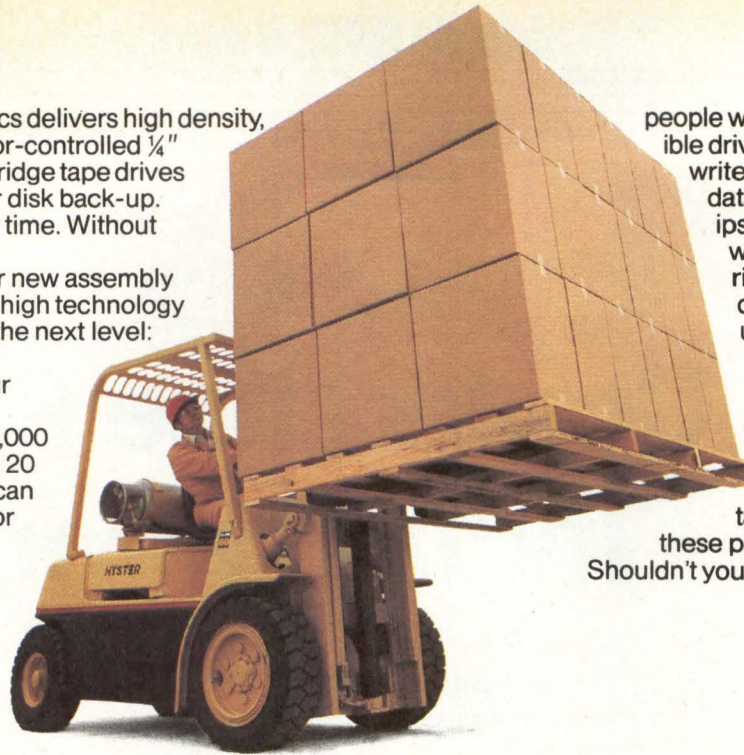

people who demand compatible drives that can read and write interchangeable data at either 30 or 90 ips. For people who want a family of cartridge drives that can cover multiple back-up applications.

They're the ones who called the company that invented high density streaming cartridge tape drives. And now these people are *on line*. Shouldn't you join them?

**We had what it
took to make the
first cartridge tape
drive stream.
Now we have what
it takes to keep
them flowing.**



DATA ELECTRONICS INC.

We Invented The High Density Cartridge Tape Drive.

Data Electronics, Inc., 10150 Sorrento Valley Rd., San Diego, CA 92121. Call (714) 452-7840/Telex 69-7118

Circle 55 on Reader Inquiry Card

NCC Booth 1172-74

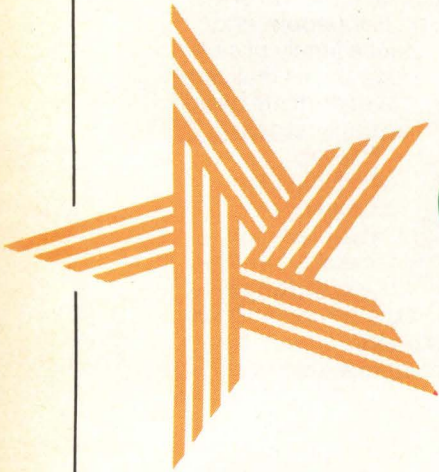

Conference Paints Industry Portrait

Bob Hirshon
Assistant Editor

"The National Computer Conference is like a snapshot of the computer industry each year," summed up Albert Hawkes, chairman of the NCC '81 steering committee. And NCC '81, by all criteria, is a superlative shot. Held in Chicago's largest exhibit hall — McCormick Place, overlooking Lake Michigan — NCC '81 presents a record 525 exhibitors sprawled over 300,000 square feet of floor space.

Attendance, projected at about 60 to 80K, may be the only subordinate aspect of the Chicago show, due to the phenomenal turn-out at Anaheim last year. There, perhaps the sunshine was as big a drawing card as the show itself. The crowd in Chicago, although smaller, should contain a higher percentage of responsive attendees. At least, with chilly Lake Michigan the only large body of water nearby, circuit boards won't have to compete for attention with surfboards, and those who travel there should be at least as interested in electronics as in the photoelectric interaction between solar radiation and skin pigmentation. By the same token, if the conference is ever held in Anchorage, you can bet that the handful of people who attend will mean business.

Speaking of which, NCC "means business" to a larger and larger extent each year — business electronics is fast becoming the peremptory area represented at the show, as evidenced by this year's technical seminars: of the 100-odd technical sessions given this year at NCC, over 40 will be business/industry related. Approximately 30 will be design-oriented, with the remainder divided among education, societal issues and

research applications. Business-related topics include "Business Communications Security Vulnerability" and "Integrating Information Systems in the Office: Data, Text, Graphics." For the design engineer, there are "Design Tools for System Architecture" and "Contemporary Fault-Tolerant Computer Designs." Finally, there are assorted sundry topics, from "Computers and the Future of Literacy" to "Computer Applications in Magnetic Fusion Energy Research."

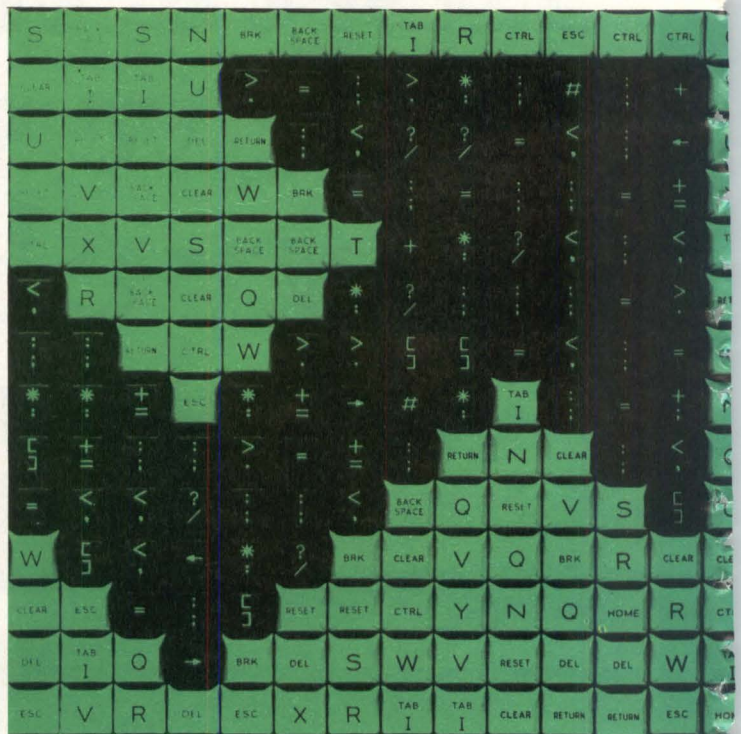

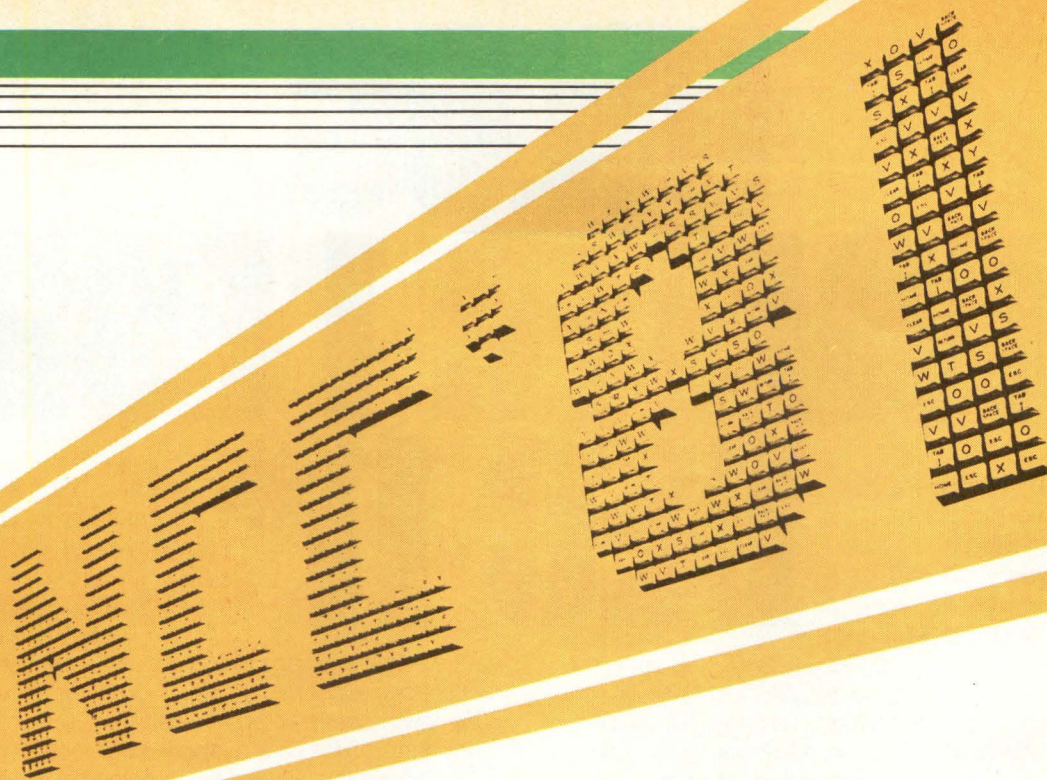

In addition, twenty-one Professional Development Seminars will cover diverse topics in personal productivity — for an added fee. These seminars include topics such as Computer Law, Office Automation, Packaging Your Image, and Sexual Conditioning in Business.

The dollars-and-cents bent of this year's NCC is evident in its theme: "Keys to Productivity." And speaking on matters monetary and managerial will be Plenary Session Speaker W. Michael Blumenthal, ex-Secretary of the Treasury and now Chairman of Burroughs Corporation.

Keynote speaker for NCC '81 is Marisa Bellisario, who is "probably the most highly placed woman in the computer and communications industry," according to Hawkes. Bellisario left her position as President of Olivetti of America several years ago to join the largest telecommunications manufacturer in Italy, Italtel. She'll be speaking about the interaction of telecommunications and data processing, comparing European and American approaches.

NCC '77 in Dallas introduced the Personal Computing Festival. That year, "the hobbyist was king," remembers Hawkes. Since then, however, home computers, toys and games have taken a back seat to small business computers; people have become less interested in finding new ways to spend their free time than in finding new ways to avoid spending their revenue. This year's festival continues that trend, evident both in the show's exhibits and its 30 lecture sessions. It is

being held inside NCC itself, making the Festival a "conference-within-a-conference."

As for the conference-the-conference-is-within, NCC is in the enviable position of having far more business than it requires. Newer commercial conferences, however (Comdex, for one), now vie for the same growing, but finite, market. Growth of these shows, together with the withdrawal of Ramtek and other significant companies from NCC this year, suggests a decline in NCC predominance. Not being seen at NCC, apparently, is no longer a sin.

Hawkes is generous in his praise of newer shows threatening to compete with NCC — a sure sign of his lack of concern. While not smug about NCC's position as the premier computer show, he considers NCC an institution that will probably endure, even with competing conferences. "Regardless of the competition," explains Hawkes, "I think that people — certainly professionals in computing — tend to look to the NCC for that snapshot each year."

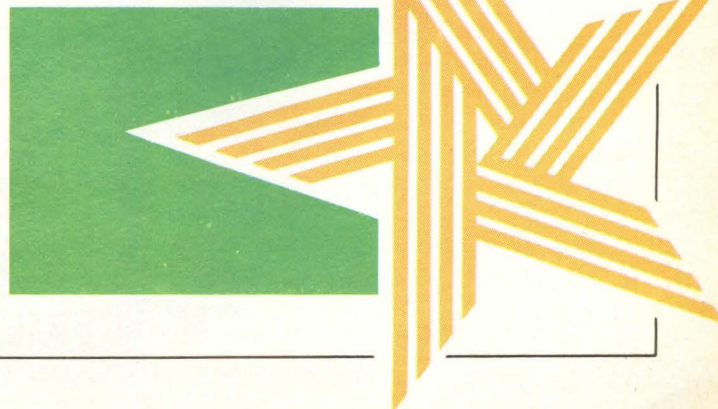

DILOG NUMBER 1 FOR DEC 11*

With LSI 11/PDP 11 Software Compatible Disc/Tape Controllers Offering Single Board Low Power μ P Based Design and Low Cost... Plus Many Other Good Reasons!

The reasons start with DILOG'S (Distributed Logic Corp.'s) full time engineering and design staff. *Not outside suppliers.* That means when you contact DILOG for product selection or after sale service, you'll get "first hand" assistance... along with years of experience manufacturing μ P based controllers that interface with DEC 11 CPUs.

The intelligent products you'll discuss all utilize common proprietary architecture and DILOG automated design techniques—products with exceptional reliability and cost efficiency... mostly available from stock. And

when you plug a DILOG controller into your DEC CPU it's ready-to-run because it's *fully operating system software compatible.*

These high performance data storage interface products also feature • minimum bus/space requirements • up to 60% less power • 10 to 50% lower cost • automatic self-test... and numerous other features for easy system integration.

Consult the DILOG/disc-tape compatibility table for your needs. Then ask for detailed data on existing, or future products from DILOG... #1 in single board DEC 11 compatible disc/tape controllers.

Distributed Logic Corp., 12800-G Garden Grove Blvd., Garden Grove, CA 92643, Phone: (714) 534-8950 • TELEX: 681 399 DILOG GGVE

DISC/TAPE DRIVE MANUFACTURER COMPATIBILITY CHART

MAGNETIC TAPE	DISC			
1/2" REEL-TO-REEL STD. & STREAMER	2315/5440/RK05 CARTRIDGE CLASS	CMD CARTRIDGE MODULE	SMD STORAGE MODULE	WINCHESTER 5 1/4", 8" OR 14"
AMPEX CIPHER CONTROL DATA DIGI-DATA KENNEDY MICRODATA PERTEC TANDBERG DATA (IDT) WANGCO TDX	AMPEX CAELUS CENTURY DATA CONTROL DATA DEC DIABLO IOMEC MICRODATA PERTEC WANGCO WESTERN DYNEX DRI	AMPEX CONTROL DATA	AMPEX CENTURY DATA CONTROL DATA BALL COMPUTER MITSUBISHI	BASF CONTROL DATA FUJITSU KENNEDY MEMOREX PRIAM SHUGART SEAGATE QUANTUM IMI
CAPACITIES 2.5 TO 300 MB				



**DISTRIBUTED
LOGIC CORP.**
DILOG

*Trademark Digital Equipment Corp.

Circle 20 on Reader Inquiry Card

See all the new DILOG products
NCC '81 BOOTH 5007 - 5009
CONCOURSE LEVEL • McCORMICK PLACE

Digital Design

Computers · Peripherals · Systems

These articles appeared in **Digital Design** in 1979 and 1980. Single back copies of the magazine are available for \$4.00. Photostat copies of articles appearing in out-of-print magazines are \$1.00 per page. Address all inquiries and requests to Circulation Director, **Digital Design**, 1050 Commonwealth Ave., Boston, MA 02215.

Communications/Fiber Optics

Acoustic Coupling for Data Transmission. Thomas J. McShane, Racal-Vadic Inc. June 1980, pg. 38.

Communicating Data With Protocols. Sandra E. Traylor, MDB Systems, Inc. July 1980, pg. 40.

Data Communications For Minicomputers. Roger L. Evans, Micom Systems, Inc. December 1980, pg. 67.

Fiber Optic Kits Simplify System Design. Leonard F. Bendiksen and Charles Intrieri, Jr., AMP, Inc. May 1979, pg. 36.

Fiber Optics Successfully Link Microcomputers. Scott Evans and Jim Herman, Motorola Semiconductor Group. April 1980, pg. 36.

Waveshaping In MODEM Transmitters. Howard Hwang, Rockwell International. November 1979, pg. 72.

Data Acquisition

A Cookbook Approach to High-Speed Data Acquisition and Microprocessor Interfacing — Part 1. Ed Sliker, Intersil, Inc. August 1980, pg. 34.

Data Acquisition/Microprocessor Interface Performance Analysis — Part 1. N. Jagannathan, Univ. of California, Irvine. August 1979, pg. 32.

Peripheral Addressing In μ P Systems. Mitchell Gooze and Henry Davis, AMI. February 1980, pg. 22.

Principles of Data Acquisition and Conversion — Part 1. Eugene L. Zuch, Datel Systems, Inc. May 1979, pg. 60; **Part 2**, July 1979, pg. 30; **Part 3**, September 1979, pg. 72; **Part 4**, October 1979, pg. 84; **Part 5**, March 1980, pg. 60.

Software Approach to Data Acquisitions. Robert L. Morrison, Burr-Brown Research Corp. March 1979, pg. 66.

DEC (other) Compatibility

Bank-Switchable Memories For LSI-11s. Mel Schwartz, Digital Pathways, Inc. March 1980, pg. 38.

Buying DEC Add-On Subsystems? Consider Service. Phillip Begich, Emulex Corp. August 1980, pg. 60.

Computer Compatible Peripherals: Calendar Clocks Provide Systems Insurance. Leonard C. Birkwood, Digital Pathways, Inc. October 1980, pg. 26.

Data General Compatible Products: Hiatus or Impending Growth? Paul Snigier, Digital Design. October 1980, pg. 28.

DEC-Compatible Equipment: How to Select Vendors. Jack Olson, Wespercorp (Western Peripherals Div.). August 1980, pg. 42.

DEC-11 Mass Storage Peripheral Controllers. Allan Krosner and Glenn Salley, Distributed Logic Corp. September 1980, pg. 26.

Designers' Guide To DEC Add-In/Add-On Products. Ken O'Mohundro and Ray Bell, Able Computer. August 1980, pg. 94.

How To Select DEC-Compatible Analog I/O Boards. Paul Severino, Data Translation, Inc. August 1980, pg. 48.

Special Report: Add-In/Add-On Computer Memories. Paul Snigier, Digital Design. January 1980, pg. 42.

Flexible Disks/Drives

A Guide to Flexible Disk Drive Selection. Robert L. Erdman
Memorex Corp. July 1979, pg. 46.

Alternatives Abound When Assembling Flexible Disk Systems.
Woody Floyd, Ex-Cell-O Corp., Remex Div. March 1979, pg. 22.

Floppy Disk Drives. Gary Goodman, Ex-Cell-O Corp., Remex
Div. December 1979, pg. 62.

Floppy Disk Drives. E. Chuck Ouellette, Ex-Cell-O Corp., Remex
Div. December 1980, pg. 44.

Special Report: Flexible Disk Drives. Staff Report, Digital
Design. April 1980, pg. 46.

Instrumentation/Development Aids

Check Microcomputer Systems With Smart DMMs. Ed Donn
and Bill Rochat, Electro Scientific Industries. May 1979, pg. 86.

Fundamentals of μ P Development Systems. Paul Wintz, Wintek
Corp. November 1980, pg. 30.

Logic Analyzers. Bruce Farley, Hewlett-Packard. January 1980,
pg. 24.

Logic Analyzers. Staff Report, Gould Inc., Biomation Div.
December 1980, pg. 58.

**Logic Analyzers and μ P Development Systems Aid in
Debugging Multiprocessor Networks.** Doug Johnson, Tektronix,
Inc. November 1980, pg. 38.

Microcomputer Development Systems. Bob Hunter, Tektronix.
December 1980, pg. 54.

μ P Development Systems. Martin J. Weisberg, Millennium
Systems Inc. December 1979, pg. 80.

μ P Development Systems Required Tools for Digital Designers.
Charles Kondrath, E-H International. March 1979, pg. 58.

New-Generation μ C Development System. Lester G. Matheson
and David J. Ulmer, GenRad/Futuredata. November 1979, pg. 38.

New Generation of Prototyping Tools Aids System Designers.
Russell Petit, Augat Inc., Interconnection Products Div. August
1979, pg. 46.

Present and Future Trends in Logic Analyzers. Keith Barnes,
Kontron Electronic Inc. April 1980, pg. 30.

**Selecting a Logic State Analyzer: How Fast, How Much, How
Wide and How Deep?** Stephen A. Rickman, Paratronics Inc. June
1979, pg. 90.

Setting Up a Microprocessor Development Lab. Bill Schweber,
Instron Corp. May 1979, pg. 42.

Keyboards/Digitizers

Capacitance Keyboards: A Look Beyond Microprocessors.
Walter Z. Davis, KeyTronic. April 1979, pg. 38.

Digitizers. Warren J. Ridge, Talos Systems, Inc. December 1979,
pg. 52.

Keyboards. Dennis L. Sullivan. December 1979, pg. 59.

Keyboards. KeyTronic Corp. December 1980, pg. 64.

μ Cs/ μ Ps

Microcomputers. Al Moore, Motorola Semiconductor Group.
January 1980, pg. 32.

Microprocessors. Bob Greene, Intel Corp. December 1980,
pg. 34.

**μ P Application: 6800 Replaces Minicomputers and Controls
Elevators.** C. Halatsis and A. Sokos, Computer Center, NRC.
April 1979, pg. 62.

Microprocessors and Microcomputers. Ian LeMair, Motorola
Semiconductor Group. December 1980, pg. 30.

μ P Selection: Some Do's and Don'ts — Part 1. Paul Snigier,
Digital Design. April 1979, pg. 28; **Part 2**, May 1979, pg. 28.

**Programmable Interval Timer Frees μ Ps to Perform More
Complicated Tasks.** Dave Wicker, National Semiconductor Corp.
May 1980, pg. 32.

Single-Chip μ C Controls Keyboard Scanning. John Wharton,
Intel Corp. November 1980, pg. 46.

Single-Chip MC6801 Offers Increase Versatility — Part 1.
James J. Farrell III, Motorola Semiconductor Product Inc.
September 1979, pg. 62; **Part 2**, October 1979, pg. 42; March
1980, pg. 56.

**Special Report: Single Board Computers — Some Do's and
Don'ts.** Paul Snigier, Digital Design. March 1980, pg. 48.

Minicomputers/Array Processors

Minicomputers. Paul Snigier, Digital Design. December 1980,
pg. 26.

Minicomputers: System Element or Pile of Bits? Scott Harris,
Computer Automation. November 1980, pg. 22.

**Programmable Array Processors Offer New Options —
Interview.** Norman Winningstad and Jon Salquist, Floating Point
Systems, Inc. July 1979, pg. 70.

Superminicomputers: Evolution or Quantum Jump — Part 1.
Larry Wade, Digital Equipment Corp. July 1979, pg. 38; **Part 2**,
August 1979, pg. 40.

**The Role of the Minicomputer in the Small Business
Marketplace.** Cathy Raftery, Lear Siegler, Inc. June 1979, pg. 42.

Miscellaneous

End-User Appeal: Key to Successful OEM Designs. David R.
Carson, Televideo, Inc. June 1980, pg. 50.

1979 National Computer Conference. May 1979, pg. 71.

Peripheral Controllers. Fred B. Cox, Emulex Corp. December
1980, pg. 48.

**Programmable μ P-Based System Provides Total Energy
Management.** Staff Report, Sunkeeper Corp. April 1979, pg. 68.

Techniques for Designing Successful Products. Ken
O'Mohundro and Les Wellington, Able Computer Technology, Inc.
August 1979, pg. 50.

Power Sources

**Evaluating Power Line and Power Supply Performance in
Computer Systems.** Stephen J. Tharp, Dranetz Engineering Labs,
Inc. February 1980, pg. 28.

Power Supply Systems for Computer-Based Applications. J.F.
McNulty, Adtech Power, Inc. March 1979, pg. 32.

Special Report: Power Supplies. Paul Snigier, Digital Design.
February 1980, pg. 50.

Switching Power Supplies. Wally Hersom and Jeff Shepard, L-H
Research. December 1979, pg. 74.

**Uninterruptible Power Systems Provide Computer System
"Insurance."** John J. Waterman, Jr., Elgar Corp. February 1980,
pg. 38.

Printers/Plotters

Computer Output Printing Technologies. Donald S. Swatik,
Computer Peripherals, Inc. July 1980, pg. 26.

Designers' Guide to Pen Plotters. Maurie D. Wagner, Houston Instruments. September 1980, pg. 66.

Guide to Color Hard Copy. Bob Hirshon, Digital Design. September 1980, pg. 46.

Hardcopy Techniques in Western Europe. Ulf Rothgordt, Philips Lab. July 1980, pg. 36.

Matrix Printers. Peter Craig, Printronix, Inc. December 1980, pg. 50.

Matrix Printing Optimizing LSI, Mechanics . . . Cost Performance. Staff Report, Printronix, Inc. March 1979, pg. 50.

New Digital Hard Copy Technologies. Alan Dawes, Versatec. September 1979, pg. 48.

New Trends in Computer Printing. Engineering Staff Report, Printronix, Inc. March 1980, pg. 42.

Optimum Design of High-Speed Non-Impact Printers. Isao Fujimoto, NTT Yokusuka Electrical Communication Lab. July 1980, pg. 32.

Plotters. Morris Samit. December 1979, pg. 39.

Printers. Peter M. Craig, Printronix, Inc. December 1979, pg. 48.

Printers and Teleprinters. David Glidewell, Mannesmann Tally. December 1980, pg. 53.

Small System Printers. Engineering Staff Report, Micro Peripherals, Inc. December 1979, pg. 42.

Synchronous Jet Ink Droplet Generator Mechanism. Richard A. Hein and David E. Lundquist, Computer Peripherals, Inc. July 1980, pg. 34.

System Designers' Guide to Hard Copy/Printers. July 1980, pg. 26.

Tactical Hard Copy Image Generation System. Larry E. Hand, R.E. Davis and R.J. Straayer, Harris Government Systems Group. July 1980, pg. 28.

The Arab Printer and Computer Market — Mideast Report. Oykué Brogna, Digital Design. January 1979, pg. 54.

Thermal Printing With Semiconductor Printheads. T. Ray Woodard, Texas Instruments. September 1980, pg. 56.

Uncovering A Printer's True Ownership Cost. Howard Kendall, Data Printer Corp. September 1980, pg. 40.

Which Printer Should You Select? George Rea, Centronics Data Computer Corp. September 1979, pg. 36.

Semiconductors/Bubble Memories

Bubble Memory Systems. Leonard M. Call, Motorola Semiconductor Group. December 1980, pg. 38.

Designers' Guide to Magnetic Bubble Memory Systems. Roger Hagard, Texas Instruments. August 1980, pg. 62.

Getting Started in Bubble Memories. Phil Spiegel, Intel Magnetics, Inc. November 1979, pg. 46.

Magnetic Bubble Memories. Paul Snigier, Digital Design. December 1979, pg. 88.

MOS RAMs. Staff Report, National Semiconductor. December 1980, pg. 35.

Programmable Devices: Their Advantages and Disadvantages, and Programming Equipment — Part 1. William E. Gundling and Peter A. Schade. International Microsystems. September 1979, pg. 26; **Part 2,** October 1979, pg. 76.

Semiconductor Memories. S. Cash Olsen, Signetics Corp. January 1980, pg. 72.

Software

Choosing a Higher Level Language for μ P Development Systems. Roger Hokanson, Logic Development Products Tektronix. February 1979, pg. 28.

μ C Software. Lance A Leventhal, Emulative Systems Co. December 1979, pg. 86.

Microcomputer Software. Lance A. Leventhal, Emulative Systems Co. December 1980, pg. 65.

Microcomputer Software Lower Parts Count. Larry A. Solomon and Dennis Block, RCA Solid State Div. May 1979, pg. 98.

Programming Efficiency Can Be Improved. Here's How. Michael D. Maples, M&E Associates. October 1980, pg. 34.

Recursive Programming In Basic. Herbert L. Dershem, Hope College. July 1980, pg. 20.

Software: Micros vs. Minis. Ken Schroeder, RCA Laboratories. April 1979, pg. 20.

Tape/Cartridges

Backup For Your 8-Inch Winchester. Bob Hirshon, Digital Design. October 1980, pg. 50.

Cartridge Drives Store Megabytes at Low Cost. Sam Thompson, Data Electronics, Inc. January 1979, pg. 42.

Cartridge Tape Drives. William Valiant, Data Electronics, Inc. December 1980, pg. 41.

Floppy Disk Provides Back-up For Winchester. E. Chuck Ouellette, Ex-Cell-O Corp., Remex Div. May 1980, pg. 38.

Half-Inch Tape Provides 8-Inch Winchester Back-up. Roy Ford, Cipher Data Products, Inc. May 1980, pg. 46.

Magnetic Media Maintenance. February 1979, pg. 84.

Magnetic Media Surfaces — Interview. Lew Whitaker, Innovative Computer Products. January 1979, pg. 62.

Need Mass Storage for Your Mini? Try 1/4-Inch Cartridges. Jack Olson, Western Peripherals Div., Wespercorp. February 1979, pg. 56.

Reel-to-Reel Tape Drives. Darell Meyer, Kennedy Co. December 1979, pg. 92.

Streaming Tape Drives. William Valiant, Data Electronics Inc. December 1979, pg. 94.

Tape Back-up for Winchester Fixed Disks: 1/4-Inch vs. 1/2-Inch. Sam Thompson, Data Electronics, Inc. May 1980, pg. 80.

The World of Magnetic Recording Media. Harry Shershow, Digital Design. May 1980, pg. 70.

Universal Controller for Tape-to-Intel Multibus. Philip Monego, Zeta Research, Inc., and Robert G. Pomeroy, Information Processing Techniques. January 1979, pg. 36.

Terminals/Displays

Alphanumeric CRT Terminals. CRT Terminals in 1980, Engineering Staff Report, TEC, Inc. **CRT Terminals Beyond 1980,** Engineering Staff Report, Perkin-Elmer Corp. December 1979, pg. 26.

Alphanumeric Data Terminals. K. Phillip Hwang, TeleVideo Inc. January 1980, pg. 38.

Alphanumeric Terminals: Some Selection Criteria. Paul Snigier, Digital Design. June 1980, pg. 28.

Color Graphics Terminals. Harry Shershow, Digital Design. December 1979, pg. 33.

Computer Graphics Terminals Track Target Drones. Engineering Staff Report, Megatek Corp. October 1979, pg. 38.

CRT Light Pen Technology and Design. Robert Klatt, Electro-Optical Products, Information Control Corp. September 1979, pg. 56.

Data Entry Peripherals: Criteria for Selecting CRT Terminals. Staff Report, RCA Service Co. June 1979, pg. 79.

Designing a Low-Cost Terminal with LSI Chips. Helge M. Mortensen, National Semiconductor. June 1979, pg. 30.

Determining The Spatial Resolution Required For Real-Time Graphic Displays. Dr. Harry C. Andrews, Comtal Corp. March 1980, pg. 34.

Digital Image Processing. Ted Driscoll and Chris Walker, Stanford Technology Corp. December 1980, pg. 70.

Evolution of Video Terminals. Mary Cole, Digital Equipment Corp. November 1979, pg. 28.

Fighting Flicker in Raster Graphics. J. V. Howell, Genisco Computers. October 1979, pg. 36.

Graphic Display Devices. Paul Snigier, Digital Design. April 1980, pg. 39.

Intelligence: How Will It Affect Alphanumeric and Graphic Terminals. Paul Snigier, Digital Design. July 1979, pg. 76.

Intelligent Terminals: What The System Designer Should Look For. Darrell Crow, Zentec Corp. November 1979, pg. 32.

Latest Semiconductor Technology Offers Users More Speed, Flexibility and Standardization. Peter J. Shaw and Walt A. Foley, Megatek Corp. February 1979, pg. 44.

New CRT Graphics Display Technology Broadens Uses. Loren Werner, Vector General, Inc. October 1979, pg. 30.

Quantitative Evaluation of Soft Copy Displays. Dr. Harry C. Andrews, Comtal. June 1979, pg. 55.

Selecting a CRT Terminal? Characteristics Need Careful Matching. Ted Ellison and Tom Hadley, Microdata Corp. February 1979, pg. 36.

Terminal Operating System Provides Unique, Functional Hooks for the OEM. Mark Crowley, Perkin-Elmer Corp. May 1979, pg. 50.

The Future of Data Entry Peripherals: Revolution, Evolution—Or the Doldrums? R. E. Kelton, TEC, Inc. June 1979, pg. 84.

Through The Looking Glass—New Frontiers in 3-D. Melvin L. Prueitt, Los Alamos Scientific Laboratory, Univ. of Calif. June 1980, pg. 54.

Winchesters

8-Inch Hard Disk Drives. George Campbell and Beau Vrolyk, International Memories, Inc. December 1979, pg. 68.

Eight-Inch Hard Disk Drives: New Focus in the Small Systems Marketplace. A. Keith Plant, Memorex. May 1980, pg. 62.

Here Come the Microdisks. Stuart Mabon, Micropolis Corp. January 1979, pg. 30.

Special Report: The Flexible Future of Rigid Disk Drives. Harry Shershow, Digital Design. May 1980, pg. 52.

System Designer's Guide to 8-Inch Hard Disk Drives. Paul Snigier, Digital Design. August 1979, pg. 18.

The 8-Inch Fixed Disc/Removable Cartridge Drive Integral Backup Aids for Small Systems Storage. A. Keith Plant, Memorex Corp. October 1980, pg. 40.

The Microdisks Are Coming. George King, Digital Design. January 1979, pg. 26.

SYSTEM OEM'S

OUR IMPROVED MICRO MUTT . . .

takes a bite out of rising user support costs

Micro Mutt provides:

- Dial-up access to your customers' CPU's with full console privileges.
- Remote software debugging and updating.
- Remote exercising of hardware diagnostics.

This means less travel for your technical support staff. You service your customers from your own facility, at minimal cost and with immediate response to their demands.

Micro Mutt is easily installed between the CPU and console of most minicomputers, requires no modification to existing hardware or software and is loaded with performance features.

Call or write for the technical details.



CUSTOM SYSTEMS INC

6850 Shady Oak Road
Eden Prairie, Minnesota 55344
Telephone: (612) 941-9480 Telex: 290975



SEE US AT NCC
BOOTH 774

Circle 35 on Reader Inquiry Card

High Performance. Perfect for multi-user multi-tasking applications, the BASF 6170 Series drives give you an average time-to-data of 50 milliseconds...four to seven times faster than standard 8" floppy drives.

Capacity. The BASF Model 6171 provides 8 megabytes and the Model 6172 provides 24 megabytes of fully usable unformatted capacity. Unique BASF circuitry eliminates user mapping.

Easy System Integration. BASF's exclusive SMD interface option offers cost-effective and convenient interface compatibility with industry-supported controllers. Low-cost BASF disk bus, or intelligent BASF host bus with integral controller/formatter also available.

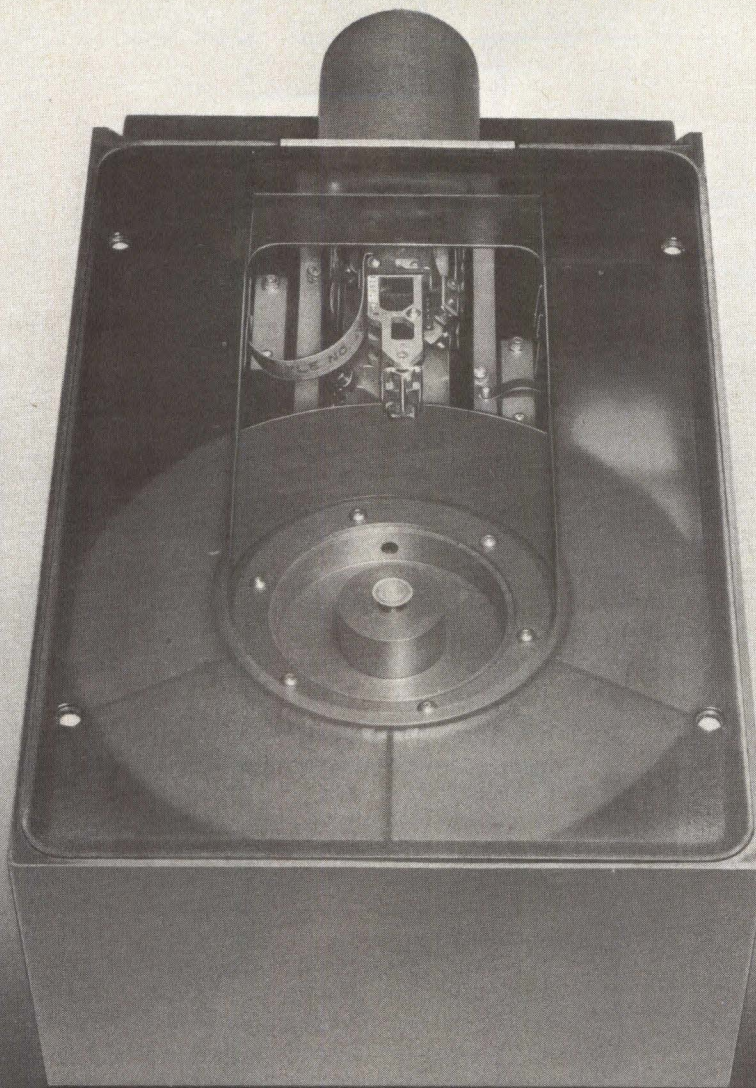

Proven Reliability. BASF, because of its experience in both magnetic media and drives, is highly qualified to develop drives using reliable 3350 Winchester technology. BASF 6170 drives have a 10,000 hour MTBF and require no scheduled maintenance or operator intervention.

Compact Size. Far smaller than 14" drives, the quiet, lightweight floppy-sized BASF 6170 drives are suitable for desktop office environments.

Competitive Price. Get the performance, capacity, and ease of system integration you need right now...at prices you'd expect to pay for far less sophisticated technology. Write now for competitive OEM prices.

If you need high performance, capacity, easy system integration, proven reliability, in a compact size, at a competitive price, right now...

write now.

DD4

BASF Systems, OEM Peripheral Sales, Crosby Drive, Bedford, MA 01730
Please send me complete details and specifications on the new BASF 6170 Series 210mm Fixed Disk Drives.

Name _____ Title _____

Company _____

Address _____ Telephone _____

City _____ State _____ Zip _____

In a hurry? In the East, call (617) 271-4168. In the West, (714) 752-6126.



BASF

Circle 54 on Reader Inquiry Card

Architecture Shuffling Ability Distinguishes Image Processor

At the SIGGRAPH show in Dallas this August, Spatial Data Systems will unveil the EyeCom III, their state-of-the-art real-time image processor. What sets it apart from other processors is its ability to switch instantly, under software control, from one hardware architecture to another as rapidly as 30 times per second. This means you can perform up to 30 different operations on a live video image, or process up to 30 different images, all within one second.

IDEX — short for Image-Data Exchange — connects the inputs and outputs of a number of different “processing modules” (image refresh memories, mapping tables, etc.), and acts as a multipoint data bus switcher, rapidly swapping architectures according to a preprogrammed plan. “One can cascade processes,” says David Rutland, SDS President, “so you can process a picture, then take the result of that and process it another way and, using many memories independently, perform very sophisticated operations on the picture in real time.”

The variety of different operations one may choose from is limited to the number of different processing modules purchased with the system. “The modular nature of the design allows the customer to choose only those modules necessary for his immediate application,” says Stan Schlosser, chief project engineer. “As his requirements change, more modules may be purchased to increase the system’s processing power up to the maximum that can be accumulated in a system chassis. Beyond that, a second chassis with its own data exchange and modules is added to communicate with the master module.”

EyeCom III consists of three subsystems. The analog processor (Figure 1) is comprised of the video input switcher, DC restorer, log/lin and scaled amplifiers, and a buffered amplifier to drive the ADC modules. Also within the analog processor are at least

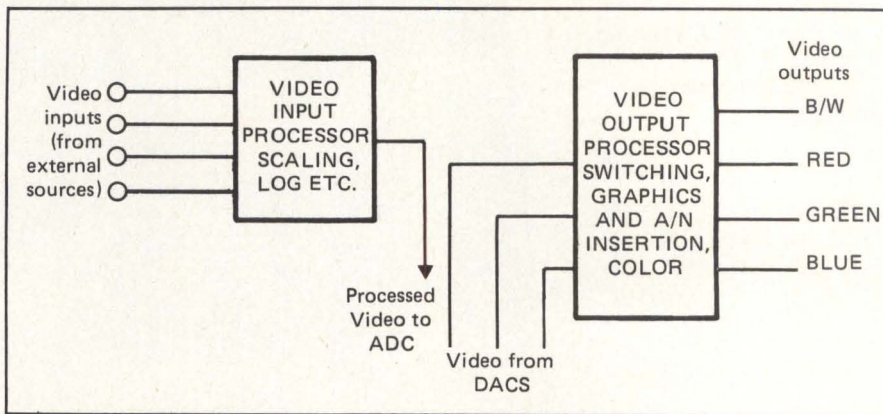

Figure 1: Analog Processor handles live incoming video.

four display amplifiers that can be switched to display the scanner video, DAC module outputs, 8-color graphics, cursors, alphanumeric, and gated pseudocolor overlay.

The core (Figure 2) contains the IDEX, CPU interface, μ P, sync and timing generator, alphanumeric generator, joystick and other cursor electronics, and the programmed increment

X,Y registers for CPU access of image memory (window DMA). Along the length of the image processor backplane run the core’s buffered timing, CPU data and control buses. Should system expansion be required, additional buffered timing lines to drive an extension chassis are available.

Image processing modules (Figure 3) represent EyeCom III’s third sub-

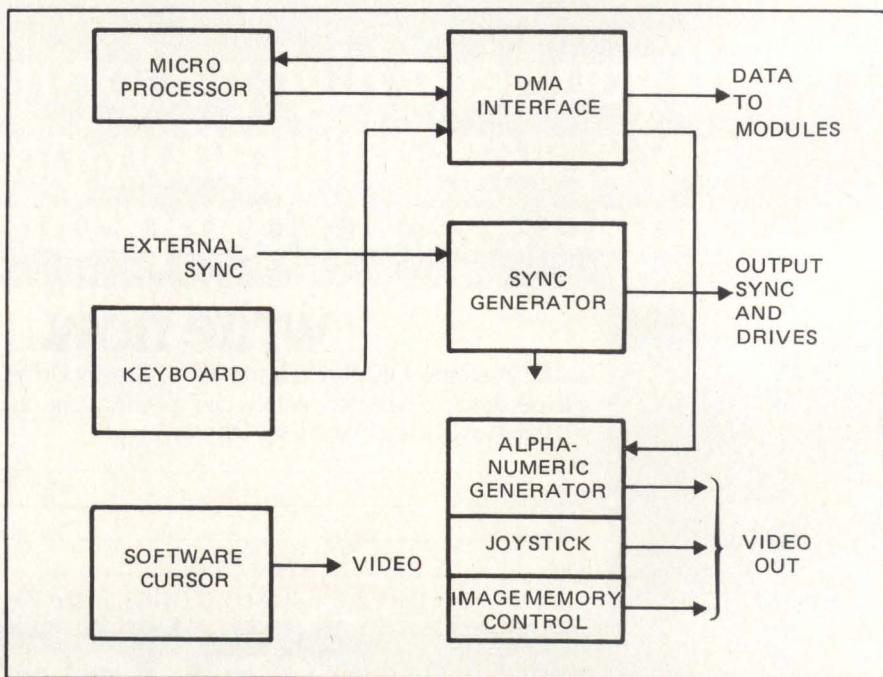

Figure 2: Core Subsystem contains the IDEX real-time bus switcher.

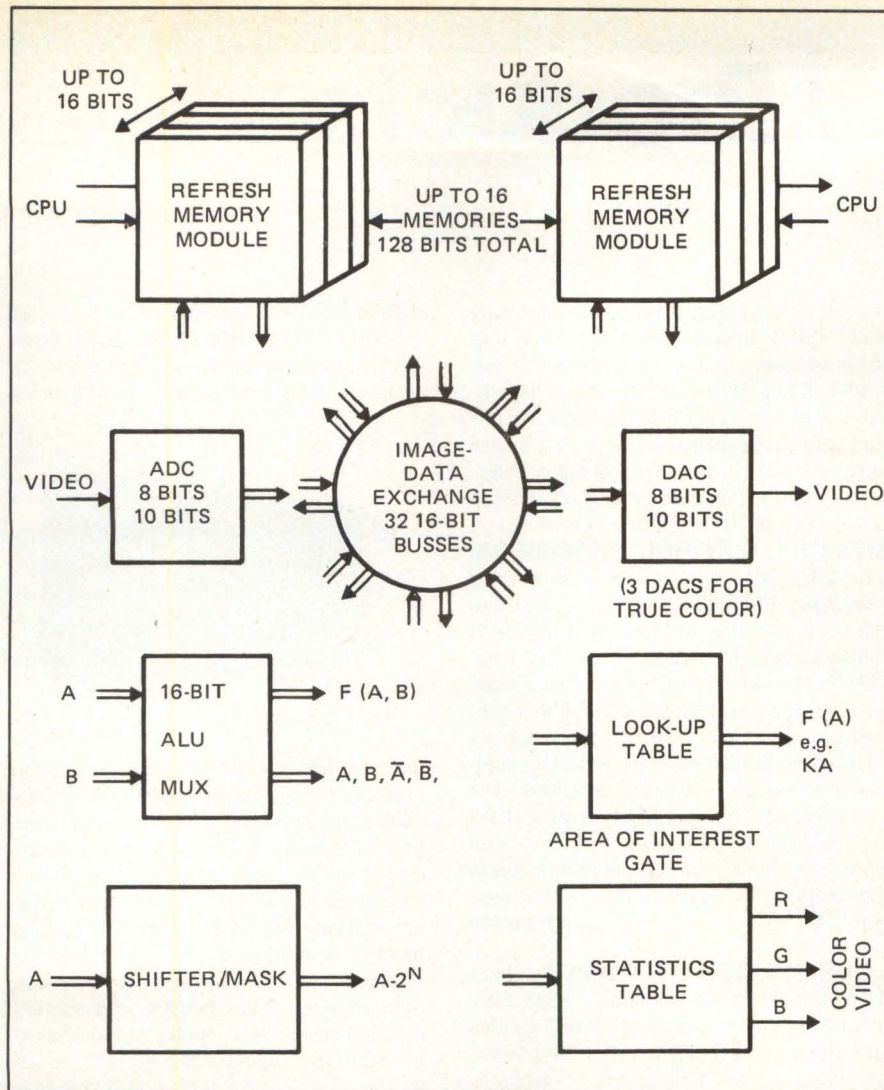

Figure 3: Image Processing Modules can be swapped by IDEX to form myriad architectures.

system. These include video ADC's refresh memories, lookup tables (LUTs), arithmetic logic units (ALUs), data shifters (that multiply or divide by twos), and video DACs. Any one of sixteen, 16-bit module outputs (sources) connects to any one of sixteen, 16-bit inputs (destinations), via IDEX.

Each module has its own 4-bit code; a single word output to IDEX specifies both source and destination for the interconnection. One code can serve as one destination, or up to sixteen sources. A single string of these codes interconnects modules in a variety of ways, providing an almost infinite array of image processing capabilities.

For industry, EyeCom III can perform complex real-time inspection on objects moving on a conveyor belt. In medicine, the unit can analyze live radiological data as it comes in, producing histograms, contrast enhancements, noise reduction, etc. all in real time. Because of its ability to shuffle architectures, one EyeCom III can serve as a real-time video processor, an image array-processor, a color display, and a video digitizer.

An average EyeCom III package will cost approximately \$55K to \$80K, including modules. Shipments will begin 3rd quarter, 1981.

— Bob Hirshon

Spatial Data Systems, Inc., PO Box 249, 508 S. Fairview Ave, Goleta, CA 93017. **Circle 200**

Bubble Memories On Cassette

For non-volatile, portable memory, Fujitsu is now marketing its bubble memory cassette system in the U.S. The device was used and tested in-house by Fujitsu in Japan before being marketed by Fujitsu America; at this year's Southcon, they introduced a 256K bit system.

Three pieces comprise the detachable bubble memory cassette system: the bubble memory cassette itself, a cassette holder with a linear circuit, and a controller board for interface with the host. The bubble cassette slips into the holder the way an audio cassette slips into a tape deck. It makes contact with pin connectors in back.

The cassette memory remains intact until purposely erased and can safely be transported or mailed. The manufacturer claims the cassettes are more

durable and reliable than paper tape or computer cards. They target the cassettes for industrial uses, especially μ P-based test equipment and numerical controls.

— Bob Hirshon

Fujitsu America, Inc. Component Sales Div, 910 Sherwood Dr-23, Lake Bluff, IL 60044. **Circle 198**

Blade Technology Makes Quiet Impact

One of the prices impact matrix printer owners have had to pay for the cheap, quick printers is aural over-stimulation — otherwise referred to as "noise pollution." To overcome the printer clatter shared by most impact printers, GE came up with a print head design of their own for their TermiNet printers.

Calling their system "blade techno-

logy," GE uses nine vertically aligned print wires that share a single magnetic field. Each print wire attaches to a blade/coil assembly. These printing assemblies are so flat that nine stacked on top of each other represent the height of one character, with descender.

Each of the nine blades may be electrically addressed. Current applied to a coil interrupts the magnetic field, causing the blade to pivot around two support arms and strike the ribbon.

Since the print wires aren't hammered into the ribbon, as in conventional impact matrix printers, acoustic levels are less than 60 dBA.

Terminet 2000 printers range in print speed from 30 to 120 cps and price from \$1495 to \$3000 (user quantity one).

— Bob Hirshon

General Electric, Data Communication Products Business Dept, Waynesboro, VA 22980. **Circle 199**



New Products

PRINTERS. The Model 150 Dot Matrix printer is a versatile unit for business system applications. Speed is 150 cps at 10 cpi with bi-directional, logic seeking. Its adjustable, snap-on tractors, top of form and condensed print capability allow for a variety of computer output. Other features include cassette ribbon; roll, cut-sheet or fan-fold paper; 40, 80 and 132 column format; paper empty detection; paper tear bar; and 100% duty cycle. Also available are band line printers, a nonimpact printer, and a series of dot

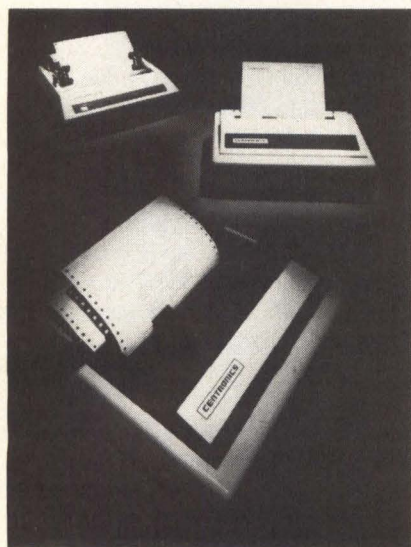

matrix printers offering a wide variety of configurations to suit any type of application. **Centronics Data Computer Corp.**, Hudson, NH 03051. **Circle 135**

AUTOMATED OFFICE PRODUCTS.

Floppy Copy, a high speed floppy diskette duplication system, can automatically copy up to 50 diskettes in less than one hour. Useful for companies who regularly send out software updates on floppy diskettes. The Trans/Media 500 is a Media conversion system which can interface various types of word processors with each other as well as phototypesetters. It can accept input from floppy diskettes, Mag tape, paper tape, and async communications. **Applied Data Communications**, 14272 Chambers Rd., Tustin CA 92680. **Circle 129**

3D INSTRUCTION SET. This locally intelligent 3D package operates an Aydin 5216 Display Computer, receiving instructions and programs from a host computer, 5116 display editor, or disk. The user can create, edit, display and store in the hierarchical, 3D data base. The system is user programmable with Forth or 8086

assembly language. It supports both binary and ASCII Instructions along with user programmable function keys, graph tablet, trackball and joystick. Capabilities include: display of surfaces, prisms, spheres, vectors and text; gives shaded surfaces with hidden surface removal; gives logical entity detection (picking); and supports Hue Intensity Saturation, RGB, or specified pixel values.

MEMORY CONTROL PROCESSOR.

The MCP-001 optimizes image processing operations on Aydin's 5216 Display Computer. It contains two μ Ps and dedicated hardware which perform a variety of functions such as high speed vector and character generation, non destructive zoom and pan, and sync functions. The first processor is a high-speed bipolar Bit Slice Processor dedicated to image processing functions. The second is a monolithic I/O Processor (IOP) dedicated to efficient data transfer control with preprocessing capability. **Aydin Controls**, 414 Commerce Dr., Ft. Washington, PA 19034. **Circle 130**

FOUR-PLATTER 5 1/4" DRIVE

utilizes 4 platters and conventional Winchester technology. An electrical brake secures spindle in power-down mode to prevent media and head damage when system is moved or shipped. Actuator is electronically dampened for servo-like positioning. A pivoting swing arm with center-mounted head optimizes access rate while enabling precise alignment. The drive uses less than 20W. Standby "power save" mode dissipates less heat (14W). Buffered step mode improves track-to-track seeking speed. Integral μ P simplifies diagnostics and control. All models fit minifloppy form factor (3.25" \times 5.75" \times 8.00") and use



standard SA1000 interfaces. In 500-unit OEM qty., RMS 503 (3.18MB) is \$750; RMS 506 (6.38MB) is \$945; RMS 512 (12.7MB) is \$1270. **Rotating Memory Systems Inc.**, 1031-A E. Duane Ave., Sunnyvale, CA 94086. **Circle 150**

40MB DRIVE is an addition to the 10- and 20-MB "7000" line of 8", fixed media Winchester disk drives. At power down, the head assembly is automatically retracted so

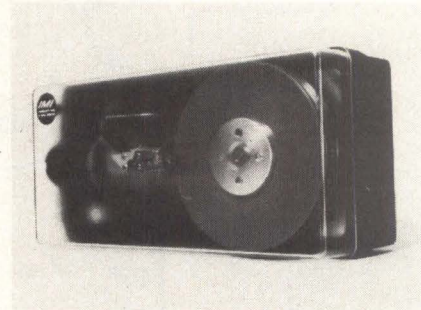

that the heads touch down in a non-data area, and the carriage assembly automatically locks in position. Thus, no data can be lost or destroyed by too frequent touch-downs in the same place, and the heads cannot be jarred or shocked against data areas during shipment. Other 7740 features include a miniature voice coil actuator, directed by a closed loop servo system; light-weight, high-strength construction; optional embedded controller for async parallel interface; and a brushless DC spindle motor. The 7740 with imbedded controller is \$2,950 in OEM qty. of 250, 90 days ARO. **International Memories Inc.**, 10381 Bandle Dr., Cupertino, CA 95014. **Circle 145**

COLOR TRANSPARENCY FILM.

A prototype 8 \times 10" film delivers a high-quality, full color instant transparency for overhead projection of computer-generated color graphics and other business data. It produces a large-format, high-resolution transparency in about 4 minutes. The transparency is exposed in an easy-loading filmholder and processed in a table-top processor. In addition to the transparency, instant color print films to record computer-generated color graphics are also available. **Polaroid Corp.**, Cambridge, MA 02139. **Circle 149**

EXPANSION CHASSIS. This 5 1/4" rack mount chassis accommodates one or two DEC four slot backplanes or one nine slot unit. The WP909 comes standard with 5 V at 15 A and ± 15 V at 2 A. Optional 25 A supplies are also available. A snap off front cover gives immediate access to all PCBs, and it comes fully equipped with rack slides, cooling fans, and mounting hardware. \$750. OEM discounts available. **Wesperline**, Div. of Wespercorp, 14321 Myford Rd., Tustin, CA 92680. **Circle 155**

CASSETTE AND PLASMA DISPLAYS.

A 256k bit bubble memory cassette is a portable detachable system. It consists of a bubble memory cassette which allows the bubble memory device to be easily loaded

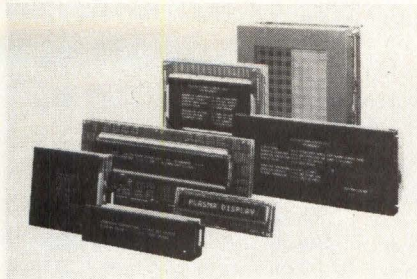

and unloaded; a cassette holder unit which combines a linear circuit with a holder into a single unit; and a controller which provides interface with the host system. It can be connected to an 8-bit μ P bus and uses advanced LSI technology. Also available are AC plasma display units featuring this flat alpha-numerical matrix units. These 32 character to 480 character displays, contain inherent memory function in the unit itself, thus eliminating the need for an IC memory chip. They can be combined with a computer, keyboard or I/O controller to accept data directly and display the registered information on the panel. **Fujitsu America, Inc.**, 910 Sherwood DR-23, Lake Bluff, IL 60044. **Circle 162**

DISK DRIVES. Model 301 minifloppy quad-density disk drive has a 1 MB capacity on a double-sided double-density 5-1/4" diskette. It is a compact disk memory device designed for random access data storage, data entry, and data output applications. A virtually frictionless band positioner provides 5 ms access time with accurate and reliable positioning. All electronics are packaged on a single PCB. Model 311 Micro-Winchester drive is an option for the

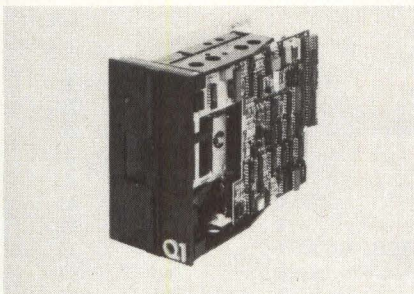

Microlite μ C system. It is mounted within the console of the Microlite system, which is a desk-top, stand-alone, multi-function μ C. A standard Winchester ferrite head is used, and data is recorded on the disks at 7500 bpi. The drive includes two motor assemblies (stepper and spindle), a head assembly with 4 Winchester heads, and a disk assembly consisting of two disks. **Q1 Corp.**, 125 Ricefield Lane, Hauppauge, NY 11787. **Circle 180**

STRIP CHART RECORDER. This 8-color strip chart recorder simulator for the IDT-2000 Color Graphics Terminal, can

display over 1,000 points/sec. The strip chart presentation can be made either in a horizontal or vertical plane. It permits a rapid, multi-color visual presentation for comparison/correlation of many variables. Other options with the IDT-2000 Terminal include MACROGRAPHICS (free form pictures, of any size, with or without imbedded colors), and RAMPICS (picture files, stored in the terminal). Both are executable by a single command. They are stored in the terminal in either RAM or PROM for fast display thereby relieving the overhead load on the host computer and on communication lines. **Industrial Data Terminals Corp.**, 1550 W. Henderson Rd, Columbus, OH 43220. **Circle 176**

DIGITAL RECORDER. This IBM/ANSI compatible magnetic tape system is plugged directly into the TI 990 TILINE. Model TI-1050 consists of a single card tape controller

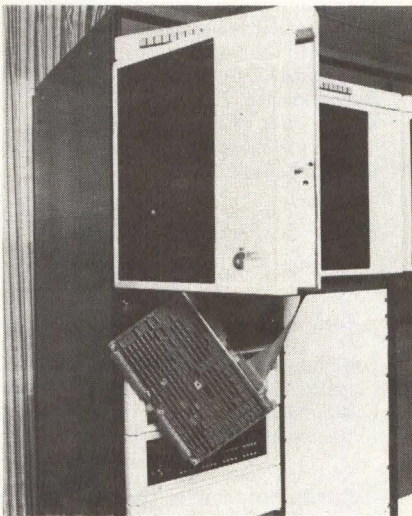

which connects to the IDT Series 1050 formatted tape transport. The complete subsystem uses a dual-density, 9-track, 45ips tape transport for either 800cpi (NRZI) or 1600cpi (PE) providing over 40 MB of data storage. **Innovative Data Technology**, 4060 Morena Blvd, San Diego, CA 92117. **Circle 178**

DATA TERMINAL includes color graphics, reverse video, programmable and resident character sets, selectable baud rates and data formats and a flexible-membrane keyboard with finger positioning overlay and aural feedback. It can be interconnected with standard RS-232 modems for communication across telephone lines and is compatible with most time sharing and data base computer networks. The character display format, 40 characters by 24 lines or 20 characters by 12 lines, is software selectable. Characters and background may be displayed in one of 8 colors (or gray scales on B/W display). There are 125 resident displayable characters or you can define your own. The terminal communications interface is industry standard async RS-232C or 20 mA current loop with 6 switch selectable baud rates. The base band video output can be directly connected to a 525 line color or



B&W video monitor or with an RF modulator to a standard color or B&W TV set. A wall receptacle type power supply is included. The VP-3301 is \$369, delivery 90 days. **RCA MicroComputer Products**, New Holland Ave, Lancaster, PA 17604. **Circle 181**

EXPANDED DS990 LINE of minicomputers includes the Model 7 with a 990/10 central processor and a new cartridge disk system, the CD1400/32. The cartridge disk features 16MB of fixed disk and 16MB in a removable cartridge disk. Model 9 uses the 990/10 central processor and the CD1400/96, a 96MB cartridge disk system with 80MB fixed disk and 16MB in removable cartridge disk. Additional space in the pedestal of both models is provided for expansion options. Model 29 is equipped with the 990/12 minicomputer with cache memory and the CD1400/96 cartridge disk system. It is housed in a 60" equipment cabinet with space for expansion options. A variety of configurations is available. From \$39,150. **Texas Instruments, Inc.**, Digital Systems Group, Box 1444, Houston, TX 77001. **Circle 170**

DATA-PANEL KEYBOARD. This low profile, tactile feel, Custom Data-Panel keyboard is designed with ergonomic concepts. Light pressure on the front surface of the Data-Panel is sufficient to close the switch contact. Features include: embossed

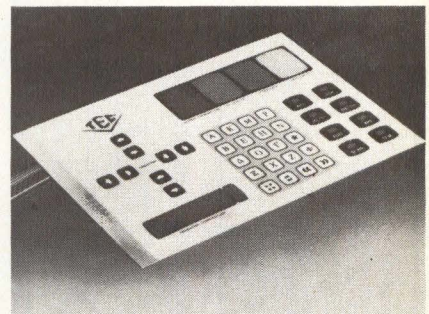

keys on velvet surface; back lighting positive mechanical contacts; contact life in excess of 5,000,000 cycles; and, parallel output. Also available are: LED indicators in keys for specific key functions; enclosure; ASCII encoding; serial output; 3 or 4 modes of operation on intelligent models; "all caps" key electronically latched on intelligent models; and, 34 pin header (direct soldering, terminals, PCB tab, flex tail, or connector interface are available). **TEC, Inc.**, 2727 No. Fairview Ave, Tucson, AZ 85705. **Circle 169**

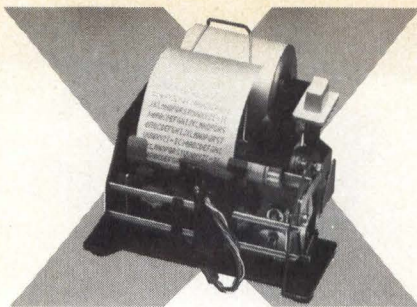

Fast reliable printer.

The DC-1606B/DC-2106D discharge printer prints 16 or 21 column alpha- numerics in a 5 x 7 dot matrix format. Its MTBF is 3.0 million lines on 2.25" paper costing about 3/4¢ per foot. Just 3.8" H x 5.4" W x 5.5" D, it is as low as \$120 in 100 quantity. Other printers with interface electronics available.

Call or write HYCOM, 16841 Armstrong Ave., Irvine, CA 92714 — (714) 557-5252

HYCOM

Circle 38 on Reader Inquiry Card

Moving?

1. For FASTEST service attach old mailing label in space below.

If mailing label is not available print your old Company name and address in this box

Please allow 6 weeks for change to take effect

2. Print your NEW business address here

NAME _____

TITLE _____

COMPANY _____

ADDRESS _____

CITY _____ STATE _____ ZIP _____

3. Mail to: Circulation Manager
Digital Design
1050 Commonwealth Ave.
Boston, MA 02215

Product Index

Product	Manufacturer	Page	Circle
Systems, Terminals			
Real Time Image Analyzers	Comtal/3M	31	23
Image Processing Systems	LogElectronics	52	29
48 MB Digital Recorder	Genisco	55	30
Smart Terminal	Beehive	57	32
Line of New DEC Terminals	Scherer's	27	48
Imaging and Graphics Terminal	AED	C-4	1
High Resolution Color Monitor	Hitachi	2	61
Smart, Ergonomically-Designed Terminal	TEC	15	11
Complete PDQ-3 Computer Under 7000	Advanced Digital	11	9
Pocket Diagnostic Terminal	G.R. Electronics	91	47
Upgrading PDP-11 Systems	Advanced Digital	17	16
Subsystems, Internal Components			
8 MB Add On Bulk Memory Compatible to DEC, etc.	Dataram	18	17
Monochips for Developing Your Own IC	Interdesign	46,47	34
DEC Compatible Backplanes	Stanford Applied	51	27,28
64K RAM Development Systems	Smoke Signal	C-3	51
Distributed I/O Control	Opto-22	C-2	2
Bubble Memory Performance in Disks	New World	27	49
Custom-made Microcomputer Control	Digital Systems	93	58
"Top-rated" Modular Encoder	Data Technology	92	21
Rugged, Reliable Encoder	BEI	85	19
Signal Sources, Transmitters			
"Butterfly" Switch with Linear Feel	Key Tronic	33	24
Printers, Plotters			
Powerful, New Intelligent Plotter	Nicolet Zeta	13	10
Complete Graphics Capable Printer	Printronix	12,14,16	12,14,15
Easy Servicing 80-column Printer	Anadex	58	46
16-21 Column Discharge Printer	Hycom	76	38
External Supports, Test Instruments			
Remote Diagnostic Tool	Custom Systems	70	35
Low Cost Array Processor	Computer Design	4	5
Microstreamer Back Up	Cipher Data	83	41
Tester for any 1Megbit MBM	Watkins Johnson	23	53
Transports and Accessories			
Disk Controller Emulates RM02 and RPOL	Plessey	9	8
10.8 to 158 MB Disk Drives w/Smart-E Interface	Priam	39	25
Disk/Tape Controllers for DEC-11 CPU	Distributed Logic	66	20
1/4" Streaming Tape Drives	Archive	1	3
Brushless DC Motors for Winchesters	Clifton	4	4
"Rock-solid" Floppy Disk Drives	TEAC	87	43
Mag Tape Controller for PDP-11/VAX-11/Eclipse	AVIV	37	52
Tape, Disk and Printer Controllers	WESPERCORP	41	26
1/4" Streaming Cartridge Tape Drives	Data Electronics	63	55
High Performance, High Capacity Drives	BASF	71	54
Automatic Loading and Threading Tape Drives	Cipher Data	5	6
Linear Motors for Disk Drives	Systems Magnetics	89	44
High Capacity Data Cartridge Drive	3M	34	40
Reliable, Removable Super Winchesters	Ampex	61	37
Stringy/Floppy Mass Storage System	Exatron	91	45
Fast Magnetic Tape Recording Systems	Dylon	36	39

To obtain detailed information on ads appearing in this issue use the Reader Inquiry Card. Circle appropriate numbers (as many as you desire), detach the card from binding and mail to Digital Design.

**This index is provided as an additional service:
the publisher assumes no liability for errors or omissions.**

EXPANDED DECWRITER IV LINE. The LA34-VA, -WA, and -RA graphics-output terminals are RO versions that can reproduce the screen display from a raster-scan video terminal. They are companion hard-copy devices to DEC's VT100,



VT132, and GIGI (VK100) video terminals, and will operate from their printer ports or directly from a host computer. The LA34-RA is the basic version of the RO terminal. The LA34-VA is designed for high-resolution graphics and uses roll paper. The LA34-WA is oriented towards output with alphanumeric characters as well as graphics and uses tractor-feed paper. The LA34 terminals are from \$1,550, qty. discounts available. The extended-logic (XL) option for the LA34 and LA38 DECwriter IV-AA models allows a number of character sets. Eight international character sets can be employed, and the terminal has APL capability. The XL feature provides auto-answerback, which allows the terminal to operate unattended when connected to a modem. An enhanced version, the XM, has a buffer capacity up to 2 kB. The extended logic option will not operate with the graphics-output terminals. The XL is \$250. **Digital Equipment Corp.**, Maynard, MA 01754. **Circle 140**

VARIABLE RESISTIVE DEVICES: how to understand and specify them. New materials and processes in today's variable resistive devices are important in performance of sophisticated circuitry in computers, instruments, communication systems, guidance control, and a host of other applications. In these applications they provide the designer with simple means for adjusting resistance or voltage and for providing position commands or feedback. The Variable Resistive Components Institute has a free handbook that guides designers in proper use of these devices. The guide identifies types of potentiometers and trimmers available, defines key performance parameters and helps select the correct device for a given application. If your designs include trimmers or potentiometers, you should have a copy of this free handbook on your desk. **VRCI**, 3451 Church St., Evanston, IL 60203. **Circle 154**

DEVELOPMENT SYSTEM. Capable of supporting up to 16 users, Z-LAB 8000 runs the ZEUS operating system, an enhanced version of Bell Labs' UNIX system. It can be used to develop code for all Zilog CPUs. The system supports up to 1.5 MB of error-correcting memory and uses 24MB 8" Winchester disk drives. Future growth to a 32-bit CPU will be accomplished via a simple board exchange. The Z-LAB concept separates hardware and software development tools into specifically tailored devices that can operate alone, with each other, or with devices made by other manufacturers. Available in November 1981. **Zilog**, 10340 Bubb Rd, Cupertino, CA 95014. **Circle 225**

LINE PRINTERS. These low cost units use raster matrix impact technology. Both models vertically space lines at 6 and 8 lpi and print on multipart forms from 1 to 6 parts. A graphics mode is included for plotting with a resolution of 60 by 72 dots/in. Normal printing is at 10 cpi, a compressed print mode shrinks character width to 16.5 cpi. Model-150 prints at 150 lpm and is field upgradable to 300 lpm. Model-300 has a 300 lpm print speed and features Non-Stop-



Printing. Its two independent printheads are constantly monitored by a μ P. When a problem occurs with either, the malfunctioning printhead is shut down and printing continues at half the original speed. Both have 90% commonality of parts and require only two spare circuit boards. TRILOG-150 is \$2600; TRILOG-300 is \$3900. OEM and distributor discounts available, delivery in 4th quarter 1981. Future additions to this family will include higher speed models. **Trilog, Inc.**, 17391 Murphy Ave, Irvine, CA 92714. **Circle 185**

PDP-11/44 ADD-IN MEMORY provides up to 1024 kB of storage on a single card. They are also available in 512 kB, 256 kB and 128 kB increments. They are compatible with regular or extended Unibus in other systems. Either 64K \times 1 or 16K \times 1 MOS storage devices are used depending on the capacity required. Memory organization is 39 bits wide, consisting of two 16-bit data

words plus 7 ECC bits. The PINCOMM 44S occupies one memory slot within the PDP-11/44, is compatible with DEC diagnostics, includes two spare on-board RAMs and an on line/off line switch. The 1024 kB version is \$13,440. Qty discounts available. **Trendata/Standard Memories**, 3400 W. Segerstrom Ave, Santa Ana, CA 92704. **Circle 224**

DOT MATRIX PRINTER/PUNCH. This compact combination printer/punch mechanism generates a 5, 6, 7 or 8 channel punched code in a paper/card ticket and

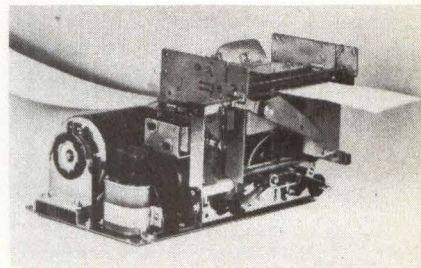

simultaneously prints an alpha numeric description on the same ticket. The ticket can be up to 3" wide, ticket length is determined by the system. Printing is at 5 lpi on roll paper and is automatically cut to size by the self-contained cutter mechanism. Model M-1400 punches 50 cps, prints bidirectionally at up to 4 lps, 20 cpl. The 7 needle Dot Matrix Print Head can print standard (5 \times 7) characters or expanded characters on the ticket. Print head life is 100 million characters. Model M-1400 is \$800 in OEM qty. **Westrex OEM Products**, 1140 Bloomfield Ave, West Caldwell, NJ 07006. **Circle 184**

SPACE SAVER MODEM. This 1200 bps single-card modem is only 30 sq. inches. The CM2020 modem is μ P-based, eliminating the need for DAAs. Self-testing, on-board auto-dialing and auto-answering are among its capabilities. Other features include: on-board test circuitry that enables either self-testing or testing via DTE; frequency-sensitive carrier detect circuitry that will not trigger DCD unless there is true in-band carrier energy present; selectable call origination that supports auto-dialing,

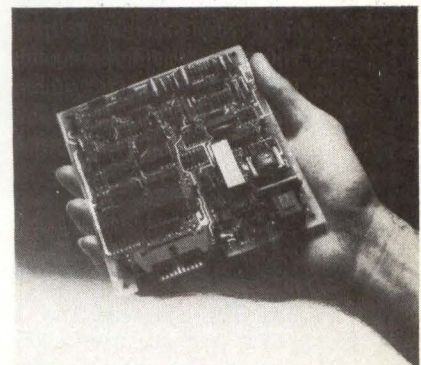

dial-through and conventional-dialing; and economical installation and operation. The CM2020 card modem is \$199. **Inteltek**, 6 Shattuck Rd, Andover, MA 01810. **Circle 177**

REPLACEMENT FOR DEC MODEM control. The DH/DM 10100-1 multiplexer replaces DEC's DH11 multiplexer and modem control. The device relieves communications problems currently facing VAX users. The DH/DM is a 16-line

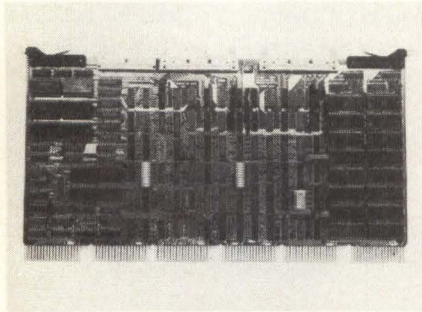

alternative that is ideal for VAX systems and works with equal effectiveness in other UNIBUS systems including PDP11, System 10 and System 20. The single hex-width board plugs into any standard hex SPC backplane slot and is diagnostic compatible with the DEC DH. Each 16-line multiplexer stands alone and runs independently. The user can install as many individual backplane-resident units as needed. **Able Computer**, 1751 Langley Ave, Irvine, CA. **Circle 127**

PERSONALITY BOARD plugs directly into the Intel Universal Prom Programmer. UPP users can now program several different EPROMs, including non-Intel types, all with one personality board. EPROM type is DIP switch selectable, and in addition to programming the Intel 2758 (TMS 2508), 2716 (TMS 2516), 2732, 2732A, the EP-710 also programs the TI 2532 EPROM types. It is completely compatible with UPP

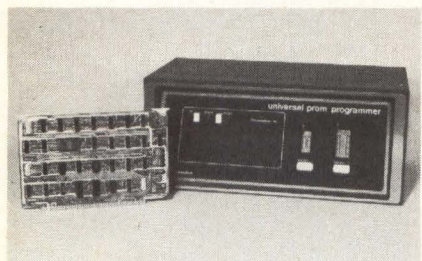

hardware and can be used in either of the two UPP card cage locations, with or without the presence of other personality boards. The EP-710 is \$625. **Eden Engineering**, 2101 Minto Dr., San Jose, CA 95132. **Circle 142**

LSI-11 PACKAGED SYSTEM. The XL-2300 packaged system integrates a DEC LSI-11/23 processor with 96-256kB memory, 24MB 8" Winchester disk, 17MB DC-450 tape cartridge as well as peripheral processors, backplane, power supply and up to 8 communications ports in a compact table-top or rack-mounted cabinet. The

system runs all DEC-compatible software without modification and also supports third-party software. Also available is a single-board, dual-density tape controller for PDP-11 Unibus computers. Model 675 controller provides full TM-11 emulation and supports up to 4 industry standard drives running any combination of speeds. **Xylogics, Inc.**, 42 Third Ave, Burlington, MA 01803. **Circle 156**

CARTRIDGE TRANSPORT WITH editing. A new enhancement on the Model 6450 cartridge transport permits editing prerecorded records without disturbing adjacent blocks. Once the record to be changed is identified by system command, the tape is read in reverse until the block is located. The tape then is stopped with the erase head in the inter-record gap. For editing, the tape is ramped to speed in the forward direction, the existing block erased and rewritten by the write head. The edited record must be the same size as the existing record. The same record may be edited 6 to

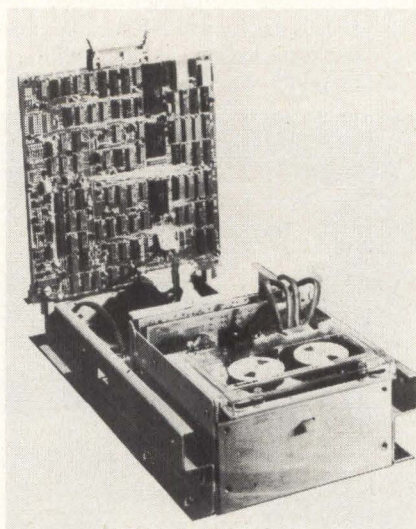

10 times before a new cartridge must be recorded. Model 6450 cartridge tape system incorporates a 6400-bpi, 30 ips cartridge drive and a μ P-based formatter in a single compact package. With a 600' cartridge, the 6450 has an unformatted capacity of 23MB; 17.3MB with a 450' cartridge, 11.5MB with a 300' cartridge. Model 6450 is \$1520 ea./100. **Kennedy Co**, 1600 Shamrock Ave., Monrovia, CA 91016. **Circle 146**

INCREASED CAPACITY Winchester. The Marksman family of Winchester disk drives has been expanded to include a series of higher capacity models. The first is an 80MB version. Features include 3 data surfaces; two 14" disks; 24,000 bytes/track; 480 tracks/in.; 7545 bpi; 50 ms average positioning time; 50 ms actuator time; and 960 kB/sec data transfer rate. The customer base is primarily companies which are integrating small business systems that require high capacity, cost effective Winchester Disk Drives with characteristics equivalent to removable products. **Century Data Systems, Inc.**, 1270 N. Kraemer Blvd, Anaheim, CA 92806. **Circle 134**

5MB ADD-ON. These Winchester disk systems interface to a wide variety of microcomputers. They are designated according to the microcomputer with which they inter-

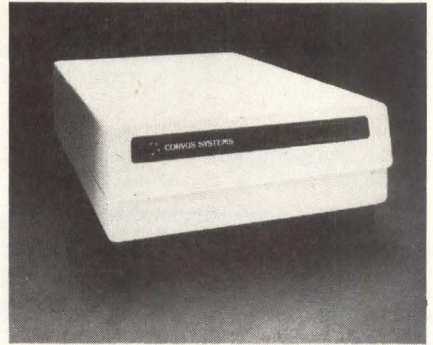

face. A system package consists of a compact drive; an intelligent, Z80-based controller card; an intelligent interface card with firmware and software appropriate to the given model of microcomputer; and a complete power supply adaptable to line standards worldwide. Specifications include an unformatted data capacity of 6.9 MB (5.8 MB formatted); a minimum seek time of 10 ms; and average seek and latency times of 50 and 8.3 ms. Power consumption is 120 W. \$3,750, qty. discounts available. **Corvus Systems**, 2029 O'Toole Ave, San Jose, CA 95131. **Circle 173**

VAX ADD-IN MEMORY is a plug compatible replacement for DEC's M8210 with complete electrical and mechanical compatibility on the VAX 11/780. The MSC 3610 brochure describes a 32K word memory system (256 kB) that includes 64 data bits and 8 bits for error control. The MSC 3610 is \$5700 per MB. **Monolithic Systems Corp**, 84 Inverness Circle East, Englewood, CO 80112. **Circle 229**

2K x 4 BIPOLAR PROMS include fast, ultrafast, low power, and power switched models. The standard Am27S184 and Am27S185 with open-collector and 3-state outputs, respectively, have a max access time of 50ns and draw only 150mA. IMOX II technology allows these PROMs to double memory density in the same 18-pin, 300-mil center package as 1K x 4 PROMs, with twice the speed and half the power. The Am27S185A guarantees a max access time of 35ns. The Am27LS185 draws only 120mA and accesses in 60 ns. The Am27PS185, power switched via the chip select line, recovers to full power (150mA) and full addressing in 10 ns. From \$23.35/

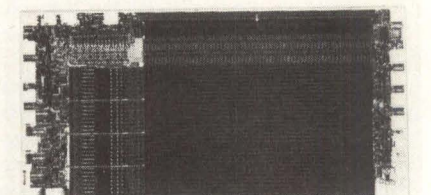

100. **Advanced Micro Devices Inc**, 901 Thompson Pl, Sunnyvale, CA 94086. **Circle 157**

CONVERSATIONAL QUERY SYSTEM.

This software package offers true English communication between users and their data bases. INTELLECT responds instantly to queries in clear, meaningful English. This newest version operates directly with data bases managed by IBM's VSAM and Software AG's ADABAS. It can be customized to a specific application, data, types of queries, and linguistic style. Interpretive ability handles complex sentence structures, pronoun references, sentence fragments and poor grammar. Other INTELLECT features include data sorting, statistical and arithmetic functions, bar graph representation, formatted reports, linking of user-specified processes, handling of ambiguous queries, data security, and logging facilities. **Artificial Intelligence Corp.**, 200 Fifth Ave., Waltham, MA 02254. **Circle 240**

S-100 BUBBLE-MEMORY SYSTEM

consists of a single printed-circuit controller module (MBC-100 Bubbl-Board) and one or more bubble-memory modules (MBB-100 Bubbl-PAC). All modules can plug directly into any S-100 system. The MBC-100 contains its own 8-bit μ P and can control up to 16 MBB-100 PAC's. The μ P

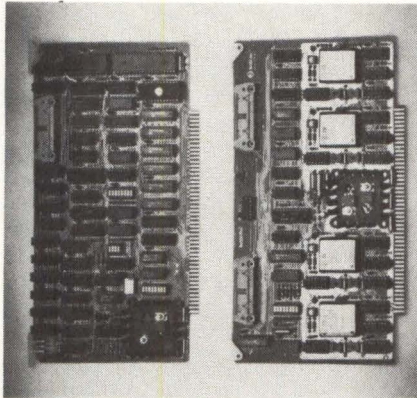

handles bubble-device formatting, error-checking and control. The MBB-100 contains 46 kB of bubble-memory mass storage. Access time is less than 4 ms average, 7.27 ms max. The MBC-100 controller is \$361; the MBB-100 is \$772 (100 ea. prices). **Bubbl-tec**, 6800 Sierra Court, Dublin, CA 94566. **Circle 242**

STD-Z80 INDUSTRIAL I/O. The Z501 enables an STD Bus system to control industry standard I/O modules (manufactured by Opto 22, Motorola, Crydom, et al.). The card can also be used to directly operate medium power loads such as relays, lamps, and motors. I/O lines are available on an edge connector configured to match the Industry Standard I/O Module Bus. Thus a simple ribbon cable can be used to interface the card to a module mounting rack. Mounting racks with 8, 16, or 24 positions can be used. They can be loaded with any desired combination of AC or DC input and output modules. Z80 Parallel I/O chips are used, resulting in a major simplification of the software required to drive the I/O channels. **Electrologic, Inc.**, 1050-A East Dominguez St., Carson, CA 90746. **Circle 249**

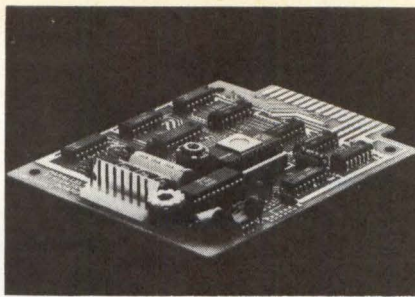

PHONETIC SPEECH KIT. This sample evaluation kit is a small self-contained circuit board consisting of a CMOS silicon speech chip, external controller, memory, and on-board audio amplifier. The unit comes preprogrammed with 250 stored words and phrases which can be intermixed with phoneme sequences to provide unlimited vocabulary. As users become familiar with phonetic programming they may optionally reconfigure and expand their own phoneme-based vocabularies. The Speech PAC is \$275. **Vodex**, Div of Votrax, 500 Stephenson Hwy, Troy, MI 48081. **Circle 244**

PDP-11 ASYNC MULTIPLEXERS are buffered, program-controlled interfaces between a PDP-11 and multiple local or remote async terminals. The compact SCD-DZ11s are available in 8-line or 16-line EIA or 20mA versions and a mixed line version which provides 8 lines each of EIA and 20mA operation on a single multiplexer. All SCD-DZ11s are software compatible with DEC operating systems and diagnostics designed for the DZ11. They feature programmable speeds up to 9600 baud, format on a per line bases and FIFO buffered input transfers. The 8-line versions are \$1615; 16-line versions, \$2733; mixed line version, \$2733; and an 8 to 16-line expansion version is \$1360. **Sigma Sales, Inc.**, 6505 Serrano, Anaheim Hills, CA. **Circle 245**

LOW COST SBC. The CompTrol-1 Model SBC681 features a 6802 μ P and up to 8kB of ROM or EPROM. RAM expansion sockets are provided for a 1kB expansion beyond the 128-bytes internal to the 6802. The board contains a 6821 PIA and/or a 6522 VIA. The VIA has an 8-bit shift register, two programmable 16-bit timers and 2 parallel ports. On-board jumper options select processor interrupt connections and ROM size. A crystal controlled clock provides 1MHz operation. (\$89.95/100-499). **Industrial Micro-Systems, Inc.**, 189 Hitchcock Rd, Southington, CT 06489. **Circle 239**

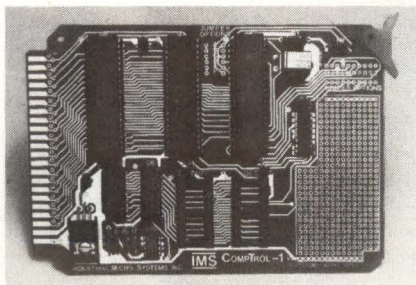

SINGLE BOARD COMPUTER. This SBC has analog, serial and power control I/O. The 4 1/2" x 6 1/2" module can be configured with analog inputs, one analog output, serial I/O, and any mix of 8 AC or DC inputs or outputs. Other features include a 6801 or 68701 MPU and watchdog timer. \$88-\$295. **Wintek Corp.**, 1801 South St, Lafayette, IN 47904. **Circle 246**

IC SOCKETS. These low profile machined contact IC sockets offer a wide range of discrete pin sockets, sockets mounted on carriers, and IC socket assemblies. They maintain .100" pin-to-pin spacing when mounted end-to-end; and, .100" row-to-row spacing. They have tin plating on the outside and gold plating at the point of contact — providing both improved solderability and lower cost. The Series 4000 are from \$.068 in 500 qty. **Stanford Applied Engineering**, 340 Martin Ave, Santa Clara, CA 95050. **Circle 238**

DOUBLE-DENSITY, DOUBLE-SIDED, 8" floppy disk controller for Apple II. LCA-22 is software compatible with APPLE DOS, contains 256 bytes of onboard Boot ROM, controls up to four 8", single or double sided, single or double density disk drives with a total storage capacity of 4.4 Mbytes. Avg. access time is 200 ms and DMA for full 62.5 Kilobyte/sec transfer rate. Run in slots 1 thru 7, not restricted to a single location. Comes complete with controller card, cable, diskette and documentation. \$699. **LOBO Drives International**, 354 S. Fairview Ave., Goleta, CA 93117. **Circle 248**

SELF-REFRESHING RAM. This 4K x 8 quasi-static RAM performs and controls its own refresh, thus acting as a static RAM. The Z6132 is organized into 4,096 8-bit words. It consumes only 1/16 the power of the equivalent amount of 2114-type static RAM. Features such as byte-wide organization, transparent self-refresh, low power and single supply voltage reduce the parts count and simplify design, saving board space. A choice of three access times (250, 300 and 350 ns are available. The Z6132 in a 28-pin plastic, ceramic or cerdip dual-in-line package are from \$39/100. **Zilog, Inc.**, 10340 Bubb Rd, Cupertino, CA 95014. **Circle 236**

DEC and DATA GENERAL

**100
SYSTEMS**
11/23, 11/34
11/44 and VAX
AVAILABLE NOW
FREE CATALOG

**NEWMAN COMPUTER
EXCHANGE**

1250 N. Main P.O. Box 8610 Ann Arbor, MI 48107

(313) 994-3200



Member
Computer Dealers
Association

S413DD

MULTI-FUNCTION I/O CONTROLLER.

This single-board DEC emulating controller is a single micro engine capable of controlling 3 device types simultaneously while providing complete DEC software compati-

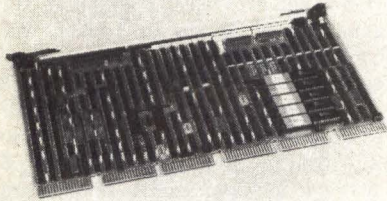

bility. Peripherals attached to the UNIBUS via the HEXACON controller include disks with SMD interface, 1/2" tapes with Pertec interface, and the NURAM auxiliary RAM memory that includes internal fault diagnostics and self-maintenance. The XPU micro-engine architecture, designed for high-speed data moving applications, features a 2MB/sec aggregate device data transfer rate and 4 kB high-speed RAM data buffer. The first configuration of HEXACON will interface up to 4 CDC 9762 disks, 4 Cipher Microstreamer 1/2" mag tape drives, and 8MB of NURAM. Available as a single-, two- or three-device unit from \$3000 to \$6500. **National Semiconductor**, 2900 Semiconductor Dr, Santa Clara, CA 95051.

Circle 220

600MB WINCHESTER. This SMD-compatible drive specifies the same 9.67-MHz transfer rate and interface/format approach as those used with DEC's PDP-11/70, VAX-11/780 and UNIBUS computers. This permits the 600MB to be used with a 300MB SMD, thereby providing DEC users benefits of both Winchester reliability and SMD flexibility. The unit features 6,000

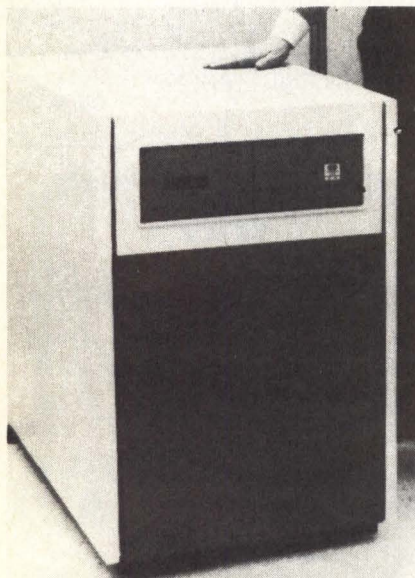

hours MTBF and a sealed head disk assembly which can be exchanged in 15 minutes. It is software transparent in RMOX configurations and can be used directly with RMOX drives. The Winchester-SMD combo interfaces to the DEC computers through the Series 9400 controller, which can interface up to 4 CPUs and 8 disk drives. The 600MB Winchester, with Series 9400 controller, is \$37,000. **System Industries**, 525 Oakmead Pkwy, Sunnyvale, CA 94086.

Circle 152

SINGLE HAMMER PRINTER. This impact printer uses a single rugged print hammer, resulting in a printer that is small, simple and reliable. The GP-80M prints both graphics and alphanumerics. The ribbon cartridge and ribbon handling mechanism eliminates the drive motors and linkages usually employed in impact printers. Standard features include ASCII upper and lower case character sets, up to 80 columns with 12 cpi, adjustable tractor feed, 3 copy reproduction, 12 W power consumption, and Centronics parallel interface. Optional interfaces are available. Dot

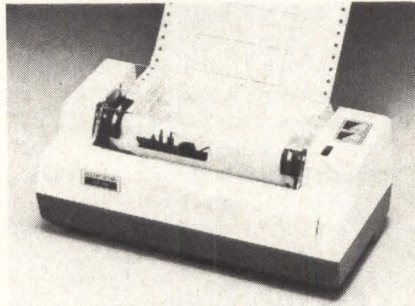

graphics, normal characters and double width characters can be intermixed on a single line under software control. The GP-80M is \$399; 1000 lot OEM price is \$250. **Axiom Corp**, 1014 Griswold Ave., San Fernando, CA 91340.

Circle 211

ALPHA/NUMERIC DISPLAY. The 12" BC Series display offers several options to allow for economical tailoring to the application. These include specified line rates up to 19,400 Hz, the use of either 20" or 25" spherical radius CRTs, various EIA phosphors or contrast-enhanced screens, several frame tilt configurations, and AC power supplies. BC-100 models operate with a standard horizontal line rate of 15,750 Hz. The BC-200 has a nominal rate of 18,400 Hz, plus an internal horizontal oscillator and a centering control. Both may be ordered for either a 12VDC or 15VDC power supply. **Ball**, Electronic Display Div, Box 43376, St. Paul, MN 55164.

Circle 132

UL LISTED 415 Hz UPS. This solid state 60 Hz to 415 Hz Converter/UPS is listed by Underwriters Laboratories Inc. (UL). Model 475 is rated at 75 KVA and achieves efficiencies of 89% at full load, 86.7% at 50% load, and 84.5% at 33% load. It incorporates patented packaging techniques which yield low repair rates (less than 30 minutes MTTR). Model 475 starts at

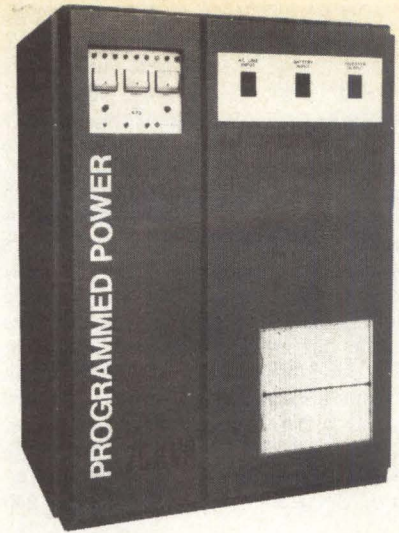

\$42,500. Production scheduled for October. A portable programmable Model 3600 Power Line Disturbance Monitor is also being shown at NCC. **Franklin Electric**, 995 Benicia Ave, Sunnyvale, CA 94086.

Circle 144

MICRO MUTT permits the user to establish a communications link between his CPU and a remote terminal device. This secondary path may be used by a distant hardware or software diagnostician to resolve many operational equipment, or software problems. The remote diagnostician may act as console master or remain in a monitor mode. Logic in the unit compensates for data rate differences between the console and the remote communications link. **Custom Systems, Inc.**, 6850 Shady Oak Rd, Eden Prairie, MN 55344.

Circle 126

512 KB for P-E 3200 SERIES. This single-board 512 kB semiconductor add-in for main memory expansion of P-E's 3200 series of minicomputers uses 16K dynamic RAMs. It is internally organized as 128K x 39 (32 data bits + 7 ECC bits). Cycle and mode timing for the DR-320S is generated by the Memory Interface Board contained in

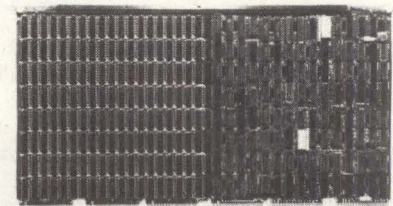

the host minicomputer. The DR-320S contains 4 single pole, double throw switches which allow the 256 kB version to be selected in increments of 256 kB up to 4.0MB. Twelve test points are available at the rear of the unit. LED's indicate proper DC voltages and also indicate that the memory is being accessed. The 512 kB unit is \$7900; the 256 kB version is \$4000. **Dataram Corp**, Princeton Rd, Cranbury, NJ 08512.

Circle 137

R/W MAGNETIC HEADS. This Thin Film 18-channel 1/2" tape head is capable of greater than .5 mV output when operated in the GCR (Group Code Recording) mode, at 18,084 frpi and 100 ips. Also available are

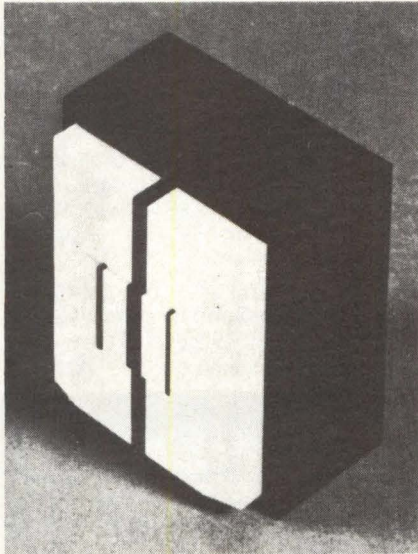

the Streamer Heads for Winchester disk backup with 2-channel serpentine with optional erase. Available in 2-, 4-, 8-, or 16-tracks per 1/4". The Flexible Disk Heads are Z-Axis double-sided models with 96/100 tpi, capable of dual density recording. The 1/2" Heads feature LTC lifetime ceramic tape surfaces. They are operational at 6250 bpi, up to 200 ips in the GCR mode. **Nortronics Co.**, 8101 Tenth Ave N., Minneapolis, MN 55427. **Circle 219**

WINCHESTER WITH BACK UP. This Winchester disk and 3M cartridge tape drive are available on one board. It interfaces to Priam Winchester Disk and Archive Streaming tape units. Handles up to 4 Winchester drives over 600MB and backs up 20MB in less than 5 minutes. \$2,250 in OEM qty, includes cabling and documentation. **Rianda Electronics, Ltd.**, 2535 Via Palma, Anaheim, CA 92801. **Circle 151**

MULTI FUNCTION INTERFACE. This async serial line adapter for PDP-11 computers combines on one board the functions of 5 DEC modules and offers RS-422, and a buffer ready circuit. The MDL-11 permits direct full or half duplex communication via RS-232-C, 20 mA current loop or RS-422 circuitry. Sixteen switch selectable baud rates from 50 to 19.2K are standard. The board includes all of the operational features of the 5 DEC DL11-A, B, C, D, and E

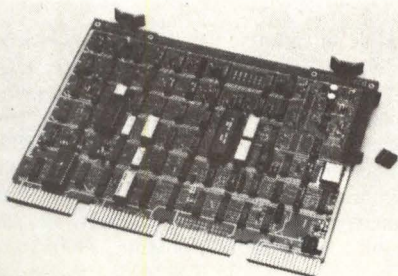

modules (i.e., RS-232-C, current loop, selectable baud rates, limited and full modem control). Selection of any of the 5 modes is made with PC mounted switches. A buffer ready/printer busy monitor circuit allows connection to a variety of low cost RS-232 serial interface printers. (\$825). **MDB Systems, Inc.**, 1995 N. Batavia St., Orange, CA 92665. **Circle 218**

DESK TOP COMPUTER includes a 5 MB Winchester disk drive. The System 1500 expands the use of low-cost desktop computers to business applications. An integrated 700 kB, double-sided, double

density flexible disk drive provides backup to the Winchester, and allows program and data transfer via removable flexible diskettes. Eight flexible diskettes can back up the full Winchester capacity. An automatic error correction feature allows the disk controller to automatically correct up to 11 bits per physical sector. System 1500 includes a solid state keyboard with a 60-key typing array and a 13-key adding machine cluster, up to 64 kB of RAM, a 12" CRT formatted in 24 lines of 80 characters each, an 8 bit Z80 processor and interfaces. **Digilog**, Babylon Rd., Horsham, PA 19044. **Circle 141**

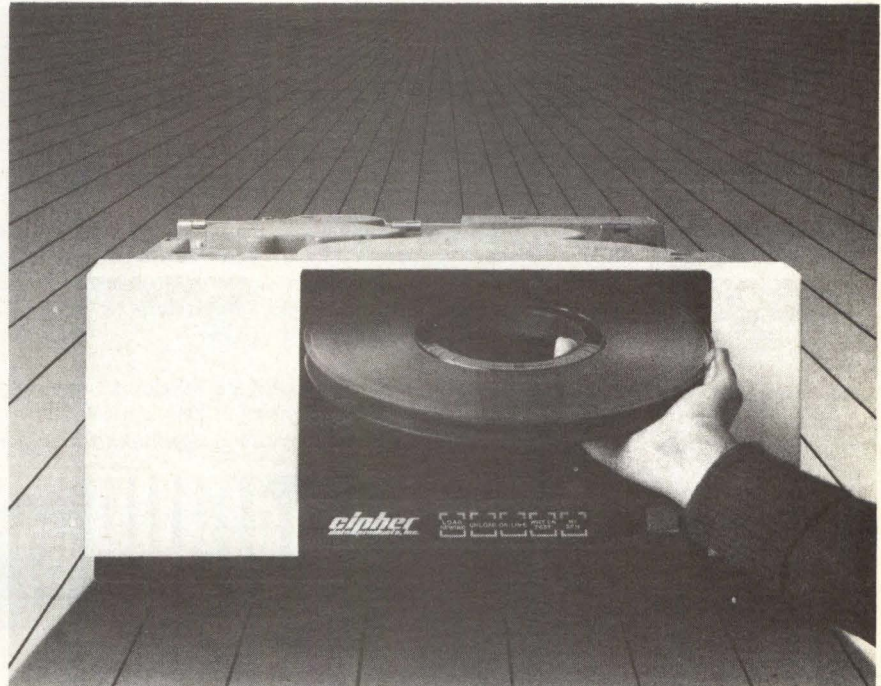

There are other streamers, but only the Microstreamer™ gives you completely automatic tape loading.

There's only one tape drive family you can buy that totally eliminates the manual handling of tape. With CIPHER's Microstreamer, loading and threading of tape reels is totally automatic. All you do is open the door, insert the tape reel and close the door. That's it. The machine threads the tape by itself. No more operator training. Anyone can use it.

That's exciting, but there's more.

In addition to offering you exclusive auto-load features, the Microstreamers also give you these exclusive benefits:

- choice of 1600 or 1600/3200 selectable recording density
- higher 25 ips speed for start/stop use

- choice of 50 or 100 ips streaming speeds
- automatic diagnostics
- smaller size
- lower cost

Catch the excitement!

CIPHER is your source for all your tape drive needs. Call us at (714) 578-9100. Or write for our free product brochure. We're at 10225 Willow Creek Road, San Diego, California 92131.

cipher
data products, inc.
the exciting company

Circle 41 on Reader Inquiry Card
See Us at NCC Booth 311

DISK CONTROLLERS/DRIVES. Model ADC-11 storage module disk controller for DEC PDP-11 computers, provides full emulation of DEC's RM02/3, RM04/5 or RK06/7 subsystems. It operates under standard RSX-11, RSTS/E, IAS, and UNIX operating systems. Model ADC-10 for Nova and Eclipse computers, provides full

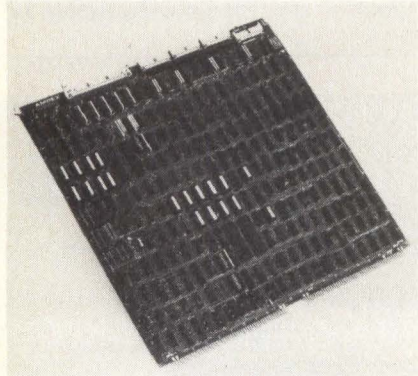

emulation of DG's 6067 subsystem. Expanded emulation is available for higher capacity SMD disk drives. It operates under standard RDOS, AOS, IRIS and BLIS/COBOL operating systems. Both controllers offer dual bipolar μ P architecture for simultaneous control of both the CPU and SMD interfaces, and a 2048 byte (4 sector) high-speed RAM buffer. The ADC-10 is \$3400; the ADC-11 is \$4000; in OEM qty. The Capricorn series of 14" rack mountable Winchester disk drives includes Model 165 with 165.9MB and Model 330 with 330.3MB. They use standard SMD interfaces, and offer an average access time of 30 ms with a data transfer rate of 1.2MB/sec. Their μ P controlled electronics, self diagnostics and environmentally sealed packaging reduce repair time. Model 165 is \$5900; Model 330 is \$7100. **Ampex Corp.**, 200 N. Nash St., El Segundo, CA 90242.

Circle 210

S-100 I/O BOARD features 4 separate serial channels and 5 parallel ports. Each of the 4 serial ports consists of a 8251 Universal Sync/Async Receiver Transmitter with individually selectable baud rates from a

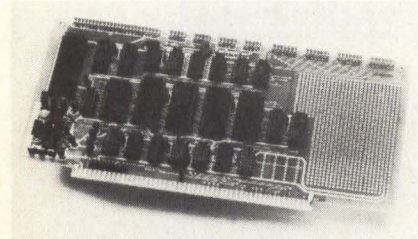

high of 9600 bps to a low of 600 bps. Other rates can be acquired under software control. Each port can be jumpered to any of the 8 vectored interrupt signals. Other features of the Multi I/O include a substantial wire

wrap area for custom applications, jumper selectable addressing, an 8253 programmable timer with two unallocated outputs available for special functions and complete documentation. **Micromation, Inc.**, 1620 Montgomery St., San Francisco, CA 94111.

Circle 217

MAGNETIC MEDIA PRODUCTS. The MLC-304 tape maintenance system cleans, re-tensions and evaluates the condition of a 2400' reel of tape in 3.3 minutes. It incorporates μ P control and refinements that eliminate troublesome calibration requirements as well as possible tape damage from operator error. The system also evaluates live data tapes without erasing stored information. The new magnetic media products include: an ANSI-compatible cassette for personal computers; a 5 1/4" mini flexible disk compatible with TRS-80, Apple, Commodore and other drives that permits recording on both the front and reverse side; a line of color-coded magnetic cards with improved wear characteristics for use on all IBM-compatible magnetic card equipment; and a line of 5 1/4" mini flexible disks critically certified error-free at 96 tpi, available in single or dual-sided, double-density formats. **Kybe Corp.**, 82 Calvary St. Waltham, MA 02154.

Circle 147

VIDEO TELEX allows telex messages to be typed on a visual display unit with full correction and editing capabilities. It can cor-

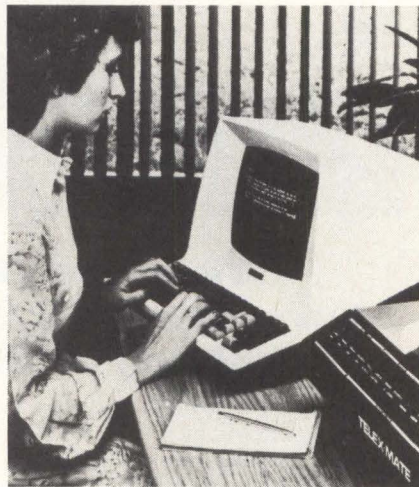

rect spelling mistakes and delete lines or paragraphs in seconds. Full tabulation gives messages a letter quality. Bottlenecks are eliminated and tape preparation is not interrupted by incoming messages. **Delpa Systems UK Ltd.**, 56 Chiswick High St., London W4.

Circle 214

DISKETTE DRIVE CONTROLLER for Intel Multibus-based systems, is a single density (FM encoding) or double density (MFM) controller which operates with IBM Diskette 1 or 2D formats in single or double sided drives. The controller allows data storage and retrieval ranging from Sector Write/Read to the File Management capabilities of advanced DOS. It also provides diskette initialization and diagnostic com-

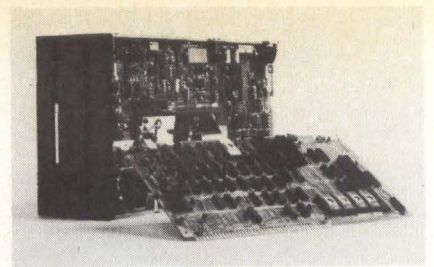

mands which require only minimum host program routines. Model 1180 can control operations on up to 8 diskette sides. (\$950). **PerSci, Inc.**, 12210 Nebraska Ave., W. Los Angeles, CA 90025.

Circle 221

MATRIX PRINTER. This heavy-duty matrix printer requires no preventive maintenance. The unit features 160 cps printing, compressed print mode, double-width char-

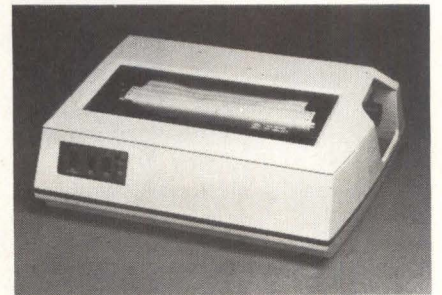

acters, 7 x 7 dot matrix with upper and lower case characters, serial RS232 communications interface, a monitor mode where all characters received by the printer, including control characters, are printed, and escape code sequences that allow for control of printer functions. Operation of the printer may be controlled locally or via the host processor. The P1600 is \$2395. **Beehive International**, 4910 Amelia Earhart Dr., Salt Lake City, UT 84125.

Circle 212

DMA INTERFACE. This high-speed DMA interface between VAX-11/780 and the IEEE Std. 488-1978 Instrumentation Bus, is a hex wide card which interfaces to the VAX UNIBUS adapter. It provides hardware for decoding various GPIB commands for implementing Talker, Listener and Controller functions, and may be used in either a

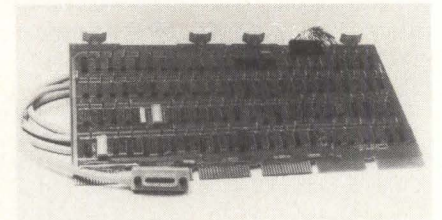

single or multiple Controller environment. The GPIB11-2/VX provides transfer rates of up to 500 kB/sec for tri-state operation and up to 250 kB/sec for open collector operation. A 4 meter cable with a GPIB connector on the outboard end allows connection of 14 instruments on a single interface. \$2495, including software and cable. **National Instruments**, 8900 Shoal Creek Blvd, Austin, TX 78758

Circle 230

CENTRONICS PRINTER INTERFACE.

An SBC-80/10B, SBC-80/24 or ZX-80/05 user can now run a Centronics Line Printer by simply plugging in the ZBX-349. No

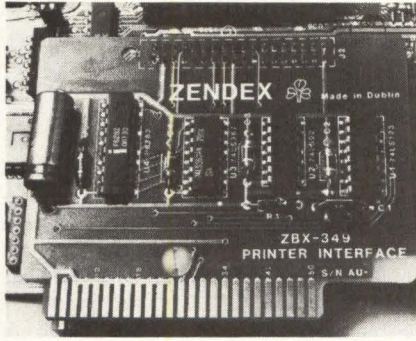

hardware or software modifications are necessary. The ZBX-349, complete with cables, is \$190 in units. **Zendex Corp.**, 6680 Sierra Lane, Dublin, CA 94566. **Circle 231**

INTEGRATED DISPLAY features a CRT mounted circuit board which eliminates the need for a chassis. This OEM design flexibility improves accessibility to most electrical components without removal of the circuit board. Ease of service reduces downtime. The DC-955 is all solid state (except for CRT). This is a high performance unit with possible options of 18.6 & 19.2 KHz horizontal scanning frequencies for 80 x 25 character format. Other features include 800 lines of resolution: separate horizontal, vertical and video drives; internal

controls for vertical frequency, size, linearity, horizontal size, raster centering, and focus; and optional external brightness and/or contrast controls. Under \$100 in OEM qty. **Audiotronics**, 7428 Bellaire Ave., North Hollywood, CA 91609. **Circle 128**

PDP PERFORMANCE MONITOR. The SRF System Reporting Facility monitors task activity, pinpoints system bottlenecks and identifies critical resources for replacement or upgrade. It measures capacity to show how much computer power is available to handle current and future workloads. Percentages for CPU utilization are logged at user defined intervals that can range from 1 to 60 minutes. One time license fees are \$2,995 for RSX-11M and \$3,495 for M-Plus; one year warranty, maintenance support and documentation included. **Gejac Inc.**, Box 188, Riverdale, MD 20840. **Circle 215**

ENHANCED MICRO-WINCHESTER.

This controller, for the Irwin 510 micro-Winchester with build in cartridge tape backup, in an interface for host computer systems. Host adapters are available for the LSI-11, IEEE S-100 bus, and the Intel Multibus. Model 1510 controls up to 8 model 510 disk units and performs all device-dependent functions, all disk and tape error recovery, and disk data caching. A Z-80 μ P performs all drive and data management functions while high speed discrete logic is used for data transfers and ECC operations.

The 1510 has 8 kB of firmware and a 32 kB RAM memory to buffer disk and tape data and to implement cache buffering. The cache buffer holds up to 118 sectors. The unit also includes an overlapped seek feature and a max data transfer rate of 1.25MB/sec. The Irwin 1510 Controller is \$900 in OEM qty. Adapters for S-100 and Multibus are \$325, the LSI-11 adapter is \$375, (OEM qty). **Irwin International**, 2000 Green Rd., Ann Arbor, MI 48105. **Circle 237**

CUSTOM POWER SUPPLY. This open frame switching power supply is designed to allow the user to custom order the output voltages at the time of purchase within the supply's power range of 75W continuous. This offers the equivalent of a custom supply without paying custom supply prices.

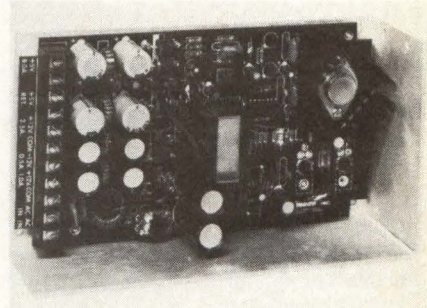

Available with either terminal blocks or Molex connectors. \$150 ea. (1-9). **Condor, Inc.**, 4880 Adohr Lane, Camarillo, CA 93010. **Circle 213**

How BEI cures your encoder headaches

FOUR WEEK DELIVERY.

On standard models. TWO WEEK priority service available if ever required. Now *that's* speedy relief.

RELIABILITY.

Specifically designed for the abusive environment of the machine tool market. Rugged cast housing. Heavy duty shaft. Class 7 bearings. Virtually impervious to normal shock, vibration and



H-25. LONG LASTING RELIEF THAT WON'T UPSET YOUR BUDGET.

temperature changes. Sealed against oil and water splash.

COST VALUE.

The unequalled quality and design features of BEI Encoders will save you money over "less expensive" encoders in the long run. Now you can get quality at competitive pricing in any quantity. For details, call BEI in the morning.

BEI ELECTRONICS, INC.



Industrial Encoder Division • 7230 Hollister Avenue • Goleta, California 93017 Tel: (805) 968-0782

Circle 19 on Reader Inquiry Card

OFFICE MANAGEMENT SYSTEM.

This software package can run on any MICOS hardware configuration. The MICOS Office Management System (MOMS) consists of 6 software modules: Word Processing, Electronic Filing, Electronic Mail Distribution, Electronic Mailing List, Electronic Calendar/Scheduling, and Electronic Call Reporting. Other products to be shown at NCC include the MICOS business system, APT programming tools, MINQ user inquiry facility, MICAPS accounting packages, MDS wholesale distributor system, FACTMATCHER information retrieval system, and the Field Service Management System. **Mini-Computer Systems**, 399 Fairview Park Dr., Elmsford, NY 10523. **Circle 148**

DUAL SCHOTTKYS. Two Dual Schottky center tap rectifiers are rated at 20 and 30 A in voltage ratings of 30, 35, 40 and 45 V. Each device has two chips, each rated at half the total current rating for the device, which

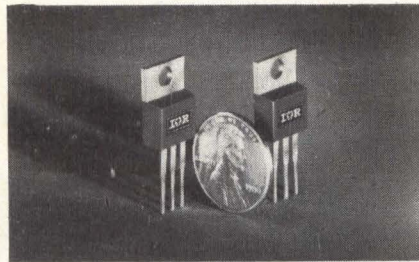

are connected by a common cathode but with electrically separated anodes. Thus they become a complete output rectifier stage in a full wave center tap configuration. The TO-220 package can be mounted directly on PC boards with appropriate heatsinks to provide a compact building block. The 20CTQ and 30CTQ feature a low reverse leakage to junction temperature ratio (6 mA at 25°C), and eliminate the need for voltage derating at junction temperatures to 175°C. **International Rectifier**, 233 Kansas St, El Segundo, CA 90245. **Circle 205**

HIGH SPEED PRINTERS. The 1200 lpm, μ P controlled, impact Chaintrain model 4260, prints a full 132-character line with a 64 ASCII character set. A 96 ASCII character version is rated at 900 lpm and both models are also available in a 136 character position version. The 300 lpm band printer has 64 ASCII characters, a second model uses the 96 character set at 240 lpm. These units have advanced features including 132 column print lines as standard format and 136 columns as an option, 12 channel vertical formatting, self-test mode with diagnostic display, and cartridge ribbon system. The 1000 lpm unit, model 4240, features the Chaintrain design and prints 132 char/line with the 64 char-

acter set. It is also available with 96 characters set, 132 character line, at 730 lpm. Model 4330 band printer prints 600 lpm with the 64 character set and 445 lpm with the 96 character set. From \$9500 to \$39,900. **Harris Corp**, 2101 W. Cypress Creek Rd, Ft. Lauderdale, FL 33309. **Circle 188**

Z8000 MASTER/SLAVE μ C. This 16-bit μ C module with a Z8001, has 8kB of EPROM and up to 20kB of local RAM as well as access to 64kB of main system

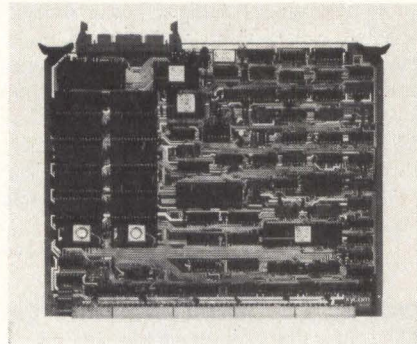

RAM. It may be used stand alone or as a master or slave in a multi-processor environment. Its two-channel serial I/O chip is capable of serial communications up to 500 kilobaud. I/O with other modules in the backplane is memory mapped. The 1868+A accepts both the 9511 arithmetic processor unit or the 9512 floating point processor unit. The module also provides direct memory access to the system's main memory. **Xycom, Inc**, 750 North Maple Rd, Saline, MI 48176. **Circle 202**

FLOATING POINT ADC. The unit is a modular 1+2+12 ADC comprised of a sign bit, 2 gain ranging bits and 12 magnitude bits. It provides a significant reduction in the per-channel cost of audio digitizing. This is done by providing 16-bit performance for the critical lower level signals (up to ± 0.625

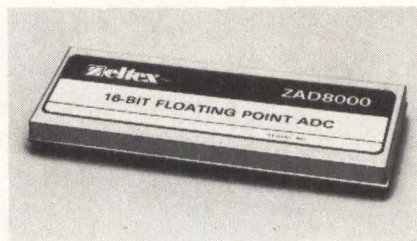

V), and by using 2 bits of automatic gain ranging to decrease effective resolution to 13 bits of performance for larger signals (over ± 2.5 V). When used with the ZDA8000 DAC, the ADC can accept broadband signals up to 20 kHz, and regenerate analog output for signals having up to 96dB dynamic range. Signal-to-noise ratio is 78dB. The ZAD8000 is \$395, (100 qty.). **Zeltex, Inc**, 940 Detroit Ave, Concord, CA 94588. **Circle 207**

RUGGED CARTRIDGE RECORDER. This fully militarized, 9-track R/W cartridge recorder utilizes a 1/2" tape in IBM/ANSI compatible recording formats. The Environmental Cartridge Recorder (ECR) is

a high performance field recorder for use in undersea, ground mobile and airborne applications. It accepts either a standard 450' recording length, or the Genisco/Newell II cartridge providing superior tape handling, higher reliability and increased recording space. The ECR-10 operates at 15 and 25 ips with an 800 bit/in. recording format. A data sheet is available. **Genisco Technology Systems Div**, 18435 Susana Rd, Rancho Dominguez, CA 90221. **Circle 227**

SMART TERMINAL. This editing CRT display terminal features a 15", non-glare, high resolution screen, 80 or 132 column format, 7 x 11 dot matrix characters in a 9 x 14 or 9 x 16 cell, screen-labeled soft keys, and English language prompts for set up and operation modes. The 8 soft keys put over 100 functions, some of which are user programmable, at the operator's fingertips. Features include bidirectional smooth or jump scroll, horizontal scroll, split screen, communications speeds to 19,200 baud, 4 pages of display memory, and a fully dis-

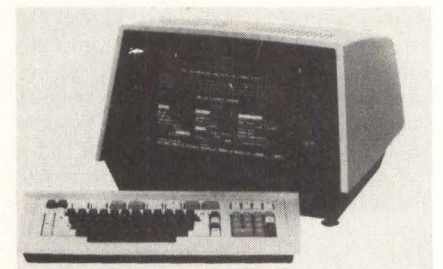

played status line. Model 132/15 is \$2,450. Maintenance plans and extended warranty are available. **TAB Products Co.**, 1451 California Ave, Palo Alto, CA 94304. **Circle 182**

SCHEMATIC EDITOR, for the SPRINT high speed simulator, is a powerful graphical language, which presents a PCB in a form the user can understand. Data entry is performed both interactively and visually, allowing the user to modify and edit the data base as required. This eliminates the time-consuming and error-prone procedure of translating schematics. Schematic Editor provides 3 windows in which the models can be viewed. The Global Window allows the user to define the initial characteristics of a loaded PCB model, or retrieve an existing model for modification. The IC Window draws a graphic picture of a selected IC, permitting the user to describe the nodal interconnections, define attributes, or edit an existing IC model. The Signal Window depicts the signal interconnections between the source of the signal and its fan-out. Each window is composed of User Workspace, System Workspace and Functional Key-space. In addition to Schematic Editor, a Screen Editor for SPRINT provides a WP type, cursor-controlled editing capability. A new CRT with powerful graphics that handle all typical alphanumeric entries, as well as full graphics is also available. This unit includes an enhanced keyboard containing 64 graphic character controls. **Com-**

puter Automation, Industrial Products Div., 2181 Dupont Dr, Irvine, CA 92713.

Circle 175

MINI-FLOPPY DRIVES are compact mechanical-only versions of the 6106/6108 disk drives. Model 6107 is a single-headed version; the 6109, a double-headed mechan-

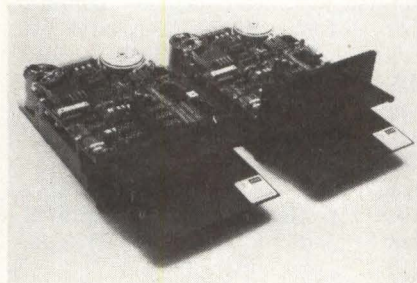

ical drive. With dimensions of 2.1" x 5.75" x 7.5", these units occupy 1/3 less space than other available drives. For full compatibility, they are also offered with an optional "industry-standard"-sized (3.75" high) front panel, allowing mechanical interchangeability in existing systems. Optional software-controllable door interlock and sensors and connectors, permit system customization and versatility. **BASF Systems Corp**, Crosby Dr, Bedford, MA 01730.

Circle 186

AC POWER LINE CONDITIONER. This series of isolated conditioners address the problems associated with utilizing utility power for high technology equipment. The PLCs provide voltage regulation of $\pm 5\%$ with less than one cycle response time, noise attenuation and a minimum efficiency of 94% at full load. The first unit is the 3KVA unit, Model PLC-302-1-1. Additional power ratings will be released during the year. From \$450. **Elgar Corp**, 8225 Mercury Ct, San Diego, CA 92111.

Circle 143

DG PRINTER CONTROLLER allows NOVA and ECLIPSE computers to interface directly to Mannesmann Tally serial and line printers. Printer speeds are from 160 cps to 300 lpm. Featuring single card construction, the controller fits into the 15" I/O card slot in a NOVA or ECLIPSE without software or hardware modification. The controller is compatible with RDOS and AOS as well as IRIS and other DG Operating Systems. Both programmable and data channel controllers are offered. A Self Test capability, isolated from the computer, sends a 96 character ASCII test pattern to the printer. The self test can locate faults to the printer, controller or computer. **Mannesmann Tally**, 8301 S. 180th, Kent, WA 98031.

Circle 187

DATA COMMUNICATIONS ADAPTER. The Current Loop Communications Multiplexor (CLCM), for the MEGAMINI line of 32-bit superminicomputers, is available. With CLCM, terminals may be located up to 5,000' from the computer system. It provides 8 async communications lines with a current loop interface. Each individually

programmable line interfaces to the multiplexor bus of any P-E 32-bit processor and provides full-duplex operation with the connected terminals. Sixteen baud rates from 50 to 19,200 are available, with groups of up to 4 baud rates programmable at one time. The Data transfers between the terminals and the CLCM are bit-serial at a program-controlled baud rate. Character size (5, 7, or 8 bits), parity (odd, even, or none), and stop bits (1 or 2) are also controlled by the program on a per-line basis. The CLCM is \$2,200. **Perkin-Elmer**, Computer systems Div, 2 Crescent Place, Oceanport, NJ 07757.

Circle 167

GRAPHICS TERMINAL operates in 11 modes to permit use for graphics memory, alphanumerics, or independent use of either, without affecting the other. Compatible with Tektronix Plot 10 software, it offers enhanced graphics input. The CPG-100 allows for full screen usage with a 640 x 480 resolution on a green-toned raster screen and a large addressable plot area of 1024 x 780 dots. Selection of 4 character sizes, dot-dashed lines, selective erase and alphanumeric overlays are all standard features. **Continental Resources, Inc.**, 175 Middlesex Tpke, Bedford, MA 01730.

Circle 174

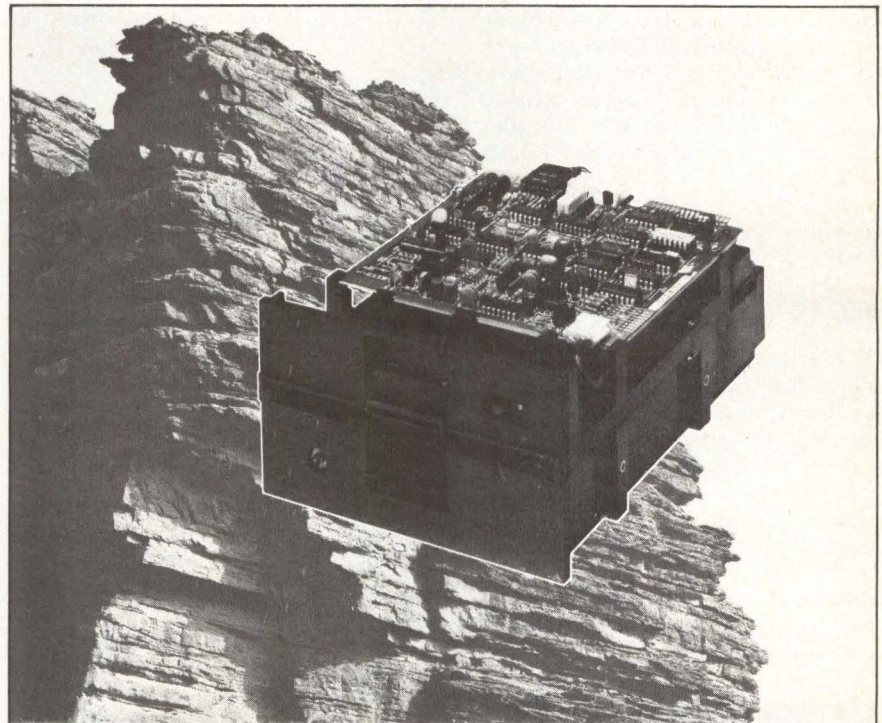

ROCK-SOLID FLOPPY DISK DRIVES FROM TEAC

Unique DC Spindle Drives feature our continuously-running brushless DC motor whose typical life expectancy is over 10,000 hours. Rock-stable, no electrical noise will interfere with the integrity of your data.

Superior Chassis features fiberglass reinforced polyester (FRP) which, unlike aluminum, won't stretch with heat. Extra-rugged and precision molded, the unit also has a shield to insulate the head from outside interference.

25 Years of Leadership in all magnetic recording technologies is your assurance of a quality product you can rely on. For complete information on all TEAC Rock-Solid Floppy Disk Drives (FD-50 Series) — including our one-year warranty and full technical support and service — just write:

TEAC

TEAC Corporation of America
Industrial Products Division
7733 Telegraph Road, Montebello, CA 90640
(213) 726-8417

Circle 43 on Reader Inquiry Card

COMMUNICATIONS CONTROLLER.

This Multibus-compatible board is a 5-channel async serial communications controller with both EIA RS232 and optically isolated current loop interface capabilities. One μ PD8251A Programmable Communications Interface Chip per channel and associated circuitry provide support for the EIA standard modem control signals. Each channel has jumper-selectable receive/transmit baud rates from 75-19,200 on the EIA interface and up to 2.4k baud on the current loop interface. The BP-0575 can be addressed in any 16-byte block beginning on any 16-byte boundary within the 256-byte I/O page. The board may be accessed through 12 jumper-selectable I/O ports within the 16-byte I/O block, and the user may address the 5 serial I/O channels and the two interrupt status registers in any order or priority within the addressed block. The BP-0575 is \$695. **NEC Microcomputers Inc.**, 173 Worcester St., Wellesley, MA 02181. **Circle 189**

DG EMULATION. This CRT terminal emulates the code structure and functions of Data General's Dasher D100 and D200 series. The 15" non-glare screen, displays 24 lines of 80 characters, upper/lower case. Blink, dim and underscore highlights are selectable in all combinations. Other commands include Erase to end of line; Erase to end of page; New line; Cursor home, return, up, down, right and left; Set cursor position; Read cursor position; Roll enable and disable; Print and Print form.

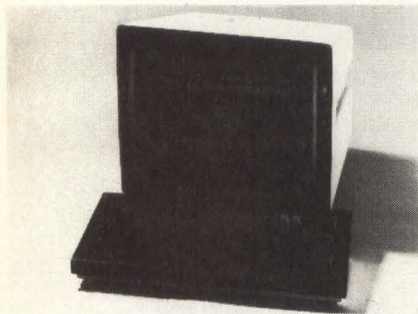

The slave printer interface is standard. The 95-key detached keyboard has separate numeric pad. It also includes a 20-key function keypad, with erase and print keys. The Model DG-Compat is \$1600; OEM and qty discounts available. **Ann Arbor Terminals, Inc.**, 6175 Jackson Road, Ann Arbor, MI 48103. **Circle 160**

DISPLAY TERMINAL is IBM 2741 compatible. In addition to the editing and communications capabilities of a standard ASCII CRT terminal, the AJ 510 offers full graphics and APL character sets with switch-selectable communications in ASCII, or IBM 2741 compatible EBCD or correspondence transmission modes. Both

character sets and transmission modes may be preset either by the host computer or locally at the terminal. Other features include preset online operation at power on; preset terminal status indicators on the display screen at power on; 15-minute display screen timeout; preset tab settings; form feed recognition; page data protection; programmable page and field delimiters; numeric field enhancement; preprinted form alignment; expanded APL overstrike combination and synonyms; and APL edit key. **Anderson Jacobson, Inc.**, 521 Charcot Ave., San Jose, CA 95131. **Circle 159**

PDP 11 SERIAL LINE CONTROLLER is completely hardware and software compatible with the DEC DL11. DL11 A, B, C, D, and E features are provided on one

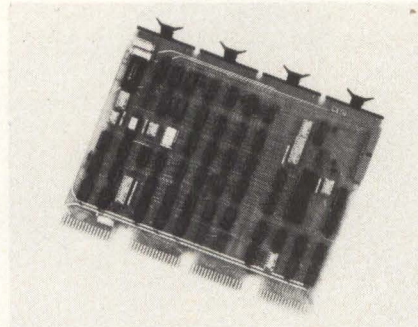

board with switch selectable convenience. On board DIP Switches allow each baud rate selection of 50 to 19.2K baud for the transmit or receive section, data format, address selection, and vector address. The SLC-11 is \$550. **Computer Extension Systems, Inc.**, 17511 El Camino Real, Houston, TX 77058. **Circle 195**

INSULATION DISPLACEMENT tests. Comparative long-term reliability of two basic insulation displacement contact designs in electrical connections — the unsupported cantilever, and the supported cantilever — are reported in a free, 6 pg. booklet. Five different contact metals and designs were tested. Test results are reported in milliohms, covering single and double wipe designs in cantilever designs, and single, double and tuning fork wipe designs in supported cantilever designs. **3M**, Dept. EP80-38, Box 33600, St. Paul, MN 55133. **Circle 168**

SPACE-SAVER CRT occupies 12 by 13" of desk space, and weighs 18-1/2 lbs. With an optional wall-mount bracket, it may be tilted and swiveled to achieve optimum viewing angle. Model 10L is a smart single-page editor, with user-programmable function memory; the 100L is a 132-column, VT100-compatible unit, with advanced video, bi-directional peripheral port and user-programmable function memory. Both are completely modular. Model 10L is \$1150, the 100L is \$1750, optional wall bracket is \$40; qty. discounts available. **Teleray**, Div. of Research Inc., Box 24064, Minneapolis, MN 55424 **Circle 183**

FLOPPY DISK MICROSYSTEM emulates the DEC RX01 single sided, single density floppy disk configuration and the RX02 single sided, double density floppy disk configuration, and is fully software, hardware and media compatible with LSI-11 based systems. The GRC RX03 yields 1MB of mass storage per disk drive and can read and write RX01 or RX02 formatted floppy diskettes. The RXV21 based Gemini with an LSI-11/2 CPU, 64 kB memory, DLV11 serial async I/O port, and two 1 MB floppy disks is \$7125/10. The RXV21 based Gemini Plus with an LSI-11/23 CPU, 256 kB memory, a QLV11 quad serial sync/async I/O port and two 1MB floppy disks is \$10,875/10 **General Robotics Corp.**, 57 N. Main St., Hartford, WI 53027. **Circle 163**

ALPHAPASCAL fully integrated into the multi-tasking, timesharing Alpha Micro Operating System (AMOS), supports both sequential and random data files. It is compatible with AlphaBASIC. AlphaPASCAL can separately compile and link PASCAL modules to form one program. Other features include adding user-defined routines to an external library where other PASCAL programmers can use them; calling external assembly language subroutines; full 11-digit accuracy for REAL variables; and labeling of BEGIN-END blocks. Full software support is provided. **Alpha Micro**, 17881 Sky Park N., Irvine, CA 92713. **Circle 158**

IN-CIRCUIT EMULATOR, for the Intel 8051 8-bit, single-chip microcomputer, provides full capability for developing and debugging application hardware and software. It includes advanced emulation software, such as symbolic debugging, HELP files, and conditional command constructs. The ICE-51 module can conditionally halt emulation (breakpoints) and record trace while emulating the 8051 at its full 12 MHz clock rate without distorting off-chip timing. It includes 8 kB of emulator-resident RAM which can be mapped into either on-chip or off-chip program memory for real-time emulation of the user's program. ICE-51 is \$4,950. **Intel Corp.**, 5200 NE Elam Young Pkwy., Hillsboro, OR 97123. **Circle 164**

MATRIX PRINTER is completely compatible with the entire IBM 3270 family, operating with the IBM System/360, System/370, 4300 or 303X. Model 2087 has a print speed of 180 cps. The μ P-controlled print mechanism produces a 7x8 dot matrix character printout up to 132 char/line at 10 cpi. The bidirectional impact matrix print-head seeks the shortest path to the next line of data. It accommodates up to 6-part fan-fold forms at a slew rate of 15 ips. Forward and reverse paper movement allows printing of subscripts, superscripts and overprints with rear tractor paper feed. Model 2087 is available in character buffer sizes from 960 to 3564 characters for \$5995. **Memorex Corp.**, San Tomas at Central Expwy., Santa Clara, CA 95052. **Circle 166**

DISTRIBUTED SYSTEMS. These fast processors for large-volume multifunction distributed data processing environments have window-into-memory architecture which allows each terminal to communicate

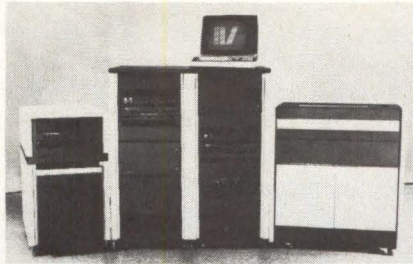

directly with the memory. Both the IV/80 and IV/95 can provide a communications interface for one or more communications lines operating at speeds up to 9600 bps. Bisync, async and SDLC communications protocols are also supported. The systems are available with a full range of peripherals. The IV/80 and IV/95 support, respectively, up to 480kB and 672kB of high-speed main memory, with 96kB of video memory. Disc storage capacity ranges from 5MB to 270MB. Each system supports up to 32 of Four-Phase's new human-engineered terminals, and is compatible with all existing Four-Phase software. The two new systems may be used with the batch processor, Systems 311 and 312, which provide IBM software- and media-compatibility and distributed batch processing capabilities. **Four-Phase Systems, Inc.**, 10700 N. DeAnza Blvd, Cupertino, CA 95014. **Circle 190**

GRAPHICS DISPLAY TERMINAL offers powerful intelligent graphics and extended alphanumeric capabilities. A Graphics Command Interpreter (GCI) executes English-like graphics commands for: relative and absolute positioning, plotting lines in polar and cartesian coordinates, plotting arcs and straight lines, defining line style patterns, drawing solid rectangles and circles, and filling any closed shape. Self-test is performed on power up. Two modes of graphic operation are selectable, the abbreviated command mode and the



mnemonic command mode. Within the GCI is a library of the lines needed to draw the characters. The user can also define an additional set of characters and the terminal can automatically scale and rotate characters on

command. New features include two user-selectable smooth scroll rates; program-accessible functions erase from the cursor to the end of the page, turn the alphanumeric cursor off, and ring either of two bell tones; and an Error Trap mode. The 12" tilt-and-swivel screen displays 1920 characters in 24 lines and 80 columns. Graphics images are plotted on a 640 x 240 pixel matrix. The detached keyboard includes a typewriter-style main keypad, 14-key numeric keypad, 15 program function keys, and 5 local function selection keys. The DASHER G300, including keyboard, is \$3900. GCI software license is \$500. As an enhancement,

TRENDVIEW software for turnkey graphics display is available. Running on the full line of ECLIPSE computers, TRENDVIEW allows AOS and AOS/VS users to present data as pie, bar and line charts. This can be done interactively through the use of stored files, or by direct control of an application program. A wide variety of symbols, line styles and fill patterns are selectable. Multiple charts may be simultaneously presented on the screen of the DASHER G300. Automatic curve fitting and linear regression trend line plotting can be used to enhance graphs. (\$3000). **Data General**, Rte 9, Westboro, MA 01581. **Circle 161**

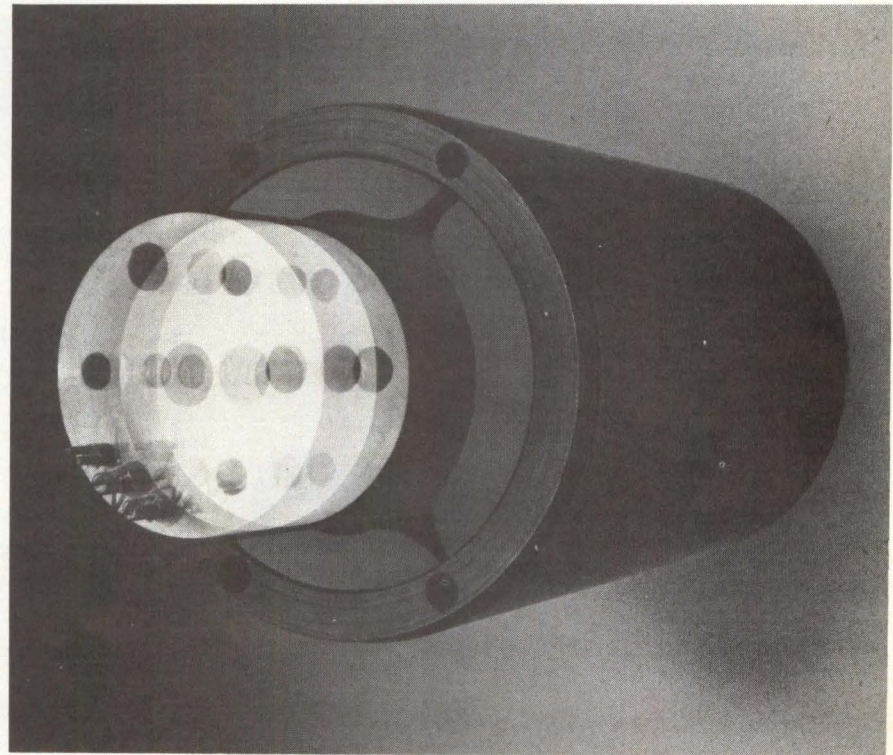

Straight Talk About Linear Motors for Disc Drives

That's what you get when you call Systems Magnetics. Coupling years of experience and know-how with creative imagination, SMC's engineering group integrates your specific needs with our capable production people to ensure functional, efficient and cost-

effective answers to your particular needs.

Contact Tom McMahon,

Vice President, Corporate Marketing, for your specific needs in linear motor actuators and linear velocity transducers. He'll talk straight with you.



Systems Magnetic Company

2837 Coronado Street, Anaheim, CA 92806, (714) 632-8400

Specialists in 5-1/4" and 8" Fixed Disc Drive Motors

Circle 44 on Reader Inquiry Card



PRINTER TERMINAL. Designed for on-line system applications requiring hard copy output or to be used as a remote or standalone printer terminal, the Miniterm Model 1201 now offers as standard a 2K buffer, polling, self-test, a serial interface, and selectable 50-60 Hz international power supply. New options include high resolution plotting, answerback, an optional 4K buffer, 20mA current loop, and 9600 baud communications. Like the earlier Model 1201, the upgraded unit also offers as standard 80/132 column switch-selectable printing, print speeds up to 50 cps, adjustable print darkness, a

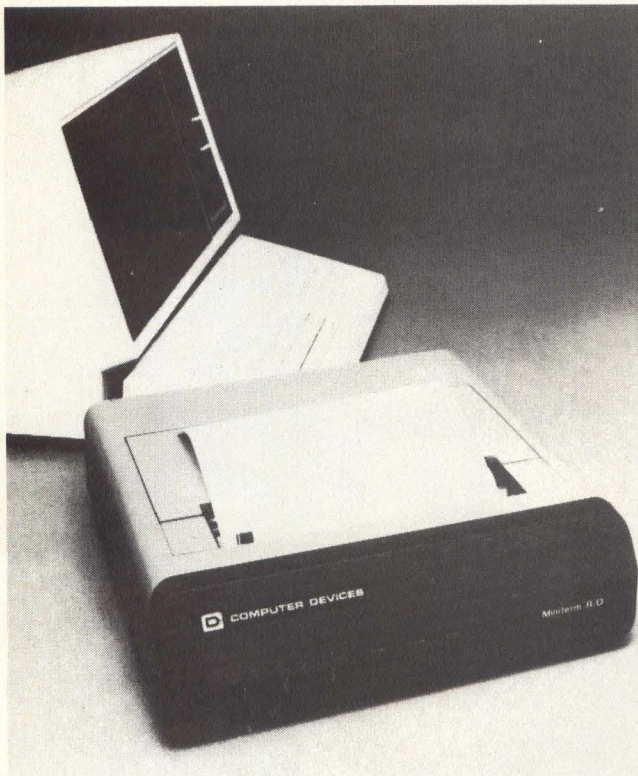

96 character upper and lower case ASCII code with underscore, remote terminal reset, and user controls for paperfeed, on-line/off-line, reset and self-test. The standard Model 1201 is \$1,385 (\$1,094/100). **Computer Devices, Inc.**, 25 North Ave., Burlington, MA 01803. **Circle 133**

IMAGE FRAME BUFFER. This family of modular, high resolution systems feature a 1024×1024 resolution and image memory capacities up to 24 bits. Complete line drawing vector graphics and alphanumerics are provided. Standard features include image pan and zoom, intensity transformations and pseudo-color assignment. Options include graphics overlay memory planes, trackball and

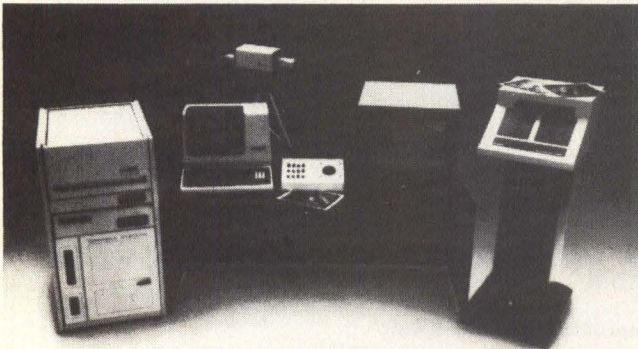

joystick controls, multiple cursor generation, additional image function memories and a hard copy color printer. All models in the GMR 260 Series are complete systems with a 16-bit parallel, TTL-compatible, bi-directional interface. Plug-compatible, DMA parallel interfaces are available. **Grinnell Systems**, 2159 Bering Dr., San Jose, CA 95131. **Circle 228**

PDP-11 EXPANSION BOARD. The Terminal Line Expansion Board contains a Z80A μ P, 8 full-duplex RS-232C channels, 32 kB RAM and space for 32 kB user PROM. The TIO Board, in conjunction with the UMC Processor Board, can provide data manipulation

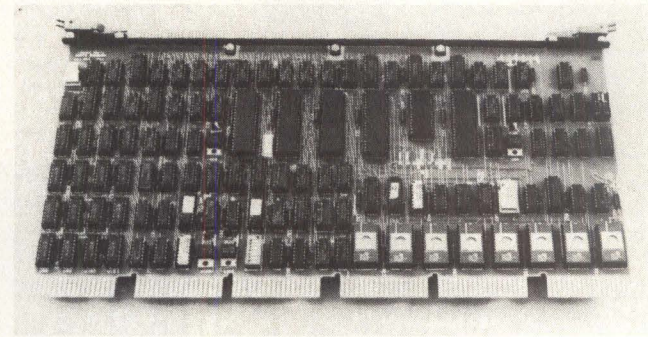

or serial line protocol processing. Its 8 channels can serve terminals, modem connections or other serial devices. Extra TIO Boards can be added as needed. **Associated Computer Consultants**, 228 E. Cota St., Santa Barbara, CA 93101. **Circle 226**

FLOPPY DISC SUBSYSTEMS. These double-sided, dual density floppy disc subsystems store up to 1 MB of data on a single floppy diskette. Both controllers can support 2 floppy disc drives for a max capacity of 2 MB. The PM-XS31, with two floppy disc drives, is used with the PDP-11. The single, quad-wide microprogrammed controller is software transparent to DEC operating systems and it is pin-to-pin, signal, and power compatible with both Plessey and DEC Unibus SPC backplanes. The PM-XSV31 consists of a single dual-wide controller board and a choice of one or two floppy disc drives, designed for use with the LSI-11. **Plessey Peripheral Systems**, 1691 Browning Ave., Irvine, CA 92714. **Circle 222**

PUNCHED TAPE EMULATOR. This line of 5 1/4" flexible disk subsystems appear to the host as punched tape peripherals. They include μ P based control electronics, one or two 5 1/4" flexible disk drives, power supply and parallel or optional serial interface in a

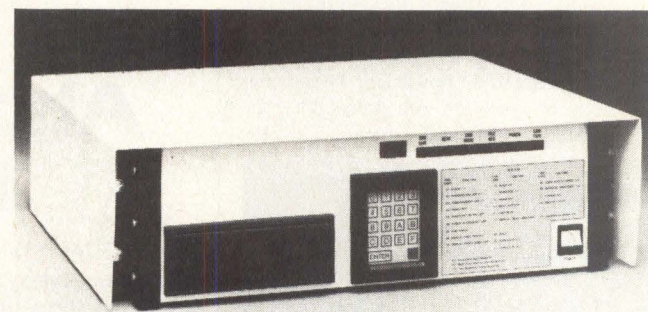

compact chassis designed for rack mounting. Access to the system is provided by an 18-key front panel keypad while LED indicators show system status. Single-drive read only versions are available as well as R/W models with one or two drives. \$1,795 for single drive R/W combination. **Remex Div, Ex-Cell-O**, Box C19533, Irvine, CA 92713. **Circle 223**

HP 64000 EMULATION. Model 64005S Emulation Terminal System lets mainframe users augment existing μ P product development tools with the real-time, transparent emulation of the HP 64000 Logic Development System. The HP 64100A Development Station can be used as an ASCII terminal or a stand-alone emulation

station. Logic analysis is available as an option. Hardware and software performance may be evaluated at any stage of development. A basic Model 64005S consists of a development station with a tape cartridge drive and emulation hardware and software for the



selected μ P. Each contains a host processor with 64 kB of host memory, I/O control, and display control. The host and emulation systems have separate buses and memories. Model 64005S Emulation Terminal System is \$14,400 to \$22,600. **Hewlett-Packard Co.**, 1507 Page Mill Rd., Palo Alto, CA 94304. **Circle 216**

CAD/CAM SOFTWARE PACKAGE. The DYNAGRAPHIC Series II vector refresh display terminal can now be supported by the AD-2000 CAD/CAM software package. The Series II features a 19" high-contrast CRT with 2048 \times 2048 addressability and built-in 16-bit μ C's. The AD-2000 includes computer-aided design, total tool path design and numerical control tape production, fully annotated drawings and comprehensive management information. It features a dimensionally accurate data base accessible for all phases

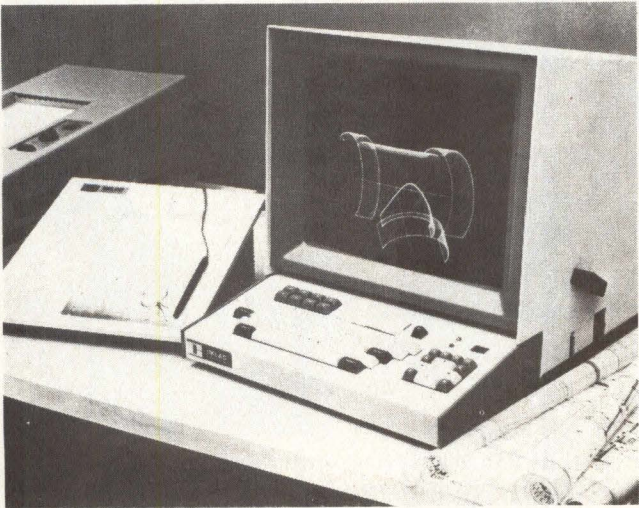

of design, drafting, management information and manufacturing. The AD-2000 software package is available from Manufacturing and Consulting Services, Inc. The IMLAC Series II terminal is available from **IMLAC Corp.** 150 A St., Needham, MA 02154. **Circle 192**

EXATRON'S RS-232C STRINGY/FLOPPY MASS STORAGE SYSTEM.



Mini-disk speed, capacity and reliability for only \$349.50.

- Standard RS-232C communications link
- Built-in operating system
- Two file management structures: ASCII and binary
- Three baud rates available: 300, 1200 and 9600
- Busy/ready handshaking supported

Call our **HOTLINE...**
(800)-538-8559
In California,
Call **(408)-737-7111**



Exatron, Inc.
181 Commercial Street
Sunnyvale, California 94086
(408)-737-7111

Circle 45 on Reader Inquiry Card

POCKET PROGRAMMER
POCKET CONTROLLER
POCKET DIAGNOSTIC
POCKET TERMINAL

If you're building, servicing or using industrial micro systems, the Pocket Terminal could save you time, money and frustration. It gives full ASCII I/O facilities with 16 segment display, 30 character memory and a wide range of signalling options in a low cost, hand-held package weighing approx. 1/2 lb.

Thousands of units are now in service in applications including instrumentation, data collection, telecommunications, radar, process control, traffic regulation, analytical and medical systems.

The Pocket Terminal is a real, cost-effective alternative to fixed control panels and bulky, expensive terminal equipment.

Try one. It could solve a lot of problems.

Further information from:

G. R. ELECTRONICS
1640 Fifth Street,
Santa Monica, CA 90401.
Telephone: (213) 395-4774
Telex: 65-2337
(BT Smedley SNM).

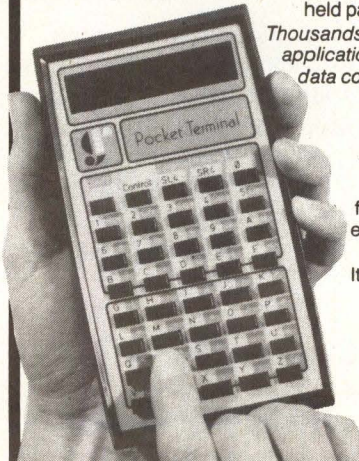

Circle 47 on Reader Inquiry Card

There's only one modular encoder worth buying. DATA TEChnology's M-20.

Reflect on that!

Over three years in development. M-20, the best performing modular encoder in the industry. Well engineered. Dependable. 100's of applications. Factory pre-alignment makes installation time minimal. The only tool required is an allen wrench. Compare costs and specs. Then, compare performance. M-20, the only modular encoder worth buying!

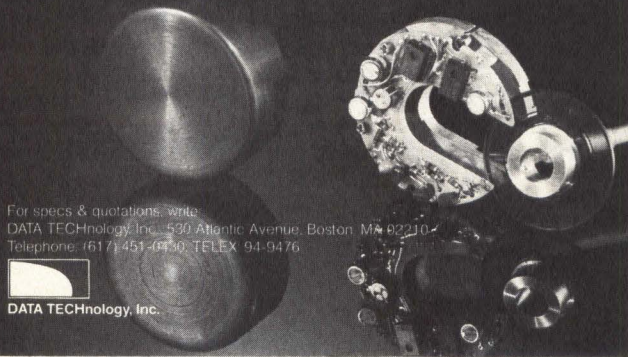

For specs & quotations, write
DATA TEChnology, Inc., 539 Atlantic Avenue, Boston, MA 02210
Telephone: (617) 451-0930; TELEX: 94-9476



DATA TEChnology, Inc.

Circle 21 on Reader Inquiry Card

IMPORTANT ANNOUNCEMENT



A red label on the cover of your magazine indicates that you must requalify at this time. Auditing regulations require that you requalify yearly in order to receive **Digital Design** at no charge.

Even if you recently requalified, please do so again. We regret any inconvenience which this causes. Requalifying at this time is necessary in order to conform to the standards of our new qualification form.

To avoid missing future issues, please return the completed qualification form to us immediately. *ALL* sections must be filled in before we are able to process your form.

Attention overseas subscriber: Due to rising international postage and printing costs, overseas subscribers have to share the cost of postage. The Surface Mail charge is \$15.00 per year, and the Air Mail charge is \$35.00 per year. You must fill out the qualification form completely, and return it with your check to the Circulation Department. Please have check payable in U.S. funds, drawn on a U.S. bank.

Before returning your qualification form, be sure that the red label from the front cover is attached to the address box on the form.

Thank you.



NCC Issue
New Products

RUGGEDIZED WINCHESTER brings on-line disk storage to remote locations. Available in 10- or 20-MB capacities, the unit comes with 8" Winchester drive, embedded controller and power supply — all shock-mounted — plus a CPU interface card. The 9800R can travel over rough terrain to monitor data as it is received.

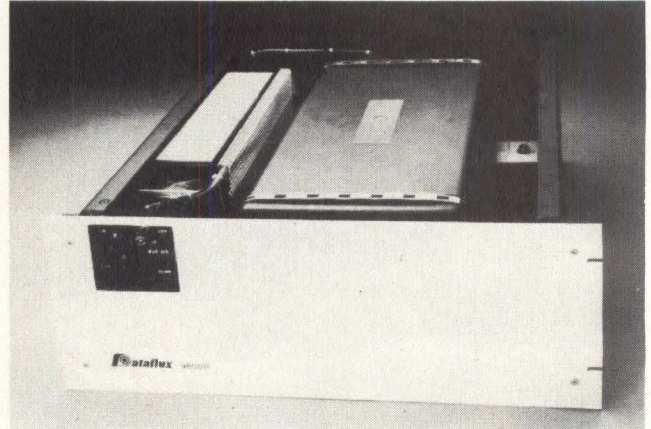

Storage can be expanded with additional 9800R systems. The system is specified to take 5Gs on all axes non-operating and 2Gs error-free, operating. An embedded Z80-based controller, plus minicomputer interface and cabling are provided. When power turns off, the 9800R retracts and locks its head carriage in a position away from the data area, thus providing additional security during system transport or power failure. The 9800R, with minicomputer interface and 10 MB storage is \$9,000. **Dataflux Corp.**, 1050 Stewart Dr., Sunnyvale, CA 94086.

Circle 138

MATRIX PRINTER/PLOTTER This unit provides program control up to 110 full 20 character lpm utilizing a graphic 140 × n dot matrix. The Sprinter 20 takes 28 seconds to produce full 280-line CRT display in hard copy. The user may select parallel 7-bit ASCII

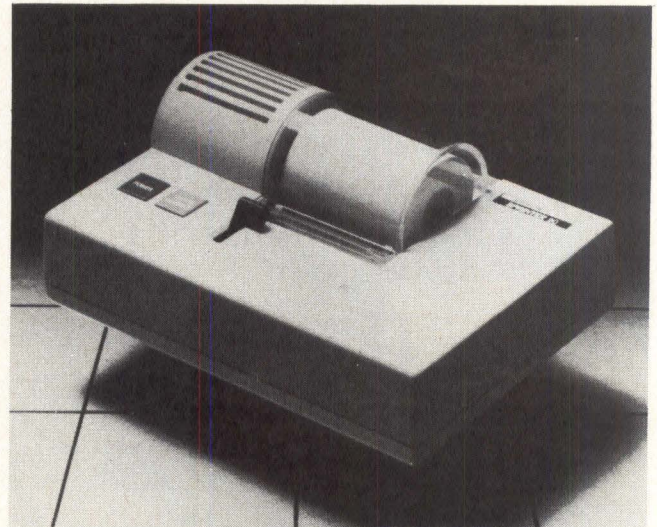

or serial RS 232 with selectable baud rates from 110 to 9600. Print mode is 20 5 × 7 dot matrix char/line with 96 ASCII upper and lower case characters. Programmable ASCII controls, include automatic carriage return and line feed, right justification, form feed, graphic control, multi-line feed and strip printing capabilities. It uses standard Thermographic paper in roll or fan-fold pack. Size is 7 1/2" W × 5" D × 3" H. The Sprinter 20 is \$175. **Alphacom, Inc.**, 3031 Tisch Way, San Jose, CA 95128.

Circle 131

PRINTER, BLOCK-MODE ASCII. Model 767 tabletop printer, compatible with IBM's 3767, transmits and receives data from an IBM system using either SNA/SDLC or 2740 line protocol. It can be used both on- and off-line for interactive or batch operations. Printing bi-directionally, the 767 produces high-quality copies on multi-part forms. Aimed at IBM Series I users, the block-mode option on the 310 terminal emulates IBM 3101 Model 22 and Model 23 terminals. The 278 Models 3, 4 and 5, are 3270-compatible terminal models with enlarged screen sizes. **Telex Computer Products Inc.**, 6422 East 41st St, Tulsa, OK 74135. **Circle 232**

DEC COMPAT. MEMORY BOARD, for the PDP-11/23, provides 256 kB (128K words by 18 bits) on a single dual width board. This replaces the need of the standard 4 dual width board requirement. The module is addressable to 4MB (22 address lines), generates and checks parity for each byte of memory, and parity logic is totally DEC hardware and software compatible. It utilizes

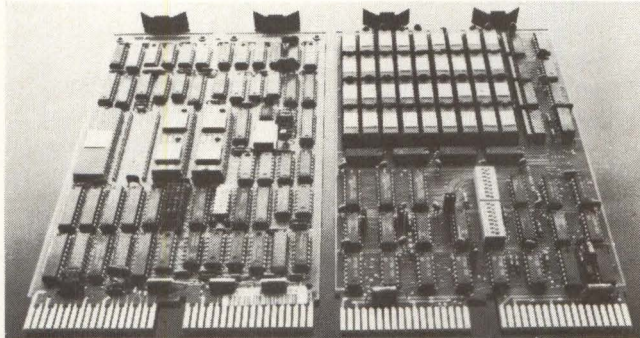

64K dynamic RAM with an access time of 240 ns and cycle time of 400 ns. Power requirement is 1.2A from a 5V supply with battery back-up operation available. The CI-1123 is \$1925 for a 128K x 9 option; \$2550 for the 256K x 9 option. **Chrislin Industries, Inc.**, 31312 Via Colinas #102, Westlake Village, CA 91361. **Circle 194**

BLUE LASERS. These HeCd blue light lasers include the Model 4205, a low-power 5mW laser; Model 4210, a 10mW laser; and, Model 4240, a laser with 40mW of output power. All have a wavelength of 442nm and are cooled by natural convection. The 4200 Series are virtually maintenance-free due to the addition of



hard-mounted mirrors, improved optical space seals and new electronic control circuitry. All are warranted for one year. The 4205 is \$3000; the 4210 is \$5000; the 4240 is \$8000. **Liconix**, 1390 Borregas Ave, Sunnyvale, CA 94086. **Circle 209**

158MB WINCHESTER. The DISKOS 15450, 158MB drive, uses 14" disks and has built-in power supply. Track density is 960 tpi. (\$3100). The 70MB 8" drive also uses the 960 tpi density with the same dimensions and mounting provisions as a standard 8" floppy disc drive. (\$2900). The SMART-E Interface incorporates disc controller functions, includes error correction, expanded DMA capability, streamlined software, and sector interleaving. **Priam**, 3096 Orchard Dr, San Jose, CA 95134. **Circle 233**

Getting a custom-made microcomputer control is easy, even if you know nothing about micro-computers. All it takes is your basic idea, and a visit to DSI.

We'll take care of initial control design. Prototype fabrication. Software. Final design and verification. Volume manufacturing. You get a custom-made microcomputer control that's exactly right for your application.

If "off the shelf" doesn't fit the bill, take a look at custom-made microcomputer controls from DSI. We make it easy. Write for our new brochure.

Microcomputer controls from DSI.

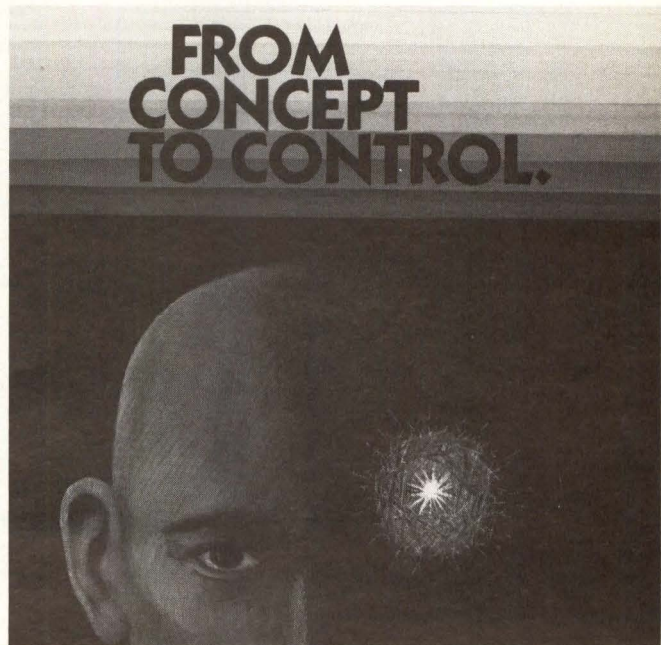

DIGITAL SYSTEMS

Division of Dahlberg Electronics, Inc.

14050 21st Avenue North, Minneapolis, MN 55441
Phone 612/553-1596

Circle 58 on Reader Inquiry Card

Up/Down Display Counter Counts Over Pos/Neg Range

Some applications keep track of the coordinates while moving an object stepwise in both directions. Sometimes it is desirable to display the coordinates as positive and negative numbers keeping the origin at (0,0) location. In these cases, the display counters are the part of the system that moves a silicon wafer on the probe station under control of a computer. To load any value to the displays in parallel from the computer, and for the displays to update them-

selves after any moving was received:

The counter should count up or down in response to the MOVE-UP (MU) or MOVE-DOWN (MD) pulses, depending on the number being currently displayed. If the current display is a positive number, MOVE-UP should increment the display while MOVE-DOWN should decrement it. If the number displayed is negative, MOVE-UP should decrement the display and MOVE-DOWN should increment it. Zero dis-

play is associated with the positive sign.

If MOVE-DOWN, MD, pulse is applied starting from the positive number displayed, the counter should decrement its count, change the sign to negative (after passing through zero), and continue incrementing while retaining the negative sign.

When MOVE-UP, MU, pulse is applied starting from the state when negative number is displayed, counter should

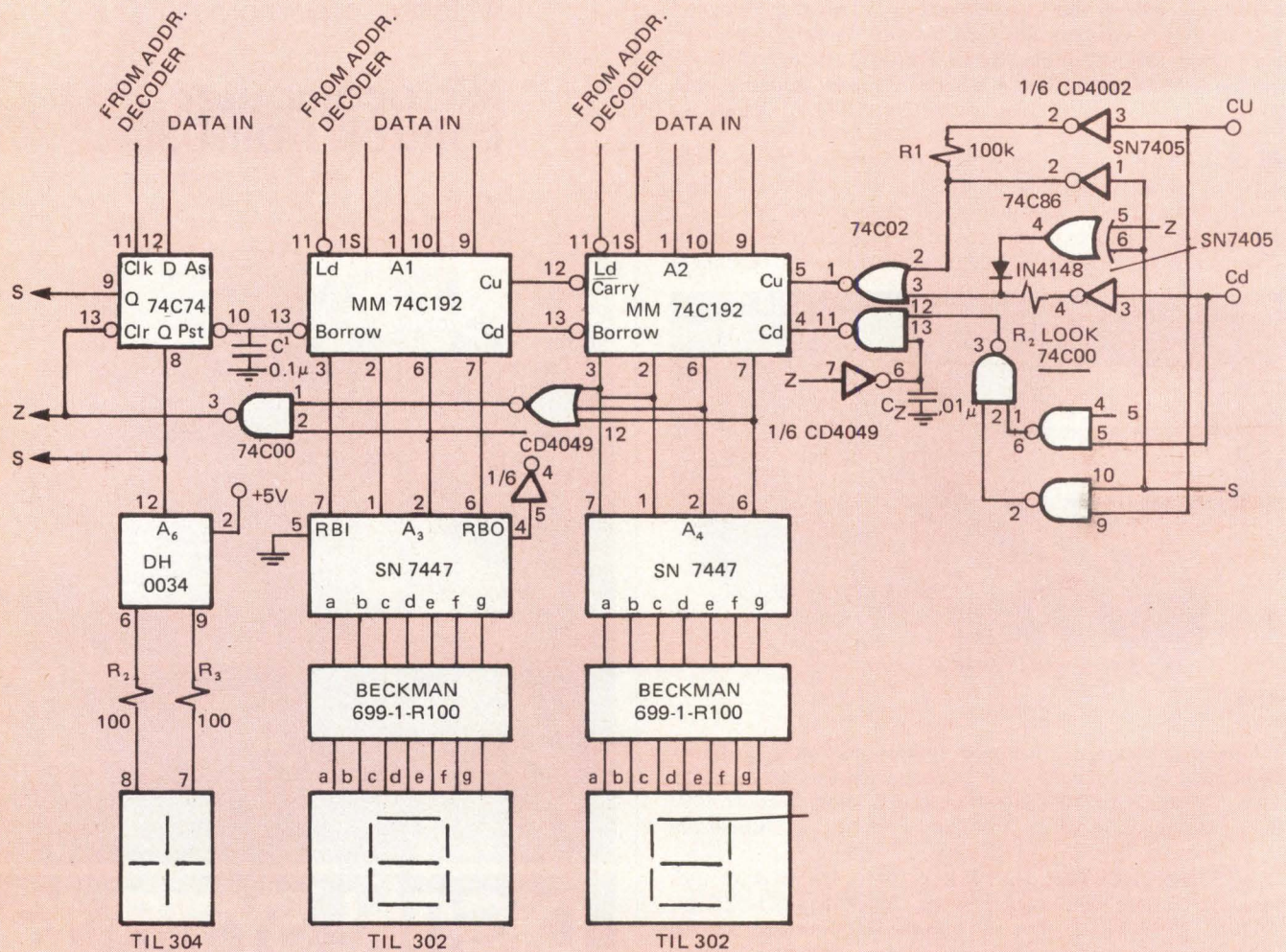

Up/Down Display Counter

be decrementing the display, change the sign to positive when reaching zero, and continue incrementing while retaining the positive sign.

Only half, the display counter is shown; the section which displays the other coordinate is identical.

The indication of zero, Z, is derived from the units counter and ripple-blanking output, Pin4, RBO, from A3, SN7447 (BCD-7 seg. decoder). The D-type flip-flop A5 holds the sign bit, S, which is taken from the Q output. If the number displayed is negative, Q=1. Capacitors C1 and C2 serve the purpose of assuring a smooth transition from +0 to -1. The rest of the logic circuitry decides to which counter input, increment (5) or decrement (4), to direct the moving pulse, depending on the number currently being displayed, S and Z status, and the move pulse applied, MU or MD.

The circuit is not intended to operate at high rates, but its response is smooth until the rate of 10 KHz, and it responds to the one-to-zero-going pulses greater than 2 μ S.

Vojin G. Oklobdzija
*Microelectronics Center,
 Xerox Corp.
 El Segundo, CA*

Debugging Via ROM Breakpoint

It is often necessary to gain access to address and register contents of ROM resident firmware during debugging or maintenance. In RAM-resident-systems, this is easily handled by available debugging software or simple instruction substitution at a suspect address. However, when a firmware controlled system has a hanging loop of unknown address or some other malfunction which requires register or RAM examination, this logic analyzer approach proves useful. The primary requirements for this technique are a logic analyzer with capacity for decoding the address/data bus in use and a trigger word output which can be used to generate an interrupt. An interrupt handling routine (described below) must be resident in ROM.

Functionally, interrupt handling routines save registers and flags on the stack (and can also read RAM locations, if desired). The routine works as soon as an interrupt trigger is generated by an address match in the logic analyzer (the

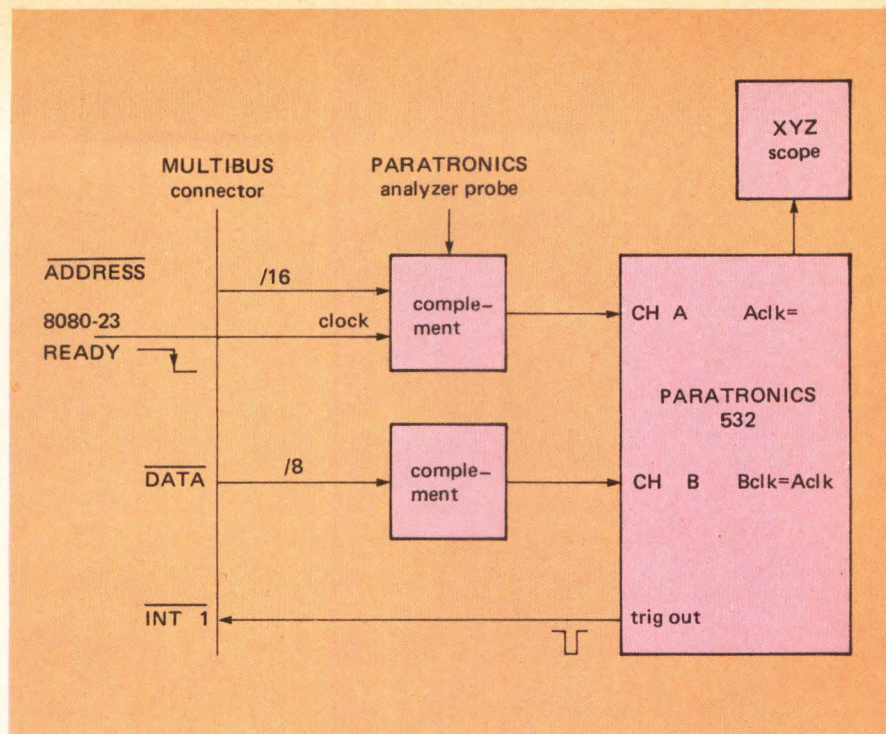

Figure 1: 80/10 connections

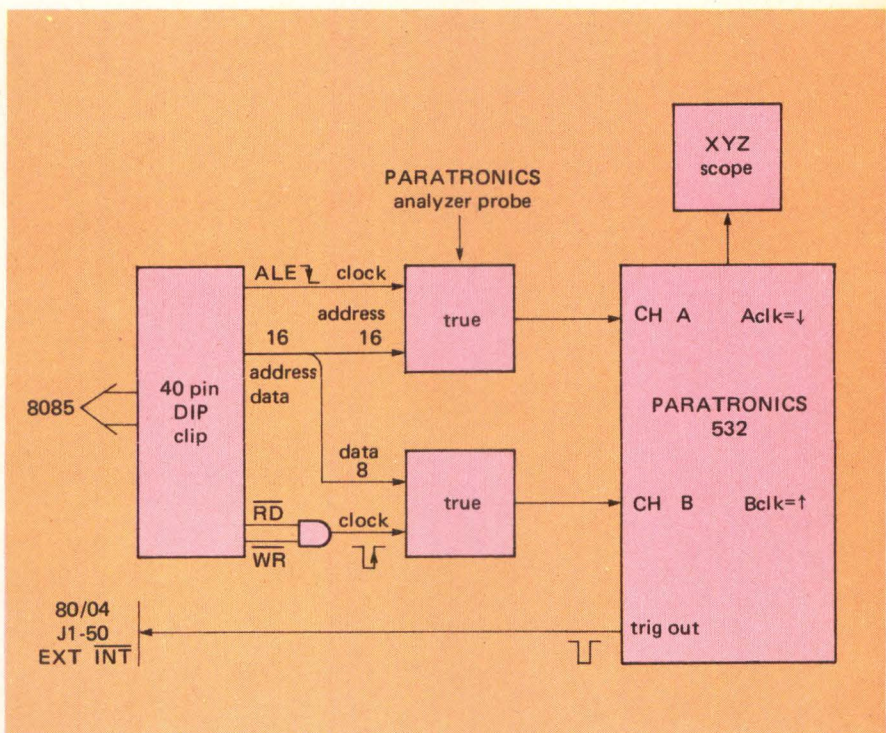

Figure 2: 80/04 connections

logic analyzer trigger word can be the "breakpoint" address or "don't care" in the case of a hung loop). The occurrence of the trigger word starts the logic analyzer address/data acquisition process. The interrupt generated by the trigger word causes a branch to the routine which puts register contents onto the bus and thus into the logic analyzer.

This technique has been employed on Intel 80/10 and 80/04 systems utilizing a Paratronics 532 logic analyzer.

The basic approach can be applied to virtually any CPU/logic analyzer combination. **Figure 1** and **2** depict interconnections used with 80/10 and 80/04 systems. The logic analyzer approach (use of trigger words) is efficient in gaining access to address and register contents.

Garry M. Fitton
*Object Recognition Systems
 Princeton, NJ*

ATTENTION BARGAIN HUNTERS!

Buy, sell or trade all types of computer equipment and software (pre-owned and new) among 20,000 readers nationwide in the BIG (11x14") pages of **COMPUTER SHOPPER**

Subscription: \$10 yr./12 issues. Money back guarantee. P.O. Box F11, Titusville, FL 32780. (305) 269-3211. **MC & VISA only, 1-800-528-6050 Ex. 184.**

EQUIPMENT & SOFTWARE BARGAINS



Zendex designs and manufactures a complete line of MULTIBUS compatible boards and MDS compatible systems.

- SBC CPU 8085A-2, 8088
- RAM 128K Dynamic
- FDC ISIS-II Compatible, RMX Compatible
- PROM Programmer 2716, 2732, 2732A
- Disk Systems
- Chassis ZX-660, ZX-655
- SBX-Modules Analog, IEEE, Digital
- MDS Systems CP/M, ISIS-II Compatible

Zendex 6680 Sierra Lane, Dublin, CA 94566
(415) 829-1284

Circle 50 on Reader Inquiry Card

SCIENCE, TECHNOLOGY WRITING

Articles, reports,
publicity, speeches,
A-V scripts, promotional.
Clear, reader-oriented.
Heavy medical
instrumentation,
industrial concentration;
30 years' experience.
Boston based

ROBERT B. HANNA
401 Albemarle Road
Newtonville
Massachusetts
02160

Advertisers' Index

Advanced Digital Products	11, 17	Hitachi America	2
Advanced Electronics Design	C-4	Hughes Aircraft, Radar Systems Div.	21
Ampex Memory	61	Hycom	76
Anadex	58	Interdesign	46, 47
Archive	1	KeyTronic	33
Aviv	37	LogEtronics	52
BASF Systems	71	Micro Peripherals	7
Beehive International	57	New World Computer	27
BEI Electronics	85	Nicolet Zeta	13
Cipher Data Products	5, 83	Opto 22	C-2
Clifton Precision Div., Litton Industries	4	Plessey Peripheral Systems ..	9
COMPAT '81	48, 49	Priam	39
Computer Design & Applications	4	Printronix	12, 14, 16
Comtal, Sub. of 3M	31	Scherer's Mini Computer Mart	27
Custom Systems	70	Smoke Signal Broadcasting ..	C-3
Data Electronics	63	Stanford Applied Engineering	51
Dataram	18	Systems Magnetics	89
DATA TECHNOLOGY	92	TEAC	87
Digital Systems	93	TEC	15
Distributed Logic	66	3M, Data Products	34, 35
Dylon	36	Watkins-Johnson	23
Exatron	91	WESPERCORP Div., Western Peripherals	41
Genisco Systems Div.	55	Zendex	96
GR Electronics	91		

Sales Offices

MA, ME, NH, RI, & VT: Jeffrey C. Hoopes, National Sales Manager, (617) 232-5470, 1050 Commonwealth Ave., Boston, MA 02215

CT, L.I. & NY CITY: Jack Flynn, (203) 673-0300, The Flynn Group, P.O. Box 675, Avon, CT 06001

MID-ATLANTIC STATES: Warren Smith, (201) 221-0184, P.O. Box 754, Bernardsville, NJ 07924

SOUTHEASTERN STATES: E. Harold Mitchell, (404) 634-7070, P.O. Box 13611, Atlanta, GA 30324

OHIO VALLEY: Doug Horst, (313) 476-3757, Horst Assocs., 27333 Bramwell, Farmington Hills, MI 48018

MID-WESTERN STATES: David Kingwill, Ed Krukowski, (312) 774-9660, The Kingwill Co., 5526 N. Elston Ave., Chicago, IL 60630

SOUTHWESTERN STATES: Jerry Ambroze, (713) 780-3326, Ambroze & Assocs., 2168 Augusta, Houston, TX 77057

SOUTHERN CA: Lindy Dolan, (213) 981-3300, Suite 1215, 15910 Ventura Blvd., Encino, CA 91436

NORTHWESTERN STATES: Neal W. Manning, Western Sales Manager, Charlotte King, Vernon D. Swart, Jr., (408) 371-9620, Suite 1005, 1901 S. Bascom, Campbell, CA 95008

JAPAN: K. Yanagihara, (03) 350-0272, 10-10 Shinjuku 3-chome, Shinjuku, Tokyo, 160
Cable Address: Yanacour Tokyo