

ESSENTIAL INFORMATION GUIDE



NEW
COMPASS
LIVE LEGENDARY

Jeep[®]

TABLE OF CONTENTS

| | | |
|---|---|----|
| 1 | INTRODUCTION | 6 |
| 2 | GETTING TO KNOW YOUR VEHICLE | 15 |
| 3 | GETTING TO KNOW YOUR INSTRUMENT PANEL | 24 |
| 4 | STARTING AND OPERATING | 56 |
| 5 | MULTIMEDIA | 74 |
| 6 | SAFETY | 75 |
| 7 | IN CASE OF EMERGENCY | 82 |

| | | |
|----|---------------------------------|-----|
| 8 | SERVICING AND MAINTENANCE | 112 |
| 9 | TECHNICAL SPECIFICATIONS | 170 |
| 10 | CUSTOMER ASSISTANCE | 181 |
| 11 | INDEX..... | 182 |

INTRODUCTION

| | |
|--|---|
| IMPORTANT NOTICE | 7 |
| Symbols Key | 8 |
| ROLLOVER WARNING | 8 |
| VEHICLE MODIFICATIONS/ALTERATIONS | 9 |
| Symbol Glossary | 9 |

GETTING TO KNOW YOUR VEHICLE

| | |
|---|----|
| DOORS | 15 |
| Child-Protection Door Lock System – Rear Doors..... | 15 |
| CLIMATE CONTROLS | 16 |
| Automatic Climate Controls Descriptions And Functions..... | 16 |
| Manual Climate Controls Descriptions And Functions..... | 18 |
| Operating Tips | 19 |
| WINDOWS | 20 |
| Reset Auto-Up..... | 20 |
| Window Lockout Switch..... | 21 |
| HOOD | 21 |
| Opening The Hood | 21 |
| Closing The Hood | 22 |

| | |
|--------------------------------|----|
| LIFTGATE | 22 |
| Unlock/Open The Liftgate | 22 |
| Lock/Close The Liftgate..... | 23 |

GETTING TO KNOW YOUR INSTRUMENT PANEL

| | |
|---|----|
| BASE / MIDLINE INSTRUMENT CLUSTER | 24 |
| Base / Midline Instrument Cluster Descriptions | 26 |
| PREMIUM INSTRUMENT CLUSTER | 28 |
| Premium Instrument Cluster Descriptions..... | 29 |
| BASE / MIDLINE INSTRUMENT CLUSTER – DIESEL | 30 |
| Base / Midline Instrument Cluster Descriptions | 32 |
| PREMIUM INSTRUMENT CLUSTER – DIESEL | 34 |
| Premium Instrument Cluster Descriptions..... | 35 |
| INSTRUMENT CLUSTER DISPLAY | 36 |
| Oil Change Reset – If Equipped..... | 36 |
| Gear Shift Indicator (GSI) – If Equipped..... | 37 |
| Diesel Displays | 37 |
| Diesel Particulate Filter (DPF) Messages..... | 38 |
| Fuel System Messages..... | 38 |

| | |
|--|----|
| WARNING LIGHTS AND MESSAGES | 41 |
| Red Warning Lights..... | 41 |
| Yellow Warning Lights..... | 45 |
| Yellow Indicator Lights..... | 50 |
| Green Indicator Lights | 52 |
| White Indicator Lights..... | 53 |
| Blue Indicator Lights..... | 55 |
| Gray Indicator Lights..... | 55 |

STARTING AND OPERATING

| | |
|---|----|
| ELECTRIC PARK BRAKE (EPB) | 56 |
| Auto Park Brake | 56 |
| SafeHold | 57 |
| SEVEN-SPEED DDCT AUTOMATIC | |
| TRANSMISSION – IF EQUIPPED | 57 |
| Gear Ranges..... | 58 |
| STOP/START SYSTEM – IF EQUIPPED | 62 |
| Operating Modes..... | 62 |
| Possible Reasons The Engine Does Not Autostop..... | 63 |
| To Start The Engine While In Autostop Mode..... | 64 |
| Manual Activation / Deactivation | 64 |

| | | | |
|--|-----------|---|------------|
| REFUELING THE VEHICLE — GASOLINE | | | |
| ENGINE | 65 | SAFETY TIPS | 77 |
| Emergency Fuel Filler Door Release | 65 | Transporting Passengers..... | 77 |
| AdBlue® (UREA) — If Equipped | 67 | Transporting Pets..... | 78 |
| AdBlue® (UREA) Storage | 67 | Safety Checks You Should Make Inside | |
| Adding AdBlue® (UREA)..... | 67 | The Vehicle | 78 |
| DRIVING TIPS | 70 | Periodic Safety Checks You Should Make | |
| On-Road Driving Tips..... | 70 | Outside The Vehicle | 80 |
| Off-Road Driving Tips..... | 70 | Exhaust Gas | 80 |
| | | Carbon Monoxide Warnings | 81 |
| MULTIMEDIA | | IN CASE OF EMERGENCY | |
| RADIO OPERATION AND MOBILE PHONES | 74 | HAZARD WARNING FLASHERS | 82 |
| SAFETY | | JACKING AND TIRE CHANGING — | |
| OCCUPANT RESTRAINT SYSTEMS | 75 | IF EQUIPPED | 83 |
| Occupant Restraint Systems Features | 75 | Preparations For Jacking | 83 |
| Important Safety Precautions..... | 75 | Jack Location/Spare Tire Stowage | 84 |
| Seat Belt Systems | 77 | Jacking Instructions | 85 |
| | | Jack Usage Precautions..... | 89 |
| | | TIRE SERVICE KIT — IF EQUIPPED | 90 |
| | | JUMP STARTING | 98 |
| | | Preparations For Jump Start | 98 |
| | | Jump Starting Procedure | 100 |
| | | REFUELING IN EMERGENCY — | |
| | | IF EQUIPPED | 101 |
| | | IF YOUR ENGINE OVERHEATS | 103 |
| | | GEAR SELECTOR OVERRIDE | 103 |
| | | FREED A STUCK VEHICLE | 104 |
| | | TOWING A DISABLED VEHICLE | 105 |
| | | Without The Key Fob..... | 107 |
| | | Front-Wheel Drive (FWD) Models — | |
| | | With Key Fob | 107 |
| | | 4x4 Models..... | 107 |
| | | Emergency Tow Hooks — If Equipped | 108 |
| | | Tow Eye Usage — If Equipped | 109 |
| | | ENHANCED ACCIDENT RESPONSE SYSTEM | |
| | | (EARS) | 111 |
| | | EVENT DATA RECORDER (EDR) | 111 |

SERVICING AND MAINTENANCE

| | |
|---|------------|
| SCHEDULED SERVICING | 112 |
| ENGINE COMPARTMENT | 113 |
| 1.4L Engine..... | 113 |
| 2.0L Diesel Engine | 114 |
| Checking Oil Level | 115 |
| Adding Washer Fluid | 115 |
| Battery | 116 |
| Pressure Washing | 117 |
| VEHICLE MAINTENANCE | 117 |
| Engine Oil | 117 |
| Engine Oil – Diesel Engine | 118 |
| Engine Oil Filter | 118 |
| Engine Air Cleaner Filter | 118 |
| Air Conditioner Maintenance | 119 |
| Body Lubrication | 120 |
| Wiper Blades | 120 |
| Exhaust System | 122 |
| Cooling System..... | 123 |
| Brake System | 127 |
| Manual Transmission – If Equipped..... | 128 |
| Automatic Transmission – If Equipped..... | 129 |
| FUSES | 130 |
| BULB REPLACEMENT | 143 |

| | |
|--|------------|
| TIRES | 153 |
| Tire Safety Information | 153 |
| Tires – General Information | 154 |
| Tire Types..... | 160 |
| Spare Tires – If Equipped | 161 |
| Tire Rotation Recommendations | 162 |
| STORING THE VEHICLE | 163 |
| BODYWORK | 164 |
| Protection From Atmospheric Agents | 164 |
| Body And Underbody Maintenance..... | 164 |
| Preserving The Bodywork | 166 |
| INTERIORS | 167 |
| Seats And Fabric Parts | 167 |
| Plastic And Coated Parts | 168 |
| Leather Surfaces..... | 169 |
| Glass Surfaces | 169 |

TECHNICAL SPECIFICATIONS

| | |
|---|------------|
| VEHICLE IDENTIFICATION NUMBER (VIN) | 170 |
| BRAKE SYSTEM | 171 |
| WHEEL AND TIRE TORQUE SPECIFICATIONS | 171 |
| Torque Specifications | 171 |

FUEL REQUIREMENTS –

| | |
|--|------------|
| GASOLINE ENGINE | 172 |
| 1.4L Engine | 172 |
| Methanol..... | 172 |
| Ethanol..... | 173 |
| E-85 Usage In Non-Flex Fuel Vehicles | 173 |
| Materials Added To Fuel..... | 173 |
| Gasoline/Oxygenate Blends..... | 173 |
| CNG And LP Fuel System Modifications | 174 |
| Fuel System Cautions | 174 |
| FUEL REQUIREMENTS – DIESEL ENGINE | 175 |
| Diesel Engine..... | 175 |
| FLUID CAPACITIES | 176 |
| ENGINE FLUIDS AND LUBRICANTS | 177 |
| CHASSIS FLUIDS AND LUBRICANTS | 179 |

CUSTOMER ASSISTANCE

| | |
|-------------------------------------|------------|
| IF YOU NEED ASSISTANCE | 181 |
| INDIA | 181 |

INTRODUCTION

Dear Customer,

Congratulations on the purchase of your new Jeep® vehicle. Every Jeep vehicle represents high precision workmanship, distinctive styling, and unmatched quality.

This Essential Information Guide has been prepared with the assistance of service and engineering specialists to acquaint you with essential information for the operation and maintenance of your vehicle. It is supplemented by customer-oriented documents. Within this information, you will find a description of the services that FCA offers to its customers as well as the details of the terms and conditions for maintaining its validity. Please take the time to read these publications carefully. Following the instructions and recommendations in this manual will help ensure safe and enjoyable operation of your vehicle. For comprehensive vehicle information, refer to your vehicle's Owner's Manual on the FCA India Jeep® website.

This Essential Information Guide describes all versions of this vehicle. Options and equipment dedicated to specific markets or versions are not explicitly indicated in the text. Therefore, you should only consider the information that is related to the trim level, engine, and version that you have purchased. Any content introduced throughout the Owner's Information, which may or may not be applicable to your vehicle, will be identified with the wording "If Equipped". All data contained in this publication are intended to help you use your vehicle in the best possible way. FCA reserves the right to make changes to the model described for technical and/or commercial reasons. For further information, contact an authorized dealer.

When it comes to service, remember that authorized dealers know your Jeep® vehicle best, and only factory-trained technicians use genuine parts and care about your satisfaction.

IMPORTANT NOTICE

ALL MATERIAL CONTAINED IN THIS PUBLICATION IS BASED ON THE LATEST INFORMATION AVAILABLE AT THE TIME OF PUBLICATION APPROVAL. THE RIGHT IS RESERVED TO PUBLISH REVISIONS AT ANY TIME.

After you have read the Owner's Manual, it should be stored in the vehicle for convenient reference and remain with the vehicle when sold.

The Owner's Manual illustrates and describes the features that are standard or available as extra cost options. Therefore, some of the equipment and accessories in this publication may not appear on your vehicle.

NOTE:

Be sure to read the Owner's Manual first before driving your vehicle and before attaching or installing parts/accessories or making other modifications to the vehicle.



In view of the many replacement parts and accessories from various manufacturers available in the market, FCA cannot be certain that the driving safety of your vehicle will not be impaired by the attachment or installation of such parts.

Even if such parts are officially approved (for example, by a general operating permit for the part or by constructing the part in an officially approved design), or if an individual operating permit was issued for the vehicle after the attachment or installation of such parts, it cannot be implicitly assumed that the driving safety of your vehicle is unimpaired. Therefore, neither experts nor official agencies are liable. FCA only assumes responsibility when parts, which are expressly authorized or recommended by FCA, are attached or installed at an authorized dealer. The same applies when modifications to the original condition are subsequently made on FCA vehicles.

Your warranties do not cover any part that FCA did not supply. Nor do they cover the cost of any repairs or adjustments that might be caused or needed because of the installation or use of non-manufacturer parts, components, equipment, materials, or additives. Nor do your warranties cover the costs of repairing damage or conditions caused by any changes to your vehicle that do not comply with FCA specifications.

FCA reserves the right to make changes in design and specifications, and/or to make additions to or improvements in its products without imposing any obligations upon itself to install them on products previously manufactured.

SYMBOLS KEY

| | |
|--|--|
| WARNING! | These statements are against operating procedures that could result in a collision, bodily injury and/or death. |
| CAUTION! | These statements are against procedures that could result in damage to your vehicle. |
| NOTE: | A suggestion which will improve installation, operation, and reliability. If not followed, may result in damage. |
| TIP: | General ideas/solutions/suggestions on easier use of the product or functionality. |
| PAGE REFERENCE ARROW  | Follow this reference for additional information on a particular feature. |
| FOOTNOTE  | Supplementary and relevant information pertaining to the topic. |

If you do not read the entire Owner's Manual, you may miss important information. Observe all Cautions and Warnings.

ROLLOVER WARNING

Utility vehicles have a significantly higher rollover rate than other types of vehicles. This vehicle has a higher ground clearance and a higher center of gravity than many passenger vehicles. It is capable of performing better in a wide variety of off-road applications. Driven in an unsafe manner, all vehicles can go out of control. Because of the higher center of gravity, if this vehicle is out of control it may roll over when some other vehicles may not.

Do not attempt sharp turns, abrupt maneuvers, or other unsafe driving actions that can cause loss of vehicle control. Failure to operate this vehicle safely may result in a collision, rollover of the vehicle, and severe or fatal injury. Drive carefully.

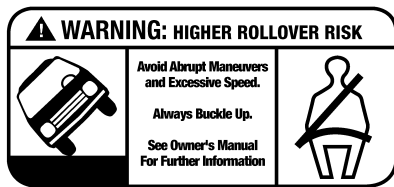

80bfe0f0

Rollover Warning Label

Failure to use the driver and passenger seat belts provided is a major cause of severe or fatal injury. In a rollover crash, an unbelted person is significantly more likely to die than a person wearing a seat belt. Always buckle up.

VEHICLE MODIFICATIONS/ALTERATIONS







WARNING!







Any modifications or alterations to this vehicle could seriously affect its roadworthiness and safety and may lead to a collision resulting in serious injury or death.







SYMBOL GLOSSARY







Some car components have colored labels with symbols indicating precautions to be observed when using this component. It is important to follow all warnings when operating your vehicle. See below for the definition of each symbol ↗ page 41.



| Red Warning Lights | |
|--------------------|---|
| | Air Bag Warning Light ↗ page 41 |
| | Brake Warning Light ↗ page 41 |
| | Battery Charge Warning Light ↗ page 42 |
| | Door Open Warning Light ↗ page 42 |



| Red Warning Lights | |
|---|--|
|  | Drowsiness Detected Warning – If Equipped ⇨ page 43 |
|  | Electric Power Steering (EPS) Fault Warning Light ⇨ page 43 |
|  | Electronic Throttle Control (ETC) Warning Light ⇨ page 43 |
|  | Engine Temperature Warning Light ⇨ page 44 |
|  | Hood Open Warning Light ⇨ page 44 |
|  | Liftgate Open Warning Light ⇨ page 44 |





| Red Warning Lights | |
|---|---|
|  | Oil Pressure Warning Light ⇨ page 44 |
|  | Oil Temperature Warning Light ⇨ page 44 |
|  | Seat Belt Reminder Warning Light ⇨ page 44 |
|  | Transmission Fault Warning Light – If Equipped ⇨ page 45 |
|  | Transmission Temperature Warning Light – If Equipped ⇨ page 45 |
|  | Vehicle Security Warning Light – If Equipped ⇨ page 45 |







| Yellow Warning Lights | |
|---|---|
|  | Anti-Lock Brake System (ABS) Warning Light ↪ page 45 |
|  | Electronic Park Brake Warning Light ↪ page 46 |
|  | Electronic Stability Control (ESC) Active Warning Light – If Equipped ↪ page 46 |
|  | Electronic Stability Control (ESC) OFF Warning Light – If Equipped ↪ page 46 |
|  | Fuel Cutoff Warning Light – If Equipped ↪ page 46 |
|  | Low Coolant Level Warning Light ↪ page 46 |



| Yellow Warning Lights | |
|---|---|
|  | Low Fuel Warning Light ↪ page 47 |
|  | Low Washer Fluid Warning Light – If Equipped ↪ page 47 |
|  | Engine Check/Malfunction Indicator (MIL) Warning Light ↪ page 47 |
|  | AdBlue® (UREA) Injection System Failure Warning Light – If Equipped ↪ page 48 |
|  | Service 4WD Warning Light – If Equipped ↪ page 48 |
|  | Service Stop/Start System Warning Light – If Equipped ↪ page 48 |



| Yellow Warning Lights | |
|---|---|
|  | Tire Pressure Monitoring System (TPMS) Warning Light – If Equipped ⇨ page 48 |
|  | Towing Hook Breakdown Warning Light – If Equipped ⇨ page 50 |





| Yellow Indicator Lights | |
|---|--|
|  | 4WD Low Indicator Light – If Equipped ⇨ page 50 |
|  | 4WD Lock Indicator Light – If Equipped ⇨ page 50 |
|  | Immobilizer Fail / VPS Electrical Alarm Indicator Light ⇨ page 50 |

| Yellow Indicator Lights | |
|---|---|
|  | Diesel Particulate Filter (DPF) Cleaning In Progress Indicator Light – Diesel Versions With DPF Only – If Equipped ⇨ page 50 |
|  | Low Diesel Emissions Additive AdBlue® (UREA) Indicator Light – If Equipped ⇨ page 51 |
|  | Rear Fog Indicator – If Equipped ⇨ page 51 |
|  | Water In Fuel Indicator Light – If Equipped ⇨ page 51 |
|  | Wait To Start Light – If Equipped ⇨ page 52 |



| Green Indicator Lights | |
|---|---|
|  | Active Speed Limiter SET Indicator Light With A Premium Instrument Cluster – If Equipped ⇨ page 52 |
|  | Active Lane Management Indicator Light – If Equipped ⇨ page 52 |
|  | Night Vision Active Indicator Light – If Equipped ⇨ page 52 |
|  | Park/Headlight On Indicator Light ⇨ page 52 |
|  | Front Fog Indicator Light – If Equipped ⇨ page 53 |
|  | Turn Signal Indicator Lights ⇨ page 53 |

| Green Indicator Lights | |
|---|---|
|  | Cruise Control SET Indicator Light With A Premium Instrument Cluster – If Equipped ⇨ page 53 |
|  | Stop/Start Active Indicator Light – If Equipped ⇨ page 53 |

| White Indicator Lights | |
|---|---|
|  | Active Speed Limiter Ready Indicator Light With A Premium Instrument Cluster – If Equipped ⇨ page 53 |
|  | Active Speed Limiter SET Indicator Light With A Base Instrument Cluster – If Equipped ⇨ page 54 |
|  | Hill Descent Control (HDC) Indicator Light – If Equipped ⇨ page 54 |

| White Indicator Lights | |
|---|---|
|  | Cruise Control Ready Indicator Light With A Premium Instrument Cluster – If Equipped ⇨ page 54 |
|  | Cruise Control SET Indicator Light With A Base Instrument Cluster – If Equipped ⇨ page 54 |
|  | Speed Warning Indicator Light – If Equipped ⇨ page 54 |
|  | Speed Alert System Indicator Light – If Equipped ⇨ page 55 |
|  | Speed Alert System Indicator Light – If Equipped ⇨ page 55 |

| Blue Indicator Lights | |
|---|--|
|  | High Beam Indicator Light ⇨ page 55 |

| Gray Indicator Lights | |
|---|--|
|  | Cruise Control Ready Indicator Light With A Base Instrument Cluster – If Equipped ⇨ page 55 |
|  | Active Speed Limiter Ready Indicator Light With A Base Instrument Cluster – If Equipped ⇨ page 55 |
|  | Night Vision Suppressed Indicator Light – If Equipped ⇨ page 55 |

GETTING TO KNOW YOUR VEHICLE

DOORS

CHILD-PROTECTION DOOR LOCK SYSTEM — REAR DOORS

To provide a safer environment for small children riding in the rear seats, the rear doors are equipped with a Child-Protection Door Lock system.

To use the system, open each rear door, use a flat blade screwdriver (or emergency key) and rotate the dial to the lock or unlock position. When the system on a door is engaged, that door can only be opened by using the outside door handle even if the inside door lock is in the unlocked position.

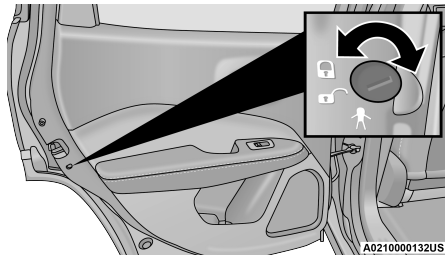

Child-Protection Door Lock Function

NOTE:

- When the Child-Protection Door Lock system is engaged, the door can be opened only by using the outside door handle even though the inside door lock is in the unlocked position.

- After disengaging the Child-Protection Door Lock system, always test the door from the inside to make certain it is in the desired position.
- After engaging the Child-Protection Door Lock system, always test the door from the inside to make certain it is in the desired position.
- For emergency exit with the system engaged, rotate the door lock button until the lock indicator is hidden (unlocked position), roll down the window, and open the door with the outside door handle.

WARNING!

Avoid trapping anyone in a vehicle in a collision. Remember that the rear doors can only be opened from the outside when the Child-Protection locks are engaged (locked).

NOTE:

- Always use this device when carrying children. After engaging the child lock on both rear doors, check for effective engagement by trying to open a door with the internal handle. Once the Child-Protection Door Lock system is engaged, it is impossible to open the doors from inside the vehicle. Before getting out of the vehicle, be sure to check that there is no one left inside.

- The Child-Protection Door Lock system is to be disabled for vehicles used for taxi application and yellow license plates as per the local government laws.

CLIMATE CONTROLS

The Climate Control system allows you to regulate the temperature, air flow, and direction of air circulating throughout the vehicle. The controls are located on the touchscreen (if equipped) and on the instrument panel below the radio.

**AUTOMATIC CLIMATE CONTROLS
DESCRIPTIONS AND FUNCTIONS**

**Uconnect 5 With 10.1-inch Display Automatic
Climate Controls**



Uconnect 5 With 8.4-inch Display Automatic Climate Controls

MAX Defrost Button



Push the MAX Defrost button to change the current airflow setting to Defrost mode. The indicator illuminates when this feature is on.

Performing this function will cause the automatic climate controls to change to manual mode. The blower speed increases to full (all LEDs on) when MAX Defrost mode is selected, the air conditioning compressor is turned on

(LED on), both driver and passenger temperature controls are set to HI, Defrost mode is selected (LED on), rear defroster is turned on (LED on) and the air recirculation is turned off (LED off). If MAX Defrost mode is turned off, the Climate Control system will return to the previous setting.

Rear Defrost Button



Press and release the button on the touchscreen, or push and release the button on the faceplate, to turn on the rear window defroster. The Rear Defrost indicator illuminates when the rear window defroster is on. The rear window defroster automatically turns off after 10 minutes.

CAUTION!

Failure to follow these cautions can cause damage to the heating elements:

- Use care when washing the inside of the rear window. Do not use abrasive window cleaners on the interior surface of the window. Use a soft cloth and a mild washing solution, wiping parallel to the heating elements. Labels can be peeled off after soaking with warm water.
- Do not use scrapers, sharp instruments, or abrasive window cleaners on the interior surface of the window.
- Keep all objects a safe distance from the window.

MANUAL CLIMATE CONTROLS DESCRIPTIONS AND FUNCTIONS

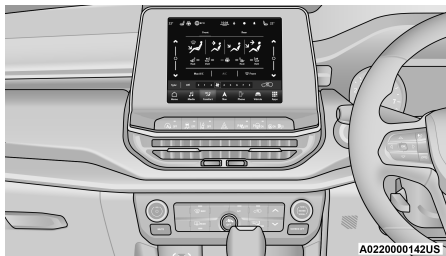

Uconnect 5 With 8.4-inch Display Manual Climate Controls

MAX Defrost Button



Push the MAX Defrost button to change the current airflow setting to Defrost mode. The indicator illuminates when this feature is on.

Performing this function will cause the automatic climate controls to change to manual mode.

The blower speed increases to full (all LEDs on) when MAX Defrost mode is selected, the air conditioning compressor is turned on (LED on), both driver and passenger temperature controls are set to HI, Defrost mode is selected (LED on), rear defroster is turned on (LED on) and the air recirculation is turned off (LED off). If MAX Defrost mode is turned off, the Climate Control system will return to the previous setting.

Rear Defrost Button



Push and release the Rear Defrost Control button to turn on the rear window defroster. The Rear Defrost indicator illuminates when the rear window defroster is on. The rear window defroster automatically turns off after 10 minutes.

CAUTION!

Failure to follow these cautions can cause damage to the heating elements:

- Use care when washing the inside of the rear window. Do not use abrasive window cleaners on the interior surface of the window. Use a soft cloth and a mild washing solution, wiping parallel to the heating elements. Labels can be peeled off after soaking with warm water.
- Do not use scrapers, sharp instruments, or abrasive window cleaners on the interior surface of the window.
- Keep all objects a safe distance from the window.

OPERATING TIPS

Summer Operation

The engine cooling system must be protected with a high-quality antifreeze coolant to provide proper corrosion protection and to protect against engine overheating. OAT coolant (conforming to MS.90032) is recommended.

Winter Operation

To ensure the best possible heater and defroster performance, make sure the engine cooling system is functioning properly and the proper amount, type, and concentration of coolant is used. Use of the Air Recirculation mode during Winter months is not recommended, because it may cause window fogging.

Vacation/Storage

For information on maintaining the Climate Control system when the vehicle is being stored for an extended period of time, please refer to the full copy of the Owner's Manual at Jeep-India.com or get in touch with the authorized service center.

Window Fogging

Vehicle windows tend to fog on the inside in mild, rainy, and/or humid weather. To clear the windows, select Defrost or Mix mode and increase the front blower speed. Do not use the Recirculation mode without A/C for long periods, as fogging may occur.

Outside Air Intake

Make sure the air intake, located directly in front of the windshield, is free of obstructions, such as leaves. Leaves collected in the air intake may reduce airflow, and if they enter the air distribution box, they could plug the water drains. In Winter months, make sure the air intake is clear of ice, slush, and snow.



Cabin Air Filter



The climate control system filters out dust and pollen from the air. Contact an authorized dealer to service your cabin air filter, and to have it replaced when needed.

Stop/Start System — If Equipped

While in an Autostop, the Climate Control system may automatically adjust airflow to maintain cabin comfort. Customer settings will be maintained upon return to an engine running condition.

Operating Tips Chart

| WEATHER | CONTROL SETTINGS |
|--|--|
| Hot Weather And Vehicle Interior Is Very Hot | Set the mode control to (Panel Mode)  , (A/C) ^{A/C} on, and blower on high. Roll down the windows for a minute to flush out the hot air. Adjust the controls as needed to achieve comfort. |
| Warm Weather | Turn (A/C) ^{A/C} on and set the mode control to (Panel Mode)  . |
| Cool Sunny | Operate in (Bi-Level Mode)  . |

| WEATHER | CONTROL SETTINGS |
|-------------------------|--|
| Cool & Humid Conditions | Set the mode control to (Floor Mode)  and turn on (A/C) ^{A/C} to keep windows clear. |
| Cold Weather | Set the mode control to (Floor Mode)  . If windshield fogging starts to occur, move the control to (Mix Mode)  . |

WINDOWS

RESET AUTO-UP

Should the Auto-Up feature stop working, the window probably needs to be reset. To reset Auto-Up:

1. Pull the window switch up to close the window completely and continue to hold the switch up for an additional two seconds after the window is closed.
2. Push the window switch down firmly to open the window completely and continue to hold the switch down for an additional two seconds after the window is fully open.

WINDOW LOCKOUT SWITCH

The window lockout switch on the driver's door trim panel allows you to disable the window controls on the rear passenger doors. To disable the window controls, push and release the window lockout switch (the indicator light on the switch will turn on). To enable the window controls, push and release the window lockout switch again (the indicator light on the switch will turn off).

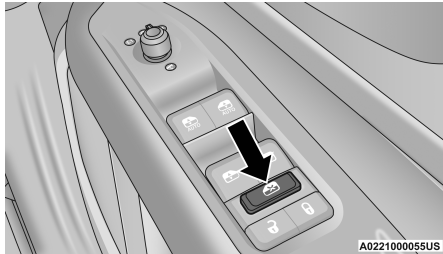

Window Lockout Switch

HOOD

OPENING THE HOOD

Two latches must be released to open the hood.

1. Pull the hood release lever located underneath the driver's side of the instrument panel.

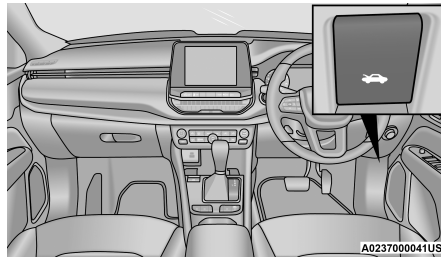

**Hood Release Location
(Underneath Instrument Panel)**

2. Move to the outside of the vehicle. The safety latch release lever is located behind the front edge of the hood at the center. Reach in at the center of the hood with a palm facing the ground. Once contact is made with the safety latch release lever, push it to the left to fully release the hood.

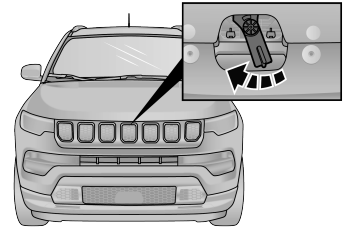

A0237000042US

Hood Safety Latch Release Lever Location

CLOSING THE HOOD

Hoods equipped with gas props are closed from the point where the props no longer hold the hood open.

WARNING!

Be sure the hood is fully latched before driving your vehicle. If the hood is not fully latched, it could open when the vehicle is in motion and block your vision. Failure to follow this warning could result in serious injury or death.

CAUTION!

To prevent possible damage, do not slam the hood to close it. Lower hood to approximately 12 inches (30 cm) and drop the hood to close. Make sure hood is fully closed for both latches. Never drive vehicle unless hood is fully closed, with both latches engaged.

LIFTGATE

UNLOCK/OPEN THE LIFTGATE

The liftgate may be released in one of several ways:

- Key fob (if equipped with power liftgate)
- Outside handle
- Button on overhead console (if equipped with power liftgate)

The overhead console switch and key fob (if equipped) will release the liftgate when the liftgate is unlocked or locked. The outside handle requires the liftgate to be unlocked.

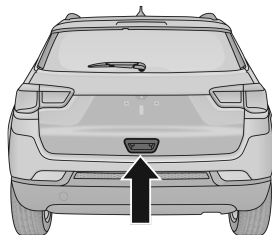

M0338000127US

Liftgate Entry

To Unlock The Liftgate

Use the key fob or the interior door unlock button on the door panel to unlock the liftgate. The manual door locks on the doors will not unlock the liftgate.

WARNING!

Driving with the liftgate open can allow poisonous exhaust gases into your vehicle. You and your passengers could be injured by these fumes. Keep the liftgate closed when you are operating the vehicle.

LOCK/CLOSE THE LIFTGATE

To manually close the liftgate, grab the liftgate closing handle and pull in a downward motion to close the liftgate.

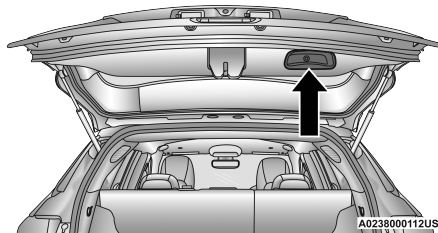

Liftgate Pull Handle/Closing Liftgate

NOTE:

Before closing the liftgate, make sure to be in possession of the key because the liftgate may be locked.

To Lock The Liftgate

Use the key fob or the interior door lock button on the door panel to lock the liftgate. The manual door locks on the doors will not lock the liftgate.

GETTING TO KNOW YOUR INSTRUMENT PANEL

BASE / MIDLINE INSTRUMENT CLUSTER

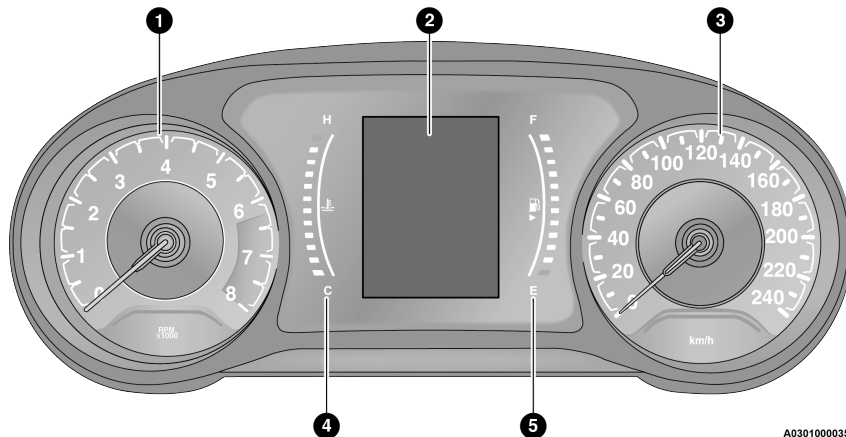

A0301000035US

Base Instrument Cluster

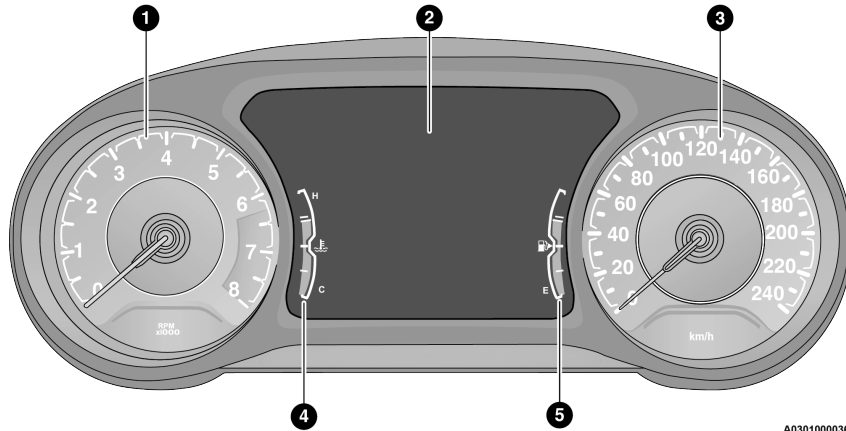

A0301000036US

Midline Instrument Cluster

BASE / MIDLINE INSTRUMENT CLUSTER DESCRIPTIONS

1. Tachometer
 - Indicates the engine speed in revolutions per minute (RPM x 1000).
2. Instrument Cluster Display
 - The instrument cluster display features a driver interactive display → page 36.

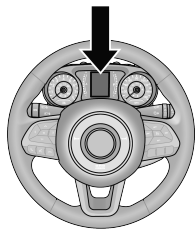

A0302000052US

Base Instrument Cluster Display Location

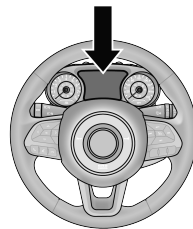

A0302000051US

Midline Instrument Cluster Display Location

3. Speedometer

- Indicates vehicle speed.

4. Temperature Gauge

- The temperature gauge shows engine coolant temperature. Any reading within the normal range indicates that the engine cooling system is operating satisfactorily.
- The gauge pointer will likely indicate a higher temperature when driving in hot weather or up mountain grades. It should not be allowed to exceed the upper limits of the normal operating range.

WARNING!

A hot engine cooling system is dangerous. You or others could be badly burned by steam or boiling coolant. It is recommended to call an authorized dealer for service if your vehicle overheats.

CAUTION!

Driving with a hot engine cooling system could damage your vehicle. If the temperature gauge reads “H” pull over and stop the vehicle. Idle the vehicle with the air conditioner turned off until the pointer drops back into the normal range. If the pointer remains on the “H”, turn the engine off immediately and call an authorized dealer for service.

5. Fuel Gauge

- The gauge shows the level of fuel in the fuel tank when the ignition switch is in the ON/RUN position.



- The fuel pump symbol points to the side of the vehicle where the fuel door is located.

NOTE:

The hard telltales will illuminate for a bulb check when the ignition is first cycled.

PREMIUM INSTRUMENT CLUSTER

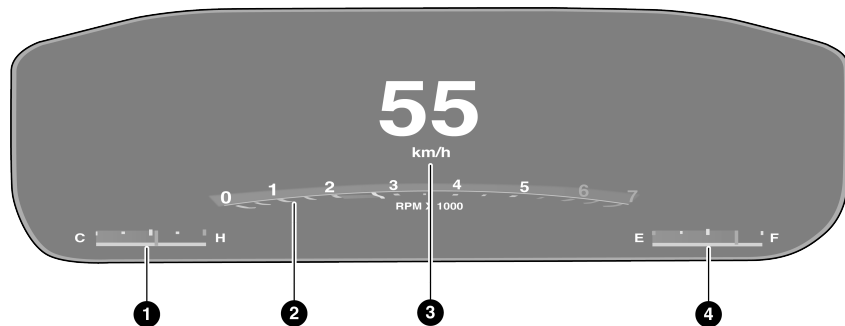

A0301000165US

Premium Instrument Cluster

PREMIUM INSTRUMENT CLUSTER DESCRIPTIONS

1. Temperature Gauge

- The temperature gauge shows engine coolant temperature. Any reading within the normal range indicates that the engine cooling system is operating satisfactorily.
- The pointer will likely indicate a higher temperature when driving in hot weather, up mountain grades, or when towing a trailer. It should not be allowed to exceed the upper limits of the normal operating range.

WARNING!

A hot engine cooling system is dangerous. You or others could be badly burned by steam or boiling coolant. It is recommended to call an authorized dealer for service if your vehicle overheats → page 123.

CAUTION!

Driving with a hot engine cooling system could damage your vehicle. If the temperature gauge reads “H” pull over and stop the vehicle. Idle the vehicle with the air conditioner turned off until the pointer drops back into the normal range. If the pointer remains on the “H”, turn the engine off immediately and call an authorized dealer for service.

2. Tachometer

- Indicates the engine speed in revolutions per minute (RPM x 1000).

3. Speedometer

- Indicates vehicle speed.

4. Fuel Gauge

- The pointer shows the level of fuel in the fuel tank when the Keyless Push Button Ignition is in the ON/RUN position.



- The fuel pump symbol points to the side of the vehicle where the fuel door is located.

NOTE:

The Instrument Cluster Warning Indicators will illuminate briefly for a bulb check when the ignition is first cycled.

BASE / MIDLINE INSTRUMENT CLUSTER — DIESEL

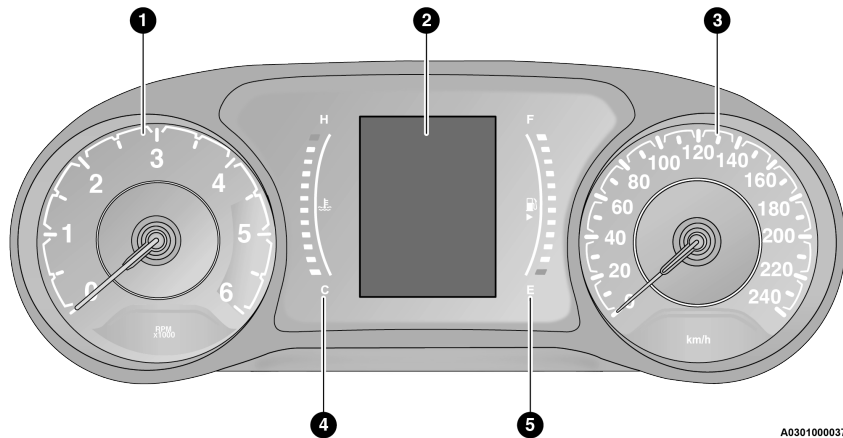

A0301000037US

Base Diesel Instrument Cluster

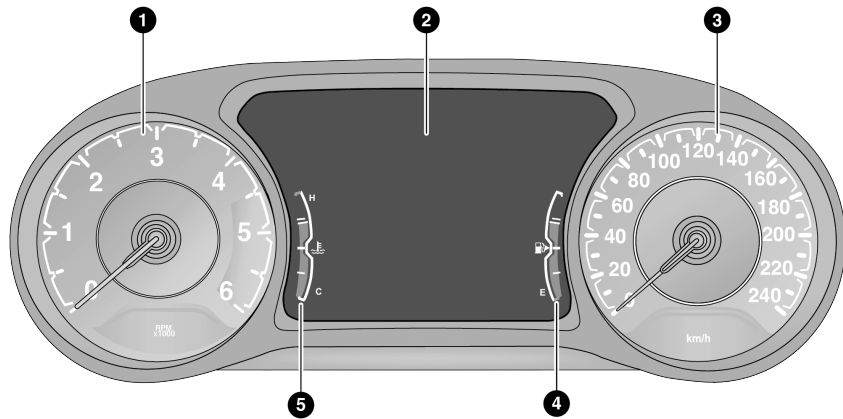

A0301000038US

Midline Diesel Instrument Cluster

BASE / MIDLINE INSTRUMENT CLUSTER DESCRIPTIONS

1. Tachometer
 - Indicates the engine speed in revolutions per minute (RPM x 1000).
2. Instrument Cluster Display
 - The instrument cluster display features a driver interactive display → page 36.

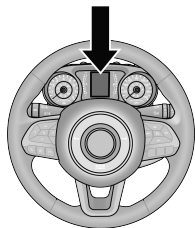

A0302000052US

Base Instrument Cluster Display Location

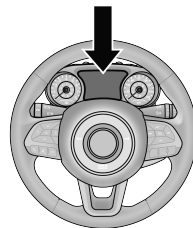

A0302000051US

Midline Instrument Cluster Display Location

3. Speedometer

- Indicates vehicle speed.

4. Temperature Gauge

- The temperature gauge shows engine coolant temperature. Any reading within the normal range indicates that the engine cooling system is operating satisfactorily.
- The gauge pointer will likely indicate a higher temperature when driving in hot weather or up mountain grades. It should not be allowed to exceed the upper limits of the normal operating range.

WARNING!

A hot engine cooling system is dangerous. You or others could be badly burned by steam or boiling coolant. It is recommended to call an authorized dealer for service if your vehicle overheats.

CAUTION!

Driving with a hot engine cooling system could damage your vehicle. If the temperature gauge reads “H” pull over and stop the vehicle. Idle the vehicle with the air conditioner turned off until the pointer drops back into the normal range. If the pointer remains on the “H”, turn the engine off immediately and call an authorized dealer for service.

5. Fuel Gauge

- The gauge shows the level of fuel in the fuel tank when the ignition switch is in the ON/RUN position.



- The fuel pump symbol points to the side of the vehicle where the fuel door is located.

NOTE:

The hard telltales will illuminate for a bulb check when the ignition is first cycled.

PREMIUM INSTRUMENT CLUSTER — DIESEL

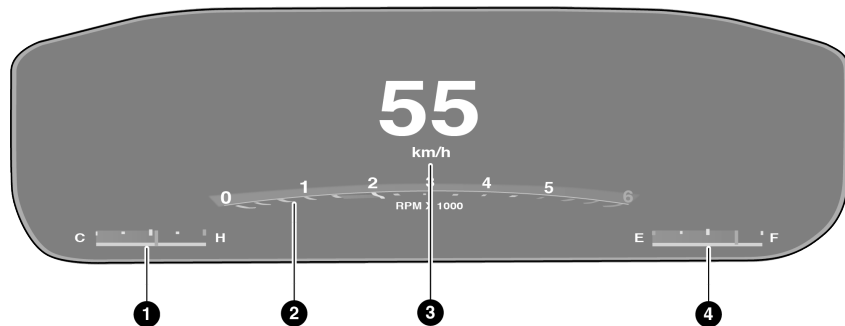

A0301000168US

Premium Diesel Instrument Cluster

PREMIUM INSTRUMENT CLUSTER DESCRIPTIONS

1. Temperature Gauge

- The temperature gauge shows engine coolant temperature. Any reading within the normal range indicates that the engine cooling system is operating satisfactorily.
- The pointer will likely indicate a higher temperature when driving in hot weather, up mountain grades, or when towing a trailer. It should not be allowed to exceed the upper limits of the normal operating range.

WARNING!

A hot engine cooling system is dangerous. You or others could be badly burned by steam or boiling coolant. It is recommended to call an authorized dealer for service if your vehicle overheats → page 123.

CAUTION!

Driving with a hot engine cooling system could damage your vehicle. If the temperature gauge reads “H” pull over and stop the vehicle. Idle the vehicle with the air conditioner turned off until the pointer drops back into the normal range. If the pointer remains on the “H”, turn the engine off immediately and call an authorized dealer for service.

2. Tachometer

- Indicates the engine speed in revolutions per minute (RPM x 1000).

3. Speedometer

- Indicates vehicle speed.

4. Fuel Gauge

- The pointer shows the level of fuel in the fuel tank when the Keyless Push Button Ignition is in the ON/RUN position.



- The fuel pump symbol points to the side of the vehicle where the fuel door is located.

NOTE:

The Instrument Cluster Warning Indicators will illuminate briefly for a bulb check when the ignition is first cycled.

INSTRUMENT CLUSTER DISPLAY

Your vehicle may be equipped with an instrument cluster display, which offers useful information to the driver. With the ignition in the OFF mode, opening/closing of a door will activate the display for viewing, and display the total miles, or kilometers, in the odometer. Your instrument cluster display is designed to display important information about your vehicle's systems and features. Using a driver interactive display located on the instrument panel, your instrument cluster display can show you how systems are working and give you warnings when they aren't. The steering wheel mounted controls allow you to scroll through and enter the main menus and submenus. You can access the specific information you want and make selections and adjustments.

OIL CHANGE RESET — IF EQUIPPED

- Your vehicle is equipped with an engine oil change indicator system. The “Oil Change Due” message will display in the instrument cluster display for five seconds after a single chime has sounded, to indicate the next scheduled oil change interval. The engine oil change indicator system is duty cycle based, which means the engine oil change interval may fluctuate, dependent upon your personal driving style.
- Unless reset, this message will continue to display each time the ignition is cycled to the ON/RUN position.

To reset the oil change indicator after performing the scheduled maintenance, refer to the following procedure:

1. Without pressing the brake pedal, push the ENGINE START/STOP button and cycle the ignition to the ON/RUN position (do not start the engine).
2. Fully press the accelerator pedal, slowly, three times within ten seconds.
3. Cycle the ignition to the OFF/LOCK position.

NOTE:

If the indicator message illuminates when you start the vehicle, the oil change indicator system did not reset. If necessary, repeat this procedure.

GEAR SHIFT INDICATOR (GSI) — IF EQUIPPED

The GSI system is enabled on vehicles with a manual transmission, or when a vehicle with an automatic transmission is in manual shift mode. The GSI provides the driver with a visual indication when the recommended gear shift point has been reached. This indication notifies the driver that changing gear will allow a reduction in fuel consumption. When the up shift indicator is shown on the instrument cluster display, the GSI is advising the driver to engage a higher gear. When the down shift indicator is shown on the display, the GSI is advising the driver to engage a lower gear.

The GSI remains illuminated until the driver changes gears, or the driving conditions return to a situation where changing gear is not required to improve fuel consumption.

DIESEL DISPLAYS

When the appropriate conditions exist, the following messages display in the instrument cluster display:

- Exhaust Filter Nearing Full Safely Drive at Consistent Speeds to Clear
- Exhaust Filter Full – Power Reduced See Dealer

- Exhaust System Service Required – See Dealer
- Exhaust System – Filter XX% Full Service Required See Dealer
- Exhaust System Regeneration in Process Continue Driving
- Exhaust System – Regeneration Completed

DIESEL PARTICULATE FILTER (DPF) MESSAGES

This engine meets all required diesel engine emissions standards. To achieve these emissions standards, your vehicle is equipped with a state-of-the-art engine and exhaust system. These systems are seamlessly integrated into your vehicle and managed by the Powertrain Control Module (PCM). The PCM manages engine combustion to allow the exhaust system's catalyst to trap and burn Particulate Matter (PM) pollutants, with no input or interaction on your part.

WARNING!

A hot exhaust system can start a fire if you park over materials that can burn. Such materials might be grass or leaves coming into contact with your exhaust system. Do not park or operate your vehicle in areas where your exhaust system can contact anything that can burn.

CAUTION!

The engine may be switched off even if the warning light is on: repeated interruptions of the regeneration process could cause an early deterioration of engine oil. For this reason it is always advisable to wait for the symbol to go off before turning off the engine, following the instructions above. Do not complete the DPF regeneration process when the vehicle is stopped.

FUEL SYSTEM MESSAGES

The following chart contains a list of different messages that may appear in the instrument cluster, depending on different system or fuel conditions. Use the descriptions to interpret what the message means and determine the best action to take.

| MESSAGE | DESCRIPTION |
|---|--|
| Diesel Emissions Additive AdBlue® (UREA) Warning Messages: | |
| <i>Low Diesel Emissions Additive AdBlue® (UREA) Level Warning</i> | <p>The first low level warning will be given at around a 1,490 miles (2,400 km) range, and is determined according to the current consumption rate. The “UREA Low Level” warning light and message will display on the instrument panel. The UREA low level warning light will remain lit until the AdBlue® (UREA) tank is topped up with at least 1.32 gallons (5 Liters) of UREA.</p> <p>If the level is not resolved, an additional warning appears whenever a certain threshold is reached until it will no longer be possible to start the engine.</p> <p>When 125 miles (200 km) are remaining before the AdBlue® (UREA) tank is empty, a message will appear on the instrument panel, accompanied by a buzzer sound. When the range is at 0, the display will show a dedicated message (if equipped). In this case, the engine will not restart.</p> <p>It will be possible to restart the engine again as soon as AdBlue® (UREA) is added; the minimum amount required is 1.32 gallons (5 Liters). Fill the AdBlue® (UREA) tank as soon as possible with at least 1.32 gallons (5 Liters) of UREA. If filling is completed with autonomy tank AdBlue® (UREA) to zero, it could be possible to wait two minutes before starting the vehicle.</p> <p>NOTE: When the AdBlue® (UREA) tank is empty, and the vehicle is stopped, it is no longer possible to restart the vehicle until a minimum of 1.32 gallons (5 Liters) of AdBlue® (UREA) is added to the AdBlue® (UREA) tank.</p> |

| MESSAGE | DESCRIPTION |
|---|--|
| Diesel Emissions Additive AdBlue® (UREA) Fault Warning Messages: | |
| <p><i>Engine Will Not Restart Service AdBlue® System See Dealer</i></p> | <p>This message will display if AdBlue® (UREA) system issue detected is not serviced during the allowed period. Your engine will not restart unless your vehicle is serviced by an authorized dealer. If the level is not resolved, an additional warning appear whenever a certain threshold is reached until it will no longer be possible to start the engine. When 125 miles (200 km) are remaining before the AdBlue® tank is empty, a message will appear on the instrument panel, accompanied by a buzzer sound.</p> |
| <p><i>Engine Will Not Start Service AdBlue® System See Dealer</i></p> | <p>NOTE:</p> <ul style="list-style-type: none"> ● The display may take up to five seconds to update after adding two gallons (7.5 Liters) or more of AdBlue® (UREA) to the AdBlue® (UREA) tank. If you have a fault related to the AdBlue® (UREA) system, the display may not update to the new level. See an authorized dealer for service. ● AdBlue® freezes at temperatures lower than 12°F (-11°C). If the car stands for a long time at this temperature, refilling could be difficult. For this reason, it is advised to park the vehicle in a garage and/or heated environment, and wait for the AdBlue® (UREA) to return to liquid state before topping up. |

WARNING LIGHTS AND MESSAGES

For a full copy of the owner's manual please visit Jeep-India.com or get in touch with the authorized service center.

The warning/indicator lights will illuminate in the instrument panel together with a dedicated message and/or acoustic signal when applicable. These indications are indicative and precautionary and as such must not be considered as exhaustive and/or alternative to the information contained in the Owner's Manual, which you are advised to read carefully in all cases. Always refer to the information in this chapter in the event of a failure indication. All active telltales will display first if applicable. The system check menu may appear different based upon equipment options and current vehicle status. Some telltales are optional and may not appear.

RED WARNING LIGHTS

Air Bag Warning Light



This warning light will illuminate to indicate a fault with the air bag, and will turn on for four to eight seconds as a bulb check when the ignition is placed in the ON/RUN position. This light will illuminate with a single chime when a fault with the air bag has been detected, it will stay on until the fault is cleared. If the light is either not on during startup, stays on, or turns on while driving, have the system inspected at an authorized dealer as soon as possible.

Brake Warning Light



This warning light monitors various brake functions, including brake fluid level and parking brake application. If the brake light turns on it may indicate that the parking brake is applied, that the brake fluid level is low, or that there is a problem with the Anti-Lock Brake System.

If the light remains on when the parking brake has been disengaged, and the fluid level is at the full mark on the master cylinder reservoir, it indicates a possible brake hydraulic system malfunction or that a problem with the Brake Booster has been detected by the Anti-Lock Brake System (ABS) / Electronic Stability Control (ESC) system. In this case, the light will remain on until the condition has been corrected. If the problem is related to the brake booster, the ABS pump will run when applying the brake, and a brake pedal pulsation may be felt during each stop.

The dual brake system provides a reserve braking capacity in the event of a failure to a portion of the hydraulic system. A leak in either half of the dual brake system is indicated by the Brake Warning Light, which will turn on when the brake fluid level in the master cylinder has dropped below a specified level.

The light will remain on until the cause is corrected.

NOTE:

The light may flash momentarily during sharp cornering maneuvers, which change fluid level conditions. The vehicle should have service performed, and the brake fluid level checked.

If brake failure is indicated, immediate repair is necessary.

WARNING!

Driving a vehicle with the red brake light on is dangerous. Part of the brake system may have failed. It will take longer to stop the vehicle. You could have a collision. Have the vehicle checked immediately.

Vehicles equipped with the Anti-Lock Brake System (ABS) are also equipped with Electronic Brake Force Distribution (EBD). In the event of an EBD failure, the Brake Warning Light will turn on along with the ABS Light. Immediate repair to the ABS system is required.

Operation of the Brake Warning Light can be checked by turning the ignition switch from the OFF position to the ON/RUN position. The light should illuminate for approximately four seconds. The light should then turn off unless the parking brake is applied or a brake fault is detected. If the light does not illuminate, have the light inspected by an authorized dealer.

The light also will turn on when the parking brake is applied with the ignition switch in the ON/RUN position.

NOTE:

This light shows only that the parking brake is applied. It does not show the degree of brake application.

Battery Charge Warning Light



This warning light will illuminate when the battery is not charging properly. If it stays on while the engine is running, there may be a malfunction with the charging system. Contact an authorized dealer as soon as possible.

This indicates a possible problem with the electrical system or a related component.

Door Open Warning Light



This indicator will illuminate when a door is ajar/open and not fully closed.

NOTE:

If the vehicle is moving, there will also be a single chime.

Drowsiness Detected Warning — If Equipped



Driver drowsiness detection helps to avoid crashes caused by fatigue by advising drivers to take a break in time. Once Drowsy Driver is detected,

A pop-up will display continuously until the driver presses the **OK** button to clear.

Once the pop-up message is cleared, it is stored until the condition is no longer true.

Electric Power Steering (EPS) Fault Warning Light



The warning light will turn on when there's a fault with the EPS system.

WARNING!

Continued operation with reduced assist could pose a safety risk to yourself and others. Service should be obtained as soon as possible.

Electronic Throttle Control (ETC) Warning Light



This warning light will illuminate to indicate a problem with the ETC system. If a problem is detected while the vehicle is running, the light will either stay on or flash depending on the nature of the problem. Cycle the ignition when the vehicle is safely and completely stopped and the transmission is placed in the PARK position.

The light should turn off. If the light remains on with the vehicle running, your vehicle will usually be drivable; however, see an authorized dealer for service as soon as possible.

NOTE:

This light may turn on if the accelerator and brake pedals are pressed at the same time.

If the light continues to flash when the vehicle is running, immediate service is required and you may experience reduced performance, an elevated/rough idle, or engine stall and your vehicle may require towing.

The light will come on when the ignition is placed in the ON/RUN position and remain on briefly as a bulb check. If the light does not come on during starting, have the system checked by an authorized dealer.

Engine Temperature Warning Light



This warning light will illuminate to warn of an overheated engine condition. If the engine coolant temperature is too high, this light will illuminate and a single chime will sound.

If the light turns on while driving, safely pull over and stop the vehicle. If the Air Conditioning (A/C) system is on, turn it off. Also, shift the transmission into NEUTRAL (N) and idle the vehicle. If the temperature reading does not return to normal, turn the engine off immediately and call for service.

Hood Open Warning Light



This warning light will illuminate when the hood is left open and not fully closed.

NOTE:

If the vehicle is moving, there will also be a single chime.

Liftgate Open Warning Light



This warning light will illuminate when the liftgate is open.

NOTE:

If the vehicle is moving, there will also be a single chime.

Oil Pressure Warning Light



This warning light will illuminate to indicate low engine oil pressure. If the light turns on while driving, stop the vehicle, shut off the engine as soon as possible, and contact an authorized dealer. A chime will sound when this light turns on.

Do not operate the vehicle until the cause is corrected. This light does not indicate how much oil is in the engine. The engine oil level must be checked under the hood.

Oil Temperature Warning Light



This warning light will illuminate to indicate the engine oil temperature is high. If the light turns on while driving, stop the vehicle and shut off the engine as soon as possible. Wait for oil temperature to return to normal levels.

Seat Belt Reminder Warning Light



This warning light indicates when the driver or passenger seat belt is unbuckled. When the ignition is first placed in the ON/RUN position and if the driver's seat belt is unbuckled, a chime will sound and the light will turn on. When driving, if the driver or front passenger seat belt remains unbuckled, the Seat Belt Reminder Light will flash or remain on continuously and a chime will sound.

Transmission Fault Warning Light — If Equipped



This light will illuminate (together with a message in the instrument cluster display and a buzzer) to indicate a transmission fault. Contact an authorized dealer if the message remains after restarting the engine.

Transmission Temperature Warning Light — If Equipped



This warning light will illuminate to warn of a high transmission fluid temperature. This may occur with strenuous usage such as trailer towing. If this light turns on, stop the vehicle and run the engine at idle or slightly faster, with the transmission in PARK or NEUTRAL, until the light turns off. Once the light turns off, you may continue to drive normally.

WARNING!

If you continue operating the vehicle when the Transmission Temperature Warning Light is illuminated you could cause the fluid to boil over, come in contact with hot engine or exhaust components and cause a fire.

CAUTION!

Continuous driving with the Transmission Temperature Warning Light illuminated will eventually cause severe transmission damage or transmission failure.

Vehicle Security Warning Light — If Equipped



This light will flash at a fast rate for approximately 15 seconds when the Vehicle Security system is arming, and then will flash slowly until the vehicle is disarmed.

YELLOW WARNING LIGHTS

Anti-Lock Brake System (ABS) Warning Light



This warning light monitors the ABS. The light will turn on when the ignition is placed in the ON/RUN position and may stay on for as long as four seconds.

If the ABS light remains on or turns on while driving, then the Anti-Lock portion of the brake system is not functioning and service is required as soon as possible. However, the conventional brake system will continue to operate normally, assuming the Brake Warning Light is not also on.

If the ABS light does not turn on when the ignition is placed in the ON/RUN position, have the brake system inspected by an authorized dealer.

Electronic Park Brake Warning Light



This warning light will illuminate to indicate the Electronic Park Brake is not functioning properly and service is required. Contact an authorized dealer.

Electronic Stability Control (ESC) Active Warning Light — If Equipped



This warning light will indicate when the ESC system is Active. The ESC Indicator Light in the instrument cluster will come on when the ignition is placed in the ON/RUN position, and when ESC is activated. It should go out with the engine running. If the ESC Indicator Light comes on continuously with the engine running, a malfunction has been detected in the ESC system.

If this warning light remains on after several ignition cycles, and the vehicle has been driven several miles (kilometers) at speeds greater than 30 mph (48 km/h), see an authorized dealer as soon as possible to have the problem diagnosed and corrected.

- The ESC OFF Indicator Light and the ESC Indicator Light come on momentarily each time the ignition is placed in the ON/RUN position.
- The ESC system will make buzzing or clicking sounds when it is active. This is normal; the sounds will stop when ESC becomes inactive.
- This light will come on when the vehicle is in an ESC event.

Electronic Stability Control (ESC) OFF Warning Light — If Equipped



This warning light indicates the ESC is off.

Each time the ignition is turned to ON/RUN position, the ESC system will be on, even if it was turned off previously.

Fuel Cutoff Warning Light — If Equipped



This warning light will illuminate after an accident has occurred, and the system has shut the fuel off.

Low Coolant Level Warning Light



This telltale will turn on to indicate the vehicle coolant level is low.

Low Fuel Warning Light



Depending on whether the tank size is 13.5 gal (51 L) or 15.8 gal (60 L), the Low Fuel Indicator Light will turn on when the fuel level goes below 1.5 gal (5.6 L) or 1.7 gal (6.6 L) respectively.

Low Washer Fluid Warning Light — If Equipped



This warning light will illuminate when the windshield washer fluid is low.

Engine Check/Malfunction Indicator (MIL) Warning Light



The MIL is a part of an Onboard Diagnostic System called OBD II that monitors engine and automatic transmission control systems. This warning light will illuminate when the ignition is

in the ON/RUN position before engine start. If the bulb does not come on when turning the ignition switch from OFF to ON/RUN, have the condition checked promptly.

Certain conditions, such as a loose or missing gas cap, poor quality fuel, etc., may illuminate the light after engine start. The vehicle should be serviced if the light stays on through several typical driving styles. In most situations, the vehicle will drive normally and will not require towing.

When the engine is running, the MIL may flash to alert serious conditions that could lead to immediate loss of power or severe catalytic converter damage. The vehicle should be serviced by an authorized dealer as soon as possible if this occurs.

WARNING!

A malfunctioning catalytic converter, as referenced above, can reach higher temperatures than in normal operating conditions. This can cause a fire if you drive slowly or park over flammable substances such as dry plants, wood, cardboard, etc. This could result in death or serious injury to the driver, occupants or others.

CAUTION!

Prolonged driving with the Malfunction Indicator Light (MIL) on could cause damage to the vehicle control system. It also could affect fuel economy and driveability. If the MIL is flashing, severe catalytic converter damage and power loss will soon occur. Immediate service is required.

AdBlue® (UREA) Injection System Failure Warning Light — If Equipped



This warning light will illuminate along with a dedicated message on the display (If Equipped) if an unknown fluid not conforming with acceptable characteristics is inserted, or if an average consumption of AdBlue® (UREA) over 50% is detected. Contact an authorized dealer as soon as possible.

If the problem is not solved, a specific message will appear on the Instrument Cluster Display whenever a certain threshold is reached until it will no longer be possible to start the engine.

When about 125 miles (200 km) are remaining before the AdBlue® tank is empty, a continuous dedicated message will appear on the instrument panel, accompanied by a buzzer sound (If Equipped).

Service 4WD Warning Light — If Equipped



This warning light will illuminate to signal a fault with the 4WD system. If the light stays on or comes on during driving, it means that the 4WD system is not functioning properly and that service is required. We recommend you drive to the nearest service center and have the vehicle serviced immediately.

Service Stop/Start System Warning Light — If Equipped



This warning light will illuminate when the Stop/Start system is not functioning properly and service is required. Contact an authorized dealer for service.

Tire Pressure Monitoring System (TPMS) Warning Light — If Equipped



The warning light switches on and a message is displayed to indicate that the tire pressure is lower than the recommended value and/or that slow pressure loss is occurring. In these cases, optimal tire duration and fuel consumption may not be guaranteed.

Should one or more tires be in the condition mentioned above, the display will show the indications corresponding to each tire.

CAUTION!

Do not continue driving with one or more flat tires as handling may be compromised. Stop the vehicle, avoiding sharp braking and steering. If a tire puncture occurs, repair immediately using the dedicated tire repair kit and contact an authorized dealer as soon as possible.

Each tire, including the spare (if provided), should be checked monthly when cold and inflated to the inflation pressure recommended by the vehicle manufacturer on the vehicle placard or tire inflation pressure label. If your vehicle has tires of a different size than the size indicated on the vehicle placard or tire inflation pressure label, you should determine the proper tire inflation pressure for those tires.

As an added safety feature, your vehicle has been equipped with a TPMS that illuminates a low tire pressure telltale when one or more of your tires is significantly underinflated. Accordingly, when the low tire pressure telltale illuminates, you should stop and check your tires as soon as possible, and inflate them to the proper pressure. Driving on a significantly underinflated tire causes the tire to overheat and can lead to tire failure. Underinflation also reduces fuel efficiency and tire tread life, and may affect the vehicle's handling and stopping ability.

Please note that the TPMS is not a substitute for proper tire maintenance, and it is the driver's responsibility to maintain correct tire pressure, even if underinflation has not reached the level to trigger illumination of the TPMS low tire pressure telltale.

Your vehicle has also been equipped with a TPMS malfunction indicator to indicate when the system is not operating properly. The TPMS malfunction indicator is combined with the low tire pressure telltale. When the system detects a malfunction, the telltale will flash for approximately one minute and then remain continuously illuminated. This sequence will continue upon subsequent vehicle start-ups as long as the malfunction exists. When the malfunction indicator is illuminated, the system may not be able to detect or signal low tire pressure as intended. TPMS malfunctions may occur for a variety of reasons, including the installation of replacement or alternate tires or wheels on the vehicle that prevent the TPMS from functioning properly. Always check the

TPMS malfunction telltale after replacing one or more tires or wheels on your vehicle to ensure that the replacement or alternate tires and wheels allow the TPMS to continue to function properly.

CAUTION!

The TPMS has been optimized for the original equipment tires and wheels. TPMS pressures and warning have been established for the tire size equipped on your vehicle. Undesirable system operation or sensor damage may result when using replacement equipment that is not of the same size, type, and/or style. Aftermarket wheels can cause sensor damage. Using aftermarket tire sealants may cause the Tire Pressure Monitoring System (TPMS) sensor to become inoperable. After using an aftermarket tire sealant it is recommended that you take your vehicle to an authorized dealer to have your sensor function checked.

Towing Hook Breakdown Warning Light — If Equipped



This light illuminates when there is a failure with the tow hook. Contact an authorized dealer for service.

YELLOW INDICATOR LIGHTS

4WD Low Indicator Light — If Equipped



This light alerts the driver that the vehicle is in the 4WD Low mode. The front and rear driveshafts are mechanically locked together forcing the front and rear wheels to rotate at the same speed. Low range provides a greater gear reduction ratio to provide increased torque at the wheels.

4WD Lock Indicator Light — If Equipped



This light alerts the driver that the vehicle is in the 4WD LOCK mode. The front and rear driveshafts are mechanically locked together, forcing the front and rear wheels to rotate at the same speed.

Active Speed Limiter Fault Indicator Light — If Equipped



This warning light will illuminate to signal when there is a fault detected with the Active Speed Limiter.

Immobilizer Fail / VPS Electrical Alarm Indicator Light



This telltale will illuminate when the Vehicle Security system has detected an attempt to break into the vehicle.

NOTE:

After cycling the ignition to the ON/RUN position, the Vehicle Security Warning Light could illuminate if a problem with the system is detected. This condition will result in the engine being shut off after two seconds.

Diesel Particulate Filter (DPF) Cleaning In Progress Indicator Light — Diesel Versions With DPF Only — If Equipped



This indicator light will illuminate, or a message will appear, to indicate that the DPF system needs to eliminate the trapped pollutants (particulate) through the regeneration process. The light/message does not switch on during every DPF regeneration, but only when driving conditions require that the driver is notified. To turn off the symbol, keep the vehicle in motion until the regeneration process is over. On average, the process lasts 15 minutes.

Optimal conditions for completing the process are achieved by traveling at 37 mph (60 km/h) with engine speed above 2000 rpm.

When this light/message switches on, it does not indicate a vehicle failure and thus it should not be taken to a workshop.

NOTE:

On some versions, together with the symbol switching on, the display shows a dedicated message.

CAUTION!

Vehicle travel speed should always be adapted to the traffic and weather conditions, and must always comply with traffic regulations.

(Continued)

CAUTION! *(Continued)*

The engine can be turned off if the DPF warning light is on; however, repeated interruptions of the regeneration process could cause premature deterioration of the engine oil. For this reason, it is important to wait for the symbol to turn off before turning off the engine. Do not complete the DPF regeneration process when the vehicle is stopped.

Low Diesel Emissions Additive AdBlue® (UREA) Indicator Light – If Equipped



The Low Diesel Exhaust Emissions Additive AdBlue® (UREA) indicator light illuminates when the AdBlue® level is low.

Fill the AdBlue® tank as soon as possible with at least 1.3 gallons (5 liters) of AdBlue®.

If filling the tank is done with a remaining range of AdBlue® in the tank equal to zero, you may need to wait two minutes before starting the vehicle.

Rear Fog Indicator – If Equipped



This indicator light will illuminate when the rear fog lights are on.

Water In Fuel Indicator Light – If Equipped



The “Water In Fuel Indicator Light” will illuminate when there is water detected in the fuel filter. If this light remains on, DO NOT start the vehicle

before you drain the water from the fuel filter to prevent engine damage, and please see an authorized dealer.

CAUTION!

The presence of water in the fuel system circuit may cause severe damage to the injection system and irregular engine operation. If the indicator light is illuminated, contact an authorized dealer as soon as possible to bleed the system. If the above indications come on immediately after refuelling, water has probably been poured into the tank: switch the engine off immediately and contact an authorized dealer.

Wait To Start Light — If Equipped

This indicator light will illuminate for approximately two seconds when the ignition is turned to the RUN position. Its duration may be longer based on colder operating conditions. Vehicle will not initiate start until telltale is no longer displayed.

NOTE:

The “Wait To Start” telltale may not illuminate if the intake manifold temperature is warm enough.

GREEN INDICATOR LIGHTS**Active Speed Limiter SET Indicator Light With A Premium Instrument Cluster — If Equipped**

This indicator light will illuminate when the Active Speed Limiter is on and set to a specific speed.

Active Lane Management Indicator Light — If Equipped

The Active Lane Management indicator light illuminates solid green when both lane markings have been detected and the system is “armed” and ready to provide visual and torque warnings if an unintentional lane departure occurs.

Night Vision Active Indicator Light — If Equipped

This light alerts the driver that the Night Vision alert status is Active.

Park/Headlight On Indicator Light

This indicator light will illuminate when the park lights or headlights are turned on.

Front Fog Indicator Light — If Equipped

This indicator light will illuminate when the front fog lights are on.

Turn Signal Indicator Lights

When the left or right turn signal is activated, the turn signal indicator will flash independently and the corresponding exterior turn signal lamps will flash. Turn signals can be activated when the multifunction lever is moved down (left) or up (right).

NOTE:

- A continuous chime will sound if the vehicle is driven more than 1 mile (1.6 km) with either turn signal on.
- Check for an inoperative outside light bulb if either indicator flashes at a rapid rate.

Cruise Control SET Indicator Light — If Equipped With A Premium Instrument Cluster

This indicator light will illuminate when the Cruise Control is set to the desired speed.

Cruise Control SET Indicator Light With A Premium Instrument Cluster — If Equipped

This indicator light will illuminate when the cruise control is set to the desired speed.

Stop/Start Active Indicator Light — If Equipped

This indicator light will illuminate when the Stop/Start function is in “Autostop” mode.

Automatic High Beam Indicator Light — If Equipped

This indicator shows that the automatic high beam headlights are on.

WHITE INDICATOR LIGHTS**Active Speed Limiter Ready Indicator Light With A Premium Instrument Cluster — If Equipped**

This light will illuminate when the Active Speed Limiter has been turned on, but not set.

Active Speed Limiter SET Indicator Light With A Base Instrument Cluster — If Equipped



This light will turn on when the Active Speed Limiter is on and set to a specific speed.

Hill Descent Control (HDC) Indicator Light — If Equipped



This indicator shows when the HDC feature is turned on. The lamp will be on solid when HDC is armed. HDC can only be armed when the transfer case is in the 4WD Low position and the vehicle speed is less than 30 mph (48 km/h). If these conditions are not met while attempting to use the HDC feature, the HDC indicator light will flash on/off.

Cruise Control Ready Indicator Light With A Premium Instrument Cluster — If Equipped



This light will turn on when the cruise control has been turned on, but not set.

Cruise Control SET Indicator Light With Base Instrument Cluster — If Equipped



This indicator light will illuminate when the cruise control is set.

Speed Warning Indicator Light — If Equipped



When Set Speed Warning is turned on and when the set speed is exceeded, a single chime will sound along with a pop-up message of “Speed Warning Exceeded.” Speed Warning can be turned on and off in the instrument cluster display.

The number “55” is only an example of a speed that can be set.

Speed Alert System Indicator Light — If Equipped

This indicator light alerts the driver when the vehicle speed is greater than the specified limits with an audible warning.

Audible warning frequency:



- Speeds above 49 mph (80 km/h) - 1 cycle / 2 minute (primary level)



- Speeds above 75 mph (120 km/h) - 1 cycle / 2 sec (secondary level)

NOTE:

Speed alert system warning signal cannot be stopped by means other than control of the speed by the driver.

BLUE INDICATOR LIGHTS

High Beam Indicator Light



This indicator light will illuminate to indicate that the high beam headlights are on. With the low beams activated, push the multifunction

lever forward (toward the front of the vehicle) to turn on the high beams. Pull the multifunction lever rearward (toward the rear of the vehicle) to turn off the high beams. If the high beams are off, pull the lever toward you for a temporary high beam on, “flash to pass” scenario.

GRAY INDICATOR LIGHTS

Cruise Control Ready Indicator Light With Base Instrument Cluster — If Equipped



This light will turn on when the cruise control has been turned on, but not set.

Active Speed Limiter Ready Indicator Light With A Base Instrument Cluster — If Equipped



This light will turn on when the Active Speed Limiter is on, but not set.

Night Vision Suppressed Indicator Light — If Equipped



This light alerts the driver that the Night Vision alert status is Suppressed.

STARTING AND OPERATING

ELECTRIC PARK BRAKE (EPB)

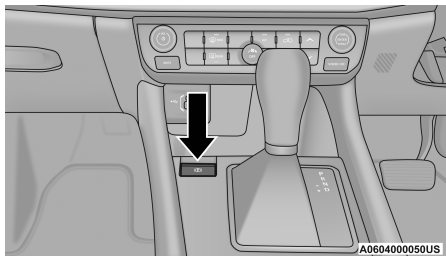

EPB Switch

If the Auto Park Brake feature is enabled, the parking brake will automatically engage whenever the transmission is placed into PARK, or with a manual transmission, when the ignition switch is turned OFF. If your foot is on the brake pedal, you may notice a small amount of brake pedal movement while the parking brake is engaging.

AUTO PARK BRAKE

The EPB can be programmed to be applied automatically whenever the vehicle speed is below 1.9 mph (3 km/h) and the automatic transmission is placed in PARK, or with a manual transmission, whenever the ignition switch is in the OFF position. Auto Park Brake is enabled and disabled by customer selection through the Customer Programmable Features section of the Uconnect Settings.

Any single Auto Park Brake application can be bypassed by pushing the EPB switch to the release position while the transmission is placed in PARK (automatic transmission) and the ignition is in the ON/RUN position.

SAFEHOLD

SafeHold is a safety feature of the EPB system that will engage the parking brake automatically if the vehicle is left unsecured while the ignition switch is in ON/RUN.

For automatic transmissions, the EPB will automatically engage if all of the following conditions are met:

- Vehicle speed is below 1.9 mph (3 km/h).
- There is no attempt to press the brake pedal or accelerator pedal.
- The seat belt is unbuckled.
- The driver door is open.
- The vehicle is not in the PARK position.

For manual transmissions, the EPB will automatically engage if all of the following conditions are met:

- Vehicle speed is below 1.9 mph (3 km/h).
- There is no attempt to press the brake pedal or accelerator pedal.
- The clutch pedal is not pressed.
- The seat belt is unbuckled.
- The driver door is open.

SafeHold can be temporarily bypassed by pushing the EPB Switch while the driver door is open and the brake pedal is pressed. Once manually bypassed, SafeHold will be enabled again once the vehicle reaches 12 mph (20 km/h) or the ignition is turned to the OFF position and back to ON/RUN again.

SEVEN-SPEED DDCT AUTOMATIC TRANSMISSION – IF EQUIPPED

The transmission gear range (PRND) is displayed both beside the gear selector and in the instrument cluster. To select a gear range, push the lock button on the gear selector and move the selector rearward or forward. You must also press the brake pedal to shift the transmission out of PARK (or NEUTRAL, when the vehicle is stopped or moving at low speeds). Select the DRIVE range for normal driving.

The electronically-controlled transmission provides a precise shift schedule. The transmission electronics are self-calibrating; therefore, the first few shifts on a new vehicle may be somewhat abrupt. This is a normal condition, and precision shifts will develop within a few hundred miles/kilometers.

Only shift from DRIVE to PARK or REVERSE when the accelerator pedal is released and the vehicle is stopped. Be sure to keep your foot on the brake pedal when shifting between these gears.

This transmission is programmed to prevent shifting from REVERSE to DRIVE or DRIVE to REVERSE, if vehicle speed is above 6 mph (10 km/h). This safety feature helps protect your transmission from damage.

The transmission gear selector provides PARK, REVERSE, NEUTRAL, DRIVE, and AutoStick (+/-) shift positions. Manual shifts can be made using the AutoStick shift control. Moving the gear selector into the AutoStick (+/-) position (beside the DRIVE position) activates AutoStick mode, providing manual shift control and displaying the current gear in the instrument cluster (as 1, 2, 3, etc.). Toggling the gear selector forward (-) or rearward (+) while in the AutoStick position will manually select the transmission gear.

NOTE:

If the gear selector cannot be moved to the PARK, REVERSE, or NEUTRAL position (when pushed forward) it is probably in the AutoStick (+/-) position (beside the DRIVE position). In AutoStick mode, the transmission gear (1, 2, 3, etc.) is displayed in the instrument cluster. Move the gear selector to the right (into the DRIVE [D] position) for access to PARK, REVERSE, and NEUTRAL.

GEAR RANGES

Do not press the accelerator pedal when shifting from PARK or NEUTRAL into another gear range.

NOTE:

After selecting any gear range, wait a moment to allow the selected gear to engage before accelerating. This is especially important when the engine is cold.

Instrument Cluster Messages

Messages will be displayed in the instrument cluster to alert the driver when certain unusual conditions occur. These messages are described below.

| MESSAGE | DESCRIPTION |
|--|--|
| PRESS BRAKE AND PUSH BUTTON TO SHIFT INTO GEAR | The transmission is locked in NEUTRAL to avoid any accidental movement of the gear selector. This occurs after two seconds with the vehicle stopped and the brake pedal released. To move the gear selector again, press the brake pedal. |
| SHIFT TO PARK TO OBTAIN DRIVABILITY | The gear selector is being moved without the brake pedal pressed while locked in PARK or NEUTRAL. The transmission will ignore the attempt to move the selector and stay in NEUTRAL, and display this message. |
| GEAR NOT AVAILABLE | In AutoStick mode, the gear selected by the driver is not available due to a fault condition. See an authorized dealer for diagnosis and service. |
| SHIFT NOT ALLOWED | The gear position requested by the driver is currently blocked. This occurs if: REVERSE is requested while moving (at 6 mph [10 km/h] or faster), if DRIVE is requested while moving backwards (at 6 mph [10 km/h] or faster), or if (in AutoStick mode) THIRD gear or higher is requested at a stop, or a requested shift would cause engine lugging or overspeed. Make sure the vehicle is stopped before engaging DRIVE or REVERSE. |

| MESSAGE | DESCRIPTION |
|--|---|
| SHIFT TO NEUTRAL – THEN D or R | The transmission has shifted itself into NEUTRAL (due to a fault condition, overheat due to excessive idling when stopped in DRIVE with the brakes released, or attempting to shift between DRIVE and REVERSE while the vehicle speed is too high), but the gear selector remains in gear. Shift into NEUTRAL and then back into gear for continued driving. If the transmission will not reengage, see an authorized dealer. |
| AUTOSTICK NOT AVAILABLE | AutoStick mode is unavailable due to a gear selector fault. See an authorized dealer for diagnosis and service. |
| AUTOMATIC MODE NOT AVAILABLE | The transmission is unable to shift itself automatically, due to a fault condition. Use the AutoStick mode to shift the transmission manually. See an authorized dealer for diagnosis and service. |
| TRANS. HOT – PULL OVER SPEED UP OR REDUCE SHIFTING | The transmission driving clutch is overheating, usually due to repeated launches in stop-and-go traffic. Pull over and allow the transmission to cool in NEUTRAL until “TRANS. COLD – READY TO DRIVE” is displayed. |
| TRANS. HOT STOP SAFELY SHIFT TO P | The transmission driving clutch has overheated. Pull over, shift the transmission into PARK, and allow the vehicle to cool until “TRANS. COLD – READY TO DRIVE” is displayed. |
| TRANS. COLD – READY TO DRIVE | The transmission has recovered from the clutch overheating. |

| MESSAGE | DESCRIPTION |
|---|--|
| SERVICE TRANSMISSION | A transmission fault has been detected. See an authorized dealer for diagnosis and service. |
| SERVICE SHIFTER | A gear selector fault has been detected. See an authorized dealer for diagnosis and service. |
| SERVICE SHIFTER continue in D – Do not Shift or turn engine Off | A gear selector fault has been detected. See an authorized dealer for diagnosis and service. |

Transmission Limp Home Mode

Transmission function is monitored electronically for abnormal conditions. If a condition is detected that could result in transmission damage, Transmission Limp Home Mode is activated. In this mode, some gears will be unavailable. The transmission will operate only in a certain select set of gears (such as FIRST, SECOND, THIRD, and REVERSE, or FIRST, THIRD, FIFTH, and REVERSE, or SECOND, FOURTH, and SIXTH [with no REVERSE]).

PARK and NEUTRAL will continue to be available. The Malfunction Indicator Light (MIL) may be illuminated. Limp Home Mode allows the vehicle to be driven to an authorized dealer for service without damaging the transmission.

In the event of a momentary problem, the transmission can be reset to regain all forward gears by performing the following steps:

1. Stop the vehicle.
2. Shift the transmission into PARK.
3. Turn the ignition to the OFF position.

4. Wait approximately 10 seconds.
5. Restart the engine.
6. Shift into the desired gear range. If the problem is no longer detected, the transmission will return to normal operation.

NOTE:

Even if the transmission can be reset, we recommend that you visit an authorized dealer at your earliest possible convenience. An authorized dealer has diagnostic equipment to determine if the problem could recur.

If the transmission cannot be reset, authorized dealer service is required.

STOP/START SYSTEM — IF EQUIPPED

The Stop/Start function is developed to reduce fuel consumption. The system will stop the engine automatically during a vehicle stop if the required conditions are met. Releasing the brake pedal, clutch pedal or pressing the accelerator pedal will automatically restart the engine.

WARNING!

Before opening the hood, make sure that the engine is off and that the ignition is in the OFF mode. Follow the indications on the plate underneath the hood. We recommend that you remove the key fob if other people remain in the vehicle. The vehicle should only be exited after the key fob has been removed and the ignition is in the OFF mode. During refueling, make sure that the engine is off (ignition device in the OFF mode).

CAUTION!

When replacing the battery, always contact an authorized dealer. Replace the battery with the same type (HEAVY DUTY) and with the same specifications.

OPERATING MODES

Engine Stopping Mode

Models equipped with a manual transmission:

With the vehicle stopped, the engine stops with the transmission in NEUTRAL and clutch pedal released.

Models equipped with an automatic transmission:

With the vehicle at a standstill and brake pedal pressed, the engine switches off if the gear selector is in a position other than REVERSE.

In the event of stops uphill, the engine switching will be disabled to activate the "Hill Start Assist" function (works only with the engine running).

The warning light on the instrument panel switches on to signal that the engine was stopped.

Engine Restarting Mode

Models equipped with manual transmission:

To restart the engine, press the clutch pedal.

If the vehicle does not start pressing the clutch, place the gear selector in NEUTRAL and repeat the procedure. If the problem persists, contact an authorized dealer.

Models equipped with an automatic transmission:

To restart the engine, release the brake pedal.

With the brake pedal pressed, if the gear selector is in DRIVE, the engine can be restarted moving the selector to REVERSE or NEUTRAL or "AutoStick".

With the brake pedal pressed, if the gear selector is in "AutoStick" mode, the engine can be restarted moving the selector to "+" or "-", or REVERSE or NEUTRAL.

POSSIBLE REASONS THE ENGINE DOES NOT AUTOSTOP

Prior to engine shut down, the system will check many safety and comfort conditions to see if they are fulfilled. Detailed information about the operation of the Stop/Start system may be viewed in the instrument cluster display Stop/Start Screen. In the following situations the engine will not stop:

- Driver's seat belt is not buckled.
- Driver's door is not closed.
- Battery temperature is too warm or cold.
- Battery charge is low.
- The vehicle is on a steep grade.
- Cabin heating or cooling is in process and an acceptable cabin temperature has not been achieved.
- HVAC is set to full defrost mode at a high blower speed.
- HVAC is set to MAX A/C.
- Engine has not reached normal operating temperature.
- The transmission is not in a forward gear.
- Hood is open.
- Vehicle is in 4WD Low transfer case mode.
- Brake pedal is not pressed with sufficient pressure.
- Accelerator pedal input.
- Engine temperature too high.
- 5 mph (8 km/h) threshold not achieved from previous Autostop.

- Steering angle beyond threshold.
- Adaptive Cruise Control is on and speed is set.

It may be possible for the vehicle to be driven several times without the Stop/Start system going into a STOP/START READY state under more extreme conditions of the items listed above.

To Start The Engine While In AUTOSTOP MODE

While in a forward gear, the engine will start when the brake pedal is released or the throttle pedal is pressed. The transmission will automatically re-engage upon engine restart.

Conditions That Will Cause The Engine To Start Automatically While In Autostop Mode:

- The transmission selector is moved out of DRIVE (D).
- To maintain cabin temperature comfort.

- HVAC is set to full defrost mode.
- HVAC system temperature or fan speed is manually adjusted.
- Battery voltage drops too low.
- Stop/Start OFF switch is pushed.
- A Stop/Start system error occurs.
- Vehicle is in 4WD Low transfer case mode.

Conditions That Force An Application Of The Electric Park Brake While In Autostop Mode:

- The driver's door is open and brake pedal released.
- The driver's door is open and the driver's seat belt is unbuckled.
- The engine hood has been opened.
- A Stop/Start system error occurs.

MANUAL ACTIVATION / DEACTIVATION

To activate/deactivate the system manually, push the button on the instrument panel.

- LED off: system activated
- LED on: system deactivated

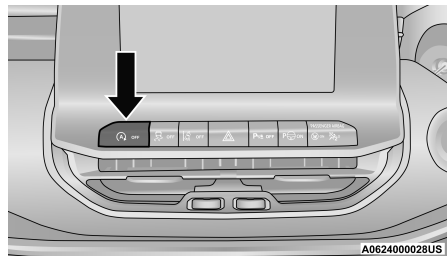

STOP/START OFF Switch

REFUELING THE VEHICLE — GASOLINE ENGINE

The Capless Fuel System uses a flapper placed at the filler pipe of the fuel tank; it opens and closes automatically upon insertion/extraction of the fuel nozzle. In certain countries, the Capless Fuel System is designed so that it prevents the filling of an incorrect type of fuel.

1. Unlock the fuel filler door by pushing the unlock button on the key fob or the unlock button on the driver-side door trim panel.
2. Open the fuel filler door by pushing on the outer edge of the fuel door.
3. There is no fuel filler cap. A flapper door inside the pipe seals the system.
4. Insert the fuel nozzle fully into the filler pipe; the nozzle opens and holds the flapper door while refueling.

5. Fill the vehicle with fuel, and when the fuel nozzle “clicks” or shuts off, the fuel tank is full.
6. Wait 10 seconds before removing the fuel nozzle to allow fuel to drain from nozzle.
7. Remove the fuel nozzle and close the fuel door.

NOTE:

In certain cold conditions, ice may prevent the fuel door from opening. If this occurs, lightly push on the fuel door to break the ice build-up and re-release the fuel door using the inside release button. Do not pry on the door.

WARNING!

- Never have any smoking materials lit in or near the vehicle when the fuel door is open or the tank is being filled.

(Continued)

WARNING! (Continued)

- Never add fuel when the engine is running. This is in violation of most countries regulations and may cause the “Malfunction Indicator Light” to turn on.
- A fire may result if fuel is pumped into a portable container that is inside of a vehicle. You could be burned. Always place fuel containers on the ground while filling.

EMERGENCY FUEL FILLER DOOR RELEASE

If you are unable to open the fuel filler door, use the fuel filler door emergency release.

1. Open the liftgate.
2. Remove package tray (if equipped).

3. Remove access door located on right interior trim panel for release cable with the tip of your key.

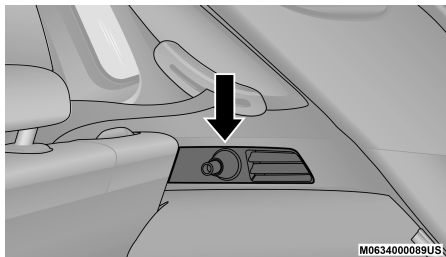

Fuel Door Release Location

4. Grab the release cable tether and gently pull up while simultaneously push the fuel filler door to unlock.

NOTE:
Adding excessive pull force may lead to cable tether breakage.

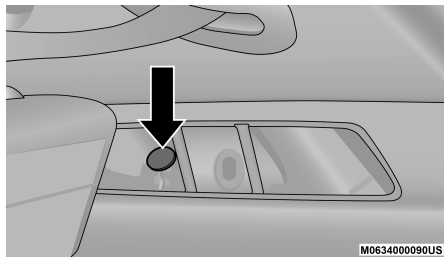

Fuel Door Release

5. Push on the outer edge to open the fuel door.

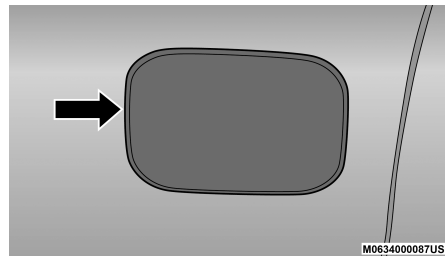

Fuel Filler Door

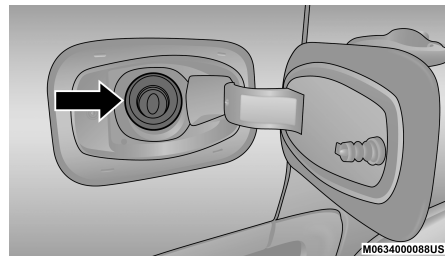

Filler Pipe

ADBLUE® (UREA) — IF EQUIPPED

The vehicle is equipped with an UREA injection system and Selective Catalytic Reduction to meet emission standards. These two systems ensure compliance with the diesel emissions requirements; at the same time, they ensure fuel-efficiency, handling, torque and power. For messages and system warnings ⇨ page 41. AdBlue® (UREA) is a very stable product with a long shelf life. Stored at temperatures LOWER than 90 °F (32 °C), it has a shelf life of at least one year. For more information on the AdBlue® liquid type ⇨ page 177. The vehicle is equipped with an automatic AdBlue® heating system when the engine starts allowing the system to work correctly at temperatures lower than 12 °F (-11 °C).

NOTE:

AdBlue® freezes at temperatures lower than 12 °F (-11 °C).

ADBLUE® (UREA) STORAGE

AdBlue® (UREA) is considered a very stable product with a long shelf life. If AdBlue® (UREA) is kept in temperatures between 10 ° and 90 °F (-12 ° and 32 °C), it will last a minimum of one year.

AdBlue® (UREA) is subject to freezing at the lowest temperatures. For example, AdBlue® (UREA) may freeze at temperatures at or below 12 °F (-11 °C). The system has been designed to operate in this environment.

NOTE:

When working with AdBlue® (UREA), it is important to know that:

- Any containers or parts that come into contact with AdBlue® (UREA) must be AdBlue® (UREA) compatible (plastic or stainless steel). Copper, brass, aluminum, iron or non-stainless steel should be avoided as they are subject to corrosion by AdBlue® (UREA).

- If AdBlue® (UREA) is spilled, it should be wiped up completely.

ADDING ADBLUE® (UREA)

Preliminary Conditions

AdBlue® (UREA) freezes at temperatures lower than 12 °F (-11 °C). If the car stands for a long time at this temperature refilling could be difficult. For this reason, it is advised to park the vehicle in a garage and/or heated environment and wait for the UREA to return to liquid state before topping up.

Proceed as follows:

- Park the car on flat ground and stop the engine by placing the ignition in the OFF position.
- Open the fuel door, undo and remove the cap (blue) from the AdBlue® (UREA) filler.

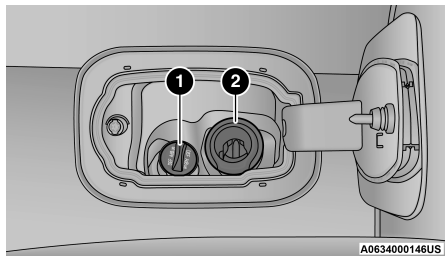

Fuel Filler

- 1 – AdBlue® (UREA) Filler Cap
2 – Fuel Filler

Refilling With Nozzles

You can fill up at any AdBlue® (UREA) distributor.

CAUTION!

Never fill AdBlue® (UREA) or diesel fuel into the wrong filling ports. This may result in serious damage to the engine, fuel system, and emission system components. If wrongly filled do not start the engine, contact an authorized dealer.

Proceed as follows:

- Insert the AdBlue® (UREA) nozzle in the filler, start refilling and stop refilling at the first shut-off (the shut-off indicates that the AdBlue® (UREA) tank is full). Do not proceed with the refilling, to prevent spillage of AdBlue® (UREA).
- Extract the nozzle.

Refilling With Containers

Proceed as follows:

- Check the expiration date.
- Read the advice for use on the label before pouring the content of the bottle into the AdBlue® (UREA) tank.
- If systems which cannot be screwed in (e.g. tanks) are used for refilling, after the indication appears on the instrument panel display  page 41, fill the AdBlue® (UREA) tank with no more than 2 Gallons (8 liters).
- If containers which can be screwed to the filler are used, the reservoir is full when the AdBlue® (UREA) level in the container stops pouring out. Do not proceed further.



Operations After Refilling

Proceed as follows:

- Fit the cap back on the AdBlue® (UREA) filler by turning it clockwise and screwing it completely.
- Place the ignition to RUN (it is not necessary to start the engine).
- Wait for the indication on the instrument panel to switch off before moving the car. The indication may stay on for a few seconds to approximately half a minute. If the engine is started and the car is moved, the indication will remain on for longer. This will not compromise engine operation.
- If the AdBlue® (UREA) was topped up when the tank was empty, wait for two minutes before starting the engine.

NOTE:

- If AdBlue® (UREA) is spilled out of the filler neck, clean up well the area and proceed to filling up again. If the liquid crystallizes, eliminate it with a sponge and warm water.
- **DO NOT EXCEED THE MAXIMUM LEVEL:** this could cause damage to the reservoir. AdBlue® (UREA) freezes at under 12 °F (-11 °C). Although the system is designed to operate below the freezing point of the UREA, it is advisable not to fill the tank beyond the maximum level because if the UREA freezes the system can be damaged. Follow the instructions in this section.
- If the AdBlue® (UREA) is spilled on painted surfaces or aluminum, immediately clean the area with water and use absorbent material to collect the fluid that has been spilled on the ground.

- Do not try to start the engine if AdBlue® (UREA) was accidentally added to the diesel fuel tank, this can result in serious engine damage; contact an authorized dealer.
- Do not add additives or other fluids to AdBlue® (UREA), doing so could damage the system.
- The use of non-conforming or degraded AdBlue® (UREA) may lead to indications appearing on the instrument panel display  page 41.
- Never pour AdBlue® (UREA) into another container: it could be contaminated.
- If the AdBlue® (UREA) runs out, see  page 41 to continue using the vehicle normally.

DRIVING TIPS

ON-ROAD DRIVING TIPS

Utility vehicles have higher ground clearance and a narrower track to make them capable of performing in a wide variety of off-road applications. Specific design characteristics give them a higher center of gravity than conventional passenger cars.

An advantage of the higher ground clearance is a better view of the road, allowing you to anticipate problems. They are not designed for cornering at the same speeds as conventional passenger cars any more than low-slung sports cars are designed to perform satisfactorily in off-road conditions. Avoid sharp turns or abrupt maneuvers. As with other vehicles of this type, failure to operate this vehicle correctly may result in loss of control or vehicle rollover.

OFF-ROAD DRIVING TIPS

When To Use 4WD LOW

When off-road driving, shift to 4WD LOW for additional traction and control on slippery or difficult terrain, ascending or descending steep hills, and to increase low-speed pulling power. This range should be limited to extreme situations such as deep snow, mud, or sand where additional low speed pulling power is needed. Vehicle speeds in excess of 25 mph (40 km/h) should be avoided when in 4WD LOW.

Driving Through Water

Although your vehicle is capable of driving through water, there are a number of precautions that must be considered before entering the water:

CAUTION!

When driving through water, do not exceed 5 mph (8 km/h). Always check water depth before entering as a precaution, and check all fluids afterward. Driving through water may cause damage that may not be covered by the New Vehicle Limited Warranty.

Driving through water more than a few inches/centimeters deep will require extra caution to ensure safety and prevent damage to your vehicle. If you must drive through water, try to determine the depth and the bottom condition (and location of any obstacles) prior to entering. Proceed with caution and maintain a steady controlled speed less than 5 mph (8 km/h) in deep water to minimize wave effects.

Flowing Water

If the water is swift flowing and rising (as in storm run-off) avoid crossing until the water level recedes and/or the flow rate is reduced. If you must cross flowing-water, avoid depths in excess of 9 inches (22 cm). The flowing water can erode the streambed causing your vehicle to sink into deeper water. Determine exit point(s) that are downstream of your entry point to allow for drifting.

Standing Water

Avoid driving in standing water deeper than 16 inches (40.5 cm), and reduce speed appropriately to minimize wave effects. Maximum speed in 16 inches (40.5 cm) of water is less than 5 mph (8 km/h).

(Trailhawk only): Avoid driving in standing water deeper than 19 inches (48 cm), and reduce speed appropriately to minimize wave effects. Maximum speed in 19 inches (48 cm) of water is less than 5 mph (8 km/h).

CAUTION!

Do not drive the vehicle in water logged, standing and flowing water in areas when there is a traffic movement. The relative movement of other vehicles in water logged areas will displace huge amounts of water and create abnormally high waves. Driving through water may cause damage to your vehicle, use extra caution to ensure safety and prevent damage to your vehicle.

Maintenance

After driving through deep water, inspect your vehicle fluids and lubricants (engine, transmission, Power Transfer Unit, and Rear Drive Module) to ensure they have not been contaminated. Contaminated fluids and lubricants (milky, foamy in appearance) should be flushed/changed as soon as possible to prevent component damage.

Driving In Snow, Mud And Sand

In heavy snow, when pulling a load, or for additional control at slower speeds, shift the transmission to a low gear and shift the 4WD system to the appropriate terrain mode, using 4WD LOW if necessary. Do not shift to a lower gear than necessary to maintain headway. Over-revving the engine can spin the wheels and traction will be lost.

Avoid abrupt downshifts on icy or slippery roads because engine braking may cause skidding and loss of control.

Hill Climbing

NOTE:

Before attempting to climb a hill, determine the conditions at the crest and/or on the other side.

Before climbing a steep hill, shift the transmission to a lower gear and shift the 4WD System to 4WD LOW. Use FIRST gear and 4WD LOW for very steep hills.

NOTE:

Brakes should be applied at increased slippage, but before coming to a stop to avoid digging into the loose surface and rendering the operator of the vehicle stuck/immobile.

If you stall or begin to lose headway while climbing a steep hill, allow your vehicle to come to a stop and immediately apply the brakes. Once stopped, shift to REVERSE. Back slowly down the hill allowing the compression braking of the engine to help regulate your speed. If the brakes are required to control vehicle speed, apply them lightly and avoid locking or skidding the tires.

WARNING!

If the engine stalls or you lose headway or cannot make it to the top of a steep hill or grade, never attempt to turn around. To do so may result in tipping and rolling the vehicle. Always back straight down a hill in REVERSE gear carefully. Never back down a hill in NEUTRAL using only the brake.

NOTE:

Remember, never drive diagonally across a hill - drive straight up or down.

If the wheels start to slip as you approach the crest of a hill, ease off the accelerator and maintain headway by turning the front wheels slowly left and right. This may provide a fresh “bite” into the surface and may provide traction to complete the climb.

Traction Downhill

Shift the transmission into a low gear and the four-wheel drive system to 4WD Low range or select Hill Descent Control (if equipped). Let the vehicle go slowly down the hill with all four wheels turning against engine compression drag. This will permit you to control the vehicle speed and direction.

When descending mountains or hills, repeated braking can cause brake fade with loss of braking control. Avoid repeated heavy braking by downshifting the transmission whenever possible.

After Driving Off-Road

Off-road operation puts more stress on your vehicle than does most on-road driving. After going off-road, it is always a good idea to check for damage.

- Completely inspect the underbody of your vehicle. Check tires, body structure, steering, suspension, and exhaust system for damage.
- Inspect the radiator for mud and debris and clean as required.

- Check threaded fasteners for looseness, particularly on the chassis, drivetrain components, steering, and suspension. Retighten them, if required, and torque to the values specified in the Service Manual.
- Check for accumulations of plants or brush. These things could be a fire hazard. They might hide damage to fuel lines, brake hoses, axle pinion seals, and propeller shafts.
- After extended operation in mud, sand, water, or similar dirty conditions, have the radiator, fan, brake rotors, wheels, brake linings, and axle yokes inspected and cleaned as soon as possible.

WARNING!

Abrasive material in any part of the braking system may cause excessive wear or unpredictable braking performance. Full braking power may not be available to prevent a collision. If you have been operating your vehicle in dirty conditions, inspect and clean the braking components as soon as possible.

- Impacted material can cause wheel imbalance. Freeing the wheels of impacted material will likely rectify imbalance condition.

MULTIMEDIA

RADIO OPERATION AND MOBILE PHONES

Under certain conditions, the mobile phone being on in your vehicle can cause erratic or noisy performance from your radio. This condition may be lessened or eliminated by repositioning the mobile phone within the vehicle. This condition is not harmful to the radio. If your radio performance does not satisfactorily improve from repositioning the mobile phone, it is recommended that the volume be turned down or off during mobile phone operation when not using the Uconnect system.

SAFETY

OCCUPANT RESTRAINT SYSTEMS

Some of the most important safety features in your vehicle are the restraint systems:

OCCUPANT RESTRAINT SYSTEMS FEATURES

- Seat Belt Systems
- Supplemental Restraint Systems (SRS) Air Bags
- Child Restraints

Some of the safety features described in this section may be standard equipment on some models, or may be optional equipment on others. If you are not sure, ask an authorized dealer.

IMPORTANT SAFETY PRECAUTIONS

Please pay close attention to the information in this section. It tells you how to use your restraint system properly, to keep you and your passengers as safe as possible.

Here are some simple steps you can take to minimize the risk of harm from a deploying air bag:

1. Children 12 years old and under should always ride buckled up in the rear seat of a vehicle with a rear seat.



Warning Label On Front Passenger Sun Visor

2. A child who is not big enough to wear the vehicle seat belt properly must be secured in the appropriate child restraint or belt-positioning booster seat in a rear seating position .

For information on Child Restraints, please refer to the full copy of the Owner's Manual at Jeep-India.com or get in touch with the authorized service center.

3. If a child from 2 to 12 years old (not in a rear-facing child restraint) must ride in the front passenger seat, move the seat as far back as possible and use the proper child restraint .

For information on Child Restraints, please refer to the full copy of the Owner's Manual at Jeep-India.com or get in touch with the authorized service center.

4. Never allow children to slide the shoulder belt behind them or under their arm.
5. You should read the instructions provided with your child restraint to make sure that you are using it properly.
6. All occupants should always wear their lap and shoulder belts properly.
7. The driver and front passenger seats should be moved back as far as practical to allow the front air bags room to inflate.
8. Do not lean against the door or window. If your vehicle has side air bags, and deployment occurs, the side air bags will inflate forcefully into the space between occupants and the door and occupants could be injured.

9. If the air bag system in this vehicle needs to be modified to accommodate a disabled person, see ⇨ page 181 for customer service contact information.

WARNING!

- NEVER use a rearward facing child restraint on a seat protected by an ACTIVE AIRBAG in front of it, DEATH or SERIOUS INJURY to the CHILD can occur.
- It is advisable to always carry children in a child restraint system on the rear seat, which is the most protected position in the event of a collision.

(Continued)

WARNING! *(Continued)*

- Should it be necessary to carry a child on the passenger side front seat in a rear-facing child restraint system, the passenger side front air bag must be deactivated. Always make sure the airbag deactivation indicator light is illuminated when using a child restraint system. The passenger seat must also be positioned backward as far as possible to avoid the child restraint system from coming into contact with the dashboard.
- A deploying passenger front air bag can cause death or serious injury to a child 12 years or younger, including a child in a rear-facing child restraint.

SEAT BELT SYSTEMS

Buckle up even though you are an excellent driver, even on short trips. Someone on the road may be a poor driver and could cause a collision that includes you. This can happen far away from home or on your own street.

Research has shown that seat belts save lives, and they can reduce the seriousness of injuries in a collision. Some of the worst injuries happen when people are thrown from the vehicle. Seat belts reduce the possibility of ejection and the risk of injury caused by striking the inside of the vehicle. Everyone in a motor vehicle should be belted at all times.

SAFETY TIPS**TRANSPORTING PASSENGERS**

NEVER TRANSPORT PASSENGERS IN THE CARGO AREA.

WARNING!

- Do not leave children or animals inside parked vehicles in hot weather. Interior heat build-up may cause serious injury or death.
- It is extremely dangerous to ride in a cargo area, inside or outside of a vehicle. In a collision, people riding in these areas are more likely to be seriously injured or killed.
- Do not allow people to ride in any area of your vehicle that is not equipped with seats and seat belts.
- Be sure everyone in your vehicle is in a seat and using a seat belt properly.

TRANSPORTING PETS

Air Bags deploying in the front seat could harm your pet. An unrestrained pet will be thrown about and possibly injured, or injure a passenger during panic braking or in a collision.

Pets should be restrained in the rear seat (if equipped) in pet harnesses or pet carriers that are secured by seat belts.

SAFETY CHECKS YOU SHOULD MAKE INSIDE THE VEHICLE

Seat Belts

Inspect the seat belt system periodically, checking for cuts, frays, and loose parts. Damaged parts must be replaced immediately. Do not disassemble or modify the system.

Front seat belt assemblies must be replaced after a collision. Rear seat belt assemblies must be replaced after a collision if they have been damaged (i.e., bent retractor, torn webbing, etc.). If there is any question regarding seat belt or retractor condition, replace the seat belt.

Air Bag Warning Light

The Air Bag Warning Light  will turn on for four to eight seconds as a bulb check when the ignition switch is first placed in the ON/RUN position. If the light is either not on during starting, stays on, or turns on while driving, have the system inspected at an authorized dealer as soon as possible. After the bulb check, this light will illuminate with a single chime when a fault with the Air Bag System has been detected. It will stay on until the fault is removed. If the light comes on intermittently or remains on while driving, have an authorized dealer service the vehicle immediately → page 75.

Defroster



Check operation by selecting the defrost mode and place the blower control on high speed. You should be able to feel the air directed against the windshield. See an authorized dealer for service if your defroster is inoperable.

Floor Mat Safety Information

Always use floor mats designed to fit your vehicle. Only use a floor mat that does not interfere with the operation of the accelerator, brake or clutch pedals. Only use a floor mat that is securely attached using the floor mat fasteners so it cannot slip out of position and interfere with the accelerator, brake or clutch pedals or impair safe operation of your vehicle in other ways.

WARNING!

An improperly attached, damaged, folded, or stacked floor mat, or damaged floor mat fasteners may cause your floor mat to interfere with the accelerator, brake, or clutch pedals and cause a loss of vehicle control. To prevent **SERIOUS INJURY** or **DEATH**:

- ALWAYS securely attach  your floor mat using the floor mat fasteners. **DO NOT** install your floor mat upside down or turn your floor mat over. Lightly pull to confirm mat is secured using the floor mat fasteners on a regular basis.
- ALWAYS REMOVE THE EXISTING FLOOR MAT FROM THE VEHICLE  before installing any other floor mat. **NEVER** install or stack an additional floor mat on top of an existing floor mat.

(Continued)

WARNING! *(Continued)*

- **ONLY** install floor mats designed to fit your vehicle. **NEVER** install a floor mat that cannot be properly attached and secured to your vehicle. If a floor mat needs to be replaced, only use a FCA approved floor mat for the specific make, model, and year of your vehicle.
- **ONLY** use the driver's side floor mat on the driver's side floor area. To check for interference, with the vehicle properly parked with the engine off, fully depress the accelerator, the brake, and the clutch pedal (if present) to check for interference. If your floor mat interferes with the operation of any pedal, or is not secure to the floor, remove the floor mat from the vehicle and place the floor mat in your trunk.
- **ONLY** use the passenger's side floor mat on the passenger's side floor area.

(Continued)

WARNING! *(Continued)*

- **ALWAYS** make sure objects cannot fall or slide into the driver's side floor area when the vehicle is moving. Objects can become trapped under accelerator, brake, or clutch pedals and could cause a loss of vehicle control.
- **NEVER** place any objects under the floor mat (e.g., towels, keys, etc.). These objects could change the position of the floor mat and may cause interference with the accelerator, brake, or clutch pedals.
- If the vehicle carpet has been removed and re-installed, always properly attach carpet to the floor and check the floor mat fasteners are secure to the vehicle carpet. Fully depress each pedal to check for interference with the accelerator, brake, or clutch pedals then re-install the floor mats.

(Continued)

WARNING! *(Continued)*

- It is recommended to only use mild soap and water to clean your floor mats. After cleaning, always check your floor mat has been properly installed and is secured to your vehicle using the floor mat fasteners by lightly pulling mat.

PERIODIC SAFETY CHECKS YOU SHOULD MAKE OUTSIDE THE VEHICLE**Tires**

Examine tires for excessive tread wear and uneven wear patterns. Check for stones, nails, glass, or other objects lodged in the tread or sidewall. Inspect the tread for cuts and cracks. Inspect sidewalls for cuts, cracks, and bulges. Check the lug nuts/bolt torque for tightness. Check the tires (including spare) for proper cold inflation pressure.

Lights

Have someone observe the operation of brake lights and exterior lights while you work the controls. Check turn signal and high beam indicator lights on the instrument panel.

Door Latches

Check for proper closing, latching, and locking.

Fluid Leaks

Check area under the vehicle after overnight parking for fuel, coolant, oil, or other fluid leaks. Also, if gasoline fumes are detected or if fuel or brake fluid leaks are suspected, the cause should be located and corrected immediately.

EXHAUST GAS**WARNING!**

Exhaust gases can injure or kill. They contain carbon monoxide (CO), which is colorless and odorless. Breathing it can make you unconscious and can eventually poison you. To avoid breathing (CO), follow these safety tips:

- Do not run the engine in a closed garage or in confined areas any longer than needed to move your vehicle in or out of the area.
- If you are required to drive with the trunk/liftgate/rear doors open, make sure that all windows are closed and the climate control BLOWER switch is set at high speed. **DO NOT** use the recirculation mode.

(Continued)

WARNING! *(Continued)*

- If it is necessary to sit in a parked vehicle with the engine running, adjust your heating or cooling controls to force outside air into the vehicle. Set the blower at high speed.

The best protection against carbon monoxide entry into the vehicle body is a properly maintained engine exhaust system.

Whenever a change is noticed in the sound of the exhaust system, when exhaust fumes can be detected inside the vehicle, or when the underside or rear of the vehicle is damaged, have an authorized dealer inspect the complete exhaust system and adjacent body areas for broken, damaged, deteriorated, or mispositioned parts.

Open seams or loose connections could permit exhaust fumes to seep into the passenger compartment. In addition, inspect the exhaust system each time the vehicle is raised for lubrication or oil change. Replace as required.

CARBON MONOXIDE WARNINGS**WARNING!**

Carbon monoxide (CO) in exhaust gases is deadly. Follow the precautions below to prevent carbon monoxide poisoning:

- Do not inhale exhaust gases. They contain carbon monoxide, a colorless and odorless gas, which can kill. Never run the engine in a closed area, such as a garage, and never sit in a parked vehicle with the engine running for an extended period. If the vehicle is stopped in an open area with the engine running for more than a short period, adjust the ventilation system to force fresh, outside air into the vehicle.

(Continued)

WARNING! *(Continued)*

- Guard against carbon monoxide with proper maintenance. Have the exhaust system inspected every time the vehicle is raised. Have any abnormal conditions repaired promptly. Until repaired, drive with all side windows fully open.

IN CASE OF EMERGENCY

HAZARD WARNING FLASHERS

The Hazard Warning Flashers switch is located in the lower center area of the instrument panel.

NOTE:

Your vehicle may be equipped with an Emergency Stop Signal (ESS). For a full copy of the owner's manual please visit Jeep-India.com or get in touch with the authorized service center.

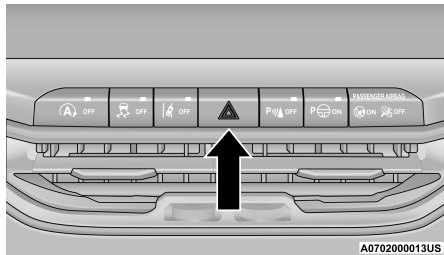

Hazard Warning Flashers Switch

Push the switch to turn on the Hazard Warning Flashers. When the switch is activated, all directional turn signals will flash on and off to warn oncoming traffic of an emergency. Push the switch a second time to turn off the Hazard Warning Flashers.

This is an emergency warning system and it should not be used when the vehicle is in motion. Use it when your vehicle is disabled and it is creating a safety hazard for other motorists.

When you must leave the vehicle to seek assistance, the Hazard Warning Flashers will continue to operate even though the ignition is placed in the OFF position.

NOTE:

With extended use, the Hazard Warning Flashers may discharge vehicle battery.

JACKING AND TIRE CHANGING — IF EQUIPPED

WARNING!

- Do not attempt to change a tire on the side of the vehicle close to moving traffic. Pull far enough off the road to avoid the danger of being hit when operating the jack or changing the wheel.
- Being under a jacked-up vehicle is dangerous. The vehicle could slip off the jack and fall on you. You could be crushed. Never put any part of your body under a vehicle that is on a jack. If you need to get under a raised vehicle, take it to a service center where it can be raised on a lift.
- Never start or run the engine while the vehicle is on a jack.

(Continued)

WARNING! *(Continued)*

- The jack is designed to be used as a tool for changing tires only. The jack should not be used to lift the vehicle for service purposes. The vehicle should be jacked on a firm level surface only. Avoid ice or slippery areas.

PREPARATIONS FOR JACKING

1. Park the vehicle on a firm level surface as far from the edge of the roadway as possible. Use warning triangle (if provided) to alert oncoming traffic when replacing tire in drive way lay by. Avoid icy or slippery areas.

WARNING!

Do not attempt to change a tire on the side of the vehicle close to moving traffic. Pull far enough off the road to avoid being hit when operating the jack or changing the wheel.

2. Turn on the Hazard Warning Flashers.
3. Apply the parking brake.
4. Place the gear selector into PARK (P) (automatic transmission) or REVERSE (R) (manual transmission).
5. Place the ignition in the OFF position.

- Block both the front and rear of the wheel diagonally opposite the jacking position. For example, if the right front wheel is being changed, block the left rear wheel.

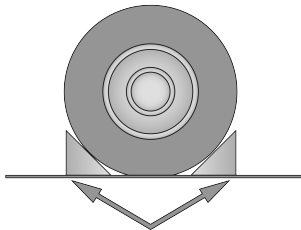

Wheel Blocked

A0707000523US

NOTE:

Passengers should not remain in the vehicle when the vehicle is being raised or lifted.

JACK LOCATION/SPARE TIRE STOWAGE

If equipped, the jack and tool kit bag are located in the rear storage compartment. The jack is located below the spare tire, and the tool kit bag is located between the spare tire and rear seat.

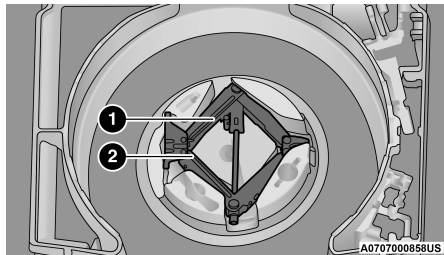

Jack Location

- 1 — Alignment Pin
- 2 — Jack

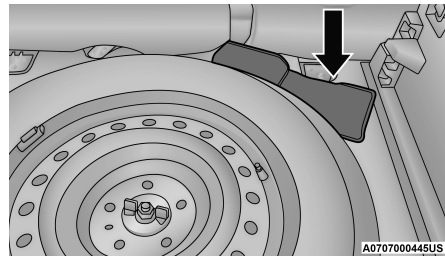

Tool Kit Bag Location —If Equipped

A0707000445US

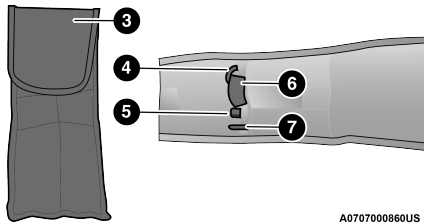

A0707000860US

Tool Kit Bag – If Equipped

- 3 – Tool Kit Bag
- 4 – Tow Hook
- 5 – Wheel Bolt Wrench
- 6 – Emergency Funnel
- 7 – Screwdriver

1. Open the liftgate.
2. Lift the access cover using the load floor handle.

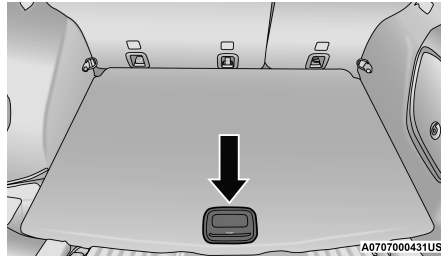

A0707000431US

Load Floor Handle

3. Remove the alignment pin from the middle, rotate the jack counterclockwise, and lift it from the foam tray.
4. Remove the jack and wheel bolt wrench.

WARNING!

A loose tire or jack thrown forward in a collision or hard stop could endanger the occupants of the vehicle. Always stow the jack parts and the spare tire in the places provided. Have the deflated (flat) tire repaired or replaced immediately.

JACKING INSTRUCTIONS

WARNING!

Carefully follow these tire changing warnings to help prevent personal injury or damage to your vehicle:

- Always park on a firm, level surface as far from the edge of the roadway as possible before raising the vehicle.
- Turn on the Hazard Warning Flashers.

(Continued)

WARNING! *(Continued)*

- Block the wheel diagonally opposite the wheel to be raised.
- Apply the parking brake firmly and set the transmission in PARK.
- Never start or run the engine with the vehicle on a jack.
- Do not let anyone sit in the vehicle when it is on a jack.
- Do not get under the vehicle when it is on a jack. If you need to get under a raised vehicle, take it to a service center where it can be raised on a lift.
- Only use the jack in the positions indicated and for lifting this vehicle during a tire change.
- If working on or near a roadway, be extremely careful of motor traffic.

*(Continued)***WARNING!** *(Continued)*

- To assure that spare tires, flat or inflated, are securely stowed, spares must be stowed with the valve stem facing the ground.

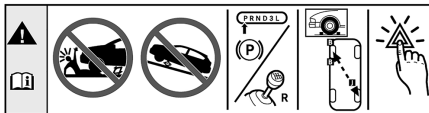
**Jack Warning Label**

060600714

CAUTION!

Do not attempt to raise the vehicle by jacking on locations other than those indicated in the Jacking Instructions for this vehicle.

1. Remove the spare tire, jack, and wheel bolt wrench.
2. If equipped with aluminum wheels where the center cap covers the wheel bolts, use the wheel bolt wrench to pry the center cap off carefully before raising the vehicle.
3. Before raising the vehicle, use the wheel bolt wrench to loosen, but not remove, the wheel bolts on the wheel with the flat tire. Turn the wheel bolts counterclockwise one turn while the wheel is still on the ground.

4. Place the jack underneath the lift area that is closest to the flat tire. Turn the jack screw clockwise to firmly engage the jack saddle with the lift area of the sill flange, centering the jack saddle inside the cutout in the sill cladding.

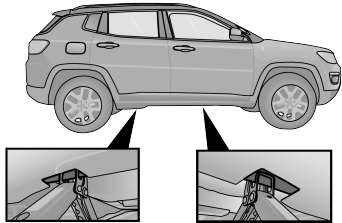

Jacking Locations

A0707000434US

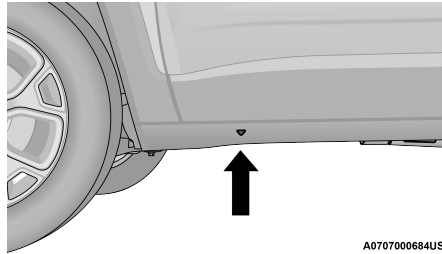

Front Lifting Point

A0707000684US

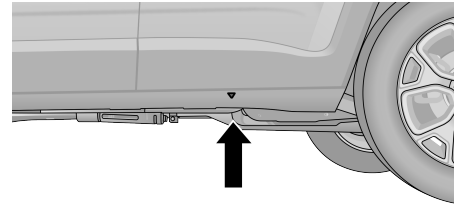

Rear Lifting Point

A0707000685US

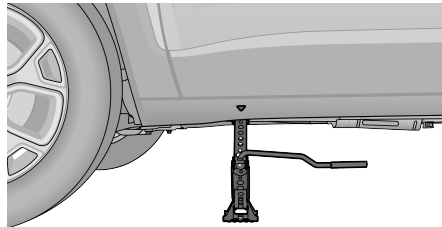

Front Jacking Location

A0707000686US

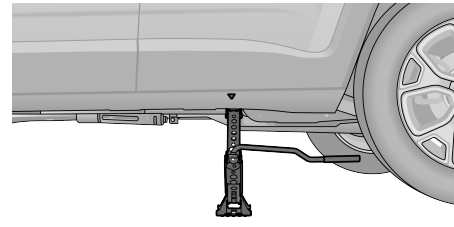

Rear Jacking Location

A0707000687US

5. Raise the vehicle just enough to remove the flat tire.

WARNING!

Raising the vehicle higher than necessary can make the vehicle less stable. It could slip off the jack and hurt someone near it. Raise the vehicle only enough to remove the tire.

6. Remove the wheel bolts and tire.
7. Remove the alignment pin from the jack assembly and thread the pin into the wheel hub to assist in mounting the spare tire.
8. Mount the spare tire.

CAUTION!

Be sure to mount the spare tire with the valve stem facing outward. The vehicle could be damaged if the spare tire is mounted incorrectly.

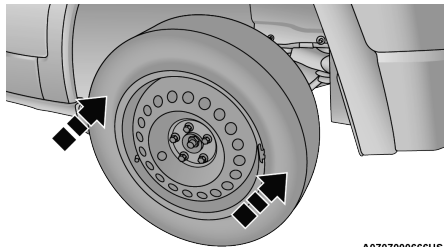

Mounting Spare Tire

NOTE:

For vehicles equipped, do not attempt to install a center cap or wheel cover on the compact spare.

9. Install and lightly tighten the wheel bolts.

WARNING!

To avoid the risk of forcing the vehicle off the jack, do not tighten the wheel nuts fully until the vehicle has been lowered. Failure to follow this warning may result in serious injury.

10. Lower the vehicle to the ground by turning the jack handle counterclockwise.
11. Finish tightening the wheel bolts. Push down on the wrench while at the end of the handle for increased leverage. Tighten the wheel bolts in a star pattern until each wheel bolt has been tightened twice  page 171. If in doubt about the correct tightness, have them checked with a torque wrench by an authorized dealer or at a service station.

12. Lower the jack until it is free. Remove the wheel blocks. Reassemble the lug wrench to the jack assembly and stow it in the spare tire area. Secure the assembly using the means provided. Release the parking brake before driving the vehicle.
13. After 25 miles (40 km), check the wheel bolt torque with a torque wrench to ensure that all wheel bolts are properly seated against the wheel.
14. Place the jack on the foam tray and open it far enough so that it is secured. Once placed in position, rotate it clockwise to lock it in. Replace the alignment pin in the center hole to lock the jack in place.

WARNING!

A loose tire or jack thrown forward in a collision or hard stop could endanger the occupants of the vehicle. Always stow the jack parts and the spare tire in the places provided. Have the deflated (flat) tire repaired or replaced immediately.

JACK USAGE PRECAUTIONS

To complete the Use and Maintenance Handbook to which this supplement is attached, given below are some instructions on the proper use of the jack.

CAUTION!

The jack is a tool designed exclusively for changing a wheel, in case of a puncture or damage to a tire of the vehicle on which it is fitted or on vehicles of the same model. Any other use, e.g. to jack up other vehicle models or different things, is strictly prohibited. Never use it to carry out maintenance or repairs under the vehicle or to change summer/winter wheels and vice versa. Never go under the raised vehicle. If any work under the vehicle is necessary, contact an authorized dealer. Incorrect placing of the jack can cause the vehicle to drop: use it only in the positions indicated. Do not use the jack for loads higher than that specified on the label. Never start the engine with vehicle raised. If the vehicle is raised more than necessary, everything can become more unstable, with the risk of the vehicle dropping violently. Therefore raise the vehicle only as much as necessary for the wheel/spare.

Maintenance

- Make sure grime does not build up on the “worm screw.”
- Keep the “worm screw” lubricated.
- Never modify the jack.

Conditions Of Non-Use:

- Temperatures below -40°C .
- On sandy or muddy ground.
- On uneven ground.
- On steep roads.
- In extreme weather conditions: thunderstorms, typhoons, hurricanes, blizzards, storms, etc.

NOTE:

- The jack requires no adjustment.
- The jack cannot be repaired, and in the event of a fault, it must be replaced by another genuine one.
- No tool other than its cranking device may be fitted on the jack.

TIRE SERVICE KIT — IF EQUIPPED

Your vehicle may be equipped with a Tire Service Kit. Small punctures up to 1/4 inch (6 mm) in the tire tread can be sealed with Tire Service Kit. Foreign objects (e.g., screws or nails) should not be removed from the tire. Tire Service Kit can be used in outside temperatures down to approximately -4°F (-20°C). This kit will provide a temporary tire seal, allowing you to drive your vehicle up to 100 miles (160 km) with a maximum speed of 50 mph (80 km/h).

Tire Service Kit Storage

The Tire Service Kit is stowed under the load floor behind the rear seat.

1. Open the liftgate.
2. Lift the access cover using the load floor handle.

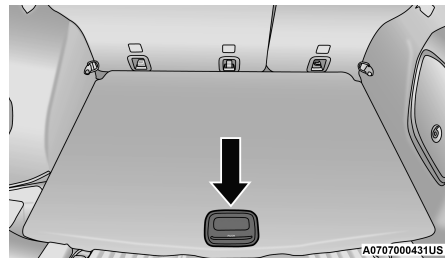

Load Floor Handle

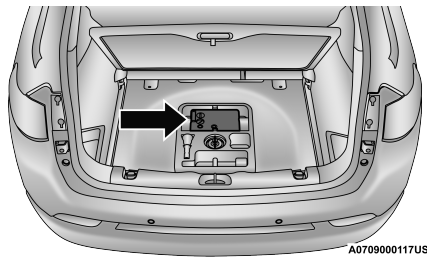

A0709000117US

Tire Service Kit Location

Tire Service Kit And Components And Operation

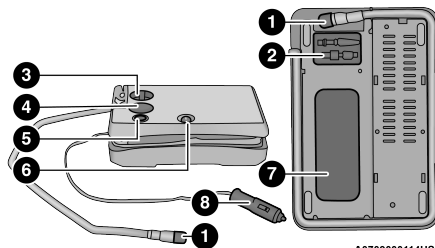

A0709000114US

Tire Service Kit Components

- 1 – Sealant/Air Hose
- 2 – Hose Accessories
- 3 – Mode Select Knob
- 4 – Pressure Gauge
- 5 – Deflation Button
- 6 – Power Switch
- 7 – Sealant Bottle
- 8 – Power Plug

Using The Mode Select Knob And Hoses

Your Tire Service Kit is equipped with the following symbols to indicate the air or sealant mode.

- *Selecting Air Mode*



Push in the Mode Select Knob and turn to this position for air pump operation only.

- *Selecting Sealant Mode*



Push in the Mode Select Knob and turn to this position to inject the Tire Service Kit Sealant and to inflate the tire.

- *Using The Power Button*



Push and release the Power Button once to turn the Tire Service Kit on. Push and release the Power Button again to turn the Tire Service Kit off.

- *Using The Deflation Button*



Push the Deflation Button to reduce the air pressure in the tire if it becomes overinflated.

Tire Service Kit Usage Precautions

- Replace the Tire Service Kit Sealant Bottle prior to the expiration date (printed at the lower right hand corner on the bottle label) to assure optimum operation of the system.
- The Sealant Bottle is a one tire application use and needs to be replaced after each use. Always replace these components immediately at your original equipment vehicle dealer.
- When the Tire Service Kit sealant is in a liquid form, clean water, and a damp cloth will remove the material from the vehicle or tire and wheel components. Once the sealant dries, it can easily be peeled off and properly discarded.
- For optimum performance, make sure the valve stem on the wheel is free of debris before connecting the Tire Service Kit.
- You can use the Tire Service Kit air pump to inflate bicycle tires. The kit also comes with two needles, located in the Accessory Storage Compartment (on the bottom of the air pump) for inflating sport balls, rafts, or similar inflatable items. However, use only the Air Pump and make sure the Mode Select Knob is in the Air Mode when inflating such items to avoid injecting sealant into them. The Tire Service Kit Sealant is only intended to seal punctures less than 1/4 inch (6 mm) diameter in the tread of your vehicle.
- Do not lift or carry the Tire Service Kit by the hoses.

WARNING!

- Do not attempt to seal a tire on the side of the vehicle closest to traffic. Pull far enough off the road to avoid the danger of being hit when using the Tire Service Kit.
- Do not use Tire Service Kit or drive the vehicle under the following circumstances:
 - If the puncture in the tire tread is approximately 1/4 inch (6 mm) or larger.
 - If the tire has any sidewall damage.
 - If the tire has any damage from driving with extremely low tire pressure.
 - If the tire has any damage from driving on a flat tire.
 - If the wheel has any damage.
 - If you are unsure of the condition of the tire or the wheel.

(Continued)

WARNING! *(Continued)*

- Keep Tire Service Kit away from open flames or heat source.
- A loose Tire Service Kit thrown forward in a collision or hard stop could endanger the occupants of the vehicle. Always stow the Tire Service Kit in the place provided. Failure to follow these warnings can result in injuries that are serious or fatal to you, your passengers, and others around you.
- Take care not to allow the contents of Tire Service Kit to come in contact with hair, eyes, or clothing. Tire Service Kit sealant is harmful if inhaled, swallowed, or absorbed through the skin. It causes skin, eye, and respiratory irritation. Flush immediately with plenty of water if there is any contact with eyes or skin. Change clothing as soon as possible, if there is any contact with clothing.

*(Continued)***WARNING!** *(Continued)*

- Tire Service Kit Sealant solution contains latex. In case of an allergic reaction or rash, consult a physician immediately. Keep Tire Service Kit out of reach of children. If swallowed, rinse mouth immediately with plenty of water and drink plenty of water. Do not induce vomiting! Consult a physician immediately.

Sealing A Tire With Tire Service Kit*Whenever You Stop To Use Tire Service Kit:*

1. Pull over to a safe location and turn on the vehicle's Hazard Warning Flashers.
2. Verify that the valve stem (on the wheel with the deflated tire) is in a position that is near to the ground. This will allow the Tire Service Kit Hose to reach the valve stem and keep the Tire Service Kit flat on the ground. This will provide the best positioning of the kit

when injecting the sealant into the deflated tire and running the air pump. Move the vehicle as necessary to place the valve stem in this position before proceeding.

3. Place the transmission in PARK and cycle the ignition in the OFF position.
4. Apply the parking brake.

Setting Up To Use Tire Service Kit:

1. Uncoil the Sealant Hose and then remove the cap from the fitting at the end of the hose.
2. Place the Tire Service Kit flat on the ground next to the deflated tire.



3. Remove the cap from the valve stem and then screw the fitting at the end of the Sealant Hose onto the valve stem.



4. Uncoil the Power Plug and insert the plug into the vehicle's 12 Volt power outlet.

NOTE:

Do not remove foreign objects (e.g., screws or nails) from the tire.

Injecting Tire Service Kit Sealant Into The Deflated Tire:



1. Always start the vehicle before turning the Tire Service Kit on.



2. Ensure the Mode Select Knob is to the Sealant Mode position.



3. After pushing the Power Button, the sealant (white fluid) will flow from the Sealant Bottle through the Sealant Hose and into the tire.

NOTE:

Sealant may leak out through the puncture in the tire.

If the sealant (white fluid) does not flow within 0 – 10 seconds through the Sealant Hose:

1. Push the Power Button to turn the Tire Service Kit off. Disconnect the Sealant Hose from the valve stem. Make sure the valve stem is free of debris. Reconnect the Sealant Hose to the valve stem. Check that the Mode Select Knob is in the Sealant Mode position and not Air Mode. Push the Power Button to turn the Tire Service Kit on.
2. Connect the Power Plug to a different 12 Volt power outlet in your vehicle or another vehicle, if available. Make sure the vehicle is running before turning the Tire Service Kit on.
3. The Sealant Bottle may be empty due to previous use. Call for assistance.

If the sealant (white fluid) does flow through the Sealant Hose:



1. Continue to operate the pump until sealant is no longer flowing through hose (typically takes 30 - 70 seconds). As the sealant flows through the Sealant Hose, the Pressure Gauge can read as high as 70 psi (4.8 Bar). The Pressure Gauge will decrease quickly from approximately 70 psi (4.8 Bar) to the actual tire pressure when the Sealant Bottle is empty.
2. The pump will start to inject air into the tire immediately after the Sealant Bottle is empty. Continue to operate the pump and inflate the tire to the cold tire inflation pressure found on the tire and loading information label located in the driver-side door opening. Check the tire pressure by looking at the Pressure Gauge.



If the tire does not inflate to at least 26 psi (1.8 Bar) pressure within 15 minutes:

- The tire is too badly damaged. Do not attempt to drive the vehicle further. Call for assistance.

If the tire inflates to the recommended pressure or is at least 26 psi (1.8 Bar) pressure within 15 minutes:

NOTE:

If the tire becomes overinflated, push the Deflation Button to reduce the tire pressure to the recommended inflation pressure before continuing.



1. Push the Power Button to turn off the Tire Service Kit.



2. Remove the speed limit label from the Tire Service Kit and place sticker on the steering wheel.

3. Immediately disconnect the Sealant Hose from the valve stem, reinstall the cap on the fitting at the end of the hose, and place the Tire Service Kit in the vehicle storage location.



Drive Vehicle:

Immediately after injecting sealant and inflating the tire, drive the vehicle 5 miles (8 km) or ten minutes to ensure distribution of the Tire Service Kit Sealant within the tire. Do not exceed 50 mph (80 km/h).

WARNING!

The Tire Service Kit is not a permanent flat tire repair. Have the tire inspected and repaired or replaced after using the Tire Service Kit. Do not exceed 50 mph (80 km/h) until the tire is repaired or replaced. Failure to follow this warning can result in injuries that are serious or fatal to you, your passengers, and others around you. Have the tire checked as soon as possible at an authorized dealer.

After Driving:

1. Uncoil the Sealant Hose, and then remove the cap from the fitting at the end of the hose.
2. Place the Tire Service Kit flat on the ground next to the deflated tire.



3. Remove the cap from the valve stem, and then screw the fitting at the end of the Sealant Hose onto the valve stem.



4. Uncoil the power plug and insert the plug into the vehicle's 12 Volt power outlet.



5. Uncoil the Hose and screw the fitting at the end of the hose onto the valve stem.



6. Turn the Mode Select Knob and turn to the Air Mode position.

7. Check the pressure in the tire by reading the Pressure Gauge.

If tire pressure is less than 19 psi (1.3 Bar):

The tire is too badly damaged. Do not attempt to drive the vehicle further. Call for assistance.

If the tire pressure is 19 psi (1.3 Bar) or higher:



1. Push the Power Button to turn on Tire Service Kit and inflate the tire to the cold tire inflation pressure found on the tire and loading information label located in the driver-side door opening.

NOTE:

If the tire becomes overinflated, push the Deflation Button to reduce the tire pressure to the recommended inflation pressure before continuing.

2. Disconnect the Tire Service Kit from the valve stem, reinstall the cap on the valve stem and unplug from 12 Volt outlet.
3. Place the Tire Service Kit in its proper storage area in the vehicle.
4. Have the tire inspected and repaired or replaced at the earliest opportunity at an authorized dealer or tire service center.
5. Remove the Speed Limit sticker from the steering wheel after the tire has been repaired.
6. Replace the Sealant Bottle at an authorized dealer as soon as possible.

NOTE:

When having the tire serviced, advise the authorized dealer or service center that the tire has been sealed using the Tire Service Kit.

Sealant Bottle Replacement:

1. Unwrap the power cord.
2. Unwrap the hose.

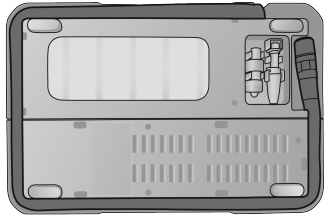

A0709000070US

Unwrap The Hose

3. Remove the bottle cover.

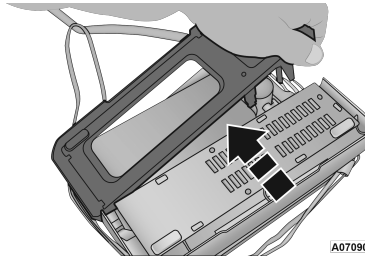

A0709000074US

Remove The Bottle Cover

4. Rotate the bottle up beyond vertical to release.

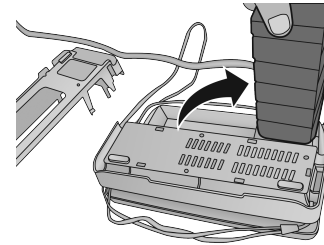

A0709000075US

Rotate The Bottle Up

5. Pull the bottle away from the Compressor.

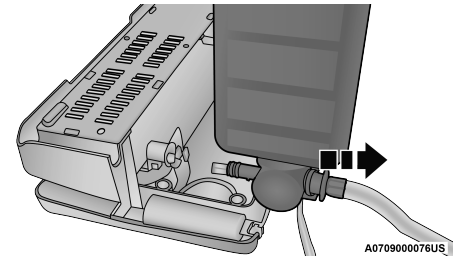

A0709000076US

Remove The Bottle

NOTE:

- For sealant bottle installation, follow these steps in reverse order.
- Replacement sealant bottles are available at authorized service centers.

JUMP STARTING

If your vehicle has a discharged battery, it can be jump started using a set of jumper cables and a battery in another vehicle or by using a portable battery booster pack. Jump starting can be dangerous if done improperly, so please follow the procedures in this section carefully.

NOTE:

When using a portable battery booster pack, follow the manufacturer's operating instructions and precautions.

WARNING!

Do not attempt jump starting if the battery is frozen. It could rupture or explode and cause personal injury.

CAUTION!

Do not use a portable battery booster pack or any other booster source with a system voltage greater than 12 Volts or damage to the battery, starter motor, alternator or electrical system may occur.

PREPARATIONS FOR JUMP START

The battery in your vehicle is located in the front of the engine compartment, behind the left headlight assembly.

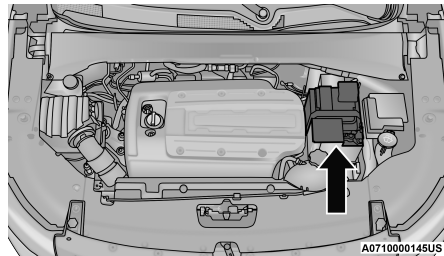
**Under Hood Battery Location****NOTE:**

The positive battery post is covered with a protective cap. Lift up on the cap to gain access to the post.

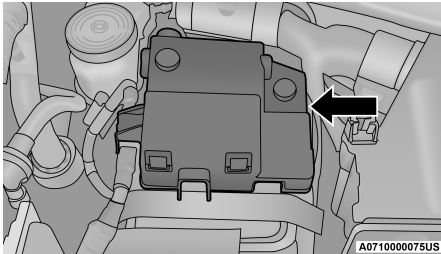
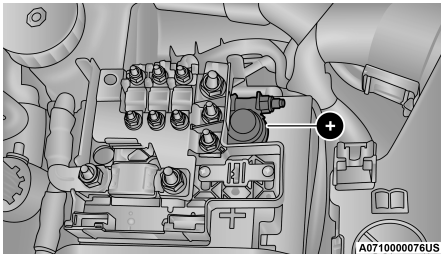
**Battery Post Cover****Positive (+) Battery Post**

See below steps to prepare for jump starting:

1. Apply the parking brake, shift the automatic transmission into PARK (manual transmission in NEUTRAL) and turn the ignition to OFF.
2. Turn off the heater, radio, and all electrical accessories.
3. If using another vehicle to jump start the battery, park the vehicle within the jumper cables reach, set the parking brake and make sure the ignition is OFF.

WARNING!

Do not allow vehicles to touch each other as this could establish a ground connection and personal injury could result.

WARNING!

- Take care to avoid the radiator cooling fan whenever the hood is raised. It can start anytime the ignition switch is ON. You can be injured by moving fan blades.
- Remove any metal jewelry such as rings, watch bands and bracelets that could make an inadvertent electrical contact. You could be seriously injured.
- Batteries contain sulfuric acid that can burn your skin or eyes and generate hydrogen gas which is flammable and explosive. Keep open flames or sparks away from the battery.

JUMP STARTING PROCEDURE

WARNING!

Failure to follow this jump starting procedure could result in personal injury or property damage due to battery explosion.

CAUTION!

Failure to follow these procedures could result in damage to the charging system of the booster vehicle or the discharged vehicle.

Connecting The Jumper Cables

1. Connect the positive (+) end of the jumper cable to the positive (+) post of the discharged vehicle.
2. Connect the opposite end of the positive (+) jumper cable to the positive (+) post of the booster battery.

3. Connect the negative (-) end of the jumper cable to the negative (-) post of the booster battery.
4. Connect the opposite end of the negative (-) jumper cable to a good engine ground (exposed metal part of the discharged vehicle's engine) away from the battery and the fuel injection system.

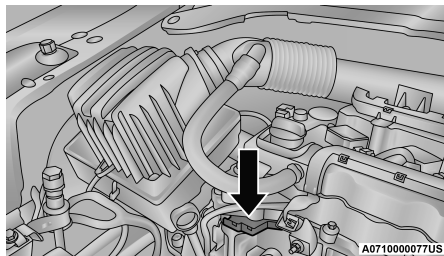

Suitable Engine Ground (Example Engine Shown)

WARNING!

Do not connect the jumper cable to the negative (-) post of the discharged battery. The resulting electrical spark could cause the battery to explode and could result in personal injury. Only use the specific ground point, do not use any other exposed metal parts.

5. Start the engine in the vehicle that has the booster battery, let the engine idle for a few minutes, and then start the engine in the vehicle with the discharged battery.
6. Once the engine is started, remove the jumper cables in the reverse sequence.

Disconnecting The Jumper Cables

1. Disconnect the negative (-) end of the jumper cable from the engine ground of the vehicle with the discharged battery.
2. Disconnect the opposite end of the negative (-) jumper cable from the negative (-) post of the booster battery.
3. Disconnect the positive (+) end of the jumper cable from the positive (+) post of the booster battery.
4. Disconnect the opposite end of the positive (+) jumper cable from the positive (+) post of the vehicle with the discharged battery.

If frequent jump starting is required to start your vehicle, you should have the battery and charging system inspected at an authorized dealer.

CAUTION!

Accessories plugged into the vehicle power outlets draw power from the vehicle's battery, even when not in use (i.e., cellular devices, etc.). Eventually, if plugged in long enough without engine operation, the vehicle's battery will discharge sufficiently to degrade battery life and/or prevent the engine from starting.

REFUELING IN EMERGENCY — IF EQUIPPED

The vehicle is equipped with a refueling funnel
 ⇨ page 84 for a Cap-Less Fuel System. If refueling is necessary, while using an approved gas can, insert the refueling funnel into the filler neck opening. Take care to open both flappers with the funnel to avoid spills.

NOTE:

In certain cold conditions, ice may prevent the fuel door from opening. If this occurs, lightly push on the fuel door to break the ice buildup and re-release the fuel door using the inside release button. Do not pry on the door.

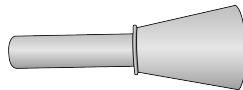

Refueling Funnel

A0711000008US

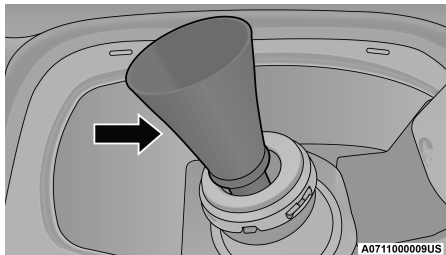
**Inserting Funnel****CAUTION!**

To avoid fuel spillage and overfilling, do not “top off” the fuel tank after filling.

Emergency Gas Can Refueling

Most gas cans will not open the flapper doors. A funnel is provided to allow emergency refueling with a gas can.

See below steps for refueling:

1. Retrieve funnel from the spare tire storage area.
2. Insert funnel into same filler pipe opening as the fuel nozzle.
3. Ensure funnel is inserted fully to hold flapper doors open.
4. Pour fuel into funnel opening.
5. Remove funnel from filler pipe, clean off prior to putting back in the spare tire storage area.

WARNING!

- Never have any smoking materials lit in or near the vehicle when the fuel door is open or the tank is being filled.
- Never add fuel when the engine is running. This is in violation of most countries regulations and may cause the Malfunction Indicator Light to turn on.
- A fire may result if fuel is pumped into a portable container that is inside of a vehicle. You could be burned. Always place fuel containers on the ground while filling.

IF YOUR ENGINE OVERHEATS

If the vehicle is overheating, it will need to be serviced by an authorized dealer.

CAUTION!

Driving with a hot cooling system could damage your vehicle. If the temperature gauge reads “H,” pull over and stop the vehicle. Idle the vehicle with the air conditioner turned off until the pointer drops back into the normal range. If the pointer remains on the “H” and you hear continuous chimes, turn the engine off immediately and call for service.

In any of the following situations, you can reduce the potential for overheating your engine by taking the appropriate action.

- On the highways — slow down.
- In city traffic — while stopped, place the transmission in NEUTRAL, but do not increase engine idle speed.

NOTE:

There are steps that you can take to slow down an impending overheat condition:

- If your Air Conditioner (A/C) is on, turn it off. The A/C system adds heat to the engine cooling system and turning the A/C off can help remove this heat.
- You can also turn the temperature control to maximum heat, the mode control to floor and the blower control to high. This allows the heater core to act as a supplement to the radiator and aids in removing heat from the engine cooling system.

WARNING!

You or others can be badly burned by hot engine coolant (antifreeze) or steam from your radiator. If you see or hear steam coming from under the hood, do not open the hood until the radiator has had time to cool. Never try to open a cooling system pressure cap when the radiator or coolant bottle is hot.

GEAR SELECTOR OVERRIDE

If a malfunction occurs, and the gear selector cannot be moved out of the PARK position, you can use the following procedure to temporarily move the gear selector:

1. Turn the engine OFF.
2. Apply the park brake.

- Grab the boot material rearward of the gear selector and pull up to carefully separate the gear selector bezel and boot assembly from the center console.

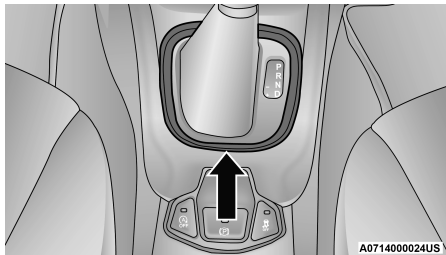
**Gear Selector Bezel**

- Press and maintain firm pressure on the brake pedal.

- Insert a small screwdriver or similar tool down into the gear selector override access hole (at the right rear corner of the gear selector assembly), and push and hold the override release lever down.

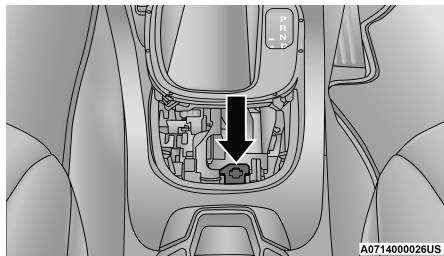
**Gear Selector Override Access Hole**

- Move the gear selector to the NEUTRAL position.
- The vehicle may then be started in NEUTRAL.
- Reinstall the gear selector boot.

FREEING A STUCK VEHICLE

If your vehicle becomes stuck in mud, sand or snow, it can often be moved using a rocking motion. Turn the steering wheel right and left to clear the area around the front wheels. For vehicles with automatic transmission, push and hold the lock button on the gear selector. Then shift back and forth between DRIVE (D) and REVERSE (R) (for automatic transmission) or SECOND gear and REVERSE (for manual transmission) while gently pressing the accelerator.

NOTE:

For vehicles with automatic transmission, shifts between DRIVE and REVERSE can only be achieved at wheel speeds of 5 mph (8 km/h) or less. Whenever the transmission remains in NEUTRAL (N) for more than two seconds, you must press the brake pedal to engage DRIVE or REVERSE.

Use the least amount of accelerator pedal pressure that will maintain the rocking motion without spinning the wheels or racing the engine.

WARNING!

Fast spinning tires can be dangerous. Forces generated by excessive wheel speeds may cause damage, or even failure, of the axle and tires. A tire could explode and injure someone. Do not spin your vehicle's wheels faster than 30 mph (48 km/h) or for longer than 30 seconds continuously without stopping when you are stuck and do not let anyone near a spinning wheel, no matter what the speed.

NOTE:

Push the ESC OFF switch (if necessary), to place the Electronic Stability Control (ESC) system in "Partial Off" mode, before rocking the vehicle. Once the vehicle has been freed, push the ESC OFF switch again to restore "ESC On" mode.

For a full copy of the owner's manual please visit Jeep-India.com or get in touch with the authorized service center.

CAUTION!

- Racing the engine or spinning the wheels may lead to transmission overheating and failure. Allow the engine to idle with the transmission in NEUTRAL for at least one minute after every five rocking-motion cycles. This will minimize overheating and reduce the risk of clutch or transmission failure during prolonged efforts to free a stuck vehicle.
- When "rocking" a stuck vehicle by shifting between DRIVE/SECOND gear and REVERSE, do not spin the wheels faster than 15 mph (24 km/h), or drivetrain damage may result.

(Continued)

CAUTION! *(Continued)*

- Revving the engine or spinning the wheels too fast may lead to transmission overheating and failure. It can also damage the tires. Do not spin the wheels above 30 mph (48 km/h) while in gear (no transmission shifting occurring).

TOWING A DISABLED VEHICLE

This section describes procedures for towing a disabled vehicle using a commercial towing service.

Proper towing or lifting equipment is required to prevent damage to your vehicle. Use only tow bars and other equipment designed for this purpose, following equipment manufacturer's instructions. Use of safety chains is mandatory. Attach a tow bar or other towing devices to main structural members of the vehicle, not to fascia/bumpers or associated brackets.

State and local laws regarding vehicles under tow must be observed.

NOTE:

- You must ensure that the Auto Park Brake feature is disabled before towing this vehicle to avoid inadvertent Electric Park Brake engagement. The Auto Park Brake feature is enabled or disabled via the customer programmable features in the Uconnect Settings.
- Vehicles with a discharged battery, or total electrical failure when the Electric Park Brake (EPB) is engaged, will need a wheel dolly or jack to raise the rear wheels off the ground when moving the vehicle onto a flatbed.

If you must use the accessories (wipers, defrosters, etc.) while being towed, the ignition must be in the ON/RUN mode.

Note that the Safehold feature will engage the Electric Park Brake whenever the driver's door is opened (if the battery is connected, ignition is ON, transmission is not in PARK, and brake pedal is released). If you are towing this vehicle with the ignition in the ON/RUN mode, you must manually disable the Electric Park Brake each time the driver's door is opened by pressing the brake pedal and then releasing the EPB.

If the vehicle's battery is discharged, instructions on shifting the automatic transmission out of PARK so that the vehicle can be moved ⇨ page 103.

CAUTION!

- Do not use sling-type equipment when towing. Vehicle damage may occur.
- When securing the vehicle to a flatbed truck, do not attach to front or rear suspension components. Damage to your vehicle may result from improper towing.
- Ensure that the Electric Park Brake is released, and remains released, while being towed.
- Do not use a fascia/bumper mounted clamp-on tow bar on your vehicle. The fascia/bumper face bar will be damaged.

WITHOUT THE KEY FOB

Special care must be taken when the vehicle is towed with the ignition in the LOCK/OFF mode. The only approved method of towing without the key fob is with a flatbed truck. Proper towing equipment is necessary to prevent damage to the vehicle.

FRONT-WHEEL DRIVE (FWD) MODELS — WITH KEY FOB

FCA recommends towing your vehicle with all four wheels **OFF** the ground using a flatbed.

If flatbed equipment is not available, this vehicle must be towed with the front wheels **OFF** the ground (using a towing dolly, or wheel lift equipment with the front wheels raised).

Ensure that the Electric Park Brake is released, and remains released, while being towed. The Electric Park Brake does not need to be released if all four wheels are **OFF** the ground.

CAUTION!

Towing this vehicle in violation of the above requirements can cause severe engine and/or transmission damage. Damage from improper towing is not covered under the New Vehicle Limited Warranty.

4x4 MODELS

FCA requires towing with all four wheels **OFF** the ground.

Acceptable methods are to tow the vehicle on a flatbed, or with one end of the vehicle raised and the opposite end on a towing dolly.

CAUTION!

- Front or rear wheel lifts must not be used (if the remaining wheels are on the ground). Internal damage to the transmission or transfer case will occur if a front or rear wheel lift is used when towing.

CAUTION! *(Continued)*

- Towing this vehicle in violation of the above requirements can cause severe transmission and/or transfer case damage. Damage from improper towing is not covered under the New Vehicle Limited Warranty.
- Proper towing or lifting equipment is required to prevent damage to your vehicle. Use only tow bars and other equipment designed for this purpose, following equipment manufacturer's instructions.
- Use of safety chains is mandatory. Attach a tow bar or other towing devices to main structural members of the vehicle, not to fascia/bumpers or associated brackets.

(Continued)

EMERGENCY TOW HOOKS — IF EQUIPPED

NOTE:

For off-road recovery, it is recommended to use both of the front tow hooks to minimize the risk of damage to the vehicle.

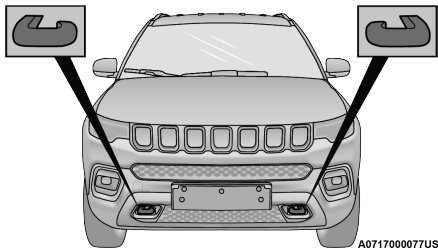

Front Tow Hook Location



Rear Tow Hook Location

Place the ignition in the ON/RUN position, and subsequently in OFF/LOCK, without opening the door. During towing, remember that not having the aid of the power brakes and the electromechanical power steering will require greater force when applying the brakes and steering of the vehicle.

WARNING!

- Do not use a chain for freeing a stuck vehicle. Chains may break, causing serious injury or death.
- Stand clear of vehicles when pulling with tow hooks. Tow straps may become disengaged, causing serious injury.

CAUTION!

Tow hooks are for emergency use only, to rescue a vehicle stranded off road. Do not use tow hooks for tow truck hookup or highway towing. You could damage your vehicle.

TOW EYE USAGE — IF EQUIPPED

Your vehicle is equipped with a tow eye that can be used to move a disabled vehicle.

When using a tow eye, follow the precautions below.

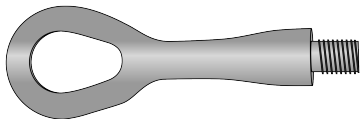

Tow Eye

A0717000043US

Tow Eye Usage Precautions

CAUTION!

- The tow eye must only be used for roadside emergencies. Use with an appropriate device in accordance with highway code (a rigid bar or rope) to maneuver the vehicle in preparation for transport via a tow truck.
- The tow eye must not be used to move the vehicle off the road or where there are obstacles.
- Do not use the tow eyes for tow truck hookup or highway towing.
- Do not use the tow eye to free a stuck vehicle → page 104.
- Damage to your vehicle may occur if these guidelines are not followed → page 105.

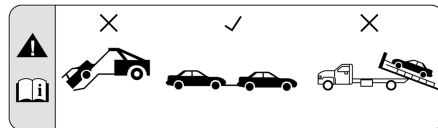

0614050352

Tow Eye Warning Label

WARNING!

Stand clear of vehicles when pulling with tow eyes.

- Do not use a chain with a tow eye. Chains may break, causing serious injury or death.
- Do not use a tow strap with a tow eye. Tow straps may break or become disengaged, causing serious injury or death.

(Continued)

WARNING! *(Continued)*

- Failure to follow proper tow eye usage may cause components to break resulting in serious injury or death.
- The brake and steering power assist systems will not function while the vehicle is being towed. You will, therefore, need to apply more force on the brake pedal and steering wheel. Do not use flexible ropes when towing, and avoid jerky movements. Do not start the engine while towing the car. Before tightening the ring, clean the threaded housing thoroughly. Make sure that the ring is fully screwed into the housing before towing the car.

Tow Eye Installation**Front Tow Eye**

The front tow eye receptacle is located behind a small access door on the passenger's side of the front fascia/bumper.

To install the tow eye, open the door using the vehicle key or a small screwdriver. Thread the tow eye into the receptacle, making sure it is fully tightened.

The tow eye must be securely seated to the attaching bracket through the lower front fascia/bumper. If the tow eye is not securely seated to the attaching bracket, the vehicle should not be moved.

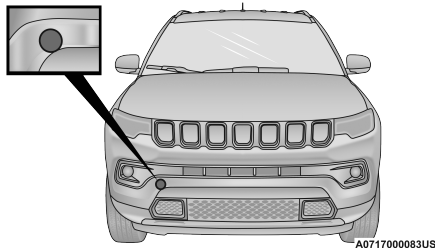
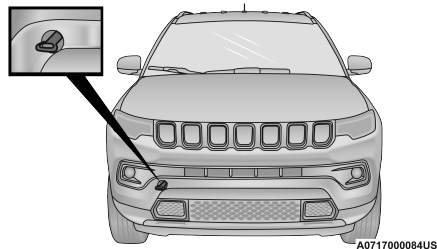
**Front Tow Eye Access Door****Front Tow Eye Installed****Rear Tow Eye**

The rear tow eye receptacle is located behind a small access door on the passenger's side of the rear fascia/bumper.

To install the tow eye, open the door using the vehicle key or a small screwdriver. Thread the tow eye into the receptacle, making sure it is fully tightened.

The tow eye must be securely seated to the attaching bracket through the lower front fascia/bumper. If the tow eye is not securely seated to the attaching bracket, the vehicle should not be moved.

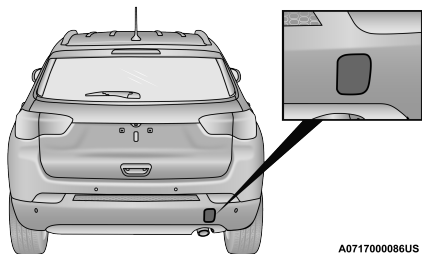

Rear Tow Eye Access Door

A0717000086US

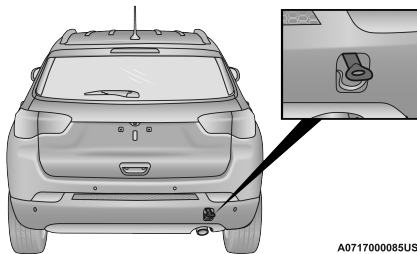

Rear Tow Eye Installed

A0717000085US

ENHANCED ACCIDENT RESPONSE SYSTEM (EARS)

This vehicle is equipped with an Enhanced Accident Response System.

This feature is a communication network that takes effect in the event of an impact. For a full copy of the owner's manual please visit Jeep-India.com or get in touch with the authorized service center.

EVENT DATA RECORDER (EDR)

This vehicle is equipped with an event data recorder (EDR). The main purpose of an EDR is to record data that will assist in understanding how a vehicle's systems performed under certain crash or near crash-like situations, such as an air bag deployment or hitting a road obstacle. For a full copy of the owner's manual please visit Jeep-India.com or get in touch with the authorized service center.

SERVICING AND MAINTENANCE

SCHEDULED SERVICING

Refer to the “Service And Warranty Handbook” for scheduled servicing.

ENGINE COMPARTMENT

1.4L ENGINE

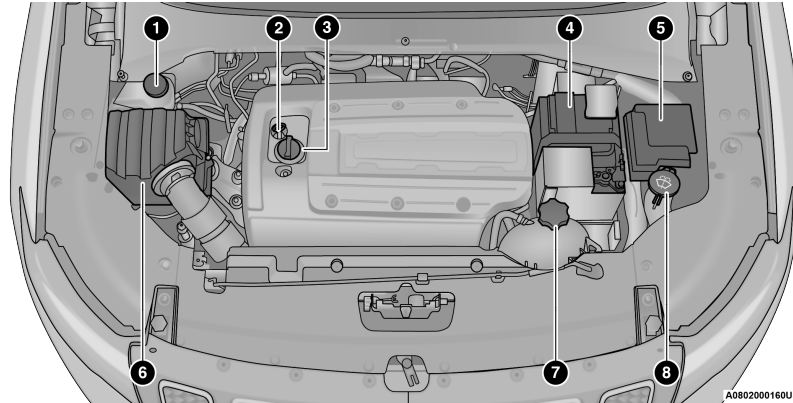

- 1 – Brake Fluid Reservoir Cap
- 2 – Engine Oil Dipstick
- 3 – Engine Oil Fill Cap
- 4 – Battery

- 5 – Power Distribution Center (Fuses)
- 6 – Engine Air Cleaner Filter
- 7 – Engine Coolant Pressure Cap
- 8 – Washer Fluid Reservoir Cap

2.0L DIESEL ENGINE

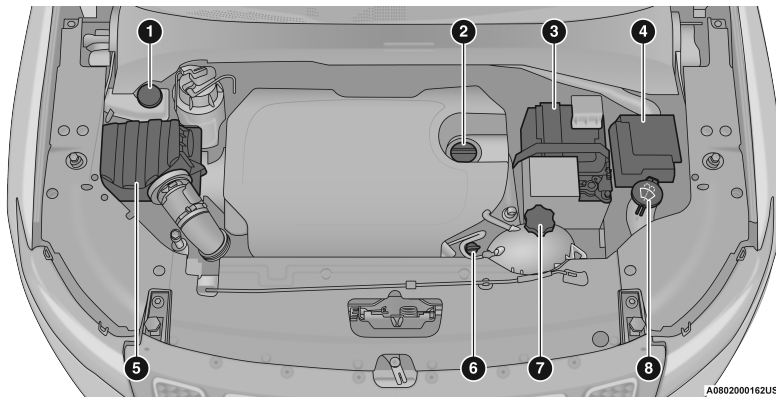

- 1 – Brake Fluid Reservoir Cap
- 2 – Engine Oil Fill
- 3 – Battery
- 4 – Power Distribution Center (Fuses)

- 5 – Engine Air Cleaner Filter
- 6 – Engine Oil Dipstick
- 7 – Engine Coolant Pressure Cap
- 8 – Washer Fluid Reservoir Cap

CHECKING OIL LEVEL

To ensure proper engine lubrication, the engine oil must be maintained at the correct level. Check the oil level at regular intervals, such as every fuel stop. The best time to check the engine oil level is about five minutes after a fully warmed up engine is shut off.

Checking the oil while the vehicle is on level ground will improve the accuracy of the oil level readings.

There are four possible dipstick types:

- Crosshatched zone.
- Crosshatched zone marked SAFE.
- Crosshatched zone marked with MIN at the low end of the range and MAX at the high end of the range.
- Crosshatched zone marked with dimples at the MIN and the MAX ends of the range.

NOTE:

Always maintain the oil level within the cross-hatch markings on the dipstick.

Adding 1 quart (1 liter) of oil when the reading is at the low end of the dipstick range will raise the oil level to the high end of the range marking.

CAUTION!

Overfilling or underfilling the crankcase will cause aeration or loss of oil pressure. This could damage your engine.

ADDING WASHER FLUID

The fluid reservoir is located in the front of the engine compartment. Be sure to check the fluid level in the reservoir at regular intervals. Fill the reservoir with windshield washer solvent (not radiator antifreeze) and operate the system for a few seconds to flush out the residual washer fluid.

When refilling the washer fluid reservoir, take some washer fluid, apply it to a cloth or towel, and wipe clean the wiper blades; this will help blade performance.

To prevent freeze-up of your windshield washer system in cold weather, select a solution or mixture that meets or exceeds the temperature range of your climate. This rating information can be found on most washer fluid containers.

WARNING!

Commercially available windshield washer solvents are flammable. They could ignite and burn you. Care must be exercised when filling or working around the washer solution.

BATTERY

Your vehicle is equipped with a low maintenance enhanced flooded battery. The battery de-mineralized water needs to be inspected and topped up every six months. Have the vehicle battery inspected by an authorized dealer.

NOTE:

Maintenance not required for AGM battery.

WARNING!

- Using the battery with low fluid will irreparably damage the battery and may cause an explosion.
- When performing any operation on the battery or near it, always protect your eyes with special goggles.

(Continued)

WARNING! *(Continued)*

- Batteries contain substances which are very dangerous for the environment. For battery replacement, contact an authorized dealership.
- Battery fluid is a corrosive acid solution and can burn or even blind you. Do not allow battery fluid to contact your eyes, skin, or clothing. Do not lean over a battery when attaching clamps. If acid splashes in eyes or on skin, flush the area immediately with large amounts of water.
- Battery gas is flammable and explosive. Keep flame or sparks away from the battery. Do not use a booster battery or any other booster source with an output greater than 12 Volts. Do not allow cable clamps to touch each other.
- Battery posts, terminals, and related accessories contain lead and lead compounds. Wash hands after handling.

CAUTION!

- It is essential when replacing the cables on the battery that the positive cable is attached to the positive post and the negative cable is attached to the negative post. Battery posts are marked positive (+) and negative (-) and are identified on the battery case. Cable clamps should be tight on the terminal posts and free of corrosion.
- If a “fast charger” is used while the battery is in the vehicle, disconnect both vehicle battery cables before connecting the charger to the battery. Do not use a “fast charger” to provide starting voltage.

PRESSURE WASHING

Cleaning the engine compartment with a high pressure washer is not recommended.

CAUTION!

Precautions have been taken to safeguard all parts and connections however, the pressures generated by these machines is such that complete protection against water ingress cannot be guaranteed.

VEHICLE MAINTENANCE

An authorized dealer has the qualified service personnel, special tools, and equipment to perform all service operations in an expert manner. Service Manuals are available which include detailed service information for your vehicle. Refer to these Service Manuals before attempting any procedure yourself.

NOTE:

Intentional tampering with emissions control systems may void your warranty and could result in civil penalties being assessed against you.

WARNING!

You can be badly injured working on or around a motor vehicle. Only do service work for which you have the knowledge and the proper equipment. If you have any doubt about your ability to perform a service job, take your vehicle to a competent mechanic.

ENGINE OIL

Engine Oil Selection — Gasoline Engine

For engine oil selection → page 177.

American Petroleum Institute (API) Engine Oil Identification Symbol



This symbol means that the oil has been certified by the American Petroleum Institute (API). The manufacturer only recommends API Certified engine oils.

This symbol certifies 0W-20, 5W-20, 0W-30, 5W-30 and 10W-30 engine oils.

CAUTION!

Do not use chemical flushes in your engine oil as the chemicals can damage your engine. Such damage is not covered by the New Vehicle Limited Warranty.

Synthetic Engine Oils

You may use synthetic engine oils provided the recommended oil quality requirements are met, and the recommended maintenance intervals for oil and filter changes are followed.

Synthetic engine oils which do not have both the engine oil certification mark and the correct SAE viscosity grade number should not be used.

Materials Added To Engine Oil

The manufacturer strongly recommends against the addition of any additives (other than leak detection dyes) to the engine oil. Engine oil is an engineered product and its performance may be impaired by supplemental additives.

Disposing Of Used Engine Oil And Oil Filters

Care should be taken in disposing of used engine oil and oil filters from your vehicle. Used oil and oil filters, indiscriminately discarded, can present a problem to the environment. Contact an authorized dealer, service station or governmental agency for advice on how and where used oil and oil filters can be safely discarded in your area.

ENGINE OIL — DIESEL ENGINE

Engine Oil Selection — Diesel Engine

For engine oil selection → page 177.

ENGINE OIL FILTER

The engine oil filter should be replaced with a new filter at every engine oil change.

Engine Oil Filter Selection

A full-flow type disposable oil filter should be used for replacement. The quality of replacement filters varies considerably. Only high quality Mopar® certified filters should be used.

ENGINE AIR CLEANER FILTER

Refer to the “Service and Warranty Handbook” for the proper maintenance intervals. See an authorized dealer for the replacement of the filter.

NOTE:

Be sure to follow the “Severe Duty Conditions” maintenance interval if applicable.

WARNING!

The air induction system (air cleaner, hoses, etc.) can provide a measure of protection in the case of engine backfire. Do not remove the air induction system (air cleaner, hoses, etc.) unless such removal is necessary for repair or maintenance. Make sure that no one is near the engine compartment before starting the vehicle with the air induction system (air cleaner, hoses, etc.) removed. Failure to do so can result in serious personal injury.

Engine Air Cleaner Filter Selection

The quality of replacement filters varies considerably. Only high quality Mopar® certified filters should be used.

AIR CONDITIONER MAINTENANCE

For best possible performance, your air conditioner should be checked and serviced by an authorized dealer at the start of each warm

season. This service should include cleaning of the condenser fins and a performance test. Drive belt tension should also be checked at this time.

WARNING!

- Use only refrigerants and compressor lubricants approved by the manufacturer for your air conditioning system. Some unapproved refrigerants are flammable and can explode, injuring you. Other unapproved refrigerants or lubricants can cause the system to fail, requiring costly repairs. Refer to Warranty Information Book, located in your owner's information kit, for further warranty information.
- The air conditioning system contains refrigerant under high pressure. To avoid risk of personal injury or damage to the system, adding refrigerant or any repair requiring lines to be disconnected should be done by an experienced technician.

CAUTION!

Do not use chemical flushes in your air conditioning system as the chemicals can damage your air conditioning components. Such damage is not covered by the New Vehicle Limited Warranty.

Refrigerant Recovery And Recycling R-134a – If Equipped

R-134a Air Conditioning Refrigerant is a hydrofluorocarbon (HFC) that is an ozone-friendly substance. The manufacturer recommends that air conditioning service be performed by an authorized dealer or other service facilities using recovery and recycling equipment.

NOTE:

Use only manufacturer approved A/C system PAG compressor oil and refrigerants.

Refrigerant Recovery And Recycling HFO 1234yf — If Equipped

HFO 1234yf Air Conditioning Refrigerant is a hydrofluoroolefin (HFO) that is endorsed by the Environmental Protection Agency and is an ozone-friendly substance with a low global-warming potential. The manufacturer recommends that air conditioning service be performed by authorized dealer using recovery and recycling equipment.

NOTE:

Use only manufacturer approved A/C system PAG compressor oil, and refrigerants.

Cabin Air Filter

Refer to the “Service And Warranty Handbook” for the proper maintenance intervals. See an authorized dealer for service.

BODY LUBRICATION

Locks and all body pivot points, including such items as seat tracks, door hinge pivot points and rollers, liftgate, tailgate, decklid, sliding doors and hood hinges, should be lubricated periodically with a lithium based grease, such as Mopar® Spray White Lube to assure quiet, easy operation and to protect against rust and wear. Prior to the application of any lubricant, the parts concerned should be wiped clean to remove dust and grit; after lubricating, excess oil and grease should be removed. Particular attention should also be given to hood latching components to ensure proper function. When performing other underhood services, the hood latch, release mechanism and safety catch should be cleaned and lubricated.

The external lock cylinders should be lubricated twice a year, preferably in the Autumn and Spring. Apply a small amount of a high quality lubricant, such as Mopar® Lock Cylinder Lubricant directly into the lock cylinder.

WIPER BLADES

Clean the rubber edges of the wiper blades and the windshield and rear window periodically with a sponge or soft cloth and a mild nonabrasive cleaner. This will remove accumulations of salt, waxes, or road film, and help reduce streaking and smearing.

Operation of the wipers on dry glass for long periods may cause deterioration of the wiper blades. Always use washer fluid when using the wipers to remove salt or dirt from a dry windshield or rear window.

Avoid using the wiper blades to remove frost or ice from the windshield or rear window. Make sure that they are not frozen to the glass before turning them on to avoid damaging the blade. Keep the wiper blade out of contact with petroleum products such as engine oil, gasoline, etc.

NOTE:

Life expectancy of wiper blades varies depending on geographical area and frequency of use. Poor performance of blades may be present with chattering, marks, water lines or wet spots. If any of these conditions are present, clean the wiper blades or replace as necessary.

Wiper Blade Removal/Installation**CAUTION!**

Do not allow the wiper arm to spring back against the glass without the wiper blade in place or the glass may be damaged.

1. Lift the wiper arm to raise the wiper blade off of the glass, until the wiper arm is in the full up position.
2. To disengage the wiper blade from the wiper arm, flip up the locking tab.
3. Tilt the lower end of the wiper blade away from the arm and use one finger push the release tab toward the wiper arm.
4. Slide the wiper blade down towards the base of the wiper arm.
5. With the wiper blade disengaged, remove the wiper blade from the wiper arm by holding the wiper arm with one hand and separating the wiper blade from the wiper arm with the other hand (move the wiper blade down toward the base of the wiper arm and away from the J hook in the end of the wiper arm).
6. Gently lower the wiper arm onto the glass.

Installing The Front Wipers

1. Lift the wiper arm off of the glass, until the wiper arm is in the full up position.
2. Position the wiper blade under the hook on the tip of the wiper arm with the wiper locking tab open.
3. Insert the receiver bracket on the wiper assembly into the hook on the tip of the arm through the opening in the wiper blade under the locking tab.
4. Slide the wiper blade up into the hook on the wiper arm until it is latched (engagement will be accompanied by an audible click). Fold down the latch release tab and snap it into its locked position.
5. Gently lower the wiper blade onto the glass.

EXHAUST SYSTEM

The best protection against carbon monoxide entry into the vehicle body is a properly maintained engine exhaust system.

If you notice a change in the sound of the exhaust system; or if the exhaust fumes can be detected inside the vehicle; or when the underside or rear of the vehicle is damaged; have an authorized technician inspect the complete exhaust system and adjacent body areas for broken, damaged, deteriorated, or mispositioned parts. Open seams or loose connections could permit exhaust fumes to seep into the passenger compartment. In addition, have the exhaust system inspected each time the vehicle is raised for lubrication or oil change. Replace as required.

WARNING!

- Exhaust gases can injure or kill. They contain carbon monoxide (CO), which is colorless and odorless. Breathing it can make you unconscious and can eventually poison you. To avoid breathing CO
➔ page 80.
- A hot exhaust system can start a fire if you park over materials that can burn. Such materials might be grass or leaves coming into contact with your exhaust system. Do not park or operate your vehicle in areas where your exhaust system can contact anything that can burn.

CAUTION!

- The catalytic converter requires the use of unleaded fuel only. Leaded gasoline will destroy the effectiveness of the catalyst as an emissions control device and may seriously reduce engine performance and cause serious damage to the engine.
- Damage to the catalytic converter can result if your vehicle is not kept in proper operating condition. In the event of engine malfunction, particularly involving engine misfire or other apparent loss of performance, have your vehicle serviced promptly. Continued operation of your vehicle with a severe malfunction could cause the converter to overheat, resulting in possible damage to the converter and vehicle.

Under normal operating conditions, the catalytic converter will not require maintenance. However, it is important to keep the engine properly tuned to ensure proper catalyst operation and prevent possible catalyst damage.

NOTE:

Intentional tampering with emissions control systems can result in civil penalties being assessed against you.

In unusual situations involving grossly malfunctioning engine operation, a scorching odor may suggest severe and abnormal catalyst overheating. If this occurs, stop the vehicle, turn off the engine and allow it to cool. Service, including a tune-up to manufacturer's specifications, should be obtained immediately.

To minimize the possibility of catalytic converter damage:

- Do not interrupt the ignition when the transmission is in gear and the vehicle is in motion.
- Do not try to start the vehicle by pushing or towing the vehicle.
- Do not idle the engine with any ignition components disconnected or removed, such as when diagnostic testing, or for prolonged periods during very rough idle or malfunctioning operating conditions.

COOLING SYSTEM**WARNING!**

- You or others can be badly burned by hot engine coolant (antifreeze) or steam from your radiator. If you see or hear steam coming from under the hood, do not open the hood until the radiator has had time to cool. Never open a cooling system pressure cap when the radiator or coolant bottle is hot.
- Keep hands, tools, clothing, and jewelry away from the radiator cooling fan when the hood is raised. The fan starts automatically and may start at any time, whether the engine is running or not.
- When working near the radiator cooling fan, disconnect the fan motor lead or turn the ignition to the OFF mode. The fan is temperature controlled and can start at any time the ignition is in the ON mode.

Coolant Checks

Check engine coolant (antifreeze) protection every 12 months (before the onset of freezing weather, where applicable). If the engine coolant is dirty or rusty in appearance, the system should be drained, flushed and refilled with fresh engine coolant. Check the front of the A/C condenser for any accumulation of bugs, leaves, etc. If dirty, clean by gently spraying water from a garden hose vertically down the face of the condenser.

Cooling System — Drain, Flush And Refill

NOTE:

Some vehicles require special tools to add coolant properly. Failure to fill these systems properly could lead to severe internal engine damage. If any coolant is needed to be added to the system please contact an authorized dealer.

If the engine coolant (antifreeze) is dirty or contains visible sediment, have an authorized dealer clean and flush with Organic Additive Technology (OAT) coolant (conforming to MS.90032).

Refer to the “Service And Warranty Handbook” for the proper maintenance intervals.

Selection Of Coolant

NOTE:

- Mixing of engine coolant (antifreeze) other than specified Organic Additive Technology (OAT) engine coolant, may result in engine damage and may decrease corrosion protection. OAT engine coolant is different and should not be mixed with Hybrid Organic Additive Technology (HOAT) engine coolant or any “globally compatible” coolant. If a non-OAT engine coolant is introduced into the cooling system in an emergency, the cooling

system will need to be drained, flushed, and refilled with fresh OAT coolant (conforming to MS.90032), by an authorized dealer as soon as possible.

- Do not use water alone or alcohol-based engine coolant products. Do not use additional rust inhibitors or anti-rust products, as they may not be compatible with the radiator engine coolant and may plug the radiator.
- This vehicle has not been designed for use with propylene glycol-based engine coolant. Use of propylene glycol-based engine coolant is not recommended.
- Some vehicles require special tools to add coolant properly. Failure to fill these systems properly could lead to severe internal engine damage. If any coolant is needed to be added to the system please contact an authorized dealer.

Adding Coolant

Your vehicle has been built with an improved engine coolant (OAT coolant conforming to MS.90032) that allows extended maintenance intervals. This engine coolant (antifreeze) can be used up to ten years or 150,000 miles (240,000 km) before replacement. To prevent reducing this extended maintenance period, it is important that you use the same engine coolant (OAT coolant conforming to MS.90032) throughout the life of your vehicle.

Please review these recommendations for using Organic Additive Technology (OAT) engine coolant that meets the requirements of the manufacturer Material Standard MS.90032. When adding engine coolant:

- We recommend using Mopar® PARAFLU^{UP} Formula OAT that meets the requirements of the manufacturer Material Standard MS.90032.

- Mix a minimum solution of 50% OAT engine coolant that meets the requirements of the manufacturer Material Standard MS.90032 and distilled water. Use higher concentrations (not to exceed 70%) if temperatures below -34°F (-37°C) are anticipated. Please contact an authorized dealer for assistance.
- Use only high purity water such as distilled or deionized water when mixing the water/engine coolant solution. The use of lower quality water will reduce the amount of corrosion protection in the engine cooling system.

NOTE:

- It is the owner's responsibility to maintain the proper level of protection against freezing according to the temperatures occurring in the area where the vehicle is operated.

- Some vehicles require special tools to add coolant properly. Failure to fill these systems properly could lead to severe internal engine damage. If any coolant is needed to be added to the system, please contact a local authorized dealer.
- Mixing engine coolant types is not recommended and can result in cooling system damage. If HOAT and OAT coolant are mixed in an emergency, have a authorized dealer drain, flush, and refill with OAT coolant (conforming to MS.90032) as soon as possible.

Cooling System Pressure Cap

The cap must be fully tightened to prevent loss of engine coolant (antifreeze), and to ensure that engine coolant will return to the radiator from the coolant expansion bottle/recovery tank (if equipped).

The cap should be inspected and cleaned if there is any accumulation of foreign material on the sealing surfaces.

WARNING!

- Do not open hot engine cooling system. Never add engine coolant (antifreeze) when the engine is overheated. Do not loosen or remove the cap to cool an overheated engine. Heat causes pressure to build up in the cooling system. To prevent scalding or injury, do not remove the pressure cap while the system is hot or under pressure.
- Do not use a pressure cap other than the one specified for your vehicle. Personal injury or engine damage may result.

Disposal Of Used Coolant

Used ethylene glycol-based coolant (antifreeze) is a regulated substance requiring proper disposal. Check with your local authorities to determine the disposal rules for your community. To prevent ingestion by animals or children, do not store ethylene glycol-based coolant in open containers or allow it to remain in puddles on the ground, clean up any ground spills immediately. If ingested by a child or pet, seek emergency assistance immediately.

Coolant Level

The coolant expansion bottle provides a quick visual method for determining that the coolant level is adequate. With the engine off and cold, the level of the engine coolant (antifreeze) in the bottle should be between the “MIN” and “MAX” marks.

As long as the engine operating temperature is satisfactory, the coolant bottle need only be checked once a month.

When additional engine coolant is needed to maintain the proper level, it should be added to the coolant bottle. Do not overfill.

Cooling System Notes

NOTE:

When the vehicle is stopped after a few miles/kilometers of operation, you may observe vapor coming from the front of the engine compartment. This is normally a result of moisture from rain, snow, or high humidity accumulating on the radiator and being vaporized when the thermostat opens, allowing hot engine coolant (antifreeze) to enter the radiator.

If an examination of your engine compartment shows no evidence of radiator or hose leaks, the vehicle may be safely driven. The vapor will soon dissipate.

- Do not overfill the coolant expansion bottle.
- Before the onset of freezing weather (where applicable) check the condition of coolant in radiator and coolant expansion bottle. If the coolant needs to be added, the contents of the coolant expansion bottle must also be protected against freezing ⇨ page 125.
- Check the coolant freeze point in the radiator and in the coolant expansion bottle. If engine coolant needs to be added, the contents of the coolant expansion bottle must also be protected against freezing.
- If frequent engine coolant additions are required, the cooling system should be pressure tested for leaks.
- Maintain engine coolant concentration at a minimum of 50% OAT coolant (conforming to MS.90032) and distilled water for proper corrosion protection of your engine which contains aluminum components.
- Make sure that the coolant expansion bottle overflow hoses are not kinked or obstructed.
- Keep the front of the radiator clean. If your vehicle is equipped with air conditioning, keep the front of the condenser clean.
- Do not change the thermostat for Summer or Winter operation. If replacement is ever necessary, install ONLY the correct type thermostat. Other designs may result in unsatisfactory engine cooling performance, poor gas mileage, and increased emissions.

BRAKE SYSTEM

WARNING!

Riding the brakes can lead to brake failure and possibly a collision. Driving with your foot resting or riding on the brake pedal can result in abnormally high brake temperatures, excessive lining wear, and possible brake damage. You would not have your full braking capacity in an emergency.

Brake Master Cylinder

The fluid in the master cylinder should be checked when performing under hood services or immediately if the “Brake Warning Light” is illuminated.

Be sure to clean the top of the master cylinder area before removing the cap. If necessary, add fluid to bring the fluid level up to the requirements described on the brake fluid reservoir.

With disc brakes, fluid level can be expected to fall as the brake pads wear. Brake fluid level should be checked when pads are replaced. However, low fluid level may be caused by a leak and a checkup may be needed.

WARNING!

- To avoid contamination from foreign matter or moisture, use only new brake fluid or fluid that has been in a tightly closed container. Keep the master cylinder reservoir cap secured at all times. Brake fluid in an open container absorbs moisture from the air resulting in a lower boiling point. This may cause it to boil unexpectedly during hard or prolonged braking, resulting in sudden brake failure. This could result in a collision.

(Continued)

WARNING! *(Continued)*

- Overfilling the brake fluid reservoir can result in spilling brake fluid on hot engine parts, causing the brake fluid to catch fire. Brake fluid can also damage painted and vinyl surfaces, care should be taken to avoid its contact with these surfaces.
- Do not allow petroleum based fluid to contaminate the brake fluid. Brake seal components could be damaged, causing partial or complete brake failure. This could result in a collision.

MANUAL TRANSMISSION — IF EQUIPPED**Fluid Level Check**

Check the fluid level by removing the fill plug. The fluid level should be between the bottom of the fill hole and a point not more than 3/16 inch (4.7 mm) below the bottom of the hole.

Add fluid, if necessary, to maintain the proper level.

Please see an authorized dealer for service.

Frequency Of Fluid Change

Under normal operating conditions, the fluid installed at the factory will give satisfactory lubrication for the life of the vehicle. Fluid changes are not necessary unless lubricant has become contaminated with water.

NOTE:

If contaminated with water, the fluid should be changed immediately. See an authorized dealer.

Lubricant Selection

AUTOMATIC TRANSMISSION — IF EQUIPPED

Special Additives

The manufacturer strongly recommends against using any special additives in the transmission. Automatic Transmission Fluid (ATF) is an engineered product and its performance may be impaired by supplemental additives. Therefore, do not add any fluid additives to the transmission. Avoid using transmission sealers as they may adversely affect seals.

CAUTION!

Do not use chemical flushes in your transmission as the chemicals can damage your transmission components. Such damage is not covered by the New Vehicle Limited Warranty.

Fluid Level Check

The fluid level is preset at the factory and does not require adjustment under normal operating conditions. Routine fluid level checks are not required; therefore the transmission has no dipstick. An authorized dealer can check your transmission fluid level using special service tools. If you notice fluid leakage or transmission malfunction, visit an authorized dealer immediately to have the transmission fluid level checked. Operating the vehicle with an improper fluid level can cause severe transmission damage.

CAUTION!

If a transmission fluid leak occurs, visit an authorized dealer immediately. Severe transmission damage may occur. An authorized dealer has the proper tools to adjust the fluid level accurately.

Fluid And Filter Changes

Under normal operating conditions, the fluid installed at the factory will provide satisfactory lubrication for the life of the vehicle.

Routine fluid and filter changes are not required. However, change the fluid and filter if the fluid becomes contaminated (with water, etc.), or if the transmission is disassembled for any reason.

Selection Of Lubricant

NOTE:

No chemical flushes should be used in any transmission; only the approved lubricant should be used.

CAUTION!

Using a transmission fluid other than the manufacturer's recommended fluid may cause deterioration in transmission shift quality and/or torque converter shudder.

FUSES

General Information

WARNING!

- When replacing a blown fuse, always use an appropriate replacement fuse with the same amp rating as the original fuse. Never replace a fuse with another fuse of higher amp rating. Never replace a blown fuse with metal wires or any other material. Do not place a fuse inside a circuit breaker cavity or vice versa. Failure to use proper fuses may result in serious personal injury, fire and/or property damage.
- Before replacing a fuse, make sure that the ignition is off and that all the other services are switched off and/or disengaged.
- If the replaced fuse blows again, contact an authorized dealer.

(Continued)

WARNING! (Continued)

- If a general protection fuse for safety systems (air bag system, braking system), power unit systems (engine system, transmission system) or steering system blows, contact an authorized dealer.

The fuses protect electrical systems against excessive current.

When a device does not work, you must check the fuse element inside the blade fuse for a break/melt.

Also, please be aware that when using power outlets for extended periods of time with the engine off may result in vehicle battery discharge.

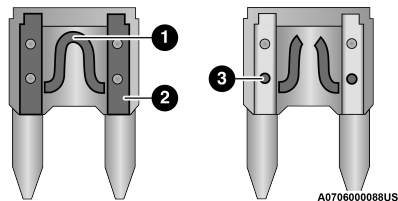

Blade Fuses

- 1 – Fuse Element
- 2 – Blade Fuse with a good/functional fuse element
- 3 – Blade fuse with a bad/not functional fuse element (blown fuse)

Fuse Location

The fuses are grouped into controllers located in the engine compartment.

Power Distribution Center/Fuses

The Front Power Distribution Center is located in the engine compartment. This module contains fuses and relays. Fuse cavity location are printed on the inside of the power distribution center cover.

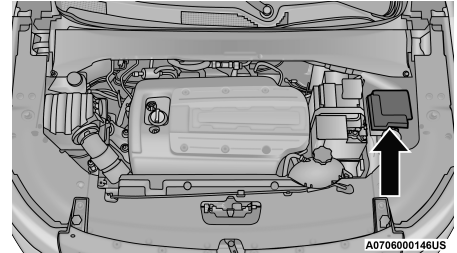

Fuse Panel & Cover Location

| * If Equipped | | | |
|---------------|----------------|-----------|-----------------------|
| Cavity | Cartridge Fuse | Mini Fuse | Description |
| F03 | 40 Amp | - | PTC Feed 1* |
| F04 | 30 Amp Tan | - | Rear Defroster (EBL)* |
| F05 | - | - | Spare |
| F06 | 40 Amp | - | TTM* |
| F07 | 40 Amp | - | SCR* |
| F08 | 20 Amp | - | SLM Feed LT* |

| * If Equipped | | | |
|---------------|----------------|------------------|--|
| Cavity | Cartridge Fuse | Mini Fuse | Description |
| F09 | 30 Amp | - | AGSM/DCSM/TCM/DTCM/SCCM |
| F10 | 20 Amp | - | SLM Feed RT* |
| F11 | 20 Amp | - | BCM Feed 3 / (Run/Start & FB Relay and /Start/Stop& FB Relay in BCM) |
| F12 | 40 Amp | - | BSM Pump |
| F13 | 40 Amp | - | BSM Valves |
| F14 | 40 Amp | - | Diesel Filter Heater Diesel vehicles only |
| F15 | 40 Amp | - | Starter Motor Solenoid Fuse - 2.4 XHZ |
| F16 | 40 Amp | - | Starter Motor Solenoid Fuse Single battery applications |
| F17 | 40 Amp | - | HVAC Fan |
| F18 | - | - | Spare |
| F19 | - | 2 Amp Micro Fuse | Steering Column Control Module (SCCM) |

| * If Equipped | | | |
|---------------|----------------|------------------|---|
| Cavity | Cartridge Fuse | Mini Fuse | Description |
| F20 | - | 7.5 Amp | Engine Control Module (ECM) ECM/Radiator fan relay coil |
| F21 | - | - | Spare |
| F22 | - | 7.5 Amp | AC Compressor |
| F23 | - | - | Spare |
| F24 | - | 7.5 Amp | Side Mirrors Defrost |
| F25 | - | - | Spare |
| F26 | - | 20 Amp | Lumbar Adjust (Driver Seat Only)* |
| F27 | - | 25 Amp 20 Amp | Engine Control Module (ECM) / Fuel Injectors / SNSR GPF EGT 1.4L gas application* |
| F28 | - | 7.5 Amp | Blow By Heater (Diesel) |
| F29A & B | - | - | Spare |
| F30 | - | - | Spare |

| * If Equipped | | | |
|---------------|----------------|---------------------------------|---|
| Cavity | Cartridge Fuse | Mini Fuse | Description |
| F31 | - | 15 Amp | Wireless Charging Pad / SW Bank Lower 2 / SW Bank Lower LT & RT / Port UCI 2 |
| F32 | - | 20 Amp (Gas) 15 Amp (Diesel) | Fuel Injectors / Ignition Coils / Ignition Coil Capacitors (Gas Engine) UEGO (O2) Sensor - Upstream & Downstream / Glow Plug Module / Oil Pump / Mass Airflow Sensor / EGR Cooling Bypass / Swirl Actuator / SNSR UEGO DSL Upstream / Pump UREA Cooling (Diesel Engine) |
| F33 | - | 10 Amp | Relay Coil Power Control Relay 2.4 Dual battery application only (XHZ) |
| F34A & B | - | - | Spare |
| F35 | - | - | Spare |
| F36 | - | 10 Amp | Port UCI2 / Mod CVPM |

| * If Equipped | | | |
|---------------|----------------|-----------|--|
| Cavity | Cartridge Fuse | Mini Fuse | Description |
| F37 | - | 10 Amp | Powertrain Control Module (PCM) / Purge Solenoid / Surge Solenoid / Wastegate Solenoid / O2 Sensor Upstream & Downstream 1.4L (Gas Engine) |
| F38 | - | 10 Amp | ECM/TCM/AGSM/DCSM/STM/Fuel Pump Relay Coil |
| F39 | - | - | Spare |
| F40 | - | - | Spare |
| F41 | - | - | Spare |
| F42 | - | 20 Amp | Cargo Power Outlet – Ignition power |
| F43 | - | - | Cargo Power Outlet (Can be replaced with 20 Amp fuse in F42 direct battery power) |
| F44 | - | - | Spare |
| F45 | - | - | Spare |

| * If Equipped | | | |
|---------------|----------------|-----------|--|
| Cavity | Cartridge Fuse | Mini Fuse | Description |
| F46 | - | 30 Amp | Drivetrain Control Module (DTCM) AWD Power |
| F47 | - | 30 Amp | Front Windshield Defrost* |
| F48 | - | - | Spare |
| F49 | - | 15 Amp | Transmission Control Module (TCM) / (TCM, AISIN) / Dual Clutch Transmission Module (DCTM) Supply 2 |
| F50 | - | 5 Amp | Drive Train Control Module (DTCM) ECU Power |
| F51 | - | 20 Amp | NOX SNSR Feed (Diesel Engine) |
| F52 | - | 5 Amp | Automatic Gearbox Shifter Module (AGSM) (Diesel & Gas) / Dual Clutch Shifter Module (DCSM) (Gas Engine) |
| F53 | - | 7.5 Amp | Dual Clutch Transmission Module (DCTM) Supply 1 (Gas Engine) 7DDCT Transmission |

| * If Equipped | | | |
|---------------|----------------|-----------|--|
| Cavity | Cartridge Fuse | Mini Fuse | Description |
| F54 | - | - | Spare |
| F55 | - | - | Spare |
| F56 | - | 10 Amp | PM SNSR (Diesel Engine) |
| F57 | - | 20 Amp | RR Power Outlet (12 Volt APO) |
| F58 | - | - | Spare |
| F59 | - | - | Spare |
| F60 | - | - | Spare |
| F61 | - | 20 Amp | Fuel Pump |
| F62 | - | 5 Amp | Intelligent Battery Sensor (IBS) |
| F63 | - | 15 Amp | SCR (Diesel Engine) |
| F64 | - | 10 Amp | MOD DCSD / ACT Grille Shutter / Handsfree Liftgate / UCI + USB Port / HRLS |
| F65 | - | 20 Amp | Horn |
| F66 | - | 20 Amp | Cigar Lighter* |
| F67 | - | 10 Amp | Engine Control Module (ECM) |

Interior Fuses

The interior fuse panel is located in the passenger compartment on the left side dash panel under the instrument panel.

| Cavity | Blade Fuse | Description |
|---------------|-------------------|--|
| F31 | 7.5 Amp Brown | Occupant Restraint Controller |
| F33 | 20 Amp Yellow | Window Motor Passenger |
| F34 | 20 Amp Yellow | Window Motor Driver |
| F36 | 20 Amp Yellow | Intrusion Module/Siren, Radio, UCI/USB Port, VSU, Climate Control, Electronic Steering Lock, Power Folding Mirrors, Security Gateway/DTV |
| F37 | 10 Amp Red | Instrument Panel Cluster, Drivetrain Control Module, Adaptive Cruise, ECC (HVAC) Blower |
| F38 | 20 Amp Yellow | Door Lock/Unlock, Liftgate Release |
| F42 | 7.5 Amp Brown | Brake System Module, Electric Power Steering |
| F43 | 20 Amp Yellow | Washer Pump Front And Rear |
| F47 | 20 Amp Yellow | Rear Left Window Lifter |
| F48 | 20 Amp Yellow | Rear Right Window Lifter |

| Cavity | Blade Fuse | Description |
|---------------|-------------------|---|
| F49 | 7.5 Amp Brown | Park Assist, Blind Spot, Voltage Stabilizer, Humidity Sensor, Electronic Steering Lock, Temp Sense, Mirror, Heated Seats, Light And Rain Sensor, Start Stop Switch |
| F50 | 7.5 Amp Brown | Occupant Restraint Controller |
| F51 | 7.5 Amp Brown | Electronic Climate Control, Occupant Classification, Rear View Camera, Climate Control, Headlamp Leveling, Terrain Select, Heated Rear Window, Trailer Tow, Haptic Lane Departure |
| F53 | 7.5 Amp Brown | Keyless Ignition Node Module, Electric Park Brake, RF Hub, Cluster |
| F94 | 15 Amp Blue | Lumbar Adjust Driver Seat, Power Outlets |

Rear Cargo Fuse/Relay Distribution Unit -If Equipped

To access the fuses, remove the access door from the left rear panel of the rear cargo area.

The fuses may be contained in two units. Fuse holder No. 1 is located closest to the rear of the vehicle and fuse holder No. 2 (If equipped with trailer towing) is located closest to the front of the vehicle.

NOTE:

The fuse may be contained in a In-line Fuse holder (If equipped with a Sun Roof or Power Inverter Module).

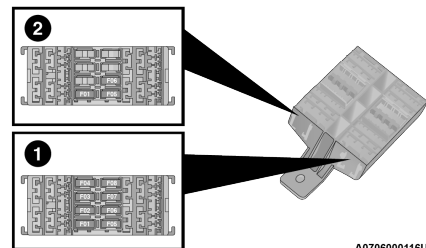

A0706000116US

Rear Cargo Fuse Cavities

1 – Fuse Holder No. 1

2 – Fuse Holder No. 2

Fuse Holder No. 1

| * If Equipped | | |
|----------------------|------------------|-----------------------------|
| Cavity | Mini Fuse | Description |
| F2 | 30 Amp Green | Memory Seat |
| F3 | 20 Amp Yellow | Sun Roof* |
| F4 | 30 Amp Green | Power Seat (Passenger Side) |
| F5 | 30 Amp Green | Power Seat (Driver Side) |
| F6 | 7.5 Amp Brown | Power Lumbar (Power Seats) |
| F8 | 20 Amp Yellow | Heated Seats* |

142 SERVICING AND MAINTENANCE

On the Rear Cargo Fuse/Relay Distribution Unit bracket, there is a Maxi Fuse holder for the Power Liftgate and an ATO / Uni Val fuse holder for the HIFI Audio System.

| * If Equipped | | |
|----------------------|------------------|--------------------|
| Cavity | Maxi Fuse | Description |
| F01 | 30 Amp Green | Power Liftgate* |

| * If Equipped | | |
|----------------------|---------------------------|--------------------|
| Cavity | ATO / Uni-Val Fuse | Description |
| F02 | 25 Amp Clear | HIFI Audio System* |

BULB REPLACEMENT

Replacement Bulbs

NOTE:

See an authorized dealer for LED bulb replacement.

| Interior Bulbs | |
|---|-------------|
| Lamps | Bulb Number |
| Front Courtesy Light | C5W |
| Front Courtesy Lights (Sun Visors) - If Equipped | C5W |
| Rear Dome Light (Models Without Retractable roof) | C5W |
| Rear Interior Lights (Models With Retractable roof) | C5W |
| Interior Lights | HT-168 |
| Dome Light (Glove Box) | HT-168 |

| Exterior Bulbs | |
|--|---|
| Lamps | Bulb Number |
| Low Beam Headlamps | LED (Serviced at an authorized dealer) |
| High Beam Headlamps | LED (Serviced at an authorized dealer) |
| Front Position/Daytime Running Lights (DRL) | LED (Serviced at an authorized dealer) |
| Front Direction Indicator Lamps | Base:WY21W Premium: LED (Serviced at an authorized dealer) |
| Front Position | LED (Serviced at an authorized dealer) |
| Front Fog Lamps | LED (Serviced at an authorized dealer) |
| Side Indicators (Front - HID) | LED (Serviced at an authorized dealer) |
| Side Indicators (Side View Mirror) | LED (Serviced at an authorized dealer) |
| Tail/Brake Lights | Premium Tail Lights: LED (Serviced at an authorized dealer) Base Tail Lights: W21/5WLL-M |
| Turn Signal Light | W21WLL For Premium Tail Lamps W21/5WLL For Base Tail Lamps |

| Exterior Bulbs | |
|---------------------------------------|--|
| Lamps | Bulb Number |
| Center High Mounted Stop Lamp (CHMSL) | LED (Serviced at an authorized dealer) |
| License Plate Lamp | LED (Serviced at an authorized dealer) |
| Liftgate Lamp Reverse | W21WLL |
| Liftgate Lamp Tail | LED (Serviced at an authorized dealer) |

Replacing Exterior Bulbs

Turn Signal Light

To replace the bulbs proceed as follows:

1. Open hood.
2. Remove the cover over the head lamps.
3. Remove the electrical connectors.

4. For the turn signal bulb, rotate in a counter-clockwise direction and remove the bulb and bulb socket. Pull the bulb axially to remove it from the socket.
5. Install the bulb and sockets and rotate them clockwise making sure that it is properly locked.
6. Reconnect the electrical connectors.
7. Reinstall cover over the head lamps.

NOTE:

It is advised referring to an authorized dealer for service.

Rear Body Side Tail Lamps

Contain the following:

- Position lights
- Stop lights
- Direction indicator

To replace the bulbs proceed as follows:

1. Open the liftgate.
2. Using a suitable tool remove fasteners.

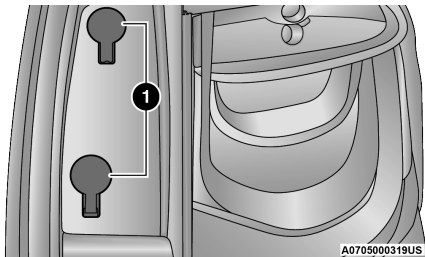

Body Side Tail Lamp Opening

1 – Fasteners

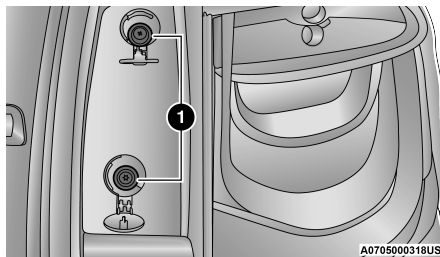

Body Side Tail Lamp Opening

1 – Fasteners

3. Disconnect the electrical connector by pushing the release.

4. Remove the rear body side tail lamp, sliding it away from the back of the vehicle.

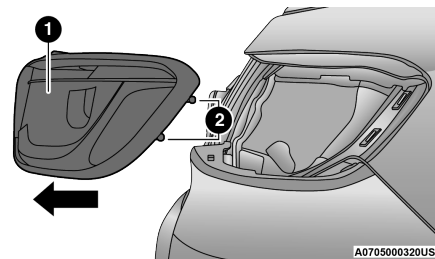

Body Side Tail Lamp

1 – Rear Body Side Tail Lamp
2 – Ball Stud

- Replace the bulb as necessary by turning and removing the bulb housing.

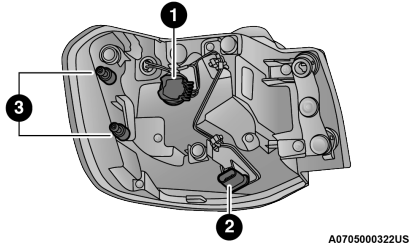

Reverse Side of Tail Lamp

- 1 – Direction Indicator Bulb / Stop Lamp Bulb
- 2 – Electrical Connector
- 3 – Ball Studs

- Insert the new bulb, making sure it is properly locked.
- Reposition the rear body side lamp assembly on the vehicle.

- Reconnect the electrical connector.
- Reinstall the body side lamp making sure to align the ball studs.

NOTE:

Ensure uniform gap between body and lamp assembly. Lamp touching the body can create excessive stress in lens surface and lamp lens can develop a crack in the future.

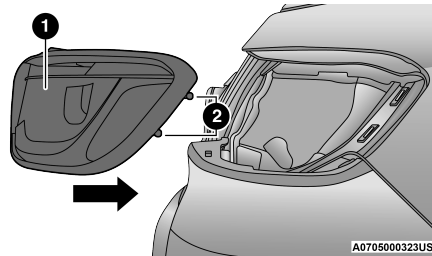

Body Side Tail Lamp

- 1 – Rear Body Side Tail Lamp
- 2 – Ball Stud

- Install fasteners and tighten body side lamp assembly.
- Finally close the tailgate.

Rear Fog Lamps

- Using a suitable non-marking tool, carefully pry at the top inboard edge of the fog lamp to disengage the snap features.
- Disconnect the electrical connector by pushing down on locking mechanism.
- Remove socket by turning it counter-clockwise and remove from lamp.
- Pull the bulb to remove it from the socket.
- Replace bulb and twist the socket clockwise to reinstall.
- Reconnect the electrical connector.
- Reinstall the lamp by snapping in the locking tab features on the left and right edges of the fog lamp.

Reverse Lamps

1. Open the liftgate.
2. Using a suitable tool remove the access panel for body side lamps, remove liftgate access cover for liftgate lamps.

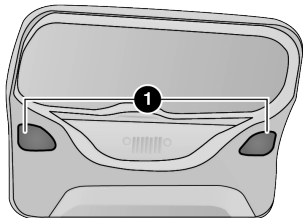

A0705000324US

Liftgate

1 – Liftgate Access Covers

3. Disconnect the electrical connector by pushing the release.

4. Remove bulb and replace making sure it is properly locked.
5. Reconnect the electrical connector.
6. Reinstall the access panels making sure they are locked in correctly.
7. Finally close the tailgate.

WARNING!

- Modifications or repair of the electrical system performed incorrectly and without taking into account the technical characteristics can cause malfunctions with the risk of fire.
- Halogen lamps contain gas under pressure, in the event of breakage be careful of the projection of fragments of glass.

(Continued)

WARNING! (Continued)

- Halogen lamps must be handled by touching only the metallic part. If the transparent bulb is in contact with the fingers, it reduces the intensity of the emitted light and you can also affect the life of the lamp. In case of accidental contact, rub the bulb with a cloth dampened with alcohol and allow to dry.

3rd Stop Lamp

The CHMSL is LED. See an authorized dealer for replacement.

License Plate Lights

The license plate light is LED. See an authorized dealer for replacement.

Replacing Interior Bulbs

Front Courtesy Light

To replace the bulbs proceed as follows:

1. Using a suitable tool remove the front courtesy light assembly.

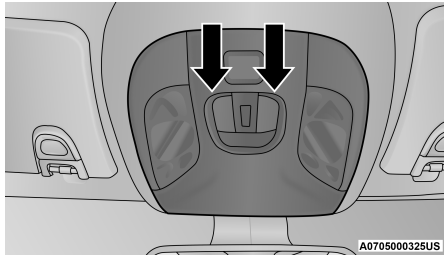

Front Courtesy Light

2. Release the retainer clips and bulb housing as shown.

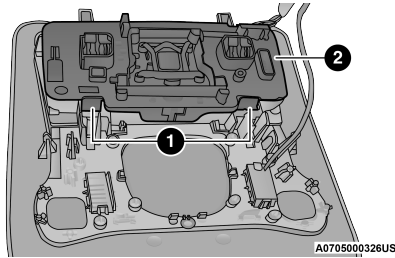

Front Courtesy Bulb Housing

- 1 – Retaining Clips
2 – Bulb Housing

3. Replace the bulbs by pulling straight out of bulb housing.

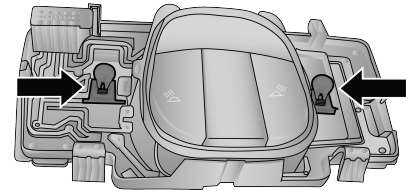

Front Courtesy Bulb Housing

4. Insert the new bulbs, making sure that they are properly locked.
5. Reassemble the bulb housing and courtesy light housing making sure that they are properly locked.
6. Install the front courtesy light, making sure that it is properly locked.

Dome Light Vanity Mirror — If Equipped

To replace the bulbs proceed as follows:

1. Lift the cover of the mirror and pull out the mirror frame with the mirror light cover attached.
2. Replace the bulb, releasing it from the side contacts, and then insert the new bulb, making sure that it is properly locked between the contacts.

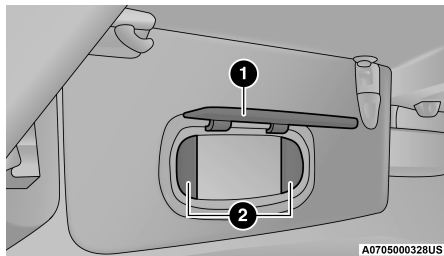

Visor

- 1 — Visor Mirror Cover
- 2 — Visor Mirror Light

3. Reinstall the visor mirror light cover making sure that it is properly locked.
4. Finally lower the visor mirror cover to the mirror.

Dome Light Glove Compartment

To replace the bulb proceed as follows:

1. Open the glove compartment.
2. Place your fingers inside the light assembly, pull the bulb to replace it.

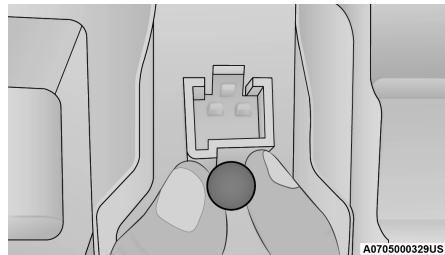

Bulb Removal/Installation

3. Insert the new bulb, making sure it is properly locked.

Dome Light

To replace the bulbs proceed as follows:

1. Lower the handle in the direction shown; remove the dome light.

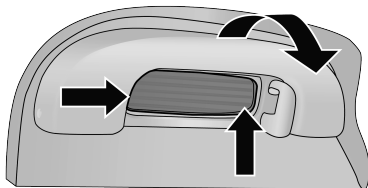

A0705000330US

Grab Handle/Dome Light

2. Replace the bulb by removing it from the side contacts.

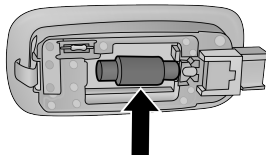

A0705000331US

Bulb

3. Insert the new bulb, locking it between the contacts.
4. Reinstall the dome light.

Interior Cargo Lights

To replace the bulbs proceed as follows:

1. Using thumb with slight pressure – push bulb holder to the side.

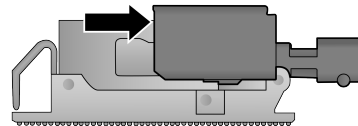

A0705000332US

Bulb Holder

2. Fully disengage the bulb holder from the housing.

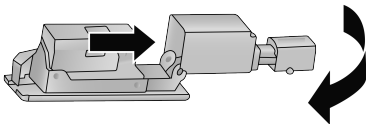

Bulb Holder

A0705000333US

3. Rotate bulb holder to replace bulb.

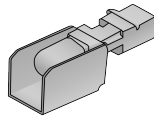

Bulb

A0705000334US

WARNING!

- Modifications or repair of the electrical system performed incorrectly and without taking into account the technical characteristics can cause malfunctions with the risk of fire.

(Continued)

WARNING! (Continued)

- Halogen lamps contain gas under pressure, in the event of breakage be careful of the projection of fragments of glass.
- Halogen lamps must be handled by touching only the metallic part. If the transparent bulb is in contact with the fingers, it reduces the intensity of the emitted light and you can also affect the life of the lamp. In case of accidental contact, rub the bulb with a cloth dampened with alcohol and allow to dry.

NOTE:

It is recommended to have your bulbs replaced by an authorized dealer.

TIRES

TIRE SAFETY INFORMATION

Tire safety information will cover aspects of the following information: Tire Markings, Tire Identification Numbers, Tire Terminology and Definitions, Tire Pressures, and Tire Loading.

Tire Markings

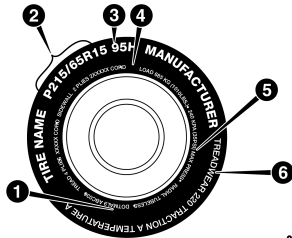

Tire Markings

0601085396US

- 1 – US DOT Safety Standards Code (TIN)
- 2 – Size Designation
- 3 – Service Description
- 4 – Maximum Load
- 5 – Maximum Pressure
- 6 – Treadwear, Traction and Temperature Grades

Tire Loading And Tire Pressure

NOTE:

The proper cold tire inflation pressure is listed on the driver's side B-pillar or the rear edge of the driver's side door.

Check the inflation pressure of each tire, including the spare tire (if equipped), at least monthly and inflate to the recommended pressure for your vehicle.

Tire And Loading Information Placard

This placard tells you important information about the:

1. Number of people that can be carried in the vehicle.
2. Total weight your vehicle can carry.
3. Tire size designed for your vehicle.
4. Cold tire inflation pressures for the front, rear, and spare tires.

Loading

The vehicle maximum load on the tire must not exceed the load carrying capacity of the tire on your vehicle. You will not exceed the tire's load carrying capacity if you adhere to the loading conditions, tire size, and cold tire inflation pressures specified on the Tire and Loading Information placard. For a full copy of the owner's manual, please refer to Jeep-India.com or get in touch with the authorized service center.

NOTE:

Under a maximum loaded vehicle condition, gross axle weight rating (GAWR) for the front and rear axles must not be exceeded. For further information on GAWR, vehicle loading, and trailer towing please refer to Jeep-India.com or get in touch with the authorized service center.

TIRES — GENERAL INFORMATION

Tire Pressure

Proper tire inflation pressure is essential to the safe and satisfactory operation of your vehicle. Four primary areas are affected by improper tire pressure:

- Safety
- Fuel Economy
- Tread Wear
- Ride Comfort and Vehicle Stability

Safety

WARNING!

- Improperly inflated tires are dangerous and can cause collisions.
- Underinflation increases tire flexing and can result in overheating and tire failure.

(Continued)

WARNING! (Continued)

- Overinflation reduces a tire's ability to cushion shock. Objects on the road and chuckholes can cause damage that result in tire failure.
- Overinflated or underinflated tires can affect vehicle handling and can fail suddenly, resulting in loss of vehicle control.
- Unequal tire pressures can cause steering problems. You could lose control of your vehicle.
- Unequal tire pressures from one side of the vehicle to the other can cause the vehicle to drift to the right or left.
- Always drive with each tire inflated to the recommended cold tire inflation pressure.

Both underinflation and overinflation affect the stability of the vehicle and can produce a feeling of sluggish response or over responsiveness in the steering.

NOTE:

- Unequal tire pressures from side to side may cause erratic and unpredictable steering response.
- Unequal tire pressure from side to side may cause the vehicle to drift left or right.

Fuel Economy

Underinflated tires will increase tire rolling resistance resulting in higher fuel consumption.

Tread Wear

Improper cold tire inflation pressures can cause abnormal wear patterns and reduced tread life, resulting in the need for earlier tire replacement.

Ride Comfort And Vehicle Stability

Proper tire inflation contributes to a comfortable ride. Overinflation produces a jarring and uncomfortable ride.

Tire Inflation Pressures

The proper cold tire inflation pressure is listed on the left side B-pillar or rear edge of the passenger door.

At least once a month:

- Check and adjust tire pressure with a good quality pocket-type pressure gauge. Do not make a visual judgment when determining proper inflation. Tires may look properly inflated even when they are underinflated.
- Inspect tires for signs of tire wear or visible damage.

CAUTION!

After inspecting or adjusting the tire pressure, always reinstall the valve stem cap. This will prevent moisture and dirt from entering the valve stem, which could damage the valve stem.

Inflation pressures specified on the placard are always “cold tire inflation pressure”. Cold tire inflation pressure is defined as the tire pressure after the vehicle has not been driven for at least three hours, or driven less than 1 mile (1.6 km) after sitting for a minimum of three hours. The cold tire inflation pressure must not exceed the maximum inflation pressure molded into the tire sidewall.

Check tire pressures more often if subject to a wide range of outdoor temperatures, as tire pressures vary with temperature changes.

Tire pressures change by approximately 1 psi (7 kPa) per 12°F (7°C) of air temperature change. Keep this in mind when checking tire pressure inside a garage, especially in the Winter.

Example: If garage temperature = 68°F (20°C) and the outside temperature = 32°F (0°C) then the cold tire inflation pressure should be increased by 3 psi (21 kPa), which equals 1 psi (7 kPa) for every 12°F (7°C) for this outside temperature condition.

Tire pressure may increase from 2 to 6 psi (13 to 40 kPa) during operation. DO NOT reduce this normal pressure build-up or your tire pressure will be too low.

Tire Pressures For High Speed Operation

The manufacturer advocates driving at safe speeds and within posted speed limits. Where speed limits or conditions are such that the vehicle can be driven at high speeds, maintaining correct tire inflation pressure is very important. Increased tire pressure and reduced vehicle loading may be required for high-speed vehicle operation. Refer to an authorized tire dealer or original equipment vehicle dealer for recommended safe operating speeds, loading and cold tire inflation pressures.

WARNING!

High speed driving with your vehicle under maximum load is dangerous. The added strain on your tires could cause them to fail. You could have a serious collision. Do not drive a vehicle loaded to the maximum capacity at continuous speeds above 75 mph (120 km/h).

Radial Ply Tires

WARNING!

Combining radial ply tires with other types of tires on your vehicle will cause your vehicle to handle poorly. The instability could cause a collision. Always use radial ply tires in sets of four. Never combine them with other types of tires.

Tire Repair

If your tire becomes damaged, it may be repaired if it meets the following criteria:

- The tire has not been driven on when flat.
- The damage is only on the tread section of your tire (sidewall damage is not repairable).
- The puncture is no greater than a ¼ of an inch (6 mm).

Consult an authorized tire dealer for tire repairs and additional information.

Damaged Run Flat tires, or Run Flat tires that have experienced a loss of pressure should be replaced immediately with another Run Flat tire of identical size and service description (Load Index and Speed Symbol). Replace the tire pressure sensor as well as it is not designed to be reused.

Run Flat Tires — If Equipped

Run Flat tires allow you the capability to drive 50 miles (80 km) at 50 mph (80 km/h) after a rapid loss of inflation pressure. This rapid loss of inflation is referred to as the Run Flat mode. A Run Flat mode occurs when the tire inflation pressure is of/or below 14 psi (96 kPa). Once a Run Flat tire reaches the Run Flat mode it has limited driving capabilities and needs to be replaced immediately.

A Run Flat tire is not repairable. When a Run Flat tire is changed after driving with underinflated tire condition, please replace the TPM sensor as it is not designed to be reused when driven under Run Flat mode 14 psi (96 kPa) condition.

NOTE:

TPM Sensor must be replaced after driving the vehicle on a flat tire condition.

It is not recommended driving a vehicle loaded at full capacity or to tow a trailer while a tire is in the Run Flat mode.

For a full copy of the owner's manual, please refer to Jeep-India.com or get in touch with the authorized service center.

Tire Spinning

When stuck in mud, sand, snow, or ice conditions, do not spin your vehicle's wheels above 30 mph (48 km/h) or for longer than 30 seconds continuously without stopping.

WARNING!

Fast spinning tires can be dangerous. Forces generated by excessive wheel speeds may cause tire damage or failure. A tire could explode and injure someone. Do not spin your vehicle's wheels faster than 30 mph (48 km/h) for more than 30 seconds continuously when you are stuck, and do not let anyone near a spinning wheel, no matter what the speed.

Tread Wear Indicators

Tread wear indicators are in the original equipment tires to help you in determining when your tires should be replaced.

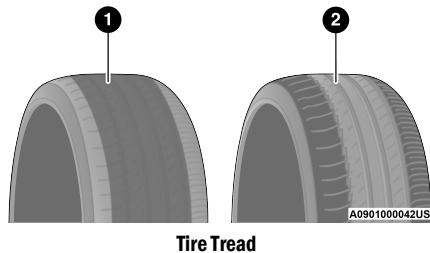

- 1 – Worn Tire
2 – New Tire

These indicators are molded into the bottom of the tread grooves. They will appear as bands when the tread depth becomes a 1/16 of an inch (1.6 mm). When the tread is worn to the tread wear indicators, the tire should be replaced.

For further information → page 159.

Life Of Tire

The service life of a tire is dependent upon varying factors including, but not limited to:

- Driving style.
- Tire pressure - Improper cold tire inflation pressures can cause uneven wear patterns to develop across the tire tread. These abnormal wear patterns will reduce tread life, resulting in the need for earlier tire replacement.
- Distance driven.
- Terrain

- Performance tires, tires with a speed rating of V or higher, and Summer tires typically have a reduced tread life. Rotation of these tires per the vehicle's Service and Warranty Handbook is highly recommended.

WARNING!

Tires and the spare tire should be replaced after six years, regardless of the remaining tread. Failure to follow this warning can result in sudden tire failure. You could lose control and have a collision resulting in serious injury or death.

NOTE:

Wheel valve stem must be replaced as well when installing new tires due to wear and tear in existing tires.

Keep dismounted tires in a cool, dry place with as little exposure to light as possible. Protect tires from contact with oil, grease, and gasoline.

Replacement Tires

The tires on your new vehicle provide a balance of many characteristics. They should be inspected regularly for wear and correct cold tire inflation pressures. The manufacturer strongly recommends that you use tires equivalent to the originals in size, quality and performance when replacement is needed → page 158. Refer to the Tire and Loading Information placard or the Vehicle Certification Label for the size designation of your tire. The Load Index and Speed Symbol for your tire will be found on the original equipment tire sidewall.

It is recommended to replace the two front tires or two rear tires as a pair. Replacing just one tire can seriously affect your vehicle's handling. If you ever replace a wheel, make sure that the wheel's specifications match those of the original wheels.

It is recommended you contact an authorized tire dealer or original equipment dealer with any questions you may have on tire specifications or capability. Failure to use equivalent replacement tires may adversely affect the safety, handling, and ride of your vehicle.

WARNING!

- Do not use a tire, wheel size, load rating, or speed rating other than that specified for your vehicle. Some combinations of unapproved tires and wheels may change suspension dimensions and performance characteristics, resulting in changes to steering, handling, and braking of your vehicle. This can cause unpredictable handling and stress to steering and suspension components. You could lose control and have a collision resulting in serious injury or death. Use only the tire and wheel sizes with load ratings approved for your vehicle.

(Continued)

WARNING! (Continued)

- Never use a tire with a smaller load index or capacity, other than what was originally equipped on your vehicle. Using a tire with a smaller load index could result in tire overloading and failure. You could lose control and have a collision.
- Failure to equip your vehicle with tires having adequate speed capability can result in sudden tire failure and loss of vehicle control.

CAUTION!

Replacing original tires with tires of a different size may result in false speedometer and odometer readings.

TIRE TYPES

All Season Tires — If Equipped

All Season tires provide traction for all seasons (Spring, Summer, Autumn, and Winter). Traction levels may vary between different all season tires. All season tires can be identified by the M+S, M&S, M/S or MS designation on the tire sidewall. Use all season tires only in sets of four; failure to do so may adversely affect the safety and handling of your vehicle.

Summer Or Three Season Tires — If Equipped

Summer tires provide traction in both wet and dry conditions, and are not intended to be driven in snow or on ice. If your vehicle is equipped with Summer tires, be aware these tires are not designed for Winter or cold driving conditions. Install Winter tires on your vehicle when ambient temperatures are less than 40° F (5° C) or if roads are covered with ice or snow.

For more information, contact an authorized dealer.

Summer tires do not contain the all season designation or mountain/snowflake symbol on the tire sidewall. Use Summer tires only in sets of four; failure to do so may adversely affect the safety and handling of your vehicle.

WARNING!

Do not use Summer tires in snow/ice conditions. You could lose vehicle control, resulting in severe injury or death. Driving too fast for conditions also creates the possibility of loss of vehicle control.

Snow Tires

Some areas of the country require the use of snow tires during the Winter. Snow tires can be identified by a “mountain/snowflake” symbol on the tire sidewall.



If you need snow tires, select tires equivalent in size and type to the original equipment tires. Use snow tires only in sets of four; failure to do so may adversely affect the safety and handling of your vehicle.

Snow tires generally have lower speed ratings than what was originally equipped with your vehicle and should not be operated at sustained speeds over 75 mph (120 km/h). For speeds above 75 mph (120 km/h) refer to original equipment or an authorized tire dealer for recommended safe operating speeds, loading and cold tire inflation pressures.

While studded tires improve performance on ice, skid and traction capability on wet or dry surfaces may be poorer than that of non-studded tires. Some states prohibit studded tires; therefore, local laws should be checked before using these tire types.

SPARE TIRES — IF EQUIPPED

NOTE:

For vehicles equipped with Tire Service Kit instead of a spare tire, please refer to “Tire Service Kit” in “In Case Of Emergency” for further information.

CAUTION!

Because of the reduced ground clearance, do not take your vehicle through an automatic car wash with a compact or limited use temporary spare installed. Damage to the vehicle may result.

Spare Tire Matching Original Equipped Tire And Wheel — If Equipped

Your vehicle may be equipped with a spare tire and wheel equivalent in look and function to the original equipment tire and wheel found on the front or rear axle of your vehicle. This spare tire may be used in the tire rotation for your vehicle.

If your vehicle has this option, refer to an authorized tire dealer for the recommended tire rotation pattern.

Compact Spare Tire — If Equipped

The compact spare is for temporary emergency use only. You can identify if your vehicle is equipped with a compact spare by looking at the spare tire description on the Tire and Loading Information Placard located on the driver’s side door opening or on the sidewall of the tire. Compact spare tire descriptions begin with the letter “T” or “S” preceding the size designation. Example: T145/80D18 103M.

T, S = Temporary Spare Tire

Since this tire has limited tread life, the original equipment tire should be repaired (or replaced) and reinstalled on your vehicle at the first opportunity.

Do not install a wheel cover or attempt to mount a conventional tire on the compact spare wheel, since the wheel is designed specifically for the compact spare tire. Do not install more than one compact spare tire and wheel on the vehicle at any given time.

WARNING!

Compact and collapsible spares are for temporary emergency use only. With these spares, do not drive more than 50 mph (80 km/h). Temporary use spares have limited tread life. When the tread is worn to the tread wear indicators, the temporary use spare tire needs to be replaced. Be sure to follow the warnings, which apply to your spare. Failure to do so could result in spare tire failure and loss of vehicle control.

Full Size Spare — If Equipped

The full size spare is for temporary emergency use only. This tire may look like the originally equipped tire on the front or rear axle of your vehicle, but it is not. This spare tire may have limited tread life. When the tread is worn to the tread wear indicators, the temporary use full size spare tire needs to be replaced. Since it is not the same as your original equipment tire, replace (or repair) the original equipment tire and reinstall on the vehicle at the first opportunity.

Limited Use Spare — If Equipped

The limited use spare tire is for temporary emergency use only. This tire is identified by a label located on the limited use spare wheel. This label contains the driving limitations for this spare. This tire may look like the original equipped tire on the front or rear axle of your vehicle, but it is not. Installation of this limited use spare tire affects vehicle handling. Since it

is not the same as your original equipment tire, replace (or repair) the original equipment tire and reinstall on the vehicle at the first opportunity.

WARNING!

Limited use spares are for emergency use only. Installation of this limited use spare tire affects vehicle handling. With this tire, do not drive more than the speed listed on the limited use spare wheel. Keep inflated to the cold tire inflation pressures listed on your Tire and Loading Information Placard located on the driver's side B-pillar or the rear edge of the driver's side door. Replace (or repair) the original equipment tire at the first opportunity and reinstall it on your vehicle. Failure to do so could result in loss of vehicle control.

TIRE ROTATION RECOMMENDATIONS

The tires on the front and rear of your vehicle operate at different loads and perform different steering, handling, and braking functions. For these reasons, they wear at unequal rates.

These effects can be reduced by timely rotation of tires. The benefits of rotation are especially worthwhile with aggressive tread designs such as those on On/Off Road type tires. Rotation will increase tread life, help to maintain mud, snow, and wet traction levels, and contribute to a smooth, quiet ride.

Refer to the "Service and Warranty Handbook" for the proper maintenance intervals. The reasons for any rapid or unusual wear should be corrected prior to rotation being performed.

The suggested tire rotation method is the "forward cross" shown in the following diagram.

This rotation pattern does not apply to some directional tires that must not be reversed.

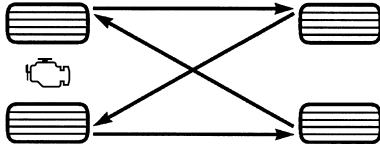

055707139

Tire Rotation (Forward Cross)

CAUTION!

Proper operation of four-wheel drive vehicles depends on tires of equal size, type and circumference on each wheel. Any difference in tire size can cause damage to the power transfer unit. Tire rotation schedule should be followed to balance tire wear.

STORING THE VEHICLE

If the vehicle should remain stationary for more than a month, observe the following precautions:

- Check that the Electric Park Brake is not engaged.
- Disconnect the negative (-) terminal from the battery post and be sure that the battery is fully charged. During storage check battery charge quarterly.
- If you do not disconnect the battery from the electrical system, check the battery charge every 30 days.

- Whenever you leave the vehicle stationary for two weeks or more, idle the engine for approximately five minutes, with the air conditioning system on and high fan speed. This will ensure proper lubrication of the system, thus minimizing the possibility of damage to the compressor when the vehicle is put back into operation.

CAUTION!

Before removal of the positive and negative terminals to the battery, wait at least a minute with ignition switch in the OFF position and close the driver's door. When reconnecting the positive and negative terminals to the battery be sure the ignition switch is in the OFF position and the driver's door is closed.

BODYWORK

PROTECTION FROM ATMOSPHERIC AGENTS

Vehicle body care requirements vary according to geographic locations and usage. Chemicals that make roads passable in snow and ice and those that are sprayed on trees and road surfaces during other seasons are highly corrosive to the metal in your vehicle. Outside parking, which exposes your vehicle to airborne contaminants, road surfaces on which the vehicle is operated, extreme hot or cold weather and other extreme conditions will have an adverse effect on paint, metal trim, and underbody protection.

The following maintenance recommendations will enable you to obtain maximum benefit from the corrosion resistance built into your vehicle.

What Causes Corrosion?

Corrosion is the result of deterioration or removal of paint and protective coatings from your vehicle.

The most common causes are:

- Road salt, dirt and moisture accumulation.
- Stone and gravel impact.
- Insects, tree sap and tar.
- Bird droppings.
- Salt in the air near seacoast localities.
- Atmospheric fallout/industrial pollutants.

BODY AND UNDERBODY MAINTENANCE

Wheel And Wheel Trim Care

All wheels and wheel trim, especially aluminum and chrome plated wheels, should be cleaned regularly using mild (neutral Ph) soap and water to maintain their luster and to prevent corrosion. Wash wheels with the same soap solution recommended for the body of the vehicle and remember to always wash when the surfaces are not hot to the touch.

Your wheels are susceptible to deterioration caused by salt, sodium chloride, magnesium chloride, calcium chloride, etc., and other road chemicals used to melt ice or control dust on dirt roads. Use a soft cloth or sponge and mild soap to wipe away promptly. Do not use harsh chemicals or a stiff brush. They can damage the wheel's protective coating that helps keep them from corroding and tarnishing.

CAUTION!

Avoid products or automatic car washes that use acidic solutions or strong alkaline additives or harsh brushes. Many aftermarket wheel cleaners and automatic car washes may damage the wheel's protective finish. Such damage is not covered by the New Vehicle Limited Warranty. Only car wash soap, Mopar® Wheel Cleaner or equivalent is recommended.

When cleaning extremely dirty wheels including excessive brake dust, care must be taken in the selection of tire and wheel cleaning chemicals and equipment to prevent damage to the wheels. Mopar® Wheel Treatment or Mopar® Chrome Cleaner or their equivalent is recommended or select a non-abrasive, non-acidic cleaner for aluminum or chrome wheels.

CAUTION!

Do not use scouring pads, steel wool, a bristle brush, metal polishes or oven cleaner. These products may damage the wheel's protective finish. Such damage is not covered by the New Vehicle Limited Warranty. Only car wash soap, Mopar® Wheel Cleaner or equivalent is recommended.

NOTE:

If you intend parking or storing your vehicle for an extended period after cleaning the wheels with wheel cleaner, drive your vehicle and apply the brakes to remove the water droplets from the brake components. This activity will remove the red rust on the brake rotors and prevent vehicle vibration when braking.

Dark Vapor Chrome, Black Satin Chrome, or Low Gloss Clear Coat Wheels**CAUTION!**

If your vehicle is equipped with these specialty wheels, DO NOT USE wheel cleaners, abrasives, or polishing compounds. They will permanently damage this finish and such damage is not covered by the New Vehicle Limited Warranty. HAND WASH ONLY USING MILD SOAP AND WATER WITH A SOFT CLOTH. Used on a regular basis; this is all that is required to maintain this finish.

Cleaning Headlights

Your vehicle is equipped with plastic headlights and fog lights that are lighter and less susceptible to stone breakage than glass headlights.

Plastic is not as scratch resistant as glass and therefore different lens cleaning procedures must be followed.

To minimize the possibility of scratching the lenses and reducing light output, avoid wiping with a dry cloth. To remove road dirt, wash with a mild soap solution followed by rinsing.

Do not use abrasive cleaning components, solvents, steel wool or other aggressive material to clean the lenses.

PRESERVING THE BODYWORK

Washing

- Wash your vehicle regularly. Always wash your vehicle in the shade using Mopar® Car Wash, or a mild car wash soap, and rinse the panels completely with water.
- If insects, tar, or other similar deposits have accumulated on your vehicle, use Mopar® Super Kleen Bug and Tar Remover to remove.

- Use a high quality cleaner wax, such as Mopar® Cleaner Wax to remove road film, stains and to protect your paint finish. Use precautions to not scratch the paint.
- Avoid using abrasive compounds and power buffing that may diminish the gloss or thin out the paint finish.

CAUTION!

- Do not use abrasive or strong cleaning materials such as steel wool or scouring powder that will scratch metal and painted surfaces.
- Use of power washers exceeding 1,200 psi (8,274 kPa) can result in damage or removal of paint and decals.

Special Care

- If you drive on salted or dusty roads or if you drive near the ocean, hose off the undercarriage at least once a month.
- Oxidation marks can also be seen on brake rotors during storage due to weather conditions like monsoon, ice, areas near the sea, and after washing the vehicle. Drive your vehicle slowly and apply the brakes several times. This activity will remove red oxidation from the brake rotors. Oxidation is normal due to the above factors.
- It is important that the drain holes in the lower edges of the doors, rocker panels, and trunk be kept clear and open.
- If you detect any stone chips or scratches in the paint, touch them up immediately.

- If your vehicle is damaged due to a collision or similar cause that destroys the paint and protective coating, have your vehicle repaired as soon as possible.
- If you carry special cargo such as chemicals, fertilizers, de-icer salt, etc., be sure that such materials are well packaged and sealed.
- If a lot of driving is done on gravel roads, consider mud or stone shields behind each wheel.
- Use Mopar® Touch Up Paint on scratches as soon as possible. An authorized dealer has touch up paint to match the color of your vehicle.

INTERIORS

SEATS AND FABRIC PARTS

Use Mopar® Total Clean to clean fabric upholstery and carpeting.

WARNING!

Do not use volatile solvents for cleaning purposes. Many are potentially flammable, and if used in closed areas they may cause respiratory harm.

Stain Repel Fabric Cleaning Procedure — If Equipped

Stain Repel seats may be cleaned in the following manner:

- Remove as much of the stain as possible by blotting with a clean, dry towel.
- Blot any remaining stain with a clean, damp towel.
- For tough stains, apply Mopar® Total Clean, or a mild soap solution to a clean, damp cloth and remove stain. Use a fresh, damp towel to remove soap residue.

- For grease stains, apply Mopar® Multi-Purpose Cleaner to a clean, damp cloth and remove stain. Use a fresh, damp towel to remove soap residue.
- Do not use any harsh solvents or any other form of protectants on Stain Repel products.

Seat Belt Maintenance

Do not bleach, dye or clean the belts with chemical solvents or abrasive cleaners. This will weaken the fabric.

If the belts need cleaning, use a mild soap solution or lukewarm water. Do not remove the belts from the vehicle to wash them. Dry with a soft cloth.

Sun damage can also weaken the fabric. Replace the belts if they appear frayed or worn or if the buckles do not work properly.

WARNING!

A frayed or torn belt could rip apart in a collision and leave you with no protection. Inspect the belt system periodically, checking for cuts, frays, or loose parts. Damaged parts must be replaced immediately. Do not disassemble or modify the system. Seat belt assemblies must be replaced after a collision if they have been damaged (i.e., bent retractor, torn webbing, etc.).

PLASTIC AND COATED PARTS

Use Mopar® Total Clean to clean vinyl upholstery.

CAUTION!

- Direct contact of air fresheners, insect repellents, suntan lotions, or hand sanitizers to the plastic, painted, or decorated surfaces of the interior may cause permanent damage. Wipe away immediately.
- Damage caused by these type of products may not be covered by your New Vehicle Limited Warranty.

Cleaning Plastic Instrument Cluster Lenses

The lenses in front of the instruments in this vehicle are molded in clear plastic. When cleaning the lenses, care must be taken to avoid scratching the plastic.

Clean with a wet soft cloth. A mild soap solution may be used, but do not use high alcohol content or abrasive cleaners. If soap is used, wipe clean with a clean damp cloth. Dry with a soft cloth.

LEATHER SURFACES

Mopar® Total Clean is specifically recommended for leather upholstery.

Your leather upholstery can be best preserved by regular cleaning with a damp soft cloth. Small particles of dirt can act as an abrasive and damage the leather upholstery and should be removed promptly with a damp cloth. Stubborn soils can be removed easily with a soft cloth and Mopar® Total Clean. Care should be taken to avoid soaking your leather upholstery with any liquid. Please do not use polishes, oils, cleaning fluids, solvents, detergents, or ammonia-based cleaners to clean your leather upholstery.

NOTE:

If equipped with light colored leather, it tends to show any foreign material, dirt, and fabric dye transfer more so than darker colors. The leather is designed for easy cleaning, and FCA recommends Mopar® total care leather cleaner applied on a cloth to clean the leather seats as needed.

CAUTION!

Do not use Alcohol and Alcohol-based and/or Ketone based cleaning products to clean leather upholstery, as damage to the upholstery may result.

GLASS SURFACES

All glass surfaces should be cleaned on a regular basis with Mopar® Glass Cleaner, or any commercial household-type glass cleaner. Never use an abrasive type cleaner. Use caution when cleaning the inside rear window equipped with electric defrosters or windows equipped with radio antennas. Do not use scrapers or other sharp instruments that may scratch the elements.

When cleaning the rear view mirror, spray cleaner on the towel or cloth that you are using. Do not spray cleaner directly on the mirror.

TECHNICAL SPECIFICATIONS

VEHICLE IDENTIFICATION NUMBER (VIN)

The VIN is found on the left front corner of the windshield and is visible from the outside of the vehicle. The VIN number also is stamped into the right front body, on the front floor. With the right front seat in the rear most position, a door in the carpet can be opened to reveal the VIN. It also appears on the Automobile Information Disclosure Label affixed to a window on your vehicle, the vehicle registration, and the title.

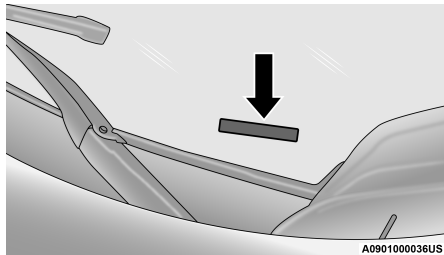

Vehicle Identification Number

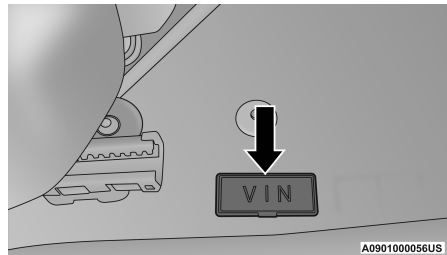

Right Front Body VIN Location

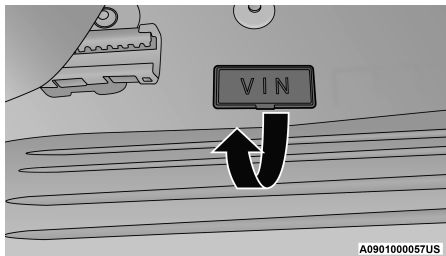

Opening The VIN Door

NOTE:
It is illegal to remove or alter the VIN.

BRAKE SYSTEM

Your vehicle is equipped with power assisted brakes as standard equipment. In the event power assist is lost for any reason (for example, repeated brake applications with the engine off), the brakes will still function. However, the effort required to brake the vehicle will be much greater than that required with the power system operating.

If either of the two hydraulic systems lose normal capability, the remaining system will still function with some loss of overall braking effectiveness. This will be evident by increased pedal travel during application and greater pedal force required to slow or stop. In addition, if the malfunction is caused by an internal leak, as the brake fluid in the master cylinder drops, the Brake Warning Light will light.

WARNING!

Driving a vehicle with the “Brake Warning Light” on is dangerous. A significant decrease in braking performance or vehicle stability during braking may occur. It will take you longer to stop the vehicle or will make your vehicle harder to control. You could have a collision. Have the vehicle checked immediately.

WHEEL AND TIRE TORQUE SPECIFICATIONS

Proper lug nut/bolt torque is very important to ensure that the wheel is properly mounted to the vehicle. Any time a wheel has been removed and reinstalled on the vehicle, the lug nuts/bolts should be torqued using a properly calibrated torque wrench using a six sided (hex) deep wall socket.

TORQUE SPECIFICATIONS

| Lug Nut/Bolt Torque | **Lug Nut/Bolt Size | Lug Nut/Bolt Socket Size |
|------------------------|---------------------|--------------------------|
| 100 Ft-Lb (135 N·m) | M12 x 1.25 | 17 mm |

**Use only authorized dealer recommended lug nuts/bolts and clean or remove any dirt or oil before tightening.

Inspect the wheel mounting surface prior to mounting the tire and remove any corrosion or loose particles.

Tighten the lug nuts/bolts in a star pattern until each nut/bolt has been tightened twice. Ensure that the socket is fully engaged on the lug nut/bolt (do not insert it halfway).

NOTE:

If in doubt about the correct tightness, have them checked with a torque wrench by an authorized dealer or service station.

After 25 miles (40 km), check the lug nut/bolt torque to be sure that all the lug nuts/bolts are properly tightened.

WARNING!

To avoid the risk of forcing the vehicle off the jack, do not tighten the lug nuts/bolts fully until the vehicle has been lowered. Failure to follow this warning may result in personal injury.

CAUTION!

Do not use pneumatic wrench to tighten the wheel bolts. This may overtighten the wheel bolts and damage the chrome caps of the wheel nut.

FUEL REQUIREMENTS — GASOLINE ENGINE

Light spark knock at low engine speeds is not harmful to your engine. However, continued heavy spark knock at high speeds can cause damage, and immediate service is required. Poor quality gasoline can cause problems such as hard starting, stalling, and hesitations. If you experience these symptoms, try another brand of gasoline before considering service for the vehicle.

1.4L ENGINE

This engine is designed to meet all emission regulations and provide satisfactory fuel economy and performance when using

high-quality unleaded gasoline having a minimum research octane rating (RON) of 95. For optimum performance and fuel economy the use of minimum research octane rating (RON) of 98 or higher is recommended.

METHANOL

(Methyl) is used in a variety of concentrations when blended with unleaded gasoline. You may find fuels containing 3% or more methanol along with other alcohols called cosolvents. Problems that result from using methanol/gasoline are not the responsibility of the manufacturer. While MTBE is an oxygenate made from methanol, it does not have the negative effects of methanol.

WARNING!

Do not use gasolines containing methanol. Use of these blends may result in starting and drivability problems and may damage critical fuel system components.

ETHANOL

The manufacturer recommends that your vehicle be operated on fuel containing no more than 10% ethanol. Purchasing your fuel from a reputable supplier may reduce the risk of exceeding this 10% limit and/or of receiving fuel with abnormal properties.

CAUTION!

Use of fuel with ethanol content higher than 10% may result in engine malfunction, starting and operating difficulties, and materials degradation. These adverse effects could result in permanent damage to your vehicle.

E-85 USAGE IN NON-FLEX FUEL VEHICLES

Non-Flex Fuel Vehicles (FFV) are compatible with gasoline containing up to 15% ethanol (E-15). Gasoline with higher ethanol content may void the New Vehicle Limited Warranty.

If a Non-FFV vehicle is inadvertently fueled with E-85 fuel, the engine will have some or all of these symptoms:

- Operate in a lean mode.
- OBD II “Malfunction Indicator Light” on.
- Poor engine performance.
- Poor cold start and cold drivability.
- Increased risk for fuel system component corrosion.

MATERIALS ADDED TO FUEL

Indiscriminate use of fuel system cleaning agents should be avoided. Many of these materials intended for gum and varnish removal may contain active solvents or similar ingredients. These can harm fuel system gasket and diaphragm materials.

GASOLINE/OXYGENATE BLENDS

Some fuel suppliers blend unleaded gasoline with oxygenates such as ethanol.

CAUTION!

DO NOT use E-85, gasoline containing methanol, or gasoline containing more than 15% ethanol (E-15). Use of these blends may result in starting and drivability problems, damage critical fuel system components, cause emissions to exceed the applicable standard, and/or cause the Malfunction Indicator Light to illuminate. Please observe pump labels as they should clearly communicate if a fuel contains greater than 15% ethanol (E-15).

CNG AND LP FUEL SYSTEM MODIFICATIONS

Modifications that allow the engine to run on Compressed Natural Gas (CNG) or Liquid Propane (LP) may result in damage to the engine, emissions, and fuel system components. Problems that result from running

CNG or LP are not the responsibility of FCA and may void the New Vehicle Limited Warranty.

FUEL SYSTEM CAUTIONS

CAUTION!

Follow these guidelines to maintain your vehicle's performance:

- The use of leaded gasoline is prohibited by law. Using leaded gasoline can impair engine performance and damage the emissions control system.
- An out-of-tune engine or certain fuel or ignition malfunctions can cause the catalytic converter to overheat. If you notice a pungent burning odor or some light smoke, your engine may be out of tune or malfunctioning and may require immediate service. Contact an authorized dealer for service assistance.

(Continued)

CAUTION! *(Continued)*

- The use of fuel additives, which are now being sold as octane enhancers, is not recommended. Most of these products contain high concentrations of methanol. Fuel system damage or vehicle performance problems resulting from the use of such fuels or additives is not the responsibility of the manufacturer and may void or not be covered under the New Vehicle Limited Warranty.

NOTE:

Intentional tampering with the emissions control system can result in civil penalties being assessed against you.

FUEL REQUIREMENTS — DIESEL ENGINE

DIESEL ENGINE

Use good quality diesel fuel from a reputable supplier. If the outside temperature is very low, the diesel fuel thickens due to the formation of paraffin clots with consequent defective operation of the fuel supply system.

In order to avoid these problems different types of fuel are distributed according to the season: Summer type, Winter type and arctic type (cold/mountain areas). If fueling with diesel fuel whose features are not suitable for the temperature of use, it is advisable to mix in a suitable additive with the fuel. With the proportions shown on the container, pour the additive in the tank before fueling.

When using or parking the vehicle for a long time in the mountains or cold areas, it is advisable to refuel using locally available fuel. In this case, it is also advisable to keep the tank over half full.

This vehicle must only use premium diesel fuel that meets the requirements of EN 590.

WARNING!

Do not use alcohol or gasoline as a fuel-blending agent. They can be unstable under certain conditions and hazardous or explosive when mixed with diesel fuel.

Diesel fuel is seldom completely free of water. To prevent fuel system trouble, drain the accumulated water from the fuel/water separator using the provided fuel/water separator drain. If you buy good quality fuel and follow the cold weather advice above, fuel conditioners should not be required in your vehicle. If available in your area, a high cetane “premium” diesel fuel may offer improved cold-starting and warm-up performance.

FLUID CAPACITIES

| | US | Metric |
|--|--------------|------------|
| Fuel (Approximate) | | |
| All Engines | 15.9 Gallons | 60 Liters |
| AdBlue® (UREA) Fluid Tank – If Equipped | 3.4 Gallons | 13 Liters |
| Engine Oil With Filter | | |
| 1.4L Gasoline Engine | 4.0 Quarts | 3.8 Liters |
| 2.0L Diesel Engine | 5.1 Quarts | 4.8 Liters |
| Cooling System* | | |
| 1.4L Gasoline Engine | 5.5 Quarts | 5.2 Liters |
| 2.0L Diesel Engine | 6.8 Quarts | 6.5 Liters |
| * Includes heater and coolant recovery bottle filled to MAX level. | | |

ENGINE FLUIDS AND LUBRICANTS

| Component | Fluid, Lubricant, or Genuine Part |
|--|---|
| Engine Coolant | We recommend you use Mopar® Antifreeze/Coolant 10 Year/150,000 mile (240,000 kilometers) Formula OAT (Organic Additive Technology) meeting the requirements of the manufacturer Material Standard MS.90032. |
| Engine Oil – 1.4L Gasoline Engine | We recommend you use 0W-30 ACEA C2 – FCA 9.55535-GS1 synthetic engine oil. |
| Engine Oil – 2.0L Diesel Engine Without AdBlue® (UREA) | We recommend you use (API certified SAE 5W-30 ACEA C2 - FCA 9.55535-S1 synthetic engine oil). |
| Engine Oil – 2.0L Diesel Engine With AdBlue® (UREA) | We recommend you use (API certified SAE 0W-20 ACEA C2 - FCA 9.55535-DSX synthetic engine oil). |
| Engine Oil Filter | We recommend you use a Mopar® Engine Oil Filter. If a Mopar® Engine Oil Filter is unavailable only use filters that meet or exceed SAE/USCAR-36 Filter Performance Requirements. |
| Fuel Selection – 1.4L Gasoline Engine | Minimum of 95 Research Octane Number (RON). |
| Fuel Selection – Diesel Engine | Specification EN590. |
| Additive For Diesel Emissions AdBlue® (UREA) | AdBlue® (Urea-Water Solution) According To DIN 70 070 and ISO 22241-1. |

CAUTION!

- Mixing of engine coolant (antifreeze) other than specified Organic Additive Technology (OAT) engine coolant, may result in engine damage and may decrease corrosion protection. OAT engine coolant is different and should not be mixed with Hybrid Organic Additive Technology (HOAT) engine coolant or any “globally compatible” coolant. If a non-OAT engine coolant is introduced into the cooling system in an emergency, the cooling system will need to be drained, flushed, and refilled with fresh OAT coolant (conforming to MS.90032), by an authorized dealer as soon as possible.

(Continued)

CAUTION! *(Continued)*

- Do not use water alone or alcohol-based engine coolant products. Do not use additional rust inhibitors or anti-rust products, as they may not be compatible with the radiator engine coolant and may plug the radiator.

(Continued)

CAUTION! *(Continued)*

- This vehicle has not been designed for use with propylene glycol-based engine coolant. Use of propylene glycol-based engine coolant is not recommended.

CHASSIS FLUIDS AND LUBRICANTS

| Component | Fluid, Lubricant, or Genuine Part |
|---|--|
| Manual Transmission – If Equipped | We recommend you use Mopar® C Series Manual & Dual Dry Clutch Transmission Fluid. |
| Automatic Transmission 6 Speed (FWD Models) – If Equipped | Use only Mopar® AW-1 Automatic Transmission Fluid or equivalent. Failure to use the correct fluid may affect the function or performance of your transmission. |
| Automatic Transmission 7 Speed DDCT – If Equipped | <p>Gearbox: Use only Mopar® C Series Manual & Dual Dry Clutch Transmission Fluid or equivalent.</p> <p>Control System: Use only Mopar® C Series DDCT SAE 75W Hydraulic Fluid or equivalent.</p> <p>Failure to use the correct fluid may affect the function or performance of your transmission.</p> |
| Automatic Transmission 9 Speed (4WD Models) – If Equipped | Use only Mopar® ZF 8&9 Speed ATF Automatic Transmission Fluid, or equivalent. Failure to use the correct fluid may affect the function or performance of your transmission. |
| Power Transfer Unit (PTU) – If Equipped | We recommend you use Mopar® Front Axle/PTU Synthetic Axle Lubricant SAE 75W-90 (API GL-5). |
| Rear Differential (RDM) – If Equipped | We recommend you use Mopar® Rear Axle/RDM Synthetic Axle Lubricant SAE 75W-90 (API GL-5). |
| Brake Master Cylinder | <p>We recommend you use Mopar® DOT 4. If DOT 4 brake fluid is not available, then DOT 3 is acceptable.</p> <p>If using DOT 4 brake fluid, the fluid must be changed every 24 months regardless of mileage.</p> |

| Component | Fluid, Lubricant, or Genuine Part |
|----------------|---|
| Refrigerant | Refrigerant R134a – If Equipped Charge Amount: All engines – 567g (1.25 lb) Refrigerant R-1234yf – If Equipped Charge Amount: All engines – 482 g (1.063 lb) |
| Compressor Oil | Use Only PAG Oil PSD1: 1.4L Gasoline engines – 120ml (4.1 fl oz) Use Only PAG Oil ND12: 2.0L Diesel engines – 90 ml (3.0 fl oz) |

CUSTOMER ASSISTANCE

IF YOU NEED ASSISTANCE

FCA's distributors are vitally interested in your satisfaction with their products and services. If a servicing problem or other difficulty should occur, we recommend that you take the following steps:

Discuss the problem at the authorized dealer with the dealer principal or the service manager. Management personnel at the authorized dealer are in the best position to resolve the problem.

When you contact the distributor please provide all of the following information:

- Your name, address and phone number.
- Vehicle Identification Number (this 17-digit number is found on a label, located on the left front corner of the instrument panel, visible through the windshield. It is also available from your vehicle registration or title).
- Selling and servicing authorized dealer.
- Vehicle's delivery date and current odometer distance.
- Service history of your vehicle.
- An accurate description of the problem and the conditions under which it occurs.

INDIA

FCA India Automobiles Private Limited

Registered Office:

1601 (III), 16th Floor, B Wing,
The Capital, Plot #C-70, G Block,
Bandra Kurla Complex,
Bandra (East), Mumbai 400 051,
India.

Tel: +91 22 39462600

Toll free: 1800-266-5337

INDEX

- A**
- Adding Engine Coolant (Antifreeze) 125
 - Additives, Fuel 173
 - Air Bag
 - Enhanced Accident Response 111
 - Event Data Recorder (EDR) 111
 - Air Bag Light 78
 - Air Cleaner, Engine
 - (Engine Air Cleaner Filter) 118
 - Air Conditioner Maintenance 119
 - Air Conditioner Refrigerant 119, 120
 - Air Conditioner System 119
 - Air Conditioning Filter 19, 120
 - Air Conditioning, Operating Tips 19
 - Air Filter 118
 - Air Pressure
 - Tires 155
 - Alarm
 - Security Alarm 45
 - Alterations/Modifications
 - Vehicle 9
- B**
- Antifreeze (Engine Coolant) 124, 176
 - Disposal 126
 - Anti-Lock Warning Light 45
 - Automatic Transmission
 - Adding Fluid 129, 179
 - Fluid And Filter Change 129
 - Fluid Change 129
 - Fluid Level Check 129
 - Fluid Type 129, 179
 - Gear Ranges 58
 - Special Additives 129
 - Axle Lubrication 179
- B**
- Battery 42, 116
 - Charging System Light 42
 - Belts, Seat 78
 - Body Mechanism Lubrication 120
 - B-Pillar Location 153
 - Brake Fluid 179
- C**
- Brake System 127, 171
 - Fluid Check 127, 179
 - Master Cylinder 127
 - Warning Light 41
 - Brakes 171
 - Bulb Replacement 143
 - Bulbs, Light 80
- C**
- Capacities, Fluid 176
 - Caps, Filler
 - Fuel 65
 - Oil (Engine) 113
 - Radiator (Coolant Pressure) 125
 - Car Washes 166
 - Carbon Monoxide Warning 80
 - Cellular Phone 74
 - Change Oil Indicator 36
 - Changing A Flat Tire 83
 - Checking Your Vehicle For Safety 77
 - Checks, Safety 77

| | | | | | |
|--|---------------|--|--------|--|---------------|
| Child Safety Locks | 15 | D | | Emergency, In Case Of | |
| Cleaning | | Defroster, Windshield | 78 | Hazard Warning Flasher | 82 |
| Wheels | 164 | Diesel | | Jacking..... | 83 |
| Windshield Wiper Blades | 120 | Display Messages..... | 37, 38 | Jump Starting | 98 |
| Climate Control..... | 16 | Fuel System Messages..... | 38 | Tow Hooks | 108 |
| Compact Spare Tire..... | 161 | Diesel Fuel..... | 175 | Towing | 105 |
| Cooling Pressure Cap (Radiator Cap)..... | 125 | Diesel Fuel Requirements..... | 175 | Engine..... | 113 |
| Cooling System | 123 | Dipsticks | | Air Cleaner | 118 |
| Adding Coolant (Antifreeze)..... | 125 | Oil (Engine) | 115 | Checking Oil Level | 115 |
| Coolant Level | 124, 126 | Disabled Vehicle Towing..... | 105 | Coolant (Antifreeze) | 177 |
| Cooling Capacity..... | 176 | Disposal | | Cooling..... | 123 |
| Disposal Of Used Coolant..... | 126 | Antifreeze (Engine Coolant) | 126 | Exhaust Gas Caution | 80 |
| Drain, Flush, And Refill..... | 124 | Door Ajar..... | 42, 44 | Jump Starting | 98 |
| Inspection | 126 | Door Ajar Light | 42, 44 | Oil | 117, 176, 177 |
| Points To Remember..... | 126 | Driving | 70 | Oil Filler Cap | 113 |
| Pressure Cap..... | 125 | E | | Oil Filter | 118 |
| Radiator Cap | 125 | Electric Parking Brake..... | 56 | Oil Selection..... | 117, 118, 176 |
| Selection Of Coolant | | Electronic Throttle Control Warning Light..... | 43 | Oil Synthetic..... | 118 |
| (Antifreeze) | 124, 176, 177 | Emergency Gas Can Refueling..... | 101 | Overheating | 103 |
| Corrosion Protection | 164 | | | Engine Oil Viscosity | 118 |
| Cruise Light | 53, 54, 55 | | | Enhanced Accident Response Feature | 111 |
| Customer Assistance | 181 | | | | |

| | | | | | |
|-------------------------------|----------|---------------------------------|---------------|--------------------------------------|--------------------|
| Ethanol | 172, 173 | Fuel..... | 172, 175 | Hood Prop | 21 |
| Exhaust Gas Cautions..... | 80 | Additives..... | 173 | Hood Release..... | 21 |
| Exhaust System | 80, 122 | Ethanol | 172, 173 | I | |
| Exterior Lights..... | 80 | Filler Cap (Gas Cap)..... | 65 | Instrument Cluster | 24, 26, 28, 32, 36 |
| F | | Gasoline | 172 | Descriptions..... | 26, 29, 32, 35 |
| Filters | | Light | 47 | Display..... | 36 |
| Air Cleaner..... | 118 | Materials Added | 173 | Gear Shift Indicator (GSI)..... | 37 |
| Air Conditioning..... | 19, 120 | Methanol | 173 | Instrument Panel Lens Cleaning | 168 |
| Engine Oil | 118, 177 | Octane Rating..... | 172, 175, 177 | Interior Appearance Care | 167 |
| Engine Oil Disposal | 118 | Specifications..... | 177 | Interior Fuses | 138 |
| Flashers | | Tank Capacity..... | 176 | | |
| Hazard Warning..... | 82 | Fuses | 130 | J | |
| Turn Signals | 53, 80 | G | | Jack Location | 84 |
| Fluid Capacities | 176 | Gas Cap (Fuel Filler Cap) | 65 | Jack Operation | 83, 85 |
| Fluid Leaks | 80 | Gasoline, (Fuel)..... | 172 | Jacking Instructions | 85 |
| Fluid Level Checks | | Gear Ranges | 58 | Jump Starting..... | 98 |
| Brake | 127 | Gear Selector Override | 103 | L | |
| Engine Oil | 115 | Glass Cleaning | 169 | LaneSense | 52 |
| Fluid, Brake | 179 | H | | Latches | 80 |
| Fog Lights | 51 | Hazard Warning Flashers..... | 82 | Hood | 21 |
| Freeing A Stuck Vehicle | 104 | Headlights | | Leaks, Fluid..... | 80 |
| | | Cleaning | 165 | Life Of Tires..... | 158 |

| | | | | | |
|--|------------|--|--------|---------------------------------------|--------|
| Liftgate | 22, 23 | Electronic Park Brake | 46 | Oil Temperature | 44 |
| Light Bulbs..... | 80 | Electronic Stability Control (ESC) Active..... | 46 | Park | 52 |
| Lights..... | 80 | Electronic Stability Control (ESC) OFF..... | 46 | Seat Belt Reminder | 44 |
| 4WD Lock..... | 50 | Electronic Throttle Control (ETC)..... | 43 | Security Alarm | 45 |
| 4WD Low..... | 50 | Engine Temperature..... | 43 | Service..... | 143 |
| Active Speed Limiter Fault..... | 50 | Exterior..... | 80 | Service 4WD..... | 48 |
| Active Speed Limiter Ready..... | 53, 55 | Fog | 51, 53 | Service StopStart System | 48 |
| Active Speed Limiter SET | 52, 54 | Fuel Cutoff..... | 46 | Speed | 54 |
| AdBlue (UREA) Injection System | | High Beam..... | 55 | StopStart Active..... | 53 |
| Failure..... | 48 | Hill Descent Control (HDC)..... | 54 | Tire Pressure Monitoring (TPMS) | 48 |
| Air Bag..... | 41, 78 | Hood Open | 44 | Towing Hook Breakdown | 50 |
| Anti Lock Brake System (ABS)..... | 45 | Immobilizer Fail VPS Electrical Alarm | 50 | Transmission Fault | 44 |
| Automatic High Beam..... | 53 | LaneSense | 52 | Transmission Temperature..... | 45 |
| Battery Charge | 42 | Liftgate Open..... | 44 | Turn Signals..... | 53, 80 |
| Brake Warning | 41 | Low Coolant Level | 46 | Vehicle Security | 45 |
| Bulb Replacement..... | 143 | Low Diesel Emissions Additive | | Wait To Start..... | 52 |
| Cruise..... | 53, 54, 55 | AdBlue (UREA)..... | 51 | Water In Fuel | 51 |
| Diesel Particulate Filter (DPF) | | Low Fuel | 47 | Loading Vehicle | |
| Cleaning In Progress | 50 | Low Washer Fluid | 47 | Tires..... | 153 |
| Door Open | 42 | Malfunction Indicator (Check Engine)..... | 47 | Locks | |
| Drowsiness Detected | 43 | Night Vision Active | 52 | Child Protection | 15 |
| Electric Power Steering (EPS) Fault..... | 43 | Night Vision Suppressed | 55 | Lubrication, Body | 120 |
| | | Oil Pressure | 44 | Lug Nuts/Bolts..... | 171 |

M

| | |
|--|----------|
| Maintenance Free Battery | 116 |
| Malfunction Indicator Light (Check Engine) | 47 |
| Manual Transmission | 128 |
| Fluid Level Check | 128 |
| Frequency Of Fluid Change | 128 |
| Lubricant Selection | 129 |
| Methanol | 172, 173 |
| Methanol Fuel | 172 |
| Modifications/Alterations | |
| Vehicle | 9 |

O

| | |
|--------------------------------------|----------|
| Occupant Restraints | 75 |
| Octane Rating, Gasoline (Fuel) | 172, 177 |
| Oil Filter, Change | 118 |
| Oil Filter, Selection | 118 |
| Oil Pressure Light | 44 |
| Oil, Engine | 117, 177 |
| Capacity | 176 |
| Checking | 115 |
| Diesel | 118 |

| | |
|------------------------------|---------------|
| Dipstick | 115 |
| Disposal | 118 |
| Filter | 118, 177 |
| Filter Disposal | 118 |
| Identification Logo | 117 |
| Materials Added To | 118 |
| Pressure Warning Light | 44 |
| Recommendation | 117, 118, 176 |
| Synthetic | 118 |
| Viscosity | 118, 176 |
| Overheating, Engine | 103 |

P

| | |
|---|-----|
| Paint Care | 164 |
| Parking Brake | 56 |
| Placard, Tire And Loading Information | 153 |
| Preparation For Jacking | 83 |

R

| | |
|---|----------|
| Radial Ply Tires | 156 |
| Radiator Cap (Coolant Pressure Cap) | 125 |
| Radio Operation | 74 |
| Refrigerant | 119, 120 |
| Release, Hood | 21 |

| | |
|-------------------------|-----|
| Replacement Tires | 159 |
| Roll Over Warning | 8 |
| Rotation, Tires | 162 |

S

| | |
|---|----------|
| Safety Checks Inside Vehicle | 78 |
| Safety Checks Outside Vehicle | 80 |
| Safety Information, Tire | 153 |
| Safety Tips | 77 |
| Safety, Exhaust Gas | 80 |
| Seat Belt Reminder | 44 |
| Seat Belts | 77, 78 |
| Front Seat | 77 |
| Inspection | 78 |
| Seat Belts Maintenance | 167 |
| Security Alarm | 45 |
| Selection Of Coolant (Antifreeze) | 177 |
| Service Assistance | 181 |
| Shift Lever Override | 103 |
| Signals, Turn | 53, 80 |
| Snow Tires | 160 |
| Spare Tires | 161, 162 |

| | | |
|--|--------------|--|
| Specifications | | |
| Fuel (Gasoline)..... | 177 | |
| Oil..... | 118, 177 | |
| Storage, Vehicle..... | 19 | |
| Stuck, Freeing | 104 | |
| Synthetic Engine Oil..... | 118 | |
| T | | |
| Tire And Loading Information Placard | 153 | |
| Tire Markings..... | 153 | |
| Tire Safety Information | 153 | |
| Tire Service Kit | 90 | |
| Tires..... | 80, 154, 161 | |
| Aging (Life Of Tires) | 158 | |
| Air Pressure..... | 154 | |
| Changing..... | 83 | |
| Compact Spare | 161 | |
| General Information | 154, 161 | |
| High Speed..... | 156 | |
| Inflation Pressure..... | 155 | |
| Jacking | 83 | |
| Life Of Tires | 158 | |
| Load Capacity..... | 153, 154 | |
| Pressure Monitoring System (TPMS) | 48 | |
| Radial | 156 | |
| Replacement..... | 159 | |
| Rotation..... | 162 | |
| Safety | 153, 154 | |
| Snow Tires..... | 160 | |
| Spare Tires | 161, 162 | |
| Spinning | 157 | |
| Tread Wear Indicators | 158 | |
| Wheel Nut Torque..... | 171 | |
| To Open Hood | 21 | |
| Tow Hooks | | |
| Emergency..... | 108 | |
| Towing | | |
| Disabled Vehicle..... | 105 | |
| Towing Eyes | 109 | |
| Transmission | | |
| Automatic | 129 | |
| Maintenance | 129 | |
| Tread Wear Indicators | 158 | |
| Turn Signals..... | 53 | |
| V | | |
| Vehicle Identification Number (VIN) | 170 | |
| Vehicle Loading..... | 154 | |
| Vehicle Maintenance | 117 | |
| Vehicle Modifications/Alterations | 9 | |
| Vehicle Storage..... | 19 | |
| Viscosity, Engine Oil | 118 | |
| W | | |
| Warnings, Roll Over..... | 8 | |
| Washers, Windshield | 115 | |
| Washing Vehicle..... | 166 | |
| Wheel And Wheel Tire Care..... | 164 | |
| Wheel And Wheel Tire Trim | 164 | |
| Window Fogging..... | 19 | |
| Windows | 20 | |
| Windshield Defroster | 78 | |
| Windshield Washers | 115 | |
| Fluid..... | 115 | |
| Windshield Wiper Blades | 120 | |
| Wipers Blade Replacement..... | 120 | |

