

Operation Manual

Embroidery Machine

Product Code: 884-T15

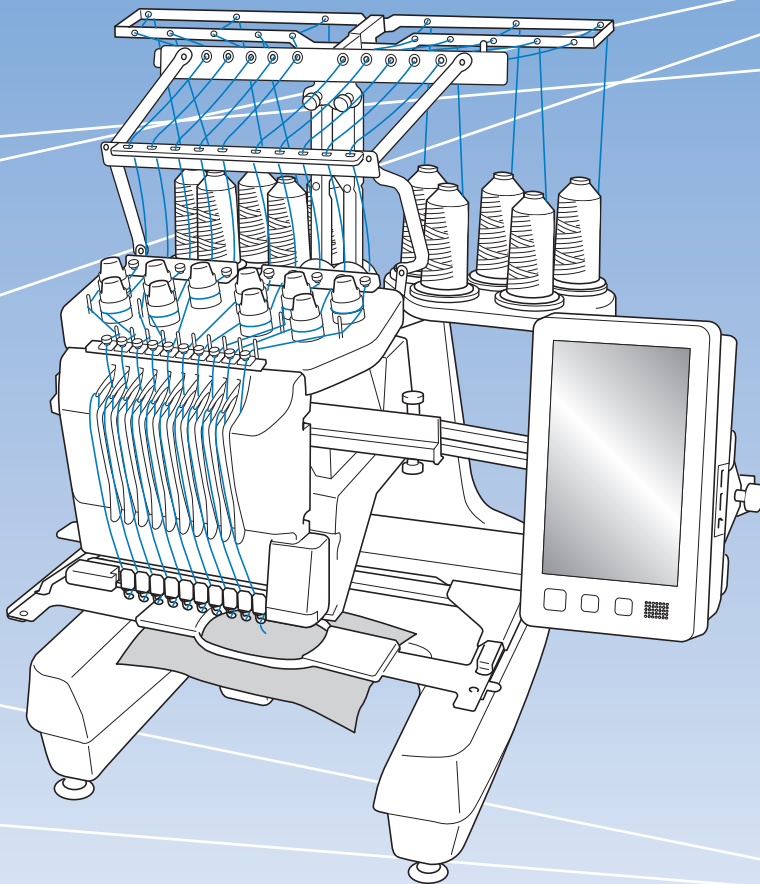

Be sure to read this document before using the machine.
We recommend that you keep this document nearby for future reference.

INTRODUCTION

Thank you for purchasing this machine. Before using this machine, carefully read the "IMPORTANT SAFETY INSTRUCTIONS", and then study this manual for the correct operation of the various functions.

In addition, after you have finished reading this manual, store it where it can quickly be accessed for future reference.

Failure to follow these instructions may result in an increased risk of personal injury or damage to property, including through fire, electrical shock, burns or suffocation.

IMPORTANT SAFETY INSTRUCTIONS

Please read these safety instructions before attempting to use the machine.

DANGER

- To reduce the risk of electric shock

1 Always unplug the machine from the electrical outlet immediately after using, when cleaning, when making any user servicing adjustments mentioned in this manual, or if you are leaving the machine unattended.

WARNING

- To reduce the risk of burns, fire, electric shock, or injury to persons.

2 Always unplug the machine from the electrical outlet when lubricating it or when making any other user servicing adjustments mentioned in the Operation Manual.

- To unplug the machine, switch the machine to the symbol "O" position to turn it off, then grasp the plug and pull it out of the electrical outlet. Do not pull on the cord.
- Plug the machine directly into the electrical outlet. Do not use an extension cord.
- Always unplug your machine if the power is cut.

3 Electrical Hazards:

- This machine should be connected to an AC power source within the range indicated on the rating label. Do not connect it to a DC power source or inverter. If you are not sure what kind of power source you have, contact a qualified electrician.
- This machine is approved for use in the country of purchase only.

4 Never operate this machine if it has a damaged cord or plug, if it is not working properly, if it has been dropped or damaged, or water is spilled on the unit. Return the machine to the nearest authorized Brother dealer or service center for examination, repair, electrical or mechanical adjustment.

- To avoid electric shock or fire; do not use a damaged power supply plug or loose electrical outlet, and ensure that the power supply plug is fully inserted and secure.
- While the machine is stored or in use if you notice anything unusual, such as an odor, heat, discoloration or deformation, stop using the machine immediately and unplug the power cord.
- When transporting the machine, be sure to lift it from the bottom positions. Lifting the machine by any other part may damage the machine or result in the machine falling, which could cause injuries.
- When lifting the machine, be careful not to make any sudden or careless movements, otherwise you may injure your back or knees.
- While the machine is being transported, be careful not to touch the operation panel, thread guides or any other part, otherwise injuries may result.

5 Always keep your work area clear:

- Never operate the machine with any air openings blocked. Keep ventilation openings of the machine free from the build up of lint, dust, and loose cloth.
- Do not use extension cords. Plug the machine directly into the electrical outlet.
- Never drop or insert any object into any opening.
- Keep fingers out of all machine openings, such as near the carriage, otherwise injuries may result.
- Do not operate where aerosol (spray) products are being used or where oxygen is being administered.
- Do not use the machine near a heat source, such as a stove or iron; otherwise, the machine, power cord or garment being embroidered may ignite, resulting in fire or an electric shock.
- Do not use this machine near an open flame; the movement of the embroidery frame could cause the garment being embroidered to catch fire.

- Do not place this machine on an unstable surface, such as an unsteady or slanted table, otherwise the machine may fall, resulting in injuries.
- While attaching or detaching an embroidery frame or other included accessory or while maintaining the machine, be careful not to hit the machine with your body or any other part of it.

6 Special care is required when embroidering:

- Always pay close attention to the needle. Do not use bent or damaged needles.
- Keep fingers away from all moving parts. Special care is required around the machine needle.
- While the machine is in operation, keep your hands away from the needle bar case and all moving parts near the needle bar case, otherwise injuries may result.
- Switch the machine to the symbol "O" position to turn it off when making any adjustments in the needle area, such as changing the needle.
- Do not use a damaged or incorrect needle plate, as it could cause the needle to break.

7 This machine is not a toy:

- Your close attention is necessary when the machine is used by or near children.
- This machine is not intended for use by young children or infirm persons without supervision.
- Young children should be supervised to ensure that they do not play with this machine.
- Do not use the included scissors or seam ripper in any other way than how they are intended. In addition, when opening a hole with the seam ripper, do not place your hands or fingers in the cutting path, otherwise injuries may result if the seam ripper slips.
- The plastic bag that this machine was supplied in should be kept out of the reach of children or disposed of. Never allow children to play with the bag due to the danger of suffocation.
- Do not use outdoors.

8 For a longer service life:

- When storing this machine, avoid direct sunlight and high humidity locations. Do not use or store the machine near a space heater, iron, halogen lamp, or other hot objects.
- Use only neutral soaps or detergents to clean the case. Benzene, thinner, and scouring powders can damage the case and machine, and should never be used.

- Always consult the Operation Manual when replacing or installing any assemblies, the presser feet, needle, or other parts to assure correct installation.

9 For repair or adjustment:

- Do not try to disassemble, repair or alter this machine in any way, otherwise a fire, electric shock or injuries may result.
- If the light unit is damaged, it must be replaced by an authorized Brother dealer.
- In the event a malfunction occurs or adjustment is required, first follow the troubleshooting table in the back of the Operation Manual to inspect and adjust the machine yourself. If the problem persists, please consult your local authorized Brother dealer.

Use this machine only for its intended use as described in the manual.

Use accessories recommended by the manufacturer as contained in this manual.

Use the interface cable (USB cable) included with this machine.

The contents of this manual and specifications of this product are subject to change without notice.

For additional product information and updates, visit our website at www.brother.com

SAVE THESE INSTRUCTIONS

This machine is intended for household use.

FOR USERS IN COUNTRIES EXCEPT CENELEC COUNTRIES

This appliance is not intended for use by persons (including children) with reduced physical, sensory or mental capabilities, or lack of experience and knowledge, unless they have been given supervision or instruction concerning use of the appliance by a person responsible for their safety. Children should be supervised to ensure that they do not play with the appliance.

FOR USERS IN CENELEC COUNTRIES

This appliance can be used by children aged from 8 years and above and persons with reduced physical, sensory or mental capabilities or lack of experience and knowledge if they have been given supervision or instruction concerning use of the appliance in a safe way and understand the hazards involved. Children shall not play with the appliance. Cleaning and user maintenance shall not be made by children without supervision.

FOR USERS IN THE UK, EIRE, MALTA AND CYPRUS ONLY

IMPORTANT

- In the event of replacing the plug fuse, use a fuse approved by ASTA to BS 1362, i.e. carrying the  mark, rating as marked on plug.
- Always replace the fuse cover. Never use plugs with the fuse cover omitted.

- If the available electrical outlet is not suitable for the plug supplied with this equipment, you should contact your authorized Brother dealer to obtain the correct lead.

Federal Communications Commission (FCC) Supplier's Declaration of Conformity (For U.S.A. Only)

Responsible Party: Brother International Corporation
200 Crossing Boulevard
P.O. Box 6911
Bridgewater, NJ 08807-0911
USA
TEL : (908) 704-1700

declares that the product

Product Name: Brother Embroidery Machine
Model Number: PR1055X

This device complies with Part 15 of the FCC Rules. Operation is subject to the following two conditions: (1) this device may not cause harmful interference, and (2) this device must accept any interference received, including interference that may cause undesired operation.

This equipment has been tested and found to comply with the limits for a Class B digital device, pursuant to Part 15 of the FCC Rules. These limits are designed to provide reasonable protection against harmful interference in a residential installation. This equipment generates, uses, and can radiate radio frequency energy and, if not installed and used in accordance with the instructions, may cause harmful interference to radio communications. However, there is no guarantee that interference will not occur in a particular installation. If this equipment does cause harmful interference to radio or television reception, which can be determined by turning the equipment off and on, the user is encouraged to try to correct the interference by one or more of the following measures:

- Reorient or relocate the receiving antenna.
- Increase the separation between the equipment and receiver.
- Connect the equipment into an outlet on a circuit different from that to which the receiver is connected.
- Consult the authorized Brother dealer or an experienced radio/TV technician for help.

- This transmitter must not be co-located or operated in conjunction with any other antenna or transmitter.

Important

Changes or modifications not expressly approved by Brother Industries, Ltd. could void the user's authority to operate the equipment.

This equipment complies with FCC/IC radiation exposure limits set forth for an uncontrolled environment and meets the FCC radio frequency (RF) Exposure Guidelines and RSS-102 of the IC radio frequency (RF) Exposure rules. This equipment should be installed and operated keeping the radiator at least 20cm or more away from person's body.

For Users in Canada

This device complies with Industry Canada's licence-exempt RSSs. Operation is subject to the following two conditions:

- (1) This device may not cause interference; and
- (2) This device must accept any interference, including interference that may cause undesired operation of the device.

This equipment complies with FCC/IC radiation exposure limits set forth for an uncontrolled environment and meets the FCC radio frequency (RF) Exposure Guidelines and RSS-102 of the IC radio frequency (RF) Exposure rules. This equipment should be installed and operated keeping the radiator at least 20cm or more away from person's body.

For Users in Mexico

The operation of this equipment is subject to the following two conditions:

- (1) it is possible that this equipment or device may not cause harmful interference, and
- (2) this equipment or device must accept any interference, including interference that may cause undesired operation.

Declaration of Conformity (Europe and Turkey only)

We, Brother Industries, Ltd. 15-1 Naeshiro-cho, Mizuho-ku, Nagoya 467-8561 Japan declare that this product is in conformity with the essential requirements of all relevant directives and regulations applied within the European Community.

The Declaration of Conformity (DoC) can be downloaded from Brother support website.

Visit support.brother.com and:

- click "Manuals"
- select your model
- click "Declaration of Conformity"
- click "Download"

Your Declaration will be downloaded as a PDF file.

Declaration of Conformity for RE Directive 2014/53/ EU (Europe and Turkey only)

(Applicable to models with radio interfaces)

We, Brother Industries, Ltd. 15-1 Naeshiro-cho, Mizuho-ku, Nagoya 467-8561 Japan declare that these products are in conformity with the provisions of the RE Directive 2014/53/ EU. A copy of the Declaration of Conformity can be downloaded by following the instructions in the Declaration of Conformity (Europe and Turkey only) section.

Wireless LAN (Models with Wireless LAN function only)

This machine supports wireless interface.

Frequency band(s): 2400-2483.5 MHz

Maximum radio-frequency power transmitted in the frequency band(s): Less than 20 dBm(e.i.r.p)

For Users in Norway

This subsection does not apply for the geographical area within a radius of 20 km from the centre of Ny-Alesund on Svalbard.

Dette underavsnittet gjelder ikke for det geografiske området innenfor en radius av 20 km fra sentrum av Ny-Ålesund på Svalbard.

For Users in Thailand

This telecommunication equipment conforms to NTC technical requirement.

Terms of Use

IMPORTANT-PLEASE READ CAREFULLY:

This Terms of Use ("Agreement") is a legal agreement between Brother Industries, Ltd. ("Company") and you that governs your use of any Software, installed on or made available by Company for use with sewing or craft products ("Company Product"). The term of "Software" means any and all contents data, design data, data format, firmware of Company Product, and PC application or mobile device application.

By using the Software and Company Product, you shall be deemed to have agreed to be bound by the terms of this Agreement. If you do not agree to the terms of this Agreement, Company is unwilling to license the Software and you are not allowed to use the Software. Amendments and supplements to this Agreement may be attached to the Software.

An individual who accepts this Agreement on behalf of an entity represents to Company that he or she has the legal right to enter into a binding legal agreement for that entity.

Terms and Conditions

1 Grant of License.

- 1.1 Subject to this Agreement, Company hereby grants you a personal, non-exclusive, non-transferable and revocable license to use the Software only within the Company Product.
- 1.2 Your right to use of the Software is licensed and not sold, and solely for your use subject to this Agreement. Company or its suppliers retains all right, title, and interest relating to Software, including without limitation all intellectual property rights relating thereto.

2 Restrictions

- 2.1 Except as expressly set out in this Agreement or as required by any local law, you shall undertake:
 - 2.1.1 not to disassemble, de-compile, reverse engineer, translate or otherwise attempt to learn the source code of the Software (including the data or contents created by using the Company Product or contents editing application software; hereinafter the same shall apply in this Clause 2.);
 - 2.1.2 not to create derivative works based on the whole or any part of the Software;
 - 2.1.3 not to distribute, provide or make available the Software in any form, in whole or in part to any person without prior written consent from Company;
 - 2.1.4 not to copy the Software, except where such copying is incidental to normal use of the Software with Company Product or where it is necessary for the purpose of back-up or operational security;

- 2.1.5 not to transfer, rent, lease, sub-license, loan, translate, merge, adapt, vary, alter or modify, the whole or any part of the Software nor permit the Software or any part of it to be combined with, or become incorporated in, any other programs;
- 2.1.6 to include Company's copyright notice and this Agreement on all entire and partial copies of the Software; and
- 2.1.7 not to use the Software for any purpose (including, but not limited to, use with unauthorized sewing/craft products or software) other than as provided under Clause 1 of this Agreement.

3 No warranty

TO THE EXTENT PERMISSIBLE BY APPLICABLE LAW, THIS SOFTWARE IS PROVIDED TO YOU "AS IS" WITHOUT WARRANTIES OR CONDITIONS OF ANY KIND, WHETHER ORAL OR WRITTEN, EXPRESS OR IMPLIED. COMPANY SPECIFICALLY DISCLAIMS ANY IMPLIED WARRANTIES OR CONDITIONS OF MERCHANTABILITY, SATISFACTORY QUALITY, NON-INFRINGEMENT AND/OR FITNESS FOR A PARTICULAR PURPOSE.

4 Limitation of liability

- 4.1 COMPANY SHALL NOT BE LIABLE TO YOU, ITS END-USERS OR ANY OTHER ENTITY FOR ANY LOSS OF PROFITS OR INCOME OR SAVINGS, LOSS OF DATA, INTERRUPTION OF USE, OR CONSEQUENTIAL, INCIDENTAL, SPECIAL, PUNITIVE OR INDIRECT DAMAGES INCURRED BY SUCH PARTY (WHETHER IN AN ACTION IN CONTRACT OR TORT), EVEN IF COMPANY HAS BEEN ADVISED OF THE POSSIBILITY OF SUCH DAMAGES, ARISING OUT OF OR RELATING TO THE SOFTWARE, SUPPORT SERVICE OR THIS AGREEMENT. THESE LIMITATIONS SHALL APPLY TO THE MAXIMUM EXTENT ALLOWED BY APPLICABLE LAW NOTWITHSTANDING ANY FAILURE OF ESSENTIAL PURPOSE OF ANY LIMITED REMEDY.
- 4.2 NOTWITHSTANDING THE CLAUSE 3 OR 4.1 HEREOF, THIS AGREEMENT DOES NOT PURPORT TO EXCLUDE OR RESTRICT COMPANY'S LIABILITY FOR DEATH OR PERSONAL INJURY RESULTING FROM NEGLIGENCE OR LIMIT THE STATUTORY RIGHTS OF A CONSUMER.

5 Termination

- 5.1 Company shall have the right to terminate this Agreement at any time by providing a written notice to you if you commit a material breach of any terms of this Agreement and fail to immediately rectify such breach upon Company's request.
- 5.2 Upon termination for any reason all rights granted to you under this Agreement shall cease, you shall cease all activities authorized by this Agreement and you shall immediately delete or remove the Software from all computer equipment in your possession and delete or destroy all copies of the Software or its derivative works in your possession. In addition to the above, you shall delete contents or design data created by you from the Company Product in your possession.

6 Miscellaneous terms

- 6.1 You shall not export or re-export the Software or any copy or adaptation thereof in violation of any applicable laws or regulations.
- 6.2 You shall not assign all or any part of this Agreement to any third party or any interest therein, without prior written consent of Company. A change of control or reorganization of you pursuant to a merger, sale of assets or stock shall be deemed to be an assignment under this Agreement.
- 6.3 You agree that a breach of this Agreement will cause irreparable injury to Company for which monetary damages would not be an adequate remedy and Company shall be entitled to seek equitable relief in addition to any remedies it may have hereunder or at law without a bond, other security, or proof of damages.
- 6.4 If any provisions of this Agreement shall be declared or determined as void or unenforceable by a court of competent jurisdiction, such provisions shall be severable and independent from the other provisions of this Agreement and the validity of the other provisions and of the entire Agreement shall not be affected thereby.
- 6.5 This Agreement, together with all exhibits or other attachments referenced herein, constitutes the entire agreement between the parties on the subject matter hereof, and supersedes all proposals, oral and written, between the parties on this subject.
- 6.6 If Company fails to insist that you perform any of your obligations under this Agreement, or if Company does not enforce any rights against you, or if Company delay in doing so, that will not mean that Company have waived any rights against you and will not mean that you do not have to comply with those obligations. If Company does waive a default by you, Company will only do so in writing, and that will not mean that Company will automatically waive any later default by you.

- 6.7 The laws of the state or country where you live (or, if a business, where your principal place of business is located) govern all claims and disputes concerning the Software or this Agreement.

LICENSE AGREEMENT

The enclosed machine includes data, software and/or documentation (collectively "CONTENT") that are proprietary products of Brother Industries, Ltd. ("BROTHER"). BY USING THE CONTENT, THE CUSTOMER ACCEPTS THE TERMS AND CONDITIONS OF THIS AGREEMENT. BROTHER retains ownership of all rights to CONTENT and to the copies of the CONTENT included in this package. The CONTENT are licensed (not sold) to you ("CUSTOMER") under the terms and conditions of this Agreement.

CUSTOMER is licensed to:

- Use the CONTENT in combination with an embroidery machine to create embroidery.
- Use the CONTENT in combination with an embroidery machine that CUSTOMER owns or uses, provided that the CONTENT is not used on more than one embroidery machine at a time.

Except as otherwise provided herein, CUSTOMER may not:

- Allow more than one copy of the CONTENT to be available for use at any one time.
- Reproduce, modify, publish, distribute, sell, rent, sublicense or otherwise make available to others CONTENT.
- Distribute, rent, sublicense, lease, sell, transfer or assign the media card or CONTENT.
- Decompile, disassemble or otherwise reverse engineer the CONTENT or assist others to do the same.
- Alter, translate, modify or adapt the CONTENT or any part thereof for business, commercial or industrial purposes.
- Sell or otherwise distribute the EMBROIDERY created by use of the CONTENT, WHICH ORIGINALLY BEARS CERTAIN COPYRIGHT NOTICE UNDER THE NAME OF ANY THIRD PARTIES OTHER THAN BROTHER (e.g. "©DISNEY").

BROTHER retains all rights not expressly granted to CUSTOMER herein.

Nothing in this agreement constitutes a waiver of the rights of BROTHER under any law. This agreement shall be governed by the laws of Japan.

Please direct all inquiries concerning this Agreement in writing by regular mail, to Brother Industries, Ltd., 1-1-1 Kawagishi, Mizuho-ku, Nagoya 467-8562, Japan, Attention: P&H business division Sales and Marketing Dept.

WARNING LABELS

The following warning labels are on the machine. Be sure to observe the precautions described in the labels.

Label locations

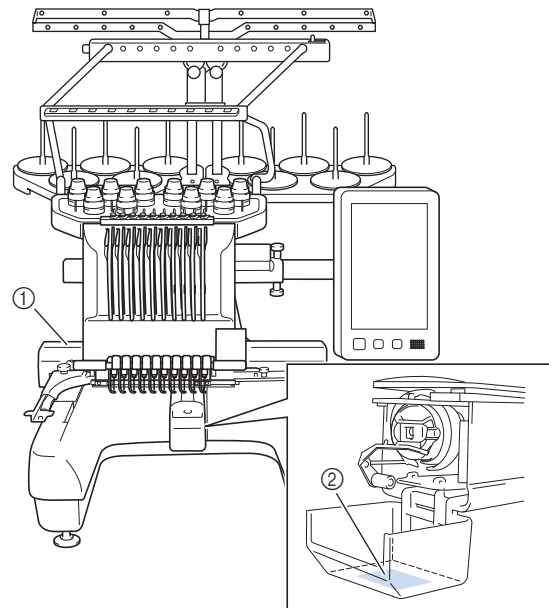

①		▲CAUTION Carriage may cause injury. Do not put hands in carriage traveling path.	▲VORSICHT Um Verletzungen mit dem Stickarm zu vermeiden, nicht die Hände in die Nähe des Stickarms halten.	▲ATTENTION Le chariot peut provoquer des blessures. Ne pas mettre les mains dans le chemin du chariot.	▲PRECAUCIÓN El carro puede provocar lesiones. No poner las manos por donde pasa el carro.	▲CUIDADO O carro de transporte pode causar ferimentos. Não coloque as mãos sobre o trilho do carro de transporte.
---	--	---	--	---	--	--

②		▲VOORZICHTIG De borduurarm kan verwondingen veroorzaken. Houdt uw handen buiten bereik van de borduurarm.	▲ATTENZIONE Il carrello potrebbe ferirvi. Non appoggiate la mano nel percorso del carrello.	▲ОСТОРОЖНО! Движущаяся каретка может быть причиной травмы. Не кладите руки на пути движения каретки.	▲注意 刺しゅう機のキャリッジが動いている時に、手や物を近づけないでください。 ケガの原因になります。	▲注意 在绣花机的导轨或绣花机移动时，为避免造成伤害，请不要将手或物品靠近。
---	--	--	--	---	--	--

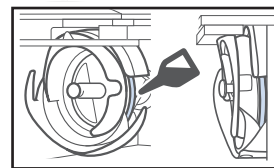

Please put a drop of oil onto the hook once a day before use.

TRADEMARKS

IBM is a registered trademark or a trademark of International Business Machines Corporation.
WPA™ and WPA2™ are trademarks of Wi-Fi Alliance®.
Secure Digital (SD) Card is a registered trademark or a trademark of SD-3C, LLC.
CompactFlash is a registered trademark or a trademark of Sandisk Corporation.
Memory Stick is a registered trademark or a trademark of Sony Corporation.
SmartMedia is a registered trademark or a trademark of Toshiba Corporation.
MultiMediaCard (MMC) is a registered trademark or a trademark of Infineon Technologies AG.
xD-Picture Card is a registered trademark or a trademark of Fuji Photo Film Co. Ltd.
This software is based in part on the work of the Independent JPEG Group.
Android and Google Play are trademarks of Google LLC.
App Store is a service mark of Apple Inc.

Each company whose software title is mentioned in this manual has a Software License Agreement specific to its proprietary programs.

Any trade names and product names of companies appearing on Brother products, related documents and any other materials are all trademarks or registered trademarks of those respective companies.

OPEN SOURCE LICENSING REMARKS

This product includes open-source software.
To see the open source licensing remarks, please go to the manual download section on your model's home page of Brother support website at "<http://s.brother/cpbag/>".

PRECAUTION FOR WIRELESS CONNECTION

Make sure you use a router or firewall when connecting your machine to the Internet to protect it against unauthorized access from the Internet.

CONTENTS

Chapter 1 GETTING READY	11	PREVIEWING THE IMAGE	60
NAMES OF MACHINE PARTS	11	Checking a preview image	60
Included accessories	12	PREPARING THE FABRIC	60
Accessories that are included in some countries or regions	14	Attaching stabilizer (backing) to fabric	60
Optional accessories	14	Fabric/stabilizer compatibility chart.....	61
SETTING UP THE MACHINE	16	Hooping the fabric in the embroidery frame	61
Setup and transporting precautions	16	ATTACHING THE EMBROIDERY FRAME TO THE MACHINE	64
Setup location	17	Attaching the embroidery frame	64
Setting up the machine	18	Correctly using the embroidery frames	65
Remove the fixing plates	18	SPECIFYING EMBROIDERING SETTING	69
Adjusting the operation panel position	19	Understanding the embroidering settings screen.....	69
Preparing the thread guide assembly	19	Automatic lock stitch setting.....	71
Preparing the spool stand	20	Thread color sorting	71
Attaching the embroidery frame holder	21	CHECKING THE EMBROIDERY AREA	72
TURNING ON THE MACHINE	22	Displaying the fabric while aligning the embroidery position	72
LCD SCREEN	24	Using the built-in camera	75
Using the settings key	25	Using the included embroidery positioning sticker	78
Using the machine help	28	Checking the embroidery pattern	79
WIRELESS NETWORK CONNECTION FUNCTIONS	29	UPPER THREADING	81
Enabling a wireless network connection	29	Checking the needle bars and thread colors	81
Setting up the wireless network connection	30	Upper threading	82
OTHER FUNCTIONS	32	Threading the needle.....	85
Using a USB mouse	32	PERFORMING THE EMBROIDERY	87
Monitoring App	32	Starting embroidering	87
		Stopping embroidering	88
		Understanding the embroidering screen	89
		REMOVING THE EMBROIDERY FRAME	90
		EMBROIDERING A PATTERN CONTAINING 11 OR MORE COLORS	91
		Checking if thread spool changes are necessary	91
		CHANGING THE THREAD SPOOLS	92
		About spool thread indicators.....	92
		Easily changing the thread spools	92
		ADJUSTING WHILE EMBROIDERING	93
		If the thread breaks or the bobbin thread runs out while embroidering.....	93
		Embroidering from the beginning or middle of the pattern....	96
		Resume embroidering after turning off the machine	97
Chapter 2 BASIC EMBROIDERY	33	Chapter 3 ADVANCED EMBROIDERY	99
BASIC PROCEDURES	33	VARIOUS EMBROIDERY FUNCTIONS	99
INSTALLING THE BOBBIN	33	Basting embroidery	99
Removing the bobbin case	33	Embroidering appliqué patterns	100
Installing the bobbin	34	Creating an appliqué piece.....	101
Installing the bobbin case	35	Using a frame pattern to create appliqués.....	103
SELECTING AN EMBROIDERY PATTERN	35	Creating stippling or echo patterns automatically	104
General pattern selection	35	QUILTING BORDERS	105
Embroidery patterns	36	USING THE CAMERA TO CONNECT PATTERNS	109
Frame patterns	37	Connecting three patterns.....	109
Utility embroidery patterns/Large buttonhole patterns	37	Changing the position of a sticker.....	114
Monogram and frame designs	38	Resume feature.....	115
Character patterns	39	MAKING EMBROIDERY ADJUSTMENTS	116
Decorative alphabet patterns	41	Adjusting the tension of the bobbin thread	116
Combining patterns.....	42	Adjusting the tension of the upper thread	118
EDITING THE EMBROIDERY PATTERN	44	Setting the machine to stop at color changes	119
Understanding the pattern editing screen	44	Temporary needle bar setting	120
Changing the size and the density of the pattern	47	Reserved needle bar and embroidery speed settings	121
Trimming the threads between characters	47	Changing the display guides	123
Combining the separated character patterns.....	48	Changing the thread color information	123
Changing the thread density.....	48	Specifying jump stitch trimming / "DST" jump codes for trimming	123
Aligning the embroidery patterns	49	Deleting short stitches	124
Designing repeated patterns	49	Specifying the remaining length of thread.....	124
EDITING COLORS	54		
Specifying multi-color text	54		
Changing the colors of the pattern	54		
Find new color schemes with the color shuffling function....	55		
SWITCHING THE THREAD COLORS ON THE SCREEN	57		
SELECTING/MANAGING THREAD COLORS FOR EACH NEEDLE BAR [Manual Color Sequence] ...	58		
Convenience of the manual color sequence.....	58		
Specifying the manual color sequence	58		
Using the manual color sequence	59		
Precautions on the manual color sequence	59		

Changing the embroidery basting distance	124
Deselect region setting	125
Starting/ending position settings	126
USING THE MEMORY FUNCTION.....	130
Saving embroidery patterns	130
Retrieving embroidery patterns.....	130
Connecting the USB using the included USB cord clamps	131
SENDING EMBROIDERY PATTERNS FROM A COMPUTER TO THE MACHINE (LINK FUNCTION)	132
Operations available with the Link function	132
Embroidering using the Link function	132
Disabling the Link function	135
EMBROIDERY APPLICATIONS.....	135
Embroidering split (large-size) patterns	135
INSTALLING THE INCLUDED WIDE TABLE....	137
Removing the wide table.....	139
EMBROIDERY PATTERNS FOR THE OPTIONAL JUMBO FRAME	140
USING THE OPTIONAL BOBBIN WINDER	142
Precautions	142
Optional bobbin winder and its accessories	142
Setting up the optional bobbin winder.....	143
Connecting the AC adapter	144
Winding the bobbin	144

Chapter 4 MY DESIGN CENTER 147

ABOUT MY DESIGN CENTER	147
PATTERN DRAWING SCREEN	147
Before creating designs.....	149
Drawing lines.....	149
Drawing regions.....	151
Using the stamp key	152
Using the erase key	153
Using the select key	153
STITCH SETTINGS SCREEN.....	154
Specifying individual stitch settings	154
Specifying global stitch settings	156
MY DESIGN CENTER WITH SCAN.....	156
Attaching the scanning frame	156
Scanning to trace background image.....	158
LINE SCAN	160
Using the scanning frame to create a pattern with Line Scan	160
ILLUSTRATION SCAN.....	162
Using the scanning frame to create a pattern with Illustration Scan	162
STIPPLING.....	164
Basic stippling with My Design Center	164
Scanning drawing to create stippling pattern	165
Scanning fabric and stippling	168
Decorative stitching around a pattern in embroidery (a quilting function).....	170

Chapter 5 APPENDIX 173

MAINTENANCE.....	173
Cleaning the LCD.....	173
Cleaning the machine surface	173
Cleaning the hook	173
Cleaning around the needle plate.....	174
Cleaning the bobbin case	175
Cleaning the thread paths of the upper threads	175
Replacing the needle.....	176
Oiling the machine	178
About the maintenance message	179

TROUBLESHOOTING	179
Troubleshooting.....	179
Error messages	185
If the machine does not respond when a key is touched	189
SPECIFICATIONS.....	190
Machine specifications	190
UPGRADING YOUR MACHINE'S SOFTWARE.....	192
Upgrade procedure using USB media	192
INDEX.....	194

Chapter 1 GETTING READY

Note

- Be sure to install the latest software. Refer to "UPGRADING YOUR MACHINE'S SOFTWARE" on page 192.
<http://s.brother/cubah/>

NAMES OF MACHINE PARTS

Main parts

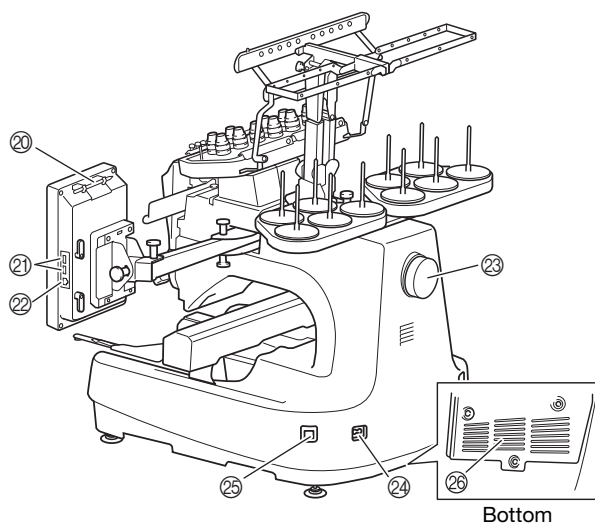
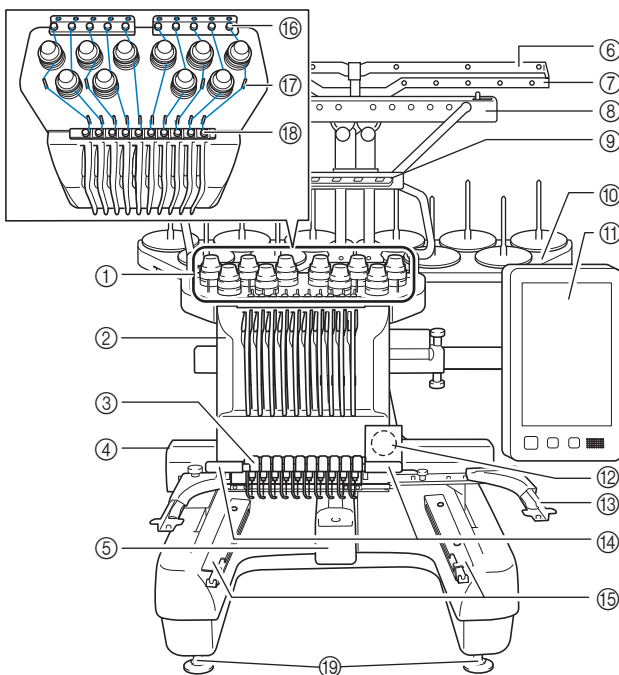

- ① **Thread tension knobs (page 118)**
- ② **Needle bar case**
Moves to the left and right to move the needle to the embroidering position.
- ③ **Lower thread guide**
- ④ **Carriage**
Attach the embroidery frame to the carriage. When the machine is turned on or when the machine is embroidering, the carriage moves forward, backward, left and right.
- ⑤ **Hook cover/Hook (page 33)**
- ⑥ **Thread guide A (page 83)**
- ⑦ **Thread guide B (page 83)**
- ⑧ **Thread guide C (page 83)**
- ⑨ **Thread guide D (page 83)**
- ⑩ **Spool stand (page 20)**
- ⑪ **Operation panel (page 12)**
- ⑫ **Built-in camera (page 72)**
- ⑬ **Embroidery frame holder (page 21)**
- ⑭ **Embroidery light**
The brightness of the embroidery light can be adjusted in the settings screen.
- ⑮ **Wide table brackets (page 137)**
- ⑯ **Upper thread guide (page 83)**
- ⑰ **Thread guide pins (page 84)**
- ⑱ **Middle thread guide (page 84)**
- ⑲ **Feet (page 18)**
- ⑳ **Touch pen holder**
Use the touch pen holder to hold the touch pen when not in use.
- ㉑ **USB port for media (page 32, page 130)**
In order to send patterns from/to USB media, plug the USB media directly into the USB port.
Connect a USB mouse to the USB port marked with .
- ㉒ **USB port for computer (page 130)**
In order to import/export patterns between a computer and the machine, plug the USB cable into the USB port.
- ㉓ **Handwheel**
Rotate the handwheel to move the needle up and down. Be sure to rotate the handwheel toward the LCD panel.
- ㉔ **Power supply plug (page 22)**
- ㉕ **Main power switch (page 22)**
Do not turn the power on soon after turning the power off. It is recommended that you wait 5 seconds before turning the power back on.
- ㉖ **Ventilation slots**
The ventilation slots allow the air surrounding the motor to circulate. Do not cover the ventilation slots while the machine is being used.

■ Operation panel

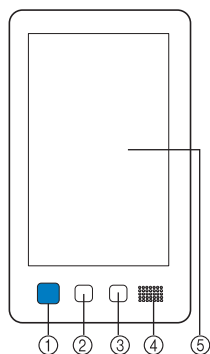

① “Start/Stop” button

Press the “Start/Stop” button to start or stop the machine. The lighting status and color of the button changes depending on the operation condition of the machine.

- Lit in red : When the machine cannot start embroidering
- Flashing in green : When the machine can start embroidering
- Lit in green : While the machine is embroidering
- Flashing in orange : When the machine can cut the thread
- Off : When the machine is turned off

② Thread trimming button

Press the thread trimming button to trim both the upper and the bobbin threads.

③ Automatic needle-threading button

Press the automatic needle threading button to thread the needle.











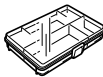
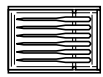

④ Speaker











⑤ LCD (touch panel)









Touch the keys that appear on the touch panel to select and edit patterns and confirm various information.

Included accessories

After opening the box, check that the following accessories are included. If any item is missing or damaged, contact your authorized Brother dealer.

	Part Name
	Part Code
1. 	Accessory case XC6482-051
2. 	Needle set × 2 XC6469-001
3. 	Prewound bobbin × 6 XH3619-001
4. 	Spool net × 10 S34455-000
5. 	Seam ripper XF4967-001
6. 	Scissors XF2052-001
7. 	Tweezers XC6542-051
8. 	Touch pen XA9940-051
9. 	Threader XE8362-001
10. 	Needle changing tool XF0793-001
11. 	Needle plate cover XC6499-151
12. 	Spacer (on machine) XF1978-001
13. 	Phillips screwdriver XC6543-051
14. 	Standard screwdriver X55468-051





	Part Name
	Part Code
15.	Allen screwdriver  XC5159-051
16.	3 way screwdriver  XH4670-001
17.	Wrench 13 mm × 10 mm  XC6159-051
18.	Oiler  D01H2M-001 (Korea) D01H2N-001 (other areas)
19.	Cleaning brush  X59476-051
20.	Weight (L)  XC5974-151
21.	USB cord clamp × 2  XE8396-002
22.	Spool mat × 10  XC7134-051
23.	Spool cap × 10  130012-057
24.	USB cable  XD1851-051
25.	Embroidery frame (extra-large) 360 mm (W) × 200 mm (H) (14 inches (W) × 7-7/8 inches (H)) PRPH360 (Americas) PRPH360: XG6733-001 (Europe) PRPH360CN: 115D02E6024 (China) PRPH360: 115D02E7024 (other areas)
26.	Embroidery frame (large) 180 mm (W) × 130 mm (H) (7-1/8 inches (W) × 5-1/8 inches (H)) PRH180 (Americas) PRH180: XG6647-001 (Europe) PRH180CN: 115D02E6018 (China) PRH180: 115D02E7018 (other areas)
27.	Embroidery frame (medium) 100 mm (W) × 100 mm (H) (4 inches (W) × 4 inches (H)) PRH100 (Americas) PRH100: XG6649-001 (Europe) PRH100CN: 115D02E6017 (China) PRH100: 115D02E7017 (other areas)

	Part Name
	Part Code
28.	Embroidery frame (small) 60 mm (W) × 40 mm (H) (2-3/8 inches (W) × 1-1/2 inches (H)) PRH60 (Americas) PRH60: XG6651-001 (Europe) PRH60CN: 115D02E6020 (China) PRH60: 115D02E7020 (other areas)
29.	Embroidery sheet (extra large) 360 mm (W) × 200 mm (H) (14 inches (W) × 7-7/8 inches (H)) XE7158-101
30.	Embroidery sheet (large) 180 mm (W) × 130 mm (H) (7-1/8 inches (W) × 5-1/8 inches (H)) XC5721-051
31.	Embroidery sheet (medium) 100 mm (W) × 100 mm (H) (4 inches (W) × 4 inches (H)) XC5759-051
32.	Embroidery sheet (small) 60 mm (W) × 40 mm (H) (2-3/8 inches (W) × 1-1/2 inches (H)) XC5761-051
33.	Embroidery positioning sticker sheets × 4  XE4912-501
34.	Embroidery frame holder A (with white corner cover)  XE7374-001
35.	Embroidery frame holder B (with light gray corner cover)  XE7376-001
36.	Operation Manual  This manual
37.	Quick Reference Guide  Visit your authorized Brother dealer.
38.	Embroidery Design Guide  Visit your authorized Brother dealer.
39.	Wide table  PRWT1 (Americas) PRWT1: XG6731001 (Europe) PRWT1CN: 115K02E6001 (China) PRWT1: 115K02E7001 (other areas)
40.	Power cord  Visit your authorized Brother dealer.
41.	Bobbin case (on machine)  XC7206-001

Memo

- The included touch pen can be stored in the touch pen holder on the back of the operation panel. (page 11)



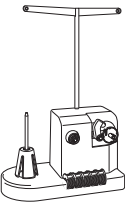

Accessories that are included in some countries or regions

	Part Name
	Part Code
1.	 Scan frame XG5300-001
2.	 Magnet × 6 XF9325-001
3.	 Needle plate cover (additional) XC6499-151
4.	 Embroidery Design Guide (additional) Visit your authorized Brother dealer.
5.	 Bobbin winder set (Refer to page 142.) PRBW1

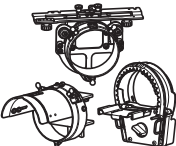
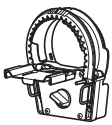
Optional accessories

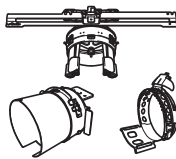

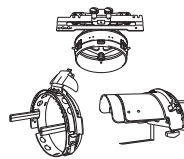

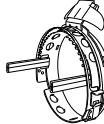
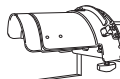
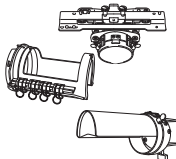
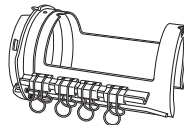
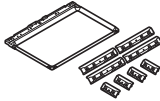

The following are available as optional accessories to be purchased separately.

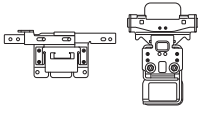
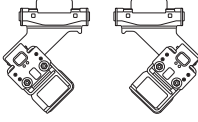
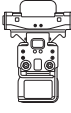
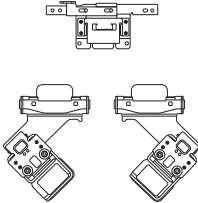
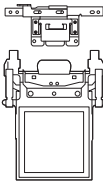
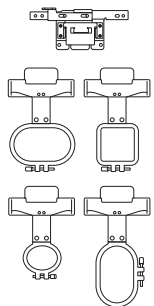
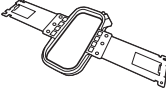
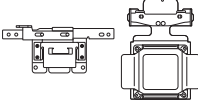
	Part Name
	Part Code
1.	 Flat brim cap frame set PRCF5 (Americas) PRCF5: D01FAB-001 (Europe) PRCF5AP: 115D02E700J (other areas)
2.	 Flat brim cap frame 130 mm (W) × 60 mm (H) (5-1/8 inches (W) × 2-3/8 inches (H)) PRCFH5 (Americas) PRCFH5: D01FA5-001 (Europe) PRCFH5AP: 115D02E700G (other areas)

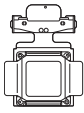
	Part Name
	Part Code
3.	 Wide cap frame set PRPCF1 (Americas) PRPCF1: XE8408-201 (Europe) PRPCF1CN: 115D02E6001 (China) PRPCF1: 115D02E7001 (other areas)
4.	 Wide cap frame 360 mm (W) × 60 mm (H) (14 inches (W) × 2-3/8 inches (H)) PRPCFH4 (Americas) PRPCFH4: XG6735-001 (Europe) PRPCFH4: 115D02E7023 (other areas)
5.	 Advanced cap frame 2 set PRCF3 (Americas) PRCF3: XE2158-201 (Europe) PRCF3CN: 115D02E6002 (China) PRCF3: 115D02E7002 (other areas)
6.	 Advanced cap frame 2 130 mm (W) × 60 mm (H) (5-1/8 inches (W) × 2-3/8 inches (H)) PRCFH3 (Americas) PRCFH3: XG6695-001 (Europe) PRCFH3: 115D02E7008 (other areas)
7.	 Advanced cap frame 130 mm (W) × 50 mm (H) (5-1/8 inches (W) × 2 inches (H)) PRCFH2 (Americas) PRCFH2: 115D02E7007 (other areas*) * Not available in Europe
8.	 Mounting jig PRCFJ2 (Americas) PRCFJ2: XG6661-001 (Europe) PRCFJ2: 115D02E7009 (other areas)
9.	 Cylinder frame set PRCL1 (Americas) PRCL1: XG6697-001 (Europe) PRCL1CN: 115D02E6011 (China) PRCL1: 115D02E7011 (other areas)
10.	 Cylinder frame 90 mm (W) × 80 mm (H) (3-1/2 inches (W) × 3 inches (H)) PRCLH1 (Americas) PRCLH1: XG6699-001 (Europe) PRCLH1: 115D02E7010 (other areas)
11.	 Magnetic sash frame 360 mm (W) × 200 mm (H) (14 inches (W) × 7-7/8 inches (H)) PRMS360 (Americas) PRMS360: D01FAN-001 (Europe) PRMS360AP: 115D02E700K (other areas)

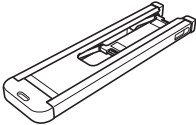
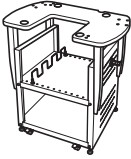
	Part Name
	Part Code
12.	Quilt frame 200 mm (W) × 200 mm (H) (7-7/8 inches (W) × 7-7/8 inches (H)) PRPQF200 (Americas) PRPQF200: XG6727-001 (Europe) PRPQF200CN: 115D02E6025 (China) PRPQF200: 115D02E7025 (other areas)
13.	Border frame 300 mm (W) × 100 mm (H) (11-3/4 inches (W) × 4 inches (H)) PRPBF1 (Americas) PRPBF1: XG6729-001 (Europe) PRPBF1CN: 115D02E6022 (China) PRPBF1: 115D02E7022 (other areas)
14.	Jumbo frame 360 mm (W) × 360 mm (H) (14 inches (W) × 14 inches (H)) PRPJF360 (Americas) PRPJF360: XE8405-301 (Europe) PRPJF360CN: 115D02E6003 (China) PRPJF360: 115D02E7003 (other areas)
15.	Round frame set PRPRFK1 (Americas) PRPRFK1: XG6725-001 (Europe) PRPRFK1CN: 115D02E6029 (China) PRPRFK1: 115D02E7029 (other areas)
16.	Round frame (Ø100 mm (4 inches)) PRPRF100 (Americas) PRPRF100: XG6737-001 (Europe) PRPRF100CN: 115D02E6026 (China) PRPRF100: 115D02E7026 (other areas)
17.	Round frame (Ø130 mm (5 inches)) PRPRF130 (Americas) PRPRF130: XG6739-001 (Europe) PRPRF130CN: 115D02E6027 (China) PRPRF130: 115D02E7027 (other areas)
18.	Round frame (Ø160 mm (6 inches)) PRPRF160 (Americas) PRPRF160: XG6741-001 (Europe) PRPRF160CN: 115D02E6028 (China) PRPRF160: 115D02E7028 (other areas)
19.	Embroidery frame holder C (with dark gray corner covers) PRPARMC (Americas) PRPARMC: XG6743-001 (Europe) PRPARMC: 115D02E7021 (other areas)
20.	Flat frame 300 mm (W) × 200 mm (H) (11-3/4 inches (W) × 7-7/8 inches (H)) PRF300 (Americas) PRF300: XG6693-001 (Europe) PRF300: 115D02E7016 (other areas)
21.	Embroidery frame (extra-large) 300 mm (W) × 200 mm (H) (11-3/4 inches (W) × 7-7/8 inches (H)) PRH300 (Americas) PRH300: XG6645-001 (Europe) PRH300CN: 115D02E6019 (China) PRH300: 115D02E7019 (other areas)

	Part Name
	Part Code
22.	 Clamp frame S straight set 45 mm (W) × 24 mm (H) (1-3/4 inches (W) × 7/8 inches (H)) PRCLP45B (Americas) PRCLP45B: XF2251-001 (Europe) PRCLP45BCN: 115D02E6012 (China) PRCLP45B: 115D02E7012 (other areas)
23.	 Clamp frames S L & R 45 mm (W) × 24 mm (H) (1-3/4 inches (W) × 7/8 inches (H)) PRCLP45LR (Americas) PRCLP45LR: XF2255-001 (Europe) PRCLP45LR CN: 115D02E6013 (China) PRCLP45LR: 115D02E7013 (other areas)
24.	 Clamp frame S straight 45 mm (W) × 24 mm (H) (1-3/4 inches (W) × 7/8 inches (H)) PRCLP45S (Americas) PRCLP45S: 115D02E7015 (other areas*) * Not available in Europe
25.	 Clamp frames S L & R set 45 mm (W) × 24 mm (H) (1-3/4 inches (W) × 7/8 inches (H)) PRCLP45LRD (Americas) PRCLP45LRD: 115D02E7014 (other areas*) * Not available in Europe
26.	 Clamp frame M set 100mm (W) × 100 mm (H) (4 inches (W) × 4 inches (H)) PRCLPM1 (Americas) PRCLP100B: XG6235-001 (Europe) PRCLPM1CN: 115D02E600B (China) PRCLPM1AP: 115D02E700B (other areas)
27.	 Compact frame set 70: 70 mm (W) × 41 mm (H) (2-3/4 inches (W) × 1-5/8 inches (H)) 50: 50 mm (W) × 50 mm (H) (2 inches (W) × 2 inches (H)) 44: 44 mm (W) × 38 mm (H) (1-3/4 inches (W) × 1-1/2 inches (H)) Portrait orientation: 75 mm (W) × 33 mm (H) (2-15/16 inches (W) × 1-5/16 inches (H)) PRHCK1 (Americas) PRSFK1: XG6209001 (Europe) PRHCK1CN: 115D02E600A (China) PRHCK1AP: 115D02E700A (other areas)
28.	 Sleeve frame 70 mm (W) × 200 mm (H) (2-3/4 inches (W) × 7-7/8 inches (H)) PRHSL200 (Americas) PRHSL200: XG5284-001 (Europe) PRHSL200CN: 115D02E600C (China) PRHSL200AP: 115D02E700C (other areas)
29.	 Magnetic frame set 50 mm (W) × 50 mm (H) (2 inches (W) × 2 inches (H)) PRMHA50 (Americas) PRMFA50: XG8593-001 (Europe) PRMFA50AP: 115D02E700E (other areas)

	Part Name
	Part Code
30.	 Magnetic frame 50 mm (W) x 50 mm (H) (2 inches (W) x 2 inches (H)) PRMH50 (Americas) PRMF50: XG8597-001 (Europe) PRMF50AP: 115D02E700F (other areas)
31.	 Scan frame set PRSCANFKIT1: XG8237-001 (Europe) PRSCANFKIT1AP: 115D02E700D (other areas)
32.	 Tubular frame table PRTT1 (Americas) PRTT1: D01FAF-001 (Europe) PRTT1AP: 115K02E7002 (other areas)
33.	 Embroidery Stand PRNSTD2 (Americas) VRPRNSTD: XG3199-001 (Europe) VRPRNSTDCN: 115Z05E6005 (China) VRPRNSTD: 115Z05E7005 (other areas)
34.	 Metal bobbin 100376-051
35.	 Weight (S) XC6631-051
36.	 Embroidery positioning sticker sheets x 8 SAEPS2 (U.S.A.) / SAEPS2C (Canada) EPS2: XG6749-001 (Europe) EPS2CN: 115Z05E600E (China) EPS2: 115Z05E700E (other areas)

Note

- Visit your nearest authorized Brother dealer for a complete listing of optional accessories and embroidery cards available for your machine.

Memo

- Always use accessories recommended for this machine.
- All specifications are correct at the time of printing. Please be aware that some specifications may change without notice.

SETTING UP THE MACHINE

Setup and transporting precautions

CAUTION

- The temperature of the operating environment should be between 5 °C (40 °F) and 40 °C (104 °F). If the machine is operated in an environment that is either too cold or too hot, the machine may malfunction.
- Do not use the machine in a location where it will be exposed to direct sunlight, otherwise the machine may malfunction.
- Set up the machine with its four adjustable feet completely in contact with the desk or table, so that the machine is level.
- Do not put anything under the machine that could block the ventilation slots found on the rear underside of the machine, in order to avoid the possibility of the machine's motor overheating, resulting in a fire or in damage to the machine.
- The machine weight is approximately 41.8 kg (92 lb). The transporting or setting up of the machine should be performed by two people.
- When transporting the machine, be sure to have two people lift the machine from the bottom at the indicated slots (1). Lifting the machine from any other area may damage the machine or result in the machine falling, which could cause injuries.

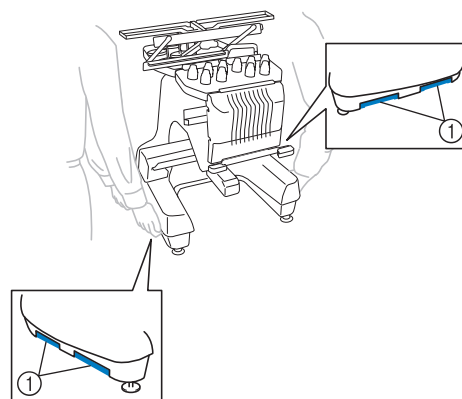

- When lightning occurs, turn off the machine and unplug the power supply cord. Lightning may cause the machine to malfunction.
- Do not plug in the power supply cord until setup of the machine is completed, otherwise injuries may result if the "Start/Stop" button is accidentally pressed and the machine starts embroidering.

- When lubricating the machine, wear protective eyeglasses and gloves to prevent the oil or grease from getting into your eyes or on your skin. Do not put the oil or grease into your mouth. Keep the oil and grease out of the reach of children.
- While attaching or detaching an embroidery frame or other included accessory or while maintaining the machine, be careful nothing interferes with the moving parts of the machine.

Setup location

Set up the machine in a location that meets the following requirements.

- Position the machine a minimum of 50 mm (2 inches) away from the wall.
- Allow sufficient space around the machine.
- Place no objects within the moving range of the embroidery frame.
- Set-up machine near an electrical outlet.
- Use a level and stable surface, such as a desk or stand.
- Use a surface that can support the weight of the machine (about 41.8 kg (92 lb)).
- Allow open space around the ventilation slots found on the rear underside of the machine.

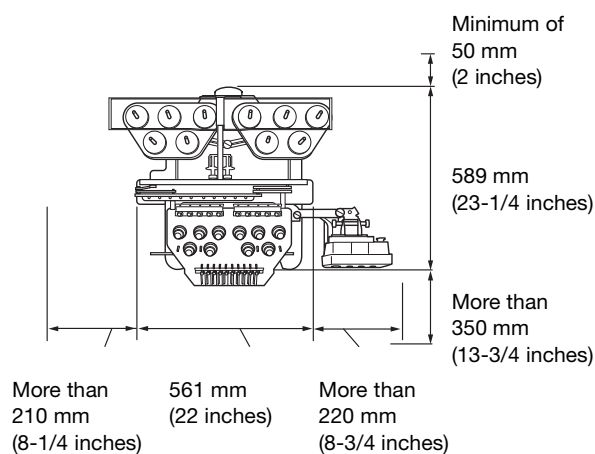
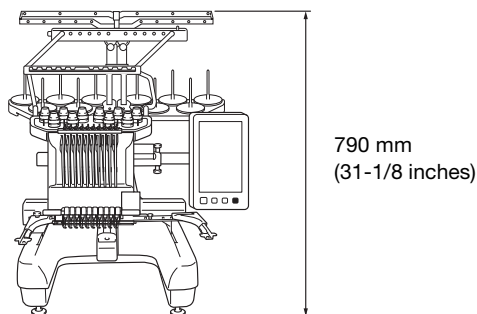

⚠ CAUTION

- In order to prevent malfunctions or damage, do not set up the machine in a location exposed to the following conditions.
 - Liquids, such as water
 - Extreme dust
 - Direct sunlight
 - Extremely high or extremely low temperatures. The operating environment should be between 5 °C (40 °F) and 40 °C (104 °F).
 - Insufficient space
 - Objects within the moving range of the embroidery frame
 - Blocked ventilation slots
 - An unstable surface
- Do not use extension cords or multi-plug adapters with many other appliances plugged in to them.

Setting up the machine

When setting up the machine, adjust the legs so that the machine is steady.

- 1 Make sure that all packing tape affixed to the machine is peeled off and that all packing material is removed.

- 2 Set up the machine while making sure that there is sufficient space around it.

For details on the setup location, refer to page 17.

- 3 Adjust the legs so that the machine is steady.

Use the included wrench to loosen the lock nut on the leg that you wish to adjust.

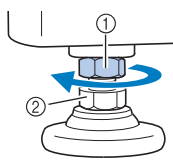

- 1 Lock nut
- 2 Adjustable foot nut

→ The foot can be turned.

- 4 Use the included wrench to turn the adjustable foot nut on the foot.

Turning the nut in direction 1 lengthens the leg; turning the nut in direction 2 shortens the leg.

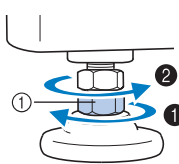

- 1 Adjustable foot nut

- Adjust all four legs so that they securely contact the desk or table, and the machine is level.

- 5 After adjusting the legs to the desired length, use the included wrench to tighten the nuts.

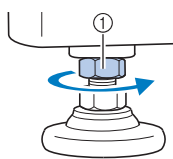

- 1 Lock nut

- 6 Press down on each corner of the machine to check that it is stable.

If it is still unstable, perform steps 3 through 5 again to adjust the legs.

Remove the fixing plates

CAUTION

- Remove the fixing plates before turning on the machine, otherwise the machine may malfunction.

- 1 Using the included Phillips screwdriver, remove each of screws on the fixing plates.

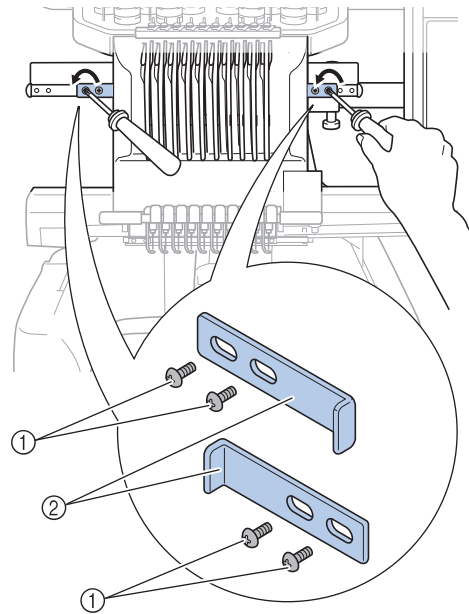

- 1 Screws
- 2 Fixing plates

Memo

- After removing the fixing plates, be sure to keep them to be used again. Before transporting the machine, consult your authorized Brother dealer.

Adjusting the operation panel position

- 1 Loosen 2 thumb screws to bring the operation panel forward.

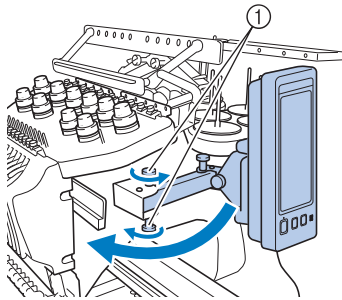

- 1 Thumb screws

Note

- Using the 3 way screwdriver included, loosen and firmly tighten the thumb screws.

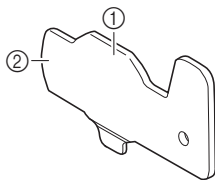

- 1 Use this part to tighten the upper and lower thumb screws.
- 2 Use this part to tighten the left and right thumb screws.

- 2 Adjust the operation panel to an easy-to-operate position, and then tighten the thumb screws.

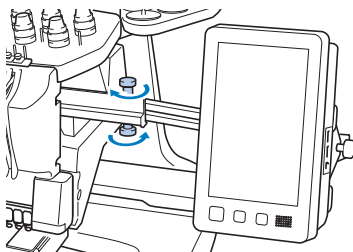

- 3 Adjust the orientation of the operation panel.

Loosen the thumb screw, adjust the operation panel to an easy-to-view orientation, and then tighten the thumb screw.

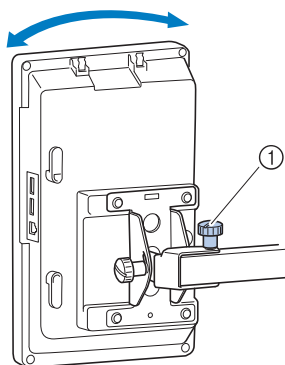

- 1 Thumb screw

- 4 Adjust the angle of the operation panel.

Loosen the 2 thumb screws behind the operation panel, adjust the operation panel to an easy-to-view angle, and then tighten the thumb screws.

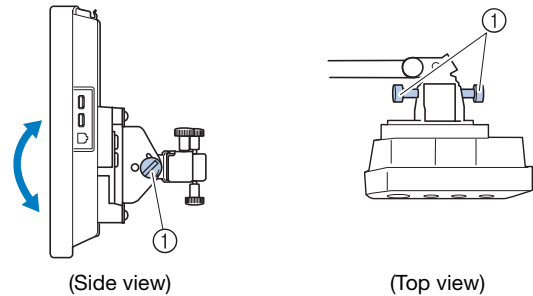

- 1 Thumb screws

Preparing the thread guide assembly

CAUTION

- When setting up the thread guide assembly, set it up with the needle bar 6 position selected, otherwise the machine may malfunction. (Refer to "Moving and threading a selected needle bar" on page 86 for moving the needle bar.)

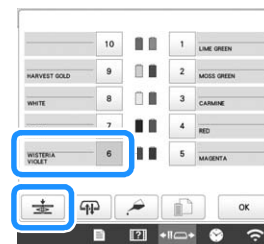

- 1 Loosen the two thumb screws on top of the thread guide assembly support.

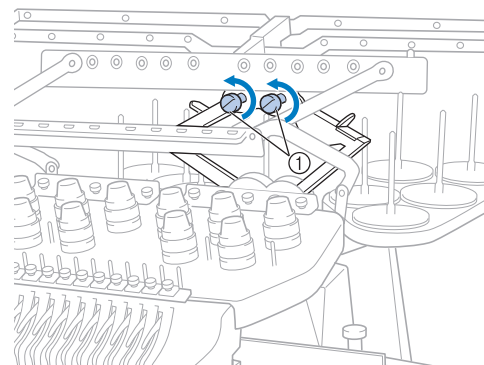

- 1 Turn the screw counterclockwise three or four times to loosen it.

- 2** Grab the grips on the thread guide assembly support and push toward the middle.

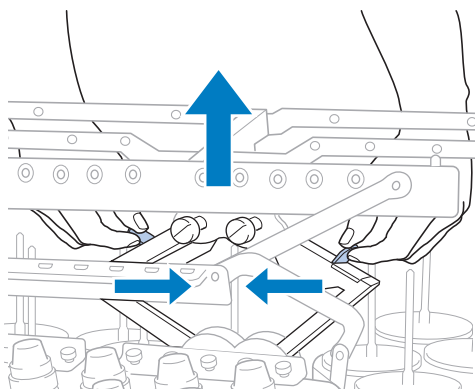

- 3** After the thread guide assembly support is extended and the thread guide assembly is raised to its highest position, tighten the two thumb screws to secure the thread guide assembly in place.

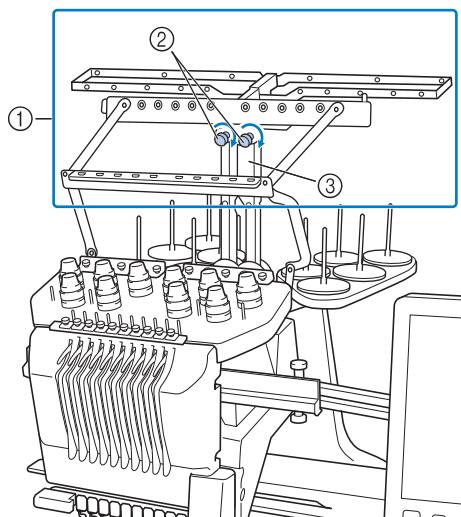

- ① Thread guide assembly
- ② Thumb screws
- ③ Thread guide assembly support

Note

- If the thumb screws are not loosened enough, it may not be easy to move the thread guide assembly support. Do not apply extreme force when moving the thread guide assembly support. Be sure that the thumb screws are loosened well enough before moving the part.
- Be sure to tighten each thumb screw well enough that the thread guide assembly support is secured.

Preparing the spool stand

- 1** Loosen the thumb screw two or three turns, and then fold out the spool stand.

Rear view

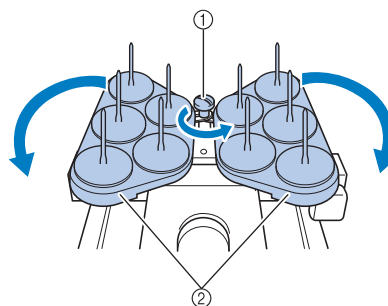

- ① Thumb screw
- ② Spool stand

- 2** After the spool stand is fully opened up, tighten the thumb screw.

Rear view

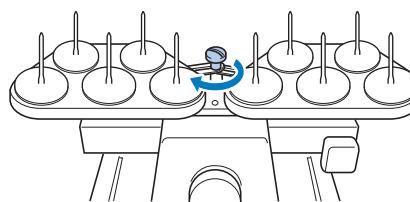

→ Secure the spool stand in the opened position.

Attaching the embroidery frame holder

1 Use the embroidery frame holder appropriate for the embroidery frame that you are using (page 66 to page 68).

2 Remove the two thumb screws of the embroidery frame holder.

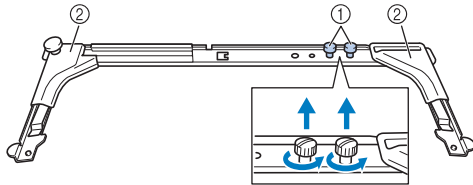

- ① Thumb screws
- ② Corner covers

Note

- Using the 3 way screwdriver included, loosen and firmly tighten the thumb screws.

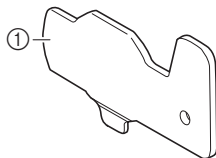

- ① Use this part to tighten the thumb screws of the embroidery frame holder.

3 Align the holes in the embroidery frame holder with the pins on the frame-mounting plate of the carriage.

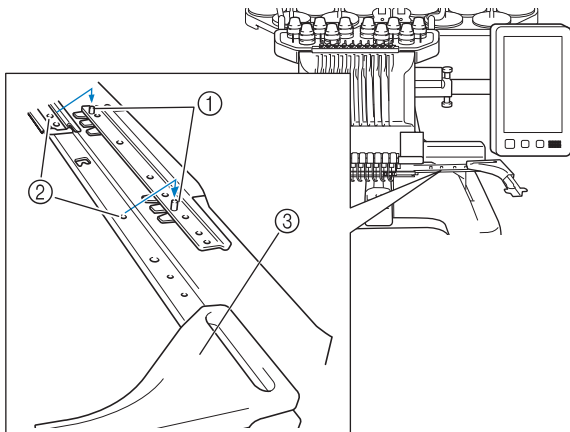

- ① Pins on the frame-mounting plate
- ② Holes in the embroidery frame holder
- ③ Corner covers

Note

- Each embroidery frame holder has different color of corner cover.
Holder A: White corner covers
Holder B: Light gray corner covers
Holder C: Dark gray corner covers (Optional)

4 Secure the embroidery frame holder with the two thumb screws removed in step 2.

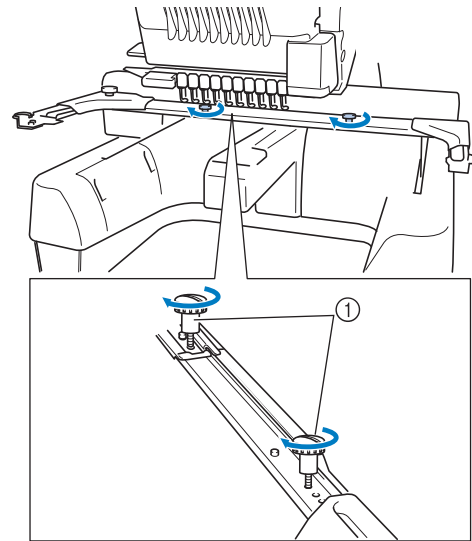

- ① Thumb screws

Note

- Two types of embroidery frame holders are included with this machine. Embroidery frame holder A is used with the four included embroidery frames. (page 66)
- Refer to page 67 for hoops used with frame holder B and other optional frame holders.

This completes the preparation of the machine.

TURNING ON THE MACHINE

⚠ WARNING

- Use only regular household electricity for the power source. Using other power sources may result in fire, electric shock, or damage to the machine.
- Make sure that the plugs on the power supply cord are firmly inserted into the electrical outlet and the power supply cord receptacle on the machine. Otherwise, a fire or electrical shock may result.
- Do not insert the plug on the power supply cord into an electrical outlet that is in poor condition.
- If any of the following occur, turn off the machine and unplug the power supply cord, otherwise a fire, an electric shock or damage to the machine may result.
 - When you are away from the machine.
 - After using the machine.
 - If a power outage occurs while the machine is being operated.
 - If the machine is not operating properly, for example, when there is a loose or cut connection.
 - During electrical storms.

⚠ CAUTION

- Be sure to use the included power cord for this machine.
- Do not plug this machine in with extension cords or multi-plug adapters with any other appliances plugged into them, otherwise a fire or an electric shock may result.
- Do not plug in or unplug the power supply cord with wet hands, otherwise an electric shock may result.
- When unplugging the power supply cord, be sure to first turn off the machine, and then grasp the plug when unplugging the cord. Pulling on the cord may damage it or result in a fire or an electric shock.
- Do not allow the power supply cord to be cut, damaged, modified, forcefully bent, pulled, twisted, or bundled. In addition, do not place heavy objects on the cord or expose it to heat, otherwise damage to the cord, fire or an electric shock may result. If the power supply cord or its plug is damaged, stop using the machine, and then take the machine to your authorized Brother dealer for repairs before continuing use.

- If the machine is not to be used for a long period of time, unplug the power supply cord, otherwise a fire may result.
- For U.S.A. only
This appliance has a polarized plug (one blade wider than the other). To reduce the risk of electrical shock, this plug is intended to fit in a polarized outlet only one way. If the plug does not fit fully in the electrical outlet, reverse the plug. If it still does not fit, contact a qualified electrician to install the proper electrical outlet. Do not modify the plug in any way.

- 1** Insert the power supply cord into the power cord receptacle, then insert the plug into a wall outlet.

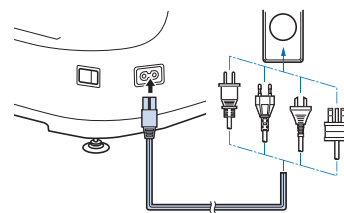

- 2** Switch on the main power switch on the right side of the machine to "I".

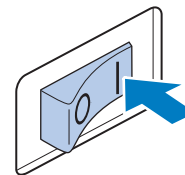

→ The LCD screen comes on.

- 3** When the machine is turned on, the opening movie is played. Touch anywhere on the screen to display the message below.

- 4** Touch .

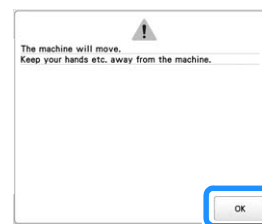

→ The pattern type selection screen appears, and the "Start/Stop" button lights up in red.

- 5** The carriage moves to its initial position.
- If the number 1 needle bar is not already at the embroidering position, the needle bar case moves and the number 1 needle bar moves to the embroidering position.

⚠ CAUTION

- Make sure to keep your hands and other items away from the carriage, in order to prevent any injuries.



- 6** Set the main power switch to "O" to turn off the machine.

📝 Memo

- If the machine is turned off in the middle of embroidering, the machine will automatically save the design position when turned on again. At that time, you will be asked if you wish to continue embroidering or begin a new operation. (page 97)

■ Setting your machine for the first time

When you first turn on the machine, set the language and time/date to your language and local time/date. Follow the procedure below when the settings screen appears automatically.

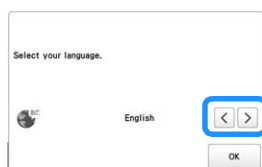

- 1** Touch  and  to set your local language and then touch .

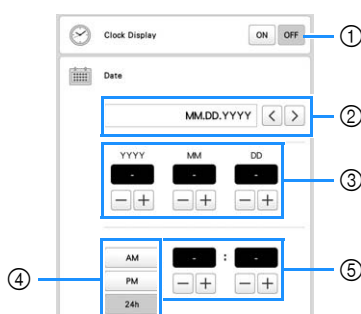

→ The carriage moves to its initial position.

- 2** The message screen, confirming if you want to set time/date, appears. Touch .



- Select [ON] to display time/date on the screen.
- Touch  or  to select the date display format.
- Set the year [YYYY], month [MM] and date [DD].
- Select whether 24h or 12h setting to display.
- Set the current time.

- 3** Touch  to start using your machine.

→ The clock starts from 0 second of the time you set.

💡 Note

- The time/date you set may be cleared, if you don't turn on the machine for an extended period of time.
- Time setting is also available by touching  on the bottom right of the LCD screen.

LCD SCREEN

Touch the LCD screen, or a key, with your finger or the included touch pen to select a machine function.

⚠ CAUTION

- Only touch the screen with your finger or the touch pen included with the machine. Do not use a mechanical pencil, screwdriver or any other hard or sharp object. In addition, do not touch the screen with extreme pressure. Otherwise the screen may be damaged.
- All or part of the screen may sometimes become darker or lighter due to changes in the surrounding temperature or other changes in the environment. This is not a sign of a malfunction. If the screen is difficult to read, adjust its brightness.

■ Pattern type selection screen

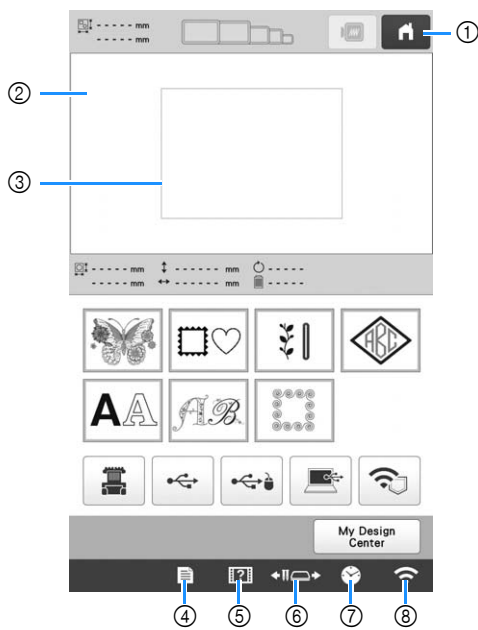





No.	Display	Function	Page
	Key Name		
①		Cancel all operations previously performed and return to the initial pattern type selection screen.	-
	Home key		
②	-	This area displays the selected pattern.	123
	Pattern display area		



No.	Display	Function	Page
	Key Name		
③	-	Shows the available embroidering area for the attached embroidery frame. The embroidery frame indications, the grid lines and other display settings can be specified from the machine settings screen.	123
	Embroidering area line		
④		Change the machine settings.	25
	Settings key		
⑤		Check a machine operation.	28
	Machine operations guide key		
⑥		Move or thread a selected needle bar, to position the carriage, or to oil the machine so the embroidery frame can easily be removed or attached.	66, 86
	Needle bar/Frame move key		
⑦		Set the clock to your local time.	23
	Clock key		
⑧		Specify the wireless LAN settings. Also, this key shows the machine's wireless LAN signal strength.	27
	Wireless LAN key		

* The keys in the table above appear and can be used in most of the screens described later in this manual.

Using the settings key

Touch  to change the default machine settings (light, volume, speaker volume, opening display etc.). To display the different settings screens, touch  for “Embroidery settings”,  for “General settings”, or  for “Wireless LAN settings”.

Memo

- The machine default setting is highlighted.
- Touch  or  to display a different settings screen.

Embroidery settings

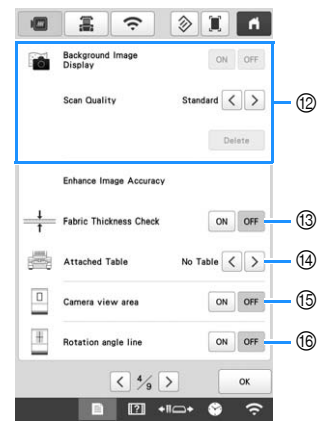
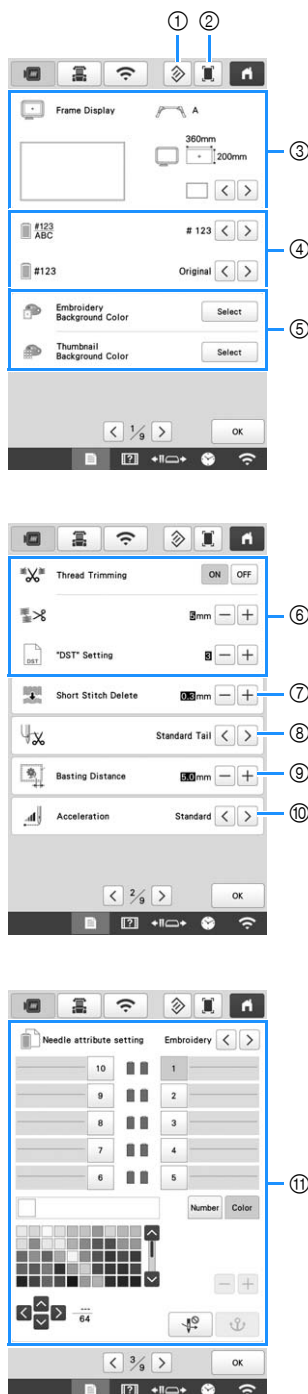

- ① The settings on the page containing this key will be reverted to their defaults.
- ② An image of the current settings screen can be saved on USB media.
- ③ The guides (center point marker and grid) for the pattern display area can be specified. (page 123)
- ④ The color information in the thread color sequence display and the needle bar thread information can be switched to the color name, the thread brand and color number or the embroidering time. (page 123)
- ⑤ Depending on the color of the embroidery, changing the background color of the pattern display area and thumbnails may make them more visible and easier to select.
- ⑥ Specifies whether or not jump stitches are cut. In addition, the jump stitch length can be specified. When using Tajima embroidery data (.dst), you can specify whether or not the thread is cut according to the specified number of jump codes. (page 123)
- ⑦ Specifies the length of short stitches that are to be deleted. (page 124)
- ⑧ Specifies the length of upper thread that remains threaded through the needle after the thread is trimmed (length of thread passed through the eye of the needle). (page 124)
- ⑨ Specify the distance between the pattern and the basting stitching. (page 124)
- ⑩ Specifies the acceleration from the initial speed (when embroidery begins) until the maximum embroidery speed is reached.

Note

- If the settings for [“DST” Setting] ⑥ or [Short Stitch Delete] ⑦ are changed from the previous setting, the new settings are applied to the subsequent embroidery.

- ⑪ A specific thread color can be set to a needle bar. The specified color remains assigned to the needle bar until the setting is cancelled. You can also specify the maximum embroidery speed for a needle bar as well as cancel automatic needle threading. This feature is not accessible through the embroidering screen. (page 121)
- ⑫ Select whether or not the fabric is displayed in the background. (page 72)
- ⑬ When the fabric is scanned and displayed as a background image, the thickness of the fabric can be checked to ensure that the camera correctly detects the fabric. (page 74)
- ⑭ Before scanning the fabric to display it as a background image for a pattern or before using the built-in camera to display a camera image of the fabric, select the table installation setting. (page 73)
- ⑮ A blue box can be displayed in the embroidering settings screen to indicate the area detected by the camera.
- ⑯ Grid line can be displayed in the camera screen to support setting the pattern at the desired angle.

■ General settings

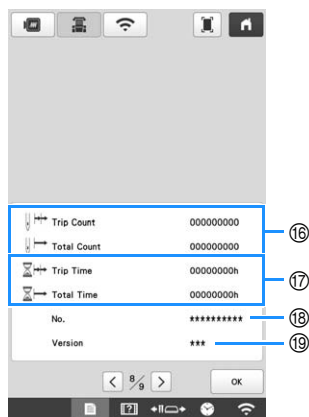
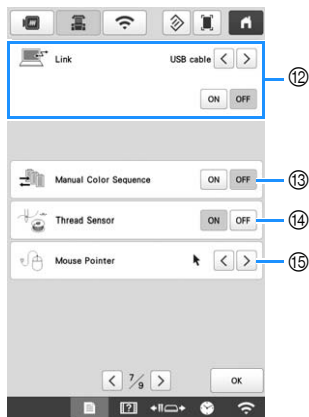
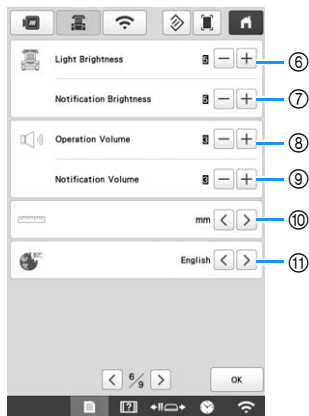
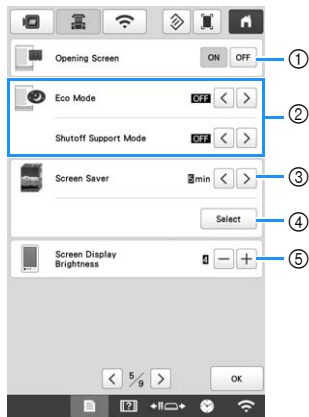

⚠ CAUTION

- When [Thread Sensor] is set to [OFF], the machine cannot detect tangled upper thread. Continuing to use the machine with tangled thread may cause damage.

- ① The machine can be set so that the opening screen is either displayed ([ON]) or not displayed ([OFF]) when the machine is turned on.
 - ② Select settings for the [Eco Mode] and [Shutoff Support Mode]. (page 27)
 - ③ Select the length of time until the screen saver appears.
 - ④ Select the image of the screen saver. (page 27)
 - ⑤ Adjust the brightness of the screen display.
 - ⑥ Adjust the brightness of the embroidery light.
 - ⑦ Adjust the brightness of the embroidery light when lighting effects are used to notify that the thread spool must be changed or an error has occurred.
 - ⑧ Adjust the volume of operation beep. Increase the number for louder volume, decrease for softer volume.
 - ⑨ Adjust the volume of error notification. Increase the number for louder volume, decrease for softer volume.
 - ⑩ Select the display units for embroidering (mm/inch).
 - ⑪ Select the display language. The keys and messages appear in the selected language.
 - ⑫ Select the Link function [ON] or [OFF]. You can choose the USB cable connection or the wireless LAN connection. (page 132)
 - ⑬ Set the [Manual Color Sequence] [ON] or [OFF]. (page 58)
 - ⑭ Turn both the upper and bobbin thread sensors [ON] or [OFF]. If it is turned [OFF], the machine can be used without upper thread.
 - ⑮ Change the shape of the pointer when a USB mouse is used.
 - ⑯ [Total Count] shows the total number of stitches embroidered, and [Trip Count] shows the number of stitches that have been embroidered since the machine's last maintenance.
 - ⑰ [Total Time] shows the total amount of time that the machine has been used, and [Trip Time] shows the amount of time that the machine has been used since the machine's last maintenance.
- * Use counters ⑯ and ⑰ as a standard for performing periodic maintenance and for receiving maintenance for the machine.
- ⑱ Shows the internal machine number for this machine.
 - ⑲ Shows the version of the software installed on this machine.

Note

- Install the latest software. Check with your local authorized Brother dealer or at "<http://s.brother/cubah/>" for available updates (page 192).

■ Wireless LAN settings

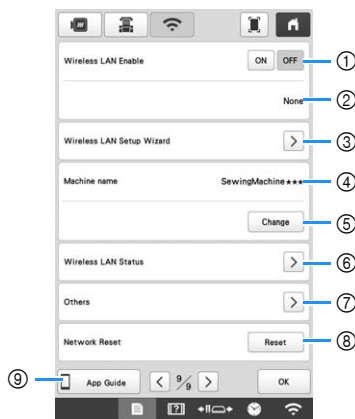

- ① Enable/Disable the wireless LAN function.
- ② Shows the connected SSID.
- ③ Set the machine to connect wireless LAN function.
- ④ Shows the machine name used on the wireless network. This name is used when transferring files from the machine to the embroidery editing software (PE-DESIGN version 11 or later).
- ⑤ Change the machine name used on the wireless network.
- ⑥ Check the wireless LAN status.
- ⑦ Display other menus.
- ⑧ Reset network operations.
- ⑨ Display the introduction to the application.

■ Setting the [Eco Mode] and the [Shutoff Support Mode]

You can save the machine power by setting the [Eco Mode] and the [Shutoff Support Mode]. If you leave the machine turned on without using it for the set period of time, the machine enters in each mode.

[Eco Mode]:

Machine will enter a sleep mode after the set period of time. Touch the screen or press the "Start/Stop" button to continue operating.

[Shutoff Support Mode]:

Machine will turn off after set period of time. Turn the machine off and then back on to restart operating.

Touch  to display [Eco Mode] and [Shutoff Support Mode]. (page 26)

Note



- If you turn off the machine while the machine is in the [Eco Mode] or the [Shutoff Support Mode], wait for about 5 seconds before turning on the machine again.

■ Changing the screen saver image

You can select your own personal images for the screen saver of your machine.

Before changing the screen saver image, prepare the image on your computer or USB media.

For details on compatible image files, refer to "SPECIFICATIONS" on page 190.

- 1 Touch , then .
→ The general settings screen appears.

- 2 Locate [Screen Saver] in the general settings screen.

- 3 Touch .

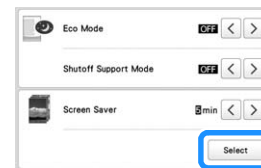

- 4 Touch .



- 5 Connect the USB media or the computer (using a USB cable) that contains your personal image to the USB port of the machine.

- 6 Touch  to select the first image.

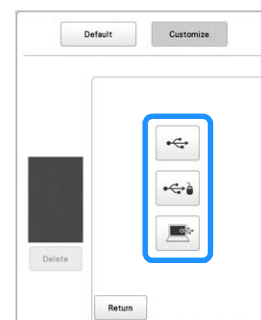
- 7 Select the device that is connected.



→ A list of your personal images appear on the screen.

- Touch  to delete the selected image.
- Touch  to return to the previous screen.

- 8 Touch a file name to select image and then touch .

→ The selected image is stored on your machine.

- 9 Repeat steps 6 through 8 to set the remaining images.

- 10 Touch  to return to the original screen.

Using the machine help

Touch  to display the machine help screen.
Functions are available from the screen shown below.

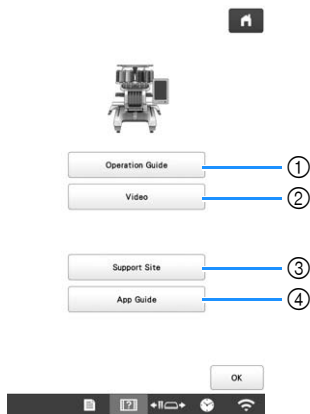

- ① Explanation for upper threading, installing the bobbin, preparing to embroider a pattern, and how to use the machine (page 28)
- ② Tutorial videos or MPEG-4 (MP4) videos from USB media (page 28, page 29)
- ③ Display the link information to Brother support website.
- ④ Display the introduction to the application.

Using the operation guide function

Touch  to display the screen shown below. Categories are displayed at the top of the screen. Touch a key to see more information about that category. Some of the functions are described in the movies. Watch these movies for a better understanding of the functions.



- ① Information about the main parts of the machine and their functions
- ② Information about threading the machine, hooping the fabric in the embroidery frame, etc.
- ③ Information about troubleshooting
- ④ Information about cleaning the machine, etc.

Playing a tutorial video

This machine provides tutorial videos on how to use the machine.

1 Touch .

2 Touch .

3 Select the category and the tutorial video.

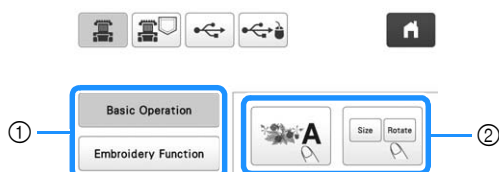





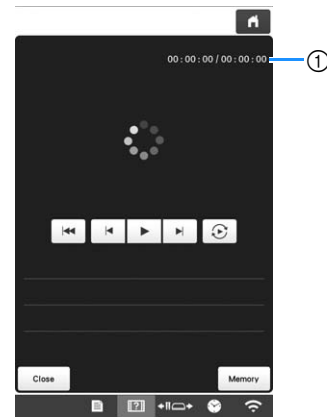



- ① Category
 - ② Tutorial video
- The selected tutorial video begins playing.

4 Play the tutorial video.



① Number of seconds elapsed/Total number of seconds

Operation keys

	Play
	Pause
	Skip back 10 seconds
	Skip forward 10 seconds
	Return to beginning
	Repeat
	Delete video (when playing from the machine's memory)
	Save to machine (when playing from USB media)

Memo

- A frequently viewed tutorial video can be saved to  (favorites) of the machine, from where it can be played.

5 After you are finished playing the video, touch .

■ Playing MPEG-4 (MP4) videos

Your MP4 videos can be played from USB media. In addition, the MP4 video can be saved to the machine so that a tutorial video on creating a project, for example, can be viewed at any time. For details on compatible video files, refer to "SPECIFICATIONS" on page 190.

Memo





- Some type of MP4 file cannot be viewed with the machine.

1 Touch .

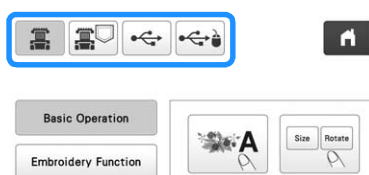
2 Touch .

3 Select the device where the video is saved.



-  : play a tutorial video
-  : Play a video saved on the machine (favorites)
-  : Play a video from USB media plugged into the USB port
-  : Play a video from USB media plugged into the USB port for mouse

4 Select the video that you want to play.

5 Play the video.

- * Use the operation keys as described in "Playing a tutorial video" on page 28.

6 After you are finished playing the video, touch .

WIRELESS NETWORK CONNECTION FUNCTIONS

This machine supports a wireless network connection. Using this function, an embroidery pattern edited in embroidery editing software (PE-DESIGN version 11 or later) with wireless transfer functions can be transferred to the machine from a computer. Embroidery patterns can be transferred from the machine to the embroidery editing software. The machine and computer must be connected to the same network. For detailed procedures, refer to the manual for the embroidery editing software. The wireless network must be set up and enabled to use the special application to transfer images to the machine.

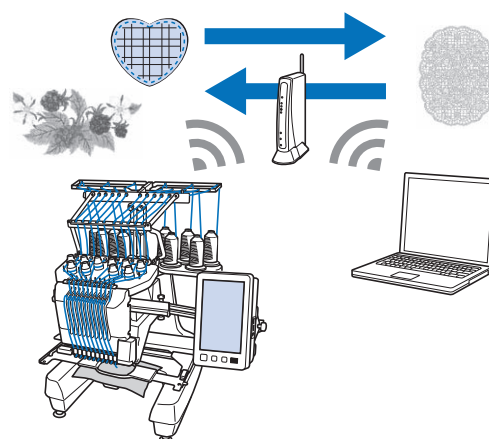

Enabling a wireless network connection

The machine can be connected to your wireless network.

1 Touch , then .

2 Set [Wireless LAN Enable] to [ON].

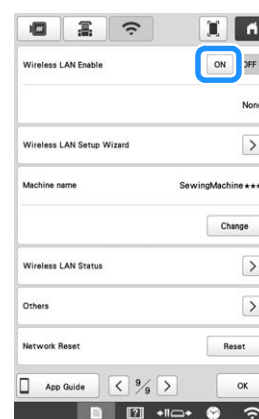

→ The machine prepares for wireless transmission.

■ Requirements for a wireless network connection

The wireless network connection complies with IEEE 802.11 n/g/b standards and uses the 2.4 GHz frequency.

Memo

- A wireless network cannot be set up with WPA/WPA2 Enterprise.

Setting up the wireless network connection

There are multiple ways to set up the wireless network connection. We recommend the method that uses the wizard on this machine.

■ Using the wizard to set up the wireless network connection

- 1 In order to connect your machine to a wireless network, the security information (SSID and network key) for your network will be required. The network key may also be called a password, security key or encryption key. Find your security information and note it in the table below.

SSID	Network Key (Password)

Memo

- The wireless network connection cannot be set up if you do not have the security information.
- How to find the security information
 - ① Check the manual provided with your network.
 - ② The default SSID may be the manufacturer's name or the model name.
 - ③ If you cannot find the security information, contact the manufacturer of the router, your network administrator or your Internet provider.

- 2 Touch  beside [Wireless LAN Setup Wizard].

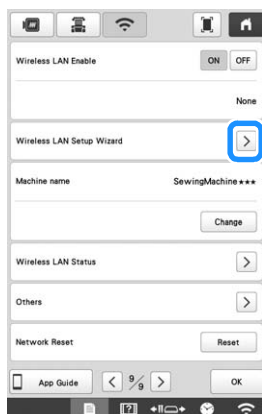



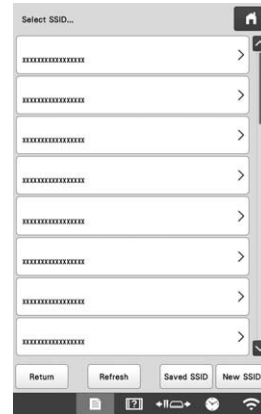

→ A list of available SSIDs appears.

- 3 Touch  beside the SSID that was noted.



→ The screen for entering the network key (password) appears.

Memo

- If the SSID that was noted does not appear in the list, touch .
- If the SSID that was noted is not displayed, specify it as described below.
 - ① Select  in the list of SSIDs.
 - ② Enter the desired network SSID, and then touch .
 - ③ Select the authentication method and encryption mode.
- If the machine had already been connected to the home network, touch , and then select the saved SSID.

- 4 Enter the network key (password) that was noted, and then touch .



- 5 When the following message appears, touch .



→ When a connection is established, the following message appears.

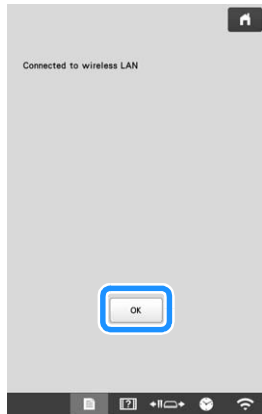

- 6 Touch  to exit the setup.

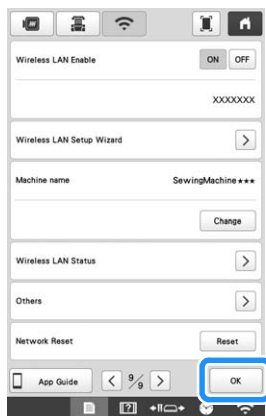

Memo

- While connected, the signal strength is indicated by the icon in the lower-right corner of the display.
- Once a wireless network connection has been set up, a connection will be established each time the machine is turned on. However, [Wireless LAN Enable] in the network settings screen must remain set to [ON].

■ Using the [Others] menu to set up the wireless network connection

The [Others] menu contains the following items.

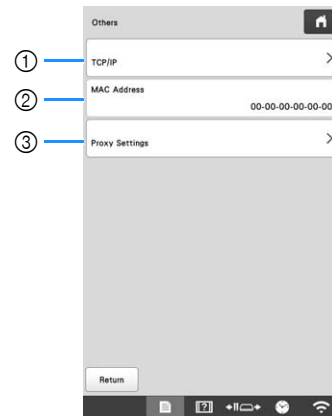

- ① TCP/IP settings can be manually entered.
- ② Shows the MAC address.
- ③ Use when proxy settings are required.

OTHER FUNCTIONS

Using a USB mouse

A USB mouse, connected to the machine, can be used to perform a variety of operations in the screens.

Connect a USB mouse to the USB port marked with . You can also connect a USB mouse to the other USB port.

Memo

- Use a basic computer mouse to operate the machine functions. Some USB mouse devices may not be compatible with this machine.

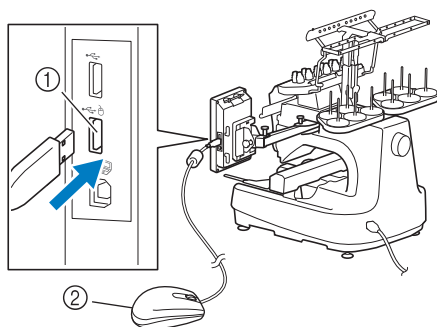

- ① USB port marked with 
- ② USB mouse

Note

- A USB mouse can be connected or disconnected at any time.
- The left mouse button can be used to perform operations such as choosing a design and choosing menu keys.
- The mouse pointer does not appear in the screen saver.

Monitoring App

With the monitoring app installed on your smart device and the machine and smart device connected to the same wireless network, you can check the operating status of the machine. You can also check when to change the thread spool and what thread spool color to change to. In addition, you can receive notifications when the machine stops.

- 1 **Connect the machine to your wireless network.**
(page 29)
- 2 **Use a QR Reader app on your smart device to capture the appropriate QR code (Android™ or iOS) and visit the Google Play™ or App Store.**



Google Play™



App Store

- 3 **Install [My Stitch Monitor] to monitor embroidering.**



My Stitch Monitor

Chapter 2 BASIC EMBROIDERY

BASIC PROCEDURES

Basic embroidering procedures are described below. Check the overall procedure below, before operating the machine.

Step	Operation	Reference Page
1	Install the bobbin.	33
2	Turn on the machine.	22
3	Select an embroidery pattern.	35
4	Edit the embroidery pattern.	44
5	Check the previewed image.	60
6	Hoop the fabric in the embroidery frame.	61
7	Attach the embroidery frame to the machine.	64
8	Specify the embroidering settings.	69
9	Check the embroidery area.	72
10	Thread the upper threads.	81
11	Touch the "Start/Stop" button to start embroidering. (Once embroidering is completed, the machine automatically stops.)	87
12	Remove the embroidery frame.	90
13	Turn off the machine.	22

INSTALLING THE BOBBIN

When the machine is purchased, only the bobbin case is installed in the hook. Insert a bobbin wound with bobbin thread for embroidering.

⚠ CAUTION

- Be sure to use prewound bobbins (Fil-Tec/ TRU-SEW POLYESTER "Filaments") or metal bobbins designed specifically for this machine.
- When winding a bobbin, use optional bobbin winder (page 142) and metal bobbins.

💡 Note

- Before starting to embroider make sure that there is enough bobbin thread for the pattern.
- Make sure to clean the bobbin case every time the bobbin is changed. (page 175)

Removing the bobbin case

- 1 **Open the hook cover.**
Pull the hook cover toward you.

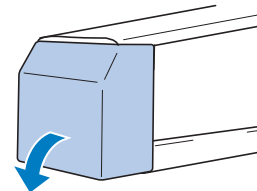

- 2 **Pull the thread picker toward you if it was not pulled toward the front.**

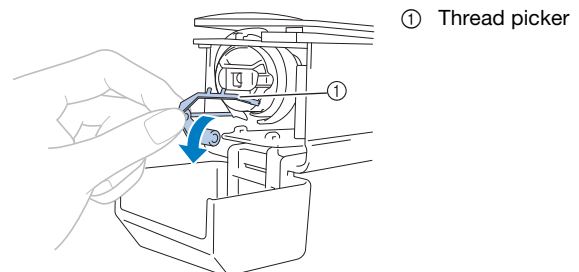

To gain access to the bobbin case easily, pull the thread picker toward front.

📝 Memo

- Thread picker is a device that is used to hold the thread when beginning to embroider or when trimming the thread.

⚠ CAUTION

- The thread picker can only be moved within a certain range. Do not pull it with extreme force.

- 3** Grab the bobbin case latch, and remove the bobbin case.

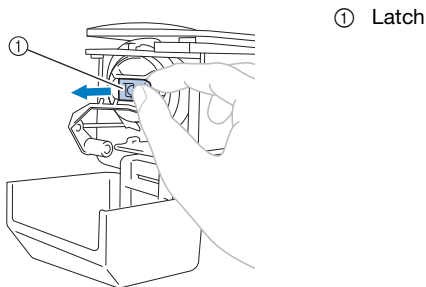

■ Oiling the machine

After removing the bobbin case, apply oil to the machine. For details on oiling the machine, refer to “Oiling the machine” on page 178.

💡 Note

- Put a drop of oil onto the hook once a day before use.

Installing the bobbin

- 1** Insert the bobbin into the bobbin case.

- Prewound bobbin

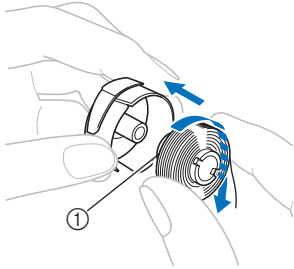

- ① Magnet Tip
- Metal bobbin (page 142)

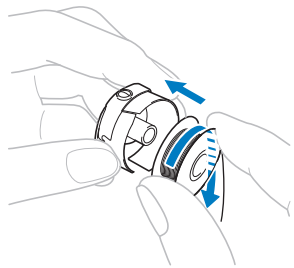

💡 Note

- Check that the thread winds off the bobbin clockwise as shown in the illustration. If the bobbin is installed with the thread winding off in the opposite direction, the embroidery will not be stitched correctly.

- 2** Pass the thread through the thread slit and under the tension-adjusting spring.

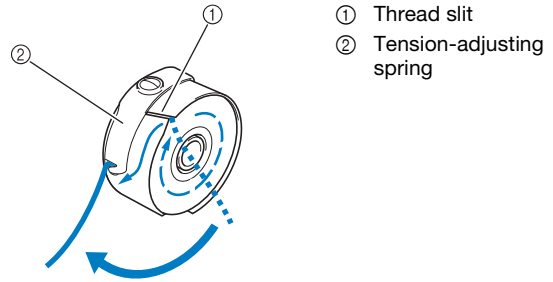

- 3** Pull the thread through the opening in the tension-adjusting spring.

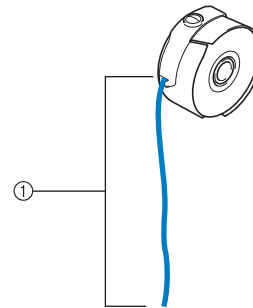

- ① About 50 mm (2 inches).

- For details, refer to “Adjusting the tension of the bobbin thread” on page 116.

Installing the bobbin case

- 1 Insert the bobbin case into the hook.**
Insert the bobbin case while aligning the tab on the bobbin case with the notch in the hook, as shown in the illustration.

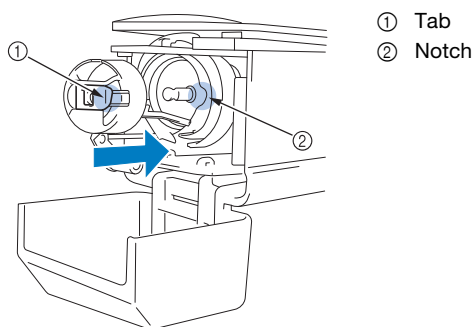

- Fully insert the bobbin case until it snaps into place.

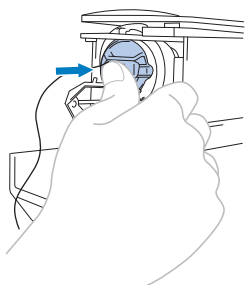

- 2 Close the hook cover.**

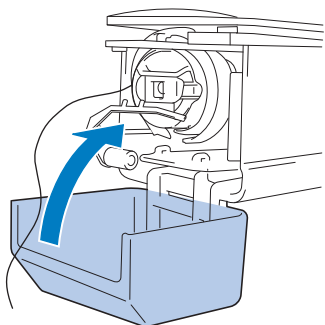

SELECTING AN EMBROIDERY PATTERN

General pattern selection

The procedure for selecting a pattern differs depending on the type of pattern; however, the general procedure for selecting a pattern is described below.

- 1 In the pattern type selection screen, touch the key for the desired category.**

■ Pattern type selection screen

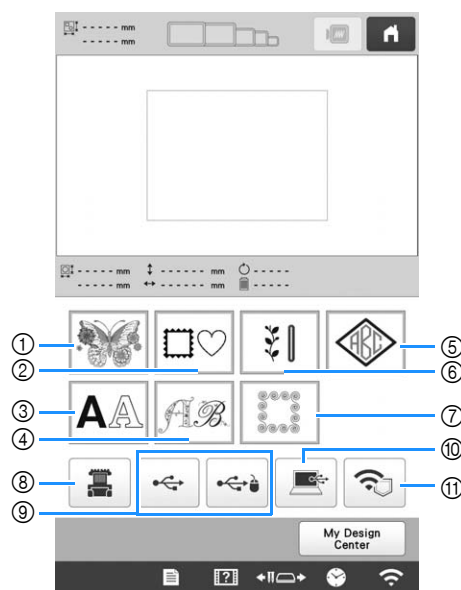

- ① Embroidery patterns (page 36)
- ② Frame patterns (page 37)
- ③ Character patterns (page 39)
- ④ Decorative alphabet patterns (page 41)
- ⑤ Monogram and frame patterns (page 38)
- ⑥ Utility embroidery patterns/Large buttonhole patterns (page 37)
- ⑦ Quilting border patterns (page 105)
- ⑧ Patterns stored in the machine's memory (page 130)
- ⑨ Patterns saved on USB media (page 130)
- ⑩ Patterns saved on a computer (page 130)
- ⑪ Patterns to be transferred via the wireless network (page 130)

- 2 In the pattern category list screen, which appears next, touch the desired pattern category to select it.**

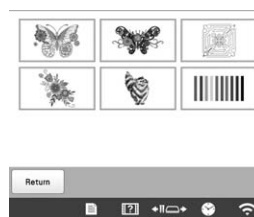

- 3 In the pattern list screen, which appears next, touch the desired pattern to select it.

Pattern list screen

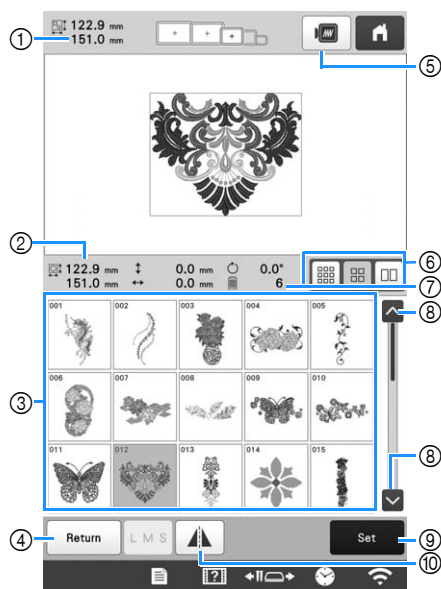

- 1 Size of the entire combined pattern
- 2 Size of the pattern being selected
- 3 Touch a pattern to display the information of the pattern.
- 4 Return to pattern category list screen to change category.
- 5 Preview the embroidery image.
- 6 Select the size of pattern thumbnails from small, medium and large sizes.
- 7 Number of thread color changes
- 8 Touch until the desired page is displayed if there is more than one page.
- 9 Confirm the pattern, and move to the pattern editing screen.
- 10 Flip the pattern being edited horizontally.

Embroidery patterns

- 1 Touch .

- 2 Select an embroidery pattern category.



→ The list of embroidery patterns appears.

- 3 Select an embroidery pattern.

→ The selected pattern appears in the pattern display area.

- 4 Touch **Set**.

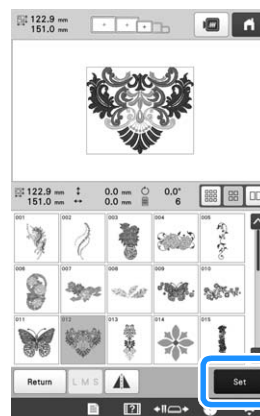

→ The pattern editing screen appears.

- 5 Edit the selected pattern. (page 44)



- 6 Hoop the stabilizer and fabric in the embroidery frame. (page 61)

- 7 Attach the embroidery frame to the machine. (page 64)

- 8 Touch **Edit End**.

→ The embroidering settings screen appears.

- 9 Edit the entire pattern. (page 69)

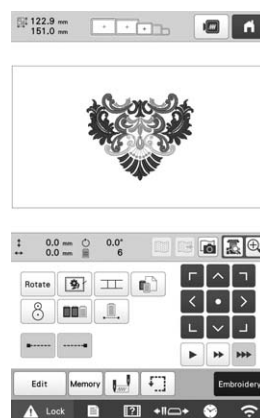

- 10 Touch **Embroidery**.

→ The embroidering screen appears.

- 11 Check the embroidering screen and thread the upper threads. (page 81)

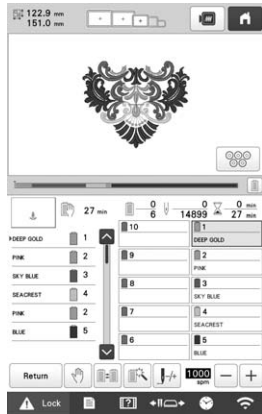

- 12 Start embroidering. (page 87)

Frame patterns

- 1 Touch .
- 2 From the upper tabs, select the desired frame shape.
→ Frame patterns appear below.

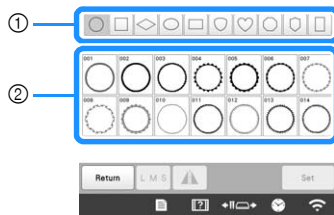

- ① Frame shapes
- ② Frame patterns

- 3 Touch the desired frame pattern.
→ The selected pattern appears in the pattern display area.
- 4 Touch .
- 5 Follow the procedure from step 5 to 12 of "Embroidery patterns" on page 36.

Utility embroidery patterns/Large buttonhole patterns

- 1 Touch .
- 2 Select the desired category of the utility embroidery patterns or the large buttonhole patterns.



→ The list of patterns of the selected category appears.

- 3 Select a pattern.
→ The selected pattern appears in the pattern display area.
- 4 If necessary, edit the pattern.

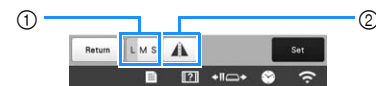
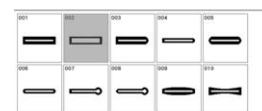

- ① Large buttonhole patterns can be selected from small, medium and large sizes.
- ② Flip the pattern horizontally.

- 5 Touch .
- 6 Follow the procedure from step 5 to 12 of "Embroidery patterns" on page 36.

Monogram and frame designs

Monogram designs can be created by combining two or three letters.

1 Touch .

2 Touch the button for the desired character style.

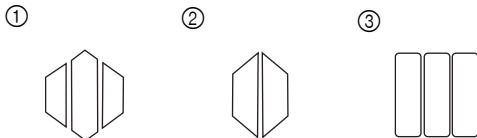
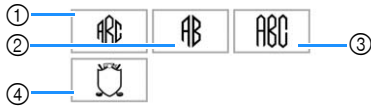

→ The text input screen appears.

- If ④ is selected, the frame pattern list appears. When creating a pattern by combining letters with a frame, it does not matter which of the two, the letters or the frame, is selected first. The embroidering order follows the order in which the parts of the monogram are selected. For this example, we will select the letters first.

3 Select the characters.

Touch the tabs to select different character fonts, and then touch the key for one letter on each tab.

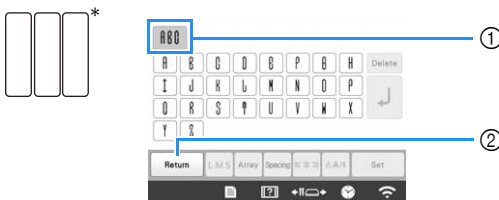

* Since the shapes of the letters are the same with this design, there are no tabs to select.

- 1 Tabs
- 2 To change the character font, touch **Return** to return to the design selection screen.

→ The selected characters appear in the text preview area and the pattern display area.

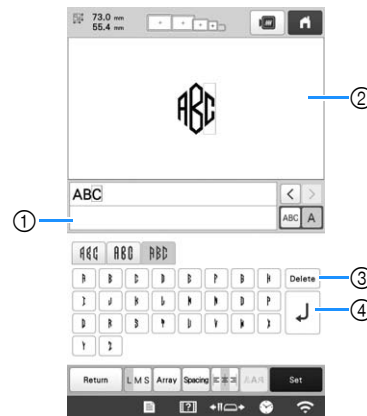

- 1 Text preview area
- 2 Pattern display area
- 3 If the wrong character was selected or you wish to select a different character, touch **Delete** to delete the last character selected, and then touch the desired character.
- 4 Line feed key

Memo

- Depending on the design, there is a preset number of letters; however, more than the preset number of letters can be entered. If too many letters are selected, touch **Delete** to delete the letters.
- If desired, multiple letters can be selected to use these characters in the same way as any other character pattern without creating a monogram.

4 If necessary, edit the characters. (page 40)



- 1 Select to edit all characters or one character.
- 2 Change the size of the characters.
- 3 Change the text arrangement.
- 4 Change the spacing of the character patterns.
- 5 Change the text alignment.

5 Touch **Set**.

→ The pattern editing screen appears. Next, we will combine the letters with a frame.

6 Touch **Add**.

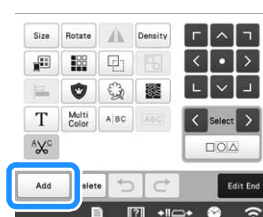

→ The pattern type selection screen appears.

7 Touch .



→ The design selection screen appears.

8 Touch .



→ The list of frame patterns appears.

9 Touch the desired pattern.

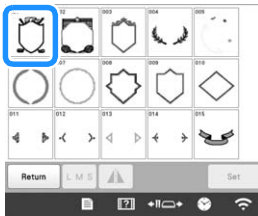

→ The selected frame pattern appears in the pattern display area.

10 Touch .

→ The pattern editing screen appears.

 **Memo**

- Due to size or shape, some frame patterns cannot be used with the  design.
- The frame patterns are just some of the patterns that can be used. Character patterns other than the 3-letter monogram patterns can be used in the combination.

11 Follow the procedure from step 5 to 12 of “Embroidery patterns” on page 36.

Character patterns

1 Touch .

2 Touch the desired character font.

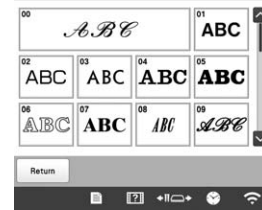

- Touch  or  for additional selections.

→ The text input screen appears.

3 Select the character category and then type in the text. (page 40)

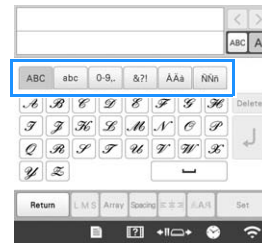

4 Touch .

→ The pattern editing screen appears.

5 Follow the procedure from step 5 to 12 of “Embroidery patterns” on page 36.

2

Character pattern input keys

Memo

- If a key display is grayed out, you cannot use that function with the selected pattern.

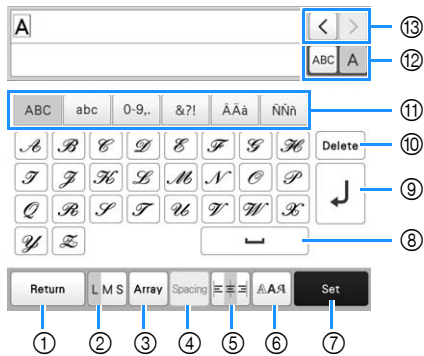

No.	Display	Function
	Key Name	
①		Return to the previous screen.
	Return key	
②		Change the size of the character patterns. To change the size of one character, touch to display and then select the character. The size of the selected character is changed.
	Size key	
③		Change the layout of the character patterns.
	Array key	
		<ul style="list-style-type: none"> To arrange the character patterns on an arc, touch , , or . : Make the arc flatter. : Make the arc rounder. To arrange the character patterns on an incline, touch . : Change the incline counterclockwise. : Change the incline clockwise. : Reset the layout.

No.	Display	Function
	Key Name	
④		Change the spacing of the character patterns.
	Character spacing key	
		<ul style="list-style-type: none"> : Increase the character spacing. : Decrease the character spacing. To change the spacing after one character, touch to display and then select the character. The spacing between the selected character and the next character is changed.
		<p> ABCD E ⇄ ABCDE</p> <p> A B C D E ⇄ ABCDE</p> <p> </p> <ul style="list-style-type: none"> : Move the one selected character up. : Move the one selected character down. : Reset the spacing.
⑤		Switch alignment. This function is available when multiple lines of characters are input.
	Alignment key	
		<ul style="list-style-type: none"> : Right alignment <p>ABCDE FGH IJKLMN</p> <ul style="list-style-type: none"> : Left alignment <p>ABCDE FGH IJKLMN</p> <ul style="list-style-type: none"> : Center alignment <p>ABCDE FGH IJKLMN</p>
⑥		Change the font of the characters. Depending on the font that was selected, it may not be possible to change the font.
	Font type key	
		<ul style="list-style-type: none"> To change the font of one character, touch to display and then select the character. The font of the selected character is changed.

No.	Display	Function
	Key Name	
⑦		Apply the character pattern editing to go to the editing screen.
	Set key	
⑧		Enter a space.
	Space key	
⑨		Make a new line.
	Line feed key	
⑩		Delete the character.
	Delete key	
⑪	—	Select the category of character.
	Category keys	
⑫		Select to edit all characters or one character.
	Select one/all key	
⑬		Move the cursor and select a character.
	Character selection keys	
⑭		Switch between text written vertically and horizontally. (Japanese font only)
	Vertical/horizontal text key	

Decorative alphabet patterns

① Touch .

② Touch the desired category.

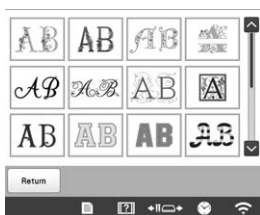

③ Touch the desired pattern.

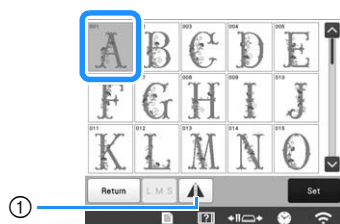

① Flip the pattern horizontally.
→ The selected pattern appears in the pattern display area.

④ Touch .
→ The pattern editing screen appears.

⑤ Follow the procedure from step ⑤ to ⑫ of “Embroidery patterns” on page 36.

■ Appliqué alphabet

① Touch .

② Touch .

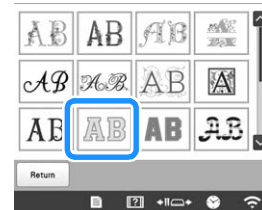

→ The list of appliqué alphabets appears.

③ Touch the desired pattern.

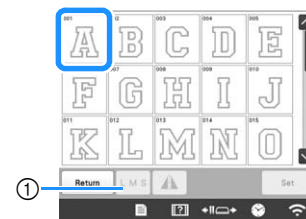

① Change the character size.
→ The selected pattern appears in the pattern display area.

④ Touch .
→ The pattern editing screen appears.

Memo

- For details on embroidering appliqués, refer to “Embroidering appliqué patterns” on page 100.

Combining patterns

Example:



1 Select a pattern and then touch **Set**.

2 Touch **Add**.

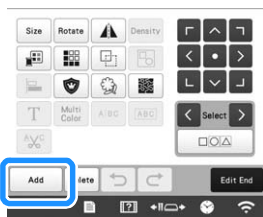

3 Touch **AA**.

4 Select **ABC** and enter "LOVE".

→ The characters you enter will be displayed in the center of the embroidery pattern area.

5 Touch **Set**.

6 Use  to move the characters.

* Characters can also be moved by directly dragging them with your finger or the touch pen.

7 Touch  to change the color of the characters. (page 54)



8 Touch **OK**.

9 When all editing is finished, touch **Edit End**.

Note

- Combined patterns will be embroidered in the order they were entered.

Selecting the pattern to be edited

If multiple patterns have been combined, use **<** or **>** to select the pattern to be edited. Patterns can also be selected by directly touching the screen with your finger or touch pen.

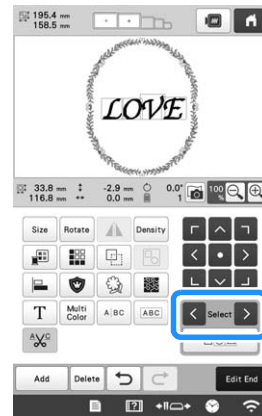

Selecting multiple patterns at the same time

Multiple patterns can easily be edited, for example, when moving patterns that are combined, if they are all selected together.

1 Touch .

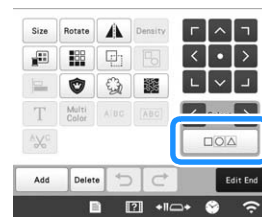

→ The multiple selection screen appears.

- 2** Select the multiple patterns by dragging your finger in the screen to create a box around the desired patterns.

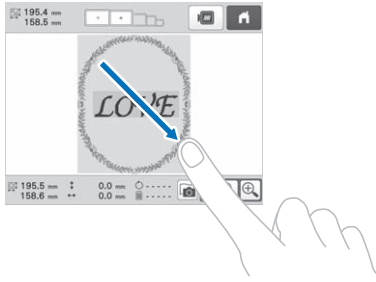

Memo

- Multiple patterns can be selected or deselected from the multiple selection screen. Touch **<** or **>** to check the patterns to be selected, and then touch **Set**.

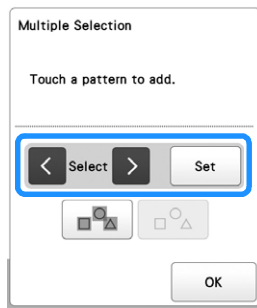

The selected pattern is surrounded with a red box.

- Touch to select all patterns in the pattern display area.
- Touch to deselect all selected patterns.
- The patterns can also be selected by touching them in the screen.
- While the multiple selection screen is displayed, patterns can be moved with .

- 3** Touch **OK** to return to the pattern editing screen.

- The multiple selected patterns are surrounded with a red box.

Grouping multiple selected patterns

If the multiple patterns selected in "Selecting multiple patterns at the same time" on page 42 are grouped, they can be edited as a single pattern.

- 1** Touch .

→ The selected patterns are grouped.



- Touch to ungroup the patterns. If there are multiple grouped patterns, the selected pattern group is ungrouped.

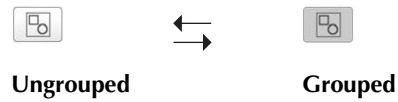

EDITING THE EMBROIDERY PATTERN

Understanding the pattern editing screen

Memo

- If a key display is grayed out, you cannot use that function with the selected pattern.

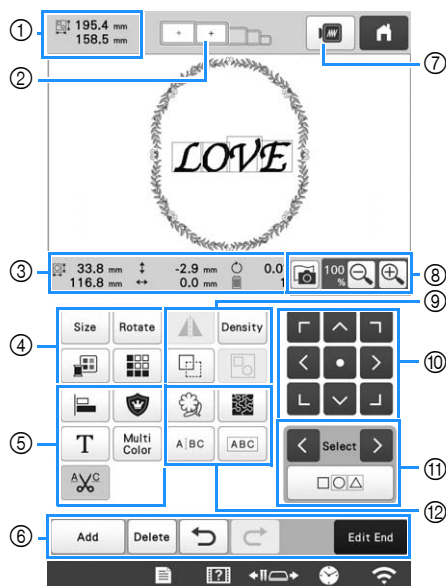

No.	Display	Function	Page
	Key Name		
①		Shows the size of the embroidery pattern currently displayed in the pattern display area. The top value shows the height and the bottom value shows the width. If the embroidery pattern consists of multiple patterns that have been combined, the size will include all patterns.	—
	Pattern size		
②		Shows the sizes of embroidery frames that can be used to embroider the pattern currently displayed in the pattern display area.	61
	Embroidery frame indicators		

No.	Display	Function	Page
	Key Name		
③		Shows the size of the pattern being edited. The top value shows the height and the bottom value shows the width.	—
	Size		
③		Shows the vertical distance that the pattern being edited is moved.	—
	Distance from center (vertical)		
③		Shows the horizontal distance that the pattern being edited is moved.	—
	Distance from center (horizontal)		
③		Shows the rotation angle that the pattern being edited is rotated.	—
	Rotation angle		
③		Shows the total number of thread colors for the pattern that is being edited.	—
	Number of thread colors		

No.	Display Key Name	Function	Page
④	Size	<p>Display the pattern sizing window.</p> <ul style="list-style-type: none"> : Decrease the pattern proportionately. : Decrease the pattern vertically. : Decrease the pattern horizontally. : Enlarge the pattern proportionately. : Stretch the pattern vertically. : Stretch the pattern horizontally. : Change the pattern size while maintaining the number of stitches. (normal resizing mode) : Change the pattern size while maintaining the thread density. (stitch recalculator mode) : Select the pattern that you want to change. : Move the pattern in the direction shown by the arrow. : Reset the size. : Close this screen. : Change the size of the pattern (character patterns only). 	—
	Rotate	<p>Display the pattern rotating window.</p> <ul style="list-style-type: none"> : Reset the angle. <p>Rotate the pattern using the rotate keys or by dragging the red point at the corner of the pattern. You can also use the move keys during the rotation process.</p>	—
	Change thread color key	Change the color of the pattern.	54
	Border key	Make and edit the repeated pattern.	49

No.	Display Key Name	Function	Page
⑤	Alignment key	Arrange multiple patterns on a line.	49
	Embroidery appliqué key	Change the pattern being edited into an appliqué pattern.	101
	Letter Edit key	Edit characters.	46
	Multi color key	Enable the thread color of each character in a character pattern to be changed; can only be used when a character is selected.	54
	Thread trim setting key	Automatically trim any excess thread jumps within the letters of character pattern.	47
	Add key	Add a pattern. If touched, the pattern type selection screen appears.	42
	Delete key	Deletes the pattern. If touched, the pattern being edited is deleted.	—
⑥	Undo key	Undo the last operation that was performed and return to the previous state. Each touch of this key will undo one operation.	—
	Redo key	Redo the operation that was undone.	—
	Edit end key	Finish editing and continue to the embroidering settings screen.	—
	Preview key	Display an image of the pattern so that it can be previewed.	—
⑧	Fabric scan key	Scan the fabric in the embroidery frame with the built-in camera to display it as the background of the pattern.	72
	Enlarge key	Select from 100%, 125%, 150% or 200% to adjust how the pattern being edited is displayed.	—

No.	Display	Function	Page
	Key Name		
⑨		Change the pattern to a horizontal mirror image.	—
	Horizontal mirror image key		
		Change thread density for some character and frame patterns. Other patterns' density can be adjusted in the stitch recalcuator mode.	48
	Density key		
		Duplicate the pattern. The duplicated pattern will be positioned slightly lower and to the right from the original pattern.	—
Duplicate key			
	Group selected multiple patterns.	43	
Group key			
⑩		<ul style="list-style-type: none"> : Move the pattern in the direction shown by the arrow. : Move to the center of the embroidering area. 	42
	Positioning keys		
⑪		Selects the pattern that is being edited when the embroidery pattern consists of multiple patterns that have been combined.	43
	Pattern selection keys		
⑫		Choose multiple patterns to be edited at the same time.	42
	Multiple selection key		
⑬		Extract the outline of the pattern. The extracted pattern can be used with My Design Center.	170
	Outline key		
		Create stippling or echo quilting around the pattern.	104
	Stippling/Echo Quilting key		
		Separate the continuous character patterns to adjust the spacing or edit separately afterwards. <ul style="list-style-type: none"> : Select where the patterns is to be separated. : Separate the pattern. A separated character pattern can be combined by using . 	—
Text dividing key			
	Combine the selected character patterns.	48	
Text combining key			

■ Editing letters

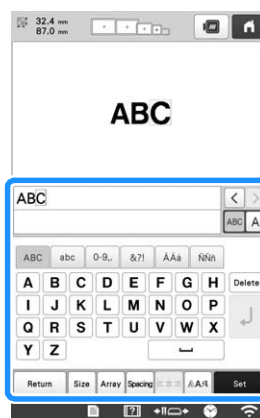

For details on input keys, refer to page 40.

Memo

- To edit character patterns with multiple lines in the edit screen, ungroup the pattern. (page 43)

Changing the size and the density of the pattern

If  is selected, you can change the pattern size while maintaining the thread density. The machine recalculates the stitch density automatically. With this function, the pattern can be enlarged or reduced at a larger ratio than with normal pattern resizing.

Note

- This function cannot be used with character patterns, frame patterns, repeated patterns or large buttonhole patterns.
- Patterns with a large number of stitches (100,001 or more) cannot be resized while maintaining a thread density.

Memo

- Depending on the pattern, the size of the pattern increases up to 200% or reduces to 60%.
- You can also change the size by dragging the red point around the pattern.

1 Select  or  in the size window.

*  : Change the pattern size while maintaining the number of stitches. The thread density for the pattern increases or decreases.

*  : Change the pattern size while maintaining the thread density. After the pattern size is changed, the thread density can be changed. The number of stitches is recalculated depending on the pattern size.

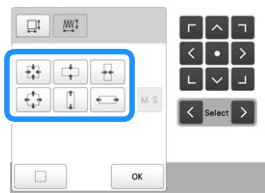

2 When you select  in step 1, the message to reset the pattern to its original size, angle and position will appear. Touch .

3 Touch each key to change the pattern size, if desired.





4 Touch .

Memo

- When you select  in step 1, touch , and then change the thread density.

Trimming the threads between characters

If the machine is set to trim the threads between the characters, the jump stitches between the characters are reduced and any other necessary procedures after embroidering are reduced. However, the embroidering time will increase if the threads are trimmed between each of the characters.

1 Touch  so that it changes to .

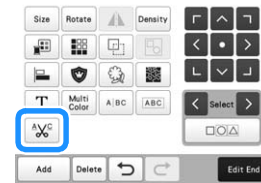

- Each touch of the key turns the setting either on or off.

 ← → 
Threads are not trimmed.

 → ← 
Threads are trimmed.

Combining the separated character patterns

Two separated lines of character patterns can be combined. The characters can be aligned to the specified order. You cannot combine the lines of character patterns if the text contains a line feed using the Line Feed function.

1 Touch **ABC**.



2 Select the group of character patterns that you want to combine.

- The selected character is assigned as Number [1].
- You can select the patterns by touching them on the screen, or touching **<** or **>** to check the patterns to be selected, and then touch **Set**.



→ Numbers [1] and [2] are assigned temporarily to the patterns.

3 Touch **12** or **21** to choose the order of the 2 patterns.

4 Touch **OK** to return to the previous screen.

Changing the thread density

The thread density for some character and frame patterns can be changed. Other patterns' density can be adjusted in the stitch recalcuator mode. (page 47)

A setting between 80% and 120% in 5% increments can be specified.

1 Touch **Density**.



→ The screen shown below appears.

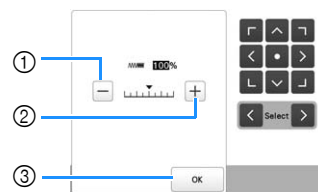

- ① Make the pattern less dense.
- ② Make the pattern more dense.
- ③ Close this screen.

■ Selects a less/more thread density

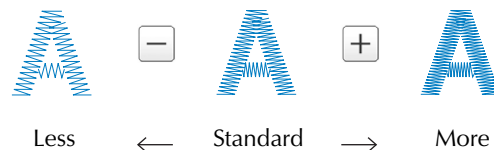

1 Touch the keys to select the desired thread density.

Each touch of a key slightly increases or decreases the thread density.

- To return to the original thread density (standard), select [100%].

2 After making the desired changes, touch **OK**.

Aligning the embroidery patterns

1 Select patterns that you want to align. (page 42)

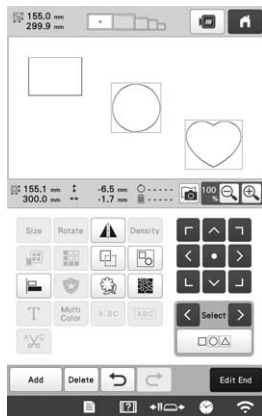

2 Touch , and then select the key for the desired alignment.

Example

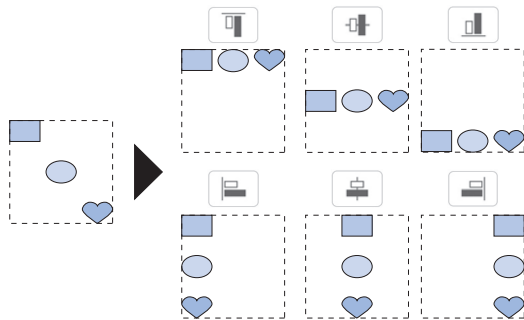

Memo

- You can select desired multiple patterns by directly touching each pattern on this screen.

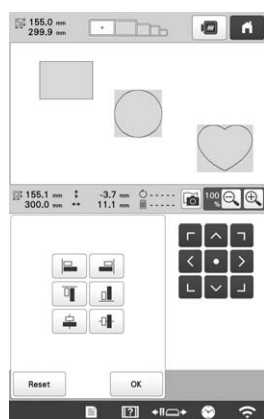

- Touch  to reset the alignment.

Designing repeated patterns

Using the border function, you can create an arrangement using repeated patterns.

1 Touch .

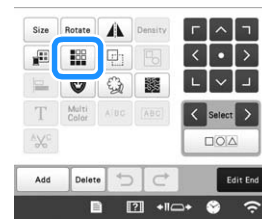



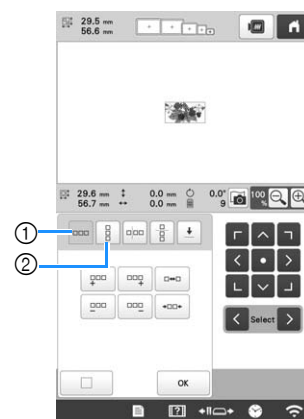

2 Select the direction in which the pattern will be repeated.



- ① Horizontal direction
- ② Vertical direction

→ The pattern direction indicator will change depending on the direction selected.

3 Use  to repeat the pattern on the left and  to repeat the pattern on the right.

- To delete the left pattern, touch .
- To delete the right pattern, touch .



4 Adjust the spacing of the repeated pattern.

- To widen spacing, touch .

- To tighten spacing, touch .

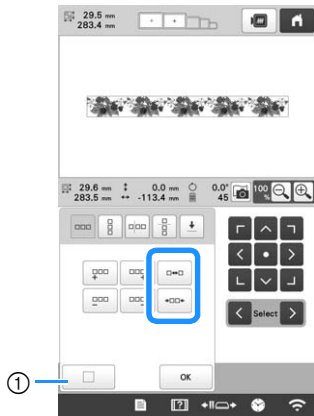

- 1 Touch  to change a repeated pattern back to one single pattern.

Memo

- You can only adjust the spacing of patterns included in the red frame.

5 Complete repeated patterns by repeating steps 2 through 4.

- 6 After making the desired changes, touch .

Memo

- When there are two or more patterns, all patterns will be grouped together as one pattern in the red frame.

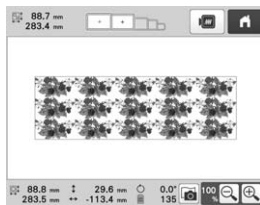



- When changing the direction in which the pattern will be repeated, all of the patterns in the red frame will automatically be grouped as one repeating unit.

■ Repeating one element of a repeated pattern

By using the Cut function, you can select one element of a repeated pattern and repeat only that single element. This function allows you to design complex repeated patterns.

1 Choose the direction in which the repeated pattern will be cut.

- Touch  to cut horizontally.
- Touch  to cut vertically.

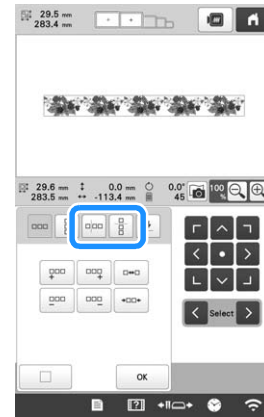

→ The pattern direction indicator will change depending on the direction selected.

2 Use and to select the cut line.

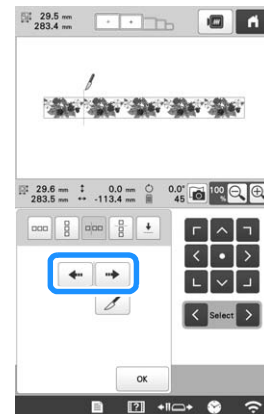

→ The cut line will move.

3 Touch .

→ The repeated pattern will be divided into separate elements.

4 Touch .

5 Use **<** and **>** to select the element to repeat.



6 Repeat the selected element.

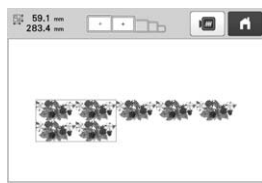

7 After making the desired changes, touch **OK**.

Note

- Once you have cut a repeated pattern into separate elements, you cannot return to the original repeated pattern.
- Each element can be edited separately in the edit screen. Refer to “Selecting the pattern to be edited” on page 42.

Assigning thread marks

By embroidering thread marks, you can easily align patterns when embroidering a series. When embroidery is finished on a pattern, a thread mark in the shape of an arrow will be embroidered using the final thread. When embroidering a series of patterns, use the point of this arrow for positioning the following designs to be embroidered.

Memo

- When repeatedly embroidering individual patterns, thread marks can be embroidered around the perimeter of the pattern only.

1 Touch .

2 Touch .

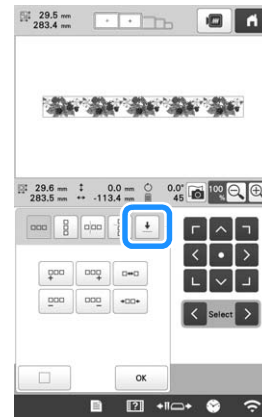

3 Touch  to select the thread mark to be embroidered.

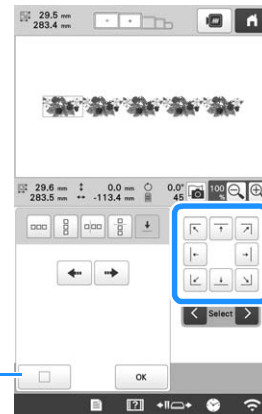

① Touch to cancel thread mark setting.

Memo

- When there are two or more elements, use **<** and **>** or **←** and **→** to select a pattern that you want to assign a thread mark(s) to.

4 Touch **OK**.

Memo

- If the combined border pattern is rotated in the embroidering settings screen, the thread mark will be removed.

■ Embroidering the pattern repeatedly

After creating the repeated pattern, rehoop the embroidery frame and keep embroidering for the next pattern.

Memo

- Using the optional magnetic sash frame, the fabric can be easily rehooped without removing the frame from the machine. For details, refer to the manual included with magnetic sash frame.

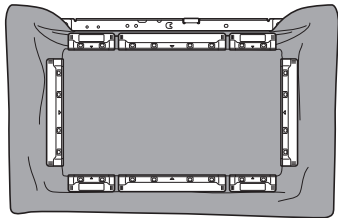

- 1 Create the repeated pattern with the thread mark at the center of the end of the pattern. (page 51)

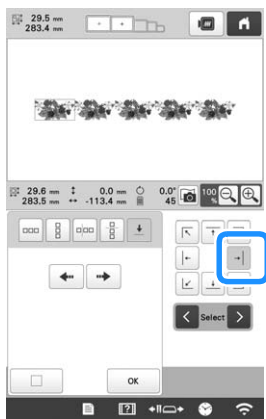

- 2 Touch **OK**, **Edit End**, then **Embroidery**.

- 3 Touch **Lock**, and then press the “Start/Stop” button to start embroidering.

→ When embroidering is finished, the thread mark is embroidered with the last thread color.



- 4 Remove the embroidery frame.

- 5 Rehoop the fabric in the embroidery frame.

Note

- Adjust the position of the fabric so that the embroidering area for the next pattern is within the embroidering area of the embroidery sheet.

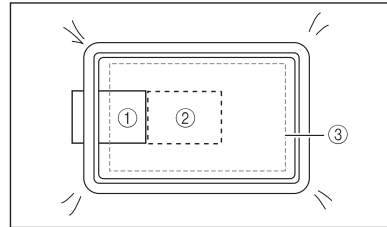



- ① Pattern embroidered first
- ② Position of pattern to be embroidered next
- ③ Embroidering area of embroidery sheet

- 6 Attach the embroidery frame to the machine, and then touch  in the embroidering settings screen.

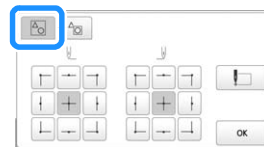

- 7 Touch .



- 8 Touch  to set the starting point to the left side of the pattern.

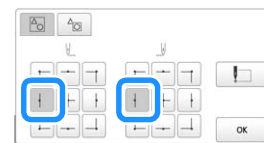

- 9 Touch **OK**.

- 10 Touch .

- 11 Touch  to display the needle drop point.

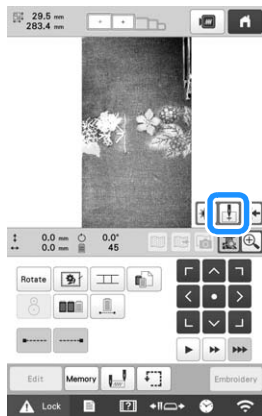

- 12 Touch the positioning keys to move the embroidery frame until the thread mark on the fabric is aligned on the needle drop point in the camera view window.

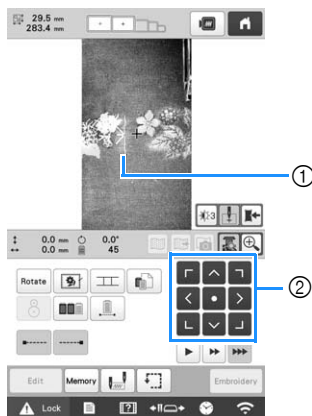

- ① Thread mark on the fabric
② Positioning keys

- Touch  to check the embroidering position.

Memo

- Touch  to enlarge the camera view. By enlarging the camera view, you can make a close adjustment for the needle drop position moving the embroidery frame little by little.

Touch  to return to the normal camera image.

- 13 If the pattern position cannot be aligned using the positioning keys, rehoop the fabric, and then try again to align the position with the positioning keys.

Note

- After you have aligned the position of the combined border pattern, do not rotate the pattern in the embroidering settings screen. If the pattern is rotated in the embroidering settings screen after alignment, the pattern will not be properly aligned with the thread mark or starting point.

- 14 Touch  to return to the previous screen.

- 15 Remove the thread mark.

- 16 Touch .

- 17 Touch , and then press the “Start/Stop” button to start embroidering.

EDITING COLORS

Specifying multi-color text

The alphabet pattern characters selected on page 39 are set to black. The color of the characters can be changed using the change thread color key; however, to change the color of individual characters, touch the Multi Color key to turn it on, and then specify the color for each character.

- 1 Touch **Multi Color** so that it changes to **Multi Color**.



- Each touch of the key turns the setting either on or off.



Multi-color text turned off



Multi-color text turned on

- For details on changing the thread color, refer to “Changing the colors of the pattern” below.

Changing the colors of the pattern

The colors of the pattern can be changed and previewed on the screen.

- 1 Touch .

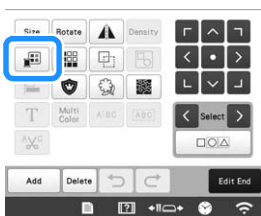

→ The change thread color screen appears.



- 2 From the thread color sequence display, select the thread color whose color is to be changed.

- If the desired thread color is not displayed, use the scroll bar on the right side to display it.

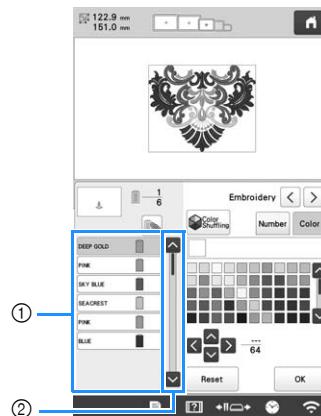
→ The selected thread color image appears.





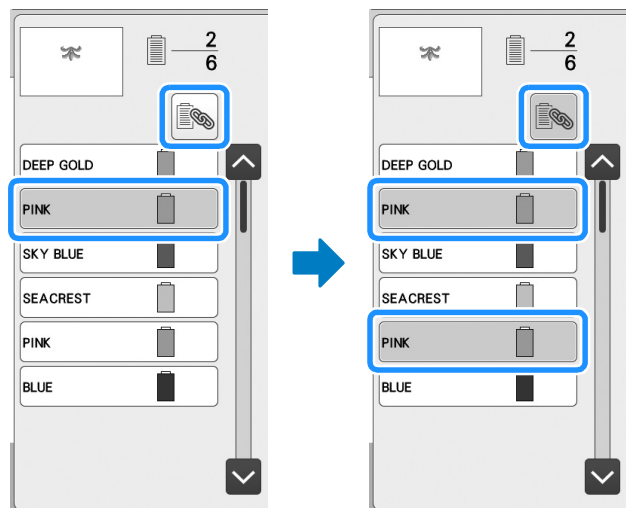

- 1 Selected thread color image
- 2 Scroll bar

- To combine the same thread color when it is used more than once, select the thread color, and then touch . The key changes to , and all thread colors in the thread color sequence display that are the same as the one that was selected are highlighted in blue.



- The part of the pattern whose thread color is to be changed can be directly selected in the pattern.

- 3 Select the thread brand, and then touch , ,  or , or directly touch the desired color, to select the new color from the color palette.

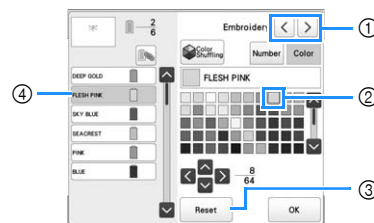

- 1 Select the thread brand.
- 2 The color in the box is the color that is selected.
- 3 Return to the original color.
- 4 Displays the name of the selected thread color.

→ In the pattern display area, the color of the selected part of the pattern is changed.

Memo

- Touch **Number** to specify a thread color by entering its number.

4 After changing the colors, touch **OK**.

Find new color schemes with the color shuffling function

With the Color Shuffling function, the machine suggests new color schemes for the embroidery pattern that you have selected. After you select the desired effect from one of the four available color schemes ([Random], [Vivid], [Gradient] and [Soft]) the sample for the selected effect is displayed.

1 Touch .

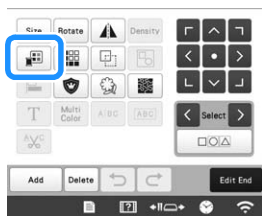

→ The change thread color screen appears.

2 Touch .

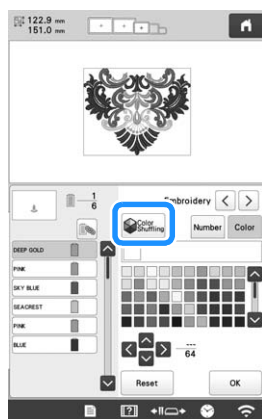

Note

- This function may not be available depending on the pattern you select (ex. a bordered pattern, licensed pattern). If  is grayed out, select another pattern.

3 Select the thread brand for colors and the number of colors you want to create the pattern with.

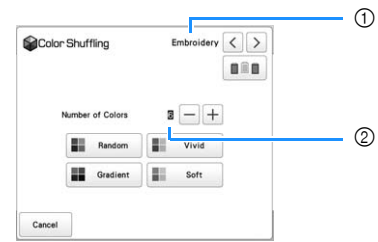

- ① Thread brand for colors
- ② Number of colors to be used

4 Select the desired effect.

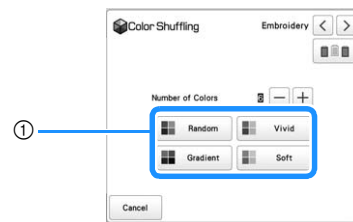

- ① Effects for schemes
- If you select [Random] or [Gradient], the color specifying screen will appear.
- If you select [Vivid] or [Soft], there is no color specifying screen. Proceed to step **7**.

5 Touch **Auto** **Manual** to set **Manual** and specify the thread color to use in the effect.

- * If you don't need to specify the thread color, just set to **Auto**.

[Manual] setting for [Random]

You can select up to 6 colors to be used in the [Random] effect. The effect will be created using the selected colors.

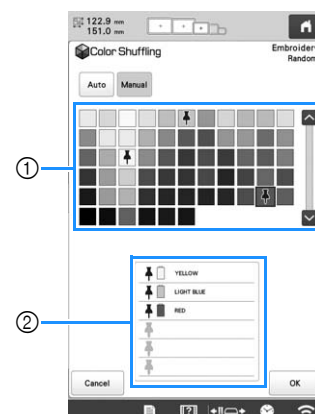

- ① Select colors from the palette.
- ② Selected colors are listed.

[Manual] setting for [Gradient]

You can select one color to be used in the [Gradient] effect. The effect will be created with the color you select.

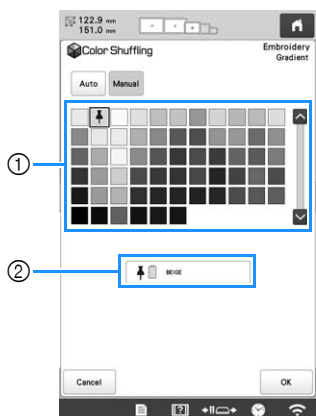

- ① Select a color from the palette.
- ② Selected color is displayed.

6 Touch .

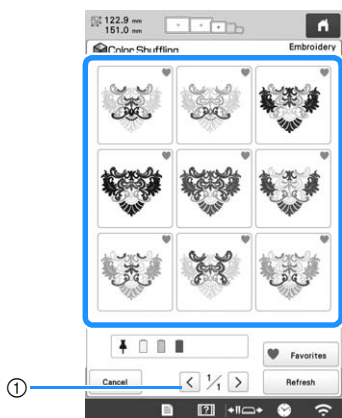

7 Select the color scheme from samples.

* Touch to add the new schemes.



- ① Touch to review the previous schemes.

Memo

- To temporarily register your favorite schemes, touch  (to release your favorite schemes, touch  again). 9 color schemes can be saved on the page*. Touch to check the registered favorite schemes. To cancel the registration, touch .

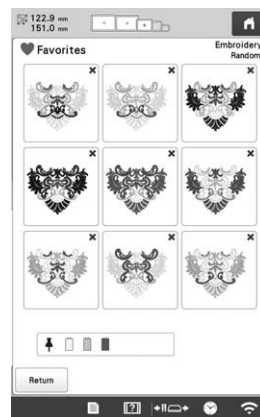

* Maximum 20 pages of schemes can be reviewed.

8 Check the displayed color scheme, and then touch .

* : Return to the previous screen.

* or : Display the other color schemes.

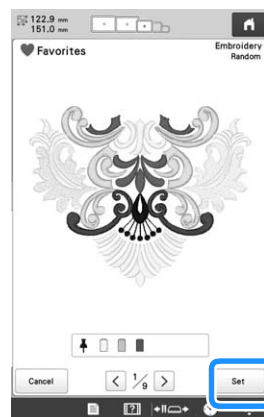

→ The change thread color screen will appear.

9 Touch to display to the pattern editing screen.

SWITCHING THE THREAD COLORS ON THE SCREEN

If a thread color on the spool stand is different than the needle position thread color on the screen, the thread colors on the screen can be switched to match the spool stand thread color position.

Memo

- This function is not available when you set [Manual Color Sequence] to [ON] in settings screen.

1 Touch  in the embroidering screen.



→ The spool selection screen appears.

2 Touch the number of the first needle bar that will be switched.

- To cancel the selection, touch the same needle number again.



3 Touch the number of the other needle bar that will be switched. The two needle numbers are connected with an arrow.

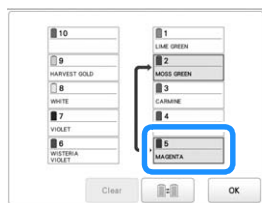

4 Touch  to switch the two thread colors.

5 After making the desired changes, touch .

■ To cancel the thread color settings for all previously stitched design

Memo

- The color settings will be completely canceled even if the machine is in the middle of the embroidery.

1 Touch .



→ The thread color setting is canceled.

2 Touch .

→ Thread colors are assigned by the machine again, regardless of the previous spool setting.

Note

- This function will not clear anchor settings of any of the needles which have been assigned a thread color. (page 121)

2

SELECTING/MANAGING THREAD COLORS FOR EACH NEEDLE BAR [Manual Color Sequence]

The thread colors assigned to each needle bar can be manually specified/managed. In addition, the thread colors can be assigned to needle bars automatically and more efficiently than when the settings are normally specified.

Convenience of the manual color sequence

The manual color sequence is convenient when the machine is being used under the following conditions.

■ When using embroidery data that has no thread color information, such as with DST files

The thread spools to be used can easily be selected for data with no thread color information. (For details, refer to "SPECIFICATIONS" on page 190.)

■ When the same combination of thread colors is always used

If specific thread colors are assigned to certain needle bars, the thread color settings can be changed with the needle bar number assignments, even when the pattern is changed. The operation is simplified if the same thread colors are always used.

■ When continuously embroidering with the same needle bar settings



If the settings are specified normally, the needle bar settings are canceled when the embroidering settings screen appears after embroidering stops. However, with [Manual Color Sequence], the needle bar settings continue to be applied unless the pattern is deleted or the machine is turned off.

This is useful if the same pattern is to be embroidered continuously multiple times.

Specifying the manual color sequence

Note

- The [Manual Color Sequence] cannot be changed while operations are being performed in the embroidering screen.

1 Touch , then .
→ The general settings screen appears.

2 Locate [Manual Color Sequence].

3 Touch [ON], and then select the manual color sequence.

- When the machine is purchased, [OFF] is selected.

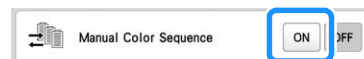

4 Touch  to return to the previous screen.

→ The icon for [Manual Color Sequence] appears in the screen.



Using the manual color sequence

Manually assign thread colors to all needle bars

By specifying the thread colors used with this machine, embroidery can continue more efficiently simply by changing the needle bar assignments after a pattern is selected. With the normal method of specifying settings, only a maximum of 9 needle bars can be manually assigned thread colors; however, with the manual color sequence, all 10 needle bars can be assigned thread colors.

(For details on specifying the settings, refer to page 121.)

Needle bar number settings

The needle bar used with each thread color can be specified.

Memo

- Using the procedure described in “Reserved needle bar and embroidery speed settings” on page 121, the finished embroidery colors can be checked in the screen if thread colors are assigned to thread spools.

1 In the embroidering settings screen, touch .

→ A screen appears, allowing the needle bar numbers to be selected.

2 From the thread color sequence display, select the thread color whose needle bar is to be changed.

- If the desired thread color is not displayed, use the scroll bar on the right side to display it.

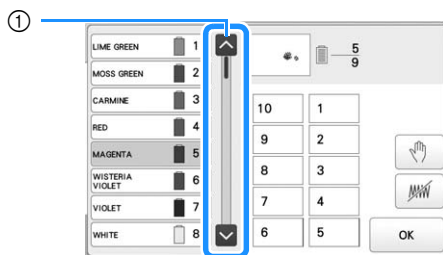

① Scroll bar

3 Touch a number button (between 1 and 10) to select the number of the needle bar whose settings are to be specified.

→ The needle bar number for the thread color selected in step 2 changes to the selected needle bar number.

If the needle bar number was specified with reserved needle bar settings, the color of the thread spool on the left side changes to the specified thread color, and the pattern in the pattern display area also changes to the color of the specified needle bar.



- Needle bar number specified with reserved needle bar settings
- Needle bar set to a different number (needle bar 5)
- If a color is selected by touching this key, the machine stops before embroidering the selected color.
- If a color is selected by touching this key, the machine does not embroider the selected color when embroidering.

- ④ takes precedence if ③ and ④ are set at the same time.

Initializing thread color settings

With the manual color sequence, the thread color information on the machine can be initialized each time a new pattern is selected, and then the needle bars can be assigned. This allows the needle bar settings to be specified without being affected by the thread color information from the previous pattern.

Precautions on the manual color sequence

When embroidering a pattern containing 11 or more colors

With the manual color sequence, the machine does not monitor the timing for replacing thread spools. Since the machine does not automatically stop and no message indicating that the thread spool be changed appears, as with the normal needle bar settings, follow the procedure below to set the machine to stop with thread spools that must be changed.

- Step 3 of “Using the manual color sequence” on page 59
- “Stopping the machine at the next color change” on page 119
- “Specifying pause locations before embroidering” on page 119

PREVIEWING THE IMAGE

Checking a preview image

Display the preview image to check that the embroidery will be performed as desired.



- 1 Touch .



→ The preview image is displayed.

Memo

- A preview image in a landscape orientation cannot be rotated to a portrait orientation, even if there is space at the top and bottom.

- 2 Touch  or  to select the type of embroidery frame holder, and then select the embroidery frame you are going to use.

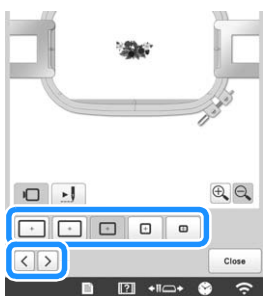

- After determining the type of embroidery frame holder and size of embroidery frame that are best for your embroidery, change the embroidery frame holder and embroidery frame that are installed. The machine will automatically detect the embroidery frame holder and embroidery frame and change the display.

- 3 Touch  to check the embroidering order.

→ The stitch simulator screen appears.



- ① Select the simulation speed.
- ② Operation keys

- Touch  to return to the embroidery frame holder/embroidery frame selection screen.

- 4 Touch  to return to the previous screen.

PREPARING THE FABRIC

CAUTION

- Your machine can embroider fabric that is up to 2 mm (5/64 inch) thick. If thicker fabric is embroidered, the needle may bend or break.

Attaching stabilizer (backing) to fabric

In order to prevent shrinkage of the stitching or misaligned patterns, we recommend that stabilizer (backing) be used for embroidering.

CAUTION

- When embroidering on thin or stretch fabrics, fabrics with a coarse weave or fabrics that easily allow the stitching to shrink, be sure to use stabilizer (backing) for embroidering. If stabilizer (backing) is not used while embroidering, the needle may bend or break or the pattern may become misaligned.

- 1 Using a steam iron, affix the iron-on stabilizer (backing) to the back of the fabric.

- Use a piece of stabilizer which is larger than the embroidery frame being used.

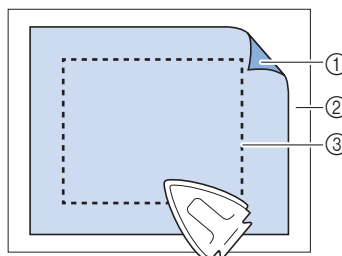

- ① Adhesive side of iron-on stabilizer (backing)
- ② Fabric (wrong side)
- ③ Size of the embroidery frame

Memo

- When embroidering light or open designs on thin fabrics, such as organza or lawn, use a water-soluble stabilizer (backing). Water-soluble stabilizers dissolve when washed, allowing you to create beautiful embroidery that is not stiff.
- When embroidering fabric that should not be ironed or when embroidering an area that is difficult to iron, hoop a layer of the stabilizer (backing) under the fabric in the embroidery frame without ironing it.

Fabric/stabilizer compatibility chart

Fabric/ Garment	No. of Backing Pieces	No. of Topping Pieces
	Comments	
Terry cloth	1 tear-away	1 water-soluble
	Increase density and/or satin stitch width. Fine details and small lettering tend to get caught in the terry loops.	
Satin jacket	Heavy lining: None Light or no lining: 1 tear-away	None
	If garment slips in frame, causing alignment problems, wrap inner frame with masking tape or fabric bias tape. This provides a rough surface to grip garment and also helps minimize frame burn.	
Cotton sheeting	1 tear-away	None
	High-density or highly detailed designs may require more backing. If so, use two pieces of lightweight backing instead of one piece of heavy backing.	
Denim	1 tear-away	None
	Reduce speed if needle begins to heat up and the thread breaks.	
Headwear	Optional	Optional
	Change needles more often than usual because the buckram backing dulls needles faster. A lightweight tear-away backing helps reduce thread breaks and regulates thread tension. Use a topping on corduroy or foam cap fronts.	
Dress shirt (woven)	1 tear-away	None
	High-density or highly detailed designs may require more backing. If so, use two pieces of lightweight backing instead of one piece of heavy backing.	
Golf shirt	1 cut-away or iron-on cut-away	Optional
	Use topping for designs containing small lettering or a lot of detail, and also for piqué knits.	
Canton fleece	1 tear-away	Optional
	Use a topping if the garment has a textured surface, such as a basketweave or pronounced twill.	
Canvas	1 tear-away	None
	Frame tightly.	

Fabric/ Garment	No. of Backing Pieces	No. of Topping Pieces
	Comments	
Corduroy	1 tear-away	1 water-soluble
	A higher stitch density or more under stitches, as well as a topping, may be necessary to prevent stitches from sinking into the fabric.	
Lingerie or silk	1 or 2 lightweight tear-away	Optional
	Reduce embroidery speed. The thread tension should be low. Use topping for designs with high detail or small lettering. For very fine fabrics, use a thinner thread. Avoid extremely narrow satin stitching on letters or details; instead increase satin stitch width or use a bean stitch. Gently remove (don't pull) backing and topping from garment.	
Sweater knit	1 cut-away or iron-on cut-away	1 water-soluble
	Use tightly woven organza or curtain fabric in a matching color as a backing for bulky or "holey" knits.	
Sweatshirt	1 cut-away or adhesive tear-away	Optional
	Highly detailed designs may require two layers of lightweight cut-away stabilizer. Use a topping on extra-thick fabrics or with fine-detail designs.	
T-shirt	1 light-weight cut-away or iron-on cut-away	Optional
	Use a topping on designs with fine detail or small lettering. Tensions should be light. Avoid stitch-heavy designs.	

Note

- Due to the wide variety of fabrics and stabilizers available, the above information should be used as guideline only. If unsure of a particular fabric/stabilizer combination, please embroider test a sample prior to the finished garment.

Hoooping the fabric in the embroidery frame

Note

- If the fabric is not taut, the pattern may be misaligned or the fabric may pucker. Follow the procedure described below to firmly smooth the fabric in the embroidery frame so that the fabric is not loose. In addition, be sure to work on a level surface when putting the fabric in the embroidery frame.

1 Select an embroidery frame.

From the sizes of embroidery frames indicated in the screen, select the embroidery frame that you wish to use.



Embroidery frames that can be used appear lighter () embroidery frames that cannot be used appear darker ().

Memo

- If the embroidery frame holder is not attached to the machine, the embroidering area will not display the correct frame size. (page 64)

■ Embroidery frame types

There are four sizes of embroidery frames included with this machine, which are used with the included embroidery frame holder A. For details on the uses for each frame, refer to "Correctly using the embroidery frames" on page 65.

Icon	Name
	Embroidery area
	Extra-large embroidery frame
	360 mm (W) × 200 mm (H) (14 inches (W) × 7-7/8 inches (H))
	Extra-large embroidery frame (optional)
	300 mm (W) × 200 mm (H) (11-3/4 inches (W) × 7-7/8 inches (H))
	Large embroidery frame
	180 mm (W) × 130 mm (H) (7-1/8 inches (W) × 5-1/8 inches (H))
	Medium embroidery frame
	100 mm (W) × 100 mm (H) (4 inches (W) × 4 inches (H))
	Small embroidery frame
	60 mm (W) × 40 mm (H) (2-3/8 inches (W) × 1-1/2 inches (H))

If you use any of the optional embroidery frames, the following icons appear in the screen.

: Embroidery frame holder B

: Embroidery frame holder C

: Embroidery frame holder D

: Embroidery frame holder E

: Cap frame

: Cylinder frame

: Magnetic sash frame

⚠ CAUTION

- Use the four included frames or recommended optional frames.
- If the size of the embroidery frame is wrong, the embroidery frame may hit the presser foot and damage the machine, or cause injury to the user. (For details on embroidery frames, refer to page 66.)

Note

- The embroidery frame indicators show all embroidery frame sizes in which the embroidery pattern can be embroidered. Be sure to use an embroidery frame of the most suitable size. If the embroidery frame that is too large is used, the pattern may be misaligned or the fabric may pucker. (page 65)

■ Hooping the fabric in the embroidery frame

1 Loosen the screw on the outer frame.

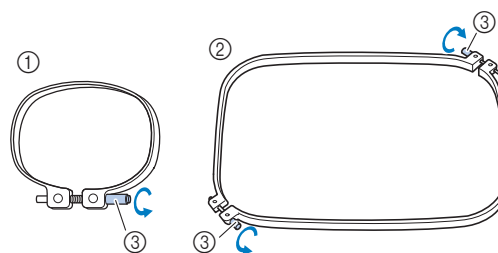

- ① Small or medium embroidery frame
- ② Extra-large, extra-large (optional) or large embroidery frame
- ③ Screw

2 Place the stabilizer and fabric with right side up on top of the outer frame.

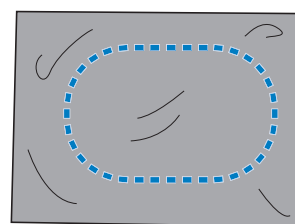

- The outer frame does not have a front or back side. Either side can be used as the front.

3 Press the inner frame into the outer frame.

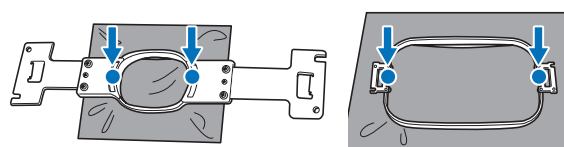

- Be sure that there are no wrinkles in the fabric after it is hooped in the embroidery frame.

4 Lightly tighten the screw.

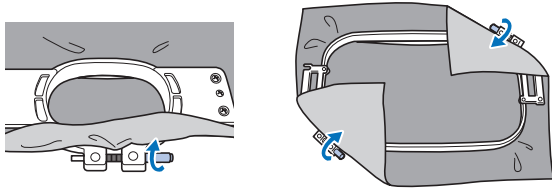

5 Securely tighten the screw, and then check to make sure that the fabric is taut.

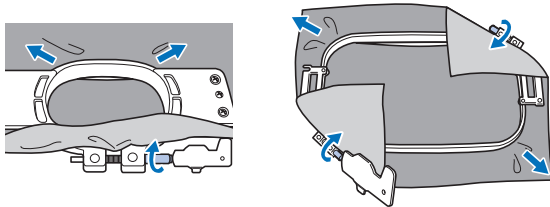

- Use the 3 way screwdriver to tighten the screw securely.
- After securing the fabric, lightly tapping it should produce a drum-like sound.
- Firmly clamp together the inner and outer frames so that their tops are even.

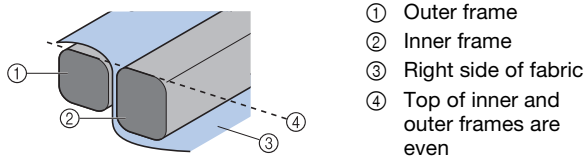

Memo

- To correctly frame the fabric in the embroidery frame, we recommend using a flat surface.

Using the embroidery sheet

In order to hoop the fabric so that the pattern will be embroidered in the correct position, use the guidelines on the embroidery sheet to accurately align the fabric in the frame.

1 With a fabric marker, mark the area of the fabric you want to embroider.

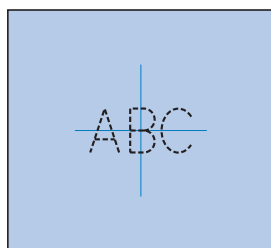

2 Place the embroidery sheet on the inner frame. Align the guidelines on the embroidery sheet with the marks that you drew on the fabric.

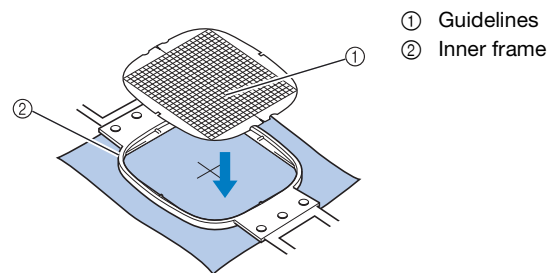

3 Gently stretch the fabric, so that there are no folds or wrinkles.

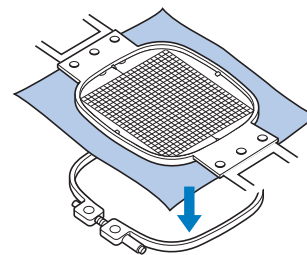

4 Remove the embroidery sheet.

Embroidering large pieces of fabric or heavy clothing

When embroidering large pieces of fabric or heavy pieces of clothing, use a clothespin or binder clip to fasten the excess fabric to the embroidery frame so that it does not hang down from the frame. Embroidering with excess fabric hanging down from the embroidery frame may prevent the frame from moving properly and may result in a misaligned pattern.

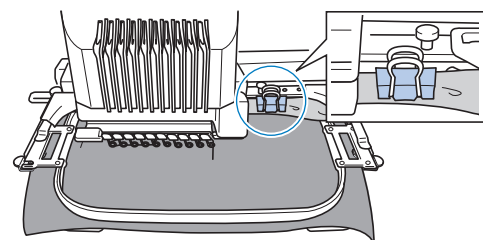

- Use a clothespin or binder clip to fasten the excess fabric to the embroidery frame.

■ Embroidering small pieces of fabric

When embroidering small pieces of fabric that cannot be hooped in an embroidery frame, use stabilizer material as a base. After lightly ironing the fabric to the stabilizer material, hoop it in the embroidery frame. If stabilizer material cannot be ironed onto the fabric, attach it with a basting stitch. After completing the embroidery, remove the stabilizer material carefully.

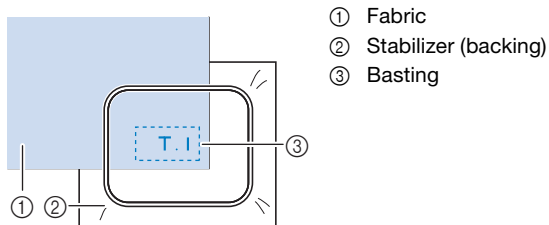

- ① Fabric
- ② Stabilizer (backing)
- ③ Basting

■ Embroidering items, such as bags and tubular items, that have limitations to being hooped in the embroidery frame

Rotate the pattern before embroidery. For details on rotating the pattern, refer to “Understanding the pattern editing screen” on page 44.

Example: When embroidering a pillowcase Rotate the pattern 90 degrees to the left before embroidering.

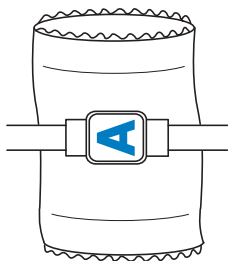

Example: When embroidering a T-shirt Rotate the pattern 180 degrees. Pass the machine bed through from the waist of the T-shirt, not from the neck, and attach the embroidery frame to the machine. This will prevent the neck of the shirt from being stretched when the embroidery frame is moving.

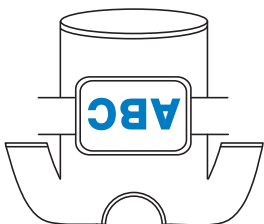

ATTACHING THE EMBROIDERY FRAME TO THE MACHINE

After hooping the fabric in the embroidery frame, attach the frame to the machine. Embroidery frame holders A and B are included accessories with this machine.

Install embroidery frame holder A when an included embroidery frame is to be used. (For details on the embroidery frame holders, refer to page 66.)

⚠ CAUTION

- If the embroidery frame is not correctly attached it may hit the presser foot and damage the machine, or cause injury to the user.
- When attaching the embroidery frame, make sure that the “Start/Stop” button is lit in red. If the “Start/Stop” button is flashing in green, the machine may start embroidering. If the machine accidentally starts operating, injuries may result.
- When attaching the embroidery frame, make sure that the embroidery frame does not hit any other part of the machine.

Attaching the embroidery frame

Adjust the width of the embroidery frame holder to the size of the embroidery frame, and then attach the embroidery frame to the machine. As an example, the procedure for attaching the small embroidery frame is described below.

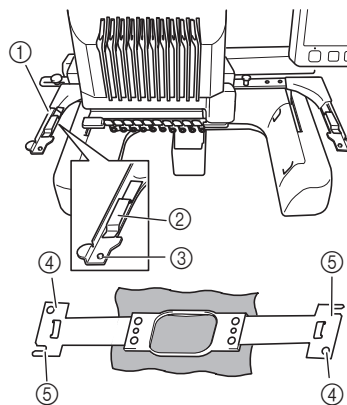

- ① Left arm of embroidery frame holder
Move the arm of the embroidery frame holder to the left or right to adjust it to the size of the embroidery frame.
- ② Clip on embroidery frame holder
Insert the embroidery frame into the clips on the embroidery frame holder.
- ③ Positioning pin
- ④ Holes
- ⑤ Positioning slots

1 Loosen the two left thumb screws on the embroidery frame holder.

If the screw is too tight, please use the included 3 way screwdriver.

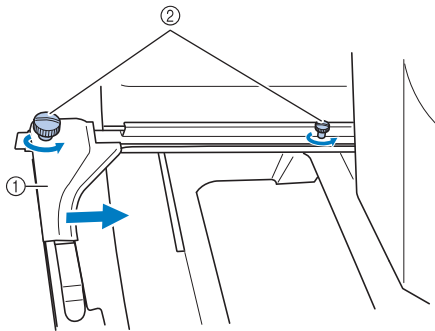

- ① Left arm
- ② Thumb screws

→ The left arm of the embroidery frame holder can be moved.

- Only loosen the thumb screws a maximum of 2 turns counterclockwise. Do not remove the screw.

2 Move the left arm to align the screw on the right side with the mark for the embroidery frame to be installed, and then tighten the thumb screws.

For this example, align the small thumb screw with mark ⑤.

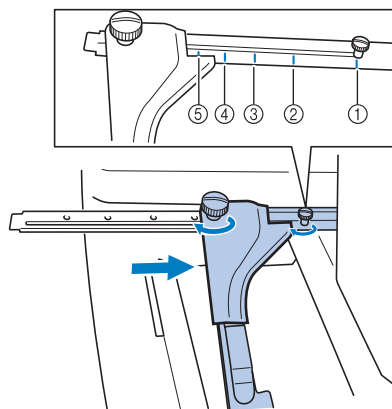

- ① Mark for extra-large embroidery frame
360 mm (W) × 200 mm (H)
(14 inches (W) × 7-7/8 inches (H))
- ② Mark for extra-large embroidery frame
300 mm (W) × 200 mm (H)
(11-3/4 inches (W) × 7-7/8 inches (H)) (optional)
- ③ Mark for large embroidery frame
180 mm (W) × 130 mm (H)
(7-7/8 inches (W) × 5-1/8 inches (H))
- ④ Mark for medium embroidery frame
100 mm (W) × 100 mm (H)
(4 inches (W) × 4 inches (H))
- ⑤ Mark for small embroidery frame
60 mm (W) × 40 mm (H)
(2-3/8 inches (W) × 1-1/2 inches (H))

Note

- Please firmly tighten the two thumb screws with included 3 way screwdriver. If the thumb screws are not tightened, any of the following problems may occur.

- The machine will detect the embroidery frame size incorrectly.
- The starting position for the embroidery frame is misaligned.
- The embroidery pattern is misaligned.

→ The embroidery frame holder is ready for the embroidery frame to be attached.

3 Hold the embroidery frame level, and then simultaneously align both the left and right mounts with the embroidery frame holder clips.

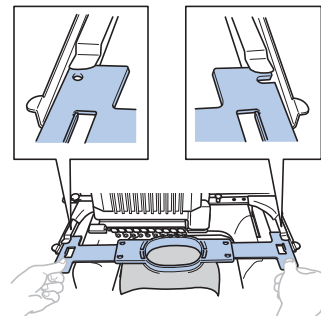

- The inner frame should be on top.

4 Insert the embroidery frame until it snaps into place.

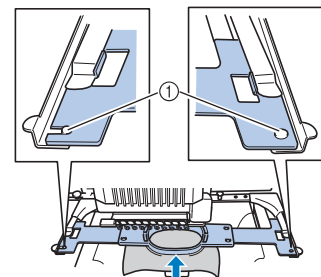

- ① Make sure that the pins on the left and right arms of the embroidery frame holder fit into the positioning slot and hole on the embroidery frame.

Correctly using the embroidery frames

Various types of embroidery frames can be used with this machine to suit your project.

In addition to the included embroidery frames, there are many frames that can be used with this machine. (Refer to "Optional accessories" on page 14.)

⚠ CAUTION

- Only use embroidery frames of the sizes indicated in the screen, otherwise the embroidery frame may hit the presser foot, which may result in injuries.

■ Embroidery frame holders

Two types of embroidery frame holders (embroidery frame holder A and embroidery frame holder B) are included with this machine.

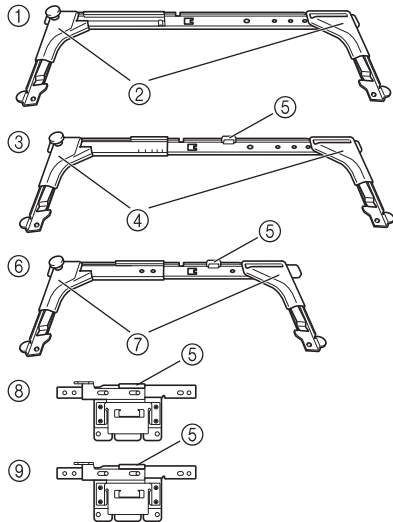

Embroidery frame holder A is used with the four included embroidery frames and the optional 300 mm (W) × 200 mm (H) (11-3/4 inches (W) × 7-7/8 inches (H)) hoop. Embroidery frame holder B is used with the optional embroidery frames. In addition, if you purchase optional round frame set, clamp frame set or compact frame set, specified frame holder C, D or E is included. For details on which embroidery frame can be installed on each embroidery frame holder, refer to "Types of embroidery frames/frame holders and their applications" on page 66.



- ① Embroidery frame holder A
- ② White corner covers
- ③ Embroidery frame holder B
- ④ Light gray corner covers
- ⑤ Magnet
- ⑥ Embroidery frame holder C (optional)
- ⑦ Dark gray corner covers
- ⑧ Embroidery frame holder D (optional)
- ⑨ Embroidery frame holder E (optional)

■ When difficult to replace the embroidery frame

Depending on the position of the needle bars, it may be difficult to replace the embroidery frame. In that case, follow the procedure described below to move the embroidery frame.

1 Touch  .

→ The needle bar move screen appears.

2 Touch .

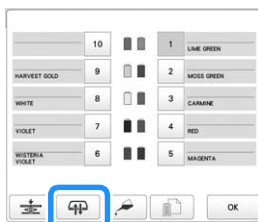











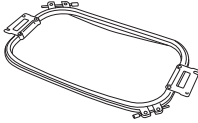

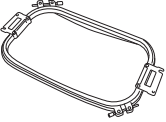
→ The carriage automatically moves to a position where the embroidery frame can easily be replaced.

- Touch  to close the needle bar move screen and to move the carriage to the previous position.

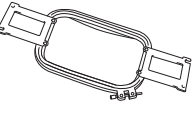



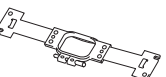



■ Types of embroidery frames/frame holders and their applications

When the reference page is "*", contact your authorized Brother dealer.

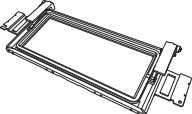

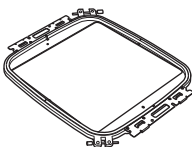

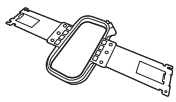
Embroidery frames that use embroidery frame holder A

Embroidery frame	Embroidering area	
	Usage	
	Reference page	
Extra-large embroidery frame 	360 mm (W) × 200 mm (H) (14 inches (W) × 7-7/8 inches (H))	
	Use when embroidering connecting characters or patterns, combined patterns or large patterns. page 62	
Extra-large embroidery frame (optional) 	300 mm (W) × 200 mm (H) (11-3/4 inches (W) × 7-7/8 inches (H))	
	Use when embroidering connecting characters or patterns, combined patterns or large patterns. page 62	
Flat frame (optional) 	300 mm (W) × 200 mm (H) (11-3/4 inches (W) × 7-7/8 inches (H))	
	Use when embroidering jackets and other thick garments. *	
Large embroidery frame 	180 mm (W) × 130 mm (H) (7-1/8 inches (W) × 5-1/8 inches (H))	
	Use when embroidering patterns with a size less than 180 mm (W) × 130 mm (H) (7-1/8 inches (W) × 5-1/8 inches (H)). page 62	
Medium embroidery frame 	100 mm (W) × 100 mm (H) (4 inches (W) × 4 inches (H))	
	Use when embroidering standard-sized patterns. page 62	
Small embroidery frame 	60 mm (W) × 40 mm (H) (2-3/8 inches (W) × 1-1/2 inches (H))	
	Use when embroidering small-sized patterns, such as name tags. page 62	





Embroidery frames that use embroidery frame holder B

Embroidery frame	Embroidering area	
	Usage	
	Reference page	
Quilt frame (optional) 	200 mm (W) × 200 mm (H) (7-7/8 inches (W) × 7-7/8 inches (H))	
Use when embroidering pieces for quilts. *		
Border frame (optional) 	300 mm (W) × 100 mm (H) (11-3/4 inches (W) × 7-7/8 inches (H))	
Use when embroidering a long string of characters or patterns. *		
Jumbo Frame (optional) 	360 mm (W) × 360 mm (H) (14 inches (W) × 14 inches (H))	
Use when embroidering patterns that have been split into two regions in PE-DESIGN editing software and with a size less than 200 mm (W) × 360 mm (H) (7-7/8 inches (W) × 14 inches (H)) or patterns with a maximum size of 350 mm (W) × 350 mm (H) (13-3/4 inches (W) × 13-3/4 inches (H)). page 140		
Sleeve frame (optional) 	70 mm (W) × 200 mm (H) (2-3/4 inches (W) × 7-7/8 inches (H))	
Use when embroidering long items such as shirt sleeves. *		



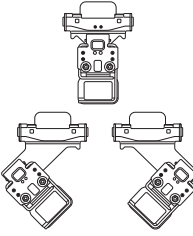

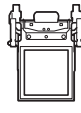

Embroidery frames that use embroidery frame holder C (optional)

Embroidery frame	Embroidering area	
	Usage	
	Reference page	
Round frame (optional) ∅=diameter 	∅100 mm (4 inches) ∅130 mm (5 inches) ∅160 mm (6 inches)	  
Use when adding a built-in embroidery pattern to a sleeve. Select the frame appropriate for the size of the pattern. *		

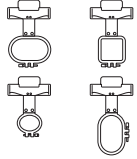



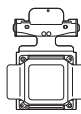



Embroidery frames that use embroidery frame holder D (optional)

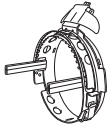

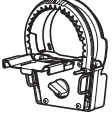
Embroidery frame	Embroidering area	
	Usage	
	Reference page	
Clamp frame S (optional) 	45 mm (W) × 24 mm (H) (1-3/4 inches (W) × 7/8 inches (H))	
Use when embroidering specialty shaped items that cannot be held in normal frames, such as shoes and gloves. *		
Clamp frame M (optional) 	100 mm (W) × 100 mm (H) (4 inches (W) × 4 inches (H))	
Use when embroidering specialty shaped items, such as narrow bags. *		

Embroidery frames that use embroidery frame holder E (optional)

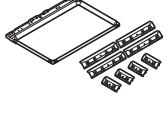
Embroidery frame	Embroidering area	
	Usage	
	Reference page	
Compact frame (optional) 	70: 70 mm (W) × 41 mm (H) (2-3/4 inches (W) × 1-5/8 inches (H)) 50: 50 mm (W) × 50 mm (H) (2 inches (W) × 2 inches (H)) 44: 44 mm (W) × 38 mm (H) (1-3/4 inches (W) × 1-1/2 inches (H)) Vertical: 75 mm (W) × 33 mm (H) (2-15/16 inches (W) × 1-5/16 inches (H))	   
Use when embroidering logos or patterns on small items. *		
Magnetic frame (optional) 	50 mm (W) × 50 mm (H) (2 inches (W) × 2 inches (H))	
Use to prevent the embroidery frame from leaving traces in the fabric. *		

Embroidery frames that do not use embroidery frame holders

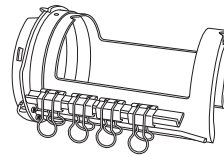
Embroidery frame	Embroidering area	
	Usage	
	Reference page	
Advanced cap frame 2 (optional) 	130 mm (W) × 60 mm (H) (5-1/8 inches (W) × 2-3/8 inches (H)) 	<p>Use when embroidering caps. Baseball (golf) caps, tulip hats and bucket hats can be embroidered with these frames. This frame cannot be used with hats having a front area of 50 mm (2 inches) or less, such as sun visors and children's hats. In addition, this frame cannot be used with hats that have a brim longer than 80 mm (3-1/8 inches).</p> <p>*</p>
Flat brim cap frame (optional) 	130 mm (W) × 60 mm (H) (5-1/8 inches (W) × 2-3/8 inches (H)) 	<p>Use when embroidering caps. In addition to caps compatible with advanced cap frame 2, this frame can be used to embroider flat brim caps and children's caps. Compared with advanced cap frame 2, this frame can be used to embroider closer to the cap brim.</p> <p>*</p>
Wide cap frame (optional) 	360 mm (W) × 60 mm (H) (14 inches (W) × 2-3/8 inches (H)) 	<p>Use when embroidering caps. This frame has larger embroidering area than other cap frames. This frame cannot be used with hats having a front area of 50 mm (2 inches) or less, such as sun visors and children's hats. In addition, this frame cannot be used with hats that have a brim longer than 80 mm (3-1/8 inches).</p> <p>*</p>
Magnetic sash frame (optional) 	360 mm (W) × 200 mm (H) (14 inches (W) × 7-7/8 inches (H)) 	<p>Use when embroidering connecting characters or patterns, combined patterns or large patterns. It is also convenient to use when embroidering quilt sash patterns.</p> <p>*</p>

Embroidery frame	Embroidering area	
	Usage	
	Reference page	
Cylinder frame (optional) 	90 mm (W) × 80 mm (H) (3-1/2 inches (W) × 3 inches (H)) 	<p>Use when embroidering tubular and curved fabric, such as shirt sleeves and turtlenecks.</p> <p>*</p>

Note

- The embroidery frame indicators show all embroidery frame sizes in which the embroidery pattern can be embroidered. Be sure to use an embroidery frame of the most suitable size. If the embroidery frame that is used is too large, the pattern may be misaligned or the fabric may pucker.
- All genuine embroidery frames that can be used with PR series machines can be installed on this machine.
- When embroidering with an optional embroidery frame (jumbo frame, border frame, quilt frame, flat frame or magnetic sash frame), the included wide table must be installed onto the machine.
- Due to the weight of the embroidery frame and fabric it is recommended that the included wide table be used, to prevent the frame holder from bending, which may result in the distortion of your design or machine damage.

SPECIFYING EMBROIDERING SETTING

Understanding the embroidering settings screen





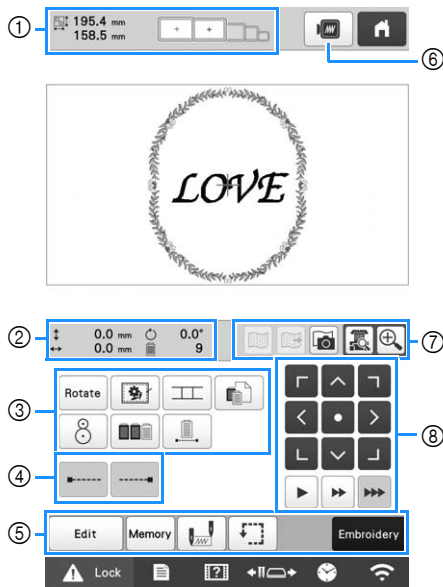



Memo







- Keys available in this screen differ when you set [Manual Color Sequence] to [ON] in settings screen. (page 58, page 70)



No.	Display Key Name	Function	Page
①		Shows the size of the embroidery pattern currently displayed in the pattern display area. The top value shows the height and the bottom value shows the width. If the embroidery pattern consists of multiple patterns that have been combined, the size of the entire pattern, including all patterns, is shown.	—
		Shows the sizes of embroidery frames that can be used to embroider the pattern currently displayed in the pattern display area.	61
②		Shows the vertical distance that the pattern being combined/edited is moved.	—
		Shows the horizontal distance that the pattern being combined/edited is moved.	—



No.	Display Key Name	Function	Page
②		Shows the rotation angle that the pattern being edited is rotated.	—
②		Shows the total number of thread colors for the pattern that is being edited.	—
③		Rotate the entire embroidery pattern.	—
		When stabilizer material is not affixed to the fabric, embroider basting stitches along the outline of the pattern to minimize shrinkage of the stitching and misaligned patterns.	99
③		Start pattern connecting embroidering with the built-in camera.	109
		Change the settings for individual thread colors, such as temporarily stopping or skipping embroidering.	119
③		Align the embroidering position using the built-in camera.	78
		Specify that the embroidering sequence for multiple patterns that have been combined be rearranged by thread color.	71
④		Touch to embroider the pattern in the same color, regardless of specified color changes. The entire thread color sequence display will appear in the same color.	120
		Specify that automatic lock stitch is embroidered at the beginning of the pattern and at the beginning of embroidering after thread trimming.	71
④		Specify that automatic lock stitch is embroidered when the thread is trimmed.	71
		Return to the pattern editing screen.	—
⑤		Save a pattern in the machine's memory, USB media or a computer.	130

No.	Display	Function	Page
	Key Name		
⑤		Specify the needle position at the beginning of embroidering and at the end.	126
	Starting/ending position key		
		Move the embroidery frame so that the embroidering position can be checked.	79
⑥		Finish all operations in the embroidering settings screen and continue to the embroidering screen.	—
	Embroidery key		
⑥		Display an image of the pattern that is to be embroidered so it can be previewed.	60
	Preview key		
⑦		Display or hide the background image scanned in with the built-in camera.	73
	Background image display key		
		Save, onto USB media, the background image scanned in with the built-in camera.	73
	Save background image key		
		Scan (with the built-in camera) fabric hooped in an embroidery frame and display it as a background image for the pattern.	72
	Fabric scan key		
	View (on the LCD) the image below the needle or display an image of the edited embroidery pattern at the actual embroidering position.	75, 79	
Camera view key			
	Display the image (after touching the camera view key) enlarged to double the size. This key is available even if the camera view key was not touched.	53	
Camera zoom key			

No.	Display	Function	Page
	Key Name		
⑧		Move the embroidering position of the whole pattern in the direction of the arrow. (If  is touched, the embroidering position is moved to the center of the embroidering area.)	—
	Positioning keys		
		Select the speed to move the frame.  : Touch to move the frame by 0.1 mm (1/64 inch).  : Touch to move the frame by 0.5 mm (1/32 inch).  : Keep touching to move the frame at maximum speed. When viewing the camera image, the frame moves by 2.0 mm (1/16 inch).	—
Frame movement speed keys			

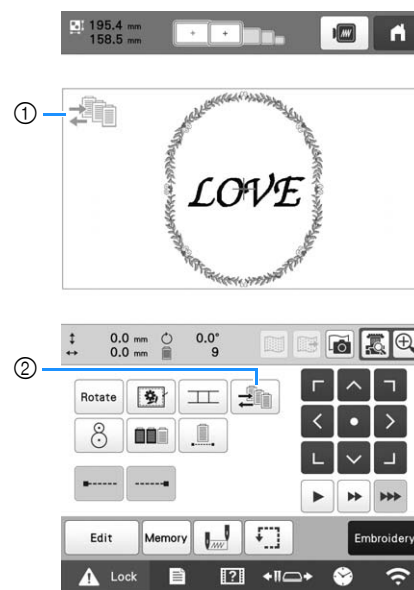
■ In the [Manual Color Sequence] mode



No.	Display	Function	Page
	Key Name		
①		This icon appears when the machine is in the [Manual Color Sequence] mode.	58
②		Change the needle bar color setting. This key appears when you set [Manual Color Sequence] to [ON] in settings screen.	59

Automatic lock stitch setting

When the machine is purchased, it is set to automatically embroider lock stitches at the beginning of the pattern, before embroidering after each thread color change, and before trimming the thread.

- To change the lock stitches being embroidered at the beginning of the pattern, at the beginning of embroidering each thread color change and at the beginning of embroidering after the thread trim.

1 Touch so that it changes to .



- Each touch of the key turns the setting either on or off.



Automatic lock stitch setting turned on

Automatic lock stitch setting turned off

Memo

- If the first stitch length is less than 0.8 mm (1/32 inch), the lock stitch won't be inserted.
- If [Thread Trimming] is set [OFF] in the settings screen, the lock stitch won't be inserted. (page 123)

- To change the lock stitches being embroidered before the thread is trimmed.

1 Touch so that it changes to .



- Each touch of the key turns the setting either on or off.



Automatic lock stitch setting turned on

Automatic lock stitch setting turned off

Memo

- The automatic lock stitch setting stays the same until the key is touched to turn it off. The setting specified before the machine is turned off remains selected the next time that the machine is turned on.
- If [Thread Trimming] is set [OFF] in the settings screen, the lock stitch won't be inserted. (page 123)

Thread color sorting

You can embroider while replacing the thread spool a minimal number of times.

Before starting to embroider, touch in the embroidering settings screen to rearrange the embroidering order and sort it by thread colors.

Embroidery screen

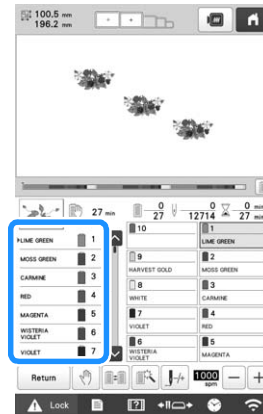

Embroidering settings screen

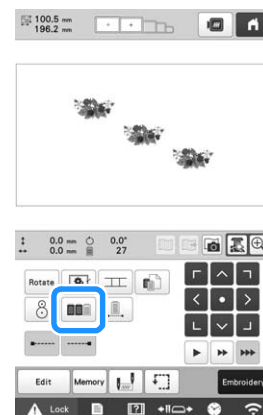

Embroidery screen

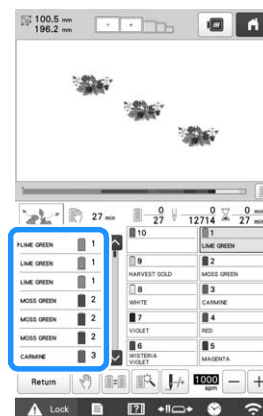

The embroidery color order is rearranged and sorted by thread colors.

Touch  to cancel the color sorting and embroider with the embroidery color order.

Note

- This function does not work on overlapping designs.

CHECKING THE EMBROIDERY AREA

The pattern is usually placed at the center of the embroidery frame. If you want to change where in the fabric the pattern will be embroidered, you can check the position before starting embroidering.

Displaying the fabric while aligning the embroidery position

The fabric hooped in the embroidery frame can be displayed on the LCD so that the embroidery position can be aligned.

This feature can be used from the pattern editing screen and embroidering settings screen.



Note

- When installing the optional embroidery frame holder D, embroidery holder E, Cap frame, or Cylinder frame, the built-in camera cannot be used to align the embroidering position.
- For details on using fabric thicker than 2 mm (5/64 inch), refer to “Positioning the pattern on thick fabric” on page 74.

1 Hoop the fabric in the embroidery frame, and then attach the frame to the machine.

2 Select the pattern.

Note

- Make sure [Fabric Thickness Check] is set to [OFF] when using light to medium weight fabrics. (page 74)

3 Specify the appropriate image settings in advance. (page 73)

- Better scanning results can be achieved with the appropriate settings.

4 Touch  in the pattern editing screen.



5 When the message to start scanning appears, touch .



→ The embroidery frame moves so the fabric can be scanned.

6 When the fabric appears as a background for the pattern, the pattern can be edited if it is necessary.



7 Use  to align the pattern with the desired embroidery position.

 **Memo**

- If necessary, touch  to display a preview in order to check the pattern position.
- The background can be displayed or hidden by touching  in the embroidering settings screen.

8 Touch  to display the embroidering settings screen.

 **Memo**

- The pattern can also be aligned from the embroidering settings screen.
- By touching  in the embroidery settings screen, the background image can be saved to USB media.

9 Touch .

10 Touch , and then press the “Start/Stop” button to start embroidering.



→ When embroidery is finished, the fabric displayed in the background disappears.

■ **Improving scanned images and camera images**

The machine software adjusts images according to the table installation setting.

The table installation setting must be selected before scanning the fabric to display it as a background image for a pattern or before using the built-in camera to display a camera image of the fabric.

Table installation	Setting
When no table is attached to the machine	[No Table]
When the included wide table is attached to the machine	[Wide Table]
When the optional tubular frame table is attached to the machine	[Tubular Frame Table]

1 Touch , and then touch .

→ The embroidery settings screen appears.

2 Locate [Attached Table].

3 Touch  or  to select the table installation setting.

 **Memo**

- Better camera image and scanning results can be achieved with the appropriate settings.
- When scanning in My Design Center with a scanning frame, no setting needs to be selected for [Attached Table].
- Be sure to install the wide table when using the optional magnetic sash frame, border frame, quilt frame, flat frame or jumbo frame.

■ Displaying the fabric in the background

Whether or not the fabric is displayed in the background can be specified. In addition, [Standard] or [Fine] can be selected for the quality of the background image.

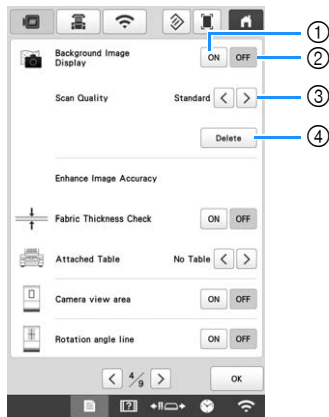

- ① Set to [ON] to leave the fabric displayed in the background.
- ② When set to [OFF], the background will disappear.
- ③ Select the quality of the background image.
- ④ Remove the background image completely.

■ Positioning the pattern on thick fabric

When positioning the pattern on the fabric thicker than 2 mm (5/64 inch), the fabric may not be detected correctly. In order for the fabric to be correctly detected, its thickness must first be measured.

- 1 Hoop the fabric in the embroidery frame, and then attach the frame to the machine.
- 2 Select the pattern.
- 3 Touch .
→ The embroidery settings screen appears.
- 4 Locate [Fabric Thickness Check] in the Settings pages.
- 5 Select [ON] to activate the setting.

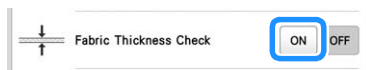

- 6 Touch to return to the previous screen.
- 7 Touch .
- 8 When the message the machine moves appears, touch .

- 9 Affix the embroidery positioning sticker to the fabric within the area indicated by the red frame in the LCD, and then touch .

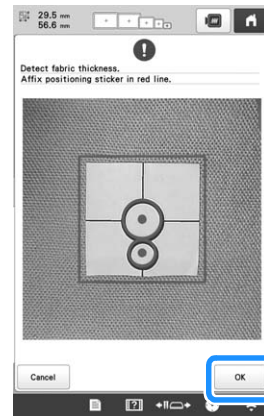

- 10 When the following message appears, remove the embroidery positioning sticker, and then touch .

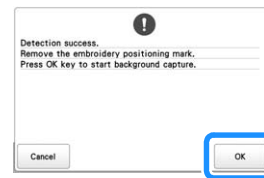

→ The embroidery positioning sticker affixed to the fabric is detected, and then the embroidery frame will be moved.

- 11 Continue with step 6 on page 73 to align the pattern with the desired embroidery position.

⚠ CAUTION

- Use fabrics with a thickness of less than 2 mm (approx. 5/64 inch). Using fabrics thicker than 2 mm (approx. 5/64 inch) may cause the needle to break.

Using the built-in camera

The camera built into this machine can be used to easily align the embroidering position. This is useful for patterns which need to be embroidered in particular position as shown below.



1 Use a chalk pencil to mark the desired embroidering position.



① Chalk pencil mark

2 Hoop the fabric.



Note

- When hooping the fabric in the embroidery frame, make sure that the embroidery pattern will fit within the embroidering area of the frame being used.

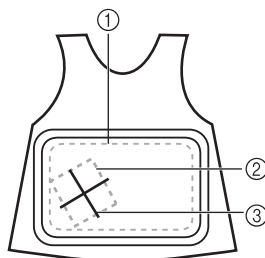

- ① Embroidering area
- ② Embroidery pattern size
- ③ Chalk pencil mark

3 Select the pattern.

4 Touch **Edit End** to display the embroidering settings screen.

5 Touch  in the embroidering settings screen.





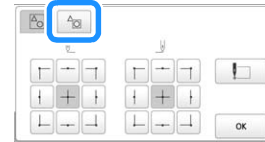

6 Select .

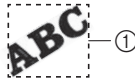

Memo

- The different methods of rotating a pattern and aligning its position while checking the image shown by the camera are described below.

When selecting 	When selecting 
	
The mask is based on the pattern after it has been rotated. If there are multiple patterns, the mask is created around all patterns.	Since the mask is based on the pattern before it has been rotated, this method is useful when embroidering in a location where the pattern cannot easily be aligned. If there are multiple patterns, a pattern can be selected as the reference for the embroidering starting position.

① Mask outline of pattern

7 Touch  to set the starting point to the left-lower of the pattern.



- ① If there are multiple patterns, select the pattern to be used as the reference for the embroidering starting position.

8 Touch **OK**.

9 Specify the appropriate image settings in advance. (page 73)

- Better camera image results can be achieved with the appropriate settings.

10 Touch .

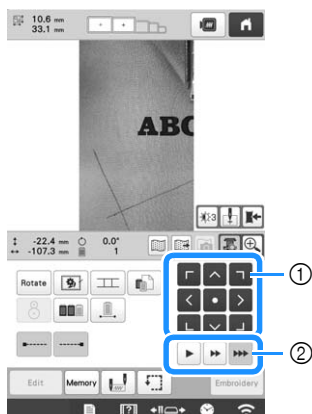

11 Touch the positioning keys to move the embroidery frame until the chalk mark drawn on the fabric is displayed in the camera view window.

Touch the frame movement speed keys to select the speed to move the frame.



- ① Positioning keys
- ② Frame movement speed keys

12 Touch  to display the needle drop point.

- Touch  to change the brightness of the camera image. The embroidering position can more easily be checked by making the image darker () on lighter fabrics or lighter () on darker fabrics.

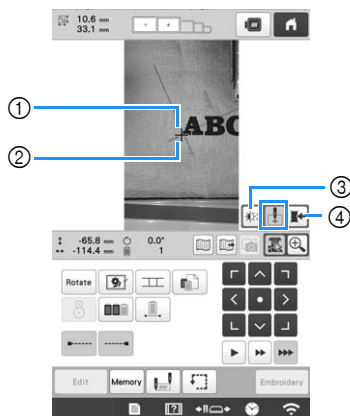

- ① Needle drop point
- ② Chalk mark on the fabric
- ③ Each touch of this key changes the brightness of the camera image.
- ④ Save the camera image on the external device.

- Touch  to check the embroidering position.

 **Memo**

- Touch  to enlarge the camera view. By enlarging the camera view, you can make a close adjustment for the left-lower point of the pattern moving the embroidery frame little by little. For details, refer to “Enlarging the camera image” on page 76.

13 Touch  and adjust the orientation of the pattern until the pattern is parallel with the chalk mark drawn on the fabric.

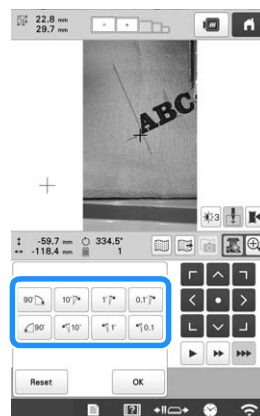

- Touch the positioning keys to move the embroidery frame until the pattern in the camera view window is aligned with the chalk mark drawn on the fabric.
- If there are multiple patterns, all patterns are rotated, not just the pattern used as the reference for the embroidering starting position.

14 Touch  to return to the previous screen.

15 Touch .

16 Touch , and then press the “Start/Stop” button to start embroidering.

■ Enlarging the camera image

1 Touch .

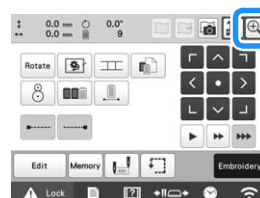

2 The camera image is displayed enlarged.

- You can change the display settings that are specified in the normal camera image display.

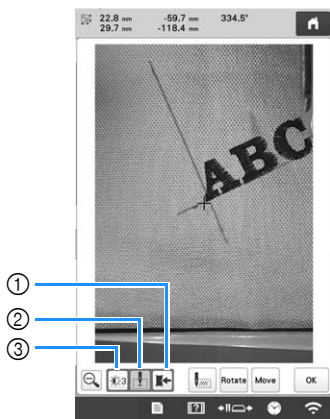

- Save the camera image on the external device.
- Specify the needle drop point mark on or off.
- Each touch of this key changes the brightness of the camera image.

3 Touch [Save], Rotate or Move to display the keys for specifying the starting position, rotating the pattern or moving the embroidery frame.

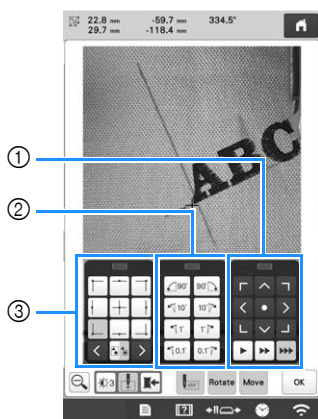

- Adjust the embroidering position by moving the embroidery frame.
 - Rotate the pattern. If there are multiple patterns, all patterns are rotated, not just the pattern used as the reference for the embroidering starting position.
 - Specify the starting position of embroidering.
- While using these key panels in the enlarged camera image, panels will be invisible to show the pattern and the camera image clearly.

Memo

- When you touch [Memo], you can change the camera mode. For details, refer to “Memo” in step 6 of “Using the built-in camera” on page 75.

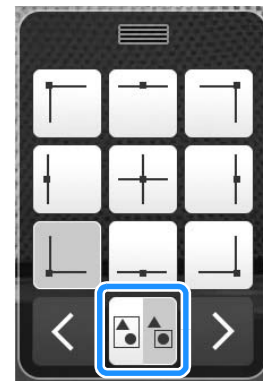

4 Touch [Memo] to return to the normal camera image.

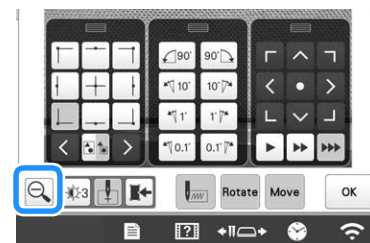

Memo

- The three key panels can be repositioned so that the pattern can easily be viewed. Touch the center of the top of a key panel to view possible locations where the panel can be repositioned. Touch the desired location to move the selected key panel.

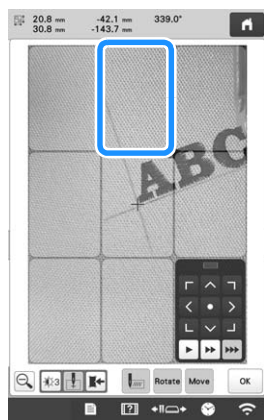
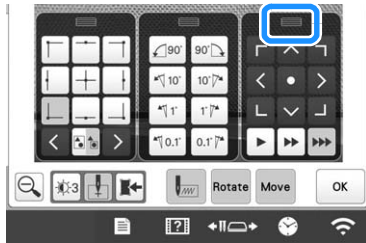

The possible locations for repositioning the panel appear in gray.

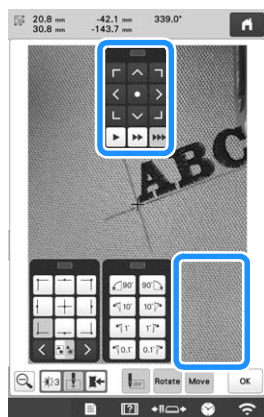

The key panel moves to the selected location.

- Touch to return to the previous screen.

Note

- When using the camera to align the embroidering position on thick fabric, use the thick fabric sensor as described in "Positioning the pattern on thick fabric" on page 74.

Using the included embroidery positioning sticker

Using the camera built into this machine and the included embroidery positioning stickers, the embroidering position can easily be aligned.

- Affix an embroidery positioning sticker to the fabric at the desired embroidering position. Align the center of the large circle in the embroidery positioning sticker with the center of the embroidery pattern.

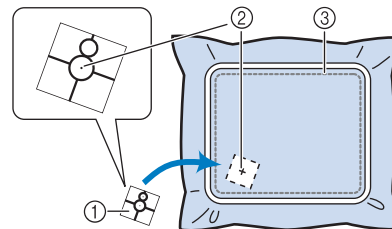

- Embroidery positioning sticker
- Center of embroidery pattern
- Embroidering area

Note

- When hooping the fabric in the embroidery frame, make sure that the embroidery pattern will fit within the embroidering area of the frame being used.

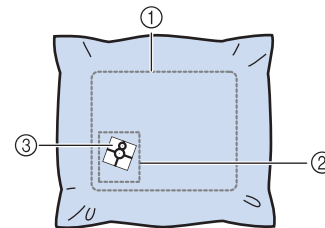

- Embroidering area
- Embroidery pattern size
- Embroidery positioning sticker

- Depending on the type of fabric to be used, it may not be possible to easily remove the embroidery positioning sticker. Before affixing the embroidery positioning sticker, check how easily the sticker can be removed by affixing it to a scrap of the same type of fabric.

- In the embroidering settings screen, touch .



- When the message to revert to original position and angle appears, touch .

4 From the reference points displayed on the screen, select the point to be used for positioning the design.



Note

- The built-in camera may not be able to detect the embroidery positioning sticker if the four corners of the sticker are not firmly affixed to the fabric. Use tape to firmly affix the sticker to the fabric or try a new sticker.

5 Touch **OK**.

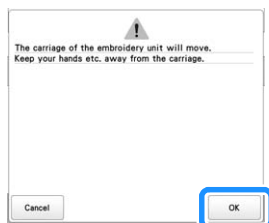

6 When the following message appears, touch **OK**.



→ The built-in camera automatically detects the embroidery positioning sticker, and then the embroidery frame is moved so that the reference point is aligned with the center of the large circle in the embroidery positioning sticker.

7 When the machine's built-in camera has finished detecting the location of the embroidery positioning sticker, the message stating to remove the embroidery positioning sticker appears.

Memo

- You can touch  to confirm the embroidery position is correctly aligned before removing the embroidery positioning sticker.
 - Touch  for the closer image.
 - Touch  again to return to the previous screen.

8 Remove the embroidery positioning sticker from the fabric.

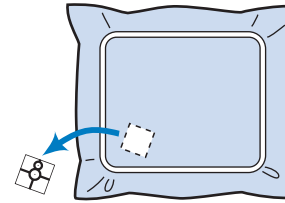

9 Touch **OK**.

Note

- If the message that could not recognize the embroidery positioning sticker appears, touch **OK**, remove the embroidery positioning sticker, and then affix it within the embroidering area. Then, touch **OK** again.

10 Touch **Embroidery**.

11 Touch **Lock**, and then press the "Start/Stop" button to start embroidering.

Note

- After all of the included embroidery positioning stickers have been used, new ones can be purchased separately. When purchasing new ones, check "Optional accessories" on page 14 for the part code, and then contact your nearest authorized Brother dealer.

Checking the embroidery pattern

The carriage moves and shows the pattern position. Watch the embroidery frame closely to make sure the pattern will be embroidered in the right place.

Note

- If you are embroidering a large project such as a jacket or curtains, your embroidering may be interrupted by the presser feet not in use catching on the fabric outside of the design area. Try to stitch the design as close to the center of the embroidery frame, using needle bars 3 through 7. (For details on selecting the needle bar, refer to page 57 or page 59.)

Touch .



→ The presser foot is lowered and the embroidery frame moves to show the embroidery area.

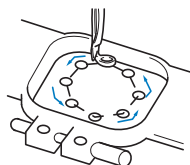



Carefully watch the movement of the embroidery frame and check that the embroidery will stitch in the desired location and that the embroidery frame does not hit the presser foot.

■ Temporarily stopping to check the area

The embroidery frame can be temporarily stopped at a desired position or the checking of the embroidering area can be stopped.

- 1 When the embroidery frame moves to the desired position, touch  again.

→ The embroidery frame stops moving, and the message asking if you want to continue the trial appears.

- 2 To continue moving the embroidery frame, touch . To stop checking the embroidering area, touch .

■ Finding the embroidering position

By locking the needle bar (securing the needle and presser foot in the down position), the needle drop point can easily be seen.

- 1 As shown in the illustration, insert the Allen screwdriver into the hole in the needle clamp to slowly lower the needle bar down till needle bar stops then clicks into the lock position.

Note

- Make sure that the needle is not lowered beyond the positioning click into the fabric.

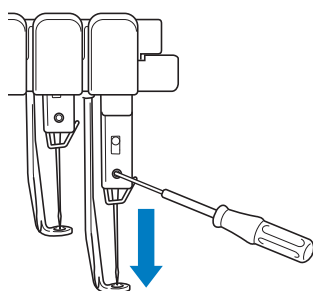

→ The needle and presser foot are locked in the down position.

- 2 Touch the arrow keys in the embroidering settings screen to move the embroidery frame so that the needle drop point is at the center of the area where you wish to embroider.

- With a USB mouse, your finger or the touch pen, drag the pattern to move it.

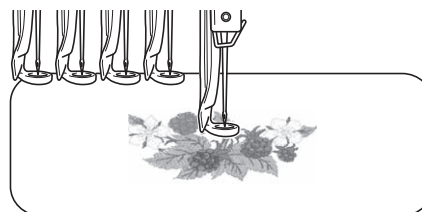

- When specifying the starting of stitching, align the needle drop point with the point specified as the starting of stitching. (For details on specifying the starting/ending of stitching, refer to page 126.)

■ Unlocking the needle bar

- 1 Display the embroidering screen, and then touch the key for any needle bar other than the one that is locked.

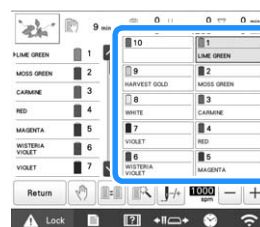

→ The needle bar is unlocked and will return to original position.

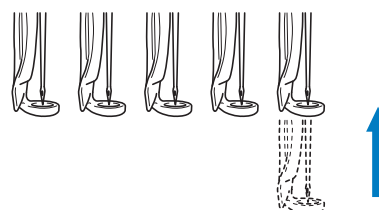

UPPER THREADING

Check the embroidering screen for information on which needle bars should be threaded with specified thread colors, and then thread the upper threads.

Checking the needle bars and thread colors

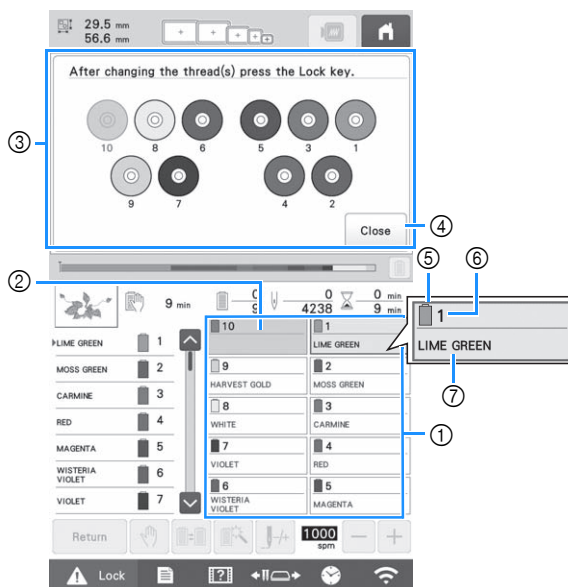

In the embroidering settings screen, touch **Embroidery** to display the embroidering screen. A screen indicating that the spools need to be changed will appear if the thread colors from the previous embroidery project will not be used. If you set [Manual Color Sequence] to [ON] in the settings screen, the message does not appear even if the thread spools need to be changed. (Refer to "SELECTING/MANAGING THREAD COLORS FOR EACH NEEDLE BAR [Manual Color Sequence]" on page 58.)

Embroidering screen (For details on the screen, refer to page 89.)







- ① Thread information for the first to tenth needle bars
 - ② If no thread color name is displayed, that needle bar has not been used.
If a thread color had been assigned to the needle bar on a previously embroidered design, the needle bar will show the previously assigned color.
 - ③ Screen indicating that the spools be changed. (page 92)
This message appears when it is necessary for the thread spools to be changed.
- Memo**
- The thread spools for needle bars whose keys do not appear in gray must be changed. When the automatic needle-threading button is pressed, the needle bar keys appear in gray.
- ④ Minimize the screen indicating that the spools be changed to .
 - ⑤ Thread color
 - ⑥ Needle bar number
 - ⑦ Thread color name or number
If the thread color number [#123] is selected in the settings screen, the thread brand will also be displayed. (page 123)

Thread with the color name that appears below each needle bar number is threaded on that needle bar.

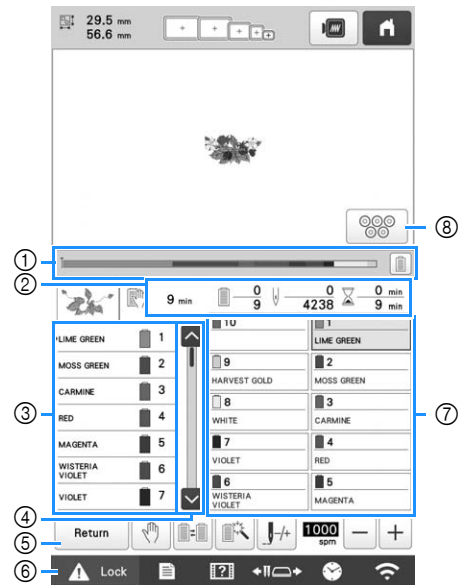
- 1 **Touch** .
→ Current assigned colors are stored in the machine's memory, and the screen indicating that the spools be changed is minimized to .

- In addition to checking the thread colors, information such as the number of stitches and the embroidering time can be checked and various embroidering settings can be specified in the embroidering screen.



- ① The embroidering progress is shown by the red mark in the bar. Touch  to display (in the indicator) only the thread color being embroidered.
- ② Shows the number of thread color changes, the number of stitches, the embroidering time and the length of time until the machine will stop.
- ③ Shows the thread colors, embroidering order and number of the needle bar assigned to the thread colors. A red triangle appears beside the thread color being embroidered. In addition, the box changes to gray when embroidering is finished.
- ④ Touch  and  to view the embroidering order and needle bar number for thread colors that cannot be seen in the screen.
- ⑤ Return to the embroidering settings screen.
- ⑥ When starting the machine or cutting the threads, touch this button to unlock the machine, and then press the "Start/Stop" button or thread trimming button.
- ⑦ Touch a key to move the selected needle bar to the embroidering position. Use when threading the needle with the automatic needle-threading mechanism.
- ⑧ Displays screen indicating that the spools be changed.

Note

- Available keys are not the same if you set [Manual Color Sequence] to [ON] in the settings screen. (page 58)



⚠ CAUTION

- When  (unlock key) in the embroidering screen is touched, the “Start/Stop” button begins flashing in green and the machine can start embroidering. If the upper threading is being performed or the needle is being threaded, be careful that the machine is not accidentally started, otherwise injuries may result.

Upper threading

Use machine embroidery thread to thread the needle bars in order, starting with needle bar 1.

⚠ CAUTION

- When threading the upper thread, carefully follow the instructions. If the upper threading is not performing correctly, the thread may break or become tangled, causing the needle to bend or break.

Note

- It is recommended that rayon or polyester machine embroidery thread be used (120 den/2, 135 dtex/2, 40 weight (in Americas and Europe), #50 (in Japan)).
- Certain types of thread may break or have improper tension. In such a case, change the thread.

Memo

- The path that the machine should be threaded is indicated by a line on the machine. Be sure to thread the machine as indicated.

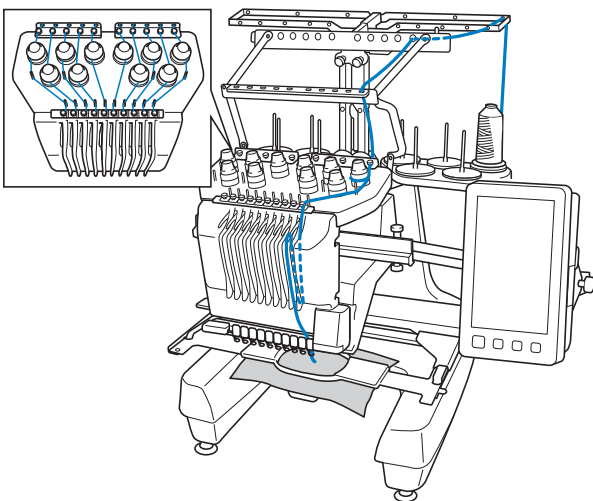

- 1 On the spool pin, place a spool with the thread color specified for the corresponding needle bar.

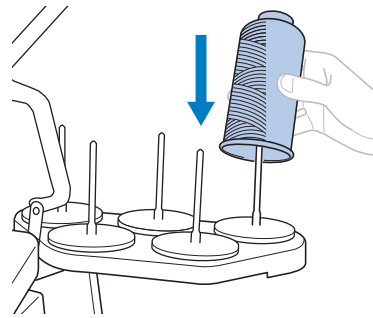

- When using metallic thread or any other strong thread, place the included spool net over the spool. If the spool net is too long, fold it once to match the size of the spool before placing it over the spool. It may be necessary to adjust thread tension when using the spool net.

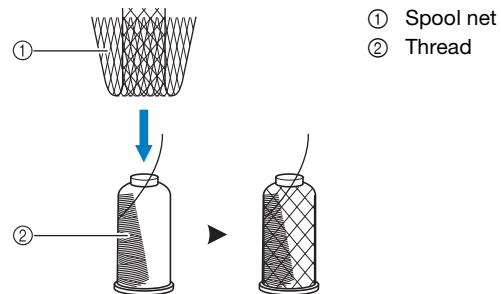

- Check that the spool stand has been completely opened.
- When using small spools of thread, be sure to place the included spool mat on the spool pin before placing the spool on the pin.
- Place the thread in the center of the spool stand so that the thread feeds off the spool correctly and does not get tangled around the spool pin directly under the thread spool.

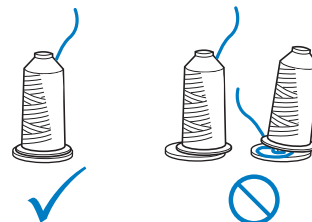

- Use spool cap on all spools of thread shorter than the height of the spool pin.

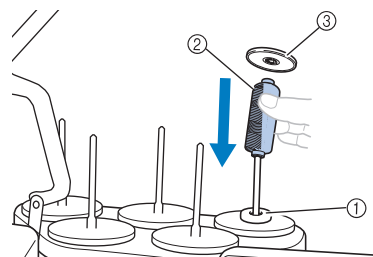

- 1 Spool mat
- 2 Small spool
- 3 Spool cap

The numbers indicate the thread path for each of the numbered needle bars. Be very careful to correctly thread the needle bars.

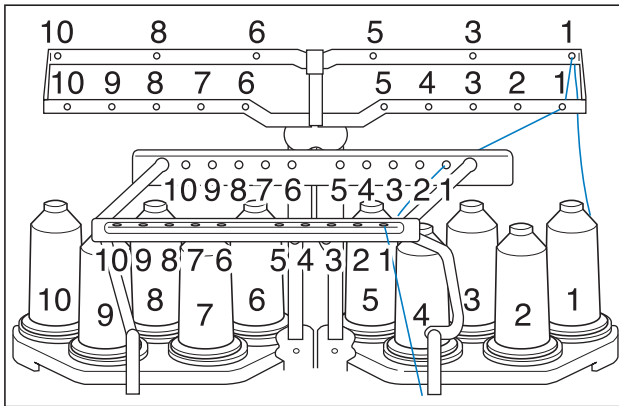

- 2** Pass the thread of a specified color through the holes on the thread guide, making sure that you have the thread color matched to the coordinating needle bar. Pass the thread from spool pins 1, 3, 5, 6, 8 and 10 through the holes in both thread guides A and B. Pass the thread from spool pins 2, 4, 7 and 9 through the hole in thread guide B only.

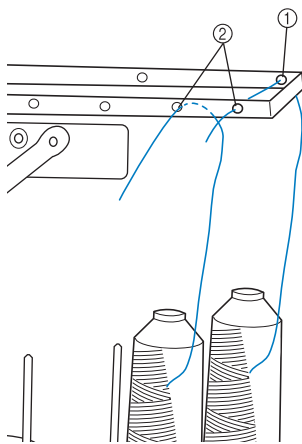

- ① Thread guide A (There are 6 holes in this thread guide)
 ② Thread guide B (There are 10 holes in this thread guide)

- 3** Pass the thread through the hole (with the corresponding needle bar number) in thread guide C, then through the corresponding hole in thread guide D. As an example, the threading for spool pin 1 is shown.

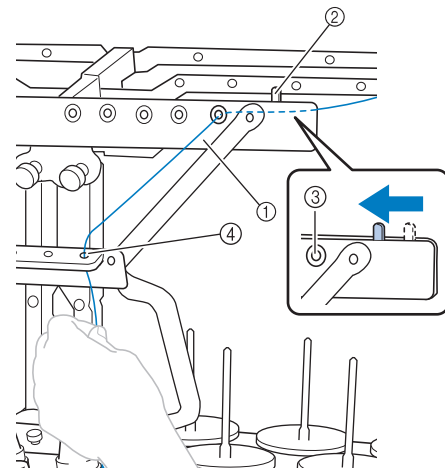

- ① Thread guide C
 ② Thread tension lever
 ③ Holes in thread guide C
 ④ Thread guide D

Note

- Before threading, make sure to slide the thread tension lever to the left so that the holes in thread guide C are fully open.

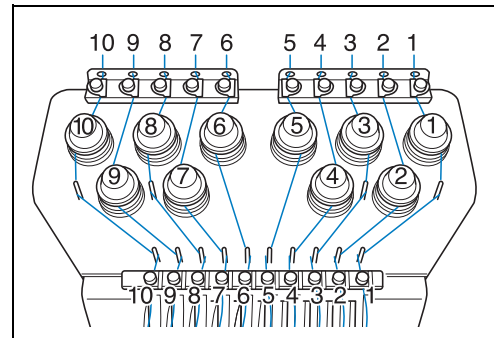

- 4** Pass the thread through the hole in the number 1 upper thread guide and pull the thread toward you.

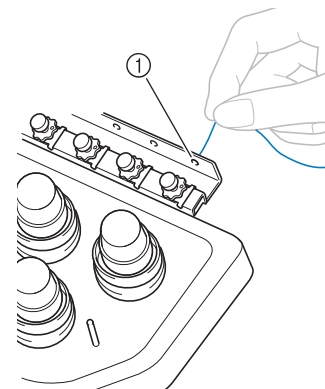

- ① Hole in upper thread guide

- 5** Hold the thread with both hands, and then pass it under the guide plate from the right.

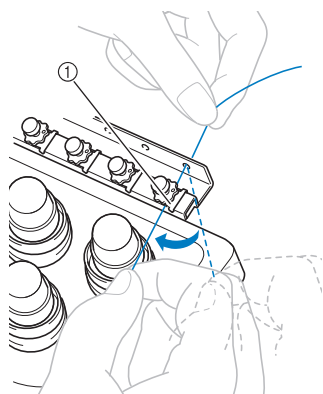

① Upper thread guide plate

- 6** Wind the thread clockwise once around the number 1 thread tension disc.

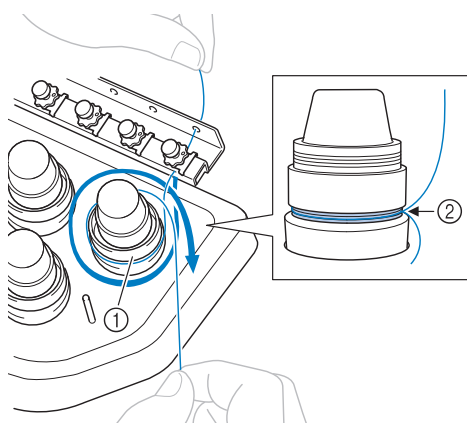

① Thread tension disc

- ② Pass thread in a clockwise direction at this location on the tension discs.

- Make sure that the thread is securely positioned in the thread tension.

Note

- All thread tension discs are threaded in clockwise direction.

- 7** Lead the thread along the thread path and around the correct thread guide pins as indicated on the machine, then slip the thread under the number 1 middle thread guide plate from the right.

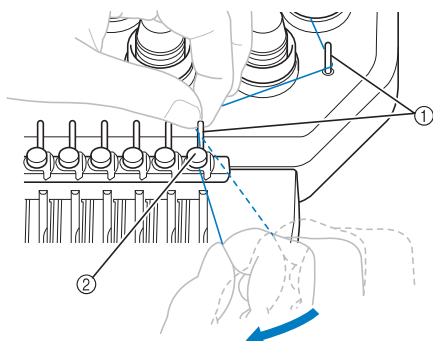

① Thread guide pin

② Middle thread guide

- The path from the upper thread guide around the thread tension disc and to the middle thread guide

(steps **6** through **7**) may differ depending on the spool number. Passing the thread through the thread guide pins is designed to prevent the thread from becoming tangled. Be sure to follow the thread path indicated on the machine.

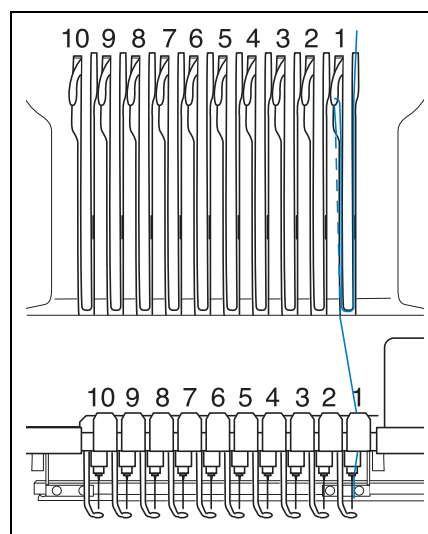

- 8** Pass the thread along the number 1 slot to pass it through the number 1 take-up lever hole from right to left.

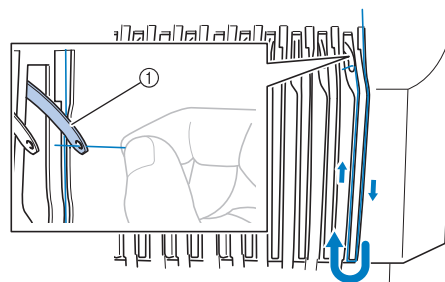

① Thread take-up lever

- 9** Pass the thread down through the slot to the lower thread guide, and then through the hole in the number 1 lower thread guide.

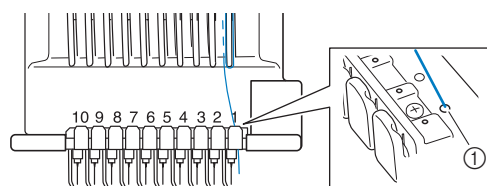

① Hole in lower thread guide

- 10 Use the included threader to pass the thread into the number 1 needle bar thread guide.

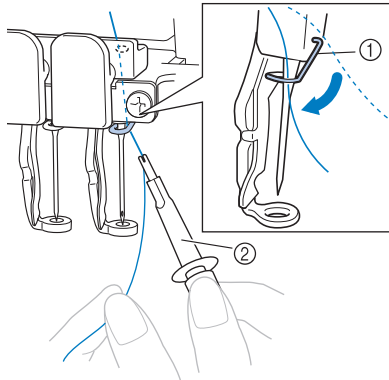

- ① Needle bar thread guide
② Threader

Threading the needle

Use the automatic needle-threading mechanism to thread the needle.

Note

- The automatic needle-threading mechanism can thread one needle at the embroidering position. When this mechanism is used, be sure that the needle bar that you want to thread is positioned at the embroidering position, otherwise the automatic needle-threading mechanism cannot be used at the particular needle. If the needle bar is not at the embroidering position, move it there. (page 86)

- 1 Press the automatic needle-threading button.

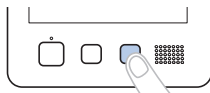

→ The hook on the automatic needle-threading mechanism passes through the eye of the needle.

CAUTION

- If the needle is not fully inserted, the hook of the automatic needle-threading mechanism will not pass through the eye of the needle during automatic needle threading, and the hook may bend or the needle cannot be threaded.
- If the hook of the automatic needle-threading mechanism is bent or damaged, contact your authorized Brother dealer.
- While the hook of the automatic needle-threading mechanism is passed through the eye of the needle, do not rotate the handwheel. The automatic needle-threading mechanism may be damaged. If you turn the handwheel, the automatic needle-threading mechanism will return to its initial position to avoid damage.

- 2 Pull out about 150 mm (6 inches) of thread. Then, as shown in the illustration, pass the thread under the fork of the automatic needle-threading mechanism from the right, and then catch the thread with the hook that passes through the eye of the needle.

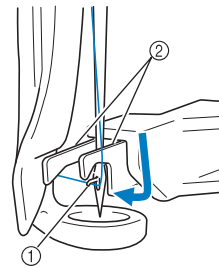

- ① Hook
② Fork

Note

- When catching the thread with the hook, be careful that the thread does not become loose.

- 3 Pass the thread under the guide on the presser foot.

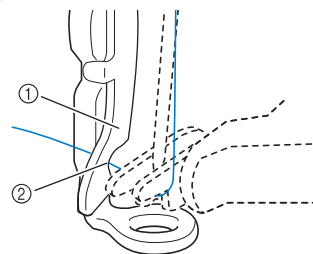

- ① Guide on presser foot
② Notch in guide on presser foot

- Make sure that the thread securely passes through the notch in the guide on the presser foot.

- 4 Securely pass the thread through the groove in the thread cutter, and then lightly pull the thread to cut it.

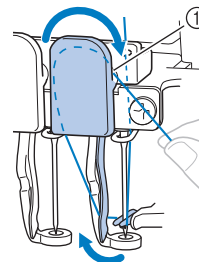

- ① Groove in thread cutter

Note

- If the thread is not correctly passed through the groove in the thread cutter, the message [Wiper error] appears and the needle cannot be threaded. Be sure to securely pass the thread through the groove.
- If enough thread is not pulled out, the thread cannot be pulled through the thread cutter.

Memo

- The Wiper is the mechanism for pulling the thread to back when the needle threader is used and when the thread is trimmed during embroidery.

5 Press the automatic needle-threading button.

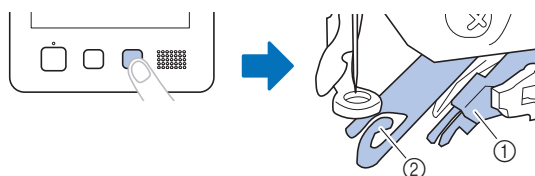

- ① Automatic needle-threading mechanism
 - ② Wiper
- The threader moves back away from the needle. The thread is pulled through the needle eye.
 - The wiper comes out and catches the thread between the needle and the threader.
 - The threader goes back to the original home position.

This completes the upper threading for needle bar 1. Thread the remaining needle bars in the same way.

Note

- If the needle bar to be threaded is not moved to the embroidering position, the needle cannot be threaded with the automatic needle-threading mechanism.

For the remaining needle bars, perform the following operation to move the needle bar to the embroidering position before trying to thread the needle.

- If the thread is not taut, it may come out of the thread tension disc. After upper threading is finished, check again to make sure that the thread is correctly passed into the thread tension disc. (step 6 on page 84)

6 When all upper threading is complete, be sure to slide the thread tension lever for thread guide C to the right, closing the holes in the thread guide.

- Embroidering with the holes in thread guide C fully open may cause the thread to become tangled or break.

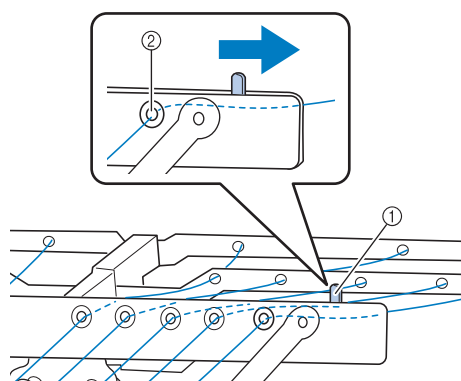

- ① Thread tension lever
- ② Holes in thread guide C

Moving and threading a selected needle bar

You can move and thread a selected needle bar to the embroidering position at any time.

1 Touch .



→ The needle bar move screen appears.

Memo

- In the embroidering screen, touching the number of the needle bar to be threaded will move the needle bar to the embroidering position.



2 Touch the key for the needle bar that you wish to move or thread.

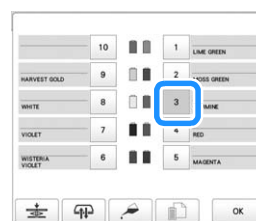

→ The selected needle bar moves to the position of embroidery.

3 Press the automatic needle-threading button while the needle bar move screen appears.

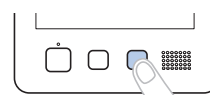

4 Touch to return to the previous screen.

Memo

- In the embroidering screen, a blue frame appears around the thread information box of the selected needle bar.



- When changing one of the upper thread colors, it is easy to re-thread by cutting the thread currently being used between the spool and the thread guide above the spool. Place the new spool on the spool pin and tie the end of the new thread to the end of the previous thread. Then pull the thread through to the needle (page 92).

PERFORMING THE EMBROIDERY

Now, the machine is ready to begin embroidering. When the machine starts embroidering, the presser foot is automatically lowered, the necessary thread trimming operations at the beginning of stitching and at the end of stitching are performed, the threads are changed as necessary while the embroidery is performed, and the machine stops when the end of the stitching is reached.

CAUTION

- For safety reasons, the machine must not be left unattended while it is embroidering.
- While the machine is in operation, pay special attention to the needle location. In addition, keep your hands away from all moving parts such as the needle, needle bar case, thread take-up lever and carriage, otherwise injuries may result.
- When embroidering overlapping stitches, it is difficult for the needle to penetrate the fabric, possibly resulting in the needle bending or breaking.

Starting embroidering

Note

- Make sure that there are no objects within the moving area of the embroidery frame. If the embroidery frame hits another object, the pattern may become misaligned.
- When embroidering large pieces of fabric, make sure that the fabric is not caught in the carriage.

1 Touch  to unlock the machine.



- The “Start/Stop” button changes from lit in red (locked machine) to flashing in green (unlocked machine), and the machine is ready to begin embroidering.
- If the “Start/Stop” button is not pressed within 10 seconds after unlocking the machine, the machine becomes locked again.

2 Press the “Start/Stop” button.

Press the “Start/Stop” button while it is flashing in green. If the “Start/Stop” button returns to being lit in red, perform this procedure again from step 1.



→ The “Start/Stop” button lights up in green and begins embroidering the first color.

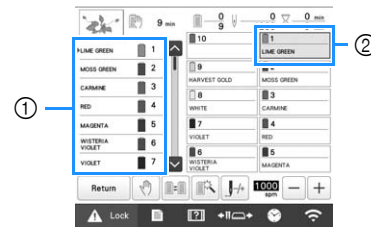

- ① The thread color for the needle bar that is currently being used for embroidery or will soon be used for embroidery appears at the top of the thread color sequence display. The remaining thread colors are listed in embroidering order, starting from the top.
- ② A blue frame appears around the thread information box of the needle bar currently being selected.

- While the machine is embroidering, the point being embroidered is indicated by the green cross hairs in the pattern display area. In addition, the number of stitches and the time count up.

3 After embroidery of the first color is finished, the machine automatically stops and trims the thread. The needle bar case moves to the second color position and embroidery of the second color begins.

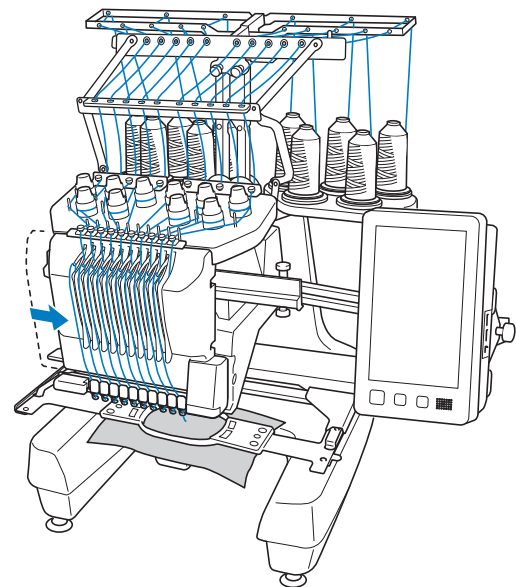

→ The thread color display in the screen continues to the second color, and the thread information for the second needle bar is surrounded by the blue frame.

4 This continues until the last color is embroidered, and the machine automatically stops.

- The embroidering settings screen reappears.
- The “Start/Stop” button lights up in red.
- No thread trimming operations at the beginning of stitching and at the end of stitching are necessary.

Memo

- When embroidering a pattern that contains 11 or more colors, it is necessary to change the thread spools. (page 91)

Continuing embroidering

To embroider the same pattern again, touch .

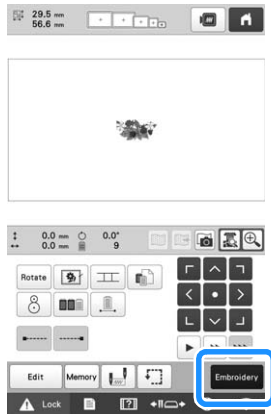

→ The embroidering screen appears so the same pattern can be embroidered again.

To select a new pattern, touch .

→ The pattern type selection screen appears.

Note

- Automatic lock stitch setting can be set so that it is performed at the beginning of the embroidery, when starting to embroider after changing thread colors, and when trimming the thread. (page 71)

Stopping embroidering

The machine can be stopped during embroidering.

Temporarily pausing

- 1 Press the “Start/Stop” button.

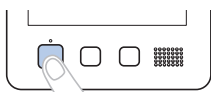

→ The machine stops and the “Start/Stop” button lights up in red.

- Embroidering can also be stopped by touching an area displaying the pattern.
- The thread is not trimmed.
- To continue embroidering, after checking that the upper thread is taut, touch the unlock key, and then press the “Start/Stop” button.

Memo

- If the reserve stop key is touched while embroidery is being performed, the machine stops embroidering before the next color begins. (page 119)
- Before starting to embroider, the machine can be set to stop at any thread color change. (page 119)

Temporarily pausing for extended periods of time

- 1 Press the “Start/Stop” button.



→ The machine stops and the “Start/Stop” button lights up in red.

- The thread is not trimmed.

- 2 Touch  to unlock the machine.

- 3 Press the thread trimming button.



→ The bobbin and upper threads are trimmed.

- Before turning off the machine, be sure to trim the threads.

- 4 Set the main power switch to “O” to turn off the machine.

→ The display and the “Start/Stop” button indicator go off.

- Embroidery can resume after the machine is turned on again. Back up several stitches to overlap the stitching. (page 97)

Memo

- The machine can be stopped at any time, even while it is embroidering; however, if the machine is stopped when the thread color is changed, it is not necessary to go back through the stitching when embroidering is continued. The machine can be set to stop when the thread color is changed. (page 119)

If the thread breaks while embroidering

If a problem occurs while embroidering, such as if the thread breaks, the machine stops automatically.

Re-thread the broken thread, back up several stitches, and then continue embroidering. (page 93)

Understanding the embroidering screen

From this screen, the total number of thread colors, the embroidering order and embroidering time can be checked, the needle bar settings can be specified, and the needle placement forward or backward can be done. Keys available in this screen differ when you set [Manual Color Sequence] to [ON] in settings screen. (page 58)

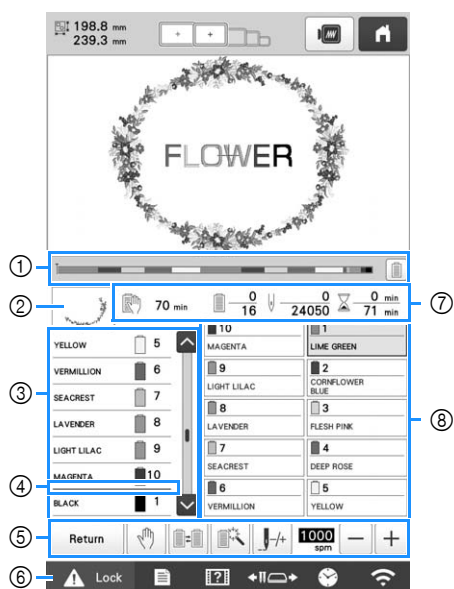

No.	Display Key Name	Function	Page
①		The embroidering progress is shown by the red mark in the indicator. Touch to display (in the indicator) only the thread color being embroidered.	—
	Progress bar		
②		Shows the part of the pattern that will be embroidered with the thread color shown first in the thread color sequence display.	—
	Region display		
③		Shows the order for the thread color changes. During embroidering, this display scrolls automatically so that the color of the thread currently being embroidered appears at the top.	—
	Thread color sequence display		
		Indicates the needle bar number where the thread color at the left is assigned.	—
	Needle bar number		
	The thread color sequence display shows the first seven thread colors. To check the sequence for the eighth and later thread colors, touch or , or touch the scroll bar.	—	
Scroll bar			

No.	Display Key Name	Function	Page
④		This red line indicator shows when the thread spools will need to be changed.	91
	Spool change indicator		
⑤		Quit embroidering and return to the embroidering settings screen.	—
	Return key		
		While embroidering, touch this key for the machine to stop prior to the next color beginning.	119
	Reserve stop key		
	Change the needle bar settings from the screen without changing the thread spools on the machine.	57	
Switch spool key (Not available in the [Manual Color Sequence] mode)			
⑤		Enable the needle bar settings to manually be specified.	120
	Temporary needle bar settings key		
⑤		Move the needle forward or backward through the stitching. Use this key in the following situations: <ul style="list-style-type: none"> • If the thread breaks or runs out while embroidering • To restart embroidering from the beginning • To continue embroidering after the machine was turned off 	93
	Forward/Backward stitch key		
⑤		Specify the maximum embroidery speed. <ul style="list-style-type: none"> • Specify a low speed for thin, thick or heavy fabrics. • When using a weak thread such as metallic thread, specify an embroidery speed of 400 spm. 	190
	Maximum embroidery speed key		
⑥		Unlocks the machine so it can start embroidering within 10 seconds. When this key is touched, the "Start/Stop" button flashes in green.	87
	Unlock key		

No.	Display	Function	Page
	Key Name		
⑦	70 min	Shows the amount of time until the machine will stop. When the last thread spool is being embroidered, the number appears in red. If the thread color needs to be changed, this shows the time until the thread spool will need to be changed.	91
	Time until the machine stops		
	0 / 16	The bottom value shows the total number of thread colors in the pattern and the top value shows the thread color that is currently being embroidered.	—
	Embroidering order		
	0 / 24050	The bottom value shows the total number of stitches in the pattern and the top value shows how many stitches have already been embroidered.	—
	Stitch count		
0 min / 71 min	The bottom value shows the total amount of time required to embroider the pattern and the top value shows how much time has already passed embroidering.	—	
Embroidering time			
⑧	1 LIME GREEN	Move the needle bar position to the selected needle bar number. Use when threading the needle with the automatic needle-threading mechanism.	—
	Needle bar key		
	Thread color set up display	Shows the color and the thread color name (number) for the thread on the needle bar indicated on the key. Thread the machine as indicated here.	81

Memo

- The thread color numbers in the thread color sequence display and the thread color set up display can be changed, for example, to the color name or the thread color number for other brands. (page 123)

REMOVING THE EMBROIDERY FRAME

CAUTION

- When removing the embroidery frame, make sure that the “Start/Stop” button is lit in red. If the “Start/Stop” button is flashing in green, the machine may start embroidering. If the machine accidentally starts operating, injuries may result.
- When removing the embroidery frame, be careful that the embroidery frame does not hit any other part of the machine.
- Do not lift up the embroidery frame holder with extreme force, otherwise it may be damaged.

- 1 With both hands, grab the left and right sides of the arms of the embroidery frame holder, and then slightly lift up the frame.

The pins on the arms of the embroidery frame holder should come out of the holes in the sides of embroidery frame.

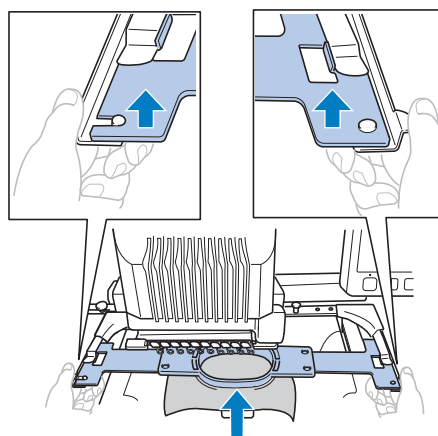

- 2 Pull off the embroidery frame toward you.

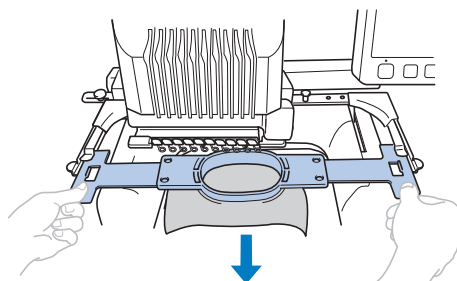

→ Remove the fabric from the frame.

EMBROIDERING A PATTERN CONTAINING 11 OR MORE COLORS

When embroidering a pattern that uses 11 or more thread colors, it is necessary to change the thread spools. When changing the thread spools, instruction to change the thread spools will appear with the machine automatically stopping.

Memo

- This function is not available when you set [Manual Color Sequence] to [ON] in settings screen.

Checking if thread spool changes are necessary

When selecting a pattern, the number of thread changes can be viewed; however, which thread colors are used in the pattern cannot be checked on this screen. Whether or not, and when, thread spools will need to be changed can be checked with the following indicators.

Time until the machine stops embroidering

This indicator shows the amount of time until the machine stops embroidering. The machine stops when a spool change is required, or when the machine is set to be stopped by other settings.

If the spool change indicator appears, the machine will require a spool change. When the time is indicated in red, it is the last color embroidering before the machine stops.

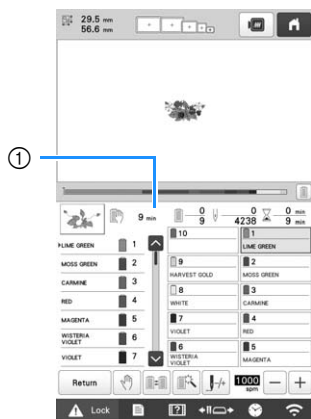

① Time until the machine stops

Spool change indicator (—)

The spool change indicator in the stitch navigating screen indicates the number of times that the thread spools will need to be changed and the amount of time between changes.

- 1 Use the scroll bar on the right side of the thread color sequence display in the embroidering screen.

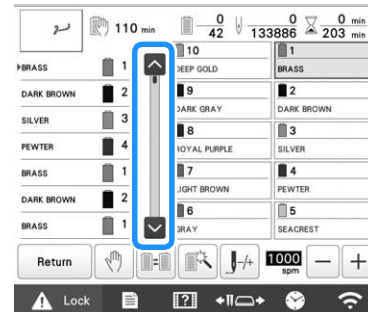

→ Each time is touched, the thread color sequence display scrolls down to the next color. After reaching the last color in the thread color sequence display, the first color is selected.

- 2 Check the position of .



① indicates when the thread spools will need to be changed. The thread spools will need to be changed the number of times that this indicator is displayed and between the two thread colors at the point where it is displayed.

- 3 After checking the desired information, touch or the top of the scroll bar to return to the first color.

2

CHANGING THE THREAD SPOOLS

This section provides details on the spool thread indicators in addition to the procedure for easily changing the spools.

Memo



- This feature is not available if [Manual Color Sequence] has been set to [ON] in the settings screen.

About spool thread indicators

When it is necessary to replace the thread spool, the machine automatically stops embroidering and the screen shown below appears.

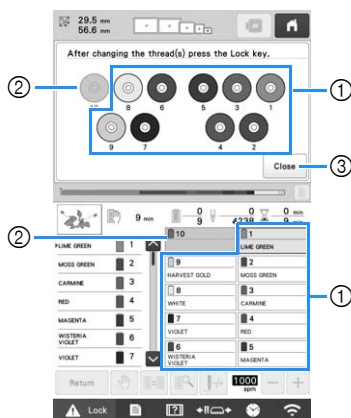
In addition, when a new pattern is selected, the screen shown below appears. Change the thread spools according to their new assignments.



- ① The thread spools needing to be changed appear in other than gray.
- ② The thread spools needing not to be changed appear in gray.
- ③ Minimize the screen indicating that the spools be changed to . To display the screen again, touch .

Note

- Touch needle bar key to move the needle into the correct position for threading with the new thread color. (page 86)
- When the embroidering screen appears, the needle bar settings are saved.
- If the needle bar settings are saved and the next pattern that is opened contains thread colors that are the same as those from the previous pattern, the same needle bars will be assigned the same thread colors from the previous pattern.
- If you wish to delete all assigned colors on display, refer to "To cancel the thread color settings for all previously stitched design" on page 57.

Memo

- To use a different thread color than the one that was specified, use the temporary needle bar setting key, and then change the thread color setting. (page 120)
- To minimize changing the thread spools, frequently used thread colors can be specifically assigned to certain needle bars. (page 121)

Easily changing the thread spools

When replacing the thread spools, it is necessary to re-thread the upper thread. However, the thread spools can easily be changed when replacing a thread spool whose thread is correctly threaded through the machine.

- 1 Cut the thread between the thread spool and the thread guide.

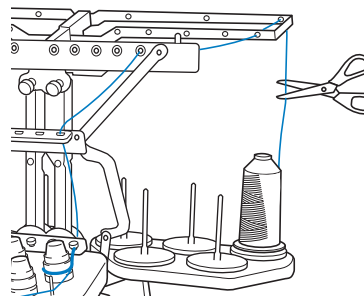

- 2 Change the thread spool.

- 3 Tie the end of the thread on the new spool with the end of the thread remaining from the previous color.

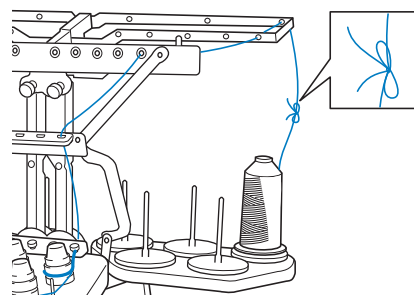

- 4 Pull out the old thread just after the needle bar thread guide.

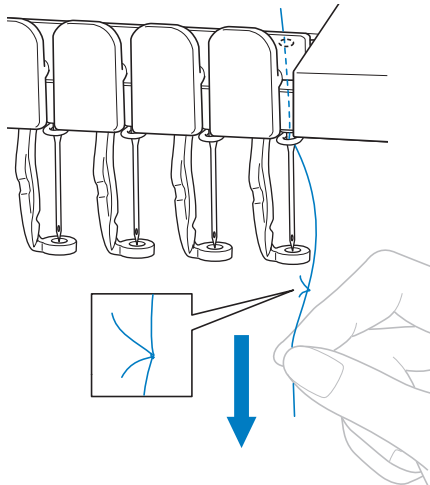

Continue pulling the thread until the knot is below the needle. Cut the knot.

- 5 Use the automatic needle-threading mechanism to thread the needle with the new thread. (page 85)

→ This completes the changing of the thread spool.

Note

- When pulling out the thread, do not pull the knot through the eye of the needle. If the knot is pulled through the eye of the needle, the needle may be damaged.

ADJUSTING WHILE EMBROIDERING

If the thread breaks or the bobbin thread runs out while embroidering

If the thread breaks or the bobbin thread runs out while embroidering, the machine will automatically stop. Since some stitches may be embroidered with only one thread, go back through the stitching to a point prior to the stoppage before continuing embroidering.

Note

- If [Thread Sensor] is set to [OFF], the machine does not stop until embroidering is finished. Normally, the [Thread Sensor] should be set to [ON].
- Be careful when going back or forward through the stitching since the embroidery frame moves at the same time.

■ If the upper thread breaks

- 1 Re-thread the upper thread. (page 82)

- 2 Touch .

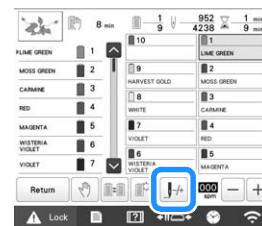

→ The stitch navigating screen appears.

- 3 Touch  to check the needle drop point on the LCD screen.

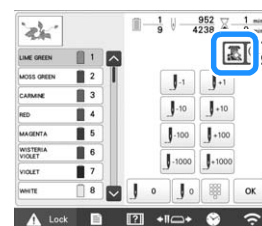

→ The camera view window appears.

- Touch  to zoom up the camera view twice the size of normal view.

- 4 Touch **[-1]** and **[-10]** to go back through the stitching to a point where stitches have already been embroidered.

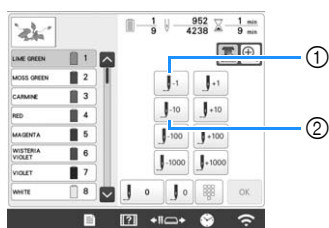

- ① Each touch of this key moves one stitch back through the stitching.
- ② Each touch of this key moves ten stitches back through the stitching.

As you move to the area where your design was last stitched, by touching the **[-1]** or **[-10]**, the embroidery frame will move, allowing you to place the cross mark directly on the last stitch shown.

Note

- It is recommended to stitch over the top of the last two or three stitches for complete coverage.

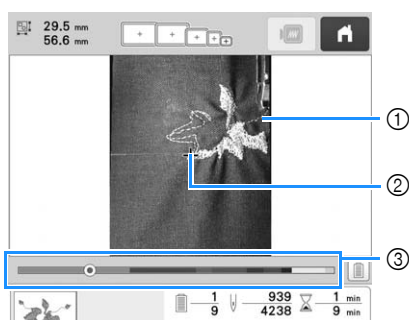

- ① Stitch line
- ② Cross mark
- ③ Embroidery progress bar

You can also touch the specific point of the embroidery progress bar to move the stitch count to the desired point. If the needle bar is moved back too far through the stitching, touch **[-1]** or **[-10]** to go forward through the stitching.

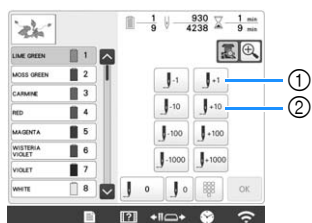

- ① Each touch of this key moves one stitch forward through the stitching.
- ② Each touch of this key moves ten stitches forward through the stitching.

- 5 Touch **[Lock]**.

- 6 Touch **[OK]**.

→ The embroidering screen appears again.

- 7 Touch **[Start/Stop]**, and then press the “Start/Stop” button to continue embroidering.

Specifying a stitch number

- 1 Touch **[Stitch Number]**.

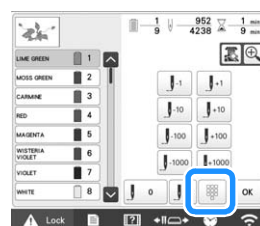

- 2 Use the number keys to enter the desired stitch number, and then touch **[Set]**.

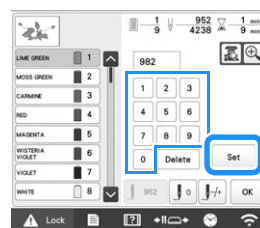

→ The embroidery frame moves to the specified stitch.

→ When **[Magnify]** is touched in this screen to enlarge the display, a stitch number can be specified with the number keys.

- 3 Touch **[Back]** to return to the previous screen, and then continue with step 5 on page 94.

Memo

- Touch **[0]** to reset the stitch number and embroider from the first stitch.
- To specify the last stitch number, select the last thread color, and then touch **[v]**.

■ If the bobbin thread breaks or runs out

- 1 Touch  Lock, and then press the thread trimming button.

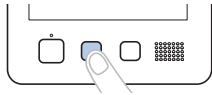

→ The upper thread is trimmed.

- If the bobbin thread breaks or runs out, also trim the upper thread.

- 2 Remove the stitches embroidered only with the upper thread.

Pull the trimmed end of the upper thread.

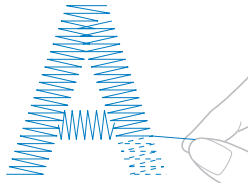

- If the stitches cannot be cleanly removed, trim the thread with scissors.

■ If the bobbin thread ran out, replace the bobbin at this point in the procedure.

- 3 Replace the bobbin with a bobbin wound with bobbin thread. (page 33)

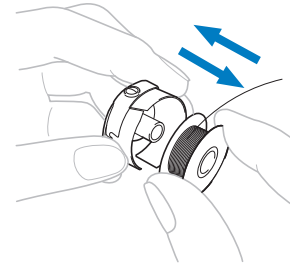

- If the hook cover can be opened, replace the bobbin without removing the embroidery frame from the machine.
- If the machine bed is hidden, for example, with a bag-shaped piece of fabric, or if the hook cover cannot be opened, temporarily remove the embroidery frame. (page 90) After replacing the bobbin, re-attach the embroidery frame. (page 64)

Note

If the embroidery frame is removed before embroidering of the pattern is finished, take caution, otherwise the pattern may become misaligned.

- Do not apply extreme pressure to the framed fabric and cause it to become loose.
- When removing and re-attaching the embroidery frame, do not allow the frame to hit the carriage or the presser foot.
If the carriage is hit and moves, turn the machine off, then on again. The correct frame position at the time that the machine was stopped is stored in the machine's memory, and the embroidery frame is returned to the correct position.
- When the embroidery frame is re-attached, make sure that the pins on the left and right arms of the embroidery frame holder securely fit into the holes in the handles on the embroidery frame.

- 4 Go back through the stitching in the same way as that described in step 2 through 7 of "If the upper thread breaks" on page 93, and then continue embroidering.

Embroidering from the beginning or middle of the pattern

If you wish to restart embroidering from the beginning, for example, if trial embroidery was performed and an incorrect thread tension was used or if the wrong thread color was used, restart the embroidering using the forward/backward stitch key. In addition, you can go forward or back through the stitching by thread color or by stitch to start stitching at any position of the pattern.

Note

- Be careful when going back or forward through the stitching since the embroidery frame moves at the same time.

1 Press the "Start/Stop" button to stop the machine.



- If necessary, trim and remove the embroidered stitches.

2 Touch .

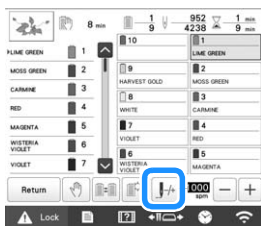

→ The stitch navigating screen appears.

3 Touch to check the needle drop point on the LCD screen.

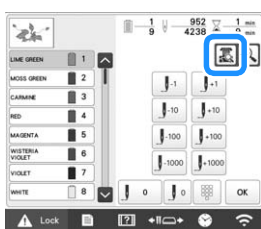

→ The camera view window appears and the cross mark in the camera view indicates the needle drop point.

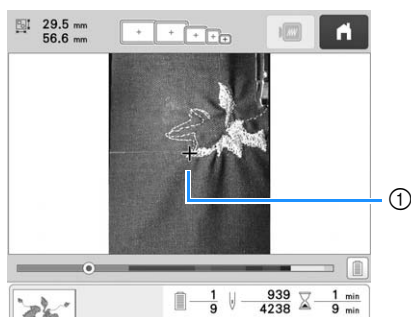

① Needle drop point

- Touch  to zoom up the camera view twice the size of normal view.

4 Use the scroll bar to select the thread color, and then touch , , , , , , and to select the specific stitch.

- Touch  to embroider from the beginning.

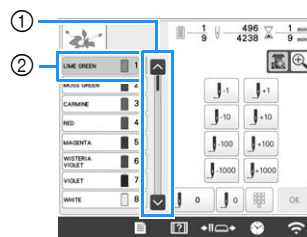

- ① The stitch from where embroidering is to begin can also be specified by using the scroll bar.
- ② The thread color at the top of the thread color sequence display is the color of the area currently selected. Touch this area to specify the stitch from where embroidering is to begin.

→ The needle bar case moves and the current needle bar moves to the embroidering position, and then the embroidery frame moves and current needle position is indicated.

5 Touch .

6 After selecting the stitch from where embroidering is to begin, touch .

→ The embroidering screen appears again.

7 Touch , and then press the "Start/Stop" button to begin embroidering.

→ Embroidering begins from the specified point.

Specifying a stitch number

1 Touch .

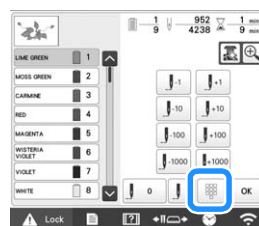

2 Use the number keys to enter the desired stitch number, and then touch .



→ The embroidery frame moves to the specified stitch.

→ When  is touched in this screen to enlarge the display, a stitch number can be specified with the number keys.

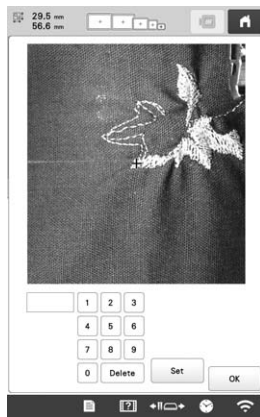

3 Touch  to return to the previous screen, and then continue with step **5** on page 96.

Memo

- If no stitch number was entered when  is touched, embroidering will begin from the first stitch.

Resume embroidering after turning off the machine

In either of the following cases, the remaining stitches of the embroidery are stored in the machine's memory.

- If the machine's power switch is pressed to turn off before stopping embroidering.
Cut the thread before the machine's main power switch is turned off, otherwise the thread may be pulled or may catch when the carriage returns to its initial position after the machine is turned on again.
- If the machine was accidentally turned off, for example, due to a power outage, while it was embroidering.

The remainder of the embroidery can be performed when the machine is turned on again; however, some of the stitches that were already embroidered may be embroidered again.



- ① Cancel embroidering and display the pattern type selection screen to select a new pattern.
 - ② Continue embroidering.
- The embroidering screen displayed before the machine was turned off appears.

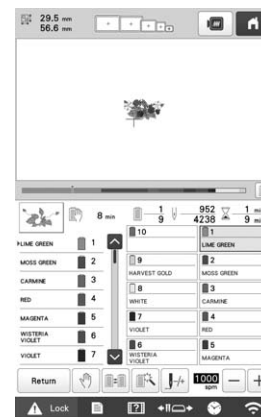

Note

- You may need to advance or reverse through the stitches to get to the correct needle drop position.

Chapter 3 ADVANCED EMBROIDERY

VARIOUS EMBROIDERY FUNCTIONS

Basting embroidery

Before embroidering, basting stitches can be embroidered along the outline of the pattern. This is useful for embroidering fabric that cannot have stabilizer material affixed with an iron or adhesive. By stitching stabilizer material to the fabric, shrinkage of the stitching or misaligned pattern can be minimized.

Note

- It is recommended to finish combining and editing the pattern before selecting the basting setting. If the pattern is edited after selecting the basting setting, the basting and pattern may become misaligned, and the basting under the pattern may be difficult to remove after embroidering is complete.

- 1 Touch , then .
→ The embroidery settings screen appears.
- 2 Locate [Basting Distance].
- 3 Use and to specify the distance from the pattern to the basting stitching.



Memo

- The higher the setting, the farther the basting is from the pattern.
- The setting remains selected even if the machine is turned off.

- 4 Touch to return to the embroidering settings screen.
- 5 Touch to select the basting setting.

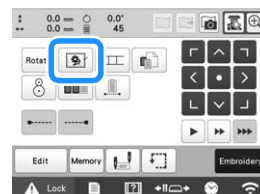

Note

- When is touched, the pattern is moved to the center. After selecting the basting setting, move the pattern to the desired position.
- To cancel the setting, touch .
→ Basting is added to the beginning of the embroidering order.

- 6 Touch to continue to the embroidering screen.
- 7 Touch , and then press the "Start/Stop" button to begin embroidering.
- 8 When embroidering is finished, remove the basting stitching.

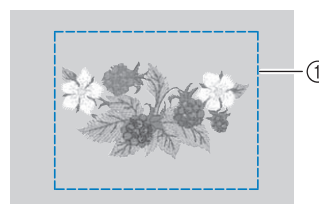



① Basting stitching

Embroidering appliqué patterns

Some of the built-in embroidery patterns can be used for embroidering appliqués. Follow the procedures described below to embroider appliqués using the patterns with [APPLIQUE MATERIAL], [APPLIQUE POSITION] or [APPLIQUE] in the region display at the top of the thread color sequence display.

[APPLIQUE MATERIAL], [APPLIQUE POSITION] and [APPLIQUE] are assigned to a specific needle bar number.

*Depending on the thread color display setting, the display may appear as  (Appliqué Material),  (Appliqué Position) or  (Appliqué).

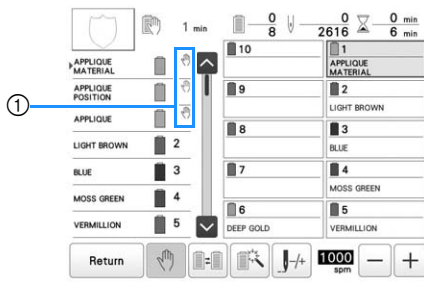

①  appears in the screen at places where the machine is stopped.

■ Procedure for embroidering appliqués

- 1 Place stabilizer on the back of the appliqué fabric/material.
- 2 Frame the fabric for the appliqué (from step 1) in the embroidery frame, and then embroider an [APPLIQUE MATERIAL] pattern. The line that indicates where the appliqué will be cut out is embroidered, and then the machine stops.

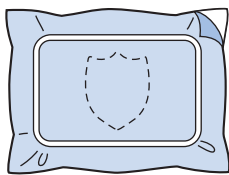

- 3 Remove the appliqué fabric from the embroidery frame, and then carefully cut along the embroidered cut line.

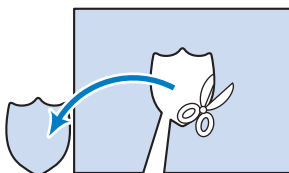

- If the appliqué is cut out along the inside of the embroidered cut line, the appliqué may not be correctly attached to the fabric. Therefore, carefully cut out the appliqué along the embroidered cut line. If this step is not performed carefully, the appliqué will not be cleanly finished. In addition, carefully remove any excess threads.

- 4 Frame the base fabric or garment in the embroidery frame, and then embroider an "APPLIQUE POSITION" pattern. The appliqué position is embroidered, and then the machine stops.

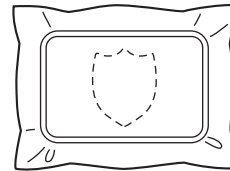

- 5 Lightly apply fabric glue or spray adhesive to the back of the appliqué piece that was cut out, and then attach the appliqué piece to the base fabric at the position embroidered using the [APPLIQUE POSITION] pattern in step 4.

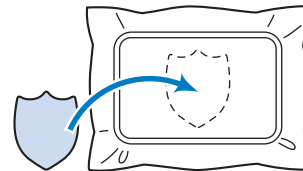

- If an iron-on stabilizer is used to attach the appliqué piece to the base fabric, iron the pieces together without removing the base fabric from the embroidery frame.

- 6 After attaching the appliqué piece, embroider an [APPLIQUE] pattern. The appliqué is finished.

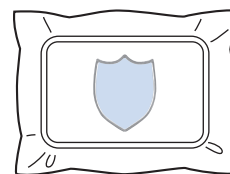

- Depending on the pattern, an [APPLIQUE] pattern may not be available. In this case, embroider the appliqué using thread in the color of a part of the embroidery.

- 7 Finish stitching the embroidery.

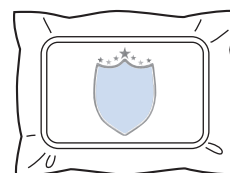

Creating an appliqué piece

Appliqué pieces can be created from the built-in patterns and patterns from other sources. This is convenient for fabrics that cannot be embroidered or when you wish to attach an appliqué to a garment.

■ Creating an appliqué piece

The following pattern will be used to create an appliqué piece.



Note

- Felt or denim fabrics are recommended to make the appliqué piece. Depending on the pattern and fabric used, lighter weight fabrics may cause the stitching to appear smaller.
- For best results, be sure to use stabilizer material for embroidering.
- Select a frame that matches the pattern size. Frame options are displayed on the LCD screen.
- Finish combining and editing the pattern before selecting the appliqué setting. If the pattern is edited after selecting the appliqué setting, the appliqué stitching and pattern may become misaligned.
- Since an outline is added, the pattern for an appliqué piece (when the appliqué setting is selected) will be larger than the original pattern. First, adjust the size and position of the pattern as shown below.

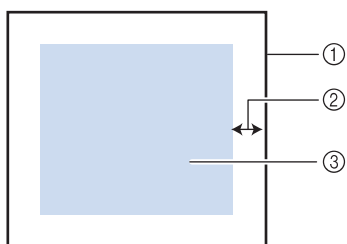



- ① Embroidering area
- ② Approx. 10 mm (3/8 inch)
- ③ Pattern size

1 Select the pattern to be used for the appliqué.

2 In the pattern editing screen, touch .

3 Select the outline.

If  is selected, an outline can be created most closely fits the edges of the pattern.

→ Use  or  to specify the distance between the pattern and the appliqué outline.

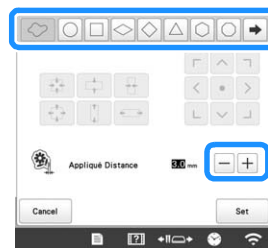

Memo

- If a frame pattern is selected for the outline, the frame pattern can be enlarged, reduced or moved.
- Touch  to select a different outline pattern.

4 Check the preview in the screen, and then touch



Note

- At this time, the pattern and outline will be grouped.

5 After specifying the various settings, touch .

6 Specify the embroidering settings, and then touch  to continue to the embroidering screen.

Memo

- Three steps are added to the embroidering order: appliqué cutting line, position of pattern placement on the garment, and appliqué stitching.

WHITE		8
HARVEST GOLD		9
APPLIQUE MATERIAL		10  ①
APPLIQUE POSITION		10  ②
APPLIQUE		10  ③

- ① Cutting line for appliqué
- ② Position of pattern placement on garment
- ③ Appliqué stitching

- We recommend using thread for the cutting line [APPLIQUE MATERIAL] that is closest to the color of the fabric.

7 Fuse or stick a piece of stabilizer to the back of the felt or denim fabric to be used as the appliqué piece.

8 Hoop the appliqué fabric in the embroidery frame, attach the embroidery frame to the machine, and then start embroidering.

9 After the cutting line [APPLIQUE MATERIAL] is embroidered, stop the machine and remove the appliqué material from the embroidery frame.

- 10 Carefully cut along the stitching. After cutting, carefully remove all of the cutting line thread.

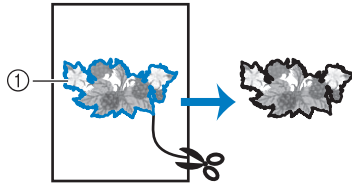

① Cutting line for appliqué

Note

- Depending on the pattern density and fabric used, there may be shrinking of the pattern or the appliqué may be misaligned with the placement line. We recommend cutting slightly outside of the cutting line.
- When using patterns that are vertically and horizontally symmetrical, use a chalk pencil to indicate the pattern orientation before cutting it out.
- Carefully cut out the pattern on the outline you just embroidered. Do not cut inside the cutting line, otherwise the appliqué fabric will not be caught by the appliqué stitch.

- 11 Use two layers of adhesive water-soluble stabilizer material with their sticky sides together, and then hoop them in the embroidery frame.

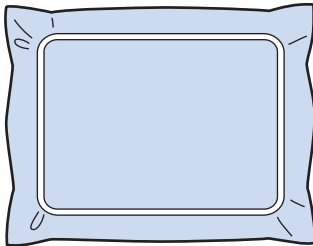

Note

- If water-soluble stabilizer is used, it is not necessary to remove the stabilizer material after embroidering the appliqué outline. To reduce shrinkage of the pattern, we recommend using water-soluble stabilizer.
- Put together two layers of water-soluble stabilizer, otherwise the stabilizer material may tear during embroidering.

- 12 Embroider the placement line for the appliqué position [APPLIQUE POSITION].

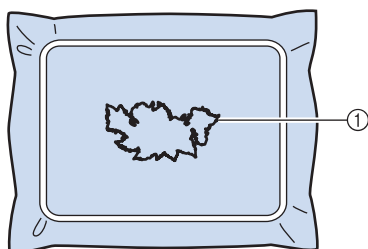

① Pattern placement line

- 13 Lightly apply glue or spray adhesive, and paste the appliqué piece so that it aligns with the placement line.

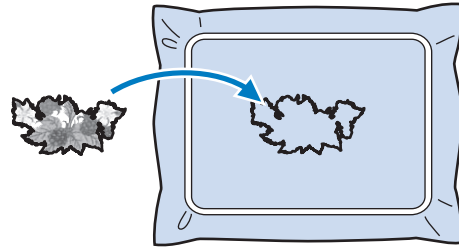

Note

- Before pasting the appliqué piece down, make sure the appliqué piece is positioned correctly within the placement line.

- 14 Embroider the outline [APPLIQUE].

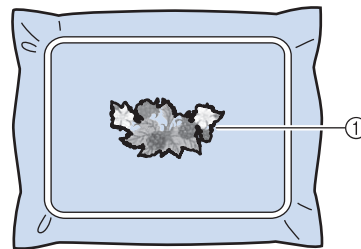

① Outline of appliqué piece

- 15 After embroidering is finished, remove the stabilizer material from the embroidery frame.

- 16 Use scissors to cut the excess water-soluble stabilizer from outside the appliqué outline.

- 17 Soak the appliqué piece in water to dissolve the water-soluble stabilizer.

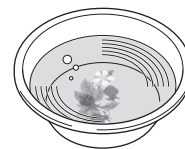

- 18 Dry the appliqué piece, and then iron it if necessary.

Note

- Do not apply a strong force when ironing, otherwise the stitching may be damaged.

Memo

- The outline is embroidered using satin stitching.
- Some glue may get onto the presser foot, needle, and needle plate at this time. Finish embroidering the appliqué pattern, and then clean off the glue.

Using a frame pattern to create appliqués

With this method, there is no need to change the fabric in the embroidery frame. The appliqué can be created by embroidering two frame patterns of the same size and shape—one embroidered with straight stitches and the other embroidered with satin stitches.

- 1 Select a frame pattern embroidered with straight stitches and embroider onto the base fabric.

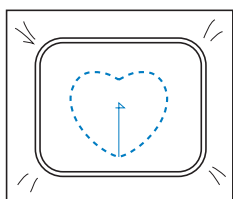
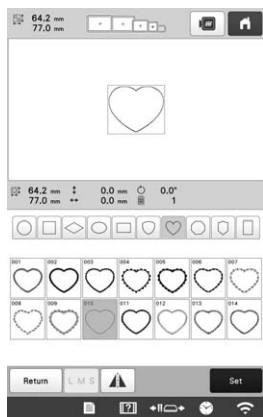

- 2 Place the appliqué fabric over the embroidery stitched in step 1. Make sure that the appliqué fabric is larger than the embroidered area.

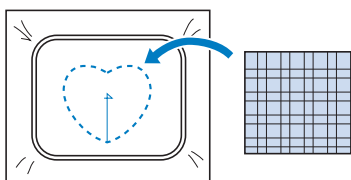

- 3 Embroider over the appliqué fabric using the same frame pattern.

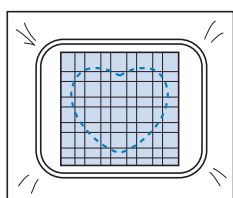

- Be sure to stop the machine before the cross at the center is embroidered.

- 4 Remove the embroidery frame from the machine, and then cut off the excess appliqué fabric along the outside of the stitching.

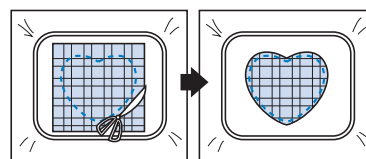

Note

- Leave the fabric in the embroidery frame when cutting off the excess appliqué fabric. In addition, do not apply extreme pressure to the framed fabric, otherwise the fabric could become loose.

- 5 Select the satin-stitched frame pattern with the same shape.

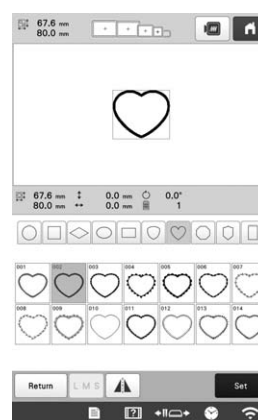

Note

- If the size or embroidering position of the straight-stitched frame pattern is changed, be sure to change the size or embroidering position of the satin-stitched frame pattern in the same way.

- 6 Attach the embroidery frame removed in step 4, and then finish embroidering the appliqué.

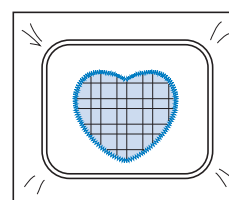

3

Creating stippling or echo patterns automatically

Stippling or echo quilting patterns can be created around the machine's built-in patterns or original embroidery data without using My Design Center.

Memo

- If this simple stippling operation is used with batting sandwiched between two layers of fabric, the embroidery pattern and stippling may become misaligned. For details on quilting, refer to "Decorative stitching around a pattern in embroidery (a quilting function)" on page 170.

1 Select the pattern that stippling will be added around.



2 Touch  in the embroidery edit screen.

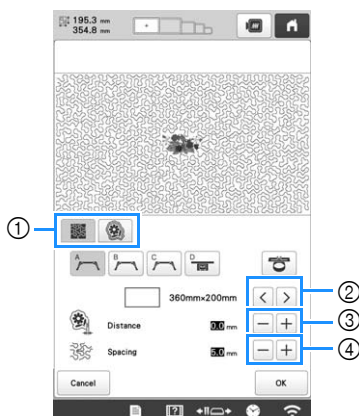

→ Stippling is automatically applied around the selected pattern.
To select multiple patterns, refer to page 42.

3 After specifying the stitch settings for the stippling, touch .



- ① To create a stippling pattern, touch . When you create an echo quilting pattern, touch .
- ② If an embroidery frame size is selected, the stippling is added within the area of the selected frame size. If the pattern is larger than the selected frame size, the area indicating the frame size will appear in gray.

- ③ Specify the distance from the outline of the pattern to the stippling.
- ④ Specify the spacing for the stippling.

QUILTING BORDERS

By rehooping the fabric to embroider connecting patterns, a quilting border of 3 m × 3 m (approx. 118 inches × 118 inches) can be created.

Using the camera

When embroidering a quilting border, use the built-in camera to display a camera image of the fabric in order to align the pattern.

Specify the appropriate image settings in advance. (page 73)

- Better camera image results can be achieved with the appropriate settings.

Creating quilting border data

- 1 With a chalk pencil, mark the fabric with the inner outline of the quilting border to be embroidered. Measure the size of the quilting border.

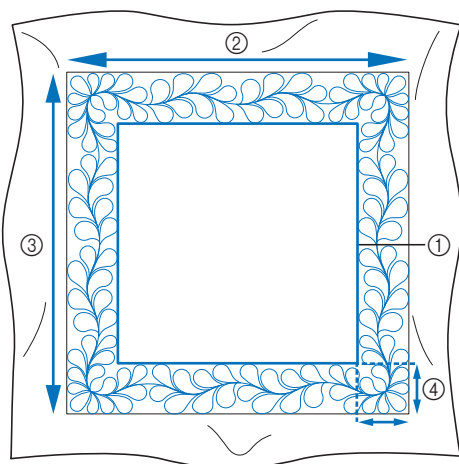

- ① Inner outline (used for positioning)
- ② Width
- ③ Height
- ④ Width of quilting border

Memo

- Be sure to cut the fabric with an excess of about 10 cm (4 inches) so that its edges extend from the embroidery frame.

- 2 Touch .

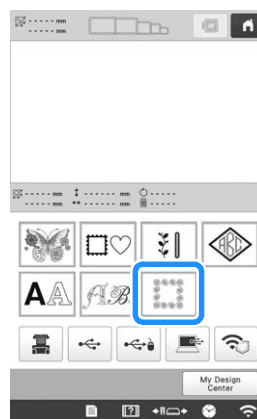

- 3 Select the category for the number of thread colors.

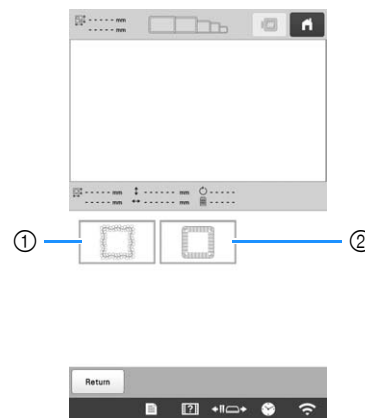



- ① Single color pattern
- ② Multi-color pattern

- 4 Select the pattern that you want to embroider, and then touch **Set**.

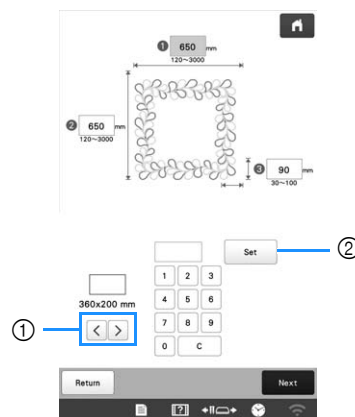
- 5 Specify the size of embroidery frame to be used and the size of the quilting border.



- ① Touch  or  to select the embroidery frame size.
- ② Specify the width (①), height (②) and quilting border width (③), and then touch **Set** after each entry.

- 6 Touch **Next**.

7 Check the pattern, and then touch **Memory to save it.**

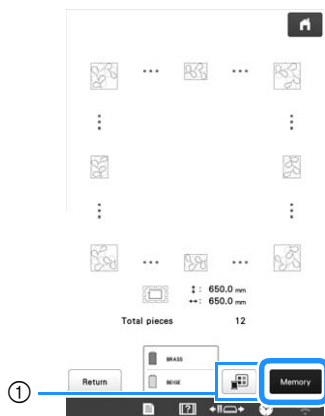

① The thread colors can be changed.

Memo

- The edges of the pattern may be shortened when they are displayed.

8 After the following message appears, touch **OK.**

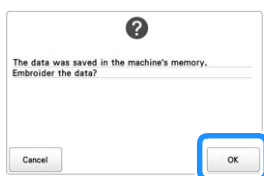

→ A screen appears so that a pattern from the machine's memory can be selected.

Embroidering a quilting border

1 In the screen for selecting a pattern from the machine's memory, select the saved data.

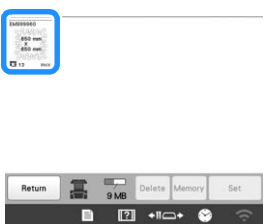

→ A thumbnail of the entire quilting border pattern and a thumbnail of each split pattern appear.

2 For this example, since we will embroider the quilting border according to the on-screen instructions, select the thumbnail for the entire quilting border, and then touch **Set.**

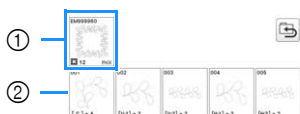

- ① Embroider the quilting border pattern according to the on-screen instructions. The number in the lower-left corner indicates the total number of split patterns in the quilting border.
- ② To embroider by visually aligning the patterns, touch each split pattern.

You can check where and how many times the pattern will be embroidered with the codes written on each key.

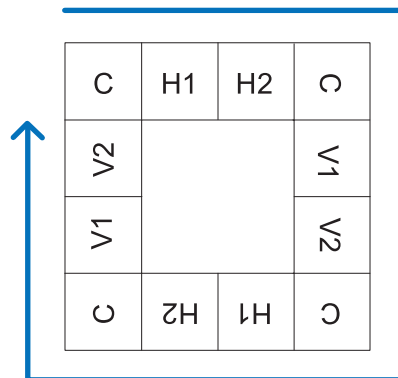

- C: Corner
- V1: First pattern of the vertical side
- V2: Second pattern of the vertical side
- H1: First pattern of the horizontal side
- H2: Second pattern of the horizontal side

3 Hoop the fabric in the embroidery frame so that the upper-left corner of the quilting border pattern is in the embroidering area, and then attach the embroidery frame to the machine.

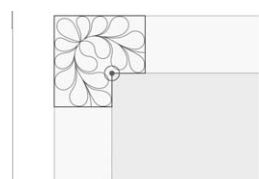

4 Align the position for the pattern in the upper-left corner.



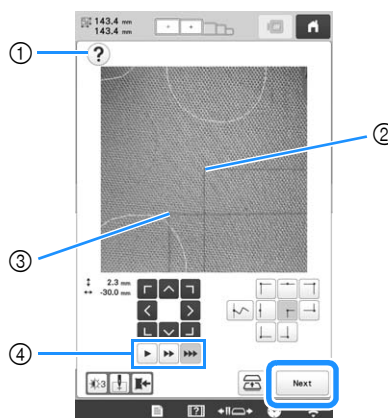

With  highlighted, use the move pattern keys to align the inside corner of the reference lines previously drawn on the fabric with the inner corner of the pattern, and then touch **Next**.



- ① Display the on-screen instructions again.
- ② Inner corner of the pattern
- ③ Corner of the reference lines drawn on the fabric
- ④ Select the speed for moving the embroidery frame.

	Move the embroidery frame to the position where the fabric can be rehooped easily. For details, refer to "Rehooping the fabric" on page 108.
	Save the camera image to the external device.

	Select whether or not to display the needle drop point
	Each touch of this key changes the brightness of the camera image.

5 Rotate the pattern so that it is aligned with the chalk reference lines, and then touch **Embroidery** to display the embroidering screen.



① The screen where the pattern can be moved appears again.

6 Touch **Lock** to unlock the machine, and then press the "Start/Stop" button to embroider the first pattern.

7 When embroidering is finished and the following message appears, touch **OK**.



→ The next pattern to be embroidered appears.

8 Position each pattern and embroider it according to the on-screen instructions.

You will be prompted to align the starting point, rotate the design, and rehoop the fabric when necessary. For details, refer to "Rehooping the fabric" on page 108.

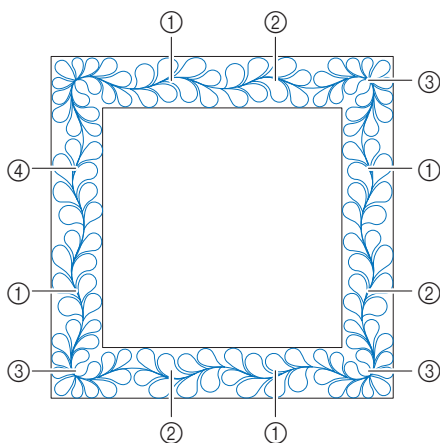

① When embroidering the edge pattern

If the fabric has just been rehooped, use the move pattern keys to align the start point on the screen with the end point of the previous pattern, and then touch **Next**. Then, rotate the pattern to align the corner with the reference line, and then touch **Embroidery**.



② When embroidering the pattern immediately before a corner

If the fabric has just been rehooped, use the move pattern keys to align the start point on the screen with the end point of the previous pattern, and then touch **Next**. Then, align the point of the pattern (inner corner of the next pattern to be embroidered) with the corner of the reference lines. If the pattern is not angled correctly, rotate it. If the length of the pattern does not match, enlarge or reduce the pattern so that the point of the pattern is at the corner of the reference lines.



* Inner corner of next pattern to be embroidered

After making adjustments, touch **Embroidery**.

Note

- For the accurate start point, turn the handwheel toward the LCD panel to lower the needle. Check the needle drop point, and then turn the handwheel again until the needle is raised to its highest position.



③ When embroidering the corner pattern

Rotate the fabric 90 degrees counterclockwise, rehoop it, and then attach the embroidery frame to the machine. Use the move pattern keys to align the start point on the screen with the end point of the previous pattern, and then touch **Next**.

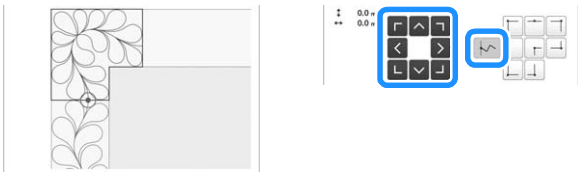

Then, align the inner corner of the pattern with the corner of the reference lines, and touch **Embroidery**.



④ When embroidering the last edge pattern

Use the move pattern keys to align the start point on the screen with the end point of the previous pattern, and then touch **Next**.



Then, align the end point of the last pattern with the start point of the first pattern. If the pattern is not angled correctly, rotate it. If the length of the pattern does not match, enlarge or reduce the pattern.

After making adjustments, touch **Embroidery**.

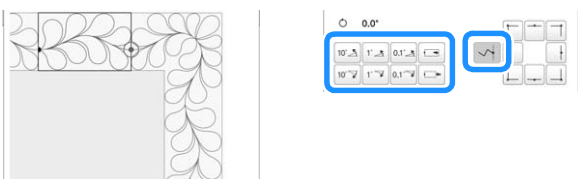

■ Rehooping the fabric

If necessary, the on-screen instructions to rehoop the fabric appears. While the on-screen instructions are being displayed, the embroidery frame moves to the position where the fabric can be rehooped easily. Rehoop the fabric, and then touch **OK**.

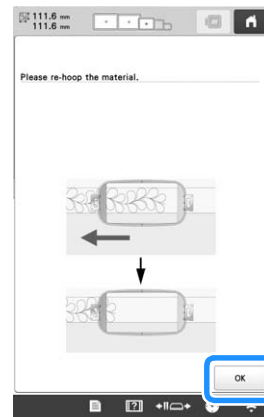

If you want to rehoop the fabric while the camera image is being displayed, touch . After the on-screen instructions appear, rehoop the fabric.

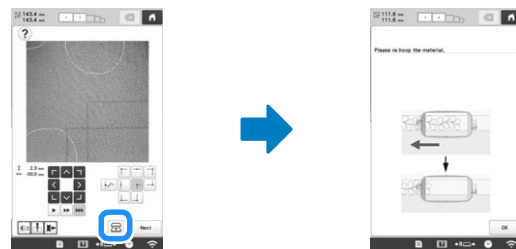

 **Memo**

- Using the optional magnetic sash frame, the fabric can be easily rehooped without removing the frame from the machine. For details, refer to the manual included with magnetic sash frame.

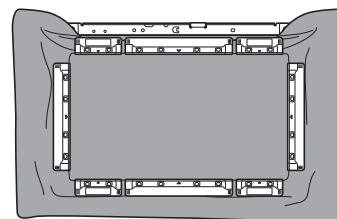

USING THE CAMERA TO CONNECT PATTERNS

Instead of using thread marks, the camera can be used to connect patterns.

An area of 330 mm × 170 mm (13 inches × 6-1/2 inches) can be embroidered when the camera is used to connect patterns. Select the appropriate frame depending on the size of the embroidery. We recommend using the extra-large embroidery frame (360 mm × 200 mm (14 inches × 7-7/8 inches)) when using the camera to connect patterns.

Note

- When installing the embroidery frame (small) (60 mm × 40 mm (2-3/8 inches × 1-1/2 inches)), cap frames, cylinder frame, sleeve frame, clamp frames, name frame or the round frames, you cannot connect patterns using this function.
- Split (large-size) patterns created with PE-DESIGN version 7 or later cannot be used with this function.
- You cannot connect patterns using this function while the machine is set to the Link mode.

Connecting three patterns

Example:

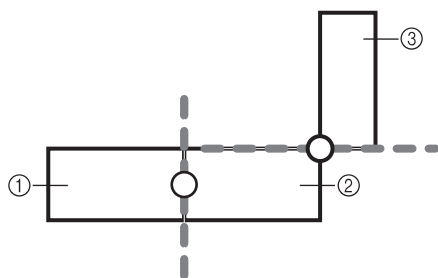

- ① Pattern A
- ② Pattern B
- ③ Pattern C

1 Specify the appropriate image settings in advance. (page 73)

- Better scanning results can be achieved with the appropriate settings.

2 Select the first pattern A, and then touch **Set**.

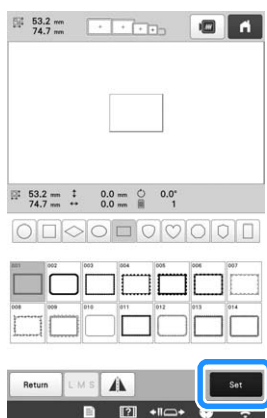

3 Hoop fabric in the extra-large embroidery frame (360 mm × 200 mm (14 inches × 7 7/8 inches)), and then attach the frame to the machine.

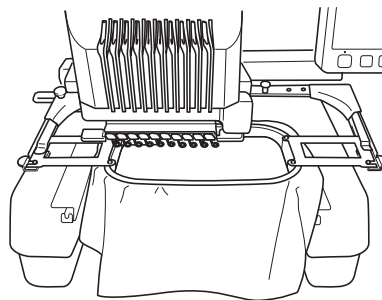

4 Touch **Edit End** to display the embroidering settings screen. Touch

- needs to be selected in order to continue connecting patterns.

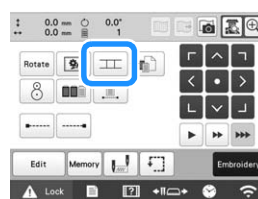

→ appears at the bottom left side of pattern display area, and then changes to

Memo

- A pattern cannot be saved in the machine's memory while patterns are being connected.

5 Touch **Embroidery**, then touch **Lock** and then press the "Start/Stop" button to embroider the first pattern.

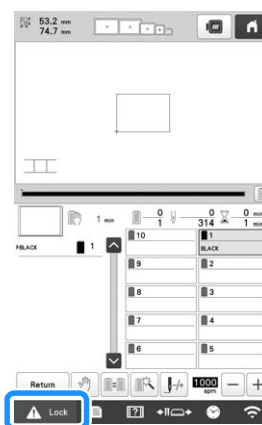

6 After embroidering of the first pattern is finished, the message to confirm to connect the next pattern appears. Touch **OK**.

7 When the following message appears, touch **OK**.

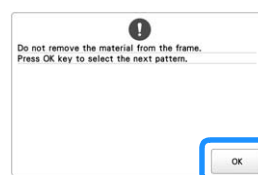

8 Select the second pattern B, then touch **Set**.

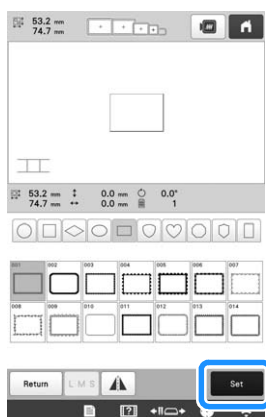

9 Touch **II**, and then select how the pattern will be connected.

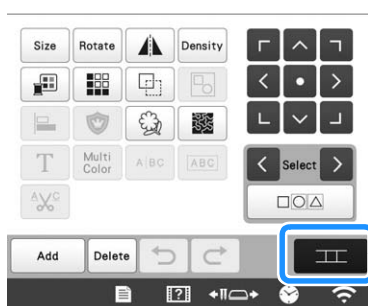

→ The pattern connection setting screen appears.

10 Touch the position for the second pattern will be connected on the screen, and then touch **OK**. In this example, touch the right side of the first pattern.

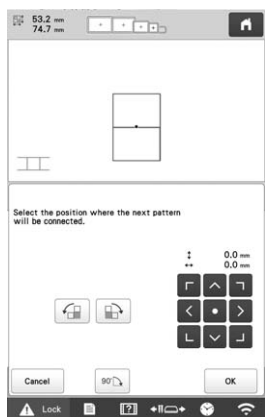
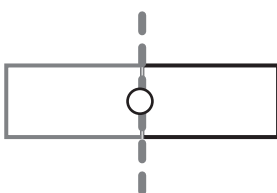

- You can adjust the position of the second pattern, using the keys described below.

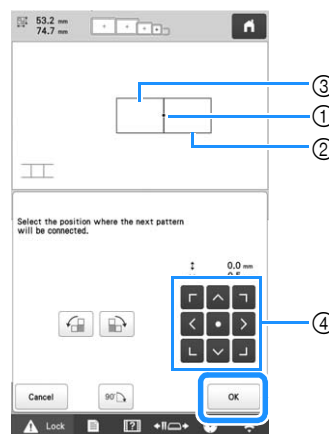

- ① Touch the connecting area
- ② Second pattern B
- ③ First pattern A
- ④ Move the second pattern.

	Rotate the second pattern in a clockwise arc referring the first pattern as a center.
	Rotate the second pattern in a counterclockwise arc referring the first pattern as a center.
	Rotate the second pattern 90 degrees in a clockwise arc.

→ Message appears on screen and carriage will move after touching **OK**.

Note

- The second pattern will be automatically connected to the first pattern without adjustment. Change the position of the second pattern

manually using

- The position of the second pattern can be moved using your finger or the included touch pen.
- Use , or if you want to align the pattern to the corner of the center of the first pattern, when changing the pattern's connecting position.

11 Prepare two embroidery positioning stickers.

We will follow the on-screen instructions to affix these two stickers to the fabric so that the positioning marks can be detected by the camera.

Note

- Use the positioning stickers included with this product or purchase replacement stickers (refer to "Optional accessories" on page 14) from your Brother dealer. If any other sticker is used, the camera may not recognize it.

12 Affix the first embroidery positioning sticker onto the fabric as shown on machine. Then, touch **OK**.

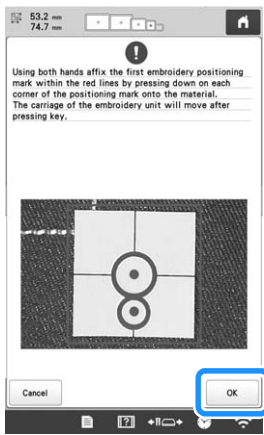

→ The camera detects the first positioning sticker.

Note

- Use new positioning stickers. If a sticker is reused, it may easily peel off. If the sticker peels off during this procedure, the patterns cannot be connected. Start the project again with new fabric and stabilizer.
- Using fingers apply pressure to the corners of the positioning sticker to firmly affix it to the fabric. If the sticker is not firmly attached, the camera may incorrectly detect the sticker.
- If any of the following messages appear, reattach the positioning sticker in the correct position. Make sure that the sticker is affixed with the large circle at the top.

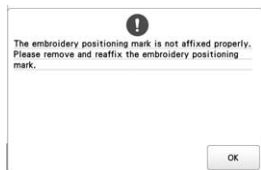

13 Affix the second embroidery positioning sticker onto the fabric as shown on machine. Then, touch **OK**.

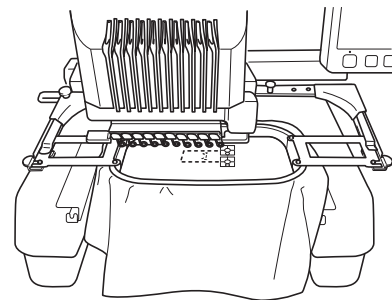
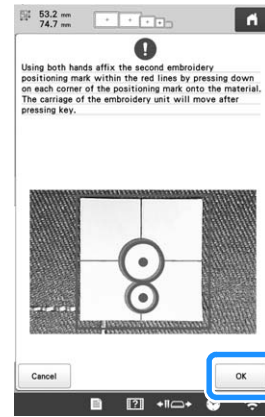

→ The camera detects the second positioning sticker.

14 After the two positioning stickers have been detected, the following message appears.

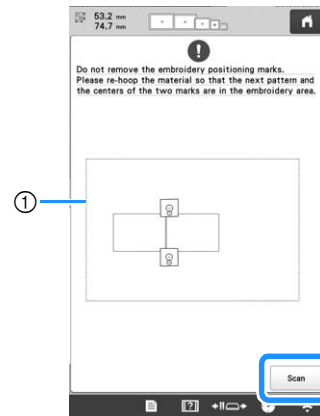

① Embroidering area

While making sure that the two positioning stickers do not peel off, remove the embroidery frame from the machine, and then rehoop the fabric. Be sure to hoop the fabric so the next pattern and both the positioning stickers are within the embroidering area. Reattach the frame and touch .

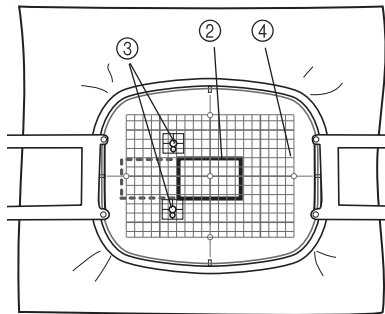
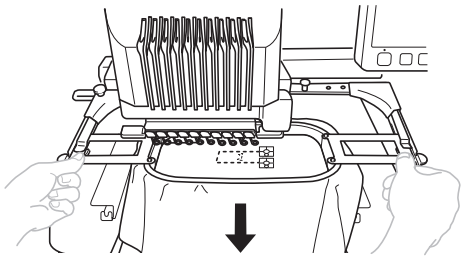



- ② Pattern to be embroidered next
 - ③ Centers of large circles for stickers
 - ④ Embroidery sheet
- The camera detects the two positioning stickers.

 **Note**

- If the next pattern and the centers of the large circles of the two positioning stickers do not fit within the embroidering area, use a larger embroidery frame. If a larger embroidery frame cannot be used, continue to step 15, and then refer to “Changing the position of a sticker” on page 114 to reposition the sticker.
- If the sticker peels off during this procedure, the patterns cannot be connected. If this occurs, restart the procedure from the beginning.
- If either of the following messages appear, rehoop the fabric so that the next pattern and both the positioning stickers are within the embroidering area as indicated in the screen.

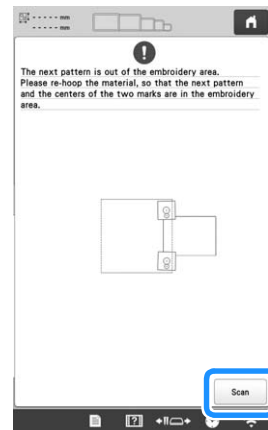
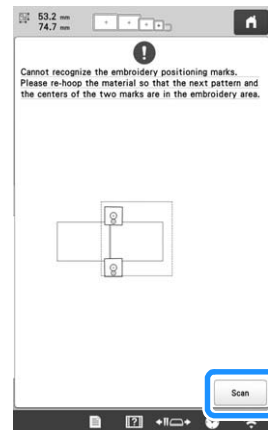
Touch  to detect the positioning stickers.



- 15** After the positioning stickers have been detected, the message to inform you that it recognized the embroidery positioning sticker appears. Touch , and then remove the stickers.

- 16 Touch **Embroidery**, then touch **Lock** and then press the "Start/Stop" button to embroider the second pattern.

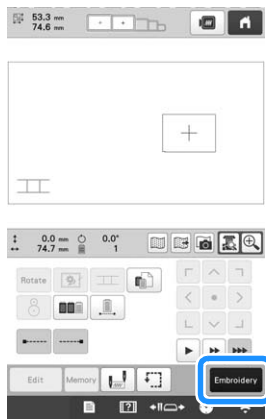

→ After embroidering of the second pattern is finished, the message to confirm to connect the next pattern appears. Touch **OK**.

- 17 When the following message appears, touch **OK**.

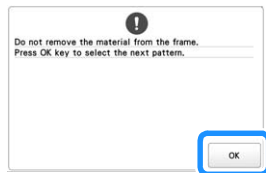

- 18 Select the third pattern C, and touch **Set**.

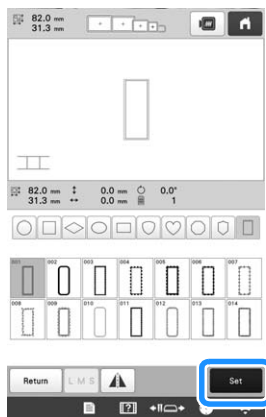

- 19 Touch **II** to display the pattern connection setting screen. In this example, we will select the top point of the right edge for the second pattern.

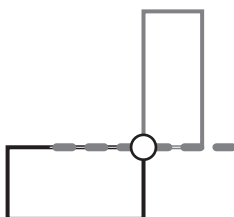

- 20 Touch the position where the third pattern will be connected on the screen, and then touch **OK**. In this example, touch the upper right side of the second pattern.

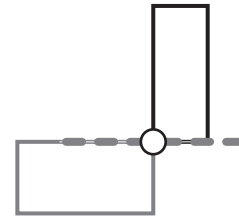

- Pattern rotates automatically when corner position is selected.

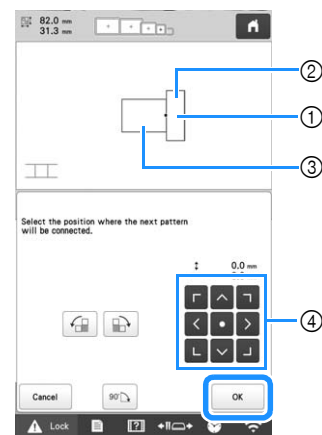

- ① Touch the connecting area
- ② Third pattern C
- ③ Second pattern B
- ④ Move the third pattern.

→ Message appears on screen and carriage will move after touching **OK**.

- 21 Follow the on-screen instruction to perform steps 11 to 15.

- 22 Touch **Embroidery**.

- 23 Touch **Lock** and then press the "Start/Stop" button to embroider the third pattern.

→ After embroidering of the third pattern is finished, the message to confirm to connect the next pattern appears. When finished connecting patterns, touch **Cancel**.

→ After embroidering is finished, **II** at the top left side of the screen disappears.

The three patterns have been connected.

Touch **Home** to clear the pattern.

Changing the position of a sticker

If the selected pattern or positioning stickers for connecting the next pattern do not easily fit in the embroidering area, follow the on-screen instructions that appear after step 13 on page 111 in order to move the positioning stickers.

For an example, the on-screen instruction appears when you use the embroidery frame with a size of 10 cm × 10 cm (4 inches × 4 inches) to connect patterns as shown below.

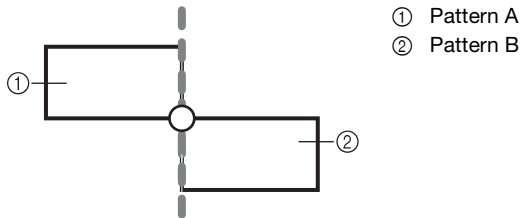

- 1 Refer to steps 1 through 13 of “Connecting three patterns” on page 109 using the embroidery frame with a size of 100 mm × 100 mm (4 inches × 4 inches) to embroider the first pattern and to connect the second pattern.

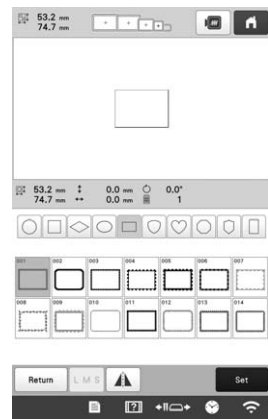

Note

- When referring to steps 1 through 13 of “Connecting three patterns” on page 109, make sure you select the pattern position to reflect this exercise.

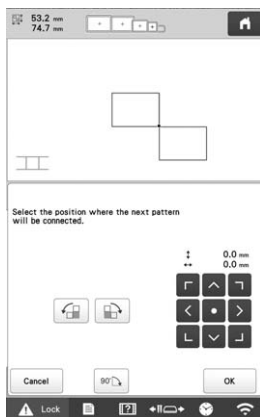

- 2 Following message appears in step 14 if the next pattern or affixed positioning stickers are close to being out of the embroidering area. Follow the instructions and then touch .

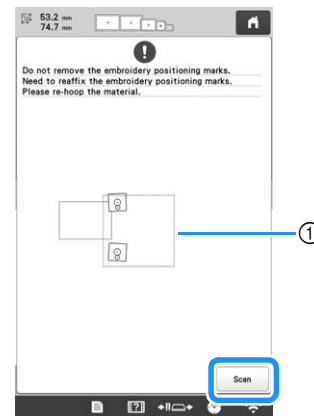

- ① Embroidering area

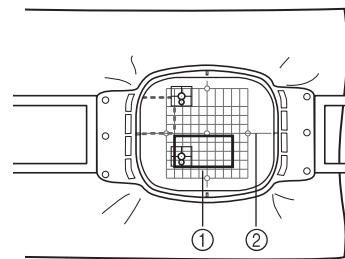

Note

- If the message that could not recognize the embroidery positioning sticker appears, rehoop the fabric as indicated in the screen, and then touch .

- 3 After the positioning stickers have been detected, the message to inform you that it recognized the embroidery positioning sticker appears. Touch , and then remove the stickers.

- 4 Affix the two positioning stickers again according to the on-screen instructions so that the next pattern or positioning marks can fit in the embroidering area.

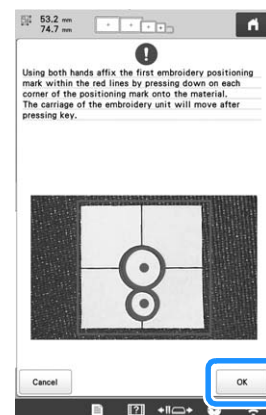

- Touch so that the camera detects the first positioning sticker.

5 Affix the second sticker and then touch  .

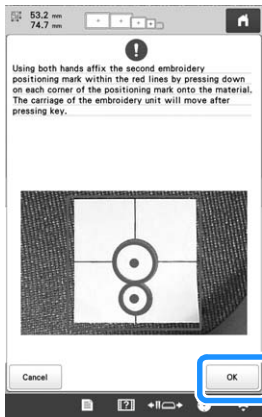

→ The camera detects the second positioning sticker.

6 After the two positioning stickers have been detected, the following message appears. While making sure that the positioning stickers do not peel off, rehoop the fabric according to the example displayed on the on-screen instruction.

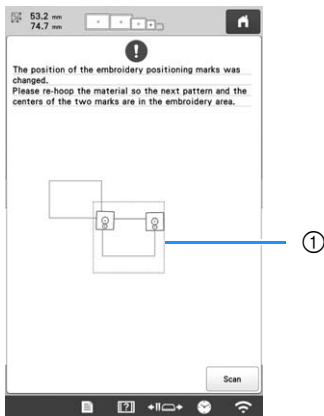

① Embroidering area

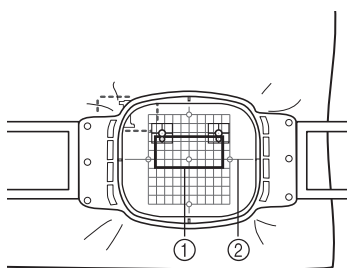

① Pattern to be embroidered next
② Embroidery sheet

7 Continue the operation from step **15** on page 112 after touching  .

Resume feature

If the machine is turned off while the pattern connecting function is being used, the machine will return to the operation indicated below when it is turned on again. The machine operation will differ depending on when it is turned off.

Example: When connecting two patterns

Select the first pattern. Touch the pattern connection key  .
Begin embroidering the first pattern.



Finish embroidering the first pattern. (A)

If the machine is turned off during any operation in this box, the machine will return to (A) when it is turned on again.



Select the second pattern.



Touch  .



Specify the reference point for connecting the pattern.



Start detecting positioning stickers (2 locations).



Finish detecting positioning stickers. (B)

If the machine is turned off during any operation in this box, the machine will return to (B) when it is turned on again.

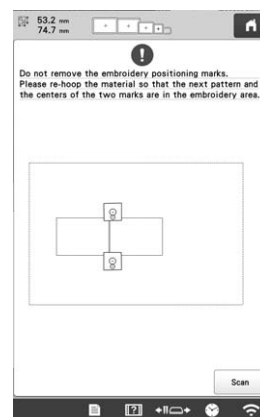

Rehoop the fabric.



3

Finish detecting positioning stickers (2 locations).

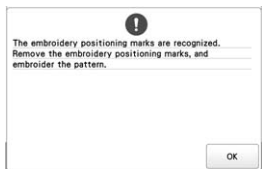

Begin embroidering the second pattern.



Finish embroidering the second pattern.

MAKING EMBROIDERY ADJUSTMENTS

Adjusting the tension of the bobbin thread

Note

- Be sure to check the tension of the bobbin thread each time that the bobbin is changed. Depending on the bobbin thread type and whether a prewound bobbin is used, the tension of the bobbin thread may differ. For example, when replacing an empty prewound bobbin with one of the same type, be sure to check the tension of the bobbin thread and adjust the tension if necessary.
- Be sure to adjust the tension of the bobbin thread before adjusting the tension of the upper thread.

- 1 Tie the included weight to the end of the thread extending from the bobbin case.

Prewound bobbins

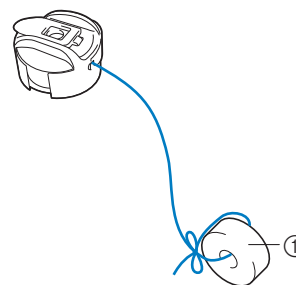

- ① Weight (L)

Note

- Different weights are used to adjust prewound bobbins and metal bobbins.

Metal bobbins:

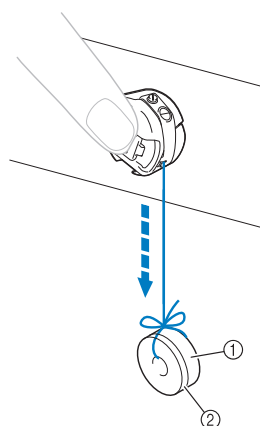

- ① Weight (L)
- ② Weight (S) (included with the optional bobbin winder)

- 2 As shown in the illustration, hold the bobbin case against a smooth vertical surface.

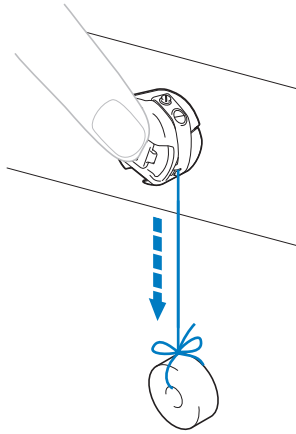

- If the thread with the weight attached is slowly pulled out, the thread tension is correct.

- 3 Use the included standard screwdriver to turn the tension-adjusting screw and adjust the thread tension.

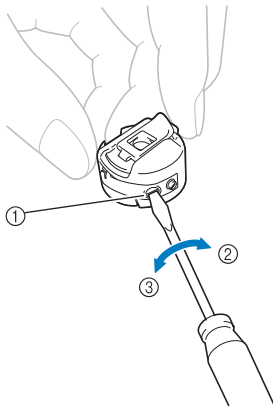

- ① Tension-adjusting screw
- ② Tighter
- ③ Looser

- 4 After making the adjustments, try embroidering with all needle bars to check the thread tension.

Memo

- In the built-in embroidery patterns, one pattern is used for checking the thread tension. By embroidering this pattern, the thread tension can easily be checked. From the wrong side of the fabric, the bobbin thread should be adjusted to be about one third of the stitch width.

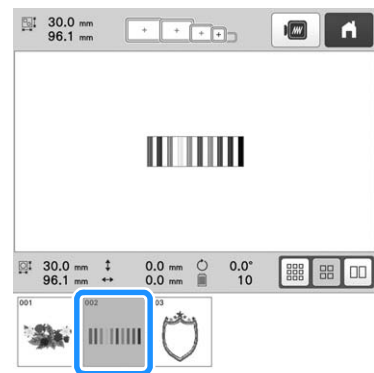
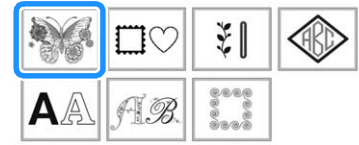

Adjusting the tension of the upper thread

When embroidering, the thread tension should be set so that the upper thread can be seen slightly on the wrong side of the fabric.

1 Turn the thread tension knobs.

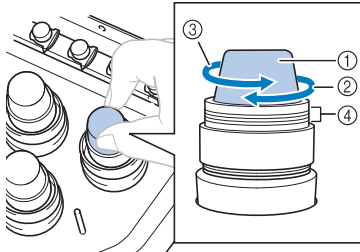

- ① Thread tension knobs
- ② Tighter
- ③ Looser
- ④ Mark

→ If the thread tension is not still correctly adjusted, turn the upper thread guide pretension knob.

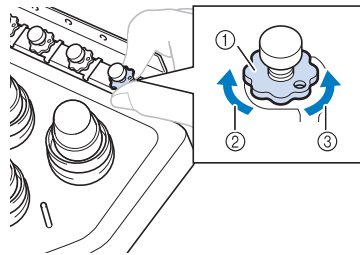

- ① Upper thread guide pretension knob
- ② Tighter
- ③ Looser

■ Correct Thread Tension

The pattern can be seen from the wrong side of the fabric. If the thread tension is not set correctly, the pattern will not finish well. The fabric may pucker or the thread may break.



Follow the operations described below to adjust thread tension according to the situation.

Note

- If you decrease the thread tension further than the red line, the tension knob may be disassembled. This is not a sign of a malfunction. Increase the thread tension slightly, and begin embroidering again.
- If necessary, refer to page 176 for reassembling the tension unit.

■ Upper thread is too tight

The tension of the upper thread is too tight, resulting in the bobbin thread being visible from the right side of the fabric.



Turn the knob in the direction of the arrow to decrease the tension of the upper thread.

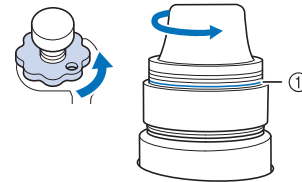

- ① Red line

If the red line is visible, the thread tension cannot be decreased any further. Increase the tension of the bobbin thread. (page 116)

Note

- If you decrease the thread tension further than the red line, the tension knob may be disassembled.
- If necessary, refer to page 176 for reassembling the tension unit.

■ Upper thread is too loose

The tension of the upper thread is too loose, resulting in a loose upper thread, loose thread locks or loops appearing on the right side of the fabric.



Turn the knob in the direction of the arrow to increase the tension of the upper thread.

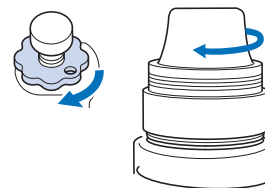



Setting the machine to stop at color changes

The machine can be stopped at any time; however, if the machine is stopped while it is embroidering, it is better to go back a few stitches before continuing embroidering to overlap the stitching. If the machine stops at a color change, it is not necessary to go back through the stitching before continuing embroidering.

Stopping the machine at the next color change

The machine can be set to stop before embroidering the next color.

- 1 While embroidering the color before the point where you wish to stop the machine, touch  so that it changes to .



- 2 After finishing embroidering the area for the current color, the next needle bar moves into position and the machine stops before embroidering the next color.

→  changes back to .

- If the machine is temporarily turned off, you will be asked if you wish to continue embroidering or select a new pattern when the machine is turned on again.

Touch  to continue embroidering. (page 97)

Specifying pause locations before embroidering

Pause locations can be specified in the pause setting screen, displayed by touching .

- 1 Touch  in the embroidering settings screen.

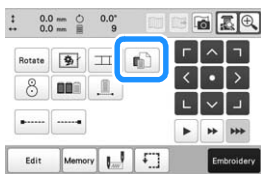

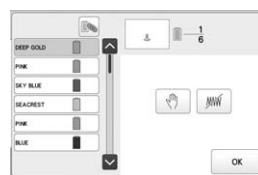

→ The pause setting screen appears.

- 2 From the thread color sequence display, select the thread color where you wish to stop the machine before continuing to embroider.



→ The selected thread color is highlighted in blue.

- If the same thread color is used more than once, they can be combined. After selecting a thread color, touch . The key changes to , and all thread colors in the thread color sequence display that are the same as the one that was selected are highlighted in blue.

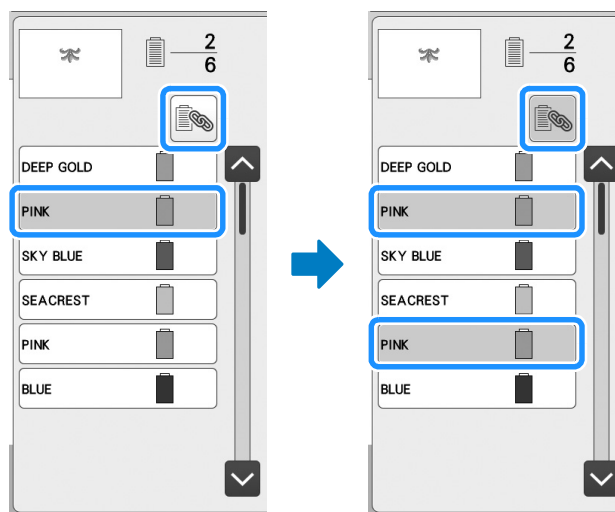

- 3 Touch .

→ The  mark appears to indicate where the machine will stop.



- 1  mark

- To cancel the setting, touch  again.

- 4 Repeat steps 2 and 3 for each pause that you wish to specify.

- Any number of pauses can be specified.

3

5 After specifying the desired settings, touch .

- If the machine is temporarily turned off when it is stopped at the specified location after embroidering, you will be asked if you wish to continue embroidering or select a new pattern when the machine is turned on again.

Touch  to continue embroidering. (page 97)

 **Memo**

- If the machine is temporarily turned off, the settings to stop the machine at color changes specified before the machine was turned off are not cancelled. However, the settings are cancelled if a new pattern is selected.
- If a pattern with the settings to stop the machine at color changes is saved, the settings to stop the machine at color changes are also saved.

Temporary needle bar setting

After embroidering begins, the machine can be stopped at a color change and a different needle bar can be specified for the next color to be embroidered.

By substituting an upper thread color already threaded on a different needle bar, the time for embroidering can be saved. For example, similar color thread can be substituted for temporary use.

1 Touch .



→ The temporary needle bar setting screen appears.

2 Touch the key for the needle bar threaded with the thread that you wish to embroider with.

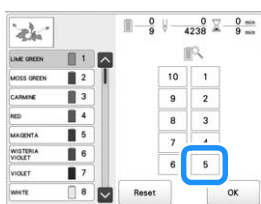

→ The needle bar number changes and  appears to indicate the selected needle bar.

→ To cancel the setting, touch .

3 Touch .



→ The embroidering screen appears again.

 **Memo**

- The thread color (needle bar) cannot be changed in the middle of an area that is being embroidered.

■ Uninterrupted embroidering (one color)

A selected pattern can be stitched out in one color instead of multi color. The machine will hesitate but not stop between color steps, and then continue till the pattern is completed.

1 Touch  in the embroidering settings screen.

- The selected pattern will be embroidered in one color, instead of changing the thread while embroidering.
- Touch  again to return to the pattern's original settings.

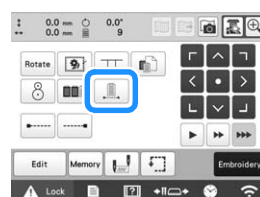

2 Touch  to continue to the embroidering screen.

3 Touch the key for the needle bar threaded with the thread you wish to embroider uninterruptedly.



→ The thread color sequence display and pattern for the thread color of the selected needle bar appear.

 **Memo**

- Even if uninterrupted embroidering has been set, the DST thread trimming function can be used. (page 123)
- After finishing the embroidery, uninterrupted embroidery will be canceled.

Reserved needle bar and embroidery speed settings

Normally, the machine automatically assigns thread colors to the needle bars; however, a specific thread color can be manually assigned to a certain needle bar. If a needle bar is specified, that needle bar is removed from the machine's automatic assignments and the specified color remains assigned to it.

By specifically assigning often used thread colors to certain needle bars, the trouble of changing the thread spools can be reduced.

Also, the maximum embroidery speed can be specified to the assigned needle bar. It is useful when you specially set a weak thread such as a metallic thread to the assigned needle bar.

Note

- This feature is not accessible through the embroidering screen.
- You can assign thread colors up to 9 needle bars in normal mode. When you set [Manual Color Sequence] to [ON] in settings screen, it is available to assign up to 10 needle bars. If you assign all the 10 needle bars in the [Manual Color Sequence] mode, and then you set the machine to the normal mode, the setting of needle bar 10 is canceled automatically. (page 58)

Once a manual needle bar setting is specified, it remains applied until the setting is cancelled.

- 1 Touch , then .
→ The embroidery settings screen appears.
- 2 Locate [Needle attribute setting].
- 3 Touch any of the key from to for the number of the needle bar that you wish to specify.



- ① The number of the selected needle bar turns blue.

4 Select the color to be assigned to the needle bar.

Touch , , and , or directly touch a color, to select the desired color.

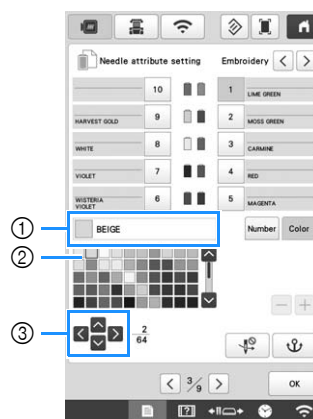

- ① Displays the color that is selected and its name
- ② The color in the box is the color that is selected.
- ③ The box moves in the direction of the arrow on the key that is touched.

5 Touch .

→ The selected color of thread and appear on the spool.

6 Touch or to set the maximum embroidery speed for the assigned needle bar.

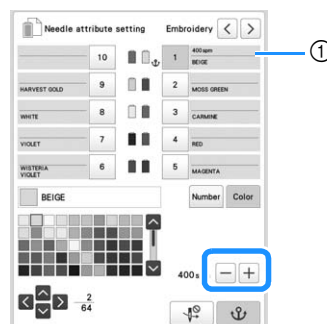

- ① Value of maximum embroidery speed setting

Memo

- Decrease the embroidery speed to 400 spm when using a specialty thread, such as a metallic thread, assigned to a needle bar. ("spm" is the number of stitches embroidered in one minute.)
- The maximum embroidery speed specified here is always effective to the assigned needle bar, even if you set the faster speed in the embroidering screen. (page 89)

- 7 If necessary, touch  to cancel automatic needle threading.

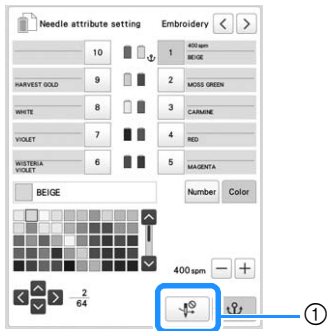

- ① Disable needle threader key

- 8 Touch .

- Specified needle bar is indicated with  and the specified maximum embroidery speed in the embroidering screen.

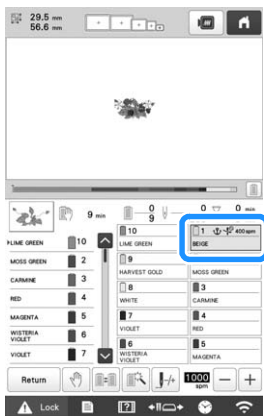

■ Cancelling the setting

To change the setting, first cancel it, and then select the new setting.

- 1 Touch any of the key from  to  for the number of the needle bar whose setting you wish to cancel.

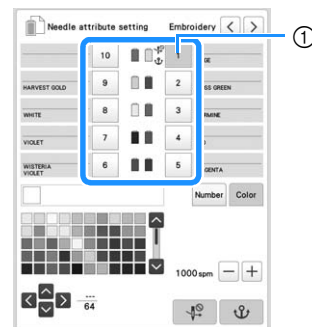

- ① The number of the selected needle bar turns blue.

- 2 Touch .

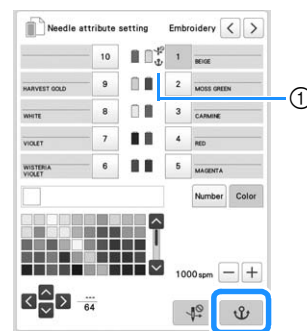

- ①  disappears from the thread spool.
→ This cancels the manual needle bar setting.

- 3 To cancel the cancel needle threading setting, touch  again.

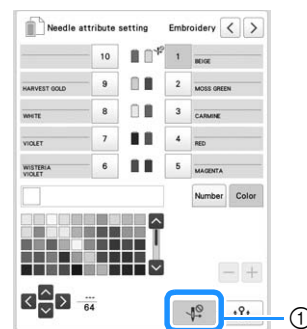

- ① Disable needle threader key

Memo

- Follow the procedure from step 4 on page 121, to assign the other thread color to the needle bar you canceled the setting.

Changing the display guides

The guides in the pattern display area can be specified. The machine automatically detects the type of embroidery frame holder and embroidery frame that are installed and displays them.

Touch , then .

→ The embroidery settings screen appears.

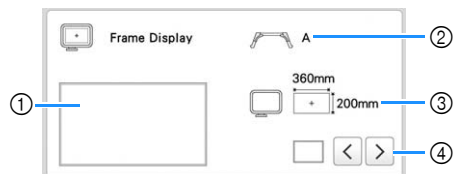





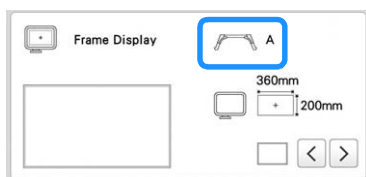

- ① How the guides will appear with the specified settings can be previewed here.
- ② Type of embroidery frame holder
Displays the type of the embroidery frame holder.
- ③ Area
Displays the size of the embroidery frame that is actually installed. (page 66)
- ④ Center point marker or grid lines
Select the type of the center point marker and the grid lines, and whether or not to display them.

■ Type of embroidery frame holder

The machine automatically detects the type of embroidery frame holder that is installed. If no embroidery frame holder is installed, the setting for "Cap frame/Cylinder frame" is displayed.



Embroidery frame holder A (included)	 A
Embroidery frame holder B (included)	 B
Embroidery frame holder C (Optional)	 C
Embroidery frame holder D (Optional)	 D
Embroidery frame holder E (Optional)	 E
Cap frame/Cylinder frame (Optional)	 *
Magnetic sash frame (Optional)	*

* No icon appears since this frame is installed without an embroidery frame holder.

Changing the thread color information

You can display the name of the thread colors, embroidery thread number or the embroidering time.

When the machine is purchased, the thread color number [#123] is selected.

Memo



- Colors on the screen may vary slightly from actual spool colors.
- [Original], imported data retains the brand thread created with the software, is set as a default.

1 Touch , then .

→ The embroidery settings screen appears.

2 Touch  and  to display the name of the thread colors, the embroidery thread number or the embroidering time.



3 When the thread number [#123] is displayed, touch  and  to select from the embroidery thread brand.



Specifying jump stitch trimming / "DST" jump codes for trimming

You can specify whether or not jump stitches are cut. In addition, when using Tajima embroidery data (.dst), you can specify whether or not the thread is cut according to the specified number of jump codes.

[ON]: The machine converts the "jump" code to a trim code, based on the number specified on the next line.

[OFF]: The machine does not convert the "jump" code to a trim code.

When the machine is purchased, [ON] is selected and the number of jumps is set to [3].

Note

- If the setting is changed from the previous setting, the new setting is applied to the subsequent embroidery.

1 Touch , then .

→ The embroidery settings screen appears.

2 Locate [Thread Trimming].

3 Touch [ON] or [OFF] to select the desired setting.

→ When [ON] is selected, touch and to specify the jump stitch length. For example, when the value is set to [5 mm], jump stitches will be cut at 5 mm (13/64 inch), but not at 4 mm (5/32 inch).

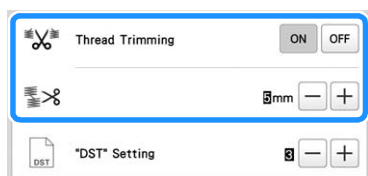

Note

- Even if [Thread Trimming] is set to [ON], this setting is not applied to the jump stitch trimming of threads between character patterns. For details on jump stitch trimming for character patterns, refer to “Trimming the threads between characters” on page 47.

Memo

- The length of jump stitch trimming cannot be specified to Tajima embroidery data (.dst).

■ When using Tajima embroidery data (.dst)

4 If [Thread Trimming] is set to [ON], touch and to select the number of feed codes.

The desired setting is displayed.

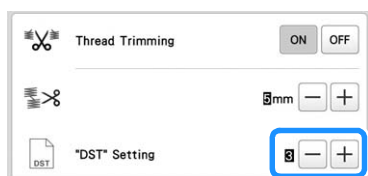

- A value between [1] and [8] can be specified. For example, if [3] is specified, sequential 3 jump codes will be converted to the trim code. But sequential 2 jump codes will not be converted to the trim code, it will be embroidered as the feed (jump) stitch.

Note

- You need to set the jump number same as the number that was used when the particular Tajima data was created. If the jump number is not matched, either unexpected trim or no trimming at trim expected point will happen.

Deleting short stitches

If embroidery data other than our original patterns are used, the stitch length may be too short, possibly resulting in the thread or the needle breaking. In order to prevent this problem from occurring, the machine can be set to delete stitches with a short stitch length. Stitches with a length less than that specified in this function, can be deleted.

When the machine is purchased, [0.3] was selected.

1 Touch , then .

→ The embroidery settings screen appears.

2 Locate [Short Stitch Delete].

3 Touch and to select the stitch length.

The desired size is displayed.

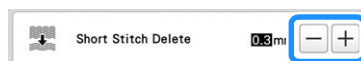

- A value between 0 and 1 millimeters if the units of measurements is set to [mm] (or a value between 0 and 0.04 inch if the units of measurements is set to [inch]) can be specified.

Note

- If the setting is changed from the previous setting, the new setting is applied to the subsequent embroidery.

Specifying the remaining length of thread

This setting specifies whether the length of upper thread that remains threaded through the needle after the thread is trimmed (length of thread passed through the eye of the needle) has a standard tail or long tail.

When the machine is purchased, [Standard Tail] is selected.

1 Touch , then .

→ The embroidery settings screen appears.

2 Display .

3 Touch and to select the setting.

The desired length is displayed.



- If the machine misses stitches with a standard length of thread after it is trimmed, select [Long Tail].
- When using metallic thread, select [Long Tail].

Changing the embroidery basting distance

The distance from the pattern to the basting stitching can be set to 0.0 mm (0 inch) to 12.0 mm (1/2 inch).

When the machine is purchased, [5.0 mm] is selected. Refer to page 99 when using this setting.

1 Touch , then .

→ The embroidery settings screen appears.

2 Locate [Basting Distance].

3 Use and to specify the distance from the pattern to the basting stitching.



Deselect region setting

The deselect region setting (which specifies that a thread color will not to be embroidered) can be applied to a part of the pattern with a specific color. In this way, you can arrange the embroidery without actually editing the pattern.

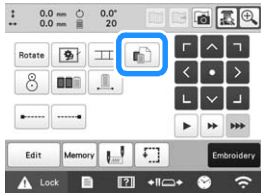

1 Touch  in the embroidering settings screen.

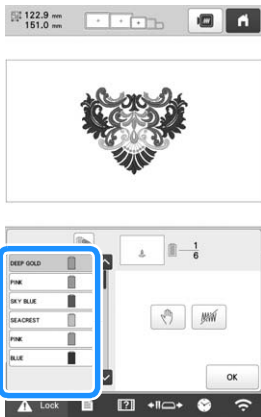

→ A screen appears, allowing the needle bar numbers to be selected.

2 From the thread color sequence display, select the thread color that will not be embroidered.



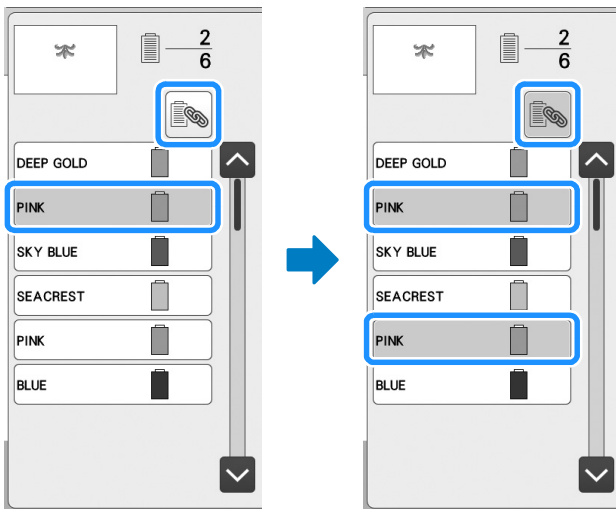

→ The selected thread color is highlighted in blue.
 • If the same thread color is used more than once, they can be combined. After selecting a thread color, touch . The key changes to , and all thread colors in the thread color sequence display that are the same as the one that was selected are highlighted in blue.

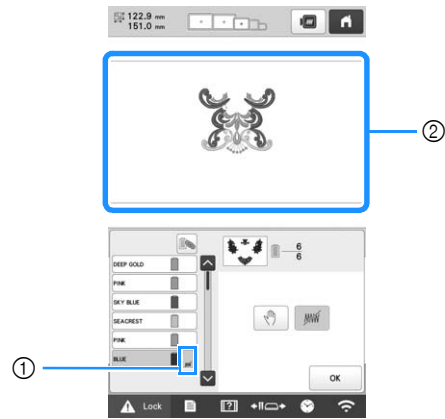

3 Touch .

→ The  mark appears to indicate that the selected thread color will not be embroidered.





- ①  mark
- ② The parts of the pattern that will not be embroidered are hidden.

4 Repeat steps 2 and 3 for all thread colors that will not be embroidered.

3

5 After specifying the desired settings, touch .

Memo

- If the deselect region setting is applied to a character pattern, all characters in the pattern will not be embroidered. To deselect region for a single character, use  to separate the character pattern (page 44), or use  (page 54). If the Multi Color key is used to specify that thread colors not be embroidered, multi-color text cannot be turned off.
- The parts with the deselect region setting applied are not deleted. They can be reverted to being embroidered (refer to “Cancelling the deselect region setting” on page 126).
- If the deselect region setting has been applied to all thread colors, a red  appears at the location of the pattern.

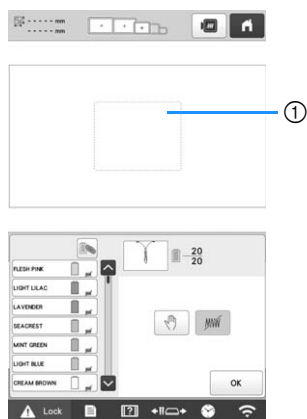

① Red 

- If the machine is temporarily turned off, the settings to deselect region that were specified before the machine was turned off are not cancelled. However, the settings are cancelled if the same pattern is selected again.
- When a pattern with the deselect region setting applied is saved, the deselect region setting is also saved. However, the pattern cannot be saved if the deselect region setting is applied to all thread colors.

■ Cancelling the deselect region setting

1 Select the thread color whose setting is to be cancelled, and then touch .

→ The key changes to , and the deselect region setting is cancelled.

- If thread colors were combined with , the deselect region setting will also be cancelled for all thread colors that are the same as the one that was selected.

Starting/ending position settings

1 Touch  in the embroidering settings screen.



→ The starting/ending position settings screen appears.

2 Select  or .

- When selecting 

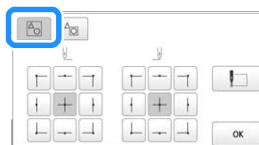

The machine can set the starting point and the ending point separately from the 9 points of the pattern. Those are upper-left corner, upper-center, upper-right corner, center-left, center, center-right, lower-left corner, lower-center and lower-right corner.

This function can be used to repeatedly embroider a pattern along a diagonal. (page 127)

- When selecting 



When rotating the pattern while checking the embroidering position shown by the camera, the embroidering starting position can be set using a mask based on the pattern before it has been rotated, which is useful for aligning. (page 75)

Memo

- When the machine is purchased,  is selected and both the starting position and the ending position are set to the center of the pattern.
- The starting/ending position settings do not change until the key for a new setting is touched. The settings specified before the machine is turned off remain selected the next time that the machine is turned on. (If an embroidery positioning sticker is used to align the pattern, or basting is added or removed, the setting will return to its default.)

Repeatedly embroidering a pattern along a diagonal

Example



- 1 Touch  in the embroidering settings screen to display the starting/ending position settings screen.

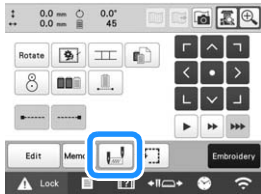



- 2 Select .

- 3 Specify the upper-left corner as the starting position and the lower-right corner as the ending position.

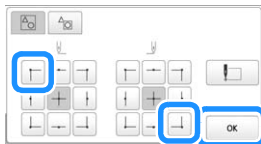

For the starting position, touch  so that it changes to .

For the ending position, touch  so that it changes to .



Touch  to close the starting/ending position settings screen.

- 4 Embroider the first pattern.

Touch  to display the embroidering screen, and then touch  and press the "Start/Stop" button.



- ① Starting position
- ② Ending position

- 5 After embroidering is finished, the machine stops at the lower-right corner of the pattern.



- 6 Touch  and repeat steps 4 and 5 three times.

Note

- If the next embroidery pattern of the series will be stitched outside the embroidery field, the message to inform you that it cannot set the starting/ending position will appear. Rehoop the fabric to continue to repeat the embroidery pattern. Touch  and repeat steps 4 and 5.

Memo

- If the starting position and ending position settings are changed, instead of embroidering the patterns in a fixed direction, various pattern designs are possible.



3

■ Embroidering aligned characters

Follow the procedure described below to embroider aligned characters in a single row when the pattern extends beyond the embroidery frame.

Example: Aligning "DEF" to the characters "ABC"

A B C D E F

1 Select the character patterns for "ABC".

2 Touch  in the embroidering settings screen.

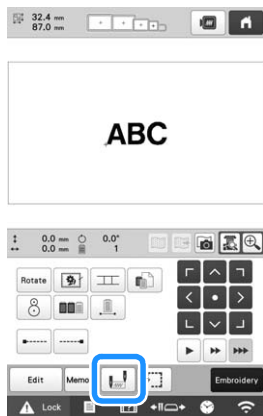

3 Select .

4 Touch .

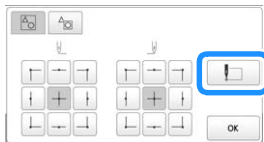



→ The needle bar is positioned in the lower-left corner of the pattern. The embroidery frame moves so that the needle is positioned correctly.



Note

- To cancel the starting point setting and return the starting point to the center of the pattern, touch



- Use  to select a different starting point for embroidering.

5 Touch  to return to the embroidering settings screen, and then touch  to continue to the embroidering screen.

→  changes to  while the starting point is set in the lower-left corner of the pattern.

6 Touch , and then press the "Start/Stop" button to begin embroidering.

7 After the characters are embroidered, cut the threads, remove the embroidery frame, and then attach the embroidery frame again so that the remaining characters ("DEF") can be embroidered.

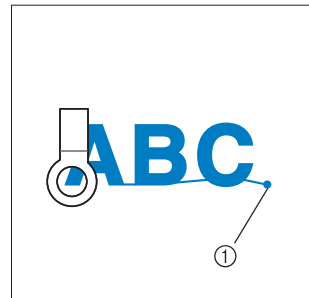

① End of the embroidering

8 As in step 1, select the character patterns for "DEF".

9 In the embroidering settings screen, touch .

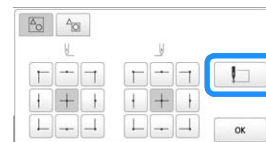

10 Touch .



→ The needle bar is positioned in the lower-left corner of the pattern. The embroidery frame moves so that the needle is positioned correctly.

11 Touch .

12 Use  to align the needle with the end of embroidering for the previous pattern.

- Touch  to check the needle drop point on the LCD screen. Before displaying the camera image, specify the appropriate image settings. (page 73)
- Better camera image results can be achieved with the appropriate settings.
- Touch  to zoom up the camera view.

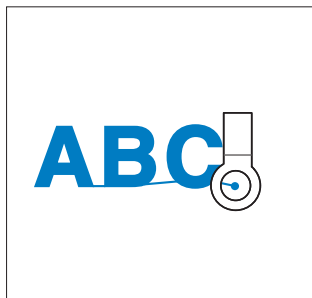

Note

- You can also follow the procedure of “Finding the embroidering position” on page 80, by directly place the needle over the end of the previous pattern.

13 Touch .

14 Touch , and then press the “Start/Stop” button to begin embroidering the remaining character patterns.



■ **Embroidering a pattern aligned with a mark on the fabric**

By specifying the beginning of stitching and the end of stitching, the exact position of the pattern can be checked.

1 Touch  in the embroidering settings screen.

2 Select .

3 Set the beginning of stitching in the lower-left corner.

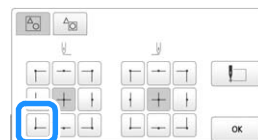

→ The frame moves so that the needle drop point aligns with the beginning of stitching.

4 With a fabric marker, mark this point on the fabric.

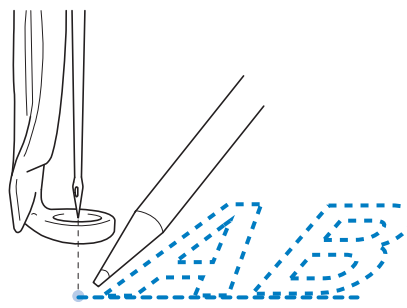

5 Set the beginning of stitching in the lower-right corner.



→ The frame moves so that the needle drop point aligns with the beginning of stitching.

6 With a fabric marker, mark this point on the fabric.

7 Remove the embroidery frame from the machine, and then connect these two points to check the embroidering position.



- If the baseline is misaligned or intersects another line, reframe the fabric in the embroidery frame or adjust the position of the pattern.

USING THE MEMORY FUNCTION

Saving embroidery patterns

Note

- Do not turn the main power to OFF while the [Saving...] screen is displayed. You will lose the pattern you are saving.
- Embroidery patterns cannot be transferred via wireless transmission if the computer and machine are connected to different home networks. Be sure to connect to the same home network.
- For details on supported computers, refer to "SPECIFICATIONS" on page 190.

- 1 Touch **Memory** when the pattern you want to save is in the embroidering settings screen.

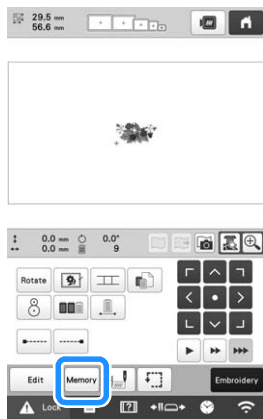

- 2 Touch the desired destination to start saving.

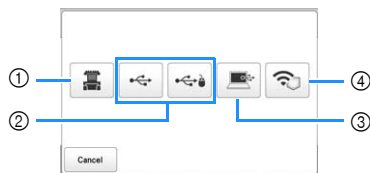

- 1 Save to the machine's memory.
- 2 Save to the USB media. The pattern is saved in a folder labeled [bPocket].
When saving the embroidery pattern in a USB media, insert the USB media into the USB port on the machine.

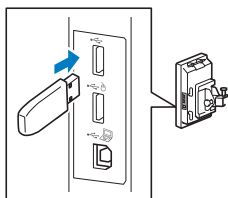

- 3 Save to the computer.
When saving the embroidery pattern to a computer, connect a computer and the machine by using the included USB cable. Plug the included USB cable into the USB ports on the machine.

- Select the pattern's .phx file in "Removable Disk" and copy the file to the computer.

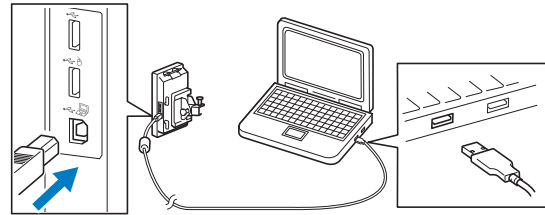

- 4 Save the pattern to the computer via the wireless network connection. For detailed procedures, refer to PE-DESIGN manual (version 11 or later).

Retrieving embroidery patterns

- 1 Touch the desired destination, and then select the desired embroidery pattern.

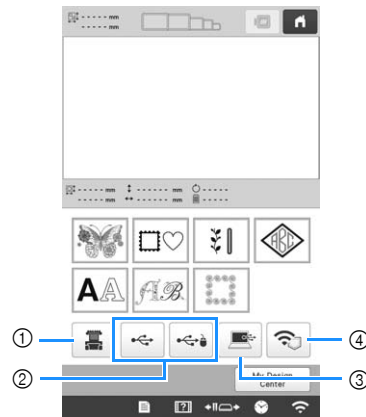

- 1 Retrieve from the machine's memory.
- 2 Retrieve from a USB media.
When retrieving the patterns from a USB media, insert the USB media into the USB port on the machine.
- 3 Retrieve from a computer.
When retrieving the patterns from a computer, use the included USB cable to connect the computer and the machine. Plug the USB cable connector into the corresponding USB ports for the computer and for the machine.
- 4 Retrieve the pattern via the wireless network connection.
For detailed procedures, refer to PE-DESIGN manual (version 11 or later).

Memo

- If the embroidery pattern to be retrieved is in a folder of the USB media, touch the key for that folder. Touch **Back** to return to the previous screen.

- 2 Touch **Set**.



- * To save embroidery patterns to another memory, touch **Memory**, and then select the desired destination.
- * Touch **Delete** to delete the embroidery pattern.

Connecting the USB using the included USB cord clamps

When connecting the machine to a computer, use the included USB cord clamps to keep the cord away from the carriage.

Included cord clamps



Installation positions of the USB cord clamps

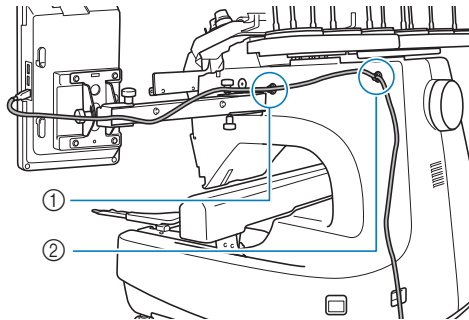

- ① Front screw hole on the side of the machine
- ② Rear screw hole on the side of the machine

1 Using the included Allen screwdriver, remove the protective cap covering the front screw on the side of the machine.

- Insert the end of the Allen screwdriver into the hole in the protective cap, and then lightly pull out the protective cap to remove it.

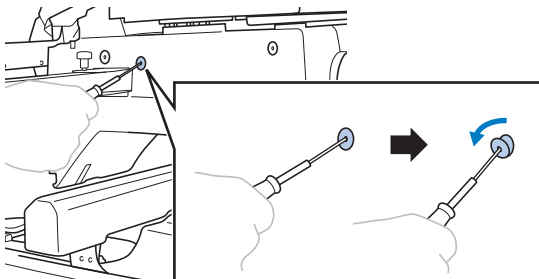

Note

- Do not insert the Allen screwdriver too far into the hole in the protective cap; otherwise, the machine or the Allen screwdriver may be damaged.

2 Open the USB cord clamp.

- With your fingernail, press on the tab to open the clamp.

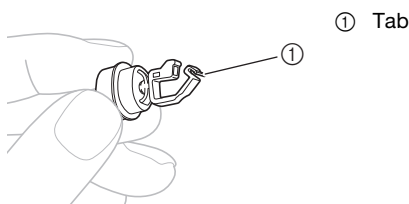

3 Hold the clip end of the USB cord clamp, and then firmly insert the other end into the screw hole where the protective cap was removed.

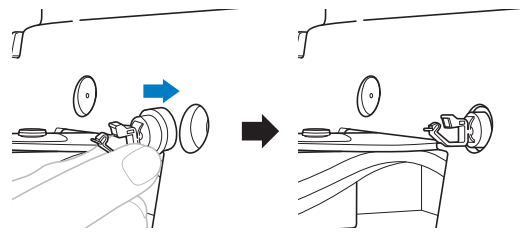

4 As described in steps 1 through 3, remove the protective cap from the rear screw hole on the side of the machine, and then insert an opened USB cord clamp.

5 Check that the USB cord clamps have been firmly inserted into the front and rear screw holes on the side of the machine.

- If the USB cord clamps are not firmly inserted into the screw holes, they are not correctly installed. Firmly insert the cord clamps into the screw holes.

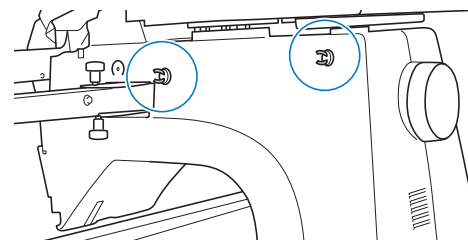

6 Pass the USB cable through the front USB cord clamp, and then close the clamp to secure the cable.

- When passing the USB cable through the clamp, do not insert it with excessive force; otherwise, the clamp may break.

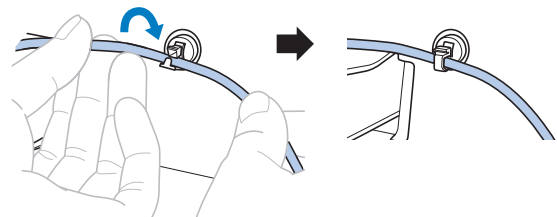

7 Using the same operation described in step 5, secure the USB cable with the rear USB cord clamp.

8 Arrange the USB cable between the USB cord clamps so that the cable does not interfere with the operation of the machine.

Memo

- Store the protective caps, which were removed in step 1, in the included accessory case so they will not be lost.

SENDING EMBROIDERY PATTERNS FROM A COMPUTER TO THE MACHINE (LINK FUNCTION)

This machine is compatible with the Link function. This function allows embroidery patterns edited in embroidery software with the Link function, such as PE-DESIGN NEXT or later, to be transferred from a computer to multiple machines. As many as 100 embroidery patterns can be transferred to a machine, and the embroidering status of the patterns being transferred can be viewed from the computer monitor.

Use the included USB cable or the wireless LAN function to connect the machine to a computer. To transfer patterns via the wireless network connection, use PE-DESIGN version 11.2 or later.

Operations available with the Link function

■ Send multiple embroidery patterns to connected machines

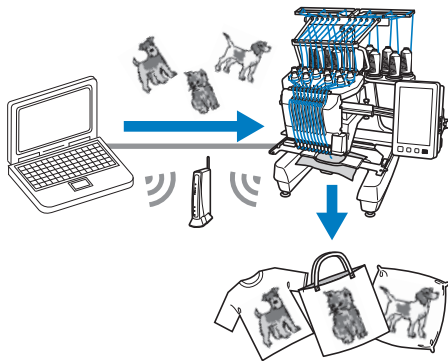

■ Check the embroidering status of the machine (this model) from the computer

(Example of multiple machines connected by the USB cable)

- A maximum of four machines can be connected.

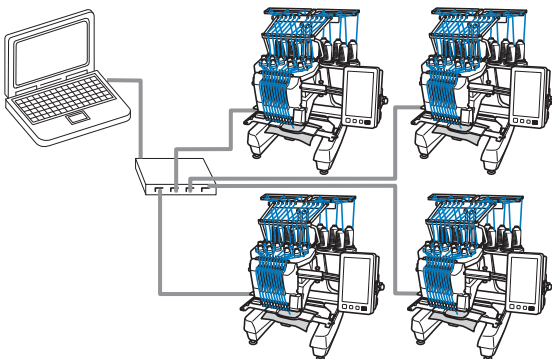

Memo

- When connecting multiple machines to the computer, use a commercially available USB hub. Please note that we recommend you use a self-powered USB hub. Do not use USB extension cables or repeater cables. For details on using the USB hub, refer to its operating instructions.

(Example of multiple machines connected by the wireless LAN function)

- A maximum of ten machines can be connected.

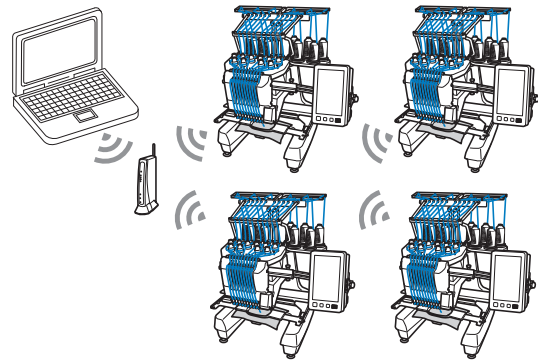

Embroidering using the Link function

First, use the embroidery editing software to create the embroidery pattern to be sent to the machine.

Note

- Embroidery data in the PES format (.pes) can be embroidered using the Link function.
- The Link function cannot be used with split (large-size) patterns. (page 135)
- Attach to the machine the embroidery frame for the size of the pattern to be sent.

1 Touch , then .
→ The general settings screen appears.

2 Locate [Link].

3 Touch and to select [USB cable] or [Wireless LAN].



4 Touch [ON] to enable the Link function.

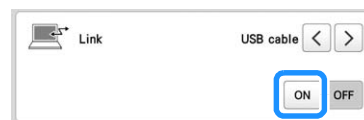

→ When the following message appears, touch .



Memo

- When the Link function by the USB cable connection is turned on while [Wireless LAN Enable] is set to [ON], the message to set [Wireless LAN Enable] to [OFF] appears.
- When the Link function by the wireless LAN connection is turned on while [Wireless LAN Enable] is set to [OFF], the message to set [Wireless LAN Enable] to [ON] appears.

5 Turn off the machine.

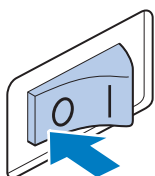

Note

- When you turn off the machine, wait for about 5 seconds before turning on the machine again.

6 Connect the machine to the computer.

- USB cable connection

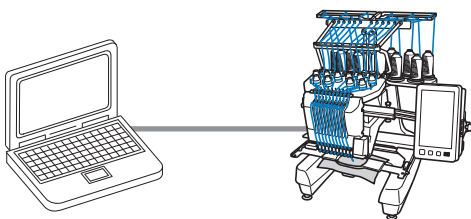

When connecting the machine to the computer, use the included USB cord clamps. (page 131)

- Wireless LAN connection

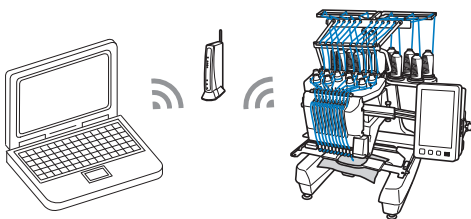

For details on the wireless LAN connection, refer to page 29.

7 Turn on the machine.

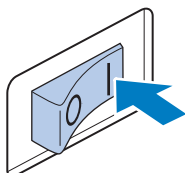

8 Using embroidery editing software with the Link function, such as PE-DESIGN NEXT or later from a computer, send the pattern to the machine in the Link mode.

9 When the following message appears, touch OK.

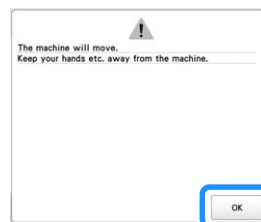

- USB cable connection
- Wireless LAN connection

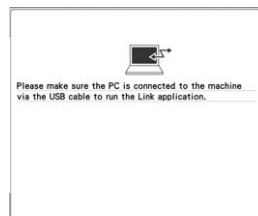

→ A message appears in the machine's LCD while the machine is connecting to computer.



Note

- For details on using the embroidery editing software, refer to the Instruction Manual included with it.



- * This Link dialog box is found in PE-DESIGN NEXT software.
- If the following error message appears, the type of embroidery frame installed on the machine is not compatible with the size of the pattern. Replace the embroidery frame with one compatible with the size of the pattern.



10 After the embroidery pattern has been opened by the machine, the embroidering screen appears.

→ The opened embroidery pattern appears in the pattern display area with the icon for the Link function.

- USB cable connection
- Wireless LAN connection

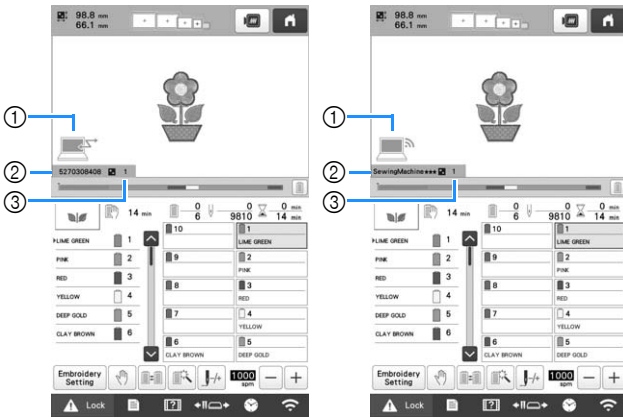

- | | |
|--------------------------------------|--------------------------------------|
| ① Icon for Link function | ① Icon for Link function |
| ② 10-digit machine ID | ② The machine's name |
| ③ Number of the pattern in the queue | ③ Number of the pattern in the queue |

Memo

- While the machine is connected to the computer, the machine's status can be displayed by using a function of the embroidery editing software. If multiple machines are connected at the same time, check the status of the machines using the 10-digit machine ID that appears in the machine's screen. The following information can be viewed from the computer.
 - Machine's status
 - Information on the embroidery data being embroidered and received by the machine (time until the next time that the machine stops, number of color changes, embroidering time, maximum embroidery speed, pattern size, size of frame being used on the machine)

11 To change the embroidering settings for the opened embroidery pattern, touch **Embroidery Setting**.

- Touch **OK** when the following message appears.
- Touch **Cancel** to return to the embroidering screen.

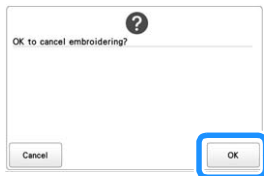

→ The embroidering settings screen appears.

12 After the desired settings have been specified, touch **Embroidery** to return to the embroidering screen.

- USB cable connection
- Wireless LAN connection

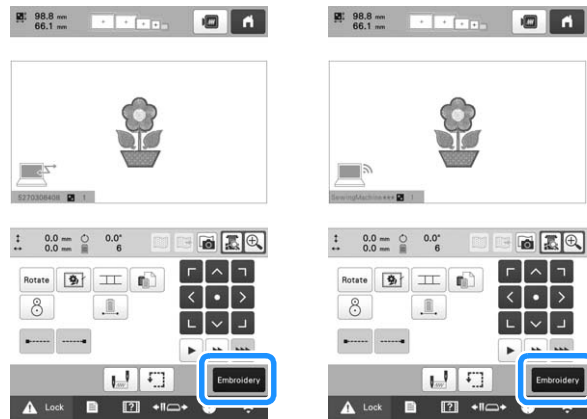

13 Touch **Lock**, and then press the "Start/Stop" button to start embroidering.

→ When embroidering is finished, the following message appears.



14 To open another pattern sent from the computer, touch **OK**, and then repeat the procedure starting from step 10 to continue embroidering.

To stop embroidering or to embroider the same pattern again, touch **Cancel**.



Note

- The embroidering screen settings specified in step 12 are saved even if **OK** was touched to continue embroidering after embroidering is finished.

Memo

- If the machine is turned off while it is embroidering, the resume operation can be used the next time it is turned on.

Disabling the Link function

- 1 Touch , then .
→ The general settings screen appears.
- 2 Locate [Link].
- 3 Touch [OFF] to disable the Link function.

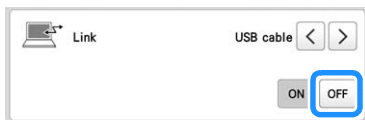

→ When the message to finish the Link mode appears, touch .

- 4 Turn off the machine.

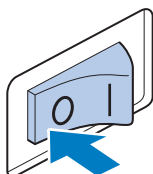

Note

- When you turn off the machine, wait for about 5 seconds before turning on the machine again.

EMBROIDERY APPLICATIONS

Embroidering split (large-size) patterns

Split (large-size) patterns created with PE-DESIGN version 7 or later can be embroidered. With large-size patterns, embroidery designs larger than the embroidery hoop are divided into multiple sections, which combine to create a single pattern after each section is embroidered.

For details on creating large-size embroidery patterns and for more detailed embroidering instructions, refer to the manual included with PE-DESIGN version 7 or later.

The following procedure describes how to read the large-size embroidery pattern shown below from USB media and embroider it.

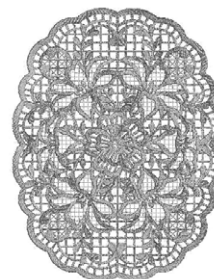

- 1 Connect to the machine the media containing the created large-size embroidery pattern, and then select the large-size embroidery pattern to be embroidered.

* For details on retrieving patterns, refer to page 130.

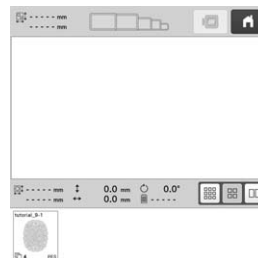

→ A screen appears so that a section of the large-size embroidery pattern can be selected.

2 Select section  to be embroidered, then touch

Set.

- Select the sections in alphabetical order.

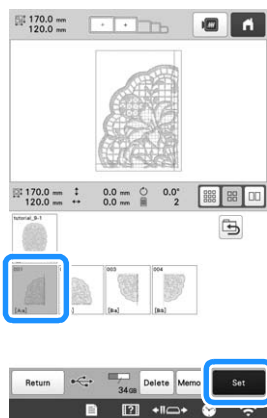

3 If necessary, edit the pattern. Then, touch **Edit End**.

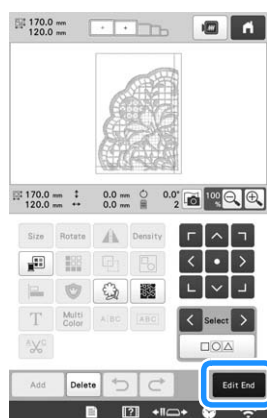

- For details, refer to “EDITING THE EMBROIDERY PATTERN” on page 44.

4 Confirm the pattern size, and then select the appropriate fabric and the embroidery frame.

- Be sure to select fabric of the size of combined pattern.

5 Hoop the appropriate part of the fabric. In this case, hoop upper-left part of the fabric.

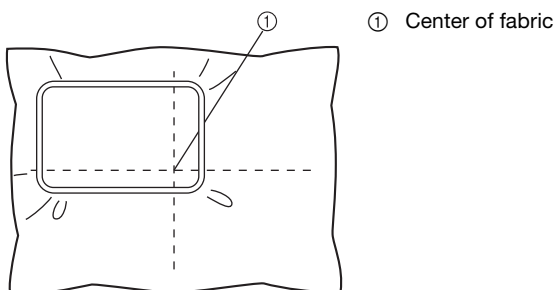

6 Touch **Embroidery**.

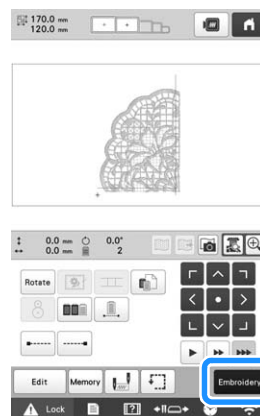

Memo

- The pattern can be rotated to either the left or right when **Rotate** is touched.

7 Touch **Lock**, and then press the “Start/Stop” button to embroider the pattern section.

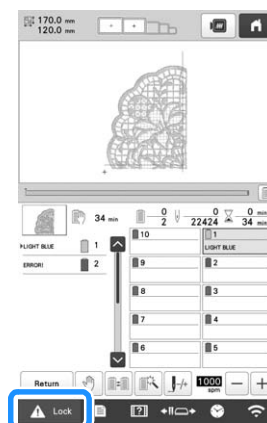



Note

- The last step of the stitching of the pattern section will be an alignment stitching. Use this stitching for placement of adjacent pattern section.

8 When embroidering is finished, the message to confirm to embroider the next part appears. Touch **OK**.

→ A screen appears so that a section of the large-size embroidery pattern can be selected.

- 9 Touch  to select the next section of the pattern, and then touch .

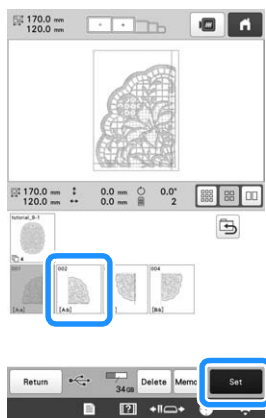

- 10 Touch , and then .

- 11 Hoop the fabric for the next design section aligning on the alignment stitching. In this case, align the left side of the hoop on the right side of the design section embroidered in step 6.

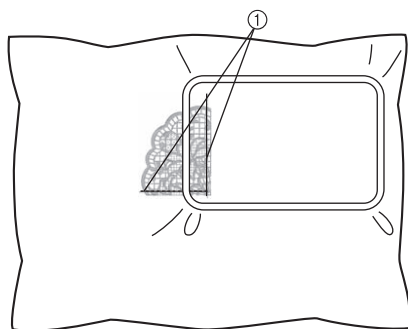

① Alignment stitching

 **Note**

- Make sure that the alignment stitching is completely within the embroidery field. Set the embroidery sheet inside the embroidery frame and align the grid with the alignment stitching for easier placement.

- 12 Repeat steps 7 to 10 to embroider and combine the remaining sections of the pattern.

INSTALLING THE INCLUDED WIDE TABLE

CAUTION

- Be sure to install the wide table when using the optional magnetic sash frame, jumbo frame, border frame, quilt frame or flat frame. If these frames are used without the wide table installed, the weight of the frame and fabric may cause the frame to slant and result in poor embroidering quality.

 **Note**

- When carrying the wide table, be sure to hold it with both hands.
- Attach the wide table to the machine before installing the embroidery frame.
- Do not place heavy objects on top of the installed wide table or press down on it.
- Remove the wide table from the machine while using embroidery frame that do not need to be used with the wide table or while embroidering tubular items, bags or caps. The embroidery frames for these types of objects cannot be installed while the wide table is attached to the machine.

- 1 Loosen the two thumb screws 5 to 6 turns.

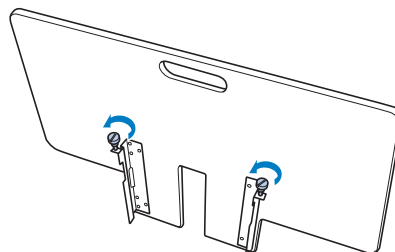

- 2** Position the wide table so that the notch at the center aligns with the machine bed, and then place the wide table flat on the guide plates.

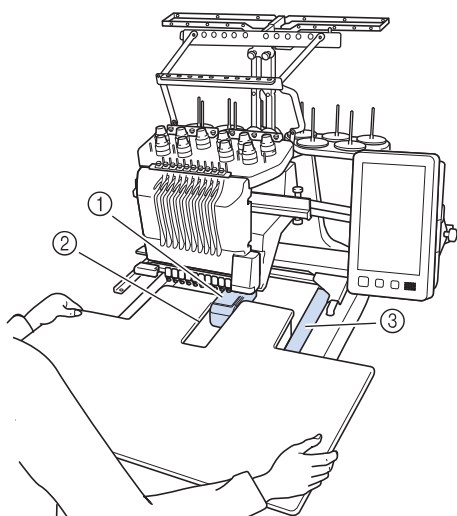

- ① Machine bed
- ② Guide plate
- ③ Notch in wide table

- 3** Pull the wide table toward you until the pins on the mounting brackets (attached on each side to the bottom of the wide table) fit into the notches in the guide plates.

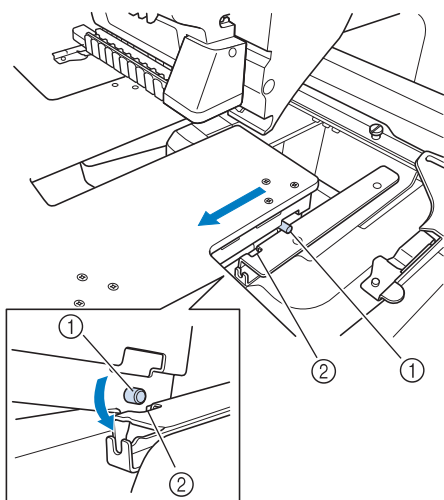

- ① Pin
- ② Notch

- 4** Slide in the wide table while supporting it so that it remains level. Push the wide table in until it lightly touches the machine.

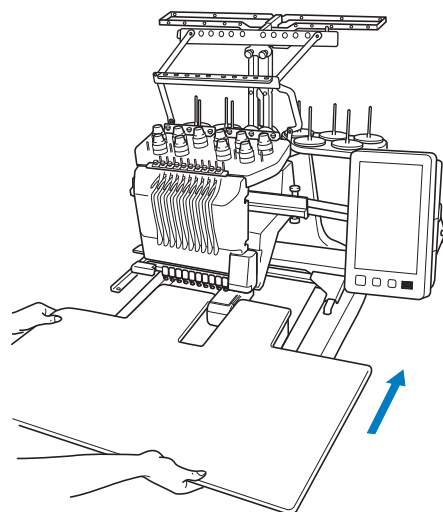

- If the wide table does not move smoothly, slightly lift it up, and then slide it in.

- 5** While looking below the wide table, lightly lift it up, and then lower it so that the screw fits into the notch at the front of the guide plate.

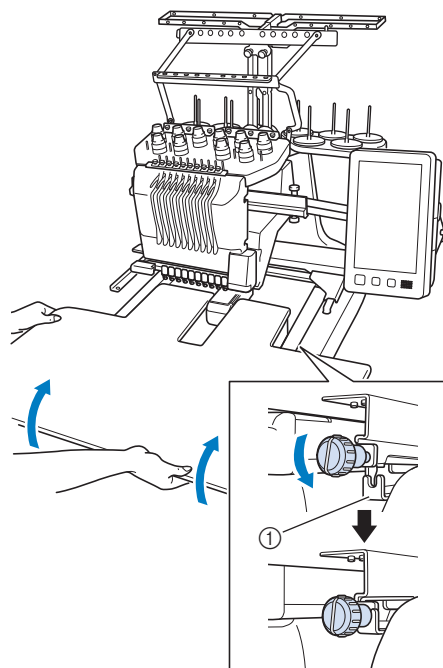

- ① Notch at front

- 6 Tighten the two thumb screws so that the wide table is secured.

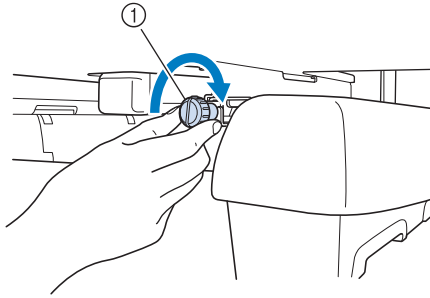

① Thumb screw

Removing the wide table

- 1 Loosen the two thumb screws, lift up the wide table, and then pull it off toward you.

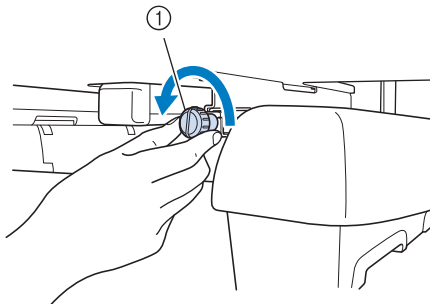

① Thumb screw

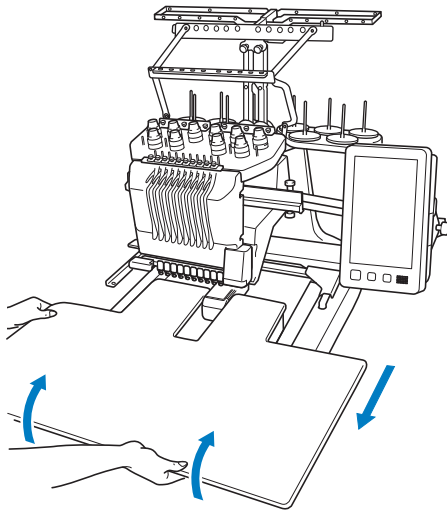

- 2 After the pins on each side reach the notches in the guide plates, raise the wide table to lift the pins up through the notches.

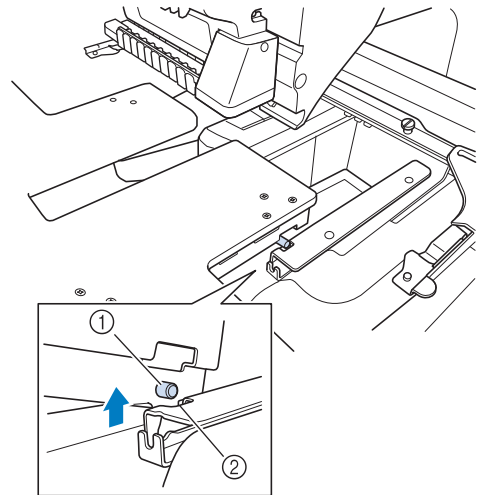

- ① Pin
- ② Notch

→ Remove the wide table from the machine.

- 3 Carefully pull out the wide table so that it does not hit the machine.

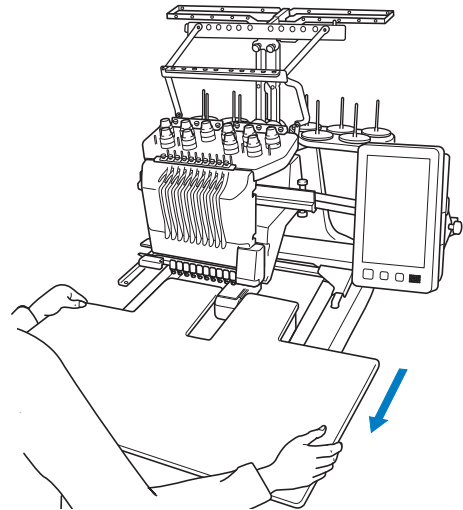

- 4 Tighten the thumb screws on the wide table.

3

EMBROIDERY PATTERNS FOR THE OPTIONAL JUMBO FRAME

Patterns can be created in embroidery editing software version PE-DESIGN NEXT or later to be used with the Jumbo frame (optional).

When using the jumbo frame you must also use the included wide table (PRWT1).

When a jumbo frame pattern is created in embroidery editing software, the pattern is automatically divided into two sections that can be combined into a single embroidery design when it is embroidered with the jumbo frame. When the jumbo frame is used, embroidery with a maximum size of 350 mm × 350 mm (14 inches × 14 inches) can be embroidered without having to shift the fabric within the frame.

For details on creating jumbo frame patterns, refer to the Instruction Manual provided with the embroidery editing software version PE-DESIGN NEXT or later. After the jumbo frame pattern has been created, follow the procedure described below to transfer the pattern to the machine using external connection and begin embroidering.

Jumbo frame patterns consist of a set of two patterns. To be able to use them as a jumbo frame pattern, do not save them in the machine's memory.

1 Connect the device containing the jumbo frame pattern to this machine, and then select the jumbo frame pattern from the pattern selection screen.

- * For details on retrieving the pattern, refer to page 130.

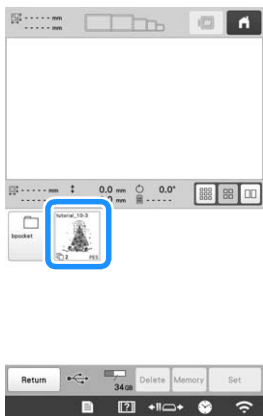

2 Touch to select the first section of the pattern to be embroidered, and then touch .

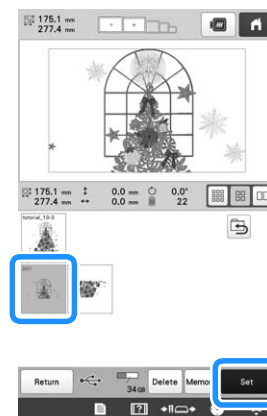

Note

- Before you start embroidering the jumbo frame pattern, prepare the optional jumbo frame.
- Contact your authorized Brother dealer for purchasing the optional jumbo frame.



- After hooping fabric or a garment, make sure that the inner frame is lower than the outer frame so that the frame sits flat against the extension table.

3 Check the size of the pattern, and then hoop fabric that is large enough in the optional jumbo frame.

- * For details on attaching the optional jumbo frame, refer to "Hooping the fabric in the embroidery frame" on page 62.

Note

- When hooping the fabric, position it within the embroidery frame so there is at least 10 mm (3/8 inch) of space to the inside of the frame.

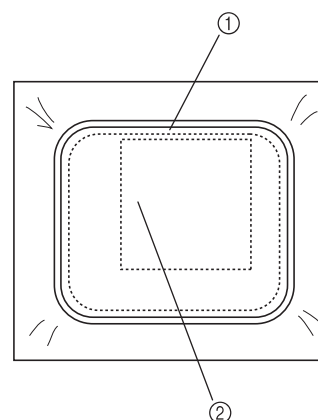

- ① more than 10 mm (3/8 inch)
- ② Location where the pattern is to be embroidered

4 Attach the jumbo frame to the machine.

5 Touch **Embroidery**.

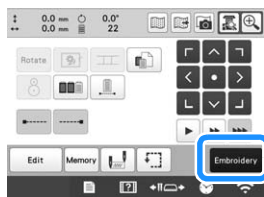

Note

- When you change the embroidering position using the jumbo frame, be sure to be aware of the size of the combined pattern. You cannot change the position exceeding the embroidery area.

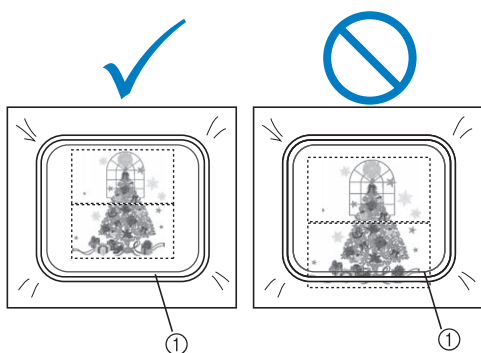

① Embroidery area

6 Touch **Lock**, and then press the “Start/Stop” button to start embroidering the first section of the pattern.

7 After embroidering of the first section of the pattern is finished, the message to confirm to embroider the next part appears. Touch **OK**.

8 An image of the needle location appears in the screen with the positioning detection area framed by a red line. Affix an embroidery positioning sticker so that it fits within the red line, and then touch **OK**.

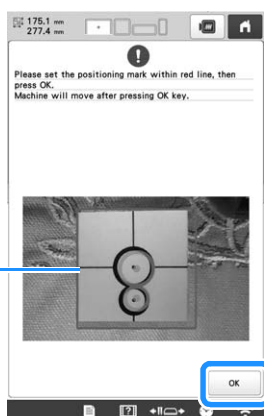

① Red line

- The positioning detection area is under the built-in camera.

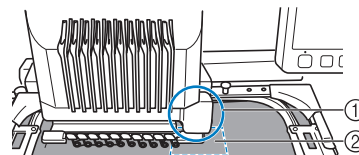

- ① Built-in camera is in this box.
- ② Affix the sticker in this area.

9 When the machine's built-in camera has finished detecting the location of the embroidery positioning sticker, the following message appears.



Note

- If the built-in camera cannot detect the location of the embroidery positioning sticker, the message that could not recognize the embroidery positioning sticker appears. Touch **OK**, and then perform the procedure again starting from step 8.

10 Remove the jumbo frame from the machine, turn the frame around, and then attach it to the machine.

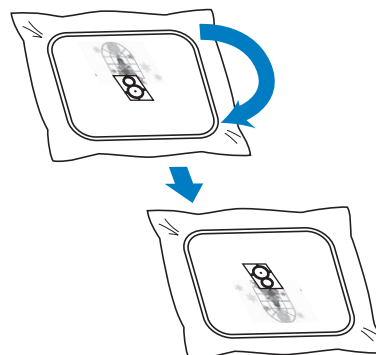

11 Touch **OK**, then the machine starts to detect the location of the embroidery positioning sticker.

12 When the machine's built-in camera has finished detecting the location of the embroidery positioning sticker, the following message appears. Touch **OK**.

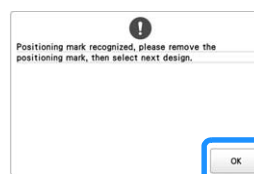



Note

- If the built-in camera cannot detect the location of the embroidery positioning sticker, the following error message appears. Touch **OK**, return the jumbo frame to its previous orientation, and then perform the procedure again starting from step 8.

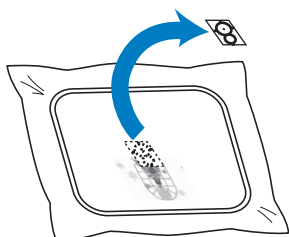

- 13 Remove the embroidery positioning sticker from the fabric.



- 14 Touch  to select the next section of the pattern to be embroidered, and then touch **Set**.

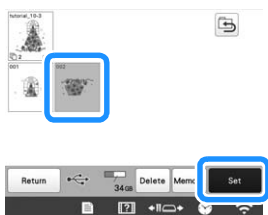

- 15 Touch **Embroidery**.

- 16 Touch  **Lock**, and then press the "Start/Stop" button to start embroidering the next section of the pattern.

USING THE OPTIONAL BOBBIN WINDER

When winding the bobbin thread onto a metal bobbin, use the optional bobbin winder. The procedures for using the optional bobbin winder are described below.

Precautions



For precautions concerning the power supply, refer to page 22.

CAUTION

- Be sure to place the bobbin winder on a level, stable surface.
- Be sure to use the bobbins supplied with this bobbin winder.

Optional bobbin winder and its accessories

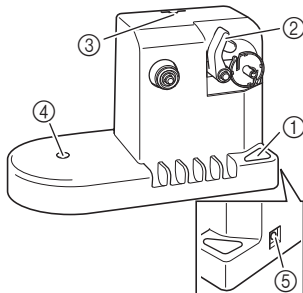
Check that the following bobbin winder and accessories are included. When the part code is "*", contact your authorized Brother dealer.

	Part Name
	Part Code
1.	Bobbin winder
	PRBW1
	<ul style="list-style-type: none"> ① Main power switch ② Bobbin winder shaft ③ Hole for thread guide ④ Hole for spool pin ⑤ DC input connector
2.	Spool pin
	XC5949-051
3.	Spool cushion
	XA0679-050

	Part Name
	Part Code
4.	Thread guide
	XC6644-151
5.	AC adapter
	*
6.	Power supply cord
	*
7.	Metal bobbin × 5
	100376-051
8.	Spool cap
	130012-057
9.	Weight (L)
	XC5974-151
10.	Weight (S)
	XC6631-051

 **Memo**

- The part code of the bobbin winder set may differ depending on the country/area where the machine was purchased.
- Depending on the model you purchased, the bobbin winder may be included with the machine.

Setting up the optional bobbin winder

1 Insert the spool pin and the spool cushion.

Lower the holder, and then insert the spool pin straight into the hole. And insert the spool cushion.

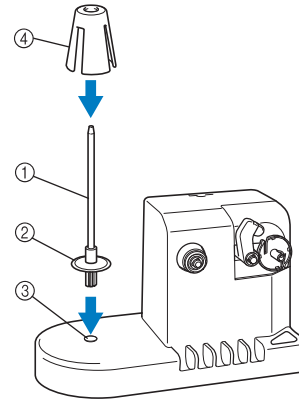

- ① Spool pin
- ② Spool pin holder
- ③ Hole for spool pin
- ④ Spool cushion

2 Insert the thread guide.

Insert the thread guide straight into the hole with the pins on the thread guide aligned with the notches on the sides of the hole.

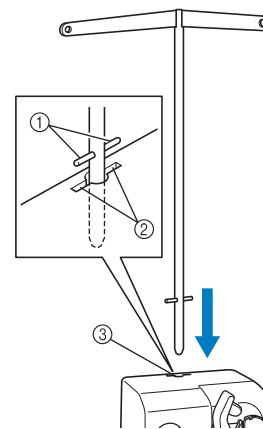

- ① Pins on thread guide
 - ② Notches on hole for thread guide
 - ③ Hole for thread guide
- Firmly insert the thread guide as far as possible and make sure that it is secure.

Connecting the AC adapter

- 1 Insert the plug of the power supply cord into the AC adapter.

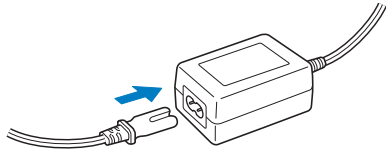

- 2 Plug the cord on the AC adapter into the DC input connector of the bobbin winder, and then insert the plug of the power supply cord into a household electrical outlet.

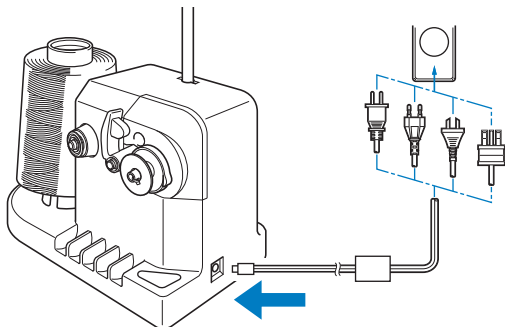

- Be sure to firmly insert the plug on the AC adapter into the DC input connector of the bobbin winder.

⚠ CAUTION

- Be sure to use the included AC adapter and power cord of the bobbin winder.
- Before connecting or disconnecting the AC adapter, be sure that the unit is not operating.
- After using the bobbin winder, disconnect it from the electrical outlet.

Winding the bobbin

Prepare the bobbin and the spool of bobbin thread. Use cotton or spun polyester bobbin thread (from 74 dtex/2 to 100 dtex/2).

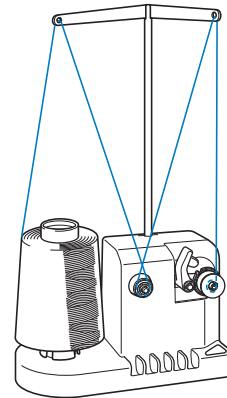

- 1 Align the groove in the bobbin with the spring on the bobbin winder shaft, and set the bobbin on the shaft.

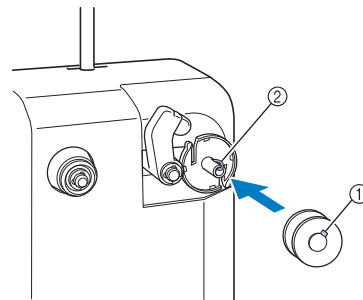

- ① Groove in the bobbin
- ② Spring on the shaft

- 2 Set the thread spool on the spool pin.

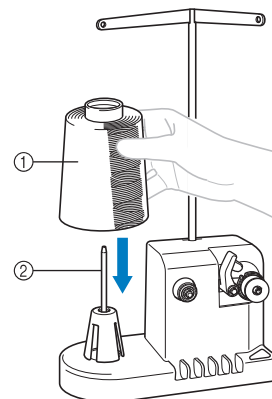

- ① Thread spool
- ② Spool pin

Note

- When using a small spool, remove the spool cushion and set the spool directly onto the spool pin. Also use the included spool cap to keep the small spool stable.

- 3** Pass the thread through the hole in the left of the thread guide toward the front of the winder.

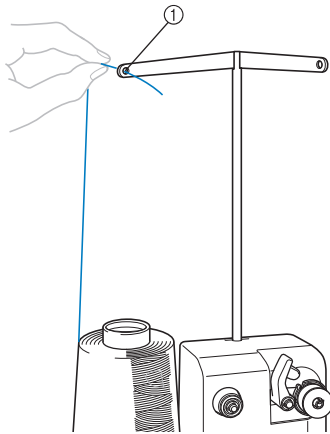

① Hole in the thread guide

- 4** Pass the thread around the tension disc as shown in the illustration. Make sure that the thread is correctly fed into the tension disc.

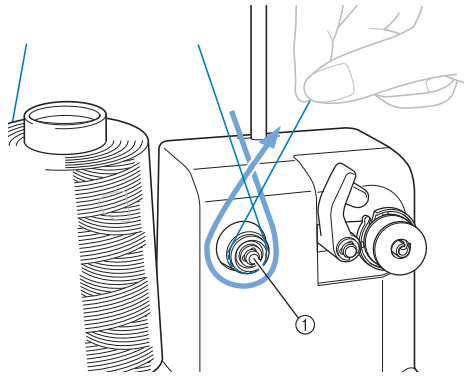

① Tension disc

- 5** Pass the thread through the hole in the right of the thread guide toward the back of the machine.

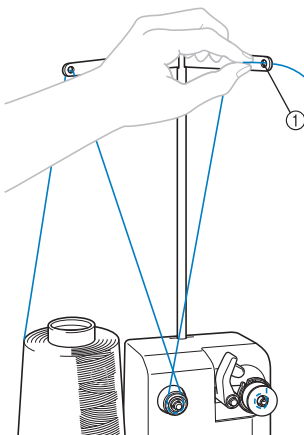

① Hole in the thread guide

- 6** Wind the thread clockwise around the bobbin 4 or 5 times, as shown in the illustration.

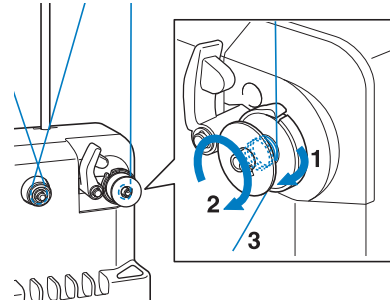

- 7** Pass the end of the thread through the guide slit in the bobbin winder seat, and pull the thread. The cutter will cut the thread.

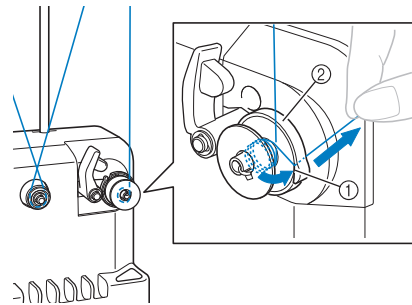

- ① Guide slit
② Bobbin winder seat

Note

- Be sure to follow the procedure described. If the bobbin is wound without the thread being cut with the cutter, when the bobbin thread runs low, the thread may become tangled around the bobbin and cause the needle to break.

- 8** Slide the bobbin holder, until it clicks into place.

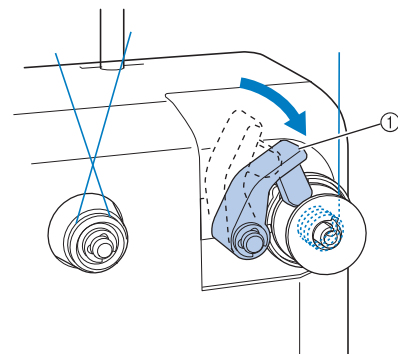

① Bobbin holder

3

- 9 Press the main power switch to start winding the bobbin.

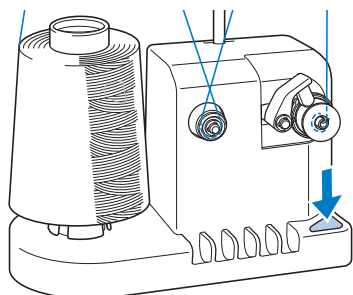

→ Start winding the bobbin.

- 10 The bobbin will stop rotating automatically when it is done winding, and the bobbin holder will return to its original position.

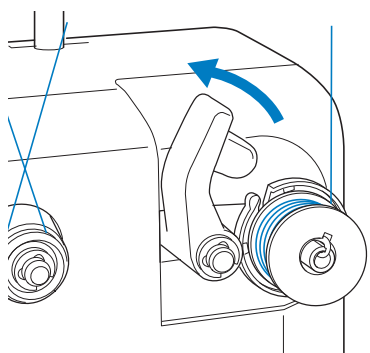

- 11 Remove the bobbin.

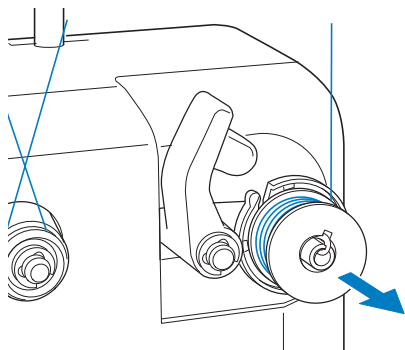

Note

- When removing the bobbin, do not pull on the bobbin winder seat. Doing so could loosen or remove the bobbin winder seat, resulting in damage to the bobbin winder.

- 12 Pull the thread through the guide slit in the bobbin winder seat to cut the thread with the cutter.

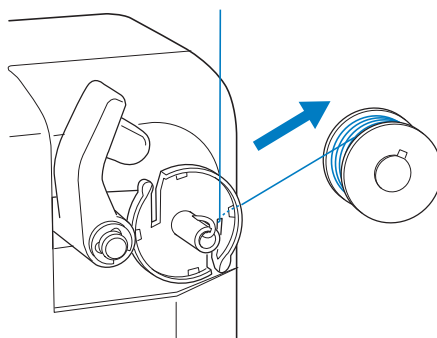

CAUTION

- Check that the bobbin thread has been wound correctly, otherwise the needle may break or the thread tension will be incorrect.

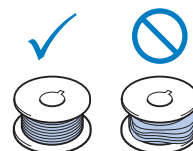

- Be sure to clean the bobbin case each time that the bobbin is changed. For details, refer to "Cleaning the bobbin case" on page 175.
- Be sure to check the tension of the bobbin thread each time that the bobbin is changed. For detailed instructions on how to adjust the bobbin tension, refer to page 116.

■ If bobbin winding is stopped before it is finished

The bobbin winder stops automatically if the thread does not feed, for example, if it becomes tangled on the spool pin. If this occurs, correctly thread the bobbin winder, and then wind the bobbin correctly.

Chapter 4 MY DESIGN CENTER

ABOUT MY DESIGN CENTER

With My Design Center, you can use the functions listed below:

- Hand-drawn functions - create embroidery patterns by drawing on the LCD screen
- Scanning functions - create embroidery patterns by not only scanning drawings /illustrations with built-in camera, but also importing data from USB media or computer.

You can also combine patterns that you have created with the machine's built-in patterns.

Start My Design Center by touching  in the pattern type selection screen.

PATTERN DRAWING SCREEN

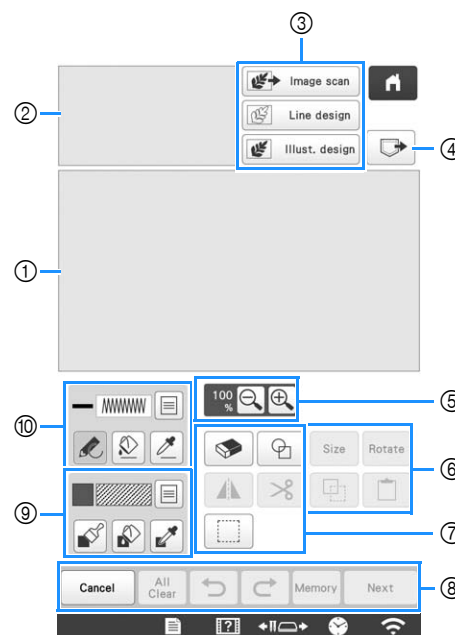





















- ① Pattern drawing area
- ② Pattern preview area





Memo

- The actual dimension of the pattern area is the size of the embroidery frame, which is 360 mm × 200 mm (approx. 14 inches × 7-7/8 inches). The pattern you drew may be bigger than you expected. Please resize the pattern after converting the design to the embroidery pattern.
- When the pattern is enlarged so that only a part of it appears in the pattern drawing area, the entire pattern is displayed in the pattern preview area. The red frame in the pattern preview area indicates the part of the pattern displayed in the pattern drawing area. Move the red frame in the pattern preview area with the touch pen or your finger to display the corresponding area in the pattern drawing area.

■ Key Functions

No.	Display	Explanation	Page
	Key Name		
③	 Image scan	Scan the attached frame and display on the screen as the background while using the My Design Center. You can scan the fabric as the background or scan the picture as the reference when creating the pattern.	158
	Image scan key		
	 Line design	Scan the line drawing to edit and convert to the embroidery data using the built-in camera. You can also import the line drawing image from USB media or computer and create the embroidery design.	160
	Line design key		
	 Illust. design	Scan the illustration to edit and convert to the embroidery data using the built-in camera. You can also import the illustration from USB media or computer and create the embroidery design.	162
	Illustration design key		
④		Recall pattern data created with My Design Center from the machine's memory, USB media or the computer.	—
	Recall key		
⑤	 100% 	Magnify the pattern.	151
	Magnify key		
⑥		Rotate the selected section.	—
	Rotate key		
		Change the size of the selected section.	164
	Size key		
		Paste in the previously duplicated or cut section.	—
	Paste key		
		Duplicate the selected section. The temporarily positioned section can immediately be rotated, enlarged, reduced or moved.	—
Duplicate key			

No.	Display	Explanation	Page
	Key Name		
⑦		Select the stamp shape for pattern drawing.	152
	Stamp key		
		Erase lines and shapes that have been drawn. You can select the size/shape of the eraser.	153
	Eraser key		
	Flip the selected section horizontally.	—	
Horizontal mirror image key			
		Cut out the selected section.	—
	Cut key		
		Select a section by finger or pen for moving, copying, deleting, changing size and rotating lines and shapes that have been drawn.	153
	Select key		
⑧		Continue to the stitch settings screen.	—
	Next key		
		Store the pattern being created.	—
	Memory key		
		Redo the operation that was undone with the undo key. Each touch of this key will redo one operation.	—
	Redo key		
		Undo the last operation that was performed and return to the previous state. Each touch of this key will undo one operation.	—
	Undo key		
	Clear all the lines and shapes and start from the beginning. The background image is also cleared.	—	
All clear key			
	Exit from the My Design Center. All lines and shapes are erased when you touch this key.	—	
Cancel key			

No.	Display	Explanation	Page
	Key Name		
⑨		Paint with brush and set the color. You can select the brush type, fill type and color as you need. Painted lines and areas will be converted to the pattern embroidered with fill stitch. Touch  to pick up the color and fill type from a region in the pattern within the pattern drawing area. The picked up color is shown as the currently selected region color beside the button and as the selected color in the Region Property screen.	151
	Brush tool key		
⑩		Draw lines and set the color. You can select the line type, stitch type and color as you need. Touch  to pick up the color and stitch type from a line in the pattern within the pattern drawing area. The picked up color is shown as the currently selected line color beside the button and as the selected color in the Line Property screen.	149
	Line tool key		



Before creating designs

Select the center point marker or grid lines setting for [Frame Display] to apply the frame display to the pattern drawing area of My Design Center.

For details on the types of embroidery frames and grids available, refer to “Changing the display guides” on page 123.

Memo

- The frame type cannot be changed in the settings screen.

- 1 Attach the frame to be used.**
- 2 Touch , then .**
→ The embroidery settings screen appears.
- 3 Select the grid line of the [Frame Display].**

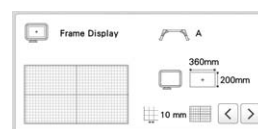
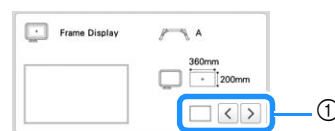

- ① Grid types
* Select the grid size 10 mm (3/8 inch) or 25 mm (1 inch).



Drawing lines

- 1 Touch  and draw lines.**

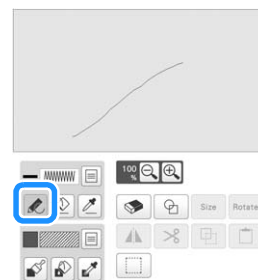

Memo

- When  is touched, all regions will be displayed in the background to clarify the drawing lines on the screen.

■ Setting the line types, stitch types and colors

You can set or change the line types, stitch types and colors anytime. You can also specify the line types, stitch types and colors before drawing lines.

- 1 Touch  to set the line types, stitch types and colors.

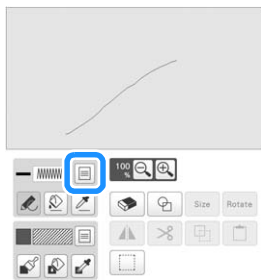



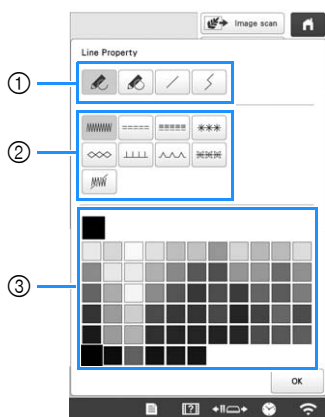

→ The settings screen appears.













- ① Line types
- ② Stitch types
- ③ Line color selection: touch the color palette to activate the drawing pen color.

Line types

	Freehand line with the end open.
	Freehand line closing the end automatically.
	Straight line with one stroke
	Straight line changing directions to the point you select. If the end point is created near the start point, a closed object will be created.

Stitch types

	Zigzag stitch
	Running stitch
	Triple stitch
	Candlewicking stitch
	Chain stitch
	E stitch
	V stitch
	Select motif stitches Displays motif stitch selection screen, where  can be touched to select a pattern.
	Line without stitch for creating a region. Created region will be defined by the gray line.

- 2 Touch  to return to the pattern drawing screen.

→ The color bar on the line tool key is changed to the selected color.

- * The appearance of the line does not change even if the stitch type was changed. The specified stitch type can be checked in the stitch settings screen.

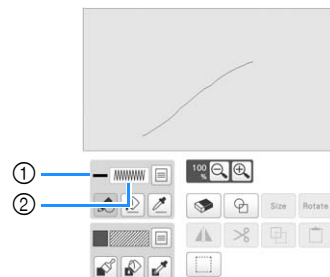



- ① Color bar
- ② Stitch type

- 3 Touch , and then touch on the line to change its color.

→ The connected line will be changed to the selected color.

Memo

- Touch  to magnify the image when you cannot touch on the line correctly.
- Touch , and then select a color within the pattern drawing area to apply the same color to other lines or parts of the pattern.

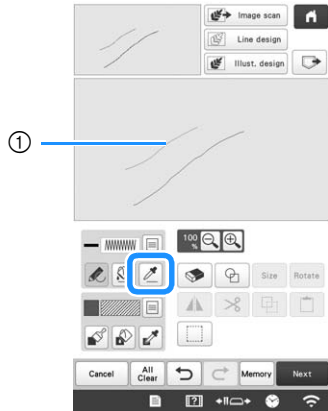

① Use  to select the line color.

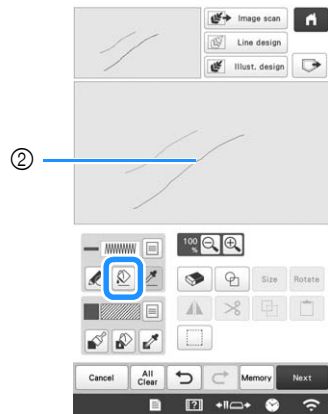

② Touch  for changing the line color, and then select the pattern to be changed.

Drawing regions

1 Touch  and draw with brush.

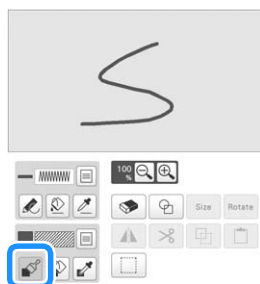

Setting the brush types, fill patterns and fill colors

1 Touch  to set the brush types, fill patterns and fill colors.

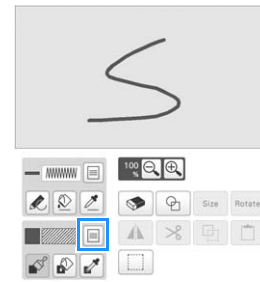



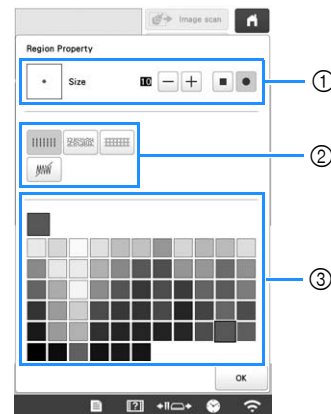



→ The setting screen appears.







- ① Brush types
- ② Fill stitch types
- ③ Fill color selection: touch the color palette to activate the paint brush color.

Brush shapes/sizes

	Square brush	
	Round brush	

To select the brush size, touch  or .

Fill stitch types

	Fill stitch
	Stippling stitch
	Decorative fill stitches Displays a stitch selection screen, where  can be touched to select a stitch.

Select  when you don't want fill stitches.



2 Touch to return to the pattern drawing screen.

→ The color bar on the brush tool key is changed to the selected color.

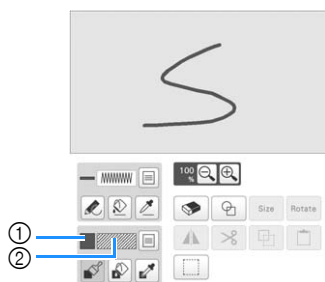

- ① Color bar
- ② Fill stitch type
- * If a stippling pattern or decorative fill pattern has been specified, the settings are displayed.

3 Touch and touch on the brush line to change color and fill stitch type. You can also set the color and fill stitch type of a closed region made of the line.

Memo

- Touch to magnify the image when you cannot touch on the fill correctly.
- Touch , and then select a pattern color in the pattern drawing area to apply that fill color to other patterns.

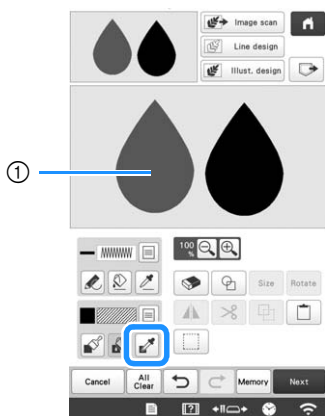

① Use to select the fill color.

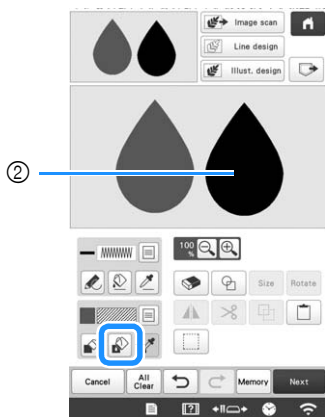

② Touch for changing the fill color, and then select the pattern to be changed.

Using the stamp key

1 Touch .

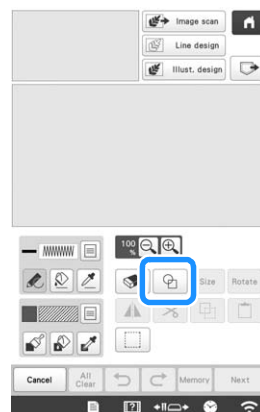

2 Select a stamp type and stamp shape.

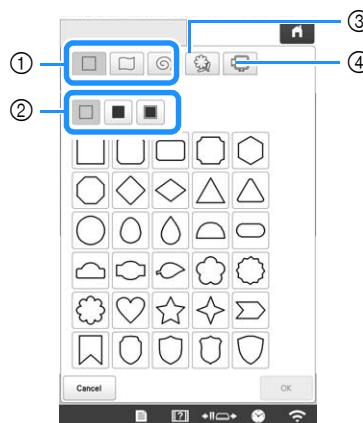

- ① Stamp shapes
- ② Stamp types
- ③ Saved outlines
- ④ Frame embroidering areas

Stamp shapes

	Basic shapes
	Closed shapes
	Open shapes

Stamp types (Only for Basic shapes)

	Outline
	Fill stitch
	Outline and fill stitch

* Select the outline () , fill stitch () , or outline and fill stitch () of a basic shape.

Saved outlines

	Embroidery pattern outlines can be registered as stamp shapes. When registering stamp shapes, select from the last six embroidery patterns used. If more than six shapes are registered, the oldest one is automatically erased. For details on registering a stamp shape, refer to “Decorative stitching around a pattern in embroidery (a quilting function)” on page 170.
---	--



Frame embroidering areas

	The shape of the embroidering area for the selected embroidery frame is displayed.
---	--

* Touch  to return to the pattern drawing screen.

3 Touch  to set the selected stamp.

→ The pattern drawing screen appears.

* You can change size of, rotate or move the shape right after you create it by touching  or .

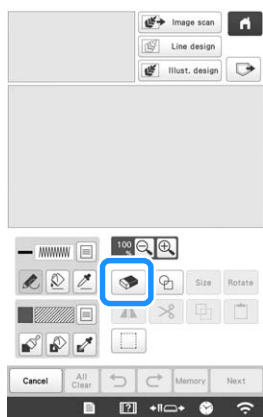

Using the erase key

1 Touch .



2 Select the shape of the eraser.



→ To select the eraser size, touch  or .

3 Drag along the area or line that you want to erase while the key appears as .

Using the select key



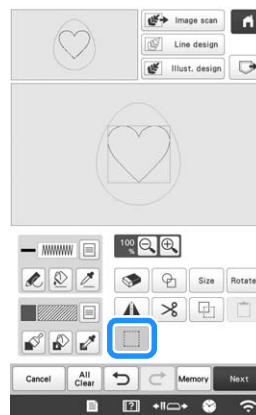

You can select the part of the design to move and/or edit. Some keys are available only after you select the part.

1 Touch .



2 Select the method for selecting an area.



	Box selection	Selects all objects within the box that is drawn.
	Polygonal shape selection	Selects all objects within the polygonal shape that is drawn.
	Freestyle curve selection	Selects all objects within the curved line that is drawn.
	Automatic selection	Selects the pattern that is touched. This allows you to select only a single line or only the outer pattern of a donut shape.
	Select all	Selects all patterns.



3 Select the area you want to edit, and then touch



* To select an area you want to edit, hold the touch pen at a point on the screen and drag the touch pen to create the red box around your selected area to be edited.

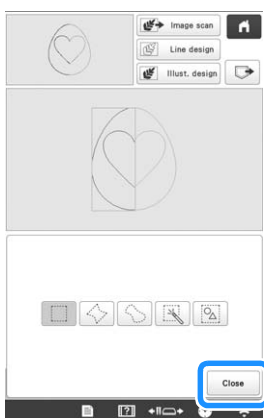

4 Edit the design with available keys. (page 148)

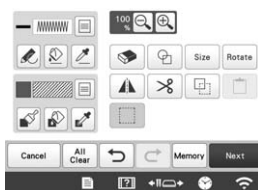

5 Touch **Next, and then specify the stitch setting.**

STITCH SETTINGS SCREEN

Before creating the embroidery pattern, specify the stitch settings. Lines of the design are embroidered with various stitches and regions are embroidered with fill stitches or stippling stitches. Stitching of the regions was already selected in “Drawing regions” on page 151, so specify values of detailed settings.

After specifying the settings, touch **OK** to create the embroidery pattern.

Specifying individual stitch settings

Select a pattern in the stitch settings screen to specify its line and region stitch settings. If multiple patterns are selected, the settings are applied to those patterns.

1 Use **< **>** to select the line or region to be changed.**

→ Each touch of **<** **>** moves the highlighting of the selected pattern in order.

Line settings

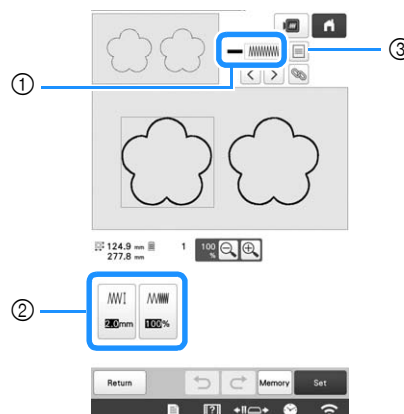

- ① Shows the stitch type and color for the selected line.
- ② Shows/Changes the stitch settings for the selected line.
- ③ Choices for stitch type and color of selected line.

Line stitch settings

Select the type of stitching you want applied to your line art.

Zigzag stitch



[Zigzag width]	Specifies the width of the zigzag stitches used to embroider the lines of the design.
[Density]	Specifies the density of the zigzag stitches used to embroider the lines of the design.

Running stitch /Triple stitch



* Both includes an under embroidery.

[Run Pitch]	Specifies the length of the stitch.
-------------	-------------------------------------





Candlewicking Stitch 

 [Size]	Increases/reduces the size of the stitch.
 [Spacing]	Specifies the spacing of the candlewicking stitch.





Chain stitch 

 [Size]	Increases/reduces the size of the stitch.
 [Thickness]	Sets repeated embroidering at the same part.



E stitch 

 [Stitch Width]	Increases/reduces the size of the stitch.
 [Spacing]	Specifies the spacing of the E stitch.
 [Thickness]	Sets repeated embroidering at the same part.
 [Flip]	Specifies the decorative line showing up to the inside or to the outside.

V stitch 

 [Stitch Width]	Increases/reduces the size of the stitch.
 [Spacing]	Specifies the spacing of the V stitch.
 [Thickness]	Sets repeated embroidering at the same part.
 [Flip]	Specifies the decorative line showing up to the inside or to the outside.

Motif stitch 



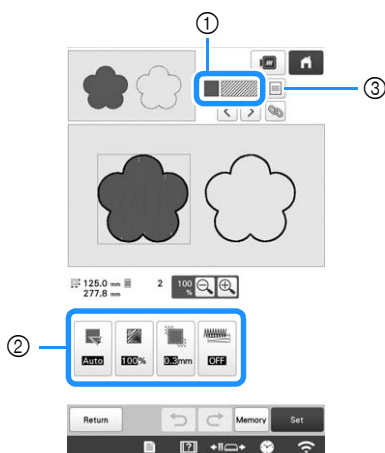

 [Size]	Increases/reduces the size of the stitch.
 [Spacing]	Specifies the spacing of the motif stitch.
 [Flip]	Specifies the decorative line showing up to the inside or to the outside.

■ Region Settings







- ① Shows the stitch type and color for the selected region.
- ② Shows/Changes the stitch settings for the selected region.
- ③ Choices for stitch type and color of selected region.







Fill stitch settings 

 [Direction]	Specifies the embroidering direction. Select [Manual] to change to the desired direction of fill stitch.
 [Density]	Specifies the stitch density of fill stitch.
 [Pull compensation]	Specifies to correct the shrinkage of the pattern by slightly shortening or lengthening the stitching. Change the setting after you test embroidering the pattern and can check the shrinkage.
 [Under sewing]	Select if you need or do not need the under embroidery for the stabilized fabric.

Stippling stitch settings 

 [Run Pitch]	Specifies the length of a stitch of the stippling stitch.
 [Spacing]	Specifies the spacing between the stitches when embroidering the stippling stitch.
 [Distance]	Specifies the offset from the pattern outline.
 [Stitch]	Specifies the stitch type.

Decorative fill stitch settings 

 [Size]	Increases/reduces the size of the pattern.
 [Direction]	Specifies the rotation angle of the pattern.
 [Outline]	Select whether [ON] or [OFF]. The outline is also converted to embroidery data. If [ON] is selected, the number of thread jumps can be reduced.
 [Random shift]	Randomly varies the line.
 [Position Offset]	Specifies the reference point for the pattern.
 [Thickness]	Sets repeated embroidering at the same part.

- 2 Select the setting to be changed, and then change the setting in the screen that appears. (In this example, the embroidering direction will be changed.)

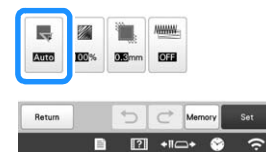

→ The setting screen appears.

- 3 Touch **Manual**, and then use **-** **+** to change the direction.

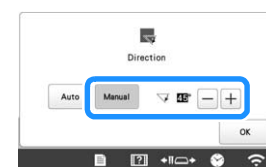

- 4 Touch **OK** to apply the setting.

* Change other settings in the same way.

Specifying global stitch settings

The same stitch settings can be changed at the same time for multiple patterns of the same type.

- 1 Use to select the stitch whose settings are to be changed, and then touch .

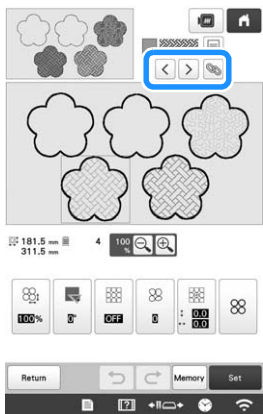

→ The same stitch type areas will be selected at the same time.

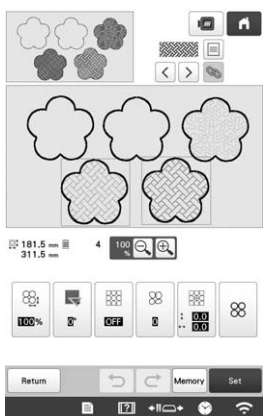

- 2 Follow steps 2 through 4 in "Specifying individual stitch settings" on page 154 to change the settings.
- 3 Touch , to display the embroidering settings screen.

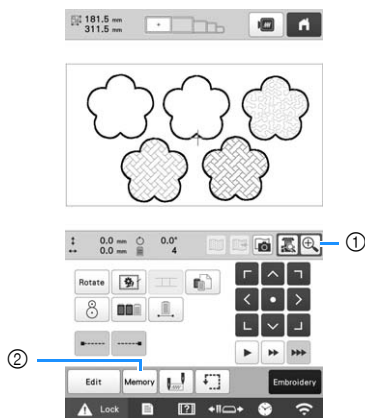

- 1 Touch to check an enlarged view of the pattern.
- 2 Touch to save the embroidery data.

MY DESIGN CENTER WITH SCAN

Memo

- The scanning frame is an optional accessory in some countries or regions.

Attaching the scanning frame

- 1 Prepare the desired drawing/illustration.

CAUTION

- To avoid having the embroidery foot strike the frame during the scanning process and possibly causing injury, check the following: the thickness of the fabric or paper, creases or folds in the fabric or paper that may be rolled up too close to the frame.

Memo

- 2 Position the paper to be scanned so that it is aligned with the lower-left corner, securing the paper in place with the magnets.
 - * Place the magnets at six locations around the paper to secure it, making sure that the line drawing is not covered.

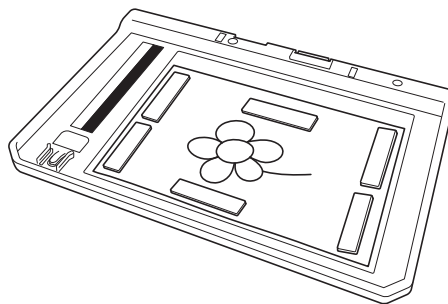

Note

- The scanning area is 300 mm × 200 mm (approx. 11-3/4 inches × 7-7/8 inches). There are scan area marks within the frame. Make sure that the paper is placed within the mark. Any part of the image that is outside the mark will not be scanned.

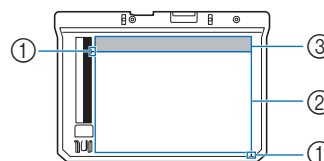

- ① 300 mm × 200 mm (approx. 11-3/4 inches × 7-7/8 inches) mark (maximum scanning field)
- ② Scan area
- ③ Outside the scan area

Memo

- If you want to scan an image from a small piece of paper that can't be held with the magnets, copy that image onto a larger piece of paper, and then place it on the scanning frame.

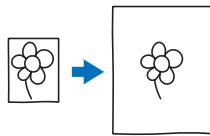

Note

- When placing the paper in the scanning frame, make sure that the white balance area is not hidden; otherwise, the drawing cannot be scanned correctly. At the same time, be sure to place the scan image within the scan area. The image out of the scan area will not be scanned.

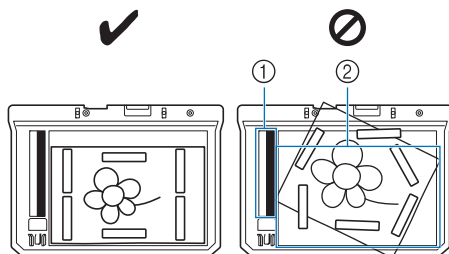

- ① White balance area
- ② Scan area

- Make sure that the white balance area or the scan area is not dirty or scratched; otherwise, the image cannot be scanned correctly.
- Use the magnets which are included with the scanning frame. If any other magnets are used, they may become attached to the machine during scanning, or other problems, such as a misaligned scan image, may occur.
- Be sure to place the magnets so that they secure the paper firmly. If the paper is placed unevenly, the image cannot be scanned correctly.
- If the scanning frame is dirty, wipe it with a cloth dampened with a diluted neutral detergent solution.

3 Remove the two thumb screws securing the embroidery frame holder, and then remove the frame holder from the machine.

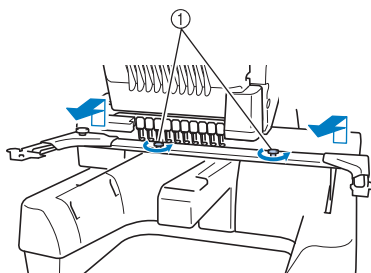

- ① Thumb screws

4 Install the needle plate cover included with the machine.

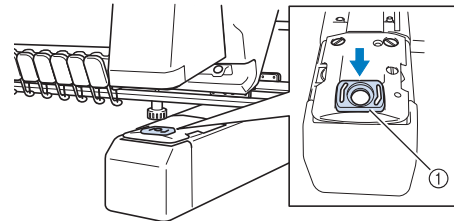

- ① Needle plate cover

5 Align the holes in the scanning frame with the pins on the frame-mounting plate of the carriage.

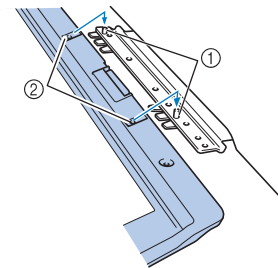

- ① Pins on the frame-mounting plate
- ② Holes in the scanning frame

6 Secure the scanning frame with the two thumb screws removed in step 3.

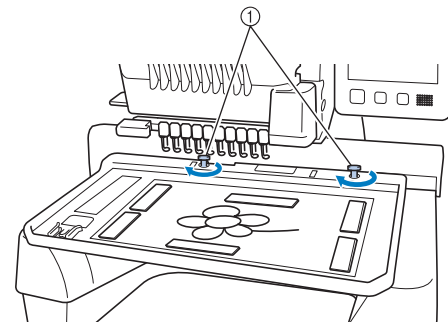

- ① Thumb screws

Scanning with an embroidery frame

Drawings and illustrations can also be scanned using an embroidery frame. Hoop the embroidery frame with fabric larger than the frame. Place the paper to be scanned on the fabric, and then secure it, with tape.

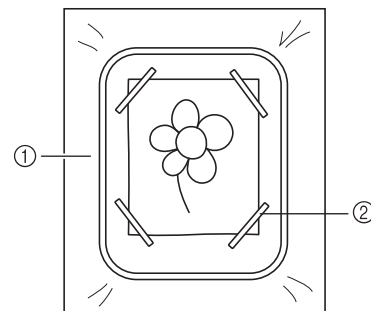

- ① Fabric
- ② Tape

Scanning to trace background image

If you have a favorite picture or drawing, it can easily be traced on the scanned background image and you can create your own pattern.

- 1 Touch  .

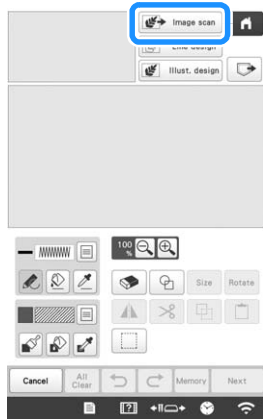

→ The image display screen appears.

- 2 Using the magnets, affix a picture to the scanning frame and attach the frame to the machine. Refer to “Attaching the scanning frame” on page 156.

- 3 Touch  .

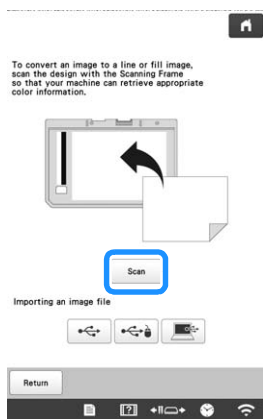

Note

- When scanning starts, some of the machine lights will turn off in certain circumstances, in order to increase the scan quality. The machine lights will return to their original brightness when scanning ends.

→ When the message to start scanning appears, touch





→ Scanning starts.

→ If the following message appears, remove the scanning frame, install the needle plate cover, and then re-install the scanning frame, and then touch

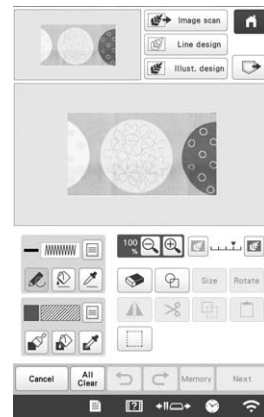

- 4 When scanning is finished, scanned image is displayed transparently in the pattern drawing area.





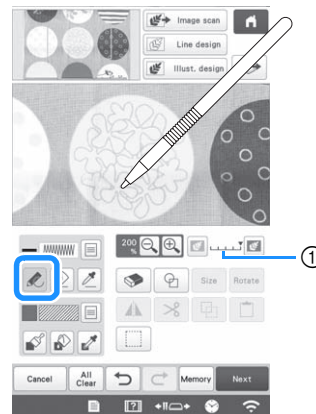

- 5 Using the included touch pen, touch , and then draw lines to trace the image.

* For details on drawing lines, refer to “Drawing lines” on page 149.



- ① Transparency adjustment

* Touch  or  to adjust the transparency of the background.

Each touch of  lightens the background, making the line pattern darker. Each touch of  darkens the background, making the line pattern lighter.

- 6 After editing the pattern, touch  to specify the settings for pattern.

- 7 Touch  to display the pattern editing screen.

■ Importing the background image

You can import an image as a background from computer or USB media.

1 Touch Image scan .

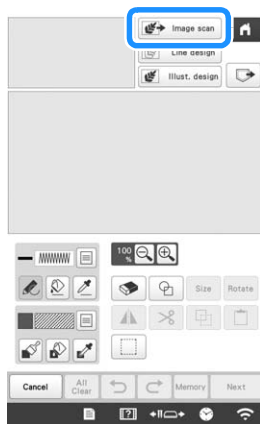

→ The image display screen appears.

2 Select the device you saved the data to.

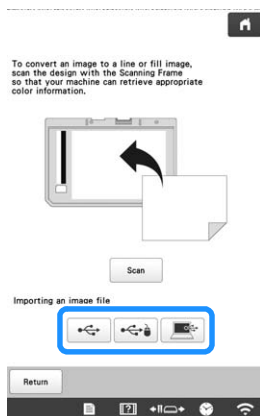

Note

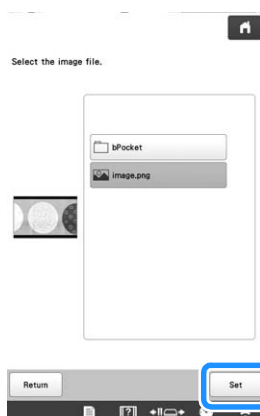

- You can import an image of 2 MB or smaller from computer or USB media.

3 Select the data, and then touch .

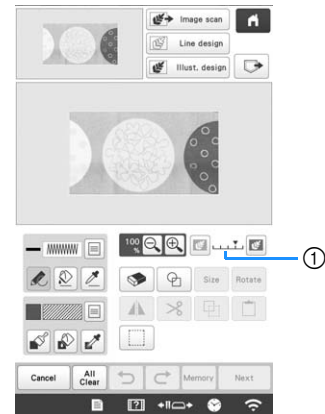

4 The selected image is displayed transparently in the pattern drawing area.



- * After the scanned image is converted to stitching, it appears as a background in the pattern drawing screen. Use gauge ① to adjust the transparency of the background. Each touch of  lightens the background, making the line pattern darker. Each touch of  darkens the background, making the line pattern lighter.

LINE SCAN

Custom patterns can be created from drawings. You can create patterns by scanning your drawings using the scanning frame* or importing an image from USB media or computer.

- * The scanning frame is an optional accessory in some countries or regions.

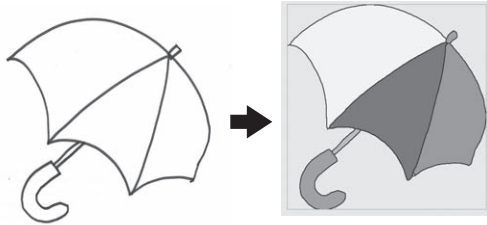

Recommended line drawings for Line Scan

- Line drawings must be drawn clearly using lines with approximately 1 mm (3/64 inch) thickness.
- Line drawings should be drawn in a strong contrast.
- If the lines are too short or gathered too densely, they will not be scanned correctly.

Note

- For details on creating patterns using color illustrations, refer to “ILLUSTRATION SCAN” on page 162.
- If you cannot scan the drawings as expected, you can edit the design in My Design Center. Refer to “PATTERN DRAWING SCREEN” on page 147.
- Line drawings are scanned without recognizing the thickness of lines. If you want to change the thickness of lines, specify in the settings screen. Refer to “STITCH SETTINGS SCREEN” on page 154.
- Line drawings are scanned as black lines. If you want to change the colors, specify in My Design Center. Refer to “Drawing lines” on page 149.

Using the scanning frame to create a pattern with Line Scan

- 1 Touch Line design .

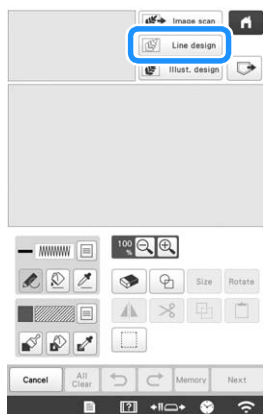

- When the background image has already imported, continue with step 3.
- When the background image has not imported, continue with step 2.

- 2 Touch Scan .

- * If you scan the image, make sure that the scanning frame is attached to the machine. (page 156)

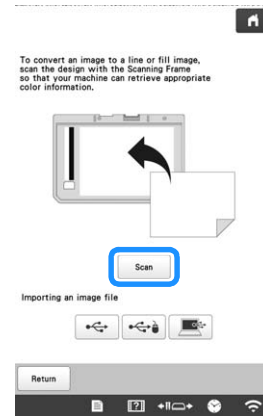

Note

- When scanning starts, some of the machine lights will turn off in certain circumstances, in order to increase the scan quality. The machine lights will return to their original brightness when scanning ends.
- You can import an image of 2 MB or smaller from USB media or computer.

- * To import an image from USB media or computer, touch , , or . (page 159)

→ When the message to start scanning appears, touch



→ Scanning starts.

- 3 When scanning is finished, specify the [Gray-Scale Detection level] on the screen if necessary.

The [Gray-Scale Detection level] can change the black and white threshold for the image.

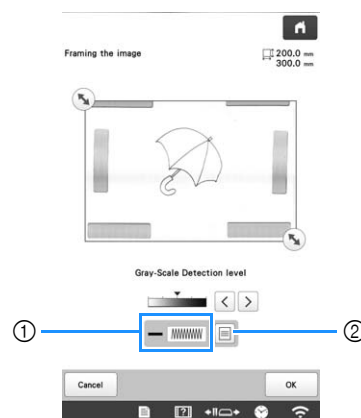

- ① Shows the stitch type and color of line.
- ② Choices for stitch type and color of line.

- * If you do not know how the settings should be changed, first continue the operation without specifying settings and check the results.

- 4 Move to frame the image for the pattern.

5 Touch **OK**.

→ The screen for confirming the converted image appears.

6 In the screen for confirming the converted image, you can adjust the [Gray-Scale Detection level], the line color and stitch type again, if necessary.

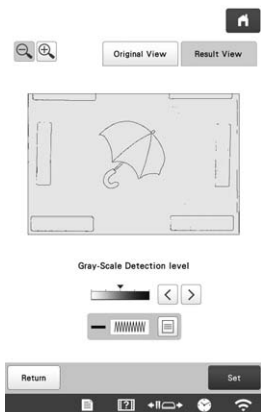

- * If you do not know how the settings should be changed, first continue the operation without specifying settings and check the results.
- * To display the image before being converted, touch

Original View. Compare the images before and after being converted, and then change the settings if necessary.



→ After changes to the settings described above have been applied, **Set** changes to **Retry**. Touch **Retry** to check that the image is as desired.

7 Touch **Set**.

→ The pattern drawing screen appears.

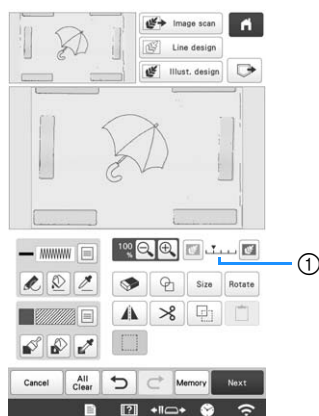
8 If necessary, edit the scanned image.



- * After the scanned image is converted to stitching, it appears as a background in the pattern drawing screen. Use gauge ① to adjust the transparency of the background. Each touch of  lightens the background, making the line pattern darker. Each touch of  darkens the background, making the line pattern lighter.

Note

- During scanning, the small dots that appear and unnecessary lines can be erased.

ILLUSTRATION SCAN

Custom patterns can be created from color illustrations. You can create patterns by scanning an illustration using the included scanning frame* or importing an image from USB media or computer.

* The scanning frame is an optional accessory in some countries or regions.

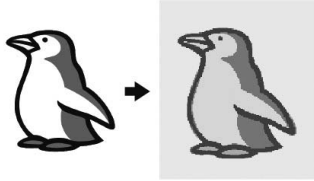

Recommended illustrations for Illustration Scan

- Illustrations that are clearly drawn, with no gradation, fading or blurriness.
- Illustrations that are at least a 5 mm (13/64 inch) square
- Illustrations that are extremely simple images

Using the scanning frame to create a pattern with Illustration Scan

1 Touch  Illust. design .



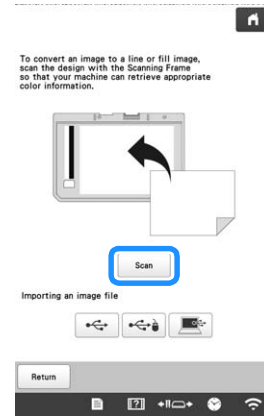

- When the background image has already imported, continue with step 3.
- When the background image has not imported, continue with step 2.

2 Touch  .



Note

- When scanning starts, some of the machine lights will turn off in certain circumstances, in order to increase the scan quality. The machine lights will return to their original brightness when scanning ends.

* To import an image from USB media or computer, touch ,  or  . (page 159)

→ When the message to start scanning appears, touch

 .

→ Scanning starts.

3 When scanning is finished, specify the necessary settings in the scan image confirmation screen.

Change the settings to adjust the image so it can easily be converted to the desired pattern.

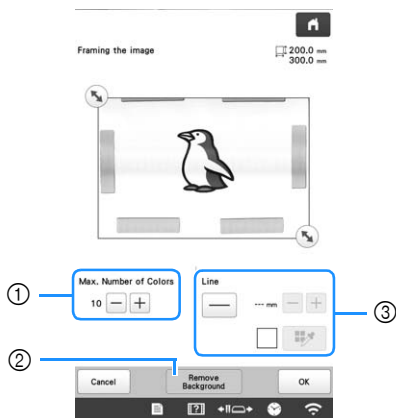

①	[Max. Number of Colors]	The number of colors in an image will be reduced less than the number specified here, and then the outline will be extracted.
②	[Remove Background]	Select whether or not the background color will be included as one of the colors.
③	[Line]	Select whether or not the outline will be detected as a line. A thick outline can also be detected as a region. When detected as a line, the line thickness and color can be specified.

Memo

- Touch to detect the outline. Line thickness can be specified from 1.0 mm (1/16 inch) to 5.0 mm (3/16 inch).

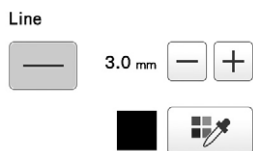

- Touch to select the outline color. Select by touching the color, or moving icon using



4 Move to frame the image for the pattern.

5 Touch .

→ The screen for confirming the converted image appears.

6 In the screen for confirming the converted image, adjust the image as necessary as in step 3.

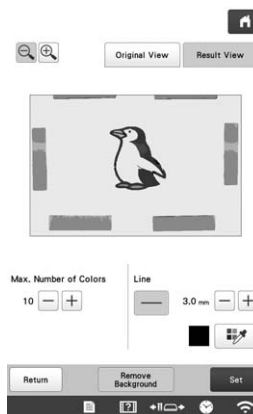

- * To display the image before being converted, touch . Compare the images before and after being converted, and then change the settings if necessary.

→ After changes to the settings described above have been applied, changes to . Touch to check that the image is as desired.

7 Touch .

→ The pattern drawing screen appears.

8 If necessary, edit the scanned image.

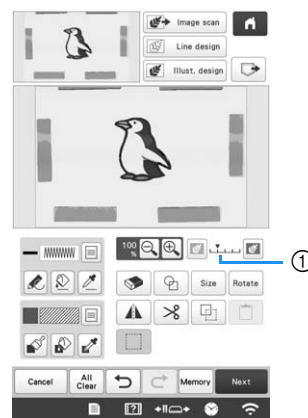

- * After the scanned image is converted to stitching, it appears as a background in the pattern drawing screen. Use gauge ① to adjust the transparency of the background. Each touch of lightens the background, making the illustration pattern darker. Each touch of darkens the background, making the illustration pattern lighter.

Note

- During scanning, the small dots that appear and unnecessary lines can be erased.

STIPLING

Basic stippling with My Design Center

Create a stippling design with the basic procedure.

Example:

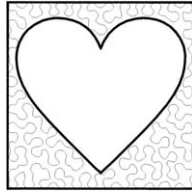

1 Touch **My Design Center**.

2 Touch .

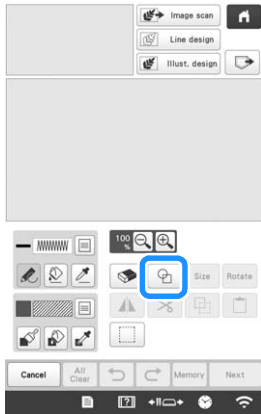

3 Select the square shape, and then touch **OK**.

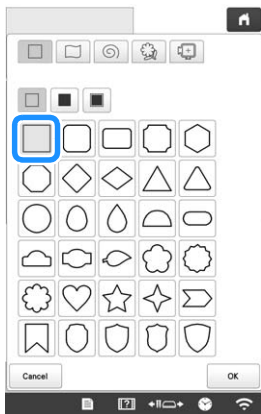

4 Touch .

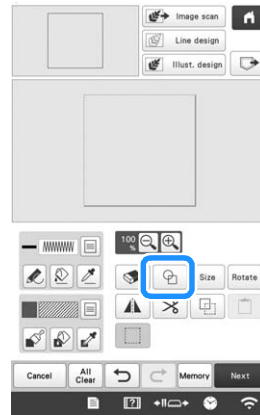



5 Select the heart shape, and then touch **OK**.



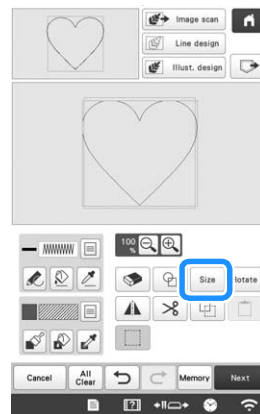

6 Touch **Size**.

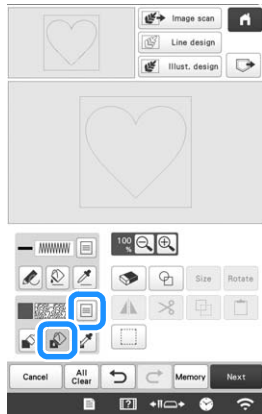

7 Touch  until the heart shape fits in the square shape, and then touch .

8 Touch , and then touch .



9 Touch , and then select the stitch color. Touch  after setting the color.

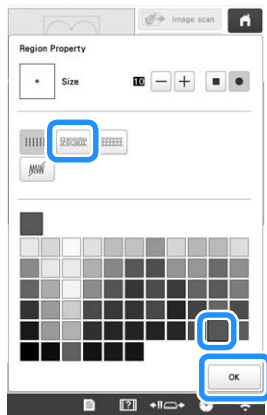

10 Select the area you want to set stippling effect.

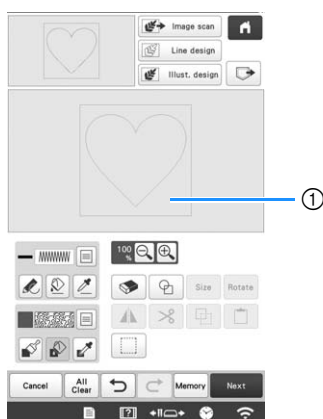

① Select this area.

11 Touch .

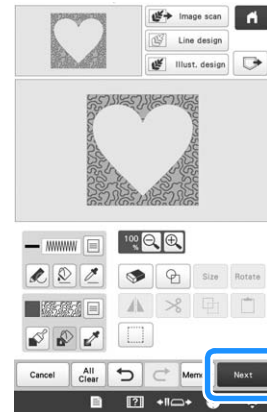

12 Adjust the stippling stitch settings to create the desired effect, and then touch .

* For details, refer to "Specifying individual stitch settings" on page 154.

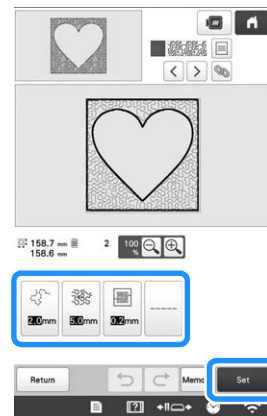

13 Follow the procedure described on "EDITING THE EMBROIDERY PATTERN" on page 44 to edit the pattern as desired.

Scanning drawing to create stippling pattern

Create a custom pattern with stippling design.

Example:

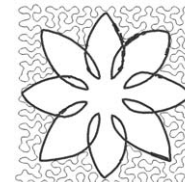

1 Place a drawing of your design on the scanning frame.

2 Touch .

3 Touch  Line design .

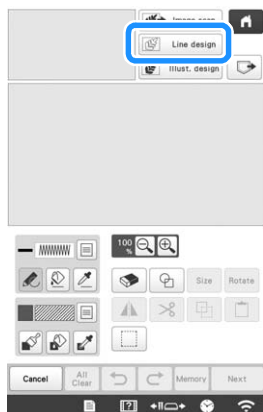

- When the background image has already imported, continue with step 5 .
- When the background image has not imported, continue with step 4 .

4 Position the scanning frame on the machine, and then touch  Scan .

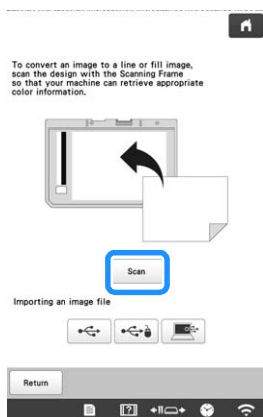



Note

- When scanning starts, some of the machine lights will turn off in certain circumstances, in order to increase the scan quality. The machine lights will return to their original brightness when scanning ends.
- You can import an image of 2 MB or smaller from USB media or computer.

→ When the message to start scanning appears, touch  .

→ Scanning starts.

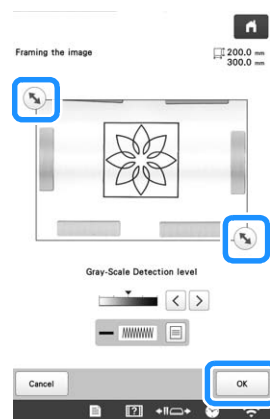

5 When scanning is finished, move  to frame the image for the pattern, and then touch  .



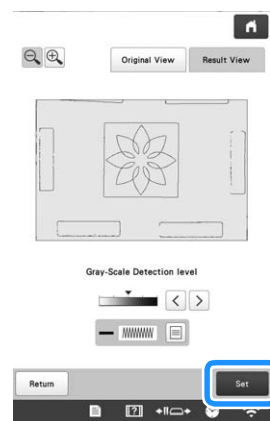

6 The screen for confirming the converted image appears, adjust the image if necessary and then touch  .

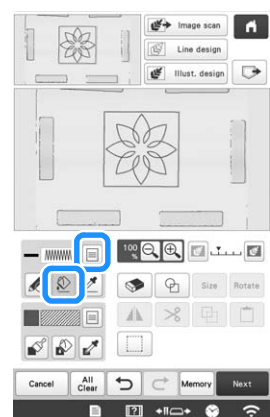

→ The pattern drawing screen is displayed.

7 To set the outline of the pattern, touch , and then  .



- 8 Touch  and then  .
This will set the outline without a stitch.

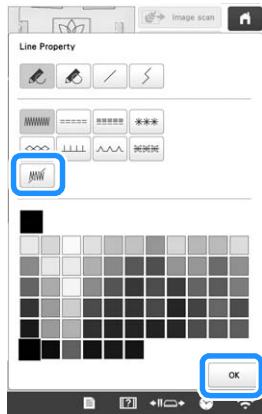

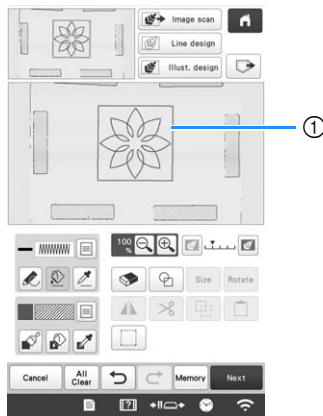

- 9 Select the outline of the pattern.

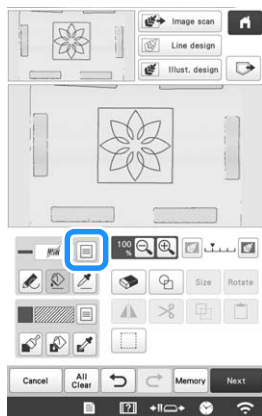

① Outline of the pattern

- 10 Touch  to select the color of the stitch around the stippling effect.



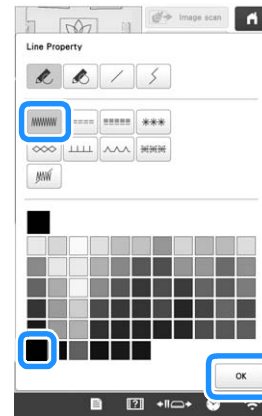

- 11 Touch  and select the stitch color, and then touch  .

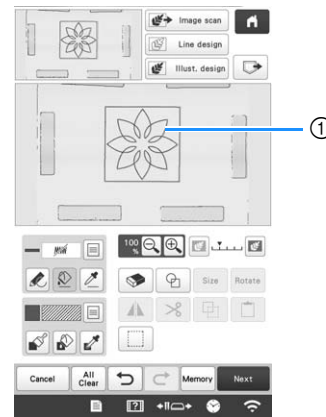

- 12 Select the stitch line around the stippling effect.



① Stitch line

- 13 To set the stitch color and fill stitch type, touch , and then  .

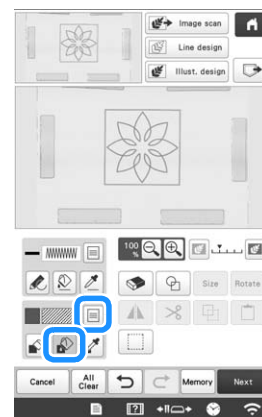

4

14 Touch , and then select the stitch color.

Touch  after setting the color.

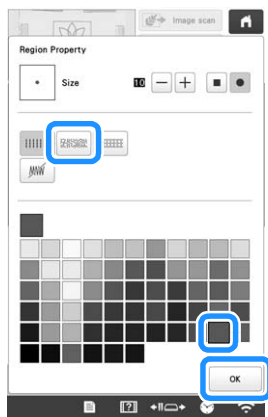

15 Select the area you want to set stippling effect.

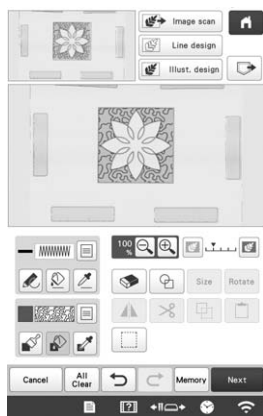

16 Follow the procedure from step 11 on page 165 of "Basic stippling with My Design Center".

Scanning fabric and stippling

Use the fabric pattern to coordinate with the stippling pattern.

1 Hoop the fabric in the embroidery frame.

2 Touch .

3 Touch .

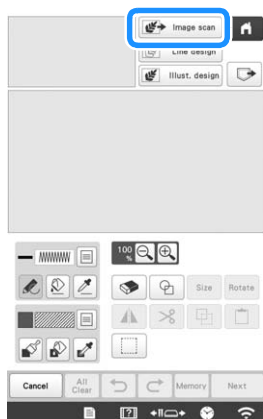

→ The image display screen appears.

4 Attach the embroidery frame on the machine, and then

touch .

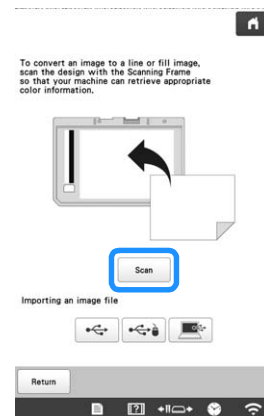

Memo

- Although the instructions in the LCD screen refer to the scanning frame, this example uses an embroidery frame for scanning.

Note

- When scanning starts, some of the machine lights will turn off in certain circumstances, in order to increase the scan quality. The machine lights will return to their original brightness when scanning ends.
- You can import an image of 2 MB or smaller from USB media or computer.

→ When the message to start scanning appears, touch

.

→ Scanning starts.

5 Touch .



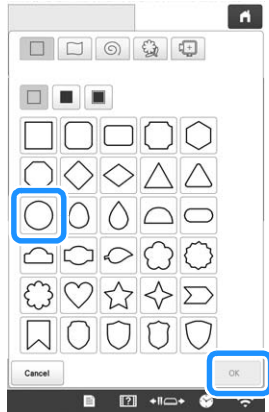

6 Select the circle shape, and then touch .



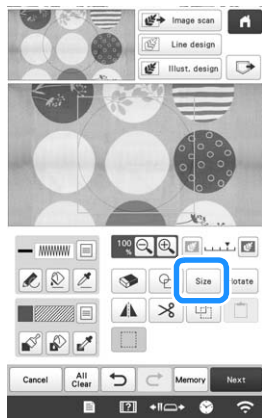

7 Touch  to increase or decrease the size of the circle.



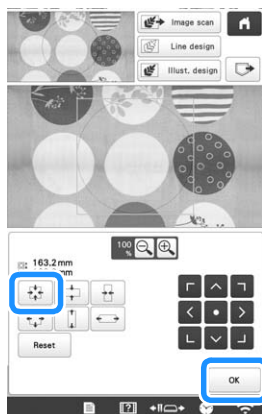

8 Touch  until the size of circle fits the pattern on the fabric, and then touch .

* Use  to align the position of the circle to the pattern on the fabric.

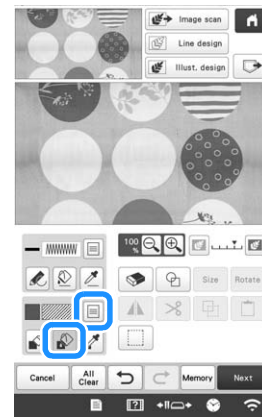

9 To set the stitch color and fill stitch type, touch , and then .



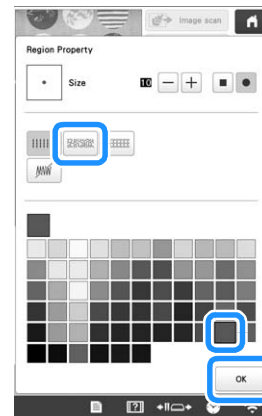

10 Touch , and then select the stitch color. Touch  after setting the color.

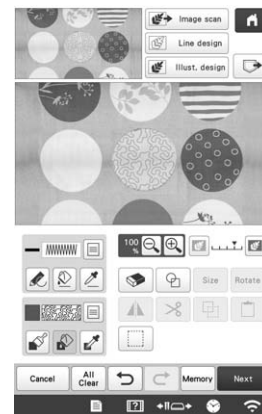

11 Select the area you want to set stippling effect.



4

- 12 To set the outline of the pattern, touch , and then .



- 13 Touch  and then . This will set the outline without a stitch.

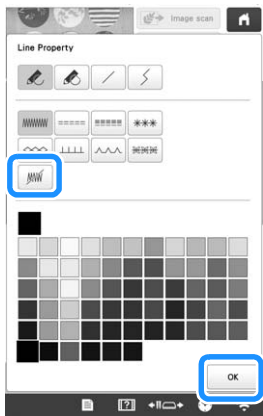

- 14 Select the outline of the pattern.

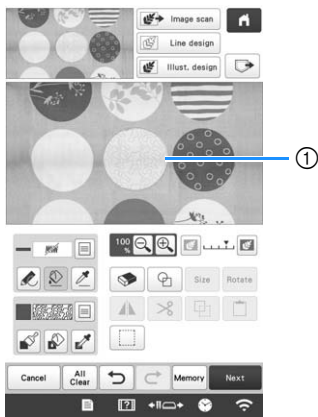

① Outline of the pattern

- 15 Follow the procedure from step 11 on page 165 of "Basic stippling with My Design Center".
→ Start embroidering on the fabric that you scanned at first.

Decorative stitching around a pattern in embroidery (a quilting function)

Memo

- For best results, reduce the embroidery speed.
- For best results, hoop the stabilizer and fabric and embroidery the design prior to adding the batting and backing under the hoop for quilting.

A quilt can be created with stippling around an embroidery pattern.

- 1 Hoop the embroidery frame with batting sandwiched between two layers of fabric, and then attach the frame to the machine.
- 2 Select the pattern that decorative stitching will be added around, and then touch  in the edit screen.

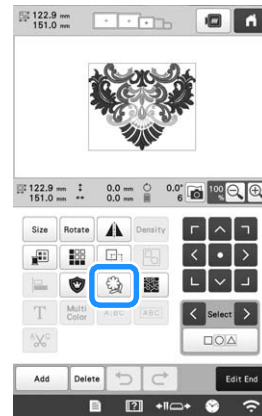

→ The outline of the pattern is displayed.

- 3 Set the distance and touch .

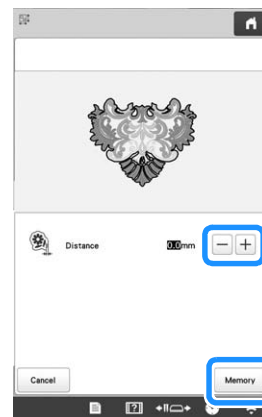

→ A message appears, and the pattern outline is registered as a stamp shape in My Design Center.

Touch .

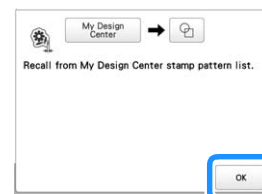

4 Touch **Edit End**, **Embroidery** to continue to the embroidery screen, and then embroider the pattern.

5 Touch **My Design Center** in the pattern type selection screen to start My Design Center.

6 Touch **Image scan** to scan the embroidered fabric.

Touch **Scan**, and then touch **OK**.

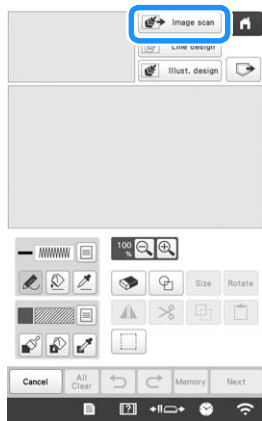

7 Touch **Stamp**, and then touch **Stamp** to recall the stamp shape registered in step 3, and then arrange it over the scanned pattern.

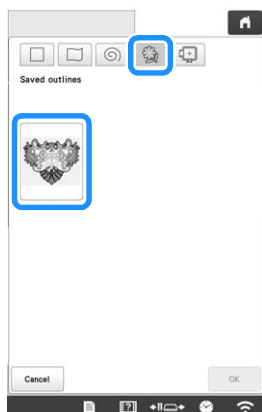
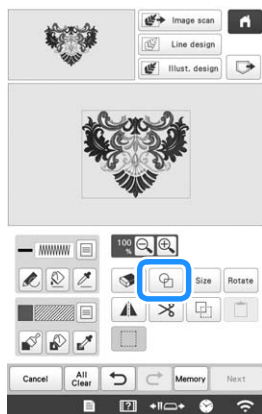

8 Touch **Stamp** to use a stamp or rectangular frame to determine the area to be stitched.

Note

- If the area is to be drawn by hand, be sure to draw a completely closed shape. If the area is not closed, it cannot be correctly filled with the decorating.

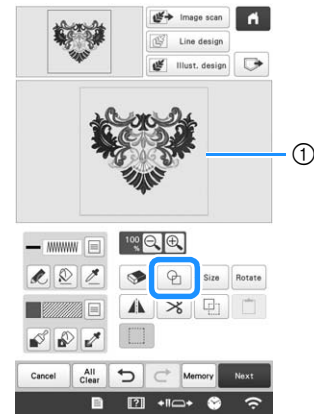

① Stamp or rectangular frame

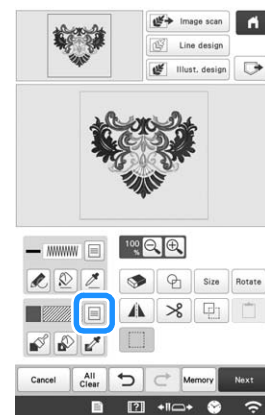

9 Touch **Brush tool** for the brush tool keys to select the pattern and color of the decorative stitching.



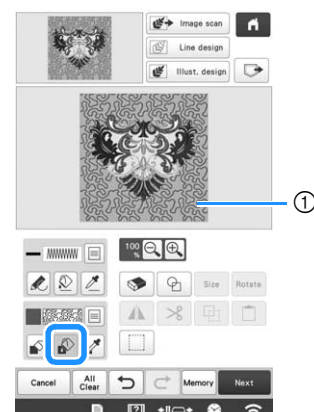

10 Touch **Fill**, and then fill the area to be stitched outside of the stamp shape outline.

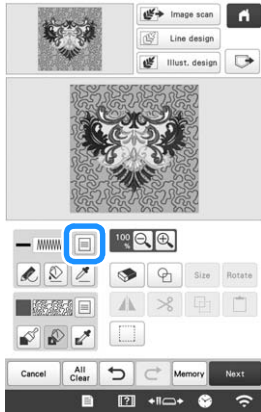

① Fill the area.

11 Touch  for the line tool keys to select .



12 Touch , then select the frame outline, and then touch .

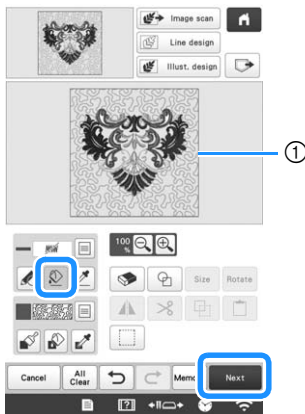

① Frame outline

13 Adjust the stipling stitch settings to create the desired effect, and then touch .

* For details, refer to “Specifying individual stitch settings” on page 154.

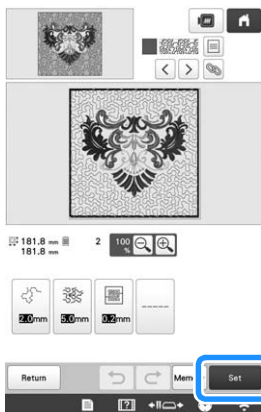

14 Follow the procedure described on “EDITING THE EMBROIDERY PATTERN” on page 44 to edit the pattern as desired.

15 Embroider the stipling stitch around the embroidery pattern.

Chapter 5 APPENDIX

MAINTENANCE

Simple machine maintenance operations are described below. Always keep the machine clean, otherwise malfunctions may occur.

Cleaning the LCD

If the surface of the LCD is dirty, lightly wipe it with a soft dry cloth. Do not use organic cleansers or detergents.

Cleaning the machine surface

If the surface of the machine is slightly dirty, wipe it with a soft dry cloth. If the machine is heavily dirty, lightly soak a cloth in neutral detergent, squeeze it out firmly, and then wipe the surface of the machine. After cleaning it once with a wet cloth, wipe it again with a dry cloth.

⚠ CAUTION

- Unplug the power supply cord before cleaning the machine, otherwise injuries or an electric shock may occur.

Note

- Do not use chemical products, such as benzene or thinner.

Cleaning the hook

Periodically remove lint and dust for better performance from Hook race area.

Use the included cleaning brush.

- 1 Set the main power switch to "O" to turn off the machine.

⚠ CAUTION

- Unplug the power supply cord before cleaning the machine, otherwise injuries or an electric shock may occur.

- 2 Open the hook cover, and remove the bobbin case. (page 33)

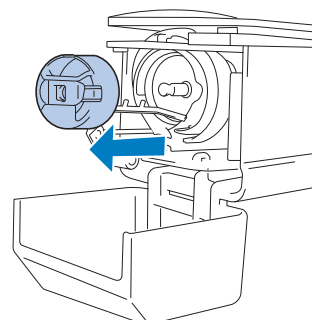

- 3 Use the included cleaning brush to remove any lint and dust from the hook and its surrounding area.

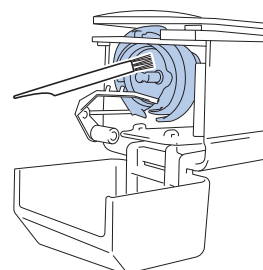

⚠ CAUTION

- If the hook is scratched or damaged, consult your authorized Brother dealer.

- 4 After cleaning is finished, insert the bobbin case into the hook, and then close the hook cover. (page 35)

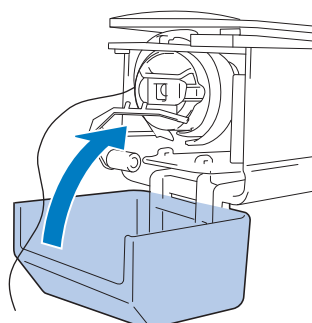

Cleaning around the needle plate

If lint and dust collect around the moving knife, the fixed knife or the thread retaining plate, the thread may not be cut correctly and various parts of the machine may be damaged. Make sure to clean around the needle plate once a month. Use the included 3 way screwdriver and cleaning brush.

- 1 Set the main power switch to "O" to turn off the machine.

⚠ CAUTION

- Unplug the power supply cord before cleaning the machine, otherwise injuries or an electric shock may occur.

- 2 Remove the needle plate.

With the 3 way screwdriver, loosen the screws, remove the needle plate, and then open the hook cover.

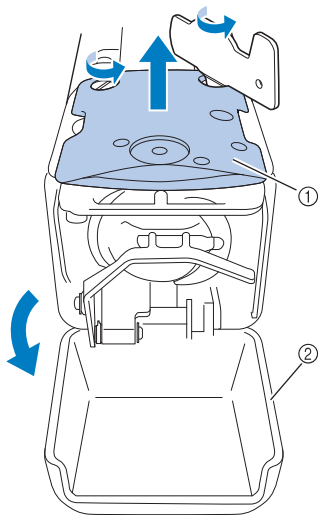

- 1 Needle plate
- 2 Hook cover

- 3 Remove the spacer.

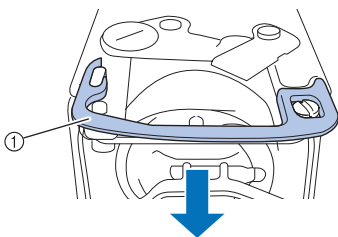

- 1 Spacer

- 4 Use the included cleaning brush to remove any lint and dust from the moving knife, the fixed knife, the thread retaining plate, and their surrounding areas.

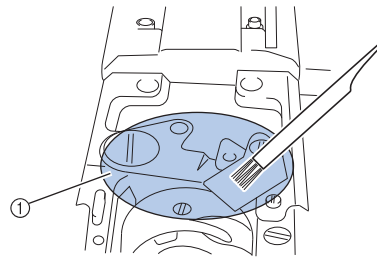

- 1 Remove all lint in this area

- 5 After cleaning is finished, install the spacer back.

First, position the spacer so that it hooks around the elliptical notch, then position the spacer so that it surrounds the screw head. Slide the spacer in the direction of the arrow to secure it.

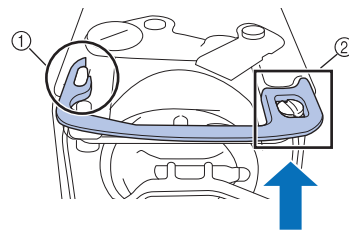

- 1 Elliptical notch
- 2 Screw head

- 6 Attach the needle plate in the opposite way that it was removed in step 2, and then close the hook cover.

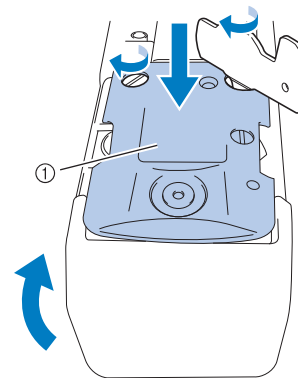

- 1 Needle plate

Cleaning the bobbin case

Thread wax and dust easily collect around the hole in the tension-adjusting spring on the bobbin case, resulting in an incorrect thread tension. Therefore, it should be cleaned each time when the bobbin is changed.

Use a piece of paper with the thickness of a business card.

- 1 Open the hook cover, remove the bobbin case, and then remove the bobbin. (page 33)

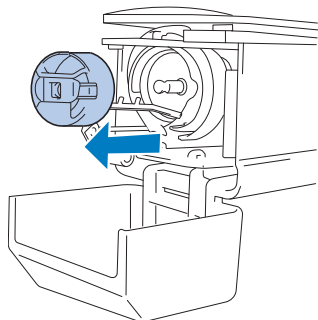

- 2 Slide the paper under the tension-adjusting spring to remove any dust.

Use a corner of the paper to remove any dust from around the hole.

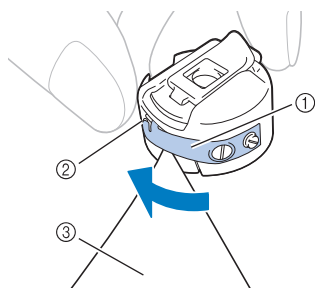

- 1 Tension-adjusting spring
- 2 Hole
- 3 Paper

Note

- Do not bend the tension-adjusting spring. In addition, do not use anything other than thick paper or paper of the specified thickness to clean the bobbin case.

- 3 Use the included cleaning brush to remove any lint and dust from inside the bobbin case.

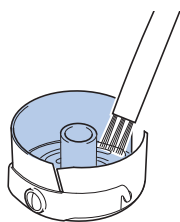

- 4 After cleaning is finished, insert the bobbin into the bobbin case and the bobbin case into the hook, and then close the hook cover. (page 34)

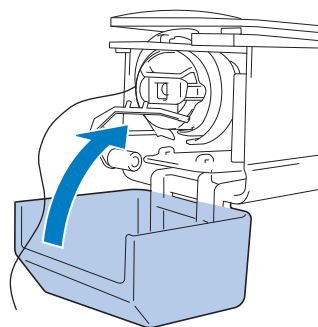

Cleaning the thread paths of the upper threads

If dust or lint has accumulated in the thread guides or tension unit in the paths of the upper threads, the thread may break while embroidery is being performed. Periodically clean the thread paths.

Cleaning the thread guides

- 1 Use the included cleaning brush to remove any lint and dust from below the thread guide plates.

Clean the thread guide plates for both the upper thread guides and the middle thread guides.

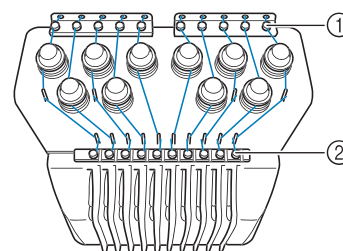

- 1 Upper thread guide
- 2 Middle thread guide

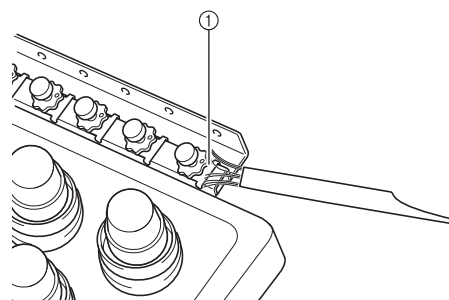

- 1 Thread guide plate

■ Disassembling and cleaning the tension unit

- 1 To remove tension dial, turn dial counterclockwise as shown on illustration.

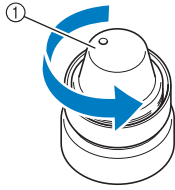

① Tension dial

- 2 Using the included cleaning brush, remove any lint and dust from the two pieces of felt washers (top, bottom) inside the tension dial.

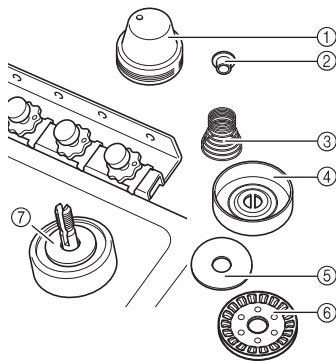

- ① Tension dial
 ② Nylon shoulder washer
 ③ Tension spring
 ④ Tension base spring
 ⑤ Felt washer (top)
 ⑥ Tension disc
 ⑦ Felt washer (bottom)

- 3 Reassembling the tension unit.

Note

- When reassembling the tension unit, be sure not to install the tension disc upside-down. There is a magnet on the bottom.

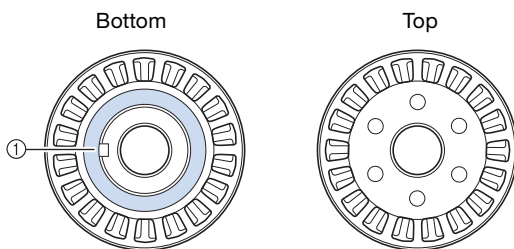

① Magnet

- When reassembling the tension unit, be careful not to lose any parts or install any parts in an incorrect order. The machine may not operate correctly if the tension units are incorrectly reassembled.

Replacing the needle

CAUTION

- Be sure to turn off the machine before replacing the needle, otherwise injuries may result if the machine starts embroidering.
- Your machine is designed to use household embroidery needles. The factory recommended needle is "HAX 130 EBBR" (Organ). Schmetz needles 130/705 H-E may be used as a substitute.
- Never use bent needles. Bent needles can easily break, possibly resulting in injuries.

Memo

- To check the needle correctly, place the flat side of the needle on a flat surface. Check the needle from the top and the sides. Throw away any bent needles.

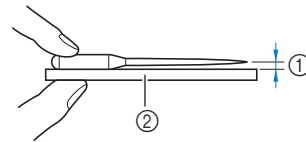

- ① Parallel space
 ② Flat surface (glass, etc.)

- 1 Set the main power switch to "O" to turn off the machine.

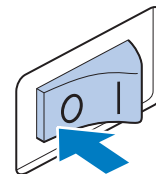

- 2 Loosen the needle set screw and remove the needle.

Hold the needle with your left hand, and then hold the Allen screwdriver in your right hand and turn the needle set screw counterclockwise.

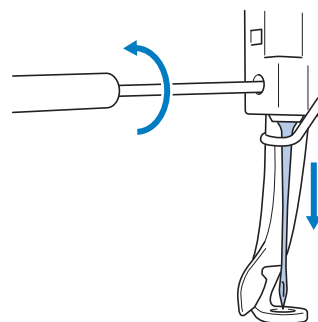

Note

- Be sure to use the included Allen screwdriver to replace the needle.

- Do not apply extreme force when loosening or tightening the needle set screw, otherwise the machine may be damaged.

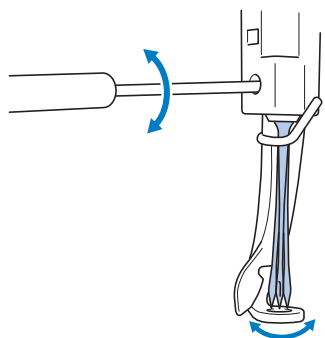

- 3** With the flat side of the needle toward the back of the machine, insert the needle all the way up until it touches the needle bar stopper.

Pass the needle through the hole in the presser foot, and then use the needle changing tool to lift up the needle.

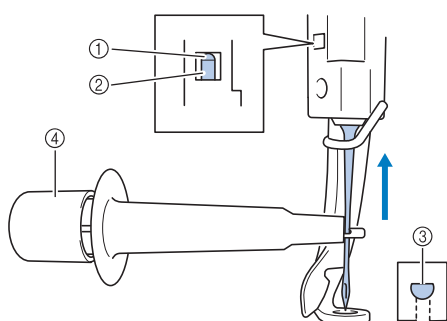

- ① Needle bar stopper
- ② Needle
- ③ Flat side of needle
- ④ Needle changing tool

Hold the needle changing tool and press the end of the needle changing tool ① in to extend the needle-mounting clamp ②. Attach the clamp to the needle, and then release the pressed area to clamp the needle. To unclamp the needle, press ① again.

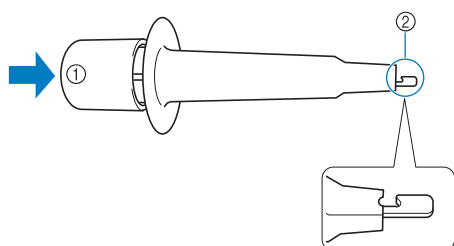

- ① End of the needle changing tool
- ② Needle mounting clamp

- 4** While holding the needle in place with your left hand, tighten the needle set screw.

Use the Allen screwdriver to turn the needle set screw clockwise.

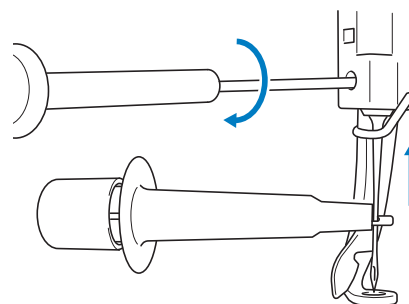



⚠ CAUTION

- Be sure to insert the needle in the needle bar chamber until it reaches the needle bar stopper and securely tighten the needle set screw with the Allen screwdriver, otherwise the needle may break or the machine may be damaged.
- If the needle is not fully inserted, the hook of the automatic needle-threading mechanism will not pass through the eye of the needle during automatic needle threading, and the hook may bend or the needle cannot be threaded.
- If the hook of the automatic needle-threading mechanism is bent or damaged, contact your authorized Brother dealer.

Oiling the machine

In order to extend the life of the machine's parts and keep the machine operating correctly, be sure to oil the machine before the first time that it is used. Afterward, put a drop of oil onto the hook once a day before use.

Note

- Touch , , , then , in that order, to see a video of how to oil the machine.

■ Oiling the race

1 Touch .

2 Touch .

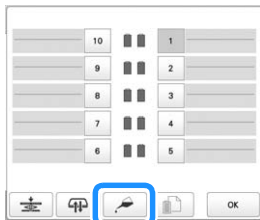

→ Following message appears.



3 Open the hook cover, and remove the bobbin case. (page 33)

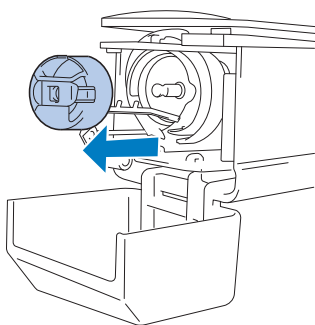

4 Touch .

→ The race moves to the correct position for oiling.

5 Put a drop of oil onto the hook.

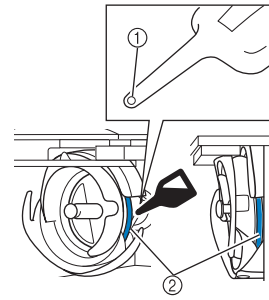

Front angle view

Side view

- ① Punch a small hole in oil bottle.
- ② Apply oil here.

6 Touch appeared in the following screen.

→ The race returns to its original position.

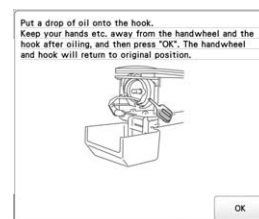

7 After oiling, insert the bobbin case into the hook, and then close the hook cover. (page 35)

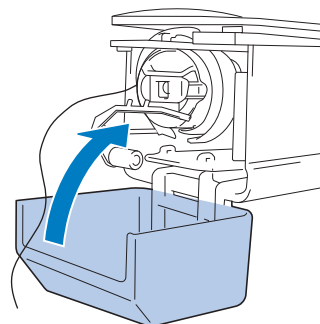

■ Oiling the needle bars

From embroidering screen, select one needle bar at a time. (page 86) Rotate the handwheel toward the LCD panel bringing the needle bar to its lowest position. Put one drop of oil, as high as possible on the needle bar above the felt washer.

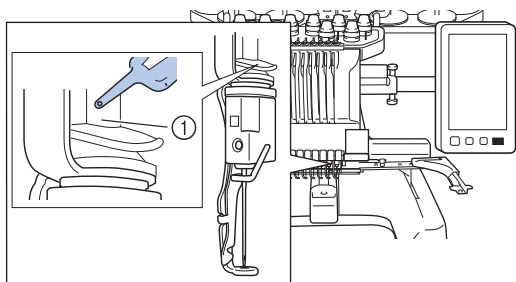

① Apply oil here.

- Too much oil may drip onto embroidery project.

Note

- Put a drop of oil onto the hook once a day before use.
- Apply one drop of oil on the lower needle bar above the felt washer every 40 – 50 hours of embroidering time.
- Apply only machine oil. Use of any other type of oil may result in damage to the machine.
- Do not apply too much oil. Fabric or thread may get contaminated. If too much oil is applied, wipe off any excess with a rag.
- If the thread breaks while embroidering or the operating noise of the hook becomes loud, apply oil onto the race hook.

About the maintenance message



Once this message appears, it is recommended to take your machine to your nearest authorized Brother dealer for a regular maintenance check. Although this message will disappear and the machine will continue to function once

you touch , the message will display several more times until the appropriate maintenance is performed.

Please take the time to arrange for the maintenance that your machine requires once this message appears. Such steps will help to ensure you receive continued, uninterrupted hours of machine operation for the future.

TROUBLESHOOTING

Troubleshooting

If the machine does not operate correctly, check for the following points/issues before requesting service.

If the reference page is "*" or the suggested remedy does not correct the problem, contact your authorized Brother dealer.

Symptom		
	Probable Cause/Remedy	Page
The machine does not operate.		
	The machine is not turned on.	22
	The machine has not been unlocked.	87
	The "Start/Stop" button was not pressed.	87
The embroidery frame cannot be attached to the machine.		
	The embroidery frame holder attached to the machine is not appropriate for the selected embroidery frame.	66
The embroidery frame cannot be removed or attached.		
	Depending on the position where the machine's carriage has stopped, it may be difficult to remove or attach the embroidery frame. <ul style="list-style-type: none"> • Touch the Needle bar/Frame move key to position the carriage, so the embroidery frame can easily be removed or attached. 	66
Embroidering is interrupted while embroidering a large project.		
	Embroidering is interrupted by the presser feet not in use catching on the fabric outside of the design area. <ul style="list-style-type: none"> • Stitch the design as close to the center of the embroidery frame using needle bars 3 through 7, keeping the head of the machine as centered as possible. 	57, 58
The needle breaks.		
	The needle is not installed correctly.	176
	The needle set screw is loose.	176
	The needle is bent or blunt.	176

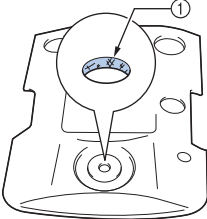
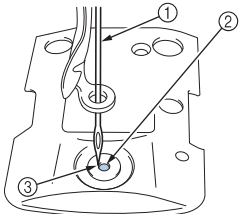
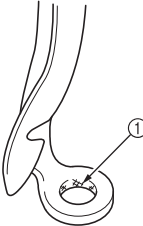
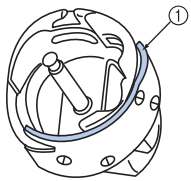
Symptom		
	Probable Cause/Remedy	Page
The needle breaks.		
	<p>The area around the hole in the needle plate is damaged.</p>  <p>① Scratches/Burrs</p> <ul style="list-style-type: none"> • Replace the needle plate. 	*
	<p>The needle hits/touches the needle plate.</p>  <p>① Needle ② Hole in needle plate ③ Needle hits hole</p> <ul style="list-style-type: none"> • Replace the needle. 	176 *
	<p>The presser foot is set too high and not correctly positioned. The needle hits/touches the presser foot.</p>	*
	<p>The area around the embroidery foot hole is damaged.</p>  <p>① Scratches or Burrs</p> <ul style="list-style-type: none"> • Replace the presser foot. 	*
	<p>Sliding surface on hook race is not smooth. There are scratches or burrs on it.</p>  <p>① Hook race area</p>	*
	<p>The bobbin or bobbin case are not correctly installed.</p>	33, 35
	<p>The hook is not correctly installed.</p>	*

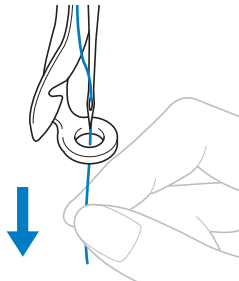
Symptom		
	Probable Cause/Remedy	Page
	<p>The hook stopper is not correctly installed, the hook is making a complete rotation.</p>	*
	<p>The upper thread is not threaded correctly. The upper thread is catching somewhere.</p>  <ul style="list-style-type: none"> • Pull the upper thread by hand from below the presser foot, and check that the thread moves smoothly. If the thread does not move, it is not threaded correctly. Thread the upper thread correctly. Make sure the thread is caught by the needle bar thread guide. 	82
	<p>The upper thread tension is set too high.</p>	118
	<p>A bobbin designed specifically for this machine is not used.</p>	33
	<p>The needle and the hook are not correctly passing each other.</p> <ul style="list-style-type: none"> • Hook timing may be OFF. 	*
	<p>There is backlash play (forward/backward) in the needle bar case.</p>	*
	<p>The thread density of the embroidery data is too fine. Three or more overlapping stitches are being embroidered.</p> <ul style="list-style-type: none"> • Using a data design system, correct the thread density and over stitching settings in the embroidery data. 	190
The thread is not cut automatically.		
	<p>Lint or dust has accumulated around the needle plate (moving knife, fixed knife or thread retaining plate).</p>	174
	<p>A bobbin case designed specifically for this machine is not used.</p> <ul style="list-style-type: none"> • Use the correct bobbin case. 	—
	<p>Lint or dust has accumulated in the thread tension disc.</p>	176
After the threads are automatically cut, the upper thread is too short and comes out of the needle.		
	<p>Lint or dust has accumulated around the needle plate (moving knife, fixed knife or thread retaining plate).</p>	174

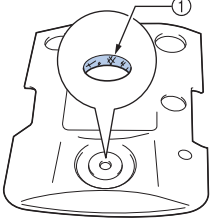
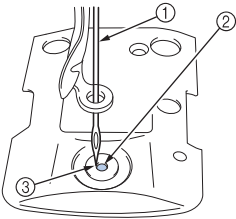
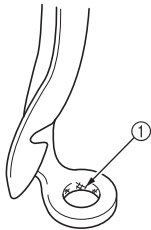
Symptom		
	Probable Cause/Remedy	Page
The upper thread breaks.		
	The needle is not correctly installed.	176
	The needle set screw is loose.	176
	The needle is bent or blunt.	176
	The area around the hole in the needle plate is damaged.	*
	 <p>① Scratches/Burrs</p> <ul style="list-style-type: none"> • Replace the needle plate. 	
	The needle is touching the needle plate.	*
	 <p>① Needle ② Needle plate hole ③ Needle touching hole</p>	
	The presser foot is set too high and not correctly positioned. The needle hits/touches the presser foot.	*
	The area around the embroidery foot hole is damaged.	*
	 <p>① Scratches/Burrs</p> <ul style="list-style-type: none"> • Replace the presser foot. 	
	Using a specialty thread like a metallic thread.	89
	<ul style="list-style-type: none"> • Slow down the machine embroidery speed. 	

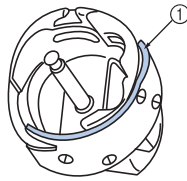
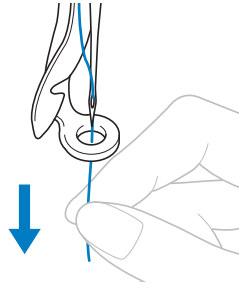
Symptom		
	Probable Cause/Remedy	Page
	Sliding surface on hook is not smooth. There are burns on it.	*
	 <p>① Hook race area</p>	
	The thread is loose in the hook area.	173
	The play between the hook and the race is too much.	*
	The hook does not rotate smoothly.	173, 178
	<ul style="list-style-type: none"> • Remove lint, clean and apply oil. 	
	The space between the hook stopper and the hook cannot be adjusted.	*
	The upper thread is not threaded correctly.	82
	 <ul style="list-style-type: none"> • Pull the upper thread by hand from below the presser foot, and check that the thread moves smoothly. If the thread does not move smoothly, it is not correctly threaded. Un-thread the machine and re-thread the machine. Make sure the thread is correctly positioned in the needle bar thread guide. 	
	Upper thread is not positioned in upper or middle thread guide.	82
	<ul style="list-style-type: none"> • Make sure thread passes completely under upper and middle thread guide. 	
	There are knots or tangles in the thread.	—
	<ul style="list-style-type: none"> • Remove any knots or tangles. 	
	The upper thread tension is too high.	118
	The bobbin thread tension is incorrect. The thread does not roll out of the bobbin case smoothly.	116
	The bobbin case is damaged.	33
	<ul style="list-style-type: none"> • Replace the bobbin case with a new one. 	
	The bobbin thread is not wound correctly.	33
	<ul style="list-style-type: none"> • Check that the bobbin is wound so that it is about 80% full and that the thread is evenly wound. If the bobbin is not correctly wound, replace the bobbin with one that is correctly wound or rewind the bobbin. 	

Symptom		
	Probable Cause/Remedy	Page
The upper thread breaks.		
	A bobbin designed specifically for this machine is not used.	33
	The automatic needle-threading mechanism is broken.	*
	Adhesive is attached to the needle. <ul style="list-style-type: none"> Replace the needle. 	176
	The fabric is not taut.	61, 62
	The thread quality is poor. <ul style="list-style-type: none"> The thread quality is too weak due to age of thread. Replace thread. 	—
	The embroidery data contains stitches with a pitch of zero.	124
	The embroidery data contains many stitches with an extremely small pitch.	124
	The thread density of the embroidery data is too fine. <p>Three or more overlapping stitches are being embroidered.</p> <ul style="list-style-type: none"> Using a data design system, correct the thread density and overstitching settings in the embroidery data. 	190
	Lint or dust has accumulated in the thread tension disc.	176
The bobbin thread breaks.		
	The bobbin thread is not correctly threaded.	34
	The bobbin is scratched or does not rotate smoothly. <ul style="list-style-type: none"> Replace the bobbin. 	33
	The bobbin case is damaged. <ul style="list-style-type: none"> Replace the bobbin case. 	33
	The thread is tangled.	173
	A bobbin designed specifically for this machine is not used.	33
	Lint or dust has accumulated in the thread tension disc.	176
Stitches are skipped.		
	The upper thread is not threaded correctly.	82
	The needle is bent or blunt.	176
	The needle is not installed correctly.	176
	Dust has accumulated under the needle plate or in the hook.	173, 174
	The needle and the hook are not correctly passing each other.	*
	The thread twist is either too tight or too loose. <ul style="list-style-type: none"> Improper twisting results in irregular loop formation. Try using a new spool. 	—

Symptom		
	Probable Cause/Remedy	Page
The embroidery pattern is misaligned.		
	The thread is tangled. <ul style="list-style-type: none"> Use tweezers to remove any tangled thread from the hook. 	—
	The fabric is not secured in the embroidery frame (for example, the fabric is not taut).	61, 62
	The embroidery frame is too large for the size of the embroidery.	65
	The thumb screws on the embroidery frame holder are loose.	21
	Appropriate stabilizer (backing) is not used.	60
	The embroidery frame is not correctly attached to the carriage. <ul style="list-style-type: none"> Correctly attach the embroidery frame to the carriage. Make sure that the pins on the left and right arms of the embroidery frame holder securely fit into the holes in the handles on the embroidery frame. 	64
	The carriage or the embroidery frame is hitting objects. <ul style="list-style-type: none"> The pattern may become misaligned if the carriage or embroidery frame is hitting objects. 	—
	The fabric is caught or pinched. <ul style="list-style-type: none"> Stop the machine, and then correctly position the fabric. 	—
	The carriage moved while removing embroidery frame. <ul style="list-style-type: none"> The pattern may become misaligned if the presser foot was hit or the carriage was moved while embroidery. Be careful when removing and reattaching the embroidery frame while embroidery. If the carriage is moved, turn the machine off, then on again. The correct frame position at the time that the machine was stopped is stored in the machine's memory, and the embroidery frame is returned to the correct position. 	—
	The design was not digitized correctly. <ul style="list-style-type: none"> The design may need more pull compensation or underlay to accommodate stretchy or high-napped fabrics. 	—
The size of the installed embroidery frame is not correctly detected.		
	The thumb screws on the embroidery frame holder are loose.	21
The starting position for the embroidery frame is horizontally misaligned.		
	The thumb screws on the embroidery frame holder are loose.	21

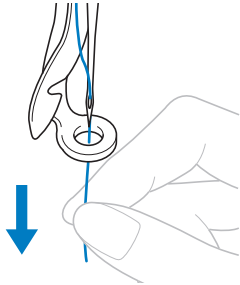
Symptom		
Probable Cause/Remedy		Page
There are loops in the upper thread.		
<p>The upper thread tension is low.</p>  <ul style="list-style-type: none"> After passing the upper thread through the hole in the presser foot, pull the thread by hand to check the thread tension. If it is difficult to determine, compare it with other needle bars where looping does not occur. 		—
<p>The thread tension does not correspond to the amount that the thread tension knob was tightened.</p> <ul style="list-style-type: none"> If the thread tension cannot be adjusted, thread wax and dust may have collected in the upper or middle thread guide plates, causing the thread tension guide plates to rise. Clean the thread tension guide plates. 		175
<p>Thread is not correctly threaded around upper thread tension discs.</p> <ul style="list-style-type: none"> Clean upper thread tension disc. Rethread and make sure tension disc rotates when pulling on thread. 		176
<p>The thread quality is poor.</p> <ul style="list-style-type: none"> Try embroidery with different thread. If the problem no longer occurs after the thread is changed, the thread quality is the problem. Replace the thread with one of good quality. 		—
The machine is noisy.		
Lint may be wound in the hook.		173
The upper thread is not threaded correctly.		82
<p>The hook is damaged.</p> <ul style="list-style-type: none"> Replace the hook. 		*
Not enough oil was applied.		178
The needle threader cannot be used.		
<p>The needle is not at the correct position.</p> <ul style="list-style-type: none"> Touch the key to move the desired needle bar to be threaded into embroidering position. 		86
Recommended needles are not used on this machine.		176
The needle is not installed correctly.		176
The hook on the automatic needle-threading mechanism is bent.		*

Symptom		
Probable Cause/Remedy		Page
The thread tension is incorrect.		
The upper thread is not threaded correctly.		82
The bobbin thread is not correctly threaded.		34
The bobbin thread tension is incorrect.		116
Lint or dust has accumulated in the thread tension disc.		176
The upper thread comes out of the needle when embroidering begins.		
<p>If a short length of thread remains after the thread is trimmed, the needle may become unthreaded when embroidering begins again.</p> <ul style="list-style-type: none"> Set the remaining length of thread to [Long Tail] on settings screen. 		124
The upper thread does not reach the bobbin thread when embroidering begins.		
<p>There is no more thread in the bobbin, the thread does not feed from the bobbin, or the thread that is fed from the bobbin is too short.</p> <ul style="list-style-type: none"> Correctly thread the bobbin thread. 		34
Although the thread is not broken, a broken thread error occurs and the machine stops.		
<p>If the thread breakage sensor in the thread tension disc of the thread tension knobs cannot detect that the thread is being fed, even if the machine is running, a broken thread error occurs and the machine is stopped.</p> <ul style="list-style-type: none"> Correctly pass the thread through the thread tension disc. If the broken thread error occurs after the machine is rethreaded, the sensor may be damaged. 		176 *
The thread is worn.		
Lint or dust has accumulated in the thread tension disc.		176
Jump stitches are long.		
Lint or dust has accumulated in the thread tension disc.		176
There are needle cuts or holes in the garment.		
<p>The needle is dull.</p> <ul style="list-style-type: none"> Replace the needle. Dull needles have a difficult time passing through the garment, causing fabrics to tear. 		176
<p>The fabric is too delicate.</p> <ul style="list-style-type: none"> The simple penetration of the needle could damage delicate fabrics. Use stabilizer on top of fabric. 		—

Symptom		
	Probable Cause/Remedy	Page
Fabric is puckering.		
	The thread tension is too tight. <ul style="list-style-type: none"> Adjust the tension according to the type of fabric and thread being used. Polyester thread will stretch during embroidery especially if the tensions are set too high. After the stitching is complete, the thread returns to its original strength, causing puckers in the fabric. 	118
	The framing tension of the fabric is incorrect. <ul style="list-style-type: none"> Tightly frame non-stretchable, woven fabrics. Loose framing will cause the fabric to bunch up under the stitching. Tautly frame soft knits using a stable backing. Overstretching the garment will cause it to look puckered when the frame is removed. 	—
	The column stitches are too long. <ul style="list-style-type: none"> Re-digitize the design with fill stitching or with multiple rows of column stitching. 	—
	The needle is dull. <ul style="list-style-type: none"> Dull needles push fabric down and damage material. Replace the needle. 	176
	The design density is too heavy. <ul style="list-style-type: none"> Too many stitches in an area pull fabric, causing it to pucker. Slightly decrease the design density by 5% to 10%. 	124
The LCD cannot be read.		
	The LDC screen is too bright or too dark. <ul style="list-style-type: none"> Adjust the brightness of the screen display. 	—
When embroidering thick fabric, the fabric cannot be correctly hooped.		
	Fabric slips within the frame because of its thickness. <ul style="list-style-type: none"> Wrap masking tape or bias tape around the outer frame. The tape will provide resistance so that the fabric does not easily slip. 	—
There is flickering in built-in camera image displayed in the LCD screen.		
	If the machine is being used in a very cold environment, there may be flickering in the built-in camera image displayed in the LCD screen. <ul style="list-style-type: none"> This is not a malfunction. Leave the machine turned on, and then wait a while before using the built-in camera. 	—
The machine does not detect the embroidery positioning sticker.		
	Sunlight or light from the outside comes into the machine. <ul style="list-style-type: none"> Block light from the outside. 	—
The scanned image is too bright or too pale.		
	Sunlight or light from the outside comes into the machine. <ul style="list-style-type: none"> Block light from the outside. 	—



Symptom		
	Probable Cause/Remedy	Page
There is misalignment in the scanned image or camera image.		
	The correct table installation setting has not been selected. <ul style="list-style-type: none"> The machine software adjusts scanned images and camera images according to the table installation setting. Select the appropriate setting. 	73
	The thickness of the fabric was not checked by the machine. <ul style="list-style-type: none"> Before scanning fabric thicker than 2 mm (approx. 5/64 inch) or before using the camera to align patterns, activate [Fabric Thickness Check]. 	74





CAUTION





- This machine is equipped with a thread detecting mechanism. If the machine is not threaded with the upper thread, the machine will not operate correctly, even if the “Start/Stop” button is pressed after unlocking the machine.
- If the machine suddenly stops:
 - Turn off the machine, and unplug the power cord.
 - Restart the machine with the correct operating procedure. (page 22)





Error messages

If the “Start/Stop” button is pressed while the machine is not correctly set up or if an incorrect operation is performed, the machine stops and informs you of the error with a buzzer and an error message. If an error message appears, correct the problem according to the instructions in the message.

To close the message, touch  or perform the correct operation, then touch . If the message appears again, consult your nearest authorized Brother dealer.

	Error messages	Cause/solution
1	Can not find the positioning mark, please set the frame to the previous position.	This message is displayed when the embroidery positioning sticker cannot be found while embroidering a pattern for the optional jumbo frame. Perform the operation again from step  in “EMBROIDERY PATTERNS FOR THE OPTIONAL JUMBO FRAME” on page 140.
2	Cannot change the configuration of the characters.	This message is displayed when there are too many characters in the curved text arrangement. Change the text arrangement or the embroidery frame.
3	Cannot communicate between PC and machine. Please check the USB cable connections to run the Link application.	This message is displayed when the machine cannot receive any data from the computer in the Link mode with the USB cable connection. Turn off the machine, and check the USB connection. After connect the USB cord securely, turn on the machine again. (page 132)
4	Cannot connect to the PC. Please check the network connection.	This message is displayed when the machine cannot receive any data from the computer in the Link mode with the wireless LAN connection. Check the wireless LAN connection between the computer and the machine, and then turn off and on the machine. (page 132)
5	Cannot recognize the data for the selected pattern. The data may be corrupted. Please turn off the power and turn on again.	This message is displayed when trying to recall damaged pattern data or data created using another manufacturer’s data design system. Turn the machine off, then on again to return it to its normal condition.
6	Cannot recognize the embroidery positioning mark.	This message is displayed when the machine fails to recognize the embroidery positioning mark. Confirm that the embroidery positioning mark is in the selected area. If problem persists, reposition the mark.
7	Can’t use this key during camera mode.	This message is displayed when a key that cannot be used is touched after  was touched to enter camera mode. Touch  to exit camera mode.
8	Change to a larger embroidery frame.	This message is displayed when the thumb screws of the embroidery frame holder are loose. Using the included 3 way screwdriver, firmly tighten the two thumb screws. (page 64)
		This message is displayed when the installed embroidery frame is too small. Check which embroidery frames can be used, and then install a larger embroidery frame. (page 62)
9	Check upper and bobbin thread.	This message is displayed when the thread tension is too tight. Check the tensions of the upper thread and bobbin thread, and then adjust them. (page 116)
		This message is displayed when the upper thread breaks or the thread comes out of the thread tension disc or a thread guide. Check that the thread passes under the upper and middle thread guides, and correctly thread the upper thread. (page 82)
		This message is displayed when lint or dust has accumulated in the thread tension disc. Remove the tension dials, and then remove any lint or dust accumulated between the felt washers. (page 176)
		This message is displayed when the bobbin thread breaks or runs out. Check that there is thread on the bobbin and that approximately 50 mm (2 inches) of thread has been pulled out, and then re-install the bobbin. (page 33)
		This message is displayed when there may be another cause. Refer to “The upper thread breaks.” on page 181 or “The bobbin thread breaks.” on page 182. Touch  to advance or reverse through the stitching. (page 93)
10	Communication error.	When this message is displayed, consult your nearest authorized Brother dealer.

	Error messages	Cause/solution
11	Communication time out error.	When this message is displayed, consult your nearest authorized Brother dealer.
12	Data receiving command error.	When this message is displayed, consult your nearest authorized Brother dealer.
13	EEPROM read/write error.	When this message is displayed, consult your nearest authorized Brother dealer.
14	Embroidering stop.	When this message is displayed, consult your nearest authorized Brother dealer.
15	Failed to save file.	This message is displayed when you try to save more than 100 camera image or settings screen image files in the USB media. In this case, delete a file from the USB media or use different USB media.
16	Go to Embroidering Screen and press the unlock key.	This message is displayed when the thread trimming button is pressed while a screen other than the embroidering screen or embroidering settings screen is displayed. Display either the embroidering screen or embroidering settings screen.
17	Impossible to set the start & the end points.	This message is displayed when embroidery cannot begin from the specified starting position. Change the starting position or move the frame and change the embroidering position. (page 126)
18	Inappropriate needle stop position	This message is displayed when the needle has stopped at an incorrect position. Turn the handwheel so that the mark on the handwheel is at the top, and then touch  .
19	Includes a special pattern that cannot be saved to external memory. Save the pattern in the machine's memory.	This message is displayed when you try to save a copyright protected pattern to USB media or computer. According to copyright laws, patterns that are illegal to reproduce or edit cannot be saved to USB media or computer. If this message is displayed, save the pattern in the machine's memory.
20	Machine PCB power off.	When this message is displayed, consult your nearest authorized Brother dealer.
21	Machine PCB reset.	When this message is displayed, consult your nearest authorized Brother dealer.
22	Main motor current error.	When this message is displayed, consult your nearest authorized Brother dealer.
23	Main motor encoder connect error.	When this message is displayed, consult your nearest authorized Brother dealer.
24	Main motor encoder signal error.	When this message is displayed, consult your nearest authorized Brother dealer.
25	Main motor rotate error.	When this message is displayed, consult your nearest authorized Brother dealer.
26	Main motor speed error.	When this message is displayed, consult your nearest authorized Brother dealer.
27	Needle bar case home position error.	This message is displayed when the needle bar case cannot be moved to its initial position. Touch  to automatically reset the needle bar case.
28	Needle bar case position error	This message is displayed when the needle bar case has stopped at an incorrect position. Touch  to automatically reset the needle bar case.
29	Needle case motor has been locked.	This message is displayed when the needle bar case motor has locked up. Touch  to automatically reset the needle bar case.
30	Needle threader error	This message is displayed when the automatic needle-threading mechanism does not operate correctly. Remove the thread entangled in the automatic needle-threading mechanism, and then touch  .

	Error messages	Cause/solution
31	Needle threader is in threading position.	This message is displayed when another operation is performed while the automatic needle-threading mechanism is threading the needle. Press the automatic needle-threading button, and then perform the other operation after the needle is threaded. (page 85)
32	No more patterns can be added to this combination.	This message is displayed when trying to combine 101 or more patterns. Up to 100 patterns can be combined.
33	Not enough available memory to save the pattern. Delete another pattern?	This message is displayed when the pattern cannot be saved because the memory is full. Delete some patterns.
34	Not enough space. Delete some patterns or use a different USB media.	This message is displayed when the memory capacity of the USB media has been exceeded. Delete some patterns or use a different USB media.
35	OK to recall and resume previous memory?	This message is displayed when the machine is turned off, then on again before embroidering is completed. Touch  to resume embroidering. If the embroidering screen was displayed before the machine was turned off, back up several stitches, and then continue embroidering. (page 97)
36	OK to revert to previous color changes?	This message is displayed when  is touched while thread colors are being changed.
37	OK to separate the combined border pattern?	This message is displayed when a combined border pattern is being rotated in the embroidering settings screen.
38	Panel communication error.	When this message is displayed, consult your nearest authorized Brother dealer.
39	Pattern extends to the outside of embroidery frame. Add no additional characters.	This message is displayed when the entered character patterns exceed the width of the embroidery frame.
40	Pattern extends to the outside of embroidery frame. This function cannot be used at this time.	This message is displayed when the font of the character pattern is changed to one with a larger size, causing the pattern to extend beyond the embroidery frame.
41	Picker error	This message is displayed when the thread picker (page 33) does not operate correctly. Remove the thread entangled on the thread picker, and then touch  .
42	Please set up the "Thread antenna"	This message is displayed when thread guide assembly support is not prepared. Prepare the thread guide assembly. (page 19)
43	Power supply voltage error.(24V high)	When this message is displayed, consult your nearest authorized Brother dealer.
44	Power supply voltage error.(24V low)	When this message is displayed, consult your nearest authorized Brother dealer.
45	Power supply voltage error.(40V high)	When this message is displayed, consult your nearest authorized Brother dealer.
46	Power supply voltage error.(40V low)	When this message is displayed, consult your nearest authorized Brother dealer.
47	Press the unlock key to unlock the machine.	This message is displayed when the thread trimming button is pressed before the machine is unlocked. Touch  to use the thread trimming function.
48	Preventive maintenance is recommended.	This message is displayed when the machine needs maintenance. (page 179)
49	Remove the embroidery positioning mark.	This message is displayed when the machine has recognized the embroidery position mark. Remove the embroidery positioning sticker and touch  to continue.
50	Select a pattern.	This message is displayed when there is no embroidery pattern selected and the "Start/Stop" button is pressed.
51	Set the clock.	This message is displayed when the time/date is not set. Set time/date. (page 23)

	Error messages	Cause/solution
52	Stop while needle bar case transferring.	This message is displayed when the machine has stopped while the needle bar case is moving. Touch <input type="button" value="OK"/> to automatically reset the needle bar case.
53	The pattern combination is too large for the extra large embroidery frame. If you plan to add more patterns, rotate the pattern combination.	This message is displayed when a long vertical pattern is recalled and no longer fits in the embroidery frame. Rotate the pattern 90 degrees.
54	The pattern extends out of the pattern area. Change position of the pattern and scan the new area.	This message is displayed when the built-in camera is being used to align the embroidery position, but the embroidery positioning sticker is too near an edge or the pattern extends from the embroidery frame. Change the position of the embroidery positioning sticker, and then try aligning the position again.
55	The safety device has been activated. Is the thread tangled? Is the needle bent?	This message is displayed when a malfunction occurred, such as the thread becoming tangled or the needle is bent. The machine stops when it detects a malfunction. Check that the machine is correctly threaded (page 82) and that the needle is not bent.
56	This file cannot be used.	This message is displayed when the file format is incompatible with this machine. Check the list of compatible file formats. (page 190)
57	This pattern cannot be used since it exceeds the data capacity.	This message is displayed when the pattern has too many stitches and cannot be used. Data with stitches that exceed specifications (500,000 stitches) cannot be displayed. Use data design software to reduce the number of stitches.
58	This pattern cannot be used.	This message is displayed when you try to retrieve a pattern that was downloaded for a different machine.
59	This pattern cannot combine.	This message is displayed when a split (large-size) pattern is selected to be combined with another embroidery pattern.
60	Trimming sensor error.	This message is displayed when lint or dust may have accumulated within the moving knife, the fixed knife, the thread retaining plate, and their surrounding areas. Clean them. (page 174)
61	USB media error	This message is displayed when USB media cannot be read correctly or when USB media is damaged. Touch <input type="button" value="OK"/> and try again.
62	USB media is not loaded. Load USB media.	This message is displayed when you tried to recall or save a pattern while no USB media is loaded. Load USB media.
		This message is displayed when you try to use incompatible USB media. For a list of compatible USB media, visit " http://s.brother/cpbag/ ".
63	Wiper error	This message is displayed when thread is tangled on the wiper. Remove the tangled thread.
		This message is displayed when lint or dust may have accumulated within the moving knife, the fixed knife, the thread retaining plate, and their surrounding areas. Clean them. (page 174)
		This message is displayed when the thread does not pass through the groove in the thread cutter. Pass the thread through the groove securely.
64	X-axis home position error.	When this message is displayed, consult your nearest authorized Brother dealer.
65	XY moving error.	When this message is displayed, either replace the embroidery frame with a larger one or return to the pattern editing screen and move the pattern position.
66	Y-axis home position error.	When this message is displayed, consult your nearest authorized Brother dealer.

If the machine does not respond when a key is touched

If nothing happens when a key on the screen is touched (no key can be selected or the keys are misaligned), adjust the touch panel as described below.

- 1 Touch anywhere inside the touch panel, and turn the machine off, then on again.

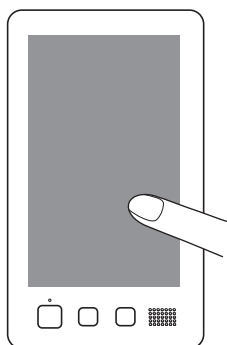

- Continue touching the touch panel until the screen shown below appears.
 - The "Start/Stop" button is red.
- The adjustments screen appears.

- 2 Use the included touch pen to touch the center of the numbered crosses on the screen, from 1 to 13.

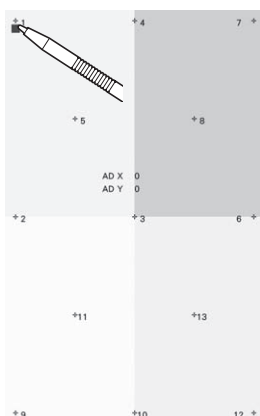

⚠ CAUTION

- Be sure to use the included touch pen to adjust the touch panel. Do not use a mechanical pencil, screwdriver or any other hard or sharp object. Do not apply pressure to the LCD screen display, otherwise damage to the display may result.

- 3 After making the necessary touch panel adjustment, [SUCCESS] will show on the screen.

- If the buzzer sounds when cross number 13 is touched, an error occurred during setting, and [ERROR] appears on the screen. Touch the crosses again, starting with the number indicated on the screen.

Note

- If the keys still do not respond, even after the touch panel is adjusted, or if the touch panel cannot be adjusted, contact your nearest authorized Brother dealer.

- 4 Turn the machine off, and on again.

SPECIFICATIONS

Machine specifications

Item	Specification	
Weight	41.8 kg (92 lb)	
Machine size	561 (W) × 589 (D) × 790 (H) mm (22 (W) × 23-1/4 (D) × 31-1/8 (H) inches)	
Embroidery speed	Speed range / Max.: 1,000 spm, Min.: 400 spm Depending on the embroidery frame, maximum stitches in one minute is 600.	
Hook Type	Vertical fully rotary hook	
Hook size	Normal size (Type L)	
Needle	HA130EBBR / #11	
Number of needle	10 needles	
Thread tension	Manual	
Thread trimming	Upper and bobbin thread	
Thread breakage sensor	Yes / Upper thread and bobbin thread	
Automatic needle threader	Yes	
Connecting your machine to PC	Compatible interfaces	USB ^{*1} / Wireless LAN ^{*2}
	Compatible models	IBM PC with a USB port as standard equipment IBM PC-compatible computer equipped with a USB port as standard equipment
	Compatible operating systems	Microsoft Windows 7, Windows 8.1, Windows 10
Memory	Embroidery patterns	10 MB
	Images can be imported to the machine (My Design Center)	100 MB
Data Types	Embroidery patterns ^{*3}	.pes .phc .phx .dst
	Data that can be loaded when using My Design Center	.jpg .png .bmp
Data Size	Embroidery patterns	Up to 360 mm (W) × 200 mm (H) (approx. 14 inches (W) × 7-7/8 inches (H))
	.pes files that can be displayed	Up to 500,000 stitches
		Up to 127 color changes
Types of USB Devices/ Media that can be Used ^{*4}	Embroidery patterns	Embroidery data can be saved to or recalled from USB media. Use media that meets the following specifications. <ul style="list-style-type: none"> • USB Flash drive (USB Flash memory) Embroidery data can be recalled only. <ul style="list-style-type: none"> • USB external CD/DVD drives You can also use the following types of USB media with the USB Memory Card Reader/USB card writer module. <ul style="list-style-type: none"> • Secure Digital (SD) Card • CompactFlash • Memory Stick • Smart Media • Multi Media Card (MMC) • xD-Picture Card

Item	Specification		
Condition of the [Eco Mode] and [Shutoff Support Mode]	[Eco Mode]	Available time	[OFF], 10 - 120 (minute)
		"Start/Stop" button	Green flashing
		Suspended function	Machine light, Screen display
		After recovering	The machine starts from the previous operation.
	[Shutoff Support Mode]	Available time	[OFF], 1 - 12 (hour)
		"Start/Stop" button	Green slow flashing
		Suspended function	All functions
		After recovering	An error message appears. You need to turn off and on the machine to restart.
Compatible image files of the Screen Saver Image	Format		JPEG format (.jpg)
	File size		Max. 2 MB for each image
	File dimension		1280 (H) × 1200 (W) pixels or less (If the size is more than 1280 (H) × 800 (W) pixels, the image will be displayed in a smaller size.)
	Number allowed		5 or less
Videos that can be played	MP4 file format		Video - H.264/MPEG-4 AVC, Audio – AAC
	Size		1280 (H) × 800 (W) pixels or less (If the size is more than 450 (H) × 800 (W) pixels, the video will be displayed in a smaller size.)
	Maximum file size		100 MB

*1 Do not create folders in "Removable Disk" on a computer.

If embroidery data is stored in a folder in "Removable Disk", that embroidery data cannot be retrieved by the machine.

*2 The wireless network connection complies with IEEE 802.11 n/g/b standards and uses the 2.4 GHz frequency.

A wireless network cannot be set up with WPA/WPA2 Enterprise.

*3 Using data other than that saved using our data design systems or this machine may cause this machine to malfunction.

When the machine is used to save a file with any extension, it is saved as a .phx data file.

.dst data is displayed in the pattern list screen by file name (the actual image cannot be displayed).

The full file name may not be displayed depending on the number of characters in the file name.

Since Tajima (.dst) data does not contain specific thread color information, it is displayed with our default thread color sequence.

Check the preview and change the thread colors as desired.

*4 USB media is commercially available, but some USB media may not be usable with this machine.

Please visit our website "<http://s.brother/cpbag/>" for more details.

* Depending on the type of USB devices/media being used, either directly plug the USB device into the machine's USB port or plug the USB media Reader/Writer into the machine's USB port.

* Please be aware that some specifications may change without notice.

⚠ CAUTION

- When using embroidery data other than our original patterns, the thread or needle may break when embroidering with a stitch density that is too fine or when embroidering three or more overlapping stitches. In that case, use one of our original data design systems to edit the embroidery data.

UPGRADING YOUR MACHINE'S SOFTWARE

You can use USB media to download software upgrades for your machine.

When an upgrade program is available on "<http://s.brother/cubah/>", please download the files following the instructions on the website and steps below.

You can use USB to download software upgrades/updates (*****.upf) for your machine.

Note

- When using USB media to upgrade the software, check that no data other than the upgrade file is saved on the USB media being used for this upgrade.

Upgrade procedure using USB media

- 1 While pressing the automatic threading button, turn the main power to on.

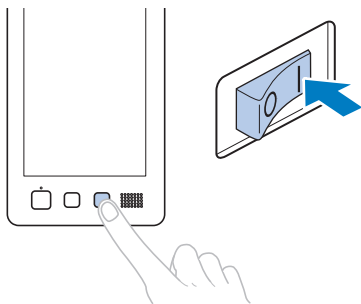

→ The following screen will appear on the LCD.

- 2 Touch .

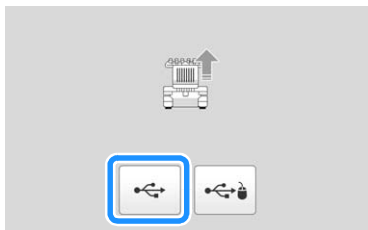

- 3 Insert the USB media into the USB port on the machine. The media device should only contain the upgrade file.

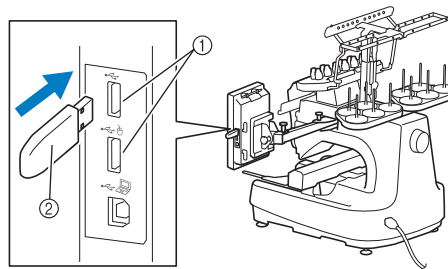

- ① USB port
- ② USB media

Note

- The access lamp will begin blinking after inserting USB media, and it will take about 5 to 6 seconds to recognize the media. (Time will differ depending on the USB media).

- 4 Touch .

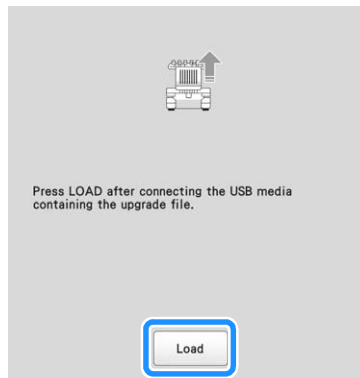

→ The upgrade file is downloaded.



Note

- If an error occurs, a red text error message will appear. When the download is performed successfully, following message will appear.



- 5** Remove the USB media, and turn the machine off and on again.

INDEX

Symbols

"DST" Setting 123

A

AC adapter 144
Adjusting
 camera view 73
 legs 18
 operation panel 19
 scanning results 73
 touch panel 189
Aligned characters 128
Appliqué alphabet 41
Appliqué embroidery 100
Automatic lock stitch 71
Automatic needle-threading button 12, 85
Automatic needle-threading mechanism 85

B

Background image 72
Basic procedures 33
Basting 99
Bobbin case 33, 175
 removing 33
Bobbin winder 142
Border function 49
Built-in camera 11, 75, 109

C

Canton fleece 61
Canvas 61
Cap frames 68
Carriage 11
Change thread color key 45, 54, 55
Changing
 basting distance 124
 colors of the pattern 54
 display guides 123
 position of a sticker 114
 thread color display 123
 thread density 48
Checking
 needle bars and thread colors 81
 preview image 60
 thread spool changes 91
Cleaning
 around the needle plate 174
 bobbin case 175
 hook 173
 LCD 173
 machine surface 173
 maintenance message 179
 oiling machine 178
 thread paths 175
Clock set 23, 24
Color shuffling 55
Combining patterns 42
Connecting patterns 109
Corduroy 61
Cotton sheeting 61

D

Delete key 45
Deleting
 short stitches 124

Denim 61
Density key 46, 48
Display guides 123
Distance from center (horizontal) 44
Distance from center (vertical) 44
Dress shirt (woven) 61

E

Edit end key 45
Edit key 69
Editing 44
 restart from beginning or middle 96
Embroidering position
 align 72
Embroidering screen 81, 89
Embroidering settings screen 69
Embroidering time 90
Embroidery 87
 aligned characters 128
 baseline on the fabric 129
 basic method 87
 repeating along a diagonal 127
 small fabric 64
Embroidery frame
 attaching to the machine 64
 types 66
Embroidery frame holder
 attaching 21
Embroidery frame holders 66
Embroidery frame indicators 44, 61, 69
Embroidery key 70
Embroidery light 11
Embroidery patterns
 editing 44
 selecting 35
Embroidery positioning sticker 78, 110, 114, 141
Embroidery sheet 63
Embroidery thread 82
Error messages 185

F

Fabric Thickness Check 25, 74
Fabric/stabilizer compatibility chart 61
Feet 11
Forward/Backward stitch key 89, 93, 96

G

Going back through the stitching 93, 96
Golf shirt 61
Grouping 43

H

Handwheel 11
Headwear 61
Hook 173
Hook cover/Hook 11
Hooping 62
Horizontal mirror image key 46

I

Included accessories 12

J

Jumbo frame 140

Jump code	123	Silk	61
Jump stitch trimming	123	Size (horizontal)	44
L		Size (vertical)	44
LCD	12, 24	Size key	45
Lingerie or silk	61	Speaker	12
Link function	132	Specifications	190
Lock stitching key	69, 71	Split (large-size) patterns	135
Locking the needle bar	80	Spool	82
Lower thread guide	11	Spool change indicator	89, 91
M		Spool stand	11, 20
Magnetic sash frame	52, 108	Stabilizer	60, 61
Main power switch	11, 22	Start/Stop button	12, 87
Manual color sequence	58	Starting/ending position key	70, 126, 127
Maximum embroidery speed key	89	Stitch count	90
Middle thread guide	11	Stitch simulator screen	60
Monitoring App	32	Stopping embroidering	88
My Design Center	147	at color changes	119
N		pause	119
Needle		Sweater knit	61
threading	85	Sweatshirt	61
Needle bar case	11	T	
Needle bar key	81, 90	Tajima data	123
Needle bar/Frame move key	24	Temporary needle bar setting key	89, 120
Number of thread color changes	69	Terms of Use	5
O		Terry cloth	61
Oiling	178	Thread	82
Operation panel	11, 12, 19	Thread color display	123
Optional accessories	14	Thread color sequence display	89
P		Thread color set up display	90
Pattern display area	24	Thread density	48
Pattern editing screen	44	Thread guide	11, 83
Pattern selection keys	46	Thread guide assembly	19
Pattern size	44, 69	Thread guide pins	11
Positioning keys	46, 70	Thread mark	51
Power supply cord	22, 144	Thread spools	
Power supply plug	11	easily changing	92
Preview key	45, 70	Thread tension disc	84
Previewing the image	60	Thread tension knobs	11, 118
Q		Thread trimming button	12, 88
Quilting borders	105	Thread trimming key	47
R		Threading	
Region display	89	bobbin thread	33
Remaining length	124	needle	85
Reserve stop key	89, 119	upper thread	81
Reserved needle	25, 121	Touch pen holder	11
Restart from beginning	93, 96	Trial embroidery key	70
Resume embroidering	97	Troubleshooting	179
Return key	89	T-shirt	61
Rotate key	45, 69	Tubular frame table	73
Rotation angle	44	U	
S		Uninterrupted embroidering (one color)	120
Satin jacket	61	Unlock key	89
Scan	156	Upgrading machine's software	192
Selecting		USB media	192
embroidery pattern	35, 42	Upper thread guide	11
Setting remaining length	25	Upper thread guide pretension knob	118
Setting up	16	Upper threading	81, 82
Short stitch delete	25, 124	USB port	
L		computer connection	130
M		USB media connection	130
N		USB mouse connection	32
O		V	
P		Ventilation slots	11
Q		Version	26
R		W	
S		Wide table	73, 137



Please visit us at <http://s.brother/cpbag/> where you can get product support and answers to frequently asked questions (FAQs).



Please visit us at <http://s.brother/cvbak/> to view Instruction Videos.



Brother SupportCenter is a mobile app that provides the support information for your Brother product.



My Stitch Monitor is a mobile app that monitors the operating conditions of your machine.
Visit the Google Play™ or App Store to download.



Google Play™



App Store



Be sure to install the latest software.
A variety of functional improvements are being performed in the latest version.

This machine is approved for use in the country of purchase only. Local Brother companies or their dealers will only support machines purchased in their own countries.

