

Xerox[®] Color C60/C70 Printer

User Guide



©2016 Xerox Corporation. All rights reserved. Xerox® and Xerox and Design® are trademarks of Xerox Corporation in the United States and/or other countries.

SquareFold®, CentreWare®, Scan to PC Desktop®, and Xerox Extensible Interface Platform®, are trademarks of Xerox Corporation in the United States and/or other countries. Product status, build status, and/or specifications are subject to change without notice.

Microsoft®, Windows®, Windows XP®, Windows Vista®, and Word are registered trademarks of Microsoft Corporation in the United States and/or other countries.

Adobe, the Adobe logo, Acrobat, the Acrobat logo, Adobe Reader, Adobe PDF logo are registered trademarks of Adobe Systems, Inc. PostScript is an Adobe registered trademark used with the Adobe PostScript Interpreter, the Adobe page description language, and other Adobe products.

Apple®, Macintosh®, and Mac OS® are trademarks or registered trademarks of Apple Computer, Inc., registered in the U.S. and other countries. Elements of Apple's Technical User Documentation used by permission from Apple Computer, Inc.

GBC® and AdvancedPunch™ are trademarks or registered trademarks of General Binding Corporation.

HP and PCL are registered trademarks of Hewlett-Packard Corporation in the United States and/or other countries.

Linux® is a registered trademark of Linus Torvalds.

TWAIN is a trademark of TWAIN Working Group.

UNIX® is a registered trademark of the Open Group.

Universal Serial Bus is a trademark of USB Implementors Forum, Inc. (USB-IF)

BR10124

Table of Contents

1	-ii
1 Safety.....	1-1
Warning Symbols.....	1-1
Notices and Safety.....	1-1
Emergency Turn Off.....	1-2
General Guidelines.....	1-2
Electrical Safety.....	1-3
Electrical Supply.....	1-3
Emergency Turn Off.....	1-3
Power Cord Safety Information.....	1-3
Operational Safety.....	1-4
Printer Location.....	1-5
Operational Guidelines.....	1-5
Consumable Information.....	1-5
Vacuum Cleaner Use for Toner Spills.....	1-6
Ozone Release.....	1-6
Maintenance Safety.....	1-6
Printer Symbols.....	1-7
Environmental, Health, and Safety Contact Information.....	1-7
2 Product Overview.....	2-1
Introduction.....	2-1
Printer Configurations.....	2-2
Parts of the Printer.....	2-2
Right-Front View.....	2-2
Right-Rear View.....	2-3
Duplex Automatic Document Feeder.....	2-3
Control Panel.....	2-4
Internal Components.....	2-5
Paper Trays.....	2-5
Paper Trays 1 and 2.....	2-5
Paper Trays 3 and 4.....	2-5
Bypass Tray (Tray 5).....	2-6
Offset Catch Tray.....	2-6
Telephone and Fax Connection Option.....	2-6
Standard Features.....	2-6
Energy Saver Mode.....	2-7

Printer Information.....	2-7
Consumables.....	2-7
Drum Cartridges.....	2-7
Toner Cartridges.....	2-8
Fuser.....	2-8
Charge Corotron.....	2-8
Waste Toner Container.....	2-8
Optional Accessories.....	2-8
Input Devices.....	2-8
High-Capacity Feeder.....	2-8
Oversized High-Capacity Feeder.....	2-8
Finishing Devices.....	2-8
Business Ready Finisher.....	2-9
Business Ready Finisher with Booklet Maker.....	2-9
Standard Finisher/Booklet Maker Finisher.....	2-9
Xerox® SquareFold® Trimmer.....	2-10
GBC® AdvancedPunch™.....	2-10
GBC AdvancedPunch Pro.....	2-11
CZ Fold Unit.....	2-11
Required Finishing Accessories.....	2-11
Interface Module.....	2-11
Vertical Transport Module.....	2-12
Getting Additional Information.....	2-12
3 Installation and Setup.....	3-1
Before Using the Printer.....	3-1
Xerox Welcome Center.....	3-1
Installation and Setup Overview.....	3-2
Physical Connection.....	3-2
Turning On the Printer.....	3-3
Turning On Main Power.....	3-3
General Power On.....	3-4
Turning Off the Printer.....	3-5
General Power Off.....	3-5
Turning Off Main Power.....	3-5
Assigning a Network Address.....	3-6
Using CentreWare Internet Services.....	3-6
Finding the Printer's IP Address.....	3-7
Accessing CentreWare Internet Services.....	3-7
4 Loading Media.....	4-1
Accepted Media.....	4-1

Recommended Media.....	4-1
General Media Loading Guidelines.....	4-1
Printing/Copying on Labels.....	4-2
Printing/Copying on Glossy Paper.....	4-2
Media That Can Damage Your Printer.....	4-2
Paper Storage Guidelines.....	4-3
Paper Types/Weights Accepted in Trays.....	4-3
Tray Capabilities.....	4-5
Loading Paper in Trays 1 - 4.....	4-5
Loading Paper in Tray 5 (Bypass Tray).....	4-6
Loading Envelopes in Tray 5 (Bypass Tray).....	4-7
Loading Paper in the High Capacity Feeder.....	4-8
Loading Paper in the Oversized High Capacity Feeder.....	4-9
Loading Paper in the Post-Process Inserter.....	4-10
5 Printing.....	5-1
Printing Overview.....	5-1
Saving a Set of Commonly Used Printing Options in Windows.....	5-1
Saving a Set of Commonly Used Printing Options for Macintosh.....	5-2
Xerox® Services for UNIX® Systems (XSUS).....	5-2
Launching XSUS.....	5-2
Printing from Linux.....	5-3
Launching Xerox Printer Manager.....	5-3
Printing from a Linux Workstation.....	5-3
Printing Features.....	5-4
Media Types for Automatic 2-Sided Printing.....	5-4
Printing a 2-Sided Document.....	5-4
Selecting the Paper to Use.....	5-5
Printing Multiple Pages to a Single Sheet (N-Up).....	5-5
Color Correction.....	5-5
Booklets.....	5-5
Cover Pages.....	5-6
Insert Pages.....	5-6
Exception Pages.....	5-7
Scaling.....	5-7
Watermarks.....	5-7
Creating and Saving Custom Sizes.....	5-8
Job Completion Notification.....	5-8
Secure Print Jobs.....	5-8
Sample Sets.....	5-8
Delayed Printing.....	5-8

Saving Print Jobs to the Printer.....	5-8
Folding.....	5-8
Printing from a USB Flash Drive.....	5-9
Printing from a Media Card Reader.....	5-9
6 Copying.....	6-1
Basic Copying.....	6-1
Document Glass.....	6-2
Duplex Automatic Document Feeder.....	6-2
Basic Settings.....	6-3
Selecting Color or Black and White Copies.....	6-3
Reducing or Enlarging the Image.....	6-3
Selecting the Tray to Use for Copies.....	6-4
Specifying 2-Sided Originals or Copies.....	6-4
Collated Copies.....	6-5
Uncollated Copies.....	6-5
Offset Stacking.....	6-6
Stapling Copies.....	6-6
Hole Punching Copies.....	6-6
Image Quality Adjustments.....	6-7
Specifying the Original Type.....	6-7
Adjusting the Darkness, Sharpness, and Saturation.....	6-7
Automatically Suppressing Background Variations.....	6-8
Adjusting the Contrast.....	6-8
Selecting Color Effects.....	6-8
Adjusting the Color Balance.....	6-8
Adjusting the Color Shift.....	6-9
Adjusting the Gloss Level.....	6-9
Layout Adjustments.....	6-9
Book Copying.....	6-10
2-Sided Book Copying.....	6-10
Specifying the Original Size.....	6-11
Erasing the Edges of a Copy.....	6-11
Shifting the Image.....	6-12
Rotating the Image.....	6-12
Inverting the Image.....	6-13
Output Format Adjustments.....	6-13
Creating Booklets.....	6-13
Including Covers.....	6-14
Page Layout.....	6-15
Creating Posters.....	6-15
Adding Annotations.....	6-16

Adding Watermarks.....	6-17
ID Card Copy.....	6-18
Tab Margin Shift.....	6-18
Advanced Copying.....	6-19
Building a Job.....	6-19
Printing a Sample Copy.....	6-20
Combining Original Sets.....	6-21
Delete Outside/Delete Inside.....	6-21
Saving Copy Settings.....	6-22
Folding.....	6-22
7 Scanning.....	7-1
Scanning Overview.....	7-1
Loading Original Documents.....	7-2
Document Glass.....	7-2
Duplex Automatic Document Feeder.....	7-2
Storing a Scan to a Folder.....	7-3
Scanning to a Folder.....	7-3
Printing Stored Files at the Printer.....	7-3
Additional Send from Folder Options.....	7-4
Using Job Flow Sheets.....	7-5
Printing Stored Files Using CentreWare Internet Services.....	7-5
Retrieving Scanned Files to Your Computer Using CentreWare Internet Services.....	7-5
Creating a Folder.....	7-6
Deleting a Folder.....	7-7
Scanning to a Network File Repository.....	7-8
Scanning to an Email Address.....	7-9
Setting Email Options.....	7-9
Scanning to a Computer.....	7-10
Scanning to a Home Directory.....	7-10
Storing to a USB Flash Drive.....	7-11
Setting Scan Options.....	7-12
Scan Settings.....	7-12
Additional Scanning Options.....	7-12
Advanced Settings.....	7-12
Layout Adjustment.....	7-13
Filing Options/E-mail Options.....	7-13
8 Faxing.....	8-1
Fax Overview.....	8-1
Loading Original Documents.....	8-2

Document Glass.....	8-2
Duplex Automatic Document Feeder.....	8-2
Sending a Fax.....	8-2
Server Fax.....	8-3
Sending a Server Fax.....	8-4
Sending an Internet Fax.....	8-4
Faxing from Your Computer.....	8-5
Receiving Faxes.....	8-5
Selecting Fax Settings.....	8-6
Setting 2-Sided Faxing.....	8-6
Selecting the Original Type.....	8-6
Setting the Fax Resolution.....	8-6
Adjusting Layout.....	8-6
Lighten/Darken.....	8-6
Adjusting the Original Size.....	8-6
Book Faxing.....	8-7
Reduce/Enlarge.....	8-7
Fax Options.....	8-7
More Fax Options.....	8-8
Internet Fax Options.....	8-8
Adding Address Book Entries.....	8-9
Adding an Individual Address.....	8-9
Deleting an Individual Address.....	8-9
Adding a Group.....	8-10
Deleting a Group.....	8-10
Using Chain Dial.....	8-10
Creating Fax Comments.....	8-11
9 Maintenance.....	9-1
General Precautions.....	9-1
Locating the Serial Number.....	9-2
Billing and Usage Information.....	9-2
Cleaning the Printer.....	9-2
Cleaning the Document Glass and Document Cover.....	9-3
Cleaning the Exterior.....	9-3
Ordering Supplies.....	9-3
Consumables.....	9-4
When to Order Supplies.....	9-4
Routine Maintenance Items.....	9-4
Replacing the Toner Cartridges.....	9-5
Replacing the Fuser.....	9-6
Replacing the Waste Toner Container.....	9-7

Replacing the Drum Cartridges.....	9-8
Replacing the Charge Corotron.....	9-10
Recycling Supplies.....	9-11
10 Troubleshooting.....	10-1
Control Panel Messages.....	10-1
General Troubleshooting.....	10-2
Printer Does Not Turn On.....	10-2
Printing Takes Too Long.....	10-2
Printer Resets or Turns Off Frequently.....	10-3
2-Sided Printing Problems.....	10-3
Scanner Error.....	10-3
Troubleshooting Paper Jams.....	10-3
The Printer Pulls Multiple Sheets Together.....	10-3
Paper Jam Message Stays On.....	10-4
Media Misfeeds.....	10-4
Clearing Paper Jams.....	10-5
Clearing Paper Jams from Tray 1, Tray 2, Tray 3, or Tray 4.....	10-5
Clearing Paper Jams from Tray 5 (Bypass Tray).....	10-6
Clearing Paper Jams in Document Feeder.....	10-6
Clearing Paper Jams in the High Capacity Feeder.....	10-6
Clearing Paper Jams in the Oversized High Capacity Feeder.....	10-6
Clearing Paper Jams in the Fuser.....	10-6
Clearing Jams in the C/Z Folder.....	10-7
Clearing Jams at 2a in the C/Z Folder.....	10-7
Clearing Jams at 2b in the C/Z Folder.....	10-8
Clearing Jams at 2e in the C/Z Folder.....	10-9
Clearing Jams at 2f in the C/Z Folder.....	10-10
Clearing Jams at 2g in the C/Z Folder.....	10-11
Minimizing Paper Jams.....	10-12
Print Quality Problems.....	10-13
Copy and Scan Problems.....	10-13
Fax Problems.....	10-14
Problems Sending Faxes.....	10-14
Problems Receiving Faxes.....	10-15
Getting Help.....	10-16
Control Panel Messages.....	10-16
Alerts.....	10-16
Web Resources.....	10-16

11 Printer Specifications.....	11-1
Physical Specifications.....	11-1
Base Unit.....	11-1
Base Unit, High Capacity Feeder, Interface Module, and Standard Finisher.....	11-2
2-Drawer Oversized High Capacity Feeder with Base Unit and Business Ready Finisher/Booklet Maker.....	11-2
Environmental Specifications.....	11-2
Temperature and Relative Humidity.....	11-2
Electrical Specifications.....	11-2
Performance Specifications.....	11-3
Resolution.....	11-3
Print Speed.....	11-3
12 Business Ready Finisher and Booklet Maker.....	12-1
Overview.....	12-1
Identifying the Components.....	12-2
Maintenance.....	12-2
Replacing Staples in the Main Stapler Unit.....	12-2
Replacing Staples in the Booklet Maker Component.....	12-3
Emptying the Hole Punch Waste Container.....	12-4
Troubleshooting.....	12-5
Clearing Jams in the Finisher at Position 3a.....	12-5
Clearing Jams in the Finisher at Position 3c.....	12-6
Clearing Jams in the Finisher at Position 3d.....	12-7
Clearing Jams in the Finisher at Position 4.....	12-8
Clearing Jams in the Booklet Tray.....	12-9
13 Standard/Booklet Maker Finisher.....	13-1
Standard/Booklet Maker Finisher Components.....	13-2
Manual Decurling Feature on the Finisher.....	13-4
Folding Feature.....	13-5
Fold Types.....	13-5
Loading Paper/Tabs in Tray T1 (Post-Process Inserter).....	13-5
Maintenance.....	13-6
Standard/Booklet Maker Consumable Supplies.....	13-6
Replace the Standard Staple Cartridge.....	13-7
Replace the Booklet Staple Cartridge.....	13-8
Replacing the Staple Waste Container on the Finisher.....	13-9
Empty the Punch Waste Container.....	13-10
Finisher Problem Solving.....	13-12
Paper jams in Tray T1 (Post Process Inserter).....	13-12

Paper Jams at Lever 1a and Knob 1c.....	13-12
Paper Jams at Lever 1d.....	13-13
Paper Jams at Lever 1b.....	13-14
Paper Jams at Lever 3b and 3d.....	13-15
Paper Jams at Lever 3e and Knob 3c.....	13-16
Paper Jams at Lever 3g and Knob 3f.....	13-16
Paper Jams at Lever 4b and Knob 3a.....	13-17
Paper Jams at Lever 2a and Knob 3a.....	13-18
Paper Jams at Lever 2b and Knob 2c.....	13-19
Paper Jams at 2c, 2e, 2f, and 2d.....	13-20
Paper Jams at 2d and Lever 2g.....	13-20
Paper Jams at Unit 4 and Knob 4a.....	13-21
Paper Jams at Finisher Top Tray.....	13-22
Paper Jams at Finisher Stacker Tray.....	13-23
Paper Jams at the Optional Booklet Maker Tray.....	13-23
Stapler Faults.....	13-24
Staple Jams in the Standard Staple Cartridge.....	13-25
Staple Jams in the Booklet Maker Cartridge.....	13-26
Reinserting a Misaligned Standard Staple Cartridge.....	13-27
Fault Codes.....	13-29
Specifications.....	13-31
Standard/Booklet Maker Finisher Specifications.....	13-31
Optional C/Z Folder Specifications.....	13-33
14 SquareFold Trimmer Module.....	14-1
Overview.....	14-1
Identifying the Components.....	14-2
Main Components.....	14-2
Paper Path.....	14-3
Control Panel.....	14-3
Square Fold Feature.....	14-4
Square Fold Options.....	14-4
Trimmer Feature.....	14-6
Trimmer Options.....	14-6
Trim Guidelines.....	14-7
Hints and Tips.....	14-8
Printing Full-page Images on Booklets.....	14-8
Follow These Tips.....	14-9
Problem Solving.....	14-9
Jam Clearance.....	14-9
Clearing Jams.....	14-10
Clearing E1/E2 jams.....	14-10

Clearing E3 Jams.....	14-11
Fault Codes.....	14-12
Specifications.....	14-14
15 Regulatory Information.....	15-1
Basic Regulations.....	15-1
United States FCC Regulations.....	15-1
Canada.....	15-2
Certifications in Europe.....	15-2
European Union Lot 4 Imaging Equipment Agreement Environmental Information.....	15-3
Environmental Information Providing Environmental Solutions and Reducing Cost.....	15-3
Germany.....	15-5
Blendschutz.....	15-5
Lärmemission.....	15-5
Importeur.....	15-5
Turkey RoHS Regulation.....	15-5
Eurasian Economic Community Certification.....	15-5
Ozone Release.....	15-5
Wireless Compliance.....	15-5
Labeling Requirements.....	15-6
Copy Regulations.....	15-6
United States.....	15-6
Canada.....	15-8
Other Countries.....	15-9
Fax Regulations.....	15-10
United States.....	15-10
Fax Send Header Requirements.....	15-10
Data Coupler Information.....	15-10
Canada.....	15-11
Canada CS-03 Issue 9.....	15-12
European Union.....	15-12
Radio Equipment and Telecommunications Terminal Equipment Directive.....	15-12
New Zealand.....	15-13
South Africa.....	15-14
Safety Certification.....	15-14
Material Safety Data Sheets.....	15-14
16 Recycling and Disposal.....	16-1
All Countries.....	16-1
North America.....	16-1



European Union.....	16-1
Domestic/Household Environment.....	16-2
Professional/Business Environment.....	16-2
Collection and Disposal of Equipment and Batteries.....	16-2
Business Users in the European Union.....	16-3
Disposal Outside of the European Union.....	16-3
Battery Symbol.....	16-3
Battery Removal.....	16-3
Other Countries.....	16-3

Table of Contents

Safety

Your printer and the recommended supplies have been designed and tested to meet strict safety requirements. Attention to the following information ensures the continued safe operation of your Xerox® printer.

Warning Symbols

Symbol	Description
	WARNING or CAUTION: Ignoring this warning could cause serious injury or even death. To avoid personal injury, use caution. To avoid property damage, use caution.
	WARNING: Hot surface on or in the printer. To avoid personal injury, use caution.
	WARNING: Moving parts. To avoid personal injury, use caution.

Notices and Safety

Carefully read the following instructions before operating your printer. Refer to these instructions to ensure the continued safe operation of your printer.

Your Xerox® printer and supplies are designed and tested to meet strict safety requirements. Safety requirements include safety agency evaluation and certification, and compliance with electromagnetic regulations and established environmental standards.

The safety and environment testing and performance of this product have been verified using Xerox® materials only.

 **Warning**

Unauthorized alterations, which can include the addition of new functions or connection of external devices, can affect the product certification. For details, contact your Xerox® representative.

Emergency Turn Off

If any of the following conditions occur, turn off the printer immediately and disconnect the power cord from the electrical outlet. Contact an authorized Xerox service representative to correct the problem if:

- The equipment emits unusual odors or makes unusual noises.
- The power cable is damaged or frayed.
- A wall panel circuit breaker, fuse, or other safety device has been tripped.
- Liquid is spilled into the printer.
- The printer is exposed to water.
- Any part of the printer is damaged.

General Guidelines

 **Warning**

Do not push objects into slots or openings on the printer. Touching a voltage point or shorting out a part could result in fire or electric shock.

Do not remove the covers or guards that are fastened with screws unless you are installing optional equipment and are instructed to do so. Turn off the printer when performing these installations. Disconnect the power cord when removing covers and guards for installing optional equipment. Except for user-installable options, there are no parts that you can maintain or service behind these covers.

The following are hazards to your safety:

- The power cord is damaged or frayed.
- Liquid is spilled into the printer.
- The printer is exposed to water.
- The printer emits smoke, or the surface is unusually hot.
- The printer emits unusual noise or odors.
- The printer causes a circuit breaker, fuse, or other safety device to activate.

If any of these conditions occur, do the following:

1. Turn off the printer immediately.
2. Disconnect the power cord from the electrical outlet.
3. Call an authorized service representative.

Electrical Safety

Carefully read the following instructions before operating your printer. Refer to these instructions to ensure the continued safe operation of your printer.

Your Xerox® printer and supplies are designed and tested to meet strict safety requirements. These include safety agency evaluation and certification, and compliance with electromagnetic regulations and established environmental standards.

The safety and environment testing and performance of this product have been verified using Xerox® materials only.

Warning

Unauthorized alterations, which can include the addition of new functions or connection of external devices, can affect the product certification. For details, contact your Xerox® representative.

Electrical Supply

The electrical supply for the device must meet the requirements stated on the data plate on the rear of the device. If you are not sure that your electrical supply meets the requirements, consult your local electricity provider or a licensed electrician.

Warning

The device must be connected to a grounded electrical circuit. The device is supplied with a grounded electrical plug that fits into a grounded electrical outlet. The power cord plug only fits into a grounded electrical outlet. The power cord design is a safety feature. If you are unable to insert the power cord plug into your electrical outlet, consult your local electricity provider or a licensed electrician. Always connect the device to a properly grounded electrical outlet.

Emergency Turn Off

If any of the following conditions occur, turn off the printer immediately and disconnect the power cord from the electrical outlet. Contact an authorized Xerox service representative to correct the problem if:

- The equipment emits unusual odors or makes unusual noises.
- The power cable is damaged or frayed.
- A wall panel circuit breaker, fuse, or other safety device has been tripped.
- Liquid is spilled into the printer.
- The printer is exposed to water.
- Any part of the printer is damaged.

Power Cord Safety Information

Carefully read the following instructions before operating your printer. For details, contact your Xerox representative.

Safety

Warning

The electrical supply for the device must meet the requirements stated on the data plate on the rear of the device. If you are not sure that your electrical supply meets the requirements, consult your local electricity provider or a licensed electrician.

Do not use an extension cord.

Do not remove or modify the power cord.

Refer to these instructions to ensure the continued safe operation of your printer.

- Use the power cord supplied with your printer.
- Plug the power cord directly into a properly grounded electrical outlet. Ensure that each end of the cord is connected securely. If you do not know if an outlet is grounded, ask an electrician to check the outlet.
- Do not use a ground adapter plug to connect the printer to an electrical outlet that does not have a ground connection terminal.

Warning

Avoid the potential of electrical shock by ensuring that the printer is grounded properly. Electrical products can be hazardous if misused.

- Verify that the printer is plugged into an outlet that is providing the correct voltage and power. Review the electrical specification of the printer with an electrician if necessary.
- Do not place the printer in an area where people can step on the power cord.
- Do not place objects on the power cord.
- Replace the power cord if it becomes frayed or worn.
- Do not unplug or plug the power cord while the printer is turned on.
- To avoid electrical shock and damage to the cord, grasp the plug when unplugging the power cord.
- The electrical outlet must be near the printer and must be easily accessible.

The power cord is attached to the printer as a plug-in device on the back of the printer. If it is necessary to disconnect all electrical power from the printer, disconnect the power cord from the electrical outlet. For details, see [Turning Off the Printer](#).

Operational Safety

Your printer and supplies were designed and tested to meet strict safety requirements. These include safety agency examination, approval, and compliance with established environmental standards.

Your attention to the following safety guidelines helps to ensure the continued, safe operation of your printer.

Printer Location

- Place the printer on a level, solid, non-vibrating surface with adequate strength to hold the weight of the printer. To find the weight for your printer configuration, see [Physical Specifications](#).
- Do not block or cover the slots or openings on the printer. These openings are provided for ventilation and to prevent overheating of the printer.
- Place the printer in an area where there is adequate space for operation and servicing.
- Place the printer in a dust-free area.
- Do not store or operate the printer in an extremely hot, cold, or humid environment.
- Do not place the printer near a heat source.
- Do not place the printer in direct sunlight to avoid exposure to light-sensitive components.
- Do not place the printer where it is directly exposed to the cold air flow from an air conditioning system.
- Do not place the printer in locations susceptible to vibrations.

Operational Guidelines

- Do not remove the paper source tray that you selected using either the print driver or Control Panel while the printer is printing.
- Do not open the doors when the printer is printing.
- Do not move the printer when it is printing.
- Keep hands, hair, neckties, and so on, away from the exit and feed rollers.
- Covers, which require tools for removal, protect the hazard areas within the printer. Do not remove the protective covers.
- Ensure that the rear right cover is attached. Open this cover when connecting an interface cable.

Consumable Information

- Store all supplies in accordance with the instructions given on the package or container.
- Keep all supplies away from the reach of children.
- Never throw toner, print/drum cartridges, or toner containers into an open flame.
- When handling supplies, avoid skin or eye contact. Eye contact can cause irritation and inflammation.
- Do not attempt to disassemble supplies, which can increase the risk of skin or eye contact.

 **Caution**

Use of non-Xerox supplies is not recommended. The Xerox Warranty, Service Agreement, and Total Satisfaction Guarantee do not cover damage, malfunction, or degradation of performance caused by use of non-Xerox supplies, or the use of Xerox supplies not specified for this printer. The Total Satisfaction Guarantee is available in the United States and Canada. Coverage could vary outside these areas. Please contact your Xerox representative for details.

Vacuum Cleaner Use for Toner Spills

Use a broom or wet cloth to wipe off spilled toner. To minimize generation of dust particles, sweep or wipe slowly. Avoid using a vacuum. If you must use a vacuum, ensure the unit is designed to contain combustible dusts. Ensure that the vacuum includes an explosion rated motor and non-conductive hose.

Ozone Release

This printer produces ozone during normal operation. The amount of ozone produced is dependent on copy volume. Ozone is heavier than air and is not produced in amounts large enough to harm anyone. Install the printer in a well-ventilated room.

For more information in the United States and Canada, go to www.xerox.com/environment. In other markets, please contact your local Xerox representative or go to www.xerox.com/environment_europe.

Maintenance Safety

Your Xerox® printer and supplies are designed and tested to meet strict safety requirements. Safety requirements include safety agency evaluation and certification, and compliance with electromagnetic regulations and established environmental standards. Refer to these instructions to ensure the continued safe operation of your printer. For details, contact your Xerox® representative.

- Follow all warnings and instructions marked on, or supplied with, the product, options, and supplies.
- Do not attempt any maintenance procedure that is not specifically described in the documentation supplied with your printer.
- Always exercise care when moving or relocating your printer. Contact your Xerox® representative to arrange the relocation of your printer.
- Never throw toner, print/drum cartridges, or toner containers into an open flame.

⚠ Warning

Before cleaning the printer, unplug it from the electrical outlet.

Do not use aerosol cleaners. Aerosol cleaners can cause explosions or fires when used on electromechanical equipment.







The metallic surfaces in the fuser area are hot. To avoid personal injury, use caution.

Do not attempt to remove paper that is jammed deeply inside the product. Switch off the product promptly and contact your local Xerox® representative.

Do not apply excessive force on the document glass.

Do not override any electrical or mechanical interlock devices.

Printer Symbols

Symbol	Description
	WARNING or CAUTION: Ignoring this warning could cause serious injury or even death. To avoid personal injury, use caution. To avoid property damage, use caution.
	WARNING: Hot surface on or in the printer. To avoid personal injury, use caution.
	Do not burn the waste container.
	Do not expose the drum cartridge to light for more than 10 minutes.
	Do not touch the drum cartridge.
	Hot surface. Wait the indicated time before handling.
	WARNING: Moving parts. To avoid personal injury, use caution.

For a complete list of Printer Symbols, refer to www.xerox.com/support.

Environmental, Health, and Safety Contact Information

For more information on Environment, Health, and Safety in relation to this Xerox product and supplies, contact the following customer help lines:

Safety

United States and Canada: 1-800-ASK-XEROX (1-800-275-9376)

Europe: +44 1707 353 434

For product safety information in the United States and Canada, go to www.xerox.com/environment.

For product safety information in Europe, go to www.xerox.com/environment_europe.

2

Product Overview

This chapter contains the following sections:

- Introduction
- Printer Configurations
- Parts of the Printer
- Standard Features
- Energy Saver Mode
- Printer Information
- Consumables
- Optional Accessories
- Getting Additional Information

Introduction



The Xerox Color C60/C70 shown alone and configured with the following: 2-drawer OHCF, Vertical Transport, CZ-Folder, and Business Ready Finisher with Booklet Maker.

Your machine is not simply a conventional copier. It is a digital light production printer capable of being used for copying, scanning, faxing and printing documents both in color and in black and white.

The Control Panel user interface on the printer is an easy-to-use touch screen for adjusting settings and performing tasks.

Printer Configurations

Printer Model/Configuration	Description
The Xerox Color 60	This printer model prints at speeds of up to 65 ppm for Black and white, and up to 60 ppm for color
The Xerox Color 70	This printer model prints at speeds of up to 75 ppm for Black and white, and up to 70 ppm for color

Parts of the Printer

This section includes:

- Right-Front View
- Right-Rear View
- Document Feeder
- Control Panel
- Internal Components
- Paper Trays
- Telephone and Fax Connection Option

Right-Front View



1. Control Panel

2. USB Port

3. Stylus

4. Tray 5 (Bypass)

- 5. Paper Trays 1 - 4
- 6. Duplex Automatic Document Feeder
- 7. 5. Power On/Off Button
- 8. Front Cover
- 9. Main Power Switch (located behind front cover). See [Internal Components](#).

Right-Rear View

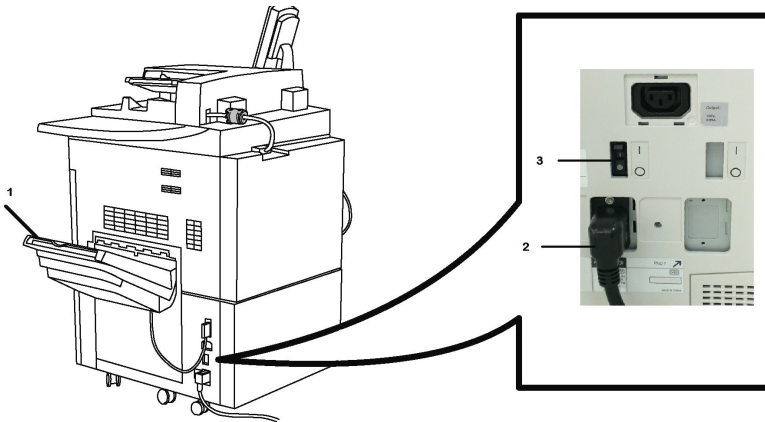

- 1. Output Tray
- 2. Power Cord
- 3. Ground Fault Interrupt Switch

Duplex Automatic Document Feeder

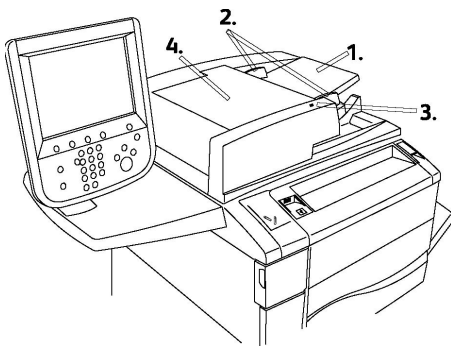

- 1. Document Feeder Tray
- 2. Document Guides
- 3. Confirmation Indicator
- 4. Top Cover

Note

The Document Glass is located under the Top Cover and is used for scanning, faxing and copying. Use for single pages or paper that cannot be fed using the Document Feeder.

Control Panel

The Control Panel contains a touch screen, pathway buttons, a keypad and feature buttons.



- 1 Touch Screen.** The touch screen allows you to select all the available programming features. It also displays fault clearance procedures and general machine information.
- 2 Services Home.** Allows access to the All Services screen where all features (Copy, Fax, etc.) that are installed on the machine can be viewed and programmed.
- 3 Services.** The Services button takes you to the last Service screen accessed.
- 4 Job Status.** Displays job progress information on the touch screen.
- 5 Machine Status.** Displays the current status of the machine on the touch screen.
- 6 Log In/Out.** Provides password protected access to the System Administration menu used to adjust the defaults of the machine.
- 7 Energy Saver Button.** If the Energy Saver option is selected, the machine will immediately enter an energy saving mode. If there are any jobs in the queue, a second pop-up screen displays.
- 8 Clear All.** If pressed once, resets the default settings and displays the first screen for the current pathway. If pressed twice, resets all the features to their machine default settings.
- 9 Stop.** Temporarily stops the current job. Follow the message to cancel or resume your job.
- 10 Start.** Starts the job.
- 11 Interrupt.** Temporarily stops the current job to allow a priority job to be run.

- 12 **Keypad buttons.** Type letters and/or numbers when entering values or a password.
- 13 **Language.** Press to change the touch screen language and keyboard settings.
- 14 **Help.** Access the Online Help system.

Internal Components



- 1. **Toner Cartridges**
- 2. **Drum Cartridges**
- 3. **Main Power Switch**
- 4. **Fuser Unit**
- 5. **Waste Toner Container**

The Main Power Switch is one of three power switches or buttons to turn on. Refer to [Turning On the Printer](#) for information on properly starting up the machine.

Paper Trays

For more feeding options, refer to [Input Devices](#).

Paper Trays 1 and 2

Trays 1 and 2 are identical. Each tray has a capacity of 520 sheets of 20 lb./75 gsm paper. The trays are pulled out by the operator for loading. The trays accommodate paper weights from 64-300 gsm (18 lb. bond - 80 lb. cover) and are fully adjustable for all stock sizes in the range 7.2 x 5.5 in./182 x 140 mm to 13 x 19.2 in./330 x 488 mm. All stock types (pre-formatted paper, letterhead) can be used except for envelopes. Stock can be loaded either long- or short-edge feed (portrait or landscape).

Paper Trays 3 and 4

Tray 3 holds up to 870 sheets of 8.5 x 11 inch/A4 paper.

Tray 4 holds up to 1,140 sheets of 8.5 x 11 inch/A4 paper.

Bypass Tray (Tray 5)

The Bypass Tray is a paper tray on the left side of your machine and can be folded away when not in use. It accommodates all types of stock in a range of sizes between 7.2 x 5.5 in./182 x 140 mm to 13 x 19.2 in./330 x 488 mm and has a capacity of approximately 250 sheets of 20 lb./75 gsm bond paper or a maximum stack height of 0.4.

Offset Catch Tray

The Offset Catch Tray (OCT) is an output tray that can hold up to 500 sheets of paper and allows each set or stack to be offset from the previous to enable easy separation.

Telephone and Fax Connection Option

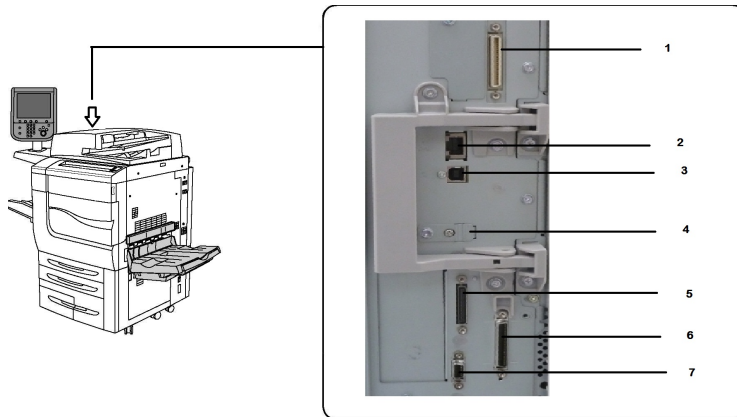

1. Digital Front End Video Select Switching Circuit (DFE VSEL)
2. Ethernet Connection
3. A to D Connection
4. Fax Connection (port is covered unless fax option is purchased)
5. Control Panel Connection
6. DADF Connection
7. Foreign Device Interface Connection

Standard Features

- Copy, print, mobile print
- Standard fax, Internet fax
- Scan to PC, USB, or e-mail
- Network Accounting
- Single-pass, duplex automatic document feeder
- 2400 x 2400 dpi resolution

- Automatic 2-sided printing
- Integrated scanner
- Standard paper capacity (4 Trays and Bypass): 3,260 sheets
- Color touch screen on integrated Control Panel
- Xerox Extensible Interface Platform® to connect to third-party software from the touch screen
- Foreign Device Interface
- PDL Support for PCL 5 and PCL 6
- Support for Ethernet 10/100BaseTX connection
- Support for coated and uncoated stock, up to 110 lb cover (300 gsm)
- Paper Catalog for stock type selection

Energy Saver Mode

Energy Saver mode reduces the printer's power consumption when the printer is inactive for a preset time.

The printer enters energy saving mode after a preset time has elapsed. If no jobs are sent to the printer for an additional preset time, it then enters Sleep Mode. The touch screen is dark and the Energy Saver button is lit in both modes.

Press the **Energy Saver** button to return the printer to normal operation. Receipt of a job or accessing the printer using CentreWare Internet Services also cancels Power Saver mode.

Printer Information

Your printer provides status information from the touch screen on the Control Panel and in printed reports. Usage and billing information are also available from the touch screen. For details, see Billing and Usage Information.

Consumables

There are several Consumables included in your machine. The machine will inform you when you need to order a new module and when to install it.

Drum Cartridges

The machine display and this documentation will enable you to successfully install the new cartridges so you do not have to wait for a service call.

Toner Cartridges

The Toner Cartridges can be loaded while the machine is running. Supplied with the toner cartridge is the waste toner container.

Fuser

The fuser will provide approximately 200,000 prints or copies.

Charge Corotron

The machine display and this documentation will enable you to successfully install the new Charge Corotron so you do not have to wait for a service call.

Waste Toner Container

The waste toner container will need changing after approximately 30,000 prints or copies at 6 % area coverage.

Optional Accessories

Input Devices

These optional input devices are compatible with your printer.

High-Capacity Feeder



The one-tray, high-capacity feeder (HCF) provides a 2,000 sheet, letter-size (A4) input feeding source (Tray 6).

Oversized High-Capacity Feeder



The one-tray or two-tray oversized high-capacity feeder (OHCF) is an alternative to the high-capacity feeder. It feeds oversized stock up to 13 x 19 in. (330 x 488 mm) paper. Each drawer holds 2,000 sheets of standard weight paper.

Finishing Devices

Your printer is compatible with any of the following finishing devices.

Business Ready Finisher



The Business Ready finisher supports hole punching and stapling. The Right Top Tray is used for stacked output, and can receive up to 500 sheets of paper. The Stacker is used for offset and/or stapled output, and can hold up to 3,000 sheets.

Business Ready Finisher with Booklet Maker



The Business Ready finisher with booklet maker supports hole punching, stapling, and booklet making. The Right Top Tray is used for stacked output, and can receive up to 500 sheets of paper. The Right Center Tray is used for offset and/or stapled output and can hold up to 1,500 sheets. Both trays can be used for hole punched output (optional). The Bottom Finisher Tray is used for receiving saddle-stapled booklets.

Standard Finisher/Booklet Maker Finisher

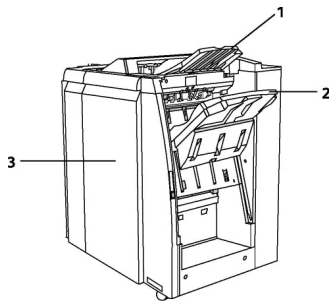

- 1 Top Tray
- 2 Stacker Tray
- 3 Front Cover

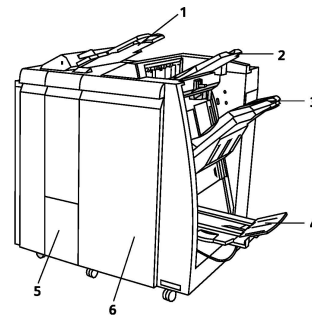

- 1 Post Process Inserter
- 2 Top Tray
- 3 Stacker Tray
- 4 Booklet Tray
- 5 Folder Output Tray
- 6 Front Cover

The Standard Finisher and Booklet Maker Finisher provide a range of finishing/folding options.

Note

The required Interface Module acts as a communication device and paper path between the printer and the Light Production C Finishers. It is required for both finishers.

The **Post Process Inserter** is standard on these devices and is used to load paper that serves as separators and covers. This tray holds up to 200 sheets.

The **Top Tray** is used for stacked output and can receive up to 500 sheets of 20 lb. (80 gsm) paper.

The **Stacker Tray** is used for offset and/or stapled output and can hold up to 3,000 sheets of 20 lb. (80 gsm) paper.

The **Bottom Tray** is the optional Booklet Maker Tray and is used for receiving saddle-stapled booklets.

The Booklet Maker Finisher contains all of the features of the Standard Finisher but also creates saddle stitched booklets of up to 25 sheets and from 8.5 x 11 in./A4 or 12 x 18 in./SRA3.

The optional Folder is used for C-folding and Z-folding of 8.5 x 11 in./A4 output and 11 x 17 in./A3.

Xerox® SquareFold® Trimmer



This optional finishing device is used in conjunction with a finisher that contains a booklet maker. The booklet is assembled and stapled in the booklet area of the finisher and enters the Trimmer Module already assembled.

The trimmer module flattens the booklet spine which reduces the booklet's thickness and gives it the appearance of a perfect-bound book. It then trims/cuts away the face (edge) of the booklet, resulting in a neat finished edge.

GBC® AdvancedPunch™



The GBC® AdvancedPunch™ finishing module provides another level of finishing to your output by allowing you to punch holes in 8.5 x 11 in./A4 documents that support a variety of binding styles. For 8.5 x 11 in media, the punch supports from 19 holes to a maximum of 32 holes. A4 media supports from 21 holes up to 47 holes.

This device requires an Interface Module and a follow-on finisher. The Interface Module uncurls paper and provides a communication hub to the print engine and controller. A follow-on finisher, such as the Standard Finisher, is necessary to gather punched output.

For more information, go to www.xerox.com and select the *GBC AdvancedPunch User Documentation*.

GBC AdvancedPunch Pro



Similar to the GBC AdvancedPunch, the GBC AdvancedPunch Pro may be attached to a variety of optional finishing accessories and provides the same capabilities as the AdvancedPunch. However, the AdvancedPunch Pro also provides additional capabilities that are not available with its predecessor. Those additional capabilities include the following:

- A larger range of media sizes and types
- Trail edge, LEF and SEF punching without die change
- Full-bleed processing for common sizes including SRA4, oversized LTR and more
- Die set detection control panel shows die type and cycle count
- User die set options include comb, wire, coil, and 3–7 hole varieties to enable most popular binding formats
- Operates at rated print engine speed for most paper sizes
- Quick-change die sets that can be interchanged without any tools
- Each die set includes an identification label providing the user with the hole pattern and name
- A convenient storage area located above the sheet bypass on the device for up to three extra die sets
- Expanded Media Range to enhance punching of cover up to 300 gsm
- 2-up punching (double-punch) on large sheets

This device requires an Interface Module for communication with the print engine and a follow-on finisher to gather the punched media.

For more information, go to www.xerox.com and select the *GBC AdvancedPunch Pro User* Documentation.

CZ Fold Unit

The optional folder enables you to create publications featuring bi-fold, C-fold, Z-fold, and Engineering Z-fold.

Required Finishing Accessories

Depending on the type of finishing device you use, one of the following accessories may also be required.

Interface Module



The interface module acts as a communication device and provides a paper path between the printer and the finishing device. The interface module is required for use with the Standard Finisher, the Booklet Maker Finisher, and the GBC Punch.

Vertical Transport Module



The vertical transport module acts as a communication device and provides a vertical transport path between the printer output location and the input to the finishing device.

The vertical transport module is required for use with the Business Ready Finisher and the Business Ready Finisher with Booklet Maker.

Getting Additional Information

Refer to the following sources for more information about your printer and its capabilities.

- **Recommended Media List:**
 - For the **United States:** www.xerox.com/printer-supplies/recommended-paper/enus.html
 - For the **European Union:** www.xerox.com/europaper
- **User Guide (PDF) Software and Documentation:** www.xerox.com/support. Enter Xerox Color C60/C70 Printer in the **Search or Choose** field and select the desired documentation.
- **Online Support Assistant, driver downloads, and Technical support:** www.xerox.com/Support
- **Ordering Supplies:** www.xerox.com/Supplies

3

Installation and Setup

This chapter contains the following sections:

- Before Using the Printer
- Installation and Setup Overview
- Physical Connection
- Turning On the Printer
- Turning Off the Printer
- Assigning a Network Address
- Using CentreWare Internet Services

Before Using the Printer

Xerox Welcome Center

If you need assistance during or after product installation, visit the Xerox website for online solutions and support: www.xerox.com/office/worldcontacts.

If you require further assistance, contact our experts at the Xerox Welcome Center:

- Xerox US Welcome Center: 1-800-821-2797
- Xerox Canada Welcome Center: 1-800-93-XEROX (1-800-939-3769)

Note

A local representative telephone number may have been provided when the product was installed. For convenience and future reference, record the telephone number.

When contacting Xerox, the Welcome Center will need the following information:

- the nature of the problem
- the serial number of the printer
- the fault code (if any)
- the name and location of your company

Installation and Setup

To learn the serial number of the printer, follow these steps:

1. On the Control Panel, press **Machine Status**.
2. The **Machine Information** tab appears. The serial number is displayed on the left side of the touch screen.

Note

If the serial number cannot be read from the printer's touch screen, it can also be found on the machine frame inside the lower left cover of the printer.

If you need any additional help using your printer:

- Refer to this User Guide.
- Contact the Key Operator.
- Visit our Customer Website at www.support.xerox.com/support (enter Xerox Color C60/C70 Printer in the **Search or Choose** field and select the desired documentation) or contact the Xerox Welcome Center.

Installation and Setup Overview

Before you can use the printer, you must:

1. Make sure the printer is connected correctly and switched on.
2. Install software print drivers and utilities.
3. Configure the software.

Note

Instructions for installing the print drivers, utilities, and setting up the network are provided in the System Administrator's Guide.

Locate the *System Administrator Guide* at www.xerox.com/support. Enter **Xerox Color C60/C70 Printer** in the **Search or Choose** field and select the desired documentation.

Physical Connection

You can connect to the printer over a network. Connect to a functioning and dedicated fax telephone line for the optional fax. Communication cables are not included with the printer and must be purchased separately.

To physically connect the printer:

1. Connect the power cable to the printer, and plug it into an electrical outlet.
2. Connect one end of a Category 5 (or better) Ethernet cable to the Ethernet port on the left side of the printer. Connect the other end of the cable to your network drop.
3. If the fax option is installed, connect to a functioning telephone line using a standard RJ11 cable.

Turning On the Printer

The printer has three power switches:

- The **Ground Fault Interrupt Switch**, located on the right side of the printer and near the power cord. At installation and setup, make sure that this switch is in the On position.

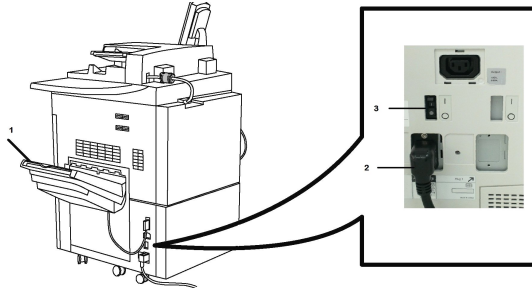

- The **Main Power Switch**, located behind the front cover door. Verify that this switch is also in the On Position. Do not use this switch to turn the printer on and off for general purposes.

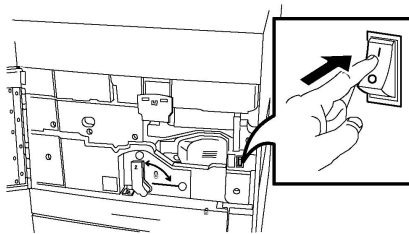

- The **Power On/Off Button**, located on the right side of the top front panel. This is the power button you will use to turn the printer on and off as workflow requires.

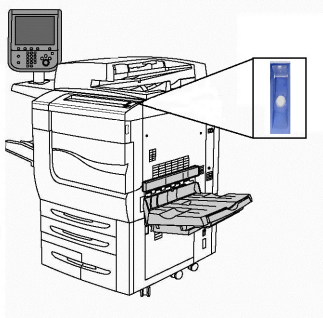

Turning On Main Power

Main printer power is controlled by the Main Power Switch. Main power should be left on for normal printer operation and should only be switched off when connecting a cable to the printer, when cleaning the printer, or when a complete reboot is required.

⚠ Caution

Switch main power on first using the Main Power Switch to avoid damaging the printer's internal hard drive or causing a printer malfunction.

! **Caution**

Do not turn main power off immediately after turning it on. Doing so may damage the printer's internal hard drive or cause a printer malfunction.

To turn on the main printer power:

1. Open the front cover.

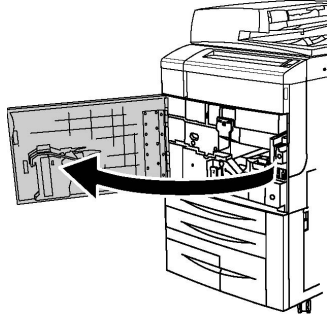

2. Press the **Main Power Switch** to the On position.

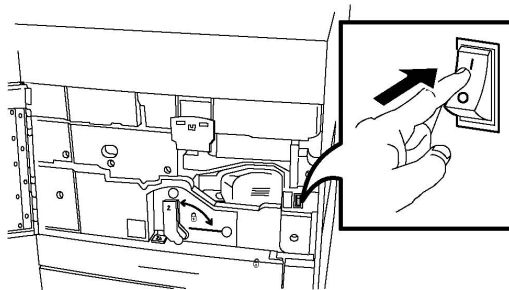

3. Close the front cover.

General Power On

To Turn the Printer On:

1. Check that the **Main Power Switch**, located inside the front cover, is turned On.
2. Press the **Power On/Off button**, located on the right side of the top front panel.

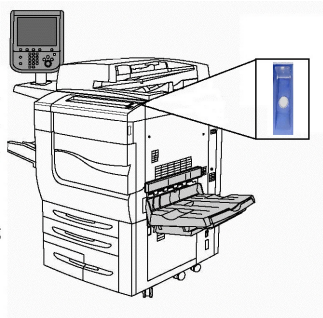

Note

The entire powering-up process (to power on and complete a self-test) takes approximately 3 minutes. Certain functions of the machine, such as copying, will be available before other functions, such as printing.

Turning Off the Printer

General Power Off

Note

Wait five seconds after any active job completes before switching off the printer.

To Turn the Printer Off:

Press the **Power On/Off button** to turn your machine off. This is the method you should use to turn the printer on and off for general purposes. Do not use the Main Power Switch.

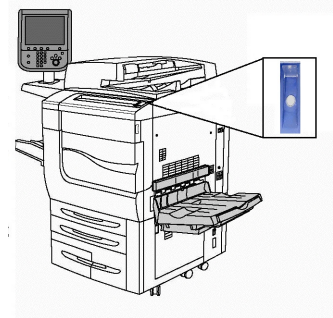

If the Energy Saver option is selected, the machine will immediately enter an energy saving mode. If there are any jobs in the queue, a second pop-up screen is displayed.

Note

To re-activate the machine when in Energy Saver mode, press the Energy Saver button.

Turning Off Main Power

Main printer power is controlled by the Main Power Switch. Main power should be left on for normal printer operation and should only be switched off when connecting a cable to the printer, when cleaning the printer, or when a complete reboot is required.

⚠ Caution

Switch the main power off before unplugging the power cord. Unplugging the power cord with the main power on may damage the printer's internal hard drive or cause a printer malfunction.

⚠ Caution

Do not switch main power off immediately after switching it on. Doing so may damage the printer's internal hard drive or cause a printer malfunction.

⚠ Caution

Do not switch the main power off immediately after pressing the On/Off Power Button. Doing so may damage the printer's internal hard drive or cause a printer malfunction. Instead, wait until the Control Panel touch screen goes dark, wait an additional 10 seconds, and then turn off the main power.

 **Caution**

Do not switch off the main power while a job is being processed or while the Energy Saver button is blinking. This may cause damage to the printer's internal hard drive or cause a printer malfunction.

To turn Off the Main Power Switch:

1. Open the front cover.

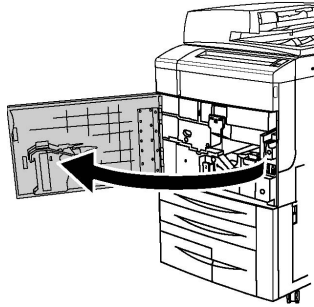

2. Press the **Main Power Switch** to the Off position.

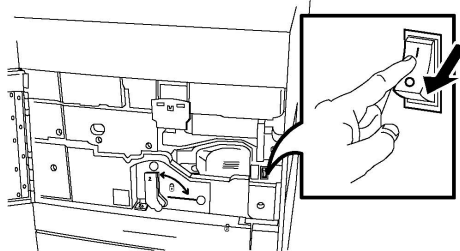

3. Close the front cover.

Assigning a Network Address

If the network uses a DHCP server, the printer automatically acquires a network address. To assign a static IP address, configure DNS server settings, or configure other TCP/IP settings, refer to the *System Administrator Guide* at www.xerox.com/support. Enter **Xerox Color C60/C70 Printer** in the **Search or Choose** field and select the desired documentation.

Using CentreWare Internet Services

CentreWare Internet Services provides access to the printer's embedded Web server. It enables you to easily manage, configure, and monitor the printer using a Web browser on a network computer.

CentreWare Internet Services enables you to:

- Access printer status, configuration, and security settings
- Check supplies status from your computer
- Access job accounting records to allocate printing costs and plan supplies purchases

- Retrieve scanned document files stored in the printer

Note

Some printer capabilities must be enabled using CentreWare Internet Services. Unless your system administrator has unlocked the printer, you will need to log in as an administrator to access these settings.

CentreWare Internet Services requires:

- A Web browser and a TCP/IP connection between the printer and the network (in Windows, Macintosh, or UNIX environments).
- JavaScript must be enabled in the Web browser. If JavaScript is disabled, a warning message appears and CentreWare Internet Services may not function properly.
- TCP/IP and HTTP must be enabled in the printer.

For details, refer to the *System Administrator Guide* at www.xerox.com/support. Enter **Xerox Color C60/C70 Printer** in the **Search or Choose** field and select the desired documentation.

Finding the Printer's IP Address

The printer's IP address is required to use CentreWare Internet Services. If you do not know the IP Address, print the Configuration Report. The printer's IP address appears in the Communication Settings section.

To print the Configuration Report:

1. At the Control Panel, press the **Machine Status** button.
2. Touch the **Machine Information** tab, then touch **Print Reports**.
3. Touch **Printer Reports**, touch **Configuration Report**, then press the green **Start** button on the Control Panel.
4. After the report prints, touch **Close**.

Accessing CentreWare Internet Services

1. Make sure the printer is connected correctly and switched on.
2. At your computer, open a Web browser.
3. Type the IP address of the printer in the Web browser's address field.

The CentreWare Internet Services Welcome page appears.

4

Loading Media

This section includes the following:

- Accepted Media
- Paper Types/Weights Accepted in Trays
- Tray Capabilities
- Loading Paper in Trays 1-4
- Loading Paper in Tray 5 (Bypass Tray)
- Loading Envelopes in Tray 5 (Bypass Tray)
- Loading Paper in the High Capacity Feeder
- Loading Paper in the Oversized High Capacity Feeder
- Loading Paper in the Post-Process Inserter

Accepted Media

Your printer is designed to be used with a variety of media types. Follow the guidelines in this section to ensure the best print quality and to avoid jams. For best results, use Xerox printing media specified for your printer.

Recommended Media

A complete list of recommended media types is available at:

- <http://www.xerox.com/printer-supplies/recommended-paper/enus.html>.
- <http://www.xerox.co.uk/printer-supplies/printer-papers/engb.html>. Select **Colour Presses** and select the appropriate Production device.

General Media Loading Guidelines

Follow these guidelines when loading paper and media in the appropriate trays:

- Fan paper before loading it in the paper tray.

Loading Media

- Do not overfill the paper trays. Do not load paper above the maximum fill line in the tray.
- Adjust the paper guides to fit the paper size.
- Use only paper envelopes. Print envelopes 1-sided only. Use Tray 5 to print envelope and set Media Type to Heavyweight 2.
- Make sure the correct paper type is selected on the printer's touch screen after loading paper in a tray.

Printing/Copying on Labels

Labels can be printed from Trays 1, 2, 3, 4, and 5 (Bypass Tray).

When printing on labels, adhere to the following guidelines:

- Rotate stock frequently. Long periods of storage in extreme conditions can cause labels to curl and jam in the printer.
- Use labels designed for laser printing.
- Do not use vinyl labels.
- Do not use dry gum labels.
- Print only on one side of the sheet of labels.
- Do not use any sheet where labels are missing; it may damage the printer.
- Store unused labels flat in their original packaging. Leave the sheets of labels inside the original packaging until ready to use. Return any unused sheets of labels to the original packaging and reseal it.
- Do not store labels in extremely dry or humid conditions or extremely hot or cold conditions. Storing them in extreme conditions may cause print quality problems or cause them to jam in the printer.

Printing/Copying on Glossy Paper

Glossy paper can be printed from Tray 1, 2, 3, 4, and 5 (Bypass Tray).

When printing on glossy paper, adhere to the following guidelines:

- Do not open sealed packages of glossy paper until you are ready to load them into the printer.
- Store glossy paper flat in the original packaging.
- Remove all other paper from the tray before loading glossy paper.
- Load only the amount of glossy paper you plan to use and remove the unused portion from the tray when you are finished printing. Replace the unused portion in the original wrapper and seal for later use.
- Rotate stock frequently. Long periods of storage in extreme conditions can cause glossy paper to curl and jam in the printer.

Media That Can Damage Your Printer

Your printer is designed to use a variety of paper and media types for print jobs. However, some media can cause poor output quality, increased paper jams, or damage to your printer.

Do not use the following:

- Rough or porous media
- Inkjet paper
- Paper that has been photocopied
- Paper that has been folded or wrinkled
- Paper with cutouts or perforations
- Stapled paper
- Envelopes with windows, metal clasps, side seams, or adhesives with release strips
- Padded envelopes
- Plastic media

Paper Storage Guidelines

Providing good storage conditions for your paper and other media contributes to optimum print quality.

- Store paper in dark, cool, relatively dry locations. Most paper is susceptible to damage from ultraviolet and visible light. Ultraviolet light, which is emitted by the sun and fluorescent bulbs, is particularly damaging to paper.
- The intensity and length of exposure to visible light on paper should be reduced as much as possible.
- Maintain constant temperatures and relative humidity.
- Avoid storing paper in attics, kitchens, garages, or basements. These spaces are more likely to collect moisture.
- Store paper flat, either on pallets, cartons, shelves, or in cabinets.
- Avoid having food or drinks in the area where paper is stored or handled.
- Do not open sealed packages of paper until you are ready to load them into the printer. Leave stored paper in the original packaging. The paper wrapper usually contains an inner lining that protects the paper from moisture loss or gain.
- Some specialty media is packaged inside resealable plastic bags. Store the media inside the bag until you are ready to use it. Keep unused media in the bag and reseal it for protection.

Paper Types/Weights Accepted in Trays

When loading media in a paper tray, refer to the following chart for the paper types and weights that are accepted in each of the feeder paper trays available. Select the appropriate tray depending on the media you plan to use.

Note

The Oversize High Capacity Feeder (OHCF) provides the best feeding performance, especially for coated media.

Loading Media

Paper Type weight range can be selected in one of two ways:

- Select the Paper Type from the following table and apply the proper weight range using the options available from the Control Panel screen, or
- Select **Other Media Selection...** and select the specific media weight range from the available list on the Control Panel screen. Some features such as Printing Reports or Auto Tray Switching may be limited.

Note

If you want to define the image quality setting with a different paper weight range to optimize image quality, refer to the Paper Tray Settings section of the *System Administrator Guide*.

Paper Trays	Accepted Types and Weights
All Trays	Other Media Selection...
All Trays (cont.)	Plain (64-79 gsm)* Plain Reloaded (64-79 gsm) * Recycled (64-79 gsm) * Hole Punched (64-79 gsm) * Pre-Printed Letterhead Other Type Heavyweight 1 (106-128 gsm) * HW 1 Reloaded (106 -128 gsm) * Heavyweight 2(177-220 gsm)
All Trays (cont.)	HW 2 Reloaded (177-220 gsm) Heavyweight 3 (221-256 gsm) HW 3 Reloaded (221-256 gsm) Hole Punched HW 1 (106-128 gsm) * Hole Punched HW 2 (177-220 gsm) Hole Punched HW 3 (221-256 gsm) Coated 1 (106 -128 gsm) * Coated 1 Reloaded (106-128 gsm) * Coated 2 (151-176 gsm) *
All Trays (cont.)	Coated 2 Reloaded (151-176 gsm) * Labels (106-128 gsm) * Heavyweight Labels (177-220 gsm) Tab Stock (106-128 gsm) * HW Tab Stock (177-220 gsm) X-HW Tab Stock (221-256 gsm) Custom Type 1 (64-79 gsm) Custom Type 2 (64-79 gsm) Custom Type 3 (64-79 gsm) Custom Type 4 (64-79 gsm) Custom Type 5 (64-79 gsm)

Paper Trays	Accepted Types and Weights
Trays 5, 6, 7, OHCF	Heavyweight 4 (257-300 gsm) HW 4 Reloaded (257-300 gsm) Hole Punched HW 4 (257-300 gsm) Coated 3 (221-256 gsm) * Coated 3 Reloaded (221-256 gsm) * X-HW Labels (221-256 gsm) *
Tray 5	Transparency Transfer (129-150 gsm) * X-HW Tab Stock (257-300 gsm)

Note

*Media weight for this Paper Type displayed on the User Interface is limited. To optimize image quality, change the weight range. Refer to the Paper Tray Settings section of the System Administrator Guide.

Tray Capabilities

- Trays 1 and 2 can each hold up to 500 sheets of 90 gsm paper.
- Trays 1, 2, 3, and 4 can all accept paper from 60-220 gsm.
- Tray 1 can accommodate paper sizes from 5.5" x 8.5" to 12" x 18" /SRA3.
- Tray 2 can accommodate paper sizes from 5.5" x 8.5" to 11" x 17" /A3.
- Tray 3 can hold up to 870 sheets of 90 gsm paper.
- Tray 3 can accommodate paper sizes including 8.5" x 11"/A4, 7.25" x 10.5", and B5.
- Tray 4 can hold up to 1140 sheets of 90 gsm paper.
- Tray 4 can accommodate paper sizes including 8.5" x 11"/A4, 7.25" x 10.5", and B5.

Loading Paper in Trays 1 - 4

To load paper:

Warning

Do not open all trays at once. The printer could topple forward, possibly causing injury.

Note

Do not load paper above the maximum fill line. Doing so may cause paper jams.

1. Pull the paper tray out towards you until it stops.
2. Before loading paper into the paper trays, fan the edges to separate any sheets of paper that are stuck together. This reduces the possibility of paper jams.
3. If required, move the paper tray guides further out to load the new paper. To adjust the side and front guides, pinch the guide lever on each guide and slide the guides to their new position. To secure the guides in position, release the levers.

Loading Media

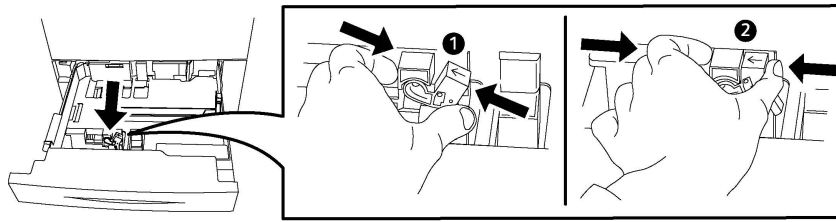

4. Load the paper against the left-hand side of the tray.

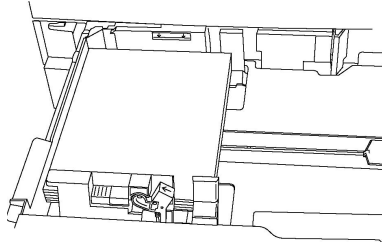

5. Adjust the guides so they touch the edges of the stack.

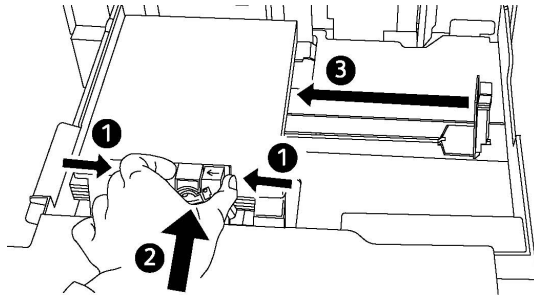

6. Push the tray completely into the printer.
7. If you have changed the media type, select an option on the Control Panel touch screen:
 - To choose paper size, type, or color, touch **Paper Supply**.
 - To choose a specific paper stock, touch **Paper Catalog**.
8. Touch **Save** and **Confirm**.
9. If you have not changed the media type, touch **Cancel** to retain the previous settings.

Loading Paper in Tray 5 (Bypass Tray)

Use the bypass tray for a variety of media types and custom sizes. It is primarily intended for small quantity jobs using special media. The bypass tray is located on the left-hand side of the printer. A tray extension is provided to accommodate larger paper. After loading paper in the bypass tray, make sure that the tray settings on the touch screen match the paper size and type loaded.

Tray Capabilities

- Tray 5 can hold up to 250 sheets of 90 gsm paper.
- Tray 5 can accept paper from 64-300 gsm.
- Tray 5 can accommodate paper sizes from 4" x 6" to 13.2" x 19.2" /SRA3.

To load paper in Tray 5 (Bypass Tray):

Note

Do not load paper above the maximum fill line.

1. Open Tray 5 and pull out the extension tray for larger sizes. If already opened, remove any paper that is a different size or type.
2. Move the width guides to the edges of the tray.
3. Insert the paper either long-edge or short-edge first, face up. Larger paper sizes can only be fed short-edge first. Load punched paper with holes to the right. Load labels and transparencies face up with top edge towards the front of the tray.

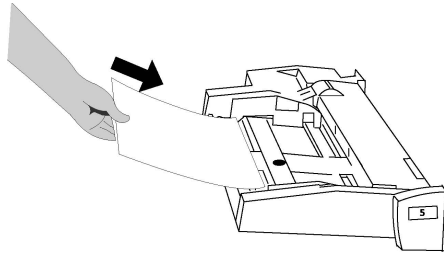

4. Adjust the width guides until they just touch the edges of the stack.

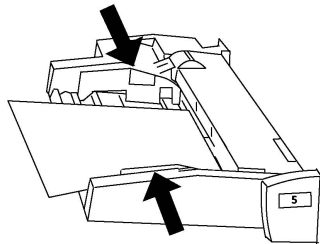

5. If required, select an option on the Control Panel touch screen:
 - To choose paper size, type, or color, touch **Paper Supply**.
 - To choose a specific paper stock, touch **Paper Catalog**.
6. Touch **Save** and **Confirm**.
7. If you have not changed the media type, touch **Cancel** to retain the previous settings.

Loading Envelopes in Tray 5 (Bypass Tray)

Tray 5 accepts Monarch and Commercial 10 envelopes with paper weights from 75 gsm to 90 gsm.

To load envelopes in Tray 5 (Bypass Tray):

1. Insert envelopes in Tray 5 (Bypass Tray) long edge feed (LEF) with flaps open and at the trail edge.
2. Adjust the guides until they just touch the edges of the stack.
3. Choose the envelope size on the printer's touch screen, then touch **Confirm**.

If the envelope size does not appear, touch **Change Settings**. Select **HeavyWeight 2** as the Media Type and **Custom Size**.

Use the +,- signs to enter the envelope size. Touch **Save**.

Note

To help avoid jams, do not load more than 30-50 envelopes.

Caution

Never use envelopes with windows or metal clasps; they can damage the printer. Damage caused by using unsupported envelopes is not covered under the Xerox warranty, service agreement, or Total Satisfaction Guarantee. The Total Satisfaction Guarantee is available in the United States and Canada. Coverage may vary outside these areas; please contact your local representative for details.

- Successful envelope printing is dependent on the quality and construction of the envelopes. Try another envelope brand if the desired results are not achieved.
- Maintain constant temperatures and relative humidity.
- Store unused envelopes in their original packaging to avoid the excess moisture or dryness which can affect print quality and cause wrinkling. Excessive moisture can cause the envelopes to seal before or during printing.
- Do not use padded envelopes.
- Some wrinkling or embossing may occur when printing on envelopes.

Loading Paper in the High Capacity Feeder

The optional High Capacity Feeder (HCF) is primarily intended for use as a large quantity feeder and accommodates 8.5 x 11 in./A4 Long Edge Feed (LEF) stock. The High Capacity Feeder can hold paper of weights between 18 lb./64gsm bond to 80 lb./220 gsm cover, and can hold a maximum of 2000 sheets of 20lb./75 gsm paper.

Note

Stock can only be loaded long-edge feed (LEF).

Note

The paper or media must not be loaded above the maximum fill line.

1. Slowly pull out the tray towards you until it stops.
2. Fan the sheets before loading them into the tray.
3. Load and register the stack of paper or media against the right side of the tray.
4. Move the paper guide to just touch the edges of the stack.
5. After stock is loaded into the High Capacity Feeder, a pop-up window may appear asking you to change or confirm the type and size of the stock. The tray may not be ready for use until you change or confirm the size and type of stock.
6. If you have changed the media type, select an option on the Control Panel touch screen:
 - To choose paper size, type, or color, touch **Paper Supply**.

- To choose a specific paper stock, touch **Paper Catalog**.
7. Touch **Save** and **Confirm**.
 8. If you have not changed the media type, touch **Confirm** on the touch screen.

Loading Paper in the Oversized High Capacity Feeder

The optional Oversized High Capacity Feeder (OHCF) provides an alternative to the HCF. The OHCF feeds oversized stock up to 13 x 19 in./SRA3/330 x 488 mm paper, 18 lb./64 gsm bond to 110 lb./300 gsm cover stock. Each drawer holds 2000 sheets of standard weight paper. The OHCF can be either a 1-drawer or a 2-drawer Feeder.

Note

The paper or media must not be loaded above the maximum fill line.

Note

The Paper Weight Switches work in conjunction with the blowers in the tray(s). The blowers help control environmental conditions in the paper trays and ensure optimum feed capability.

1. Slowly pull out the tray towards you until it stops.
2. After opening the tray, register the stack of paper or media against the front right side of the paper tray.

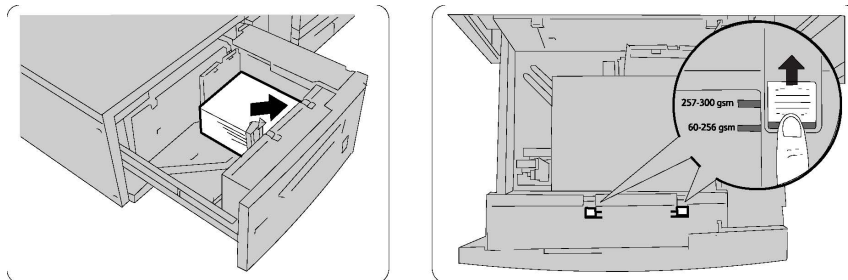

3. Move both Paper Weight Switches to their appropriate positions.
4. If the paper weight is between 60 gsm and 256 gsm, the position of the air adjustment levers (switches) should be toward the front of the tray. If the paper weight is between 257 and 300 gsm, the position of the air adjustment levers (switches) should be positioned toward the rear of the tray.

! Caution

For paper heavier than 256 gsm, slide both Paper Weight switches to the heavier weight position (257-300 gsm). Failure to do so may result in paper jams.

5. Push in the tray gently and completely. When the loaded tray is closed, the tray position is automatically adjusted in the front/back direction based on the paper size. A pop-up window may appear asking you to confirm the type and size of the stock.

Loading Media

6. If you have changed the media type, select an option on the Control Panel touch screen:
 - To choose paper size, type, or color, touch **Paper Supply**.
 - To choose a specific paper stock, touch **Paper Catalog**.
7. Touch **Save** and **Confirm**.
8. If you have not changed the media type, touch **Cancel** to retain the previous settings.

Loading Paper in the Post-Process Inserter

The Post-Process Inserter is standard component of the Standard Finisher and Standard Finisher with Booklet Maker. It is used to load blank or pre-printed paper that will be used for separators and covers. The Inserter holds a maximum of 200 sheets.

1. Remove any paper that remains loaded into the Inserter.
2. Hold the center of the paper guides and slide them to the desired paper size.
3. Load the paper, aligning to the front side of the tray.
4. If the paper is preprinted, load the paper with the printed side facing up and with the tab side to be fed first.
5. After stock is loaded into the Post-Process Inserter, a pop-up window may appear asking you to change or confirm the type and size of the stock. The tray may not be ready for use until you change or confirm the size and type of stock.
6. If you have changed the media type, select an option on the Control Panel touch screen:
 - To choose paper size, type, or color, touch **Paper Supply**.
 - To choose a specific paper stock, touch **Paper Catalog**.
7. Touch **Save** and **Confirm**.
8. If you have not changed the media type, touch **Cancel** to retain the previous settings.

5

Printing

This chapter contains an overview of printing from different operating systems and a brief description of many of the key printing features supported by the printer.

For detailed feature descriptions and instructions on how to use the print drivers, access the print driver help by clicking the **Help** button (?) located at the bottom left side of the print driver dialog.

Printing Overview

1. Select the appropriate media and ensure the media you want to use is loaded.

If the media is not loaded, load it in the tray and select an option on the Control Panel touch screen:

- Touch **Paper Supply** to specify the size, color, and type.
 - Touch **Paper Catalog** to specify a paper stock.
2. In your software application, click **File**, then **Print**.
 3. Select your printer from the list.
 4. Access the print driver settings by selecting **Properties** (Windows) or **Xerox Features** (Macintosh). The title of the button may vary depending on your application.
 5. Modify the print driver settings as necessary, then click **OK**.
 6. Click **Print** to send the job to the printer.

Saving a Set of Commonly Used Printing Options in Windows

You can define and save a set of printing options, so that you can quickly apply them to future print jobs.

To save a set of printing options:

Printing

1. With the document open, in your application click **File**, then click **Print**.
2. Select the printer, then click **Properties**. Click the tabs in the **Properties** window, then click the desired settings.
3. Click **Saved Settings** at the bottom of the **Properties** window, then click **Save As**.
4. Type a name for the set of printing options you have chosen, then click **OK**. The set of options is saved and the name you specified will appear in the list.
5. To print using these options, select the name from the list.

Saving a Set of Commonly Used Printing Options for Macintosh

You can define and save a set of options, so that you can quickly apply them to future print jobs.

To save a set of printing options:

1. With the document open in your application, click **File**, then click **Print**.
2. Select your printer from the Printer list.
3. Select the desired printing options from the drop-down lists on the **Print** menu screen.
4. Click the **Presets** menu, then click **Save As**.
5. Type a name for the printing options, then click **OK**.
6. The set of options is saved and will appear in the **Presets** list. To print using these options, select the name from the list.

Xerox[®] Services for UNIX[®] Systems (XSUS)

XSUS is an application that allows you to manage and print to multiple printers in UNIX[®] and Linux[®] environments. With XSUS you can:

- Configure and check the status of network-connected printers.
- Set up a printer on your network as well as monitor the operation of the printer once installed.
- Perform maintenance checks and view supplies status at any time.
- Provide a common look and feel across the many different suppliers of UNIX[®] and Linux[®] operating systems.

Launching XSUS

To launch XSUS from a terminal window prompt as root, type **xpadmin**, then press **Enter** or **Return**.

Note

XSUS automatically detects if your system's X server is able to run in graphical mode or not and starts accordingly.

For more information on managing printers and queues through XSUS, see the XSUS Administrator Online Help.

Printing from Linux

Launching Xerox Printer Manager

To launch Xerox® Printer Manager:

To launch Xerox® Printer Manager from a terminal window prompt as root, type **xeroxprtmgr**, then press **Enter** or **Return**.

Printing from a Linux Workstation

To print from a Linux Workstation:

1. Create a print queue.
2. With the desired document or graphic open in your application, open the Print dialog box. For most software applications, click **File > Print** or press **CTRL+P**.
3. Select the target print queue.
4. Close the Print dialog box.
5. In the Xerox® print driver, select the desired features.
6. Click **Print**.

The Xerox® print driver accepts job ticket setting files that select additional settings or features. You can also submit print requests through the command line using `lp/lpr`.

To create a job ticket using the Xerox® print driver:

1. Open the Xerox® print driver.
2. Select the desired options.
3. Click **Save As**, then store the job ticket in a public location, such as `/tmp`.

Note

Personally identifiable information, such as a Secure Print passcode, is not saved in the job ticket. You can specify the information on the command line.

The following commands are examples are how to print using a job ticket:

- `lp -d{Target_Queue} -oJT={Absolute_Path_To_Job_Ticket} {Path_To_Print_File}`
- `lp -dMyQueue -oJT=/tmp/DuplexedLetterhead /home/user/PrintReadyFile`
- `lp -dMyQueue -oJT=/tmp/Secure -oSecurePasscode=1234 /home/user/PrintReadyFile`

Printing Features

Media Types for Automatic 2-Sided Printing

The printer can automatically print a 2-sided document on supported paper. Before printing a 2-sided document, verify that the paper type and weight are supported. Paper weights in the range of 60 to 150 gsm can be used for automatic 2-sided printing.

The following paper types can be used for automatic 2-sided printing:

- Plain
- Letterhead
- Heavyweight
- Recycled
- Bond
- Pre-printed
- Gloss
- Punched

The following paper and media cannot be used for 2-sided printing:

- Reload (paper previously laser printed or copied)
- Envelopes
- Labels
- Any die-cut specialty media, such as business cards
- Extra Heavyweight
- Heavyweight Gloss

Printing a 2-Sided Document

Options for automatic 2-Sided Printing are specified in the print driver. Application settings for portrait or landscape orientation are used.

You can specify the page layout for 2-Sided Printing, which determines how the printed pages turn. These settings override the application page orientation settings.

For **Portrait**:

2-Sided Print / 2-Sided, Flip on Short Edge



For **Landscape**:

2-Sided Print / 2-Sided Print, Flip on Short Edge



Selecting the Paper to Use

When you send your print job to the printer, you can choose from the following options to select the paper:

- Allow the printer to select which paper to use automatically based on the document size, paper type and paper color that you select
- Select a specific tray loaded with the desired paper.
- Select a specific paper stock from the Paper Catalog.

Printing Multiple Pages to a Single Sheet (N-Up)

When printing a multiple-page document, you can print more than one page on a single sheet of paper. Print one, two, four, six, nine, or 16 pages per side.

Color Correction

The Color Correction options provide simulations of different color devices. Automatic is the recommended correction for general image processing. Different color reference models are supported and may vary based on your operating system and/or print driver type.

Booklets

With 2-sided printing, you can print a document in the form of a small booklet. Create booklets for any paper size that is supported for 2-sided printing. The driver automatically reduces each page image and prints four page images per sheet of paper (two on each side). The pages are printed in the correct order so that you can fold and staple the pages to create the booklet.

Note

Booklets can be created using 8.5 x 11 in. (A4 210 mm x 297 mm) paper and 11 x 17 in. (A3 297 mm x 420 mm) paper.

Some print drivers enable you to specify the gutter and creep.

- **Gutter:** Specifies the horizontal distance (in points) between the page images. A point is 0.35 mm (1/72 in.).
- **Creep:** Specifies how much the page images are shifted outward (in 10ths of a point). This compensates for the thickness of the folded paper, which otherwise would cause

the page images to shift slightly outward when folded. You can select a value from zero to 1 point.

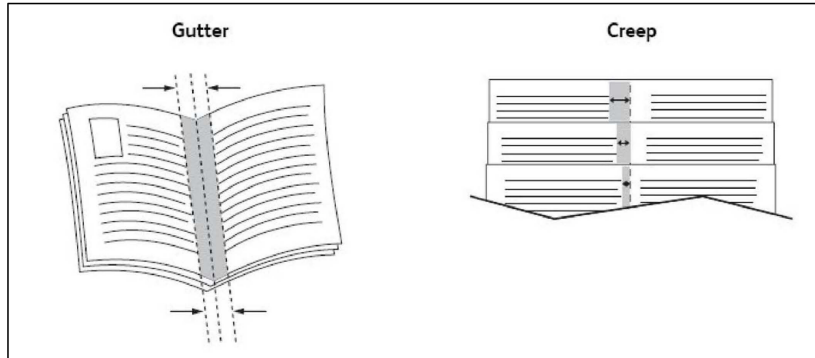

If your printer also includes a finisher with a booklet maker, you can use the features of that device for more robust booklet making capabilities.

Cover Pages

A cover page is the first or last page of a document. You can choose a different paper source for the cover page than for the body of a document. For instance, use your company letterhead for the first page of a document, or use heavyweight paper for the first and last pages of a report.

- Use the applicable paper tray as the source for printing cover pages.
- Verify that the cover page is the same size as the paper used for the rest of your document. If you specify a different size in the printer driver than the tray you select as a cover page source, your cover prints on the same paper as the rest of your document.

You have the following options for cover pages:

- **No Covers:** Prints the first and last pages of your document from the same tray as the rest of your document.
- **Front Only:** Prints the first page on paper from the specified tray.
- **Back Only:** Prints the back page on paper from the specified tray.
- **Front and Back: Same:** Front and back cover pages print from the same tray using blank or pre-printed paper.
- **Front and Back: Different:** Front and back cover pages print from different trays. The front cover can be pre-printed, but the back cover must use blank or pre-printed paper. If you require printing on the back page, you must use an exception page.

Insert Pages

An insert is a divider page or slipsheet that can be inserted after a print job, between copies of a print job, or between individual pages of a print job. You must specify the tray to use as the source for the insert pages.

- **Insert Options:** place insert After Page(s) or Before Page(s).
- **Insert Quantity:** Specifies the number of pages to be inserted at each location.

- **Page(s):** Specifies the location, either a page or a range of pages, to place the inserts. Separate individual pages or page ranges with commas. Specify page ranges with a dash. For example, to add inserts after pages 1, 6, 9, 10, and 11, type: 1, 6, 9-11.
- **Paper:** The Paper field displays the Use Job Settings default size, color, and type of paper to use for the insert pages.
- **Job Settings:** Displays the attributes of the paper for the majority of the document.

Exception Pages

You can specify the characteristics of any pages in the print job that differ from the settings used for the majority of the print job.

For example, your print job contains 30 pages that print on standard-sized paper, and two pages that must print on a different size of paper. In the **Add Exceptions** window, set the characteristics of these two exception pages and select the alternate paper size to use.

- **Page(s):** Specify the location (page or range of pages) to place the inserts. Separate individual pages or pages ranges with commas. Specify ranges with a dash. For example, to add inserts after pages 1, 6, 9, 10, and 11, type: 1, 6, 9-11.
- **Paper:** The **Paper** field displays the Use Job Settings default size, color, and type of paper to use for the exception pages.
- **2-Sided Printing:** Choose the desired 2-sided printing option.
- **Job Settings:** Displays the attributes of the paper for the majority of the document.

Scaling

To reduce or enlarge your printed page images, select a scaling value between 1 and 999 percent. The default value is 100 percent.

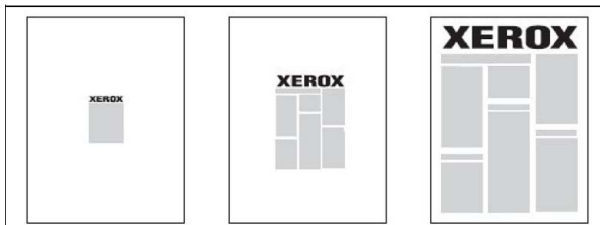

Watermarks

A watermark is additional text that can be printed across one or more pages. For example, terms like *Draft* and *Confidential*, which you might stamp on a page before distribution, can be inserted as a watermark.

You can:

- Create a watermark.
- Edit an existing watermark's text, color, density, location, and angle.
- Place a watermark on either the first page or every page in a document.
- Print a watermark in the foreground or background or blend with the print job.
- Use a picture for the watermark.

Printing

- Use a time stamp for the watermark.

Note

Not all applications support watermark printing.

Creating and Saving Custom Sizes

You can print custom size paper from Trays 1, 2, 3, 4 and 5 (Bypass Tray). Custom size paper settings are saved in the print driver and are available for you to select in all your applications.

Job Completion Notification

You can choose to be notified when your job is done printing. A message appears in the lower right corner of your computer screen with the name of the job and the name of the printer where it was printed.

Note

This feature is only available when your printer is connected to your computer over a network. It is not supported in all operating systems.

Secure Print Jobs

The Secure Print job type allows you to print a job after you select your user identification and enter your passcode at the printer Control Panel.

Sample Sets

The Sample Set job type allows you to send a multiple-copy job, print a sample copy of the job, and hold the remaining copies of the job at the printer. After you review the sample copy, you can release or delete the remaining copies.

Delayed Printing

A print job can be delayed for up to 24 hours from the original job submission time. Enter the time at which you would like the job to print. Use either a 12-hour format or a 24-hour format.

Saving Print Jobs to the Printer

The Store File in Folder job type stores a print job in a folder in the printer. You can print the job from the printer Control Panel. The job is not automatically deleted after printing, but it can be manually deleted at the printer Control Panel.

Folding

If your machine is equipped with a finisher, you can make prints using the folding option. The option folds your prints in half (single or bifolding) or in thirds (C-fold or Z-fold types). The folding option is selected from the print driver.

These fold types are available:

- Single Fold (Bi-Fold)
- C-Fold

- Z-Fold
- Z-Fold Half Sheet

The Single Fold (Bi-Fold) option is available only with a Booklet Maker Finisher. The C-Fold and Z-Fold options are available only with the C/Z Folder.

Note

In order to use the folding option, the orientation of documents must be short-edge feed (SEF). You must select a paper tray that contains SEF stock.

Printing from a USB Flash Drive

PDF, JPG, TIFF, and XPS files can be printed directly from a USB Flash Drive using the **Media Print - Text** feature.

Note

The print from USB option must be enabled by the System Administrator.

Note

The USB port and the optional Media Card Reader cannot be used at the same time. If present, remove the cable for the Media Card Reader before using the USB port on the printer front panel.

Printing from a Media Card Reader

JPEG, TIFF, DCF 1.0 JPEG and TIFF files can be printed directly from a Compact Flash card inserted in the optional Media Card Reader.

Note

Ensure that a USB Flash Drive is not present in the USB port located on the left side of the top front panel.

6

Copying

This chapter contains the following sections:

- Basic Copying
- Advanced Copying

Basic Copying

To make copies:

1. On the Control Panel, press the yellow **Clear All** button to remove previous copy settings.
2. Load the original document. Use the document glass for single copies or paper that cannot be fed using the document feeder. Use the document feeder for multiple or single pages.
3. On the Control Panel touch screen, touch **Copy**.
4. Use the alphanumeric keypad to enter the number of copies. The number of copies appears in the upper-right corner of the touch screen.
 - To correct the number of copies entered using the alphanumeric keypad, press the **C** button, then re-enter the number.
 - To stop a copy job, press the red **Stop** button. On the touch screen, touch **Resume** to continue the job, or **Cancel** to cancel the job completely.
5. If desired, change the copy settings. For details, see [Basic Settings](#).
6. Press the green **Start** button on the Control Panel.

Document Glass



- Lift the document feeder cover and place the original facedown, toward the back-left corner of the document glass.
- The original must be aligned to the matching paper size printed on the edge of the glass.
- The document glass accepts paper sizes from 15 x 15 mm (0.59 x 0.59 in.) to A3/297 x 432 mm (11.6 x 17 in.).
- The document glass automatically detects standard paper sizes.

Caution

When scanning a bound document, do not attempt to force the document feeder cover closed. Doing so may damage the document feeder cover.

Duplex Automatic Document Feeder

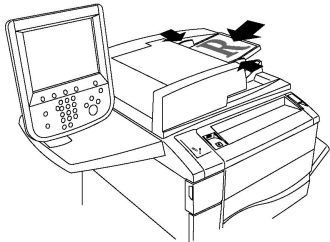

Insert originals face up, with page 1 on top. The duplex automatic document feeder scans both sides of 2-sided documents at the same time.

- The confirmation indicator illuminates when the originals are correctly loaded.
- Adjust the paper guides so they fit against the originals.
- The document feeder will automatically detect standard paper sizes.
- The automatic document feeder accommodates the following original paper weights: 38-128 g/m².
- The automatic document feeder accommodates the following originals: 85 x 125 mm (3.3 x 4.9 in) through 297 x 432 mm (11.7 x 17 in).
- The automatic document feeder accommodates approximately the following quantity of paper by weight: 130 sheets of 80 g/m².

Basic Settings

The **Copy** tab appears when the touch screen **Copy** button is touched. Use the **Copy** tab to change the following basic settings:

- Selecting Color or Black and White Copies
- Reducing or Enlarging the Image
- Selecting the Tray to Use for Copies
- Specifying 2-Sided Originals or Copies
- Collated Copies
- Uncollated Copies
- Stapling Copies
- Hole Punching Copies

Selecting Color or Black and White Copies

If the original document contains color, you can create copies in full color, in single color (monochrome), in dual color, or in black and white.

To select the output color:

1. Touch **Copy** on the touch screen.
2. Touch the desired output color:
 - **Auto Detect:** This option detects the color content in the original document and makes copies in full color if the original is a color document or in black only if the original is a black and white document.
 - **Color:** This option copies in full color output using all four printing colors (cyan, magenta, yellow, and black).
 - **Black and White:** This option copies in black and white only. Colors in the original are converted to shades of gray.
 - **Dual Color:** This option allows you to separate the colors of the original into two groups of colors for copying. The Source Color will be extracted from the original and be replaced by the Target Area Color. The rest of the colors will be replaced by the Non-Target Area Color you select.
 - **Single Color:** This option allows you to copy in one of six preset or custom colors.

Reducing or Enlarging the Image

To reduce or enlarge the image:

1. Touch **Copy** on the Control Panel.
2. To reduce or enlarge the image proportionally, do one of the following:
 - Touch the plus or minus buttons.
 - Touch **More**, then touch the plus or minus buttons.

Copying

3. To reduce or enlarge the image proportionally by a preset amount, such as to fit a particular paper size:

- Touch **More**.
- Touch **Proportional %**, then touch one of the **Preset %** buttons.

Note

You can also use the plus or minus buttons to change the percentage.

- To center the image on the page, touch **Auto Center**. Touch **Save**.
- To perform a minor adjustment, select **Slight Reduction Improved Fit**.

4. To reduce or enlarge the width and length of the image by different percentages:

- Touch **More**, then touch **Independent X-Y%**.
- To scale the width (X axis) of the image, touch the Width percentage plus or minus buttons.
- To scale the length (Y axis) of the image, touch the Length percentage plus or minus buttons.

Note

You can also reduce or enlarge an image by touching one of the **Presets**.

- To center the image on the page, touch **Auto Center**.

5. Touch **Save**.

Selecting the Tray to Use for Copies

The printer automatically selects the paper tray to use for copying based on settings made by the System Administrator. To use a different paper type for copying on letterhead, colored paper, or different paper sizes, select the paper tray loaded with the desired paper.

To select the tray to use:

1. Touch **Copy** on the Control Panel.
2. Under **Paper Supply**, touch the desired tray.
3. To use another tray:
 - Touch **More**.
 - Touch the desired tray in the list.
 - Touch **Save**.

Specifying 2-Sided Originals or Copies

The document feeder and the document glass can be used to copy one or both sides of a 2-sided original.

To copy both sides of a 2-sided original:

1. Touch **Copy** on the touch screen.
2. Touch **2 Sided Copying**.
3. Under 2-Sided Copying, touch **2 > 2 Sided**.
4. Press the green **Start** button.

The document feeder automatically copies both sides of a 2-sided original.

Note

When using the document glass for 2-sided copying, a message appears at the top of the touch screen when it is time to place the next original on the glass.

Other options are available under 2-Sided Copying:

- **1 → 1 Sided:** Scans only one side of the originals and produces 1-sided copies.
- **1 → 2 Sided:** Scans only one side of the originals and produces 2-sided copies.
- **2 → 1 Sided:** Scans both sides of the originals and produces 1-sided copies.
- **Rotate Side 2:** Rotates the side two image of 2-sided copies 180 degrees.

Collated Copies

You can automatically collate multi-page copy jobs. For example, when making three 1-sided copies of a six-page document, the copies are printed in this order:

1, 2, 3, 4, 5, 6; 1, 2, 3, 4, 5, 6; 1, 2, 3, 4, 5, 6

To choose collated copies:

1. Touch **Copy** on the touch screen.
2. Touch **Copy Output**.
3. Touch **Collated**.

Uncollated Copies

Uncollated copies are printed in this order:

1, 1, 1, 2, 2, 2, 3, 3, 3, 4, 4, 4, 5, 5, 5, 6, 6, 6

To choose uncollated copies:

1. Touch **Copy** on the touch screen.
2. Touch **Copy Output**.
3. Touch **Uncollated**.

To choose uncollated copies with separators:

1. Under **Copy Output**, touch **Uncollated with Separators**.
2. To choose the tray loaded with separator sheets, touch **Separator Tray**, then touch **Save**.

Offset Stacking

To choose Offset Stacking:

1. Touch **Copy** on the touch screen.
2. Touch **Copy Output**.
3. Touch **Output/Offset**.
4. If an Output Destination appears, select the desired destination.
5. Touch **Offset Stacking** and select the type of offset you want to use.
6. Touch **Save** until you return to the Copy tab.

Stapling Copies

If the printer has a finisher installed, copies can be automatically stapled.

To select stapling:

1. Touch **Copy** on the Control Panel.
2. Touch **Copy Output**.
3. Under **Staple**, touch **1 Staple**, **2 Staples**, or **4 Staples** for the appropriate page orientation. The screen shows the location of the staple on the page.

Note

Stapling options are dependent upon paper feed orientation (short edge or long edge). If the desired stapling option is unavailable, touch **Paper Supply**, then choose the appropriate tray.

4. Touch **Save**.

Hole Punching Copies

If the printer has an appropriate finisher installed, copies can be automatically hole punched.

Note

Hole punch options are dependent on paper size and feed orientation. The paper can be fed from a tray with the paper loaded for short edge feed or long edge feed. If the desired hole punch option is unavailable, touch **Paper Supply**, then choose the tray containing the paper in the correct orientation.

1. Touch **Copy** on the Control Panel.
2. Touch **Copy Output**.
3. Under **Hole Punch**, select the desired hole punch type/location from the list.

Note

Hole punch settings vary by printer configuration.

4. Touch **Save**.

Image Quality Adjustments

Use the **Image Quality** tab to change the following image quality settings:

- Specifying the Original Type
- Adjusting the Darkness, Sharpness, and Saturation
- Automatically Suppressing Background Variations
- Adjusting the Contrast
- Selecting Color Effect
- Adjusting the Color Balance
- Adjusting the Color Shift
- Adjusting the Gloss Level

Specifying the Original Type

The printer optimizes the image quality of the copies based on the type of images in the original document and how the original was created.

To specify the original type:

1. Touch **Copy** on the touch screen, then touch the **Image Quality** tab.
2. Touch **Original Type**.
3. In the **Original Type** window:
 - a. From the 1st column, select the content type of the original document.
 - b. If known, select how the original was produced.
 - c. Touch **Save**.

Adjusting the Darkness, Sharpness, and Saturation

You can lighten or darken copies and adjust the sharpness and saturation.

To adjust these image options:

1. On the Control Panel, touch **Copy**, then touch the **Image Quality** tab.
2. Touch **Image Options**.
3. In the Image Options window:
 - To lighten or darken the image, touch the **Lighten/Darken** pointer, then move it toward **Lighten** or **Darken**.
 - To sharpen or soften the image, touch the **Sharpness** pointer, then move it toward **Sharpen** or **Soften**.
 - To make the image colors more or less vivid, touch the **Saturation** pointer, then move it toward **Vivid** or **Pastel**.
 - Touch **Save**.

Automatically Suppressing Background Variations

When you are using originals printed on thin paper, text or images printed on one side of the paper can sometimes be seen on the other side of the paper. Use **Auto Suppression** to minimize the visibility of background colors in your copies.

Note

The printer may not reproduce low densities when Auto Suppression is selected. Turn Auto Suppression off to achieve better output in these cases.

To change this setting:

1. Touch **Copy** on the touch screen, then touch the **Image Quality** tab.
2. Touch **Image Enhancement**.
3. Under **Suppress Background**, touch **Auto Suppression**.
4. Touch **Save**.

Adjusting the Contrast

Contrast is the difference between light and dark areas in an image. To reduce or increase the contrast of the copies:

1. Touch **Copy** on the Control Panel, then touch the **Image Quality** tab.
2. Touch **Image Enhancement**.
3. Do one of the following:
 - To automatically adjust the contrast, touch **Auto Contrast**.
 - Touch **Manual Contrast**, touch the **Contrast** pointer, then move it toward **More** or **Less**.
4. Touch **Save**.

Selecting Color Effects

If you have a color original, you can adjust the color using presets called **Color Effects**. For example, the copy colors can be adjusted to be warmer or cooler.

To select a color preset:

1. On the Control Panel, touch **Copy**, then touch the **Image Quality** tab.
2. Touch the **Color Effects** button.
3. Touch the desired color preset. The sample images show how the colors are adjusted.
4. Touch **Save**.

Adjusting the Color Balance

If you have a color original, you can adjust the balance of the printing colors between cyan, magenta, yellow, and black before you print your copy.

To adjust the color balance:

1. Touch **Copy** on the Control Panel, then touch the **Image Quality** tab.
2. Touch **Color Balance**.
3. To adjust the density levels of all four colors:
 - Select **Basic Color** on the **Color Balance** window.
 - To adjust the level for each color, touch its pointer, then move it toward + or –.
4. To adjust the highlight, midtone, and shadow density levels by color:
 - Touch **Advanced Color**.
 - Touch the desired color.
 - To adjust the levels for highlights, midtones, and shadows, touch the pointer, then move it toward + or –.
5. Touch **Save**.

Adjusting the Color Shift

If you have a color original, you can adjust the hue of the copy colors.

Note

This feature is only available when the output color is set to **Auto Detect** or **Color**.

To adjust the color shift:

1. Touch **Copy** on the Control Panel, then touch the **Image Quality** tab.
2. Touch **Color Shift**. The **Original Color** bar represents the colors of the original document. The **Copy Color** bar represents the copy colors.
3. Touch one of the five buttons from Minus to Plus to select the desired color shift.
4. Touch **Save**.

Adjusting the Gloss Level

Gloss level enables you to specify the paper gloss level as normal or enhanced.

Note

This feature does not apply to all paper types.

To adjust the gloss level:

1. Touch **Copy**.
2. Touch **Image Quality**.
3. Touch **Gloss Level**.
4. Touch **Normal** or **Enhanced** and then touch **Save**.

Layout Adjustments

Use the Layout Adjustment tab to change the following settings:

- Book Copying

Copying

- 2-Sided Book Copying
- Specifying the Original Size
- Erasing the Edges of a Copy
- Shifting the Image
- Rotating the Image
- Inverting the Image
- Specifying the Orientation of the Original

Book Copying

When copying a book, magazine, or other bound document, you can copy either the left or right page, or both pages onto a single sheet of paper.

You must use the document glass to make copies from books, magazines, or other bound documents. Do not place bound originals in the document feeder.

Note

This feature and 2-Sided Book Copying cannot be activated simultaneously.

Note

Non-standard size documents will not be separated into two pages accurately.

To copy pages from a book or other bound document:

1. Touch **Copy** on the touch screen, then touch the **Layout Adjustment** tab.
2. Touch **Book Copying**. On the next screen, touch **On**.
3. To copy both pages of an open book in page order, touch **Both Pages**. To specify the **Binding Edge Erase** amount, the space between the image area and the binding, touch the plus or minus buttons.
4. To copy only the left page of an open book touch **Left Page Only**. To specify the **Binding Edge Erase** amount, the space between the image area and the binding, touch the plus or minus buttons.
5. To copy only the right page of an open book, touch **Right Page Only**. To specify the **Binding Edge Erase** amount, the space between the image area and the binding, touch the plus or minus buttons.
6. Touch **Save**.

Note

The facing pages of a bound document must be placed in a horizontal orientation on the document glass as shown on the touch screen.

2-Sided Book Copying

This feature allows you to make 2-Sided copies of facing pages of the original bound document.

Note

This feature and Book Copying cannot be activated simultaneously.

Note

You must use the document glass to make copies from books, magazines, or pamphlets. Do not place bound originals in the document feeder.

Note

Non-standard size documents will not be separated into two pages accurately.

To copy pages from a book or other bound document:

1. Touch **Copy** on the Control Panel, then touch the **Layout Adjustment** tab.
2. Touch **2-Sided Book Copying**. In the next screen, touch **On**.
3. To specify the copy start page and copy end page, touch **Starting and Ending Page**.
 - For Starting Page: touch **Left Page** or **Right Page**.
 - For Ending Page: touch **Left Page** or **Right Page**.
4. To specify the Binding Edge Erase amount, the space between the image area and the binding, touch the plus or minus buttons.
5. Touch **Save**.

Specifying the Original Size

To specify the original size so that the correct area is copied:

1. On the touch screen, touch **Copy**, then touch the **Layout Adjustment** tab.
2. Touch **Original Size**.
3. The printer can pre-scan the first page of the originals to determine the area to copy. Touch **Auto Detect**.
4. If the area to be copied matches a particular paper size, touch **Manual Size Input** and then touch the desired paper size. To view the entire list, touch the scroll arrows.
5. If the original contains pages of different sizes, touch **Mixed Size Originals**.
6. Touch **Save**.

Erasing the Edges of a Copy

You can erase content from the edges of your copies by specifying the amount to erase on the right, left, top, and bottom edge.

To erase edges on copies:

1. Touch **Copy** on the touch screen, then touch the **Layout Adjustment** tab.
2. Touch **Edge Erase**.
3. To erase all the edges by the same amount, touch **All Edges** and touch the plus or minus buttons.
4. To specify different amounts for the edges, touch **Individual Edges**. For each edge, touch the plus or minus buttons.
5. If you selected 2-sided copies: to specify the amount to erase from each edge on Side 2, touch the plus or minus buttons, or touch **Mirror Side 1**.
6. To cancel edge erase, touch **Print to Edge**.

Copying

7. To specify the original's orientation as you place it in the document feeder or on the document glass, touch **Original Orientation**, then touch either **Upright Image** or **Sideways Image** (top to left), then touch **Save**.
8. Touch **Save**.

Note

If preset values such as Hole Punch Erase or Header/Footer Erase were previously saved, you can touch the preset in the lower-left corner of the window.

Shifting the Image

You can change the placement of the image on the copy page. This is useful if the image size is smaller than the page size.

Originals must be positioned correctly for image shift to work correctly. For details, see [Basic Copying](#).

- Document feeder: position originals faceup, left (long) edge entering the feeder first.
- Document glass: position originals facedown, in the back-left corner of the document glass, long edge to the left.

To change image placement:

1. Touch **Copy** on the touch screen, then touch the **Layout Adjustment** tab.
2. Touch **Image Shift**.
3. To center the image on the page, touch **Auto Center**.
4. To shift the image to one of the edges or corners of the paper, touch **Corner Shift**.
5. To specify the position of the image, Touch **Margin Shift**.
6. To specify the amount of Up/Down and Left/Right shift for Side 1, touch the plus or minus buttons.
7. If you selected 2-sided copies: to specify the amount to erase from each edge on Side 2, touch the plus or minus buttons, or touch **Mirror Side 1**.
8. To specify the original's orientation as you place it in the document feeder or on the document glass, touch **Original Orientation**, then touch either **Upright Image** or **Sideways Image** (top to left), then touch **Save**.
9. Touch **Save**.

Note

If preset values were previously saved, select the preset in the lower-left corner of the window.

Rotating the Image

If the orientation of the paper currently loaded in the selected tray differs from that of your original, the printer automatically rotates the image to fit on the paper.

1. Touch **Copy** on the touch screen, then touch the **Layout Adjustment** tab.
2. Touch **Image Rotation**, then select from the following:
 - To cancel rotation, touch **Off**.

- For automatic rotation of the image of your original to fit correctly on your selected paper, touch **Always On**.
- For automatic rotation of the image of your original when **Auto Paper Select** or **Auto %** is selected, touch **On during Auto**.

3. Touch **Save**.

Inverting the Image

Originals can be printed as mirror images; this reflects each image left to right on the page. Originals can be printed as negative images; the positive image is printed as a negative.

To invert images:

1. Touch **Copy** on the touch screen, then touch the **Layout Adjustment** tab.
2. To mirror images, touch **Invert Image**, then touch **Mirror Image**. The default is **Normal Image**, which does not mirror the images.
3. To create negative images, touch **Negative Image**. The default is **Positive Image**, which does not print the image as a negative.
4. Touch **Save**.

Output Format Adjustments

Use the Output Format tab to make the following changes:

- Creating Booklets
- Including Covers
- Page Layout
- Creating Posters
- Adding Annotations
- Adding Watermarks
- ID Card Copy
- Tab Margin Shift

Creating Booklets

Copies can be printed in the form of a booklet. The page images are reduced to print two images per side of each printed page. The pages can then be folded and stapled manually, or with the appropriate finisher, they can be creased and stapled automatically.

Note

In this mode, the printer does not print the copies until it has scanned all the originals.

To create a booklet:

1. Touch **Copy** on the touch screen, then touch the **Output Format** tab.
2. Touch **Booklet Creation**, then touch **On** under **Booklet Options**.
3. Touch **Original Input**, then touch **1-Sided Originals**, **2-Sided Originals**, or **2-Sided Rotate Side 2**.

Copying

4. Folding: If a finisher with booklet making capabilities is installed, touch **Off**, **Fold Only**, or **Fold and Staple**.
 5. You can add margins in the center binding area to compensate for the thickness of the booklet:
 - a. Touch **Binding Shift**, then touch the plus or minus (+/-) buttons to set the shift.
 - b. Touch **Save**.
 6. To add covers, touch **Covers**, then touch **Blank Cover**, **Print on Both** or **1-Sided Covers Print Outside**.
 - a. Touch the tray loaded with cover paper and the tray loaded with main body paper. Touch **Save**.
 - b. To print the copy of the last original page on the back cover for **Blank Cover** and **Print on Both**, touch **Last Page on Back Cover**, then touch **Save**.
 7. To sub-divide a large booklet into subsets, touch **Divide Output**, then touch **On**.
 8. To enter the number of sheets for each subset, touch the plus or minus (+/-) buttons, then touch **Save**.
 9. Offset Stacking places each stack of printed pages slightly to the left or right of the previous stack for easier separation.
 - a. Touch **Output/Offset**.
 - b. Touch **Center Tray Upper** or **Center Tray Lower**. For automatic fold, touch **Right Middle Tray**.
- Note**
- Specific selections may vary based on the finisher installed.
- c. Touch **Offset Stacking**, then touch **System Default**, **No Offset**, **Offset Per Set** or **Offset Per Job**, then touch **Save**.
10. If desired, select **Auto Image Positioning** and choose **Off** or **On**.
 11. Touch **Save**.

Including Covers

To add covers to a copy job, select different trays for the first and last page. Those trays can be loaded with heavier stock, color or pre-printed paper. The covers can be blank or printed.

Note

The paper used for the covers must be the same size as the paper used for the rest of the document.

To select the type of covers and the tray to use for the cover paper:

1. Touch **Copy** on the touch screen, then touch the **Output Format** tab.
2. Touch **Covers**.
3. Touch the appropriate option for your front cover and back cover.
4. To include both a front and back cover that use the same tray and printing options:

- a. Touch a printing option for each cover: **Blank Cover**, **Print on Side 1**, **Print on Side 2**, or **Print on Both**.
 - b. Touch the tray to use for the covers, then touch the tray to use for the main body.
5. To include only a front cover or only a back cover:
- a. Touch a printing option for each cover: **Blank Cover**, **Print on Side 1**, **Print on Side 2**, or **Print on Both**.
 - b. Touch the tray to use for the covers, then touch the tray to use for the main body of the document.
6. Touch **Save**.

Page Layout

You can copy multiple original pages onto one side of a sheet of paper. The size of the page images is reduced proportionally to fit on the selected paper.

To copy multiple pages on a sheet:

1. Touch **Copy** on the touch screen, then touch the **Output Format** tab.
2. Touch **Page Layout**.
3. Touch **Pages per Side**.
4. To select the number of original pages for each sheet of paper, touch **2 Pages**, **4 Pages**, or **8 Pages**. For 4 Pages Up or 8 Pages Up, touch the desired **Reading Order**.
5. To change the orientation of the copies, touch **Original Orientation**, then touch **Upright Images**, or **Sideways Images**, then touch **Save**.
6. To repeat the same image on a page, touch **Repeat Image**.
7. Touch **2 Times**, **4 Times**, or **8 Times**.
8. To automatically calculate the number of times to repeat vertically or horizontally (based on document size, paper size, and the enlarge/reduction ratio), touch **Auto Repeat**.
9. To specify the number of times to repeat the image vertically or horizontally, touch **Variable Repeat**, then touch the plus or minus buttons. You can repeat an image between 1 to 23 times vertically (columns), and between 1 to 33 times horizontally (rows). To arrange the images evenly on the page, touch **Evenly Spaced**. To arrange the images with no space between them, touch **Side by Side**.
10. To change the orientation of the copies, touch **Original Orientation**, then touch **Upright Images** or **Sideways Images**, then touch **Save**.

Creating Posters

You can create a large size copy of an original, fitting it to more than one sheet of paper. You then reassemble the pages into a poster and tape them together.

To create a poster:

1. Touch **Copy > Copy Output > Uncollated** on the touch screen.
2. Touch **Poster**.
3. Touch **Output Size**, then touch the desired size of the poster.

Copying

4. To select the width and length enlargement percentages independently, touch **Enlargement %**, then touch the plus or minus buttons. To set the width and length proportionally, touch **Lock X-Y%**.
5. To select the paper tray, touch **Paper Supply**, touch the desired tray, then touch **Save**.

Adding Annotations

Annotations, such as page numbers and the date, can be automatically added to copies.

To add annotations:

1. Touch **Copy** on the touch screen, then touch the **Output Format** tab.
2. Touch **Annotations**.

To insert a comment:

1. Touch **Comment**, then touch **On**.
2. On the next screen, touch the desired comment in the list of stored comments.
3. To create a comment, touch an **Available** comment, then touch **Edit**. Using the touchscreen keyboard, enter the new comment, then touch **Save**.
4. Touch **Apply To**, then touch **First Page Only**, **All Pages**, or **All Pages Except First**, then touch **Save**.
5. To select the location of the comment on the page, touch **Position**, then touch the desired location. Touch **Save** twice.

To insert the current date:

1. Touch **Date**, then touch **On**.
2. Touch the format to use for the date.
3. To select which pages the date appears on, touch **Apply To**, then touch **First Page Only**, **All Pages**, or **All Pages Except First**, then touch **Save**.
4. To select the position of the date stamp on the page, touch **Position**, then select the desired position.
5. Touch **Save** twice.

To insert page numbers:

1. Touch **Page Numbers**, then touch **On**.
2. To enter the starting page number, touch the plus or minus (+/-) buttons.
3. To select which pages the page number appears on, touch **Apply To**, then touch **All Pages** or **All Pages Except First**, then touch **Save**.
4. To select the position of the date stamp on the page, touch **Position**, then select the desired position.
5. Touch **Save** twice.

To insert a Bates Stamp:

1. Touch **Bates Stamp**, then touch **On**.

2. Touch an existing stored prefix to use for the Bates Stamp. To create a new prefix, touch an **Available** prefix, then touch **Edit**. Using the touch screen keyboard, enter the new prefix, then touch **Save**.
3. To enter the starting page number, touch the plus or minus (+/-) buttons.
4. To select which pages the Bates Stamp appears on, touch **Apply To**, then touch **All Pages** or **All Pages Except First**, then touch **Save**.
5. To select the position of the Bates Stamp on the page, touch **Position**, then touch the desired position, then touch **Save**.
6. To specify the number of digits, touch **Number of Digits**. To select the minimum number of digits necessary, touch **Auto Assign**, then touch **Save**. To select a specific number of digits, touch **Manual Assign**, then touch the plus or minus (+/-) buttons to insert up to 9 leading zeros, then touch **Save**.
7. Touch **Save**.

To specify the original's orientation as you place it in the document feeder or on the document glass:

1. Under **Original Orientation**, touch either **Upright Images** or **Sideways Images**.

To change the format used for annotations:

1. Touch **Format and Style**.
2. To select the font point size, touch the plus or minus (+/-) buttons. Touch the desired font color.
3. To select the placement of the annotations on the second side when printing 2-sided copies, touch **Same as Side 1** or **Mirror Side 1**.
4. Touch **Save**.

Adding Watermarks

You can add a watermark beneath the original image on your copies. Information such as predetermined text, date and time, and the printer serial number can be added.

1. Touch **Copy** on the touch screen, then touch the **Output Format** tab.
2. Touch **Watermark**.
3. To add a control number, touch **Control Number**, touch **Add**. To select the starting number, touch the plus or minus buttons.
4. Touch **Save**.
5. To add a stored watermark, touch **Stored Watermarks**, then touch **On**. Touch a stored watermark in the list, then touch **Save**.
6. To print the current date and time on the copies, touch **Date & Time**, touch **Add**, then touch **Save**.
7. To print the printer's serial number on the copies, touch **Serial Number**, touch **Add**, then touch **Save**.
8. The watermark image is faint so the content of the page can be seen. To make the watermark visible on copies used as originals, touch **Watermark Effect**, then touch **Embossed** or **Outline**, then touch **Save**.
9. Touch **Save**.

ID Card Copy

This feature allows you to copy both sides of a small original, such as an identification card, onto the same side of a page.

1. Open the document feeder and place the card in the upper left hand corner of the document glass.
2. Close the document feeder, touch **Copy** on the touch screen, then touch the **Output Format** tab.

Note

Place the card slightly away from the top left corner of the document glass to capture the whole image of the card.

3. Touch **ID Card Copy**, touch **On**, then touch **Save**.
4. To scan side one, press the green **Start** button.
5. To scan side two, turn the card over without changing its location on the document glass, then touch **Start** on the touch screen.

Both sides of the card will then print onto the same side of a sheet of paper.

Tab Margin Shift

The **Tab Margin Shift** option allows you to copy images from a document onto tabbed stock.

Note

Only Tray 5 (Bypass) can be used with the Tab Margin Shift option. Load the paper into Tray 5 with the side to be copied facing up and with the tabbed edge trailing.

1. Touch **Copy** on the touch screen, then touch the **Output Format** tab.
2. Touch **Tab Margin Shift**.
3. Choose from the following options:
 - a. The **Shift to Tab** option will print the edge of the original document image onto the tab of the tabbed stock. You can change the amount of shift required by using the **Shift Value** arrow keys on the touch screen.
 - b. The **Shift All** options are shown here. This option will print the entire original document image onto the tabbed stock. You can change the amount of shift required by using the **Shift Value** arrow keys on the touch screen.

For both shift options, you can specify the **Tab Stock Size** and **Tab Stock Type** using the buttons on the touch screen.

4. Touch **Save**.

Advanced Copying

Use the Job Assembly tab to change the following settings:

- Building a Job
- Printing a Sample Copy
- Combining Original Sets
- Delete Outside/Delete Inside
- Save Copy Settings
- Folding

Building a Job

Complex copy jobs that include a variety of originals requiring different copy settings can be produced using this feature. Each “segment” can have different copy settings. After all segments are programmed and scanned, the page images are stored temporarily in the printer. The complete copy job is then printed.

To build a copy job with multiple segments:

1. Touch **Copy** on the touch screen.
2. Program and scan the first segment:
 - a. Place the originals in the document feeder or on the document glass for the first segment.
 - b. Touch the desired copy settings for the first segment.
 - c. Touch the **Job Assembly** tab.
 - d. Touch the **Build Job** button, touch **On**, then touch **Save**.
 - e. To scan the first set of originals, press the green **Start** button on the Control Panel. The Copy screen appears on the touch screen.
3. Program and scan additional segments:
 - a. Place the originals in the document feeder or on the document glass for the next segment, then touch **Next Original**.
 - b. When printing 2-sided jobs, the start page of the next segment is set using Chapter Start. To set the start page of the next 2-sided segment, touch **Chapter Start**, then choose from the following:

Off: the first page of the next segment prints on the next available side.

On: the first page of the next segment prints on Side 1 of a new sheet of paper.

Pages per Side-New Page: if the first segment has an odd number of pages the second segment will start on side 1. If the first segment has an even number of pages the second segment will start on side 2.
 - c. Touch **Change Settings**. Touch the settings for the segment.

Copying

- d. To scan the next set of originals, press the green **Start** button on the control panel.
4. For each additional segment you wish to copy, repeat Step 3.
5. When all segments have been scanned, in the Copy screen, touch **Last Original**.

The entire copy job prints.

Note

Because all the segments print as one job, you can select options such as covers or booklet creation that will apply to the entire job.

To select Build Job options:

1. Touch **Copy** on the touch screen, then touch the **Job Assembly** tab.
2. Touch **Build Job**, then touch **On**.

Choose from:

- **Copy Output:** touch **Paper Supply, Stapling, Collation** and **Output/Offset** options, then touch **Save**.
- **Booklet Creation:** (See [Creating Booklets](#).) Select the desired settings, then touch **Save**.
- **Covers:** (See [Including Covers](#).) Select the desired settings, then touch **Save**.
- **Annotations:** (See [Adding Annotations](#).) Select the desired settings, then touch **Save**.
- **Segment Separators:** to insert separator pages between segments, touch **Segment Separators**, then choose from the following:

No Separators: separators are not inserted. Touch **Save**.

Blank Separators: blank separators are inserted. To specify the quantity of separators, touch the plus or minus buttons, then touch **Save**.

1-Sided Separators Side 1 Only: the first page of the loaded documents is copied on the front side of a separator. Touch **Save**.

1-Sided Separators Side 2 Only: the first page of the loaded documents is copied on the back side of a separator. Touch **Save**.

2-Sided Separators: the first two pages of the loaded documents are copied onto each side of a separator. Touch **Save**.

- **Watermarks:** (See [Adding Watermarks](#).) Select settings, then touch **Save**.
- **Face Up/Down Output:** Select the desired orientation then touch **Save**.

3. Touch **Save**.

Printing a Sample Copy

With a complicated copy job, it can be helpful to print a test copy before printing multiple copies. This feature prints a single copy and holds the remaining copies. After inspection of the sample, the remaining copies can be printed using the same settings, or cancelled.

Note

The sample copy is counted as part of the total quantity selected. For example, when copying a book, if 3 is entered as the number of desired copies; one copy of the book will be printed, and two other copies will be held until they are released for printing.

To print the sample copy:

1. Touch **Copy** on the touch screen, then touch the desired copy settings.
2. Touch the **Job Assembly** tab.
3. Touch **Sample Job**, then touch **On**.
4. Touch **Save**.
5. Press the green **Start** button on the Control Panel; the sample set is printed.

To print the remaining copies or delete the job:

1. To print the remaining copies of the job, touch **Start**, or press the green **Start** button on the Control Panel.
2. If the sample copy is unsatisfactory, touch **Delete**.

Combining Original Sets

If the number of originals exceeds the capacity of the document feeder, you can combine the sets into one job.

To Combine Original Sets:

1. Touch **Copy** on the touch screen. Touch the desired copy settings, then enter the number of copies using the alphanumeric keypad on the Control Panel.
2. Touch the **Job Assembly** tab, then touch **Combine Original Sets**.
3. Touch **On**, then touch **Save**.
4. Place the first set of originals in the document feeder.
5. Press the green **Start** button on the control panel. Copying begins. The Copy screen appears on the touch screen.
6. Scan additional sets:
 - Place the originals for the next set in the document feeder.
 - In the Copy screen, touch **Next Original**.
 - Touch **Start** on the touch screen, or press the green **Start** button on the Control Panel. Copying continues.
7. For each additional set, repeat Step 6.
8. When the final set has been copied, in the Combine Original Sets screen, touch **Last Original**. The final copies print.
9. To cancel the job, touch **Delete**.

Delete Outside/Delete Inside

This feature allows you to delete everything inside or outside a specified rectangular area. Up to three areas can be defined for deletion.

Copying

To select areas to delete:

1. Touch **Copy** on the touch screen, then touch the **Job Assembly** tab.
2. Touch **Delete Outside/Delete Inside**.
3. To delete everything outside the specified area when copying:
 - a. Touch **Delete Outside**.
 - b. The area is defined by the rectangle formed between the points as shown on the touch screen. Touch **Area 1**, then touch each coordinate on the touch screen. Use the alphanumeric keypad on the Control Panel to enter the coordinate values for X1, X2, Y1 and Y2. When all values have been entered, touch **Save**.
 - c. To apply the deleted area for 2-Sided copying, under Originals touch **Both Sides, Side 1 Only** or **Side 2 Only**.
 - d. Touch **Save**.
 - e. Additional areas can be defined by selecting Area 2 and Area 3.
4. To delete everything inside the specified area when copying:
 - a. Touch **Delete Inside**.
 - b. The area is defined by the rectangle formed between the points as shown on the touch screen. Touch **Area 1**, then touch each coordinate on the touch screen. Use the alphanumeric keypad on the Control Panel to enter the coordinate values for X1, X2, Y1 and Y2. When all values have been entered, touch **Save**.
 - c. To apply the deleted area for 2-Sided copying, under Originals, touch **Both Sides, Side 1 Only**, or **Side 2 Only**.
 - d. Touch **Save**.
 - e. Additional areas can be defined by selecting **Area 2** and **Area 3**.

Saving Copy Settings

To use a particular combination of copy settings for future copy jobs, you can save the settings with a name and retrieve the settings for later use with other copy jobs.

To save the current copy settings:

1. On the touch screen, touch **Copy**.
2. Touch the **Job Assembly** tab, then touch **Stored Programming**.
3. Using the touch screen keyboard, enter a name for the saved settings.
4. Touch **Save**.

Folding

If your machine is equipped with a Booklet Maker Finisher and/or the optional C/Z Folder, you can make copies using the folding option. This option folds your prints in half (Single or Bi-folding) or in thirds (C-fold or Z-fold types). The folding option for copies is selected from the **Output Format** tab.

Note

In order to use the folding option, the orientation of documents must be short-edge feed (SEF). You must select a paper tray that contains SEF stock.

Fold Types

These fold types are available:

- Single Fold (Bi-Fold)
- C-Fold
- Z-Fold
- Z-Fold Half Sheet

Note

The Single Fold (Bi-Fold) option is available only with a Booklet Maker Finisher. The C-Fold and Z-Fold options are available only with the C/Z Folder.

Depending on your overall printer configuration, you can also specify stapling, covers, and collation options on the Folding page.

Note

To create booklets with booklet formatting, use the Booklet Creation feature. Folding does not apply the same characteristics to the page.

7

Scanning

This chapter contains the following sections:

- Scanning Overview
- Loading Original Documents
- Storing a Scan to a Folder
- Scanning to a Network File Repository
- Scanning to an Email Address
- Scanning to a Computer
- Scanning to a Home Directory
- Storing to a USB Flash Drive
- Setting Scan Options
- Using the Xerox Scan Utility

Scanning Overview

Note

Scanning must be enabled before use. For details, see the *System Administrator Guide*.

Note

Scanning functions require installation of the Scan Drivers. For more information, see *Installing the Software*.

Scanning is an optional printer feature providing several methods for scanning and storing an original document. The scanning procedure used with the printer differs from that of desktop scanners. Because the printer is normally connected to a network rather than directly to a single computer, you select a destination for the scanned image at the printer.

Scanning

The scanning feature allows you to scan a document and store the image to any of the following destinations:

- Folder on the printer's hard drive
- Document repository on a network server
- Email address
- Windows computer
- Home directory
- USB Flash Drive
- Computer using Xerox Scan Utility
- Application using TWAIN or WIA

Note

Print, copy, and fax jobs can print while you are scanning original documents or downloading files from the printer's hard drive.

Note

The printer must be connected to a network to retrieve a scan file.

Loading Original Documents

All scanning tasks begin with loading the original document in the printer. Use the document glass for single-page jobs, or originals that will not feed through the document feeder. Use the document feeder for multiple- or single-page jobs.

Document Glass

Lift the document feeder cover and place the original facedown, toward the back-left corner of the document glass.



⚠ Caution

When scanning a bound document, do not attempt to force the document feeder cover closed. Doing so may damage the document feeder cover.

Duplex Automatic Document Feeder

1. Insert originals face up, with page 1 on top.
2. The confirmation indicator illuminates when the originals are correctly loaded.
3. Adjust the paper guides so they fit against the originals.

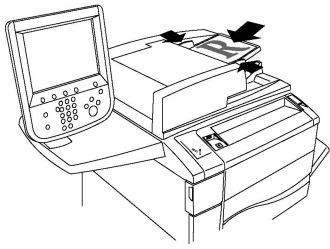

Storing a Scan to a Folder

Storing a scanned file to a folder is the simplest scanning method. A document scanned at the printer is stored as a file to a folder on the printer's hard drive. You can then print the file, or you can copy the stored file to your computer using a Web browser and CentreWare Internet Services.

Folders are accessible to all users unless protected with a password. For details, see [Creating a Folder](#).

Note

Scanning to a folder must be enabled by the System Administrator.

Scanning to a Folder

To store a scanned file to a folder:

1. Load the original on the document glass or in the document feeder.
2. Press the **Services Home** button.
3. On the touch screen, touch **Store to Folder**.
4. Touch the desired folder. If a password is required, enter the password using the alphanumeric keypad, then touch **Confirm** on the touch screen.
5. To change any of the scan settings, use the four menus at the bottom of the touch screen: **Color Scanning**, **2-Sided Scanning**, **Original Type**, and **Scan Presets**. For details, see [Setting Scan Options](#).
6. Press the green **Start** button. The **Store to Folder** progress screen appears on the touch screen.

When the scan is complete, the touch screen will re-display the **Store to Folder** tab. The file is stored to the folder on the printer's hard drive. You can then print the file or retrieve it to your computer using CentreWare Internet Services.

Printing Stored Files at the Printer

To print a file stored to a folder at the printer:

1. Press the **Services Home** button.
2. On the touch screen, touch **Send from Folder**.
3. Touch the desired folder. If a password is required, enter the password using the alphanumeric keypad, then touch **Confirm** on the touch screen.
4. In the file list, touch the desired file. To print multiple files, touch them in succession.

Scanning

5. Touch **Print**.
6. If desired, select from the following options: **Paper Supply**, **2-Sided Printing**, or **Output**.
7. To set the number of copies, touch **Print Quantity**, then enter the desired quantity using the alphanumeric keypad.
8. Touch **Print**.

Note

To view a thumbnail preview of the file, from the **List** drop-down list, select **Thumbnail**.

Additional Send from Folder Options

To view an enlarged file preview:

1. While in the Send from Folder view, touch the desired file in the file list.
2. Touch **File Details**. Use the icons at the top of the page to enlarge the view. Touch the scroll buttons to examine the enlarged preview.
3. To rotate the preview, touch the **Rotate View** button until you reach the desired orientation.

Note

Rotating the preview does not rotate the printed output.

4. When finished, touch **Close**.

To view a summary of file information:

1. While in the Send from Folder view, touch the desired file in the file list.
2. Touch **Review**.
3. When finished, touch **Close**.

To delete a file:

1. While in the Send from Folder view, touch the file to be deleted.
2. Touch **Delete** twice.

To change a file name:

1. While in the Send from Folder view, touch the desired file in the file list.
2. Touch **File Details**.
3. Touch **Change File Name**.
4. Using the touch screen keyboard, enter the new name.
5. Touch **Save**, then touch **Close**.

To access Job Flow Settings:

1. If Job Flow Sheets have been created, touch **Job Flow Settings**. The Job Flow Sheet currently linked to the folder is displayed.
2. To make changes to the Job Flow settings, touch **Create/Change Link** or **Select Job Flow Sheet**.

Note

If **Send from Folder** is not enabled, contact your System Administrator. For details, refer to the System Administrator Guide at www.xerox.com/support. Enter Xerox Color C60/C70 Printer in the **Search or Choose** field and select the desired documentation.

Using Job Flow Sheets

Job Flow Sheets allow you to execute a series of registered actions, such as Send as Fax or Print, for a file stored in a folder. Job Flow Sheets are created by the System Administrator and are stored in the printer where they can be linked by the user to a stored file. For details, see the System Administrator Guide.

Printing Stored Files Using CentreWare Internet Services

1. At your computer, launch your Web browser.
2. Type the printer's IP address into the Web browser's address bar, then press **Enter** to open CentreWare IS.

Note

If you do not know the printer's IP address, see [Finding the Printer's IP Address](#).

3. Click the **Scan** tab.
4. In the **Scan** navigation pane at the left of the page, click **Folder**.
5. In the **Folder** list, click the desired folder. If required, enter the folder password, then click **Apply**. The **Folder: List of Files** page appears.
6. Select the desired file.
7. Scroll the page to see the **Print File** section.
8. If desired, make selections from the following printing options: **Paper Supply**, **Output Destination**, **Quantity**, **2-Sided Printing**, **Staple**, **Hole Punch**, or **Batch Print**.
9. Click **Print File**.

Retrieving Scanned Files to Your Computer Using CentreWare Internet Services

Stored files are retrieved by copying them from the printer folder to your computer's hard drive.

1. At your computer, launch your Web browser.
2. Type the printer's IP address into the Web browser's address bar, then press **Enter** to open CentreWare Internet Services.

Note

If you do not know the printer's IP address, see [Finding the Printer's IP Address](#).

3. Click the **Scan** tab.
4. In the **Scan** navigation pane at the left of the page, click **Folder**.
5. In the **Folder** list, click the desired folder. If required, enter the folder password, then click **Apply**. The **Folder: List of Files** page appears.

Note

If necessary, scroll down to see all files.

6. Select the desired file.
7. Scroll down to reveal **Retrieving Format**. From the **Retrieving Format** drop-down list, click the desired file format. If desired, select options for the file format using the check boxes and drop-down lists. Options vary by file format.
8. Click **Retrieve**.
9. On the **Retrieve Files from Folder** page, click the link to the selected file.
10. Click **Save**, select the desired storage location, then click **Save**.
11. If a stored file is no longer needed, select the desired file. In the upper right corner of the page, click **Delete**. When prompted, click **OK**.

Additional File Retrieve Options

The following options are available when retrieving a stored file:

1. To retrieve a single page of a multiple-page document, select the **Enabled** check box next to **Retrieve Page**. Type the page number in the **Page Number** field.
2. To add a thumbnail view when using XPS format, select the **Enabled** check box next to **Add Thumbnail**.
3. To apply MRC High Compression to PDF and XPS format files, select the **Enabled** check box next to **MRC High Compression**. Select the desired quality from the **Quality** drop-down list.
4. To create a searchable-text PDF or XPS file:
 - a. Select the **Enabled** check box next to **Searchable Text**.
 - b. From the **Language of the Original** drop-down list, select the language.
 - c. To apply Text Compression, from the **Text Compression** drop-down list, select **Enabled**.

Creating a Folder

To create a folder using the printer's touch screen:

1. On the Control Panel, press the **Machine Status** button.
2. Touch the **Tools** tab, then under **Setup & Calibration > Setup > Features**, touch **Create Folder**.
3. Touch an **Available** folder.
4. To assign a password to the folder:
 - a. Under **Check Folder Passcode**, touch **On**.
 - b. Using the alphanumeric keypad, enter the password.
 - c. Touch **Save**.
5. Assign folder attributes:
 - a. Touch **Folder Name**.
 - b. Using the touch screen keyboard, enter the name, then touch **Save**.

- c. Touch **Delete Files After Retrieval**, touch **Yes** or **No**, then touch **Save**.
 - d. Touch **Delete Expired Files**, touch **Yes** or **No**, then touch **Save**.
 - e. Touch **Link Job Flow Sheets to folder**, then touch **Cut Link** or **Create Change Link**.
 - f. Select **Auto Start** if you want the job to start automatically.
6. Touch **Close** three times to return to the Tools tab.

To create a folder using CentreWare Internet Services:

1. At your computer, launch your Web browser.
2. Type the printer's IP address into the Web browser's address bar, then press **Enter** to open CentreWare Internet Services.

Note

If you do not know the printer's IP address, see [Finding the Printer's IP Address](#).

3. Click the **Scan** tab.
4. In the **Scan** navigation pane at the left of the page, click **Folder**.
5. In the **Folder** list, click **Create** next to an **Available** folder.

Note

If necessary, scroll the page to see available folders.

6. Assign folder attributes:
 - **Folder Name**: type the name.
 - **Delete Files After Print or Retrieve**: set or clear.
 - **Delete Expired Files**: set or clear.
7. To assign a password to the folder:
 - In the **Folder Passcode** field, type the password.
 - In the **Retype Passcode** field, retype the password.
 - In the **Check Folder Passcode** drop-down list, select **Always, Save** or **Print/Delete**.

Your folder is now available for use. Its contents will be stored on the printer's hard drive. The folder will appear on the printer's touch screen, and in the folder list in CentreWare Internet Services.

Deleting a Folder

Caution

Files in the folder will be deleted.

To delete a folder using the printer touch screen:

1. On the Control Panel, press the **Machine Status** button.
2. Touch the **Tools** tab, then under **Setup & Calibration > Setup > Features**, touch **Create Folder**.

Scanning

3. Touch the desired folder. If a password is required, enter the password using the alphanumeric keypad, then touch **Confirm** on the touch screen.
4. Touch **Delete Folder**, then touch **Delete**.

To delete a folder using CentreWare Internet Services:

1. At your computer, launch your Web browser.
2. Type the printer's IP address into the Web browser's address bar, then press **Enter** to open CentreWare Internet Services.

Note

If you do not know the printer's IP address, see [Finding the Printer's IP Address](#).

3. Click the **Scan** tab.
4. In the **Scan** navigation pane at the left of the page, click **Folder**. If necessary, scroll the page to see available folders.
5. In the **Folder** list, click **Delete** for the folder to be deleted.

Note

If the folder contains files, they must be deleted before the folder can be deleted.

6. Click **OK** to confirm that you want to delete the folder. If required, enter the folder password, then click **Apply**.

Scanning to a Network File Repository

Scanning to a network file repository is a feature of Network Scanning. Documents you scan are sent to a document repository on a network server configured by your system administrator. A template, also created by the System Administrator, defines the scan settings and the destination of the scanned image.

Note

Scanning to a network file repository must be configured by your System Administrator.

Note

Templates must be created using CentreWare Internet Services. For details, see the System Administrator Guide.

To use the scan to a network file repository feature:

1. Load the original on the document glass or in the document feeder.
2. On the Control Panel, press the **Services Home** button.
3. Touch **Network Scanning**.
4. Touch the desired template.
5. To override the template scan settings:
 - For scanning options, use the four menus at the bottom of the touch screen: **Color Scanning**, **2-Sided Scanning**, **Original Type**, and **Scan Presets**. For details, see [Setting Scan Options](#).

- For additional scanning options, use the three tabs at the top of the touch screen. For details, see [Additional Scanning Options](#).
6. Press the green **Start** button.

Scanning to an Email Address

Scanning to an email address sends scanned documents as attachments to email.

Note

This feature must be enabled by your System Administrator.

To send a scanned image to an email address:

1. Load the original on the document glass or in the document feeder.
2. On the Control Panel, press the **Services Home** button.
3. Touch **E-Mail**.
4. Specify the recipient using one of these methods:
 - Touch **New Recipient**: using the touch screen keyboard, enter the complete email address, touch **Add**, then touch **Close**.
 - Touch **Address Book**: touch the desired recipient, then touch **To**.
5. Repeat Step 4 to add additional recipients to the list. When all recipients have been added to the list, touch **Close**.
6. A default subject is provided for the email. To change the subject, touch **Subject**. Using the touch screen keyboard, enter the new subject, then touch **Save**.
7. To change any of the scan settings, touch the four menus at the bottom of the Control Panel: **Color Scanning**, **2-Sided Scanning**, **Original Type**, and **Scan Presets**. For details, see [Setting Scan Options](#).
8. Press the green **Start** button.

Setting Email Options

You can override the template settings created by your System Administrator, and change the following email settings:

- File Name
- File Format
- Reply To
- Read Receipts

To change the File Name or Reply to E-mail options:

1. On the printer Control Panel, press the **Services Home** button.
2. Touch **E-Mail**, then touch the **E-mail Options** tab.
3. Touch **File Name** or **Reply to**. Using the touch screen keyboard, delete or modify the text.
4. Touch **Save**.

Scanning

To change the file format:

1. On the printer Control Panel, press the **Services Home** button.
2. Touch **E-Mail**, then touch the **E-mail Options** tab.
3. Touch **File Format**, then select the desired file type. Each file format is described when selected.
4. To accept the file format, touch **Save**.

To request a read receipt:

1. On the printer Control Panel, press the **Services Home** button.
2. Touch **E-Mail**, then touch the **E-mail Options** tab.
3. Touch **Read Receipts**, then touch **On**.
4. Touch **Save**.

Scanning to a Computer

The Scan to PC feature allows you to scan a document to your computer.

Note

This feature must be enabled by your System Administrator.

To use the Scan to PC feature:

1. Load the original on the document glass or in the document feeder.
2. On the printer Control Panel, press the **Services Home** button.
3. Touch **Scan to PC**.
4. Touch **Transfer Protocol**, then touch **FTP**, **SMB**, or **SMB (UNC Format)**, then touch **Save**.
5. Touch **Server**, **Save in**, **User Name**, and **Password**. For each setting, using the touch screen keyboard, enter the data. Touch **Save**.

Note

If the server name was previously stored, touch **Address Book**, touch the desired server, touch **Add**, then touch **Close**.

6. To change any of the scan settings, touch the four menus at the bottom of the touch screen: **Color Scanning**, **2-Sided Scanning**, **Original Type**, and **Scan Presets**. For details, see [Setting Scan Options](#).
7. Press the green **Start** button.
8. Access the scanned image at your computer.

Scanning to a Home Directory

The Scan to Home feature allows you to scan a document to your home directory. The network location of your home directory is defined by the System Administrator.

Note

This feature must be configured by the System Administrator.

To use the Scan to Home feature:

1. Load the original on the document glass or in the document feeder.
2. On the printer Control Panel, press the **Services Home** button.
3. Touch **Network Scanning**.
4. Touch the template created by your System Administrator.
5. The template defines the scan settings as well as the destination of the image. To change any of the scan settings, touch the four menus at the bottom of the touch screen: **Color Scanning**, **2-Sided Scanning**, **Original Type**, and **Scan Presets**. For details, see [Setting Scan Options](#).
6. Press the green **Start** button.

For details, see the System Administrator Guide.

Storing to a USB Flash Drive

The Store to USB feature allows you to scan a document to a USB Flash Drive using the USB port on the left side of the front printer panel.

Note

This feature must be enabled by your System Administrator.

Note

This feature cannot be used when the Media Card Reader option is connected.

To use the Store to USB feature:

1. Load the original on the document glass or in the document feeder.
2. Insert a USB Flash Drive in the USB port on the left side of the front printer panel. The USB Device Detected window appears.
3. Touch **Store to USB**.
4. Touch **Save in**.
5. Touch the desired folder. To move down one directory level, touch **Next**. To move up one directory level, touch **Previous**.
6. To select the storage location, touch **Save**.
7. To change any of the scan settings, touch the four menus at the bottom of the touch screen: **Color Scanning**, **2-Sided Scanning**, **Original Type**, and **Scan Presets**. For details, see [Setting Scan Options](#).
8. To change any of the additional scanning options, use the three tabs at the top of the touch screen. For details, see [Additional Scanning Options](#).
9. To scan the original and store the file, press the green **Start** button.
10. Touch the **Services Home** button, then remove the USB Flash Drive.
11. To print files stored on a USB Flash Drive, see [Printing from a USB Flash Drive](#).

 **Caution**

Do not remove the USB Flash Drive while a file is being stored. Damage to stored files may occur. Remove the USB Flash Drive before turning the printer off.

Setting Scan Options

Scan Settings

Scanning can be adjusted using optional settings. After selecting the desired scanning method, use the four menus at the bottom of the Control Panel touch screen to change the following scan settings:

- Color Scanning - Overrides automatic detection; set to Auto Detect, Color, Black & White, or Grayscale
- 2-Sided Scanning - one side, 2 sides, or 2 sides with second side rotated
- Original Type - Choose from Photo and Text, Text, or Photo
- Scan Presets - Choose from Sharing and Printing, Archival Record, OCR, High Quality Printing, or Simple Scan

To change the scan settings:

1. On the printer Control Panel, press the **Services Home** button.
2. Touch the desired scan method.
3. Touch the desired settings in the four menus at the bottom of the touch screen.

Additional Scanning Options

Additional scanning options allow precise control of the scanning process. Many of these optional settings override the automatic settings. Instructions on the touch screen describe the use of these options.

After selecting the desired scanning method, use the tabs along the top of the touch screen to change the following scanning options:

- Advanced Settings
- Layout Adjustment
- Filing Options

Advanced Settings

Advanced settings allow you to control Image Options, Image Enhancements, Scan Resolution, File Size, Photographs, and Shadow Suppression.

To use Advanced Settings:

1. On the printer Control Panel, press **Services Home**.
2. Touch the desired scan method.
3. Touch the **Advanced Settings** tab.
4. Touch the desired setting.

Setting	Use
Image Options	Choose from Lighten/Darken or Sharpness/Soften.
Image Enhancement	Choose Background Auto Suppression to hide background color or Contrast.
Resolution	Choose from 200 to 600 dpi.
Quality/File Size	Choose from Good image quality with small file size, higher image quality with larger file size, or highest image quality with largest file size.
Photographs	Enhances the appearance of scans of photographic originals. Color scanning must be set to Color.
Shadow Suppression	Choose Auto Suppression to hide background color and image bleed for color scanning.

Layout Adjustment

Layout adjustment provides additional settings for original orientation, original size, edge erase, Book Scanning and Reduce/Enlarge.

1. On the printer Control Panel, press **Services Home**.
2. Touch the desired scan method.
3. Touch the **Layout Adjustment** tab.
4. Touch the desired setting.

Setting	Use
Original Orientation	Choose from Upright Images or Sideways Images
Original Size	Choose from Auto Detect, Manual Size Input or Mixed Size Originals
Edge Erase	Choose from All Edges, Print to Edge, Individual Edges or from a previously created Preset. Using the plus or minus buttons, enter the value.
Book Scanning	Choose from Left Page then Right, Right Page then Left or Top Page then Bottom. Using the plus or minus buttons, enter the Binding Edge Erase value.
Reduce/Enlarge	Choose from Proportional %, a Preset, or Enter Output Size. Using the plus or minus buttons, enter the value.

Filing Options/E-mail Options

Filing Options/E-mail Options provide additional settings for naming images, choosing image formats, adding meta data, and behavior if a file name already exists.

Scanning

To use Filing Options:

1. On the printer Control Panel, press **Services Home**.
2. Touch the desired scan method.
3. Touch the **Filing Options** tab.
4. Touch the desired setting.

Setting	Use
File Name	Enter a filename prefix.
File Format	Choose from: PDF (image Only or Searchable), PDF/A (Image Only or Searchable), Multi-page TIFF, TIFF (1 file per page), JPEG (1 file per page), or XPS (Image Only or Searchable). Choose Compression Method, MRC High Compression or Optimize for Fast Web View.
Meta Data	Assign descriptive meta data to a scanned image.
File Name Conflict	Choose from: Do Not Save, Rename New File, Overwrite Existing File, Add to Existing Folder, or AddDateStamp to File Name.
Login Name	Enter Login Name if required.
Password	Enter password if required.

Faxing

This chapter contains the following sections:

- Fax Overview
- Sending a Fax
- Server Fax
- Sending an Internet Fax
- Faxing from Your Computer
- Receiving Faxes
- Selecting Fax Options
- Adding Address Book Entries
- Creating Fax Comments

Fax Overview

Faxing is an optional feature of your multi-function printer. It can be configured in a variety of different ways to offer you the most convenient method for faxing an original document.

- **Embedded Fax:** A document is scanned at the multi-function printer and sent directly to a fax machine.
- **Server Fax:** A document is scanned at the multi-function printer and sent over an Ethernet network to a fax server. The fax server then sends the fax to a fax machine.
- **Internet Fax:** A document is scanned at the multi-function printer and emailed to a recipient.
- **Faxing from your Computer:** Using the settings in the print driver, the current print job is sent as a fax.

Note

Fax capability must be enabled by the System Administrator before use. For details, see the System Administrator Guide.

Loading Original Documents

With the exception of Faxing from Your Computer, all fax transmissions begin with loading the original document at the multi-function printer.

- Use the document glass for single page jobs or for originals that will not feed through the document feeder.
- Use the document feeder for multiple or single page jobs.

Document Glass

Lift the document feeder cover and place the original facedown, toward the back-left corner of the document glass as shown.

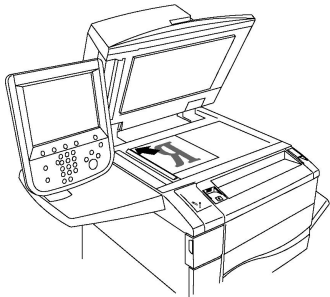

⚠ Caution

When scanning a bound document, do not attempt to force the document feeder cover closed. Doing so may damage the document feeder cover.

Duplex Automatic Document Feeder

Insert originals face up. Adjust the paper guides so they fit against the originals.

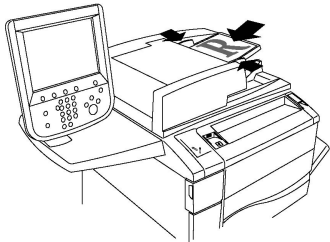

Sending a Fax

To send a fax using the multi-function printer's Embedded Fax:

1. Load the original on the document glass or in the document feeder.
2. On the Control Panel, press **Services Home**.
3. Touch **Fax**.
4. To manually enter the recipient fax number do one of the following:
 - a. Enter the fax number using the alphanumeric keypad, then touch **Add**.

- b. Touch **New Recipients**, enter the number using the touch screen keyboard, touch **Add**, then touch **Close**.
5. To use a number previously stored in the Address Book:
 - a. Touch **Address Book**.
 - b. Select an option from the drop-down list.
 - c. Touch the arrows to scroll through the list.
 - d. Touch the desired address.
 - e. Touch **Add**, then touch **Close**.

Note

Addresses must be entered in the Address Book to use the address book. For details, see [Adding Address Book Entries](#).

Note

Chain Dial can be performed when viewing the list of individual addresses in the Address Book. For details, see [Using Chain Dial](#).

6. To include a cover page:
 - a. Touch **Cover Page**, then touch **Print Cover Page**.
 - b. To add a previously created comment, touch **Comments**, then under either **Recipient's Comment** or **Sender's Comment**, touch an available comment, then touch **Save**. For details, see [Creating Fax Comments](#).
 - c. Touch **Save**.
7. Adjust fax options if required. For details, see [Selecting Fax Settings](#).
8. Press the green **Start** button. The printer scans the pages and transmits the document when all pages have been scanned.

Inserting Pauses in Fax Numbers

Some fax numbers require one or more pauses during the dialing sequence. To insert a pause in a fax number:

1. Using the alphanumeric keypad, begin entering the fax number.
2. Press the **Dial Pause** button on the control panel to insert a pause, represented by a hyphen, in the desired location.
3. Continue entering the fax number.

Server Fax

When using the Server Fax, a document is scanned and sent to a fax server on the network. The fax server then sends the fax over a telephone line to a fax machine.

Note

The Server Fax service must be enabled before use, and a fax server must be configured.

Note

Server Fax cannot be used together with the Embedded Fax feature. When Server Fax is in use, the touch screen Fax button activates Server Fax.

Note

Server Fax cannot be used together with the Internet Fax feature. When Server Fax is in use, the touch screen Internet Fax button does not appear.

Sending a Server Fax

1. Load the original on the document glass or in the document feeder.
2. On the Control Panel, touch **Services Home**.
3. Touch **Fax**.
4. Enter the number using the alphanumeric keypad, then touch **Add**.
5. Touch **New Recipients**, enter the number using the touch screen keyboard, touch **Add**, then touch **Close**.
6. To use a number previously stored in the Address Book:
 - a. Touch **Address Book**.
 - b. Touch the arrows to scroll through the list.
 - c. Touch the desired address.
 - d. Touch **Add**, then touch **Close**.
7. Adjust fax options if necessary. For details, see [Selecting Fax Settings](#).
8. Press the green **Start** button. The printer scans the pages and transmits the fax document when all pages have been scanned.

Sending an Internet Fax

If an SMTP email server is connected to the network, a document can be sent to an email address. This feature eliminates the need for a dedicated telephone line. When sending an Internet Fax, the document is scanned and sent to an email address.

Note

The Internet Fax service must be enabled before use, and an SMTP server must be configured. For details, refer to the System Administrator Guide at www.xerox.com/support. Enter **Xerox Color C60/C70 Printer** in the **Search or Choose** field and select the desired documentation.

To send an Internet Fax:

1. Place the original on the document glass or in the document feeder.
2. On the printer touch screen, touch **Services Home**, then touch **Internet Fax**.
3. Touch **New Recipient**.
4. To enter the recipient's email address, do one of the following:
 - Enter the address using the touch screen keyboard, then touch **Add**. Repeat for each recipient, then touch **Close**.

- Touch **Address Book**, touch the desired address in the scrolling list, then touch **Add**. When all recipients have been added, touch **Close**.
5. Adjust fax options if necessary. For details, see [Selecting Fax Settings](#).
 6. Press the green **Start** button. The printer scans the pages and sends the document as an email attachment when all pages have been scanned.

Faxing from Your Computer

A document stored on your computer can be sent as a fax using the print driver.

Note

To fax from your computer, fax must be installed in the multi-function printer and enabled by the System Administrator.

1. In your software application, click **File**, then **Print**.
2. Select your printer from the list.
3. Access the print driver settings by selecting **Properties** or **Preferences** (Windows), or **Xerox Features** for Macintosh. The title of the button may vary depending on your application.
4. Select printer features.
 - Windows: Click the **Paper/Output** tab.
 - Macintosh: Click **Copies and Pages**, then click **Xerox Features**.
5. Click the **Job Type** menu, then click **Fax**.
6. Click **Add Recipients**.
7. Enter the recipient's name and fax number. If desired, complete the additional information.
8. If desired, click the **Cover Sheet** tab, choose an option, then click **OK**.
9. If desired, click the **Options** tab, choose your options, then click **OK**.
10. Click **OK**.
11. Send the fax:
 - Windows: Click **OK**.
 - Macintosh: Click **Print**.

For details, click the **Help** button in the Fax window.

Receiving Faxes

The printer must be configured by the System Administrator to receive and print a fax using the Embedded Fax, Server Fax, and Internet Fax. For more information, see the System Administrator Guide at www.xerox.com/support. Enter **Xerox Color C60/C70 Printer** in the **Search or Choose** field and select the desired documentation.

Selecting Fax Settings

Setting 2-Sided Faxing

1. Touch **Fax** on the touch screen.
2. Touch **2 Sided Scanning**, then touch the desired option: **2 Sided** or **2 Sided, Rotate Side 2**.

Selecting the Original Type

1. Touch **Fax** on the touch screen.
2. Touch **Original Type**, then touch the desired option (**Text, Photo and Text, Photo**).

Setting the Fax Resolution

1. Touch **Fax** on the touch screen.
2. Touch **Resolution**, then touch the desired option:
 - **Standard 200x100 dpi**
 - **Fine 200 dpi**
 - **Super Fine 400 dpi**
 - **Super Fine 600 dpi**

Note

For Server Fax, touch **Standard** or **Fine**.

Adjusting Layout

Layout settings allow you to adjust the original size, set page scanning for book faxing, and reduce or enlarge the fax image.

Lighten/Darken

1. Touch **Fax** on the touch screen.
2. Touch the Layout Adjustment tab, then touch **Lighten/Darken**.
3. Adjust the settings to lighten or darken the fax.
4. Touch **Save**.

Adjusting the Original Size

1. Touch **Fax** on the touch screen.
2. Touch the **Layout Adjustment** tab, then touch **Original Size**.
3. Touch one of the following:
 - **Auto Detect**, to automatically identify standard size originals.
 - **Manual Size Input**, for manual definition of the scan area using standard paper dimensions.
 - **Mixed Size Originals**, for scanning originals of different standard sizes.
4. Touch **Save**.

Book Faxing

1. Touch **Fax** on the touch screen.
2. Touch the **Layout Adjustment** tab, then touch **Book Faxing**.
3. Touch one of the following options:
 - **Off** (Default).
 - **Left Page then Right**, then touch **Both Pages**, **Left Page Only** or **Right Page Only**.
 - **Right Page then Left**, then touch **Both Pages**, **Left Page Only** or **Right Page Only**.
 - **Top Page then Bottom**, then touch **Both Pages**, **Top Page Only** or **Bottom Page Only**.
4. Touch **Save**.

Reduce/Enlarge

1. Touch **Fax** on the touch screen.
2. Touch the **Layout Adjustment** tab, then touch **Reduce/Enlarge**.
3. Touch a preset percentage, or touch the plus or minus buttons to specify a variable percentage.
4. Touch **Save**.

Fax Options

The Fax Options tab contains options that allow you to specify how the fax is transmitted.

Note

With the exception of Priority Send/Delay Start, these settings are not available for Server Fax.

To adjust these settings:

1. On the touch screen, touch **Fax**, then touch the **Fax Options** tab.
2. Touch the desired option, touch the desired settings, then touch **Save**.

Option	Values
Confirmation Options	Off/On; print report after each fax transmission.
Starting Rate	G3 Auto, Forced 4800 bps
Priority Send/Delay Start	Priority Send: Off/On; Delay Start: Off, Specific Time (touch Specific Time and then touch desired settings)
Transmission Header Text	Off, Display Header
Recipient Print Sets	1 Set, Multiple Sets (touch Multiple Sets, then touch plus or minus buttons to set quantity)

Option	Values
Pages per Side	Off/On (touch plus or minus buttons to set quantity)
Remote Folder	Send to Folder: Off/On, Folder Number, Folder Passcode (enables sending a file directly to a folder on a remote fax machine by setting the Folder Number and Folder Passcode using the alphanumeric keypad)
F Code	Off/On (F Code is a file transmission method enabled by setting the F Code and Folder Password using the alphanumeric keypad or touch screen keyboard)

More Fax Options

Further optional fax settings are provided. To adjust these settings:

1. On the touch screen, touch **Fax**, then touch the **More Fax Options** tab.
2. Touch the desired option, touch the desired settings, then touch **Save**.

Note

These settings are not available for Server Fax.

Option	Values
Remote Polling	Off, poll a Remote Device (retrieve files stored on a remote fax machine by using the Remote Folder feature)
Store for Polling	Off, Store for Free Polling and Store for Secure Polling (fax documents stored in the printer are made available for remote polling by enabling Free Polling or Secure Local Polling, then touching the folder and file)
On-Hook (Manual Send/Receive)	Manual Send: touch On-Hook, touch Manual Send, then use the touch screen keyboard to enter destination and passcode Manual Receive: touch On-Hook, touch Manual Receive, then press green Start button

Internet Fax Options

Additional Internet Fax options are provided. To make these settings:

1. On the touch screen, touch **Internet Fax**, then touch the **Internet Fax Options** tab.
2. Touch the desired option, touch the desired settings, then touch **Save**.

Note

For details, see the System Administrator Guide.

Option	Values
Acknowledgement Report	Confirmation Options: Off, print report after each fax transmission Read Receipts: request read receipt from recipient's fax server to be sent to sender indicating the result of the transmission; recipient's server must support the MDN standard.
Internet Fax Profile	TIFF-S: use for A4, 210 x 297mm (8.5 x 11 in.) originals with Standard or Fine Resolution TIFF-F or TIFF-J: use for A3, 297x420mm (11 x 17 in.) originals with Superfine Resolution
Pages per Side	Off, On (touch plus or minus buttons to set quantity)
Starting Rate	G3 Auto, Forced 4800 bps, G4 Auto
Transmission Header Text	Off, Display Header

Adding Address Book Entries

The address book can store email, server, fax, and Internet fax addresses. Addresses can be stored for individuals, or groups containing multiple individuals.

Note

Address Book entries can also be managed in CentreWare Internet Services. For details, refer to the System Administrator Guide at www.xerox.com/support. Enter **Xerox Color C60/C70 Printer** in the **Search or Choose** field and select the desired documentation.

Adding an Individual Address

1. On the Control Panel, press the **Machine Status** button.
2. On the touch screen, touch the **Tools** tab.
3. Touch **Setup + Calibration**, touch **Setup**, then touch **Add Address Book Entry**.
4. On the next screen, touch an (available) address in the scrolling list.
5. Touch **Address Type**, touch the desired address type, then touch **Save**. Each address book type requires different settings.
6. Touch each desired item in the list, enter the information using the alphanumeric keypad or touch screen keyboard, then touch **Save**.
7. When all desired settings have been configured, touch **Save** to complete the address book entry.

Deleting an Individual Address

1. On the Control Panel, press the **Machine Status** button.
2. On the touch screen, touch the **Tools** tab.
3. Touch **Setup + Calibration**, touch **Setup**, then touch **Add Address Book Entry**.
4. On the next screen, touch the desired address in the scrolling list.
5. Touch **Delete Entry**, then touch **Delete** to confirm.

Adding a Group

Create a group to send a fax to multiple individuals. Groups can include both previously stored individuals and group entries.

Note

Individual entries must be configured before groups can be defined.

1. On the Control Panel, press the **Machine Status** button.
2. On the touch screen, touch the **Tools** tab.
3. Touch **Setup and Calibration**, touch **Setup**, then touch **Create Fax Group Recipients**.
4. On the next screen, touch an (available) group in the scrolling list.
5. On the next screen, touch the **Group Name** field, enter a name for the group using the touch screen keyboard, then touch **Save**.
6. Touch the **Speed Dial** field, then enter the Speed Dial number for the desired individual using the alphanumeric keypad.
7. Touch **Add to this Group**.
8. Repeat steps 6 and 7 until all individuals have been added to the group.
9. When all entries have been added, touch **Save**, then touch **Close**.

Deleting a Group

1. On the Control Panel, press the **Machine Status** button.
2. On the touch screen, touch the **Tools** tab.
3. Touch **Setup and Calibration**, touch **Setup**, then touch **Create Fax Group Recipients**.
4. On the next screen, touch the desired group in the scrolling list.
5. Touch **Delete**, then touch **Delete** to confirm.

Using Chain Dial

Chain Dial creates a single fax recipient telephone number by adding two or more fax numbers together into a single number. For example, an area code or extension number could be stored separately from the rest of the telephone number. Access Chain Dial from the Address Book.

1. On the touch screen, touch **Fax**.
2. Touch **Address Book**.
3. Touch **List all public entries** from the drop-down list.
4. Touch **Chain Dial**.
5. To add numbers do one of the following:
 - Touch the desired speed dial entry from the scrolling list. Touch the scroll arrows if necessary.
 - Enter a number using the alphanumeric keypad.
 - Touch the keyboard button, enter a number using the touch screen keyboard, then touch **Save**.
6. Touch **Add**. The numbers are added together in the **Recipient List**.

7. Touch **Save**. The combined number appears as a single recipient in the **Recipient(s)** list.
8. Touch **Close**. The fax can now be sent.

Creating Fax Comments

1. On the Control Panel, press the **Machine Status** button.
2. On the touch screen, touch the **Tools** tab.
3. Touch **Setup**, then touch **Add Fax Comment**.
4. On the next screen, touch an (available) comment in the scrolling list.
5. Enter the comment using the touch screen keyboard, then touch **Save**.
6. Touch **Close**. The comment is ready to use.

Faxing

Maintenance

This chapter contains the following sections:

- General Precautions
- Locating the Serial Number
- Billing and Usage Information
- Cleaning the Printer
- Ordering Supplies
- Routing Maintenance Items
- Recycling Supplies

General Precautions

Warning

When cleaning your printer do **not** use organic or strong chemical solvents or aerosol cleaners. Do **not** pour fluids directly into any area. Use supplies and cleaning materials only as directed in this documentation. Keep all cleaning materials out of the reach of children.

Warning

Internal parts of the printer may be hot. Use caution when doors and covers are open.

Warning

Do **not** use pressurized air spray cleaning aids on or in the printer. Some pressurized air spray containers contain explosive mixtures and are not suitable for use in electrical applications. Use of such cleaners can result in a risk of explosion and fire.

Warning

Do **not** remove the covers or guards that are fastened with screws. You cannot maintain or service any parts that are behind these covers and guards. Do **not** attempt any maintenance procedure that is **not** specifically described in the documentation supplied with your printer.

To avoid damaging the printer, keep the following guidelines in mind:

- Do not place anything on top of the printer.
- Do not leave the covers and doors open for any length of time, especially in well-lit places. Light exposure can damage the drum cartridges.
- Do not open covers and doors during printing.
- Do not tilt the printer while in use.
- Do not touch the electrical contacts, gears, or laser devices. Doing so may damage the printer and cause the print quality to deteriorate.
- Make sure any parts removed during cleaning are replaced before you plug in the printer.

Locating the Serial Number

When ordering supplies or contacting Xerox for assistance, you will be asked to provide the printer's serial number.

View the printer serial number from the printer's touch screen:

1. Press the **Machine Status** button. The Machine Information tab appears.
2. Notice the serial number at the left of the Machine Information screen.

If the serial number cannot be read from the printer's touch screen, it can also be found on the machine frame inside the lower left cover of the printer or inside the front door.

Billing and Usage Information

The Billing Information screen displays billing and printer usage information.

1. Press the **Machine Status** button.
2. Touch the **Billing Information** tab.

The total impressions counters appear on the left of the screen.

For more detail:

1. Touch **Usage Counters**, then touch the down arrow to choose the desired counter. Touch the scroll arrows to view the entire list.
2. Touch **Close**.

Cleaning the Printer

- Cleaning the Document Glass and Document Cover
- Cleaning the Exterior
- Ordering Supplies

Cleaning the Document Glass and Document Cover

To ensure optimum print quality, regularly clean the glass areas of the printer. This helps avoid output with streaks, smears, and other marks that transfer from the glass area while scanning documents.

Use a lint-free cloth lightly dampened with Xerox Anti-Static or another suitable non-abrasive glass cleaner to clean the document glass and the CVT glass to its left.

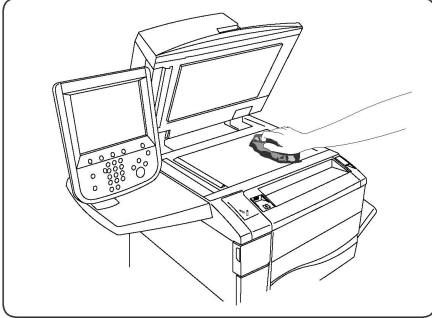

Use a lint-free cloth, Xerox Cleaning Fluid or Xerox Film Remover to clean the under side of the document cover and the document feeder.

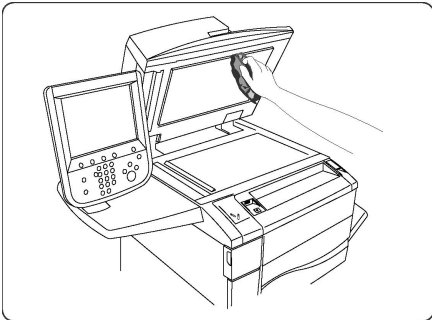

Cleaning the Exterior

Regular cleaning keeps the touch screen and control panel free from dust and dirt. To remove finger prints and smudges, clean the touch screen and control panel with a soft, lint-free cloth.

Use a cloth to clean the document feeder, output trays, paper trays and outside areas of the printer.

Ordering Supplies

This section includes:

- Consumables
- When to Order Supplies

Certain consumables and routine maintenance items need to be ordered occasionally. Each supply item includes installation instructions.

Consumables

Use genuine Xerox® Toner Cartridges (Cyan, Magenta, Yellow, and Black).

Note

Each toner cartridge includes installation instructions.

Caution

Use of toner other than Genuine Xerox® Toner may affect print quality and printer reliability. It is the only toner designed and manufactured under strict quality controls by Xerox for specific use with this printer.

When to Order Supplies

The printer Control Panel displays a warning when a supply nears its replacement time. Verify that you have replacements on hand. It is important to order supplies when the messages first appear to avoid interruptions in printing. The touch screen displays an error message when the supply must be replaced.

Order supplies from your local reseller or from the Xerox Supplies website at: www.xerox.com.

Caution

Use of non-Xerox supplies is not recommended. The Xerox Warranty, Service Agreements, and Total Satisfaction Guarantee do not cover damage, malfunction, or degradation of performance caused by use of non-Xerox supplies, or the use of Xerox supplies not specified for this printer. The Total Satisfaction Guarantee is available in the United States and Canada. Coverage may vary outside these areas; please contact your local representative for details.

Routine Maintenance Items

Routine maintenance items are printer parts that have a limited life and require periodic replacement. Replacements may be parts or kits. Routine maintenance items are typically customer replaceable.

The following items are routine maintenance items:

- Toner cartridges
- Fuser Assembly
- Waste Toner Container
- Drum Cartridge
- Charge Corotrons

Replacing the Toner Cartridges

This procedure shows you how to remove a used toner cartridge and replace it with a new toner cartridge. The machine will notify you when a new toner cartridge is needed, and when installation is to occur. If you continue copying or printing without replacing the toner cartridge, a message will appear and the machine will stop after copying or printing around 1,800 pages for Black, or around 1200 pages for Cyan, Magenta and Yellow.

Follow the disposal instructions for the old cartridge when you receive with the new cartridge.

Warning

Before you begin the procedure, ensure that the machine has been allowed to cool down. Failure to do so may result in burns if certain parts of the machine are touched.

1. Replace the toner cartridge while the machine is on. Open the toner cover, located just above the machine front door.

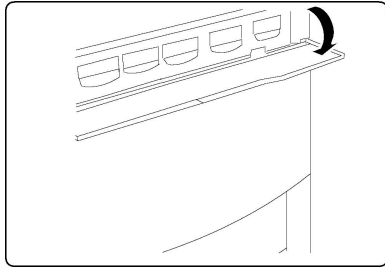

2. Lay paper on the floor before removing the cartridge. This will allow any excess toner to fall on the paper. Hold the handle of the color indicated in the message, and gently pull it out.

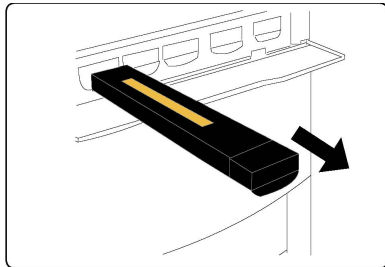

3. Remove the toner cartridge by holding the handle on the top of the cartridge while gently pulling it straight out. Be careful to not get toner on clothing.
4. Dispose the toner cartridge as normal office waste or recycle the cartridge.
5. Remove the new toner cartridge from its packaging.
6. Gently tilt the new cartridge up and down, and then left and right to redistribute the toner.
7. Install the toner cartridge by aligning the arrows on the cartridge evenly with the printer until you hear a click.

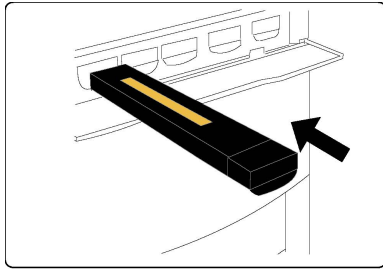

8. Close the Front Door. If the door will not close completely, make sure the cartridge is in the lock position and the toner cartridge is installed into the appropriate toner location.

⚠ Caution

Never use a vacuum cleaner when you clean spilled toner. It can cause explosion as the toner fills the vacuum cleaner and gets sparks. Use a broom or a cloth moistened with a neutral detergent.

Replacing the Fuser

This procedure shows you how to remove a used Fuser and replace it with a new Fuser. The machine will tell you when you need to install a new one. The Fuser can be recycled so please follow the disposal instructions you receive with the new cartridge.

1. Make sure the machine has stopped running, and open the Front Door.
2. Grasp **Handle #2** and turn it to the unlocked position.

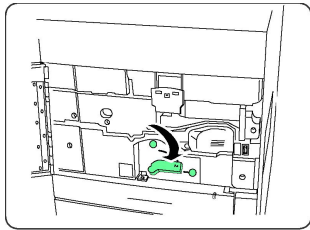

⚠ Warning

To avoid burns wait at least 5-10 minutes after powering off the printer to allow the fuser to cool down, and observe warning labels inside.

3. Carefully pull out the Transfer Module.

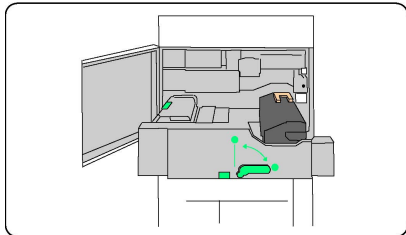

4. Grab and lift the Amber-Gold colored handle only, lift and pull up and out of the Transfer Module.

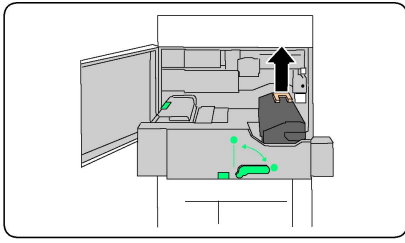

5. Dispose the Fuser as normal office waste or recycle the fuser.
6. Remove the new Fuser from its packaging.
7. Insert the new Fuser into the Transfer module while holding the Amber-Gold handle.

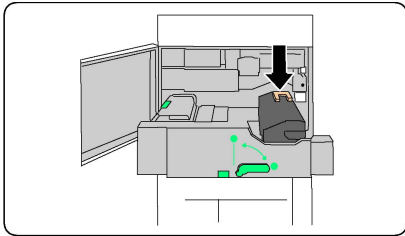

8. Close the Transfer module.
9. Turn **Handle #2** to the locked position.
10. Close the Front Door of the printer.

Replacing the Waste Toner Container

This procedure shows you how to remove the used Waste Toner Container and replace it with a new Waste Toner Container. The machine will tell you when you need to order a new Container and when to install it.

1. Make sure the machine has stopped running, and open the Front Door.
2. Open the waste toner container cover, located to the right of the Area #2 lever.

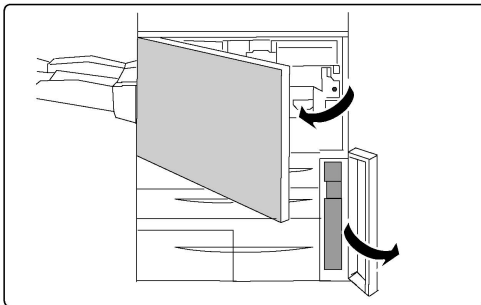

3. Grip the handle of the waste toner container and pull out about half of it.

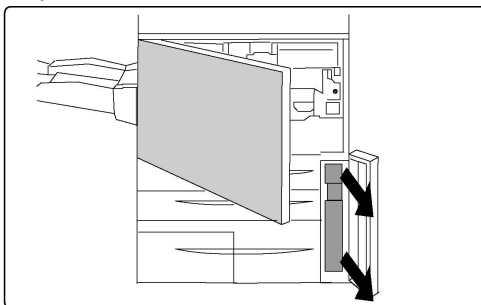

4. Hold the center part on the top of the container, and then remove it.

! **Caution**

Never use a vacuum cleaner when you clean spilled toner. It can cause explosion as the toner fills the vacuum cleaner and gets sparks. Use a broom or a cloth moistened with a neutral detergent.

5. Hold the used waste toner container firmly with both hands and put it into the provided plastic bag.
6. Hold the center part on the top of a new container and insert it until it comes to a stop.
7. Close the waste toner container cover.
8. Close the Front Door of the printer.

Replacing the Drum Cartridges

This procedure shows you how to remove a used Drum Cartridge and replace it with a new Drum Cartridge. The machine will tell you when you need to order a new cartridge and when to install it. The Drum Cartridges can be recycled so please follow the disposal instructions you receive with the new items.

! **Caution**

Do not expose drum cartridges to direct sunlight or strong light from indoor fluorescent lighting for more than two minutes. Image quality may deteriorate when the drum cartridges are exposed to light.

1. Leave the machine power **on** and proceed to the next step.
2. Make sure the machine has stopped running, and open the Front Door.
3. Pull down the R1-R4 handle.

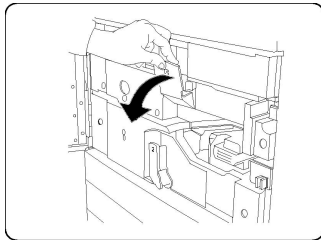

4. Raise the Release Handle.

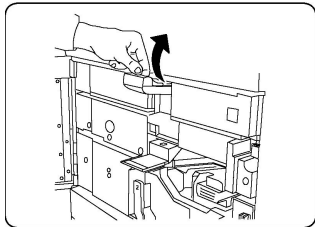

5. Open a bag including a new drum cartridge. Place the new drum cartridge near the machine.

! **Caution**

Do not touch or scratch the surface of the drum when you take it out from the bag.

! Caution

Do not expose drum cartridges to direct sunlight or strong light from indoor fluorescent lighting for more than two minutes. Image quality may deteriorate when the drum cartridges are exposed to light.

6. Unwrap the sheet covering the new drum cartridge and place it under the cartridge. Some drum cartridges may include a protective film. Remove the the film on the drum cartridge, if it is present.

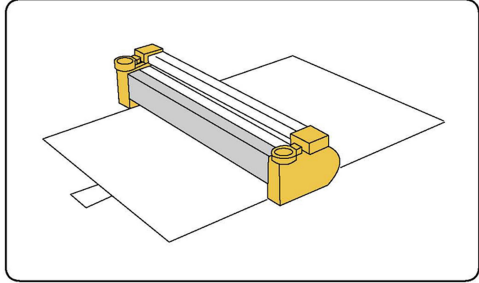

7. Open the Drum Drawer.

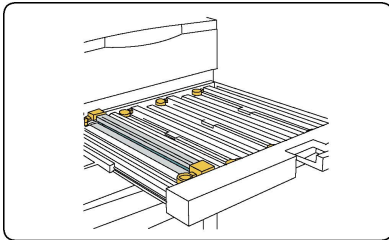

8. Remove the old drum cartridge by holding the finger rings provided at the both ends of the drum cartridge and gently lifting up.

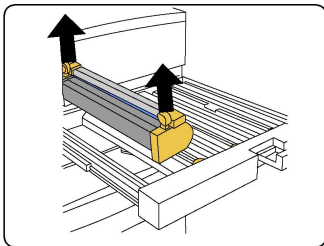

9. Place the new drum cartridge in the machine following the guides with the side marked front facing the front.

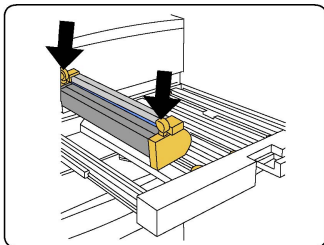

10. Press both ends of the drum cartridge to place it in a horizontal position.

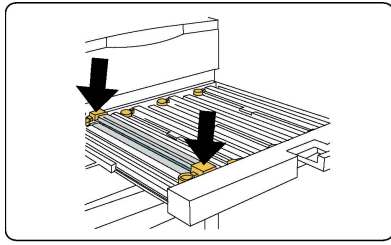

11. Immediately close the Drum Drawer to protect the other drums from light.
12. Return the Release Handle to its original position.
13. Return the R1-R4 handle to the original position and close the front door.
14. Insert the used drum cartridge into an empty container for recycling.

Replacing the Charge Corotron

1. Make sure the machine has stopped running, and open the Front Door.
2. Pull down the R1-R4 handle.
3. Raise the Release Handle.
4. Open the packaging for the new Charge Corotron and gently place the new Charge Corotron on a flat surface near the machine.

⚠ Caution

Do not expose drum cartridges to direct sunlight or strong light from indoor fluorescent lighting for more than two minutes. Image quality may deteriorate when the drum cartridges are exposed to light.

5. Open the Drum Drawer.

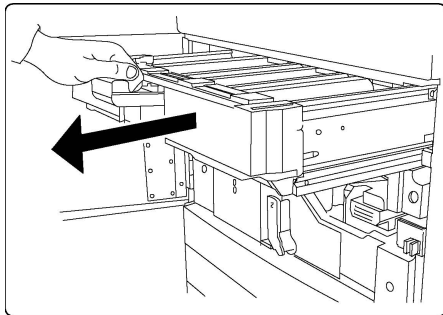

6. Grasp both of the amber-gold colored casings on the old Charge Corotron and push towards the back of the machine. You will hear a clicking noise indicating that it is being released.
7. Remove the old Charge Corotron by holding the amber-gold colored casings provided at the both ends of the Charge Corotron and gently pulling straight up.
8. Gently lower the new Charge Corotron into the machine straight down, and not at an angle.
9. Grasp the amber-gold colored casings on the new Charge Corotron and pull towards the front of the machine until you hear a clicking noise to indicate the Charge Corotron is in place.
10. Push in the Drum Drawer completely. Return the Release Handle to its original position.

11. Return the R1-R4 handle to the original position and close the front door.
12. Insert the used Charge Corotron into an empty container for recycling.

Recycling Supplies

For information on Xerox supplies recycling programs, go to www.xerox.com/gwa. Some routine maintenance items come with a prepaid return label. Please use it to return used components in their original boxes for recycling.

10

Troubleshooting

This chapter contains the following sections:

- Control Panel Messages
- General Troubleshooting
- Clearing Paper Jams
- Clearing Staple Jams
- Print Quality Problems
- Fax Problems
- Getting Help

Control Panel Messages

The Control Panel touch screen provides information and troubleshooting help. When an error or warning condition occurs, the touch screen displays a message. The touch screen may also display an animated graphic showing the location of the problem, such as the location of a paper jam.

Problems which prevent the full operation of the printer have associated fault codes. These codes will help pinpoint the specific subsystem with the problem. Current faults and fault history can be retrieved at any time.

To see a list of the fault messages that have been displayed on the printer:

1. Press the **Machine Status** button.
2. On the touch screen, touch the **Faults** tab.
3. Touch Current Faults, Current Messages, or Fault History.
4. Touch **Close**.

General Troubleshooting

This section contains procedures to help you locate and resolve problems. Some problems can be resolved by simply restarting the printer.

If the problem is not resolved by restarting the printer, see the table in this chapter that best describes the problem.

Printer Does Not Turn On

Probable Causes	Solutions
The power switch is not correctly turned on.	Turn off the printer using the power switch visible on the Control Panel. Wait two minutes, then turn the printer on. Ensure that the main power switch behind the front cover of the printer is in the On position.
The power cord is not correctly plugged into the outlet.	Turn off the printer, and plug the power cord securely into the outlet.
Something is wrong with the outlet connected to the printer.	Plug another electrical appliance into the outlet and see whether it operates properly. Try a different outlet.
The printer is connected to an outlet with a voltage or frequency that does not match the printer specifications.	Use a power source with the specifications listed in Electrical Specifications.

 **Caution**

Plug the three-wire power cord (with grounding prong) directly into a grounded AC outlet only. Do not use a power strip. If necessary, contact a licensed electrician to install a properly grounded outlet.

Printing Takes Too Long

Probable Causes	Solutions
The printer is set to a slower mode (for example, heavyweight stock).	It takes more time to print with special media. Make sure that the media type is set properly in the printer driver and at the printer Control Panel.
The printer is in power saving mode.	It takes time for printing to start in power saving mode.
The job is very complex.	Wait. No action needed.

Printer Resets or Turns Off Frequently

Probable Causes	Solutions
The power cord is not correctly plugged into the outlet.	Turn off the printer, confirm that the power cord is correctly plugged into the printer and the outlet, then turn on the printer.
A system error occurred.	Contact your local Xerox service representative with the fault information. Check the fault history. For details, see Control Panel Messages.

2-Sided Printing Problems

Probable Causes	Solutions
Media or settings are not correct.	Make sure that you are using correct media. For details, see Accepted Media. Envelopes, labels, gloss, and extra heavyweight stock cannot be used for 2-Sided Printing. In the print driver, choose 2-Sided Printing.

Scanner Error

Probable Causes	Solutions
Scanner is not communicating.	Turn off the printer using the power button visible on the right side of the printer top panel. Wait two minutes, then turn the printer on. Ensure that the main power switch behind the front cover of the printer is in the On position.

Troubleshooting Paper Jams

The printer is designed to function with minimal paper jams using Xerox-accepted media types only. Other media types may cause more frequent paper jams. If accepted media is jamming frequently in one area, that area may need to be cleaned or repaired.

The Printer Pulls Multiple Sheets Together

Probable Cause	Solutions
The paper tray is too full.	Remove some of the paper. Do not load paper past the fill line.
The front edges of the paper are not even.	Remove the media, align the front edges, then reload it.

Troubleshooting

Probable Cause	Solutions
The media is moist from humidity.	Remove the media from the tray, and replace it with new dry media.
Too much static electricity is present.	Try a new ream of paper.
Unsupported media.	Use only Xerox-approved media. See Accepted Media.
Humidity is too high for coated paper.	Feed the paper one sheet at a time.

Paper Jam Message Stays On

Probable Causes	Solutions
Some paper remains jammed in the printer.	Recheck the media path and make sure that you have removed all of the jammed paper.

Media Misfeeds

The table below lists solutions to paper jams in the duplex unit, Document Feeder and paper trays.

Probable Causes	Solutions
Unaccepted media of the wrong size, thickness, or type is in use.	Do not use unaccepted media. Use only Xerox-approved media. For details, see Accepted Media. Recheck the paper path inside the module and remove all jammed paper. Make sure you do not have mixed media types in the tray. Do not print envelopes, labels, extra heavyweight or gloss paper 2 sided.
Warped or wrinkled media is loaded in the tray. The media is moist from humidity.	Remove the media, smooth it out, and reload it. If it still misfeeds, do not use that media. Remove the moist media and replace it with new, dry media.
The documents loaded in the document feeder exceed the maximum capacity allowed.	Place fewer documents in the document feeder.
The document feeder guides are improperly adjusted.	Ensure the media guides fit snugly against the media loaded in the document feeder.
The media is not correctly positioned in the tray	Remove the misfed media and reposition the media properly in the tray. Ensure that the media guides in the tray are set correctly.
The number of sheets in the tray exceeds the maximum capacity allowed.	Remove the excess paper and load paper below the fill line.

Probable Causes	Solutions
The media guides are not correctly adjusted to the media size.	Adjust the media guides in the tray to match the size of the media.
The label sheet is facing the wrong way in the tray.	Load the label sheets according to the manufacturer's instructions.
Envelopes are facing the wrong way in Tray 5 (Bypass Tray).	Load the envelopes facedown in Tray 5 (Bypass Tray) with the flaps closed, on the leading edge.

Clearing Paper Jams

When a jam occurs, the control panel touch screen displays an animated graphic showing the location of the jam.

To avoid damage, always remove misfed media gently, without tearing it. Try to remove the paper in the direction that the paper would normally feed. Any piece of media left in the printer, whether large or small, can obstruct the media path and cause further misfeeds. Do not reload media that has misfed.

Note

The printed side of jammed pages may smudge, and the toner may stick to your hands. Do not touch the printed side of the media when removing it. Make sure not to spill any toner inside the printer.

Warning

If you accidentally get toner on your clothes, lightly dust them off as best as you can. If some toner remains on your clothes, use cool, not hot water, to rinse the toner off. If toner gets on your skin, wash it off with cool water and a mild soap. If you get toner in your eyes, wash it out immediately with cool water and consult a doctor.

Clearing Paper Jams from Tray 1, Tray 2, Tray 3, or Tray 4

1. Pull the tray out toward you until it stops.
2. Remove the paper from the tray.

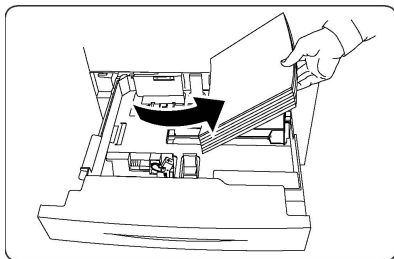

3. If the paper is torn, remove the tray completely and check inside the printer for torn pieces of paper.
4. Reload the tray with undamaged paper, then push the tray in until it stops.
5. On the printer touch screen, touch **Confirm**.

Clearing Paper Jams from Tray 5 (Bypass Tray)

1. Remove the jammed paper from the tray. Make sure there are no sheets of paper in the paper feed entrance area where the tray connects to the printer.
2. If the paper is torn, check inside the printer for torn pieces of paper.
3. Reload the tray with undamaged paper. The leading edge of the paper should lightly touch the paper feed entrance.
4. On the printer touch screen, touch **Confirm**.

Clearing Paper Jams in Document Feeder

1. Open the Document Feeder Top Cover until it comes to a stop.
2. Open the Left Cover until it comes to a stop.
3. If the document is not caught in the document feeder, pull out the document.
4. Close the Top Cover until it clicks into place.
5. Close the Left Cover until it clicks into place.
6. If the document cannot be found, raise the Document Feeder slowly.
7. Gently return the Document Feeder Tray to its original position.

Clearing Paper Jams in the High Capacity Feeder

1. Open Tray 6 and remove any jammed paper.
2. If paper is torn, check for any torn pieces of paper inside the machine.
3. Gently close Tray 6.
4. Gently move Tray 6 to the left until it stops.
5. Open the Tray 6 Top Cover and remove any jammed paper.
6. Close the Tray 6 Top Cover and gently move Tray 6 to its original position.

Clearing Paper Jams in the Oversized High Capacity Feeder

1. Open the tray where the paper jam occurred.
2. Remove the visible jammed paper.
3. If paper is torn, check for any torn pieces of paper inside the machine.
4. Gently close the tray.

Clearing Paper Jams in the Fuser

1. Open the Bottom Right Cover and tear off the Lead Edge from any jammed sheet. Also, clear any jammed sheets from the Bypass (Tray 5) feeder. Then, open the Front Cover.
2. Turn Handle 2 to the right until it is in the horizontal position, then pull out the Transfer Module.

Warning

Never touch a labeled area (found on the Fuser or nearby) indicating “High Temperature” and “Caution”. You may get burned.

3. Remove the visible jammed paper.
4. If paper is torn, check for any torn pieces of paper inside the machine.

5. Move Handle 2a to the right and remove any jammed paper.
6. Pull down Handle 2b and remove the jammed paper.
7. Return Handle 2a and Handle 2b to their original position.
8. Push in the Transfer Module completely and turn Handle 2 to the left.
9. Close the front cover.

Clearing Jams in the C/Z Folder

This section includes:

- [Clearing Jams at 2a in the C/Z Folder](#)
- [Clearing Jams at 2b in the C/Z Folder](#)
- [Clearing Jams at 2e in the C/Z Folder](#)
- [Clearing Jams at 2f in the C/Z Folder](#)
- [Clearing Jams at 2g in the C/Z Folder](#)

Clearing Jams at 2a in the C/Z Folder

To clear jams at 2a in the C/Z Folder:

1. Open the front door of the C/Z Folder.

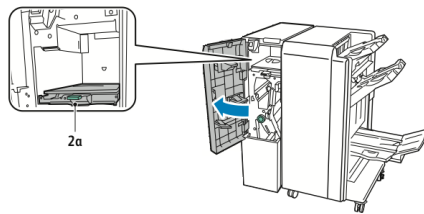

2. Lift up green handle 2a.

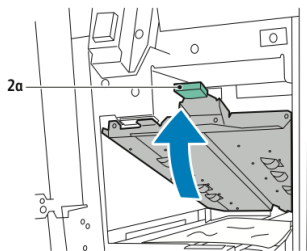

3. Carefully remove the paper.

Note

If the paper is torn, remove all torn pieces from the folder.

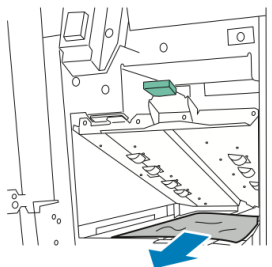

Troubleshooting

- Return green handle **2a** to its original position.

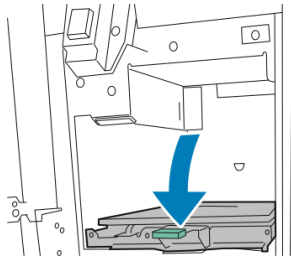

- Close the front door of the C/Z Folder.

Clearing Jams at 2b in the C/Z Folder

To clear jams at 2b in the C/Z Folder:

- Open the front door of the C/Z Folder.

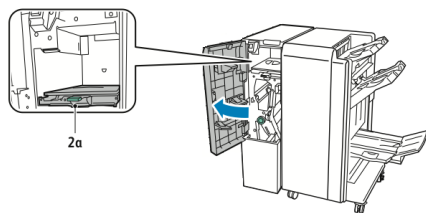

- Move green lever **2b** to the left.

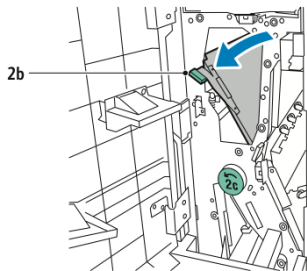

- Carefully remove the paper.

Note

If the paper is torn, remove all torn pieces from the folder.

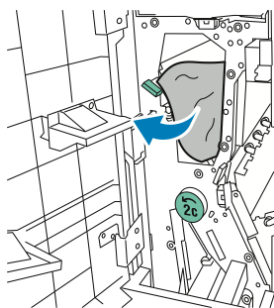

- Return lever **2b** to its original position.

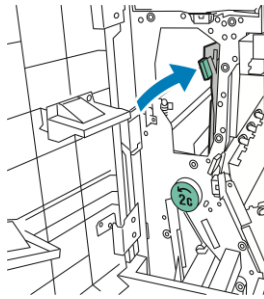

5. Close the front door of the C/Z Folder.

Clearing Jams at 2e in the C/Z Folder

To clear jams at 2e in the C/Z Folder:

1. To access lever **2e**, open the front door of the C/Z Folder and then open the Folder tray **2d**.

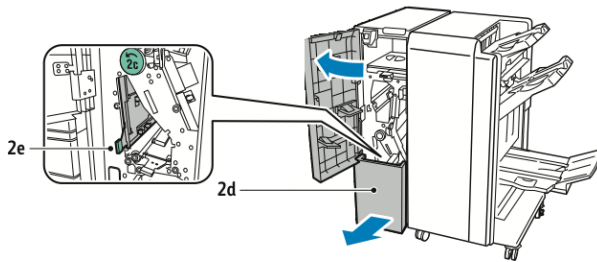

2. Move green lever **2e** to the right.

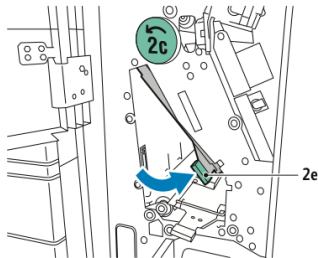

3. Carefully remove the paper.

Note

If the paper is torn, remove all torn pieces from the folder.

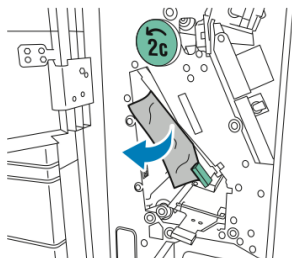

4. Return green lever **2e** to its original position.

Troubleshooting

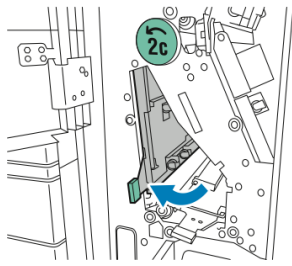

5. Close the Folder tray, and then close the front door of the C/Z Folder.

Clearing Jams at 2f in the C/Z Folder

To clear jams at 2f in the C/Z Folder:

1. To access lever 2f, open the front door of the C/Z Folder and then open the Folder tray 2d.

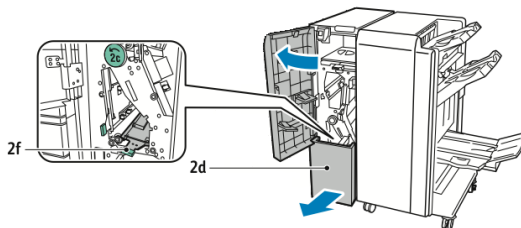

2. Move green lever 2f to the right.

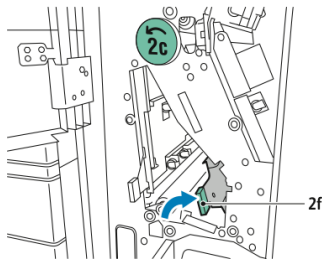

3. Carefully remove the paper.

Note

If the paper is torn, remove all torn pieces from the folder.



4. Return green lever 2f to its original position.

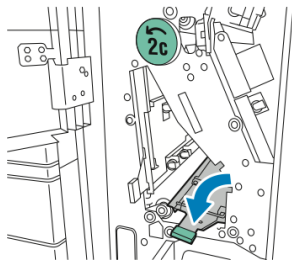

5. Close the folder tray, and then close the front door of the C/Z Folder.

Clearing Jams at 2g in the C/Z Folder

To clear jams at 2g in the C/Z Folder:

1. Open the front door of the C/Z Folder:

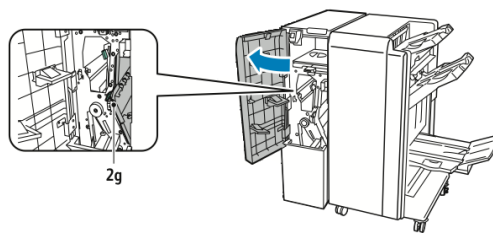

2. Move green lever **2g** to the right.

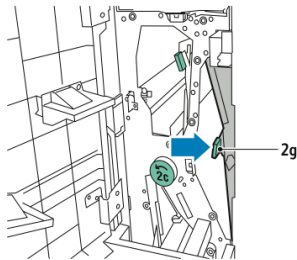

3. Carefully remove the paper.

Note

If the paper is torn, remove all torn pieces from the folder.

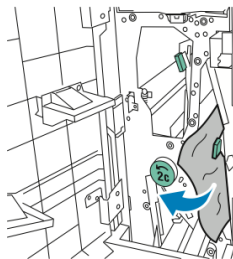

4. Return green lever **2g** to its original position.

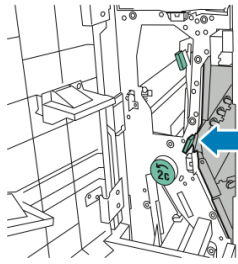

5. Close the front door of the C/Z Folder.

Minimizing Paper Jams

The printer is designed to function with minimal paper jams using Xerox supported paper. Other paper types can cause jams.

Adhere to the following:

- If supported paper is jamming frequently in one area, clean that area of the paper path.
- To avoid damage, always remove jammed paper carefully without tearing it. Try to remove the paper in the same direction in which it normally moves through the printer. Even a small piece of paper left in the printer can cause a jam.
- Do not reload paper that has jammed.

The following can cause paper jams:

- Selecting the incorrect paper type in the print driver.
- Using damaged paper.
- Using unsupported paper.
- Loading paper incorrectly.
- Overfilling the tray.
- Adjusting the paper guides improperly.

Most jams can be prevented by following a simple set of rules:

- Use only supported paper. For details, see the Recommended Media list at: www.xerox.com/printer-supplies/recommended-paper/enus.html.
- Follow proper paper handling and loading techniques.
- Always use clean, undamaged paper.

Print Quality Problems

 **Caution**

The Xerox Warranty, Service Agreement, or Total Satisfaction Guarantee does not cover damage caused by using unsupported paper or specialty media. The Total Satisfaction Guarantee is available in the United States and Canada. Coverage may vary outside these areas; please contact your local representative for details.

Note

To ensure print quality, toner/print cartridges for many models of equipment are designed to cease functioning at a predetermined point.

Note

Grayscale images printed with the composite black setting count as color pages, because color consumables are used. This is the default setting on most printers.

Copy and Scan Problems

When the copy or scan quality is poor, select the closest symptom from the following table to correct the problem.

If the copy quality does not improve after carrying out the appropriate action, contact Xerox Customer Support or your reseller.

Symptom	Solution
Lines or streaks only present in copies made from the document feeder.	There is debris on the document glass. When scanning, the paper from the document feeder passes over the debris creating lines or streaks. Clean all glass surfaces with a lint free cloth.
Spots present in copies taken from the document glass.	There is debris on the document glass. When scanning, the debris creates a spot on the image. Clean all glass surfaces with a lint free cloth.
The reverse side of the original is showing on the copy or scan.	Copy: Turn on Background Suppression Scan: Turn on Background Suppression
Image is too light or dark.	Copy: Use the Image Quality settings to lighten, darken or adjust contrast. Scan: Use the Advanced Settings tab to lighten, darken or adjust contrast.
Colors are off.	Copy: Use the Image Quality settings to adjust color balance. Scan: Confirm the correct Original Type is set.

Fax Problems

If a fax cannot be sent or received correctly, refer to the following table, then perform the indicated operation. If a fax still cannot be sent or received correctly, even after performing the described operations, contact your service representative.

Problems Sending Faxes

Symptom	Cause	Solution
The document is not scanned using the document feeder.	The document is too thick, too thin, or too small.	Use the document glass to send the fax.
The document is scanned at an angle.	The document feeder guides are not adjusted to the width of the document.	Adjust the document feeder guides to fit the width of the document.
The fax is received by the recipient is blurry.	The document is incorrectly positioned.	Position the document correctly.
	The document glass is dirty.	Clean the document glass.
	The text in the document is too faint.	Adjust the resolution. Adjust the contrast.
	There may be a problem with the telephone connection.	Check the telephone line, then send the fax again.
	There may be a problem with the caller's fax machine.	Make a copy to check that your printer is operating correctly, and then, if the copy was printed correctly, have the recipient check the condition of their fax machine.
The fax received by the recipient is blank.	The document was loaded incorrectly.	Document feeder: place the document to be faxed face up. Document glass: place the document to be faxed facedown.
Fax was not transmitted.	The fax number may be wrong.	Check the fax number.
	The telephone line may be incorrectly connected.	Check the telephone line connection. If it is disconnected, connect it.
	There may be a problem with the recipient's fax machine.	Contact the recipient.

Problems Receiving Faxes

Symptom	Cause	Solution
The received fax is blank.	There may be a problem with the telephone connection or with the caller's fax machine.	Check that the printer can make clean copies. If it can, have the caller send the fax again.
	The sender may have loaded the pages incorrectly.	Contact the sender.
The printer answers the call, but will not accept incoming data.	Not enough memory.	If the job contains several graphics, the printer might not have enough memory. The printer will not answer if memory is low. Delete stored documents and jobs and wait for the existing job to complete. This will increase available memory.
The received fax size is reduced.	The paper supply in the printer may not match the document size sent.	Confirm the original size of the documents. Documents might be reduced based on the available paper supply in the printer.
Faxes cannot be received automatically.	The printer is set to receive faxes manually.	Set the printer to automatic reception.
	The memory is full.	Load paper if it is empty, and then print the faxes stored in the memory.
	The telephone line is incorrectly connected.	Check the telephone line connection. If it is disconnected, connect it.
	There may be a problem with the sender's fax machine.	Make a copy to check that your printer is operating correctly. If the copy was printed correctly, have the recipient check the condition of their fax machine.

Getting Help

Control Panel Messages

Xerox provides several automatic diagnostic tools to help you produce and maintain print quality. The control panel provides you with information and troubleshooting help. When an error or warning condition occurs, the control panel touch screen displays a message informing you of the problem. In many cases, the touch screen also displays an animated graphic showing the location of the problem, such as the location of a paper jam.

Alerts

Alerts provide messages and instructions to help solve problems. Alerts can be viewed on:

- The **Status** page in the CentreWare Internet Services.
- All tabs in the printer driver Properties window. For detailed status information, click **More Status**.

Online Support Assistant

The Online Support Assistant is a knowledge base that provides instructions and troubleshooting help to solve your printer problems. You can find solutions for problems with print quality, copy quality, media jams, software installation, and more. To access the Online Support Assistant, go to www.xerox.com/support.

Web Resources

Xerox provides several websites that offer additional help.

Resource	Link
Technical support information for the printer includes online Technical Support, Recommended Media List, Online Support Assistant, driver downloads, documentation, and more.	To access the Online Support Assistant, go to www.support.xerox.com/support and enter Xerox Color C60/C70 in the <i>Search</i> or <i>Choose</i> field.
Supplies for the printer	http://www.xerox.com/printer-supplies/enus.html
A resource for tools and information, such as printing templates, helpful tips, and customized features to meet your individual needs.	www.xerox.com/office/businessresourcecenter
Local sales and support center	www.xerox.com/office/worldcontacts
Printer registration	www.xerox.com/office/register

Resource	Link
Material Safety Data Sheets identify materials, and provide information on safely handling and storing hazardous materials.	www.xerox.com/msds (U.S. and Canada) www.xerox.com/environment_europe (European Union)
Information about recycling supplies	www.xerox.com/gwa
Information about recycling the printer	www.xerox.com/gwa (U.S. and Canada) www.xerox.com/environment_europe (European Union)

Printer Specifications

This chapter contains the following sections:

- Physical Specifications
- Environmental Specifications
- Electrical Specifications
- Performance Specifications
- Controller Specifications

For media specifications and capacities, see Supported Media.

Physical Specifications

This section contains some sample specifications of representative printer/finisher input/output configurations available with this printer. It may not include your specific configuration.

Base Unit

Measurement/Description	Unit	Unit
Width, no trays installed	24.41 in	620 mm
Width, with Tray 5 and OCT	61.96 in	1573.8 mm
Depth	32 in	804 mm
Height to top of Document Feeder	45.43 in	1153.9 mm
Height to top of Control Panel	54.72	1390 mm
Weight	544 lb	247 kg

Base Unit, High Capacity Feeder, Interface Module, and Standard Finisher

Measurement/Description	Unit	Unit
Width	97.7 in	2481 mm
Depth	32 in	804 mm
Weight	969.3 lb	440.6 kg

2-Drawer Oversized High Capacity Feeder with Base Unit and Business Ready Finisher/Booklet Maker

Measurement/Description	Unit	Unit
Width of all components	105 in	2567 mm
Depth	32 in	804 mm
Weight	1133 lb	515.1 kg

Environmental Specifications

Temperature and Relative Humidity

- **Operating Temperature:** 10° to 28° C/50° to 83° F
- When the humidity is 85 %, temperature must be 28° C/83° F or below
- **Operating Relative Humidity:** 15 to 85 %
- When the temperature is 32°C /90° F, humidity must be 62.5 % or below

Electrical Specifications

For North America:

- 110 - 127 VAC +10/-6 %
- Power Consumption 1.936 kVA or less
- Frequency 50/60 (Hz) +/- 3 %
- Receptacle NEMA Number 5-20R
- Cycles 60 Hz

For Europe:

- 220-240 VAC +/- 10 %

- Power Consumption 2.2 KVA or less
- Frequency 50/60 (Hz) +/- 3 %
- Cycles 50 Hz

This is an ENERGY STAR qualified product.

Performance Specifications

Resolution

Maximum Resolution: 600x600 dpi

Print Speed

Maximum print speeds vary by printer model and whether you are printing color pages or black and white pages.

Xerox Color C60:

- Color: 60 ppm
- Black and White: 65 ppm

Xerox Color C70:

- Color: 70 ppm
- Black and White: 75 ppm

Printer Specifications

12

Business Ready Finisher and Booklet Maker

This section contains:

- Overview
- Identifying the components
- Maintenance
- Troubleshooting

Overview

The Business Ready finisher adds several professional-level finishing options to your printer while requiring minimal additional space to do so. The finisher is available with or without an optional booklet maker.



Business Ready Finisher



Business Ready Finisher with Booklet Maker

Identifying the Components

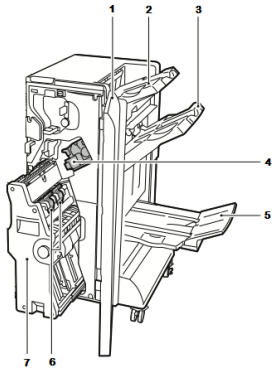

1. Finisher Front Cover

2. Right Top Tray

3. Right Middle Tray

4. Staple Cartridge

5. Booklet Maker Tray

6. Booklet Staple Unit

7. Booklet Maker Unit

Maintenance

This section contains:

- [Replacing Staples in the Main Stapler Unit](#)
- [Replacing Staples in the Booklet Maker Component](#)
- [Emptying the Hole Punch Waste Container](#)

Replacing Staples in the Main Stapler Unit

To replace staples in the main stapler unit:

1. Open the front door of the Business Ready finisher.
2. Hold the stapler assembly by the orange lever **R1** and push it to the right.

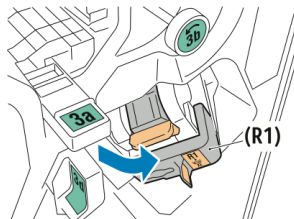

3. Grip the staple cartridge by the orange handle and pull it firmly toward you to remove it.

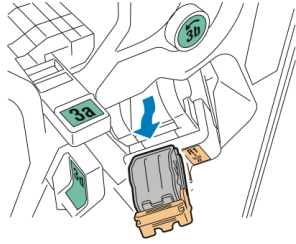

4. Pinch both sides of the staple refill (1) and remove it from the cartridge (2).

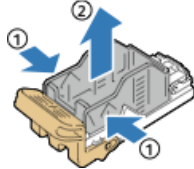

5. Insert the front side of the new staple refill into the staple cartridge (1), then push the rear side into the cartridge (2).

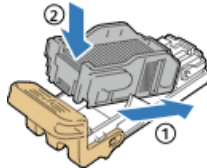

Replacing Staples in the Booklet Maker Component

To replace staples in the booklet maker component:

1. Open the front door of the Business Ready finisher.
2. Grasp the booklet maker handle and pull the unit toward you until the staple cartridges appear on the top edge of the device.

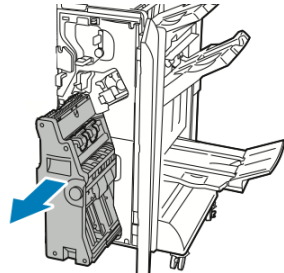

3. To remove the staple cartridge from the booklet maker, push down on the staple cartridge handle as shown, then pull the cartridge out and up.

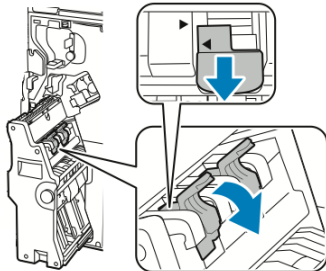

4. Turn the staple cartridge over.
5. To permit the staple cartridge handle to open out and away from the staple refill, press in the green tabs, then pull back the handle.

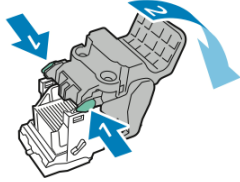

6. To remove the staple refill, press the rear of the refill container as shown.

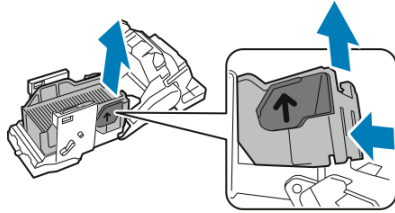

7. Replace the staple refill, then return the staple cartridge to the booklet maker.

Emptying the Hole Punch Waste Container

A message appears on the Control Panel when the hole punch waste container is full.

Warning

Do not perform this procedure while the printer is copying or printing.

To empty the hole punch waste container:

1. Open the front door of the Business Ready finisher.
2. Remove the hole punch waste container from its slot near the top left of the finisher.
 - Wait 10 seconds before reinserting the container into the printer. The hole punch counter resets after 10 seconds.
 - If you remove the hole punch waste container before the device instructs you to, empty the container before you reinsert it into the finisher.

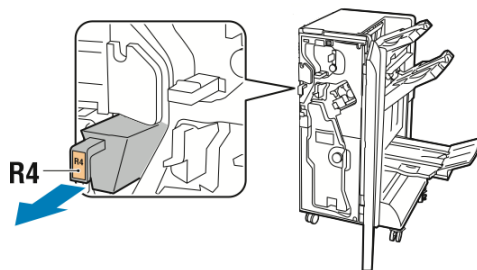

3. Empty the container.

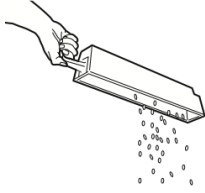

4. Insert the container all the way into the finisher.

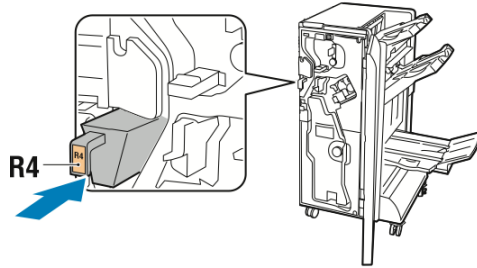

5. Close the front door of the Business Ready finisher.

Troubleshooting

This section includes:

- [Clearing Jams in the Finisher at Position 3a](#)
- [Clearing Jams in the Finisher at Position 3c](#)
- [Clearing Jams in the Finisher at Position 3d](#)
- [Clearing Jams in the Finisher at Position 4](#)
- [Clearing Jams in the Booklet Tray](#)

Clearing Jams in the Finisher at Position 3a

To clear jams at position 3a:

1. If the paper is visible at the output tray exit, remove the paper by pulling it gently in the direction shown.

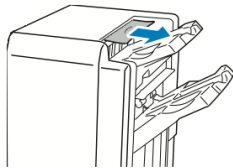

2. Open the front door of the Business Ready finisher.

3. Lift green handle **3a**.

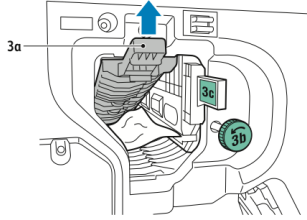

4. Carefully remove the paper.

- If the paper is torn, remove all torn pieces from the finisher.
- If the paper is inaccessible, or if the Control Panel prompts you to release the paper, turn green handle knob **3b** in the direction shown.

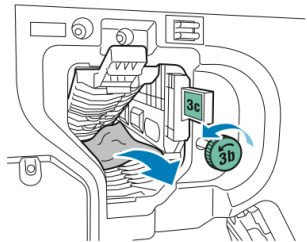

5. Return green handle **3a** to its original position.

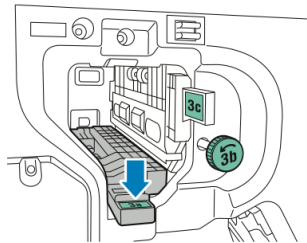

6. Close the front door of the Business Ready finisher.

Clearing Jams in the Finisher at Position 3c

To clear jams at position 3c:

1. Open the front door of the Business Ready finisher.
2. Move green lever **3c** to the left.

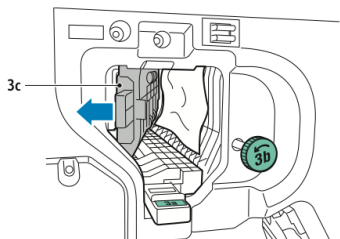

3. Carefully remove the paper.

- If the paper is torn, remove all torn pieces from the finisher.

- If the paper is inaccessible, or if the Control Panel prompts you to release the paper, turn green handle knob **3b** in the direction shown.

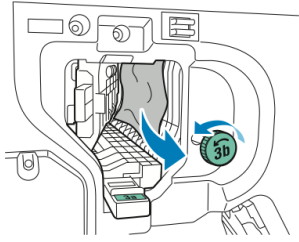

4. Return green lever **3c** to its original position.

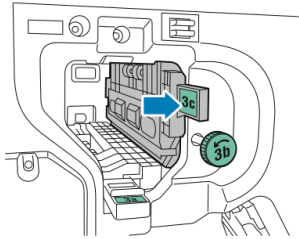

5. Close the front door of the Business Ready finisher.

Clearing Jams in the Finisher at Position 3d

To clear jams at position 3d:

1. Open the front door of the finisher, and locate green lever **3d**.

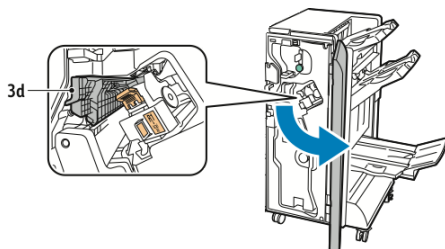

2. Move green lever **3d** to the right.

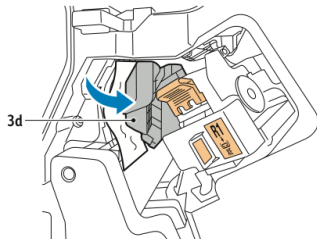

3. Carefully remove the paper.

Note

If the paper is torn, remove all pieces from the finisher.

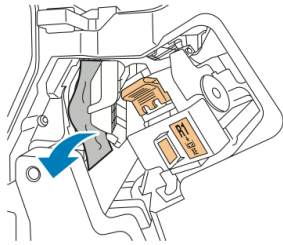

4. Return green lever **3d** to its original position.

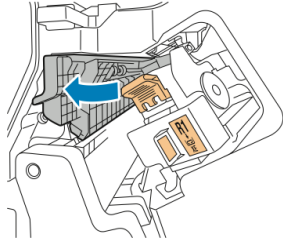

5. Close the front door of the Business Ready finisher.

Clearing Jams in the Finisher at Position 4

To clear jams at position 4:

1. Open the front door of the Business Ready finisher.
2. Using the green handle, pull out unit **4** until it stops.

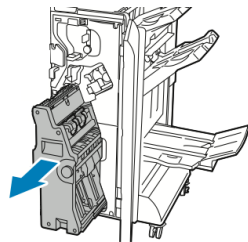

3. To remove the jammed paper, turn green knob **4** in either direction as shown.

Note

If the paper is torn, remove all torn pieces from the finisher.

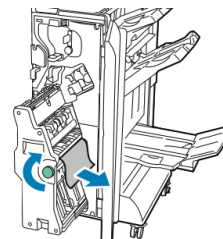
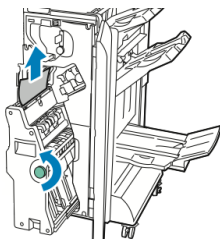

4. Return unit 4 to its original position.

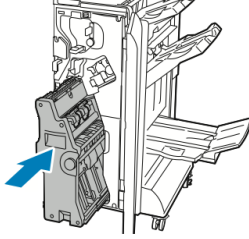

5. Close the front door of the Business Ready finisher.

Clearing Jams in the Booklet Tray

To clear jams in the booklet tray:

1. Open the front door of the Business Ready finisher.
2. To release the jammed paper, turn green knob 4 in the direction shown.

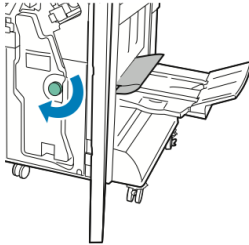

3. To remove the paper, pull it in the direction shown.

Note

If the paper is torn, remove all torn pieces from the finisher.

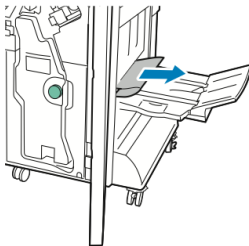

4. Close the front door of the Business Ready finisher.

13

Standard/Booklet Maker Finisher

This chapter includes:

- Standard/Booklet Maker Finisher Components
- Loading Paper/Tabs in Tray T1 (Post-Process Inserter)
- Maintenance
- Finisher Problem Solving
- Specifications

Standard/Booklet Maker Finisher Components

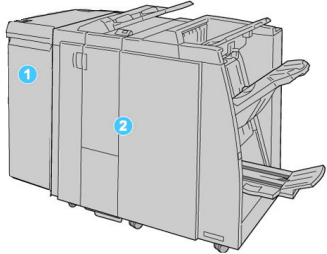

1. The required Interface Module (IM) which acts as a communication device and paper path between the machine and the Standard/Booklet Maker Finisher
2. The Standard or Booklet Maker Finisher (above illustration shows the Booklet Maker Finisher)

Note

The Standard Finisher or Booklet Maker Finisher may be referred to simply as the Finisher.

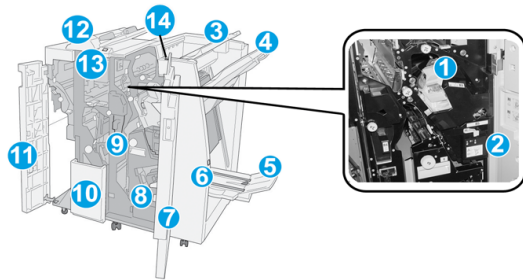

The Standard/Booklet Maker finisher is comprised of the following components:

No.	Component	Function
1	Staple cartridge	Contains staples; remove this cartridge to replace staples and clear staple jams.
2	Staple waste container	Container for staple waste; remove this container when full.
3	Top tray	The Top Tray is used for stacked output, and can receive up to 500 sheets of 20 lb./80 gsm paper. Copies are delivered here when specific output features are selected, such as Automatic sorting, Collated, Uncollated, or Normal.

No.	Component	Function
4	Stacker (middle) tray	<p>The Stacker Tray is used for offset and/or stapled output, and can hold up to 2000 sheets of 20 lb./80 gsm paper. This tray also receives copies when you punched and Z-folded copies.</p> <p>Note</p> <p>Both the Top and Stacker Trays can be used for hole punched output (optional)</p>
5	Booklet output tray	This is available only with the Booklet Maker Finisher. The Booklet tray receives saddle-stitched booklets when you select C-Fold or C-Fold + Stapling.
6	Booklet output tray button	This is available only with the Booklet Maker Finisher. When you press this button, the booklet output tray is raised so you can retrieve booklets from the output area.
7	Right cover	Open to clear paper jams, replace staples, clear jammed staples, or remove the scraps from the puncher.
8	Staple cartridges for booklet	This is available only with the Booklet Maker Finisher. There are two staple cartridge for booklet. Remove this cartridge to replace staples and clear staple jams.
9	Punch scrap container	Collects the scraps from the puncher. Open to remove the scraps.
10	C/Z-Fold output tray (optional)	The optional Folder tray receives copies when you select C-folding or Z-folding of 8.5 x 11 in./A4 output and 11 x 17 in./A3 media.
11	Left cover.	Open this cover to access the machine and to clear paper jams.
12	Post-process inserter/Tray T1	<ul style="list-style-type: none"> • Tray T1 (Post-Process Inserter) is standard on this finisher and is used to load paper that will be used as separators and covers. • Paper loaded here is not printed on; use this tray for pre-printed stock and for insertion into the printed output. (This tray is also known as the Interposer). • Tray T1 holds a maximum of 200 sheets when using 20 lb./75 gsm paper. • Paper can be loaded in the LEF or SEF direction.
13	C/Z-Fold output tray button	Press this button to open C/Z-Fold output tray.

No.	Component	Function
14	Manual decurl button	When you press this button, it activates a decurling feature for the output material. This applies especially to lighter weight paper.

Manual Decurling Feature on the Finisher

The finisher provides a manual decurling feature which allows you to adjust the curl of the print output at point of need.

Pressing the Decurler button on the finisher switches the decurl feature between the Auto, On, and Off modes.

Note

Before the paper reaches the decurling unit on the finisher, it passes through a more robust decurling unit on the Interface Module.

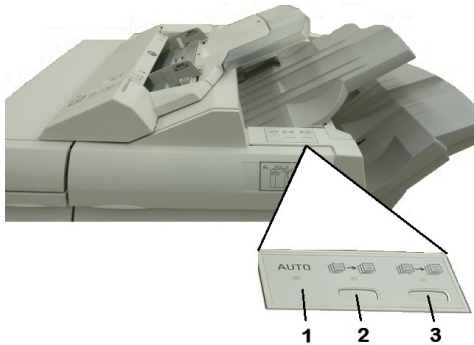

1. Auto button

When this indicator is lit, the appropriate curl correction is automatically performed depending on the paper type, size, and orientation of the printed output. The button should be set to Auto for most situations. The button automatically switches to the Auto mode when:

- The machine is switched on

- The machine exits the Energy Saver mode

2. Prevent Upward Curl button

When this button is pressed and the upward curl indicator is lit, upward curl correction is performed on all printed output. If your output is curled upward, press this button to prevent upward curls.

3. Prevent Downward Curl button

When this button is pressed and the downward curl indicator is lit, downward curl correction is performed on all printed output. If your output is curled downward, press this button to prevent downward curls.

Note

When no indicator is lit, the machine does not perform any curl correction to the printed output.

Folding Feature

If your machine is equipped with the Booklet Maker Finisher and/or the optional C/Z Folder, you can make prints using the folding option. The option folds your prints in half (single or bifolding) or in thirds (C-fold or Z-fold types). The folding option is selected from the print driver.

Note

In order to use the folding option, the orientation of documents must be short-edge feed (SEF). You must select a paper tray that contains SEF stock.

Fold Types

Note

The Single Fold (Bi-Fold) option is available only with a Booklet Maker Finisher. The C-Fold and Z-Fold options are available only with the C/Z Folder.

These fold types are available:

- Single Fold (Bi-Fold)
- C-Fold
- Z-Fold
- Z-Fold Half Sheet

Loading Paper/Tabs in Tray T1 (Post-Process Inserter)

1. If necessary, remove any remaining media that is currently loaded in Tray T1.
2. Hold the center of the paper guides and slide them to their desired paper size.



3. Load the paper/tabs, aligning it to the front side of the tray.



- a. If the paper is preprinted, load the paper with the printed side facing up.
 - b. If the media is tab stock, load the tab side to be fed first (in the direction of the arrow as shown in the above illustration).
4. If enabled by your System Administrator, the Paper Tray Properties may display on the Control Panel touch screen. Select an option:
 - To choose paper size, type, or color, touch **Paper Supply** and enter the correct paper information, including size, type, weight, and if necessary, decurler and/or alignment option.
 - To choose a specific paper stock, touch **Paper Catalog** and select a stock from the list.
 5. Touch **Save** and **Confirm**.

Maintenance

Standard/Booklet Maker Consumable Supplies

Xerox supplies, including staples, staple cartridges, and staple waste containers can be ordered from Xerox by going to www.xerox.com and clicking on either the Contact Us link for specific contact information/telephone numbers in your area or by clicking on the Supplies and entering/selecting your specific machine information (product family and model type).

Note

Always refer to www.xerox.com for the latest Consumable Replaceable Units (CRUs) part numbers.

Store supply items and Xerox parts in their original packages in a convenient location.

Supply Item	Supply Unit Shipped with finisher/reorder quantity
Staple cartridge / staple waste container	4 staple cartridges (5000 staples per cartridge) and 1 staple waste container per carton
Booklet Maker Finisher staple cartridge	4 pack: 5000 staple refills each

Replace the Standard Staple Cartridge

A message displays on the UI when it is time to replace a staple cartridge.

1. Make sure that the machine has stopped printing.
2. Open the Right Cover on the finisher.

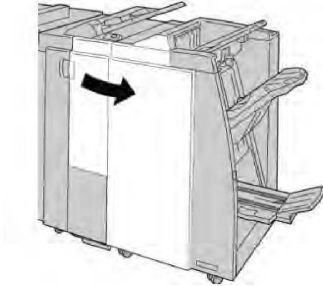

3. Grasp the Staple Cartridge handle located at **R1**, and pull out the staple cartridge from the finisher.



4. Hold the positions as indicated by the arrow and remove the staple cartridge from the unit.

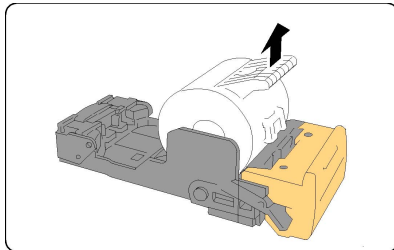

5. Push a new staple cartridge into the unit.

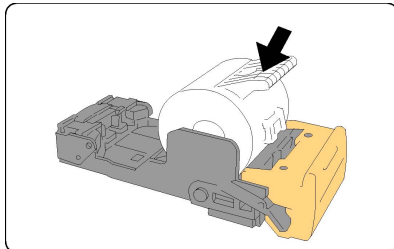

6. Reinstall the cartridge unit to its original position in the finisher.

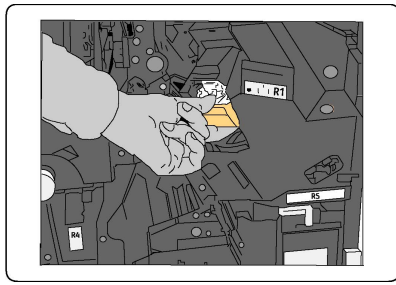

7. Close the Right Cover on the finisher.

Note

A message will display and the machine will not operate if the right cover is open even slightly.

Replace the Booklet Staple Cartridge

In addition to the standard stapler, the Booklet Maker Finisher is equipped with a booklet stapler. When this booklet stapler needs to be replaced, a message appears on the UI.

1. Make sure that the machine has stopped printing.
2. Open the Right Cover on the finisher.

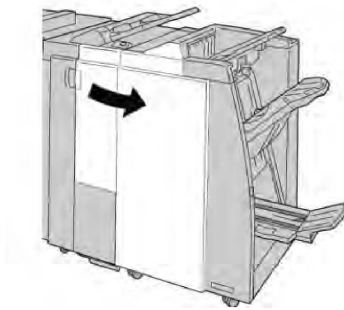

3. While pressing the lever to the right, pull out the booklet staple cartridge unit.

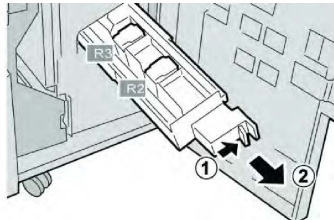

4. Hold the tabs of the staple cartridge unit and lift to remove it.

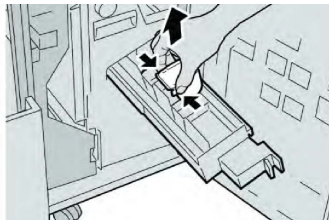

5. While holding the tabs of a new staple cartridge, push it into the unit.

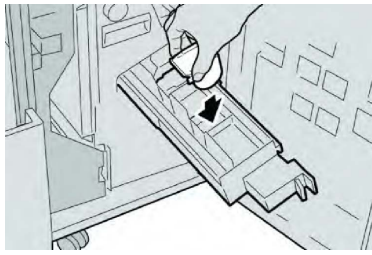

6. Push the staple cartridge unit to its original position in the machine.

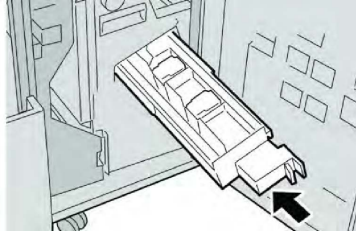

7. Close the Right Cover on the finisher.

Note

A message will display and the machine will not operate if the right cover is open even slightly.

Replacing the Staple Waste Container on the Finisher

The machine displays a message indicating that the Staple Waste Container is full. To replace the container:

1. Make sure that the machine has stopped printing.
2. Open the Right Cover on the finisher.

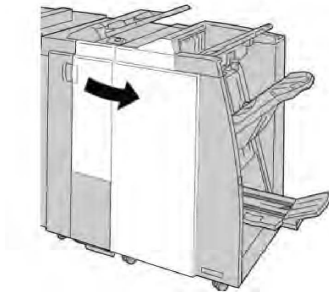

3. Locate the Staple Waste Container (**R5**) in the finisher, and move the lock lever to the unlock position.

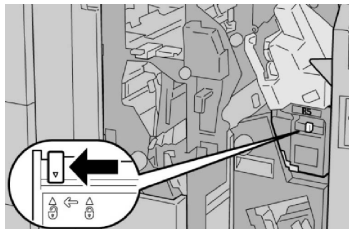

4. Hold **R5** as shown in the figure and remove the staple waste container from the machine.

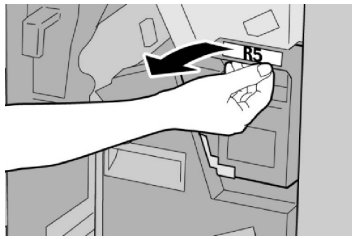

5. Place the used staple waste container into a supplied plastic bag.



Note

Do not return a disassembled (used) container to the Customer Support Center.

6. Hold the new staple waste container by the **R5** handle area and push it into the machine.

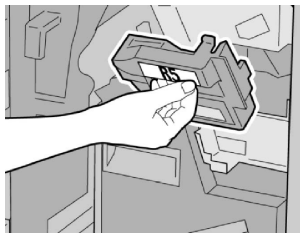

Note

To prevent injury, do not put your fingers on top of the container.

7. Push **R5** until the lock lever moves to the locked position.

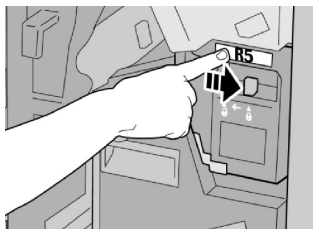

8. Close the Right Cover on the finisher.

Note

A message will display and the machine will not operate if the right cover is open even slightly.

Empty the Punch Waste Container

The UI displays a message indicating when it is time to empty the Punch Waste Container.

! **Caution**

Only remove the Punch Waste Container while the system is powered ON. If you switch off the power when emptying the container, the machine cannot detect that the container was emptied.

1. Make sure that the machine has stopped printing.
2. Open the Right Cover on the finisher.

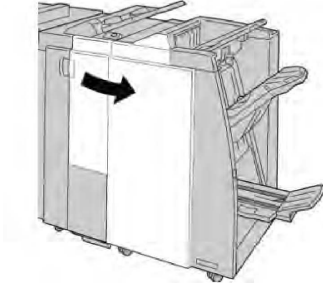

3. Pull the container out of the finisher (R4).

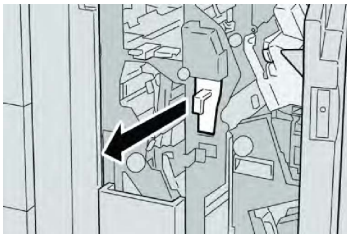

4. Discard all the punch scraps in an appropriate container.

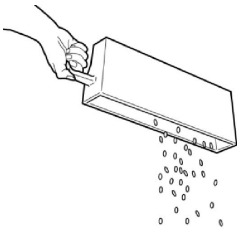

5. Reinsert the empty container into the machine.

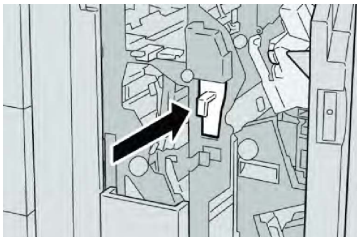

6. Close the Right Cover on the finisher.

Note

A message will display and the machine will not operate if the right cover is open even slightly.

Finisher Problem Solving

Tip

Always ensure that all paper jams, including any small ripped pieces of paper, are cleared before proceeding with your print jobs.

Note

Remedies differ according to the paper jam location. Follow the instructions displayed to remove the jammed paper.

Paper jams in Tray T1 (Post Process Inserter)

1. Press the **Cover** button.

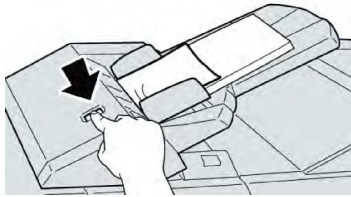

2. Open cover **1e** and then remove the jammed paper and all paper loaded in the tray.

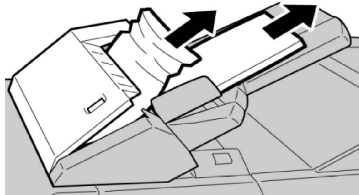

Note

If paper is torn, check inside the machine and remove it.

3. Fan the paper you removed, making sure that all four corners are neatly aligned, and then load them again.
4. Push cover **1e** until you hear it click into place.

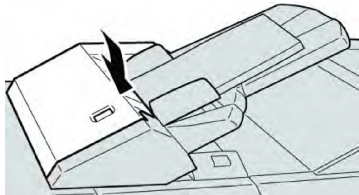

Note

A message will be displayed and the machine will not operate if the cover is open even slightly.

Paper Jams at Lever 1a and Knob 1c

1. Make sure that the machine has stopped printing.
2. Open the finisher left cover.

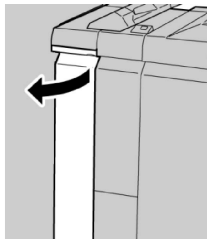

3. Move lever **1a** downwards and turn knob **1c** left. Remove the jammed paper.

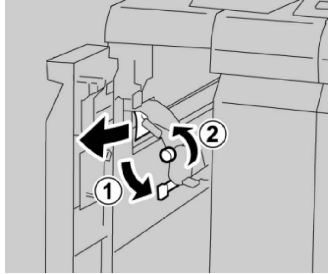

Note

If paper is torn, check inside the machine and remove it.

4. Return lever **1a** to the original position.

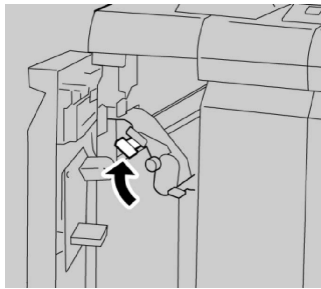

5. Close the finisher left cover completely.

Note

The machine will not operate if the cover is open even slightly.

Paper Jams at Lever 1d

1. Make sure that the machine has stopped printing.
2. Open the finisher left cover.

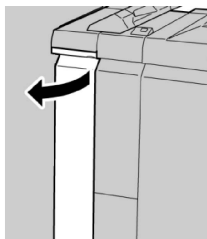

3. Move lever **1d** upwards and remove the jammed paper.

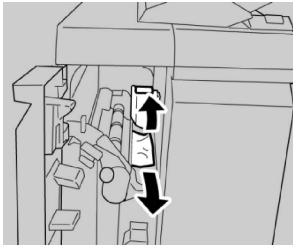

Note

If paper is torn, check inside the machine and remove it.

4. Move the lever **1d** to the original position.

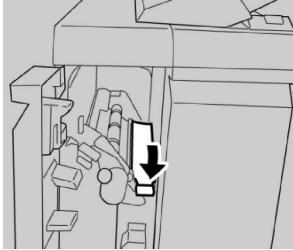

5. Close the finisher left cover completely.

Note

The machine will not operate if the cover is open even slightly.

Paper Jams at Lever 1b

1. Make sure that the machine has stopped printing.
2. Open the finisher left cover.

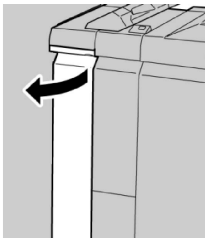

3. Move the lever **1b** to the right and remove the jammed paper.

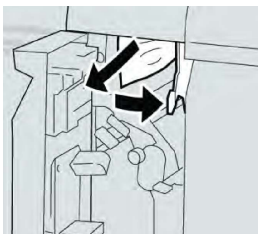

Note

If paper is torn, check inside the machine and remove it.

4. Move the lever **1b** to the original position.

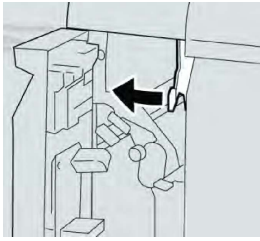

5. Close the finisher left cover completely.

Note

The machine will not operate if the cover is open even slightly.

Paper Jams at Lever 3b and 3d

1. Make sure that the machine has stopped printing.
2. Open the Right Cover on the finisher.

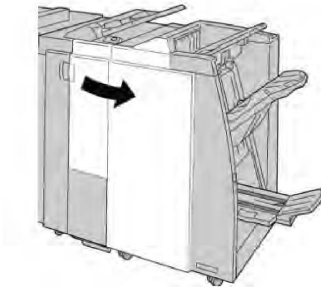

3. Move the levers **3b** and **3d**; remove the jammed paper.

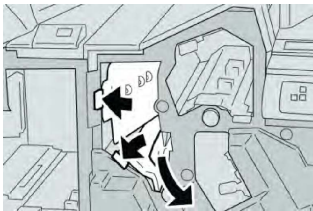

Note

If paper is torn, check inside the machine and remove it.

4. Return the levers **3b** and **3d** to their original positions.

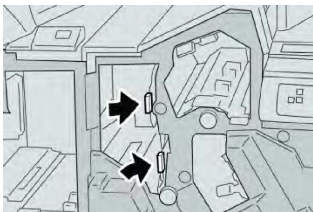

5. Close the Right Cover on the finisher.

Note

A message will display and the machine will not operate if the right cover is open even slightly.

Paper Jams at Lever 3e and Knob 3c

1. Make sure that the machine has stopped printing.
2. Open the Right Cover on the finisher.

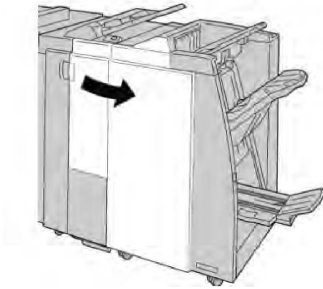

3. Move the lever 3e and turn the knob 3c; remove the jammed paper.



Note

If paper is torn, check inside the machine and remove it.

4. Return the lever 3e to its original position.

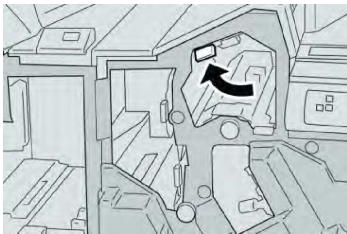

5. Close the Right Cover on the finisher.

Note

A message will display and the machine will not operate if the right cover is open even slightly.

Paper Jams at Lever 3g and Knob 3f

1. Make sure that the machine has stopped printing.
2. Open the Right Cover on the finisher.

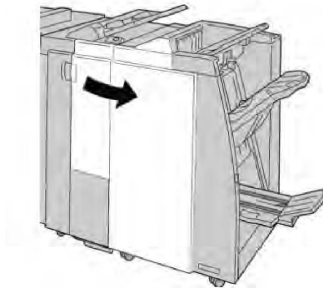

3. Move the lever **3g** and turn the knob **3f** and remove the jammed paper.

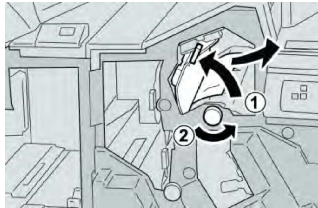

Note

If paper is torn, check inside the machine and remove it.

4. Return the lever **3g** to its original position.

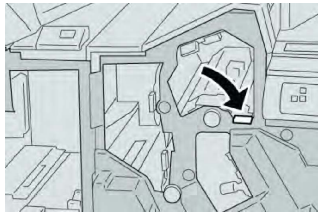

5. Close the Right Cover on the finisher.

Note

A message will display and the machine will not operate if the right cover is open even slightly.

Paper Jams at Lever 4b and Knob 3a

1. Make sure that the machine has stopped printing.
2. Open the Right Cover on the finisher.

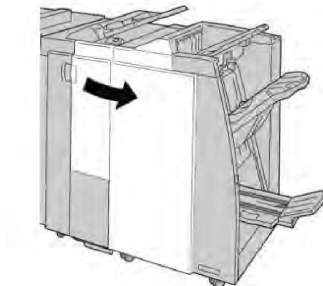

3. Move the lever **4b** and turn the knob **3a**; remove the jammed paper.

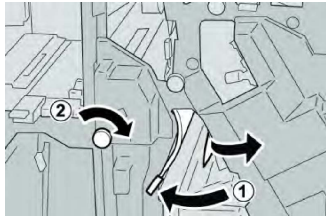

Note

If paper is torn, check inside the machine and remove it.

4. Return the lever **4b** to its original position.

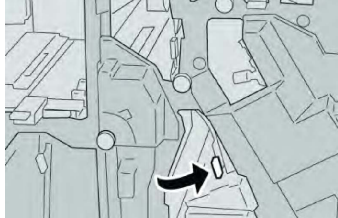

5. Close the Right Cover on the finisher.

Note

A message will display and the machine will not operate if the right cover is open even slightly.

Paper Jams at Lever 2a and Knob 3a

1. Make sure that the machine has stopped printing.
2. Open the Right Cover on the finisher.

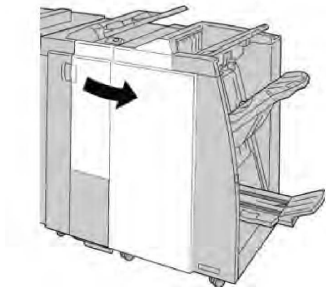

3. Move the lever **2a** and turn the knob **3a**; remove the jammed paper.

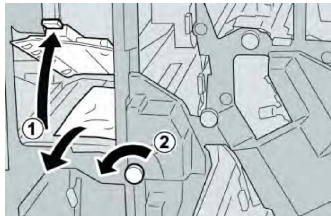

Note

If paper is torn, check inside the machine and remove it.

4. Return the lever **2a** to its original position.

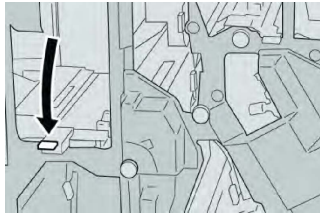

5. Close the Right Cover on the finisher.

Note

A message will display and the machine will not operate if the right cover is open even slightly.

Paper Jams at Lever 2b and Knob 2c

1. Make sure that the machine has stopped printing.
2. Open the Right Cover on the finisher.

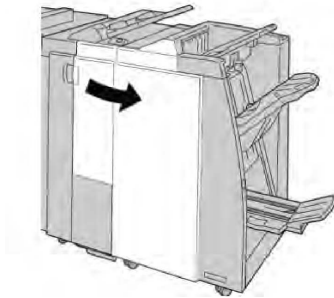

3. Move the lever **2b** to the left and turn the knob **2c** to the right; remove the jammed paper.

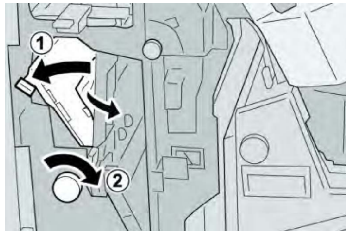

Note

If paper is torn, check inside the machine and remove it.

4. Return the lever **2b** to its original position.

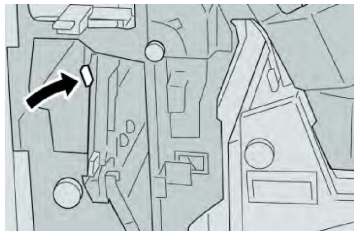

5. Close the Right Cover on the finisher.

Note

A message will display and the machine will not operate if the right cover is open even slightly.

Paper Jams at 2c, 2e, 2f, and 2d

1. Make sure that the machine has stopped printing.
2. Open the Right Cover on the finisher.

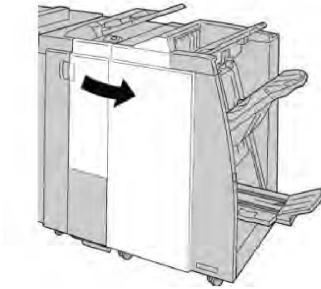

3. Pull out the folder output tray (2d), swing lever 2e/2f to the right, and remove the jammed paper.

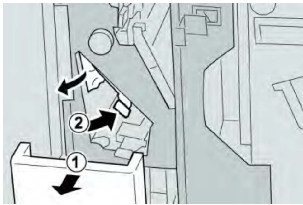

Note

If paper is torn, check inside the machine and remove it.

4. If you cannot remove the paper, return the lever 2e/2f to its original position. Swing the lever 2e/2f, turn the knob 2c to the right, and remove the jammed paper.

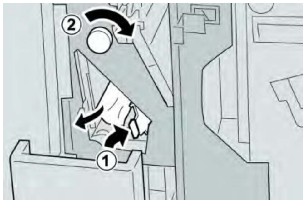

5. Return the opened lever (2f) or (2e) to its original position, and close the output tray (2d).

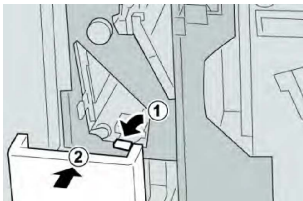

6. Close the Right Cover on the finisher.

Note

A message will display and the machine will not operate if the right cover is open even slightly.

Paper Jams at 2d and Lever 2g

1. Make sure that the machine has stopped printing.

2. Open the Right Cover on the finisher.

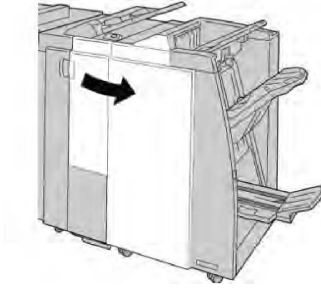

3. Pull out the folder output tray (2d), swing lever 2g out, and remove the jammed paper.

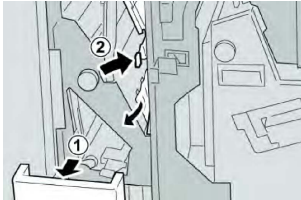

Note

If paper is torn, check inside the machine and remove it.

4. Return the opened lever (2g) to its original position, and close the output tray (2d).

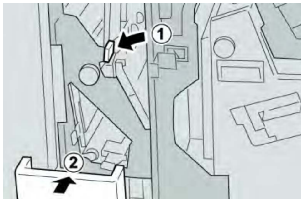

5. Close the Right Cover on the finisher.

Note

A message will display and the machine will not operate if the right cover is open even slightly.

Paper Jams at Unit 4 and Knob 4a

1. Make sure that the machine has stopped printing.
2. Open the Right Cover on the finisher.

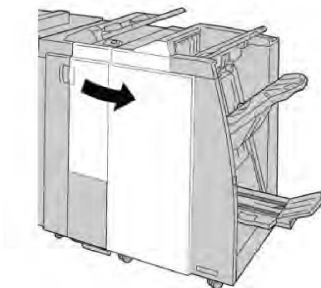

3. Pull out unit 4.

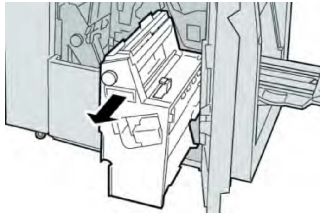

4. Turn the knob **4a** to remove the jammed paper from the left side of unit **4**.



Note

If paper is torn, check inside the machine and remove it.

5. Return unit **4** to its original position.

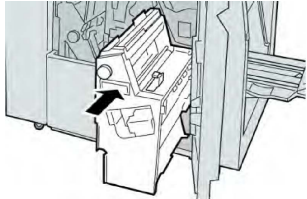

6. Close the Right Cover on the finisher.

Note

A message will display and the machine will not operate if the right cover is open even slightly.

Paper Jams at Finisher Top Tray

1. Make sure that the machine has stopped printing.
2. Remove jammed paper from the finisher top tray.



Note

If paper is torn, check inside the machine and remove it.

3. Open and close the finisher right cover.

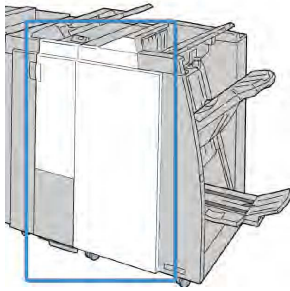

Note

The machine will not operate if the cover is open even slightly.

Paper Jams at Finisher Stacker Tray

1. Make sure that the machine has stopped printing.
2. Remove jammed paper from the finisher stacker tray.



Note

If paper is torn, check inside the machine and remove it.

3. Open and close the finisher right cover.

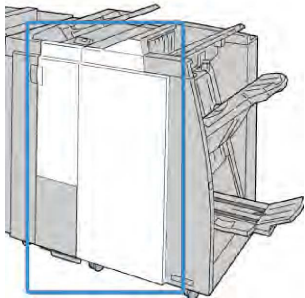

Note

The machine will not operate if the cover is open even slightly.

Paper Jams at the Optional Booklet Maker Tray

1. Make sure that the machine has stopped printing.
2. Open the Right Cover on the finisher.

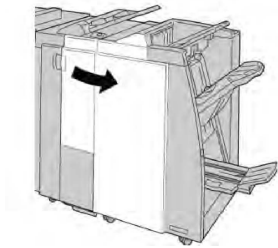

3. Turn knob **4a** and remove any jammed paper from the optional booklet maker tray.

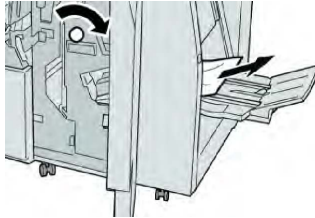

Note

If paper is torn, check inside the machine and remove it.

4. Close the Right Cover on the finisher.

Note

A message will display and the machine will not operate if the right cover is open even slightly.

Stapler Faults

Follow the procedures provided when the output is not stapled or the staples are bent. Contact our Customer Support Center if the problem persists after you have tried the following solutions. Stapler faults on output may look similar to the ones shown in the following illustration.

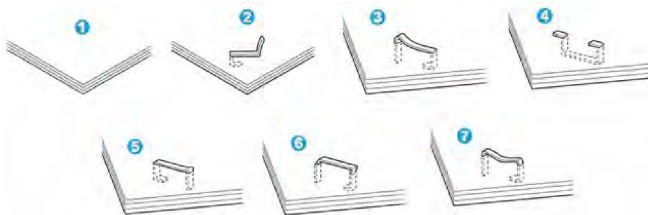

1. No staple
2. Bent staple
3. One side of staple rising up
4. Staple bent in reverse direction
5. Flattened staple
6. Entire staple rising up
7. Staple rising up with center pressed in

If the output is stapled as shown in the figure above, contact our Customer Support Center.

Note

Depending on the type of paper that is being stapled, the stapled nails may be bent. If the bent nails are stuck inside the machine, they may eventually cause paper jams. Remove the bent staple when opening the staple cartridge cover. If you do not remove the bent staple, a staple jam may occur as a result. Use the staple cartridge cover only when removing the bent staple.

Staple Jams in the Standard Staple Cartridge**Note**

Always check inside the finisher for any individual staples or staple remnants.

1. Make sure that the machine has stopped printing.
2. Open the Right Cover on the finisher.

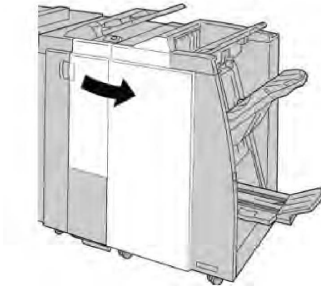

3. Grasp the Staple Cartridge handle located at **R1**, and pull out the staple cartridge from the finisher.



4. Check the inside of the finisher for any remaining staples, and if necessary, remove them.
5. Open the staple cartridge unit as shown and remove the jammed staple.

⚠ Warning

To avoid injury to your fingers, carefully remove the jammed staples from the cartridge.

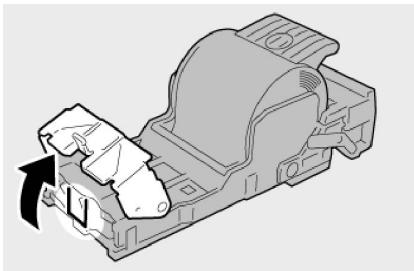

6. Reinstall the cartridge unit to its original position in the finisher.

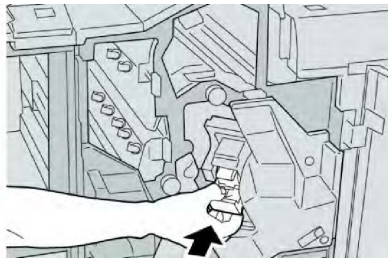

7. Close the Right Cover on the finisher.

Note

A message will display and the machine will not operate if the right cover is open even slightly.

Staple Jams in the Booklet Maker Cartridge

Note

Always check inside the finisher for any individual staples or staple remnants.

1. Make sure that the machine has stopped printing.
2. Open the Right Cover on the finisher.

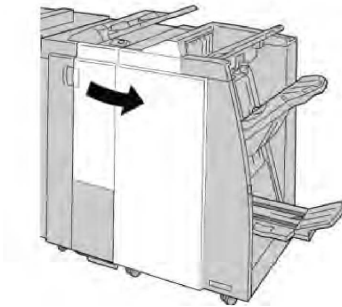

3. While pressing the lever to the right, pull out the booklet staple cartridge unit.

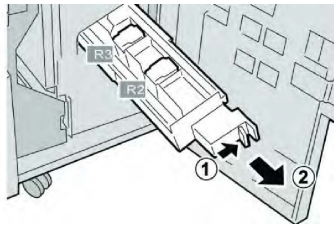

4. Hold the tabs of the staple cartridge unit and lift to remove it.

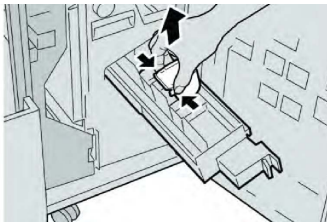

5. Remove the jammed staples from the cartridge.

! Warning

To avoid injury to your fingers, carefully remove the jammed staples from the cartridge.

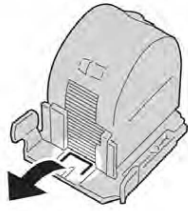

6. While holding the tabs of a new staple cartridge, push it into the unit.

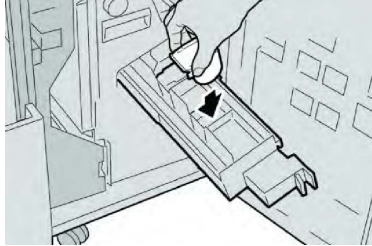

7. Push the staple cartridge unit to its original position in the machine.

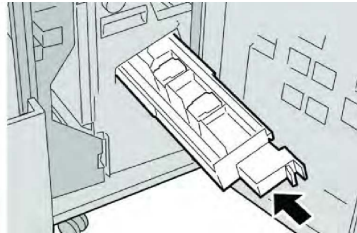

8. Close the Right Cover on the finisher.

Note

A message will display and the machine will not operate if the right cover is open even slightly.

Reinserting a Misaligned Standard Staple Cartridge

Use this procedure if the standard staple cartridge is inserted incorrectly into the machine.

Note

Always check inside the finisher for any individual staples or staple remnants.

1. Make sure that the machine has stopped printing.
2. Open the Right Cover on the finisher.

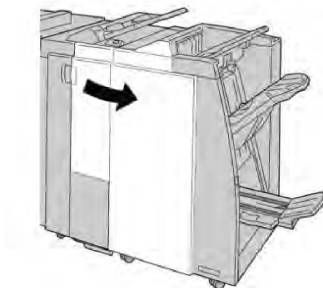

3. Grasp the Staple Cartridge handle located at (R1), and pull out the staple cartridge from the finisher.



4. If necessary, raise the staple cartridge unit as shown and remove the jammed staple.

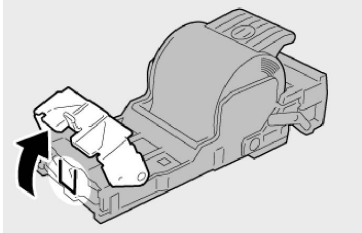

5. Move the lever on the rear of the staple cartridge unit in the downward direction.

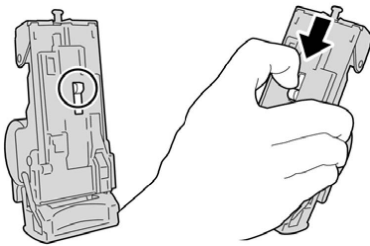

6. While holding the lever down, turn over the unit and remove the staple cartridge from the unit.

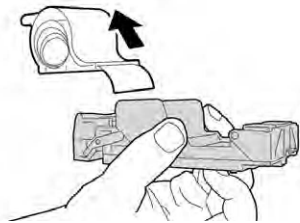

7. Detach the outside staples along the line.

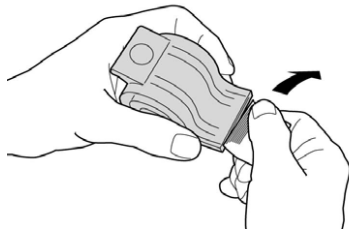

8. Push a new staple cartridge into the unit.

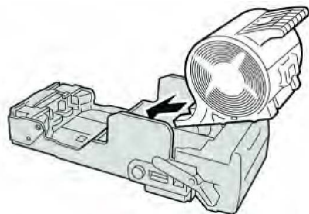

9. Reinstall the cartridge unit to its original position in the finisher.

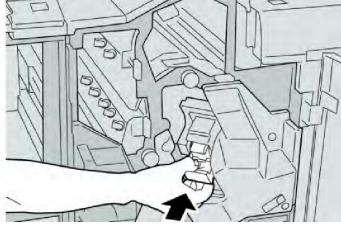

10. Close the Right Cover on the finisher.

Note

A message will display and the machine will not operate if the right cover is open even slightly.

Fault Codes

If an error caused the printing to end abnormally, or a malfunction occurred in the Booklet Maker Finisher, then an error code is displayed.

If an error code appears that is not listed in the table below, or if an error persists after following the listed solution, then contact your Xerox Customer Support Center.

If an error code is displayed, all print data of the machine as well as print data stored in the machine's built-in memory is discarded.

Fault Code	Possible Cause	Recommended Solution
012-125, 012-132, 012-211, 012-212, 012-213, 012-214, 012-215, 012-216, 012-217, 012-218, 012-219, 012-221, 012-223, 012-225, 012-226, 012-227, 012-228, 012-229, 012-230, 012-235, 012-236, 012-237, 012-238, 012-239, 012-240, 012-241, 012-243, 012-246, 012-247, 012-248, 012-250, 012-251, 012-252, 012-253, 012-254, 012-255, 012-260, 012-263, 012-264, 012-265, 012-282, 012-283, 012-291, 012-296	The Finisher malfunctioned	<ul style="list-style-type: none"> Check for any obstructions in the paper path and clear them. Power Off/On the machine, and if necessary, resend/restart your print job. If the error persists, contact the Customer Support Center.
012-400	Staple Waste Container near full	Follow the procedures to remove and replace the staple waste container in the finisher.
012-949	Finisher Puncher Waste Container is not attached	Check that the punch waste container is installed in the finisher and inserted correctly.

Fault Code	Possible Cause	Recommended Solution
024-931	The Staple Waste Container is full or near full	Remove the Staple Waste Container and reinstall a new one.
024-932	The Staple Waste Container is not attached	Check that the Staple Waste Container is installed in the finisher and inserted correctly.
024-943	The booklet staple cartridge is empty or stapling error occurred.	Check the staple cartridge and reset correctly. If necessary, replace with a new cartridge. Resume job.
024-957	Insertor trays are empty / out of paper	Add paper to the paper trays of the Insertor.
024-974	Designated paper size and the size of paper in the tray differs when feeding paper	Reset the paper or cancel the job.
024-976	Finisher staple fault	Check staples and reset correctly.
024-977	Finisher staple feeding is not ready	Check staples and reset correctly.
024-978	Booklet Finisher staple operation is not ready	Check staples and reset correctly.
024-979	The staple cartridge is empty	Check staples. Follow procedures to remove and replace staple cartridge.
024-980	The finisher stacker tray is full	Remove all paper from the stacker tray.
024-981	The finisher top tray is full	Remove all paper from the finisher top tray.
024-982	The finisher stacker tray lower safety warning is on	Remove all paper from the stacker tray and remove any other obstructions.
024-983	The finisher booklet tray is full	Remove all paper from the booklet tray.
024-984	The booklet stapler low staple F signal is on	Remove all paper from the booklet tray.
024-985	The booklet stapler low staple R signal is on	Remove all paper from the booklet tray.
024-987	The booklet folder tray is full	Remove all paper from the tray. Set the output tray for threefold.

Fault Code	Possible Cause	Recommended Solution
024-988	The booklet folder tray is full	Check that the folder tray is correctly attached and set.
024-989	There is a problem with the booklet maker stapler	Check the staple cartridge and reset correctly.
047-320	A communication error has occurred with the Finisher	Power Off/On the machine. If the error persists, contact the Customer Support Center.
112-700	Punch Waste Container is full or near full	Remove and empty the waste container and reinstall.
116-790	The settings for stapling are canceled and prints the data	Confirm the staple position and try to print again.
124-705	The settings for punching are canceled	Confirm the punching position and try to print again.
124-706	The settings for folding are canceled	Confirm the folding settings and try to print again.
124-709	The number of pages exceeds the number of pages that can be stapled	Decrease the number of pages, or cancel the stapling settings, then try to print again.

Specifications

Standard/Booklet Maker Finisher Specifications

Item	Specification
Top Tray	Capacity: 500 sheets
	Supported paper sizes: Maximum: SRA3, 13x19 in., 12.6 x 19.2 in., 330x488mm (custom size) Minimum: 100x148mm (SEF), 4x6 in. (SEF), A6 (SEF) postcards
	Supported paper weight: 64-300 gsm
	Transparencies: send to top tray of the finisher only; stacker middle tray cannot accept
	Collated / uncollated

Item	Specification
Stacker (middle) tray	Capacity: 2,000 sheets, 200 sets
	Supported paper sizes: Maximum: SRA3, 13x19 in., 330x488mm (custom size) Minimum: B5, Executive (7.25 x 10.5 in.)
	Supported paper weight: 64-300 gsm
	Collated / uncollated (offset available)
Tray T1 (Post-Process Insert-er; also called "Interposer")	Supported paper sizes: Maximum: A3/11 x 17 in. Minimum: B5, Executive (7.25 x 10.5 in.)
	The machine does not print on paper loaded in Tray 8.
	Capacity: 200 sheets when using Xerox 20 lb./75 gsm paper.
	Paper type: 64-220 gsm
Optional C/Z Fold tray	Capacity: minimum 30 sheets
	Supported paper weight: 64-90 gsm
	Supported paper sizes: A4 (SEF) and 8.5x11 in. (SEF)
Booklet Creation/Single Fold	<p>Maximum number of sheets:</p> <ul style="list-style-type: none"> • Fold and Staple: 25 sheets (64 - 79 gsm) (May need service call to enable.) • Fold only: 5 sheets <p>When using Xerox 20 lb./75 gsm paper, only 14 sheets can be stapled if adding a cover. Paper sizes:</p> <ul style="list-style-type: none"> • Maximum: A3, 13 x 18 in. • Minimum: A4 SEF, 8.5 x 11 in. SEF
	Paper Type: Fold only or Fold and Staple: 64-220 gsm uncoated, 106-220 gsm coated up to 17 inches long.
	<p>Paper Weights/Booklet Capacity:</p> <ul style="list-style-type: none"> • 64-79 gsm, Uncoated: 25 sheets (May need service call to enable.) • 80-90 gsm, Uncoated: 20 sheets • 91-105 gsm, Uncoated: 10 sheets • 106-128 gsm, Uncoated: 10 sheets, Coated: 10 sheets • 129-150 gsm, Uncoated: 10 sheets, Coated: 10 sheets • 151-176 gsm, Uncoated: 10 sheets, Coated: 10 sheets • 177-220 gsm, Uncoated: 5 sheets, Coated: 5 sheets

Note

When using light-weight stocks, media jams may occur with Booklet Creation, Single Fold, and stapling for output that is 25 sheets or more. If media jams do occur, it is recommended that a different media type is selected for the job.

Optional C/Z Folder Specifications

Item	Specification
Z-Fold Half Sheet	Z-paper size: 11 x 17 in./A3, 10 x 14 in./B4, 8K
	Paper type: 16-24 lb./64-90 gsm
	Output tray: Stacker (middle) tray
	Maximum Capacity: 80 sheets (A3/11 x 17 in. Xerox 20 lb./75 gsm paper Z folding) 20 sheets for 8K and 10 x 14 in./B4
C-Fold and Z-Fold	Paper size: A4/8.5 x 11 inches
	Number of sheets to be folder: 1 sheet
	Minimum capacity: 30 sheets when using Xerox 20 lb. / 75 gsm paper.
	Paper Type: 16-24 lb. / 64-90 gsm
	Output Tray: C/Z Folder tray
Single Fold	Refer to Booklet Creation/Single Fold specifications for more information

SquareFold Trimmer Module

This chapter includes:

- Overview
- Identifying the Components
- Square Fold Feature
- Trimmer Feature
- Hints and Tips
- Problem Solving
- Specifications

Overview

The SquareFold Trimmer Module is an optional finishing device that is used in conjunction with another optional finishing device that contains a booklet maker.

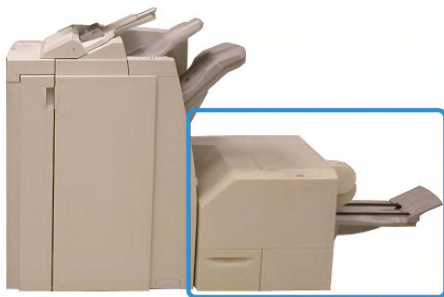

Note

The SquareFold Trimmer Module requires a finisher with a booklet maker attached.

The SquareFold Trimmer Module:

- Receives the booklet from the booklet maker area of the finisher

SquareFold Trimmer Module

- Flattens the booklet spine, thereby reducing the booklet's thickness and giving it the appearance of a perfect-bound book
- Trims/cuts away the face (edge) of the booklet, resulting in a neat finished edge

The booklet is assembled and stapled in the booklet area of the finisher; therefore, the booklet enters the SquareFold Trimmer Module already assembled. Any adjustments to the image of the original and its placement on the booklet page must be done either from the machine's UI or from your print driver.

Note

Always refer to the [Hints and Tips](#) section of this manual before using the SquareFold Trimmer Module. The Hints and Tips section provides valuable information about setting up your jobs, which in turn ensures the best possible output for your print/copy jobs.

You may want to run one or more test prints/copies before running larger jobs.

Identifying the Components

Main Components

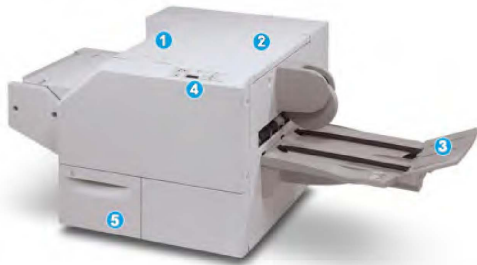

The main components consist of:

1. **Top Left Cover:** Open this cover to remove paper jams. The square fold mechanism is found in this area.
2. **Top Right Cover:** Open this cover to remove paper jams. The trimming mechanism is found in this area.
3. **Booklet Output Tray:** This tray receives square-fold booklet output from the finisher.
4. **Control Panel:** The Control Panel consists of a mimic display, buttons, and various indicator lights.
5. **Trimmer Waste Container:** Collects scrap/waste from the trimmer. Pull open to remove and dispose of trimmer waste scraps.

Note

The top covers cannot be opened during normal operation or when the machine is idle. The covers can be opened only when an indicator is lit and a jam/fault occurs within the SquareFold Trimmer Module.

Paper Path

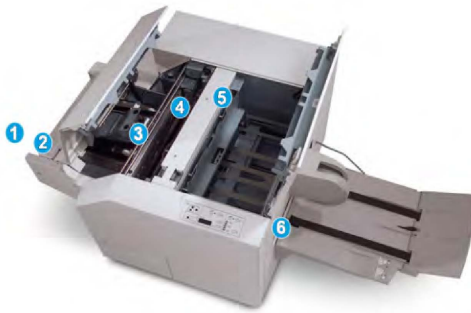

1. The booklet leaves the booklet area of the finisher and enters the SquareFold Trimmer Module.
2. The Booklet Exit sensor (in the SquareFold Trimmer Module) detects the lead edge (spine) of the booklet and moves the booklet to square fold area.
3. Once the booklet spine reaches the square fold area, the booklet is clamped and the square-folding operation begins.
4. The booklet is flattened and the spine squared according to the square-fold setting indicated on the Control Panel.
5. After the booklet is flattened and the spine squared, it is moved to the trimmer area.
 - Based on the finished booklet size, the booklet is moved until the trail edge reaches the trimmer cutter.
 - The trail edge is trimmed/cut (based on the finished booklet size entered for the Trimmer Mode Setting).
6. The booklet then moves to the exit area where it is transported to the Booklet Output Tray.

Note

Booklets exiting/leaving the SquareFold Trimmer Module may contain trim remnants/scrap from the previously trimmed booklet. This is due to static electricity build-up and is normal. If booklets contain trim remnants/scrap, simply remove and discard them.

Control Panel

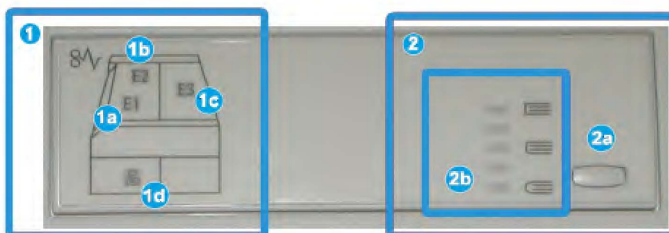

The Control Panel consists of the following:

1. **Fault indicators:** These indicators light when a fault or jam occurs in a particular area of the SquareFold Trimmer Module.

SquareFold Trimmer Module

- 1a) This indicator lights when a jam occurs as the booklet is leaving the exit area of the finisher.
- 1b) This indicator lights when a jam occurs in the square fold area.
- 1c) This indicator lights when a jam occurs in the trimmer area.
- 1d) This indicator lights when the Trimmer Waste Container is pulled out or when it is full.

Note

If one of these indicators (1a, 1b, 1c) is lit, the top covers can be opened, and the jam/fault cleared; otherwise, during normal operation or when the machine is idle, the top covers cannot be opened.

2. Square Fold options: This area of the control panel contains the following:
 - 2a) Settings button: Press this button to adjust the Square Fold setting; refer to the next item.
 - 2b) Square Fold options: Select the desired setting; these settings are discussed in more detail in the section entitled "Square Fold options."

Note

The Square Fold options are available from your computer's print driver, from your print server, or from your machine's UI (if it is a copier/printer). This is discussed in more detail in the section entitled "Square Fold options."

Square Fold Feature

The Square Fold feature can be selected/accessed from your computer's print driver or from the print server.

Note

The Square Fold feature is available only when your machine is connected to both a finisher with a booklet maker and the SquareFold Trimmer Module.

Note

The term "Book Pressing" is used synonymously with the terms "Square Fold" or "Square Folding."

Square Fold Options

The Square Fold (Book Pressing) feature can be switched on or off based on user preference. When the feature is switched on, you can select one of five options depending on your requirements for the finished booklet job.

Note

For the remainder of this section, the SquareFold Trimmer Module's Control Panel and the machine's UI screen are shown. The individual print server and print driver screens are not shown. The descriptions given for each of the Square Fold options are applicable for network print jobs and apply to any print server/print driver connected to the machine.

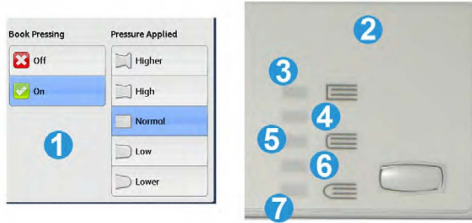

1. Square Fold/Book Pressing options as shown on the machine's UI
2. SquareFold Trimmer Module Control Panel
3. **+2/Higher/High 2:** Use this setting when you want the most amount of pressure applied to the spine of the booklet. The more pressure applied to the booklet, the more square the booklet spine will be. +2 is the greatest amount of pressure that can be applied to the booklet.

Additionally, you may want to select this setting when your finished booklet is five pages or less and on heavier weight paper (200 gsm or greater).

4. **+1/High/High 1:** Use this setting when you want a greater amount of pressure applied to the spine of the booklet, but not as much pressure as the +2 setting uses.
5. **Auto/Normal:** This is the machine default setting and is used for most jobs.
6. **-1/Low/Low 1:** Use this setting when you want less pressure applied to the spine of the booklet. The less pressure applied to the booklet, the more rounded the booklet spine will be.
7. **-2/Lower/Low 2:** Select this setting when your finished booklet is five pages or less and on lighter weight paper (100 gsm or lower). -2 is the least amount of pressure that can be applied to the booklet.

Choose the setting that best fits your needs for the booklet output.

Note

You may want to run one or more test prints before running larger jobs.

The following illustration shows two different booklets: one booklet which was square-folded and one booklet that was not square-folded.



1. This booklet was not square-folded. It has a more rounded, thicker appearance to the spine of the booklet.
2. This booklet was square-folded. The booklet spine is flattened and squared, giving it the appearance of a perfect-bound book.

Trimmer Feature

The Trimmer Feature can be selected/accessed from your computer's print driver or from the print server.

Note

The Trimmer feature is available only when your machine is connected to both a finisher with a booklet maker and the SquareFold Trimmer Module.

Trimmer Options

When using the Trimmer Options, always consider the following:

- Booklets exiting/leaving the SquareFold Trimmer Module may contain trim remnants/scraps from the previously trimmed booklet. This is due to static electricity build-up and is normal. If booklets contain trim remnants/scraps, simply remove and discard them.
- The Trimmer feature can be switched on or off based on user preference. When the feature is switched on, you can adjust the trim setting in 0.1 mm/0.0039 in. increments depending on your requirements for the finished booklet job.

Note

For the remainder of this section, the machine's UI screen is shown. The individual print server and print driver screens are not shown. The descriptions given for each of the Trimmer options are applicable for network print jobs, and apply to any print server/print driver connected to the machine.

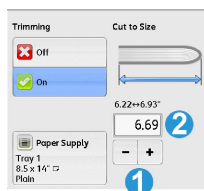

1. Select the buttons to decrease or increase the trimmer setting. Adjustments are made in 0.1 mm/0.0039 inch increments.
2. The trimmer setting is based on:
 - The number of sheets in the finished booklet,
 - The finished booklet width size (such as 8.5 in./210 mm or 5.5 in./149 mm),
 - The media type (for example coated/uncoated, glossy), and
 - The media weight

Note

Important! You may have to experiment with various settings in order to determine the best settings for your particular job. Also, you may want to run one or more test prints before running larger jobs in order to ensure the best possible booklet output.

Note

Trim settings cannot be adjusted to remove less than 2 mm (0.078 in.) or more than 20 mm (0.787 in.) of edge material from the booklet. Adjustments less than 2 mm (0.078 in.) may produce poor trim quality, and adjustments greater 20 mm (0.078 in.) will result in no trimming to the booklet edge.

Choose the setting that best fits your needs for the booklet output.

Trim Guidelines

The following table shows various scenarios using different paper weights, media types, and trim setting selections. Use this table as a guideline when selecting a trim setting for your specific job.

Note

The settings shown in the following table are provided as examples and are not meant to represent every possible job scenario; again, use this table as a guideline only.

	Paper Size	Finished Booklet Size	Paper Weight (lbs / gsm)	Trim Setting (mm)	Pages in Finished Booklet
1	8.5x11 in./A4 (210x298mm)	5.5x8.5 in. (149x210mm)	20 lbs. (75 gsm)	130	20
2	8.5x11 in./A4 (210x298mm)	5.5x8.5 in. (149x210mm)	24 lbs. (90 gsm)	125	14
3	8.5x11 in./A4 (210x298mm)	5.5x8.5 in. (149x210mm)	32 lbs. (120gsm)	135	10
4	8.5x11 in./A4 (210x298mm)	5.5x8.5 in. (149x210mm)	20 lbs. (75 gsm)	125	10
5	8.5x11 in./A4 (210x298mm)	5.5x8.5 in. (149x210mm)	80 lbs. (120gsm)	135	12
6	8.5x14 in./B4 (250x353mm)	8.5x7 in. (250x176.5mm)	20 lbs. (75 gsm)	172	6
7	8.5x14 in./B4 (250x353mm)	8.5x7 in. (250x176.5mm)	24 lbs. (90 gsm)	170	6
8	11x17 in./A3 (297x420mm)	8.5x11 in./A4 (210x297mm)	24 lbs. (90 gsm)	200	14
9	11x17 in./A3 (297x420mm)	8.5x11 in./A4 (210x297mm)	80 lbs. (216gsm)	205	5
10	11x17 in./A3 (297x420mm)	8.5x11 in./A4 (210x297mm)	20 lbs. (80 gsm)	210	22

	Paper Size	Finished Booklet Size	Paper Weight (lbs / gsm)	Trim Setting (mm)	Pages in Finished Booklet
11	11x17 in./A3 (297x420mm)	8.5x11 in./A4 (210x297mm)	24 lbs. (90 gsm)	210	8
12	11x17 in./A3 (297x420mm)	8.5x11 in./A4 (210x297mm)	80 lbs. (120gsm)	205	10
13	12x18 in. (305x458mm)	6x9 in. (152x229mm)	80 lbs. (120gsm)	220	6
14	12x18 in. (305x458mm)	6x9 in. (152x229mm)	80 lbs. (120gsm)	215	5
15	12x18 in. (305x458mm)	6x9 in. (152x229mm)	80 lbs. (120gsm)	210	4
16	12x18 in. (305x458mm)	6x9 in. (152x229mm)	28 lbs. (105gsm)	220	16
17	12x18 in. (305x458mm)	6x9 in. (152x229mm)	80 lbs. (120gsm)	210	14

Hints and Tips

Printing Full-page Images on Booklets

When using full-page images, ensure that the finished booklet size accommodates any full-page images, and that when the booklet is trimmed, these images are not truncated. Refer to the illustration.



1. This booklet has preprinted front and back covers with a full-page image. It was printed on 8.5 x 14 in./B4 paper. The front cover, which was trimmed, displays the entire image.
2. This same booklet was printed on 8.5 x 11 in./A4 paper. The image on the front cover is truncated after trimming it.

Before you print any booklet job, you should consider your whole job, including the following:

- What is the desired size of the finished booklet?
- Does the booklet contain full-page images?
- Are you using preprinted covers with full-page images?
- Are you trimming the booklet?
- Do you need to shift any full-page images in order to ensure they fit on the finished booklet?

These are important questions which can affect the output of your booklet jobs, especially if you are using full-page images and trimming the booklet edges.

Follow These Tips

Follow these tips to ensure you get your desired output:

- Always run one or more test prints of your job before running a larger output quantity.
- Review your test prints for truncated images/text.
- If any images/text need shifting, use the various selections from your application's print driver; refer to your print driver's Help information.
- Remember: it may take one or more test prints before you achieve your desired output.

Problem Solving

Jam Clearance

Note

The top covers cannot be opened during normal operation or when the machine is idle. The covers can be opened only when an indicator is lit and a jam/fault occurs within the SquareFold Trimmer Module. For indicator details, refer to the Control Panel information earlier in this section.

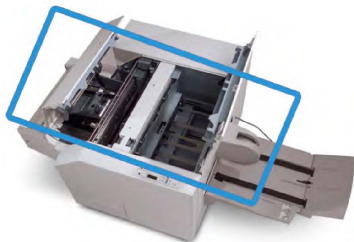

The paper path is shown in the above illustration. Clear any paper jams that may occur along the paper path. If a jam occurs, the machine stops printing, and a message may be displayed on the User Interface (UI).

Note

To determine if the jam/fault is within the finisher or with the SquareFold Trimmer Module, always begin your troubleshooting with the SquareFold Trimmer Module.

Clearing Jams

Use the following procedure to clear jams or faults and then resume printing:

1. Follow the instructions displayed on the machine's UI.
2. If instructed by the machine's UI, open the Top Left Cover and the Top Right Cover of the SquareFold Trimmer Module.
3. Look for any jammed booklets within the SquareFold Trimmer Module paper path and remove them.
4. Check for loose trim scraps along the paper path and remove them.
5. Close the Top Left and Right Covers.
6. Empty the Trimmer Waste Container.
7. Ensure that the Trimmer Waste Container is completely pushed in/closed.
8. Ensure that all covers on the SquareFold Trimmer Module are closed.
9. If the SquareFold Trimmer Module Control Panel and/or the machine's UI indicate there is a still a jam, recheck the SquareFold Trimmer Module (steps 1-8).
10. If necessary, open the finisher to look for jams/faults along the finisher path.
11. Follow the instructions displayed on the machine's UI to resume printing.

Clearing E1/E2 jams

Use the following procedure to clear jams when the E1 and/or E2 LED is lit on the SquareFold Trimmer Module Control Panel.

1. Make sure that the machine is not in operation, and press the button on the left cover of the Trimmer unit to open the cover.

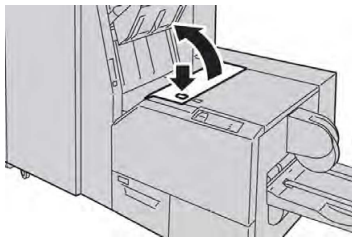

2. Remove the jammed paper.

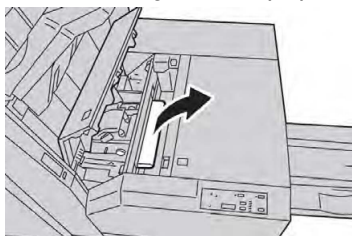

3. If you cannot remove the paper in Step 2, open the right cover of the finisher.

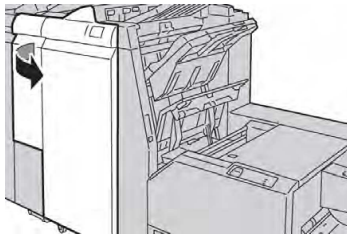

4. Turn the knob 4a to the right, and then remove the jammed paper.



5. Close the left cover of the Trimmer unit.

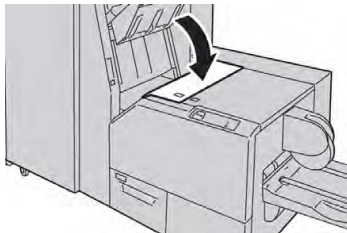

6. If you opened the right cover of the finisher in Step 3, close the cover.

Note

A message will be displayed and the machine will not operate if the right cover of the finisher is even slightly open.

Clearing E3 Jams

Use the following procedure to clear jams when the E3 LED is lit on the SquareFold Trimmer Module Control Panel.

1. Make sure that the machine is not in operation, and press the button on the right cover of the Trimmer unit to open the cover.

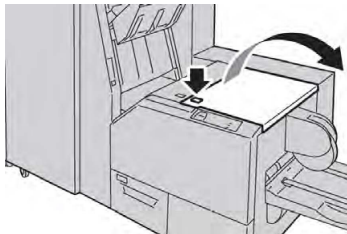

2. Remove the jammed paper.

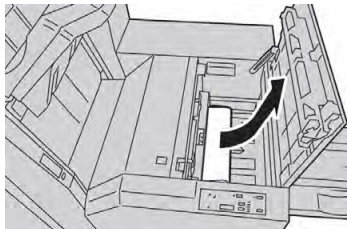

SquareFold Trimmer Module

3. Close the right cover of the Trimmer unit.

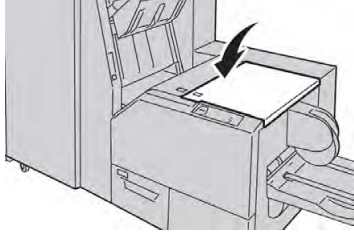

Fault Codes

If a jam/fault occurs in the SquareFold Trimmer Module, the machine's UI displays a jam/fault message. The following table provides a list of fault codes for the SquareFold Trimmer Module and a list of related finisher fault codes.

Note

The top covers cannot be opened during normal operation or when the machine is idle. The covers can be opened only when an indicator is lit and a jam/fault occurs within the SquareFold Trimmer Module. For indicator details, refer to the control panel information earlier in this section.

Fault Code	Possible Cause	Recommended Solution
013-100013- 101013-102013- 103013-104013- 105013-106013- 303013-915013- 916013-917013- 918013-919	Jam/fault with the SquareFold Trimmer Module	<ol style="list-style-type: none">1. Open the Top Left and Right Covers of the SquareFold Trimmer Module.2. Carefully remove all sheets and paper scraps from jam clearance areas.3. Close the SquareFold Trimmer Module Top Left and Right Covers.4. Check the Trimmer Waste Container:<ul style="list-style-type: none">• If full, empty the container and reinsert it into the SquareFold Trimmer Module• If the container is partially pulled out, push it completely in5. If necessary, follow any remaining instructions on the machine's UI.6. If fault persists, repeat Steps 1-5; if fault persists after that, call for service.

Fault Code	Possible Cause	Recommended Solution
013-221013- 222013-223013- 224013-225013- 226013-227013- 228013-229013- 230013-231013- 232013-233013- 234013-235013- 236013-237013- 238013-239013- 240013-241013- 242013-243013- 246	Jam or communication error with the SquareFold Trimmer Module	<ol style="list-style-type: none"> 1. Power off/on the machine. 2. If fault persists, call for service.
013-303013-304	A top cover is open.	<ol style="list-style-type: none"> 1. Open the Top Left and Right Covers of the SquareFold Trimmer Module. 2. Close the SquareFold Trimmer Module Top Left and Right Covers. 3. If fault persists, power off/on the machine. 4. If fault persists, call for service.
013-208013- 940013-941	The Trimmer Waste Container is full or has a fault.	<ol style="list-style-type: none"> 1. Pull open the container and empty any trimmer scraps from it. 2. Reinsert the container into the SquareFold Trimmer Module. 3. Ensure that the container is fully pushed in, and that the indicator light is not lit. 4. If fault persists, repeat steps 1-3. 5. If fault persists, power off/on the machine. 6. If fault persists, call for service.
013-943	Booklet Tray on the Square-Fold Trimmer Module is full.	<ol style="list-style-type: none"> 1. Remove any booklets from the tray. 2. If fault persists, power off/on the machine. 3. If fault persists, call for service.

SquareFold Trimmer Module

Fault Code	Possible Cause	Recommended Solution
012-115012-264012-302	Finisher jam or fault.	<ol style="list-style-type: none"> 1. If machine's UI continues to reflect a fault/jam, open the finisher and remove any jams. Close the finisher covers. 2. Follow the instructions shown on the machine's UI to resume printing. 3. If fault persists, power off/on the machine. 4. If fault persists, call for service.

Specifications

Item	Specifications
Paper Size	<ul style="list-style-type: none"> • Maximum: 13x18 in. (330x457 mm) • Minimum: 8.5x11 in./A4 SEF <p>Note The SquareFold Trimmer Module requires both Interface Module and the Booklet Maker Finisher.</p>
Trim Capacity	<ul style="list-style-type: none"> • 5-20 sheet booklet (up to 80 imaged sides) at 24 lb. (90 gsm) • 5-25 sheet booklet (up to 100 imaged sides) at 200 lb. (79 gsm) • Cut amount: 2-20mm, adjustable in 0.1 mm increments
Paper Weights	16 lb. bond-90 lb. cover (60-220 gsm)

15

Regulatory Information

This chapter includes:

- Basic Regulations
- Copy Regulations
- Fax Regulations
- Product Safety Certification
- Material Safety Data Sheets

Basic Regulations

Xerox has tested this printer to electromagnetic emission and immunity standards. These standards are designed to mitigate interference caused or received by this printer in a typical office environment.

United States FCC Regulations

This equipment has been tested and found to comply with the limits for a Class A digital device, pursuant to Part 15 of the FCC Rules. These limits are designed to provide reasonable protection against harmful interference when the equipment is operated in a commercial environment. This equipment generates, uses, and can radiate radio frequency energy. If the equipment is not installed and used in accordance with these instructions, it can cause harmful interference to radio communications. Operation of this equipment in a residential area is likely to cause harmful interference. Users are required to correct the interference at their own expense.

If this equipment does cause harmful interference to radio or television reception, which can be determined by turning the equipment off and on, the user is encouraged to try to correct the interference by one or more of the following measures:

- Reorient or relocate the receiving antenna.
- Increase the separation between the equipment and receiver.

Regulatory Information

- Connect the equipment into an outlet on a circuit different from that to which the receiver is connected.

Consult the dealer or an experienced radio/TV technician for help.

Changes or modifications to this equipment not approved by Xerox can void the authority of the user to operate this equipment.

Warning

To ensure compliance with Part 15 of the FCC rules, use shielded interface cables.

Canada

This Class A digital apparatus complies with Canadian ICES-003.

Cet appareil numérique de la classe A est conforme à la norme NMB-003 du Canada.

Certifications in Europe



The CE mark applied to this equipment symbolizes a declaration of conformity by Xerox with the following applicable Directives of the European Union as of the dates indicated:

December 12, 2006 Council Directive 2006/95/EC as amended. This is a directive on the approximation of the laws of the member states related to low voltage equipment.

December 15, 2004 Council Directive 2004/108/EC as amended. This directive is an approximation of the laws of the member states related to electromagnetic compatibility.

A full declaration of conformity, defining the relevant directives and referenced standards, can be obtained from your authorized local dealer.

Warning

Changes or modifications to this equipment not specifically approved by the Xerox Corporation may void the user's authority to operate this equipment.

External radiation from Industrial, Scientific, and Medical (ISM) equipment can interfere with the operation of this Xerox® device. If external radiation from ISM equipment interferes this device, contact your Xerox® representative for assistance.

This is a class A product. In a domestic environment, this product can cause radio frequency interference, in which case the user can be required to take adequate measures.

Shielded cables must be used with this equipment to maintain compliance with Council Directive 2004/108/EC.

European Union Lot 4 Imaging Equipment Agreement Environmental Information

Environmental Information Providing Environmental Solutions and Reducing Cost

The following information has been developed to assist users and has been issued in relation to the European Union (EU) Energy Related Products Directive, specifically the Lot 4 study on Imaging Equipment. This requires manufacturers to improve environmental performance of in scope products and supports the EU action plan on energy efficiency.

In scope products are Household and Office equipment that meet the following criteria:

- Standard monochrome format products with a maximum speed less than 66 A4 images per minute.
- Standard color format products with a maximum speed less than 51 A4 images per minute

Environmental Benefits of Duplex Printing

Most Xerox® products have duplex printing, also known as 2-sided printing, capability. This enables you to print on both sides of the paper automatically, and therefore helps to reduce the use of valuable resources by reducing your paper consumption. The Lot 4 Imaging Equipment agreement requires that on models greater than or equal to 40 ppm color or greater than or equal to 45 ppm monochrome the duplex function has been auto enabled, during the setup and driver installation. Some Xerox® models below these speed bands may also be enabled with 2-sided printing settings defaulted on at the time of install. Continuing to use the duplex function will reduce the environmental impact of your work. However, should you require simplex/1-sided printing, you may change the print settings in the print driver.

Paper Types

This product can be used to print on both recycled and virgin paper, approved to an environmental stewardship scheme, which complies with EN12281 or a similar quality standard. Lighter weight paper (60 g/m²), which contains less raw material and thus save resources per print, may be used in certain applications. We encourage you to check if this is suitable for your printing needs.

ENERGY STAR



The ENERGY STAR program is a voluntary scheme to promote the development and purchase of energy efficient models, which help to reduce environmental impact. Details on the ENERGY STAR program and models qualified to ENERGY STAR can be found at the following website: www.energystar.gov/index.cfm?fuseaction=find_a_product.showProductGroup&pgw_code=IEQ.

The ENERGY STAR and ENERGY STAR mark are registered United States trademarks. The ENERGY STAR Imaging Equipment Program is a team effort between United States, European Union, and Japanese governments and the office equipment industry to promote energy-efficient copiers, printers, fax, multifunction printers, personal computers, and monitors. Reducing product energy consumption helps combat smog, acid rain, and long-term changes to the climate by decreasing the emissions that result from generating electricity.

Power Consumption and Energy Saver Activation Time

The amount of electricity a product consumes depends on the way the device is used. This product is designed and configured to enable you to reduce your electricity costs.

After the last print, the device switches to Ready mode. In this mode, the device can print again immediately. If the device is not used for an interval of time, the device switches to Energy Saver mode. In Energy Saver mode, only essential functions remain active, which permits reduced product power consumption.

The product takes slightly longer to produce the first print after it exits Energy Saver mode than it takes in Ready mode. This delay is the result of the system waking up from Energy Saver mode and is typical of most imaging products on the market.

Before you turn off Energy Saver mode or set a long activation time, consider the increase in product power consumption.

Before you turn off Energy Saver mode or set a long activation time, consider the increase in product power consumption.

To learn more about Xerox participation in sustainability initiatives, go to: www.xerox.com/about-xerox/environment/enus.html.

Default Energy Saver Settings for Product

The printer is ENERGY STAR® qualified under the ENERGY STAR Program Requirements for Imaging Equipment. The transition time from Standby to Energy Saver mode, which can be up to 240 minutes, is set to a default value of 1 minute. The transition time from Energy Saver mode to Sleep, which can be up to 240 minutes, is set to a default value of 1 minute. The transition time from Standby to Sleep for this printer can be up to 480 minutes.

To configure Energy Saver settings, refer to Setting Energy Saver Mode on page 28.

Germany

Blendschutz

Das Gerät ist nicht für die Benutzung im unmittelbaren Gesichtsfeld am Bildschirmarbeitsplatz vorgesehen. Um störende Reflexionen am Bildschirmarbeitsplatz zu vermeiden, darf dieses Produkt nicht im unmittelbaren Gesichtsfeld platziert werden.

Lärmemission

Maschinenlärminformations-Verordnung 3. GPSGV: Der höchste Schalldruckpegel beträgt 70 dB(A) oder weniger gemäß EN ISO 7779.

Importeur

Xerox GmbH

Hellersbergstraße 2-4

41460 Neuss

Deutschland

Turkey RoHS Regulation

In compliance with Article 7 (d), we hereby certify "it is in compliance with the EEE regulation."

“EEE yönetmeliğine uygundur.”

Eurasian Economic Community Certification



Russia, Belarus, and Kazakhstan are working to establish a common customs union, the Eurasian Economic Community, or EurAsEC. The Eurasian Economic Community members anticipate sharing a common regulatory scheme and common EurAsEC certification mark, the EAC Mark.

Ozone Release

This printer produces ozone during normal operation. The amount of ozone produced is dependent on copy volume. Ozone is heavier than air and is not produced in amounts large enough to harm anyone. Install the printer in a well-ventilated room.

For more information in the United States and Canada, go to www.xerox.com/environment. In other markets, please contact your local Xerox representative or go to www.xerox.com/environment_europe.

Wireless Compliance

This product generates 13.56 MHz using an Inductive Loop System as a Radio Frequency Identification Device (RFID). This RFID device complies with the requirements specified in FCC Part 15, Industry Canada RSS-210, European Council Directive 99/5/EC, and all applicable local laws and regulations.

Regulatory Information

Operation of this device is subject to the following two conditions:

- This device may not cause harmful interference.
- This device must accept any interference received, including interference that may cause undesired operation.

Changes or modifications to this equipment not specifically approved by the Xerox® Corporation may void the user's authority to operate this equipment.

Labeling Requirements

United States

Radio Frequency Identification Device (RFID) manufacturer and model name must be listed on the RFID device.

European Union

A CE mark is required on the host product. A notified body number is required next to the CE mark in cases where a notified body was involved in the RFID approval process. Notified Body involvement is not mandatory.

Brazil

A Radio Frequency Identification Device model name must be listed on the device.

Copy Regulations

United States

Congress, by statute, has forbidden the reproduction of the following subjects under certain circumstances. Penalties of fine or imprisonment may be imposed on those guilty of making such reproductions.

1. Obligations or Securities of the United States Government, such as:
 - Certificates of Indebtedness.
 - National Bank Currency.
 - Coupons from Bonds.
 - Federal Reserve Bank Notes.
 - Silver Certificates.
 - Gold Certificates.
 - United States Bonds.
 - Treasury Notes.
 - Federal Reserve Notes.
 - Fractional Notes.
 - Certificates of Deposit.
 - Paper Money.
 - Bonds and Obligations of certain agencies of the government, such as FHA and so on.
 - Bonds. United States Savings Bonds may be photographed only for publicity purposes in connection with the campaign for the sale of such bonds.
 - Internal Revenue Stamps. If it is necessary to reproduce a legal document on which there is a canceled revenue stamp, this may be done provided the reproduction of the document is performed for lawful purposes.
 - Postage Stamps, canceled or uncanceled. For philatelic purposes, Postage Stamps may be photographed, provided the reproduction is in black and white and is less than 75 % or more than 150 % of the linear dimensions of the original.
 - Postal Money Orders.
 - Bills, Checks, or Drafts of money drawn by or upon authorized officers of the United States.
 - Stamps and other representatives of value, of whatever denomination, which have been or may be issued under any Act of Congress.
 - Adjusted Compensation Certificates for Veterans of the World Wars.
2. Obligations or Securities of any Foreign Government, Bank, or Corporation.

Regulatory Information

3. Copyrighted materials, unless permission of the copyright owner has been obtained or the reproduction falls within the "fair use" or library reproduction rights provisions of the copyright law. Further information of these provisions may be obtained from the Copyright Office, Library of Congress, Washington, D.C. 20559. Ask for Circular R21.
4. Certificate of Citizenship or Naturalization. Foreign Naturalization Certificates may be photographed.
5. Passports. Foreign Passports may be photographed.
6. Immigration papers.
7. Draft Registration Cards.
8. Selective Service Induction papers that bear any of the following Registrant's information:
 - Earnings or Income.
 - Court Record.
 - Physical or mental condition.
 - Dependency Status.
 - Previous military service.

Exception: United States military discharge certificates may be photographed.
9. Badges, Identification Cards, Passes, or Insignia carried by military personnel, or by members of the various Federal Departments, such as FBI, Treasure, and so on (unless photograph is ordered by the head of such department or bureau).

Reproducing the following is also prohibited in certain states:

- Automobile Licenses.
- Drivers' Licenses.
- Automobile Certificates of Title.

The preceding list is not all inclusive, and no liability is assumed for its completeness or accuracy. In case of doubt, consult your attorney.

For more information about these provisions contact the Copyright Office, Library of Congress, Washington, D.C. 20559. Ask for Circular R21.

Canada

Parliament, by stature, has forbidden the reproduction of the following subjects under certain circumstances. Penalties of fine or imprisonment may be imposed on those guilty of making such reproductions.

- Current bank notes or current paper money
- Obligations or securities of a government or bank
- Exchequer bill paper or revenue paper

- The public seal of Canada or of a province, or the seal of a public body or authority in Canada, or of a court of law
- Proclamations, orders, regulations, or appointments, or notices thereof (with intent to falsely cause same to purport to have been printed by the Queens Printer for Canada, or the equivalent printer for a province)
- Marks, brands, seals, wrappers, or designs used by or on behalf of the Government of Canada or of a province, the government of a state other than Canada or a department, board, Commission, or agency established by the Government of Canada or of a province or of a government of a state other than Canada
- Impressed or adhesive stamps used for the purpose of revenue by the Government of Canada or of a province or by the government of a state other than Canada
- Documents, registers, or records kept by public officials charged with the duty of making or issuing certified copies thereof, where the copy falsely purports to be a certified copy thereof
- Copyrighted material or trademarks of any manner or kind without the consent of the copyright or trademark owner

This list is provided for your convenience and assistance, but it is not all-inclusive, and no liability is assumed for its completeness or accuracy. In case of doubt, consult your solicitor.

Other Countries

Copying certain documents may be illegal in your country. Penalties of fine or imprisonment may be imposed on those found guilty of making such reproductions.

- Currency notes
- Bank notes and checks
- Bank and government bonds and securities
- Passports and identification cards
- Copyright material or trademarks without the consent of the owner
- Postage stamps and other negotiable instruments

This list is not inclusive and no liability is assumed for either its completeness or accuracy. In case of doubt, contact your legal counsel.

Fax Regulations

United States

Fax Send Header Requirements

The Telephone Consumer Protection Act of 1991 makes it unlawful for any person to use a computer or other electronic device, including a fax machine, to send any message unless such message clearly contains in a margin at the top or bottom of each transmitted page or on the first page of the transmission, the date and time it is sent and an identification of the business or other entity, or other individual sending the message and the telephone number of the sending machine or such business, other entity, or individual. The telephone number provided may not be a 900 number or any other number for which charges exceed local or long-distance transmission charges.

For instructions on programming the Fax Send Header information, refer to the section of the System Administrator Guide on Setting Transmission Defaults.

Data Coupler Information

This equipment complies with Part 68 of the FCC rules and the requirements adopted by the Administrative Council for Terminal Attachments (ACTA). On the cover of this equipment is a label that contains, among other information, a product identifier in the format US:AAAEQ##TXXXX. If requested, this number must be provided to the Telephone Company.

A plug and jack used to connect this equipment to the premises wiring and telephone network must comply with the applicable FCC Part 68 rules and requirements adopted by the ACTA. A compliant telephone cord and modular plug is provided with this product. It connects to a compatible modular jack that is also compliant. See installation instructions for details.

You can safely connect the printer to the following standard modular jack: USOC RJ-11C using the compliant telephone line cord (with modular plugs) provided with the installation kit. See installation instructions for details.

The Ringer Equivalence Number (REN) is used to determine the number of devices that can be connected to a telephone line. Excessive RENs on a telephone line could result in the devices not ringing in response to an incoming call. In most but not all areas, the sum of RENs should not exceed five (5.0). To be certain of the number of devices that can be connected to a line, as determined by the RENs, contact the local Telephone Company. For products approved after July 23, 2001, the REN is part of the product identifier that has the format US:AAAEQ##TXXXX. The digits represented by ## are the REN without a decimal point (for example, 03 is a REN of 0.3). For earlier products, the REN is separately shown on the label.

To order the correct service from the local Telephone Company, you could also have to quote the codes in the following list:

- Facility Interface Code (FIC) = 02LS2

- Service Order Code (SOC) = 9.0Y

 **Caution**

Ask your local Telephone Company for the modular jack type installed on your line. Connecting this machine to an unauthorized jack can damage telephone company equipment. You, not Xerox, assume all responsibility and/or liability for any damage caused by the connection of this machine to an unauthorized jack.

If this Xerox® equipment causes harm to the telephone network, the Telephone Company could temporarily discontinue service to the telephone line to which it is connected. If advance notice is not practical, the Telephone Company notifies you of the disconnection as soon as possible. If the Telephone Company interrupts your service, they can advise you of your right to file a complaint with the FCC if you believe that it is necessary.

The Telephone Company could change its facilities, equipment, operations, or procedures which could affect the operation of the equipment. If the Telephone Company changes something that affects the operation of the equipment, they should notify you in order for you to make necessary modifications to maintain uninterrupted service.

If you experience trouble with this Xerox® equipment, please contact the appropriate service center for repair or warranty information. Contact information is contained in the Machine Status menu on the printer and in the back of the Troubleshooting section of the User Guide. If the equipment is causing harm to the telephone network, the Telephone Company may request you to disconnect the equipment until the problem is resolved.

Only a Xerox Service Representative or an authorized Xerox Service provider are authorized to make repairs to the printer. This applies at any time during or after the service warranty period. If unauthorized repair is performed, the remainder of the warranty period is null and void.

This equipment must not be used on party lines. Connection to party line service is subject to state tariffs. Contact the state public utility commission, public service commission, or corporation commission for information.

Your office could have specially wired alarm equipment connected to the telephone line. Make sure that the installation of this Xerox® equipment does not disable your alarm equipment.

If you have questions about what could disable alarm equipment, consult your Telephone Company or a qualified installer.

Canada

This product meets the applicable Industry Canada technical specifications.

A representative designated by the supplier should coordinate repairs to certified equipment. Repairs or alterations made by the user to this device, or device malfunctions, could cause the telecommunications company to request you to disconnect the equipment.

For user protection, make sure that the printer is properly grounded. The electrical ground connections of the power utility, telephone lines, and internal metallic water pipe systems, if present, must be connected together. This precaution could be vital in rural areas.

⚠ Warning

Do not attempt to make such connections yourself. Contact the appropriate electric inspection authority, or electrician, to make the ground connection.

The REN assigned to each terminal device provides an indication of the maximum number of terminals allowed to be connected to a telephone interface. The termination on an interface could consist of any combination of devices. The only limitation to the number of devices is the requirement that the sum of the RENs of the devices does not exceed 5. For the Canadian REN value, please see the label on the equipment.

Canada CS-03 Issue 9

This product has been tested to and is compliant with CS-03 issue 9.

European Union

Radio Equipment and Telecommunications Terminal Equipment Directive

This Xerox® device has been self-certified by Xerox® for pan-European single terminal connection to the analog public switched telephone network (PSTN) in accordance with Directive 1999/5/EC.

This device has been designed to work with the national public switched telephone networks and compatible PBX devices of the following countries:

Pan-European Analog PSTN and Compatible PBX Certifications		
Austria	Greece	Netherlands
Belgium	Hungary	Norway
Bulgaria	Iceland	Poland
Cyprus	Ireland	Portugal
Czech Republic	Italy	Romania
Denmark	Latvia	Slovakia
Estonia	Liechtenstein	Slovenia
Finland	Lithuania	Spain
France	Luxembourg	Sweden
Germany	Malta	United Kingdom

This product has been tested to and is compliant with TBR21 OR ES 103 021-1/2/3 or ES 203 021-1/2/3 technical specifications for terminal equipment for use on analog-switched telephone networks in the European Economic Area.

If you have problems with your product, contact your local Xerox representative. This product can be configured to be compatible with other country networks. Before reconnecting the device to a network in another country, contact your Xerox representative for assistance.

Note

Although this product can use either loop disconnect (pulse) or DTMF tone signaling, Xerox recommends that you use DTMF signaling. DTMF signaling provides reliable and faster call setup.

Note

Modification of this product, or connection to external control software or control apparatus not authorized by Xerox, invalidates its certification.

New Zealand

1. The grant of a Telepermit for any item of terminal equipment indicates only that Telecom has accepted that the item complies with minimum conditions for connection to its network. It indicates no endorsement of the product by Telecom, it does not provide any sort of warranty, and it does not imply that any Telepermitted product is compatible with all Telecom network services. Above all, it provides no assurance that any item will work correctly in all respects with another item of Telepermitted equipment of a different make or model.

The equipment may not be capable of correct operation at the higher data speeds designated. 33.6 kbps and 56 kbps connections are likely to be restricted to lower bit rates when connected to some PSTN implementations. Telecom will accept no responsibility for difficulties that arise in such circumstances.

2. Immediately disconnect this equipment should it become physically damaged, then arrange for its disposal or repair.
3. This modem shall not be used in any manner which could constitute a nuisance to other Telecom customers.
4. This device is equipped with pulse dialing, while the Telecom standard is DTMF tone dialing. There is no guarantee that Telecom lines will always continue to support pulse dialing.
5. Use of pulse dialing, when this equipment is connected to the same line as other equipment, may give rise to 'bell tinkle' or noise and cause a false answer condition. If you encounter such problems, do not contact the Telecom Faults Service.
6. DTMF tones dialing is the preferred method because it is faster than pulse (decadic) dialing and is readily available on almost all New Zealand telephone exchanges.

Warning

No '111' or other calls can be made from this device during a mains power failure.

7. This equipment may not provide for the effective hand-over of a call to another device connected to the same line.

8. Some parameters required for compliance with Telecom Telepermit requirements are dependent on the equipment (computer) associated with this device. The associated equipment shall be set to operate within the following limits for compliance with Telecom Specifications:

For repeat calls to the same number:

- There shall be no more than 10 call attempts to the same number within any 30 minute period for any single manual call initiation, and
- The equipment shall go on-hook for a period of not less than 30 seconds between the end of one attempt and the beginning of the next attempt.

For automatic calls to different numbers:

The equipment shall be set to ensure that automatic calls to different numbers are spaced such that there is no less than five seconds between the end of one call attempt and the beginning of another.

9. For correct operation, total of the RNs of all devices connected to a single line at any time should not exceed five.

South Africa

This modem must be used in conjunction with an approved surge protection device.

Safety Certification

This device is certified by the following agencies using the following safety standards:

Agency	Standard
Underwriters Laboratories Inc. (US/Canada)	UL60950-1 (2007) 2nd Edition CSA 22.2 No. 60950-1-07 2nd Edition
Underwriters Laboratories Inc. (Europe)	IEC60950-1:2005 (2nd Edition) +A1:2009 EN60950-1:2006 (2nd Edition) +A11:2009 +A1:2010+A12:2011 (CB Scheme)

Material Safety Data Sheets

For Material Safety Data information regarding your printer, go to:

- North America: www.xerox.com/msds
- European Union: www.xerox.com/environment_europe

For the Customer Support Center phone numbers, go to www.xerox.com/office/worldcontacts.

16

Recycling and Disposal

All Countries

If you are managing the disposal of your Xerox product, please note that the printer may contain lead, mercury, perchlorate, and other materials whose disposal may be regulated due to environmental considerations. The presence of these materials is fully consistent with global regulations applicable at the time that the product was placed on the market. For recycling and disposal information, contact your local authorities. Perchlorate Material: This product may contain one or more Perchlorate-containing devices, such as batteries. Special handling may apply, please see www.dtsc.ca.gov/hazardouswaste/perchlorate.

North America

Xerox operates an equipment take-back and reuse/recycle program. Contact your Xerox representative (1-800-ASK-XEROX) to determine if this Xerox product is part of the program. For more information about Xerox environmental programs, visit www.xerox.com/environment, or for recycling and disposal information, contact your local authorities.

European Union

Some equipment may be used in both a domestic/household and a professional/business application.

Domestic/Household Environment



Application of this symbol on your equipment is confirmation that you should not dispose of the equipment in the normal household waste stream.

In accordance with European legislation, end of life electrical and electronic equipment subject to disposal must be segregated from household waste.

Private households within EU member states may return used electrical and electronic equipment to designated collection facilities free of charge. Please contact your local disposal authority for information.

In some member states, when you purchase new equipment, your local retailer may be required to take back your old equipment free of charge. Please ask your retailer for information.

Professional/Business Environment



Application of this symbol on your equipment is confirmation that you must dispose of this equipment in compliance with agreed national procedures.

In accordance with European legislation, end of life electrical and electronic equipment subject to disposal must be managed within agreed procedures.

Prior to disposal, please contact your local reseller or Xerox representative for end of life take-back information.

Collection and Disposal of Equipment and Batteries



These symbols on the products and/or accompanying documents mean that used electrical and electronic products and batteries should not be mixed with general household waste.

For proper treatment, recovery, and recycling of old products and used batteries, please take them to applicable collection points, in accordance with your national legislation and the Directive 2002/96/EC and 2006/66/EC.

By disposing of these products and batteries correctly, you will help to save valuable resources and prevent any potential negative effects on human health and the environment which could otherwise arise from inappropriate waste handling.

For more information about collection and recycling of old products and batteries, please contact your local municipality, your waste disposal service or the point of sale where you purchased the items.

Penalties may be applicable for incorrect disposal of this waste, in accordance with national legislation.

Business Users in the European Union

If you wish to discard electrical and electronic equipment, please contact your dealer or supplier for further information.

Disposal Outside of the European Union

These symbols are only valid in the European Union. If you wish to discard these items, please contact your local authorities or dealer and ask for the correct method of disposal.

Battery Symbol



This wheeled bin symbol may be used in combination with a chemical symbol. Use of this symbol establishes compliance with the requirements set out by the Directive.

Battery Removal

Batteries should only be replaced by a manufacturer-approved service facility.

Other Countries

Please contact your local waste management authority to request disposal guidance.

