



Product Catalog

Water Source Heat Pump Axiom™ Variable Speed - VSV/VSH

24 to 60 MBtuh - 60 Hz





Introduction

Imagine a product that delivers superior comfort and performance while reducing operating cost. The Axiom™ Variable Speed model is Trane's most advanced water source comfort solution designed to meet these requirements. Trane achieves higher efficiency, reduced sound, improved indoor air quality and high reliability through variable speed compressor and fan technology.

Copyright

This document and the information in it are the property of Trane, and may not be used or reproduced in whole or in part without written permission. Trane reserves the right to revise this publication at any time, and to make changes to its content without obligation to notify any person of such revision or change.

Trademarks

All trademarks referenced in this document are the trademarks of their respective owners.

Revision History

- Removed information related to plenum fan.
- Updated digits 19 and 13 in Model Number Descriptions chapter.



Table of Contents

Introduction	2
Features and Benefits	4
System Advantages	4
Acoustics	4
Comfort	4
Flexibility	4
Higher Efficiency	4
Indoor Air Quality	4
Integrated Controls	5
Reliability	5
Accessories	6
Application Considerations	8
Boiler/Cooling Tower	8
Water Loop Distribution	10
Water Circulating Pumps	10
Central Pumping System	10
Distributed Pumping System	11
Duct Design for Noise Control	12
Dehumidification	13
Model Number Descriptions	14
General Data	15
Performance Data	18
Unit Fan Performance	54
MERV Filter	59
Controls	63
Tracer® UC400 Programmable BACnet® Controller	63
Features and Functions	63
Trane® Air-Fi® Wireless Systems	65
Tracer® UC400 Setup Parameters and Setpoints	67
Safety Control	68
Zone Sensors	69
Electrical Data	71
Dimensional Data	72
Mechanical Specifications	84



Features and Benefits

System Advantages

Acoustics

Variable speed units have an insulated enclosure for quiet design. Variable speed fan and compressor reduce sound levels at lower load conditions. The advanced Vortica™ fan system uses less energy to produce more airflow with minimal sound. The platform provides double isolation to the compressor and single isolation to the co-axial water coil for additional attenuation during compressor start and stop.

Comfort

Variable speed compressor varies the capacity of the unit to more closely match the load requirements in the zone than a cycling compressor, improving occupant comfort. ECM motor varies supply airflow for improved dehumidification at part load conditions compared to a constant speed fan.

Flexibility

Units support both boiler/cooling tower and ground source heat exchanger applications. There is supply and return airflow configuration flexibility and adjustable supply minimum and maximum airflow settings.

Higher Efficiency

The efficiency increases as the system unloads with EER values up to 40 (ground loop) at part-load operation. The variable speed unit is ANSI/AHRI/ASHRAE/ISO13256-1 certified performance while exceeding ASHRAE 90.1 standards for efficiency.

The variable speed unit contains the best compressor technology available to achieve the highest possible performance. The motor speed is varied through an inverter board. Variable speed compressors are outstanding for humidity control and light load cooling and heating conditions. A variety of compressors are used to accommodate dedicated voltage and tonnage size requirements. The size 33 MBtuh and lower have a rotary compressor design while the 42 MBtuh and above include a scroll compressor style. Trane utilizes different styles to provide the voltage and capacity variations along with noise reduction required in today's applications.



Indoor Air Quality

All panels of the unit have cleanable foil-faced insulation. Edges are either captured or sealed to ensure no insulation fibers get into the airstream. The cabinet insulation design meets UL 181 requirements.

The drain pan is composed of a non-corrosive polymer or stainless steel material to reduce microbial growth.



A variety of filter options are available to meet most application requirements. The units are equipped with a disposable 1-inch thick fiberglass filter as standard. Disposable 2-inch thick filters

and 2-inch thick MERV 8 or MERV 13 filters are available as an option and will meet LEED EQ Credit 5.

Integrated Controls

The Trane model VS comes standard with the Tracer® UC400 controller. The controller is a programmable, micro-processor based, direct digital controller (DDC) integral to the unit. It provides unit control for heating and cooling. The UC400 is capable of a standalone application or for simple integration into building automation systems which communicate via the BACnet® protocol.



Reliability

Part-load operation reduces cyclic operation. Fewer on/off cycles reduce stress of the components. Every unit is factory run tested in both cooling and heating cycle. The Tracer® UC400 controller improves quality and reliability with built in safeties and diagnostics. The controller provides anti-short cycle compressor protection, random start delay, heating/cooling status, occupied/unoccupied mode, filter maintenance timer, compressor status (high/low pressure), drive status (operating or failed) and condensate overflow protection.

Supply Fan Motor - ECM

All variable speed units include the new high-efficiency ECM supply fan motor. The ECM motor offers increased efficiency. The motor is attached to the fan housing using rubber isolators to minimize vibration transmission.

The motor is controlled by the unit controller and varies the airflow in tandem with the compressor speed. Minimum and maximum airflow settings are adjustable.

Serviceability to the motor is made through one air-side, side access door.



Supply Fan Motor Housing - ECM

The supply fan housing is constructed of non-corrosive galvanized steel (vertical) or a composite Vortica™ (horizontal) housing.



Accessories

Ducted Filter Rack

When it is necessary to have filter access at the unit in a ducted return, a ducted filter rack is available. This option allows access to the filter at the unit. Vertical unit filter racks are available in right or left access configurations.



Ducted Filter Rack

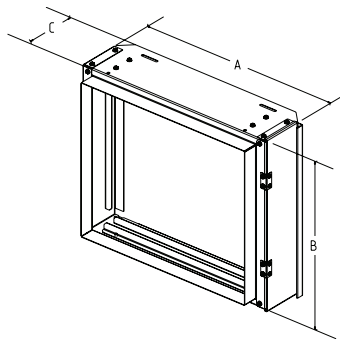

Table 1. Ducted filter rack dimensions

Unit	A	B	C
VSH 024, 033	35.8"	20.2"	5.5"
VSH 042, 050, 060	54.8"	20.2"	5.5"
VSV 024, 033	25.7"	22.4"	4.3"
VSV 042, 050	30.7"	26.6"	5.5"
VSV060	30.7"	40.2"	5.5"

System Balancing Hose Kit

Note: For more information, please reference *WSHP-PRC025*-EN*.

For automatic system balancing of a water source heat pump, the self-balancing hose kit provides a constant flow rate over the pressure differential range of 2 to 80 psid. As system pressure changes (through further addition of heat pumps, for example) each individual flow control valve will automatically adjust to the new system conditions. In variable water volume applications, a self-balancing hose kit can provide continuous balancing because of its ability to automatically adjust to the varying system conditions.

Note: At low differential pressure the flow area required to achieve higher flow can exceed the flow area available for the respective series. Therefore, the minimum pressure differential requirement is increased for the higher flow ranges of each series valve.

Motorized Water Valve (Accessory)

The motorized water valve is installed on the return line of the water loop system between the loop and the pump module loop. This isolation device is less expensive and a very effective alternative to the water regulating valve. A motorized water valve may be applied to each water source heat pump as part of the hose kit accessory.

When the compressor begins running, the valve will open, allowing water to flow through the unit. As the compressor shuts down, the valve slowly closes off. The main purpose of the motorized valve is to shut-off the flow of water through the unit when the unit is off, thus reducing water consumption. The motorized valve is fast opening to prevent compressor trip-out, and slow closing to prevent water hammer.

Application Considerations

Water-source heat pump systems are used to provide comfort in a wide range of building types and climates. The system utilizes energy-conserving, heat-recovery capabilities to transfer heat from one area to another to meet individual zone requirements. When used with system design and control strategies, these high-performance systems reduce operating costs for the building owner and improve occupant comfort. For more information on the design and control of these systems, refer to the Trane Water-Source and Ground-Source Heat Pump Systems application manual (literature number SYS-APM010*-EN).

Heat pump units are available in many different configurations and the design simplicity can be adapted to suit almost any building plan. The vertical and horizontal water-source heat pump system is versatile for installation in a boiler/cooling tower applications, as well as ground source (geothermal) applications.

Figure 1. Conventional water-source heat pump system

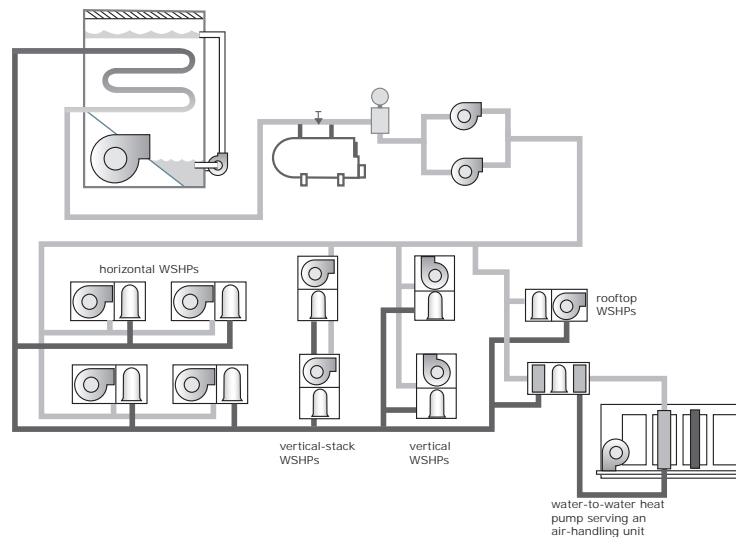

Boiler/Cooling Tower

In this type of system, units are distributed throughout the building to provide cooling and heating to the space. Units are connected to a water distribution loop which circulates water throughout the building to transfer heat from one area to another. This common water loop yields what is essentially a heat-recovery system. Units providing heating extract heat from loop water while units providing cooling reject heat to the loop. In effect the system recovers and redistributes heat where needed.

Also connected to this water loop are a “heat rejecter” such as a cooling tower, a “heat adder” such as a boiler, circulation pumps, and related accessories. Typically, outdoor air is conditioned and delivered by a separate, dedicated ventilation system.

During warm weather when all or most of the units are cooling, the cooling tower is used to dissipate heat from the condensing process. The condensing water is cooled for recirculation back to the water-to-refrigerant heat exchanger by using a combination of heat and mass transfer by evaporation.

A boiler is also used to add heat to the water loop during winter months when most units are heating. The boiler is typically enabled when the water loop temperature falls to a minimum value.

During moderate weather, such as spring or fall, the heat pumps serving the sunny side and interior of the building often operate in cooling mode and reject heat into the water loop. The heat pumps

servicing the shady side of the building often operate in heating mode and absorb heat from the water loop.

Heat rejected by the units operating in cooling mode is used to offset the heat absorbed by the units in heating mode. In this manner, a WSHP system provides a form of heat recovery and an opportunity to save energy by reducing the need to operate the boiler or cooling tower. For example, if the water temperature stays in the desired range-between 60°F (16°C) and 90°F (32°C)-neither the boiler nor the cooling tower need to operate.

In applications such as office buildings, heat generated by lights, people, and office equipment often results in the need to provide year-round cooling in the interior zones of the building. In these applications, the benefit of this heat recovery further reduces boiler energy use during the winter months.

Ground Source

The advantages of a geothermal heat pump system can literally cut business heating and cooling cost by 30 to 40 percent. In this application the cooling tower and boiler are replaced with a ground heat exchanger. The ground heat exchanger is a series of pipes buried in the earth. The earth is used as an energy storage tank. Ground-source heat pump systems offer the potential for saving energy because they can reduce (or eliminate) the energy needed to operate a cooling tower and/or boiler. Eliminating the cooling tower has architectural and maintenance advantages, and eliminating the boiler frees up floor space in the building.

Figure 2. Ground source heat pump system

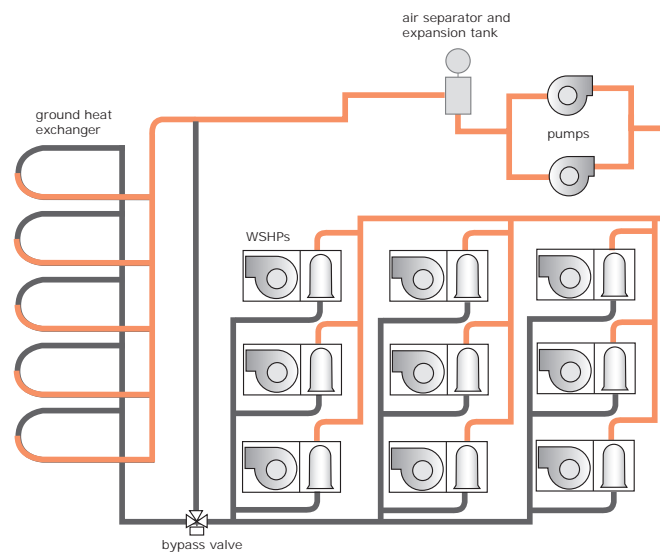

The fluctuating temperatures of fluid from the earth are more stable than air, allowing the equipment to operate at a lower discharge pressure and use fewer kilowatts. The constant earth temperature will heat or cool the fluid running through buried high density polyethylene pipe to provide heating and cooling to a building.

A geothermal loop can be installed either horizontally or vertically. Vertical loops require less overall land area to reject (i.e., sink) the excess heat from the building. Horizontal loops require trenches in the ground spanning a larger overall land area.

Although external piping is the responsibility of the installer and/or piping manufacturer, many electric utilities and rural electric cooperatives are offering monetary incentives to install geothermal systems. Utility companies offer the incentives because of reduced peak loads that flatten out their demand curve over time, and save them money. These savings are ultimately transferred to the consumer.

Hybrid Systems

Hybrid systems involve adding a small cooling tower or dry cooler to a ground source system that is installed in a cooling-dominated climate or adding a small boiler to a system in a heating-dominated climate. In either case, the geothermal heat exchanger is sized based on the smaller of the two loads: the total heat absorbed in a cooling-dominated climate or the total heat rejected in a heating-dominated climate. Then, a small cooling tower (or boiler) is added to reject (or add) the remaining heat.

A hybrid system may also be used in existing buildings with existing ground loops as additional rooms or buildings are added to the system. A cooling tower may be the solution to off-load the peak demand of the new building addition as an example. Other additions may include a requirement for fresh-air ventilation. A fresh-air, air handler, along with a water-to-water unit may be introduced to the closed loop system to allow tempered fresh-air into the building. Heat recovery from the loop itself can be shared with the other major components.

Hybrid systems can often make the system more economical, opening up the possibility to reap the potential energy savings.

Figure 3. Hybrid system

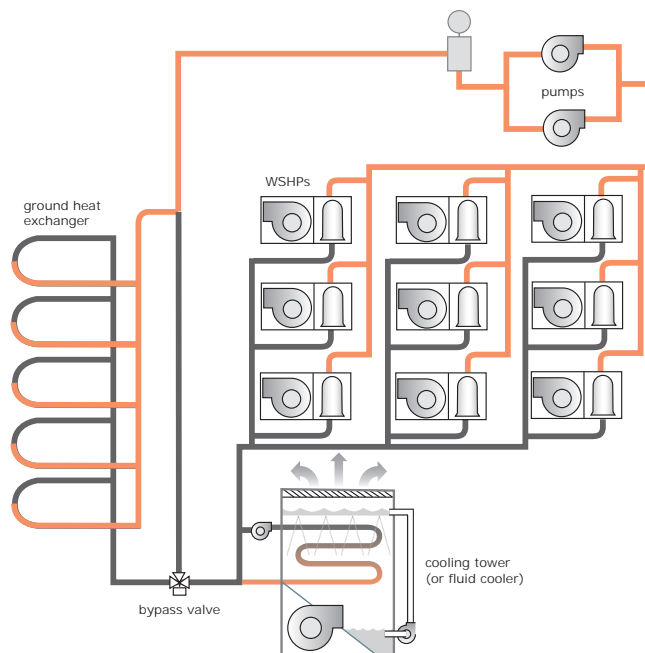

Water Loop Distribution

The individual water-source heat pumps are connected to a common water distribution loop. This loop consists of piping, pumps, valves, an air separator and expansion tank and other accessories. It connects to the heat rejecter and heat adder.

Water Circulating Pumps

Because a WSHP can only absorb or reject heat while water flows through the refrigerant-to-water heat exchanger, the water-circulating pumps play a critical role in the operation of the system.

Central Pumping System

Central pumping systems employ a single or dual pump design to fulfill pumping requirements for the entire building system. Pumps are usually installed downstream of the cooling tower and boiler

and upstream of the units to ensure positive water pressure throughout the system. The most common configuration is to use two pumps manifolded together with each pump sized to meet the flow requirements of the entire system. Only one of the pumps operates at any given time, with the second available as “standby” pump in case the operating pump was to fail.

- Hose kits are used to connect the water supply and return line to the water inlets and outlets. Trane offers various hose kit combinations to better facilitate system flow balancing. These flexible hoses also aid in the reduction of vibration between the unit and the rigid central piping system.
- A two position isolation valve is often applied to systems which incorporate variable frequency pumping. This valve is capable of stopping/starting water flow to the unit, which in turn reduces the pumping requirements for the entire system.
- The central system supply and return lines should be sized to handle the required flow with a minimum pressure drop.

Note: *Pipe will sweat if low temperature water is below the dew point of the surrounding space. Trane recommends that these lines be insulated to prevent damage from condensation when condenser loop is designed to be below 60°F. Equipment installed in attic/crawl space temperatures below 40°F may require antifreeze in the water loop.*

Distributed Pumping System

A distributed pumping system contains a single pump module connected directly to the unit’s supply and return. This module is typically field installed and piped to the unit. This design requires individual pump modules specifically sized for the flow requirement of the water-source heat pump. When the heat pump compressor turns off, the individual pump also turns off.

- Hose kits are used to connect the water supply and return line to the water inlets and outlets. Trane offers various hose kit combinations to better facilitate system flow balancing. These flexible hoses also aid in the reduction of vibration between the unit and the rigid central piping system.
- Trane's self-contained pump module and hose kit make a complete pumping package for distributed pumping systems. The module is designed for circulating commercial loops that require a maximum flow rate of 20 gpm. Each pump module is fully assembled for connection to water and electrical points. The kit contains all of the necessary components for the installation, operation and maintenance of a closed loop application. See WSHPC-IN-5 (72-9006-03) for electrical and dimensional requirements
- The distributed pumping system supply and return lines should be sized to handle the required flow with a minimum pressure drop.

Note: *Pipe will sweat if low temperature water is below the dew point of the surrounding space. Trane recommends that these lines be insulated to prevent damage from condensation when condenser loop is designed to be below 60°F. Equipment installed in attic/crawl space temperatures below 40°F may require antifreeze in the water loop.*

- The field supplied line voltage disconnect should be installed for branch circuit protection. Check local codes for requirements.
- The units 3/4-inch high voltage and 1/2-inch low voltage connections are located on the left corner of the unit. They are designed to accept conduit.
- Trane recommends that the condensate system be set-up per negative pressure trapping in consideration of the unit's draw-through design. With this properly trapped system, when condensate forms during normal operation, the water level in the trap rises until there is a constant outflow. Refer to the Axiom™ Installation and Operations manual for negative pressure trapping guidelines.
- For acoustically sensitive areas, a 1/2-inch thick field provided vibration pad should be installed below the vertical unit. This field provided piece should be equal to the overall foot-print size of the unit to provide sound damping of the unit while in operation.

Application Considerations

- Hose kits are used to connect the water supply and return lines to the water inlet and outlets. Trane includes various hose kit combinations to better facilitate system flow balancing. These flexible hoses, reduce vibration between the unit and the rigid piping system.

Duct Design for Noise Control

Proper acoustics are often a design requirement. Many problems associated with HVAC generated sound can be avoided by properly selecting and locating the components of the system. Acoustical modeling should be used to find the lowest cost design to meet a specific sound requirement.

For heat pumps that are installed outside of the occupied zone (such as horizontal, vertical, and rooftop models), a supply duct system is typically used to transport air from the WSHP to supply-air diffusers for delivery to the zone.

Figure 4. Proper return-air ducting

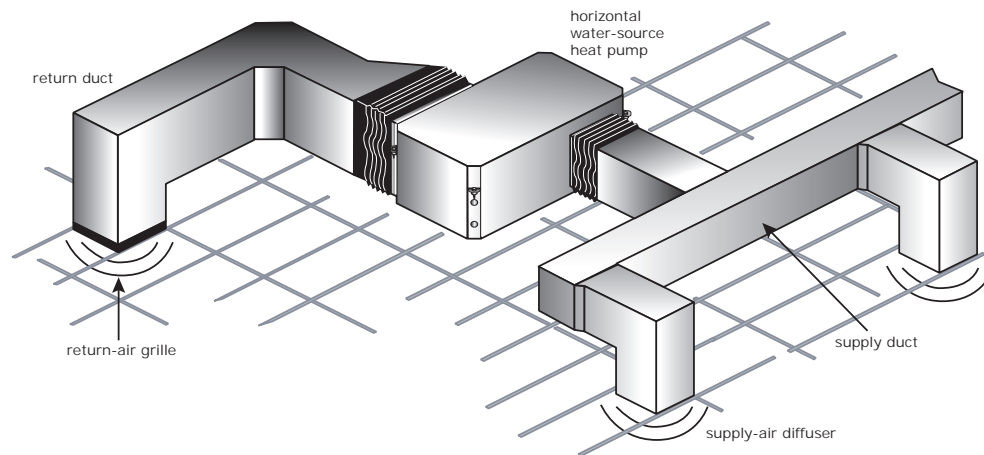

Other publications contain more complete details related to duct design, but following are a few general recommendations that should be considered when designing the supply duct system:

- Keep the duct layout as simple and symmetrical as possible.
- Use at least three diameters of straight duct for the first section downstream of the discharge from the WSHP.
- When possible, locate ceiling-mounted WSHPs above a hallway or other unoccupied area
- Limit the use of flexible ductwork
- Add a balancing damper in the run out duct for each supply air diffuser.

When designing the return-air path for a WSHP, consider the following general recommendations:

- Return-air grilles should not be undersized
- Return-air openings within the ceiling plenum should not be undersized
- Use an open ceiling plenum, rather than a ducted return whenever possible

A duct system with noise control in mind can be designed by:

- Keeping air velocities low
- Using aerodynamic fittings
- Using a duct liner if metal duct is applied
- Avoiding line-of-sight connections between a noise source and an outlet
- Avoiding line-of-site connections between a noise source and an inlet
- Properly locating balancing dampers

- Sealing cracks, seams and joints in the duct run and equipment panels
- Blocking transmission through walls, ceiling and floor
- Mounting and supporting the ductwork with isolation devices that absorb vibration
- Using flexible duct connections
- Using flexible braided hoses on the water connections

For more information on best practices for the design and layout of duct systems, refer to the Sheet Metal and Air Conditioning Contractors' National Association (SMACNA) manual, *HVAC Systems Duct Design*.

Dehumidification

The variable-speed fan motor (ECM), along with the variable-speed compressor, results in improved dehumidification performance at part-load conditions compared to a unit with a constant-speed fan. When the sensible cooling load in the space decreases, the heat pump responds by simultaneously reducing fan speed and compressor capacity. Reducing the airflow allows the coil to remove more moisture, and lengthens the compressor run-time, both of which improve dehumidification performance.

Note: This method of control does not provide independent (active) control of both space temperature and humidity. Therefore, in non-arid climates, Trane recommends the use of a dedicated outdoor-air system to dehumidify the outdoor air centrally, rather than relying on the heat pumps to provide sufficient dehumidification. This approach is more efficient than equipping the individual heat pumps with hot gas reheat.

For more information on the design and control of dedicated outdoor-air systems, refer to the Trane Dedicated Outdoor Air Systems application guide (literature number SYS-APG001*-EN).

Figure 5. Dehumidification Performance

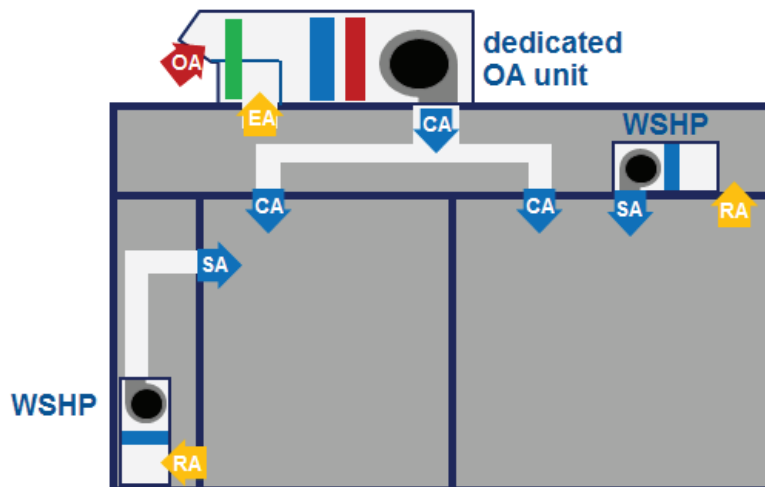



Model Number Descriptions

Digits 1-3 – Unit Configuration

VSH = Variable Speed Horizontal
VSV = Variable Speed Vertical

Digit 19 – Motor Type

A = ECM

Digit 4 – Development Sequence

E = R-410A Refrigerant

Digit 5-7 – Nominal Capacity

024 = 24 MBtuh
033 = 33 MBtuh
042 = 42 MBtuh
050 = 50 MBtuh
060 = 60 MBtuh

Digit 8 – Voltage (Volts/Hz/Phase)

1 = 208/60/1
2 = 230/60/1
4 = 460/60/3

Digit 9 – Heat Exchanger

1 = Copper Water Coil
2 = Cupro-Nickel Water Coil
7 = Insulated Copper Water Coil and Suction Lines
8 = Insulated Cupro-Nickel Water Coil and Suction Lines

Digit 10-11 – Current Design Sequence

Digit 12 – Control Type

F = UC400
G = UC400 w/Wireless Comm

Digit 13 – Freeze Protection

A = 20°F (Extended Range)
B = 35°F (Standard Range)

Digit 14 – Sales Order Special

0 = None
S = Sales Order Special

Digit 15 – Supply Air Arrangement

B = Back Supply Air
L = Left Supply Air
R = Right Supply Air
T = Top Supply Air

Digit 16 – Return Air Arrangement

L = Left Return Air
R = Right Return Air

Digit 17 – On/Off Switch

0 = None

Digit 18 – Filter Type

1 = 1" Throwaway Filter
2 = 2" Throwaway Filter
4 = 2" MERV 8
5 = 2" MERV 13

General Data

Figure 6. Horizontal Supply/Return Air Configuration

The unit's supply and return air configuration is built to order to meet unique installation requirements. The combinations include:

1. Left return air with back supply air
2. Left return air with right supply air
3. Right return air with left supply air
4. Right return air with back supply air

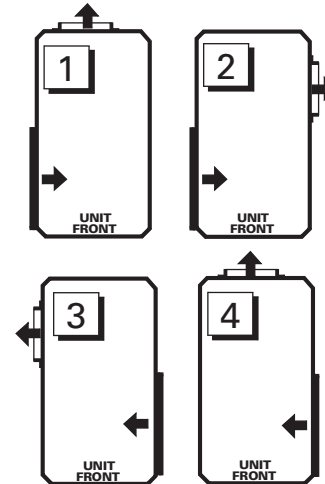

Figure 7. Vertical Supply/Return Air Configuration

The unit's supply and return air configuration is built to order to meet unique installation requirements. The combinations include:

1. Right return-air with top supply-air combination
2. Right return-air with back supply-air combination
3. Left return-air with top supply -air combination
4. Left return-air with back supply-air combination

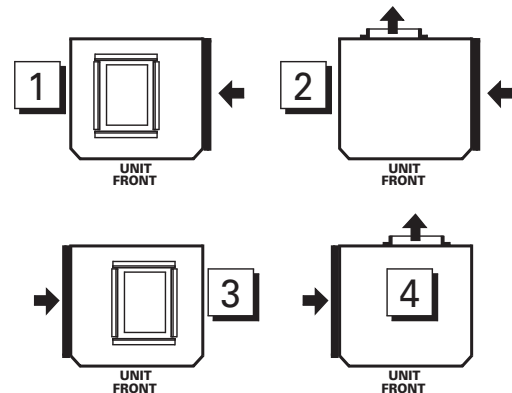

Table 2. Cabinet

Model VSH*		VSH*024	VSH*033	VSH*042	VSH*050	VSH*060
Unit size	Length (inch)	60.2	60.2	81.2	81.2	81.2
	Height (inch)	22.0	22.0	22.0	22.0	22.0
	Width (inch)	26.0	26.0	26.0	26.0	26.0
Compressor type		Rotary	Rotary	Scroll	Scroll	Scroll
Approximate weight	With pallet (lb)	381	381	591	591	591
	Without pallet (lb)	333	333	524	524	524
Nominal Filter size	Inches	16 x 20	16 x 20	20 x 25	20 x 25	20 x 25
	Inches	20 x 20	20 x 20	20 x 30	20 x 30	20 x 30
Water in/out size (NPTI)	Inches	3/4	3/4	1	1	1
Condensate size (NPTI)	Inches	3/4	3/4	3/4	3/4	3/4
Blower wheel size	Direct drive (inch)	11 x 10	11 x 10	11 x 10	11 x 10	11 x 10



General Data

Table 3. Air-to-refrigerant coil

Model VSH*	VSH*024	VSH*033	VSH*042	VSH*050	VSH*060
Working pressure	650	650	650	650	650
Tubes high	20	20	20	20	20
Tubes deep	3	3	4	4	4
Number of circuits	3	3	5	5	5
Finned volume (H, W, D: inches)	20 x 31.5 x 2.6	20 x 31.5 x 2.6	20 x 51 x 3.5	20 x 51 x 3.5	20 x 51 x 3.5
Coil surface area (ft ²)	4.375	4.375	7.083	7.083	7.083
Fins per inch	12	12	12	12	12
Tube material	Copper	Copper	Copper	Copper	Copper
Tube OD (inch)	3/8	3/8	3/8	3/8	3/8
Wall thickness (inch)	0.014	0.014	0.014	0.014	0.014
Return bends	Copper	Copper	Copper	Copper	Copper

Table 4. Water volume

Model VSH*	VSH*024	VSH*033	VSH*042	VSH*050	VSH*060
Internal water volume (in ³)	142.4	142.4	331.2	331.2	331.2
Internal water volume (ft ³)	0.082	0.082	0.192	0.192	0.192
Internal water volume (gal)	0.616	0.616	1.434	1.434	1.434

Table 5. Cabinet

Model VSV*		VSV*024	VSV*033	VSV*042	VSV*050	VSV*060
Unit size	Length (inch)	26-1/2	26-1/2	30-1/2	30-1/2	30 1/2
	Height (inch)	41-7/8	41-7/8	46-7/8	46-7/8	62 1/2
	Width (inch)	24-1/2	24-1/2	26-1/2	26-1/2	26
Compressor type		Rotary	Rotary	Scroll	Scroll	Scroll
Approximate weight	With pallet (lb)	334	334	495	495	511
	Without pallet (lb)	309	309	460	460	488
Nominal Filter size	Inches	20 x 25	20 x 25	24 x 30	24 x 30	(2) 20 x 30
Water in/out size (NPTI)	Inches	3/4	3/4	1	1	1
Condensate size (NPTI)	Inches	3/4	3/4	3/4	3/4	3/4
Blower wheel size	Direct drive (inch)	11 x 8	11 x 8	12 x 11	12 x 11	11 x 10

Table 6. Air-to-refrigerant coil

Model VSV*	VSV*024	VSV*033	VSV*042	VSV*50	VSV*060
Working pressure	650	650	650	650	650
Tubes high	18	18	24	24	39
Tubes deep	3	3	4	4	4
Number of circuits	4	4	6	6	6
Finned volume (H, W, D: inches)	18 x 21 x 2.6	18 x 21 x 2.6	24 x 25 x 3.5	24 x 25 x 3.5	39 x 29.3 x 3.5
Coil surface area (ft ²)	2.63	2.63	4.17	4.17	6.97
Fins per inch	12	12	12	12	12
Tube material	Copper	Copper	Copper	Copper	Copper
Tube OD (inch)	3/8	3/8	3/8	3/8	3/8

Table 6. Air-to-refrigerant coil (continued)

Model VSV*	VSV*024	VSV*033	VSV*042	VSV*50	VSV*060
Wall thickness (inch)	0.014	0.014	0.014	0.014	0.014
Return bends	Copper	Copper	Copper	Copper	Copper

Table 7. Water volume

Model VSV*	VSV*024	VSV*033	VSV*042	VSV*050	VSV*060
Internal water volume (in ³)	212	212	414	414	414
Internal water volume (ft ³)	0.123	0.123	0.24	0.24	0.24
Internal water volume (gal)	0.918	0.918	1.792	1.792	1.792



Performance Data

Table 8. ANSI/AHRI/ASHRAE/ISO13256-1 Ratings (VSH)^(a)

Model	Load	Rated GPM	Rated CFM	Water Loop Heat Pump				Ground Water Heat Pump				Ground Loop Heat Pump			
				Cooling 86°F		Heating 68°F		Cooling 59°F		Heating 50°F		Full Cool 77°F Part Cool 68°		Full Heat 32°F Part Heat 41°F	
				Capacity Btuh	EER	Capacity Btuh	COP	Capacity Btuh	EER	Capacity Btuh	COP	Capacity Btuh	EER	Capacity Btuh	COP
VSH*024	Full	6.2	930	25,100	18.3	30,300	6.4	28,400	31.7	24,300	5.3	26,200	21.8	18,500	4.3
VSH*024	Part	6.2	625	13,800	23.6	15,900	8.6	15,500	48.2	12,400	6.3	15,000	36.4	10,300	4.9
VSH*033	Full	8.6	1200	33,800	15.7	40,200	5.8	37,900	25.0	32,300	4.9	35,300	18.5	24,700	4.1
VSH*033	Part	8.6	720	17,600	21.9	21,000	7.7	19,700	41.8	16,600	5.9	18,900	32.2	14,300	4.9
VSH*042	Full	10.5	1650	42,600	18.6	51,800	6.7	47,300	30.9	42,000	5.6	44,600	22.0	31,500	4.5
VSH*042	Part	10.5	1065	24,100	23.2	29,800	8.2	27,200	48.4	23,500	6.4	26,100	35.3	18,800	5.3
VSH*050	Full	12.7	1890	50,200	16.5	64,400	5.8	56,200	26.0	52,500	5.1	52,400	19.3	40,100	4.2
VSH*050	Part	12.7	1200	28,400	22.2	36,100	7.5	32,400	42.0	29,100	6.1	31,000	33.6	24,000	5.2
VSH*060	Full	15.6	2100	60,700	14.8	81,600	5.3	67,300	22.8	66,800	4.7	63,200	17.0	50,400	3.8
VSH*060	Part	15.6	1323	36,400	20.5	46,500	6.7	40,900	37.5	37,400	5.7	39,100	31.4	31,300	5.0

(a) Rated in accordance with ANSI/AHRI/ASHRAE/ISO13256-1. Certified conditions are 80.6°F DB/66.2°F WB EAT in cooling and 68°F DB/59°F WB EAT in heating. Entering liquid temperature in cooling is 86°F for Water Loop, 77°F for Ground Loop (full load), 68°F for Ground Loop (part load), and 59°F for Ground Water. Entering liquid temperature in heating is 68°F for Water Loop, 32°F for Ground Loop (full load), 41°F for Ground Loop (part load), and 50°F for Ground Water.

Table 9. ANSI/AHRI/ASHRAE/ISO13256-1 Ratings (VSV)^(a)

Model	Load	Rated GPM	Rated CFM	Water Loop Heat Pump				Ground Water Heat Pump				Ground Loop Heat Pump			
				Cooling 86°F		Heating 68°F		Cooling 59°F		Heating 50°F		Full Cool 77°F Part Cool 68°		Full Heat 32°F Part Heat 41°F	
				Capacity Btuh	EER	Capacity Btuh	COP	Capacity Btuh	EER	Capacity Btuh	COP	Capacity Btuh	EER	Capacity Btuh	COP
VSV*024	Full	6.2	930	24,600	18.4	30,300	6.1	27,800	33.2	24,400	5.2	25,900	22.3	18,400	4.1
VSV*024	Part	6.2	625	13,100	22.5	15,900	7.6	15,000	48.4	12,100	6.1	14,300	35.3	9,900	4.8
VSV*033	Full	8.3	1200	32,900	15.4	40,400	5.4	36,600	24.6	32,400	4.7	34,300	18.0	24,500	3.8
VSV*033	Part	8.3	720	17,100	20.8	21,500	6.9	19,400	40.7	16,800	5.5	18,500	31.5	14,100	4.6
VSV*042	Full	10.9	1650	44,100	18.2	54,700	5.9	50,100	32.4	43,600	5.0	46,200	22.0	31,900	3.9
VSV*042	Part	10.9	1065	25,500	24.1	29,400	7.5	28,700	51.2	22,700	5.8	26,900	40.5	17,800	4.5
VSV*050	Full	13.0	1890	51,200	15.7	68,800	5.3	57,800	26.1	54,600	4.5	54,100	18.7	41,400	3.7
VSV*050	Part	13.0	1200	29,900	22.0	36,800	6.8	33,500	42.4	28,500	5.5	32,800	34.0	23,400	4.6
VSV*060	Full	15.6	2100	61,800	15.6	81,200	5.5	70,400	25.4	65,400	4.8	64,600	18.3	50,000	4.0
VSV*060	Part	15.6	1323	35,900	21.2	46,300	7.3	41,300	41.3	36,200	5.9	39,600	32.8	30,400	5.2

(a) Rated in accordance with ANSI/AHRI/ASHRAE/ISO13256-1. Certified conditions are 80.6°F DB/66.2°F WB EAT in cooling and 68°F DB/59°F WB EAT in heating. Entering liquid temperature in cooling is 86°F for Water Loop, 77°F for Ground Loop (full load), 68°F for Ground Loop (part load), and 59°F for Ground Water. Entering liquid temperature in heating is 68°F for Water Loop, 32°F for Ground Loop (full load), 41°F for Ground Loop (part load), and 50°F for Ground Water.

Table 10. Cooling capacities - VSH*024

EWT	GPM	Gross (MBtuh)	Sen (MBtuh)	SHR	Compressor Power (kW)	Reject (MBtuh)	LWT	Feet Head
45	4.0	31.3	21.9	0.70	0.60	33.3	61.7	2.1
45	5.0	31.5	22.1	0.70	0.57	33.4	58.4	3.0
45	5.6	31.6	22.2	0.70	0.55	33.5	57.0	3.7
45	6.2	31.6	22.2	0.70	0.54	33.4	55.8	4.3

Table 10. Cooling capacities - VSH*024 (continued)

EWT	GPM	Gross (MBtuh)	Sen (MBtuh)	SHR	Compressor Power (kW)	Reject (MBtuh)	LWT	Feet Head
45	6.5	31.6	22.2	0.70	0.53	33.4	55.3	4.7
45	6.8	31.7	22.2	0.70	0.53	33.5	54.9	5.0
45	7.4	31.7	22.2	0.70	0.52	33.5	54.1	5.8
55	4.0	29.6	21.3	0.72	0.88	32.6	71.3	2.0
55	5.0	29.8	21.4	0.72	0.85	32.7	68.1	2.9
55	5.6	29.8	21.4	0.72	0.83	32.6	66.6	3.5
55	6.2	29.9	21.5	0.72	0.82	32.7	65.5	4.1
55	6.5	29.9	21.5	0.72	0.81	32.7	65.1	4.4
55	6.8	29.9	21.5	0.72	0.81	32.7	64.6	4.7
55	7.4	30.0	21.6	0.72	0.80	32.7	63.8	5.4
65	4.0	28.3	20.9	0.74	1.06	31.9	81.0	1.9
65	5.0	28.5	21.0	0.74	1.03	32.0	77.8	2.7
65	5.6	28.6	21.1	0.74	1.01	32.1	76.5	3.3
65	6.2	28.6	21.1	0.74	1.00	32.0	75.3	3.9
65	6.5	28.6	21.1	0.74	0.99	32.0	74.8	4.2
65	6.8	28.7	21.2	0.74	0.99	32.1	74.4	4.5
65	7.4	28.7	21.2	0.74	0.98	32.0	73.6	5.2
75	4.0	27.2	20.6	0.76	1.22	31.3	90.7	1.8
75	5.0	27.3	20.7	0.76	1.18	31.3	87.5	2.6
75	5.6	27.4	20.8	0.76	1.17	31.4	86.2	3.1
75	6.2	27.4	20.8	0.76	1.16	31.3	85.1	3.7
75	6.5	27.5	20.9	0.76	1.15	31.4	84.7	4.0
75	6.8	27.5	20.9	0.76	1.15	31.4	84.2	4.3
75	7.4	27.5	20.9	0.76	1.14	31.4	83.5	4.9
85	4.0	26.0	20.3	0.78	1.38	30.7	100.4	1.7
85	5.0	26.1	20.4	0.78	1.34	30.7	97.3	2.5
85	5.6	26.2	20.5	0.78	1.33	30.7	96.0	3.0
85	6.2	26.2	20.5	0.78	1.32	30.7	94.9	3.5
85	6.5	26.3	20.6	0.78	1.31	30.8	94.5	3.8
85	6.8	26.3	20.6	0.78	1.31	30.8	94.1	4.1
85	7.4	26.3	20.6	0.78	1.30	30.7	93.3	4.7
95	4.0	24.6	19.9	0.81	1.54	29.9	110.0	1.6
95	5.0	24.8	20.0	0.81	1.51	30.0	107.0	2.4
95	5.6	24.9	20.1	0.81	1.50	30.0	105.7	2.8
95	6.2	24.9	20.1	0.81	1.48	30.0	104.7	3.4
95	6.5	24.9	20.1	0.81	1.48	29.9	104.2	3.6
95	6.8	25.0	20.2	0.81	1.47	30.0	103.8	3.9
95	7.4	25.0	20.2	0.81	1.47	30.0	103.1	4.5
105	4.0	23.2	19.5	0.84	1.71	29.0	119.5	1.6
105	5.0	23.4	19.6	0.84	1.68	29.1	116.6	2.3
105	5.6	23.5	19.7	0.84	1.67	29.2	115.4	2.7
105	6.2	23.5	19.7	0.84	1.65	29.1	114.4	3.2
105	6.5	23.5	19.7	0.84	1.65	29.1	114.0	3.5
105	6.8	23.6	19.8	0.84	1.64	29.2	113.6	3.8



Performance Data

Table 10. Cooling capacities - VSH*024 (continued)

EWT	GPM	Gross (MBtuh)	Sen (MBtuh)	SHR	Compressor Power (kW)	Reject (MBtuh)	LWT	Feet Head
105	7.4	23.6	19.8	0.84	1.64	29.2	112.9	4.4
115	4.0	21.8	19.1	0.88	1.89	28.2	129.1	1.5
115	5.0	21.9	19.2	0.88	1.86	28.2	126.3	2.2
115	5.6	22.0	19.3	0.88	1.84	28.3	125.1	2.6
115	6.2	22.0	19.3	0.88	1.83	28.2	124.1	3.1
115	6.5	22.1	19.3	0.87	1.82	28.3	123.7	3.4
115	6.8	22.1	19.3	0.87	1.82	28.3	123.3	3.6
115	7.4	22.1	19.3	0.87	1.81	28.3	122.6	4.2
120	4.0	21.0	18.8	0.90	1.98	27.8	133.9	1.5
120	5.0	21.1	18.9	0.90	1.95	27.8	131.1	2.1
120	5.6	21.2	19.0	0.90	1.94	27.8	129.9	2.6
120	6.2	21.3	19.1	0.90	1.92	27.9	129.0	3.0
120	6.5	21.3	19.1	0.90	1.92	27.8	128.6	3.3
120	6.8	21.3	19.1	0.90	1.91	27.8	128.2	3.6
120	7.4	21.3	19.1	0.90	1.91	27.8	127.5	4.1

Note: Cooling performance data is tabulated at 80°F DB/67°F WB entering air at ANSI/AHRI/ASHRAE/ISO13256-1 rated CFM. For ANSI/AHRI/ASHRAE/ISO13256-1 certified ratings, refer to the ANSI/AHRI/ASHRAE/ISO13256-1 performance table. See performance correction tables to correct performance at conditions other than those tabulated. Rated GPM: 6.2; Minimum CFM: 695; Rated CFM: 930; Maximum CFM: 1024.

Table 11. Heating capacities - VSH*024

EWT	GPM	Gross (MBtuh)	Absorb (MBtuh)	Compressor Power (kW)	LWT	Feet Head
25	5.6	16.4	12.4	1.18	20.6	4.2
25	6.2	16.4	12.4	1.18	21.0	5.0
25	6.5	16.4	12.4	1.18	21.2	5.4
25	6.8	16.4	12.4	1.19	21.4	5.8
25	7.4	16.4	12.4	1.19	21.6	6.7
35	4.0	19.6	15.3	1.25	27.4	2.2
35	5.0	19.7	15.4	1.26	28.8	3.3
35	5.6	19.8	15.5	1.26	29.5	3.9
35	6.2	19.8	15.5	1.26	30.0	4.6
35	6.5	19.8	15.5	1.26	30.2	5.0
35	6.8	19.9	15.6	1.26	30.4	5.4
35	7.4	19.9	15.6	1.26	30.8	6.2
45	4.0	22.7	18.3	1.30	35.9	2.1
45	5.0	22.9	18.4	1.31	37.6	3.0
45	5.6	23.0	18.5	1.31	38.4	3.7
45	6.2	23.1	18.6	1.31	39.0	4.3
45	6.5	23.2	18.7	1.31	39.2	4.7
45	6.8	23.2	18.7	1.31	39.5	5.0
45	7.4	23.3	18.8	1.31	39.9	5.8
55	4.0	25.8	21.2	1.34	44.4	2.0
55	5.0	26.1	21.5	1.34	46.4	2.9
55	5.6	26.3	21.7	1.35	47.3	3.5
55	6.2	26.5	21.9	1.35	47.9	4.1

Table 11. Heating capacities - VSH*024 (continued)

EWT	GPM	Gross (MBtuh)	Absorb (MBtuh)	Compressor Power (kW)	LWT	Feet Head
55	6.5	26.5	21.9	1.35	48.3	4.4
55	6.8	26.6	22.0	1.35	48.5	4.7
55	7.4	26.7	22.1	1.35	49.0	5.4
65	4.0	29.0	24.3	1.37	52.9	1.9
65	5.0	29.5	24.8	1.38	55.1	2.7
65	5.6	29.7	25.0	1.39	56.1	3.3
65	6.2	29.9	25.2	1.39	56.9	3.9
65	6.5	30.0	25.2	1.39	57.2	4.2
65	6.8	30.1	25.3	1.39	57.6	4.5
65	7.4	30.1	25.3	1.40	58.2	5.2
75	4.0	32.4	27.5	1.43	61.3	1.8
75	5.0	33.0	28.1	1.44	63.8	2.6
75	5.6	33.3	28.4	1.44	64.9	3.1
75	6.2	33.6	28.7	1.45	65.7	3.7
75	6.5	33.7	28.8	1.45	66.1	4.0
75	6.8	33.8	28.8	1.45	66.5	4.3
75	7.4	33.9	28.9	1.45	67.2	4.9
85	4.0	36.1	31.0	1.50	69.5	1.7
85	5.0	36.9	31.7	1.52	72.3	2.5
85	5.6	37.3	32.1	1.53	73.5	3.0
85	6.2	37.6	32.4	1.53	74.5	3.5
85	6.5	37.7	32.5	1.54	75.0	3.8
85	6.8	37.8	32.6	1.54	75.4	4.1
85	7.4	37.9	32.6	1.54	76.2	4.7

Note: Heating performance data is tabulated at 70°F DB at rated CFM. See correction factor tables to correct performance at conditions other than those tabulated. Interpolation of data is permissible; extrapolation is not. Rated GPM: 6.2; Minimum CFM: 837; Rated CFM: 930; Maximum CFM: 1024. For ANSI/AHRI/ASHRAE/ISO13256-1 certified ratings, refer to the ANSI/AHRI/ASHRAE/ISO13256-1 performance table.

Table 12. Fan correction factors - VSH*024

Entering CFM	Cooling Capacity	Sensible Capacity	Cooling Comp Watts	Heating Capacity	Heating Comp Watts
695	0.952	0.848	0.995	0.975	1.109
742	0.963	0.878	0.996	0.980	1.081
836	0.983	0.939	0.998	0.991	1.035
883	0.992	0.969	0.999	0.996	1.017
930	1.000	1.000	1.000	1.000	1.000
977	1.008	1.031	1.001	1.004	0.985
1024	1.015	1.062	1.002	1.007	0.971

Table 13. Cooling capacities - VSV*024

EWT	GPM	Gross (MBtuh)	Sen (MBtuh)	SHR	Compressor Power (kW)	Reject (MBtuh)	LWT	Feet Head
45	4.0	30.2	21.4	0.71	0.68	32.5	61.3	2.1
45	5.0	30.3	21.5	0.71	0.66	32.5	58.0	3.2
45	5.6	30.4	21.6	0.71	0.64	32.6	56.6	3.9



Performance Data

Table 13. Cooling capacities - VSV*024 (continued)

EWT	GPM	Gross (MBtuh)	Sen (MBtuh)	SHR	Compressor Power (kW)	Reject (MBtuh)	LWT	Feet Head
45	6.2	30.4	21.6	0.71	0.63	32.6	55.5	4.6
45	6.5	30.4	21.6	0.71	0.63	32.5	55.0	5.0
45	6.8	30.4	21.6	0.71	0.63	32.5	54.6	5.4
45	7.4	30.4	21.6	0.71	0.62	32.5	53.8	6.2
55	4.0	29.1	21.2	0.73	0.76	31.7	70.9	2.0
55	5.0	29.3	21.4	0.73	0.74	31.8	67.7	3.0
55	5.6	29.4	21.5	0.73	0.73	31.9	66.4	3.7
55	6.2	29.5	21.5	0.73	0.72	32.0	65.3	4.4
55	6.5	29.5	21.5	0.73	0.72	32.0	64.8	4.7
55	6.8	29.5	21.5	0.73	0.72	31.9	64.4	5.1
55	7.4	29.6	21.6	0.73	0.71	32.0	63.6	5.9
65	4.0	27.9	21.2	0.76	0.99	31.3	80.7	1.9
65	5.0	28.2	21.4	0.76	0.97	31.5	77.6	2.8
65	5.6	28.3	21.5	0.76	0.95	31.6	76.3	3.5
65	6.2	28.4	21.6	0.76	0.94	31.6	75.2	4.1
65	6.5	28.4	21.6	0.76	0.94	31.6	74.7	4.5
65	6.8	28.5	21.7	0.76	0.94	31.7	74.3	4.9
65	7.4	28.5	21.7	0.76	0.93	31.7	73.6	5.6
75	4.0	26.7	20.6	0.77	1.11	30.5	90.3	1.8
75	5.0	27.0	20.8	0.77	1.09	30.7	87.3	2.7
75	5.6	27.1	20.9	0.77	1.07	30.8	86.0	3.3
75	6.2	27.2	20.9	0.77	1.06	30.8	84.9	3.9
75	6.5	27.2	20.9	0.77	1.06	30.8	84.5	4.3
75	6.8	27.3	21.0	0.77	1.05	30.9	84.1	4.6
75	7.4	27.3	21.0	0.77	1.05	30.9	83.4	5.4
85	4.0	25.3	20.2	0.80	1.30	29.7	99.9	1.7
85	5.0	25.6	20.5	0.80	1.27	29.9	97.0	2.5
85	5.6	25.7	20.6	0.80	1.26	30.0	95.7	3.1
85	6.2	25.8	20.6	0.80	1.25	30.1	94.7	3.7
85	6.5	25.9	20.7	0.80	1.24	30.1	94.3	4.1
85	6.8	25.9	20.7	0.80	1.24	30.1	93.9	4.4
85	7.4	26.0	20.8	0.80	1.23	30.2	93.2	5.1
95	4.0	23.9	19.6	0.82	1.45	28.9	109.5	1.6
95	5.0	24.2	19.8	0.82	1.42	29.0	106.6	2.4
95	5.6	24.4	20.0	0.82	1.41	29.2	105.4	3.0
95	6.2	24.5	20.1	0.82	1.40	29.3	104.5	3.6
95	6.5	24.5	20.1	0.82	1.39	29.2	104.0	3.9
95	6.8	24.5	20.1	0.82	1.39	29.2	103.6	4.2
95	7.4	24.6	20.2	0.82	1.38	29.3	102.9	4.9

Table 13. Cooling capacities - VSV*024 (continued)

EWT	GPM	Gross (MBtuh)	Sen (MBtuh)	SHR	Compressor Power (kW)	Reject (MBtuh)	LWT	Feet Head
105	4.0	22.6	19.2	0.85	1.61	28.1	119.1	1.5
105	5.0	22.8	19.4	0.85	1.58	28.2	116.3	2.3
105	5.6	23.0	19.6	0.85	1.57	28.4	115.1	2.8
105	6.2	23.0	19.6	0.85	1.56	28.3	114.1	3.4
105	6.5	23.1	19.6	0.85	1.55	28.4	113.7	3.7
105	6.8	23.1	19.6	0.85	1.55	28.4	113.4	4.0
105	7.4	23.2	19.7	0.85	1.54	28.5	112.7	4.6
115	4.0	21.3	18.7	0.88	1.78	27.4	128.7	1.4
115	5.0	21.5	18.9	0.88	1.75	27.5	126.0	2.1
115	5.6	21.6	19.0	0.88	1.74	27.5	124.8	2.7
115	6.2	21.7	19.1	0.88	1.73	27.6	123.9	3.2
115	6.5	21.7	19.1	0.88	1.73	27.6	123.5	3.5
115	6.8	21.7	19.1	0.88	1.72	27.6	123.1	3.8
115	7.4	21.8	19.2	0.88	1.72	27.7	122.5	4.4
120	4.0	20.7	18.6	0.90	1.87	27.1	133.6	1.4
120	5.0	20.9	18.8	0.90	1.85	27.2	130.9	2.1
120	5.6	20.9	18.8	0.90	1.83	27.2	129.7	2.6
120	6.2	21.0	18.9	0.90	1.82	27.2	128.8	3.1
120	6.5	21.0	18.9	0.90	1.82	27.2	128.4	3.4
120	6.8	21.1	19.0	0.90	1.82	27.3	128.0	3.7
120	7.4	21.1	19.0	0.90	1.81	27.3	127.4	4.3

Note: Cooling performance data is tabulated at 80°F DB/67°F WB entering air at ANSI/AHRI/ASHRAE/ISO13256-1 rated CFM. For ANSI/AHRI/ASHRAE/ISO13256-1 certified ratings, refer to the ANSI/AHRI/ASHRAE/ISO13256-1 performance table. See performance correction tables to correct performance at conditions other than those tabulated. Rated GPM: 6.2; Minimum CFM: 837; Rated CFM: 930; Maximum CFM: 1023.

Table 14. Heating capacities - VSV*024

EWT	GPM	Gross (MBtuh)	Absorb (MBtuh)	Compressor Power (kW)	LWT	Feet Head
25	5.6	16.2	12.0	1.22	20.7	4.2
25	6.2	16.3	12.1	1.22	21.1	5.0
25	6.5	16.3	12.1	1.22	21.3	5.4
25	6.8	16.4	12.2	1.22	21.4	5.8
25	7.4	16.5	12.3	1.22	21.7	6.7
35	4.0	18.4	14.1	1.26	28.0	2.3
35	5.0	18.8	14.5	1.27	29.2	3.3
35	5.6	19.0	14.7	1.27	29.8	4.1
35	6.2	19.2	14.9	1.27	30.2	4.8
35	6.5	19.2	14.9	1.27	30.4	5.2
35	6.8	19.3	14.9	1.28	30.6	5.6
35	7.4	19.4	15.0	1.28	30.9	6.5
45	4.0	22.1	17.6	1.31	36.2	2.1



Performance Data

Table 14. Heating capacities - VSV*024 (continued)

EWT	GPM	Gross (MBtuh)	Absorb (MBtuh)	Compressor Power (kW)	LWT	Feet Head
45	5.0	22.6	18.1	1.32	37.8	3.2
45	5.6	22.8	18.3	1.32	38.5	3.9
45	6.2	23.0	18.5	1.33	39.0	4.6
45	6.5	23.1	18.6	1.33	39.3	5.0
45	6.8	23.2	18.7	1.33	39.5	5.4
45	7.4	23.3	18.8	1.33	39.9	6.2
55	4.0	25.0	20.3	1.36	44.9	2.0
55	5.0	25.6	20.9	1.37	46.6	3.0
55	5.6	25.9	21.2	1.38	47.4	3.7
55	6.2	26.2	21.5	1.38	48.1	4.4
55	6.5	26.3	21.6	1.39	48.4	4.7
55	6.8	26.4	21.7	1.39	48.6	5.1
55	4.0	25.0	20.3	1.36	44.9	2.0
55	7.4	26.6	21.8	1.39	49.1	5.9
65	4.0	28.1	23.4	1.39	53.3	1.9
65	5.0	28.8	24.0	1.40	55.4	2.8
65	5.6	29.2	24.4	1.41	56.3	3.5
65	6.2	29.5	24.7	1.42	57.0	4.1
65	6.5	29.7	24.9	1.42	57.3	4.5
65	6.8	29.8	24.9	1.42	57.7	4.9
75	4.0	31.4	26.4	1.45	61.8	1.8
75	5.0	32.3	27.3	1.47	64.1	2.7
75	5.6	32.8	27.7	1.48	65.1	3.3
75	6.2	33.2	28.1	1.49	65.9	3.9
75	6.5	33.4	28.3	1.49	66.3	4.3
75	6.8	33.5	28.4	1.50	66.6	4.6
75	7.4	33.8	28.7	1.50	67.2	5.4
85	4.0	34.9	29.7	1.53	70.2	1.7
85	5.0	36.1	30.8	1.55	72.7	2.5
85	5.6	36.7	31.4	1.56	73.8	3.1
85	6.2	37.1	31.7	1.58	74.8	3.7
85	6.5	37.4	32.0	1.58	75.2	4.1
85	6.8	37.5	32.1	1.58	75.6	4.4
85	7.4	37.9	32.5	1.59	76.2	5.1

Note: Heating performance data is tabulated at 70°F DB at rated CFM. See correction factor tables to correct performance at conditions other than those tabulated. Interpolation of data is permissible; extrapolation is not. Rated GPM: 6.2; Minimum CFM: 837; Rated CFM: 930; Maximum CFM: 1023. For ANSI/AHRI/ASHRAE/ISO13256-1 certified ratings, refer to the ANSI/AHRI/ASHRAE/ISO13256-1 performance table.

Table 15. Fan correction factors - VSV*024

Entering CFM	Cooling Capacity	Sensible Capacity	Cooling Input Watts	Heating Capacity	Heating Input Watts
837	0.979	0.938	0.998	0.992	1.036
884	0.988	0.967	0.999	0.996	1.017
930	0.996	0.996	1.000	1.000	1.000
977	1.004	1.026	1.001	1.004	0.985
1023	1.011	1.055	1.002	1.007	0.972

Table 16. Cooling capacities - VSH*033

EWT	GPM	Gross (MBtuh)	Sen (MBtuh)	SHR	Compressor Power (kW)	Reject (MBtuh)	LWT	Feet Head
45	5.6	41.2	27.9	0.68	1.05	44.8	61.0	3.7
45	6.9	41.4	28.0	0.68	1.01	44.8	58.0	5.1
45	7.7	41.5	28.1	0.68	0.99	44.9	56.7	6.1
45	8.6	41.5	28.1	0.68	0.97	44.8	55.4	7.3
45	9.0	41.5	28.1	0.68	0.96	44.8	55.0	7.9
45	9.5	41.6	28.2	0.68	0.96	44.9	54.5	8.6
45	10.3	41.6	28.2	0.68	0.95	44.8	53.7	9.9
55	5.6	39.8	27.7	0.70	1.44	44.7	71.0	3.5
55	6.9	40.0	27.8	0.70	1.40	44.8	68.0	4.9
55	7.7	40.1	27.9	0.70	1.38	44.8	66.6	5.8
55	8.6	40.1	27.9	0.70	1.36	44.7	65.4	7.0
55	9.0	40.2	27.9	0.69	1.35	44.8	65.0	7.5
55	9.5	40.2	27.9	0.69	1.35	44.8	64.4	8.2
55	10.3	40.2	27.9	0.69	1.33	44.8	63.7	9.4
65	5.6	38.3	27.2	0.71	1.67	44.0	80.7	3.3
65	6.9	38.5	27.3	0.71	1.63	44.1	77.8	4.6
65	7.7	38.6	27.4	0.71	1.61	44.1	76.5	5.5
65	8.6	38.7	27.5	0.71	1.59	44.1	75.3	6.6
65	9.0	38.7	27.5	0.71	1.58	44.1	74.8	7.1
65	9.5	38.7	27.5	0.71	1.58	44.1	74.3	7.8
65	10.3	38.8	27.5	0.71	1.57	44.1	73.6	8.9
75	5.6	36.8	26.7	0.73	1.88	43.2	90.4	3.1
75	6.9	37.0	26.9	0.73	1.83	43.3	87.6	4.4
75	7.7	37.1	26.9	0.73	1.81	43.3	86.2	5.3
75	8.6	37.1	26.9	0.73	1.80	43.2	85.0	6.3
75	9.0	37.2	27.0	0.73	1.79	43.3	84.6	6.8
75	9.5	37.2	27.0	0.73	1.78	43.3	84.1	7.5
75	10.3	37.2	27.0	0.73	1.77	43.2	83.4	8.6
85	5.6	35.2	26.3	0.75	2.10	42.4	100.1	3.0
85	6.9	35.4	26.4	0.75	2.05	42.4	97.3	4.2
85	7.7	35.4	26.4	0.75	2.03	42.3	96.0	5.0
85	8.6	35.5	26.5	0.75	2.02	42.4	94.9	6.1
85	9.0	35.5	26.5	0.75	2.01	42.4	94.4	6.6
85	9.5	35.6	26.6	0.75	2.00	42.4	93.9	7.2



Performance Data

Table 16. Cooling capacities - VSH*033 (continued)

EWT	GPM	Gross (MBtuh)	Sen (MBtuh)	SHR	Compressor Power (kW)	Reject (MBtuh)	LWT	Feet Head
85	10.3	35.6	26.6	0.75	1.99	42.4	93.2	8.3
95	5.6	33.5	25.8	0.77	2.33	41.5	109.8	2.8
95	6.9	33.7	25.9	0.77	2.29	41.5	107.0	4.0
95	7.7	33.7	25.9	0.77	2.27	41.4	105.8	4.8
95	8.6	33.8	26.0	0.77	2.25	41.5	104.7	5.8
95	9.0	33.8	26.0	0.77	2.25	41.5	104.2	6.3
95	9.5	33.9	26.1	0.77	2.24	41.5	103.7	6.9
95	10.3	33.9	26.1	0.77	2.23	41.5	103.1	8.0
105	5.6	31.7	25.2	0.79	2.57	40.5	119.5	2.7
105	6.9	31.9	25.4	0.80	2.52	40.5	116.7	3.9
105	7.7	31.9	25.4	0.80	2.50	40.4	115.5	4.7
105	8.6	32.0	25.4	0.79	2.49	40.5	114.4	5.6
105	9.0	32.0	25.4	0.79	2.48	40.5	114.0	6.1
105	9.5	32.1	25.5	0.79	2.47	40.5	113.5	6.7
105	10.3	32.1	25.5	0.79	2.46	40.5	112.9	7.7
115	5.6	29.8	24.6	0.83	2.80	39.4	129.1	2.6
115	6.9	30.0	24.7	0.82	2.76	39.4	126.4	3.7
115	7.7	30.1	24.8	0.82	2.74	39.4	125.2	4.5
115	8.6	30.1	24.8	0.82	2.72	39.4	124.2	5.4
115	9.0	30.1	24.8	0.82	2.71	39.4	123.8	5.9
115	9.5	30.2	24.9	0.82	2.71	39.4	123.3	6.5
115	10.3	30.2	24.9	0.82	2.70	39.4	122.7	7.5
120	5.6	28.9	24.3	0.84	2.93	38.9	133.9	2.6
120	6.9	29.0	24.4	0.84	2.89	38.9	131.3	3.7
120	7.7	29.1	24.5	0.84	2.87	38.9	130.1	4.4
120	8.6	29.1	24.5	0.84	2.85	38.8	129.0	5.4
120	9.0	29.1	24.5	0.84	2.85	38.8	128.6	5.8
120	9.5	29.2	24.6	0.84	2.84	38.9	128.2	6.4
120	10.3	29.2	24.6	0.84	2.83	38.9	127.6	7.4

Note: Cooling performance data is tabulated at 80°F DB/67°F WB entering air at ANSI/AHRI/ASHRAE/ISO13256-1 rated CFM. For ANSI/AHRI/ASHRAE/ISO13256-1 certified ratings, refer to the ANSI/AHRI/ASHRAE/ISO13256-1 performance table. See performance correction tables to correct performance at conditions other than those tabulated. Rated GPM: 8.6; Minimum CFM: 891; Rated CFM: 1200; Maximum CFM: 1324.

Table 17. Heating capacities - VSH*033

EWT	GPM	Gross Mbtuh	Absorb Mbtuh	Comp Power (kW)	LWT	Feet Head
25	7.7	22.5	16.9	1.64	20.6	7.1
25	8.6	22.5	16.9	1.65	21.1	8.5
25	9.0	22.5	16.9	1.65	21.2	9.1
25	9.5	22.6	17.0	1.65	21.4	9.9
25	10.3	22.6	17.0	1.66	21.7	11.3
35	5.6	26.0	20.2	1.71	27.8	3.9
35	6.9	26.2	20.3	1.72	29.1	5.5
35	7.7	26.3	20.4	1.73	29.7	6.6
35	8.6	26.4	20.5	1.73	30.2	7.8

Table 17. Heating capacities - VSH*033 (continued)

EWT	GPM	Gross Mbtuh	Absorb Mbtuh	Comp Power (kW)	LWT	Feet Head
35	9.0	26.5	20.6	1.74	30.4	8.4
35	9.5	26.5	20.6	1.74	30.7	9.2
35	10.3	26.6	20.7	1.74	31.0	10.5
45	5.6	29.8	23.7	1.80	36.5	3.7
45	6.9	30.2	24.0	1.81	38.0	5.1
45	7.7	30.3	24.1	1.82	38.7	6.1
45	8.6	30.5	24.3	1.82	39.3	7.3
45	9.0	30.5	24.3	1.83	39.6	7.9
45	9.5	30.6	24.4	1.83	39.9	8.6
45	10.3	30.8	24.5	1.83	40.2	9.9
55	5.6	33.8	27.4	1.87	45.2	3.5
55	6.9	34.3	27.9	1.88	46.9	4.9
55	7.7	34.6	28.2	1.89	47.7	5.8
55	8.6	34.8	28.3	1.89	48.4	7.0
55	9.0	34.9	28.4	1.90	48.7	7.5
55	9.5	35.0	28.5	1.90	49.0	8.2
55	10.3	35.1	28.6	1.90	49.4	9.4
65	5.6	38.1	31.5	1.94	53.8	3.3
65	6.9	38.8	32.1	1.95	55.7	4.6
65	7.7	39.1	32.4	1.96	56.6	5.5
65	8.6	39.4	32.7	1.96	57.4	6.6
65	9.0	39.5	32.8	1.97	57.7	7.1
65	9.5	39.6	32.9	1.97	58.1	7.8
65	10.3	39.8	33.1	1.97	58.6	8.9
75	5.6	42.7	35.8	2.03	62.2	3.1
75	6.9	43.6	36.6	2.05	64.4	4.4
75	7.7	44.0	37.0	2.05	65.4	5.3
75	8.6	44.3	37.3	2.06	66.3	6.3
75	9.0	44.4	37.4	2.06	66.7	6.8
75	9.5	44.6	37.6	2.06	67.1	7.5
75	10.3	44.8	37.7	2.07	67.7	8.6
85	5.6	47.8	40.4	2.17	70.6	3.0
85	6.9	48.8	41.3	2.19	73.0	4.2
85	7.7	49.3	41.8	2.19	74.1	5.0
85	8.6	49.6	42.1	2.20	75.2	6.1
85	9.0	49.8	42.3	2.20	75.6	6.6
85	9.5	49.9	42.4	2.20	76.1	7.2
85	10.3	50.2	42.7	2.21	76.7	8.3

Note: Heating performance data is tabulated at 70°F DB at rated CFM. See correction factor tables to correct performance at conditions other than those tabulated. Interpolation of data is permissible; extrapolation is not. Rated GPM: 8.6; Minimum CFM: 891; Rated CFM: 1200; Maximum CFM: 1324. For ANSI/AHRI/ASHRAE/ISO13256-1 certified ratings, refer to the ANSI/AHRI/ASHRAE/ISO13256-1 performance table.



Performance Data

Table 18. Fan correction factors - VSH*033

Entering CFM	Cooling Capacity	Sensible Capacity	Cooling Comp Watts	Heating Capacity	Heating Comp Watts
891	0.949	0.852	0.992	0.970	1.103
952	0.960	0.880	0.993	0.981	1.081
1076	0.982	0.940	0.997	0.994	1.037
1138	0.991	0.970	0.999	0.997	1.018
1200	1.000	1.000	1.000	1.000	1.000
1262	1.008	1.031	1.002	1.004	0.985
1324	1.016	1.060	1.003	1.008	0.973

Table 19. Cooling capacities - VSV*033

EWT	GPM	Gross (MBtuh)	Sen (MBtuh)	SHR	Compressor Power (kW)	Reject (MBtuh)	LWT	Feet Head
45	5.4	39.9	27.1	0.68	1.19	44.0	61.3	3.6
45	6.6	40.1	27.3	0.68	1.16	44.0	58.3	5.1
45	7.5	40.2	27.3	0.68	1.14	44.1	56.8	6.3
45	8.3	40.3	27.4	0.68	1.13	44.1	55.6	7.5
45	8.7	40.4	27.5	0.68	1.12	44.2	55.2	8.1
45	9.1	40.4	27.5	0.68	1.11	44.2	54.7	8.8
45	10.0	40.5	27.5	0.68	1.10	44.3	53.9	10.2
55	5.4	39.1	27.4	0.70	1.31	43.6	71.1	3.4
55	6.6	39.3	27.5	0.70	1.28	43.7	68.2	4.9
55	7.5	39.5	27.7	0.70	1.27	43.8	66.7	6.1
55	8.3	39.6	27.7	0.70	1.26	43.9	65.6	7.2
55	8.7	39.6	27.7	0.70	1.25	43.9	65.1	7.8
55	9.1	39.7	27.8	0.70	1.25	44.0	64.7	8.4
55	10.0	39.8	27.9	0.70	1.24	44.0	63.8	9.8
65	5.4	37.7	27.1	0.72	1.59	43.1	81.0	3.3
65	6.6	38.0	27.4	0.72	1.56	43.3	78.1	4.6
65	7.5	38.1	27.4	0.72	1.54	43.4	76.6	5.8
65	8.3	38.2	27.5	0.72	1.53	43.4	75.5	6.8
65	8.7	38.3	27.6	0.72	1.52	43.5	75.0	7.4
65	9.1	38.3	27.6	0.72	1.52	43.5	74.6	8.0
65	10.0	38.4	27.6	0.72	1.51	43.6	73.7	9.3
75	5.4	36.2	26.8	0.74	1.76	42.2	90.6	3.1
75	6.6	36.4	26.9	0.74	1.72	42.3	87.8	4.4
75	7.5	36.6	27.1	0.74	1.70	42.4	86.3	5.5
75	8.3	36.7	27.2	0.74	1.69	42.5	85.2	6.5
75	8.7	36.7	27.2	0.74	1.68	42.4	84.7	7.1
75	9.1	36.8	27.2	0.74	1.68	42.5	84.3	7.6
75	10.0	36.8	27.2	0.74	1.67	42.5	83.5	8.9
85	5.4	34.6	26.3	0.76	2.01	41.5	100.4	2.9

Table 19. Cooling capacities - VSV*033 (continued)

EWT	GPM	Gross (MBtuh)	Sen (MBtuh)	SHR	Compressor Power (kW)	Reject (MBtuh)	LWT	Feet Head
85	6.6	34.8	26.4	0.76	1.97	41.5	97.6	4.2
85	7.5	35.0	26.6	0.76	1.95	41.7	96.1	5.2
85	8.3	35.1	26.7	0.76	1.93	41.7	95.0	6.2
85	8.7	35.1	26.7	0.76	1.93	41.7	94.6	6.8
85	9.1	35.2	26.8	0.76	1.92	41.8	94.2	7.3
85	10.0	35.2	26.8	0.76	1.91	41.7	93.3	8.6
95	5.4	32.9	25.7	0.78	2.21	40.4	110.0	2.8
95	6.6	33.2	25.9	0.78	2.17	40.6	107.3	4.0
95	7.5	33.3	26.0	0.78	2.15	40.6	105.8	5.0
95	8.3	33.4	26.1	0.78	2.14	40.7	104.8	6.0
95	8.7	33.5	26.1	0.78	2.13	40.8	104.4	6.5
95	9.1	33.5	26.1	0.78	2.13	40.8	104.0	7.0
95	10.0	33.6	26.2	0.78	2.12	40.8	103.2	8.2
105	5.4	31.2	25.3	0.81	2.43	39.5	119.6	2.6
105	6.6	31.4	25.4	0.81	2.39	39.6	117.0	3.8
105	7.5	31.6	25.6	0.81	2.37	39.7	115.6	4.8
105	8.3	31.7	25.7	0.81	2.36	39.8	114.6	5.7
105	8.7	31.7	25.7	0.81	2.35	39.7	114.1	6.2
105	9.1	31.8	25.8	0.81	2.35	39.8	113.7	6.7
105	10.0	31.8	25.8	0.81	2.34	39.8	113.0	7.8
115	5.4	29.4	24.4	0.83	2.67	38.5	129.3	2.5
115	6.6	29.6	24.6	0.83	2.63	38.6	126.7	3.6
115	7.5	29.7	24.7	0.83	2.61	38.6	125.3	4.5
115	8.3	29.8	24.7	0.83	2.60	38.7	124.3	5.4
115	8.7	29.9	24.8	0.83	2.60	38.8	123.9	5.9
115	9.1	29.9	24.8	0.83	2.59	38.7	123.5	6.4
115	10.0	30.0	24.9	0.83	2.58	38.8	122.8	7.5
120	5.4	28.4	24.1	0.85	2.79	37.9	134.0	2.4
120	6.6	28.6	24.3	0.85	2.76	38.0	131.5	3.5
120	7.5	28.8	24.5	0.85	2.74	38.1	130.2	4.4
120	8.3	28.9	24.6	0.85	2.73	38.2	129.2	5.3
120	8.7	28.9	24.6	0.85	2.72	38.2	128.8	5.8
120	9.1	29.0	24.7	0.85	2.72	38.3	128.4	6.3
120	10.0	29.0	24.7	0.85	2.71	38.3	127.7	7.4

Note: Cooling performance data is tabulated at 80°F DB/67°F WB entering air at ANSI/AHRI/ASHRAE/ISO13256-1 rated CFM. For ANSI/AHRI/ASHRAE/ISO13256-1 certified ratings, refer to the ANSI/AHRI/ASHRAE/ISO13256-1 performance table. See performance correction tables to correct performance at conditions other than those tabulated. Rated GPM: 8.3; Minimum CFM: 1080; Rated CFM: 1200; Maximum CFM: 1320.



Performance Data

Table 20. Heating capacities - VSV*033

EWT	GPM	Gross (MBtuh)	Absorb (MBtuh)	Compressor Power (kW)	LWT	Feet Head
25	7.5	22.3	16.5	1.69	20.6	6.9
25	8.3	22.5	16.7	1.69	21.0	8.2
25	8.7	22.5	16.7	1.69	21.2	8.8
25	9.1	22.6	16.8	1.69	21.3	9.5
25	10.0	22.7	16.9	1.70	21.6	11.1
35	5.4	25.1	19.1	1.75	27.9	3.8
35	6.6	25.6	19.6	1.76	29.1	5.4
35	7.5	25.8	19.8	1.76	29.7	6.6
35	8.3	26.0	20.0	1.77	30.2	7.9
35	8.7	26.1	20.1	1.77	30.4	8.5
35	9.1	26.2	20.2	1.77	30.6	9.2
35	10.0	26.3	20.2	1.77	31.0	10.7
45	5.4	29.5	23.3	1.82	36.4	3.6
45	6.6	30.2	23.9	1.83	37.8	5.1
45	7.5	30.5	24.2	1.84	38.5	6.3
45	8.3	30.7	24.4	1.85	39.1	7.5
45	8.7	30.9	24.6	1.85	39.3	8.1
45	9.1	31.0	24.7	1.85	39.6	8.8
45	10.0	31.1	24.8	1.85	40.0	10.2
55	5.4	33.4	26.9	1.91	45.0	3.4
55	6.6	34.2	27.6	1.92	46.6	4.9
55	7.5	34.6	28.0	1.94	47.5	6.1
55	8.3	35.0	28.4	1.94	48.2	7.2
55	8.7	35.1	28.5	1.95	48.4	7.8
55	9.1	35.3	28.7	1.95	48.7	8.4
55	10.0	35.5	28.8	1.95	49.2	9.8
65	5.4	37.7	30.9	2.00	53.6	3.3
65	6.6	38.7	31.8	2.02	55.4	4.6
65	7.5	39.3	32.4	2.03	56.4	5.8
65	8.3	39.7	32.7	2.04	57.1	6.8
65	8.7	39.9	32.9	2.05	57.4	7.4
65	9.1	40.1	33.1	2.05	57.7	8.0
65	10.0	40.4	33.4	2.06	58.3	9.3
75	5.4	42.3	35.1	2.11	62.0	3.1
75	6.6	43.5	36.2	2.14	64.0	4.4
75	7.5	44.1	36.8	2.15	65.2	5.5
75	8.3	44.7	37.3	2.17	66.0	6.5
75	8.7	44.9	37.5	2.17	66.4	7.1
75	9.1	45.2	37.8	2.18	66.7	7.6

Table 20. Heating capacities - VSV*033 (continued)

EWT	GPM	Gross (MBtuh)	Absorb (MBtuh)	Compressor Power (kW)	LWT	Feet Head
75	10.0	45.5	38.0	2.19	67.4	8.9
85	5.4	47.1	39.5	2.23	70.4	2.9
85	6.6	48.7	41.0	2.27	72.6	4.2
85	7.5	49.4	41.6	2.29	73.9	5.2
85	8.3	50.1	42.2	2.31	74.8	6.2
85	8.7	50.4	42.5	2.31	75.2	6.8
85	9.1	50.6	42.7	2.32	75.6	7.3
85	10.0	51.1	43.1	2.33	76.4	8.6

Note: Heating performance data is tabulated at 70°F DB at rated CFM. See correction factor tables to correct performance at conditions other than those tabulated. Interpolation of data is permissible; extrapolation is not. Rated GPM: 8.3; Minimum CFM: 1080; Rated CFM: 1200; Maximum CFM: 1320. For ANSI/AHRI/ASHRAE/ISO13256-1 certified ratings, refer to the ANSI/AHRI/ASHRAE/ISO13256-1 performance table.

Table 21. Fan correction factors VSV*033

Entering CFM	Cooling Capacity	Sensible Capacity	Cooling Input Watts	Heating Capacity	Heating Input Watts
1080	0.984	0.944	0.997	0.992	1.033
1140	0.993	0.971	0.998	0.996	1.015
1200	1.002	1.002	1.000	1.000	1.000
1260	1.010	1.031	1.001	1.004	0.986
1320	1.017	1.058	1.003	1.007	0.974

Table 22. Cooling capacities - VSH*042

EWT	GPM	Gross (MBtuh)	Sen (MBtuh)	SHR	Compressor Power (kW)	Reject (MBtuh)	LWT	Feet Head
45	6.8	52.6	35.5	0.67	1.25	56.9	61.7	1.8
45	8.4	52.8	35.6	0.67	1.18	56.8	58.5	2.5
45	9.5	52.9	35.7	0.67	1.14	56.8	57.0	3.0
45	10.5	52.9	35.7	0.67	1.11	56.7	55.8	3.6
45	11.0	53.0	35.8	0.68	1.09	56.7	55.3	3.8
45	11.6	53.0	35.8	0.68	1.08	56.7	54.8	4.2
45	12.6	53.1	35.8	0.67	1.06	56.7	54.0	4.8
55	6.8	50.5	36.1	0.71	1.42	55.3	71.3	1.7
55	8.4	50.7	36.3	0.72	1.34	55.3	68.2	2.4
55	9.5	50.8	36.3	0.71	1.30	55.3	66.6	2.9
55	10.5	50.9	36.4	0.72	1.27	55.2	65.5	3.4
55	11.0	50.9	36.4	0.72	1.26	55.2	65.0	3.7
55	11.6	51.0	36.5	0.72	1.25	55.3	64.5	4.0
55	12.6	51.0	36.5	0.72	1.23	55.2	63.8	4.6
65	6.8	49.2	36.9	0.75	1.67	54.9	81.1	1.6
65	8.4	49.4	37.1	0.75	1.59	54.8	78.0	2.3
65	9.5	49.5	37.1	0.75	1.55	54.8	76.5	2.8
65	10.5	49.6	37.2	0.75	1.52	54.8	75.4	3.3
65	11.0	49.6	37.2	0.75	1.51	54.7	74.9	3.5



Performance Data

Table 22. Cooling capacities - VSH*042 (continued)

EWT	GPM	Gross (MBtuh)	Sen (MBtuh)	SHR	Compressor Power (kW)	Reject (MBtuh)	LWT	Feet Head
65	11.6	49.6	37.2	0.75	1.49	54.7	74.4	3.9
65	12.6	49.7	37.3	0.75	1.47	54.7	73.7	4.4
75	6.8	47.2	36.7	0.78	1.95	53.9	90.9	1.6
75	8.4	47.4	36.8	0.78	1.87	53.8	87.8	2.2
75	9.5	47.5	36.9	0.78	1.83	53.8	86.3	2.7
75	10.5	47.5	36.9	0.78	1.80	53.7	85.2	3.1
75	11.0	47.6	37.0	0.78	1.79	53.7	84.8	3.4
75	11.6	47.6	37.0	0.78	1.78	53.7	84.3	3.7
75	12.6	47.7	37.1	0.78	1.76	53.7	83.5	4.2
85	6.8	44.4	35.7	0.80	2.26	52.1	100.3	1.5
85	8.4	44.6	35.8	0.80	2.18	52.1	97.4	2.1
85	9.5	44.7	35.9	0.80	2.14	52.0	95.9	2.6
85	10.5	44.8	36.0	0.80	2.11	52.0	94.9	3.0
85	11.0	44.8	36.0	0.80	2.10	52.0	94.5	3.3
85	11.6	44.8	36.0	0.80	2.09	51.9	93.9	3.6
85	12.6	44.9	36.1	0.80	2.07	52.0	93.3	4.1
95	6.8	41.6	34.6	0.83	2.61	50.5	109.9	1.4
95	8.4	41.8	34.7	0.83	2.54	50.5	107.0	2.0
95	9.5	41.9	34.8	0.83	2.50	50.4	105.6	2.5
95	10.5	41.9	34.8	0.83	2.47	50.3	104.6	2.9
95	11.0	42.0	34.9	0.83	2.45	50.4	104.2	3.1
95	11.6	42.0	34.9	0.83	2.44	50.3	103.7	3.4
95	12.6	42.0	34.9	0.83	2.42	50.3	103.0	3.9
105	6.8	39.1	33.7	0.86	3.02	49.4	119.5	1.4
105	8.4	39.3	33.8	0.86	2.94	49.3	116.7	1.9
105	9.5	39.4	33.9	0.86	2.90	49.3	115.4	2.4
105	10.5	39.5	34.0	0.86	2.87	49.3	114.4	2.8
105	11.0	39.6	34.1	0.86	2.86	49.4	114.0	3.0
105	11.6	39.6	34.1	0.86	2.85	49.3	113.5	3.3
105	12.6	39.6	34.1	0.86	2.83	49.2	112.8	3.7
115	6.8	36.8	32.9	0.89	3.46	48.6	129.3	1.3
115	8.4	37.1	33.2	0.89	3.38	48.6	126.6	1.9
115	9.5	37.1	33.2	0.89	3.35	48.5	125.2	2.3
115	10.5	37.2	33.3	0.90	3.32	48.5	124.2	2.7
115	11.0	37.3	33.3	0.89	3.30	48.6	123.8	2.9
115	11.6	37.3	33.3	0.89	3.29	48.5	123.4	3.1
115	12.6	37.3	33.3	0.89	3.27	48.5	122.7	3.6
120	6.8	35.2	32.0	0.91	3.68	47.7	134.0	1.3
120	8.4	35.4	32.2	0.91	3.60	47.7	131.4	1.8
120	9.5	35.5	32.3	0.91	3.56	47.7	130.0	2.2
120	10.5	35.6	32.4	0.91	3.53	47.6	129.1	2.6
120	11.0	35.6	32.4	0.91	3.52	47.6	128.7	2.8
120	11.6	35.7	32.5	0.91	3.50	47.7	128.2	3.1

Table 22. Cooling capacities - VSH*042 (continued)

EWT	GPM	Gross (MBtuh)	Sen (MBtuh)	SHR	Compressor Power (kW)	Reject (MBtuh)	LWT	Feet Head
120	12.6	35.7	32.5	0.91	3.48	47.6	127.6	3.5

Note: Cooling performance data is tabulated at 80°F DB/67°F WB entering air at ANSI/AHRI/ASHRAE/ISO13256-1 rated CFM. For ANSI/AHRI/ASHRAE/ISO13256-1 certified ratings, refer to the ANSI/AHRI/ASHRAE/ISO13256-1 performance table. See performance correction tables to correct performance at conditions other than those tabulated. Rated GPM: 10.5; Minimum CFM: 1243; Rated CFM: 1650; Maximum CFM: 1813.

Table 23. Heating capacities - VSH*042

EWT	GPM	Gross Mbtuh	Absorb Mbtuh	Comp Power kW	LWT	Feet Head
25	9.5	28.3	21.8	1.92	20.4	3.3
25	10.5	28.4	21.9	1.92	20.8	3.9
25	11.0	28.5	22.0	1.92	21.0	4.2
25	11.6	28.6	22.0	1.92	21.2	4.5
25	12.6	28.8	22.2	1.92	21.5	5.2
35	6.8	33.3	26.4	2.02	27.2	1.8
35	8.4	33.6	26.7	2.02	28.6	2.6
35	9.5	33.8	26.9	2.03	29.3	3.1
35	10.5	34.1	27.2	2.03	29.8	3.7
35	11.0	34.2	27.3	2.03	30.0	4.0
35	11.6	34.3	27.4	2.04	30.3	4.4
35	12.6	34.6	27.6	2.04	30.6	5.0
45	6.8	38.6	31.5	2.09	35.7	1.8
45	8.4	39.1	31.9	2.10	37.4	2.5
45	9.5	39.4	32.2	2.11	38.2	3.0
45	10.5	39.8	32.6	2.11	38.8	3.6
45	11.0	39.9	32.7	2.11	39.1	3.8
45	11.6	40.1	32.9	2.12	39.3	4.2
45	12.6	40.4	33.2	2.12	39.7	4.8
55	6.8	43.9	36.6	2.14	44.2	1.7
55	8.4	44.6	37.3	2.15	46.1	2.4
55	9.5	45.1	37.7	2.16	47.1	2.9
55	10.5	45.6	38.2	2.17	47.7	3.4
55	11.0	45.8	38.4	2.17	48.0	3.7
55	11.6	46.0	38.6	2.17	48.3	4.0
55	12.6	46.3	38.9	2.17	48.8	4.6
65	6.8	49.3	41.9	2.18	52.7	1.6
65	8.4	50.3	42.8	2.19	54.8	2.3
65	9.5	50.9	43.4	2.20	55.9	2.8
65	10.5	51.4	43.9	2.21	56.6	3.3
65	11.0	51.7	44.2	2.21	57.0	3.5
65	11.6	51.9	44.3	2.21	57.4	3.9
65	12.6	52.4	44.8	2.21	57.9	4.4
75	6.8	54.8	47.2	2.22	61.1	1.6
75	8.4	56.0	48.4	2.24	63.5	2.2
75	9.5	56.7	49.0	2.24	64.7	2.7
75	10.5	57.4	49.7	2.25	65.5	3.1



Performance Data

Table 23. Heating capacities - VSH*042 (continued)

EWT	GPM	Gross Mbtuh	Absorb Mbtuh	Comp Power kW	LWT	Feet Head
75	11.0	57.7	50.0	2.25	65.9	3.4
75	11.6	57.9	50.2	2.25	66.3	3.7
75	12.6	58.4	50.7	2.25	67.0	4.2
85	6.8	60.4	52.6	2.27	69.5	1.5
85	8.4	61.8	54.0	2.29	72.1	2.1
85	9.5	62.7	54.9	2.29	73.4	2.6
85	10.5	63.4	55.6	2.30	74.4	3.0
85	11.0	63.7	55.8	2.30	74.9	3.3
85	11.6	64.1	56.2	2.30	75.3	3.6
85	12.6	64.6	56.7	2.30	76.0	4.1

Note: Heating performance data is tabulated at 70°F DB at rated CFM. See correction factor tables to correct performance at conditions other than those tabulated. Interpolation of data is permissible; extrapolation is not. Rated GPM: 10.5; Minimum CFM: 1243; Rated CFM: 1650; Maximum CFM: 1813. For ANSI/AHRI/ASHRAE/ISO13256-1 certified ratings, refer to the ANSI/AHRI/ASHRAE/ISO13256-1 performance table.

Table 24. Fan correction factors - VSH*042

Entering CFM	Cooling Capacity	Sensible Capacity	Cooling Comp Watts	Heating Capacity	Heating Comp Watts
1243	0.954	0.853	1.010	0.983	1.159
1324	0.965	0.883	1.007	0.988	1.119
1487	0.984	0.941	1.004	0.995	1.053
1569	0.992	0.970	1.002	0.997	1.025
1650	1.000	1.000	1.000	1.000	1.000
1731	1.007	1.029	0.998	1.003	0.978
1813	1.013	1.056	0.997	1.008	0.959

Table 25. Cooling capacities - VSV*042

EWT	GPM	Gross (MBtuh)	Sen (MBtuh)	SHR	Compressor Power (kW)	Reject (MBtuh)	LWT	Feet Head
45	7.1	54.8	38.9	0.71	1.03	58.3	61.4	2.1
45	8.7	55.4	39.3	0.71	0.96	58.7	58.5	2.9
45	9.8	55.7	39.5	0.71	0.92	58.8	57.0	3.5
45	10.9	55.9	39.7	0.71	0.90	59.0	55.8	4.1
45	11.4	56.0	39.8	0.71	0.88	59.0	55.4	4.4
45	12.0	56.1	39.8	0.71	0.87	59.1	54.9	4.8
45	13.1	56.2	39.9	0.71	0.86	59.1	54.0	5.5
55	7.1	52.7	38.5	0.73	1.30	57.1	71.1	1.9
55	8.7	53.3	38.9	0.73	1.23	57.5	68.2	2.7
55	9.8	53.5	39.1	0.73	1.20	57.6	66.8	3.2
55	10.9	53.7	39.2	0.73	1.17	57.7	65.6	3.8
55	11.4	53.8	39.3	0.73	1.16	57.8	65.1	4.1
55	12.0	53.9	39.3	0.73	1.15	57.8	64.6	4.5
55	13.1	54.0	39.4	0.73	1.14	57.9	63.8	5.2
65	7.1	50.5	37.9	0.75	1.59	55.9	80.7	1.7
65	8.7	51.1	38.3	0.75	1.52	56.3	77.9	2.4

Table 25. Cooling capacities - VSV*042 (continued)

EWT	GPM	Gross (MBtuh)	Sen (MBtuh)	SHR	Compressor Power (kW)	Reject (MBtuh)	LWT	Feet Head
65	9.8	51.3	38.5	0.75	1.48	56.4	76.5	3.0
65	10.9	51.5	38.6	0.75	1.46	56.5	75.4	3.6
65	11.4	51.6	38.7	0.75	1.45	56.5	74.9	3.8
65	12.0	51.6	38.7	0.75	1.44	56.5	74.4	4.2
65	13.1	51.8	38.9	0.75	1.42	56.6	73.6	4.9
75	7.1	48.2	37.1	0.77	1.92	54.8	90.4	1.6
75	8.7	48.8	37.6	0.77	1.85	55.1	87.7	2.2
75	9.8	49.0	37.7	0.77	1.81	55.2	86.3	2.8
75	10.9	49.2	37.9	0.77	1.78	55.3	85.1	3.3
75	11.4	49.3	38.0	0.77	1.77	55.3	84.7	3.6
75	12.0	49.3	38.0	0.77	1.76	55.3	84.2	3.9
75	13.1	49.4	38.0	0.77	1.74	55.4	83.5	4.6
85	7.1	45.9	36.7	0.80	2.25	53.6	100.1	1.4
85	8.7	46.4	37.1	0.80	2.17	53.8	97.4	2.1
85	9.8	46.6	37.3	0.80	2.13	53.9	96.0	2.6
85	10.9	46.8	37.4	0.80	2.11	54.0	94.9	3.1
85	11.4	46.9	37.5	0.80	2.09	54.0	94.5	3.3
85	12.0	46.9	37.5	0.80	2.08	54.0	94.0	3.7
85	13.1	47.0	37.6	0.80	2.06	54.0	93.2	4.3
95	7.1	43.5	35.7	0.82	2.64	52.5	109.8	1.3
95	8.7	44.0	36.1	0.82	2.56	52.7	107.1	1.9
95	9.8	44.2	36.2	0.82	2.52	52.8	105.8	2.4
95	10.9	44.4	36.4	0.82	2.49	52.9	104.7	2.9
95	11.4	44.4	36.4	0.82	2.48	52.9	104.3	3.2
95	12.0	44.5	36.5	0.82	2.47	52.9	103.8	3.5
95	13.1	44.6	36.6	0.82	2.45	53.0	103.1	4.1
105	7.1	41.1	34.9	0.85	3.05	51.5	119.5	1.3
105	8.7	41.5	35.3	0.85	2.97	51.7	116.9	1.9
105	9.8	41.7	35.4	0.85	2.94	51.7	115.6	2.3
105	10.9	41.9	35.6	0.85	2.91	51.8	114.5	2.8
105	11.4	41.9	35.6	0.85	2.90	51.8	114.1	3.0
105	12.0	42.0	35.7	0.85	2.89	51.9	113.7	3.3
105	13.1	42.1	35.8	0.85	2.87	51.9	112.9	3.9
115	7.1	38.6	34.0	0.88	3.49	50.5	129.2	1.4
115	8.7	39.0	34.3	0.88	3.42	50.7	126.7	1.9
115	9.8	39.2	34.5	0.88	3.39	50.8	125.4	2.3
115	10.9	39.3	34.6	0.88	3.36	50.8	124.3	2.8
115	11.4	39.4	34.7	0.88	3.35	50.8	123.9	3.0
115	12.0	39.4	34.7	0.88	3.34	50.8	123.5	3.3



Performance Data

Table 25. Cooling capacities - VSV*042 (continued)

EWT	GPM	Gross (MBtuh)	Sen (MBtuh)	SHR	Compressor Power (kW)	Reject (MBtuh)	LWT	Feet Head
115	13.1	39.5	34.8	0.88	3.32	50.8	122.8	3.8
120	7.1	37.3	33.6	0.90	3.72	50.0	134.1	1.4
120	8.7	37.7	33.9	0.90	3.65	50.2	131.5	1.9
120	9.8	37.9	34.1	0.90	3.62	50.3	130.3	2.3
120	10.9	38.0	34.2	0.90	3.59	50.3	129.2	2.8
120	11.4	38.1	34.3	0.90	3.58	50.3	128.8	3.0
120	12.0	38.1	34.3	0.90	3.58	50.3	128.4	3.3
120	13.1	38.2	34.4	0.90	3.56	50.3	127.7	3.8

Note: Cooling performance data is tabulated at 80°F DB/67°F WB entering air at ANSI/AHRI/ASHRAE/ISO13256-1 rated CFM. For ANSI/AHRI/ASHRAE/ISO13256-1 certified ratings, refer to the ANSI/AHRI/ASHRAE/ISO13256-1 performance table. See performance correction tables to correct performance at conditions other than those tabulated. Rated GPM: 10.9; Minimum CFM: 1485; Rated CFM: 1650; Maximum CFM: 1815.

Table 26. Heating capacities - VSV*042

EWT	GPM	Gross (MBtuh)	Absorb (MBtuh)	Compressor Power (kW)	LWT	Feet Head
25	9.8	28.5	21.2	2.13	20.7	3.9
25	10.9	28.7	21.4	2.13	21.1	4.6
25	11.4	28.8	21.5	2.13	21.2	4.9
25	12.0	28.9	21.6	2.13	21.4	5.3
25	13.1	29.1	21.8	2.13	21.7	6.1
35	7.1	32.6	25.2	2.17	27.9	2.3
35	8.7	33.3	25.9	2.17	29.0	3.1
35	9.8	33.6	26.2	2.18	29.7	3.7
35	10.9	33.9	26.5	2.18	30.1	4.4
35	11.4	34.0	26.6	2.18	30.3	4.7
35	12.0	34.2	26.7	2.18	30.6	5.0
35	13.1	34.4	26.9	2.19	30.9	5.8
45	7.1	39.3	31.5	2.30	36.1	2.1
45	8.7	40.2	32.3	2.31	37.6	2.9
45	9.8	40.6	32.7	2.31	38.3	3.5
45	10.9	41.0	33.1	2.32	38.9	4.1
45	11.4	41.1	33.2	2.32	39.2	4.4
45	12.0	41.2	33.3	2.32	39.5	4.8
45	13.1	41.5	33.6	2.32	39.9	5.5
55	7.1	45.2	37.1	2.36	44.5	1.9
55	8.7	46.2	38.1	2.37	46.2	2.7
55	9.8	46.7	38.6	2.38	47.1	3.2
55	10.9	47.1	39.0	2.38	47.8	3.8
55	11.4	47.3	39.2	2.38	48.1	4.1
55	12.0	47.5	39.4	2.38	48.4	4.5
55	13.1	47.8	39.7	2.39	48.9	5.2

Table 26. Heating capacities - VSV*042 (continued)

EWT	GPM	Gross (MBtuh)	Absorb (MBtuh)	Compressor Power (kW)	LWT	Feet Head
65	7.1	51.1	42.6	2.49	53.0	1.7
65	8.7	52.4	43.9	2.50	54.9	2.4
65	9.8	53.1	44.5	2.51	55.9	3.0
65	10.9	53.6	45.0	2.51	56.7	3.6
65	11.4	53.8	45.2	2.52	57.1	3.8
65	12.0	54.1	45.5	2.52	57.4	4.2
65	13.1	54.4	45.8	2.53	58.0	4.9
75	7.1	56.9	48.2	2.56	61.4	1.6
75	8.7	58.5	49.7	2.58	63.6	2.2
75	9.8	59.3	50.5	2.59	64.7	2.8
75	10.9	60.0	51.1	2.60	65.6	3.3
75	11.4	60.3	51.4	2.60	66.0	3.6
75	12.0	60.6	51.7	2.60	66.4	3.9
75	13.1	61.1	52.2	2.61	67.0	4.6
85	7.1	63.0	54.0	2.64	69.8	1.4
85	8.7	65.1	56.0	2.67	72.1	2.1
85	9.8	66.1	57.0	2.68	73.4	2.6
85	10.9	67.0	57.8	2.69	74.4	3.1
85	11.4	67.4	58.2	2.70	74.8	3.3
85	12.0	67.8	58.6	2.70	75.2	3.7
85	13.1	68.4	59.1	2.71	76.0	4.3

Note: Heating performance data is tabulated at 70°F DB at rated CFM. See performance correction tables to correct performance at conditions other than those tabulated. Interpolation of data is permissible; extrapolation is not. Rated GPM: 10.9; Minimum CFM: 1485; Rated CFM: 1650; Maximum CFM: 1815. For ANSI/AHRI/ASHRAE/ISO13256-1 certified ratings, refer to the ANSI/AHRI/ASHRAE/ISO13256-1 performance table.

Table 27. Fan correction factors - VSV*042

Entering CFM	Cooling Capacity	Sensible Capacity	Cooling Input Watts	Heating Capacity	Heating Input Watts
1485	0.983	0.938	1.003	0.991	1.052
1568	0.992	0.969	1.002	0.996	1.024
1650	1.000	1.000	1.000	1.000	1.000
1733	1.007	1.026	0.999	1.004	0.978
1815	1.014	1.059	0.997	1.007	0.958

Table 28. Cooling capacities - VSH*050

EWT	GPM	Gross (MBtuh)	Sen (MBtuh)	SHR	Compressor Power (kW)	Reject (MBtuh)	LWT	Feet Head
45	8.3	60.4	37.2	0.62	1.97	67.1	61.2	2.4
45	10.2	60.6	37.3	0.62	1.87	67.0	58.1	3.4
45	11.4	60.8	37.5	0.62	1.83	67.0	56.8	4.1
45	12.7	60.8	37.5	0.62	1.80	66.9	55.5	4.8
45	13.3	60.9	37.5	0.62	1.78	67.0	55.1	5.2



Performance Data

Table 28. Cooling capacities - VSH*050 (continued)

EWT	GPM	Gross (MBtuh)	Sen (MBtuh)	SHR	Compressor Power (kW)	Reject (MBtuh)	LWT	Feet Head
45	14.0	60.9	37.5	0.62	1.77	66.9	54.6	5.7
45	15.2	61.0	37.6	0.62	1.74	66.9	53.8	6.5
55	8.3	59.6	41.3	0.69	1.98	66.4	71.0	2.3
55	10.2	59.9	41.5	0.69	1.89	66.4	68.0	3.3
55	11.4	60.0	41.6	0.69	1.85	66.3	66.6	3.9
55	12.7	60.1	41.6	0.69	1.81	66.3	65.4	4.6
55	13.3	60.1	41.6	0.69	1.80	66.2	65.0	5.0
55	14.0	60.1	41.6	0.69	1.78	66.2	64.5	5.4
55	15.2	60.2	41.7	0.69	1.76	66.2	63.7	6.2
65	8.3	57.8	42.5	0.74	2.25	65.5	80.8	2.2
65	10.2	58.1	42.8	0.74	2.16	65.5	77.8	3.1
65	11.4	58.2	42.8	0.74	2.11	65.4	76.5	3.7
65	12.7	58.3	42.9	0.74	2.08	65.4	75.3	4.5
65	13.3	58.3	42.9	0.74	2.06	65.3	74.8	4.8
65	14.0	58.4	43.0	0.74	2.05	65.4	74.3	5.2
65	15.2	58.4	43.0	0.74	2.03	65.3	73.6	6.0
75	8.3	55.5	42.1	0.76	2.59	64.3	90.5	2.2
75	10.2	55.7	42.2	0.76	2.50	64.2	87.6	3.0
75	11.4	55.8	42.3	0.76	2.46	64.2	86.3	3.6
75	12.7	55.9	42.4	0.76	2.42	64.2	85.1	4.3
75	13.3	56.0	42.4	0.76	2.41	64.2	84.7	4.6
75	14.0	56.0	42.4	0.76	2.40	64.2	84.2	5.0
75	15.2	56.0	42.4	0.76	2.37	64.1	83.4	5.7
85	8.3	52.8	41.0	0.78	2.97	63.0	100.2	2.1
85	10.2	53.1	41.3	0.78	2.88	62.9	97.3	2.9
85	11.4	53.2	41.3	0.78	2.84	62.9	96.0	3.5
85	12.7	53.3	41.4	0.78	2.80	62.9	94.9	4.1
85	13.3	53.3	41.4	0.78	2.79	62.8	94.4	4.4
85	14.0	53.3	41.4	0.78	2.78	62.8	94.0	4.8
85	15.2	53.4	41.5	0.78	2.75	62.8	93.3	5.5
95	8.3	50.1	40.1	0.80	3.39	61.7	109.9	2.0
95	10.2	50.3	40.3	0.80	3.30	61.6	107.1	2.8
95	11.4	50.4	40.4	0.80	3.26	61.5	105.8	3.3
95	12.7	50.5	40.5	0.80	3.22	61.5	104.7	4.0
95	13.3	50.6	40.5	0.80	3.21	61.5	104.2	4.3
95	14.0	50.6	40.5	0.80	3.19	61.5	103.8	4.6
95	15.2	50.7	40.6	0.80	3.17	61.5	103.1	5.3
105	8.3	47.3	39.3	0.83	3.85	60.4	119.6	1.9
105	10.2	47.5	39.4	0.83	3.76	60.3	116.8	2.7
105	11.4	47.6	39.5	0.83	3.72	60.3	115.6	3.2
105	12.7	47.7	39.6	0.83	3.68	60.3	114.5	3.8
105	13.3	47.7	39.6	0.83	3.67	60.2	114.1	4.1
105	14.0	47.8	39.7	0.83	3.65	60.3	113.6	4.4
105	15.2	47.8	39.7	0.83	3.63	60.2	112.9	5.1

Table 28. Cooling capacities - VSH*050 (continued)

EWT	GPM	Gross (MBtuh)	Sen (MBtuh)	SHR	Compressor Power (kW)	Reject (MBtuh)	LWT	Feet Head
115	8.3	44.3	38.3	0.86	4.35	59.1	129.2	1.8
115	10.2	44.5	38.4	0.86	4.26	59.0	126.6	2.6
115	11.4	44.6	38.5	0.86	4.21	59.0	125.4	3.1
115	12.7	44.7	38.6	0.86	4.18	59.0	124.3	3.6
115	13.3	44.8	38.7	0.86	4.16	59.0	123.9	3.9
115	14.0	44.8	38.7	0.86	4.15	59.0	123.4	4.3
115	15.2	44.8	38.7	0.86	4.13	58.9	122.8	4.9
120	8.3	42.7	37.7	0.88	4.61	58.4	134.1	1.8
120	10.2	42.9	37.9	0.88	4.52	58.3	131.4	2.5
120	11.4	43.0	38.0	0.88	4.47	58.3	130.2	3.0
120	12.7	43.1	38.1	0.88	4.44	58.2	129.2	3.6
120	13.3	43.1	38.1	0.88	4.42	58.2	128.8	3.9
120	14.0	43.2	38.1	0.88	4.41	58.3	128.3	4.2
120	15.2	43.2	38.1	0.88	4.39	58.2	127.7	4.8

Note: Cooling performance data is tabulated at 80°F DB/67°F WB entering air at ANSI/AHRI/ASHRAE/ISO13256-1 rated CFM. For ANSI/AHRI/ASHRAE/ISO13256-1 certified ratings, refer to the ANSI/AHRI/ASHRAE/ISO13256-1 performance table. See performance correction tables to correct performance at conditions other than those tabulated. Rated GPM: 12.7; Minimum CFM: 1424; Rated CFM: 1890; Maximum CFM: 2077.

Table 29. Heating capacities - VSH*050

EWT	GPM	Gross Mbtuh	Absorb Mbtuh	Comp Power (kW)	LWT	Feet Head
25	11.4	36.0	27.3	2.54	20.2	4.4
25	12.7	36.1	27.4	2.54	20.7	5.2
25	13.3	36.1	27.4	2.54	20.9	5.7
25	14.0	36.2	27.5	2.54	21.1	6.1
25	15.2	36.4	27.7	2.55	21.4	7.0
35	8.3	41.7	32.7	2.63	27.1	2.5
35	10.2	42.3	33.3	2.64	28.5	3.5
35	11.4	42.6	33.6	2.64	29.1	4.2
35	12.7	42.9	33.9	2.64	29.7	5.0
35	13.3	43.0	34.0	2.64	29.9	5.4
35	14.0	43.1	34.1	2.65	30.1	5.9
35	15.2	43.4	34.3	2.65	30.5	6.7
45	8.3	47.6	38.2	2.75	35.8	2.4
45	10.2	48.5	39.1	2.76	37.3	3.4
45	11.4	49.0	39.6	2.77	38.1	4.1
45	12.7	49.4	39.9	2.77	38.7	4.8
45	13.3	49.6	40.1	2.77	39.0	5.2
45	14.0	49.7	40.2	2.78	39.3	5.7
45	15.2	50.1	40.6	2.78	39.7	6.5
55	8.3	53.4	43.6	2.87	44.5	2.3
55	10.2	54.6	44.8	2.88	46.2	3.3
55	11.4	55.2	45.3	2.89	47.1	3.9
55	12.7	55.8	45.9	2.90	47.8	4.6
55	13.3	56.0	46.1	2.90	48.1	5.0



Performance Data

Table 29. Heating capacities - VSH*050 (continued)

EWT	GPM	Gross Mbtuh	Absorb Mbtuh	Comp Power (kW)	LWT	Feet Head
55	14.0	56.3	46.4	2.90	48.4	5.4
55	15.2	56.7	46.8	2.91	48.8	6.2
65	8.3	59.5	49.3	2.98	53.1	2.2
65	10.2	60.9	50.7	3.00	55.1	3.1
65	11.4	61.7	51.4	3.00	56.0	3.7
65	12.7	62.3	52.0	3.01	56.8	4.5
65	13.3	62.6	52.3	3.02	57.1	4.8
65	14.0	62.9	52.6	3.02	57.5	5.2
65	15.2	63.5	53.1	3.04	58.0	6.0
75	8.3	66.0	55.5	3.08	61.6	2.2
75	10.2	67.6	57.0	3.10	63.8	3.0
75	11.4	68.6	58.0	3.11	64.8	3.6
75	12.7	69.3	58.7	3.12	65.8	4.3
75	13.3	69.7	59.0	3.13	66.1	4.6
75	14.0	70.0	59.3	3.13	66.5	5.0
75	15.2	70.6	59.9	3.15	67.1	5.7
85	8.3	73.1	62.3	3.17	70.0	2.1
85	10.2	75.0	64.1	3.19	72.4	2.9
85	11.4	76.1	65.2	3.20	73.6	3.5
85	12.7	76.9	65.9	3.22	74.6	4.1
85	13.3	77.3	66.3	3.23	75.0	4.4
85	14.0	77.7	66.7	3.23	75.5	4.8
85	15.2	78.4	67.3	3.25	76.1	5.5

Note: Heating performance data is tabulated at 70°F DB at rated CFM. See correction factor tables to correct performance at conditions other than those tabulated. Interpolation of data is permissible; extrapolation is not. Rated GPM: 12.7; Minimum CFM: 1424; Rated CFM: 1890; Maximum CFM: 2077. For ANSI/AHRI/ASHRAE/ISO13256-1 certified ratings, refer to the ANSI/AHRI/ASHRAE/ISO13256-1 performance table.

Table 30. Fan correction factors - VSH*050

Entering CFM	Cooling Capacity	Sensible Capacity	Cooling Comp Watts	Heating Capacity	Heating Comp Watts
1424	0.953	0.860	1.005	0.980	1.136
1517	0.964	0.888	1.004	0.987	1.103
1704	0.984	0.945	1.002	0.995	1.046
1797	0.992	0.973	1.001	0.997	1.022
1890	1.000	1.000	1.000	1.000	1.000
1983	1.008	1.028	0.999	1.003	0.981
2077	1.015	1.058	0.998	1.006	0.963

Table 31. Cooling capacities - VSV*050

EWT	GPM	Gross (MBtuh)	Sen (MBtuh)	SHR	Compressor Power (kW)	Reject (MBtuh)	LWT	Feet Head
45	8.5	62.3	42.4	0.68	1.53	67.5	60.9	2.8
45	10.4	62.8	42.7	0.68	1.45	67.8	58.0	3.8
45	11.7	63.1	42.9	0.68	1.41	67.9	56.6	4.6
45	13.0	63.3	43.0	0.68	1.38	68.0	55.5	5.4

Table 31. Cooling capacities - VSV*050 (continued)

EWT	GPM	Gross (MBtuh)	Sen (MBtuh)	SHR	Compressor Power (kW)	Reject (MBtuh)	LWT	Feet Head
45	13.7	63.3	43.0	0.68	1.37	68.0	54.9	5.9
45	14.3	63.4	43.1	0.68	1.36	68.0	54.5	6.3
45	15.6	63.5	43.2	0.68	1.34	68.1	53.7	7.3
55	8.5	61.1	42.8	0.70	1.81	67.3	70.8	2.6
55	10.4	61.6	43.1	0.70	1.74	67.5	68.0	3.5
55	11.7	61.9	43.3	0.70	1.71	67.7	66.6	4.3
55	13.0	62.1	43.5	0.70	1.69	67.9	65.4	5.1
55	13.7	62.1	43.5	0.70	1.68	67.8	64.9	5.6
55	14.3	62.2	43.5	0.70	1.67	67.9	64.5	6.0
55	15.6	62.3	43.6	0.70	1.65	67.9	63.7	6.9
65	8.5	59.4	43.4	0.73	2.18	66.8	80.7	2.3
65	10.4	59.9	43.7	0.73	2.10	67.1	77.9	3.3
65	11.7	60.2	43.9	0.73	2.06	67.2	76.5	4.0
65	13.0	60.3	44.0	0.73	2.03	67.2	75.3	4.8
65	13.7	60.4	44.1	0.73	2.02	67.3	74.8	5.2
65	14.3	60.5	44.2	0.73	2.01	67.4	74.4	5.6
65	15.6	60.6	44.2	0.73	1.99	67.4	73.6	6.6
75	8.5	57.0	42.8	0.75	2.55	65.7	90.5	2.1
75	10.4	57.4	43.1	0.75	2.47	65.8	87.7	3.0
75	11.7	57.7	43.3	0.75	2.43	66.0	86.3	3.7
75	13.0	57.9	43.4	0.75	2.40	66.1	85.2	4.5
75	13.7	57.9	43.4	0.75	2.39	66.0	84.6	4.9
75	14.3	58.0	43.5	0.75	2.38	66.1	84.2	5.3
75	15.6	58.1	43.6	0.75	2.36	66.1	83.5	6.2
85	8.5	54.0	41.6	0.77	2.94	64.0	100.1	2.0
85	10.4	54.5	42.0	0.77	2.86	64.3	97.4	2.8
85	11.7	54.7	42.1	0.77	2.82	64.3	96.0	3.5
85	13.0	54.9	42.3	0.77	2.79	64.4	94.9	4.2
85	13.7	55.0	42.4	0.77	2.77	64.5	94.4	4.7
85	14.3	55.0	42.4	0.77	2.76	64.4	94.0	5.0
85	15.6	55.2	42.5	0.77	2.74	64.6	93.3	5.9
95	8.5	51.0	40.3	0.79	3.38	62.5	109.7	1.9
95	10.4	51.4	40.6	0.79	3.30	62.6	107.0	2.7
95	11.7	51.7	40.8	0.79	3.26	62.8	105.7	3.3
95	13.0	51.9	41.0	0.79	3.23	62.9	104.7	4.0
95	13.7	52.0	41.1	0.79	3.21	63.0	104.2	4.4
95	14.3	52.0	41.1	0.79	3.20	62.9	103.8	4.8
95	15.6	52.1	41.2	0.79	3.18	63.0	103.1	5.7
105	8.5	48.2	39.5	0.82	3.86	61.4	119.4	1.8



Performance Data

Table 31. Cooling capacities - VSV*050 (continued)

EWT	GPM	Gross (MBtuh)	Sen (MBtuh)	SHR	Compressor Power (kW)	Reject (MBtuh)	LWT	Feet Head
105	10.4	48.6	39.9	0.82	3.77	61.5	116.8	2.6
105	11.7	48.9	40.1	0.82	3.73	61.6	115.5	3.2
105	13.0	49.1	40.3	0.82	3.70	61.7	114.5	3.9
105	13.7	49.1	40.3	0.82	3.69	61.7	114.0	4.3
105	14.3	49.2	40.3	0.82	3.68	61.8	113.6	4.6
105	15.6	49.3	40.4	0.82	3.66	61.8	112.9	5.4
115	8.5	45.4	38.6	0.85	4.36	60.3	129.2	1.8
115	10.4	45.9	39.0	0.85	4.28	60.5	126.6	2.6
115	11.7	46.1	39.2	0.85	4.24	60.6	125.4	3.1
115	13.0	46.3	39.4	0.85	4.21	60.7	124.3	3.8
115	13.7	46.4	39.4	0.85	4.20	60.7	123.9	4.2
115	14.3	46.4	39.4	0.85	4.19	60.7	123.5	4.5
115	15.6	46.5	39.5	0.85	4.18	60.7	122.8	5.3
120	8.5	43.7	38.0	0.87	4.62	59.5	134.0	1.9
120	10.4	44.2	38.5	0.87	4.54	59.7	131.5	2.6
120	11.7	44.4	38.6	0.87	4.51	59.8	130.2	3.1
120	13.0	44.6	38.8	0.87	4.48	59.9	129.2	3.8
120	13.7	44.7	38.9	0.87	4.47	60.0	128.8	4.1
120	14.3	44.8	39.0	0.87	4.46	60.0	128.4	4.5
120	15.6	44.9	39.1	0.87	4.45	60.1	127.7	5.2

Note: Cooling performance data is tabulated at 80°F DB/67°F WB entering air at ANSI/AHRI/ASHRAE/ISO13256-1 rated CFM. For ANSI/AHRI/ASHRAE/ISO13256-1 certified ratings, refer to the ANSI/AHRI/ASHRAE/ISO13256-1 performance table. See performance correction tables to correct performance at conditions other than those tabulated. Rated GPM: 13.0; Minimum CFM: 1701; Rated CFM: 1890; Maximum CFM: 2079.

Table 32. Heating capacities - VSV*050

EWT	GPM	Gross (MBtuh)	Absorb (MBtuh)	Compressor Power (kW)	LWT	Feet Head
25	11.7	36.7	27.0	2.84	20.4	5.1
25	13.0	37.0	27.3	2.85	20.8	6.0
25	13.7	37.1	27.4	2.85	21.0	6.5
25	14.3	37.3	27.6	2.85	21.1	6.9
25	15.6	37.5	27.8	2.86	21.4	8.0
35	8.5	41.8	31.8	2.92	27.5	3.0
35	10.4	42.7	32.7	2.93	28.7	4.1
35	11.7	43.1	33.1	2.94	29.3	4.9
35	13.0	43.5	33.5	2.94	29.8	5.7
35	13.7	43.6	33.5	2.95	30.1	6.2
35	14.3	43.7	33.6	2.95	30.3	6.6
35	15.6	44.0	33.9	2.96	30.7	7.7
45	8.5	49.5	38.9	3.10	35.8	2.8
45	10.4	50.7	40.1	3.12	37.3	3.8

Table 32. Heating capacities - VSV*050 (continued)

EWT	GPM	Gross (MBtuh)	Absorb (MBtuh)	Compressor Power (kW)	LWT	Feet Head
45	11.7	51.3	40.6	3.13	38.1	4.6
45	13.0	51.8	41.1	3.14	38.7	5.4
45	13.7	52.0	41.3	3.14	39.0	5.9
45	14.3	52.2	41.5	3.14	39.2	6.3
45	15.6	52.6	41.9	3.15	39.6	7.3
55	8.5	56.0	45.1	3.21	44.4	2.6
55	10.4	57.5	46.5	3.23	46.1	3.5
55	11.7	58.2	47.1	3.25	46.9	4.3
55	13.0	58.8	47.7	3.26	47.7	5.1
55	13.7	59.1	48.0	3.26	48.0	5.6
55	14.3	59.4	48.3	3.26	48.2	6.0
55	15.6	59.8	48.6	3.27	48.3	6.9
65	8.5	63.4	51.8	3.39	52.8	2.3
65	10.4	65.3	53.6	3.43	54.7	3.3
65	11.7	66.3	54.5	3.45	55.7	4.0
65	13.0	67.1	55.3	3.46	56.5	4.8
65	13.7	67.4	55.6	3.47	56.9	5.2
65	14.3	67.7	55.8	3.47	57.2	5.6
65	15.6	68.3	56.4	3.49	57.8	6.6
75	8.5	71.1	59.0	3.54	61.1	2.1
75	10.4	73.4	61.2	3.58	63.2	3.0
75	11.7	74.6	62.3	3.61	64.4	3.7
75	13.0	75.6	63.2	3.63	65.3	4.5
75	13.7	76.0	63.6	3.64	65.7	4.9
75	14.3	76.4	64.0	3.65	66.0	5.3
75	15.6	77.1	64.6	3.66	66.7	6.2
85	8.5	79.3	66.7	3.71	69.3	2.0
85	10.4	82.0	69.2	3.76	71.7	2.8
85	11.7	83.5	70.5	3.80	72.9	3.5
85	13.0	84.7	71.6	3.83	74.0	4.2
85	13.7	85.2	72.1	3.83	74.5	4.7
85	14.3	85.7	72.6	3.84	74.8	5.0
85	15.6	86.6	73.4	3.86	75.6	5.9

Note: Heating performance data is tabulated at 70°F DB at rated CFM. See performance correction tables to correct performance at conditions other than those tabulated. Interpolation of data is permissible; extrapolation is not. Rated GPM: 13.0; Minimum CFM: 1701; Rated CFM: 1890; Maximum CFM: 2079. For ANSI/AHRI/ASHRAE/ISO13256-1 certified ratings, refer to the ANSI/AHRI/ASHRAE/ISO13256-1 performance table.



Performance Data

Table 33. Fan correction factors - VSV*050

Entering CFM	Cooling Capacity	Sensible Capacity	Cooling Input Watts	Heating Capacity	Heating Input Watts
1701	0.980	0.939	1.002	0.991	1.047
1796	0.988	0.966	1.001	0.996	1.024
1890	0.997	0.997	1.000	1.000	1.000
1985	1.004	1.025	0.999	1.004	0.981
2079	1.012	1.054	0.999	1.007	0.964

Table 34. Cooling capacities - VSH*060

EWT	GPM	Gross (MBtuh)	Sen (MBtuh)	SHR	Compressor Power (kW)	Reject (MBtuh)	LWT	Feet Head
45	10.1	77.5	48.6	0.63	2.27	85.3	61.9	3.3
45	12.5	77.8	48.8	0.63	2.19	85.3	58.6	4.7
45	14.0	77.9	48.8	0.63	2.15	85.3	57.2	5.7
45	15.6	78.0	48.9	0.63	2.13	85.3	55.9	6.8
45	16.4	78.0	48.9	0.63	2.12	85.2	55.4	7.3
45	17.2	78.1	49.0	0.63	2.11	85.3	54.9	7.9
45	18.7	78.1	49.0	0.63	2.10	85.3	54.1	9.1
55	10.1	72.5	47.6	0.66	2.62	81.4	71.1	3.2
55	12.5	72.8	47.8	0.66	2.52	81.4	68.0	4.5
55	14.0	72.8	47.8	0.66	2.48	81.3	66.6	5.4
55	15.6	72.9	47.9	0.66	2.45	81.3	65.4	6.5
55	16.4	72.9	47.9	0.66	2.44	81.2	64.9	7.0
55	17.2	73.0	48.0	0.66	2.43	81.3	64.5	7.6
55	18.7	73.0	48.0	0.66	2.41	81.2	63.7	8.7
65	10.1	69.2	47.3	0.68	3.01	79.5	80.7	3.1
65	12.5	69.5	47.5	0.68	2.91	79.4	77.7	4.3
65	14.0	69.6	47.6	0.68	2.86	79.4	76.3	5.2
65	15.6	69.6	47.6	0.68	2.82	79.2	75.2	6.2
65	16.4	69.7	47.7	0.68	2.81	79.3	74.7	6.8
65	17.2	69.7	47.7	0.68	2.79	79.2	74.2	7.3
65	18.7	69.7	47.7	0.68	2.77	79.2	73.5	8.4
75	10.1	66.7	47.4	0.71	3.44	78.4	90.5	3.0
75	12.5	67.0	47.6	0.71	3.33	78.4	87.5	4.2
75	14.0	67.0	47.6	0.71	3.28	78.2	86.2	5.0
75	15.6	67.1	47.7	0.71	3.24	78.2	85.0	6.0
75	16.4	67.2	47.8	0.71	3.22	78.2	84.5	6.5
75	17.2	67.2	47.8	0.71	3.21	78.2	84.1	7.0
75	18.7	67.2	47.8	0.71	3.18	78.1	83.4	8.0
85	10.1	64.2	47.3	0.74	3.91	77.5	100.3	2.8
85	12.5	64.5	47.5	0.74	3.80	77.5	97.4	4.0
85	14.0	64.5	47.5	0.74	3.75	77.3	96.0	4.8
85	15.6	64.6	47.6	0.74	3.71	77.2	94.9	5.7
85	16.4	64.7	47.7	0.74	3.69	77.3	94.4	6.2
85	17.2	64.7	47.7	0.74	3.67	77.2	94.0	6.7

Table 34. Cooling capacities - VSH*060 (continued)

EWT	GPM	Gross (MBtuh)	Sen (MBtuh)	SHR	Compressor Power (kW)	Reject (MBtuh)	LWT	Feet Head
85	18.7	64.7	47.7	0.74	3.64	77.1	93.2	7.7
95	10.1	61.2	46.8	0.76	4.41	76.3	110.1	2.7
95	12.5	61.5	47.0	0.76	4.30	76.2	107.2	3.9
95	14.0	61.6	47.1	0.76	4.25	76.1	105.9	4.6
95	15.6	61.7	47.2	0.76	4.21	76.1	104.8	5.5
95	16.4	61.7	47.2	0.76	4.19	76.0	104.3	6.0
95	17.2	61.8	47.3	0.77	4.17	76.0	103.8	6.5
95	18.7	61.7	47.2	0.76	4.14	75.8	103.1	7.4
105	10.1	57.8	45.8	0.79	4.95	74.7	119.8	2.6
105	12.5	58.1	46.1	0.79	4.84	74.6	116.9	3.7
105	14.0	58.1	46.1	0.79	4.79	74.5	115.6	4.4
105	15.6	58.2	46.2	0.79	4.75	74.4	114.5	5.3
105	16.4	58.3	46.2	0.79	4.73	74.5	114.1	5.7
105	17.2	58.3	46.2	0.79	4.72	74.4	113.7	6.2
105	18.7	58.3	46.2	0.79	4.69	74.3	112.9	7.1
115	10.1	54.1	44.6	0.82	5.52	72.9	129.4	2.5
115	12.5	54.4	44.8	0.82	5.41	72.9	126.7	3.6
115	14.0	54.4	44.8	0.82	5.36	72.7	125.4	4.3
115	15.6	54.5	44.9	0.82	5.32	72.7	124.3	5.1
115	16.4	54.6	45.0	0.82	5.31	72.7	123.9	5.5
115	17.2	54.6	45.0	0.82	5.29	72.7	123.5	6.0
115	18.7	54.6	45.0	0.82	5.27	72.6	122.8	6.8
120	10.1	52.4	44.0	0.84	5.81	72.2	134.3	2.5
120	12.5	52.6	44.2	0.84	5.71	72.1	131.5	3.5
120	14.0	52.7	44.3	0.84	5.66	72.0	130.3	4.2
120	15.6	52.8	44.4	0.84	5.62	72.0	129.2	5.0
120	16.4	52.8	44.4	0.84	5.61	71.9	128.8	5.4
120	17.2	52.9	44.4	0.84	5.59	72.0	128.4	5.8
120	18.7	52.9	44.4	0.84	5.57	71.9	127.7	6.7

Note: Cooling performance data is tabulated at 80°F DB/67°F WB entering air at ANSI/AHRI/ASHRAE/ISO13256-1 rated CFM. For ANSI/AHRI/ASHRAE/ISO13256-1 certified ratings, refer to the ANSI/AHRI/ASHRAE/ISO13256-1 performance table. See performance correction tables to correct performance at conditions other than those tabulated. Rated GPM: 15.6; Minimum CFM: 1598; Rated CFM: 2120; Maximum CFM: 2329.

Table 35. Heating capacities- VSH*060

EWT	GPM	Gross (MBtuh)	Absorb (MBtuh)	Compressor Power (kW)	LWT	Feet Head
25	14.0	45.4	33.5	3.48	20.2	6.1
25	15.6	45.6	33.7	3.49	20.7	7.3
25	16.4	45.7	33.8	3.49	20.9	7.9
25	17.2	45.8	33.9	3.49	21.1	8.6
25	18.7	46.1	34.2	3.50	21.3	9.8
35	10.1	52.5	40.2	3.61	27.0	3.5
35	12.5	53.5	41.1	3.64	28.4	4.9
35	14.0	54.0	41.5	3.65	29.1	5.9



Performance Data

Table 35. Heating capacities- VSH*060 (continued)

EWT	GPM	Gross (MBtuh)	Absorb (MBtuh)	Compressor Power (kW)	LWT	Feet Head
35	15.6	54.3	41.8	3.66	29.6	7.0
35	16.4	54.5	42.0	3.66	29.9	7.6
35	17.2	54.6	42.1	3.67	30.1	8.2
35	18.7	55.0	42.5	3.68	30.5	9.4
45	10.1	60.2	47.3	3.77	35.6	3.3
45	12.5	61.6	48.6	3.81	37.2	4.7
45	14.0	62.2	49.2	3.82	38.0	5.7
45	15.6	62.7	49.6	3.83	38.6	6.8
45	16.4	63.0	49.9	3.84	38.9	7.3
45	17.2	63.2	50.1	3.84	39.2	7.9
45	18.7	63.6	50.4	3.85	39.6	9.1
55	10.1	67.9	54.4	3.94	44.2	3.2
55	12.5	69.6	56.0	3.98	46.0	4.5
55	14.0	70.5	56.8	4.00	46.9	5.4
55	15.6	71.1	57.4	4.02	47.6	6.5
55	16.4	71.4	57.7	4.02	48.0	7.0
55	17.2	71.7	57.9	4.03	48.3	7.6
55	18.7	72.2	58.4	4.04	48.8	8.7
65	10.1	75.9	61.8	4.12	52.8	3.1
65	12.5	77.9	63.7	4.17	54.8	4.3
65	14.0	79.0	64.7	4.20	55.8	5.2
65	15.6	79.8	65.4	4.22	56.6	6.2
65	16.4	80.2	65.8	4.22	57.0	6.8
65	17.2	80.5	66.1	4.23	57.3	7.3
65	18.7	81.1	66.6	4.25	57.9	8.4
75	10.1	84.4	69.7	4.32	61.2	3.0
75	12.5	86.8	71.8	4.38	63.5	4.2
75	14.0	88.0	72.9	4.41	64.6	5.0
75	15.6	89.0	73.9	4.44	65.5	6.0
75	16.4	89.5	74.3	4.45	65.9	6.5
75	17.2	89.9	74.7	4.46	66.3	7.0
75	18.7	90.6	75.3	4.48	66.9	8.0
85	10.1	93.7	78.2	4.55	69.5	2.8
85	12.5	96.5	80.7	4.62	72.1	4.0
85	14.0	97.9	82.0	4.65	73.3	4.8
85	15.6	99.1	83.1	4.68	74.3	5.7
85	16.4	99.6	83.6	4.70	74.8	6.2
85	17.2	100.1	84.0	4.71	75.2	6.7
85	18.7	100.9	84.8	4.73	75.9	7.7

Note: Heating performance data is tabulated at 70°F DB at rated CFM. See correction factor tables to correct performance at conditions other than those tabulated. Interpolation of data is permissible; extrapolation is not. Rated GPM: 15.6; Minimum CFM: 1598; Rated CFM: 2120; Maximum CFM: 2329. For ANSI/AHRI/ASHRAE/ISO13256-1 certified ratings, refer to the ANSI/AHRI/ASHRAE/ISO13256-1 performance table.

Table 36. VSH*060 fan correction factors

Entering CFM	Cooling Capacity	Sensible Capacity	Cooling Comp Watts	Heating Capacity	Heating Comp Watts
1598	0.950	0.864	1.001	0.979	1.137
1702	0.962	0.891	1.001	0.984	1.103
1911	0.982	0.945	1.000	0.993	1.046
2016	0.991	0.973	1.000	0.997	1.022
2120	1.000	1.000	1.000	1.000	1.000
2225	1.008	1.028	1.000	1.003	0.980
2329	1.016	1.056	1.000	1.006	0.962

Table 37. Cooling capacities - VSV*060

EWT	GPM	Gross (MBtuh)	Sen (MBtuh)	SHR	Compressor Power (kW)	Reject (MBtuh)	LWT	Feet Head
45	10.1	74.1	44.2	0.60	2.60	83.0	61.4	3.0
45	12.5	74.4	44.3	0.60	2.50	82.9	58.3	4.2
45	14.0	74.6	44.5	0.60	2.45	82.9	56.8	5.1
45	15.6	74.7	44.5	0.60	2.41	82.9	55.6	6.0
45	16.4	74.7	44.5	0.60	2.39	82.9	55.1	6.5
45	17.2	74.7	44.5	0.60	2.37	82.8	54.6	7.0
45	18.7	74.8	44.6	0.60	2.35	82.8	53.9	8.0
55	10.1	74.1	51.6	0.70	2.51	82.6	71.4	2.9
55	12.5	74.4	51.9	0.70	2.40	82.6	68.2	4.0
55	14.0	74.6	52.0	0.70	2.35	82.6	66.8	4.8
55	15.6	74.7	52.1	0.70	2.31	82.6	65.6	5.7
55	16.4	74.7	52.1	0.70	2.29	82.5	65.1	6.2
55	17.2	74.7	52.1	0.70	2.28	82.5	64.6	6.7
55	18.7	74.8	52.1	0.70	2.25	82.5	63.8	7.6
65	10.1	72.0	51.3	0.71	2.92	82.0	81.2	2.8
65	12.5	72.3	51.5	0.71	2.81	81.9	78.1	3.9
65	14.0	72.5	51.6	0.71	2.76	81.9	76.7	4.6
65	15.6	72.6	51.7	0.71	2.72	81.9	75.5	5.5
65	16.4	72.6	51.7	0.71	2.71	81.8	75.0	6.0
65	17.2	72.6	51.7	0.71	2.69	81.8	74.5	6.4
65	18.7	72.7	51.8	0.71	2.66	81.8	73.7	7.3
75	10.1	68.9	50.2	0.73	3.34	80.3	90.9	2.7
75	12.5	69.3	50.5	0.73	3.23	80.3	87.8	3.7
75	14.0	69.4	50.6	0.73	3.18	80.2	86.5	4.5
75	15.6	69.5	50.7	0.73	3.14	80.2	85.3	5.3
75	16.4	69.5	50.7	0.73	3.12	80.2	84.8	5.7
75	17.2	69.6	50.7	0.73	3.11	80.2	84.3	6.2
75	18.7	69.6	50.7	0.73	3.08	80.1	83.6	7.1
85	10.1	65.5	49.3	0.75	3.78	78.4	100.5	2.6
85	12.5	65.9	49.6	0.75	3.67	78.4	97.5	3.6
85	14.0	66.0	49.7	0.75	3.62	78.4	96.2	4.3
85	15.6	66.1	49.8	0.75	3.59	78.3	95.0	5.1
85	16.4	66.1	49.8	0.75	3.57	78.3	94.5	5.6



Performance Data

Table 37. Cooling capacities - VSV*060 (continued)

EWT	GPM	Gross (MBtuh)	Sen (MBtuh)	SHR	Compressor Power (kW)	Reject (MBtuh)	LWT	Feet Head
85	17.2	66.2	49.8	0.75	3.55	78.3	94.1	6.0
85	18.7	66.2	49.8	0.75	3.53	78.2	93.4	6.9
95	10.1	62.1	48.4	0.78	4.28	76.7	110.2	2.5
95	12.5	62.4	48.6	0.78	4.17	76.6	107.3	3.5
95	14.0	62.6	48.8	0.78	4.12	76.7	106.0	4.2
95	15.6	62.7	48.8	0.78	4.08	76.6	104.8	5.0
95	16.4	62.7	48.8	0.78	4.06	76.6	104.3	5.4
95	17.2	62.7	48.8	0.78	4.05	76.5	103.9	5.8
95	18.7	62.7	48.8	0.78	4.02	76.4	103.2	6.7
105	10.1	58.7	47.3	0.81	4.81	75.1	119.9	2.5
105	12.5	59.0	47.6	0.81	4.71	75.1	117.0	3.4
105	14.0	59.1	47.6	0.81	4.66	75.0	115.7	4.1
105	15.6	59.2	47.7	0.81	4.62	75.0	114.6	4.9
105	16.4	59.3	47.8	0.81	4.60	75.0	114.1	5.3
105	17.2	59.3	47.8	0.81	4.59	74.9	113.7	5.7
105	18.7	59.3	47.8	0.81	4.56	74.9	113.0	6.5
115	10.1	55.1	46.1	0.84	5.38	73.5	129.6	2.4
115	12.5	55.4	46.3	0.84	5.28	73.4	126.7	3.4
115	14.0	55.5	46.4	0.84	5.22	73.3	125.5	4.0
115	15.6	55.6	46.5	0.84	5.19	73.3	124.4	4.8
115	16.4	55.6	46.5	0.84	5.17	73.2	123.9	5.2
115	17.2	55.7	46.6	0.84	5.15	73.3	123.5	5.6
115	18.7	55.7	46.6	0.84	5.13	73.2	122.8	6.4
120	10.1	53.1	45.4	0.85	5.67	72.5	134.4	2.4
120	12.5	53.4	45.7	0.86	5.56	72.4	131.6	3.3
120	14.0	53.6	45.8	0.85	5.51	72.4	130.3	4.0
120	15.6	53.7	45.9	0.85	5.48	72.4	129.3	4.7
120	16.4	53.7	45.9	0.85	5.46	72.3	128.8	5.1
120	17.2	53.7	45.9	0.85	5.44	72.3	128.4	5.5
120	18.7	53.7	45.9	0.85	5.42	72.2	127.7	6.3

Note: Cooling performance data is tabulated at 80°F DB/67°F WB entering air at ANSI/AHRI/ASHRAE/ISO13256-1 rated CFM. For ANSI/AHRI/ASHRAE/ISO13256-1 certified ratings, refer to the ANSI/AHRI/ASHRAE/ISO13256-1 performance table. See performance correction tables to correct performance at conditions other than those tabulated. Rated GPM: 15.6; Minimum CFM: 1620; Rated CFM: 2121; Maximum CFM: 2321.

Table 38. Heating capacities - VSV*060

EWT	GPM	Gross (MBtuh)	Absorb (MBtuh)	Compressor Power (kW)	LWT	Feet Head
25	14.0	44.6	33.3	3.30	20.2	5.5
25	15.6	44.9	33.6	3.31	20.7	6.5
25	16.4	45.0	33.7	3.31	20.9	7.1
25	17.2	45.2	33.9	3.32	21.1	7.6
25	18.7	45.4	34.1	3.33	21.4	8.7
35	10.1	51.4	39.8	3.41	27.1	3.2
35	12.5	52.5	40.8	3.44	28.5	4.5

Table 38. Heating capacities - VSV*060 (continued)

EWT	GPM	Gross (MBtuh)	Absorb (MBtuh)	Compressor Power (kW)	LWT	Feet Head
35	14.0	53.0	41.2	3.46	29.1	5.3
35	15.6	53.4	41.6	3.47	29.7	6.3
35	16.4	53.6	41.8	3.47	29.9	6.8
35	17.2	53.7	41.8	3.47	30.1	7.4
35	18.7	54.0	42.1	3.48	30.5	8.4
45	10.1	59.5	47.2	3.60	35.7	3.0
45	12.5	60.8	48.4	3.63	37.3	4.2
45	14.0	61.4	49.0	3.65	38.0	5.1
45	15.6	61.9	49.4	3.66	38.7	6.0
45	16.4	62.1	49.6	3.66	39.0	6.5
45	17.2	62.3	49.8	3.66	39.2	7.0
45	18.7	62.6	50.1	3.67	39.6	8.0
55	10.1	67.7	54.8	3.78	44.1	2.9
55	12.5	69.3	56.3	3.81	46.0	4.0
55	14.0	70.0	57.0	3.82	46.9	4.8
55	15.6	70.6	57.5	3.83	47.6	5.7
55	16.4	70.8	57.7	3.84	48.0	6.2
55	17.2	71.0	57.9	3.84	48.3	6.7
55	18.7	71.4	58.3	3.85	48.8	7.6
65	10.1	76.3	62.8	3.96	52.6	2.8
65	12.5	78.1	64.5	3.99	54.7	3.9
65	14.0	79.0	65.3	4.00	55.7	4.6
65	15.6	79.7	66.0	4.01	56.5	5.5
65	16.4	80.0	66.3	4.02	56.9	6.0
65	17.2	80.3	66.6	4.02	57.3	6.4
65	18.7	80.7	66.9	4.03	57.8	7.3
75	10.1	85.5	71.3	4.17	60.9	2.7
75	12.5	87.6	73.3	4.20	63.3	3.7
75	14.0	88.7	74.3	4.22	64.4	4.5
75	15.6	89.6	75.2	4.23	65.4	5.3
75	16.4	89.9	75.5	4.23	65.8	5.7
75	17.2	90.2	75.7	4.24	66.2	6.2
75	18.7	90.8	76.3	4.25	66.8	7.1
85	10.1	95.6	80.5	4.42	69.1	2.6
85	12.5	98.1	82.9	4.45	71.7	3.6
85	14.0	99.3	84.0	4.47	73.0	4.3
85	15.6	100.4	85.1	4.48	74.1	5.1
85	16.4	100.8	85.5	4.48	74.6	5.6
85	17.2	101.2	85.9	4.49	75.0	6.0
85	18.7	101.9	86.6	4.50	75.7	6.9

Note: Heating performance data is tabulated at 70°F DB at rated CFM. See correction factor tables to correct performance at conditions other than those tabulated. Interpolation of data is permissible; extrapolation is not. Rated GPM: 15.6; Minimum CFM: 1620; Rated CFM: 2120; Maximum CFM: 2321. For ANSI/AHRI/ASHRAE/ISO13256-1 certified ratings, refer to the ANSI/AHRI/ASHRAE/ISO13256-1 performance table.



Performance Data

Table 39. VSV*060 fan correction factors

Entering CFM	Cooling Capacity	Sensible Capacity	Cooling Comp Watts	Heating Capacity	Heating Comp Watts
1620	0.953	0.866	1.002	0.980	1.129
1720	0.964	0.892	1.001	0.986	1.097
1920	0.983	0.947	1.001	0.996	1.045
2021	0.992	0.973	1.000	0.998	1.022
2121	1.000	1.000	1.000	1.000	1.000
2221	1.008	1.027	1.000	1.002	0.981
2321	1.015	1.057	0.999	1.007	0.965

Table 40. Correction factors for variation in entering air temperature VSH*024(a)

Cooling Entering Air WB°F	Cooling Capacity	Cooling Input Watts	Sensible vs Entering Dry Bulb Multipliers						Heating Entering Air DB°	Heating Capacity	Heating Input Watts
			65.0	70.0	75.0	80.0	85.0	90.0			
50	0.928	0.995	0.979	1.057	*	*	*	*	55	1.061	0.850
55	0.931	0.994	0.869	1.026	1.130	*	*	*	58	1.049	0.880
60	0.946	0.994	0.621	0.879	1.062	1.191	*	*	61	1.037	0.911
65	0.980	0.998	0.218	0.592	0.871	1.078	1.231	*	64	1.025	0.940
67	1.000	1.000		0.436	0.758	1.000	1.181	*	67	1.013	0.970
70	1.037	1.005		0.157	0.547	0.845	1.072	1.248	70	1.000	1.000
75	1.118	1.014			0.085	0.486	0.799	1.044	73	0.988	1.031
78	1.179	1.021				0.210	0.579	0.871	76	0.976	1.061

(a) * = Sensible equals total capacity

Table 41. Correction factors for variation in entering air temperature VSV*024(a)

Cooling Entering Air WB°F	Cooling Capacity	Cooling Input Watts	Sensible vs Entering Dry Bulb Multipliers						Heating Entering Air DB°	Heating Capacity	Heating Input Watts
			65.0	70.0	75.0	80.0	85.0	90.0			
50	0.944	0.994	0.983	1.048	1.116	1.185	*	*	55	1.025	0.844
55	0.943	0.994	0.899	1.048	1.116	1.183	*	*	58	1.020	0.874
60	0.942	0.994	0.623	0.882	1.110	1.180	*	*	61	1.015	0.904
65	0.971	0.997	0.342	0.602	0.858	1.111	*	*	64	1.010	0.936
67	1.000	1.000		0.489	0.744	1.000	1.233	*	67	1.005	0.968
70	1.048	1.005		0.315	0.576	0.827	1.082	1.312	70	1.000	1.000
75	1.136	1.015			0.285	0.541	0.796	1.048	73	0.995	1.034
78	1.191	1.020				0.367	0.623	0.875	76	0.990	1.068

(a) * = Sensible equals total capacity

Table 42. Correction factors for variation in entering air temperature VSH*033(a)

Cooling Entering Air WB°F	Cooling Capacity	Cooling Input Watts	Sensible vs Entering Dry Bulb Multipliers						Heating Entering Air DB°	Heating Capacity	Heating Input Watts
			65.0	70.0	75.0	80.0	85.0	90.0			
50	0.884	0.990	0.998	1.055	*	*	*	*	55	1.058	0.877
55	0.905	0.988	0.904	1.052	1.147	*	*	*	58	1.046	0.901
60	0.934	0.989	0.624	0.899	1.084	1.216	*	*	61	1.035	0.925
65	0.978	0.996	0.163	0.582	0.875	1.088	1.249	*	64	1.023	0.949

Table 42. Correction factors for variation in entering air temperature VSH*033^(a) (continued)

67	1.000	1.000		0.414	0.752	1.000	1.190	*	67	1.012	0.974
70	1.039	1.008		0.123	0.531	0.834	1.067	1.251	70	1.000	1.000
75	1.121	1.024			0.080	0.476	0.783	1.027	73	0.988	1.026
78	1.180	1.035				0.220	0.572	0.854	76	0.977	1.052

(a) * = Sensible equals total capacity

Table 43. Correction factors for variation in entering air temperature VSV*033^(a)

Cooling Entering Air WB°F	Cooling Capacity	Cooling Input Watts	Sensible vs. entering dry bulb multipliers						Heating Entering Air DB°F	Heating Capacity	Heating Input Watts
			65.0	70.0	75.0	80.0	85.0	90.0			
50	0.931	0.987	1.021	1.088	1.156	1.226	*	*	55	1.031	0.860
55	0.930	0.987	0.906	1.088	1.155	1.225	*	*	58	1.025	0.886
60	0.929	0.987	0.634	0.886	1.124	1.220	*	*	61	1.019	0.914
65	0.971	0.995	0.355	0.608	0.863	1.110	*	*	64	1.012	0.943
67	1.000	1.000		0.495	0.749	1.000	1.241	*	67	1.006	0.971
70	1.048	1.009		0.322	0.580	0.828	1.080	1.316	70	1.000	1.000
75	1.136	1.025			0.290	0.543	0.793	1.041	73	0.994	1.030
78	1.189	1.035				0.365	0.621	0.868	76	0.988	1.061

(a) * = Sensible equals total capacity

Table 44. Correction factors for variation in entering air temperature VSH*042^(a)

Cooling Entering Air WB°F	Cooling Capacity	Cooling Input Watts	Sensible vs. entering dry bulb multipliers						Heating Entering Air DB°F	Heating Capacity	Heating Input Watts
			65.0	70.0	75.0	80.0	85.0	90.0			
50	0.954	1.006	0.956	1.028	*	*	*	*	55	1.051	0.777
55	0.946	1.008	0.859	1.006	1.101	*	*	*	58	1.041	0.821
60	0.950	1.008	0.623	0.874	1.046	1.166	*	*	61	1.031	0.864
65	0.979	1.003	0.225	0.603	0.874	1.070	*	*	64	1.020	0.909
67	1.000	1.000		0.452	0.768	1.000	1.171	*	67	1.010	0.954
70	1.040	0.993		0.181	0.568	0.858	1.075	1.240	70	1.000	1.000
75	1.133	0.978			0.123	0.518	0.824	1.060	73	0.989	1.046
78	1.206	0.966				0.253	0.615	0.900	76	0.979	1.094

(a) * = Sensible equals total capacity

Table 45. Correction factors for variation in entering air temperature VSV*042^(a)

Cooling Entering Air WB°F	Cooling Capacity	Cooling Input Watts	Sensible vs. entering dry bulb multipliers						Heating Entering Air DB°F	Heating Capacity	Heating Input Watts
			65.0	70.0	75.0	80.0	85.0	90.0			
50	0.944	1.011	0.981	1.047	1.116	*	*	*	55	1.015	0.773
55	0.943	1.011	0.896	1.047	1.115	*	*	*	58	1.012	0.816
60	0.943	1.011	0.621	0.879	1.115	1.184	*	*	61	1.009	0.861
65	0.971	1.006	0.341	0.602	0.857	1.111	*	*	64	1.007	0.906
67	1.000	1.000		0.490	0.745	1.000	1.242	*	67	1.003	0.953
70	1.048	0.991		0.316	0.574	0.828	1.079	*	70	1.000	1.000
75	1.137	0.972			0.285	0.546	0.796	1.048	73	0.997	1.048
78	1.191	0.961				0.368	0.626	0.875	76	0.993	1.098

(a) * = Sensible equals total capacity



Performance Data

Table 46. Correction factors for variation in entering air temperature VSH*050 (a)

Cooling Entering Air WB°F	Cooling Capacity	Cooling Input Watts	Sensible vs. entering dry bulb multipliers						Heating Entering Air DB°F	Heating Capacity	Heating Input Watts
			65.0	70.0	75.0	80.0	85.0	90.0			
50	0.896	1.003	0.979	1.045	*	*	*	*	55	1.057	0.820
55	0.914	1.003	0.874	1.021	1.115	*	*	*	58	1.045	0.854
60	0.938	1.003	0.622	0.879	1.054	1.177	*	*	61	1.034	0.889
65	0.978	1.001	0.210	0.599	0.874	1.073	1.222	*	64	1.023	0.925
67	1.000	1.000		0.446	0.765	1.000	1.176	*	67	1.011	0.962
70	1.041	0.997		0.172	0.562	0.853	1.074	1.245	70	1.000	1.000
75	1.130	0.991			0.117	0.509	0.812	1.051	73	0.989	1.039
78	1.197	0.986				0.243	0.599	0.882	76	0.977	1.079

(a) * = Sensible equals total capacity

Table 47. Correction factors for variation in entering air temperature VSV*050(a)

Cooling Entering Air WB°F	Cooling Capacity	Cooling Input Watts	Sensible vs. entering dry bulb multipliers						Heating Entering Air DB°F	Heating Capacity	Heating Input Watts
			65.0	70.0	75.0	80.0	85.0	90.0			
50	0.935	1.005	1.008	1.075	1.144	*	*	*	55	1.027	0.811
55	0.934	1.006	0.905	1.074	1.143	*	*	*	58	1.022	0.848
60	0.933	1.006	0.626	0.884	1.127	1.213	*	*	61	1.017	0.886
65	0.970	1.003	0.343	0.604	0.860	1.112	*	*	64	1.011	0.923
67	1.000	1.000		0.487	0.746	1.000	1.244	*	67	1.005	0.961
70	1.048	0.996		0.317	0.573	0.826	1.082	1.322	70	1.000	1.000
75	1.137	0.987			0.283	0.540	0.792	1.042	73	0.995	1.042
78	1.192	0.982				0.363	0.619	0.868	76	0.989	1.081

(a) * = Sensible equals total capacity

Table 48. Correction factors for variation in entering air temperature VSH*060 (a)

Cooling Entering Air WB°F	Cooling Capacity	Cooling Input Watts	Sensible vs Entering Dry Bulb Multipliers						Heating Entering Air DB°	Heating Capacity	Heating Input Watts
			65.0	70.0	75.0	80.0	85.0	90.0			
50	0.934	0.998	1.010	1.111	*	*	*	*	55	1.050	0.843
55	0.926	0.999	0.875	1.046	1.171	*	*	*	58	1.040	0.873
60	0.939	0.999	0.634	0.881	1.073	1.220	*	*	61	1.030	0.903
65	0.977	1.000	0.283	0.608	0.871	1.083	1.252	*	64	1.020	0.935
67	1.000	1.000		0.469	0.762	1.000	1.193	*	67	1.010	0.967
70	1.043	1.000		0.228	0.567	0.846	1.075	1.264	70	1.000	1.000
75	1.137	1.001			0.162	0.511	0.804	1.050	73	0.990	1.034
78	1.206	1.001				0.264	0.597	0.878	76	0.980	1.068

(a) * = Sensible equals total capacity

Table 49. Correction factors for variation in entering air temperature VSV*060(a)

Cooling Entering Air WB°F	Cooling Capacity	Cooling Input Watts	Sensible vs Entering Dry Bulb Multipliers						Heating Entering Air DB°	Heating Capacity	Heating Input Watts
			65.0	70.0	75.0	80.0	85.0	90.0			
50	0.944	1.000	1.008	1.095	*	*	*	*	55	1.046	0.836

Table 49. Correction factors for variation in entering air temperature VSV*060^(a) (continued)

Cooling Entering Air WB°F	Cooling Capacity	Cooling Input Watts	Sensible vs Entering Dry Bulb Multipliers						Heating Entering Air DB°	Heating Capacity	Heating Input Watts
			65.0	70.0	75.0	80.0	85.0	90.0			
55	0.935	1.000	0.881	1.040	1.155	*	*	*	58	1.037	0.868
60	0.942	1.000	0.631	0.881	1.066	1.207	*	*	61	1.028	0.900
65	0.978	1.000	0.251	0.606	0.873	1.079	1.243	*	64	1.018	0.933
67	1.000	1.000		0.462	0.764	1.000	1.187	*	67	1.009	0.966
70	1.041	1.000		0.209	0.568	0.849	1.074	1.258	70	1.000	1.000
75	1.129	0.999			0.152	0.514	0.807	1.047	73	0.991	1.034
78	1.190	0.998				0.264	0.599	0.876	76	0.982	1.069

(a) * = Sensible equals total capacity



Unit Fan Performance

Unit Fan Performance

Table 50. ECM fan performance

Model	External Static Pressure																									
	0		0.05		0.1		0.15		0.2		0.25		0.3		0.4		0.45		0.5		0.55		0.6			
	CFM	kW	RPM	kW	RPM	kW	RPM	kW	RPM	kW	RPM	kW	RPM	kW	RPM	kW	RPM	kW	RPM	kW	RPM	kW	RPM	kW	RPM	
VSH024	796	0.040	300	0.050	362	0.060	419	0.070	470	0.080	516	0.090	557	0.099	595											
	840	0.042	311	0.053	372	0.064	427	0.074	477	0.085	523	0.095	564	0.105	601											
	885	0.045	323	0.057	382	0.068	436	0.079	485	0.090	529	0.100	570	0.111	606											
	930	0.048	334	0.060	392	0.072	445	0.083	493	0.095	536	0.106	576	0.117	612											
	974	0.052	346	0.064	403	0.076	454	0.088	501	0.100	544	0.112	582	0.123	618											
	1019	0.056	359	0.069	414	0.081	464	0.094	509	0.106	551	0.118	589	0.130	623											
VSH024	796	0.109	629	0.118	660	0.127	689	0.136	715	0.145	739	0.155	762													
	840	0.115	634	0.125	665	0.134	693	0.144	720	0.154	745	0.163	768													
	885	0.121	640	0.131	670	0.142	698	0.152	725	0.162	750	0.172	774													
	930	0.128	645	0.139	675	0.149	703	0.160	730	0.171	755	0.181	779													
	974	0.135	650	0.146	680	0.157	708	0.168	734	0.180	760	0.191	785													
	1019	0.142	655	0.154	685	0.166	713	0.177	739	0.189	765	0.200	790													
VSH033	1014	0.084	397	0.097	451	0.110	501	0.123	546	0.135	587	0.148	624	0.160	658											
	1076	0.090	415	0.104	467	0.118	515	0.131	558	0.144	597	0.157	633	0.170	667											
	1138	0.098	433	0.112	483	0.126	529	0.140	570	0.154	608	0.168	643	0.181	675											
	1200	0.106	452	0.121	500	0.136	544	0.151	583	0.165	620	0.179	653	0.193	684											
	1262	0.116	472	0.132	518	0.147	559	0.162	597	0.177	632	0.192	664	0.206	693											
	1324	0.127	493	0.143	536	0.159	575	0.175	611	0.190	644	0.205	675	0.220	703											
VSH033	1014	0.172	690	0.184	719	0.196	747	0.208	774	0.220	799	0.232	824													
	1076	0.183	697	0.195	726	0.208	754	0.221	780	0.233	806	0.246	831													
	1138	0.195	705	0.208	733	0.221	760	0.234	787	0.247	813	0.260	839													
	1200	0.207	713	0.221	741	0.235	767	0.248	793	0.262	819	0.276	846													
	1262	0.221	722	0.235	749	0.249	775	0.264	800	0.278	826	0.292	853													
	1324	0.235	731	0.250	757	0.265	782	0.280	808	0.295	833	0.309	860													

Table 50. ECM fan performance (continued)

Model	External Static Pressure																	
	0		0.05		0.1		0.15		0.2		0.25		0.3					
	CFM	kW	RPM	kW	RPM	kW	RPM	kW	RPM	kW	RPM	kW	RPM	kW	RPM			
VSH042	1414	0.102	451	0.117	488	0.133	523	0.149	556	0.164	588	0.180	619	0.196	647			
	1485	0.117	471	0.133	507	0.150	541	0.166	573	0.183	604	0.199	633	0.216	662			
	1579	0.140	499	0.157	532	0.175	565	0.192	596	0.210	626	0.228	654	0.245	681			
	1650	0.158	519	0.177	552	0.195	583	0.214	613	0.232	642	0.251	670	0.269	697			
	1721	0.179	539	0.198	571	0.217	601	0.237	631	0.256	659	0.276	686	0.295	712			
	1815	0.208	566	0.229	596	0.250	625	0.270	654	0.291	681	0.312	707	0.332	733			
VSH042			0.35		0.4		0.45		0.5		0.55		0.6					
	CFM	kW	RPM	kW	RPM	kW	RPM	kW	RPM	kW	RPM	kW	RPM	kW	RPM			
	1414	0.211	675	0.226	701	0.241	726	0.256	749	0.270	771	0.284	792					
	1485	0.232	689	0.248	714	0.264	738	0.279	762	0.294	783	0.309	804					
	1579	0.262	708	0.279	732	0.296	756	0.312	779	0.328	800	0.344	821					
	1650	0.287	722	0.305	747	0.322	770	0.340	792	0.356	814	0.373	834					
1721	0.314	737	0.332	761	0.351	784	0.369	806	0.386	828	0.403	848						
1815	0.352	757	0.372	781	0.391	803	0.411	825	0.429	846	0.448	866						
VSH050			0.35		0.4		0.45		0.5		0.55		0.6					
	CFM	kW	RPM	kW	RPM	kW	RPM	kW	RPM	kW	RPM	kW	RPM	kW	RPM			
	1414	0.102	451	0.117	488	0.133	523	0.149	556	0.164	588	0.180	619	0.196	647			
	1485	0.117	471	0.133	507	0.150	541	0.166	573	0.183	604	0.199	633	0.216	662			
	1579	0.140	499	0.157	532	0.175	565	0.192	596	0.210	626	0.228	654	0.245	681			
	1650	0.158	519	0.177	552	0.195	583	0.214	613	0.232	642	0.251	670	0.269	697			
1721	0.179	539	0.198	571	0.217	601	0.237	631	0.256	659	0.276	686	0.295	712				
2077	0.301	624	0.326	652	0.350	679	0.374	705	0.399	730	0.423	754	0.447	778				
VSH050			0.35		0.4		0.45		0.5		0.55		0.6					
	CFM	kW	RPM	kW	RPM	kW	RPM	kW	RPM	kW	RPM	kW	RPM	kW	RPM			
	1414	0.211	675	0.226	701	0.241	726	0.256	749	0.270	771	0.284	792					
	1485	0.232	689	0.248	714	0.264	738	0.279	762	0.294	783	0.309	804					
	1579	0.262	708	0.279	732	0.296	756	0.312	779	0.328	800	0.344	821					
	1650	0.287	722	0.305	747	0.322	770	0.340	792	0.356	814	0.373	834					
1721	0.314	737	0.332	761	0.351	784	0.369	806	0.386	828	0.403	848						
2077	0.471	801	0.494	823	0.517	845	0.540	866	0.562	886	0.584	906						



Unit Fan Performance

Table 50. ECM fan performance (continued)

Model	External Static Pressure																	
	0		0.05		0.1		0.15		0.2		0.25		0.3					
	CFM	kW	RPM	kW	RPM	kW	RPM	kW	RPM	kW	RPM	kW	RPM	kW	RPM			
VSH060	1803	0.240	574	0.262	609	0.282	641	0.301	671	0.319	698	0.337	724	0.354	748			
	1908	0.275	603	0.298	637	0.319	667	0.340	696	0.360	722	0.379	747	0.397	770			
	2014	0.314	631	0.338	664	0.361	693	0.383	721	0.405	746	0.425	770	0.445	792			
	2120	0.357	659	0.383	690	0.408	719	0.431	745	0.454	770	0.476	793	0.497	815			
	2226	0.405	685	0.432	716	0.458	744	0.483	769	0.508	793	0.531	816	0.554	837			
	2332	0.457	711	0.486	741	0.514	768	0.541	793	0.567	816	0.592	838	0.617	859			
		0.35		0.4		0.45		0.5		0.55		0.6						
VSH060	1803	0.371	770	0.388	792	0.405	813	0.422	833	0.439	854	0.457	875					
	1908	0.416	792	0.434	813	0.452	834	0.470	854	0.488	874	0.507	895					
	2014	0.465	814	0.484	834	0.503	855	0.523	874	0.542	894	0.562	915					
	2120	0.518	836	0.539	856	0.560	876	0.580	895	0.601	915	0.623	935					
	2226	0.577	857	0.599	877	0.621	896	0.644	916	0.666	935	0.689	956					
	2332	0.641	879	0.665	898	0.689	917	0.712	936	0.736	955	0.761	976					

Table 51. ECM fan performance

Model	External Static Pressure																	
	0		0.05		0.1		0.15		0.2		0.25		0.3					
	CFM	kW	RPM	kW	RPM	kW	RPM	kW	RPM	kW	RPM	kW	RPM	kW	RPM			
VSV024	837	0.070	456	0.079	505	0.090	551	0.101	595	0.114	637	0.127	677	0.140	714			
	884	0.081	483	0.090	529	0.101	572	0.113	614	0.126	654	0.140	692	0.154	729			
	930	0.092	508	0.102	551	0.113	593	0.125	633	0.139	671	0.153	708	0.168	743			
	977	0.105	534	0.115	575	0.127	614	0.140	652	0.154	689	0.168	724	0.184	758			
	1023	0.118	559	0.129	597	0.141	635	0.154	671	0.169	706	0.184	739	0.200	772			
			0.35		0.4		0.45		0.5		0.55		0.6					
VSV024	837	0.153	750	0.167	784	0.180	815	0.192	845	0.204	873	0.214	899					
	884	0.168	763	0.182	796	0.196	827	0.210	857	0.222	885	0.234	911					
	930	0.183	776	0.198	808	0.213	839	0.227	868	0.240	896	0.253	923					
	977	0.200	790	0.215	821	0.231	851	0.246	880	0.261	908	0.274	935					
	1023	0.217	804	0.233	834	0.250	864	0.266	892	0.281	920	0.296	947					

Table 51. ECM fan performance (continued)

Model		External Static Pressure																		
		0		0.05		0.1		0.15		0.2		0.25		0.3						
CFM	kW	RPM	kW	RPM	kW	RPM	kW	RPM	kW	RPM	kW	RPM	kW	RPM	kW	RPM	kW	RPM		
VSV033		1080	0.118	538	0.128	571	0.138	603	0.151	634	0.164	664	0.178	693	0.192	722				
		1140	0.137	568	0.147	598	0.158	628	0.171	657	0.184	685	0.199	713	0.214	740				
		1200	0.158	596	0.168	624	0.179	652	0.192	679	0.207	705	0.222	731	0.238	757				
		1260	0.181	625	0.191	651	0.203	676	0.217	701	0.232	726	0.247	751	0.264	775				
		1320	0.206	653	0.217	676	0.229	700	0.243	723	0.259	746	0.275	770	0.292	793				
VSV033		0.35		0.4		0.45		0.5		0.55		0.6								
		CFM	kW	RPM	kW	RPM	kW	RPM	kW	RPM	kW	RPM	kW	RPM	kW	RPM	kW	RPM	kW	RPM
		1080	0.207	750	0.222	777	0.237	803	0.252	829	0.267	854	0.280	879						
		1140	0.230	766	0.246	792	0.262	818	0.278	844	0.293	869	0.308	894						
		1200	0.254	783	0.271	808	0.288	833	0.305	858	0.322	883	0.338	908						
1260	0.281	800	0.299	824	0.317	849	0.335	874	0.352	898	0.369	923								
1320	0.310	817	0.329	841	0.348	865	0.366	889	0.385	913	0.403	938								
VSV042		1485	0.175	553	0.207	599	0.237	641	0.266	680	0.294	716	0.320	750	0.346	782				
		1568	0.202	580	0.236	624	0.268	665	0.299	703	0.328	737	0.357	770	0.385	801				
		1650	0.231	607	0.267	650	0.301	689	0.334	725	0.366	758	0.396	790	0.426	820				
		1733	0.262	634	0.300	674	0.336	711	0.371	746	0.405	778	0.437	808	0.469	837				
		1815	0.294	659	0.334	698	0.373	733	0.410	766	0.446	797	0.481	826	0.515	854				
VSV042		0.35		0.4		0.45		0.5		0.55		0.6								
		CFM	kW	RPM	kW	RPM	kW	RPM	kW	RPM	kW	RPM	kW	RPM	kW	RPM	kW	RPM	kW	RPM
		1485	0.372	812	0.398	841	0.424	870	0.451	898	0.480	927	0.509	956						
		1568	0.413	830	0.441	859	0.469	887	0.498	916	0.528	944	0.559	974						
		1650	0.456	848	0.486	876	0.516	904	0.547	932	0.579	961	0.613	991						
1733	0.501	865	0.533	893	0.566	920	0.599	948	0.633	977	0.668	1007								
1815	0.549	881	0.583	908	0.617	935	0.652	963	0.689	991	0.726	1021								



Unit Fan Performance

Table 51. ECM fan performance (continued)

Model	External Static Pressure																	
	0		0.05		0.1		0.15		0.2		0.25		0.3					
	CFM	kW	RPM	kW	RPM	kW	RPM	kW	RPM	kW	RPM	kW	RPM	kW	RPM			
VSV050	1701	0.265	636	0.305	678	0.343	716	0.379	752	0.414	785	0.448	817	0.481	847			
	1796	0.304	666	0.346	706	0.387	742	0.426	776	0.463	808	0.500	838	0.535	867			
	1890	0.345	695	0.391	733	0.434	767	0.475	799	0.515	829	0.554	858	0.593	886			
	1985	0.390	724	0.438	759	0.483	791	0.528	821	0.570	850	0.612	877	0.653	903			
	2079	0.436	751	0.486	783	0.535	814	0.582	842	0.628	868	0.672	894	0.716	919			
VSV050																		
	CFM	kW	RPM	kW	RPM	kW	RPM	kW	RPM	kW	RPM	kW	RPM	kW	RPM			
	1701	0.514	875	0.547	904	0.581	932	0.615	960	0.650	990	0.687	1020					
	1796	0.571	895	0.607	922	0.643	950	0.679	978	0.717	1007	0.757	1038					
	1890	0.631	912	0.669	939	0.708	966	0.747	994	0.788	1023	0.830	1054					
	1985	0.694	929	0.735	955	0.777	981	0.819	1009	0.862	1038	0.906	1068					
2079	0.760	944	0.804	969	0.848	995	0.892	1022	0.938	1050	0.986	1081						
VSV060																		
	CFM	kW	RPM	kW	RPM	kW	RPM	kW	RPM	kW	RPM	kW	RPM	kW	RPM			
	1816	0.153	515	0.185	558	0.214	598	0.242	634	0.269	667	0.295	696	0.319	724			
	1918	0.185	542	0.218	585	0.249	623	0.279	658	0.308	690	0.335	719	0.362	746			
	2019	0.220	570	0.256	612	0.289	649	0.321	683	0.351	714	0.380	742	0.409	768			
	2121	0.261	598	0.299	639	0.334	676	0.367	708	0.400	738	0.431	765	0.461	790			
2222	0.308	627	0.347	666	0.384	702	0.420	734	0.454	763	0.487	789	0.519	813				
VSV060																		
	CFM	kW	RPM	kW	RPM	kW	RPM	kW	RPM	kW	RPM	kW	RPM	kW	RPM			
	1816	0.344	750	0.368	774	0.392	798	0.417	821	0.443	845	0.469	869					
	1918	0.388	771	0.414	794	0.440	818	0.466	840	0.493	864	0.521	888					
	2019	0.437	792	0.464	815	0.492	838	0.520	860	0.549	883	0.578	907					
	2121	0.491	814	0.520	837	0.550	859	0.579	881	0.610	903	0.641	926					
2222	0.550	836	0.582	858	0.613	880	0.645	901	0.677	923	0.710	946						

MERV Filter

Table 52. Added pressure drop through MERV filters (inches water column)

Model No.	CFM	MERV 8	MERV 13
VSH*024	742	0.08	0.09
	836	0.09	0.10
	930	0.10	0.12
	977	0.11	0.12
	1024	0.11	0.13
VSH*033	952	0.10	0.12
	1076	0.12	0.14
	1200	0.14	0.16
	1262	0.15	0.17
	1324	0.21	0.19
VSH*042	1324	0.09	0.10
	1487	0.10	0.11
	1650	0.11	0.13
	1731	0.12	0.14
	1813	0.13	0.15
VSH*050	1517	0.10	0.12
	1704	0.12	0.14
	1890	0.13	0.16
	1983	0.14	0.17
	2077	0.15	0.18
VSH*060	1890	0.13	0.16
	2016	0.14	0.17
	2120	0.15	0.18
	2225	0.16	0.19
	2329	0.17	0.21

Note: Added pressure drop should be considered when utilizing optional 2" MERV 8 and MERV 13 filters.

Table 53. Added pressure drop through MERV filters (inches water column)

Model No.	CFM	MERV 8	MERV 13
VSV*024	837	0.12	0.14
	884	0.13	0.15
	930	0.14	0.16
	977	0.15	0.17
	1023	0.15	0.18
VSV*033	1080	0.16	0.20
	1140	0.18	0.21
	1200	0.19	0.23
	1260	0.20	0.24
	1320	0.21	0.26



Unit Fan Performance

Table 53. Added pressure drop through MERV filters (inches water column) (continued)

Model No.	CFM	MERV 8	MERV 13
VSV*042	1485	0.13	0.15
	1568	0.14	0.16
	1650	0.15	0.17
	1733	0.15	0.18
	1815	0.16	0.19
VSV*050	1701	0.15	0.18
	1796	0.16	0.19
	1890	0.17	0.21
	1985	0.18	0.22
	2079	0.19	0.23
VSV*060	1900	0.14	0.16
	2021	0.15	0.17
	2121	0.16	0.19
	2221	0.17	0.20
	2321	0.18	0.21

Note: Added pressure drop should be considered when utilizing optional 2" MERV 8 and MERV 13 filters.

Table 54. Antifreeze correction factors

Methanol						
Item	Concentration by Volume					
	0%	10%	20%	30%	40%	50%
Cooling Capacity	1.000	0.998	0.997	0.995	0.993	0.992
Heating Capacity	1.000	0.995	0.990	0.985	0.979	0.974
Pressure Drop	1.000	1.023	1.057	1.091	1.122	1.160
Ethylene Glycol						
Item	Concentration by Volume					
	0%	10%	20%	30%	40%	50%
Cooling Capacity	1.000	0.996	0.991	0.987	0.983	0.979
Heating Capacity	1.000	0.993	0.985	0.977	0.969	0.961
Pressure Drop	1.000	1.024	1.068	1.124	1.188	1.263
Propylene Glycol						
Item	Concentration by Volume					
	0%	10%	20%	30%	40%	50%
Cooling Capacity	1.000	0.993	0.987	0.980	0.974	0.968
Heating Capacity	1.000	0.986	0.973	0.960	0.948	0.935
Pressure Drop	1.000	1.040	1.098	1.174	1.273	1.405
Brine (NaCl)						
Item	Concentration by Volume					
	0%	10%	20%	30%	40%	50%
Cooling Capacity	1.000	0.994	0.987	0.979	0.971	0.963
Heating Capacity	1.000	0.993	0.987	0.982	0.978	0.976
Pressure Drop	1.000	1.154	1.325	1.497	1.669	1.841

Figure 8. Cooling capacity correction factor

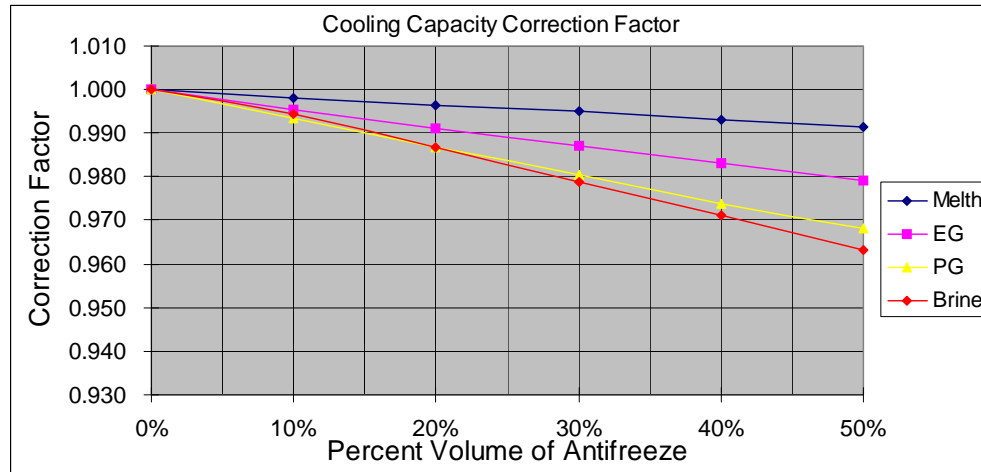

Figure 9. Heating capacity correction factor

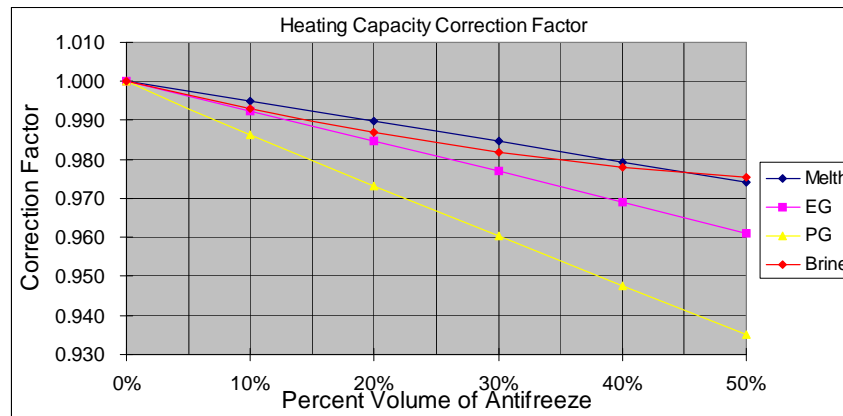
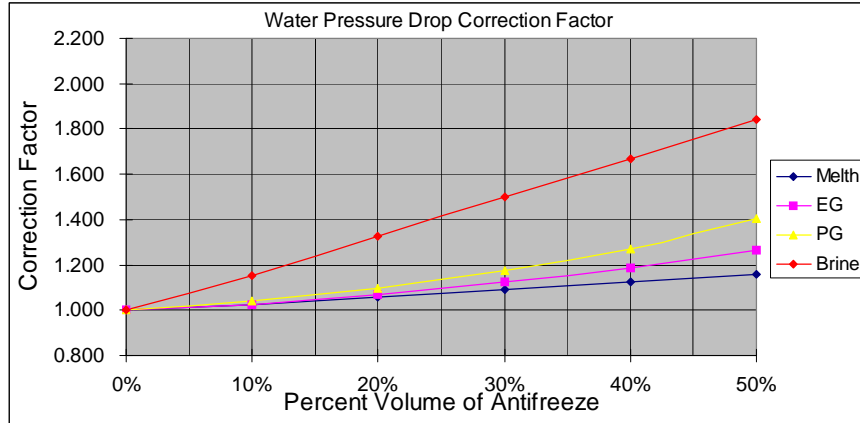

Figure 10. Water pressure drop correction factor

Example 1 (Ethylene Glycol): The antifreeze solution is 20% by volume of Ethylene Glycol. Determine the corrected cooling capacity and waterside pressure drop for a GEHE018 when the EWT is 86°F and the GPM is 4.2.

From the catalog data, the cooling capacity at these conditions with 100% water is 18.6 Mbtuh, and the waterside pressure drop is 6.0 feet of Head. At 20% Ethylene Glycol, the correction factor for cool capacity is 0.9912 and the pressure drop is 1.068.

The corrected cooling capacity (Mbtuh) = 18.6 * 0.9912 = 18.4. The corrected water side pressure drop (Ft. Head) = 6.0 * 1.068 = 6.4.

Example 2 (Propylene Glycol): The antifreeze solution is 30% by volume of Propylene Glycol. Determine the corrected heating capacity and waterside pressure drop for a GEHE042 when the EWT is 45°F and the GPM is 9.7.

From the catalog data, the heating capacity at these conditions with 100% water is 36.7 Mbtuh, and the waterside pressure drop is 16.1 feet of Head. At 30% Propylene Glycol, the correction factor for heat capacity is 0.9603 and the pressure drop is 1.174.

The corrected cooling capacity (Mbtuh) = 36.7 * 0.9603 = 35.2. The corrected water side pressure drop (Ft. Head) = 16.1 * 1.174 = 18.9.



Controls

Tracer® UC400 Programmable BACnet® Controller

The Tracer® UC400 is a programmable, direct digital control (DDC) system designed to control the water source heat pump unit. The controller provides system-level data used to optimize the overall unit performance. Stand-alone applications as well as full building automation systems via the BACnet® MS/TP protocol are supported through the controller.

Features and Functions

Complete control of the water source heat pump unit variable speed compressor and supply air fan is provided through the Tracer® UC400. The control strategies are optimized for enhanced energy efficiency and comfort.

The features and functions of the Tracer® UC400 are described in the following sections.

Anti-short Cycle Timer

The anti-short cycle timer provides a three minute time delay between compressor stop and compressor restart.

Compressor Operation

Upon a call for cooling or heating, the compressor will follow a programmed startup sequence with prescribed acceleration rates to safely enable compressor operation. Once ramp up has occurred the compressor is controlled within minimum and maximum capacity as determined by heating or cooling demands. When the compressor is no longer needed for cooling or heating, it will follow a predefined shutdown sequence to safely turn off.

When switching between heating and cooling modes, the compressor will follow the shutdown sequence prior to de-energizing the compressor. Once the compressor is off the anti-short cycle timer will provide a 3-minute time delay restarting.

Demand Limiting

The Tracer® UC400 controller supports communicated requests for demand limiting the compressor and supply fan outputs. When demand limited is enabled, the unit capacity is limited to a maximum of 50% for all unit modes (cooling and heating). Demand limit requests will not override compressor startup and shutdown sequences or unit protection modes (for example, low entering water temp).

Enhanced Dehumidification

The variable-speed fan motor (ECM), along with the variable-speed compressor, results in improved dehumidification performance at part-load conditions compared to a unit with a constant-speed fan. In addition the Tracer® UC400 controller includes an enhanced dehumidification control mode that can improve dehumidification performance by further reducing fan speed. A space humidity value is either communicated from the BAS, or input from a humidity sensor wired into the controller. When the measured space relative humidity enable/disable exceeds the setpoint, the enhanced dehumidification mode is enabled and the fan speed is further reduced to remove moisture. increase dehumidification.

Enhanced dehumidification mode does not provide independent (active) control of both space temperature and humidity. This mode can only occur when the controller is in the cooling mode, and a high cooling load (warm temperature in the zone) can override the enhanced dehumidification mode. Therefore, in non-arid climates, Trane® recommends the use of a dedicated outdoor-air system to dehumidify the outdoor air centrally, rather than relying on the heat pumps to provide sufficient dehumidification (see the Application Considerations section of this catalog).

Supply Fan Operation

The UC400 supports continuous fan and fan cycling modes.

- **Fan Cycling Mode:** For active cooling, heating, and operation, the supply fan will be commanded on and will ramp up to the appropriate minimum speed once the unit determines there is a request for active compressor output control. When there is no longer an active request and all compressor capacity is de-energized, the supply fan will be de-energized once any supply fan off delays have timed out. In heat mode, the fan will run for 30 seconds beyond compressor shutdown in both occupied and unoccupied mode.
- **Continuous Fan Mode:** The unit will energize the supply fan and hold the fan speed output at the minimum fan speed setting until there is a request for the fan speed to increase. When the unit is in unoccupied mode, however, the supply fan mode operates in cycling mode.

Filter Maintenance Timer

The controller's filter status is based on the supply fan's cumulative run hours. The controller compares the fan run time against an adjustable fan run hours limit and recommends unit maintenance as required.

Occupancy Determination

The five operations of the Tracer® UC400 controller include occupied, occupied standby, occupied bypass, unoccupied and timed override.

- **Occupied mode:** When the controller is in the OCCUPIED mode, the unit will operate to maintain the space temperature at the active occupied heating or cooling setpoint. This occupied operation is normally used during the daytime hours when the building is at the highest occupancy level.
- **Occupied Standby mode:** The occupied standby mode allows the unit to operate at heating or cooling setpoints between the occupied and unoccupied setpoints to help maintain the space while decreasing energy consumption. Unit operation in the mode is similar to the occupied mode except for the different heating and cooling setpoints. The occupied standby operation is used during daytime hours when people are not present in the space (such as lunchtime or recess).
- **Unoccupied mode:** When the controller is in the Unoccupied mode, the unit will attempt to maintain the space temperature at the stored unoccupied heating or cooling setpoint.
- **Occupied Bypass mode:** This mode is used to transition the unit from the Unoccupied mode to the Occupied mode for a period of time from 0 to 4 hours.
- **Timed Override Operation:** If the unit receives a request for timed override mode while the unit is operating in Unoccupied mode, the unit will transition to Occupied Bypass mode for the selected Occupied Bypass Time.

Random Start

To prevent all of the units in a building from energizing major loads at the same time, the controller observes a random start from 5 to 30 seconds. This timer halts the controller from starting the unit until the random start time expires.

Reversing Valve Operation

For normal unit operation, the reversing valve output is energized when the unit is in Cooling mode and de-energized in Heating mode. If de-energized, the reversing valve output shall be energized for Cooling when the compressor output is energized and the compressor speed has ramped up to the proper startup speed. Once energized, the reversing valve output will remain energized until the controller energizes the compressor output for heating and the compressor speed has ramped up to the startup speed for heating or the Unit Mode is set to Off. When a power-failure occurs, the reversing valve output defaults to the heating (de-energized) state.

Test Mode

The UC400 shall support two field test modes to allow the user to setup/troubleshoot the system. One test mode is available through the Tracer® TU service tool and the other is available through a local input on the UC400.

Water Isolation Valve

For all units, the UC400 shall support a two-position water isolation valve without needing any special configuration; by default, the UC400 will control as though isolation valves are present.

Isolation Valve “ON” Control. The isolation valve output will be energized (controlled open) during compressor heating, compressor cooling, and when forced open during manual output override testing.

When the isolation valve is driven open for compressor operation, the output will be energized 20 seconds prior to the compressor and indoor fan (if not already energized) outputs to ensure adequate water flow to the heat exchanger. To reduce excessive cycling of the isolation valve, once opened, the isolation valve will remain open for a minimum of 10 minutes.

Isolation Valve “OFF” Control. The isolation valve output will be de-energized (controlled closed) when there is no longer a call for compressor operation and the 10 min. minimum on time has expired or the manual output override test has driven it closed.

Trane® Air-Fi® Wireless Systems



Trane® Air-Fi® wireless systems provides significant advantages to better meet customer by providing a lower initial cost; ease of installation for reduced risk; increased reliability and flexibility for easier problem solving; and fewer maintenance issues for worry-free operation and cost savings over the life of the system. Trane® Air-Fi® wireless systems helps save time and money, with industry-leading technology and performance.

Air-Fi® Wireless Communications Interface (WCI)

The Air-Fi® Wireless Communications Interface (WCI) enables wireless communications between system controls, unit controls, and wireless sensors for Trane® control products that use the BACnet® protocol. The WCI replaces the need for communications wire in all system applications.

The WCI is available in three configurations:

- The universal model is the most common. It installs the same as a wired zone sensor in indoor applications.
- The outdoor model is housed in an enclosure suitable for outdoor environments. It is usually used on equipment above the roof deck.
- The flush mount model is used on fan coils, blower coils, and unit ventilators.

Air-Fi® Wireless Communications Sensor (WCS)

The Air-Fi® Wireless Communications Sensor (WCS) is compatible with any Trane® controller that uses a WCI. The WCS provides the same functions as many currently available Trane® wired sensors. No further software or hardware is necessary for site evaluation, installation, or maintenance. Space temperature is standard on all models. (A service tool cannot be connected to a Trane® wireless sensor.)

Three WCS models are available:

- Digital display (WCS-SD) model
- Base (WCS-SB) model has no exposed display or user interface

- 2% relative humidity sensor module (WCS-SH), which can be field installed inside either the WCS-SD or WCS-SB.

In most applications, one WCS-SD or WCS-SB sensor will be used per WCI acting as a router. However, up to 6 WCS-SD or WCS-SB sensors can be associated to a single equipment controller or BCI.

Compatibility with Previous Generation Wireless Zone Products

Our previous line of wireless zone sensors (WZS, WTS, and WDS) are not compatible with the Air-Fi® Wireless Communications Interface (WCI).

The new Air-Fi® Wireless Communications Sensor (WCS) are compatible with old WCIs that have updated firmware.

Wired Zone Sensors

Wired zone sensors can be used with Air-Fi® wireless systems.

Stand-alone Systems

When units are applied as a stand-alone control system, the Tracer® UC400 provides accurate temperature control directly through the wall-mounted zone sensor. This system set-up may be utilized in a replacement design where a single unit retrofit is needed or on small jobs where a building controller may not be necessary.

Direct Digital Controls for Building Automation Systems

For owners who require a complete building management “open protocol” system, the Tracer® UC400 controller may be linked directly to the Trane® Tracer® SC or other third party BACnet® MS/TP systems.

Building Control Advantages

When water source heat pumps are applied with the Trane® Tracer® SC, the potential for greater energy savings can be achieved. The UC400 controller has the ability to share information with the building automation system via a communications wire. The operation of the system can be optimized with capabilities such as:

- Centralized system scheduling and shutdown based on occupancy
- Override to allow the system to operate when a zone is occupied after scheduled hours (indicated through the use of a timed override button on the zone sensor)
- Enabling morning warm-up and cool-down sequences, including optimal start
- Centralized alarms to indicate problems, required service or needed maintenance
- Trend logging to help anticipate potential system problems
- Integration with other systems serving the building such as dedicated outdoor-air system, lighting, security, and fire safety.

Tracer® TU Service Tool Support

The UC400 for Variable Speed Water Source Heat Pump Units will be supported by the Trane® Tracer® TU Service Tool and can be used to change default setpoints as well as view active diagnostics/alarms. The UC400 will also support a version of Service Test Mode that will be available through the Tracer® TU communication link.

Tracer® UC400 Setup Parameters and Setpoints

The following setup parameters can be modified utilizing the Tracer® TU Field service tool.

Input name	Range	Default
Water Loop Configuration (Freeze Protection Setpoint)	20°F, 35°F	35°F
Diagnostic Reset	Reset Inactive	Inactive
Fan Operation (Heating and Cooling)	Continuous ¹ Cycling with Capacity	Continuous
Zone Sensor Fan Switch	Disable or Enable	Enable
Thumb wheel Setpoint	Disable or Enable	Enable
Occupancy Bypass Timer ²	30-240 minutes (1-minute resolution)	120 minutes
Maintenance timer ³	0-10000 hours	0
Maximum Supply Fan Speed	75-110% ⁶	100%
Minimum Supply Fan Speed ⁴	33-100% ⁵	33%
Demand Limit Request ⁷	Enable/Disable	Disable

Notes:

1. Fan will cycle when unoccupied.
2. The occupied bypass timer is used for timed override applications.
3. Based on Fan Run hours.
4. Only applicable during Fan Only/Ventilation Only modes.
5. The Minimum Supply Fan Speed (%) is dependent upon the Maximum Supply Fan Speed output.
6. The Maximum Supply Fan Speed is a percentage of the rated CFM per unit tonnage.
7. Demand Limit will limit the unit capacity to a maximum of 50%.

The following setpoints can be adjusted through the Tracer® TU service tool, Tracer® SC, or another third party building controls system using the BACnet® MS/TP protocol.

Input name	Range	Default
Space Temperature Setpoint Default	40°F to 115°F	72.5°F
Occupied Offset	0.9°F to 18°F	1.5°F
Standby Offset	0.9°F to 18°F	7.5°F
Unoccupied Cooling Setpoint	40°F to 115°F	85°F
Unoccupied Heating Setpoint	40°F to 115°F	60°F
Cooling Setpoint High Limit	40°F to 115°F	110°F
Cooling Setpoint Low Limit	40°F to 115°F	40°F
Heating Setpoint High Limit	40°F to 115°F	105°F
Heating Setpoint Low Limit	40°F to 115°F	40°F
Humidity Setpoint	40% to 100%	60%



Tracer® UC400 Setup Parameters and Setpoints

Safety Control

The Tracer® UC400 controller receives separate input signals from the refrigerant high and low pressure switches and water temperature sensors. These devices are provided to improve reliability and protect the unit and compressor from damage.

Compressor Protection Control

An input on the UC400 is dedicated to monitoring the status of the high pressure, low pressure and temperature and discharge line temperature devices for compressor protection control.

Condensate Overflow

All units have a UL508 condensate overflow installed as standard. When condensate reaches the trip point, a condensate overflow signal generates a diagnostic which disables the fan, unit water valve (if present), and compressor.

Discharge Air

A discharge air sensor is included to identify leaving air temperature. This is done utilizing the XM30 expansion module.

Entering Water Temperature Sampling

The UC400 shall sample the entering water temperature to determine proper control action for the unit. The entering water temperature will be measured when there is a new request for compressor operation, the isolation valve is not open, and it has been greater than one hour since the last sampling occurred.

Extended Time @ Compressor Low Speed (Oil Recovery Mode)

If the compressor operates for 90 continuous minutes at the minimum speed the compressor speed shall ramp to 50% for 3 minutes and then will be released back to normal operation.

Freeze Protection







The unit is protected from low temperature water via a leaving water temperature sensor installed in the unit.

Low Entering Water Temperature

During low entering water temperature conditions, the minimum compressor speed will be modified based on the active operating mode and the entering water temperature.





Zone Sensors

Table 55. Zone sensor selection for use with Tracer® ZN524 and UC400 Controller

Sensor	Part Number	Description
	X13790886010	Wired temperature sensor with an LCD display <ul style="list-style-type: none"> Allows an occupant to control the temperature setpoint, request timed override of system operation, and provides a COMM module to service technicians. Tracer® ZN524 and UC400 Compatible
	X13651467020	Communication Module <ul style="list-style-type: none"> Sold in packs of 12 Provides local RJ22 connection to Trane® service tools for easy, low cost maintenance.
	X13511529010	Zone Sensor <ul style="list-style-type: none"> Tracer® UC400 and ZN524 compatible External setpoint adjustment wheel
	X13511527010	Zone Sensor <ul style="list-style-type: none"> Tracer® UC400 and ZN524 compatible External setpoint adjustment wheel ON and CANCEL buttons
	X1379084501	Zone Sensor <ul style="list-style-type: none"> Tracer® UC400 and ZN524 compatible External setpoint adjustment wheel ON and CANCEL buttons Fan switch AUTO-OFF
	X1379044401	Temperature and relative humidity sensor <ul style="list-style-type: none"> Tracer® UC400 and ZN524 compatible

Zone Sensors

Table 56. Wireless zone sensor selection for use with Tracer® UC400 controller

Sensor	Part Number	Description
	X13790955050	Trane Air-Fi® WCS-SD (display) <ul style="list-style-type: none"> • Tracer® UC400 Compatible • Easy-to-use interface for clear and simple monitoring and control.
	X13790956010	Trane Air-Fi® WCS-SB (base) <ul style="list-style-type: none"> • Tracer® UC400 Compatible • Simplicity • Eliminates local temperature control when higher control level is required.
	X13790993001	Commercial Touch Screen Programmable Zone Sensor <ul style="list-style-type: none"> • Supports Standby, Occupied, and Unoccupied • 7 day, 5+2 day, and 5+1+1 day
	X13790992001	Residential Touch Screen Programmable Zone Sensor <ul style="list-style-type: none"> • Supports Awake, Away, Home, and Sleep • 7 day, 5+2 day, and 5+1+1 day



Electrical Data

Table 57. VSH* electrical data with ECM

Model No.	Unit Volts	Total Unit FLA	Comp RLA (ea)	No. of Compressors	Blower Motor FLA	Blower Motor hp	Fan Motor Num.	Minimum Circuit Ampacity	Maximum Overcurrent Protective Device
VSH*024	208/60/1	10.2	9.2	1	0.97	1/2	1	12.47	20
	230/60/1	10.2	9.2	1	0.97	1/2	1	12.47	20
	460/60/3	3.7	2.9	1	1.29	1/2	1	4.43	15
VSH*033	208/60/1	14.4	12.9	1	1.48	1/2	1	17.61	30
	230/60/1	14.4	12.9	1	1.48	1/2	1	17.61	30
	460/60/3	5.5	4.2	1	1.29	1/2	1	6.54	15
VSH*042	208/60/1	15.1	13.1	1	2.03	1	1	18.41	30
	230/60/1	15.1	13.1	1	2.03	1	1	18.41	30
	460/60/3	6.1	4.2	1	1.86	1	1	7.11	15
VSH*050	208/60/1	20.5	17.8	1	2.69	1	1	24.94	40
	230/60/1	20.5	17.8	1	2.69	1	1	24.94	40
	460/60/3	7.5	5.0	1	2.48	1	1	8.73	15
VSH*060	208/60/1	25.8	21.8	1	4.03	1	1	31.28	50
	230/60/1	25.8	21.8	1	4.03	1	1	31.28	50
	460/60/3	8.8	4.9	1	3.84	1	1	10.00	15

Note: 460/60/3 installations using the ECM fan/motor require a neutral wire.

Table 58. VSV* electrical data with ECM

Model No.	Unit Volts	Total Unit FLA	Comp RLA (ea)	No. of Compressors	Blower Motor FLA	Blower Motor hp	Fan Motor Num.	Minimum Circuit Ampacity	Maximum Overcurrent Protective Device
VSV*024	208/60/1	11.3	9.2	1	2.1	3/4	1	13.6	20
	230/60/1	11.3	9.2	1	2.1	3/4	1	13.6	20
	460/60/3	4.9	2.9	1	2.0	3/4	1	5.6	15
VSV*033	208/60/1	15.7	12.9	1	2.8	3/4	1	18.9	30
	230/60/1	15.7	12.9	1	2.8	3/4	1	18.9	30
	460/60/3	6.9	4.2	1	2.7	3/4	1	8.0	15
VSV*042	208/60/1	17.7	13.1	1	4.6	1	1	20.9	30
	230/60/1	17.7	13.1	1	4.6	1	1	20.9	20
	460/60/3	8.2	4.2	1	4.0	1	1	9.3	15
VSV*050	208/60/1	24.8	17.8	1	7.0	1	1	29.3	45
	230/60/1	24.8	17.8	1	7.0	1	1	29.3	45
	460/60/3	11.6	5.0	1	6.6	1	1	13.25	15
VSV*060	208/60/1	25.8	21.8	1	4.03	1	1	31.28	50
	230/60/1	25.8	21.8	1	4.03	1	1	31.28	50
	460/60/3	8.8	4.9	1	3.84	1	1	10.00	15

Note: 460/60/3 installations using the ECM fan/motor require a neutral wire.



Dimensional Data

Figure 11. Left return/top supply VSV

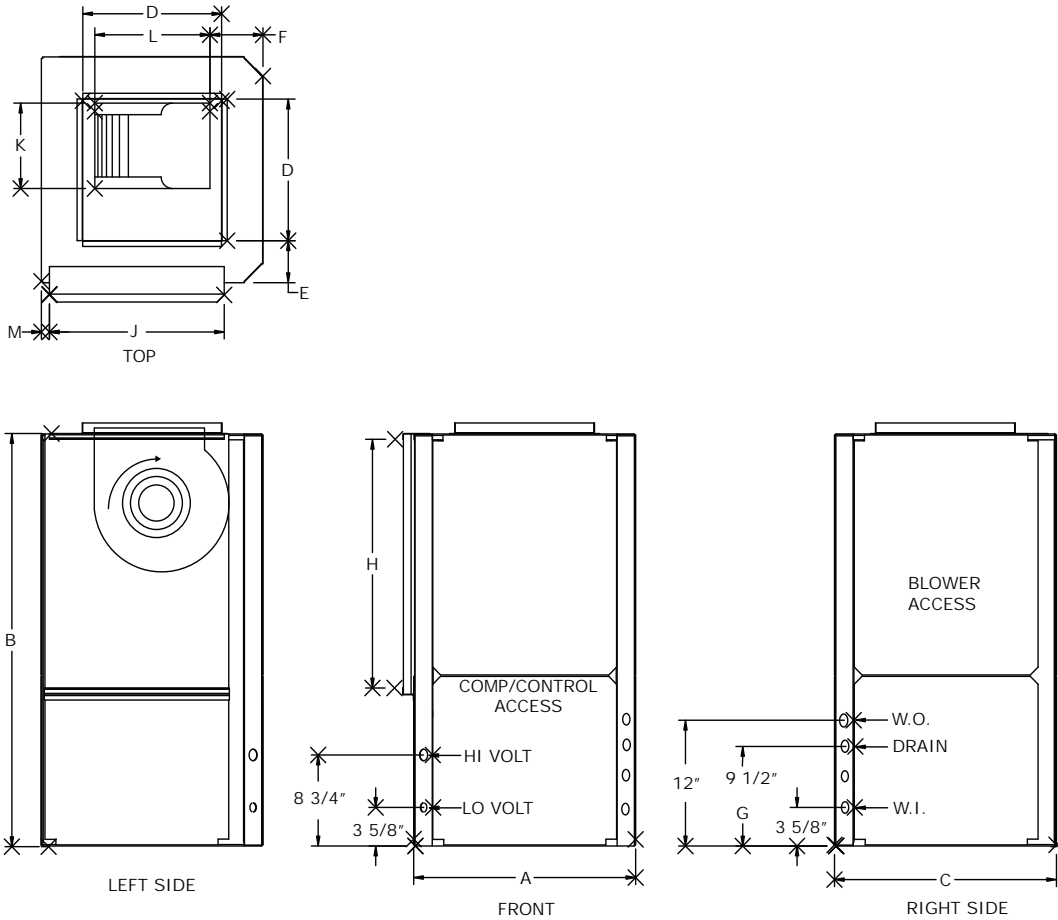

Table 59. Dimensional data—left return/top supply VSV

Units	A	B	C	D	E	F	G	H	J	K	L	M	W.I. NPTI	W.O. NPTI	Drain FPT
024-033	24-1/2	41-7/8	26-1/2	18	3-1/4	5-3/4	9-1/2	20	23	10-1/2	13-1/2	3/16	3/4	3/4	3/4
042-050	26-1/2	46-7/8	30-1/2	18	4-1/4	2	9-1/2	24-1/4	27-7/8	13-7/8	11-3/8	1/2	1	1	3/4

Note: Access to the unit for service purposes should be provided at installation. Local and/or NEC codes may require greater service clearance. Check all code requirements prior to the unit installation. Installer is responsible for following all local and NEC code requirements.

Figure 12. Left return/top supply VSV

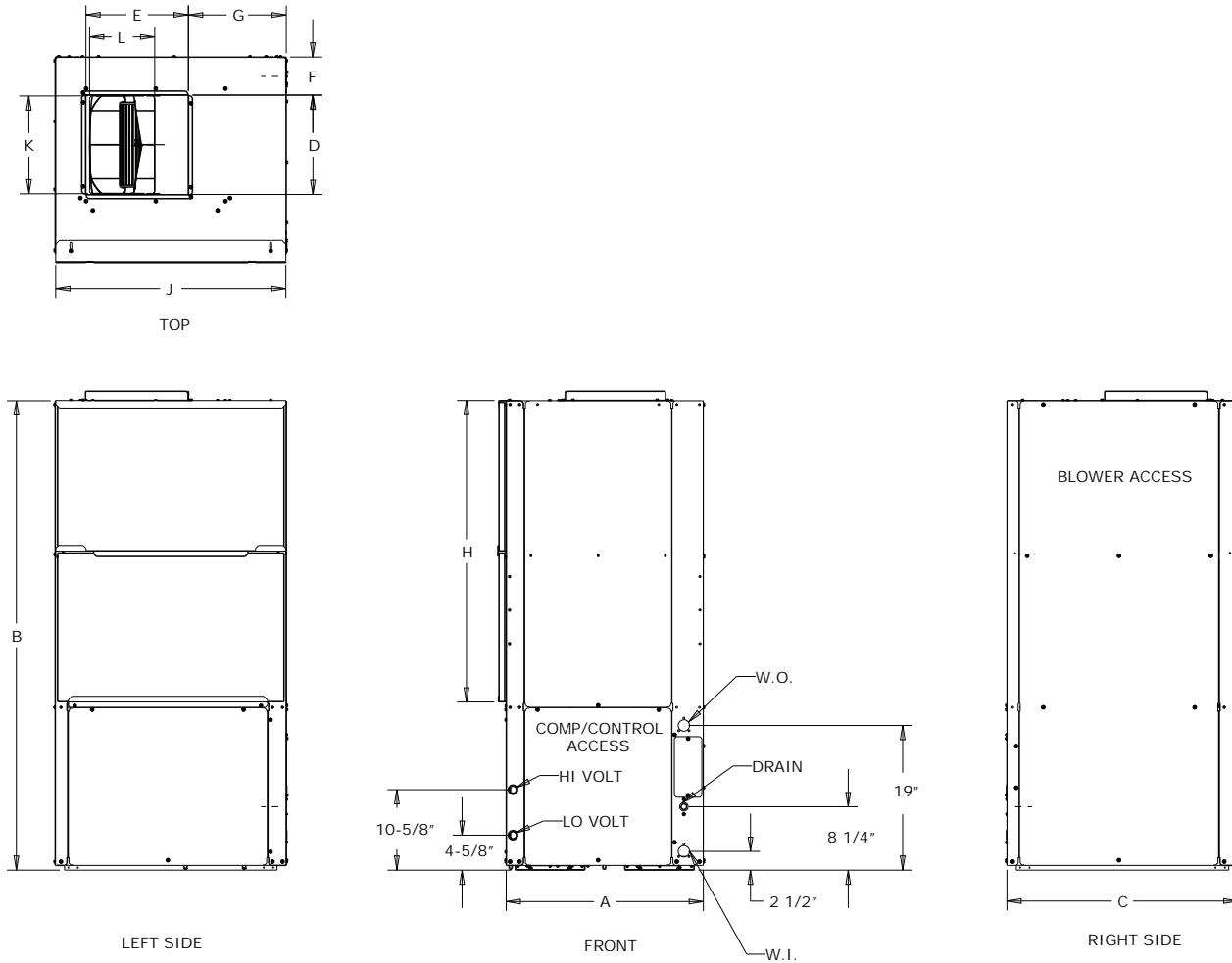

Table 60. Dimensional data—left return/top supply VSV

Units	A	B	C	D	E	F	G	H	J	K	L	M	W.I. NPTI	W.O. NPTI	Drain FPT
060	26	62	30-1/2	13-1/4	13-5/8	5	13	39-3/4	30-3/8	13	8-5/8	N/A	1	1	3/4

Note: Access to the unit for service purposes should be provided at installation. Local and/or NEC codes may require greater service clearance. Check all code requirements prior to the unit installation. Installer is responsible for following all local and NEC code requirements.

Dimensional Data

Figure 13. Left return/back supply VSV

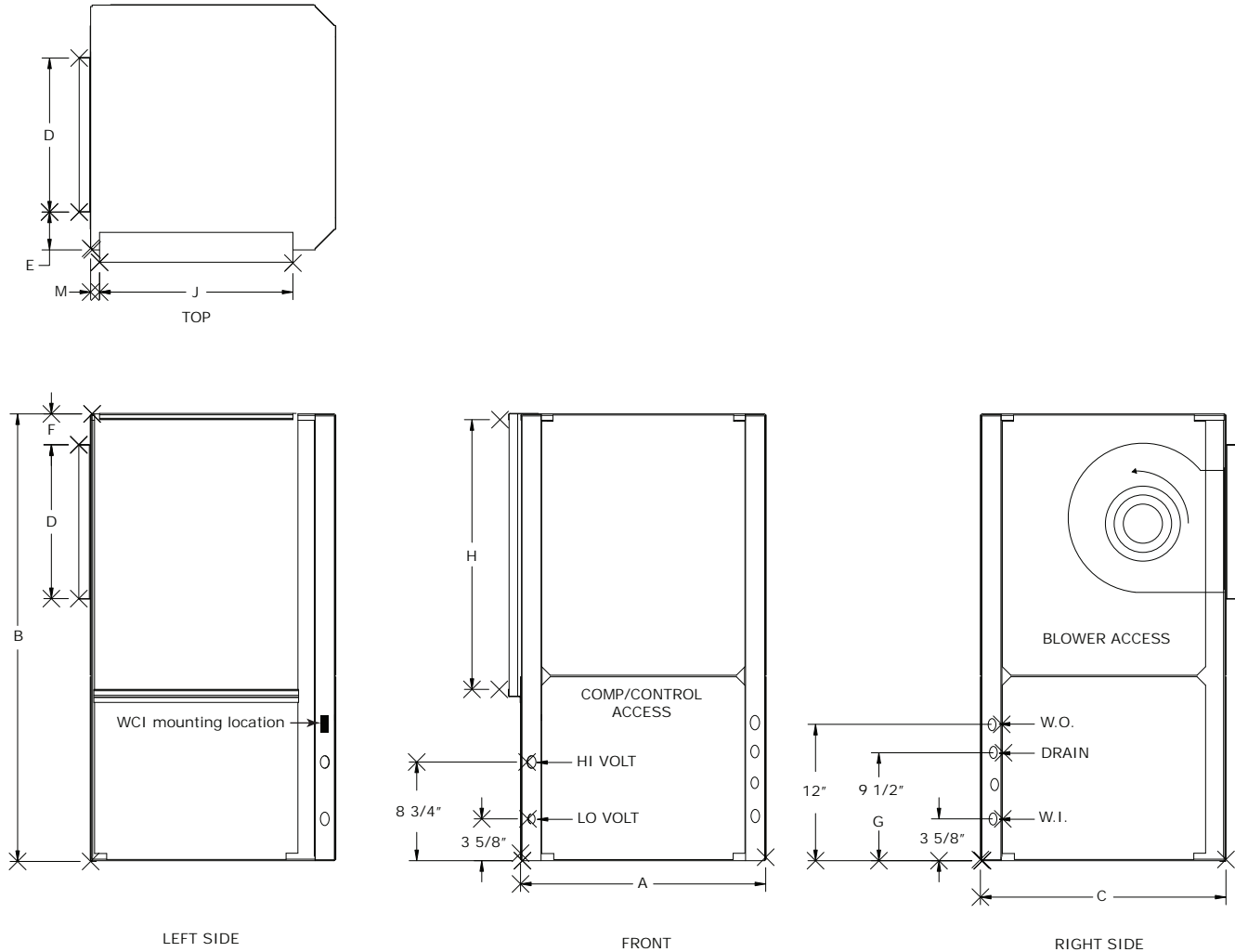

Table 61. Dimensional data—left return/back supply VSV

Units	A	B	C	D	E	F	G	H	J	K	L	M	W.I. NPTI	W.O. NPTI	Drain FPT
024-033	24-1/2	41-7/8	26-1/2	18	3-1/4	1-7/8	9-1/2	20	23	10-1/2	13-1/2	3/16	3/4	3/4	3/4
042-050	26-1/2	46-7/8	30-1/2	18	4-1/4	2	9-1/2	24-1/4	27-7/8	13-7/8	11-3/8	1/2	1	1	3/4

Note: Access to the unit for service purposes should be provided at installation. Local and/or NEC codes may require greater service clearance. Check all code requirements prior to the unit installation. Installer is responsible for following all local and NEC code requirements.

Figure 14. Left return/back supply VSV

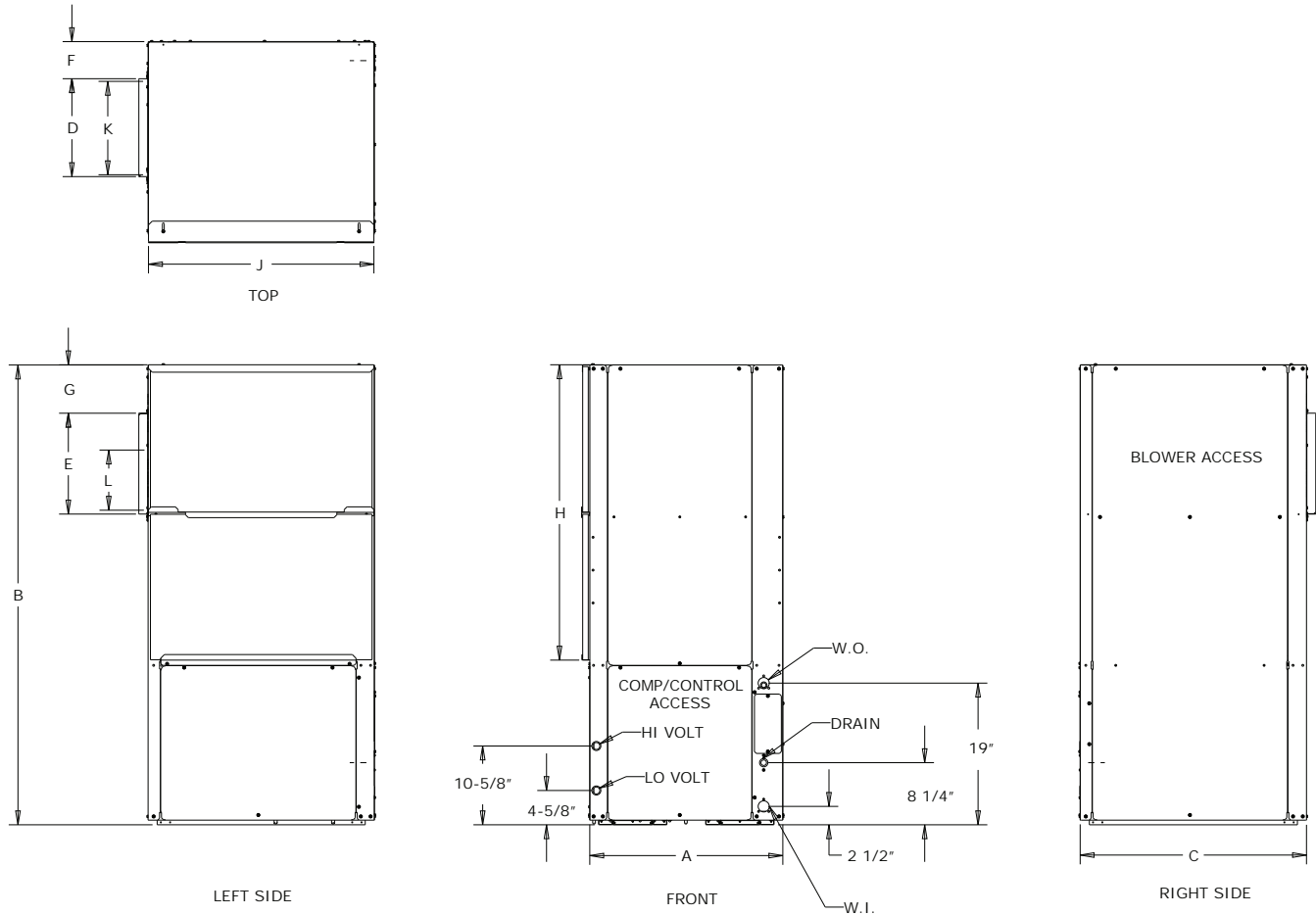

Table 62. Dimensional data—left return/back supply VSV

Units	A	B	C	D	E	F	G	H	J	K	L	M	W.I. NPTI	W.O. NPTI	Drain FPT
060	26	62	30-1/2	13-1/4	13-5/8	5	6-1/2	39-3/4	30-3/8	13	8-5/8	N/A	1	1	3/4

Note: Access to the unit for service purposes should be provided at installation. Local and/or NEC codes may require greater service clearance. Check all code requirements prior to the unit installation. Installer is responsible for following all local and NEC code requirements.

Dimensional Data

Figure 15. Right return/top supply VSV

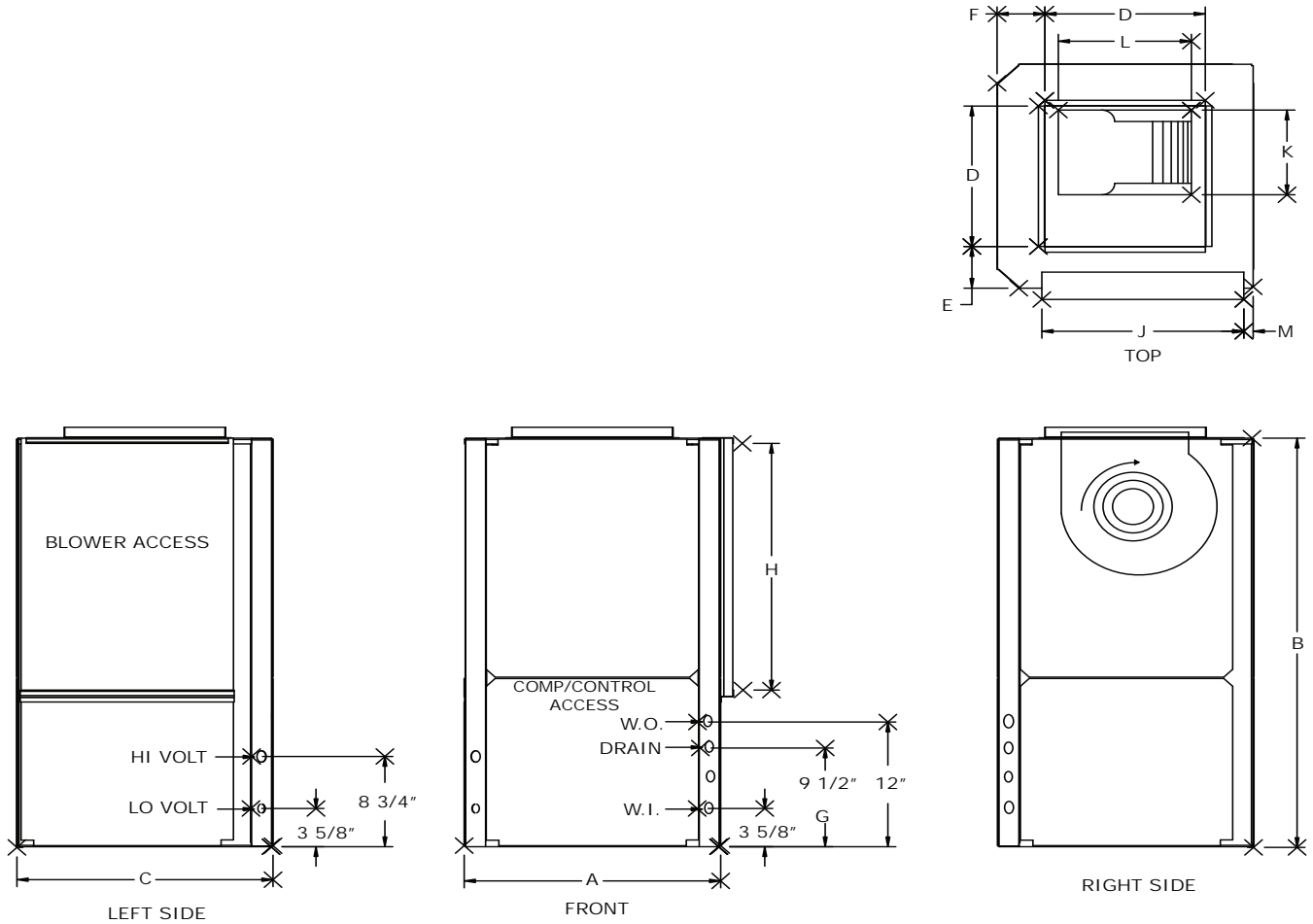

Table 63. Dimensional data—right return/top supply VSV

Units	A	B	C	D	E	F	G	H	J	K	L	M	W.I. NPTI	W.O. NPTI	Drain FPT
024-033	24-1/2	41-7/8	26-1/2	18	3-1/4	5-3/4	9-1/2	20	23	10-1/2	13-1/2	3/16	3/4	3/4	3/4
042-050	26-1/2	46-7/8	30-1/2	18	4-1/4	2	9-1/2	24-1/4	27-7/8	13-7/8	11-3/8	1/2	1	1	3/4

Note: Access to the unit for service purposes should be provided at installation. Local and/or NEC codes may require greater service clearance. Check all code requirements prior to the unit installation. Installer is responsible for following all local and NEC code requirements.

Figure 16. Right return/top supply VSV

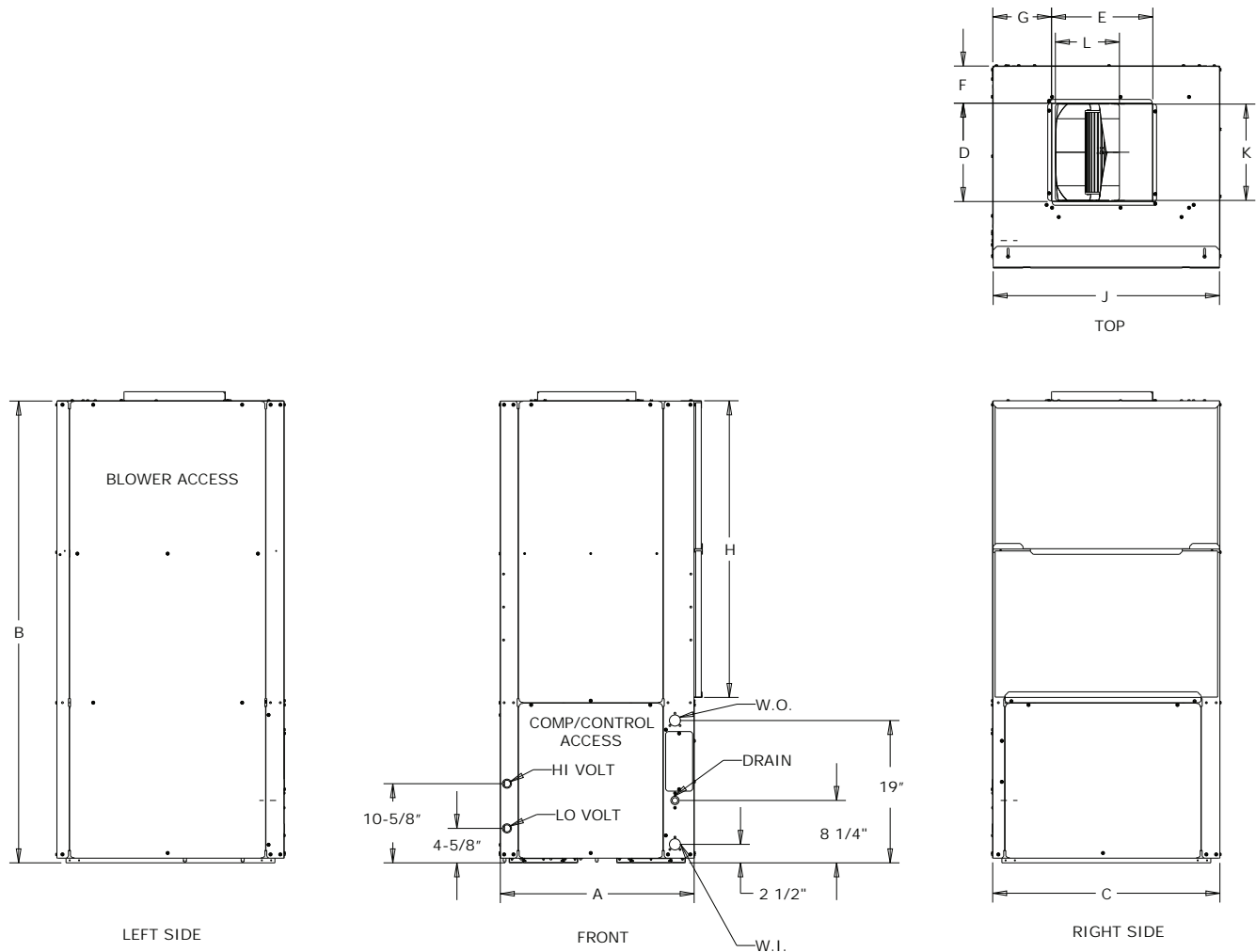

Table 64. Dimensional data—right return/top supply VSV

Units	A	B	C	D	E	F	G	H	J	K	L	M	W.I. NPTI	W.O. NPTI	Drain FPT
060	26	62	30-1/2	13-1/4	13-5/8	5	7-7/8	39-3/4	30-3/8	13	8-5/8	N/A	1	1	3/4

Note: Access to the unit for service purposes should be provided at installation. Local and/or NEC codes may require greater service clearance. Check all code requirements prior to the unit installation. Installer is responsible for following all local and NEC code requirements.

Dimensional Data

Figure 17. Right return/back supply VSV

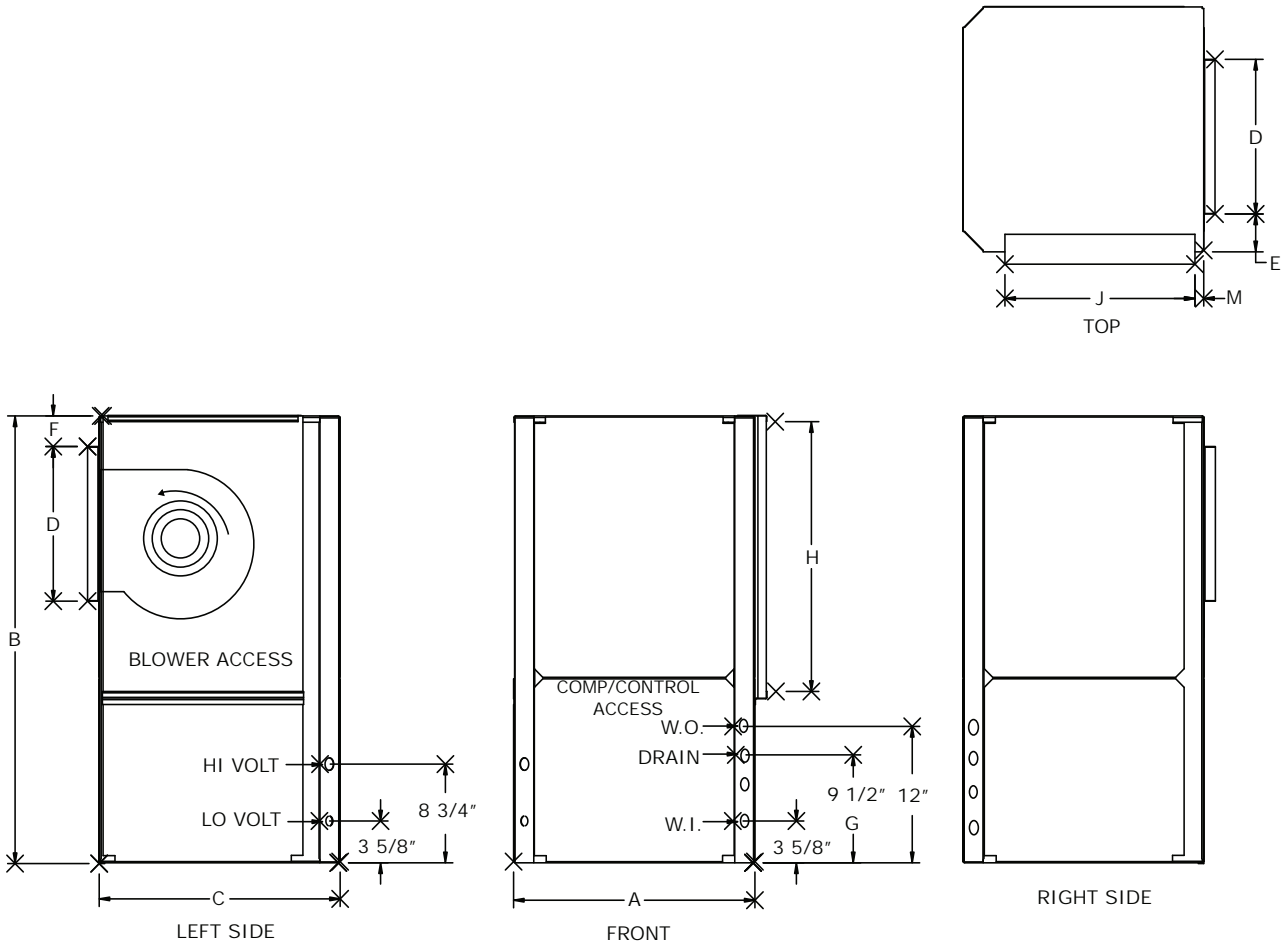

Table 65. Dimensional data—right return/back supply VSV

Units	A	B	C	D	E	F	G	H	J	K	L	M	W.I. NPTI	W.O. NPTI	Drain FPT
024-033	24-1/2	41-7/8	26-1/2	18	3-1/4	1-7/8	9-1/2	20	23	10-1/2	13-1/2	3/16	3/4	3/4	3/4
042-050	26-1/2	46-7/8	30-1/2	18	4-1/4	2	9-1/2	24-1/4	27-7/8	13-7/8	11-3/8	1/2	1	1	3/4

Note: Access to the unit for service purposes should be provided at installation. Local and/or NEC codes may require greater service clearance. Check all code requirements prior to the unit installation. Installer is responsible for following all local and NEC code requirements.

Figure 18. Right return/back supply VSV

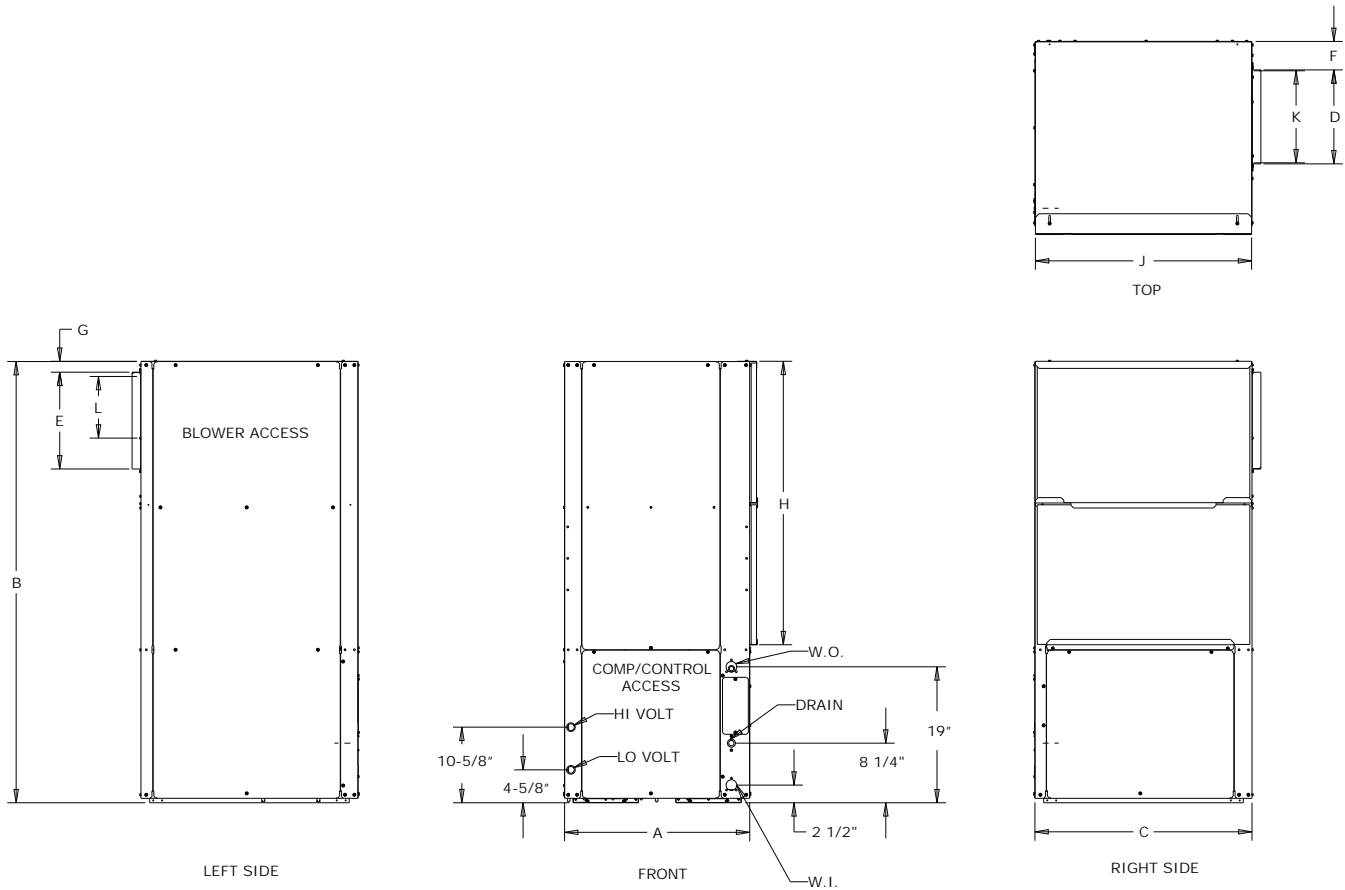

Table 66. Dimensional data—right return/back supply VSV

Units	A	B	C	D	E	F	G	H	J	K	L	M	W.I. NPTI	W.O. NPTI	Drain FPT
060	26	62	30-1/2	13-1/4	13-5/8	4	1-1/2	39-3/4	30-3/8	13	8-5/8	N/A	1	1	3/4

Note: Access to the unit for service purposes should be provided at installation. Local and/or NEC codes may require greater service clearance. Check all code requirements prior to the unit installation. Installer is responsible for following all local and NEC code requirements.

Dimensional Data

Figure 19. Left return/back supply VSH

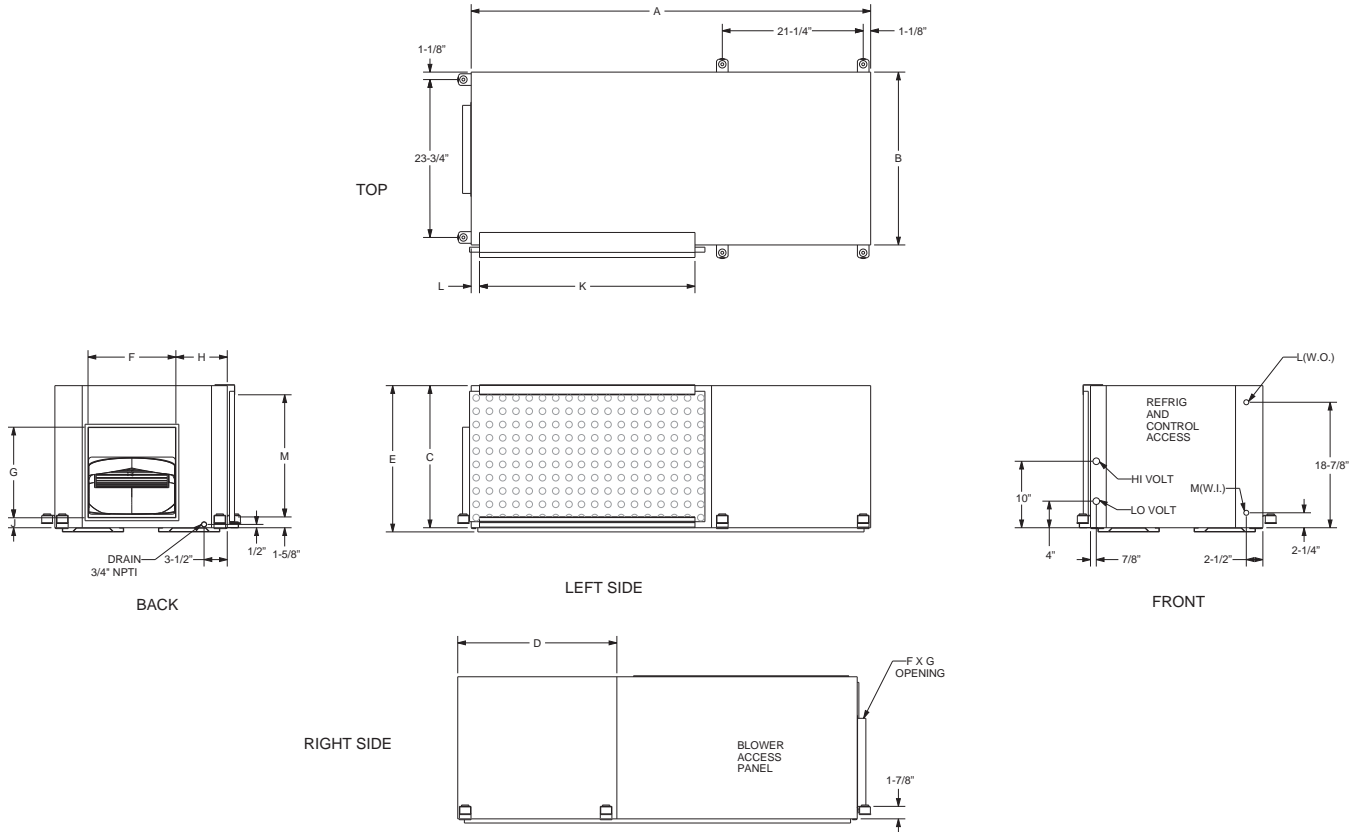

Table 67. Dimensional data— left return/back supply VSH

Units	A	B	C	D	E	F x G	H	J	K	L	M	W.I. NPTI	W.O. NPTI	Drain FPT
024-033	60-1/4	26	21-3/8	24	22	13-1/4 x 13-5/8	7-3/4	1-1/2	32-1/2	1-1/4	18-3/8	3/4	3/4	3/4
042-060	81-1/4	26	21-3/8	25-1/2	22	13-1/4 x 13-5/8	7-5/8	2-1/8	52	1-1/4	18-3/8	1	1	3/4

Note: Access to the unit for service purposes should be provided at installation. Local and/or NEC codes may require greater service clearance. Check all code requirements prior to the unit installation. Installer is responsible for following all local and NEC code requirements.

Figure 20. Left return/right supply VSH

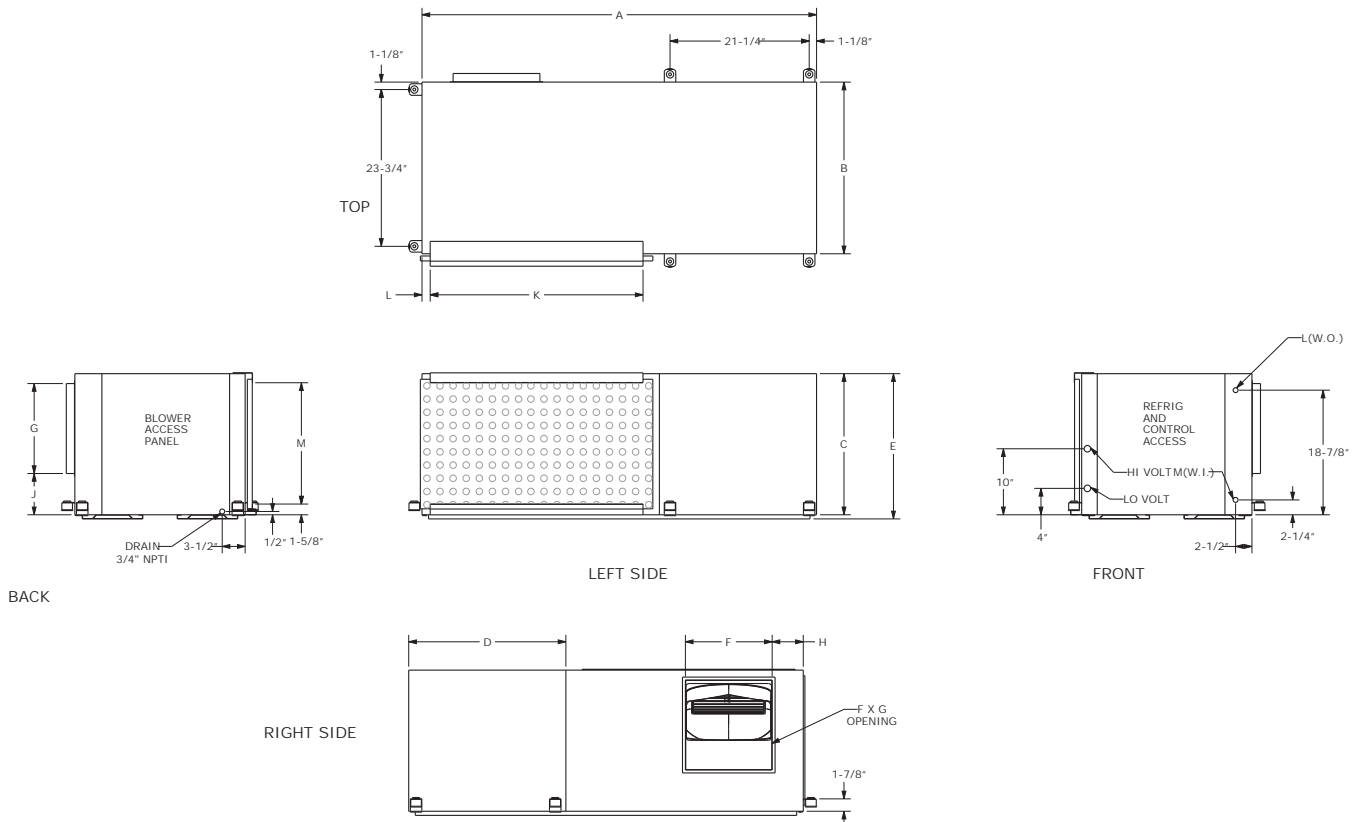

Table 68. Dimensional data— left return/right supply VSH

Units	A	B	C	D	E	F x G	H	J	K	L	M	W.I. NPTI	W.O. NPTI	Drain FPT
024-033	60-1/4	26	21-3/8	24	22	13-1/4 x 13-5/8	4-3/4	6-1/4	32-1/2	1-1/4	18-3/8	3/4	3/4	3/4
042-060	81-1/4	26	21-3/8	25-1/2	22	13-1/4 x 13-5/8	7-3/4	6-1/4	52	1-1/4	18-3/8	1	1	3/4

Note: Access to the unit for service purposes should be provided at installation. Local and/or NEC codes may require greater service clearance. Check all code requirements prior to the unit installation. Installer is responsible for following all local and NEC code requirements.

Dimensional Data

Figure 21. Right return/back supply VSH

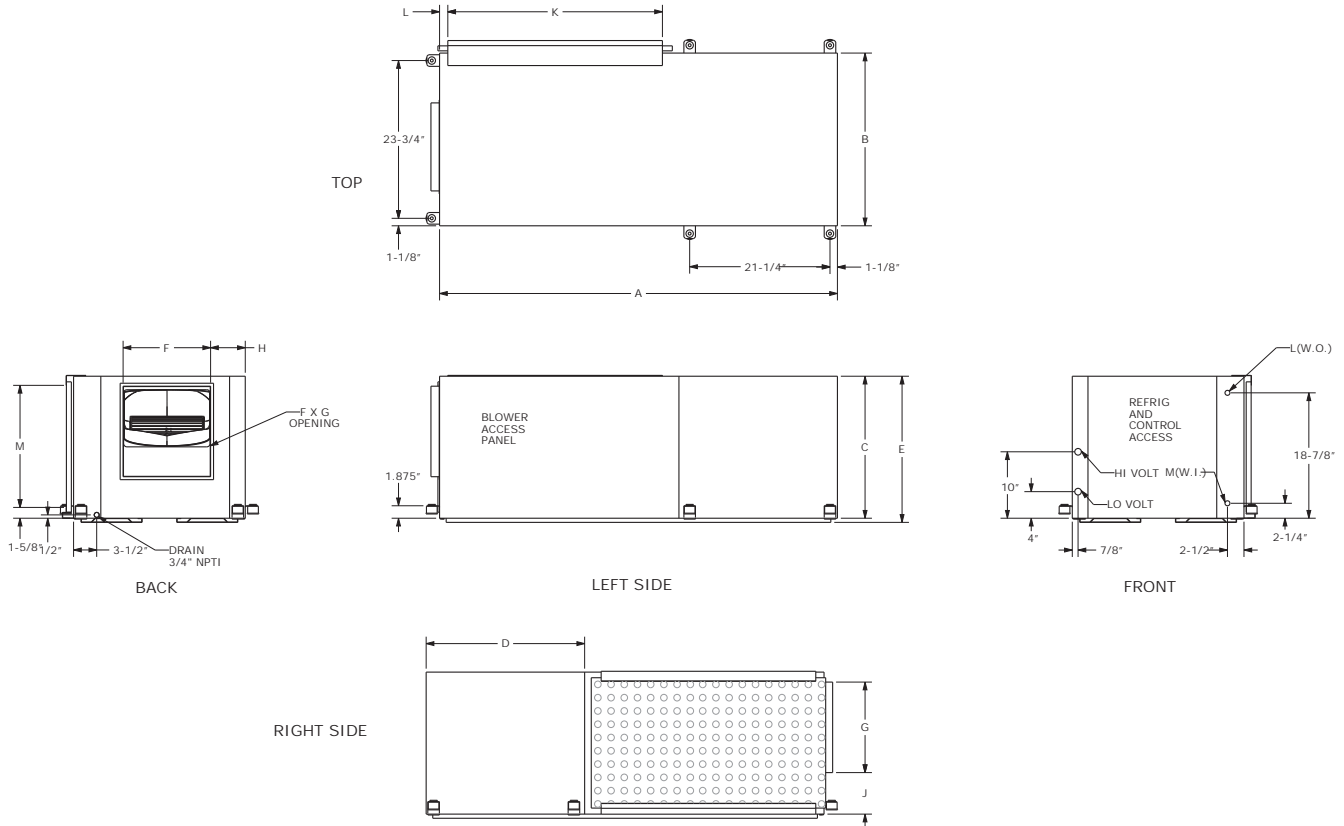

Table 69. Dimensional data — right return/back supply VSH

Units	A	B	C	D	E	F x G	H	J	K	L	M	W.I. NPTI	W.O. NPTI	Drain FPT
024-033	60-1/4	26	21-3/8	24	22	13-1/4 x 13-5/8	5-1/4	6-1/4	32-1/2	1-1/4	18-3/8	3/4	3/4	3/4
042-060	81-1/4	26	21-3/8	25-1/2	22	13-1/4 x 13-5/8	5-1/8	6-1/4	52	1-1/4	18-3/8	1	1	3/4

Note: Access to the unit for service purposes should be provided at installation. Local and/or NEC codes may require greater service clearance. Check all code requirements prior to the unit installation. Installer is responsible for following all local and NEC code requirements.

Figure 22. Right return/left supply VSH

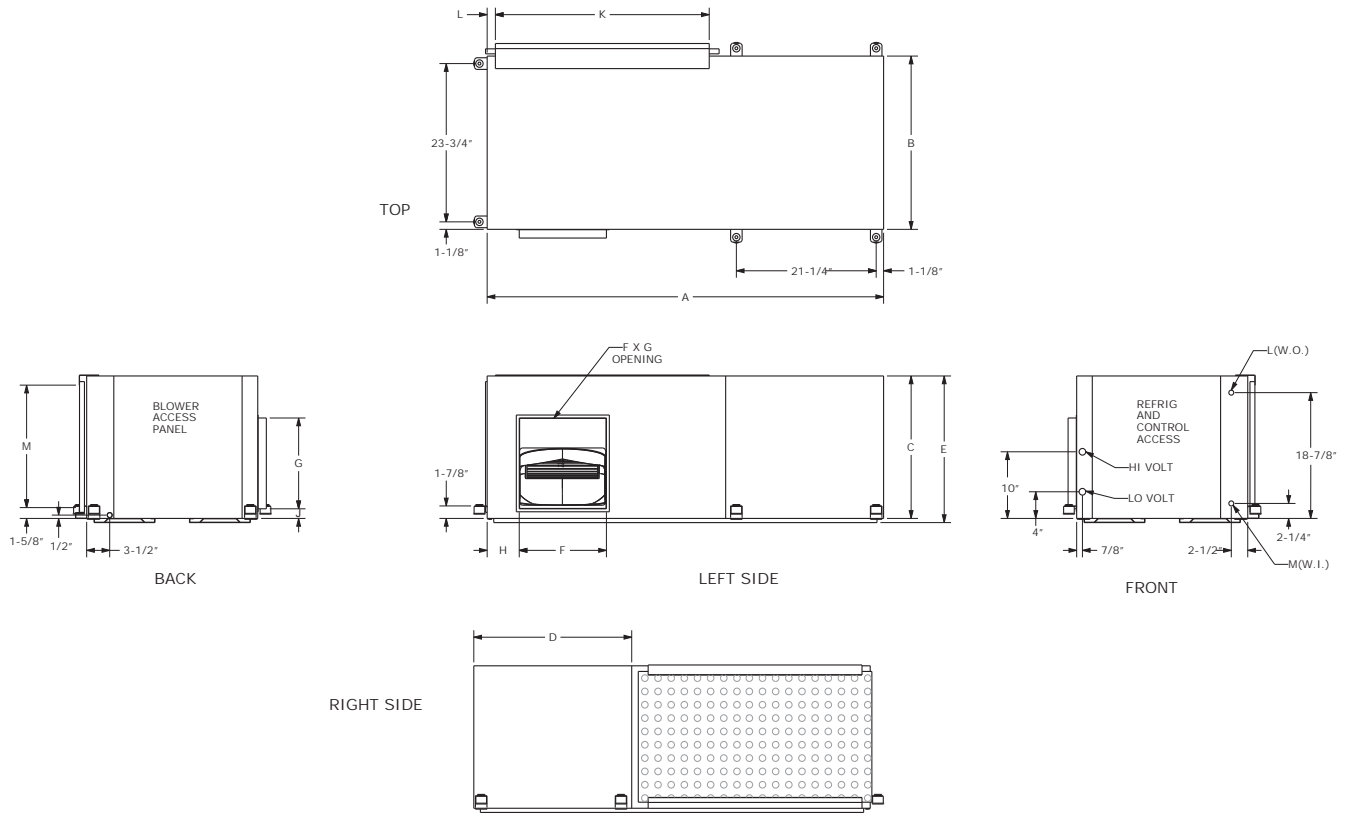

Table 70. Dimensional data — right return/left supply VSH

Units	A	B	C	D	E	F x G	H	J	K	L	M	W.I. NPTI	W.O. NPTI	Drain FPT
024-033	60-1/4	26	21-3/8	24	22	13-1/4 x 13-5/8	4-7/8	1-1/2	32-1/2	1-1/4	18-3/8	3/4	3/4	3/4
042-060	81-1/4	26	21-3/8	25-1/2	22	13-1/4 x 13-5/8	4-3/4	1-1/2	52	1-1/4	18-3/8	1	1	3/4

Note: Access to the unit for service purposes should be provided at installation. Local and/or NEC codes may require greater service clearance. Check all code requirements prior to the unit installation. Installer is responsible for following all local and NEC code requirements.



Mechanical Specifications

General

Trane water source heat pump model Axiom Variable Speed unit shall be furnished and installed.

Equipment shall be factory assembled, piped, internally wired, fully charged with R-410A refrigerant and oil and test operated at the factory. The unit shall have an operating range is 45 to 120°F entering water temperature in cooling and 25°F to 85°F entering water temperature in heating.

Equipment shall be rated, certified and labeled in accordance with ANSI/AHRI/ASHRAE/ISO13256-1 and must be tested, labeled and classified in accordance to UL 1995:2011 4th Edition and CSA C22.2 No. 236:2011 4th Edition. Service and caution labels shall be placed on the unit in their appropriate locations.

Air-to-Refrigerant Coil

The air-to-refrigerant coil shall consist of copper tubes mechanically bonded into evenly spaced aluminum fins. All coils shall be leak tested to 450 psig and pressure tested to 650 psig at the factory to ensure the pressure integrity. The tubes are completely evacuated of air and correctly charged with proper volume of refrigerant prior to shipment. The refrigerant coil distributor assembly shall be of orifice style with round copper distributor tubes. The tubes are sized consistently with the capacity of the coil. Suction headers are fabricated from rounded copper pipe.

Cabinet/Casing

The unit frame shall be constructed of heavy-gage, galvanized steel. The panels are insulated with 1/2-inch thick foil faced glass fiber insulation to provide thermal and acoustical insulation. The insulation is UL listed and meets NFPA-90A and UL 181 standard.

Access for inspection and cleaning of the unit drain pan, coils and fan section is provided. The unit shall be installed for proper access. Procedures for proper access, inspection and cleaning of the unit are included in the installation, operation and maintenance manual.

Compressors

Units shall have a high efficiency rotary (24 and 33 Mbtuh) or scroll (42, 50 and 60 Mbtuh) variable speed type compressor with a crankcase heater. An inverter board for speed control of the compressor shall also be provided as standard.

The compressor shall be dually isolated. External vibration isolation is provided by rubber mounting devices located underneath the mounting base of the compressor. A second isolation of the refrigerant assembly is supported under the compressor mounting base.

Internal thermal overload protection shall be provided. Protection against excessive discharge pressure shall be provided by means of a high pressure switch. A loss of charge shall be provided by a low pressure safety.

Controls

The unit shall utilize a factory furnished, programmed and mounted direct digital controller. The UC400 is a 23 I/O point BACnet® MS/TP controller capable of a standalone application or as applied to a full building automation system.

The controller provides anti-short cycle compressor protection, random start delay, heating/cooling status, occupied/unoccupied mode, high and low pressure safety control, filter maintenance timer, compressor status (high/low pressure), drive status (operating or failed), freeze protection and condensate overflow.

Note: Discharge air, entering and leaving water temperature sensors are standard on VSHV.

Drain Pan

VSV 024-050 unit drain pan shall be constructed of thermoplastic polymer and VSV 060 unit drain pan shall be constructed of stainless steel. The bottom of these drain pans shall be sloped in two

planes to pitch the condensate to the drain connection. These drain pans shall comply with ASHRAE62 for IAQ. VSH drain pans shall be constructed of stainless steel. A UL508 float switch shall be factory installed on all units as standard to protect against the overflow of condensate from the drain pan and the drain must be externally trapped.

Electrical

The unit control box shall contain all necessary devices to allow heating and cooling operation to occur from a remote mounted zone sensor. These devices shall be as follows:

- 75 VA transformer
- A low-voltage terminal strip located inside the control panel behind the service access panel—may be used for low-voltage (zone sensor) connections
- An additional neutral wire for installation, required by units with 460V power and ECM

Enhanced Dehumidification Control

A humidity sensor shall be available as a field installed option for dehumidification operation. In cooling mode, when the space humidity level exceeds the setpoint, the enhanced dehumidification mode will reduce the fan speed to increase dehumidification.

Fan and Motor Assembly

The fan is a forward-curved style wheel constructed of corrosion resistant galvanized material. The fan is placed in a draw-through configuration and is arranged for top or back supply air. This assembly shall attach the wheel and motor to the fan housing providing single side service access.

The fan motor is an ECM programmable type motor with electronic protection. The motor is programmed at the factory for variable air flow. Minimum and maximum airflow settings are configurable.

The motor has permanently lubricated and sealed bearings. The motor contains a quick disconnect plug for ease of maintenance. Removal of the motor and fan wheel shall be made with the assistance of a factory provided orifice ring assembly.

Filters

Units come standard with a flat filter rack for non-ducted return air applications. A one-inch disposable filter shall be provided with the unit as standard. Optional two-inch disposable, two-inch MERV 8 or two-inch MERV 13 are available as an option.

Filter Access—Ducted Return

An optional ducted filter rack shall be provided as a field installed accessory for applications requiring filter access at the unit in a ducted return. The vertical unit filter rack has side access.

Freeze Protection

Freeze protection (35°F or 20°F) shall be provided by use of a thermistor on the leaving water temperature side of the unit.

Refrigerant Circuit

Within the refrigerant circuit, access ports shall be factory supplied on the high and low pressure sides for easy refrigerant pressure or temperature testing. A filter drier shall be provided and factory-installed within the refrigeration circuit. Internal thermal overload protection is also provided. Protection against excessive discharge pressure is provided by means of a high pressure switch. A loss of charge is provided by a low pressure safety.

The refrigerant tubing shall be of 99% pure copper. This system is clean and free from contaminants and conditions such as drilling fragments, dirt, and oil. All refrigerant and water lines are insulated with an elastomeric insulation that has a 3/8" thick wall wherever air is introduced to the assembly.



Mechanical Specifications

Refrigerant Metering

The equipment is provided with a bi-directional thermal expansion valve (TXV). The device allows the operation of the equipment in the range of 25°F to 120°F entering fluid temperature and 55°F to 90°F entering air temperatures for either water loop or ground loop (geothermal) applications.

Reversing Valve

Units shall come standard with a reversing valve for heating and cooling operation. The reversing valve is a pilot operating sliding piston type with replaceable encapsulated magnetic coil. This valve shall be energized in cooling.

Sound Attenuation

Sound attenuation shall be a standard feature in the product design. The sound reduction package shall include, vibration isolation to the compressor and water-to-refrigerant coil, unit base stiffeners, insulated heavy gauge metal enclosure, and a second stage of vibration isolation to the compressor and water-to-refrigerant coil base pan.

Water-to-Refrigerant Heat Exchanger

The water-to-refrigerant heat exchanger is a high quality co-axial coil for maximum heat transfer. The copper coil is deeply fluted to enhance heat transfer and minimize fouling and scaling. The coil has a working pressure of 400 psig on the water side and 660 psig on the refrigerant side. Cupro-nickel may be provided as an option.

Zone Sensors

Zone sensors are available to interface with the UC400 controller and control the unit to the desired stage of cooling or heating. These sensors are field installed in the zone.



The AHRI Certified mark indicates Trane U.S. Inc. participation in the AHRI Certification program. For verification of individual certified products, go to ahridirectory.org.

Trane - by Trane Technologies (NYSE: TT), a global climate innovator - creates comfortable, energy efficient indoor environments for commercial and residential applications. For more information, please visit trane.com or tranetechnologies.com.

Trane has a policy of continuous product and product data improvement and reserves the right to change design and specifications without notice. We are committed to using environmentally conscious print practices.