



Installation & Service Manual

FOR AC AND DC COUPLED EVERVOLT™ SYSTEMS

Order Numbers:

EVAC-105-4 : EVERVOLT STANDARD 11 KWH AC-COUPLED SYSTEM

EVAC-105-6 : EVERVOLT PLUS 17 KWH AC-COUPLED SYSTEM

EVDC-105-4 : EVERVOLT STANDARD 11 KWH DC-COUPLED SYSTEM

EVDC-105-6 : EVERVOLT PLUS 17 KWH DC-COUPLED SYSTEM

ONLY CERTIFIED EVERVOLT INSTALLERS SHALL BE ABLE TO PURCHASE, DESIGN, SELL, AND INSTALL AN EVERVOLT SYSTEM. THE 10-YEAR EVERVOLT WARRANTY WILL ONLY BE PROVIDED TO CERTIFIED EVERVOLT INSTALLERS.

System warranty registration must be completed on na.panasonic.com/us/form/battery-storage-registration

For more information, please visit <https://na.panasonic.com/us/evervoltcertification>

FOR MORE INFORMATION ON BECOMING A CERTIFIED EVERVOLT INSTALLER VISIT:
<https://na.panasonic.com/us/panasonic-evervolttm-battery-storage-certification-program>

NAME	MANUFACTURER	MODEL	TECHNICAL DESCRIPTION	MARK(S) OF CONFORMITY
BATTERY MODULE	PANASONIC	BJ-DCB105ZKT	46.8 VDC, DC, 57.6 Ah, 19.2 BAUD	cETLus
HYBRID INVERTER	DARFON	HB51	Hybrid Inverter, 120/240 VAC, 23 AAC, 50/60 HZ, PV AC Coupled-240 VAC, 5500 W (Model: JK-Q3C41-D02)	cETLus
		H5001	Hybrid Inverter, 120/240 VAC, 23 AAC, 50/60 HZ, PV DC Coupled-250 to 430 VDC, 13ADC/13ADC, 3250W/3250W (Model: JK-Q3C31-D02)	

We are committed to quality and constant improvement. All specifications and descriptions contained in this document are verified to be accurate at the time of printing. However, we reserve the right to make modifications at any time that may result in a change of specification without notice in our pursuit of quality. If you find any inconsistencies or errors in this document, please notify us at panasonicevervoltsupport@us.panasonic.com

Check the resources page at na.panasonic.com/us/energy-solutions/battery-storage for the latest specifications and manuals.

© 2021 Panasonic Life Solutions Company of America. All rights reserved.

All information in this document is subject to copyright and other intellectual property rights of Panasonic Life Solutions Company of America. This material may not be modified, reproduced or copied, in whole or in part, without the prior written permission of Panasonic. and its licensors. Additional information is available upon request.

Table of Contents

Introduction	4
Important Safety Warnings	6
Part I: Planning for Installation, Assembly, Testing, & Commissioning	
Pre-Commissioning Checklist	14
Planning for Installation	15
What's in the Box	17
Assembly	18
1. Mounting the Battery Cabinet	18
2. Mounting the Inverter	36
3. PV Module Connection (DC-Coupled)	40
4. General Connections	42
5. Grid (Utility) Connection	43
6. Battery Connection and Charging Requirements	48
7. Installing the SmartHub	56
8. SmartHub Monitoring Portal	60
9. SmartHub Technical Specifications	62
10. Operational Testing	63
11. Finishing Touches	65
Part II: Users Guide	
12. Operation and Display Panel	66
To Start Up Equipment (Overview)	67
To Install, Service or Disconnect (Shutdown) Equipment	69
13. Configuring the Hardware	79
Part III: References, Maintenance, Cleaning, Troubleshooting, & Warranty	
14. Grid and Load Terminals	83
15. Maintenance & Cleaning	84
16. Service	84
17. Replacing and Installing Additional Batteries	86
18. Specifications	89
19. Grid Support Parameters (UL1741SA)	92
20. Troubleshooting	95

INTRODUCTION (DC-Coupled)

The EverVolt provides power to the essential loads by utilizing power from PV panels, the utility and batteries. When the PV panels (two string input) generate enough power, the inverter can support the essential loads, charge the batteries and feed back to the grid all at the same time. When the energy generated by the PV panels is not sufficient to support the essential loads, the inverter takes power from either the batteries or the utility depending on the mode the homeowner has selected.

To accommodate various power situations, the EverVolt is designed to handle continuous power from PV panels, batteries and the utility. When the MPPT input voltage from the PV panels is within the acceptable range, between 250 and 430VDC, the inverter is able to feed the grid and charge the batteries. The EverVolt inverter is compatible with monocrystalline, polycrystalline and Panasonic HIT PV panels.

Note:

- Positively grounded PV modules are not compatible with the DC-coupled EverVolt system.
- When PV input voltage is lower than 250V, the power of the inverter will de-rate.

Basic EverVolt Configuration (DC-Coupled)

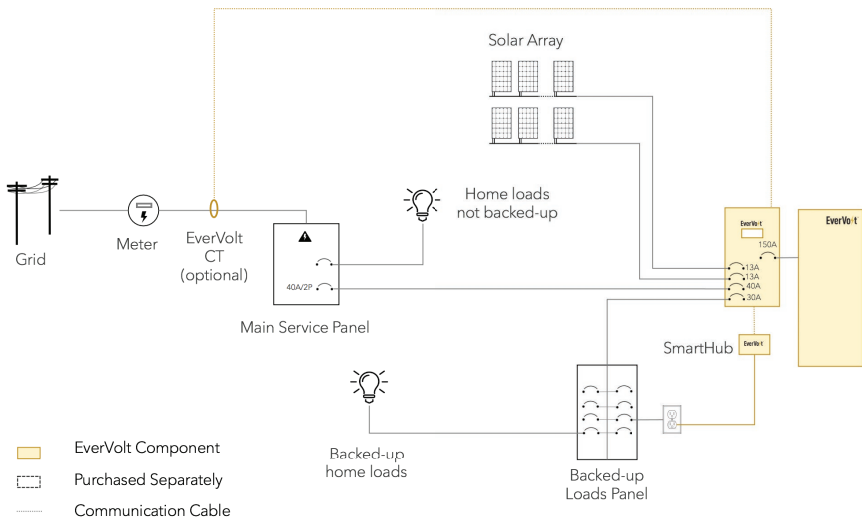

INTRODUCTION (AC-Coupled)

With the AC Coupled EverVolt, energy storage can be added to homes and small commercial buildings, with or without a PV system. The AC Coupled EverVolt can be AC-coupled with existing PV systems, either with string or micro inverters, to allow continuous use during utility outages. To facilitate easy installation, the AC Coupled EverVolt's distribution box includes quick disconnect terminals, DC and battery disconnects, AC breakers, battery connectors and an optional generator contactor. The AC Coupled EverVolt supports a wide range of applications, including peak shaving, backup, TOU with or without feed-in, and remote control.

Basic EverVolt Configuration (AC-Coupled)

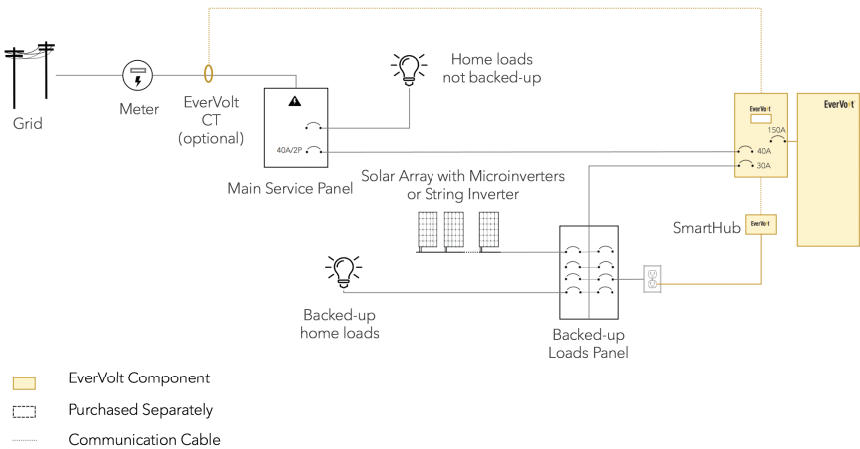



IMPORTANT SAFETY WARNINGS





PLEASE READ ALL INSTRUCTIONS AND CAUTIONARY MARKINGS ON THE UNIT AND THIS MANUAL BEFORE USING THE INVERTER. AND, STORE THIS USER MANUAL WHERE IT CAN BE ACCESSED EASILY.

WARNING: Users and homeowners should not attempt to service Evervolt. Only an authorized Panasonic technician should attempt to service EverVolt.

Safety Symbols

	WARNING: This indicates the risk of electric shock. The presence of high voltage levels may constitute a risk of injury or death to users and/or installers.
	CAUTION: This indicates important information where failure to comply may result in safety hazards or cause damage to this product.
	CAUTION: This indicates the risk of a hot surface. The surface may reach a temperature high enough to cause serious burn injuries.

General Precautions

-  **CAUTION:** Before installing and using this inverter, read all instructions and cautionary markings on the inverter and all appropriate sections of this guide. This inverter must be installed by licensed electricians only.
-  **CAUTION:** Normally grounded conductors may be ungrounded and energized when a ground fault is indicated.
-  **CAUTION:** This inverter is heavy. It should be lifted by at least two persons for safety.
-  **WARNING:** These servicing instructions are for use by qualified personnel only. To reduce the risk of electric shock, do not perform any servicing other than that specified in the operating instructions unless you are qualified to do so.



WARNING: Authorized service personnel should reduce the risk of electrical shock by disconnecting AC, DC and battery power from the inverter before attempting any maintenance or cleaning or working on any circuits connected to the inverter. Turning off controls will not reduce this risk. Internal capacitors can remain charged for five (5) minutes after disconnecting all sources of power.



WARNING: Do not disassemble this inverter yourself. It contains no user-serviceable parts. Attempting to service this inverter yourself may cause a risk of electrical shock or fire and will void the warranty from Panasonic.



WARNING: To avoid a risk of fire and electric shock, make sure that existing wiring is in good condition and that the wire is not undersized. Do not operate the Inverter with damaged or substandard wiring.



CAUTION: Under high temperature environment, the cover of this inverter could be hot enough to cause skin burns if accidentally touched. Ensure that this inverter is away from normal traffic areas.



WARNING: During the installation process, drilling, punching, and screwing the bolts can cause metal burrs, which must be cleaned up to prevent them from falling into the electronics.



WARNING: Use only recommended accessories from Panasonic.



CAUTION: To reduce risk of fire hazard, do not cover or obstruct the cooling fan.



CAUTION: Do not operate the Inverter if it has received a sharp blow, been dropped, or otherwise damaged in any way. If the Inverter is damaged, call for an RMA (Return Material Authorization).



WARNING: Exposed hazardous voltage, during servicing or for emergency procedures use a lockable manual breaker lockout on the main service panel disconnects to enable Lock-Out-Tag-Out per the Standard for Electrical Safety in the Workplace, NFPA 70E, and the Standard for Workplace Electrical Safety, CSA Z462.



BATTERY PACK WARNINGS:

There is danger of generating heat / smoke / rupture flames.

Do not disassemble battery pack.

Do not touch disassembled battery pack.

Do not reassemble battery pack.

Do not immerse the battery pack in any liquids or get it wet.

Do not short circuit battery pack.

Do not incinerate or heat the battery pack.

Do not use or leave the battery near a fire, stove or heated place.

Do not impact the battery pack or throw it.

Do not use a damaged and/or deformed battery pack.

Do not drive sharp objects into the battery pack, strike it with any object or stand on it.

Do not place the battery pack on materials such as tools, electric wire, screws, etc.

In case of a leak in the battery pack, avoid contact.

Do not touch your eyes if accidental contact with leaky battery.

Do not expose to corrosive substances such as sea breeze, steam or chemicals.

Do not install in humid places or places with condensation.

Do not install or use EverVolt if it has been damaged in any way.



WARNING: Only charge the EverVolt within the specified conditions. Failure to do so may result in damages, heat generation, smoke, fire, or explosion.

Check positive (+) and the negative (-) terminals. If the EverVolt is connected with reversed polarity, unexpected reactions may occur such as damages, heat generation, smoke, fire, or explosion.

Do not connect between the positive (+) and negative (-) terminals with a conductive material (e.g. wire, a cable, etc.). This may result in damages, heat generation, smoke, fire, or explosion.

Do not directly solder the EverVolt. This may result in damages, heat generation, smoke, fire, or explosion.



CAUTION: Do not expose the EverVolt to liquids or flooding.

Do not expose of equipment or batteries with household waste.

Do not dispose of batteries in a fire or by burning. The batteries can explode.



WARNING: Risk of electric shock. Risk of fire. Do not attempt to repair the battery(ies); it contains no user-serviceable parts. Tampering with or opening the battery(ies) will void the warranty. If the battery(ies) fails, contact Panasonic Customer Support for assistance at panasonicevervoltsupport@us.panasonic.com.



WARNING: Proper disposal of lithium-ion batteries is required. Follow all local codes and regulations for proper disposal and recycling of lithium-ion batteries. Contact your Panasonic representative with any questions or concerns. The customer cannot keep the old lithium-ion batteries because they are dangerous and considered hazardous waste.



WARNING: Take care when lifting the battery. The battery is heavy.

In the event that Inverter, one or more batteries or EverVolt is defective and needs to be removed, replaced, temporarily uninstalled, disposed of, decommissioned or if Panasonic Customer Support authorizes a replacement (RMA), perform the following steps:

1. Follow installation and service shut down.
2. Contact Panasonic Customer Support at panasonicEVERVOLTSUPPORT@us.panasonic.com or at 888-762-2097



MULTIPLE WARNINGS: Method of active anti-islanding protection: The inverter monitors for sudden changes in the impedance of the grid by looking for changes in the second to the eighth harmonic.

Perform installation and wiring in accordance with all applicable local electrical codes and standards.

Protection against lightning and resulting voltage surge must be in accordance with local standards.

Using unapproved attachments or accessories could result in damage or injury.

Use Class 1 wiring methods for field wiring connections to terminals of a Class 2 circuit. Use only 6-8 AWG (2.5mm² to 4mm²) and 1/0 wire in the junction box terminal block. Select the wire size based on the protection provided by the circuit breakers / fuses. Install properly rated over current protection as part of the system installation.

To ensure optimal reliability and to meet warranty requirements, the Inverter must be installed and/or stored according to the instructions in this guide.



WARNING: Users should not attempt to service the EverVolt.

Only an authorized technician should attempt to service the EverVolt.



WARNING: Risk of injury and equipment damage. Protect the EverVolt from damage and improper use.



WARNING - ARC FLASH AND SHOCK HAZARD: Appropriate PPE and Tools Required (protective eyewear and gloves) while working on the energized equipment. Voltages up to 400 VDC and 240 VAC Present. Arc Flash Approach Boundary 1.0 m. Arch Flash Prohibited Approach Boundary 24 mm.



INVERTER WARNINGS: The inverter is intended to operate with an internet connection. Failure to maintain an internet connection may have an impact on the warranty.

Properly mount the Inverter or place it on a flat, plain surface that can bear heavy weights. Ensure that the mounting location is structurally suited to bearing the weight of the Inverter.

During use, storage, and transport, keep the inverter:

- Properly ventilated
- Away from water, other liquids, heat, sparks, and direct sunlight
- Away from excessive dust, corrosive and explosive gases, and oil smoke
- Away from direct exposure to gas exhaust, such as from motor vehicles
- Free of vibrations
- Away from falling or moving objects, including motor vehicles
- At an elevation of less than 3,000m (9843ft) above sea-level
- In a location compliant with fire safety regulations (has a smoke alarm)
- In a location compliant with local building codes and standards
- Conditions for the inverter installation site apply also to storage conditions.

In Case of Fire or Other Emergency

In case of flooding:

- Stay out of water if any part of the system or wiring is submerged.
- If possible, protect the system by finding and stopping the source of the water, and pumping it away.
- If submerged, the whole system may need to be replaced.
- Let the area dry completely before use.

In case of unusual noise, smell:

- Ensure nothing is in contact with the system or in the venting area on top of the Inverter or Battery enclosures.
- Ventilate the room.
- Contact Panasonic Customer Support at panasonicevervoltsupport@us.panasonic.com

In case of fire or smoke:

- Fire involving Lithium-ion batteries can be extremely dangerous. Lithium-ion batteries can flash fire or explode.
- Close doors as you leave to confine fire as much as possible. If the alarm is not already sounding, pull the fire alarm on your way out of the building. If there is no alarm to activate, yell “fire” as you leave. Move quickly to an open area, away from buildings, trees, power lines, and roadways.
- When in safe location call fire department and report a possible Lithium-ion battery fire.

In all other cases:

- If safe to do so,
 1. Initiate Rapid Shutdown and allow the DC voltage to drop to a safe level,
 2. Power down inverter, and
 3. Disconnect wiring sources of AC and DC power.
- Contact the fire department or other required emergency response team.
- Evacuate the area.

Part I: Planning for Installation, Assembly, Testing, & Commissioning

Pre-Commissioning Checklist (Customer Information & Recording Serial Numbers)

Planning for Installation

What's in the Box

Assembly

Installing the Battery Enclosure, Battery & Wires

Mounting the Inverter

PV Module Connection (DC-Coupled)

Connections, General

Grid (Utility) Connection

Battery Connection and Charging Requirements

Installing the SmartHub

Connecting the SmartHub to the Internet

Waking Up the Batteries

Commissioning

Finishing Touches

Pre-Commissioning Checklist

1. Complete the EverVolt Certification to obtain installer login credentials.
2. Register the homeowner site on the EverVolt portal (www.evervoltportal.com). You will need the following information from the homeowner and the system:
 - a. First Name
 - b. Last Name
 - c. Address
 - d. Email address
 - e. LAN MAC ADDRESS of SmartHub
 - f. Serial number of inverter(s)
3. Record the following serial numbers from the system equipment:
 Note: It is strongly recommended to take pictures of all bar codes and serial numbers

SmartHub LAN MAC ADDRESS: _____

Inverter #1 S/N: _____

Inverter #2 S/N (if applicable): _____

Inverter #3 S/N (if applicable): _____

Battery Module #1: _____

Battery Module #2: _____

Battery Module #3: _____

Battery Module #4: _____

Battery Module #5 (if applicable): _____

Battery Module #6 (if applicable): _____

If more than 6 battery modules please list remaining serial numbers here:

4. After completing hardware installation, follow the commissioning steps to turn on the system.
5. Bring this sheet back to the office and register the Panasonic Warranty at:
<https://na.panasonic.com/us/form/battery-storage-registration>

Planning for Installation

1. **Essential Load Sizing:** Assure there are enough batteries so that the essential load doesn't exceed 1100W continuous per battery module.
2. **Internet Connectivity:** The most reliable connection is a CAT5/6 hardcable to the router. Other options are wifi (included), PLC (included), and cellular.
3. **System Placement:** (a) Placement of the physical system so that the batteries rest on the feet of the battery enclosure (b) a conduit between the battery and inverter be placed for easy routing of the 1/0 or 2/0 wire. The clearance spacing needs to be observed to allow for adequate cooling and servicing of the equipment.
4. **Outlet Placement:** 120V AC outlet needs to be within 4 ft of the inverter to plug in the power supply to power the SmartHub. This outlet must be fed from the backed up loads panel to ensure EverVolt maintains internet connectivity during a power outage.

System Layout & Dimensions

47.2"*28.9"*17.79" (Battery) & 17.5" x 39" x 6" (inverter). The minimum spacing between the inverter and battery enclosure is 6".

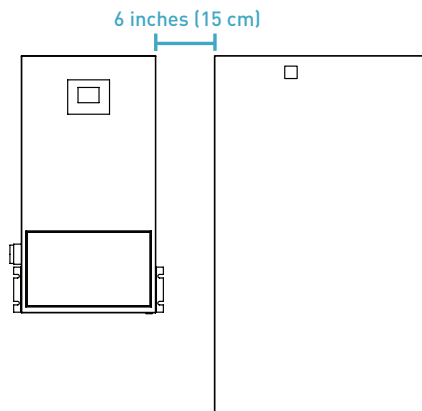

Knockout Locations

There are multiple knockouts on the inverter and battery enclosure (as shown with the red arrows).

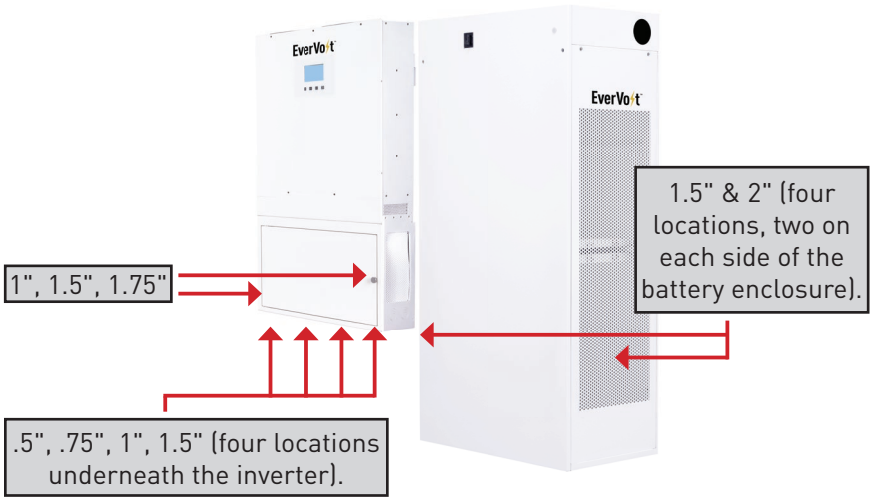

Required Tools

Below is a list of recommended tools you will need to install EverVolt:

PARTS NAME	DESCRIPTION	QTY.
Gloves	Cotton glove with urethane coating	1 Pair
Automatic Screw-driver (+)	Driver with torque setting	1
Wrench	M6/M8/M12	1
Wire Cutters	Standard wire cutters	1
Crimping Tool	Used for making power cables	1
Socket Wrench	Battery terminals are 10mm	1
Screwdriver	Standard screwdriver	1
Allen Wrench	4mm Allen wrench needed for enclosure	1

What's in the Box

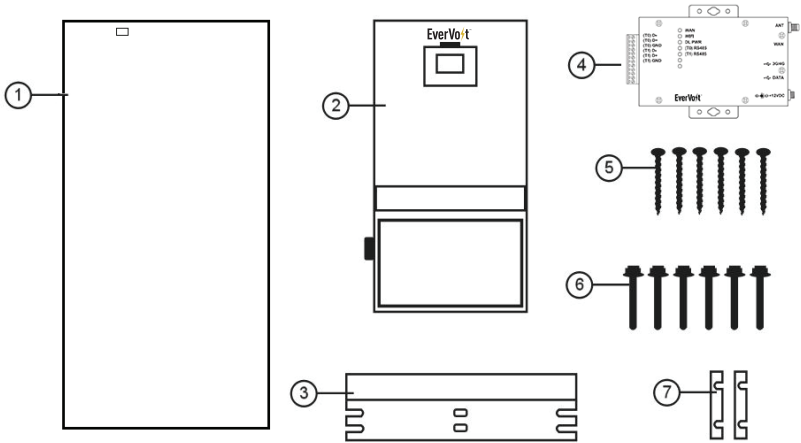

Parts Description	Qty
1. Battery Enclosure	1
2. Inverter	1
3. Enclosure Mounting Bracket	1
4. SmartHub	1
5. Wood Screws	6
6. Inverter Mounting Bracket Screws	6
7. Inverter Mounting Bracket	2

ASSEMBLY AND INSTALLATION

1. MOUNTING THE BATTERY CABINET

SPECIFICATIONS

	Item	Specification
1	Material	SECC
2	Dimensions (HxWxD)	1195mm x 590mm x 335mm or 47.05" x 23.23" x 13.19"
3	Total Weight	43kg (94.8 lbs)
4	Appearance requirements	The surface of the product must not have obvious scratches, spots, cracks, rust, dirt, liquid leakage, etc.
6	IP Rate	IP20
7	Installation Method	Installed on the ground

SYSTEM LAYOUT & DIMENSIONS

The cabinet dimension is 1195 x 590 x 335mm (47.05" x 23.23" x 13.19").

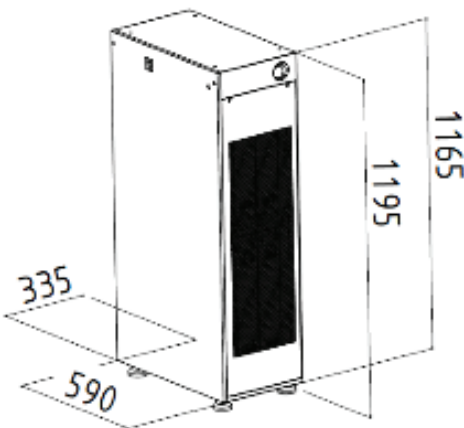



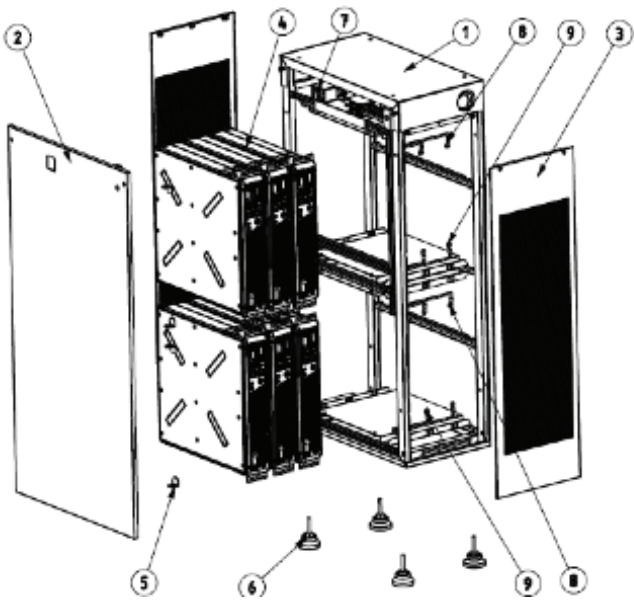











EXPLODED VIEW OF THE CABINET



NO.	
1	CASE LOWER
2	CASE UPPER
3	COVER
4	BATTERY
5	LOCK
6	FOOT PAD
7	BREAKER
8	RED WIRE (BATTERY)
9	BLACK WIRE (BATTERY)



ACCESSORY LIST

MATERIAL NAME	SPECIFICATION DESCRIPTION	QTY	IMAGE
Communication cable pack	CABLE COUPLER RJ45 125MM	4 pcs	
	CABLE COUPLER RJ45 800MM	1 pcs	
	CABLE COUPLER SR RJ45 4000MM	1 pcs	
Output/ Grounding cable pack	2500mm UL1015 3AWG PVC 105°C RED	1 pcs	
	2500mm UL1015 3AWG PVC 105°C BLACK	1 pcs	
	CABLE COUPLER UL 1015 AWG10 YELLOW-GREEN 105°C 2500mm	1 pcs	

Cabinet Accessories (Foot pad, For Wall Mount Screws/ Washers, Hole Cover	Foot pad	4 pcs	
	SCREW TAP A ROUND +&-SLOT SUS STEEL SP 1/4 50 MM (FOR CONCRETE WALL)	4 pcs	
	SCREW TAP B HEX EXTER HEX SUS STEEL (FOR WOODEN WALL)	4 pcs	
	FLAT WASHER SUS	4 pcs	
	TOP COVER HOLE NYLON UL94V2 WHITE	4 pcs	
Battery Fixing accessory kit (Battery fixed-piece, Screws and Washers For Battery Fixation)	HEXAGON SOCKET SCREWS M5x15L SUS304 FOR SCREW BATTERY 24PCS, LOCKER 8PCS AND GROUNDING 3PCS	35 pcs	
	WASHER FLAT STAINLESS STEEL FOR BATTERY	24 pcs	
	LOCK_FRONT_BATTERY Fixed pieces	8 pcs	

TOOLS PREPARATION

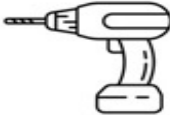
Below is a list of recommended tools you will need to install battery cabinet:

PARTS NAME	DESCRIPTION	QTY.	
Gloves	Cotton glove with urethane coating	1 pair	
Automatic Screw-driver (+)	Driver with torque setting	1	
Wrench	M3/M5/M8 hexagonal wrench	1	
Screwdriver	Standard screwdriver	1	

ASSEMBLY

Before installing the battery cabinet, make sure nothing inside the package is damaged. You should have received the following items in the package: The cabinet, output cables, communication cables, screws and this installation manual.

The following considerations must be taken into account before selecting where to install.

- The unit cannot be mounted on flammable construction materials.
- The unit must be mounted to a solid surface.
- ALLOW 20CM (8IN) OF CLEARANCE TO THE SIDES AND 50CM (20IN) TO THE TOP of the unit for proper air circulation to dissipate heat.
- The ambient temperature must be between 5°C and 50°C for charging and between -10°C and 50°C for discharging.
- Relative humidity must be between 5 and 85% to ensure optimal operation.
- Do not operate where the temperature and humidity are beyond the specified limits.
- The unit has a Pollution Degree rating of PD2. The unit must be mounted in a protected area that is dry, free of excessive dust and has adequate air flow.
- The unit was designed with an IP20 protection rating and is for indoor applications only.



WARNING: When performing and following these 12 steps, please make sure that all battery pack power switches, inverter system switch and all battery circuit breakers are turned off

To begin installing the battery enclosures, please follow the steps below:

1. Take the enclosure out of the box and move to a stable surface.

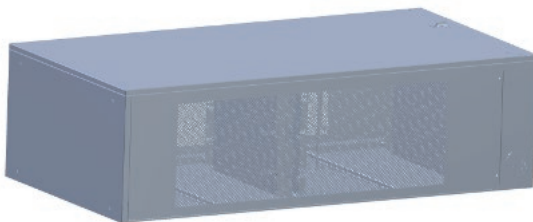

2. Tighten the four foot-pads and lift the cabinet to the wall where it is intended to be installed. As yellow arrows shown below:

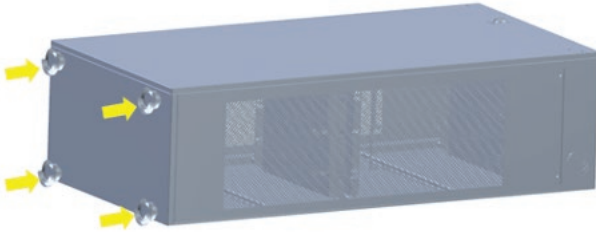

3. Remove 2 screws from the front cover or remove 2 screws from the right side of the enclosure and then take off the front cover or right cover and set aside. Please take out the accessory package from the top of battery cabinet.

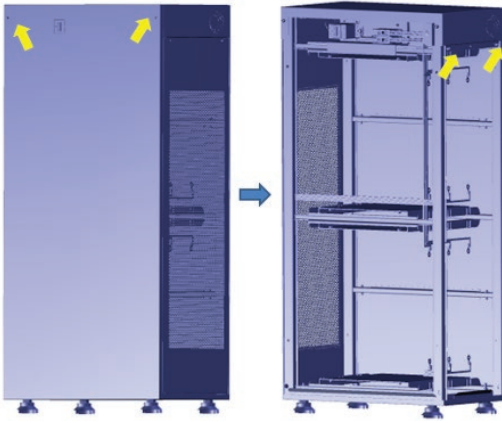

4. Place the cabinet against to the wall and screw through the hole of the cabinet to fix it on the wall. To ensure that the weight of the battery rests firmly on the bottom of the cabinet, leave a 1/4" gap between the enclosure and the wall mounting, and then adjust the foot pad to level.

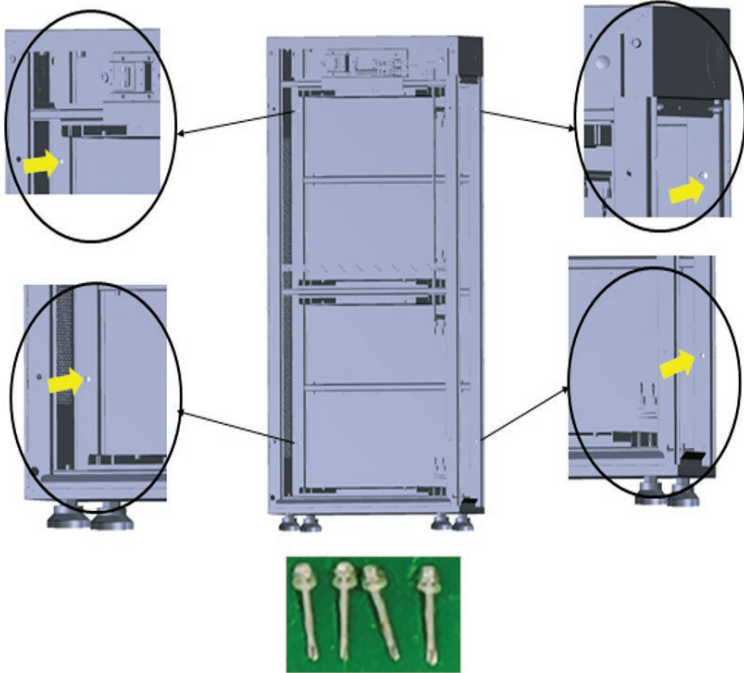

5. There are two ways for installing the battery into the cabinet; you can either install batteries from the front or from the right side of the cabinet. Each battery must have 10mm gap to avoid heat accumulation. Please insert each battery with the positive pole up and negative pole down. Use M5 screws to attach the battery brackets to the cabinet mounts.

a. Insert the battery packs from the front lower bracket of the cabinet one by one, and then insert batteries to top bracket, as yellow arrow shows.

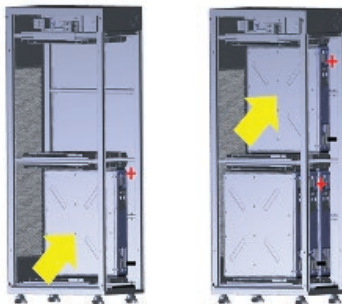

b. Insert the battery packs from the right lower bracket of the cabinet one by one, and then insert batteries to top bracket, as yellow arrow shows below.

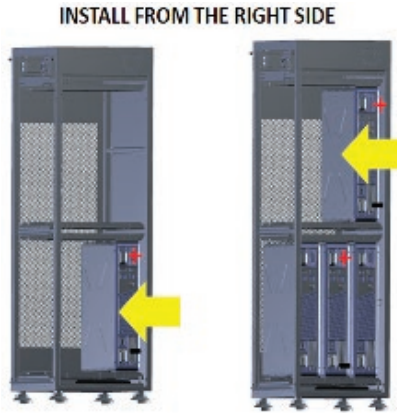

c. Use M5 screws to fix the batteries on battery holders as yellow arrows below.

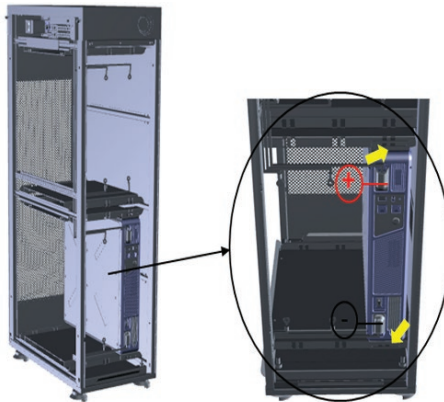

WARNING: When moving the battery pack, please make sure that the switch must be turned off and the indicator light is no flashing or constantly on.

Step 6. Please fasten all battery packs to the cabinet mounts using M5 screws.



WARNING: When fastening screws on the battery pack, please make sure in advance that the switch on the panel is turned off and the indicator light is not flashing or constantly on.

7. The included wire kits have been bundled on the frame. Please install these wires to the corresponding polarity terminals of the battery pack. The red wires are connected to the positive pole and the black wires are connected to the negative pole.

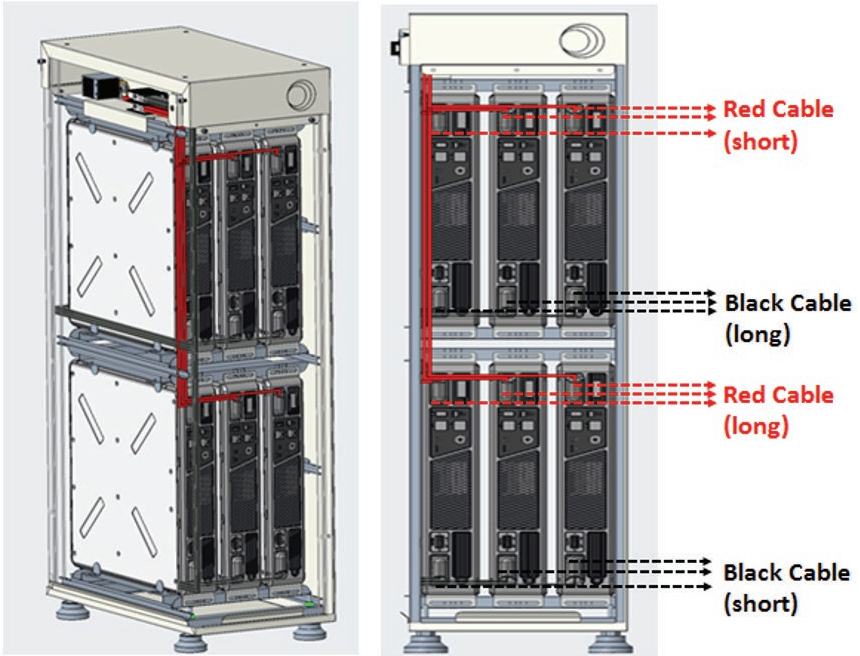



	Short Length	Long Length
10AWG--(6) Red	20in (525mm)	40in (1025mm)
10AWG--(6) Black	62in (1575mm)	82in (2075mm)

The position is indicated by the yellow arrow symbol, and the wiring direction is indicated by the blue arrow, as pictures shown below:



 **WARNING:** When wiring to polarity terminals of battery pack, please make sure in advance that the switch on the panel is turned off and the indicator light is not flashing or constantly on.

 **CAUTION:** Before making the final connection or closing the breaker, make sure the connections have the correct polarity. Check polarity labels above.

 **CAUTION:** Do NOT apply anti-oxidant substance on the terminals before terminals are connected tightly.

8. Please use 10 AWG Yellow/Green wire connected to the grounding position of the cabinet as yellow/blue arrow shown on 2 above pictures. Please make sure the end of the ground wire connect to the GND terminal block of the inverter as yellow arrow shown on below picture.

The positions are the indication of the yellow arrow and the direction in which the wires are arranged is indicated by the blue arrow as below:



⚠ WARNING: When wiring to polarity terminals of battery pack, please make sure in advance that the switch on the panel is turned off and the indicator light is not flashing or constantly on.

⚠ WARNING: When performing this step 8, please make sure that all battery pack power switches, inverter system switch and all battery circuit breakers are turned off.

9. Confirm that the preinstalled wires have been routed properly and none are missing. Follow the below steps to confirm battery wiring is complete.

1. The wiring checks on the battery cabinet side.

a. Negative power wiring (black) check.

Please use a appropriate hexagonal wrench to make sure all screws on the terminal block are tighten. Make sure all black wires direction are correct as yellow arrow and arranged are indicated by the blue arrow as below:

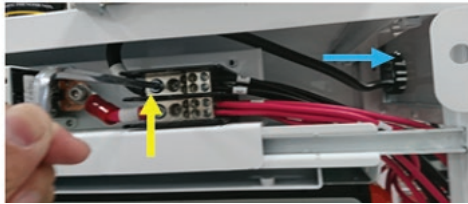
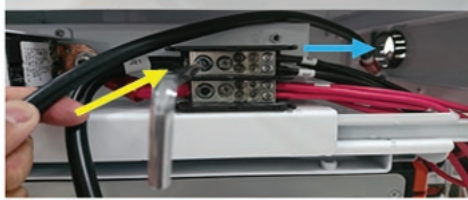

b. Positive power wiring (red)

Please make sure M8 screw to positive copper block is tightened and must use a appropriate hexagonal wrench to check again. Make sure all red wires direction are correct as yellow arrow and arranged are indicated by the blue arrow as below:



WARNING: When performing step 9-1, please make sure that all battery pack power switches, inverter system switch and all battery circuit breakers are turned off.

2. Inverter Side related connection

a. Make sure all switches / breakers on the inverter and batteries must be switched off. As blue arrows shown below.

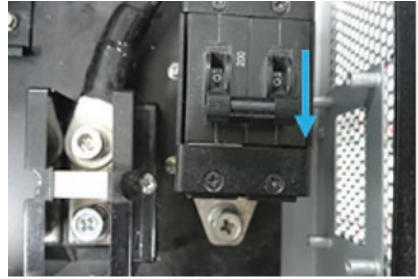
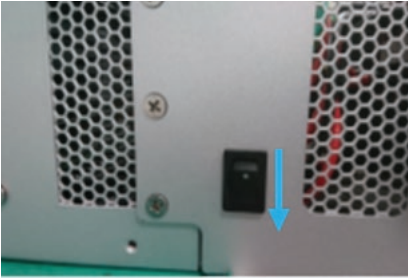

b. Make the positive (red) wire connects to POS+ terminal block and negative (black) wire connected to NEG-terminal block. As yellow arrow shown below:

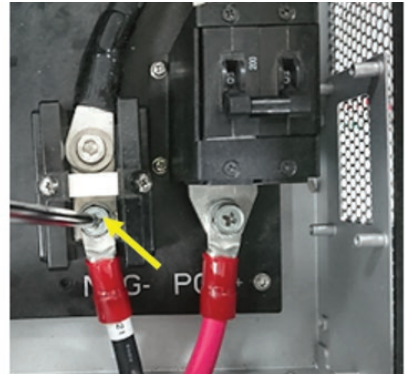
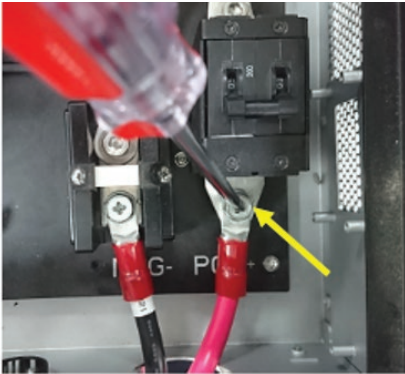

WARNING: When performing this step 9-2, please make sure that all battery pack power switches, inspector system switches and all battery circuit breakers are turned off.

10. The communication cables connection from battery to inverter. There are 3 different length types of communication cable, please install by following instruction below. For completing the battery communication cable connections, see page 54.

a. 125mm RJ45 cable

Please plug in 4 communication cables into the battery pack to next battery pack to connect upper 3 modules and lower 3 modules, as yellow arrow shown below:



b. 800mm RJ45 cable

Please plug the cable from the right side port (Ports as yellow arrow shown) of upper battery pack connect to the left side of lower battery pack port, cable connection must be as blue arrow shown below.

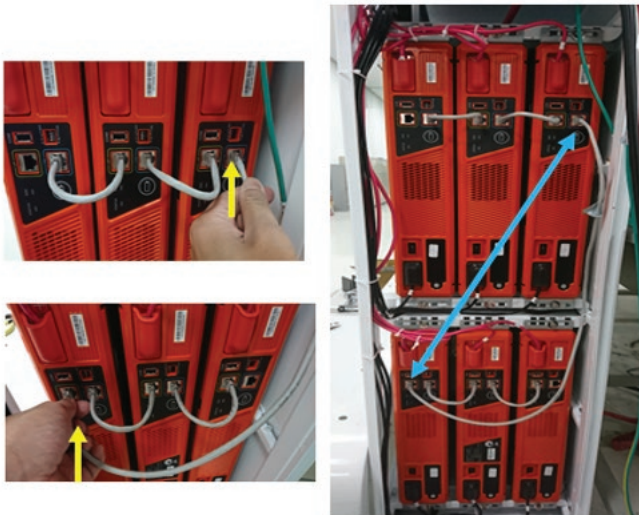

c. 4000mm RJ45 cable part

Please plug the longest communication cable from the far left side of upper battery, then avoid to touch any black and red cables, bypass the rightmost battery aside and pass through the outlet on left side. (The outlet hole must be opened before wiring)

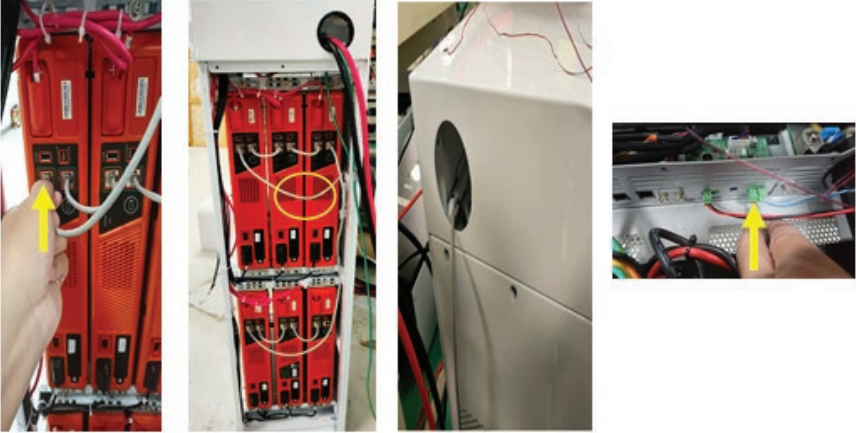

WARNING: When performing this step 11, please make sure that all battery pack power switches, inspector system switches and all battery circuit breakers are turned off, and any communication cables is not allowed to touch either black and red cables.

11. Use M5 screws to fix the batteries with fixed pieces as arrows below enclosure.

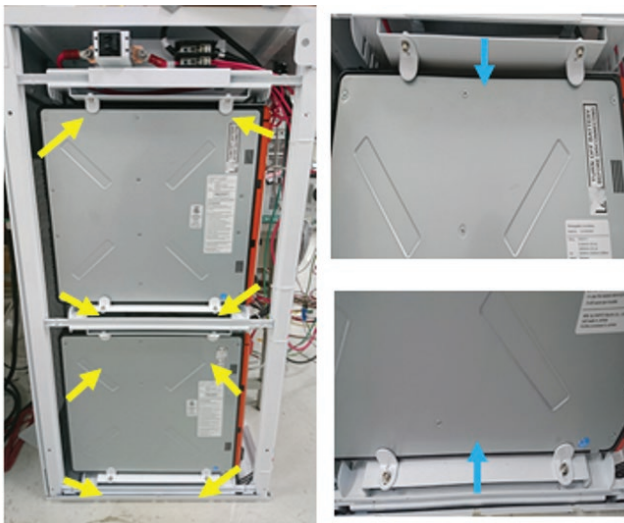

⚠ WARNING: When performing this step 12 , please make sure that all battery pack power switches, inspector system switches and all battery circuit breakers are turned off

12. Reinstall all 4 screws from the front and right side covers of the enclosure, as yellow arrow shown below.

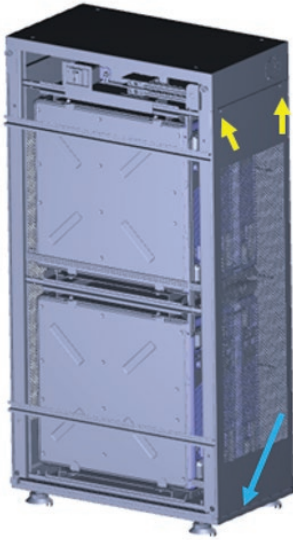

ASSEMBLY (Continued)

2. MOUNTING THE INVERTER

Before installation, make sure nothing inside the package is damaged. You should have received the following items in the package: hybrid inverter, backplate, brackets, screws and this installation manual.

The following considerations must be taken into account before selecting where to install:

- The unit cannot be mounted on flammable construction materials.
- The unit must be mounted to a solid surface.
- ALLOW 15CM (6IN) OF CLEARANCE TO THE SIDES AND 50CM (20IN) TO THE TOP AND BOTTOM OF THE UNIT for proper air circulation to dissipate heat.
- Before inverter placement, see battery operating temperature requirements.
- The ambient temperature must be between 0°C and 50°C and relative humidity must be between 5 and 85% to ensure optimal operation. Do not operate where the temperature and humidity are beyond the specified limits.
- The unit has a Pollution Degree rating of PD2. The unit must be mounted in a protected area that is dry, free of excessive dust and has adequate air flow.
- The unit was designed with an IP20 protection rating and is for indoor applications only.



CAUTION: This inverter is heavy (74lb/33.6kg -- AC-Coupled, 88lb/40kg -- DC-Coupled). For safety, mounting should be handled by two people.

Wall Types

- Stud: The inverter will need to be mounted to the wall using Unistrut. The Unistrut must be secured to two studs in the wall. There should be two rows of Unistrut installed: one for the backplate and the other for the side brackets.
- Solid: Use the backplate and mounting dimensions to mark for screw locations.

1. Mount the backplate onto the wall using at least two screws; one on each side of the backplate.

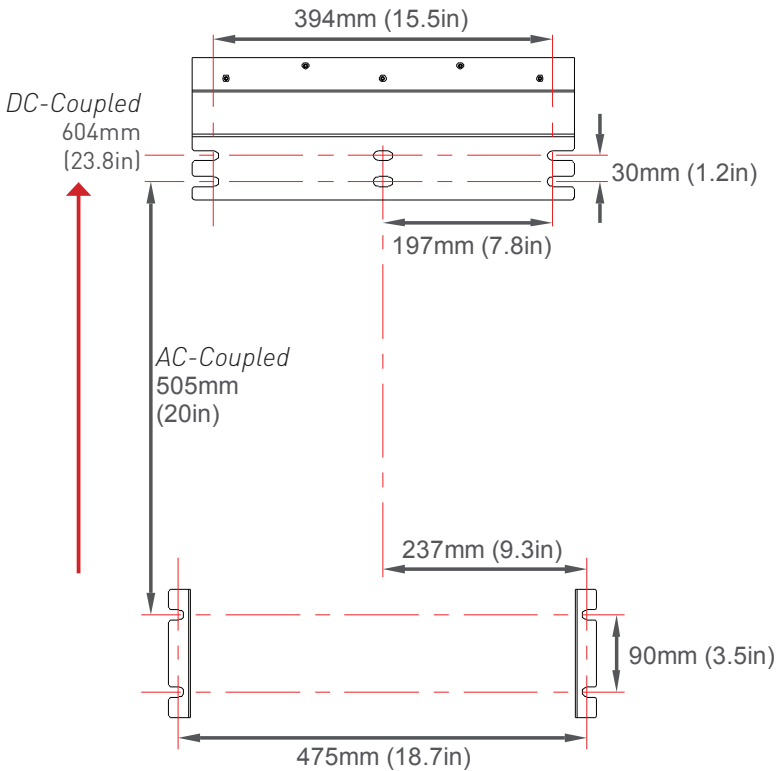

NOTE: The DC-coupled inverter bracket dimensions are all the same as the AC-coupled inverter brackets except for the distance between the top and bottom mounting brackets, which is 604mm/23.8in.

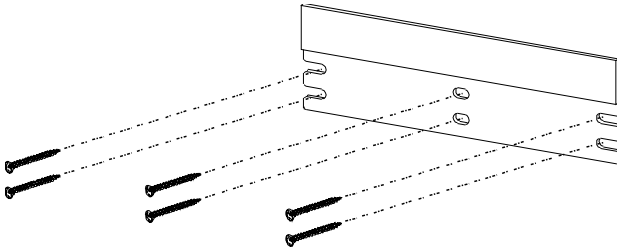

2. Install the brackets on the inverter.

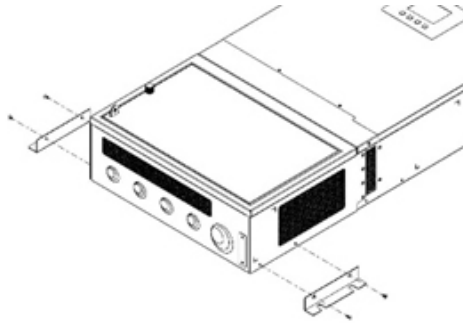

3. Hang the inverter onto the backplate and secure the brackets to the wall using at least two screws; one on each side of the inverter.

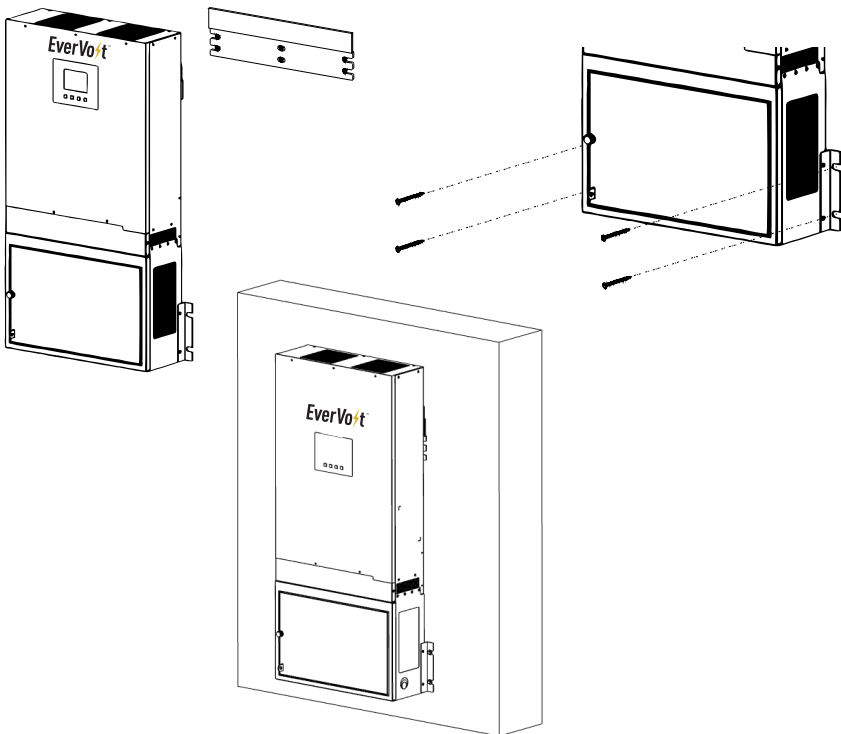

Access Cover to Terminal Block Connectors

- The cover must be removed when making or modifying connections in the distribution box, and reinstalled when connections have been completed.
 - To remove the cover, use the following steps.
 - Reverse the steps to reinstall the cover.
1. Remove the screws from the cover.
 2. Pull off the cover.

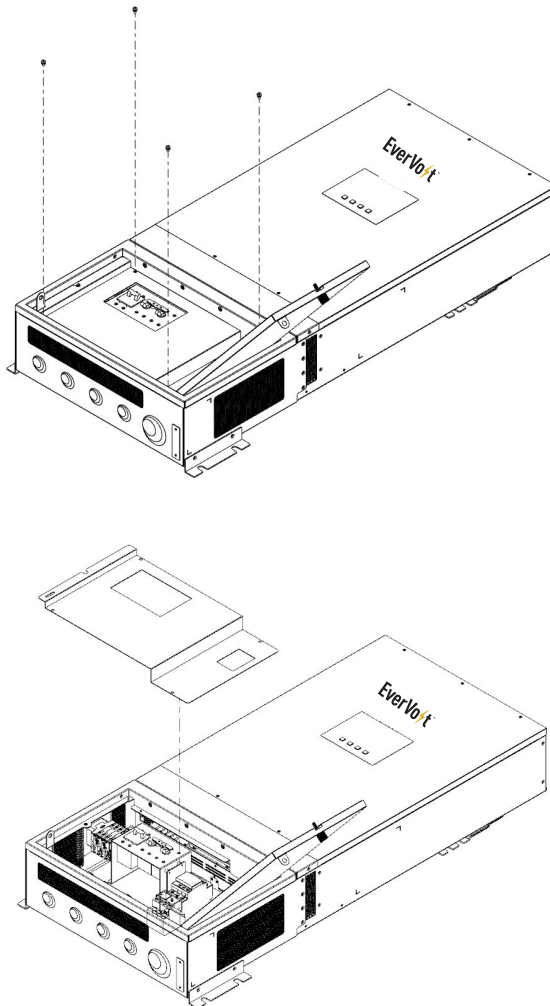

ASSEMBLY (Continued)

3. PV MODULE CONNECTION (DC-Coupled Only)

NOTE: Below information is for reference only. See Technical Bulletin for additional string sizing information.

There is a DC (PV) circuit breaker in the distribution box when using the DC coupled version of EverVolt (black). This system can connect to two strings of PV modules with MPPT control. Configure each PV input as recommended in the table below. Vmp is a PV panel's max power point voltage. The PV charging efficiency is maximized when the PV system's voltage is close to Best Vmp. **Note: Do not operate a single MPPT channel higher than 3250 W. If more than 3250 W is required, use the AP Tool to parallel the MPPT Inputs to allow single arrays to produce greater than 3250 W.**

TERMINAL MARK	MAXIMUM PV INPUT POWER	TYPICAL AMPERAGE	CABLE SIZE (MIN)	Torque	Best Vmp	VMP Range
PV Input 1	3.25 kW	13A	12 AWG	1.4 - 1.6 Nm	360V	250V - 430V
PV Input 2	3.25 kW	13A	12 AWG	1.4 - 1.6 Nm	360V	250V - 430V

Note on DC Wiring and NEC

Some electricians or installers may be unfamiliar with DC wiring in a residential setting. Make note of all relevant codes, which may include:

1. NEC 690.31(G) for DC PV circuits in buildings.
2. NEC 215.12(C)(2) for correct DC wiring coloring.
3. NEC TABLE 310.15(B)(16) for Allowable Ampacities of Insulated Conductors for Not More Than Three Current-Carrying Conductors in Raceway (conduit wiring over 12").
4. NEC TABLE 310.15(B)(17) for Allowable Ampacities of Insulated Conductors in Free Air (chassis wiring).

Rapid Shutdown

Evervolt is compatible with NEP and Tigo MLPE devices to comply to NEC 690.12. For more information on specific models, please contact your Panasonic representative.

Connecting the PV Arrays (DC coupled only)

Step 1. For each PV input string, make sure the input voltage is between 250VDC and 430VDC, and the maximum current is 13A.

Note: The inverter can still be installed if you are only using one PV input string.

Step 2. Make sure the PV Switch and inverter Main Switch located on the side of the inverter are OFF.

Step 3. Strip 15mm(0.6in) of insulation from each PV cable (PV1+, PV1-, PV2+ and PV2-).

Step 4. Insert the PV cables into the PV quick connect terminals. Make sure the polarity for each connection is correct; positive to positive and negative to negative.

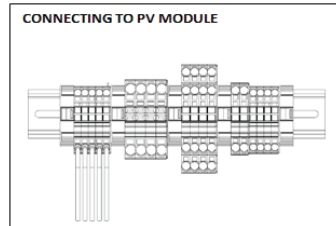
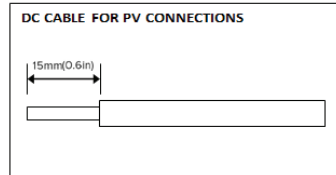

WARNING: Never touch the terminals of the inverter directly. It will cause lethal electric shock.



WARNING: The final connection for DC strings should be done at the array not at the inverter.



WARNING: Because this inverter is non-isolated, only two types of PV modules are acceptable: monocrystalline (including Panasonic HIT) and poly crystalline with only Class A-rated. To avoid any malfunction, do not connect any PV modules with possibility of leakage current to the inverter. For example, non-grounded PV modules will cause leakage current to the inverter.



CAUTION: To reduce the risk of injury, use the proper cable size for PV module connection.



CAUTION: To reduce the risk of damage due to surge, Panasonic recommends surge protection between the modules and the inverter.



CAUTION: Exceeding the maximum input voltage can destroy the unit. Check the PV string voltage before wiring the connection.

ASSEMBLY (Continued)

4. General Connections

- Order of connections should be Grid, Load, then Battery.
- Order of wire connections should be Ground, N, L1, L2.
- Connect AC wires according to the labels on the terminal block or your system



WARNINGS

- Make sure the circuit breaker is off before making or modifying any connections.
- To prevent the risk of electric shock, make sure the ground wire is properly earthed before operating this unit whether the grid is connected or not.
- To reduce the risk of injury, use the recommended wire/cable size.
- Do not apply anti-oxidant substance on battery terminals connections where are made.

Wire/Cable Requirements

	GRID	LOAD	BATTERY
SIZE	Rated for 40 AAC	Rated for 30 AAC	Rated for 150 ADC
LENGTH	--	--	Use supplied 6 ft cable. If cable over 16 ft. is needed, increase wire by one AWG size or more.

Strip 15mm(0.6in) off the AC wires and battery cables.



ASSEMBLY (Continued)

5. GRID (UTILITY) CONNECTION

There is an AC (Grid) circuit breaker in the distribution box. This will ensure the inverter can be safely disconnected during maintenance and is fully protected from overcurrent of AC input.

Installing an essential load panel provides backup power to connected circuits. There are two interlocked AC breakers to the essential loads inside the distribution box. One AC breaker labeled "FROM INVERTER" is for normal inverter operation. The other breaker labeled "FROM GRID" bypasses the "AC GRID" breaker and connects the essential loads directly to the "Grid Input" terminals.

Note: If the inverter needs to be repaired this breaker can be used to supply the essential load when the inverter has been taken off-line. This bypass can also be used while a customer waits for Permission to Operate from their utility or local Authority Having Jurisdiction.

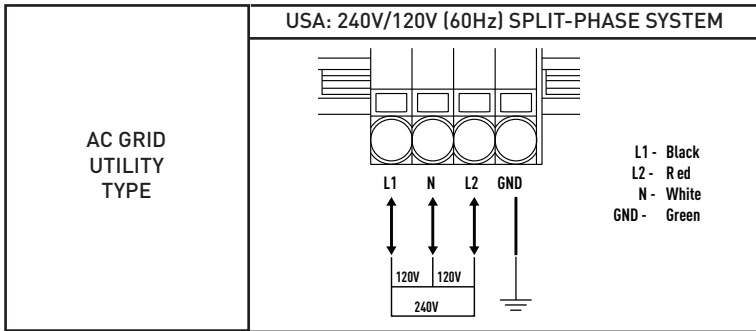

ESSENTIAL LOAD MAX POWER	NOMINAL VOLTAGE	WIRE SIZE	Torque
5.5 kW 2.75 kW	240 VAC 120 VAC	Rated for 30 AAC Rated for 30 AAC	N/A, Spring Connectors N/A, Spring Connectors



WARNING: To reduce the risk of injury, use the recommended wire size above. It is very important for system safety and efficient operation to use the appropriate wire for grid (utility) connection.



WARNING: To prevent the risk of electric shock, make sure the ground wire is properly earthed before operating this unit whether the grid is connected or not.



WARNING: Essential load terminals are to be wired to a separate subpanel. Never connect essential load lines directly to the main service panel without use of an external automatic transfer switch. Direct connection of essential loads output to the grid will result in damage to the inverter.



WARNING: Do not connect essential loads output in parallel with the grid!

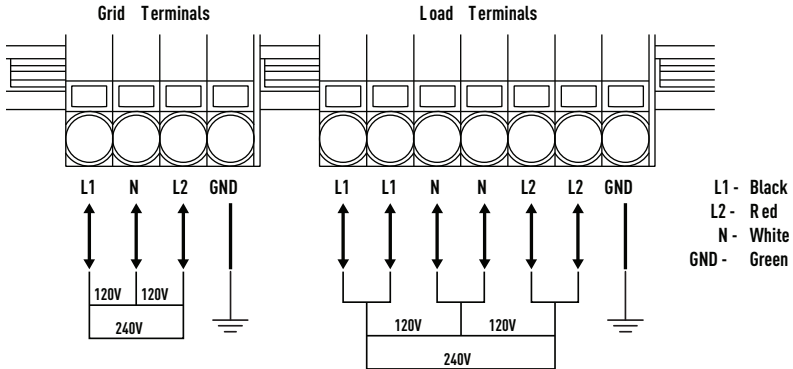

CAUTION: Make sure the AC Load and AC Grid are properly connected. Misconnecting them will damage the product.

Connecting to the Essential Load

- Step 1. Make sure the circuit breaker is off.
- Step 2. For each AC wire, strip 15mm(0.6in) of isolation.



- Step 3. Be sure to connect PE protective conductor first (GND).
- Step 4. Connect the wires according to the labels indicated on the terminal block or your grid utility type.

How to Install Conductors into the Terminal Blocks (Installation below shows the grid connection for reference. Make sure to use proper terminal block, connect grid to grid, PV to PV and Load to Load.)

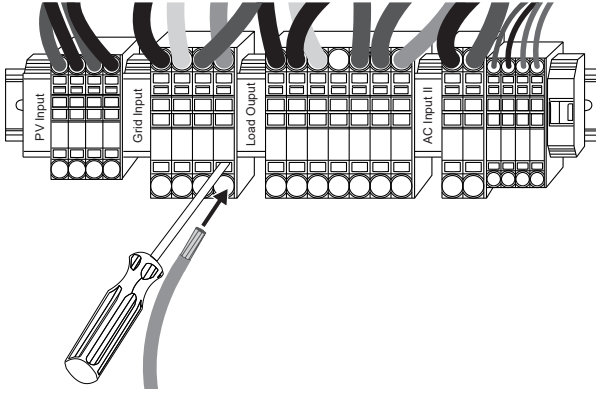

CAUTION: DO NOT USE PV INPUT TERMINALS ON AC COUPLED SYSTEMS. Plug (cap) all PV Input terminals for **AC-Coupled installations**. Under no circumstances will the PV Input terminals be used for **AC-COUPLED**.

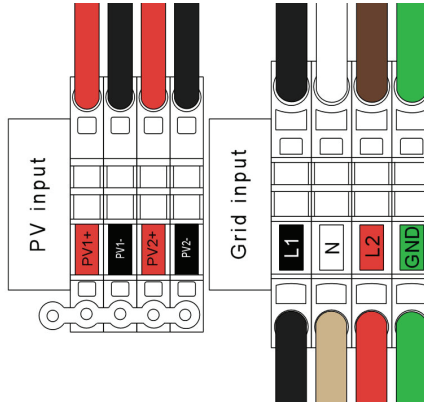

- Put a screwdriver into the terminal, insert the wire into the terminal and then remove the screwdriver. **Do not install wires into PV Inputs for AC-Coupled installations..**

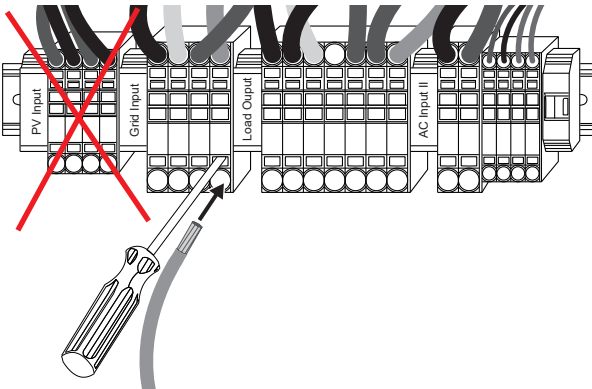

Connecting to the Grid/Utility Continued

Step 1. Check the grid voltage and frequency with an AC voltmeter. It should be within the operation AC voltage range of the product's specifications.

Step 2. Make sure the circuit breaker is off.

Step 3. For each AC wire, strip 15mm(0.6in) of insulation.

Step 4. Connect the AC wires to the inverter according to the labels indicated on the terminal block or your grid utility type.

Note: The PE protective conductor (Ground) should be the first to be connected.

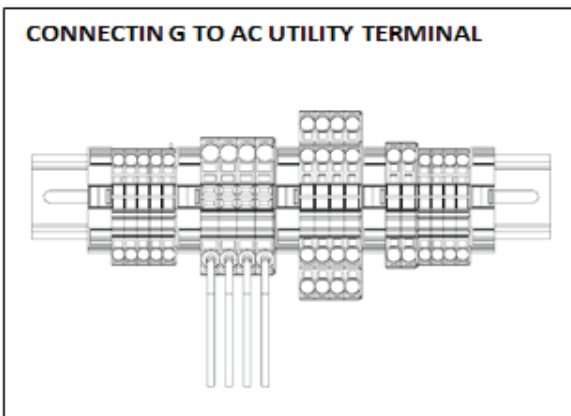
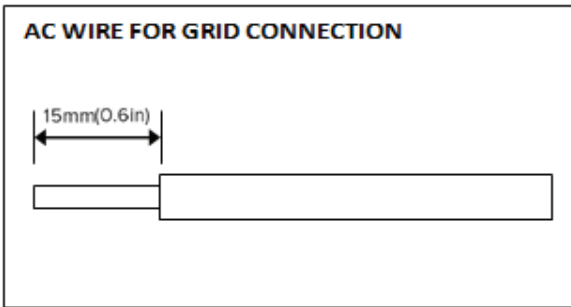

Next, make sure inverter is disconnected. Follow the below instructions to completely isolate the equipment.

Step 1. Turn off the 40 A “marked” main grid breakers located in the main service panel.

Step 2. Turn off the battery breaker located in the inverter distribution box.

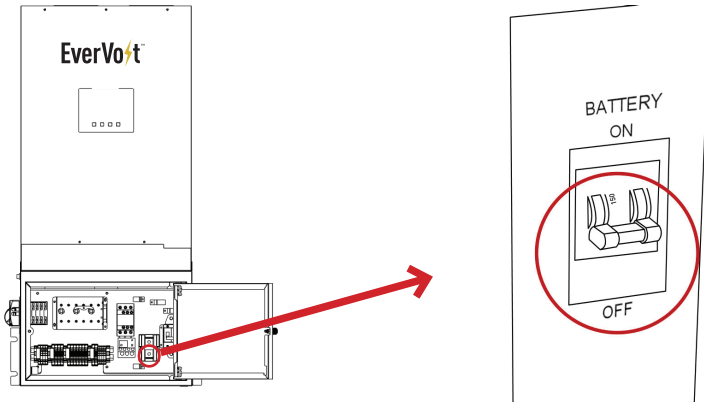

Step 3. Turn off both (interlocked) Load Input Selection breakers located on the left side, outside of the distribution box.

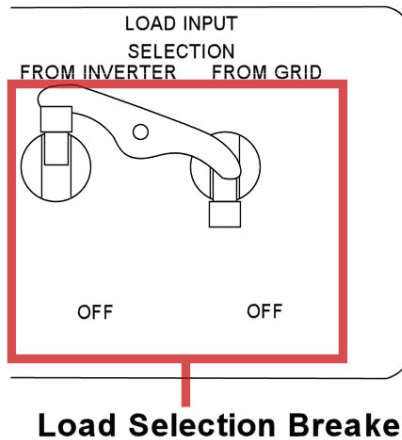

WARNING: Internal capacitors can remain charged for 5 minutes after disconnecting all above sources of power.

ASSEMBLY (CONTINUED)

6. BATTERY CONNECTION AND CHARGING INFORMATION

Note on DC Wiring and NEC

The maximum EverVolt DC charging current is 60 A for DC Coupled and 100A for AC Coupled systems.

Some electricians or installers may be unfamiliar with DC wiring in a residential setting. Make note of all relevant codes, which may include:

1. NEC 690.31(G) for DC PV circuits in buildings.
2. NEC 215.12(C)(2) for correct DC wiring coloring.
3. NEC TABLE 310.15(B)(16) for Allowable Ampacities of Insulated Conductors for Not More Than Three Current-Carrying Conductors in Raceway (conduit wiring over 12").
4. NEC TABLE 310.15(B)(17) for Allowable Ampacities of Insulated Conductors in Free Air (chassis wiring).



WARNING: To reduce the risk of injury, use proper cable size for battery's 150 A maximum current. It is very important for system safety and efficient operation to use the appropriate cable for battery connection.

Connect DC Power

Step 1. Make sure the inverter battery circuit breaker is OFF.

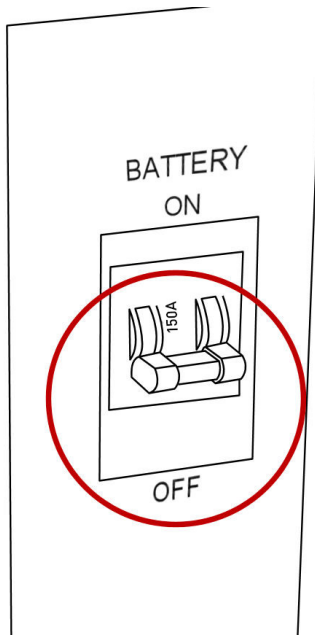

Step 2. Make sure the battery pack ON/OFF switch is OFF.

Note Press Rocker Switch here to turn OFF*

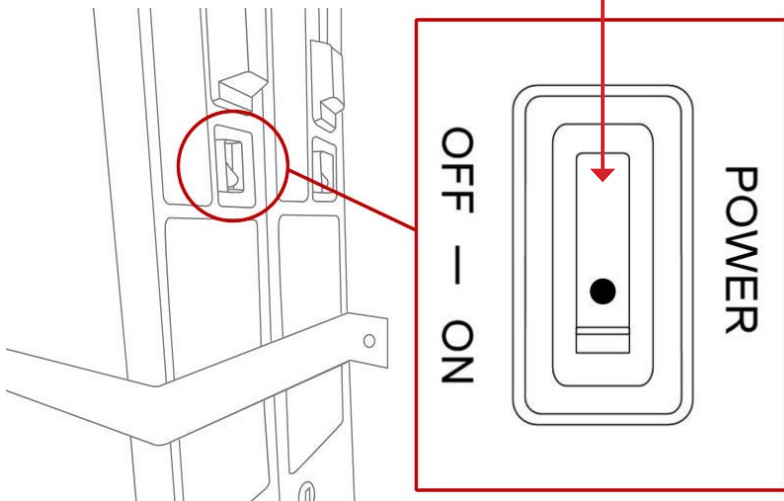



WARNING: Shock Hazard. Installation must be performed with care due to high battery current.

Inverter Battery Connection

Step 3. Strip 15mm(0.6in) of insulation from each battery cable and insert it into a ring lug. See Cable Length table above for connecting four batteries in one enclosure.

Crimp or bolt ring lugs to the battery cables.

CABLES FOR BATTERY CONNECTION

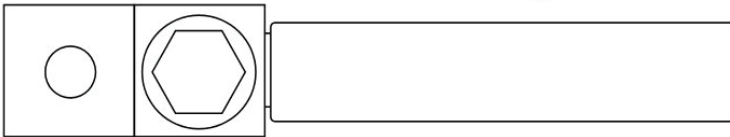

Connecting to Battery Terminals

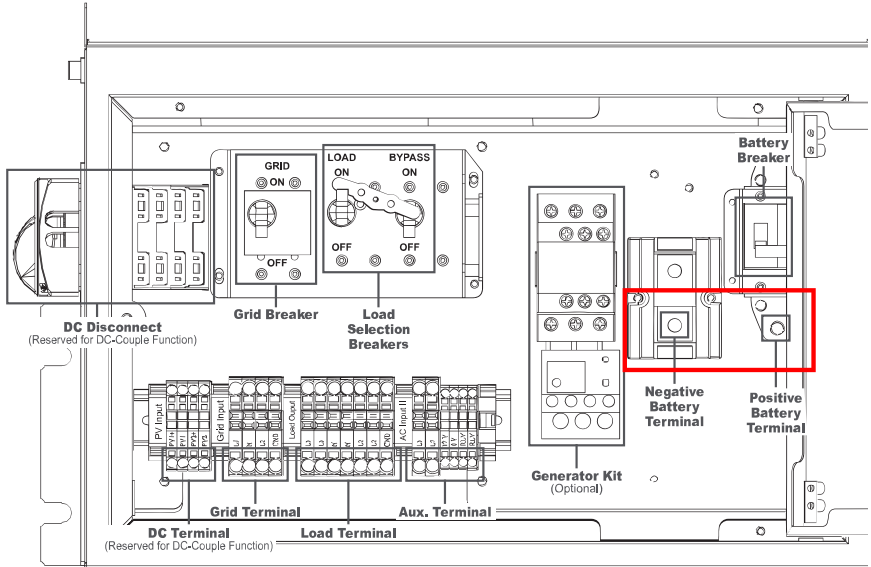

Connect the red cable to the positive (+) battery terminal and the black cable to the negative (-) battery terminal.

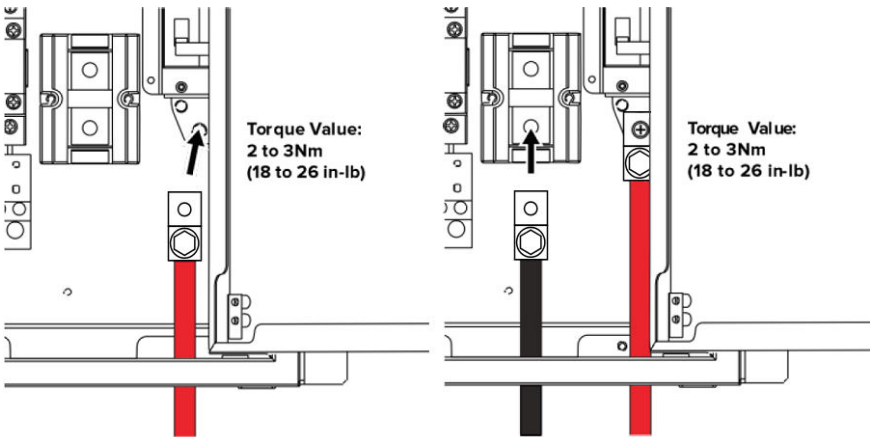



CAUTION: Before making the final connection or closing the breaker, make sure the connections have the correct polarity. Check polarity labels above.



CAUTION: Do NOT apply anti-oxidant substance on the terminals before terminals are connected tightly.



CAUTION: Do not place anything between the flat part of the inverter terminal and the ring terminal. Otherwise, overheating may occur.



WARNING: Check positive (+) and the negative (-) terminals. If EverVolt is connected with reversed polarity, unexpected reactions may occur such as damages, heat generation, smoke, fire, or explosion.



WARNING: Do not connect between the positive (+) and negative (-) terminals with a conductive material (e.g. wire, a cable, etc.). This may result in damages, heat generation, smoke, fire, or explosion.

Step 1. If not completed already from earlier, connect the other end of the battery connection cable to the large terminal block located in the battery enclosure. See image below.

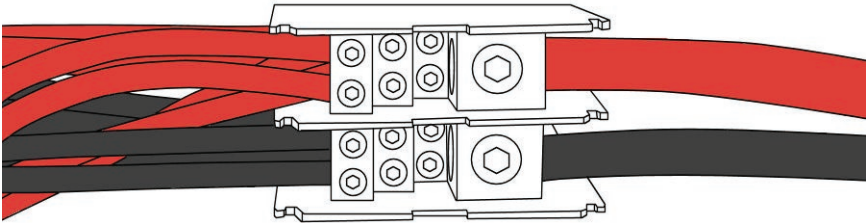

Step 2. Check that every battery has a red wire to the battery positive binding posts and to the positive terminal block. Check that every battery has a black wire to the battery negative binding posts and to the negative terminal block. Note, The larger/longer wires go to the top batteries. The smaller/shorter wires go to the middle and bottom batteries.

Connect Communication

1. Connect the supplied battery communication cable to the inverter master RS485 M connector.

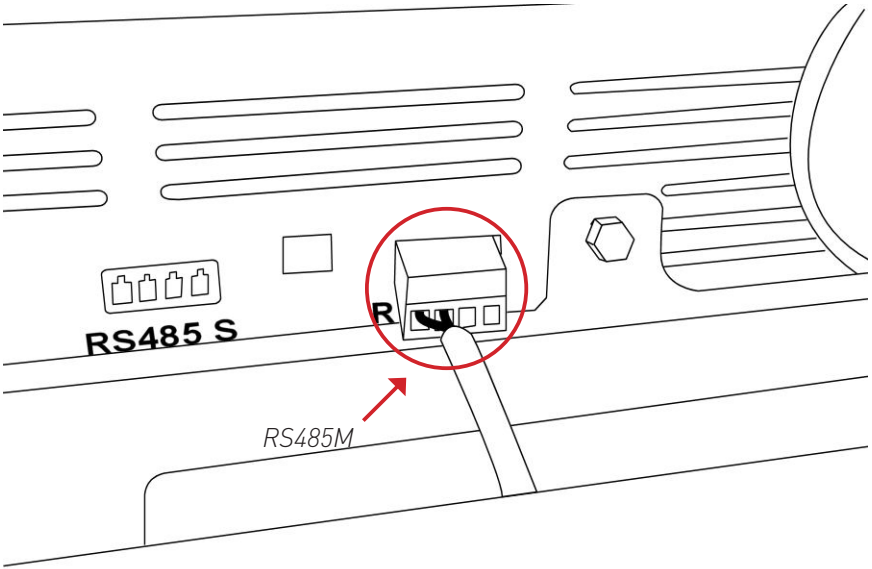

2. Route the other end of the communication cable from the inverter into battery enclosure per AHJ requirements.

3. Connect the other end of the supplied battery communication cable to upper/outer battery RJ-45 connector labeled "UP".

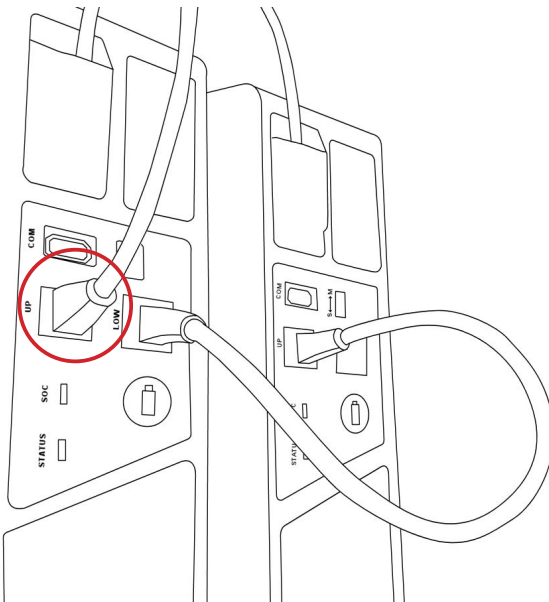

4. Verify if all four DIP switches on each battery module is set to the 'S - T OFF' position - slave (non-termination) configuration. This is the default setting.

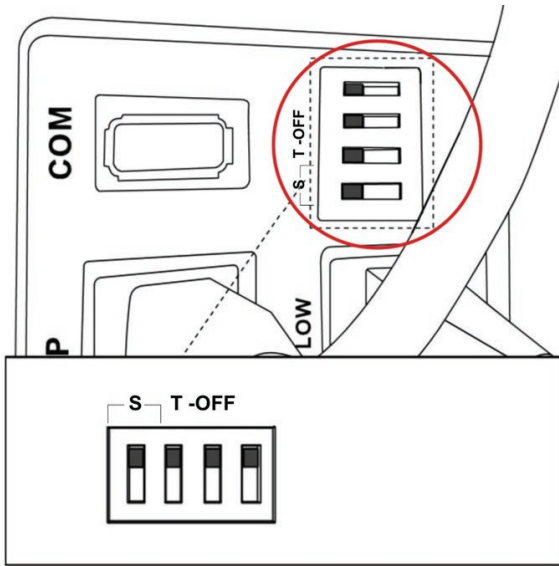

5. Connect up to eleven other communication cables starting with the first battery module, from the "LOW" to "UP" with the Ethernet RJ-45 cables. Up to 12 total modules may be string together.

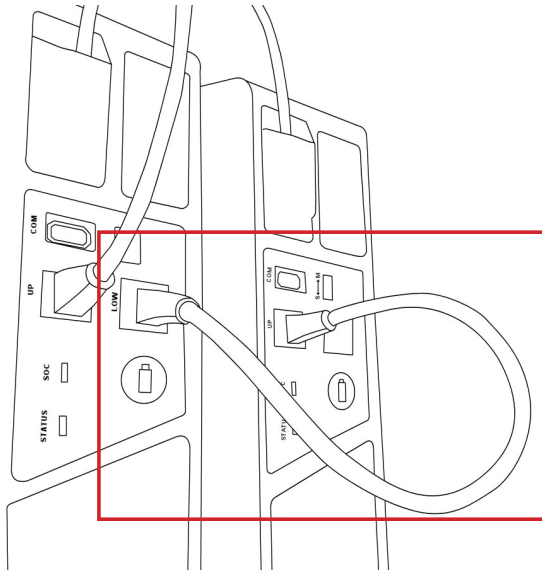

6. On all the battery modules, confirm that all the sliders are positioned to 'ON' for non-terminating batteries.

7. To read the battery status and state-of-charge (SOC) please refer to the following diagram and table shown below.

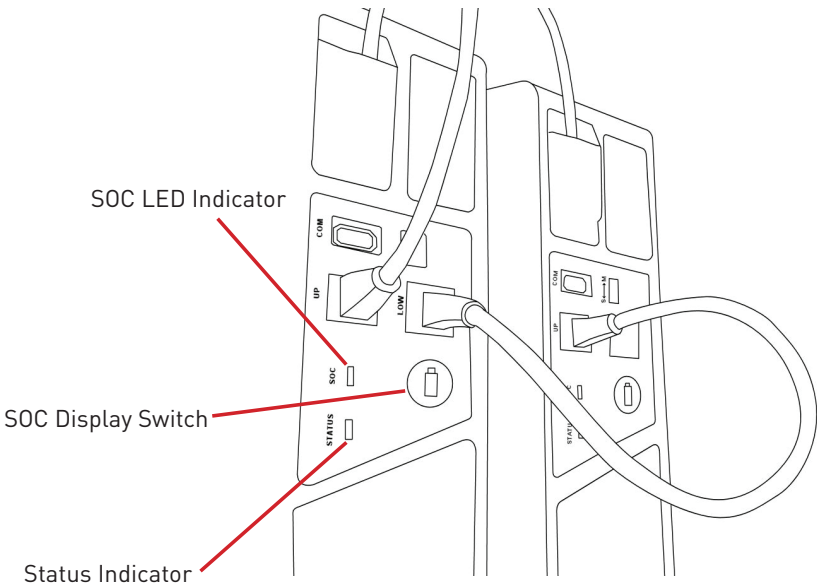

Battery Status Display (Dual Color Type)

Standby			Orange 3sec + Turn off 1sec
Ready			Green
Discharge			Blinking Green (2Hz)
Charge			Blinking Green (1Hz)
Full Charged			Green 3sec + Blinking Green (2Hz) 1sec
Warning			Red
Error			Blinking Red (2Hz) No recovery
Shutdown			Turn off

Battery SOC Display (Dual Color Type)

Standby			Orange 3sec + Turn off 1sec
Ready			Green
Discharge			Blinking Green (2Hz)
Charge			Blinking Green (1Hz)
Full Charged			Green 3sec + Blinking Green (2Hz) 1sec
Warning			Red
Error			Blinking Red (2Hz) No recovery
Shutdown			Turn off

ASSEMBLY (Continued)

7. INSTALLING THE SMARTHUB

IMPORTANT INFORMATION

The SmartHub is the hardware that connects EverVolt inverters to the cloud monitoring system. Please read all instructions before installing.

What You Need Before You Begin

- Internet service
- A computer with WiFi
- LAN MAC Address from SmartHub

FCC Compliance

This equipment has been tested and found to comply with the limits for a Class B digital device, pursuant to part 15 of the FCC Rules. These limits are designed to provide reasonable protection against harmful interference in a residential installation. This equipment generates, uses and can radiate radio frequency energy and, if not installed and used in accordance with the instructions, may cause harmful interference to radio communications. However, there is no guarantee that interference will not occur in a particular installation. If this equipment does cause harmful interference to radio or television reception, which can be determined by turning the equipment off and on, you are encouraged to try to correct the interference by one or more of the following measures:

- Reorient or relocate the receiving antenna.
- Increase the separation between the equipment and the receiver.
- Connect the equipment into an outlet on a circuit different from that to which the receiver is connected.
- Consult the dealer or an experienced radio/TV technician for help.

Changes or modifications not expressly approved by the party responsible for compliance may void the user's authority to operate the equipment.

PRODUCT OVERVIEW

What's in the Box

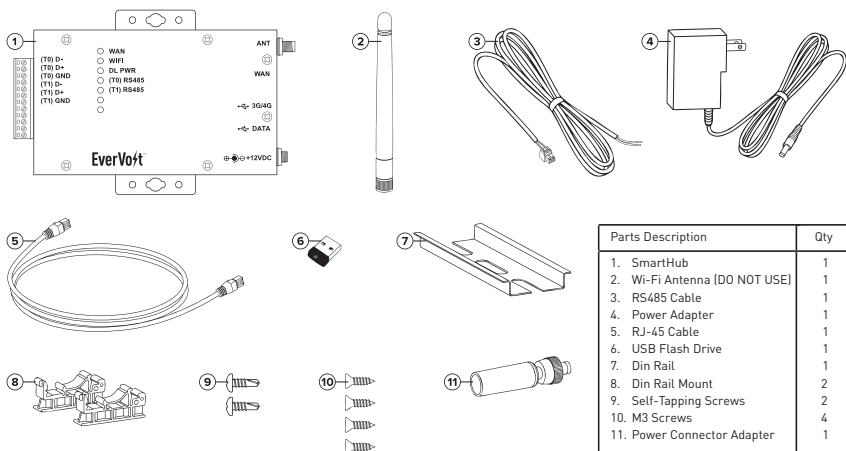

Parts Description	Qty
1. SmartHub	1
2. Wi-Fi Antenna [DO NOT USE]	1
3. RS485 Cable	1
4. Power Adapter	1
5. RJ-45 Cable	1
6. USB Flash Drive	1
7. Din Rail	1
8. Din Rail Mount	2
9. Self-Tapping Screws	2
10. M3 Screws	4
11. Power Connector Adapter	1

Connections

Port	Description
ANT	Attach the antenna for WiFi connection.
WAN	Connect the RJ-45 cable for a LAN connection [RECOMMENDED].
3G/4G	Connect a 3G/4G dongle for a cellular connection.
DATA	USB flash drive.
(T0) RS485	Connects to the inverter for two-way communication.
(T1) RS485	External RS485 sensor device reserved.
RESET	Factory default reset button. Insert a pin and hold for 30 seconds.

LED Definitions

LED	Activity	Description
WAN	● Solid	The LAN is connected.
	● Flashing	Data is being transmitted or received.
	○ Off	No connection established.
WIFI	● Solid	The WIFI is enabled.
	● Flashing	Data is being transmitted or received.
	○ Off	WIFI is disabled.
DL PWR	● Solid	Power is on.
	● Solid	System initialization.
	○ Off	There is no Power.
(T0) RS485	● Solid	A command is transmitted to the inverter(s).
	● Solid	A command is received from the inverter(s).
	○ Off	No commands are being transmitted or received.
(T1) RS485	● Solid	A command is transmitted to the device(s).
	● Solid	A command is received from the device(s).
	○ Off	No commands are being transmitted or received.

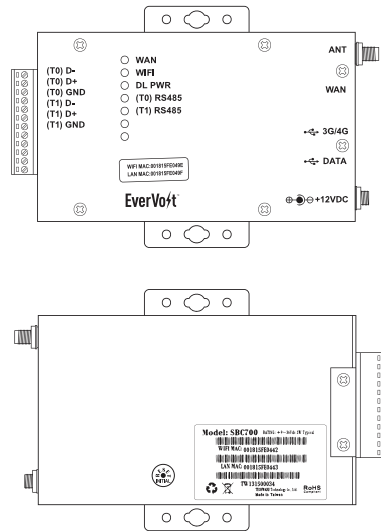

MOUNTING THE SMARTHUB

Location Requirements

- The SmartHub has an IP20 rated enclosure, which means it must be installed indoors.
- The RS485 cable is about 4' long, so the SmartHub should be mounted no more than 3 feet away from the inverter.
- The SmartHub requires an internet connection.
- The SmartHub can be mounted to the wall, or elsewhere with the use of the din rail and din rail mounts.

Step 1. If the SmartHub cannot be secured to a stud in the wall, insert drywall anchors prior to installation.

Step 2. Place the SmartHub against the wall and secure with two screws.

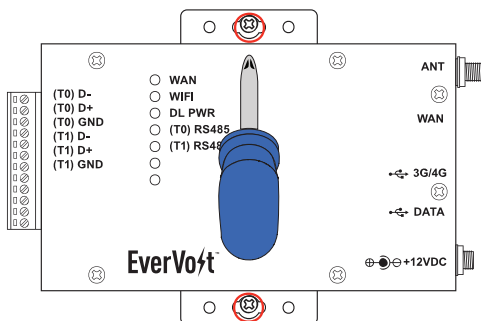

CONNECTING TO THE INVERTER

Step 1.

Insert the black wire of the RS485 cable into the first pin, (T0) D-, and the red wire into the second pin, (T0) D+, of the SmartHub. Then use a small flathead screwdriver to tighten the screws.

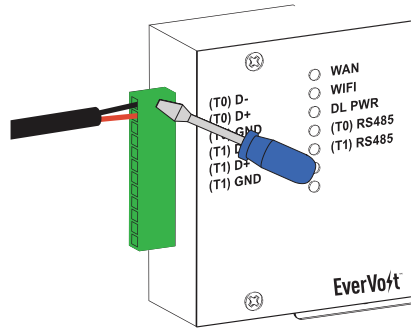

Step 2.

Open the door on the inverter and remove the dead front cover if needed (See inverter manual for instructions). Look inside and on the top bulkhead panel you should find a green socket (with 4 pins) labeled “RS485 S”.

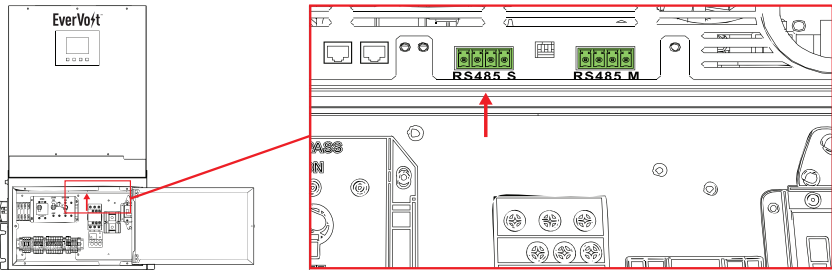

Step 3.

Connect the RS485 connector into the first two pins of the port labeled “RS485 S” on the inverter. Push the connector in hard so that it seats properly.

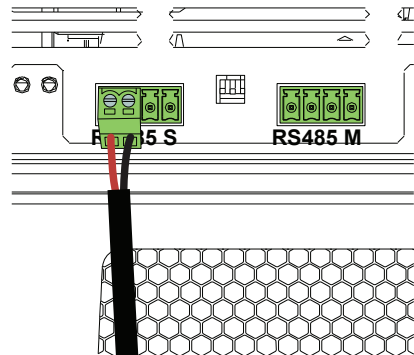

Step 4.

Insert the USB flash drive into the SmartHub

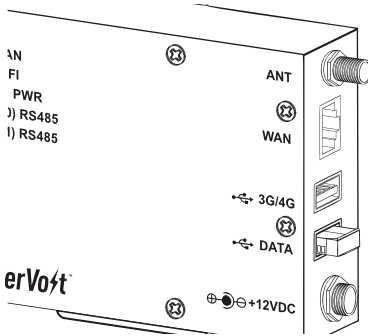

Step 5.

Internet Connection. There are three ways to establish an internet connection: LAN or PLC (Not included. Can be purchased separately if needed)

LAN Connection (PREFERRED)

Connect the ethernet cable (RJ45) to the SmartHub and to the network/router.

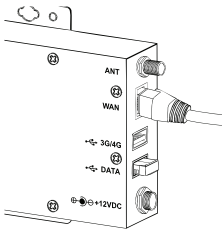

Step 6.

Connect the power adapter into the SmartHub and then to the power outlet.

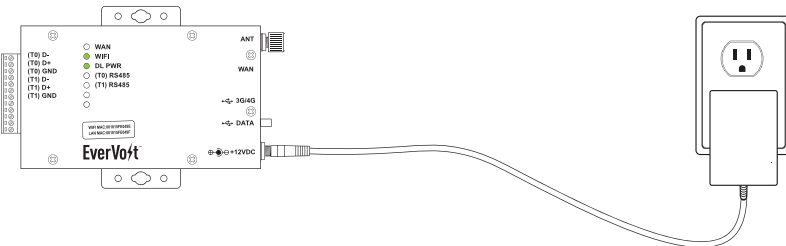

Note: The power outlet needs to be a backed up so the SmartHub will still work when there is no grid.

ASSEMBLY (Continued)

8. SMARTHUB MONITORING PORTAL

The monitoring portal can be accessed through a web browser, iOS app or android app. This manual uses a web browser for instructions.

Before creating an end-user account or registering a system, you will need the following information on hand:

- SmartHub LAN MAC address
- Installer login credentials
- Electronic copy of this manual (recommended)

Registering a new system

If you are an existing installer, please follow the following steps to create an account for your customer. If you are a new installer, please contact a Panasonic representative to create your installer account first.

Step 1.

Go to <http://evervoltportal.com/> and log into your account.

Step 2.

Go to www.evervoltportal.com directly. Or in the website menu, select [Profile Mgmt] / [Sites] to go to the [Sites list] page, then click the [Add] button.

Step 3.

Complete the all required fields, denoted by '*', then click [Save] button at the bottom of the page.

Note: To display this site on Google Maps, click the [Get GPS Location] button after filling in the address.

Step 4.

Go to www.evervoltportal.com directly. Or in the website menu, select [Profile Mgmt] / [Data Loggers] to go to the [Data Logger List] page, then click the [Add] button.

Step 5.

Select the site that was created in step 3 and complete all required fields, denoted by '*', then click the [Save].

Note: The SmartHub Name can be any nickname desired, however we recommend using the homeowner's First and Last Name for easy identification.

The [MAC] field is for the LAN MAC address that can be found on the SmartHub and must be entered in the following format, xx:xx:xx:xx:xx:xx, with colons between every two characters. For example, if the LAN MAC is 40D63C031E86, it should be entered as 40:D6:3C:03:1E:86.

Step 6.

Go to www.evervoltportal.com directly. Or in the website menu, select [Account Mgmt] / [Roles] to go to the [Roles list] page, then click the [Add] button.

Step 7.

Complete all fields on this page.

Note: The [Role name] can be anything you want, but we recommended the using the homeowner's name.

For [Viewable sites], select the site that was created in step 3. If the homeowner has more than one site, select all applicable sites.

For [Executable functions], the recommended selections are:

- Site Overview
- Hybrid Dashboard
- Energy Comparison

The homeowner will have the ability to change the operating mode via the smartphone app. The homeowner must be trained on what changes can be made, as incorrect or random changes can break a working installation.

Step 8.

Go to www.evervoltportal.com directly. Or in the website menu, select [Account Mgmt] / [Accounts] to go to the [Account list] page, then click the [Add] button.

Step 9.

Complete all required fields, denoted by '*', then click the [Save] button and you're done. Note: For [Role], select the role that was created in step 7.

Step 10.

Download the smartphone app at the iOS or Google Play Stores



9. SMARTHUB TECHNICAL SPECIFICATIONS

DEVICE CONNECTION	
Inverter Communication	RS485
Number of Inverters	Up to 3 EverVolt Inverters
Sensor Communication	RS485
DATA CONNECTION	
Ethernet (Preferred)	10/100 Base-T, RJ45
WiFi	2.4GHz 802.11 b/g/n (Detachable Antenna)
Cellular	USB 2.0 Type A for 3G/4G Dongle
Storage & Log	USB 2.0 Type A (8G Flash Drive Included)
POWER	
Power Supply Input	12Vdc, 2Adc
Power Consumption	9 to 36Vdc, 5W Typical
MECHANICAL DATA	
Dimensions (WxHxL)	99x28x147mm (3.9x1.1x5.8in)
Weight	0.17kg (0.37lb)
Installation Method	Wall-mount
Protection Rating	IP20 (Indoor Use Only)
Operating Temperature	-20 to 60°C (-4 to 140°F), 0 to 95% RH non-condensing
Storage Temperature	-20 to 80°C (-4 to 176°F), 0 to 95% RH non-condensing
POLICIES	
Compliances	FCC Part 15 Class B, EN300328 V2.11, EN61000-3-x, IEC 61000-4-x
Warranty	1 year

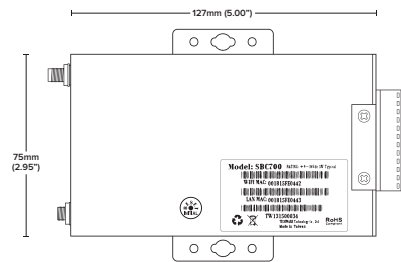
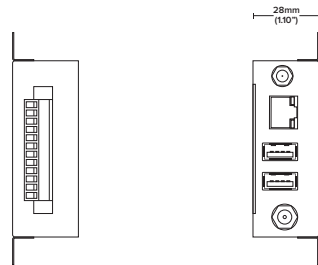
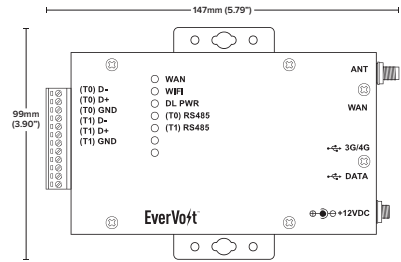

10. OPERATIONAL TESTING

To Startup Equipment:

- 1) Check that cables are properly connected,
- 2) DC Coupled EverVolt only: Turn on Solar by commissioning Solar PV Rapid Shutdown
- 3) Turn on:
 - a. "Main" Electrical Panel ESS breaker
 - b. Inverter PV Solar Switch
 - c. Inverter "Main AC Grid" Breaker
 - d. Battery Breaker (if not already on)
 - e. "LOAD INPUT" "FROM GRID" (connects Essential Loads directly to Grid)
- 4) Turn ON the Main Switch (located on the left side of the inverter)
- 5) If the inverter has PV (DC Coupled EverVolt Only) or GRID input, then the system will automatically start. If only battery starts the inverter, press the Enter button for seven seconds until two beeps are heard. The system will boot up in under sixty seconds.
- 6) After three minutes, check Load Output Voltage on the inverter POWER INFORMATION PAGE. See image below:
Test Limit L1-L2 232.8 - 247.2 VAC.

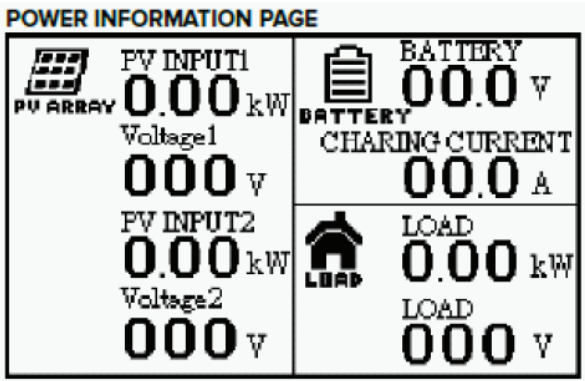

- 7) Turn on LOAD Breaker
- 8) Check PV, Battery and Load values from Power Information Page.
See Section 12, OPERATION AND DISPLAY PANEL for details on system operation.

OPERATIONAL TESTING (Continued)

SmartHub Activation:

Step 1: Verify system is turned on from the previous section "To Startup Equipment."

Step 2: make sure the SmartHub has three connections:

- a. Power, 5 VDC plug into the essential loads
- b. Communication cable, SmartHub RS485 to Inverter RS-485 S
- c. Ethernet cable from your internet source to the SmartHub, or wifi connection.

Step 3: Confirm indicators are blinking on SmartHub USB.

Step 4: Confirm Inverter Main Screen shows connection to SmartHub. See images below.



Indicates the connection the the SmartHub



11. FINISHING THE INSTALLATION

Battery Enclosure Cover

Install the battery enclosure cover by bolting the six mounting points down. Make sure each bolt has a star washer.

Inverter Access Door

Secure inverter access door using the thumb screw that is attached to the inverter door.

Part II: User Guide

Operation and Display Panel

To Install, Service or Disconnect (Shutdown) Equipment

Configuring the Hardware

Part III: References, Maintenance, Cleaning, Troubleshooting, & Warranty

Grid and Load Terminals

Generator (Optional)

Internet Connectivity Options

Maintenance & Cleaning

Service

Troubleshooting

Installing and Replacing Additional Batteries

Specifications

Grid Support Parameters (UL1741SA)



EverVolt Limited Warranty

12. OPERATION AND DISPLAY PANEL

Display Panel Overview

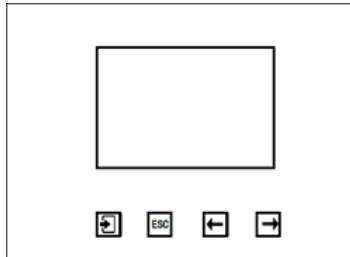
The display panel consists of four function keys and an LCD screen. The display panel will be used to manage and monitor the system.



ICON	FUNCTION	DESCRIPTION
	Enter	Confirm the selection in setting mode or enter setting mode.
ESC	Exit	Exits setting mode.
	Left	Go to previous page, move or decreasing all Number.
	Right	Go to next page; move; to increase all Number.

To Start Up Equipment (Overview): How to Turn the System On - Grid-tied

Step 1. Check that the cables are properly connected.

Step 2. Turn ON External Solar by disabling Solar PV Rapid Shutdown (if installed).

Step 3. Turn ON: (a) AC Grid Breaker, (b) Battery Breaker, (c) (DC Coupled only) PV Solar Switch.

Note: AC grid switch needs to be switched swiftly. If it does not catch, try again with greater speed.

Step 4. Turn on the Main switch (located on the left side of the inverter).

Step 5. If the inverter has multiple sources of power, the inverter will start automatically. If the battery is the only power source, then press the enter key for 7 seconds until two beeps are heard to start the inverter.

Step 6. Check Load AC output voltage: L-L 240 VAC / L-N 120 VAC.

Step 7. Turn on Load Breaker in the distribution box.

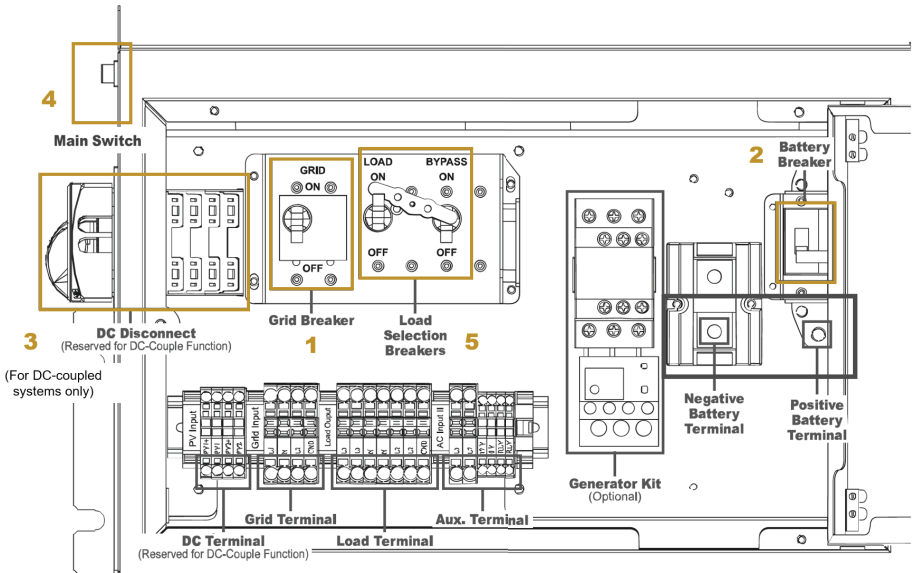

Starting the System -- Off-Grid (Black Start)

Note: the batteries will always start. The status indicator must be pressed to determine whether or not the batteries are in a state to be charged. Batteries must be above 0-10% state of charge (SoC) (blinking red) to be charged. If the batteries are blinking red, they may not charge on the inverter, you will then need an external power supply.

Note: the system will black start from PV automatically once there is enough solar power and battery SoC.

Note: the system will almost always manually “black start” the system from batteries but may not maintain (system shutdown right away) if the batteries SoC is not high enough. In that case, 1) reduce the essential load or 2) wait for either the grid voltage to return or for enough solar power and battery SoC to operate the essential loads again.

1. Check that cables are properly connected,
2. Turn ON External Solar by disabling Solar PV Rapid Shutdown (If installed)
3. Turn ON: (a) AC Grid Breaker, (b) Battery Breaker, (c) (DC Coupled only) PV Solar Switch
4. Turn ON the Main Switch (located on the left side of the inverter).
5. If the inverter has PV or GRID input, then the system will automatically start. If only battery starts the inverter, press the Enter button for five seconds until two beeps are heard. The system will boot up in under sixty seconds.
6. Check output voltage: L1-L2 240 VAC; L1-N 120 VAC and L2-N 120 VAC.
7. Turn ON LOAD Breaker.

To Install, Service or Disconnect (Shutdown) Equipment (Overview): How to Turn the System Off

Installation and service of this equipment includes risk of electric shock.

1. Initiate External Solar PV Rapid Shutdown (If installed)
2. Turn OFF the Main Switch located outside the inverter enclosure on the left side
3. Turn off the battery breaker located inside the Distribution Box behind the thumb screw latched access door
4. (DC Coupled only) Turn off the PV Switch located outside the inverter enclosure on the left side
5. Turn off all AC breakers located inside the Distribution Box behind the thumb screw latched access door
6. **Allow five minutes for all sources of supply to discharge**
7. Check that AC and DC voltages are at a safe level.
8. Access to the wiring requires opening the access door using the thumb screw and removing the four screws on the Inverter wire compartment cover.

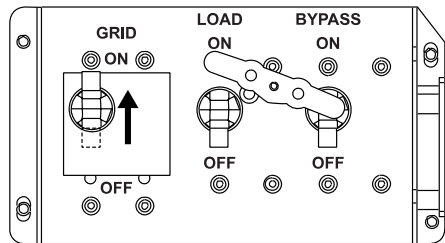
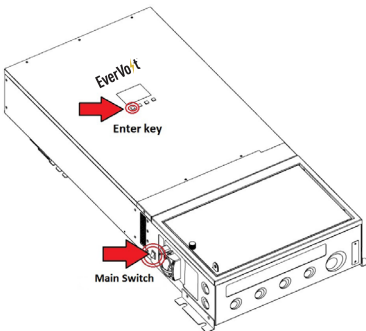
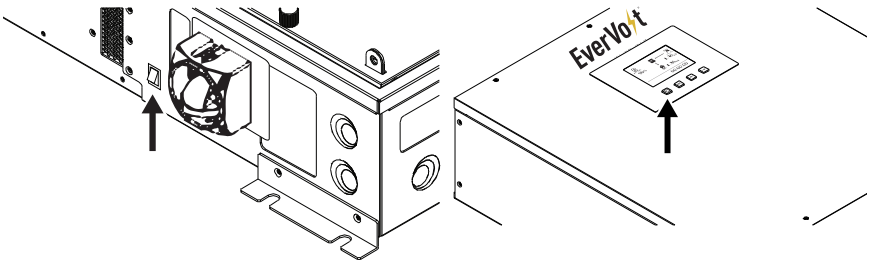

LCD Screen – Icons and Pages

The LCD screen will display three different pages: “Power Flows”, “Power Information” and “System Settings”. Use the <--> or <--> keys to toggle between the various pages. The screen will default to the “Power Flows” page.

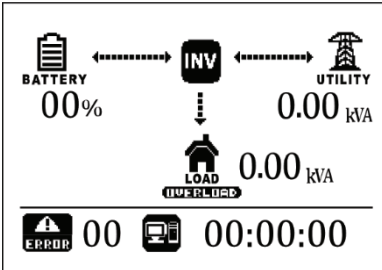

Power Flow Page w/Load Output

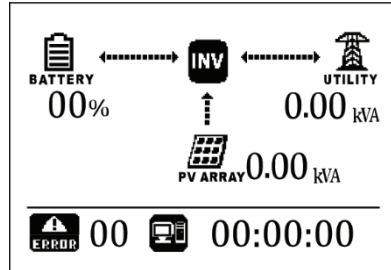



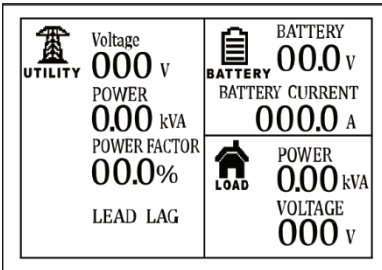



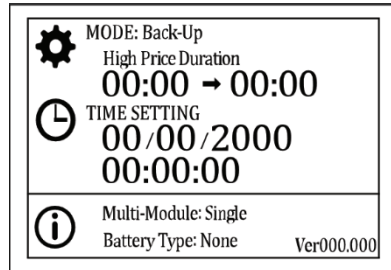



Power Flow Page w/AC-Couple Input



Power Information Page



System Settings Page

ICON	DESCRIPTION
 PV ARRAY	Represents the PV Array
 BATTERY	Represents the Battery Pack
 UTILITY	Represents the Utility
 LOAD	Represents the Load
 INV	Represents the Hybrid Inverter
 PowerHub	Indicates the Connection to a PowerHub
 ERROR 00	Indicates the Error and error codes
 OVERLOAD	Indicates an overload has occurred
 System Mode Setting	Represents the System Mode Setting
 System Time Setting	Represents the System Time Setting
 System Information	Represents the System Information

Operating Modes

The inverter has six modes of operation for backup, residential and time of use. Each mode assumes a set of conditions and prioritizes the consumption of PV, Grid or batteries accordingly to optimize energy flow.

DC Operation Mode: Backup (default)

PRESET MODES	PV USE PRIORITY			LOAD PRIORITY			CHARGE FROM		FEED GRID FROM		BATTERY RESERVE		
	Load	Batt.	Grid	PV	GRID	Batt.	PV	GRID	PV	Batt.	On-Grid	Off-Grid	
1. Back-Up (default)	2	1	3	1	2	3	Yes	Yes	Yes	No	10-60%	10%	
2. Residential	1	2	3	1	3	2	Yes	No	Yes	No	10-60%	10%	
3. Back-up Zero Grid Export	2	1	-	1	2	3	Yes	Yes	No	No	10-60%	10%	
4. Residential Zero Grid Export	1	2	-	1	3	2	Yes	No	No	No	10-60%	10%	
5. TOU w/o Batt. Feed-In	Low E. Cost	2	1	3	1	2	3	Yes	Yes	Yes	No	10-60%	10%
	High E. Cost	1	2	3	1	3	2	Yes	No	Yes	No	10-60%	10%
6. TOU w/ Batt. Feed-In	Low E. Cost	2	1	3	1	2	3	Yes	Yes	Yes	No	10-60%	10%
	High E. Cost*	1	3	2	1	3	2	Yes	No	Yes	Yes	10-60%	10%
7. String Inverter	1	-	2	1	2	-	-	-	Yes	-	-	-	
8. Remote Control	Remote controlled						Yes	Yes	Yes	Yes	10%	10%	

- * Grid Export "Feed-In Power" until "Battery Reserve Percent." is reached. PV is never curtailed.
 1) Grid export can be greater than "Feed-In Power" if there is enough PV production and battery and Essential Load cannot absorb it.
 2) If PV is low the battery will discharge to raise the Grid export to "Feed-In Power."

PRESET MODES	DESCRIPTION
1. Back-Up (default)	Keep the battery full and discharge only in cases of power outages
2. Residential	Self-consume from PV and battery first before the Grid
3. Back-up Zero Grid Export	Same as Back-up mode except power will not export back to the Grid
4. Residential Zero Grid Export	Same as Residential mode except power will not export back to the Grid
5. TOU w/o Batt. Feed-In	Low E. Cost: Operate as Back-up mode High E. Cost: Operate as Residential mode
6. TOU w/ Batt. Feed-In	Low E. Cost: Operate as Back-up mode High E. Cost*: Operate as Residential mode and Grid export constant power back to the Grid. PV is not curtailed to Grid.
7. String Inverter	Works as string inverter. Battery is disable.
8. Remote Control	Output and input power can be controlled through communication.

AC Operation Mode: Backup (default)

PRESET MODES	EXCESS PV**		LOAD PRIORITY		CHARGE FROM		FEED GRID FROM		BATTERY RESERVE		
	Batt.	Grid	Batt.	GRID	Excess PV	GRID	Excess PV	Batt.	On-Grid	Off-Grid	
1. Back-Up (default)	1	2	2	1	Yes	Yes	Yes	No	10-60%	10%	
2. Residential	1	2	1	2	Yes	No	Yes	No	10-60%	10%	
3. TOU w/o Batt. Feed-In	Low E. Cost	1	2	2	1	Yes	Yes	Yes	No	10-60%	10%
	High E. Cost	1	2	1	2	Yes	No	Yes	No	10-60%	10%
4. TOU w/ Batt. Feed-In	Low E. Cost	1	2	2	1	Yes	Yes	Yes	No	10-60%	10%
	High E. Cost*	2	1	1	2	Yes	No	Yes	Yes	10-60%	10%
5. Remote Control	Remote controlled				Yes	Yes	Yes	Yes	10%	10%	
6. Peak Shave	Peak Shave				Yes	Yes	Yes	Yes	10-60%	10%	

- * Grid Export "Feed-In Power" until "Battery Reserve Percent." is reached. PV is never curtailed.
 1) Grid export can be greater than "Feed-In Power" if there is enough PV production and battery and Essential Load cannot absorb it.
 2) If PV is low the battery will discharge to raise the Grid export to "Feed-In Power."

** Excess PV is when PV production is greater than Essential Load

PRESET MODES	DESCRIPTION
1. Back-Up (default)	Keep the battery full and discharge only in cases of power outages
2. Residential	Self-consume from PV and battery first before the Grid Note: Grid will charge the battery when battery SOC is lower than "Battery Reserve Percent."
3. TOU w/o Batt. Feed-In	Low E. Cost: Operate as Back-up mode High E. Cost: Operate as Residential mode
	Low E. Cost: Operate as Back-up mode High E. Cost*: Operate as Residential mode and Grid export constant power back to the Grid. PV is not curtailed to Grid.
5. Remote Control	Output and input power can be controlled through communication
6. Peak Shave	Output will supply power when grid power is over agreement demand

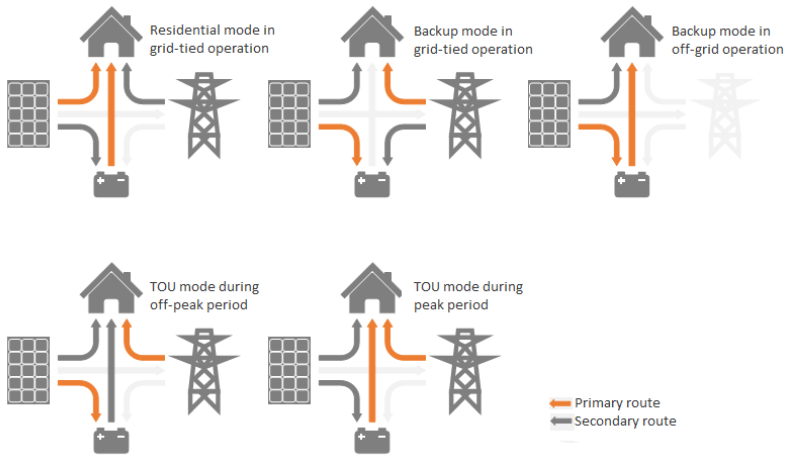

System Settings

In the display panel, use <--> or <--> keys to get to the System Setting Page. System settings are divided into two parts, "Mode" and "Time Setting." Click to enter the System Setting Page and click ESC to exit

Step 1. In the System Setting Page, press twice to enter the page to select Mode.

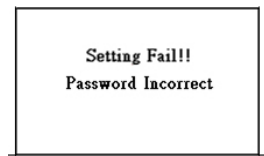
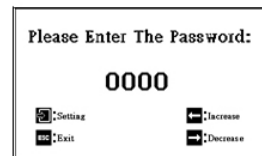
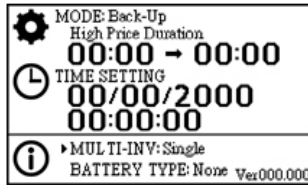

Step 2. Use the <-- or --> keys to toggle between modes and to select it.

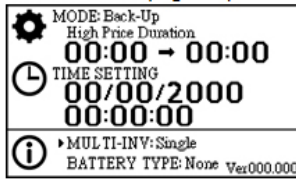

Step 3. For modes “Time of Use” or “Time of Use with Battery Feed-in (Grid Export)”, enter the start/end times for “High Price Duration” in 24-hour notation. Use the <-- or --> keys to change the number, and then to set it. Once the value for the last time field is set, press the key.

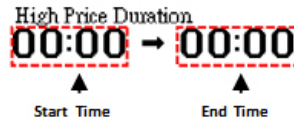
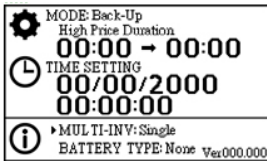

Step 4. Settings are being updated. Please wait for next message.

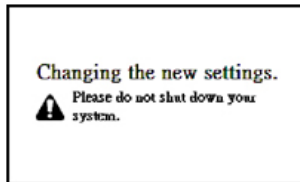

Step 5. Press any key and manually restart with the main switch located on the left side of the inverter. If you get a setting fail message, press any key. Please re-turn on the main switch and re-setting the mode again. If still get a setting fail message, please contact Panasonic.

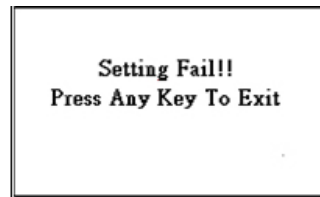
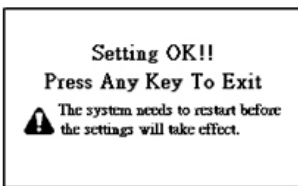

B. Setting System Time

In the System Setting Page, press --> to select "Time Setting", and then press ↵. The date format is DD/MM/YYYY, and the time format is hh:mm:ss. Use the ↵ key to toggle between the date fields and the <-- or --> keys to select the values. Once the value for the last date field is set, press the ↵ key. You will then be prompted to enter the password.

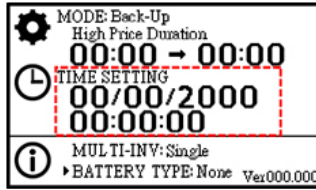

YEAR RANGE	MONTH RANGE	DAY RANGE	HOUR RANGE	MINUTE RANGE	SECOND RANGE
2010 to 2100	1 to 12	1 to 31	0 to 23	0 to 59	0 to 59

C. Setting Battery Type

Step 1. In the System Setting Page, press ↵ to enter the page and select ⓘ to select Battery Type.

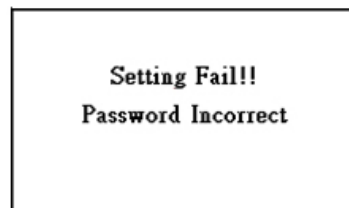
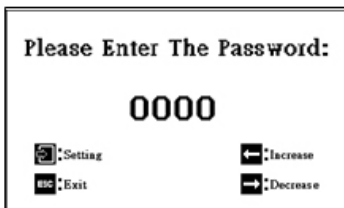
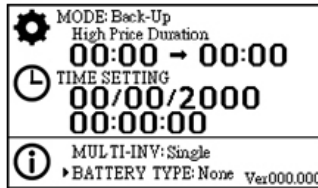

Step 2. Use the <-- or --> keys to select Battery Type and to select it.

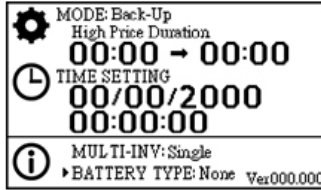

Step 3. Use the <-- or --> keys to toggle between battery types and select Panasonic and press to select it. Press any key and manually restart with the main switch located on the left side of the inverter.

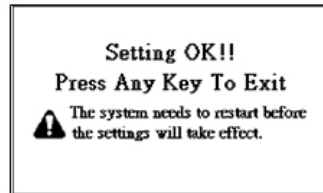
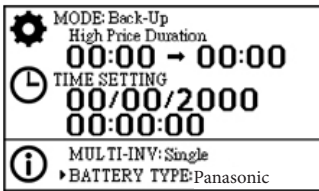

Change battery type to Panasonic

Warning and Fault Definition

On the Power Flows Page, the ERROR icon will flash when an error has occurred. Listed below are the error codes and their solutions.

CODE	FAULT EVENT	ALARM	ICON	SOLUTION
01	DC bus voltage exceeds the upper threshold	None	ERROR	<ol style="list-style-type: none"> 1. Turn off the inverter using the main switch. 2. Make sure PV voltage is below 500Vdc. 3. When the Grid is absent, disconnect any grid-tied inverter from to the load terminal. 4. Turn the inverter on. If the error remains, contact your installer.
02	Arc occurs on PV	None	ERROR	<ol style="list-style-type: none"> 1. Turn the inverter off and then back on using the main switch. 2. If the error remains, contact your installer.
03	DC bus voltage falls below the lower threshold	None	ERROR	<ol style="list-style-type: none"> 1. Turn off the inverter using the main switch. 2. Measure the voltage at the battery and at the cabling above and below the battery disconnect to make sure voltage is within 44 to 58Vdc. 3. If the voltages are in range, check if the battery went into protection mode. 4. Turn the inverter on. If the error remains, contact your installer.
04	Parallel setting is not correct	None	ERROR	<ol style="list-style-type: none"> 1. Check the parallel setting and mode setting. 2. Check the communication cable between stacking system. 3. Turn the inverter off and then back on using the main switch. 4. If the error remains, contact your installer.
05	Battery discharging current exceeds the upper threshold	On: 1s Off: 1s	ERROR	<ol style="list-style-type: none"> 1. Turn off the inverter using the main switch. 2. Make sure the Grid and Load terminals are wired properly.
06	Battery charging current exceeds the upper threshold	On: 1s Off: 1s	ERROR	<ol style="list-style-type: none"> 3. Turn the inverter on. If the error remains, contact your installer.
07	Short circuit on PV1 input	None	ERROR	<ol style="list-style-type: none"> 1. Turn the inverter off and then back on using the main switch.
08	Short circuit on PV2 input	None	ERROR	<ol style="list-style-type: none"> 2. If the error remains, have your installer check the PV array for short circuits.
09	Short circuit on AC output	Continuous	ERROR	<ol style="list-style-type: none"> 1. Turn off the inverter using the main switch. 2. Turn off the load breaker. 3. Make sure L1, L2 and N on the load circuit are not shorted. 4. Turn the inverter on. If the error remains, contact your installer.
10	Leakage current CT fault	None	ERROR	<ol style="list-style-type: none"> 1. Turn off the inverter using the main switch. 2. Turn the load breaker off. 3. On the essential loads, check all appliances are not leaking current. If so, unplug the appliance safely. 4. Turn the inverter on. If the error remains, turn the Grid and PV breakers off. <ul style="list-style-type: none"> • On the PV side, measure and make sure the impedance of PV1+, PV1-, PV2+ and PV2- to ground and to each other should be an open circuit. • On the Grid side, measure and make sure the impedance of L1, L2 and N relative to ground and to each other should be an open circuit. 5. Turn the inverter off, then back on. If the error remains, contact your installer.
11	DC/DC Current Sensor fault	None	ERROR	<ol style="list-style-type: none"> 1. Turn the inverter off and then back on using the main switch. 2. If the error remains, contact your installer.
14	EEPROM read failure	None	ERROR	
15	Communication with main & secondary controllers are interrupted	None	ERROR	
16	Over temperature fault	On: 1s Off: 1s	ERROR	<ol style="list-style-type: none"> 1. The internal temperature is too high. 2. Make sure the inverter is properly ventilated by removing any obstruction around the vents. 3. Make sure the fans are working. 4. Turn off the inverter using the main switch and let it cool down for 10 minutes before turning it back on. 5. If the error remains, contact your installer.
17	PV input voltage exceeds the upper threshold	None	ERROR	<ol style="list-style-type: none"> 1. If the PV V_{OC} is higher than 500VDC, contact your installer. 2. If the PV V_{OC} is less than 500VDC, turn off the inverter and restart it after 5 seconds. If the error remains, contact your installer.
18	Over power protection	On: 0.25s Off: 0.75s	ERROR	<ol style="list-style-type: none"> 1. The Grid/ Load power has been over 7.6kW for 30s. 2. Turn off the inverter using the main switch. 3. Make sure the load is lower than 5kW 4. Turn the inverter on using the main switch. 5. If the error remains, contact your installer.
19	PV insulation resistance is too low	None	ERROR	<ol style="list-style-type: none"> 1. Turn off the PV breaker. 2. Check if the impedance between positive and negative poles to the ground is greater than 1MΩ. 3. If the impedance is lower than 1MΩ, contact your installer.
20	Battery charging voltage is too high	None	ERROR	<ol style="list-style-type: none"> 1. Turn off the inverter using the main switch. 2. Make sure the connection between battery and inverter has firm and solid contact. 3. Make sure the battery voltage is within manufacturer's specifications. 4. Turn the inverter on. If the error remains, contact your installer.
21	Fan fault	None	ERROR	<ol style="list-style-type: none"> 1. Turn the inverter off and then back on using the main switch. 2. Make sure the fans are working. If the error remains, contact your installer.
CODE	FAULT EVENT	ALARM	ICON	SOLUTION
22	Overload	On: 0.25s Off: 0.75s	ERROR OVERLOAD	<ol style="list-style-type: none"> 1. The load exceeds available output power. This error will disappear once load is in a acceptable range. 2. If the overload occurs for more than 40 seconds, the inverter will automatically restart. The inverter only allows 3 overload restarts within 5-minute intervals. 3. If the inverter is constantly restarting due to overload, you should decrease your load.
23	PV input over power	None	ERROR	<ol style="list-style-type: none"> 1. Make sure your PV arrays does not exceed 6.5KW. 2. Turn the inverter off and then back on using the main switch. 3. If the error remains, contact your installer.
24	Battery type is wrong	None	ERROR	<ol style="list-style-type: none"> 1. Set the correct battery type according to the battery installed to the system. 2. Turn the inverter off and then back on using the main switch. 3. If the error remains, contact your installer.

25	RCMU test fault	None	ERROR	1. Turn the inverter off and then back on using the main switch. 2. If the error remains, contact your installer.
26	Model setting fault	None	ERROR	1. Turn the inverter off and then back on using the main switch. 2. If the error remains, contact your installer.
27	Battery voltage drop	None	ERROR	1. Battery voltage drop below 30V. 2. Check the battery BMS errors and the wiring. 3. Turn the inverter off and then back on using the main switch. 4. If the error remains, contact your installer.
28	Battery wake up fault	None	ERROR	1. The system try to wake up the battery but failed. 2. Check the battery voltage. 3. Check the battery breaker and wiring. 4. Check the battery communication cable. 5. Turn on the system. 6. If the error remains, contact your installer.

On the Power Flows Page, the icon will flash when there is a warning. Listed below are the warning codes and their solutions.

CODE	WARNING	ICON	SOLUTION
53	Stacking Canbus communication error		1. Turn the inverter off using the main switch and check the canbus communication cables. 2. Turn the inverter on. If error remains, contact your installer.
54	Power island		1. Turn the inverter off and then back on using the main switch.
55	Grid is disconnected		2. The inverter will wait for 5 minutes before attempting to connect to the Grid. 3. If the error remains, contact your installer.
56	Grid voltage exceeds the upper threshold		
57	Grid voltage falls below the lower threshold		
58	Grid frequency exceeds the upper threshold		
59	Grid frequency falls below the lower threshold		
61	Battery voltage is too low		1. The battery voltage is less than 44V (lead-acid) or the SOC is lower than 10% (Lithium). Battery backup function will be turned off and the system output can only work with the Grid. 2. Wait for the PV or Grid to charge up the battery. The error code will change to 62 once the battery voltage is above 44V or the SOC is above 10%.
62	Low battery SOC level		1. The battery voltage is less than 47.1V (lead-acid) or the SOC is less than 40% (Lithium). 2. Wait for the PV or Grid to charge up the battery. The error code will clear and battery backup function will be enabled once the SOC is above 60%.
63	Battery is not detected		1. Turn the inverter off using the main switch. 2. Check battery connection for any loose wiring. 3. Turn the inverter on. If error message remains, contact your installer.
64	Inverter output OCP		1. Inverter output current exceeds the upper threshold. 2. Turn the inverter off and then back on using the main switch. 3. If error remains, contact your installer.
65	RS485 communication error		Alarm – On: 1s, Off: 1s 1. Turn the inverter off using the main switch and check all communication wires. 2. Turn the inverter on. If error remains, contact your installer.
66	Output derated		1. When system temperature is too high, the output power has been derated. 2. Lower the load or lower the environmental temperature. Notes: System output lowered to 80% when the system temperature is higher than 80°C. System output lowered to 60% when the system temperature is higher than 85°C. System output restored to 100% when the system temperature is lower than 70°C.
67	Off Grid Operation		This system receives an off grid command and is operating in off grid mode.
68	Peak Shaving Over Power		The grid power is over the peak shaving settings
69	Generator mode		No grid and get into generator mode.
70	Generator Reverse Irritation		Power go back to the generator. The system turn off generator to protect the generator.
71	Battery voltage Inconsistent		Battery voltage is not consistent with the BMS value.

13. CONFIGURING THE HARDWARE

Connecting to the Hardware

Step 1: Remove the eleven screws on the bottom sides of the inverter. There are two PCB boards,

1. Left side: Communication board is used for parallel and display communication.
2. Right side: External RS485 board is used for primary RS485 (communicated with battery) and secondary RS485 (communicated with application software & HEMS unit).

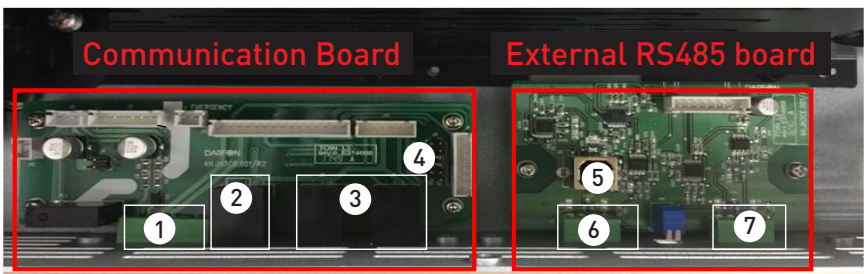
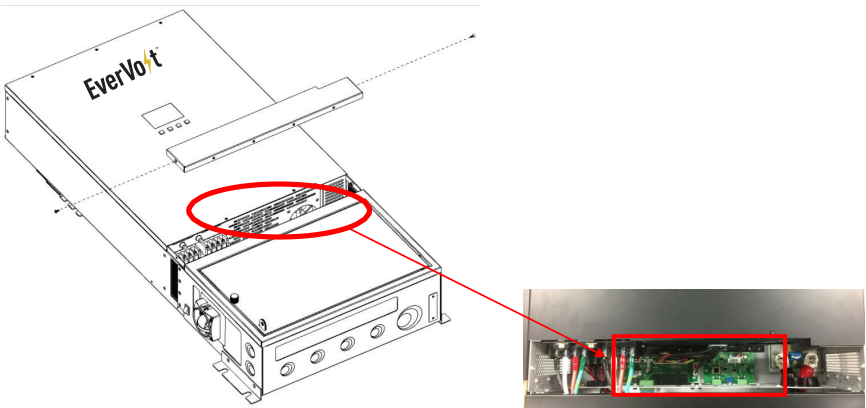

	FUNCTION DESCRIPTION	REMARKS
1.	AUX. PORT	FOR GENERATION FUNCTION
2.	EXTERNAL DISPLAY PORT	FOR H100/H200 CABINET USE
3.	PARALLELED COMMUNICATION PORT	FOR INVERTER PARALLELED FUNCTION
4.	BOOT-LOAD AND COMMUNICATION JUMPER	FIRMWARE UPDATE ONLY
5.	USB PORT	INSTALLER USE PARAMETER CHANGES
6.	RS-485 SECONDARY	FOR DATA LOGGER USE/REMOTE CONTROL USE
7.	RS-485 PRIMARY	FOR BMS USE

Step 2: Please use the USB wires (Type-A <->Type-B) and plug in the USB Type-B connector to the USB port, another side (Type A) connecting to the computer.



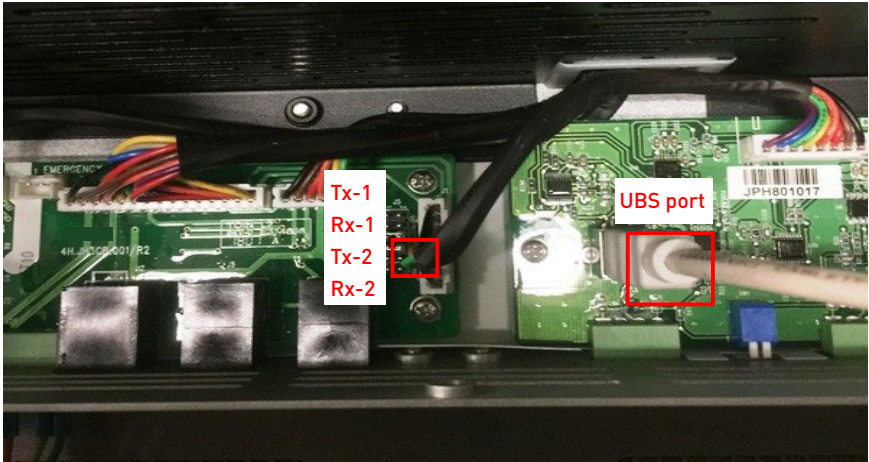

Step 3: Please make sure the jumper pins on Tx-2 and Rx-2.

Step 4: The inverter needs to connect the power, either choices PV, Battery or Grid. Then use the application software setting your parameters.

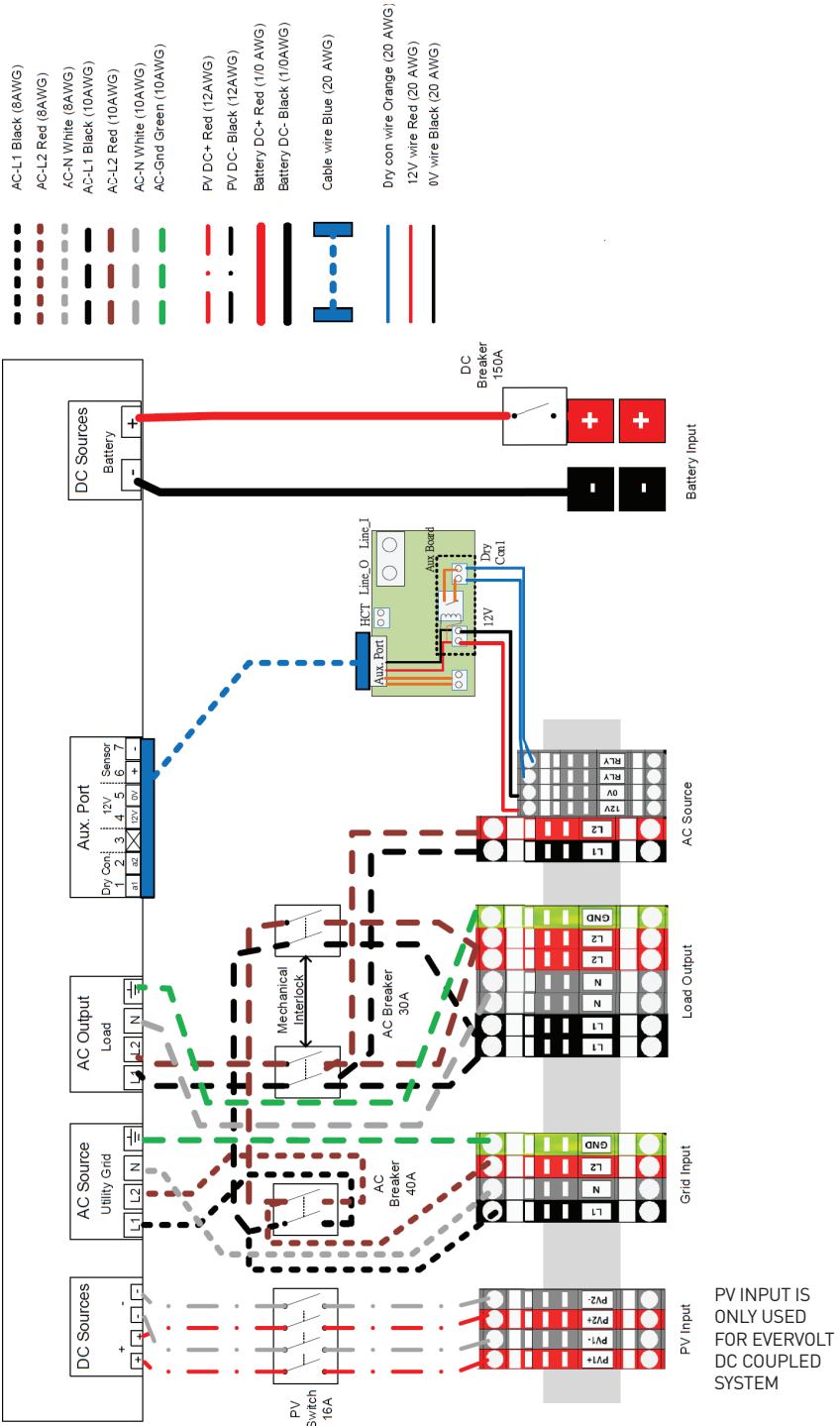

14. GRID AND LOAD TERMINALS

240V/120V 60HZ SPLIT-PHASE SYSTEM (USA)

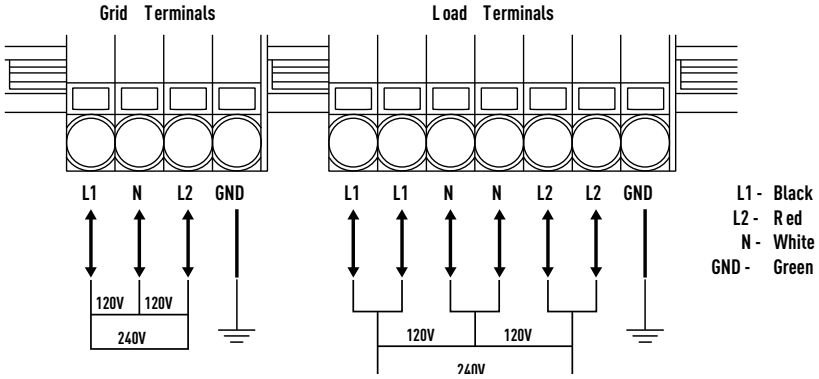

15. MAINTENANCE & CLEANING

Perform the following maintenance annually or more often if the site requires it to ensure proper operation.

- Clean this inverter, during the cool time of the day, whenever it is visibly dirty.
- Before cleaning this inverter, make sure to turn off all the breakers (AC, battery and PV).
- Ensure all connectors of this inverter are clean.
- Periodically inspect the system to make sure that all wires and supports are securely fastened in place.

16. SERVICE



CAUTION: There are no user-replaceable parts inside the inverter. Do not attempt to service the unit yourself.

Wiring Diagram

The following diagram shows how the distribution box is electrically connected to the hybrid inverter. When replacing breakers or wires on the distribution box the following rules must be observed: (1) All AC breakers must be sized for 40A or less, and (2) All wiring must be sized for 40A or more.

NOTES: EverVolt has L1 and L2 connections for two AC input sources, although it can only accept one source at a time. The inverter has separate neutral connections for grid input, generator input and output. These are electrically common. The distribution box is both an input conduit box and an AC load center. The distribution box also contains maintenance transfer switches (load selection breaker). Maintenance transfer switching assemblies allows for the inverter to be taken offline if necessary without shutting the entire system down. These assemblies include an interlock mechanism that isolates the AC Lines from each other.



WARNING: Exposed hazardous voltage, during servicing or for emergency procedures to avoid hazardous voltage, turn off the “BATTERY DISCONNECT” and all AC breakers located inside the Distribution Box behind the thumb screw latched access door. To enable Lock-Out-Tag-Out per the Standard for Electrical Safety in the Workplace, NFPA 70E, and the Standard for Workplace Electrical Safety, CSA Z462 put a lock on the lockable access door.



WARNING: These servicing instructions are for use by qualified personnel only. To reduce the risk of electric shock, do not perform any servicing other than that specified in the operating instructions unless you are qualified to do so.

Accessing Wiring

Initiate a Rapid Shutdown and allow the DC voltage to drop to a safe level. Power down inverter and disconnect all wiring sources of AC and DC power.

17. INSTALLING AND REPLACING ADDITIONAL BATTERIES

Decommissioning at End of Life (EOL)

Battery SOH is reported in the EverVolt dashboard monitoring software. When the SOH is below the level listed in Detail Battery Module Specification the batteries are at EOL and should be replaced.



WARNING: Risk of electrocution! Do not disconnect any battery leads while the system is energized.



WARNING: Risk of electric shock. Risk of fire. Do not attempt to repair the battery(ies); it contains no user-serviceable parts. Tampering with or opening the battery(ies) will void the warranty. If the battery(ies) fails, contact Panasonic Customer Support for assistance at panasonicevervoltsupport@us.panasonic.com.

Adding and Replacing the Batteries



WARNING: Battery voltage heads to be within +/- 1V.

Prior to uninstalling a battery(ies), Customer Service must ensure that the state of charge (SoC) matches the SoC as given in Replacement Battery Information sheet in the box with the Replacement Battery(ies). This is accomplished by charging or discharging the battery until SoC on Dashboard matches the SoC on the Replacement Battery Information sheet. The battery will continue to operate until it reaches the desired SoC. Since the rate at which the battery can charge or discharge is governed by the loads, it can take several hours for the desired SoC to be reached and for the Battery to be ready for replacement. Customer service will set the system to the backup power program at the desired SoC 24-48 hours in advance of the physical removal of the Battery. This is to ensure that sufficient time has passed to allow the Battery(ies) to be at the correct SoC when customer service personnel arrives to replace the battery(ies).

- Once the Battery(ies) SoC is confirmed to be at the same SoC as the Replacement Battery(ies).
- Verify that all power is removed from the system before attempting to remove the Battery(ies) by initiating Rapid Shutdown and allow the DC voltage to drop to a safe level power down Inverter and disconnect wiring sources of AC and DC power.



WARNING: Take care when lifting the Battery. The Battery is heavy and may require a lifting tool to initially lift the battery high enough to get a good hold on it.

- Once the battery(ies) have been safely removed, please follow the steps listed in Section 5 to begin the installation process of the new battery(ies).



WARNING: Proper disposal of lithium-ion battery(ies) is required. Contact the battery manufacturer for further instruction on how to dispose of batteries.

Within every city, the Authority Having Jurisdiction (AHJ) local ordinance that is responsible for the disposal of hazardous waste will need to be contacted. The customer cannot keep the old lithium-ion battery(ies) because they are dangerous and considered hazardous waste.

Example Diagram of Stacking the DC Systems

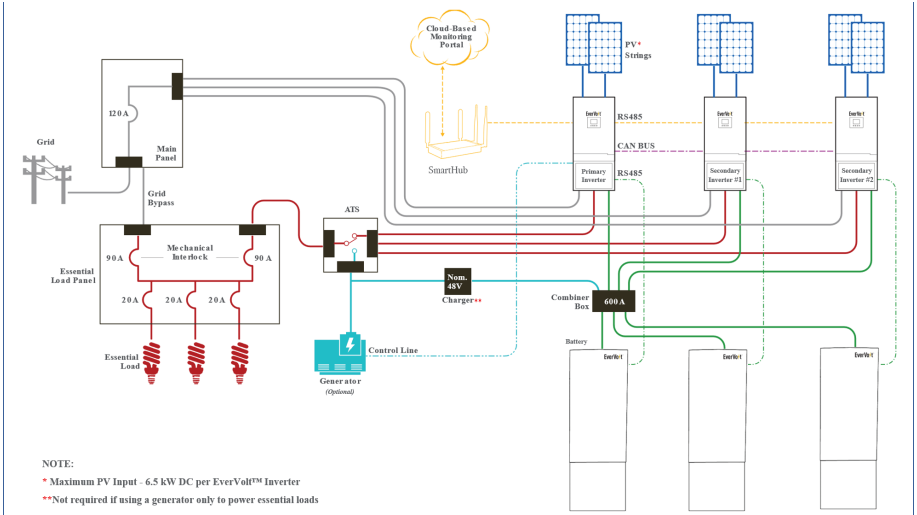

To make the battery parallel connection, use either:



Polaris Connectors from your local electrical store or Bay Marine BusBar - Dual 4-Post Power Distribution Block - 3/8" & 3/8" (available on Amazon).



18. SPECIFICATIONS

DC-Coupled System

SOLAR DC INPUT	
Maximum Power	3250 W per MPPT channel / 6500 W total
Operation / MPPT Voltage Range	120 to 500VDC / 250 to 430VDC
Minimum Start Voltage	150VDC
Maximum Input Current	13A / 13A (two string input)
AC OUTPUT TO LOAD	
Output Power (Continuous) @ 25°C	5500W
Overload 40/5/1sec @ 25°C	5500/6500/7500W
Rated Output Current	23 A (@120V and 240 V)
Output Frequency (Selectable)	50/60Hz
Output Voltage	L-N: 120V ± 3%; L-L: 240V ± 3%
Total harmonic distortion (THD) at rated power	< 5%
Power Factor	>99%
AC INPUT FROM GRID (GRID SUPPORT)	
AC Input Voltage Limits (Bypass)	L-L: 180 to 280V (240 V nominal)
Automatic Transfer Relay Rating / Typical Transfer Time	48A / 20ms
AC Input Frequency Range (Bypass)	55 to 65 Hz
AC OUTPUT TO GRID	
Output Power (Continuous) @ 25°C	5000W
Grid Sell Current Range (Depending On Operation Mode)	0 to 24A (@Low Grid, 211V)
Grid Sell Voltage Range	L-L: 211 to 264V ± 3.0V
Grid Sell Frequency Range	59.4 to 60.4Hz ± 0.05Hz
EFFICIENCY	
Peak PV to Grid	96%
CEC weighted PV to Grid	95.5%

DC BATTERY CHARGER	
Maximum Charge Current	60A
Output Voltage Range	43 to 58V (48V Nominal)
Compatible Battery Types	Li-ion
Battery Bank Range	10 to 33 kWh
GENERAL SPECIFICATIONS	
Product weight	335 to 1000 lbs
Product dimensions (H x W x D)	24.2" x 42.5" x 10" (Per enclosure)
IP degree of protection	NEMA Type 1/IP20
Temperature	Operating: -20 to 55°C (0°C Min Startup Temp. & power derated above 40°C) Storage: -25 to 70°C (-13 to 158°F)
Compliances	STANDARD COMPLIANCE Safety UL9540, UL1973, UL1741SA, CSA 22.2 Grid Connection Standards IEEE 1547A, IEEE 1547.1 Emissions FCC part15 class B Standards Rule 21, HECO

AC-Coupled System

AC OUTPUT TO LOAD	WITH GRID ABSENT	WITH GRID PRESENT
Output Power (Continuous) @ 25°C	5500W	7000W
Overload 40/20/5/1sec @ 25°C & 240V	5500/--/6500/7500W	--/9600/--/--W
Overload 40/5/1sec @ 25°C & 120V	2750/3250/3750W	--
Rated Output Current (RMS)	23A (120V and 240V)	29A (@120V and 240V)
Output Frequency (Selectable)	50/60Hz	
Output Voltage and Accuracy	L-N: 120V ± 3%; L-L: 240V ± 3%	
Output Voltage Limits	L-L: 180 to 280V (240V Nominal)	
Total harmonic distortion (THD) at rated power	< 5%	
Power Factor	>99%	

AC INPUT FROM GRID (GRID SUPPORT)	
Automatic Transfer Power Rating / Typical Transfer Time	7000W / 20ms
Input Voltage Range	L-L: 180 to 280V (240V nominal)
Input Frequency Range	45 to 54.9Hz / 55 to 65Hz
AC OUTPUT TO GRID (GRID SUPPORT)	
Output Power (Continuous) @ 25°C	5000W
Grid Feed-In Current Range	0 to 24A (@240V)
Grid Feed-In Voltage Range	L-L: 211 to 264V ± 3.0V
Grid Feed-In Frequency Range	49.3 to 50.5Hz / 59.3 to 60.5Hz ± 0.05Hz
DC BATTERY CHARGER	
Max Charge/Discharge Current	100A/150A
Output Voltage Range	44 to 58V (48V Nominal)
Compatible Battery Types	Li-Ion
GENERAL SPECIFICATIONS	
Product weight	265 to 750 lbs
Product dimensions (H x W x D)	24.2" x 42.5" x 10" (Per enclosure)
IP degree of protection	NEMA Type 1/IP20
Temperature	Operating: -20 to 55°C (0°C Min Startup Temp. & power derated above 40°C) Storage: -25 to 70°C (-13 to 158°F)
Compliances	STANDARD COMPLIANCE Safety: UL9540, UL1973, UL1741SA, CSA 22.2 Grid Connection Standards: IEEE 1547A, IEEE 1547.1 Emissions: FCC part15 class B Standards: Rule 21, HECO
EFFICIENCY	
Peak Battery to Grid	94.7%
System Standby Power	20W
System Idle Power	< 8W

19. GRID SUPPORT PARAMETERS (UL1741SA)

Manufacturer Stated Tolerances

VOLTAGE	CURRENT	FREQUENCY	TIME
2%	5%	2%	0.1 Sec

Solar DC Input

PARAMETER	RATING	DESCRIPTION
VDC _{op}	120-500V	Max input voltage
VDC _{mppt}	250-430V	Maximum power point track range
VDC _{start}	150V	Min start voltage
IDC _{max}	13A/13A	DC input current rating for each string

Inverter AC Output

PARAMETER	RATING	DESCRIPTION
V _{nom,L-N}	120V	Nominal Voltage L-N (if neutral available)
V _{nom,L-L}	240V	Nominal Voltage L-L
P _{nom}	5kW	Active Power Output
IAC _{nom}	21A	Nominal current per phase
IAC _{max}	21A	Max current at lowest operating voltage

Voltage Ride-Through

VOLTAGE ZONE	ZONE LIMITS	TRIP TIME	DESCRIPTION
HV2	$V \geq 120\%$	0.166 sec	Trip time when the voltage is above 288Vac
HV1	$110\% < V < 120\%$ $88\% \leq V \leq 110\%$	13 sec	Trip time when the voltage range is between 264Vac and 288Vac No applicable when the voltage range is between 211.2Vac and 264Vac
Nominal			
LV1	$70\% \leq V < 88\%$	21 sec	Trip time when the voltage range is between 168Vac and 211.2Vac
LV2	$50\% \leq V < 70\%$	11 sec	Trip time when the voltage range is between 120Vac and 168Vac
LV3	$V < 50\%$	1.5 sec	Trip time when the voltage is below 120Vac

Frequency Ride-Through

FREQUENCY ZONE	ZONE LIMITS (Hz)	TRIP TIME	DESCRIPTION
HF2	$F \geq 62$	0.166 sec	Trip time when the frequency is above 62Hz
HF1	$60.5 < F < 62$ $58.5 \leq F \leq 60.5$	300 sec	Trip time when the frequency range is between 60.5Hz and 62Hz Not applicable when the frequency range is between 58.5Hz and 60.5Hz
Nominal		-	
LF1	$57 \leq F < 58.5$	300 sec	Trip time when the frequency range is between 57Hz and 58Hz
LF2	$F < 57$	0.166 sec	Trip time when the frequency is below 57Hz

Power Factor

POWER	MIN INDUCTIVE, PF _{MIN,IND}	MIN CAPACITIVE, PF _{MIN,CAP}	SETTLING TIME	DESCRIPTION
5kW	70%	70%	3 Sec	Capacitive (Var production) and Inductive] (Var absorption) minimum power factor. Default PF = 1.0

Volt-VAr Q(V)

PARAMETER	RATING	DESCRIPTION
S_{rated}	5 KVA	Apparent Power Rating (VA)
P_{rated}	3.5 KW	Output Power Rating (W)
V_{nom}	240V	Nominal AC EPS voltage (V)
$V_{min} - V_{max}$	211 - 264V	AC EPS voltage range with function enabled (V)
$VA_{percent}$	5%	Reactive Power Accuracy
VA_{ramp}	500 VA/sec	Maximum ramp rate
$Q_{over-cap,max}$	3.57 VA	Maximum Rated Reactive Power Production (Capacitive, Overexcited)
$Q_{under-ind,max}$	3.57 VA	Maximum Rated Reactive Power Absorption (Inductive, Underexcited)
$VA_{slope,max}$	148 VA/V	Maximum slope of power over voltage
$D_{min} - D_{max}$	235 - 240V	Deadband range (V)

Power Ramp Rate

	RRNORM_UP_MIN	RRNORM_UP_MAX	ACCURACY	DESCRIPTION
Normal Operating	1% (Irate/sec)	50% (Irate/sec)	3%	Percentage of nominal generated power per second
Soft Start	1% (Irate/sec)	50% (Irate/sec)	3%	Percentage of nominal generated power per second for the first time startup.

20. TROUBLESHOOTING

Problem - Not all the inverters are communicating with the SmartHub.

Step 1. How many inverters are connected to the SmartHub? The SmartHub can only communicate with up to 3 inverters.

Step 2. Check all communication wires connected to the inverters.

Problem - I registered a new system, but I cannot see the SmartHub.

Step 1. Make sure the MAC address entered is the LAN MAC address and NOT the WiFi MAC address.

Step 2. Make sure the LAN MAC address was typed in correctly. It must be entered in the following format, xx:xx:xx:xx:xx:xx, with colons between every two characters. For example, if the LAN MAC is 40D63C031E86, it should be entered as 40:D6:3C:03:1E:86.

Step 3. If the SmartHub is connected to the router via a LAN connection, make sure the RJ45 cable is properly connected to the data logger and router. The WAN led indicator should be green.

Step 4. If the SmartHub is connected to a WiFi network, make sure that it is still properly connected by:

- Connect a computer to the data logger using the RJ45 cable.
- In a web browser, go to "192.168.10.1". Then log in using the username root and the password SBC700pw.

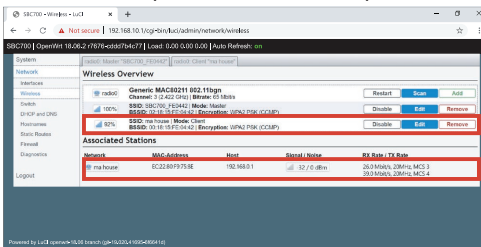

- In the sidebar menu, click on "Network" and then "Wireless" to go to the Wireless Overview page. Then confirm that your WiFi network is listed in both the Wireless Overview and Associated Stations sections.

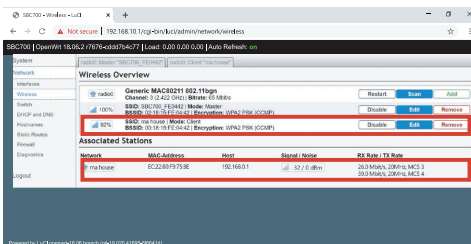



Panasonic Life Solutions Company of America
Two Riverfront Plaza, Newark, NJ 07102
panasonicevervoltsupport@us.panasonic.com

For more information
na.panasonic.com/us/evervolt

All Rights Reserved © 2021 COPYRIGHT Panasonic Corporation
Specifications are subject to change without notice