

Application Guidelines

Copeland EazyCool™ Outdoor Condensing Units ZX Range



About these guidelines	1
1 Safety instructions	1
1.1 Icon explanation	1
1.2 Safety statements	1
1.3 General instructions	2
2 Product description	3
2.1 General information about Copeland EazyCool™ ZX condensing units	3
2.2 EU Ecodesign Directive 2009/125/EC	3
2.3 Main product features	3
2.4 Product nameplate	5
2.5 Nomenclature	6
2.6 Application range	6
2.6.1 Qualified refrigerants and oils	6
2.6.2 Application limits	7
2.7 Bill of material	7
2.8 P&I diagrams	8
2.8.1 ZXME units	8
2.8.2 ZXLE units	9
2.8.3 ZXDE units	10
2.9 Main components description	11
2.9.1 Compressor	11
2.9.2 Condenser fan(s)	11
2.9.3 Housing	11
2.10 XCM25D Electronic controller – Features	12
2.10.1 Description	12
2.10.2 Functionalities	13
2.10.3 Modbus communication	13
2.10.4 Main control & safety features	14
2.10.5 Additional features for customization	15
2.11 XCM25D Electronic controller – Programming	20
2.11.1 Programming the local display	20
2.11.2 Remote display CCM60	21
2.11.3 Single commands	21
2.11.4 Double commands – Entering programming level 1 "Pr1"	22
2.11.5 How to program the parameters (Pr1 and Pr2)	22
2.11.6 Entering programming level 2 "Pr2"	22
2.11.7 Fast access menu	23
2.12 Controller keyboard	23
2.12.1 How to lock the keyboard	23
2.12.2 How to unlock the keyboard	23
2.13 Parameters level 1 – Required settings	24

2.14	Digital operation	24
2.15	Pumpdown mode	25
2.15.1	External pumpdown without XCM25D integration (not available on ZXDE units).....	25
2.15.2	Pumpdown by the unit controller (not available on ZXDE units).....	25
2.15.3	Pumpdown with room thermostat (not available on ZXDE units).....	26
2.15.4	Internal pumpdown with temperature sensor (case temperature)	26
2.16	Reset to factory settings – Emerson "Hot Key"	28
2.16.1	How to save factory settings or user settings	28
2.16.2	Applicable hot key for ZX units with XCM25D controller.....	28
2.16.3	Location of the "Hot Key" plug connection on the XCM25D controller	28
2.16.4	How to program a "Hot Key" from the controller (upload).....	28
2.16.5	How to program a controller using an Emerson "Hot Key" (download)	29
2.17	Troubleshooting – Alarm history	29
2.18	Compressor motor protection	30
2.19	System pressure protection	30
2.19.1	High-pressure safety switch	30
2.19.2	High pressure: pressure relief valve.....	30
2.19.3	Low-pressure safety switch – Optional	30
2.20	Other inputs of the XCM25D controller	30
2.20.1	Customer-supplied control (room thermostat).....	30
2.20.2	Case temperature controller.....	30
2.20.3	Ambient temperature sensor.....	31
2.21	Alarm output (DO5) of the XCM25D controller	31
3	Installation	32
3.1	Condensing unit handling	32
3.1.1	Transport and storage.....	32
3.1.2	Weights.....	32
3.2	Refrigeration piping connections	32
3.2.1	Refrigeration piping installation	32
3.2.2	Brazing recommendations.....	34
3.2.3	Brazing procedure	34
3.3	Electrical connection	35
3.3.1	Power supply connections.....	35
3.3.2	Maximum operating currents for cable selection	35
3.3.3	Electrical wiring	36
3.3.4	Electrical protection standard (protection class)	36
3.3.5	Main fuses	36
3.4	Location & fixings.....	37
4	Start-up & operation.....	39
4.1	Evacuation	39
4.2	Charging procedure	39

4.2.1	Refrigerant charging procedure	39
4.2.2	Oil charging procedure	40
4.2.3	Oil separator	40
4.3	Rotation direction of Scroll compressors	40
4.4	Maximum compressor cycle	41
4.5	Checks before starting & during operation	41
5	Maintenance & repair	42
5.1	Replacing a compressor	42
5.2	Condenser fins	42
5.3	Electrical connections	42
5.4	Routine leak testing	43
5.5	Condenser fan(s) & motor(s)	43
6	Certification & approval	43
7	Dismantling & disposal	43
	DISCLAIMER	43
	Appendix 1: Overview of the ZX unit components	44
	Appendix 2: Wiring diagram – ZXME / ZXLE / ZXDE units (380-420V / 3 Ph / 50 Hz)	45
	Appendix 3: Wiring diagram – ZXME / ZXLE units (230V / 1 Ph / 50 Hz)	46
	Appendix 4: Parameters level 1	47
	Appendix 5: Alarm menu	48
	Appendix 6: Additional features for customization	53
	Appendix 7: Temperature / resistance curve for B7 Sensor (customer option)	57
	Appendix 8: List of tables and figures	58

About these guidelines

The purpose of these application guidelines is to provide guidance in the application of Copeland EazyCool™ ZX outdoor refrigeration condensing units. They are intended to answer the questions raised while designing, assembling and operating a system with these products.

Besides the support they provide, the instructions listed herein are also critical for the proper and safe functioning of the condensing units. The performance and reliability of the product may be impacted if the product is not used according to these guidelines or is misused.

These application guidelines cover stationary applications only. For mobile applications, contact Application Engineering as other considerations may apply.

1 Safety instructions







Copeland EazyCool™ ZX outdoor refrigeration condensing units are manufactured according to the latest European safety standards. Particular emphasis has been placed on the user's safety.

These condensing units are intended for installation in machines and systems according to the Machinery Directive MD 2006/42/EC. They may be put to service only if they have been installed in these systems according to instructions and conform to the corresponding provisions of legislation. For relevant standards please refer to the Manufacturer's Declaration, available at www.climate.emerson.com/en-gb.

These instructions should be retained throughout the lifetime of both the compressor and the condensing unit.

You are strongly advised to follow these safety instructions.

1.1 Icon explanation

 <p>WARNING This icon indicates instructions to avoid personal injury and material damage.</p>	 <p>CAUTION This icon indicates instructions to avoid property damage and possible personal injury.</p>
 <p>High voltage This icon indicates operations with a danger of electric shock.</p>	 <p>IMPORTANT This icon indicates instructions to avoid malfunction of the compressor.</p>
 <p>Danger of burning or frost burn This icon indicates operations with a danger of burning or frost burn.</p>	<p>NOTE This word indicates a recommendation for easier operation.</p>
 <p>Explosion hazard This icon indicates operations with a danger of explosion.</p>	

1.2 Safety statements

- **Refrigerant compressors must be used in accordance with their intended use.**
- **Only qualified and authorized HVAC or refrigeration personnel are permitted to install, commission and maintain this equipment.**
- **Electrical connections must be made by qualified electrical personnel.**
- **All valid standards for connecting electrical and refrigeration equipment must be observed.**
- **The national legislation and regulations regarding personnel protection must be observed.**



Use personal safety equipment. Safety goggles, gloves, protective clothing, safety boots and hard hats should be worn where necessary.

1.3 General instructions



WARNING

System breakdown! Personal injuries! Never install a system in the field and leave it unattended when it has no charge, a holding charge, or with the service valves closed without electrically locking out the system.

System breakdown! Personal injuries! Only approved refrigerants and refrigeration oils must be used.



WARNING

High shell temperature! Burning! Do not touch the compressor until it has cooled down. Ensure that other materials in the area of the compressor do not get in touch with it. Lock and mark accessible sections.



CAUTION

Overheating! Bearing damage! Do not operate compressors without refrigerant charge or without being connected to the system.



CAUTION

Contact with POE! Material damage! POE lubricant must be handled carefully and the proper protective equipment (gloves, eye protection, etc.) must be used at all times. POE must not come into contact with any surface or material that it might damage, including without limitation, certain polymers, eg, PVC/CPVC and polycarbonate.



IMPORTANT

Transit damage! Compressor malfunction! Use original packaging. Avoid collisions and tilting.

The contractor is responsible for the installation of the unit and should check the following points:

- Sufficient liquid sub-cooling in the line to the expansion valve(s) to avoid "flash-gas" in the liquid line;
- Sufficient amount of oil in the compressor (in case of long piping additional oil must be charged).

2 Product description

2.1 General information about Copeland EazyCool™ ZX condensing units

Emerson has developed the Copeland EazyCool™ ZX outdoor condensing unit of second generation to meet primarily the demands of the food retail and food service sectors. It is a refrigeration air-cooled condensing unit that uses the latest Copeland™ brand products patented Scroll technology as the main driver and has electronic protection and diagnostics features built in the compact chassis. The combination of large condensers and low speed fans allows for particularly quiet operation.



2.2 EU Ecodesign Directive 2009/125/EC

The European Directive 2009/125/EC with regard to ecodesign requirements for professional refrigerated storage cabinets, blast cabinets, condensing units and process chillers requires manufacturers to decrease the energy consumption of their products by establishing minimum energy efficiency standards. Copeland™ brand products condensing units are prepared and optimized to meet the requirements of the Ecodesign Directive. The integrated variable speed fan and condenser reduce the noise level and energy consumption significantly. This, combined with Copeland scroll technology, allows for high-efficiency operation.

For the rated cooling capacity, rated power input and rated COP value please refer to Copeland™ brand products Select software at www.climate.emerson.com/en-gb.

These guidelines meet the requirements of Regulation 2015/1095, Annex V, section 2(a), with regard to product information, namely:

- (v) → See chapter 2.6 "Application range"
- (vi) → See chapters 5.2 "Condenser fins" and 5.4 "Routine leak testing"
- (vii) → See chapters 2.10.4 "Main control & safety features" and 4.2 "Charging procedure"
- (viii) → See chapter 7 "Dismantling & disposal"

2.3 Main product features

Copeland EazyCool ZX condensing units are released for multiple refrigerants. They are available in two cabinet sizes and are equipped with one or two fans.

Depending on the compressor in use they are designed for medium-temperature or low-temperature refrigeration applications.

Unit	Refrigerant types	Displacement @ 50 Hz [m³/h]	Cooling capacity* [kW]	Nominal power [kW]	Rated current [A]		PS high side [bar]	PS low side [bar]		
					TFD	PFJ				
Medium temperature standard										
ZXME020E	R404A, 407A, R407F, R507, R448A, 449A R134a, R450A & R513A	5.9	3.42	1.58	5.4	13.3	28.8	21		
ZXME025E		6.7	3.89	1.66	5.2	12.9				
ZXME030E		8.6	5.05	2.28	7.7	16.9				
ZXME040E		11.7	6.58	3.29	10.8	24.0				
ZXME050E		14.4	8.77	3.79	13.8					
ZXME060E		17.1	10.05	4.41	14.1					
ZXME075E		18.8	11.6	5.07	15.0					
Medium temperature Digital					TFD					
ZXDE030E	R404A, R407A, R407F, R507, R448A, R449A R134a, R450A & R513A	8.3	5.13	2.21	7.2					
ZXDE040E		11.4	7.21	2.72	8.9					
ZXDE050E		14.4	8.65	3.67	12.3					
ZXDE060E		17.1	10.1	4.46	12.4					
ZXDE075E		18.8	11.4	4.83	15.0					
Low temperature standard					TFD	PFJ				
ZXLE020E	R404A, 407A, R407F, R507, R448A, R449A	6.1	1.46	1.77	6.2	14.1				
ZXLE025E		7.1	1.81	2.00		16.1				
ZXLE030E		8.0	2.06	2.17	7.2	18.3				
ZXLE040E		12.7	3.16	3.72	9.7					
ZXLE050E		14.4	3.62	4.00	12.9					
ZXLE060E		17.1	4.56	5.33	14.7					
ZXLE075E		18.8	5.11	5.31	15.6					

* Operating conditions for ZXDE, ZXME: R448A/R449A; T_{evap} = -10°C; T_{amb} = 32°C; suction gas = 20°C

* Operating conditions for ZXLE: R448A/R449A; T_{evap} = -35°C; T_{amb} = 32°C; suction gas = 20°C

Table 1: ZX condensing unit technical data

Unit	Outer dimensions length/width/height with closed cover [mm]	Net weight [kg]	Fan number	Liquid receiver size [litres]
Medium temperature standard				
ZXME020E	424 / 1027 / 840	76	1	4.1
ZXME025E		79		
ZXME030E		79		
ZXME040E		91		
ZXME050E	424 / 1029 / 1244	108	2	5.9
ZXME060E		112		
ZXME075E		118		
Medium temperature Digital				
ZXDE030E	424 / 1027 / 840	82	1	4.1
ZXDE040E	424 / 1029 / 1244	104	2	5.9
ZXDE050E		108		
ZXDE060E		112		
ZXDE075E		118		
Low temperature standard				
ZXLE020E	424 / 1027 / 840	79	1	4.1
ZXLE025E		81		
ZXLE030E		81		
ZXLE040E		93		
ZXLE050E	424 / 1029 / 1244	106	2	5.9
ZXLE060E		116		
ZXLE075E		126		

Table 2: ZX condensing unit features

The figures hereafter show the overall physical dimensions of the ZX condensing units in millimetres:

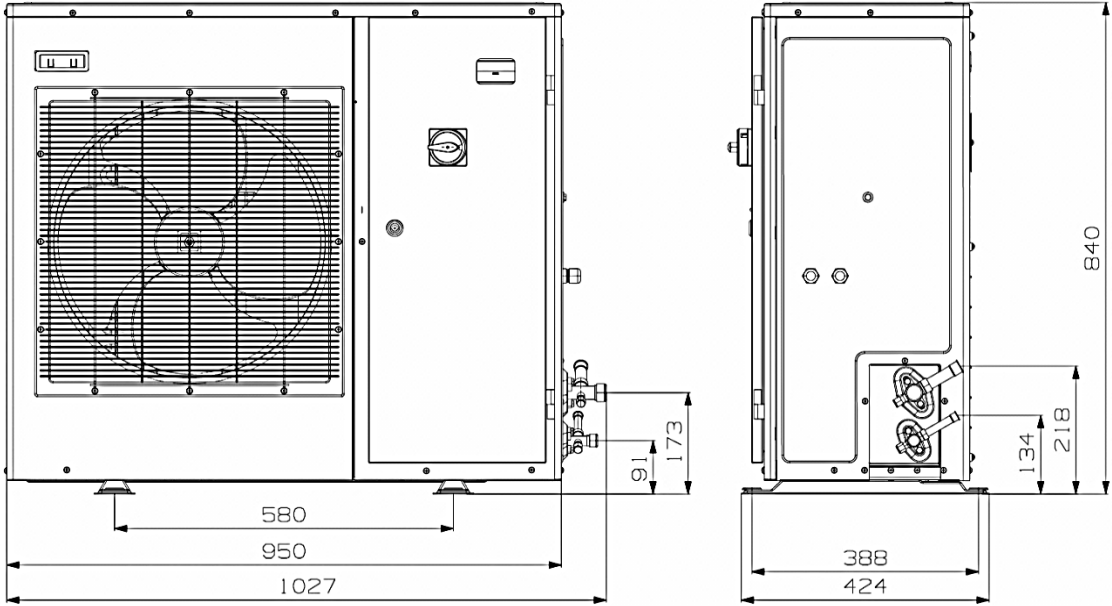

Figure 1: Dimensions of models ZXME020E to ZXME040E, ZXDE030E and ZXLE020E to ZXLE040E (single-fan units)

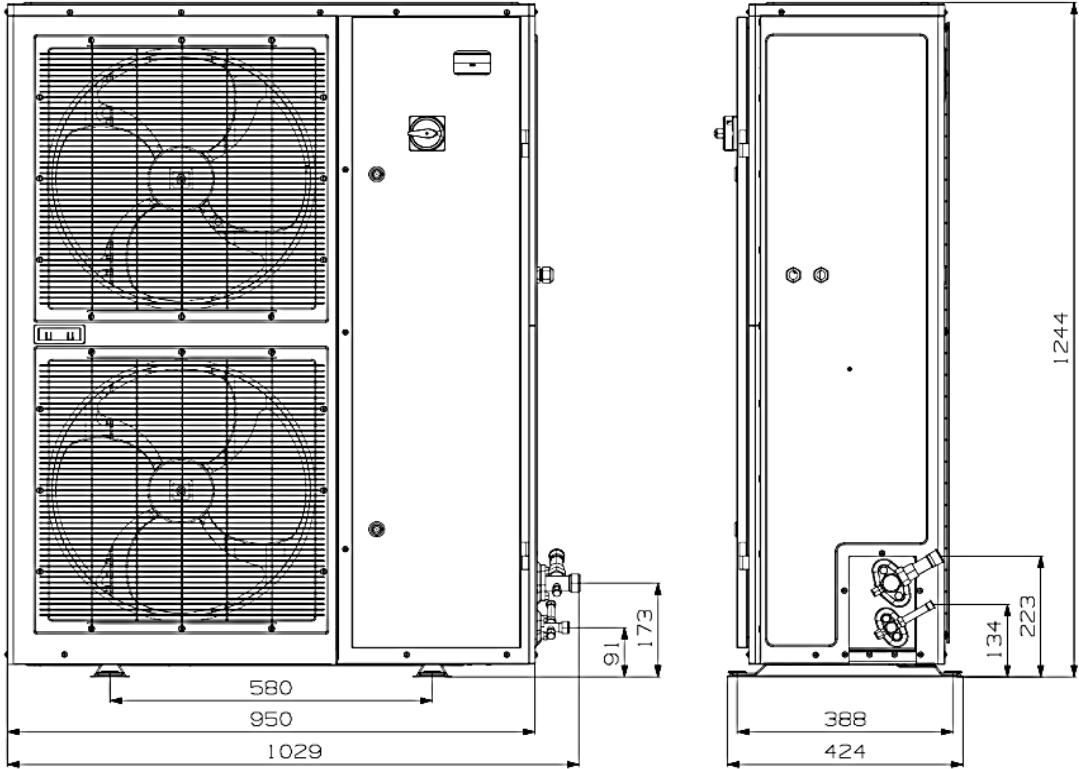

Figure 2: Dimensions of models ZXME050E to ZXME075E, ZXDE040E to ZXDE075E and ZXLE050E to ZXLE075E (dual-fan units)

2.4 Product nameplate

The condensing unit nameplate shows model designation and serial number, as well as locked rotor amps, maximum operating current, safety pressures and weight.

The compressor has its own nameplate with all electrical characteristics.

2.5 Nomenclature

The model designation contains the following technical information about the condensing unit:

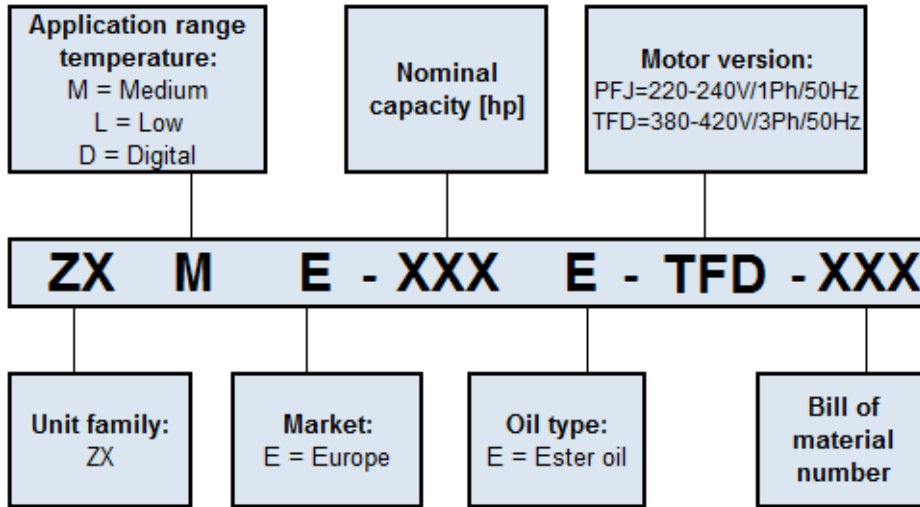

Figure 3: Nomenclature ZX units

2.6 Application range

2.6.1 Qualified refrigerants and oils

Qualified refrigerants	R404A, R407A, R407F, R507, R448A, R449A R134a*, R450A*, R513A* (* = Not for ZXLE)						
Qualified servicing oils	Emkarate RL 32 3MAF Mobil EAL Arctic 22CC						
Oil charge in litres	ZXME020E ZXME025E	ZXME030E ZXLE020E ZXLE025E ZXLE030E ZXDE030E	ZXDE040E	ZXLE040E ZXLE050E	ZXDE050E ZXDE060E ZXDE075E	ZXME040E ZXME050E ZXME060E ZXME075E	ZXLE060E ZXLE075E
	1	1.1	1.24	1.75	1.77	1.85	2.3

Table 3: Qualified refrigerants and oils



WARNING

Use of R450A and R513A refrigerants! Risk of compressor damage!

Migration of R450A or R513A into the compressor crankcase could cause low oil viscosity, which could lead to compressor damage. When using R450A or R513A it is critical to meet the following requirements:

- maintain adequate superheat settings with a minimum superheat of 8-10K;
- no liquid refrigerant migration into the compressor at any time, especially during standstill, during or after defrost, or after reverse mode for example in heat pumps;
- pumpdown is recommended (not for Digital units);
- the use of a crankcase heater is mandatory;
- retrofit to R450A and R513A is only allowed for compressors which are approved for these refrigerants.

Contact your local Application Engineering representative for any further information.

NOTE: ZXDE & ZXLE units are equipped with an oil separator. This separator is pre-charged with 0.5 liter of oil.

2.6.2 Application limits

For application envelopes, please refer to the compressor application envelopes which can be found in Copeland™ brand products Select software, available at www.climate.emerson.com/en-gb.

ZX condensing units can be used with an ambient temperature from -15°C to 45°C. For lower ambient temperatures please contact your local Application Engineering representative.

2.7 Bill of material

BOM	Family	Introduction date	Controller concept	Oil separator	Suction accumulator
302	ZXME	08/2008	Electronic main board	No	No
452	ZXLE	07/2010	Electronic main board	Yes	Yes
	ZXDE		EC2-552 (Emerson - Alco)	Yes	No
303	ZXME	03/2013	Electronic main board	No	No
453	ZXLE	03/2013	Electronic main board	Yes	Yes
	ZXDE		XC645 (Emerson - Dixell)	Yes	No
304	ZXME	01/2015	XCM25D (Emerson - Dixell)	No	No
454	ZXLE	01/2015	XCM25D (Emerson - Dixell)	Yes	Yes
	ZXDE			Yes	No

Table 4: BOM history

NOTE: These guidelines are of application only for BOM 304 and 454. For previous generations (BOM 302/452 & BOM 303/453) the dedicated guidelines can be downloaded from www.climate.emerson.com/en-gb.

2.8 P&I diagrams

2.8.1 ZXME units

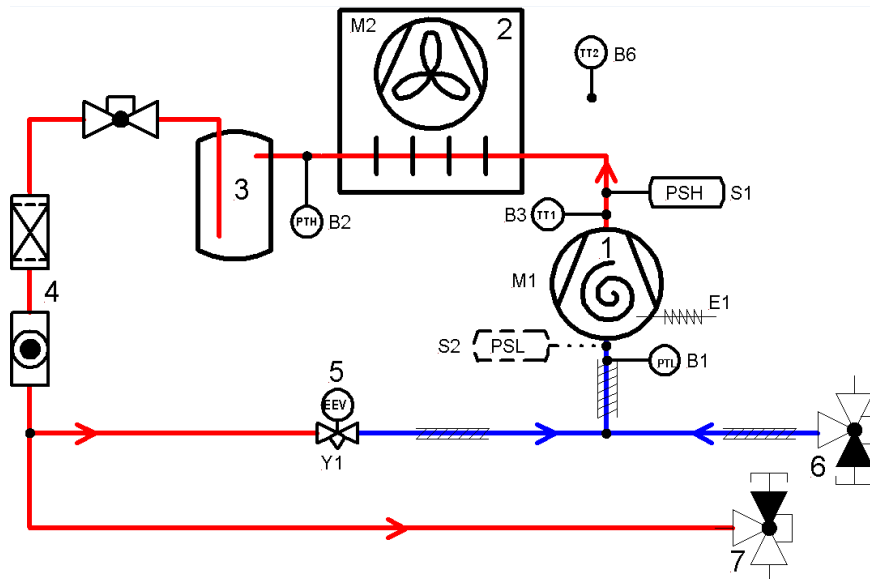

Figure 4: P&I diagram for ZXME units

Position	Description	Comments	Fast access menu
1 (M1)	High-efficiency Copeland Scroll compressor		
2 (M2)	Condenser with 1 or 2 fans		
3	Liquid receiver with service valve		
4	Filter drier / sight glass combination		
5 (Y1)	Expansion device for suction line injection		
6	Service valve, suction line		
7	Service valve, liquid line		
PSL (S2)	Adjustable low-pressure switch (not factory-mounted)	System safety (option)	
PSH (S1)	Non-adjustable high-pressure switch	System safety	
PTL (B1)	Suction pressure sensor, low pressure	Compressor setpoint	P1P
PTH (B2)	Pressure sensor, high pressure	Fan speed control	P2P
TT1 (B3)	Discharge temperature sensor	Compressor safety	P3t
TT2 (B6)	Ambient temperature sensor	Additional functions	P6t

Table 5: Legend of the P&I diagram for ZXME units

2.8.2 ZXLE units

IMPORTANT

Absence of insulation on the liquid line in ZXLE units! Air moisture condensation and lack of performance! Moisture will condensate on the liquid line and cause water droplets. The liquid line can pick up additional heat from the ambient which will adversely affect the sub-cooling desirable for the liquid refrigerant before it enters the expansion valve. Both the suction and liquid interconnecting piping between the ZX unit and the evaporator should be insulated to avoid condensation.

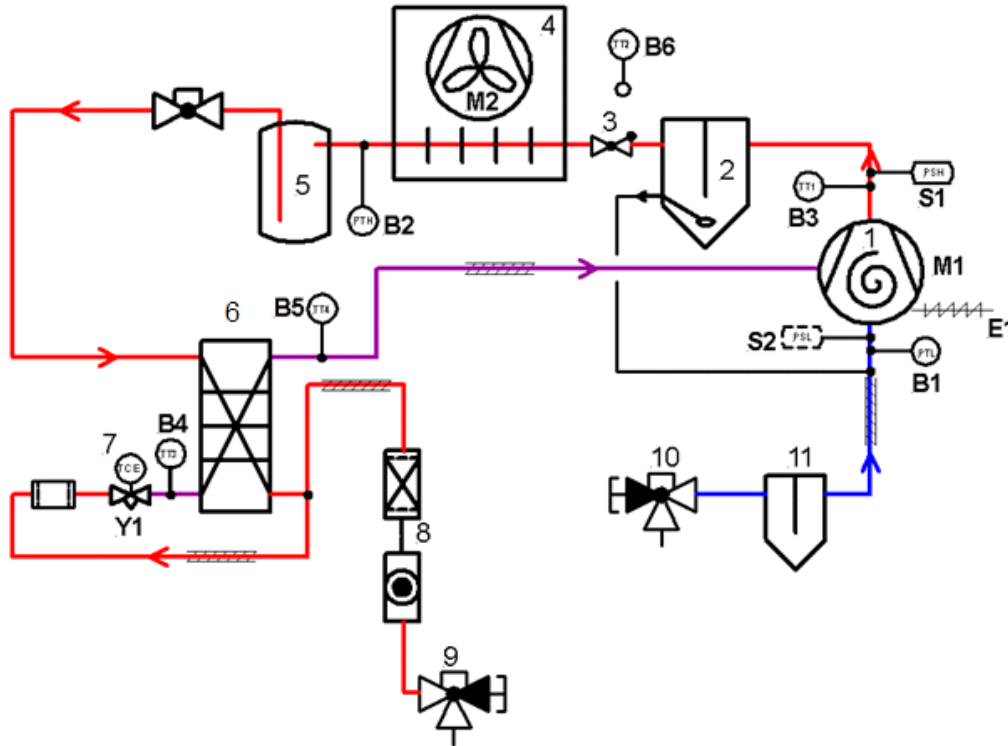

Figure 5: P&I diagram for ZXLE units

Position	Description	Comments	Fast access menu
1 (M1)	High-efficiency Copeland Scroll compressor		
2	Oil separator	Pre-charged with 0.5 L	
3	Check valve		
4 (M2)	Condenser with 1 or 2 fans		
5	Liquid receiver with service valve		
6	Plate heat exchanger for enhanced vapour injection (EVI)		
7 (Y1)	Expansion device for enhanced vapour injection (EVI)		
8	Filter drier / sight glass combination		
9	Service valve, liquid line		
10	Service valve, suction line		
11	Liquid separator		
PSL (S2)	Adjustable low-pressure switch (not factory mounted)	System safety (option)	
PSH (S1)	Non-adjustable high-pressure switch	System safety	
PTL (B1)	Suction pressure sensor, low pressure	Compressor setpoint	P1P
PTH (B2)	Pressure sensor, high pressure	Fan speed control	P2P
TT1 (B3)	Discharge temperature sensor	Compressor safety	P3t
TT2 (B6)	Ambient temperature sensor	Additional functions	P6t
TT3 (B4)	Vapour in temperature sensor	EVI control	P4t
TT4 (B5)	Vapour out temperature sensor	EVI control	P5t

Table 6: Legend of the P&I diagram for ZXLE units

2.8.3 ZXDE units

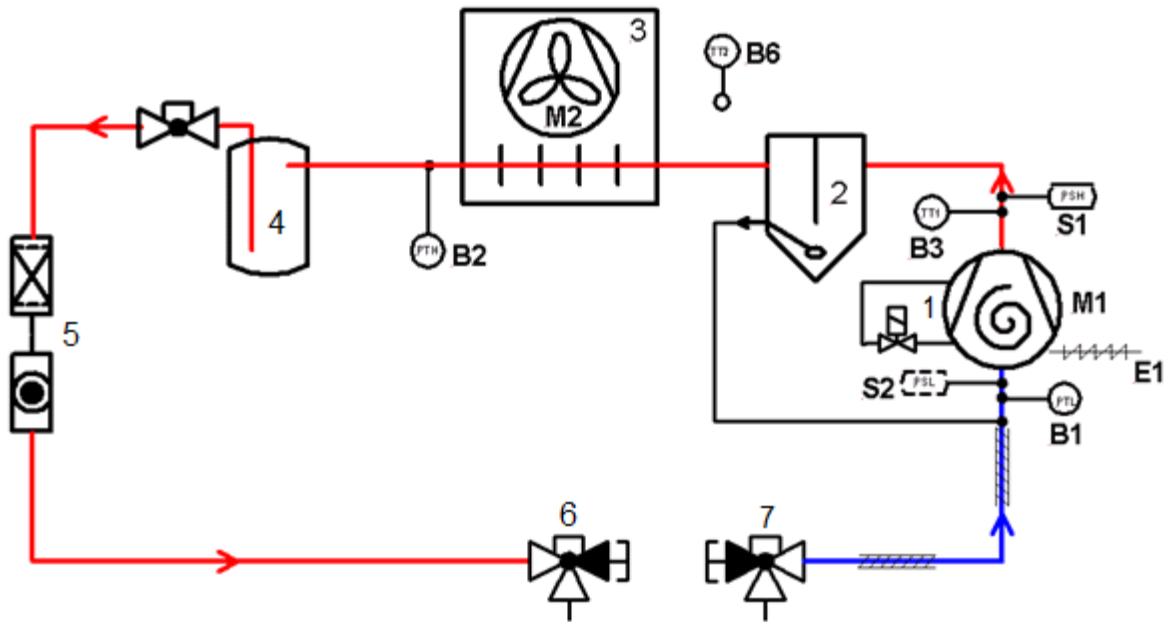

Figure 6: P&I diagram for ZXDE units

Position	Description	Comments	Fast access menu
1 (M1)	High-efficiency Copeland Scroll compressor (ZBD for Digital)		
2	Oil separator	Pre-charged with 0.5 L	
3 (M2)	Condenser with 1 or 2 fans		
4	Liquid receiver with service valve		
5	Filter drier / sight glass combination		
6	Service valve, liquid line		
7	Service valve, suction line		
PSL (S2)	Adjustable low-pressure switch (not factory mounted)	System safety (option)	
PSH (S1)	Non-adjustable high-pressure switch	System safety	
PTL (B1)	Suction pressure sensor, low pressure	Compressor setpoint	P1P
PTH (B2)	Pressure sensor, high pressure	Fan speed control	P2P
TT1 (B3)	Discharge temperature sensor	Compressor safety	P3t
TT2 (B6)	Ambient temperature sensor	Additional functions	P6t

Table 7: Legend of the P&I diagram for ZXDE units

2.9 Main components description

2.9.1 Compressor

Medium temperature		Low temperature	
Unit model	Compressor model	Unit model	Compressor model
Standard			
ZXME020E	ZX15KCE-TFD/PFJ	ZXLE020E	ZXI06KCE-TFD/PFJ
ZXME025E	ZX19KCE-TFD/PFJ	ZXLE025E	ZXI08KCE-PFJ
ZXME030E	ZX21KCE-TFD/PFJ	ZXLE030E	ZXI09KCE-TFD/PFJ
ZXME040E	ZX29KCE-PFJ or ZX30KCE-TFD	ZXLE040E	ZXI14KCE-TFD
ZXME050E	ZX38KCE-TFD	ZXLE050E	ZXI15KCE-TFD
ZXME060E	ZX45KCE-TFD	ZXLE060E	ZXI18KCE-TFD
ZXME075E	ZX51KCE-TFD	ZXLE075E	ZXI21KCE-TFD
Digital			
ZXDE030E	ZBD21KCE-TFD		
ZXDE040E	ZBD29KQE-TFD		
ZXDE050E	ZBD38KQE-TFD		
ZXDE060E	ZBD45KQE-TFD		
ZXDE075E	ZBD48KQE-TFD		

Table 8: Compressor models cross reference

2.9.2 Condenser fan(s)

The condensers of the ZX condensing units are equipped with single-phase fans.

Condensing units			Nr. of fans [pcs]	Fan speed [rpm]	Diameter [mm]	Voltage [V/ph/Hz]	Power input [W]
Medium temperature		Low temperature					
Standard	Digital						
ZXME020E		ZXLE020E	1	830	450	220-240V / 1 Ph / 50 Hz	123
ZXME025E		ZXLE025E					
ZXME030E	ZXDE030E	ZXLE030E					
ZXME040E		ZXLE040E					
	ZXDE040E		2				246
ZXME050E	ZXDE050E	ZXLE050E					
ZXME060E	ZXDE060E	ZXLE060E					
ZXME075E	ZXDE075E	ZXLE075E					

Table 9: Condenser fans technical data

2.9.3 Housing

ZX condensing units with BOM 304 & 454 have specific housing features:

- Controller-window in the cabinet door. The window is IP54 and shows the current value of the electronic controller.
- The main power switch is installed on the cabinet door and allows to de-energize the unit without opening the cabinet door. To open the door the main power switch must be in off position.
- The quick-locks allow for easy and quick opening of the cabinet door by means of the cabinet key.
- The cabinet key is delivered with the unit. It is attached to one of the piping connections by means of a cable strap.



Figure 7: ZX unit housing

2.10 XCM25D Electronic controller – Features

The XCM25D controller is designed to be a powerful, flexible controller for use in multiple applications. It has been developed for condensing units and allows the adjustment of all relevant parameters by the user.

2.10.1 Description



WARNING

Electrical pins under voltage! Electrical shock hazard! There are unused fast-on pins (C1 & DO2) on the XCM25D which could be under voltage. They are covered by insulated fast-on flags in the factory. Handle carefully when removing insulating flags during service on site.

The controller is designed for usage in an outdoor refrigeration unit. It is rated to be used for the following environment:

- Outdoor controller ambient temperature for operation: -40°C to 60°C
- Ambient temperature for storage: -40°C to 80°C
- Maximum humidity: 90% at 48°C (non-condensing)
- Board power: 24V AC +15%/-20%
- Voltage sensing capabilities - Single phase: 100-120, 200-240V AC \pm 10%
- Voltage sensing capabilities - Three phase: 200-240, 380-460, 575V AC \pm 10%

The units of measure are selectable. The factory default unit is [bar] (always considered relative) for pressure and [°C] for temperature.



Figure 8: Electronic controller

2.10.2 Functionalities

The controller allows for easy commissioning by the technician with the factory settings at the highest program level. It also offers the possibility to make substantial changes to the system optimization in further programming levels. Advanced functionalities can also be activated.

The following functions are covered by the controller:

- Condensing unit control
- Case control
- Condenser fan control
- Defrost
- Voltage and current sensing (compressor protection)
- Liquid and vapour injection
- System EXV control
- Digital compressor control
- Modbus/Canbus communication

NOTE: The XCM25D controller includes all the functions necessary for the control of the ZX units. For additional functionalities please contact your local Application Engineering representative.

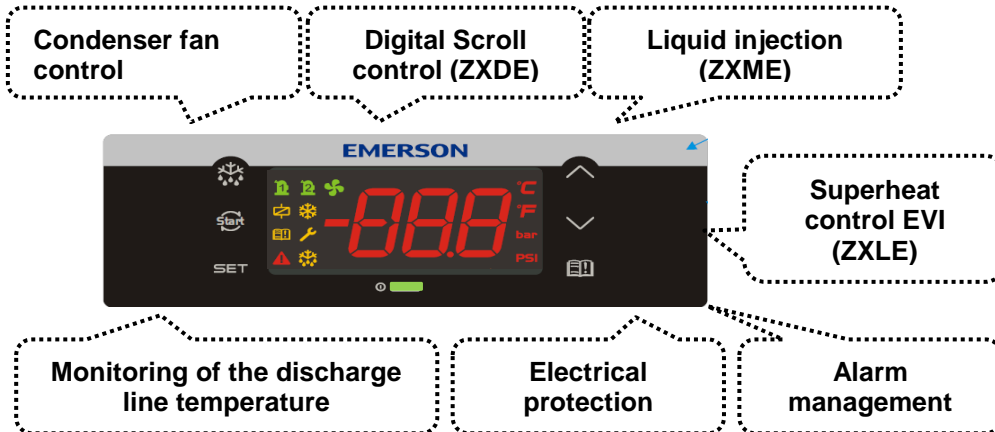

Figure 9: XCM25D controller functionality overview

2.10.3 Modbus communication

The XCM25D controller can communicate via Modbus (RS-485) connection to provide all running data. Additional commands can also be activated through Modbus connection. The Modbus map is available on request from the Application Engineering department at Emerson.

A pre-configured X-Web Supervisor device is also available and allows easy handling and connectivity with the XCM25D controller.

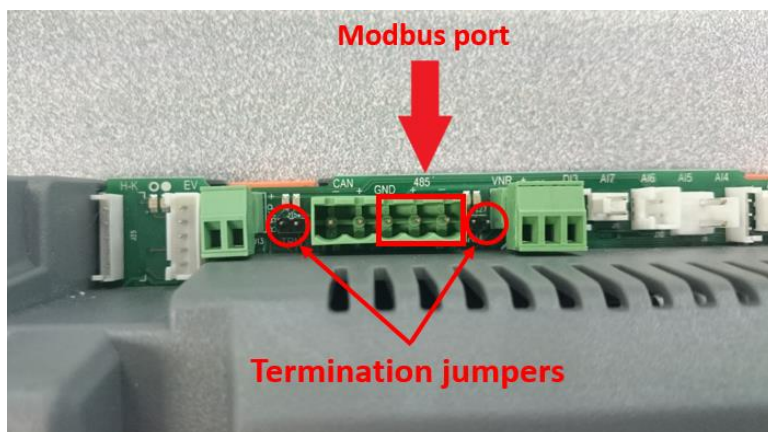

Figure 10: Modbus port and termination jumpers

NOTE: If the XCM25D controller is connected in chain the termination jumpers must be removed.

2.10.4 Main control & safety features

Suction pressure control: Each unit is equipped with a suction pressure transmitter. The XCM25D controls the suction pressure by evaluating the input signal of the pressure transmitter. When using a digital unit (ZXDE), the setpoint (**C16**) and proportional band (**C17**) need to be adjusted. The suction pressure regulation for ZXME or ZXLE units has to be defined by compressor cut-in (**C01**) and cut-out (**C02**) values. The signal of the suction pressure transmitter is also used for additional functionalities, pumpdown and keeping the compressor running within the approved envelopes.

Condensing pressure control: Each unit is equipped with a high-pressure transmitter. The XCM25D controls the condensing pressure by regulating the fan speed corresponding to the high-pressure transmitter signal. The unit controller can regulate the condensing pressure in two ways. The first approach is to keep a constant condensing temperature. This mode is utilized by the factory settings. The pre-adjusted setpoint is 27°C as a universal setting. If lower condensing pressure is required set up the condenser setpoint (**E39**) to a lower value. The second control way is fan modulation based on compressor envelope. This mode of setpoint control is only available if a suction pressure input is not used. The parameter (**E38**) enables/disables the mode as needed. If this function is unused, the condensing temperature setpoint will be set as a parameter (**E39**) value. The compressor is allowed to run different minimum condensing temperatures based on the suction pressure of the compressor. This is the most energy efficient way to minimize the condensing temperature as much as possible.

Automatic liquid injection on ZXME: The electronic controller automatically instructs liquid refrigerant to be injected into the suction line of the Scroll compressor to reduce discharge temperatures generated when the unit operates at increasing compression ratios. The electronic controller reacts automatically to a thermistor which is attached to the discharge line on all ZXME units. The controller converts this signal for the linear stepper motor driving the liquid injection valve to a position that enables the compressor to continue operating within its safe envelope.

Automatic enhanced vapour injection (EVI) on ZXLE: Control of an electronic expansion device based on the superheat in the additional heat exchanger for the EVI Scroll compressor to create subcooling in liquid refrigerant coming from the receiver. In case of excessive discharge line temperatures (DLT) the superheat control is ignored and the controller will work in liquid injection mode in order to reduce the discharge gas temperature.

NOTE: The ZXLE units have an additional subcooling of about 30K. This must be considered when selecting the expansion device.

Compressor phase reversal: Ensures that the compressor keeps running in one direction only (clockwise = right rotation) – necessary for a compliant Scroll compressor to compress and pump refrigerant. Reset is automatic once the phase rotation is correct for the compressor.

Motor current overload protection: This feature eliminates the need for external current protection for the compressor motor.

Fixed high-pressure switches: This is a non-adjustable protection device designed to prevent the compressor from operating outside of its safe high-pressure range. Reset is automatic for a set number of trips (7) then the unit will lock out and require manual restart. This feature is important to prevent the ZX unit from cycling under these controls for a long period of time.

- ZXLE & ZXME units: 28 bar cut-out / 21 bar cut-in.
- ZXDE units: 28.8 bar cut-out / 24 bar cut-in.

Adjustable high-pressure limitation: The unit controller provides the possibility to stop the unit at a required discharge pressure which is lower than the cut-out value of the fixed high-pressure switch. Detailed instructions can be found in chapter 2.10.5 "Additional features for customization" hereunder.

Discharge temperature protection: Each unit is equipped with a discharge line sensor (NTC). The information from the NTC sensor is used to activate liquid injection when required. The XCM25D controller will stop the compressor if discharge temperatures reach unacceptable levels.

Adjustable low-pressure alarm (from S/N 16EZ08855M onwards): The unit controller features an adjustable low-pressure alarm managed by the suction pressure sensor. The factory setting of this alarm is the lowest permitted pressure of the refrigerant with the lowest pressure-vapour properties. If needed the user can modify this value according to the required application.

- ZXME & ZXDE units: 0.5 bar rel
- ZXLE units: 0.1 bar rel

In case of very low cut-out pressure on ZXLE units it is possible that the suction pressure will get lower than 0.1 bar rel due to the 5-second switching off delay. In this case the user can deactivate the low-pressure alarm with parameter **D13** or activate the alarm delay with parameter **D12**.

Option: Adjustable low-pressure switches PS1: This device protects the system against low pressure operation. It must be adjusted depending on running conditions and potential special requirements like pumpdown. The compressor envelopes published in Select must be respected at all times. In case of controller breakdown, the low-pressure switch could be used for emergency operation (rewiring required).

A crankcase heater is directly connected to the controller. The crankcase heater will be energized when the ambient sensor is below a given value (10°C) and the compressor has been off for a period of time (5 minutes). The minimum off time does not apply at initial power up.

In addition to the above, the ZX condensing unit has the following features:

- Liquid line assembly (filter drier and sight glass/moisture indicator)
- Anti-corrosion treatment to the condenser fins

The electronic controller is also the base controller for the connection of many optional and customer supplied functions such as:

- Main load controller (or thermostat)
- Evaporator electric defrost heater contactor
- Evaporator fan contactor
- Superheat controller for one electronic expansion device (not available on ZXLE units)

2.10.5 Additional features for customization

A lot of additional features are provided by the XCM25D controller. In the European design of the electrical panel a few of the additional functionalities are prearranged and can easily be installed by connecting additional hardware to the electrical terminals. The tables in **Appendix 6** show the parameters that have to be changed in case a special feature of the controller should be activated. The tables do not show the required settings which have to be done by the system operator, eg, choosing correct setpoints for different components and different applications.

NOTE: After programming an additional function, the system will have to be restarted. To engage system restart, switch off the main power supply, wait for 5 seconds and switch it on again.

Component	Description	Prearranged terminals / Wiring diagram
S2	Low pressure switch, optional; can be ordered factory-installed.	Terminals: X1.2 / X1.7
Y3	Solenoid valve liquid line (not available on ZXDE units)	Terminals: X1.N / X1.8
S3	Room thermostat for pumpdown or direct control	Terminals: X1.9 / X1.10
Alarm contact	Sensor for evaporator or room	Terminals: X1.11 / X1.12
Sensor B7	Sensor for evaporator or room (NTC10kΩ)	Terminals: X1.13 / X1.14

Table 10: Prearranged additional connections

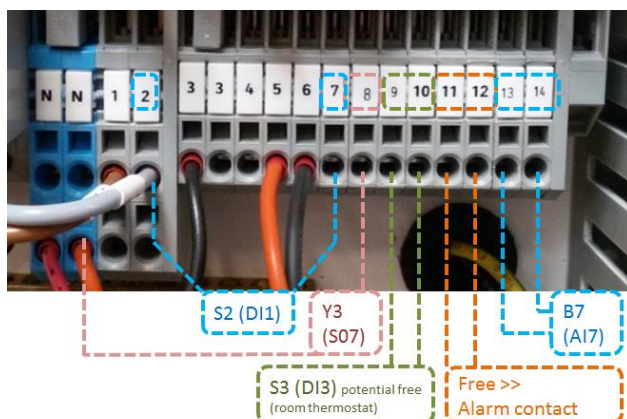

Figure 11: Prearranged additional connections

NOTE: Depending on the required functionalities additional components might be necessary. Please contact your local Application Engineering representative.

NOTE: Check the current limitations given by the controller relays.

NOTE: The solenoid valve function is not available on ZXDE units.

Digital output	Specifications
DO1, DO2 and DO3	Relay SPDT 16A, 250V AC
DO3	Relay SPST 8A, 250V AC
DO4 and DO5	Relay SPST 5A, 250V AC

Table 11: Digital output specifications

Temperature control by means of an external room thermostat (not available on ZXDE units)

The temperature of a cold room or cooling cabinet can be controlled by means of an external room thermostat (Digital Input DI3, parameter **R07**).

The parameters that must be changed to control a cooling cabinet or a cold room with a room thermostat are listed in **Table 12** below.

With these settings the controller will switch the compressor according to the status of the connected device (room thermostat):

- if the input is closed, turn the compressor on (On-Off-compressor)
- if the input is open, turn the compressor off (On-Off-compressor)

Parameter	Description	Factory settings	Recommended settings / Comments
C05	Compressor regulation probe selection	1 = Suction pressure probe = SuP	Suction pressure switch / Room thermostat input = 3 = diS
G56	Use the liquid line solenoid	NO	NO >> If a solenoid is used in the liquid line, see Chapter 2.15 "Pumpdown mode" for parameter settings
R07	Digital Input 3 function	0 = Not used = nu	Suction pressure switch / Room thermostat input = 1 = SuS
R08	Digital Input 3 polarity	1 = Closed = CL	1 = Closed = CL (no change)

Table 12: External room thermostat - Parameters

Temperature control by means of an external temperature probe (not recommended for ZXDE units)

The temperature of a cold room or cooling cabinet can be controlled by means of an additional temperature (Analog Input AI7, component B7 in wiring diagram) probe (NTC, 10kΩ - for detailed temperature-resistance-curve, see **Appendix 7**). The probe can be located in the evaporator or in the room. The location of the probe has to be considered for the configuration of the **P7C/A19** setting. Based on the value provided by the **B7**-temperature sensor the compressor will be switched on and off according to the following graphics:

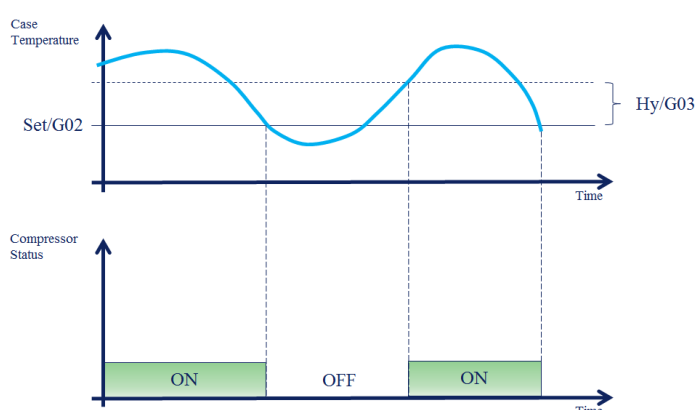

Figure 12: External temperature sensor – Functionality

The following parameters must be adjusted to control a cooling cabinet or a cold room with a temperature sensor:

Parameter	Description	Factory settings / Range	Recommended settings / Comments
A19	Probe 7 configuration	0 = Not used = nu	Thermostat temp (NTC10K) = 2 = tnt or Evaporator temp (NTC10K) = 5 = EPt
C05	Compressor regulation probe selection	1 = Suction pressure probe = SuP	Case temperature = 2 = CSt
G01	Case temperature probe selection	0 = Not used = nu	Thermostat temperature = 4 = tnt or Evaporator temperature = 5 = EPt
G02	Setpoint case temperature	2°C	Choose setpoint according to requirements of cooled goods
G03	Position differential case temperature	1K / 0.1 to 25.5K	Setpoint G02 + positive differential G03 results in cut-out value for compressor
G04	Case temperature lower limit G02	-10°C / -40°C to G05	Define limits to avoid wrong operator settings for G02
G05	Case temperature upper limit G02	+15°C / G04 to 110°C	Define limits to avoid wrong operator settings for G02
G06	Emergency run on-time	2 min / 0 to 255 min	In case of probe failure, the compressor will cycle for a time defined by G06 & G07
G07	Emergency run off-time	1 min / 0 to 255 min	In case of probe failure, the compressor will cycle for a time defined by G06 & G07

Table 13: External temperature sensor – Parameters

Please check that **G56** is set to "**NO**" (means "no solenoid valve in the liquid line") and no additional digital inputs are configured (Digital Input DI3; Parameter R07 has to be set to "not used" = **nu** = 0).

Adjustable discharge pressure limitation

The controller has dedicated parameters to provide the possibility of adjustable discharge pressure cut-out.

Parameter	Description	Factory settings	Recommended settings
E58	Condenser temperature / Pressure threshold for high alarm	27	Required value
E61	Condenser temperature / Pressure threshold for alarm recovery	23	Required value

Table 14: Discharge pressure limitations

Low ambient operation

Very low ambient temperatures can result in malfunction of expansion devices because of insufficient pressure difference. Therefore, pressure cut-out during system start-up can occur. For proper operation of the expansion devices, the unit running time must allow to build up sufficient condensing pressure.

At low ambient conditions, the compressor will need to run for a minimum period of time to allow the system pressures to stabilize. If the unit operates below a defined ambient temperature (ambient temp. < **C12**) or if the ambient sensor has failed, the compressor should run for a set period of time (**C14**) when it is started based on a low suction reading.

The unit will be turned on for the minimum run time in the following cases:

- a room thermostat input is closed
- the case temperature setting cut-in is reached
- the low-pressure input is closed,

The unit will start in any of these cases even if parameter **G56** is set to true, ie, the thermostat or case temperature controls the liquid line solenoid.

If the pressure drops below the cut-out value or the low-pressure input opens, the unit should continue to run for the remaining minimum on time (**C14**) or until a satisfactory condenser pressure is reached (**C13**).

If a suction pressure transducer is present and the suction pressure falls below a given value (**C15**) during the minimum on time (**C14**), then disregard the timer and shut the compressor off to protect against vacuum operation.

Defrost

The XCM25D is able to control defrost on evaporators. The controller can handle electrical defrost or natural / fan defrost (select with parameter **G17**). The defrost probe (parameter **G12**) provides the XCM25D with information about the temperatures in the evaporator.

The intervals between defrost cycles are controlled by parameter **G23**. This can be done based on the integrated real-time clock or by fixed intervals.

The following parameters must be adjusted to control defrost in a cooling cabinet or a cold room:

Parameter	Description	Factory settings / Range	Recommended settings / Comments
A19	Probe 7 configuration	0 = Not used = nu	Evaporator temp (NTC10K) = 5 = Ept
G12	Defrost probe selection	0 = Not used = nu	5 = Evaporator temperature sensor = Ept
G17*	Defrost type	0 = Electrical = EL	0 = Electrical = EL ; 1 = Hot gas defrost = in ; 2 = Natural defrost (pulse defrost) = PLS
G18	Interval between defrost cycles	4 hours	0 to 120 hours range; adjust to individual requirements
G19	Maximum duration of defrost	20 minutes	0 to 255 minutes; adjust to individual requirements
G20	Duration of pulse defrost	15 minutes	0 to G19
G21	Defrost termination temperature	10°C	-40°C to 110°C
G22	Defrost delay time	15 minutes	0 to 255 minutes
G23**	Defrost interval mode	0 = Not used = nu	0 = nu = Not used; 1 = in = Interval; 2 = rtC = Real time clock
G24***	Display during defrost	DEFROST " dEF "	0 = dEF = Defrost; 1 = Set = Case temperature setpoint; 2 = it = Case temperature value; 3 = rt = Standard operation
G25	Maximum display delay after defrost	0 minute	0 to 255 minutes
G26	Drip time	1 minute	0 to 120 minutes
G27	Defrost at power-on	0 = NO	Avoids defrost after initial power up. If "YES", the controller will decide on defrost-related parameters if a defrost sequence is required after initial start-up
G28	Workday defrost start 1	00:00	00:00 – 23:50 or nu = Not used
G29	Workday defrost start 2	04:00	00:00 – 23:50 or nu = Not used
G30	Workday defrost start 3	08:00	00:00 – 23:50 or nu = Not used
G31	Workday defrost start 4	12:00	00:00 – 23:50 or nu = Not used
G32	Workday defrost start 5	16:00	00:00 – 23:50 or nu = Not used
G33	Workday defrost start 6	20:00	00:00 – 23:50 or nu = Not used
G34	Holiday defrost start 1	00:00	00:00 – 23:50 or nu = Not used
G35	Holiday defrost start 2	04:00	00:00 – 23:50 or nu = Not used

Parameter	Description	Factory settings / Range	Recommended settings / Comments
G36	Holiday defrost start 3	08:00	00:00 – 23:50 or nu = Not used
G37	Holiday defrost start 4	12:00	00:00 – 23:50 or nu = Not used
G38	Holiday defrost start 5	16:00	00:00 – 23:50 or nu = Not used
G39	Holiday defrost start 6	20:00	00:00 – 23:50 or nu = Not used
G40	First weekly holiday	SUN = Sunday	0 = SUN ; 1 = MON ; 2 = TUE ; 3 = WED ; 4 = THU ; 5 = FRI ; 6 = SAT ; 7 = nu = Not used
G41	Second weekly holiday	SUN = Sunday	0 = SUN ; 1 = MON ; 2 = TUE ; 3 = WED ; 4 = THU ; 5 = FRI ; 6 = SAT ; 7 = nu = Not used
G42****	Fan operating mode	0 = cn = Stopped during defrost	0 = cn ; 1 = On ; 2 = cy ; 3 = Oy
G43	Fan stop Temperature	0°C	-40°C to 110°C
G55	Fan delay after defrost / drip time	1 minute	0 to 255 minutes
S05	Relay output 2 configuration	0 = Not used = nu	6 = Defrost = dEF

Table 15: Defrost parameters

*** G17 parameter >> Three defrost modes are available:**

- **G17 = EL** → Defrost through electrical heater Compressor Off
- **G17 = pulse** → Pulse / natural defrost Compressor Off

**** G23 parameter >> Defrost interval mode:**

- **G23 = nu (0)** → Defrost functionality not used
- **G23 = in (1)** → Defrost in intervals G18
- **G23 = rtC (2)** → Enables defrost for rtC (real time clock), allows timing of defrost cycles with G28 – G41

***** G24 parameter >> Display during defrost:**

- **G24 = dEF (0)** → Display shows "dEF" for defrost
- **G24 = SET (1)** → Display shows "G02" parameter value = Case temperature setpoint
- **G24 = it (2)** → Display shows display case temperature value
- **G24 = rt (3)** → Display will stay in standard operation

****** G42 parameter >> Evaporator fans function:**

- **G42 = cn (0)** → Will switch On and Off with the compressor, Off during defrost
- **G42 = On (1)** → Fans On, even if the compressor is off, Off during defrost
 - After defrost, there is a timed fan delay allowing for drip time, set by means of the "G55" parameter.
- **G42 = cy (2)** → Fans will switch On and Off with the compressor, On during defrost
- **G42 = Oy (3)** → Fans will run continuously also during defrost

Manual defrost

Please check settings for evaporator fans. The XCM25D controller can also control the evaporator fans during manual defrost.

NOTE: For additional features please contact your local Application Engineering representative.

2.11 XCM25D Electronic controller – Programming



CAUTION

Low refrigerant charge! Compressor damage! Never energize the unit/controller without minimum refrigerant system charge. There is a risk of malfunction of the controller in deep vacuum operation which can cause compressor damage.

2.11.1 Programming the local display

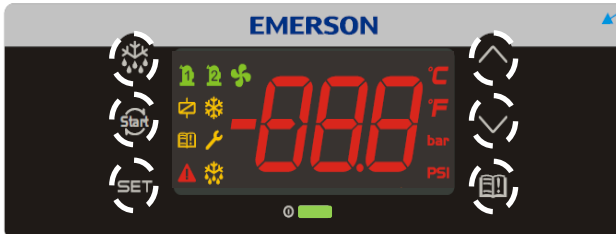

Figure 13: Local display

LED	Mode	Function
	On	Compressor 1 enabled
	Flashing	Anti-short cycle delay enabled
	On	Condensing fans enabled
	On	Bar display
	Flashing	Programming mode
	On	PSI display
	Flashing	Programming mode
	On	When browsing the service menu
	Flashing	In fast access menu
	On	When browsing the alarm menu
	Flashing	A new alarm occurred
	On	An alarm is occurring
	On	Digital unloader solenoid On
	On	In defrost
	On	Evaporator fans - Liquid line solenoid valve On

Table 16: LED functions description

NOTE: By default, the local display will show the value of the suction pressure during operation. This can be changed by choosing another value for parameter B03 (Remote Display visualization).

Setting for B03	Value shown on the display	Comments
0	P1 value = Suction pressure	
1	P2 value = Mid-coil temperature (condenser)	
2	P3 value = Discharge line temperature	
3	P4 value = Vapour inlet EVI	Only for ZXLE
4	P5 value = Vapour outlet EVI	Only for ZXLE
5	P6 value = Ambient temperature	
6	P7 value = Not used in factory setting	
7	PEr value = Probe error	
8	Aou value = Analog output	

Table 17: Display visualisation

2.11.2 Remote display CCM60

This device allows for remote monitoring and control of the XCM25D controller via cable. The CCM60 has the same interface as the XCM25D controller therefore the commands and symbols are identical. The remote display shall be mounted on a vertical panel, in a 29 x 71 mm hole, and secured using the special bracket supplied (see **Figure 14**).

The temperature range allowed for correct operation is 0°C to +60°C.

Avoid places subject to strong vibrations, corrosive gases, excessive dirt or humidity. Allow for air to circulate through the cooling holes.

When front-mounted, the remote display is IP65 rated.

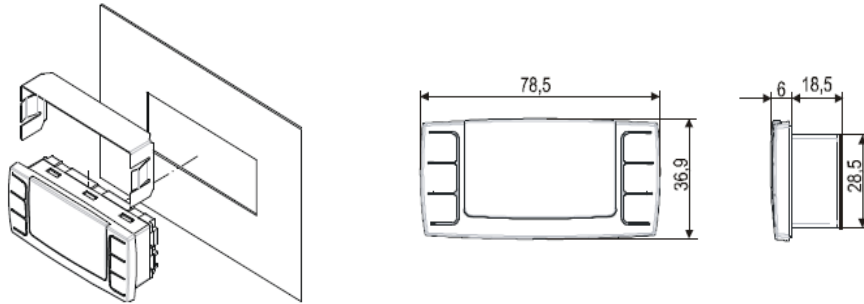

Figure 14: Remote display front panel mounting

The remote display is a proprietary bus of communication for Dixell HMI (x-rep, CCM60) interfaces. There are two connection terminals on the back of the remote display (+ and -).

NOTE: Emerson recommends using a shielded cable twisted pair 2 x 0.5mm².

The device must be connected to the VNR-terminal on the unit controller according to the polarity. **Figure 15** shows the VNR terminal on the unit controller.

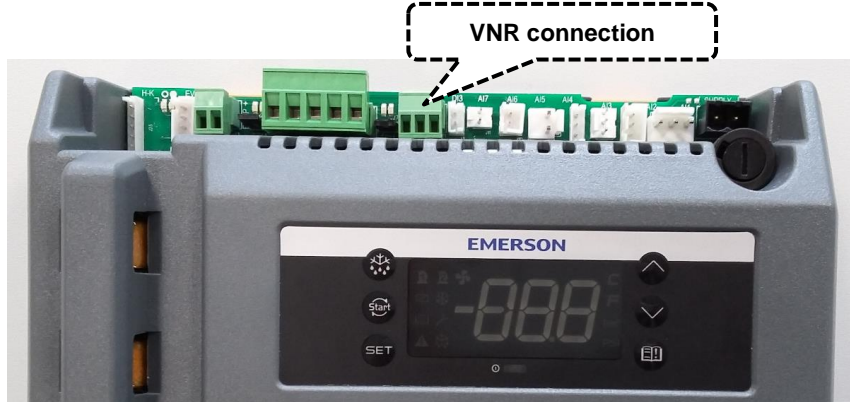

Figure 15: VNR connection for the remote display

Before connecting cables make sure the power supply complies with the hardware requirements. Separate the terminal cables from the power supply cables, the outputs and the power connections.

2.11.3 Single commands





SET	Press the SET button to display the target setpoint. In programming mode, this allows to select a parameter or to confirm an operation.
	Press the RESET button and hold for 5 seconds to reset any lockouts if the current state of the controller allows for it to be reset.
	(UP) To view the fast access menu. In programming mode, this browses the parameter codes or increases the displayed value.
	(DOWN) In programming mode, this browses the parameter codes or decreases the displayed value.
	(SERVICE) To enter the service and alarm menu.
	Hold for 3 seconds to start a manual defrost or terminate an active defrost.

Table 18: Single commands

2.11.4 Double commands – Entering programming level 1 "Pr1"



	Press simultaneously for about 3 seconds to lock (PoF) or unlock (Pon) the keyboard.
	Press simultaneously to leave the programming mode or menu. On submenus rtC and EEV this combination allows to go back to the previous level.
	Press simultaneously for about 3 seconds to access the first level of programming mode.

Table 19: Double commands

The device provides 2 programming levels:

- **Pr1** with direct access
- **Pr2** protected with a password (intended for experts)

2.11.5 How to program the parameters (Pr1 and Pr2)















Access pre-program level		Press simultaneously for about 3 seconds to access the pre-programming level. The message rtC (real time clock) appears.
Access program level	 or 	Press the Up or Down key until the message Par appears.
Access Pr1		Press the SET button to enter the program level. First parameter C01 appears.
Select item	 or 	Select the parameter or submenu using the arrows.
Show value		Press the SET button.
Modify	 or 	Use the arrows to modify the value.
Confirm and store		Press the SET button: the value will blink for 3 seconds, then the display will show the next parameter.
EXIT		Press simultaneously to exit the programming mode, or wait for 30 seconds (MTO) without pressing any key.







Table 20: Programming level 1 parameters

When entering the programming level for the first time the display will show the **rtC** (real time clock) label.

- Press  to access parameters N01/02/03/04/05 to adjust time & date. For further details, see Chapter 2.13 "Parameters level 1 – Required settings".
- Press  or  to change from the **rtC** label to the **Par** label, in order to access the programming level 1.
- Press : the parameters of programming level 1 can be changed.

2.11.6 Entering programming level 2 "Pr2"

To enter the Pr2 programming menu:

- Press  simultaneously for 3 seconds. The first parameter label will be displayed.
- Press  till the **T18** label is displayed, then press the  key;
- The blinking **PaS** label will be displayed; wait for a few seconds;
- The display will show "0 - -" with blinking 0: insert the password [**321**] using the  and  keys and confirming with the  key.

2.11.7 Fast access menu

This menu contains the list of probes and some values that are automatically evaluated by the board such as the superheat and the percentage of valve opening.

"nP" or "noP" stands for "probe not present" or "value not evaluated", "Err" means "value out of range" or "probe damaged, not connected or incorrectly configured".







Entering fast access menu		Press and release the UP arrow. The duration of the menu in case of inactivity is 3 minutes. The values that will be displayed depend on the configuration of the board.
Use the  or  arrow to select an entry, then press  to see the value or to go on with another value.		<ul style="list-style-type: none"> ▪ P1P: Pressure value of the P1 probe (suction pressure) ▪ P2t: Temperature value of the P2 probe (not valid) ▪ P2P: Pressure value of the P2 probe (discharge pressure) ▪ P3t: Temperature value of the P3 probe (discharge line temperature) ▪ P4t: Temperature value of the P4 probe (vapour in only for ZXLE) ▪ P5t: Temperature value of the P5 probe (vapour out only for ZXLE) ▪ P6t: Temperature value of the P6 probe (ambient temperature) ▪ P7t: Temperature value of the P7 probe (free) ▪ SH: Value of superheat. nA = not available ▪ oPP: Percentage of step valve opening. ▪ LlnJ: Status of the liquid line solenoid ("On" – "Off"). This information is available only if one relay is set as "Liquid Line Solenoid". ▪ SEtd: Value of the dynamic setpoint (condenser fan SET). This information is available only if the dynamic setpoint function is enabled. ▪ AOO: Percentage of the analog output (0-10V or TRIAC PWM Mod.). This information is available only if the 0-10V or TRIAC PWM Mod. is enabled. ▪ dStO: Percentage of the PWM output driving the valve of the Digital Scroll compressor. ▪ L°t: Minimum room temperature. ▪ H°t: Maximum room temperature. ▪ HM: Menu. ▪ tU1: Voltage reading V1 (not valid in standard configuration) ▪ tU2: Voltage reading V2 (not valid in standard configuration) ▪ tU3: Voltage reading V3 (not valid in standard configuration) ▪ tA1: Current reading I1 ▪ tA2: Current reading I2
Exit		Press simultaneously or wait for the timeout of about 60 seconds



Table 21: Fast access menu

2.12 Controller keyboard

2.12.1 How to lock the keyboard

Keep the  and  keys pressed simultaneously for more than 3 seconds. The "**PoF**" message will be displayed and the keyboard will be locked. At this point it is only possible to see the setpoint or the maximum or minimum temperatures stored. If a key is pressed for more than 3 seconds, the "**PoF**" message will be displayed.

2.12.2 How to unlock the keyboard

Keep the  and  keys pressed simultaneously for more than 3 seconds, till the "**Pon**" message is displayed.

2.13 Parameters level 1 – Required settings

The XCM25D is preconfigured to reduce the required settings on job-site to a minimum. In most cases, it will not be necessary to enter programming level 2 "Pr2". Table 22 gives an overview of the parameters available in programming level 1 "Pr1".

NOTE: When changing parameters C01 (Cin), C02 (CoU) and C05 (CPb) a reset of the controller (interruption of power supply) is required.

Parameter	Description	Unit	Factory settings	Comments
C01	Compressor cut-in pressure setpoint	[bar]	4.0	Not used for Digital ZXDE
C02	Compressor cut-out pressure setpoint	[bar*]	2.0	Not used for Digital ZXDE
C07	Refrigerant selection for regulation	[-]	R404A	R22, R407A, R407F, R507, R448A, R449A, R134a, R407C
C16	Digital compressor setpoint	[bar*]	3.3	Not used for ZXME & ZXLE
C17	Proportional band for compressor regulation	[bar*]	2.0	Not used for ZXME & ZXLE
C21	Cycle time for digital compressor	[sec]	10	Not used for ZXME & ZXLE
C24	Minimum capacity for digital compressor	[%]	20	Not used for ZXME & ZXLE
C25	Maximum capacity for digital compressor	[%]	100	Not used for ZXME & ZXLE
D29	Low-pressure alarm value (from S/N 16EZ08855M onwards)	[bar]	0.5	
E39	Condenser setpoint	[°C]	35.0	
E46	Regulation band of variable fan	[°C]	10.0	
N01	Current minute	[-]	[-]	
N02	Current hour	[-]	[-]	
N03	Day of the month	[-]	[-]	
N04	Month	[-]	[-]	
N05	Year	[-]	[-]	
T18	Access to Pr2 level	[-]	[-]	Password: 3 2 1

* Pressure values are always relative

Table 22: Parameters in programming level Pr1

NOTE: The full list of parameters in programming levels 1 and 2 can be found in Technical Information CC7.8.17 "Copeland EasyCool™ ZX Condensing Units – XCM25D Controller Parameter List".

2.14 Digital operation

A Digital unit is able to operate in a part-load mode. Part-load operation is achieved by loading and unloading of the Digital scroll compressor for certain periods of time (time cycles). The cycle of time can be chosen between 10 and 30 seconds. Example: if the time cycle is 20 seconds at 50% of capacity request, the compressor will run for 10 seconds loaded and 10 seconds unloaded. For proper commissioning of the Digital unit the diagram in Figure 16 must be considered.

The regulation starts when the suction pressure (AI1) increases and reaches the value $(SP-PB/2+(PB*PMI)/100)$ or $(C16-C17/2+(C17*C24)/100)$. Within the adjustment range $(SP-PB/2-SP+PB/2)$ or $(C16-C17/2 \sim C16+C17/2)$ the Digital scroll compressor is activated in PWM mode according to the value of the control variable.

When the pressure is higher than $(SP + PB/2)$ or $(C16 + C17/2)$ then the TRIAC output is at maximum capacity. When the pressure is lower than $(SP + PB/2)$ or $(C16 + C17/2)$ but higher than $(SP-PB/2)$ the Digital Scroll compressor modulates the capacity according to the proportional band. If the pressure is lower than $(SP-PB/2)/ (C16-C17/2)$ the Digital Scroll compressor switches off.

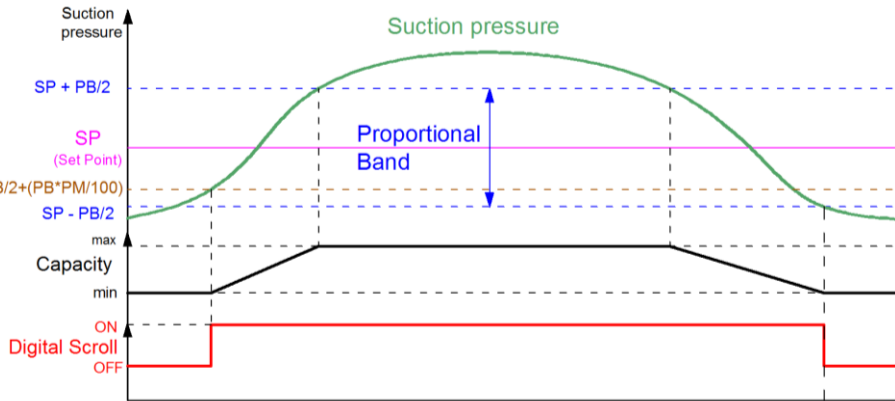

Figure 16: Digital operation

NOTE: When the digital valve on the compressor is discharged the compressor is loaded.

NOTE: At start-up the valve is energized for S_{ut}/C_{20} start-up time, ie, time interval with the digital valve energized before regulation starts. It ranges from 0 to 10 seconds.

2.15 Pumpdown mode



CAUTION

System pressure below atmospheric pressure! Compressor damage!

Never operate the system below atmospheric pressure. There is a risk of malfunction of the controller in deep vacuum operation which can cause compressor damage.

Pumpdown functionality is provided by the XCM25D controller for ZXME and ZXLE units only. It is not released for Digital units ZXDE.

NOTE: Depending on the compressor and/or system design an increase of suction pressure is possible when the unit stops. Therefore, pumpdown operation requires higher differences between cut-in and cut-out setpoints. These values must be adjusted according to application.

2.15.1 External pumpdown without XCM25D integration (not available on ZXDE units)

The easiest solution for pumpdown is to install a solenoid valve in the liquid line (not part of the standard delivery) and to control it directly with the room thermostat or other external devices. The settings on the unit for compressor cut-in and cut-out (**C01** & **C02**) can easily be adjusted for pumpdown. The disadvantage of this easy solution is that the controller is not informed that there is a solenoid valve installed and therefore some protection features of the controller, eg, maximum pumpdown time in case of blocked solenoid, will not work.

2.15.2 Pumpdown by the unit controller (not available on ZXDE units)

In case of pumpdown by the unit controller (available only for ZXME and ZXLE units) the user needs to install a solenoid valve in the liquid line (not part of the standard delivery). In addition to the liquid line solenoid valve a digital input signal from a room thermostat or a case temperature sensor must be connected to the XCM25D. There are additional terminals available in the unit which allow for easy connection of additional hardware if required. The wiring diagram also shows these optional features. The liquid line solenoid valve Y3 can be connected on terminals X1.N & X1.8. The terminals X1.9 & X1.10 can be used for a room thermostat (connected to **D13**).

If a temperature sensor is preferred the analog input **A17** can be used (Caution: controller settings are not preconfigured for temperature sensor). For details about alternative options please see Chapters 2.15.3 "Pumpdown with room thermostat (not available on ZXDE units)" and 2.15.4 "Internal pumpdown with temperature sensor (case temperature)".

In any case there are limitations for the cut-out values of the compressors given by the envelopes. The minimum cut-out settings are shown in **Table 23** below. Those values are also applicable in case pumpdown is carried out by means of an additional low-pressure switch. Operation of the unit below the suction pressures shown in the table could result in tripping of the compressor internal motor protector (Klixon, error code **E28**). The envelopes are in accordance with Select software available at www.climate.emerson.com/en-gb.

Unit family	R134a	R404A/R507	R407A	R407F
ZXME	-20°C = 0.3 bar rel	-20°C = 2 bar rel	-23°C* = 1.1 bar rel	-25°C = 1 bar rel
ZXLE	[-]	-40°C = 0.3 bar rel	-40°C = 0 bar rel	-40°C = 0 bar rel
ZXDE	Not approved for pumpdown			

* Limited to -20°C (1.35 bar rel) for ZXME020

Table 23: Minimum cut-out value for pumpdown

NOTE: ZXLE units have an additional 5-second switch-off delay which must be taken into account for the pumpdown function.

NOTE: The values in the table show the lowest suction temperatures / pressures in the envelopes. Depending on the condensing temperature in the real system it might be required to adjust / increase the cut-out value according to the approved envelope published in Select.

2.15.3 Pumpdown with room thermostat (not available on ZXDE units)

Configure parameter **C05** "Compressor regulation probe selection" to "3" (Suction pressure switch / Room thermostat input). In addition, change setting for **G56** from "0" to "1". This is information to the controller that a solenoid valve is present.

Change the functionality of Digital Input 3 (**DI3**) (Parameter **R07**) to setting 1 (Suction pressure switch / Room thermostat input) and adjust the relay output configuration **S07** to 7 (Liquid line solenoid).

Parameter	Factory settings	Pumpdown settings
C02	2 bar relative	Cut-out value for pumpdown, eg, 0.2 bar rel
C05	1 = Suction pressure probe = SuP	3 = Suction pressure switch / Room thermostat = diS
G11	3 minutes	Maximum pumpdown time
G56	0 = No	1 = Yes
R07	0 = Not used = nu	1 = Suction pressure switch / Room thermostat = SuS
S07	0 = Not used = nu	7 = Liquid line solenoid = LLS

Table 24: Pumpdown 1

Room thermostat switch status	Liquid line solenoid valve status
Closed	Switch on / Energized
Open	Switch off / De-energized

Table 25: Pumpdown 2

For example, if the room thermostat switch is closed, the liquid line solenoid valve is activated, and the compressor will run when the suction pressure value is higher than the compressor cut-in value **C01**.

The liquid line solenoid valve will be switched off if the room thermostat switch is open and pumpdown will start. The compressor will stop once the suction pressure value is lower than the compressor cut-out value **C02** or when the pumpdown duration is longer than the maximum pumpdown time **G11** setting.

The functionality of parameter **G11** protects the cooled goods in case of component damage, eg, the liquid line solenoid is mechanically blocked and not able to stop refrigerant mass flow. In that case the compressor cut-out pressure will not be reached and the compressor will continue to run. The only limitation to stop the compressor is the maximum pumpdown time. **G11** should be adjusted in a way that, at all operating conditions, it allows pumpdown to compressor cut-out value **C02** plus a defined safety time, eg, 2 minutes.

2.15.4 Internal pumpdown with temperature sensor (case temperature)

It is also possible to carry out pumpdown functionality in case a temperature sensor is used for temperature control (not part of the standard delivery). Parameters **G56** and **S07** have to be set up as described in Chapter 2.15.3 "Pumpdown with room thermostat (not available on ZXDE units)".

The control of a cold room or cooling cabinet can be realized with a temperature sensor (change parameter **G01** according to the probe location). Parameter **A19** must be set up as thermostat

temperature. The temperature setpoint is defined by parameter **G02**. Adjust the temperature range with positive differential value **G03**.

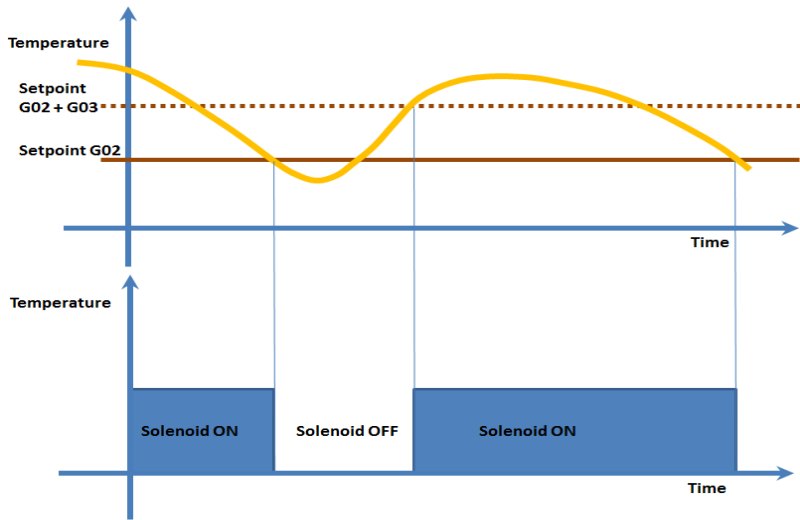

Figure 17: Pumpdown functionality with temperature sensor

If the temperature increases and reaches setpoint plus differential, the liquid line solenoid output relay will energize the coil to open the valve. The compressor will be controlled by suction pressure.

The temperature value is to be set between two parameters (**G04** and **G05**).

In case of fault in the thermostat probe the opening and the closing of the solenoid valve relay are timed through limp along parameters (**G06** and **G07**).

Parameter	Factory settings	Pumpdown settings / Comments
A19	0 = Not used = nu	2 = Thermostat temperature = tnt
C01	4 bar rel	Cut-in value for pumpdown
C02	2 bar rel	Cut-out value for pumpdown, eg, 0.2 bar rel
C05	1 = Suction pressure probe = SuP	2 = Case temperature probe = CSt
G01	0 = Not used = nu	4 = Thermostat temperature = tnt
G02	+2°C	Setpoint for temperature, eg, +2°C for meat
G03	+1°C	Positive differential defines upper cut-out value
G04	-10°C	Lower setpoint limit
G05	+15°C	Upper setpoint limit
G06	2 minutes	On time in case of probe failure
G07	1 minute	Off time in case of probe failure
G11	3 minutes	Maximum pumpdown time
G56	0 = Not used = nu	1 = Yes
S07	0 = Not used = nu	7 = Liquid line solenoid = LLS

Table 26: Internal pumpdown with temperature sensor

If temperature \geq **G02** + **G03**, switch on liquid line solenoid.

If temperature \leq **G02**, switch off liquid line solenoid and the compressor will continue to operate until most of the refrigerant on the low side boils off and is pumped through the compressor into the condenser and receiver. As the suction pressure falls below the low-pressure cut-out value (**C02**), the compressor will cycle off.

The temperature value depends both on parameter **G02** and parameter **G11** (maximum pumpdown time). It means that when the liquid line solenoid is off, the compressor will stop because of suction pressure decrease within **G11** time. If the running time of the compressor exceeds **G11** value, the compressor will be forced to shut down and the controller will generate a pumpdown alarm.

2.16 Reset to factory settings – Emerson "Hot Key"

2.16.1 How to save factory settings or user settings

There is no way to reset the XCM25D controller to factory settings other than with additional equipment. Emerson recommends to use the Emerson "Hot Key" (not part of the standard delivery) to save the factory settings at initial power up. The same hot key can also be used to save user settings.

By means of a special programming software (Emerson Wizmate) and corresponding hardware (Emerson Prog-Tool), the user can:

- preprogram hot keys;
- copy hot keys;
- change parameter levels;
- compare parameter lists.

For further information please visit our website at www.climate.emerson.com/en-gb or contact your local Application Engineering representative.

2.16.2 Applicable hot key for ZX units with XCM25D controller

The Emerson "Hot Key" **DK00000300** can be used for uploading and downloading of parameter lists. Copeland ident number 3226456.



Figure 18: Emerson "Hot Key"

2.16.3 Location of the "Hot Key" plug connection on the XCM25D controller

The "Hot Key" plug connection is located on the upper left corner of the XCM25D.

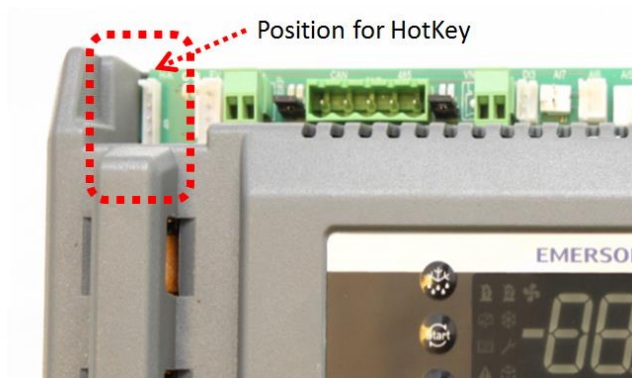

Figure 19: Location of "Hot Key" plug connection

2.16.4 How to program a "Hot Key" from the controller (upload)

- Program one controller with the front keypad.
- When the controller is on, insert the "Hot Key" and press the **UP** key; the "**uPL**" message appears followed a by a flashing "**End**" label.
- Press the **SET** key and the "**End**" label will stop flashing.
- Turn the controller off, remove the "Hot Key" then turn it on again.

NOTE: The "Err" message appears in case of a failed programming operation. In this case push the key again if you want to restart the upload or remove the "Hot Key" to abort the operation.

2.16.5 How to program a controller using an Emerson "Hot Key" (download)

- Turn the controller off.
- Insert a pre-programmed "Hot Key" into the 5-pin receptacle and turn the controller on.
- The parameter list of the hot key will be automatically downloaded into the controller memory. The "doL" message will blink followed a by a flashing "End" label.
- After 10 seconds the controller will restart working with the new parameters.
- Remove the "Hot Key".

NOTE: The message "Err" is displayed in case of a failed programming operation. In this case turn the unit off, then on again if you want to restart the download, or remove the "Hot Key" to abort the operation.

2.17 Troubleshooting – Alarm history

The controller records the total number of alarm activations (max 50) in the alarm menu (see Appendix 5).























Action	Key or display	Notes
Enter menu		Push and release the ALR key.
Waiting for action	SEC	The menu to change the section will be entered. The alarm list section is active.
Enter section list		Press SET to confirm. The following list will be available to select the proper network function.
Select active alarm code from list	 or 	Scroll the list of active alarms by alarm number (letter + number, A01-A50). Press  to see the alarm name or code. Press  to see the next active alarm.
Select the alarm to see the detailed rtC information		Enter the sub menu with alarm time details.
Select detailed information from active alarm list	 or 	<p><u>With the rtC activated:</u> The Hur (hour) parameter is displayed. Press  to see the alarm hour. Press : Min is displayed. Press  to see the alarm minute. Press : dAy is displayed. Press  to see the alarm day. Press : MOn is displayed. Press  to see the alarm month. Press : YEA is displayed. Press  to see the alarm year.</p> <p><u>Note: The clock info indicates the START time of the alarm.</u></p> <p><u>Without the rtC activated:</u> The COn (hours) parameter is displayed. Press  to see the compressor working hours.</p> <p>To exit: press  or wait for 15 seconds without pressing any key.</p>
Exit menu		Press  simultaneously or wait for about 10 seconds without pressing any key.

Table 27: How to check the alarm list

2.18 Compressor motor protection

The electronic controller protects the compressor motor against the following:

- over current;
- phase loss;
- incorrect phase rotation;
- voltage imbalance.

If the compressor motor current exceeds a predefined (non-adjustable) current limit, the electronic controller shuts the unit down and generates an error signal. For this function two of the main phase supply lines to the compressor (compressor via the contactor) are routed through the current sensors.

2.19 System pressure protection

2.19.1 High-pressure safety switch

A high-pressure switch is registered by the electronic board. The sensing device is a non-adjustable, high-pressure switch that will open in the event of an abnormally high discharge pressure (above 28 bar on ZXME & ZXLE units, 28.8 bar on ZXDE units).

- The unit will stop then and restart automatically after a 5-minute delay and after unit pressure has decreased to 21 bar (24 bar for ZXDE units).
- After 7 successive HP cut-outs over 1 hour, the unit will lock out. In this case a manual reset will be necessary.

2.19.2 High pressure: pressure relief valve

Units with serial numbers prior to 19CZ27683M (single-fan units) and 19DZ28816M (dual-fan units) are equipped with a side connection port at the top of the liquid receiver to connect a pressure relief valve. The thread is ¼"-NPT for serial numbers up to 16AZ07042M (single fan) and 16AZ07092M (dual fan), and ⅜"-NPT for subsequent serial numbers. In all cases the pressure relief valve is not factory-assembled.

Starting from serial number 19CZ27683M for single-fan units and 19DZ28816M for dual-fan units, no connection port is available on the liquid receiver any more.

2.19.3 Low-pressure safety switch – Optional

In a way similar to the high-pressure sensor, the electronic controller registers the switching action of the adjustable low-pressure switch, which will open in the event of an abnormally low suction pressure:

- The unit will stop then restart automatically after a 3-minute delay and when the unit reaches the cut-in pressure level.

The unit is always equipped with a suction pressure transmitter which also takes care for protection against vacuum operation. The use of the optional low-pressure cut-out will provide the highest protection level for the unit. In rare instances of controller breakdown the optional low-pressure switch would allow to run the unit in emergency mode.

2.20 Other inputs of the XCM25D controller

2.20.1 Customer-supplied control (room thermostat)

The electronic controller is equipped with a digital input (**DI3**) open/close signal (such as the switching action of a normal commercial thermostat) and relays a similar action as an output to the compressor contactor in the case of a thermostat-controlled (parameter "**C05**") system (see wiring diagrams in **Appendices 2 and 3**). If the system is controlled by low-pressure cut-out for a multiple evaporator system and/or pumpdown system, the controller XCM25D accepts signals directly from an adjustable low-pressure switch (optional).

2.20.2 Case temperature controller

An alternative method of system temperature control can be used. The electronic controller accepts an input from a common commercial thermostat (**DI3**, digital input). For details see Chapter 2.10.5 "Additional features for customization".

2.20.3 Ambient temperature sensor

An ambient temperature sensor is connected to the electronic controller. This temperature sensor has several functionalities like emergency mode control, lower fan speed limitation and crankcase heater control. The sensor is located on the backside of the compressor compartment.

2.21 Alarm output (DO5) of the XCM25D controller

The digital output **DO5** is pre-configured as an alarm contact. The relay (max. 5A, 250V AC) is activated in case of alarms and lockouts. Warnings will be shown only on the controller display.

3 Installation



WARNING

High pressure! Injury to skin and eyes possible! Be careful when opening connections on a pressurized item.

Copeland EazyCool ZX condensing units are delivered with a holding charge of neutral gas.

The condensing unit should be located in such a place to prevent any dirt, dust, plastic bag, leaves or papers from covering the condenser and its fins.

The unit must be installed without restricting the airflow.

A clogged condenser will increase the condensing temperature, thus reduce the cooling capacity, and lead to a high-pressure switch tripping. Clean the condenser fins on a regular basis.

3.1 Condensing unit handling

3.1.1 Transport and storage



WARNING

Risk of collapse! Personal injuries! Move units only with appropriate mechanical or handling equipment according to weight. Keep in the upright position. Respect stacking loads according to **Figure 20**. Do not stack anything on top of the unit packaging. Keep the packaging dry at all times.



Respect the maximum number of identical packages which may be stacked on one another, where "n" is the limiting number:

- **Transport: n = 0**
- **Storage: n = 0**

Figure 20: Maximum stacking loads for transport and storage

3.1.2 Weights

Condensing units					
Standard compressors				Digital compressors	
Medium temperature	Weight [kg]	Low temperature	Weight [kg]	Medium temperature	Weight [kg]
ZXME020E	76	ZXLE020E	79		
ZXME025E	79	ZXLE025E	81		
ZXME030E	79	ZXLE030E	81	ZXDE030E	82
ZXME040E	91	ZXLE040E	93	ZXDE040E	104
ZXME050E	108	ZXLE050E	106	ZXDE050E	108
ZXME060E	112	ZXLE060E	116	ZXDE060E	112
ZXME075E	118	ZXLE075E	126	ZXDE075E	118

Table 28: Weights

3.2 Refrigeration piping connections

3.2.1 Refrigeration piping installation



WARNING

High pressure! Risk of personal injury! The units are pressurized with dry air. Be careful when opening connections on a pressurized item.



WARNING

Low surface temperature! Danger of frostbite! The liquid line should be insulated with 19 mm insulation thickness. Temperature could be as low as -15°C .

IMPORTANT

Tubing quality! Installation contamination! All interconnecting piping should be of refrigeration grade, clean, dehydrated and must remain capped at both ends until installation. Even during installation, if the system is left for any reasonable period of time (say 2 hours), pipes should be re-capped to prevent moisture and contaminant from entering the system.

Connection sizes! Unsuitable refrigerant flow rate! Do not assume that the service connection sizes on the unit (at the service valves) are in fact the correct size to run your interconnecting refrigeration pipes. The service valve sizes have been selected for convenience of installation and in some cases (larger units) these may be considered too small. However, for the very short pipe run within our units these service connection sizes are adequate. All interconnecting piping should be sized to satisfy the duty required.

IMPORTANT

Absence of insulation on the liquid line in ZXLE units! Air moisture condensation and lack of performance! Moisture will condensate on the liquid line and cause water droplets. The liquid line can pick up additional heat from the ambient which will adversely affect the sub-cooling desirable for the liquid refrigerant before it enters the expansion valve. Insulate both the suction and liquid interconnecting piping between the ZX unit and the evaporator.

The pipe should be sized to ensure optimum performance and good oil return. The sizing must also take into account the full capacity range through which this particular unit will need to operate.

Unit	Suction line (ODS)	Liquid line (IDS)
ZXME020E to ZXME030E ZXDE030E ZXLE020E to ZXLE030E	3/4" (19.05 mm)	1/2" (12.7 mm)
ZXME040E to ZXME075E ZXDE040E to ZXDE075E ZXLE040E to ZXLE075E	7/8" (22.23 mm)	1/2" (12.7 mm)

Table 29: Piping connection sizes

Pipe runs should be kept as short as possible, using the minimum number of directional changes. Use large radius bends and avoid trapping of oil and refrigerant. This is particularly important for the suction line. The suction line should ideally slope gently towards the unit. Recommendation slope is 1/200 to 1/250. Upper and lower oil traps, double risers and reduced pipe diameters may be required for suction lines where long vertical risers cannot be avoided. 3/4

All pipes should be adequately supported to prevent sagging which can create oil traps. The recommended pipe clamp support distance is shown in **Table 30** below:

Tube size	Max distance between 2 clamp supports
1/2" (12.7 mm)	1.20 m
5/8" (16.0 mm)	1.50 m
7/8" (22.0 mm)	1.85 m
1 1/8" (28.5 mm)	2.20 m

Table 30: Maximum distance between 2 clamp supports

NOTE: It is strongly recommended to insulate both the suction and liquid interconnecting piping between the ZXLE unit and the evaporator.

3.2.2 Brazing recommendations

IMPORTANT

Blockage! Compressor breakdown! Maintain a flow of oxygen-free nitrogen through the system at very low pressure during brazing. Nitrogen displaces the air and prevents the formation of copper oxides in the system. If allowed to form, the copper oxide material can later be swept through the system and block screens such as those protecting capillary tubes, thermal expansion valves, and accumulator oil return holes.

Contamination or moisture! Bearing failure! Do not remove the plugs until the compressor is set into the unit. This minimises any entry of contaminants and moisture.

- Remove the discharge connection cap.
- Remove the suction connection cap.
- Open both valves mid-way. Care should be taken to avoid the holding charge releasing too quickly.
- Be sure tube fitting inner surface and tube outer surface are clean prior to assembly.
- Both tubes are extended from the condensing unit housing, therefore we recommend to isolate the housing by using a wet cloth on the copper tubing.
- Recommended brazing materials: a copper/phosphorous or copper/phosphorous/silver alloy rod should be used for joining copper to copper whereas to join dissimilar or ferric metals a silver alloy rod either flux coated or with a separate flux would be used.
- Use a double-tipped torch.

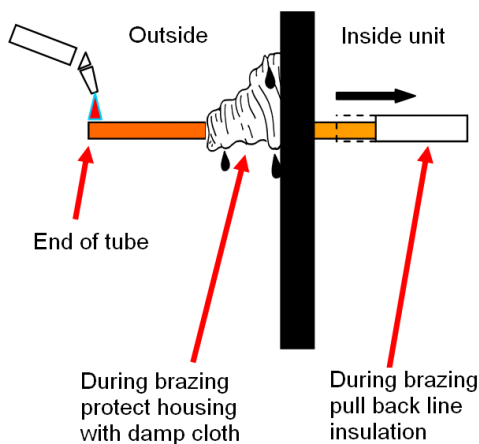

Figure 21: Brazing - Sectional view

3.2.3 Brazing procedure

For brazing of the tubes, please refer to **Figure 22** and procedure hereunder:

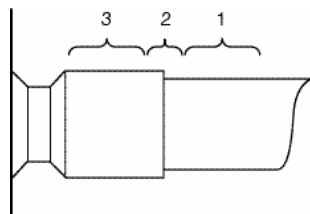

Figure 22: Suction tube brazing areas

- Fit the copper tube into the unit tube.
- Heat area 1. As the tube approaches brazing temperature,
 - Heat area 2 until braze temperature is attained. It is necessary to heat the tube evenly. Move the torch up and down and rotating around the tube.
 - Add braze material to the joint while moving the torch around the joint to flow braze material around the circumference.

- Then heat area 3. This will draw the brazing material down into the joint.

NOTE: The time spent heating area 3 should be minimal. As with any brazed joint, overheating may be detrimental to the final result.

To disconnect:

- Heat joint areas 2 and 3 slowly and uniformly until solder softens and tube can be pulled out of the fitting.

To reconnect:

- See procedure above.

3.3 Electrical connection



WARNING

Electrical shock hazard! Serious personal injuries! The power supply of these units must include an RCD protection with a sensitivity of 30 mA.



IMPORTANT

The front cover of the electrical box is protected by a ground connection. Open the electrical box cover carefully to avoid pulling out the ground wire.

3.3.1 Power supply connections



WARNING

Electrical pins under voltage! Electrical shock hazard! There are unused fast-on pins (**C1 & DO2**) on the XCM25D which could be under voltage. They are covered by insulated fast-on flags in the factory. Handle carefully when removing insulating flags during service on site.

The electrical connection of the condensing unit to the power supply must be made by qualified technicians according to the valid electrical directives, for instance DIN EN 60204-1. The voltage drop and temperatures on line must also be considered for cable selection.

Copeland EazyCool ZX units are designed for a 380-420V / 3Ph / 50 Hz power supply for TFD and 220-240V / 1Ph / 50 Hz power supply for PFJ. A voltage tolerance of ± 10% is acceptable.

The circuit breaker must be switched off before opening the front door.

3.3.2 Maximum operating currents for cable selection

Unit model	Locked rotor	Rated current A
ZXME Medium-temperature standard units, single-phase PFJ		
ZXME020E-PFJ	58.0	13.3
ZXME025E-PFJ	61.0	12.9
ZXME030E-PFJ	82.0	16.9
ZXME040E-PFJ	114.0	24.0
ZXME Medium-temperature standard units, three-phase TFD		
ZXME020E-TFD	26.0	5.4
ZXME030E-TFD	40.0	7.7
ZXME040E-TFD	49.3	10.8
ZXME050E-TFD	65.5	13.8
ZXME060E-TFD	74.0	14.1
ZXME075E-TFD	101.0	15.0
ZXDE Medium-temperature Digital units, three-phase TFD		
ZXDE030E-TFD	40.0	7.2
ZXDE040E-TFD	48.0	8.9
ZXDE050E-TFD	64.0	12.3
ZXDE060E-TFD	74.0	12.4
ZXDE075E-TFD	100.0	15.0
ZXLE Low-temperature units, single-phase PFJ		
ZXLE020E-PFJ	56.6	14.1
ZXLE025E-PFJ	73.7	16.1
ZXLE030E-PFJ	82.3	18.3
ZXLE Low-temperature units, three-phase TFD		
ZXLE020E-TFD	39.2	6.2
ZXLE030E-TFD	35.7	7.2
ZXLE040E-TFD	51.5	9.7
ZXLE050E-TFD	51.5	12.9
ZXLE060E-TFD	74.0	14.7
ZXLE075E-TFD	101.0	15.6

Table 31: Unit maximum rated currents for cable selection

3.3.3 Electrical wiring

Before commissioning, ensure that the neutral "N" and ground protection "PE" wires are connected to the main switch.

3.3.4 Electrical protection standard (protection class)

- Units: IP class IPX4.
- Scroll compressors up to ZX51: IP21 according to IEC 34.
- Fan: IP44 according to IEC 34.
- Solenoid valve coils: IP65 according to DIN 43650.

3.3.5 Main fuses

WARNING  **Isolating switch "On"! Danger of electric shock!** Before changing the fuses, turn the isolating switch off to de-energize the unit.

Follow the steps described below to replace the main fuses:

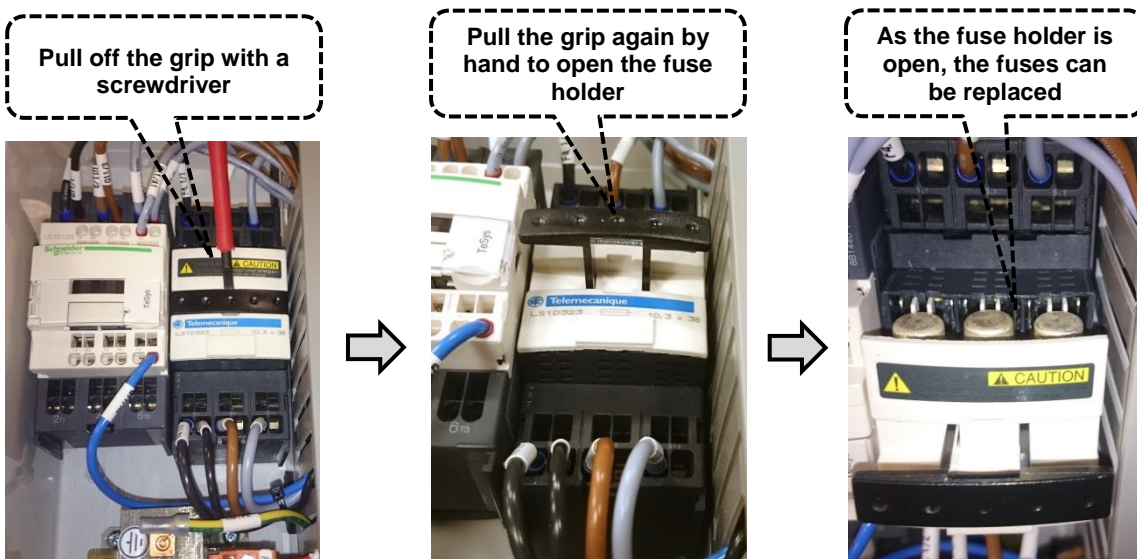
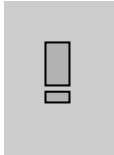

Figure 23: Replacement of the fuses

Unit	Fuse size	Fuse range	Ident number
ZXME020E to ZXME040E-TFD ZXLE020E to ZXLE040E-TFD ZXDE030E to ZXDE060E-TFD	3 x Fuse 10x38	12A	3200810
ZXME050E to ZXME075E-TFD ZXLE050E to ZXLE075E-TFD ZXDE075E-TFD	3 x Fuse 10x38	16A	3200821
ZXME020E to ZXME030E-PFJ ZXLE020E to ZXLE030E-PFJ	1 x Fuse 10x38	20A	3200832
ZXME040E-PFJ	1 x Fuse 10x38	25A	3200843

Table 32: Main fuses sizes and ranges

3.4 Location & fixings



IMPORTANT

Dust and dirt contamination! Unit lifetime reduction! The unit should always be installed in a location that ensures clean air flow. External fouling of the condenser fins also leads to high condensing temperatures and will reduce the lifetime of the unit.

It is recommended that a clearance of 300 mm from the wall (or the next unit) be maintained from the unit left and rear panels whereas a clearance of 500 mm must be maintained from the unit right, top and front panels seen facing the front of the unit – see **Figures 24 & 25**. Both service access and airflow have been considered in making these recommendations.

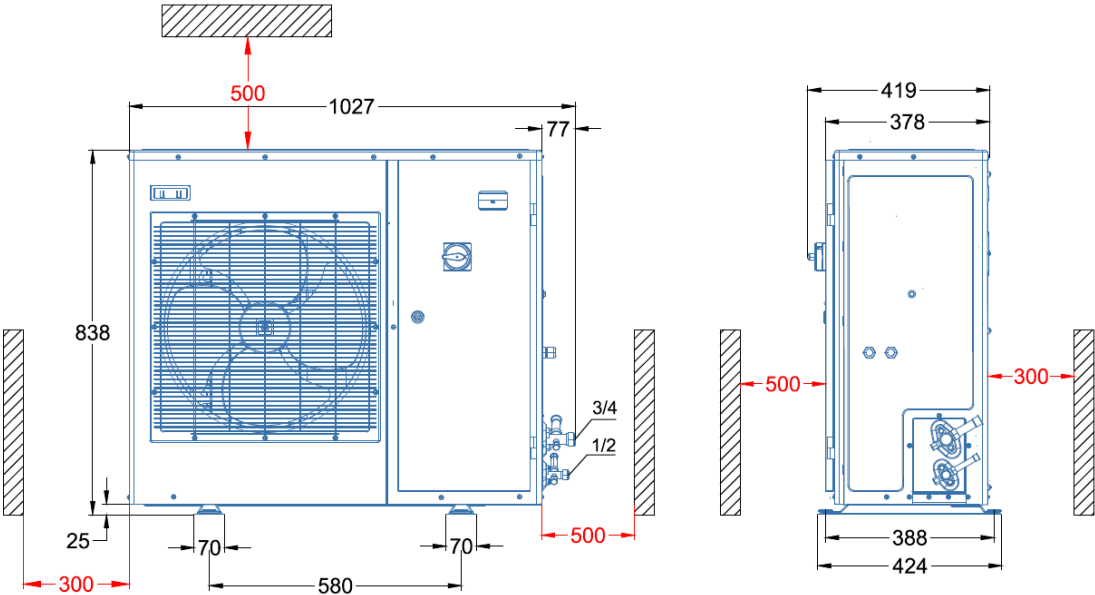

Figure 24: Fixing dimensions and distances – Single-fan units

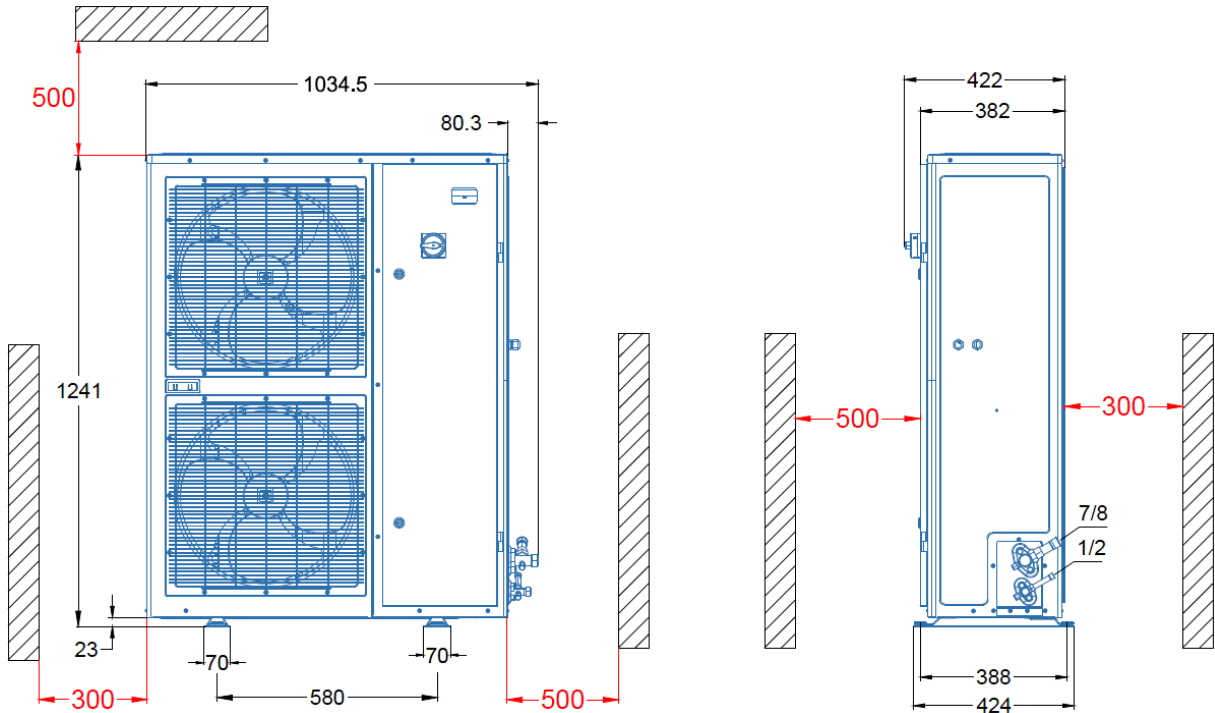

Figure 25: Fixing dimensions and distances – Dual-fan units

Where multiple units are to be installed in the same location, the contractor needs to consider each individual case carefully. There can be many variations of unit quantities and available space and it is not the intention of this manual to go over these. However, in general terms, air by-pass around each condenser and between the units should be avoided at all times.

Ideally, the unit should be mounted level on a solid concrete slab with anti-vibration pads between unit feet and concrete. However, the ZX condensing unit has also been designed for wall mounting on suitable brackets. In this case it is equally important that the dimensional guidelines given above are followed and that additional consideration is given for possible air recycling if units are stacked on top of each other. Wall mounting brackets are not part of the standard delivery.

Another factor to consider in finding a good installation site is the direction of the prevailing wind. For example, if the air leaving the condenser faces the prevailing wind, the air flow through the condenser can be impeded, causing high condensing temperatures and ultimately resulting in reducing the life of the unit. A baffle is a remedy for this situation.

4 Start-up & operation

Before commissioning, ensure that all valves on the condensing unit are fully opened.

4.1 Evacuation



CAUTION

System pressure below atmospheric pressure! Compressor damage!

Never energize the unit/controller without minimum refrigerant system charge. There is a risk of malfunction of the controller in deep vacuum operation which can cause compressor damage.



IMPORTANT

The evacuation procedure is based upon achieving an actual system vacuum standard and is NOT TIME DEPENDENT! The installation has to be evacuated with a vacuum pump before commissioning. Proper evacuation reduces residual moisture to 50 ppm. The installation of adequately sized access valves at the furthest point from the compressor in the suction and liquid lines is advisable. The system must be evacuated down to less than 3 mbar. If required break the vacuum with dry nitrogen. Pressure must be measured using a vacuum pressure gauge on the access valves and not on the vacuum pump. This serves to avoid incorrect measurements resulting from the pressure gradient along the connecting lines to the pump.

4.2 Charging procedure

4.2.1 Refrigerant charging procedure



IMPORTANT

Inadequate charge! Overheating! The Scroll compressor design requires system charging as quickly as possible with liquid refrigerant into the liquid line. This will avoid running the compressor under conditions whereby insufficient suction gas is available to cool not only the motor but also the scrolls. Temperature builds up very quickly in the scrolls if this is not done.

Service valve closed! Compressor damage! Do not charge the unit with vapour (gas). The suction service valve must not be fully closed at any time when the compressor is running. To do so would cause damage to the compressor in the same manner as explained above. This valve is provided for ease of connection and for the fitting of service gauges without removing the unit panel.



IMPORTANT

Absence of insulation on the liquid line in ZXLE units! Air moisture condensation and lack of performance! Moisture will condensate on the liquid line and cause water droplets. The liquid line can pick up additional heat from the ambient which will adversely affect the sub-cooling desirable for the liquid refrigerant before it enters the expansion valve. Both the suction and liquid interconnecting piping between the unit and the evaporator should be insulated to avoid condensation.

Pre-charging must be carried out with liquid refrigerant through the service valve on the liquid line. It is advisable to pre-fill the suction side with a partial charge to avoid vacuum operation. Further charging can be carried out by carefully filling refrigerant through the suction line while simultaneously checking the sight glass.

NOTE: In order to meet the requirements of the Ecodesign Directive 2009/125/EC with regard to efficient system operation, ensure the refrigerant charge is sufficient.

NOTE: During the charging process on ZXLE units, the liquid line (outlet of the unit) temperature must be checked. The charging is sufficient when the liquid line temperature does not decrease significantly anymore and when the subcooling reaches approximately 25-35K.

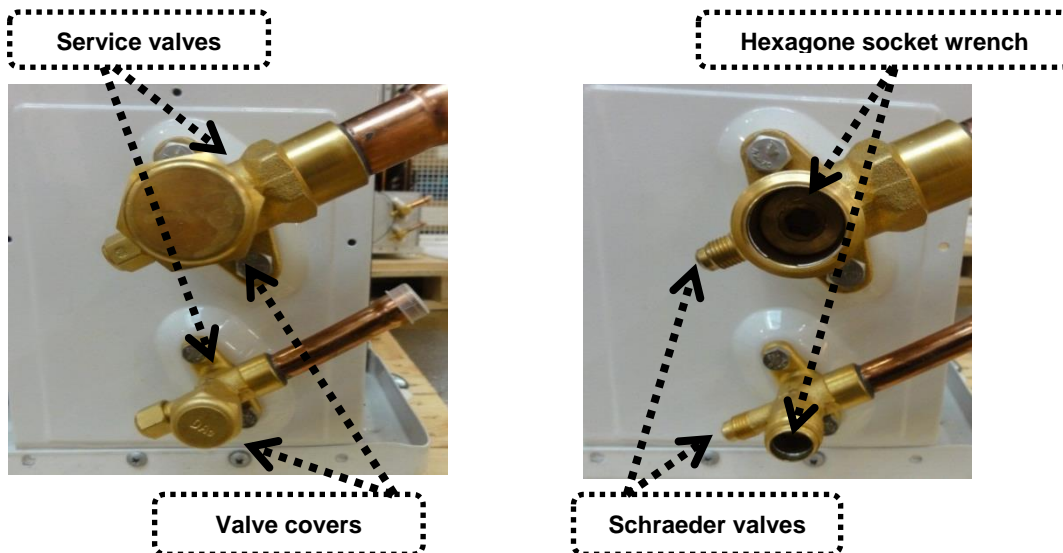

Figure 26: Service valves for refrigerant charging



Figure 27: Liquid line service port

An additional Schraeder connection is fitted on the liquid line below the filter drier in the compressor chamber. It is also possible to use this connection for charging or servicing.

Recommendation is to break vacuum in the system with partial charge of refrigerant, then start the system.

For charge adjustment it is recommended to check the liquid sight glass just before the expansion valve.

NOTE: During the charging process on low temperature ZXLE units, an error message E47 and/or E48 could occur. Both warnings indicate a lack of refrigerant charge in the system. The operation of the unit is not affected by the warning signals. Continue charging the system: as the quantity of refrigerant increases, the warning signals will automatically switch off.

4.2.2 Oil charging procedure

Copeland EazyCool ZX condensing units are pre-charged with oil. After commissioning, the oil level should be checked and topped up if necessary.

NOTE: The oil level should be approximately halfway up the sight glass.

As mentioned in chapter 2.6.1 "Qualified refrigerants and oils", Emerson recommends charging with one of the following oil types:

- Emkarate RL 32 3MAF
- Mobil EAL Arctic 22 CC

Charging is done through the Schraeder valve located on the suction valve.

4.2.3 Oil separator

ZXDE & ZXLE units are equipped with an oil separator. This separator is pre-charged with 0.5 liter of oil.

4.3 Rotation direction of Scroll compressors

Scroll compressors, like several other types of compressors, will only compress in one rotational direction. Direction of rotation is not an issue with single-phase compressors since they will always start and run in the proper direction. Three-phase compressors are protected against wrong rotation field by the unit controller.

4.4 Maximum compressor cycle

Maximum permitted starts per hour: 10. The factory setting of the XCM25D system controller already takes into account the maximum permitted starts and stops of the compressor and also controls running time and minimal downtime. It is recommended to change these settings only in exceptional cases.

4.5 Checks before starting & during operation



IMPORTANT

Liquid valves not fully opened! Liquid trap! Both valves should be fully opened on the liquid line in order to prevent liquid trapping.

Before a system runs for the first time:

- Check that the valves on the liquid line are fully opened.
- Set the essential parameters of the electronic controller in the programming level 1 (compressor cut-out/cut-in settings, condensing fan setpoint...) according to the required application.
- Carry out visual inspection.
- Perform control tests to ensure all controls operate correctly, including any manual backup system (if applied).
- Check also the following:
 - ✓ Documentation for the system and its marking, especially pressure equipment.
 - ✓ Installation of safety devices.
 - ✓ Compressor oil level.
 - ✓ Pressure test records.
 - ✓ All valves open/closed as required for operation.

After start-up and when operation conditions have stabilised:

- It is recommended to check the oil level in the compressors and to add oil if necessary to ensure a sufficient oil level (halfway up the sight glass).
- The following should also be checked:
 - ✓ Fan rotation.
 - ✓ Refrigerant charge.
 - ✓ Expansion valve superheat.

5 Maintenance & repair

5.1 Replacing a compressor



CAUTION

Inadequate lubrication! Bearing destruction! Exchange the accumulator after replacing a compressor with a burned-out motor. The accumulator oil return orifice or screen may be plugged with debris or may become plugged. This will result in starvation of oil to the new compressor and a second failure.

In the case of a motor burnout, the majority of contaminated oil will be removed with the compressor. The rest of the oil is cleaned through the use of suction and liquid line filter driers. A 100% activated alumina suction line filter drier is recommended but must be removed after 72 hours. **It is highly recommended to replace the suction accumulator, if the system contains one.** This is because the accumulator oil return orifice or screen may be plugged with debris or may become plugged shortly after a compressor failure. This will result in starvation of oil to the replacement compressor and a second failure. When a compressor is exchanged in the field, it is possible that a major portion of the oil may still be in the system. While this may not affect the reliability of the replacement compressor, the extra oil will add to rotor drag and increase power usage.

- De-energize the condensing unit before any intervention.
- Close valves to isolate the unit from the system.
- Recover the refrigerant from the unit and make sure that the compressor is not under pressure.
- Release the compressor mounting parts then lift the compressor and replace it with the new one.

NOTE: For more detailed instructions, please refer to the compressor application guidelines.

5.2 Condenser fins



CAUTION

Acid cleaning! Corrosion of condenser fins! Do not use acidic solutions to clean the coil. After cleaning, the fins should be brushed lightly with a proper fin comb.

Condenser fins become dirty over time as ambient air is induced to the condenser. Dirty coil surfaces result in high condensing temperatures and poor unit performance. Regular cleaning is recommended, the frequency of doing so being dependent on the installation and the surrounding environment. As a general guide it is advisable to do this at least once every two months.

As a general rule and for a clean environment we recommend that the fins be cleaned with liquid detergent diluted with clean water. The ZX unit has a well-designed chassis with falling levels towards a large drainage hole and provided the unit is installed level, any cleaning solution should be able to drain away. A light brush downward (in the direction of the fins) should be done before washing to remove heavy deposits.

NOTE: In order to meet the requirements of the Ecodesign Directive 2009/125/EC with regard to efficient system operation, ensure the heat exchangers remain clean at all times.

5.3 Electrical connections



WARNING

Isolating switch "On"! Danger of electric shock! Before undertaking any task on the electrical equipment, turn off the main power supply to de-energise the unit.

All condensing units will generate some degree of vibration. Copeland EazyCool ZX units are no exception. However, the vibration level from the compliant scroll technology is less severe than in units using reciprocating compressor technology. Thanks to this reduced vibration, these units can be mounted on simple, less expensive rubber mounting pads.

Nevertheless, over time, due to these slight vibrations and to temperature fluctuations within the unit housing, electrical terminations might become loose. The components most likely to be affected are the main terminal strip and the compressor contactor. It is suggested to check the main electrical terminations for tightness and to carry out a visual inspection of the low voltage crimped terminals at least once every 6 months.

5.4 Routine leak testing

All joints inside the system should be leak-tested as part of a regular maintenance schedule.

NOTE: In order to meet the requirements of the Ecodesign Directive 2009/125/EC with regard to efficient system operation, ensure the refrigerant and oil charges are sufficient.

5.5 Condenser fan(s) & motor(s)

A yearly inspection of these items is recommended. Fastenings can become loose, bearings may wear and fans may require cleaning of solid deposits that can cause rotational imbalance.

Motors come with lifelong lubrication bearings that do not require lubricating on a routine basis, but just need to be checked for wear.

6 Certification & approval

- Copeland EazyCool ZX condensing units comply with the Low Voltage Directive LVD 2014/35/EU. The applied harmonised standard is EN 60335 (Household and similar electrical appliances – Safety, Part 1: General Requirements and Part 2-89: Particular requirements for commercial refrigerating appliances with an incorporated or remote refrigerant condensing unit or compressor).
- The condensing units and their piping comply with the Pressure Equipment Directive PED 2014/68/EU (Art.4 §3 - Sound Engineering Practice).
- The condensing units and their components are CE marked as far as required and thereby establish conformity with the relevant directives.
- Conformity Declarations for components are available as far as required.
- The Manufacturer's Declaration of Incorporation has to be respected when incorporating these products into a machine.

7 Dismantling & disposal



Removing oil and refrigerant:

- **Do not disperse in the environment.**
- **Use the correct equipment and method of removal.**
- **Dispose of oil and refrigerant according to national legislation and regulations.**

Dispose of compressor and/or unit according to national legislation and regulations.

DISCLAIMER

1. The contents of this publication are presented for informational purposes only and are not to be construed as warranties or guarantees, express or implied, regarding the products or services described herein or their use or applicability.
2. Emerson Climate Technologies GmbH and/or its affiliates (collectively "Emerson"), as applicable, reserve the right to modify the design or specifications of such products at any time without notice.
3. Emerson does not assume responsibility for the selection, use or maintenance of any product. Responsibility for proper selection, use and maintenance of any Emerson product remains solely with the purchaser or end user.
4. Emerson does not assume responsibility for possible typographic errors contained in this publication.

Appendix 1: Overview of the ZX unit components

Components	Medium temperature	Medium temperature	Low temperature
	Standard	Digital	Standard
	ZXME	ZXDE	ZXLE
Compressor M1	✓	✓	✓
Fan M2.1	✓	✓	✓
Fan M2.2	ZXME050E – ZXME075E	✓	ZXLE050E & ZXLE060E
Y1 Stepper valve EVI	[-]	[-]	✓
Y1 Stepper valve liquid	✓	[-]	[-]
Y2 DGS solenoid valve	[-]	✓	[-]
E1 Crankcase heater	✓	✓	✓
S1 High-pressure switch	✓	✓	✓
S2 Low-pressure switch	[-]	[-]	[-]
S3 Room thermostat (optional)	[-]	[-]	[-]
B1 Pressure transducer suction	✓	✓	✓
B2 Pressure transducer discharge	✓	✓	✓
B3 DLT NTC discharge	✓	✓	✓
B4 EVI vapour in sensor NTC	[-]	[-]	✓
B5 EVI vapour out sensor NTC	[-]	[-]	✓
B6 Ambient temperature sensor NTC	✓	✓	✓
B7 Temperature sensor (optional)	[-]	[-]	[-]

Table 33: Overview of the ZX unit components

Appendix 2: Wiring diagram – ZXME / ZXLE / ZXDE units (380-420V / 3 Ph / 50 Hz)

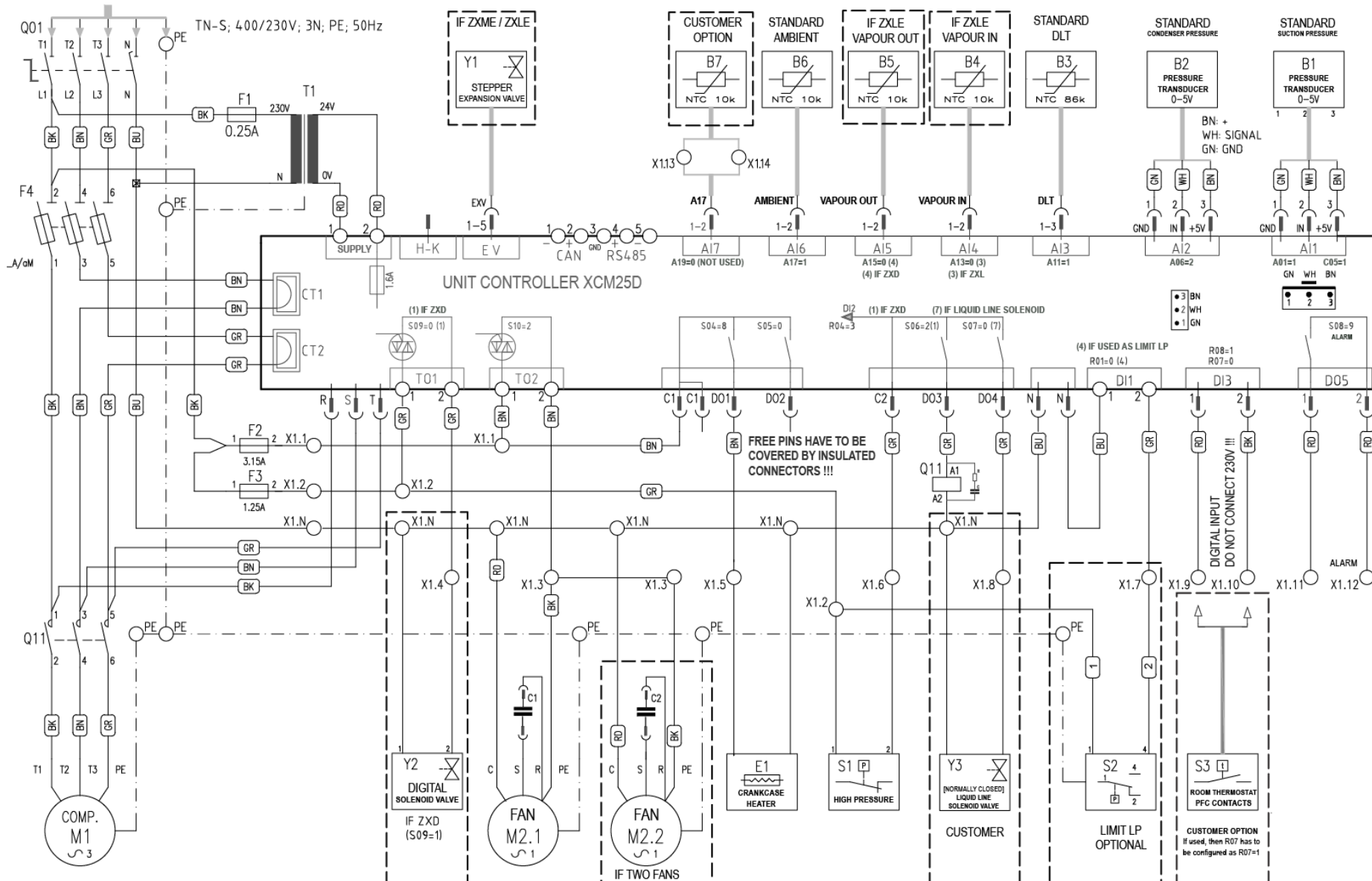

Figure 28: Wiring diagram – 3-Phase motor

C6.1.6/1017-1219/E

Appendix 3: Wiring diagram – ZXME / ZXLE units (230V / 1 Ph / 50 Hz)

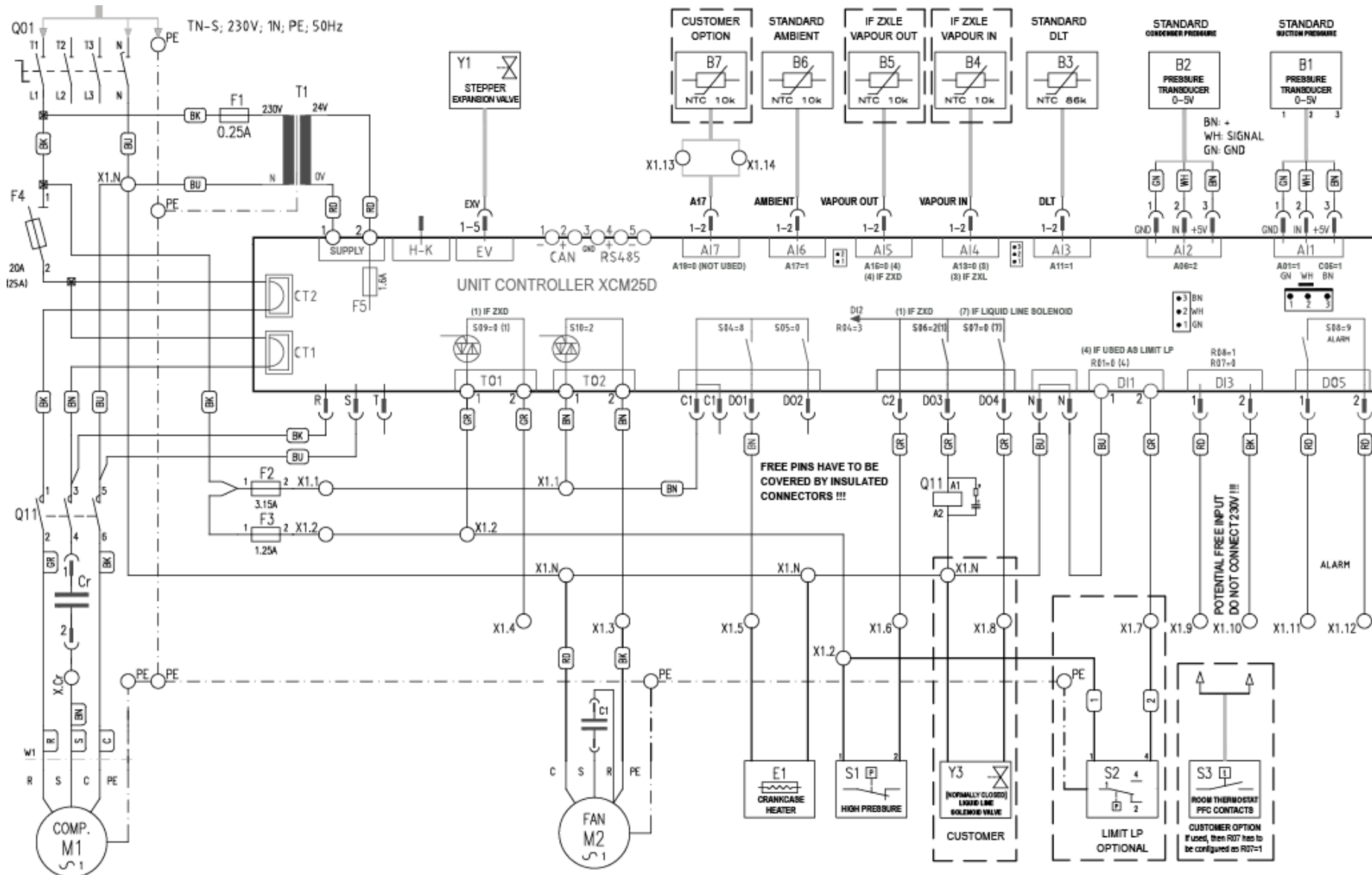

Figure 29: Wiring diagram – 1-Phase motor

Appendix 4: Parameters level 1

Legend

L1 = Parameter in level 1 (without password)

L2 = Parameter in level 2 (with password = 3 2 1)

N.V. = Parameter not accessible

NOTE: When changing parameters C01 (Cin), C02 (CoU) and C05 (CPb) a reset of the controller (interruption of power supply) is required.

Parameter	Description	Range	ZXDE	ZXME	ZXLE
C01	Compressor cut-in pressure setpoint	CoU to US; C02 to C04	N.V.	L1	L1
C02	Compressor cut-out pressure setpoint	LS to Cin; C03 to C01	L2	L1	L1
C07	Refrigerant selection for regulation	R404A (0-404) - R507 (1-507) R134a (2-134) - R22 (3-R22) R407C (4-07C) - R407A (5-07A) R407F (6-07F) - R448A (7-48A) R449A (8-49A)	L1	L1	L1
C16	Digital compressor setpoint	LS to US; C03 to C04	L1	N.V.	N.V.
C17	Proportional band for compressor regulation	0.1 to 9.9 bar; 0.1 to 99.9 PSI; 1 to 999 KPA; 0.1°C to 25.5°C	L1	N.V.	N.V.
C21	Cycle time for digital compressor	10 to 40 sec	L1	N.V.	N.V.
C24	Minimum capacity for digital compressor	0 to PMA; 0 to C25	L1	N.V.	N.V.
C25	Maximum capacity for digital compressor	PMi to 100; C24 to 100	L1	N.V.	N.V.
D29	Low pressure alarm value (from serial number 16EZ08855M onwards)	0 to 15 bar	L1	L1	L1
E39	Condenser temperature setpoint when fan setpoint modulation is disabled	-40°C to 110°C	L1	L1	L1
E46	Regulation band of variable fan	0.1°C to 25.5°C	L1	L1	L1
N01	Current minute	0 to 59	L1	L1	L1
N02	Current hour	0 to 23	L1	L1	L1
N03	Date of month	1 to 31	L1	L1	L1
N04	Month	1 to 12	L1	L1	L1
N05	Year	0 to 99	L1	L1	L1
T18	Access to Pr2 level	[0÷999]	L1	L1	L1

Table 34: Parameters level 1

Appendix 5: Alarm menu

Code	Description	Cause	Action	Reset
E01	AI1 error (Probe 1/Suction pressure transducer failure alarm)	Probe failure or out of range	Only in digital unit - compressor is activated according to C23, and compressor on & off time is according to D02 & D03	Automatically as soon as the probe restarts working.
E02	AI2 error (Probe 2/mid-coil temperature sensor failure alarm)	Probe failure or out of range	The fan speed control is disabled	Automatically as soon as the probe restarts working.
E03	AI3 error (Probe 3/discharge line temperature sensor failure alarm)	Probe failure or out of range	The discharge temperature control is disabled	Automatically as soon as the probe restarts working.
E04	AI4 error (Probe 4/PHE vapour inlet temperature sensor failure alarm)	Probe failure or out of range	PHE superheat control is disabled (ZXLE/ZXME units)	Automatically as soon as the probe restarts working.
E05	AI5 error (Probe 5/PHE vapour outlet temperature sensor failure alarm)	Probe failure or out of range	PHE superheat control is disabled (ZXLE/ZXME units)	Automatically as soon as the probe restarts working.
E06	AI6 error (Probe 6/ambient temperature sensor failure alarm)	Probe failure or out of range	The functions related to probe 6 (ambient sensor) are disabled	Automatically as soon as the probe restarts working.
E07	AI7 error	Probe failure or out of range		
E08	Battery error			
E09	Current sensor 1 error	Probe out of range	The functions related to the current sensor are disabled	Automatically as soon as the probe restarts working.
E10	Current sensor 2 error	Probe out of range	The functions related to the current sensor are disabled	Automatically as soon as the probe restarts working.
E11	Voltage sensor 1 error	Probe out of range	The functions related to the current sensor are disabled	Automatically as soon as the probe restarts working.
E12	Voltage sensor 2 error	Probe out of range	The functions related to the current sensor are disabled	Automatically: as soon as the probe restarts working.
E13	Voltage sensor 3 error	Probe out of range	The functions related to the current sensor are disabled	Automatically as soon as the probe restarts working.
E14-E19	Reserved			

Code	Description	Cause	Action	Reset
E20	Lost phase error	Power supply phase loss (3-phase unit)	The compressor will trip	Automatically: lost phase recover and H08 delay time out. If all three phases are present but the controller still shows the error message, set parameters H06 and H25 to "No".
L20	Lost phase lockout	Power supply phase loss happened for H12 time within one hour (3-phase unit)	The compressor will lock out	Hold "start" button for 5 sec or manual power off and on. If all three phases are present but the controller still shows the error message, set parameters H06 and H25 to "No".
L21	Phase sequence lockout	Incorrect phase sequence (3-phase unit)	The compressor will lock out, rotation field has to be changed	Manual power off, invert 2 phases and power on. If the phase sequence is correct but the controller still shows the error message, set parameter H25 to "No".
E22	Phase imbalance	One phase voltage lower than H18 percentage of 3 phases average voltage (3-phase unit)	The compressor is activated according to H19	Automatically: voltage recover and H16 setting delay time-out. If all three phases are present but the controller still shows the error message, set parameter H06 to "No".
E23	Over current	Electrical current larger than H09 setting	The compressor will trip	Automatically: H08 delay time-out. If the current is within the limits but the controller still shows the error message, set parameter H06 to "No".
L23	Over current lockout	Over current happened for H11 times within one hour	The compressor will lock out (if H11 equal to 0, no compressor lockout)	Hold "start" button for 5 sec or manual power off and on (if H11 equal to 0, compressor automatically starts after H08 delay time-out). If the current is within the limits but the controller still shows the error message, set parameter H06 to "No".
E24	Open run circuit error	Motor running winding open (1-phase unit)	The compressor will trip	Automatically: H08 delay time-out.
L24	Open run circuit lockout	Motor running winding open error happened for H12 times within one hour (1-phase unit)	The compressor will lock out (if H12 equal to 0, no compressor lockout)	Hold "start" button for 5 sec or manual power off and on (if H12 equal to 0, compressor automatically starts after H08 delay time-out).
E25	Open start circuit error	Motor start winding open (1-phase unit)	The compressor will trip	Automatically: H08 delay time-out.
L25	Open start circuit lockout	Motor start winding open error happened for H12 times within one hour (1-phase unit)	The compressor will lock out (if H12 equal to 0, no compressor lockout)	Hold "start" button for 5 sec or manual power off and on (if H12 equal to 0, compressor automatically starts after H08 delay time-out).

Code	Description	Cause	Action	Reset
E26	Under voltage alarm	Voltage lower than H13 setting for H15 seconds	The compressor will trip	Automatically: voltage is back within acceptable range and H16 delay time-out. If the voltage corresponds to the required voltage but the controller still shows the error message, set parameter H06 to "No".
L26	Under voltage lockout	Under voltage happened for H17 times within one hour	The compressor will lock out (if H17 equal to 0, no compressor lockout)	Hold "start" button for 5 sec or manual power off and on (if H17 equal to 0, compressor automatically starts when voltage is back within acceptable range and H16 delay time-out). If the voltage corresponds to the required voltage but the controller still shows the error message, set parameter H06 to "No".
E27	Over voltage alarm	Voltage larger than H14 setting for H15 seconds	The compressor will trip	Automatically: voltage is back within acceptable range and H16 delay time-out. If the voltage corresponds to the required voltage but the controller still shows the error message, set parameter H06 to "No".
L27	Over voltage lockout	Over voltage happened for H17 times within one hour	The compressor will lock out (if H17 equal to 0, no compressor lockout)	Hold "start" button for 5 sec or manual power off and on (if H17 equal to 0, compressor automatically starts when voltage is back within acceptable range and H16 delay time-out). If the voltage corresponds to the required voltage but the controller still shows the error message, set parameter H06 to "No".
E28	Compressor built-in protector trip	Compressor built-in thermal protector trips	Warning signal only	Automatically: as soon as electrical current is detected. Check the voltage coming to the compressor.
E30	Main power lost	Controller power supply lost		
E40	High-pressure switch alarm	High-pressure switch open	The compressor will trip	Automatically: high-pressure switch closed and D14 delay time-out. If the high pressure is below the limit but the alarm is still on, check fuse F3.
L40	High-pressure switch lockout	High-pressure switch open error happened D15 times within one hour	The compressor will lock out (if D15 equal to 0, no compressor lockout)	Hold "start" button for 5 sec or manual power off and on (if D15 equal to 0, compressor automatically starts when high-pressure switch is closed and D14 delay time-out). If the high pressure is below the limit but the alarm is still on, check fuse F3.

Code	Description	Cause	Action	Reset
E41	Low-pressure switch alarm	Low-pressure switch open	The compressor will trip	Automatically: low-pressure switch closed and D28 delay time-out.
E43	Low pressure alarm	The pressure is below D29	Warning signal only	To deactivate the alarm function set parameter D13 to "No".
E44	Discharge line temperature alarm	Discharge line temperature higher than D22 for D24 seconds	The compressor will trip	Automatically: discharge line temperature lower than D23 setting and D25 delay time-out.
L44	Discharge line temperature lockout	Discharge line temperature overheat happened for D26 times within one hour	The compressor will lock out (if D26 equal to 0, no compressor lockout)	Hold "start" button for 5 sec or manual power off and on (if D26 equal to 0, compressor automatically starts when discharge line temperature is lower than D23 setting and D25 delay time-out).
E45	High condenser pressure alarm	Not used		
E46	High condenser temperature alarm	Condenser temperature larger than E58 for E59 minutes	The compressor is activated according to E60	Automatically: as soon as condenser temperature is lower than E61.
E47	EXV full open in EVI	EXV full open for F40 minutes	Warning signal only	Automatically: as soon as EXV is not at maximum steps.
E48	Refrigerant shortage error in EVI	EXV full open and PHE super heat is larger than (F28/F29.../F37 + F39) (F28/F29.../F37 depends on refrigerant type)	Warning signal only	Automatically: as soon as PHE super heat is lower than (F28/F29.../F37 + F39).
E49	Pumpdown alarm	Not used		
E50	High side floodback alarm	The differential temperature between discharge and mid-coil is lower than H21 for accumulated H22 minutes in H23 minutes	Warning signal only	Automatically: as soon as differential temperature between discharge and mid-coil is larger than H21 for H24 minutes.
E60	Max pressure alarm of superheating	Not used		

Code	Description	Cause	Action	Reset
E61	Min pressure alarm of superheating	Not used		
E62	High superheating alarm	Not used		
E63	Low superheating alarm	Not used		
E64	High room temperature alarm	Not used		
E65	Low room temperature alarm	Not used		
E66	Open door alarm	If the door is open longer than dSA/G53	Warning signal only if rrd/G09 is "no" Alarm and compressor trip if rrd/G09 is "yes"	Manual or automatic – see Action.
E67-E79	Reserved			
E80	rtC warning, date error	HW problem in the board	Disable the rtC or change the board	
E81	rtC warning, communication error	HW problem in the board	Disable the rtC or change the board	
E82	Probe configuration error			
E83	DI configuration error			
E84	Compressor configuration error			
E85	Injection probe configuration error	Injection EXV output mode is selected, but no relevant sensors	Injection EXV will not work	Automatically: as soon as the injection EXV is properly configured.
E86	EEPROM R/W error (manual)	HW problem in the board	Change the board	
E87-E99	Reserved			

Table 35: Alarm code overview

Appendix 6: Additional features for customization

Required setting for proper functionality

Setting needs to be adjusted according to application

Room thermostat or pressure switch (not available on ZXDE units) – System restart is required!			
Parameter	Parameter description	Factory setting	Required setting
C05	Compressor regulation probe selection	SuP = Suction pressure probe	dIS = Suction pressure switch / Room thermostat
R07	Digital input 3 configuration	nu = Not used	SuS = Suction pressure switch / Room thermostat

Temperature sensor in case temperature – System restart is required!			
Parameter	Parameter description	Factory setting	Required setting
A19	Probe 7 configuration	nu = Not used	tnt = Thermostat temperature
C05	Compressor regulation probe selection	SuP = Suction pressure probe	CSt = Case temperature
G01	Case temperature probe selection	nu = Not used	tnt = Thermostat temperature
G02	Cut-out temperature	+2°C	Adjust to application requirements
G03	Positive differential defines upper cut-in temperature	1K	Adjust to application requirements

Pumpdown with room thermostat (not available on ZXDE units) – System restart is required!			
Parameter	Parameter description	Factory setting	Required setting
C05	Compressor regulation probe selection	SuP = Suction pressure probe	dIS = Suction pressure switch / Room thermostat
G56	Use the liquid line solenoid	No	Yes
R07	Digital input 3 configuration	nu = Not used	SuS = Suction pressure switch / Room thermostat
R08	Digital input 3 polarity	CL = Closed	CL = Closed
S07	Relay output 4	nu = Not used	LLS = Liquid line solenoid
C01	Compressor cut-in pressure setpoint	4 bar rel	Adjust to application requirements
C02	Compressor cut-out pressure setpoint	2 bar rel	Adjust to application requirements

Pumpdown with temperature sensor in case temperature (not available on ZXDE units) – System restart is required!			
Parameter	Parameter description	Factory setting	Required setting
A19	Probe 7 configuration	nu = Not used	tnt = Thermostat temperature
C05	Compressor regulation probe selection	SuP = Suction pressure probe	CSt = Case temperature
G01	Case temperature probe selection	nu = Not used	tnt = Thermostat temperature
G56	Use the liquid line solenoid	No	Yes
S07	Relay output 4	nu = Not used	LLS = Liquid line solenoid
C01	Compressor cut-in pressure setpoint	4 bar rel	Adjust to application requirements
C02	Compressor cut-out pressure setpoint	2 bar rel	Adjust to application requirements
G02	Cut-out temperature	+2°C	Adjust to application requirements
G03	Positive differential defines upper cut-in temperature	1K	Adjust to application requirements

Defrost with time intervals – System restart is required!			
Parameter	Parameter description	Factory setting	Required setting
A19	Probe 7 configuration	nu = Not used	EPt = Evaporator temperature
G12	Defrost probe selection	nu = Not used	EPt = Evaporator temperature
G23	Defrost interval mode	nu = Not used	In = By time (G18)
S05	Relay output 2	nu = Not used	dEF = Defrost
G18	Interval between defrost cycles	4 min	Adjust to application requirements
G19	Maximum duration of defrost	20 min	Adjust to application requirements
G21	Defrost termination temperature	10	Adjust to application requirements
G26	Drip time	1 min	Adjust to application requirements

Defrost with Real Time Clock – System restart is required!			
Parameter	Parameter description	Factory setting	Required setting
A19	Probe 7 configuration	nu = Not used	EPT = Evaporator temperature
G12	Defrost probe selection	nu = Not used	EPT = Evaporator temperature
G23	Defrost interval mode	nu = Not used	rtC = Real time clock
S05	Relay output 2	nu = Not used	dEF = Defrost
G18	Interval between defrost cycles	4 min	Adjust to application requirements
G19	Maximum duration of defrost	20 min	Adjust to application requirements
G21	Defrost termination temperature	10	Adjust to application requirements
G26	Drip time	1 min	Adjust to application requirements
G28-41	See table 32 " Parameter list Level 1 & Level 2 (Pr1 & Pr2)"	[-] min	Adjust to application requirements

Defrost with evaporator fan – System restart is required!			
Parameter	Parameter description	Factory setting	Required setting
A19	Probe 7 configuration	nu = Not used	EPT = Evaporator temperature
G12	Defrost probe selection	nu = Not used	EPT = Evaporator temperature
G23	Defrost interval mode	nu = Not used	In = By time (G18)
G42	Fans operating mode	Cn	Oy
S05	Relay output 2	nu = Not used	EPF = Evaporator fan
G18	Interval between defrost cycles	4 min	Adjust to application requirements
G19	Maximum duration of defrost	20 min	Adjust to application requirements
G21	Defrost termination temperature	10	Adjust to application requirements
G26	Drip time	1 min	Adjust to application requirements
G55	Fan delay after defrost	1 min	Adjust to application requirements

Unit On/Off – System restart is required!			
Parameter	Parameter description	Factory setting	Required setting
R07	Digital input 3 configuration	nu = Not used	OnF = On/Off
R08	Digital input 3 polarity	CL = Closed	Adjust to application requirements

Evaporator fan – System restart is required!			
Parameter	Parameter description	Factory setting	Required setting
G42	Fans operating mode	cn	cn = Switch on and off with the compressor, stop during defrost On = Always on, stop during defrost cy = Switch on and off with the compressor, run during defrost Oy = Always on, run during defrost
S05	Relay output 2	nu = Not used	EPF = Evaporator fan
G45	Fan on time	1 min	Adjust to application requirements
G46	Fan off time	1 min	Adjust to application requirements
G55	Fan delay after defrost	1 min	Adjust to application requirements

System EXV – System restart is required!			
Parameter	Parameter description	Factory setting	Required setting
A19	Probe 7 configuration	nu = Not used	SLt = Suction line temp
L02	Set of superheating	5	7
S11	EXV configuration	uin or Lin	SHt = System superheat

Door switch – System restart is required!			
Parameter	Parameter description	Factory setting	Required setting
G08	Compressor and fan status with open door	Fn	nO = Normal operation Fn = Stop fan cP = Compressor off Fc = Compressor and fans off
R07	Digital input 3 configuration	nu = Not used	dOr = Door
G53	Maximum time with open door before alarm goes off	3 min	Adjust to application requirements
R08	Digital input 3 polarity	CL = Closed	Adjust to application requirements

Table 36: Additional features for customization

Appendix 7: Temperature / resistance curve for B7 Sensor (customer option)

R25 = 10kΩ B25/85=3435K

Temp. [°C]	Resistance [kΩ]	Temp. [°C]	Resistance [kΩ]	Temp. [°C]	Resistance [kΩ]	Temp. [°C]	Resistance [kΩ]	Temp. [°C]	Resistance [kΩ]	Temp. [°C]	Resistance [kΩ]
-50	329.2	-21	71.07	8	19.48	37	6.468	66	2.512	95	1.108
-49	310.7	-20	67.74	9	18.70	38	6.246	67	2.437	96	1.080
-48	293.3	-19	64.54	10	17.96	39	6.033	68	2.365	97	1.052
-47	277.0	-18	61.52	11	17.24	40	5.829	69	2.296	98	1.025
-46	261.3	-17	58.65	12	16.55	41	5.630	70	2.229	99	0.999
-45	247.5	-16	55.95	13	15.90	42	5.439	71	2.163	100	0.974
-44	234.1	-15	53.39	14	15.28	43	5.256	72	2.101	101	0.949
-43	221.6	-14	50.95	15	14.68	44	5.080	73	2.040	102	0.925
-42	209.8	-13	48.66	16	14.12	45	4.912	74	1.981	103	0.902
-41	198.7	-12	46.48	17	13.57	46	7.749	75	1.924	104	0.879
-40	188.4	-11	44.44	18	13.06	47	4.594	76	1.870	105	0.858
-39	178.3	-10	42.45	19	12.56	48	4.444	77	1.817	106	0.836
-38	168.9	-9	40.56	20	12.09	49	4.300	78	1.766	107	0.816
-37	160.1	-8	38.76	21	11.63	50	4.161	79	1.716	108	0.796
-36	151.8	-7	37.05	22	11.20	51	4.026	80	1.669	109	0.777
-35	144.0	-6	35.43	23	10.78	52	3.897	81	1.622	110	0.758
-34	136.6	-5	33.89	24	10.38	53	3.772	82	1.577	111	0.740
-33	129.7	-4	32.43	25	10.00	54	3.652	83	1.534	112	0.722
-32	123.2	-3	31.04	26	9.632	55	3.537	84	1.492	113	0.705
-31	117.1	-2	29.72	27	9.281	56	3.426	85	1.451	114	0.688
-30	111.3	-1	28.47	28	8.944	57	3.319	86	1.412	115	0.672
-29	105.7	0	27.28	29	8.622	58	3.216	87	1.374	116	0.656
-28	100.4	1	26.13	30	8.313	59	3.116	88	1.337	117	0.641
-27	95.47	2	25.03	31	8.015	60	3.021	89	1.301	118	0.626
-26	90.80	3	23.99	32	7.725	61	2.928	90	1.266	119	0.611
-25	86.39	4	22.99	33	7.455	62	2.838	91	1.233	120	0.597
-24	82.22	5	22.05	34	7.192	63	2.752	92	1.200		
-23	78.29	6	21.15	35	6.941	64	2.669	93	1.169		
-22	74.58	7	20.30	36	6.699	65	2.589	94	1.138		

Table 37: B7 AI7 optional sensor >> Temperature / resistance curve

Appendix 8: List of tables and figures

Tables

Table 1: ZX condensing unit technical data	4
Table 2: ZX condensing unit features	4
Table 3: Qualified refrigerants and oils	6
Table 4: BOM history	7
Table 5: Legend of the P&I diagram for ZXME units	8
Table 6: Legend of the P&I diagram for ZXLE units	9
Table 7: Legend of the P&I diagram for ZXDE units	10
Table 8: Compressor models cross reference	11
Table 9: Condenser fans technical data	11
Table 10: Prearranged additional connections	15
Table 11: Digital output specifications	16
Table 12: External room thermostat - Parameters	16
Table 13: External temperature sensor – Parameters	17
Table 14: Discharge pressure limitations	17
Table 15: Defrost parameters	19
Table 16: LED functions description	20
Table 17: Display visualisation	20
Table 18: Single commands	21
Table 19: Double commands	22
Table 20: Programming level 1 parameters	22
Table 21: Fast access menu	23
Table 22: Parameters in programming level Pr1	24
Table 23: Minimum cut-out value for pumpdown	26
Table 24: Pumpdown 1	26
Table 25: Pumpdown 2	26
Table 26: Internal pumpdown with temperature sensor	27
Table 27: How to check the alarm list	29
Table 28: Weights	32
Table 29: Piping connection sizes	33
Table 30: Maximum distance between 2 clamp supports	33
Table 31: Unit maximum rated currents for cable selection	35
Table 32: Main fuses sizes and ranges	36
Table 33: Overview of the ZX unit components	44
Table 34: Parameters level 1	47
Table 35: Alarm code overview	52
Table 36: Additional features for customization	56
Table 37: B7 AI7 optional sensor >> Temperature / resistance curve	57

Figures

Figure 1: Dimensions of models ZXME020E to ZXME040E, ZXDE030E and ZXLE020E to ZXLE040E (single-fan units)	5
Figure 2: Dimensions of models ZXME050E to ZXME075E, ZXDE040E to ZXDE075E and ZXLE050E to ZXLE075E (dual-fan units)	5
Figure 3: Nomenclature ZX units	6
Figure 4: P&I diagram for ZXME units	8
Figure 5: P&I diagram for ZXLE units	9
Figure 6: P&I diagram for ZXDE units	10
Figure 7: ZX unit housing.....	12
Figure 8: Electronic controller	12
Figure 9: XCM25D controller functionality overview	13
Figure 10: Modbus port and termination jumpers	13
Figure 11: Prearranged additional connections	15
Figure 12: External temperature sensor – Functionality	16
Figure 13: Local display	20
Figure 14: Remote display front panel mounting	21
Figure 15: VNR connection for the remote display	21
Figure 16: Digital operation	25
Figure 17: Pumpdown functionality with temperature sensor	27
Figure 18: Emerson "Hot Key"	28
Figure 19: Location of "Hot Key" plug connection	28
Figure 20: Maximum stacking loads for transport and storage	32
Figure 21: Brazing - Sectional view	34
Figure 22: Suction tube brazing areas	34
Figure 23: Replacement of the fuses	36
Figure 24: Fixing dimensions and distances – Single-fan units	37
Figure 25: Fixing dimensions and distances – Dual-fan units	37
Figure 26: Service valves for refrigerant charging	40
Figure 27: Liquid line service port	40
Figure 28: Wiring diagram – 3-Phase motor	45
Figure 29: Wiring diagram – 1-Phase motor	46

BENELUX

Josephinastraat 19
NL-6462 EL Kerkrade
Tel: +31 45 535 06 73
Fax: +31 45 535 06 71
benelux.sales@emerson.com

GERMANY, AUSTRIA & SWITZERLAND

Theo-Mack Str. 3
DE-63477 Maintal
Tel: +49 6109 605 90
Fax: +49 6109 60 59 40
ECTGermany.sales@emerson.com

FRANCE, GREECE & MAGHREB

8, Allée du Moulin Berger
FR-69134 Ecully Cédex, Technoparc - CS 90220
Tel: +33 4 78 66 85 70
Fax: +33 4 78 66 85 71
mediterranean.sales@emerson.com

ITALY

Via Ramazzotti, 26
IT-21047 Saronno (VA)
Tel: +39 02 96 17 81
Fax: +39 02 96 17 88 88
italy.sales@emerson.com

SPAIN & PORTUGAL

C/ Pujades, 51-55 Box 53
ES-08005 Barcelona
Tel: +34 93 412 37 52
iberica.sales@emerson.com

CZECH REPUBLIC

Hajkova 22
CZ - 133 00 Prague
Tel: +420 733 161 651
Fax: +420 271 035 655
Pavel.Sudek@emerson.com

ROMANIA & BULGARIA

Parcul Industrial Tetarom 2
Emerson Nr. 4 400641 Cluj-Napoca
Tel: +40 374 13 23 50
Fax: +40 374 13 28 11
ro-bg.sales@emerson.com

ASIA PACIFIC

Suite 2503-8, 25/F, Exchange Tower
33 Wang Chiu Road, Kowloon Bay
Kowloon, Hong Kong
Tel: +852 2866 3108
Fax: +852 2520 6227

UK & IRELAND

Unit 17, Theale Lakes Business Park
Reading, Berkshire RG7 4GB
Tel: +44 1189 83 80 00
Fax: +44 1189 83 80 01
uk.sales@emerson.com

SWEDEN, DENMARK, NORWAY & FINLAND

Pascalstr. 65
DE-52076 Aachen
Tel: +49 2408 929 0
Fax: +49 2408 929 525
nordic.sales@emerson.com

EASTERN EUROPE & TURKEY

Pascalstr. 65
DE-52076 Aachen
Tel: +49 2408 929 0
Fax: +49 2408 929 525
easterneurope.sales@emerson.com

POLAND

Szturmowa 2
PL-02678 Warsaw
Tel: +48 22 458 92 05
Fax: +48 22 458 92 55
poland.sales@emerson.com

RUSSIA & CIS

Dubininskaya 53, bld. 5
RU-115054, Moscow
Tel: +7 - 495 - 995 95 59
Fax: +7 - 495 - 424 88 50
ECT.Holod@emerson.com

BALKAN

Selska cesta 93
HR-10 000 Zagreb
Tel: +385 1 560 38 75
Fax: +385 1 560 38 79

MIDDLE EAST & AFRICA

PO Box 26382
Jebel Ali Free Zone - South, Dubai - UAE
Tel: +971 4 811 81 00
Fax: +971 4 886 54 65
mea.sales@emerson.com

For more details, see www.climate.emerson.com/en-gb
Connect with us: facebook.com/EmersonCommercialResidentialSolutions



Emerson Commercial & Residential Solutions
Emerson Climate Technologies GmbH - Pascalstrasse 65 - 52076 Aachen, Germany
Tel. +49 (0) 2408 929 0 - Fax: +49 (0) 2408 929 570 - Internet: www.climate.emerson.com/en-gb

The Emerson logo is a trademark and service mark of Emerson Electric Co. Emerson Climate Technologies Inc. is a subsidiary of Emerson Electric Co.
Copeland is a registered trademark and Copeland Scroll is a trademark of Emerson Climate Technologies Inc.. All other trademarks are property of their respective owners.
Emerson Climate Technologies GmbH shall not be liable for errors in the stated capacities, dimensions, etc., as well as typographic errors. Products, specifications, designs and technical data contained in this document are subject to modification by us without prior notice. Illustrations are not binding.

© 2019 Emerson Climate Technologies, Inc.

EMERSON. CONSIDER IT SOLVED.™