

BYTE

JANUARY 1989

A MCGRAW-HILL PUBLICATION

REVIEWS

Mathematica
2 New IBM PS/2 Model 70s
Dolch 80386 Portable
Connection CoProcessor
2 MCA Graphics Boards
QuickBASIC for the Mac

PRODUCT FOCUS



21 Digitizing Tablets

The Annual BYTE Awards



PLUS
The Year Ahead
MIT's X Window System
Understanding The Token Ring

SHORT TAKES
dBASE IV
Extend
2 Tape Backup Units
For the Record



\$3.50 U.S.A./\$4.50 IN CANADA
0360-5280

WHY YOU SHOULD
CONSIDER THE
DELL 386 SYSTEMS,
DESPITE THEIR
SUSPICIOUSLY LOW
PRICES.



Our 386-based systems are priced about 35% less than comparable systems—like Compaq's. Which may make you wonder if we've left something important out. Like high performance.

Well we haven't.

In fact, these are among the fastest 386-based systems available. With more advanced features than you'd get in systems that list for up to \$3000 more.

Like Compaq's.

For instance, our 20 MHz System 310 offers you the best value available in any 386-based system. PC Magazine (6/14/88) describes it as "fast enough to burn the sand off a desert floor."

AND IF THAT SOUNDS FAST, WAIT TILL YOU SEE OUR NEW 25 MHz 386-BASED SYSTEM.

At 25MHz, our new System 325 offers you the highest possible performance in a 386. Like the System 310, it utilizes the very latest technology, including the Intel 82385 Cache Memory Controller, advanced 32-bit architecture and high performance drives. And of course, both systems are fully IBM PC compatible. (For more detailed specifications, see the inside pages.)

But speed isn't the only reason to buy from us. Or even the best reason.

THE FIRST PERSONAL COMPUTER THAT'S TRULY PERSONAL.

Dell configures systems to your own personal specifications. After an

evaluation of your needs, we'll help you select the features that are right for you. After your system unit is custom built, we'll burn-in everything, add-in boards and all, to make sure the entire system works perfectly.

TOLL-FREE SUPPORT AND ON-SITE SERVICE INCLUDED IN THE PRICE.

Every Dell system includes the Dell System Analyzer, a complete set of diagnostic tools. Which lets Dell's expert technicians resolve problems right over the phone. This toll-free support service is available from 7AM to 7PM (CT) every business day, at no extra charge.

And if your system requires hands-on service, a technician will be at your location the next business day. At absolutely no charge to you. Because included in the price of your system is a full year of on-site service.

But that's not all. You also get our 30-day money-back guarantee. As well as our one-year limited warranty on parts and workmanship.

AND IF YOU STILL THINK YOU GET WHAT YOU PAY FOR, CONSIDER THIS.

When you buy or lease from Dell, you buy directly from our manufacturing facility in Austin, Texas. Which means we eliminate dealer markups, allowing us to give you a lot more 386 for less.

This same principle is behind all the Dell systems. Review them in detail. Then call us at (800) 426-5150 to order the system that's right for you.

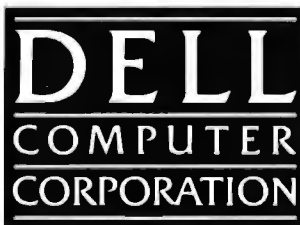

TO ALLAY YOUR SUSPICIONS

YOUR TOTAL SATISFACTION IS GUARANTEED.

Dell offers a complete line of systems, peripherals and software.

And whatever you choose, you must be absolutely, totally satisfied with it. If not, simply return it within the first 30 days for a money-back refund. No questions asked. We call this our Total Satisfaction Guarantee.

SUPPORT IS A FREE PHONE CALL AWAY.

Also included in your system price is our toll-free support line. It's open every business day from 7 AM to 7 PM (CT). Simply dial (800) 624-9896.

ON-SITE SERVICE IS INCLUDED IN YOUR SYSTEM PRICE.

For those rare problems that can't be handled over the phone, we'll send a service technician to your location by the next business day. At absolutely no charge to you.⁹ Because included in system price is a year's worth of on-site service.

ONE-YEAR WARRANTY.

Dell offers a one-year limited warranty, which warrants each system we manufacture to be free of defects in materials and workmanship for one full year. During that period we will repair or replace any defective products returned to our factory.

For a lot of companies, leasing our systems is an even better idea because of the cash flow and tax advantages. And we guarantee fixed rates, so you know exactly how much to budget each month. We can even custom design a lease plan to fit the exact needs of your business.

For the complete terms of our On-Site Service Contract, Satisfaction Guarantee, Warranty and leasing plans, write: Dell Computer Corporation, 9505 Arboretum Blvd., Austin, Texas 78759-7299.



THE NEW 25 MHz
386 SYSTEM 325.

When you need the highest possible performance of any 386, this is the technology of choice. Running at 25 MHz, the System 325 is faster than the Compaq 386/25. Besides unequalled speed, it also offers Intel's Advanced 82385 Cache Memory Controller and high performance disk drives. As a result, it gives you workstation-level performance for CAD/CAM and desktop publishing applications. It's also especially effective as a network file server, and more than capable of handling the most complex spreadsheets and databases.

STANDARD FEATURES:

- Intel 80386 microprocessor running at 25 MHz.
- 1 MB of RAM* expandable to 16 MB using a dedicated high speed 32-bit memory slot.
- Advanced Intel 82385 Cache Memory Controller with 32 KB of high speed static RAM cache.
- Page mode interleaved memory architecture.
- VGA systems include a high performance 16-bit video adapter.
- Socket for 25 MHz Intel 80387 or 25 MHz WEITEK 3167 math coprocessor.
- 5.25" 1.2 MB or 3.5" 1.44 MB diskette drive.
- Dual diskette and hard disk drive controller.
- Enhanced 101-key keyboard.
- 1 parallel and 2 serial ports.
- 200-watt power supply.
- 8 industry standard expansion slots.

OPTIONS:

- 25 MHz Intel 80387 math coprocessor.
 - 1 MB or 4 MB memory upgrade kit.
 - 2 MB or 8 MB memory expansion board kit.
- **Lease for as low as \$252/Month.**

System 325	With Monitor & Adapter	
Hard Disk Drives	VGA Mono	VGA Color Plus
150 MB-18 ms ESDI	\$6,999	\$7,299
322 MB-18 ms ESDI	\$8,999	\$9,299

The Dell System 325 is an FCC Class A device, intended for business use only.



THE DELL 20 MHz
386 SYSTEM 310.

For business users who need a 386 system, this is the best combination of performance and value available. Running at 20 MHz, this 32-bit system is faster than the IBM PS/2 Model 70 and the Compaq 386/20e. Since it has the same high performance disk drives and Intel Advanced 82385 Cache Memory Controller as our System 325, it brings a new level of performance to complex spreadsheets and databases. As you might expect, it runs windowed software at extremely high speed. It's also well-suited for desktop publishing applications, or as a network file server.

STANDARD FEATURES:

- Intel 80386 microprocessor running at 20 MHz.
- 1 MB of RAM* expandable to 16 MB using a dedicated high speed 32-bit memory slot.
- Advanced Intel 82385 Cache Memory Controller with 32 KB of high speed static RAM cache.
- Page mode interleaved memory architecture.
- VGA systems include a high performance 16-bit video adapter.
- Socket for 20 MHz Intel 80387 or 20 MHz WEITEK 3167 math coprocessor.
- 5.25" 1.2 MB or 3.5" 1.44 MB diskette drive.
- Dual diskette and hard disk drive controller.
- Enhanced 101-key keyboard.
- 1 parallel and 2 serial ports.
- 200-watt power supply.
- 8 industry standard expansion slots.

OPTIONS:

- 20 MHz Intel 80387 math coprocessor.
 - 1 MB or 4 MB memory upgrade kit.
 - 2 MB or 8 MB memory expansion board kit.
- **Lease for as low as \$148/Month.**

System 310	With Monitor & Adapter	
Hard Disk Drives	VGA Mono	VGA Color Plus
40 MB-28 ms	\$4,099	\$4,399
90 MB-18 ms ESDI	\$4,899	\$5,199
150 MB-18 ms ESDI	\$5,399	\$5,699
322 MB-18 ms ESDI	\$7,399	\$7,699

PLEASE CALL 800-426-5150.



**THE DELL 20 MHz
286 SYSTEM 220.**

It's an 80286 system that's as fast as most 386 computers. But at less than half the price. Which means you get the best price/performance of any system. The System 220 runs at 20 MHz, with less than one wait state. It also features complete compatibility with Microsoft MS-DOS and MS OS/2, plus a remarkably small footprint. The System 220 is the ideal executive workstation.

STANDARD FEATURES:

- 80286 microprocessor running at 20 MHz.
- 1 MB of RAM* expandable to 16 MB† (8 MB† on system board).
- Page mode interleaved memory architecture.
- Integrated diskette and VGA video controller on system board.
- Socket for Intel 80287 math coprocessor.
- One 3.5" 1.44 MB diskette drive.
- Integrated high performance hard disk interface on system board.
- Enhanced 101-key keyboard.
- 1 parallel and 2 serial ports integrated on system board.
- 3 full-sized industry standard expansion slots available.

OPTIONS:

- External 5.25" 1.2 MB diskette drive.
- 3.5" 1.44 MB diskette drive.
- Intel 80287 math coprocessor.
- 1 MB RAM upgrade kit.

****Lease for as low as \$85/Month.**

System 220 Disk Drives	With Monitor	
	VGA Mono	VGA Color Plus
One Diskette Drive	\$2,299	\$2,599
40 MB-29 ms Hard Disk	\$2,999	\$3,299
100 MB-29 ms Hard Disk	\$3,799	\$4,099



**THE DELL 12.5 MHz
SYSTEM 200.**

A great value in a full-featured AT compatible. An 80286 computer running at 12.5 MHz, this computer is completely Microsoft MS-DOS and MS OS/2 compatible. The System 200 offers high speed drive options, industry standard compatible BIOS and on-site service. As Executive Computing said of this computer's predecessor, "If faster processing speed and low cost are two key issues affecting your purchase decision, this machine might be the ideal choice for your office."

STANDARD FEATURES:

- 80286 microprocessor running at 12.5 MHz.
- 640 KB of RAM expandable to 16 MB† (4.6 MB† on system board).
- Socket for Intel 80287 math coprocessor.
- 5.25" 1.2 MB or 3.5" 1.44 MB diskette drive.
- Dual diskette and hard disk drive controller.
- Enhanced 101-key keyboard.
- 1 parallel and 2 serial ports.
- 200-watt power supply.
- 6 industry standard expansion slots.

OPTIONS:

- Intel 80287 math coprocessor.
- 512 KB RAM upgrade kit.

****Lease for as low as \$99/Month.**

***PERFORMANCE ENHANCEMENTS
(SYSTEMS 325, 310 AND 220):**

640 KB is available for programs and data. The remaining 384 KB is reserved for use by the system to enhance performance.

†Using 1 MB SIMMs. Inquire as to availability.

System 200 Hard Disk Drives	With Monitor & Adapter	
	VGA Mono	VGA Color Plus
40 MB-28 ms	\$2,699	\$2,999
90 MB-18 ms ESDI	\$3,499	\$3,799
150 MB-18 ms ESDI	\$3,999	\$4,299
322 MB-18 ms ESDI	\$5,999	\$6,299

LASER PRINTERS AND MORE.

The obvious companion for a high performance Dell system is a Dell laser or dot matrix printer. All printers come with 30-day money-back guarantee. And be sure to ask about our software offerings, which include most popular third-party applications as well as Dell Enhanced operating system software.

LASER PRINTERS.

- Laser System 150, 15 pages per minute: \$5,995.
- Laser System 80, 8 pages per minute: \$3,295.
- Laser System 60, 6 pages per minute: \$2,195.

All Dell laser printers come with 1.5 MB RAM, full-page 300 DPI graphics, and have 31 standard fonts (7 resident and 24 down-loadable from diskette). Dell laser printers also provide Hewlett-Packard LaserJet, Epson/FX, IBM Proprinter and Diablo 630 emulations.

DOT MATRIX PRINTERS.

- Printer System 800: \$699.95.
- Our highest resolution text and graphics, 24-pin dot matrix printer. Draft quality at 200 cps. Letter quality at 66 cps. Parallel and serial interfaces. Wide carriage.
- Printer System 600: \$499.95.
- 9-pin dot matrix. Draft quality at 240 cps. Near-letter quality at 60 cps. Parallel interface. Wide carriage.
- Printer System 300: \$199.95.
- 9-pin dot matrix. Draft quality at 144 cps. Near-letter quality at 36 cps. Four standard fonts. Parallel interface. Narrow carriage.

OPERATING SYSTEM SOFTWARE.

- Dell Enhanced Microsoft® MS-DOS® 3.3: \$99.95
- Dell Enhanced Microsoft MS-DOS 4.0: \$119.95
- (Both MS-DOS versions with disk cache and other utilities)
- Dell Enhanced MS® OS/2 Standard Edition 1.0: \$324.95

TO ORDER, PLEASE CALL

800-426-5150

IN CANADA, CALL
800-387-5752
 IN GERMANY, CALL
06103/701100
 IN THE U.K., CALL
344-860-456

BYTE

JANUARY 1989

VOL. 14/NO. 1

PRODUCTS IN PERSPECTIVE

- 67 **What's New**
- 97 **Short Takes**
Extend, a powerful simulation program for the Macintosh
Irwin Model 5080,
backing up's not hard to do
Jumbo, a tape backup unit for peanuts
dBASE IV,
setting the new standard
For the Record,
getting your affairs in order

REVIEWS

- 162 **Product Focus: Graphic Details**
by Stanford Diehl and Steve Apiki
A look at 21 high-end PC-compatible digitizing tablets.
- 79 **Strengthening Lineup**
Halliday
The PS/2 Model 10 machines provide 32-bit processing power on the desktop.

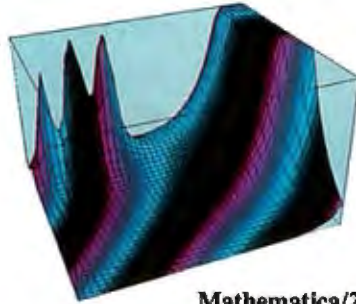

Mathematica/239

- 201 **Pixels on the March**
by Bradley Dyck Klierer
A look at the IBM 8514/A and Artist 10 MC graphics coprocessor boards for the IBM PS/2s.
- 213 **IntegrAda**
by Karl Nyberg and Jon Udell
This Ada Programming Support Environment for IBM PCs falls short of the standard.
- 223 **QuickBASIC Comes to the Macintosh**
by Namir Clement Shammas
A handy tool for exploring the Toolbox and building Macintosh applications.
- 233 **Opus I**
by Phillip Robinson
Roykore Software's duet for graphics and data.
- 239 **Symbolic Math on the Mac**
by Peter Wayner
With strong mathematic powers and excellent graphics functions, Mathematica has almost too many ways to do things.

EXPERT ADVICE

- 109 **Computing at Chaos Manor: To the Stars**
by Jerry Pournelle
Jerry ponders on portables and examines game designs.
- 127 **Applications Plus: The Blight of Bloated Software**
by Ezra Shapiro
Word processors used to be lean and mean—are they getting too big?
- 135 **Down to Business: So, Maybe You Do Need a LAN**
by Wayne Rash Jr.
The kind of network you need depends on what you need to share and how much there is of it.

- 143 **Macinations: Hooked on Smalltalk-80 for the Mac**
by Don Crabb
A new implementation of this language makes it a winner.
- 151 **OS/2 Notebook: 1988 in Review: OS/2's First Year**
by Mark Minasi
For an operating system less than a year old, OS/2 is doing well.

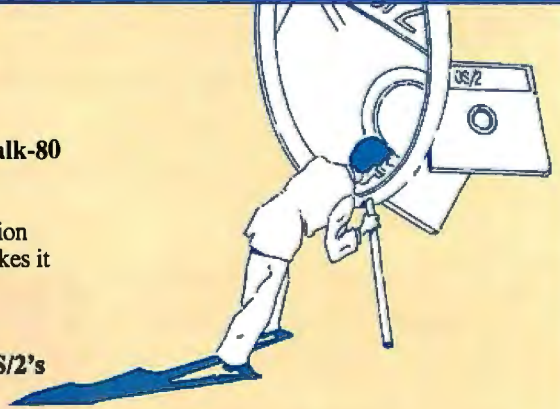

- 155 **COM1: Making Applications Talk**
by Brett Glass
The Communicating Applications Specification could take the pain out of file transfers.



IN DEPTH

- 249 Introduction: PC Communications**
- 253 Fiber vs. Metal**
by James Y. Bryce
Fiber optics is no longer considered too complicated and expensive for routine use.
- 259 Looking for Trouble**
by Harry Saal
If you manage a LAN, you must be able to identify software problems and analyze their causes.
- 267 The Data Bandits**
by William M. Adney and Douglas E. Kavanagh
When connected to a network, you must protect your data from viruses, theft, and accidental destruction.
- 273 Dialing Up 1990**
by Brock N. Meeks
The next decade of dial-up communications software is already upon us.
- 281 Whither the Modem?**
by John H. Humphrey and Gary S. Smock
The authors gaze into the future of modern modem technology.
- 285 OS/2 Hits the Networks**
by Ken Thurber
What you need to know if you want to run OS/2 on your LAN.
- 293 When One LAN Is Not Enough**
by William Stallings
Having more than one type of LAN in a corporation calls for internetworking protocols and devices.
- 301 Understanding NetBIOS**
by Brett Glass
With LANs proliferating, it pays to understand NetBIOS, a widely implemented interface.

BYTE Awards/327

- 309 A Logical Choice**
by Ralph Davis
The communications protocol APPC lays the foundation for true distributed processing.
- 317 Making the Connection**
by Ed Tittel
Networking IBM PCs, Macs, and VAXes can boost desktop power and productivity.

FEATURES

- 327 The BYTE Awards**
by the BYTE staff
Our editors and columnists give nods of approval to this year's best products.
- 343 What Lies Ahead**
by the BYTE staff
Musings about the future of computing by Marvin Minsky, Grace Hopper, and other pioneers and visionaries past and present.
- 353 The X Window System**
by Dick Pountain
Born as a means to network graphics workstations, MIT's X Window is gaining ground as a windowing system for Unix.



MIT's X Window System/353

HANDS ON

- 363 Under the Hood: The Token Ring**
by Brett Glass
Our newest columnist examines IBM's popular LAN standard.
- 379 Some Assembly Required: Trees 'n Keys, Part 1**
by Rick Grehan
Search huge databases quickly with keyed file systems.

DEPARTMENTS

- 6 Editorial:**
PM, Sun View, and the Mac
- 11 Microbytes**
- 24 Letters**
- 33 Chaos Manor Mail**
- 38 Ask BYTE**
- 51 Book Reviews**
- 435 Coming Up in BYTE**

READER SERVICE

- 434 Editorial Index by Company**
- 436 Alphabetical Index to Advertisers**
- 440 Index to Advertisers by Product Category**
Inquiry Reply Cards: after **442**

PROGRAM LISTINGS

From BIX: see **246**
From BYTEnet:
call (617) 861-9764
On disk or in print:
see card after **408**

BYTE (ISSN 0360-5280) is published monthly with an additional issue in October by McGraw-Hill, Inc. **Postmaster:** Send address changes, USPS Form 3579, undeliverable copies, and fulfillment questions to BYTE Subscriptions, P.O. Box 551, Hightstown, NJ 08520. Second-class postage paid at Peterborough, NH 03458 and additional mailing offices. Postage paid at Winnipeg, Manitoba. Registration number 9321. Printed in the United States of America.

Not responsible for lost manuscripts or photos. Opinions expressed by the authors are not necessarily those of BYTE.

Copyright © 1989 by McGraw-Hill, Inc. All rights reserved. Trademark registered in the United States Patent and Trademark Office.



Subscription questions or problems should be addressed to: BYTE Subscriber Service, P.O. Box 551, Hightstown, NJ 08520.

BYTE

EDITOR IN CHIEF
Frederic S. Langa

PUBLISHER/GROUP VICE PRESIDENT
J. Burt Totaro

OPERATIONS
Glenn Hartwig *Associate Managing Editor*

REVIEWS (Hardware, Software, Product Focus)
Michael Nadeau, *Associate Managing Editor*, Dennis Allen, *Senior Technical Editor, Software*, Stephen Apiki, *Testing Editor, BYTE Lab*, Stanford Diehl, *Testing Editor, BYTE Lab*

NEWS AND TECHNOLOGY (Microbytes, What's New, Short Takes)
Rich Malloy, *Associate Managing Editor*, D. Barker, *Senior Editor, News and Technology*, Anne Fischer, *Senior Editor, News Products*, Andrew Reinhardt, *Associate News Editor*

Peterborough: Roger Adams, *Associate News Editor*, David Andrews, *Associate News Editor*, Martha Hicks, *Associate News Editor*

West Coast: Gene Smarte, *Bureau Chief*, Costa Mesa, Nicholas Baran, *Technical Editor*, San Francisco, Frank Hayes, *Associate News Editor*, Marlene Nesary, *Associate News Editor*, Jeffrey Bertolucci, *Editorial Assistant*, San Francisco

SENIOR TECHNICAL EDITORS
Ken Sheldon, *Features*, Jane Morrill, *Tazelaar In Depth*, Richard Grehan, *At Large*, Tom Thompson, *At Large*

TECHNICAL EDITORS
Janet J. Barron, Janet Fiderio, Ben Smith, Jon Udell, Stanley Wszola

ASSOCIATE TECHNICAL EDITOR
Robert Mitchell

CONSULTING EDITORS
Jerry Pournelle, Ezra Shapiro, Don Crabb, Brett Glass, Brock N. Meeks, Mark Minasi, Wayne Rash Jr.

CONTRIBUTING EDITORS
Jonathan Amsterdam, *Programming Projects*, Mark Dahmke, *Video, Operating Systems*, Mark Haas, *At Large*, Rik Jadrnick, *CAD, Graphics, Spreadsheets*, Robert T. Kurosaka, *Mathematical Recreations*, Alastair J. W. Mayer, *Software*, Stan Miaszkowski, *New Technology*, Alan R. Miller, *Languages and Engineering*, Dick Pountain, *Algorithms*, Roger Powell, *Computers and Music*, Phillip Robinson, *Semiconductors*, Jon Shiell, *High-Performance Systems*, George Stewart, *Book Reviews*, Ernest Tello, *Artificial Intelligence*

COPY EDITORS
Lauren Stickler, *Chief*, Susan Colwell, Jeff Edmonds, Judy Grehan, Nancy Hayes, Cathy Kingery, Margaret A. Richard, Warren Williamson

EDITORIAL ASSISTANTS
Peggy Dunham, *Office Manager*, Linda C. Ryan, June N. Sheldon, Lynn Susan Valley

ART
Nancy Rice, *Director*, Joseph A. Gallagher, *Assistant Director*, Jan Muller, *Assistant*, Alan Easton, *Technical Artist*

PRODUCTION
David R. Anderson, *Director*, Virginia Reardon, *Senior Editorial Production Coordinator*, Barbara Busenbark, *Editorial Production Coordinator*, Denise Chartrand, *Editorial Production Coordinator*, Michael J. Lonsky, *Editorial Production Coordinator*

TYPOGRAPHY
Sherry Fiske, *Systems Manager*, Donna Sweeney, *Applications Manager*, Christa Patterson

ADVERTISING/PRODUCTION (603) 924-6448
Lisa Wozmak, *Director*, Lyda Clark, *Senior Account Coordinator*, Karen Cilley, Linda Fluhr, Jeanne Gatcombe, Brian Higgins, Rod Holden, Wai Chiu Li, *Quality Control Manager*, Julie Murphree, *Advertising/Production Coordinator*

ADMINISTRATION
Donna Nordlund, *Publisher's Assistant*

MARKETING COMMUNICATIONS
Horace T. Howland, *Director*, Pamela Petrakos-Wilson, *Promotion Manager*, Wilbur S. Watson, *Marketing Services Manager*, Dawn Matthews, *Public Relations Manager*, Lisa Jo Steiner, *Marketing Assistant*, Stephanie Warnesky, *Marketing Art Director*, Sharon Price, *Associate Art Director*, Julie Perron, *Market Research Analyst*

PLANNING AND RESEARCH
Michele Perron, *Director*
Faith Kluntz, *Copyrights Coordinator*, Cynthia Damato, *Sands Reader Service Coordinator*

FINANCIAL SERVICES
Philip L. Penny, *Director of Finance and Services*, Kenneth A. King, *Business Manager*, Christine Monkton, *Assistant*, Marilyn Parker, Diane Henry, JoAnn Walter, Jaime Huber

CIRCULATION
Dan McLaughlin, *Director*
James Bingham, *Newsstand Sales Manager*, Vicki Weston, *Assistant Manager*, Karen Destroches, *Distribution Coordinator*, Donna Healy, *Direct Accounts Coordinator*, Louise Manegus, *Back Issues*

PERSONNEL
Patricia Burke, *Personnel Coordinator*, Beverly Goss, *Receptionist*

BUILDING SERVICES
Tony Bennett, *Manager*, Cliff Monkton, Mark Monkton, Agnes Perry

BIX BYTE INFORMATION EXCHANGE

DIRECTOR
Stephen M. Laliberte

EXECUTIVE EDITOR
George Bond

ASSOCIATE EDITOR
Tony Lockwood

MICROBYTES DAILY
D. Barker, *Coordinator*, Peterborough, Rich Malloy, *New York*, Gene Smarte, *Costa Mesa*, Nicholas Baran, *San Francisco*, Rick Cook, *Phoenix*, Frank Hayes, *San Francisco*, Jason Levitt, *Austin, TX*, Larry Loeb, *Wallingford, CT*, Brock N. Meeks, *La Mesa, CA*, Stan Miaszkowski, *Peterborough*, Wayne Rash Jr., *Sue Rosenberg*, *Washington, DC*, David Reed, *Lexington, KY*

GROUP MODERATORS
David Allen, *Applications*, Frank Boosman, *Artificial Intelligence*, Leroy Casterline, *Other*, Marc Greenfield, *Programming Languages*, Jim Howard, *Graphics*, Gary Kendall, *Operating Systems*, Steve Krenek, *Computers*, Brock N. Meeks, *Telecommunications*, Barry Nance, *New Technology*, Donald Osgood, *Computers*, Sue Rosenberg, *Other*, Jon Swanson, *Chips*

BUSINESS AND MARKETING
Patricia Bausum, *Secretary*, Denise A. Greene, *Customer Service*, Brian Warnock, *Customer Service*, Tammy Burgess, *Customer Credit and Billing*

TECHNOLOGY
Clayton Lisle, *Director*, *Business Systems Technology*, ISCO, Fred Strauss, *Senior Business Systems Analyst*

ADVERTISING SALES
Steven M. Vito, *Associate Publisher*, *Vice President of Marketing*

Dennis J. Riley, *Eastern Regional Sales Manager*
Sandra Foster, *Administrative Assistant*

Jennifer L. Bartel, *West Coast Sales Manager*, (214) 644-1111

NEW ENGLAND
ME, NH, VT, MA, RI, ONTARIO, CANADA & EASTERN CANADA
John C. Moon, (617) 262-1160

ATLANTIC
NY, NYC, CT, NJ (NORTH)
Leah G. Rabinowitz, (212) 512-2096
(203) 968-7111

EAST
PA, KY, NJ (SOUTH), MD, W.VA, DE, DC
Thomas J. Brun, (215) 496-3833

SOUTHEAST
NC, SC, GA, FL, AL, TN, VA
Thomas H. Tolbert, (404) 252-0626

MIDWEST
IL, MO, KS, IA, ND, SD, MN, WI, NE, IN, MI, MS, OH
(312) 751-3740

SOUTHWEST, ROCKY MOUNTAIN
CO, WY, OK, TX, AR, LA, UT
Karl Heinrich, (713) 482-0757

SOUTH PACIFIC
SOUTHERN CA, AZ, NM, LAS VEGAS
Jack Anderson, (714) 557-6292
Tom Harvey, (213) 480-5243

NORTH PACIFIC
HI, WA, OR, ID, MT, NORTHERN CA, NV (except LAS VEGAS), WESTERN CANADA
Bill McAfee, (415) 348-4100
(415) 362-4600

TELEMARKETING
L. Bradley Browne, *Director*
Susan Boyd, *Administrative Assistant*

Elisa Lister, (603) 924-6630

Liz Coyman, (603) 924-9281

BYTE BITS (2x3)
Dan Harper, (603) 924-8830

THE BUYER'S MART (1x2)
Mark Stone, (603) 924-3754

REGIONAL ADVERTISING SECTIONS
Scott Gagnon, (603) 924-4380
Larry Levine, (603) 924-4376

BYTE DECK MAILINGS
National
Ed Ware, (603) 924-8168

A/E/C COMPUTING DECK
COMPUTING FOR ENGINEERS DECK
Mary Ann Goulding, (603) 924-9281

INTERNATIONAL ADVERTISING SALES STAFF
See listing on page 437.

EDITORIAL AND BUSINESS OFFICE:
One Phoenix Mill Lane, Peterborough, NH 03458, (603) 924-8281.
West Coast Branch Offices: 425 Battery St., San Francisco, CA 94111, (415) 954-9718; 3001 Red Hill Ave., Building #1, Suite 222, Costa Mesa, CA 92626, (714) 557-6292.
New York Branch Editorial Office: 1221 Avenue of the Americas, New York, NY 10020, (212) 512-3175.
- **BYTEnet:** (617) 861-9764 (set modem at 8-1-N or 7-1-E; 300 or 1200 baud).
Fax: (603) 924-7507. Telex: (603) 924-7861.
SUBSCRIPTION CUSTOMER SERVICE: Outside U.S. (603) 426-7070; Inside U.S. (800) 525-5003.
For a new subscription—(800) 257-9402 U.S. only, or write to BYTE Subscription Dept., P.O. Box 555, Hightstown, NJ 08520.

Officers of McGraw-Hill Information Services Company: President: Walter D. Sarwatka. Executive Vice Presidents: Kenneth E. Gazzola, Aerospace and Defense; Ira Herenstein, Computers and Communications; Russell C. White, Construction; Robert P. McGraw, Healthcare; Brian H. Hall, Legal. Senior Vice Presidents—Publishers: Laurence Altman, Data Communications; David J. McGrath, Engineering News-Record. Senior Vice Presidents: Robert D. Daleo, Finance; Michael J. Koeller, Human Resources. Group Vice Presidents: J. Burt Totaro, BYTE; Norbert Schumacher, Energy/Process Industries. Vice Presidents: George Eisinger, Circulation; Julia Lenard, Systems Planning and Technology.

Officers of McGraw-Hill, Inc.: Joseph L. Dionne, Chairman, President, and Chief Executive Officer; Robert N. Landes, Executive Vice President, General Counsel, and Secretary; Robert J. Bahash, Executive Vice President and Chief Financial Officer; Frank D. Penglase, Senior Vice President, Treasury Operations.

Founder: James H. McGraw (1860-1948). Executive, editorial, circulation, and advertising offices: One Phoenix Mill Lane, Peterborough, NH 03458, phone (603) 924-8281. Office hours: Monday through Thursday 8:30 AM-4:30 PM, Friday 8:30 AM-1:00 PM, Eastern Time. Address subscriptions to BYTE Subscriptions, P.O. Box 551, Hightstown, NJ 08520. Subscriptions are \$22.95 for one year, \$39.95 for two years, and \$55.95 for three years in the U.S. and its possessions. In Canada and Mexico, \$25.95 for one year, \$45.95 for two years. \$64.95 for three years. \$75 for one-year air delivery to Europe. Y28,800 for one-year air delivery to Japan. Y14,400 for one-year surface delivery to Japan, \$40 surface delivery elsewhere. Air delivery to selected areas at additional rates upon request. Single copy price is \$3.50 in the U.S. and its possessions, \$3.95 in Canada, \$4.50 in Europe, and \$5 elsewhere. Foreign subscriptions and sales should be remitted in U.S. funds drawn on a U.S. bank. Please allow six to eight weeks for delivery of first issue. Address editorial correspondence to: Editor, BYTE, One Phoenix Mill Lane, Peterborough, NH 03458. Unacceptable manuscripts will be returned if accompanied by sufficient postage. Where necessary, permission is granted by the copyright owner for libraries and others registered with the Copyright Clearance Center (CCC) to photocopy any article herein for the flat fee of \$1.50 per copy of the article or any part thereof. Correspondence and payment should be sent directly to the CCC, 29 Congress St., Salem, MA 01970. Specify ISSN 0360-5200/83, \$1.50. Copying done for other than per. or internal reference use without the permission of McGraw-Hill, Inc., is prohibited. Requests for special permission or bulk orders should be addressed to the publisher. BYTE is available in microform from Univer. Int'l Microfilms International, 300 North Zeeb Rd., Dept. PR, Ann Arbor, MI 48106 or 18 Bedford Row, Dept. PR, London WC1R 4EJ, England.

BYTE and BYTE are registered trademarks of McGraw-Hill, Inc.

Integrated Software for Schematics & PCB Artwork



Introducing HiWIRE®-Plus

Wintek's smARTWORK® pioneered low-cost printed circuit-board CAD. Then HiWIRE set the standard for productivity and ease-of-use in schematic capture. Now Wintek introduces HiWIRE-Plus, integrating HiWIRE's schematic features with a powerful printed-circuit-design facility.

Creating Schematics

With HiWIRE-Plus, simply connect library symbols with wires and buses. Changing symbols is fast and painless. Produce your drawing using a dot-matrix printer, laser printer, or pen plotter.

Circuit-Board Design

HiWIRE-Plus gives you all the design freedom you want: you choose the grid size, trace widths, and pad shapes. The board size and number of layers are virtually unlimited. HiWIRE-Plus is perfect for surface-mount, microstrip, and ECL applications.

HiWIRE-Plus Advantages

- One tool for schematics and printed-circuit artwork
- Easy-to-learn menu-driven operation; complete documentation and tutorial
- Schematic libraries with TTL, CMOS, ECL, ladder, microprocessor, and discrete components
- Netlist and bill-of-materials utilities included
- Circuit boards up to 60x60 inches and 256 layers
- Variable grid size, trace width, and pad size (.001" resolution)
- PCB library with DIPs, SIPs, SMDs, PGAs, TOs, and edge and D connectors
- Schematic-to-layout cross-checking
- Design-rule checker
- 800 number for tree support

System Requirements

- IBM PC, XT, AT, or PS/2 with 512K RAM, printer port, color monitor, and CGA, EGA, or VGA graphics card
- Microsoft Mouse
- IBM ProPrinter or Epson dot-matrix printer, and/or
- Houston Instrument or Hewlett-Packard pen plotter

Higher Performance Better Value

Still only \$895, HiWIRE-Plus delivers quality schematics and PCB artwork. You don't need to guess if HiWIRE-Plus is right for you — we *guarantee it!* Try it for 30 days at absolutely no risk. Call toll free today and put HiWIRE-Plus to work for you.

Wintek Corporation

1801 South Street
Lafayette, Indiana 47904-2993
(800) 742-6809 or
(317) 742-8428
FAX: (317) 448-4823
Telex: 70-9079

Europe: RIVA Ltd., England,
Phone: 0420 22666, FAX: 0420 23700
Australia: Entertainment Audio Pty, Ltd.,
Phone: (08) 363-0454



"HiWIRE", "smARTWORK", "Wintek", and the Wintek logo are registered trademarks of Wintek Corporation.

PM, SUNVIEW, AND THE MAC

Our early benchmarks show some interesting similarities and some surprising differences

I am writing this in my hotel room at COMDEX in Las Vegas. It's just a week after the formal release of Presentation Manager (PM). All around the show, signs dangle from the ceilings: "OS/2," they say, pointing to the booths displaying OS/2-related hardware or software. From a distance, it's impressive.

But when you follow the signs and actually go into the booths, you find more promises than products. The expected flood of OS/2 applications still is not materializing.

In a way it's a shame, because our early benchmarks of PM show that it's a very nice product: BYTE Lab's preliminary figures on text and graphics performance indicate that PM is marginally faster than either of its two chief rivals—the Macintosh and SunView (Sun's graphical interface for Unix).

What's the holdup? Senior Testing Editor Rick Grehan thinks it's in part due to "a whopping amount of starting friction," as he puts it. Programmers are facing a body of documentation that rivals (if not surpasses) the gigantic *Inside Macintosh*. "Remember how long it took decent programs to show up on the Mac? We'll probably see the same phenomenon on PM," Rick warns.

Here's a very cursory summary of some of the interesting ways that Rick and the BYTE Lab have found that PM differs from the Mac and SunView.

Macintosh Windowing

On the Macintosh, a window is a data structure that holds all the information

the Mac needs to make the window appear on-screen: The window definition function knows how to draw the window's frame, how to determine if the pointer is in the window when the mouse button is clicked, and so forth. Mac windows are more or less independent.

PM Windowing

A PM "window" is actually a bundle of separate windows, including the frame, the titlebar, and the client window (where the actual drawing/text display occurs). All are windows in their own right. This bundle is arranged in a hierarchy, the head of which is the frame.

Since windows in PM are hierarchical, a window can have children. The children's positions are relative to the parent's; when the parent is moved, its children also move. Also, when the parent window is closed, its children are also closed. PM's hierarchical approach allows applications to create an arbitrarily complex system of windows.

SunView Windowing

The Sun window system is constructed around the idea of multiple panes. A window is built as a bundle of other windows; these subwindows are akin to the PM client windows. Such subwindows can be canvases (for graphics), text subwindows (for text entry and editing), panels (that typically hold static text and buttons), or TTY subwindows (that act as a port to a command prompt).

Programming Hassles

In many ways, the Sun system takes care of many details that Mac or PM programmers have to handle explicitly. For example, because of the way user-triggered "events" are processed and the ease with which a programmer can "attach" specified actions to events, Rick has written a demonstration program on the Sun that creates and labels a button that you can click on to initiate some predefined action: It's only about four lines of C code.

In a similar program on the Mac, a mouse-down event would be detected by the program's event loop, but the application program would have to determine where the mouse was when its button was pressed, figure out what was supposed to happen next, and act accordingly.

A PM program would need a procedure for responding to a WM_BUTTON-DOWN message, then would have to call a position function to determine the location of the pointer on the screen, examine the location to see if the pointer was in the button to begin with, and initiate the desired process.

Text Handling

There are also variances in the way the three systems handle text. The Mac supports a structure called TextEdit. This is basically a string, but the Mac Toolbox contains a pile of routines that let a program manipulate that string for performing text editing-type functions. The Mac's TextEdit routines handle a lot of the work programmers would ordinarily have to do on their own.

Rick reports a parallel to the TextEdit structure on the Sun system: the text subwindow, which is a window to which you attach a memory- or file-based string. Text subwindow routines let you display and manipulate text by means of simple function calls.

However, using beta software and documentation, Rick has found no TextEdit counterpart to this structure in the PM environment.

Complexities such as these (and there are many more) add up to a steep learning curve. And that's what's taking so long.

On the other hand, our preliminary benchmarks indicate that when applications do arrive—for both PM and SunView—we'll probably feel it was well worth the wait.

—Fred Langa
Editor in Chief
(BIX name "flanga")

IBM/PC/XT/AT are registered trademarks of International Business Machines Corp. 688 ATTACK SUB is a trademark of Electronic Arts. Maxell Corp. of America, 2255 Route 208, Fair Lawn, NJ 07410.



Play the game of the decade. Free.

It's a special Maxell edition of 688 Attack Sub™, Electronic Arts' brilliant new simulation game for IBM PC/XT/AT and most compatibles. You'll command a crew aboard a fully-equipped top-secret billion dollar sub. Hunt or evade intelligent foes. Thrill to highly realistic 3-D graphics (256 colors in VGA mode). It's irresistible, easy to operate and it's yours on the free 11th disk in specially-marked MD2-D and MD2-HD 10-packs at your Maxell dealer. Don't delay.



maxell®
THE GOLD STANDARD

REPLACE YO

PC WORLD
"Upgrade product of the year."
...PC World



"Editors' choice"
...PC Magazine



Installed in minutes, the Renegade 386™ motherboard turns any IBM PC, XT, AT or inexpensive clone into a powerful new computer, lightning fast with both old software AND new OS/2 releases.

Is this you?
You would like to have extraordinary computing speed and power. You want number crunching ability. You need complex CAD capabilities. Or graphics. Or multi-tasking. And you haven't got it. (And you don't want to spend a fortune to replace good equipment with the newest standard.) Weep no more. You can turn your *present* system into the latest, high-performance system that will *equal or exceed the best of the new computers*.

Renegade 386™ **A new heart and brain for your computer.**

Renegade Technologies offers designers, engineers, architects, and computer-dependent businesses a simple and reliable alternative to obsolescence. Or the unreasonable expense of a new system.

Simply replace the "motherboard" of your present system with a Renegade 386™ motherboard.

It takes a screwdriver and less than 20 minutes. And costs but \$1695.

That's *thousands of dollars less* than a new IBM System/2 Model 80.

But it gives you more than just the latest industry standard. You can run your old software on it. Probably anything you now use on your XT or AT. Big Blue can't do that.

You can use your present 16-bit peripherals. (If you've looked at PC "add-on" cards, you already know your old equipment would be useless.)

But with Renegade 386™ you'll have to find some other excuse to throw away your current modem, network card,

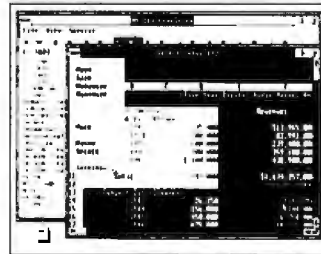

Multi-task with Lotus 1-2-3 and other applications running side-by-side on the Microsoft Windows/386 desktop.

EGA or disk controller cards.

The Renegade 386™ board comes with an iron-clad *one year limited warranty*. It uses genuine U.S. made Intel 386 chips and is designed and manufactured in the U.S.A. by Hauppauge Computer Works. Hauppauge is a major developer of software

support for Microsoft and IBM products, and is producer of the highly respected Hauppauge 8087 or 80287 high-speed math coprocessors. Over 50,000 have been sold.

Major computer magazine reviews in the last year have hailed our Hauppauge-made board as a major breakthrough in a high speed, high power, high performance upgrade product.

Not an accelerator card. Not a "turbo" gimmick. Renegade 386™ gives you a full-featured new computer.

Thanks to Renegade's 80386 microprocessor your computer will now boast a 32-bit data path—and a clock speed of 16 MHz with zero wait state access. Up to 8 expansion slots are provided depending on your computer configuration.

Your "new" computer also will now have 1 Megabyte of 100ns RAM. This is *not* a naked board. And it also includes a 32-bit high-speed RAM expansion slot which you can populate with up to *15 Mbytes* of system memory.

UR MOTHER

In practical terms that simply means that programs like Lotus 1-2-3 or new products like Foxbase 386, and almost anything else, *will run faster than anything you have ever seen.*

Which is a minor problem for some folks who are playing computer games on company time. Renegade 386™ may run them at speeds far too fast for human reactions.

The world is not perfect.

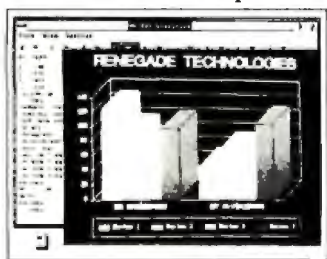

Faster, easier presentation graphics with newest software releases.

Otherwise Renegade 386™ is perfectly compatible with products like AutoCAD, Aldus PageMaker, Microsoft Windows, Ventura Publisher, the Novell Network and siz-zlers like Paradox 386. We haven't yet found a popular program we can't run with it.

Power hungry? Equip Renegade 386™ with even more RAM — without speed loss.

Add up to 15 Mbytes of system memory with Renegade™ expansion modules that plug right into your Renegade 386™ 32-bit expansion slot. *And run with no loss of speed* — something no IBM or Compaq model can match.

There's a lot of confusion in computer claims, but the fact is that with *zero* wait state, our 16 MHz is effectively the same as those highly touted machines running at 20 MHz with one wait state.

So plug in Renegade™ expansion modules in 2- and 4-Megabyte increments and run Windows 386 applications at the speed God intended.

\$1695

The Renegade 386™ motherboard. Next generation performance for \$8thousands less.



OFFER

NO-RISK

understand

yourself.

Renegade

TECHNOLOGIES

Redmond, Washington USA

(206) 885-5700

IBM PC, AT, XT, Personal System/2, Microsoft Windows 386, Foxbase 386, Paradox 386, PageMaker, 1-2-3, Novell Network, Ventura Publisher, EGA, Intel, Hauppauge, Compaq and other brands and products are trademarks or registered trademarks of their respective holders.

New Prices

OS/2

WINDOWS FOR DATA®

MULTI-LEVEL MENU SYSTEM

NESTED POP-UP FORMS

SCROLLABLE REGION

CHOICE LIST

INVOICES: Create Review Print Exit

INVOICE

Invoice No.: 008784 Date: 12/03/87 Time: 16:43:15

Customer: William Jones
Innovative Software
351 Bulletin Avenue
Needham, MA 02194
(617) 394-5512

No.	PRODUCT	DESCRIPTION	QUANTITY	PRICE	AMOUNT
5	UDMS	Windows for Data Microsoft	10	295.00	2950.00
6	UDLA	Windows for Data Lattice	5	295.00	1475.00
7	UDTC	Windows for Data Turbo C	5	295.00	1475.00
8	UDXE	Windows for Data XENIX	2	795.00	1590.00
9			0	0.00	0.00

Subtotal: 11325.00
Shipping: 0.00
TOTAL: 11325.00
Payment: 0.00

Cursor keys scroll, ENTER selects and ESC exits choice menu

CLOCK

POP-UP WINDOW

RUNNING TOTALS

MESSAGE WINDOW

If you program in C, take a few moments to learn how Windows for Data can help you build a state-of-the-art user interface.

- ✓ Create and manage menus, data-entry forms, context-sensitive help, and text displays — all within windows.
- ✓ Develop window-based OS/2 programs right now, without the headaches of learning OS/2 screen management. Run the same source code in PC DOS and OS/2 protected mode.
- ✓ Build a better front end for any DBMS that has a C-language interface (most popular ones do).

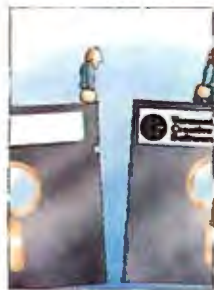

FROM END TO BEGINNING

Windows for Data begins where other screen packages end, with special features like nested pop-up forms and menus, field entry from lists of choices, scrollable regions for the entry of variable numbers of line items, and an exclusive built-in debugging system.

NO WALLS

If you've been frustrated by the limitations of other screen utilities, don't be discouraged. You won't run into walls with Windows for Data. Our customers repeatedly tell us how they've used our system in ways we never imagined — but which we anticipated by designing Windows for Data for unprecedented adaptability. You will be amazed at what you can do with Windows for Data.

YOU ARE ALWAYS IN CHARGE

Control functions that you write and attach to fields and/or keys can read, compare, validate, and change the data values in all fields of the form. Upon entry or exit from any field, control functions can call up subsidiary forms and menus, change the active field, exit or abort the form, perform almost any task you can imagine.



OUR WINDOWS WILL OPEN DOORS

Our windows will open doors to new markets for your software. High-performance, source-code-compatible versions of Windows for Data are now available for PC DOS, OS/2, XENIX, UNIX, and VMS. PC DOS

versions are fully compatible with Microsoft Windows. **No royalties.**

MONEY BACK GUARANTEE

You owe it to yourself and your programs to try Windows for Data. If not satisfied, you can return it for a full refund.

Prices: PC DOS \$295, Source \$295. OS/2 \$395. XENIX \$1295. UNIX, VMS, please call.

Call: (802) 848-7731

ext. 51

Telex: 510-601-4160 VCISOFT

FAX 802-848-3502



Vermont Creative Software

21 Elm Ave.
Richford,
VT 05476

MICROBYTES

*Staff-written highlights of developments
in technology and the microcomputer industry*

Voice-System Researchers Hope to Rise Above Noise

Although great progress has been made in the quality and accuracy of systems using voice recognition and voice synthesis, there is still much work to be done in both recognizing and synthesizing the acoustic variations of speech. That was the consensus at the annual meeting of the American Voice Input/Output Society (AVIOS), held recently in San Francisco.

The biggest problem in voice recognition is being able to accurately interpret various accents, intonations, word ambiguities, and different pitches of the male and female voice. Some progress has been made by using a technique called the Hidden Markoff Model, in which each word is broken up into syllables and each syllable's frequency response is analyzed separately. Although this method has promise, it requires a totally quiet environment and has yielded only 70 percent accuracy for vocabularies of up to 1000 words.

The main objectives of researchers working in voice recognition in the next few years are achieving a 90 percent semantic accuracy rate, real-time performance, and being able to maintain accuracy in normal, noisy environments. Another challenge facing researchers is getting voice recognition systems to sample sounds faster than once every 10 milliseconds.

Voice synthesis systems have achieved a high degree of accuracy in converting text to talk, but they don't sound natural. Part of the problem is that single phonemes, like the letter *a*, for example, produce a wide range of frequencies depending on the word. For example, "The fat man ate jam in the Cadillac" can yield variations in frequencies of up to 300 Hz in the formant frequencies for the phoneme *a*.

The trick is to develop a parser that can determine the frequency of the phoneme depending on the adjacent

letters. For example, the phrases "Sally" and "sassy" yield different frequencies because of the letters immediately following *a*.

Another major challenge facing voice synthesists is creating different voice qualities in text-to-speech synthesis. For example, there's no method for expressing breathiness, creakiness, falsetto, loud and soft intonations, and variations in stress on different syllables.

The challenge is to develop methods for quantifying the acoustic variations in speech and to develop parsers that can resolve semantic ambiguities to help assign the proper intonation to a phrase. Work in this area is being conducted at Stanford Research Institute, Speech Plus (Palo Alto, CA), and at a number of other research institutes and speech-recognition companies. AVIOS can be contacted at P.O. Box 60940, Palo Alto, CA 94306, (408) 742-2539.

NANOBYTES

- Since Lotus Development founder **Mitch Kapor** can get pages of publicity for a product that isn't even a product yet, we'll give him just a paragraph. Kapor has said that his company, **On Technology**, will develop products that make computers **easier to use** and that they'll consist of "building blocks" that will run under different operating systems. He hasn't specified how these products will make computers better, but we can bet the first On product will implement **object-oriented** principles. At a recent conference on object-oriented programming, 14 of On's 23 employees were there. Kapor, a speaker at the conference, said OOPS methodology will prompt "a different ecology of applications . . . more modular, more like kits that users assemble."

- **Mighty mouse:** **Marq Technologies** (San Diego, CA) has a new **mouse** that you can transform into an image scanner or an optical character reader by outfitting it with special cartridges that plug into the front of the input/pointing device. The **Marq-Mouse**, which is compatible with mice from Logitech, has a resolution of 600 pixels per inch. With the scanning module attached, the device can capture images at 300 dots per inch and with

continued

C++ Users Await Next Release

As the future of software engineering looks more and more object-oriented, C++ looks more and more significant. Addressing the question of how to make the programming environment more productive, Sun Microsystems' co-founder Bill Joy said recently, "The name of the answer is C++."

C++, invented by Bjarne Stroustrup at AT&T Bell Labs in the early 1980s, is an extended version of ANSI Standard C that

adds the constructs necessary for object-oriented programming. Users and researchers at a recent Usenix-sponsored conference agreed that the next major release of C++ from AT&T, version 2.0, will resolve many portability concerns and add functionality to the object-oriented paradigm, including type-safe linkage, multiple inheritance, and member-wise assignment and initialization semantics. Version 2.0, which should be released during the first

quarter of this year, should coincide roughly with the release of a document that will comprehensively describe the current state of standard C++.

The AT&T C++ compiler has been considered the standard since its release in 1985. Unlike C, for which companies have written variations on the original, incompletely specified AT&T C compiler, developers writing their own C++ compilers have been careful to

continued

NANOBYTES

16 levels of gray. It works with the IBM PC, PS/2s, and compatibles. The basic mouse is \$199; the scanner module and OCR module will each sell for \$799.

- The pact between **Tandy and Digital Equipment Corp.**, whereby Tandy will build personal computers that DEC will then sell under its own name, has advantages for both companies. DEC gets a production line run by one of the most experienced electronics manufacturers in the world. Tandy, as a result of a "technology exchange," gets, among other things, DEC's DECnet networking technology. DEC's outreach to personal computer companies like Tandy and Apple indicates an awareness that you can't plan to survive in a proprietary VMS world. DEC also signed a pact with Ashton-Tate to put dBASE on the VAX.

- DEC is "well along" in making the transition from proprietary DECnet communications protocols to **Open Systems Interconnect** protocols, said DEC vice president William Strecker at Patricia Seybold's Executive Forum recently. The move to OSI will take a couple of years, but it's at least the right direction, as OSI provides guidelines for networks of computers from different manufacturers. As Strecker agreed, the language of networks has to be open and international. "We believe everybody else will come to that conclusion," he said.

- **Metaphor** (College Place, WA) has a new li-

continued

stick closely to the example set by AT&T's own evolving version of C++. "The main players have all deferred to us [on compatibility issues]," said Jonathan Shapiro, a member of the Bell Labs technical staff.

Programmers and academics at the Usenix conference disagreed on how to implement several object-oriented constructs, but all agreed that compatibility with the AT&T C++ compiler is essential.

Not everyone is a fan of C++; some programmers think it is too unstructured, an "anarchist" in Shapiro's terms (as opposed to a "fascist"). "What he's saying is: Either programmers can do what they want, or program-

mers can do what the language designers think they should do," explained Andrew Koenig of the Bell Labs staff. Bill Joy says, "C++ gives you enough rope to hang yourself."

Technical staffers at Bell Labs point out that C++ is evolving and that version 2.0 will not be driven by market concerns. "It has taken so much more time to get things working reliably that we want to wait and make sure that it's reliable when released," said Koenig. Noting that input from the user community and consultation with vendors is vital, Stroustrup said, "We must have delays in this process [the release of 2.0]; otherwise, we may have to live

with gross mistakes."

The presence at the C++ conference in Denver of representatives from major computer companies, including IBM, Hewlett-Packard, Apple, AT&T, and Sun, makes the language's future look good. (Notably absent was Stepstone, which makes Objective C, the object-oriented programming language bundled with the NeXT machine. Objective C is not compatible with C++.) "As far as I can tell, we've had a much bigger impact than any current language, if you look at languages introduced in the last 15 years. It is no longer controversial to say C++ is the next generation of C," Shapiro said.

Prototype Big LCD Can Display 16 Colors

Liquid crystal displays will be one of the hottest potential markets heading into the 1990s. And they'll come in all flavors, sizes, colors, and resolutions. LCDs with resolutions of 640 by 480 pixels will be common on laptops in the next decade, and as the market grows, so will the size of the displays.

And now, IBM Japan and Toshiba have produced a prototype of what they say is "the world's largest color LCD." Hitachi recently announced a 2-meter-square LCD that can display eight different colors, but a Toshiba spokesperson said,

"Ours is the largest one capable of displaying 16 colors."

The prototype, developed jointly by IBM's Yamamoto Laboratory and Toshiba's Electron Technology Labs, measures almost 15 inches square. It took 2 years to develop, a Toshiba representative told Microbytes Daily. The LCD uses an "active-matrix-type thin film transistor" for each pixel. The display can switch between color and monochrome mode; in monochrome mode, the resolution is 1440 by 1000 pixels, for a total of 1.58 million pixels. Color mode is somewhat less, pro-

viding a matrix of 720 by 550 pixels. Each pixel in color mode is made up of four colors: red, green, blue, and white. You can reproduce up to 16 colors on the LCD at the same time.

A Toshiba official said that the "pitch between pixels is about 200 microns," producing the high density required for the LCD's high-resolution images. The official wouldn't speculate on when the LCD would reach production levels, nor would he provide any details on what the display might cost or when it might appear in products.

NeXTStep Won't Affect OS/2 Plans, IBM Says

IBM's deal with NeXT to license the NeXTStep Unix-based graphical interface prompted speculation that IBM might be veering from its proclaimed commitment to OS/2. But IBM claims that its use of NeXTStep will have absolutely no impact on its plans for OS/2.

IBM spokesperson Scott Brooks said that NeXTStep and OS/2 are "intended for different areas. OS/2 is a strategic system for PS/2s and Systems Application Architecture host environments. NeXTStep is purely for Unix-based environments." Brooks said users

can expect a "steady stream of enhancements to both our OS/2 and Unix-based systems. We want to offer leadership in both areas over time."

Brooks declined to comment on planned products for the NeXTStep environment

continued

If anyone
tries to tell
you that one
language
fits all, turn
the page.

To each

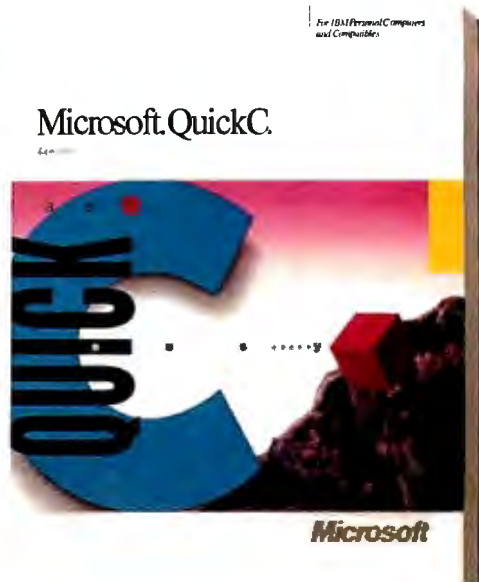
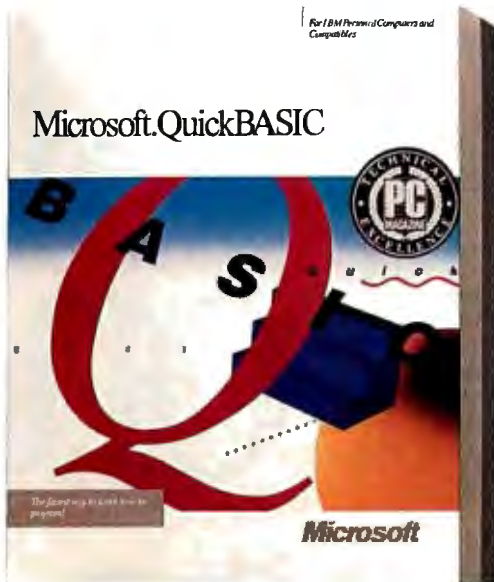

Quick.

Despite what some software companies are saying, one language just can't be all things to all programmers. Which is why Microsoft offers a language for every level.

When you're starting out, you need learning tools that make it easier. Take our Quick languages, for instance. Each one features an integrated development environment that puts a powerful editor, compiler, debugger and on-line help within easy reach. And of course, all Quick languages are mouse-driven, so all commands are just a point and a click away.



More specifically, Microsoft® QuickBASIC comes with on-line support: QB Advisor serves as a state-of-the-art electronic manual, and QB Express can teach you how to use the environment in just minutes. Of course, you'll be more productive even faster with our new Easy Menus and the instant environment.

Or maybe you already know how to program and want to be introduced to the power of C.

Microsoft QuickC® is your language. The fastest way to learn C: just use its integrated source-level debugger and advanced graphics capabilities. You'll be up and writing C programs in no time. Just like the name implies.

his own.

For Personal Computers Running the MS-DOS or MS-DOS Operating System

For Personal Computers Running the MS-DOS or MS-DOS Operating System

Microsoft C 5.1

Optimizing Compiler

Microsoft BASIC 6.0

Optimizing Compiler



Professional.

Professional programmers are in a league all their own. So are the tools Microsoft provides the professional.

Each of our professional languages offers the complete development solution. Including the acclaimed CodeView.[®] An optimizing compiler for power. OS/2 support for access to the next generation of computing. And Microsoft Editor for the most sophisticated source code editing.

As for the most powerful BASIC ever to grace a PC, there's BASIC Compiler.

With its talent you have the ability to create smaller, faster executables.

Which isn't to say Microsoft C Optimizing Compiler doesn't have a few talents of its own. Lightning fast at running executables, it also features an incremental linker and support for various powerful platforms like MS-DOS[®] and Microsoft Windows, as well as Presentation Manager.

So no matter what level of computer programmer you are, Microsoft makes a language that lets you be the best you can possibly be. Which goes to show you, one language company really does fit all.

Microsoft[®]
Making it all make sense.

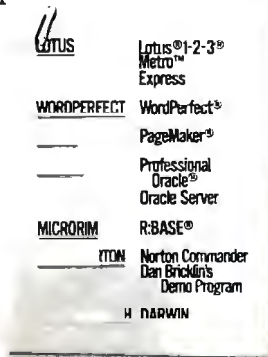

Our languages speak for themselves—all of these industry hard hitters use Microsoft languages.

PageMaker is a registered trademark of Aldus Corporation. Lotus and 1-2-3 are registered trademarks and Metro is a trademark of Lotus Development Corporation. R:BASE is a registered trademark of Microrim, Inc. Oracle is a registered trademark of Oracle Corporation. WordPerfect is a registered trademark of WordPerfect Corporation.

NANOBYTES

brary of numerical methods for Think's Lightspeed C for the Macintosh. NuTools contains 350 numerical routines and 50 I/O routines and sells for \$125. Metaphor said it plans similar libraries for Lightspeed Pascal and Borland's Turbo Pascal.

- **Mitsubishi Electronics America** (Torrance, CA) is offering a new line of **optical storage** devices to system builders. The MW-5D1 WORM (write once, read many) drive can hold 300 megabytes on each side of a 5¼-inch removable disk cartridge and has an average random access time of 80 milliseconds; track-to-track seek time is rated at 1 ms. The company's two new optical jukeboxes, primarily for document management systems, can hold as much as 90 gigabytes on 152 WORM cartridges or 34 gigabytes on 56 cartridges. Each cartridge is good for about 300,000 pages, Mitsubishi said.

- **Mitsubishi** researchers in Japan have been doing overtime in the **optical technology** department. The company says it has come up with a process that greatly increases the writing density on optical media.

- **Drexler Technology** (Mountain View, CA) says it will start marketing LaserCard-based workstations next month. The systems, designed for record keeping, security, and electronic publishing applications, use Drexler's credit-card-size **optical memory cards** for storing data; the cards can now hold as much as 2 megabytes. A

continued

but said that IBM products would follow "closely behind" the rollout of NeXT-Step 1.0 on the NeXT computer, which is scheduled to be available during the second quarter of this year. Brooks said IBM is "bound by the schedule that NeXT has." IBM will have to wait until early or mid-1989 for a bug-free version of NeXTStep.

Regarding the Open Software Foundation consortium of Unix vendors, which in-

cludes IBM and is working on a new interface for Unix, Brooks said that IBM "does not have a product to present to OSF at this time." Steve Jobs said that NeXT has not offered any products to OSF, either. So far, NeXTStep will be limited to the NeXT computer and IBM's AIX platforms. After paying a reported \$10 million for the license with NeXT, IBM may not be too anxious to share this interface with other companies,

and NeXT might feel the same way.

NeXT has a lot to gain from IBM's acceptance of NeXTStep. NeXT knows that the key to its success is widespread support from innovative applications developers. With IBM providing another major market for NeXTStep software applications, NeXT could attract developers who otherwise might have been hesitant to commit themselves to NeXTStep.

With DVI Technology, Intel Could Be Key to PC Video

Intel (Santa Clara, CA) has joined the race to commercialize interactive digital video. The company's surprising purchase of Digital Video Interactive technology from GE/RCA gives it the chance to establish a technical standard for microcomputer-based digital video, much as it has done with microprocessors. Developed by RCA, DVI consists of hardware and software that enables microcomputers to play long videos stored on conventional digital compact disks.

DVI uses a proprietary data-compression algorithm to squeeze up to an hour of

full-screen, digitized video onto a standard CD-ROM disk. Without compaction, only 30 seconds of normal video could be stored on a disk, yet the quality of DVI images is not significantly different from those generated by a VCR. Half-screen or smaller images can run for more than 2 hours, and moving pictures can be combined with computer text and graphics, high-resolution still photographs, and stereo audio. The digitized video is played back through an IBM PC AT or equivalent configured with a high-resolution monitor and three plug-in boards to be

supplied by Intel.

First demonstrated in March 1987, DVI is now in beta test at more than 20 sites. Intel plans a commercial release of the system in the second quarter of this year to software developers and OEMs. The company said it intends to improve the quality and performance of DVI over the next 2 years and reduce its cost through miniaturization and volume production. By 1990, Intel aims to package DVI in a set of chips.

Beta-site applications will include interactive education and training, simulation, and entertainment.

Japanese Giants Offer New Unix Systems

Unix workstations have been the province of American computer makers, and they got a glamour boost last year when Steve Jobs rolled out the NeXT cube, but Japanese companies aren't neglecting this growing market. Two industrial giants are showing a considerable interest.

Sony last year began offering its NeWS Unix systems in the U.S. and now will ship them with an erasable optical disk drive (594 megabytes) as a \$4650 option. The newest models are

built around Motorola 25-MHz 68030s and come with as much as 16 megabytes of main memory, room for three 286-megabyte hard disk drives, a 125-megabyte tape drive, and a 64K-byte memory cache. The prices for the NeWS series range from \$3995 (diskless) to \$54,900.

Matsushita Electric Industrial has developed four new Unix workstations it plans to start marketing this spring. The four new BE series models are a diskless machine with an Ethernet

interface; a desktop machine that can be used as an MS-DOS computer; a desktop publishing system, equipped with a 1312- by 1312-pixel display; and a desktop machine that can hold up to 1.5 gigabytes of hard disk storage internally. All four new models use 80386 CPUs and have 32K-byte memory caches. They will run Unix System V release 3.2, including X Windows and Sun's NFS. Up to four 80386s can be installed in a single machine.

continued

Take the
Advanced C Library
for only \$4.95!

when you join

The Library of Computer and Information Sciences.

Please accept my application for trial membership and send me Advanced C Library (00939) billing me only \$4.95, plus shipping and handling. I agree to purchase at least three additional Selections or Alternates over the next 12 months. Savings range up to 30% and occasionally even more. My membership is cancelable any time after I buy these three additional books. A shipping and handling charge is added to all shipments.

No-Risk Guarantee: If I am not satisfied—for any reason—I may return Advanced C Library within 10 days. My membership will be canceled, and I will owe nothing.

Name _____

Name of Firm _____
(If you want subscription sent to your office)

Address _____ Apt. _____

City _____

State _____ Zip _____

(Books purchased for professional purposes may be a tax-deductible expense. Offer good in Continental U.S. and Canada only. Prices slightly higher in Canada.)

Byte 1/89

7-FF6

Take the
Advanced C Library
for only \$4.95!

when you join

The Library of Computer and Information Sciences.

Please accept my application for trial membership and send me Advanced C Library (00939) billing me only \$4.95, plus shipping and handling. I agree to purchase at least three additional Selections or Alternates over the next 12 months. Savings range up to 30% and occasionally even more. My membership is cancelable any time after I buy these three additional books. A shipping and handling charge is added to all shipments.

No-Risk Guarantee: If I am not satisfied—for any reason—I may return Advanced C Library within 10 days. My membership will be canceled, and I will owe nothing.

Name _____

Name of Firm _____
(If you want subscription sent to your office)

Address _____ Apt. _____

City _____

State _____ Zip _____

(Books purchased for professional purposes may be a tax-deductible expense. Offer good in Continental U.S. and Canada only. Prices slightly higher in Canada.)

Byte 1/89

7-FF6

**10-Day
Free Examination**



BUSINESS REPLY MAIL

FIRST CLASS PERMIT NO. 230 RIVERSIDE, NJ

POSTAGE WILL BE PAID BY ADDRESSEE

NO POSTAGE
NECESSARY
IF MAILED
IN THE
UNITED STATES



**The Library of Computer
and Information Sciences**

Riverside, New Jersey 08075-9889



**10-Day
Free Examination**



BUSINESS REPLY MAIL

FIRST CLASS PERMIT NO. 230 RIVERSIDE, NJ

POSTAGE WILL BE PAID BY ADDRESSEE

NO POSTAGE
NECESSARY
IF MAILED
IN THE
UNITED STATES



**The Library of Computer
and Information Sciences**

Riverside, New Jersey 08075-9889



Take the 3-volume Advanced C Library for only \$4.95

as your introduction to the
Library of Computer and Information Sciences

a \$93.40 value

You simply agree to buy three more books—at handsome discounts—within the next 12 months.

Numerical Recipes in C *The Art of Scientific Computing*

Four experienced scientists bring you this authoritative "cookbook" of C routines for numeric computation. It includes sample code for almost 200 routines, as well as a mathematical and algorithmic analysis of each technique.

Over 730 pages long, NUMERICAL

RECIPES IN C covers everything from linear equations, matrix inversion, singular value decomposition, and spline arrays...to finding minima or maxima, calculating eigenvectors and eigenvalues, interpolation and extrapolation.

Publisher's price: \$44.50

Graphics Programming in C

Use the power of C to create efficient graphics. This example-packed book is filled with proven graphic routines and sample programs including many full-color illustrations. Use the code modules as is or modify them to meet your specific needs.

Learn how to create and move graph-

ics cursors... techniques for coordinate transformation... methods for creating three-dimensional figures... and more. Also includes a fascinating program for drawing iterated function systems and fractals.

Publisher's price: \$24.95.

C Database Development

Implement and manipulate relational databases in C with this time-saving source of portable, reusable C program modules.

An invaluable collection of C language functions, it shows you how to use data pointer operations, assign global alphanumeric names to integral values,

support independently compiled source files, and much more.

Containing a complete DBMS, you get a DM schema compiler, B-index files, a DB manager, full-screen data entry query, a data file manager, and report generator and utilities.

Publisher's price: \$23.95

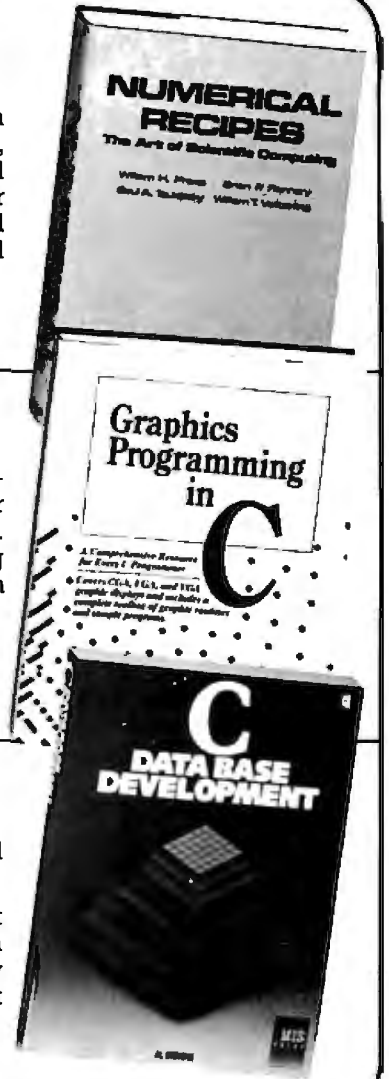

MEMBERSHIP BENEFITS

In addition to getting the Advanced C Library for only \$4.95 when you join, you keep saving substantially on the books you buy. • Also, you will immediately become eligible to participate in our Bonus Book Plan, with savings of 65% off the publishers' prices. • At 3-4 week intervals (16 times per year), you will receive the Library of Computer and Information Sciences News, describing the coming Main Selection and Alternate Selections, together with a dated reply card. • If you want the Main Selection, do nothing, and it will be sent to you automatically. • If you prefer another selection, or no book at all, simply indicate your choice on the card and return it by the date specified. • You will have at least 10 days to decide. If, because of late mail delivery of the News, you should receive a book you do not want, we guarantee return postage.

The Library of Computer and Information Sciences is the oldest, largest book club especially designed for computer professionals. In the incredibly fast-moving world of data processing, where up-to-the-moment knowledge is essential, we make it easy to keep totally informed on all areas of the information sciences. What's more, our selections offer you discounts of up to 30% or more off publishers' prices.

If reply card is missing, please write to the Library of Computer and Information Sciences, Dept. 7-F6-00939, Riverside, NJ 08075, for membership information and an application.

Byte 1/89

JANUARY 1989 • BYTE 17

NANOBYTES

new device driver card will enable the systems to run MS-DOS software. Drexler has been one of the pioneering forces behind these optical memory cards.

• NorthBank Corp. recently issued a statement saying it will offer a \$1000 reward to "the first person to write a program that will modify, erase, or otherwise write to a hard disk partition protected by the Guard Card. The program may be in the form of a virus, Trojan [Horse], or any other executable program." If you're feeling contagious, contact Richard Bronson at NorthBank, 10811 North Bank Dr.,

continued

A-T Won't Put dB into PD

Ash-ton-Tate (Torrance, CA) has no intention of putting its dBASE language into the public domain as a standard computer language, company chairman Ed Esber told a group of users recently. "Beware of Greeks bearing standards," Esber told the Boston Computer Society IBM group at one of its meetings.

"If you're talking about

putting dBASE into the realm of an ANSI standard, I'm not ready to do that yet," Esber said. "If you're suggesting that I do that, it's an issue that I've thought a lot about. . . but I'm not willing to put the dBASE language into the public domain."

On the much-publicized late shipment of the dBASE IV package, which finally came out in late October,

Esber said, "We know we screwed up."

"If you have some input to make on our products, and the first level or two you try don't work, don't assume that I don't want to hear it," Esber said. "Write to me. You'd be surprised what can happen if I get a letter, draw an arrow to so-and-so, and add a note that says 'Please make this happen.'"

Newspaper Designers Putting Desktop Systems to the Test

Although newspapers still use a delivery system that often depends on school-age children as the last link between producer and customer, they are in many ways technological leaders in production. At a

recent meeting of the Society of Newspaper Design (SND), attended by page designers from around the world, 90 percent of the members said they use personal computers in their newsrooms, and 92 percent

of those computers are Macintoshes. Those Macs are often used to create graphics relating to local news stories. Several companies now provide a national service of daily graphics

continued

Travel With A Fast Crowd.



Wherever your business takes you, take along the WorldPort 2400™ Portable Modem. Leaving the office doesn't have to mean leaving behind the world of high-speed, 2400 bps communications. Worldwide, in virtually every situation, including hotel rooms and phone booths, your ability to communicate clearly and efficiently remains intact.

Representing the cutting edge of modem technology, the WorldPort line of portable modems combine a broad range of features that bring you the best value in modems today. Features

that go far beyond costly internal units, such as Bell and CCITT standards, direct connect and acoustic interface (300 and 1200 bps), battery power, shirt pocket size, and a tiny price.

In fact, the WorldPort modems are the ultimate for both portable and desktop applications. And the WorldPort 2400 comes with Carbon Copy PLUS™ communications software, for even greater value.

If you want a modem that works where you do, put the WorldPort Series to work for you. In

the office. On the road. Or at home. For more information about our full line of WorldPort modems, or the name of your nearest dealer, call us at 800-541-0345. (In New York, 516-261-0423.)



Touchbase Systems, Inc.
160 Laurel Avenue
Northport, NY 11768
(516) 261-0423
TELEX: 6502848020
FAX: (516) 754-3491

WorldPort 2400 is a trademark of Touchbase Systems, Inc. Carbon Copy PLUS is a trademark of Meridian Technology, Inc.

R E L I A N T

BACK-UP



Only Sysgen tape backup systems are so reliable we'll back up your data with dollars. Here's how:

Two Year Data Loss Recovery Contract.

Can you really trust your backup if a failure occurs?

Yes—if you're using Sysgen™ Reliant streaming tape backup for your PC/XT™/AT™ and PS/2™ systems. Only Reliant offers you *added assurance* against data loss. We'll guarantee you this: if you're unable to retrieve your data from a Reliant tape, we'll pay your data recovery costs up to \$1500 if you're under our Data Loss Recovery Contract* (2 years: \$50, 1 year: \$25). No other tape backup manufacturer offers you this extra protection.

Sysgen's rugged design and excellent price/performance will give you peace of mind—and to give you maximum flexibility, all Reliant backups are available in both external and internal versions.

But RELIABILITY is what backup—and Sysgen—are ultimately all about.

Series 300: Streaming backup on industry standard 1/4" cartridge.

Systems are available at 60 and 125 MB capacity levels. Menu-driven software includes Reliant's exclusive *Autoverify* feature. Comprehensive backup features for Novell®, IBM®, and 3COM® make Series 300 ideal for network use.

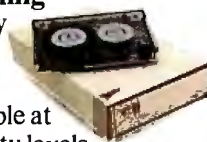

Series 200: Cost-effective streaming backup on digital cassette.

Series 200 offers 60 MB capacity in a small 6" x 8" footprint. Data is stored on a compact cassette—you'll never struggle with a pile of floppy disks again. You can pre-set your backup times for automatic operation, while fast 5 MB per minute performance assures your



data will be secure—at your convenience.

Series 500: Latest technology 72 MB streaming backup in a 3 1/2" drive.

Advanced features make Series 500 compact, fast and quiet. The external system has a small footprint and is truly portable. The internal system fits perfectly into the 3 1/2" drive slot of the PS/2. Series 500's unique servo-tracking head mechanism ensures reliable tape interchange between PC and PS/2 configurations.



Back up Your Data With Dollars. Call the Sysgen Hotline for the name of your nearest dealer: 1-800-821-2151.

SYSGEN
INCORPORATED
556 Gibraltar Drive, Milpitas, CA 95035

*All claims subject to the terms and conditions set forth in the Sysgen Data Loss Recovery Contract. Sysgen is a trademark of Sysgen, Inc. XT, AT, PS/2 are trademarks of IBM Corp. IBM, Novell and 3COM are registered trademarks.

Richmond, VA 23101
(804) 741-7591.

• Now that the grease has settled from the election of 1988, let's look back at a truly interesting race. **Eastgate Systems** (134 Main St., Watertown, MA 02172, (617) 924-9044) has a new **hypertext package**

that explores and documents the **1912 presidential election**. Remember the election? Rough-and-ready upstart Theodore Roosevelt went up against Taft and Wilson. Eastgate describes this \$45 program, appropriately called **1912**, as a hypertext book and says it doesn't have even one "nuisance"

that subscribing newspapers receive either by telephone lines and modems or by direct satellite link.

These graphics directors have become more demanding of software and hardware vendors for the tools of their trade, but they have found that they can create good-looking print publications with personal computers and off-the-shelf parts. Karl Gude of the Associated Press, for example, uses MacDraw II despite what he says are several drawbacks. What he doesn't

like is that text presentation isn't what newspaper graphics designers demand; kerning capabilities are not satisfactory; the ability to have a continuous-tone screen is lacking; and when doing color separations, text cannot be overprinted.

Bill Campbell, president of Claris (Mountain View, CA), said feedback from AP members is affecting version 1.04. "You are the pushers of the limits of technology," he told the SND.

Fred Ebrahimi of Quark (Denver), whose Quark

XPress has proved of particular interest to the newspaper market, agreed that users such as the SND members can play an important role in the growth of his product.

Quark XPress 2.0 was used to produce the 24-page color newspaper done during the meeting. About half of the full-page output was produced on a Varityper 600-dot-per-inch laser printer, and the rest was done on a Linotronic 500 with 1250 dpi. Several designers said they could not tell which pages were produced on which device in the final product. "It shows that both of these machines are good enough for production on newsprint, although I am not sure I would want to produce halftones and screens at 600 dpi for a newspaper," explained one of the designers.

TECHNOLOGY NEWS WANTED. *The news staff at BYTE is interested in hearing about new technological and scientific developments that might have an impact on microcomputers and the people who use them. If you know of advances or projects relevant to microcomputing, please contact the Microbytes staff at (603) 924-9281, send mail on BIX to Microbytes, or write to us at One Phoenix Mill Lane, Peterborough, NH 03458. An electronic version of Microbytes, which offers a wider variety of computer-related news on a daily basis, is available on BIX.*

FIVE GOOD REASONS TO BUY A MOUSE-TRAK.™



Count them. With MOUSE-TRAK, five fingers do all the work. Because it uses trackball technology, input and precision control is at your fingertips, not your elbow.

With CAD, Desktop Publishing or Spreadsheet applications, MOUSE-TRAK is easier, faster, more relaxed and a lot more comfortable to use than ordinary input devices.

MOUSE-TRAK OFFERS YOU OPTIONS

2 or 3 buttons — speed control — Multiple Interfacing

MOUSE-TRAK is stationary. Only the highly efficient trackball moves, eliminating tiresome arm and wrist movement. You can operate MOUSE-TRAK in your hand, even sit back with it on your knee. It plugs into your computer and needs no additional power supply.

User definable input keys are in easier-to-use locations. The uniquely patented shape has been developed through rigorous ergonomic studies of hand sizes and finger geometry. Made in the U.S., MOUSE-TRAK



is already in use by the military in planes, subs and tanks. Engineers at IBM™, Texas Instruments™ and Motorola™ are also using MOUSE-TRAKS.

MOUSE-TRAK carries a money back guarantee. If you don't like using MOUSE-TRAK within 30 days, we'll refund your money. And, if you do like it, we'll give you \$10 for your old mouse. MOUSE-TRAK ranges in price from \$139-\$189.



Call us toll-free for the complete story on MOUSE-TRAK and the name of a dealer near you. Our new brochure is available upon request.

MOUSE-TRAK combines mouse interface technology with the convenience and precision of a tracking ball. There's no wasted motion or time.

1-800-533-4822
(in Texas 214-494-3073)

mouse-trak®

3121 Benton Street, Garland, Texas 75042 USA. Telex 214-494-4159

IBM, Texas Instruments and Motorola are registered trademarks of their respective companies. MOUSE-TRAK is a registered trademark of ITAC Systems, Inc.

Circle 141 on Reader Service Card



These unretouched print samples show the superior print quality of QMS-PS 810 over printers using first-generation print engines.

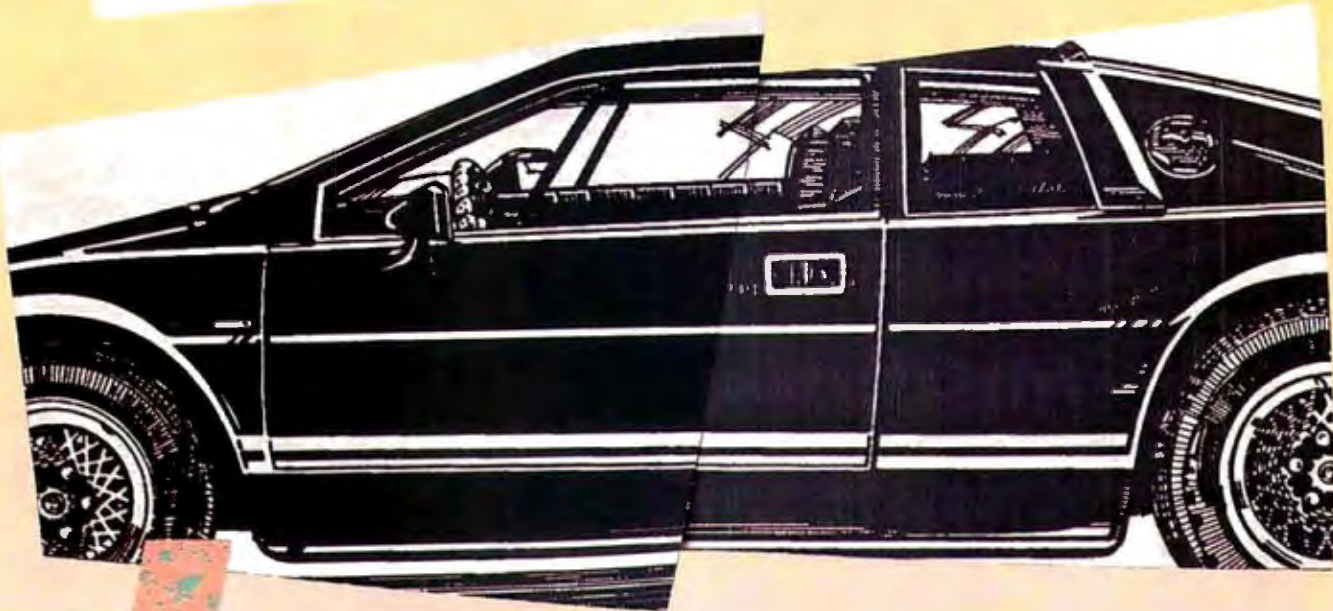

Introducing the PostScript laser printer that blacks out at high speeds.

The new QMS-PS® 810 can compose and print the most complex pages in record times, with richer, more saturated blacks than ever before. All with the desktop publishing power of Adobe PostScript®, and the superior print know-how of QMS, an industry leader.

Under the hood QMS ASAP™ (Advanced System Architecture for PostScript) is proprietary technology that helps eliminate the hardware bottlenecks that hinder other PostScript printers. As a result, QMS-PS 810 boasts processing speeds remarkably faster than other PostScript printers in its class. And faster output means greater productivity. In addition, the QMS-PS 810 laser printer's new Canon® SX® print engine covers solid areas and prints fine detail better than previous-generation engines.

Fast start, strong finish You can adorn your documents with one or all of the 35 Adobe typefaces. Thanks to PostScript, there's an infinite number of font variations available. You can also make type as large or as small as you want. And put it anywhere on the page. In fact, with PostScript you enjoy total control over the design of your page. It gives you the complete desktop publishing power to do things that would otherwise be virtually impossible. So you get high-quality output exactly how you want it.

Along with PostScript, the HP LaserJet™, Diablo® 630 and HP-GL™ printer emulations are added for your non-PostScript software.

The QMS-PS 810 laser printer is easy to use, maintain, and comes with a one-year warranty. It's available from Laser Connection dealers. Laser Connection is a sales and marketing subsidiary of QMS. For the dealer nearest you call **1-800-523-2696**.

**The new
8-page/minute
QMS-PS 810
laser
printer**



LASER CONNECTION™

A QMS® company

The following are trademarks of their respective companies: QMS, QMS-PS, ASAP, Laser Connection of QMS, Inc. PostScript of Adobe Systems, Inc. Canon, Canon SX of Canon, U.S.A. LaserJet +, HP-GL of Hewlett-Packard. Diablo of Xerox Corp.

© 1987 Laser Connection

Circle 150 on Reader Service Card

JANUARY 1989 • BYTE 21

Nobody Does It Better.

- One of the oldest and largest direct marketers of microcomputer products.
- Our qualified and courteous sales consultants can help you choose from over 4,000 products.
- Toll-Free technical support before and after the sale.
- All products are new and warranted by the manufacturer.
- Competitive pricing.
- Same day shipment on in-stock items.
- All major credit cards accepted.

Call Today!

Atari	
800XL 64K Computer	\$ 74
130XE 132K Computer	149
520ST-FM RGB/Color Syst.	849
1040ST Color System	Call
SF1224 Color Monitor	329
XF551 Disk Drive (XL/XE)	189
Access	
Leaderboard Golf	22
Accolade	
Hardball	19
Avant Garde	
PC Ditto (IBM Emulation)	64
Sub-Logic	
Flight Simulator II	33
Soft Logik Corp.	
Publishing Partner	59
Timeworks	
Desktop Publisher	89
VIP	
Professional Gem	109

*Includes: 800XL, 551 Drive & Star Raiders, Missile Command, Asteroids, Defender, & Qix
 WordPerfect Corp. \$159
 WordPerfect

Aegis Development	
Animator/Images	\$ 89
Draw Plus 2000	159
Sonix	49
Cinemaware	
Rocket Ranger	39
Electronic Arts	
Deluxe Photo Lab	99
Deluxe Video 1.2	89
Epyx Software	
XJ-500 Joystick	15
Gold Disk Software	
Professional Page	259
Micro Illusions	
Photon Paint	69
Micro Systems Int.	
Raw Copy V1.3	44
Micro Systems Software	
Excellence	189
New Tek Inc.	
Digi-View 2.0	149
Digi-Paint	44
Sub-Logic Corp.	
Flight Simulator II	39
WordPerfect Corp.	
WordPerfect	189

Olympia	
NP-30 Mac 150cps	289
Seikosha	
SP-1000AP Mac	239
Everex	
EMAC 20 Deluxe 20MB	595
EMAC 60T 60MB Backup	895
PCPC	
21MB SCSI Hard Drive	759
Cornerstone	
SinglePage Display SE	899
DualPage Display SE	1699
Magnavox	
9CM080 14" VGA Display	519
RasterOps	
1948S Trinitron	3395
Sigma Designs	
PageView SE	849
LaserView II	1899
New Image Technology	
MacScan Pro Sheetfeed	1399
MacScan Pro Flatbed	1789
Practical Peripherals	
Mac 2400 Stand Alone	239
Shiva	
NetModem V2400	479

Amdek	
Video 210 Amber	89
Video 410 TTL Monochrome	145
Color 600 14" RGB w/Text	299
Color 722 Dual Mode RGB	439
Magnavox	
7BM623 12" TTL Amber	79

7CM8515 14" Comp./RGB	\$279
CM8762 14" Comp./RGB	249
9CM053 14" HiRes EGA	369
9CM082 14" VGA Display	429
NEC	
JC-1402 Multisync	639
Packard Bell	
PB-1272 12" TTL Mono	79
PB-1472 14" TTL 132 Col.	109
PB-1422EG 14" HiRes EGA	359
Princeton Graphics	
Max-12e 12" TTL Amber	149

Zenith	
ZFM-1490 14" VGA Analog	669

ATD-ZuckerBoard	
Color Half Card	79
Monochrome Graphics Adpt.	79
AST	
Six Pak Plus Board	149
VGA Plus Adapter	389
Boca Research	
TopHat 128K Expansion	129
Boca Ram/AT 0-4MB Board	149
Boca MultiEGA	199
DCA	
Irma 2 3278 Board	749

FastWrite
\$389



Your Source for Hardware, Software & Peripherals

For Quality Computer Products.

Everex	
Magic I/O AT Par/Ser	\$ 59
Ram 3000 Deluxe 0-3MB Bd.	89
Micro Enh. Deluxe 800x600	189
5th Generation	
Logical Connection 256K	479
Hercules	
Graphics Card Plus	179
IDEAssociates	
IDE-5251 Local Emulation	579
Intel	
AboveBoard 2 Plus w/OK	319
AboveBoard PS/286 w/512K	419
Inboard 386/PC 80386 CPU	869
8087 IBM PC/XT CoP.	99
80287-8 IBM XT 8MHz CoP.	239
Orchid Technology	
TinyTurbo 286	285
Paradise	
AutoSwitch EGA 480 Adpt.	Call
Video 7	
Vega VGA Adapter	285

STORAGE DEVICES

ATD-ZuckerBoard	
Tandy 30MB HardCard	479
Everex	
Floppy Stream 40 40MB Int.	359
Excel Stream 40T 40MB Int.	529
Miniscribe	
8425 20MB 3 1/2" 40Msec	259
3650 40MB 5 1/4" 61Msec	349
Mountain Computer	
TD-4340 40MB Int. Tape	379
TD-4440 40MB Ext. Tape	479
Plus Development	
20MB HardCard	549
Seagate	
ST-225 20MB w/cont	269
ST-238 30MB w/cont	289
Sysgen	
Bridge-File 5 1/2" External	249
SmartImage 60MB Internal	479
QIC-File 60MB External	599

COMPUTERS

AST	
Premium 286/386 Desktops	Call
Compaq	
Deskpro 286/386 Desktops	Call
Portable 286/386	Call
NEC	
Multimate Laptops	Call
PC-TOO	
640K 10MHz 8088 Desktop	749
512K 8MHz 80286 Desktop	899
Sysgen	
ProSystem 12MHz w/40MB	2199
Toshiba	
T1200 Floppy/HrdD Lptp	Call
Zenith	
80286/386 Desktops	Call
SuperSport Laptops	Call

COMMUNICATIONS

Anchor	
6480 C64/128 1200 Baud	99
520 ST520/1040 1200 Baud	129
1200 Baud External	109
Atari	
XMM301 XL/XE 300 Baud	44
SX-212 ST Modem	89
Avatex	
1200 HC External	99

This Month's Featured Product:



TOSHIBA
T1000 8088
Laptop
\$799

2400 Baud External	\$179
ATD-ZuckerBoard	
2400 Baud External	129
Everex	
Evercom 24E+ 2400 Bd. Ext.	199
MiniModem 1200 Baud Pckt.	129
Hayes	
SmartModem 1200 Baud	289
SmartModem 2400 Baud	439
Intel	
2400B Classic Internal	249
Murata	
M1200 Facsimile	779
Practical Peripherals	
1200 Baud Stand Alone	109
2400 Baud Stand Alone	189
Sharp	
FO-220 Facsimile Machine	1099
Supra	
2400AT 2400 Baud Atari	169
U.S. Robotics	
1200 Baud Direct Ext.	109
2400 Baud Direct Ext.	199

PRINTERS

Brother	
M-1709 240cps, 132 Col.	489
HR-20 20cps Daisywheel	379
HR-40 40cps Daisywheel	669



EPSON LX-80
180cps, 80 Col.
\$189

Epson	
FX-850 264cps, 80 Col.	Call
FX-1050 264cps, 132 Col.	Call
Q-500 180cps, 24-Wire	Call
Q-850 330cps, 24-Wire	Call
Q-950 264cps, 24-Wire	Call
Q-1050 330cps, 132 Col.	Call
NEC	
P2200 Pinwriter 24-Wire	369
P5200 Pinwriter 265cps	579

Okidata	
ML-182+ 180cps, 80 Col.	\$249
ML-320 300cps, 80 Col.	359
ML-390 270cps, 24-Wire	519
Panasonic	
KX-P1080i 144cps, 80 Col.	169
KX-P1091i 194cps, 80 Col.	199
KX-P1124 192cps, 24-Wire	349
Star Micronics	
NX-1000 RainBow Color	239
NX-2400 24-Wire, 80 Col.	369
Toshiba	
P321-SL 216cps, 24-Wire	499

SOFTWARE

Ashton-Tate	
dBase IV	499
MultiMate Advantage II	289
Borland	
Paradox R-Database	459
Quattro	159
Central Point	
PC Tools Deluxe	49
Computer Associates	
AccPac Easy Accounting	79
DAC Software	
DAC-EASY Accounting	59

5th Generation	
FastBack Plus	\$ 99
IMSI	
OptiMouse w/Dr. Halo III	79
Logitech	
C7 Mouse w/Software	79
ScanMan Scanner	219
Lotus Development	
Lotus 1-2-3	299
MECA	
Managing Your Money	119
Meridian Technology	
CarbonCopy Plus 5.0	119
Microsoft	
Serial or Buss Mouse	109
Peter Norton	
Advanced Utilities	79
Peachtree	
Complete Accounting	169
Quarterdeck	
DESQView 2.02	79
Software Publishing	
1st Choice 3.0	89
1st Publisher 2.0	79
Professional Write 2.0	179
The Complete PC	
HandScan For PC	179
Complete Answer Machine	269
WordPerfect Corp.	
WordPerfect 5.0	229



XEROX
Ventura Publishing 2.0
\$495



Your Source for Hardware, Software & Peripherals

In U.S.A.

800-233-8950

In Canada call: 800-233-8949

All Other Areas call: 717-327-9575 Fax call: 717-327-1217
Educational, Governmental and Corporate Organizations
Call toll-free: 1-800-221-4283

CMO, 101 Reighard Ave., Dept. A1, Williamsport, PA 17701

POLICY: Add 3% (minimum \$7.00) shipping and handling. Larger shipments may require additional charges. Personal and company checks require 3 weeks to clear. For faster delivery, use your credit card or send cashier's check or bank money order. Credit cards are not charged until we ship. Pennsylvania and Maryland residents add appropriate sales tax. All prices are U.S.A. prices and are subject to change. All items are subject to availability. Defective software will be replaced with the same item only. Hardware will be replaced or repaired at our discretion within the terms and limits of the manufacturer's warranty. We cannot guarantee compatibility. All sales are final and returned shipments are subject to a restocking fee. We are not responsible for typographic or photographic errors.



A101

OUTSTANDING SOFTWARE

\$2.49

Per Disk
(\$2.99 per disk
when ordering
less than 10)



Satisfaction Guaranteed or Money Back!

BUSINESS

- 13 - (2 disks) Prepare spreadsheets w/powerful Express Calc.
- 53 - Create, fill in & print yr business forms w/EZForms. 512K.
- 79 - Generate statements, ease record keeping w/the Invoicer.
- 117 - Handle your personal/biz money picture w/Finance Mgr. I.
- 135 - (2 disks) Track inventory, sales, w/PC-Acct bookkpg mgr. I
- 159 - (2 disks) Mass Appeal mail mgr for envelopes, labels, etc.
- 190 - Make accurate job, cost estimates w/PDS'Quote. 640K.
- 201 - Log bank transactions, produce financ'l reports w/Checks.
- 226 - (2 disks) File Express menu driven al pulp database mgr.
- 232 - (2 disks) Friendly Dr. Data mail mgr is easy-to-use. 640K.
- 234 - Control & update inventory w/T-Master; know daily levels.
- 267 - Add special chars, line graphics to yr word processr w/Ct.
- 316 - Manage clients, sales prospects w/Track! 512K, hrd disk.
- 319 - (2 disks) Keep appointments, update agendas w/EzDesk.
- 337 - Analyze your credit charges, paymnts, interest w/Charge!
- 383 - Track yr portfolio, get weekly reports w/Mutual Fund Mgr.

EDUCATION

- 186 - It's painless learning DOS w/the interactive DOS Tutor.
- 191 - Learn music, US states w/PC-quizzer. Sign lang demol.
- 228 - Build dazzling typing speed practicing w/PC-Fastype. ★
- 297 - Graphic mathematical puzzle game makes learning fun!
- 366 - It's simple to keep, average student grades w/Gradescan!
- 376 - Teachers & students can summarize grades w/GradeM.
- 384 - (2 disks) XY-See graphic math for HS & college students.

GRAPHICS

- 58 - Display hi-res 3-D molecular structures w/Chemwv. EGA.
- 145 - (2 disks) Paint, draw w/Fingerpaint, design w/Altamira. ★
- 210 - (2 disks) Create advanced 3D designs! 640K, hrd disk. ★
- 285 - (3 disks) Produce grt 3-D images w/Surmodl graphics. ★
- 362 - (2 disks) Edit graphics, colorize pics w/VGACad VGA.

GAMES

- 15 - Bibleman game tests knowledge of Bible figures/events.
- 23 - Star Trek, Othello2 board game, artillery bombing. EGA.
- 28 - Play Backgammon, or Wordplay (like wheel of fortune).
- 84 - Three solitaire card games, Spider, Klondike, Canfield. ★
- 121 - Qubert, Pango, Centipede, Hopper (Ik Frogger), more! ★
- 151 - Hack puts you & trusty dog in a wild adventure (Ik Rogue.)
- 176 - Destroy enemies w/Stiker, conquer the world in Risk. ★
- 215 - Solve, create own word puzzles with Phrase Craze!
- 289 - 3-D Pacman, Kong, Spacewar, ABM (missile cmd). ★
- 309 - Blackjack (you set rules), ArmchairQB, imperial war!
- 321 - Star Trek, the origin! Colossal Caves Adventure, more.
- 365 - (5 disks) Create your own grt adventure games. 384K.
- 372 - Pinball, Othello, Dragons, Sopwith (fly one), battleship. ★

UTILITIES

- 138 - Packed w/print utils for print spooling, banners, fonts, etc.
- 141 - Print wide docmnts/spreadsheets sideways w/On-Side!
- 214 - (2 disks) Search for addresses w/Zip-Phone cross ref.
- 258 - Work around DOS w/Easy Access hard disk menu sys.
- 275 - A collection of invaluable general purpose DOS utilities.

MISCELLANEOUS

- 31 - Movie Database lists 4,000+ films available on videotape.
- 48 - (4 disks) Access 6000+ famous quotes from world history.
- 74 - Trouble w/your landlord? Learn your legal tenant rights!
- 85 - Add windows & give your Basic prog a professr look.
- 146 - PC-Lotto helps you mathematically beat state lotto odds!
- 153 - (2 disks) The popular word processing system; PC-Write.
- 291 - (2 disks) Record your own or play music w/PianoMan!
- 367 - Keep track of all your tapes, LPs, & CDs w/Music Library.
- 386 - (2 disks) 150+ fantastic cooking recipes. Add your own!

★ Disks so marked above require a color graphics adapter.

Membership Special! \$19.95 (reg. \$34.95)

For \$19.95 (\$25.95/year for 3.5") become a MicroCom Systems member and get "The Shareware Book" (\$12.95 separately), a subscription to "Shareware Review" magazine, 6 free new-release shareware disks (one featured each issue), low member prices, and any disks in this ad for only \$1.99 each! (\$2.99 for 3.5")

■ 3.5" disks desired (add \$1.00 disk to applicable price)

MicroCom Systems Cost of disks
3673 Enochs Street Membership _____
Santa Clara, CA Shipping \$3.00
95051 CA res tax _____
Total encl. _____

Phone Toll Free for Same-Day Shipment!

(800) 727-5995
©1988 MCS Mon-Fri 7am-9pm, Sat-Sun 8am-5pm BY-1/89

LETTERS

Power Reading

Congratulations on "PC Power, Part 1: Power Protection" by Mark Waller (October 1988), a much-needed article. There is altogether too much misinformation being cast about by those who pretend to know. Specifications that may sound impressive in a peddling contest often have little to do with the real issues. The problem is compounded by oft-quoted mavens and other self-proclaimed pundits who still speak from the "landmark" studies of the 1970s that have long since been determined to be invalid.

Mr. Waller described many of the shortcomings of surge suppressors and ferroresonant transformers with respect to the needs of modern electronic loads. All I want to add to his comments is that not only are these approaches less good than alternatives, they are actually harmful when misapplied. This point could have been made stronger. All in all, though, Waller's article should go a long way toward broadening the respect for the subject.

Having said all that, one technical point should be clarified. On page 280, Waller says, "... a couple of capacitors and a MOV across the secondary..." In actuality, the clamping circuit (MOV or otherwise) belongs on the primary side of the transformer.

AC power is a very complex phenomenon. But, like music, it has been made so readily available that nearly everyone takes it for granted.

David Fencl
Libertyville, IL

WE WANT TO HEAR FROM YOU. Please double-space your letter on one side of the page and include your name and address. We can print listings and tables along with a letter if they are short and legible. Address correspondence to Letters Editor, BYTE; One Phoenix Mill Lane, Peterborough, NH 03458.

Because of space limitations, we reserve the right to edit letters. Generally, it takes four months from the time we receive a letter until we publish it.

Cleaning Up Piracy in Hong Kong

The note in Nanobytes (October 1988) that software piracy in Hong Kong is getting worse is out of date. From late July to mid-August, the Hong Kong police and courts shut down all pirated-software shops and publishers in the colony. These raids were far larger and more widespread than previous halfhearted attempts, and the results have been criminal convictions, not just seizures of a few dollars' worth of disks.

No doubt some form of software piracy by private individuals will continue to exist, just as it does in the U.S. and elsewhere, but the software piracy industry is broken. There will never again be mass marketing of low-cost copies of famous packages or stores openly selling racks full of counterfeit manuals. I have been in the Hong Kong/Macao computer industry for several years, and I am certain that the changes are dramatic and permanent.

Keith Gross
Exton, PA

October Inventory

I'm not normally given to spending time writing letters to magazines, but I thought I had to offer high praise for the October 1988 issue. Here's why:

The article entitled "80386s for the Masses" by Steve Apiki and Stanford Diehl gives me a good benchmark for judging such systems, as I am considering the investment myself. As usual, your comparison covered all the major points well.

I am a heavy Borland product user. I'm not attached to Borland in any fashion, but I usually wind up buying Borland products because of the company's combination of features, price, and the excellent customer support available through the company's upgrades and technical-support staff. So I found "Borland Beefs Up Its Languages" by Rick Grehan and Tom Thompson, on the new Borland Pascal/C/Assembler packages, of interest, and I was gratified to read of the recommendation.

continued

Who Says FoxBASE+ is Better than dBASE®?



The Best Just Got Better—Now Shipping New FoxBASE+ Version 2.10!

Nicholas Petreley, *Info* Review Board:

"FoxBASE+ has outdone itself. Once again, FoxBASE+ earns an "excellent" in performance, with kudos for responding to user suggestions. For sheer productivity, there is no other choice." *InfoWorld*. "Editor's Choice" for 1987 and 1988!

P.L. Olympia, Founder & President, National Dbase Users Group / *Government Computer News*:

"FoxBASE+ is a supercharged dBASE, with all the features Ashton-Tate forgot. If you're into serious dBASE development and have not tried FoxBASE+, you are living in the dark ages and wasting your company's money."

George F. Goley IV, *Cont. Editor, Data Based Advisor*:

"The product is fast, very compatible, fast, easy to use, fast, relatively inexpensive, and very fast. In every test, FoxBASE+ outperformed the other products. And people who answer the phone at Fox know what they are talking about."

David Irwin, Former President/CEO, *Data Based Advisor*:

"From the dBASE compatibility standpoint, FoxBASE+ is flawless. From the speed standpoint, FoxBASE+ is unbelievable. From the "lazy factor" standpoint, FoxBASE+ is perfect."

Glenn Hart, Contributing Editor, *PC Magazine*:

"Initial tests of FoxBASE+ were simply stunning. In many ways, FoxBASE+ gives you the best of both worlds: all the benefits of interactive development and debugging, plus the speed and code protection of a compiler."

Adam Green, Contributing Editor, *Data Based Advisor*, *dBASE Author*:

"For the PC, FoxBASE+ has consistently set the performance standard for dBASE compatible languages. For the Macintosh, FoxBASE+/Mac will set standards for innovation and leadership in a new dBASE implementation."

Don Crabb, Contributing Editor, *InfoWorld*:

"You can expect blazing speed on the Mac. FoxBASE+/Mac breezes past tests that have proven stumbling blocks for Macintosh databases in the past. FoxBASE+/Mac combines complete dBASE compatibility with a genuine Macintosh user interface."

This is what they said about Version 2.00 of FoxBASE+. Imagine what The Experts will say about New Version 2.10 with these added features: Menu-Driven Interface, Program Documentor, Screen Painter and Template-Based Application Generator . . . and Version 2.10 is even faster than 2.00!

Join The Experts. Get your copy of the New FoxBASE+ Version 2.10 today! Now available at your nearest, quality software retailer, or directly from us by calling (419) 874-0162 Ext. 320.

Because, when it comes to speed, compatibility and value, nothing runs like the New FOX— Version 2.10!

Fox Software

Nothing Runs Like a Fox.

Fox Software

118 W. South Boundary
Perrysburg, OH 43551

(419) 874-0162 Ext. 320.

FAX: (419) 874-8678

TELEX: 6503040827 FOX

Circle 109 on Reader Service Card

FoxBASE and FoxBASE+ are trademarks of Fox Software.
dBASE and dBASE III PLUS are trademarks of Ashton-Tate.
Macintosh is a trademark of Apple Computers, Inc.



The original AnthroCart. Mobile.
Incredibly strong. So many ways to solve
your space and equipment problems.
Choose different sizes. Move
shelves around. Add space saving
options.

AnthroCart. Well designed
Technology Furniture.

Look for our name.

AnthroCart®

Call us for more information: 800-325-3841



Made in U.S.A.
All steel frame construction
Easily holds up to 150 lbs.



ANTHRO

AnthroCart and Technology Furniture are
registered trademarks of Anthro.

Anthro®
Technology Furniture®

3221 N.W. Yeon St.
Portland, OR 97210
503-241-7113
Telex: 940103

I am also impressed by the exhaustive reviewing of Sprint in no less than three articles, giving it the broadest possible treatment. Coincidentally, I bought Sprint the day before my magazine arrived and used it for the first time that day. So I think my own impressions are not influenced by the articles. Nevertheless, the articles echo many of my own sentiments.

The In Depth articles on hypertext were both informative and appreciated. Thanks for defining things for me.

Finally, I thought "PC Power, Part 1: Power Protection" by Mark Waller was very useful. Everybody I know uses a surge protector, but not a one can explain what it does, and the article was on exactly the right technical level to clarify matters. Instruction like this is easily worth the price of a subscription.

Paul E. Tichy Jr.
Houston, TX

Hypertext Update

Your In Depth section on hypertext (October 1988) was a valuable contribution to this emerging technology. As an update to your "Hyper Activity" resource guide, I would like to inform you that Hyperties, listed as an R&D project of the University of Maryland, is available from Cognetics Corp. (55 Princeton-Hightstown Rd., Princeton Junction, NJ 08550, (609) 799-5005). It costs \$249.

Hyperties runs on the IBM PC. It uses the metaphor of an interactive encyclopedia, or "hyperbook." The nodes consist of articles (text, graphics, and videodisk) linked together. Retrieval is by browsing, an alphabetical index, a topical table of contents, or string search on article content. Path history and article printing are provided. You construct databases with the Author Tool and read them with the Browser.

Hyperties continues to be an active research project of the Human-Computer Interaction Laboratory at the University of Maryland.

Charles B. Kreitzberg, Ph.D.
President, Cognetics Corp.
Princeton Junction, NJ

Missing Points

It is not easy to find in your magazine an article that is not well written, informed, and correct. If I have any criticisms, it is invariably because a specialist tends to look at particular aspects of a problem or product only, omitting, without saying so, other important aspects and sometimes drawing conclusions not warranted by his or her necessarily limited scope.

continued

PC EXPERTS AGREE:

Proteus® offers the fastest for the least, and supports them the most.

Proteus® sells the fastest personal computers you'll find. But as experts from BYTE, InfoWorld, Personal Computing, and others have discovered, our computers are more than just fast.

They're also an excellent value. You can't find better performing computers at lower prices.

And Proteus allows you to custom configure a system to your exact specifications.

Finally, Proteus provides you with 15 months of Free on-site service and support. And if you're not

satisfied with Proteus equipment within 30 days, you can return it for a full refund.

These are the reasons why the experts are so impressed with Proteus. And they're not alone. NASA, Xerox, GE, RCA, Dupont, GM, Revlon, General Dynamics, the U.S. Government, the U.N., MIT, Harvard, and Cornell have all become big Proteus users.

For the fastest, most economical, best supported computers available, follow the experts to Proteus.

"Proteus is markedly faster than any other personal computer we've worked with, including Deskpro 386/20."

Personal Computing Magazine

PROTEUS 386/25

12MHz, ZERO WAIT STATE

- Intel 80286-12 CPU
- 640K RAM expandable to 16MB
- 32KB cache memory
- 8 expansion slots
- 2 serial & 1 parallel port
- 1.2MB floppy drive or 3.5" microfloppy
- Dual HD & floppy controller
- 200W power supply, 110/220V
- 101 key tactile keyboard
- 15-month free on-site service
- Made in U.S.A.

Complete Systems

with Hard Disk and Monitor:

- 20MB mono \$1,995
- 20MB VGA color \$2,395
- 20MB VGA plus \$2,780 for 40MB add \$150 for 80MB add \$440



16 MHz opt. 20MHz ZERO WAIT STATE

- Intel 80386 CPU at 16 MHz
- Optional 80386-20MHz
- 1MB RAM-Expandable to 16MB,
- Disk cache
- 8 expansion slots
- 2 serial & 1 parallel port
- 1.2MB floppy drive
- Dual HD & floppy controller
- 200W power supply, 110/220V
- 101 key tactile keyboard
- 15-month free on-site service
- Made in U.S.A.

Complete Systems

with Hard Disk and Monitor:

- 40MB 28ms mono \$2,899
- 40MB 28ms VGA color \$3,299
- 40MB 28ms VGA plus \$3,699 for 80MB add \$175 for 100MB add \$614 for 150MB add \$1,525 or 340MB \$2,675



25MHz, ZERO WAIT STATE

- Intel 80386 CPU at 25MHz
- Cache memory
- 2 serial & 1 parallel port
- Dual HD & floppy controller
- 200W power supply, 110/220V
- 1.2MB floppy drive
- 101 key tactile keyboard
- 15-month free on-site service
- Made in U.S.A.

Complete Systems

with Hard Disk and Monitor:

- 40MB 28ms mono \$5,635
- 40MB 28ms VGA color \$5,995
- 40MB 28ms VGA plus \$6,499 for 80MB add \$175 for 90MB add \$1,125 for 150MB add \$1,525 for 340MB add



EXTRA PROTEUS POWER WITH CUSTOMIZATION

- 1:1 interleave controller
- ESDI HD up to 700MB
- microfloppy drives
- tape streamers, 40MB to 225MB
- coprocessors
- brand name monitors and cards
- floor-stand configuration on all models
- custom configuration on all models



To order, call us direct. 1-800-782-8387

For 24 hr catalog, call 1-800-548-5036 using your modem set at 1200B/N/8/1. Technical Support Hotline: 1-800-541-8933 Reseller/VAR programs available.

All trademarks recognized. © Proteus is a registered trademark of Proteus Technology Corp. All prices, terms, specs subject to change.

PROTEUS
THE INTELLIGENT CONCLUSION

377 Route 17S, Airport 17 Center
Hasbrouck Heights, NJ 07604

Circle 218 on Reader Service Card

JANUARY 1989 • BYTE 27

Everex and Sage are trademarks of Everex Systems, Inc. Sage is a trademark of Ink Corp.

EVEREX



Step 286/12	2.45 MIPS
Step 286/16	3.27 MIPS
Step 386/16	3.93 MIPS
Step 286/20	4.24 MIPS
Step 386/20	4.91 MIPS
Step 386/25	6.13 MIPS

Source: Power Meter MIPS Version 1.3. The Database Group, Inc.

"I used to be afraid of monsters. Now I can't get along without them."

Janet Johnson, President
Coordinated Digital Systems
Dayton, Ohio



"I'll be right over."

The most incredible collection of people find their way to my door. Students. Aerospace engineers. Genealogists.

They come because they hear we do more than sell computers out of a box. We try to make everything very personal.

We know our products backwards and forwards because we use them ourselves. We write custom software.

We're writing a lot of business.

We work almost exclusively with one computer company. Everex.

Because every one of their six computers is at the head of its class.

And because they take care of me the way I like to take care of my customers.

Find out more about Everex Step computers. Call 1-800-356-4283. Everex Computer Systems Division, 48431 Milmont Drive, Fremont, CA 94538.

Circle 102 on Reader Service Card (DEALERS: 103)



Take, for instance, the article entitled "The BASIC Revival" by Namir Clement Shammas (September 1988), which compares Turbo BASIC and QuickBASIC 4.0 on the one hand to Pascal and C on the other. I am professionally familiar with three of these, and I find the article correct in every detail, yet it's missing some very important points.

At least as important as all the points mentioned taken together is the advent of the "Integrated Programming Environ-

ment" in QuickBASIC: the immediate syntax checking, the very fast compilation, and the possibility to watch and modify variables during debugging and to even edit a program while it is running. Sure, the CodeView debugger is nice, but the QuickBASIC 4.0 environment is even better. In my experience, programming takes only a little bit of actual programming—the rest is debugging. That's why these developments are so very important to the practical programmer.

BASIC has now caught up with Pascal in that it can be linked to other languages. The BASIC interlanguage calls are even more powerful than Pascal's. The CodeView debugger now handles mixed-language programs, including BASIC modules.

Analogous to, for instance, C, the new BASICs introduced structures (called subprograms and functions in QuickBASIC) that allow you to add homemade functions to the language. These functions are subsequently used in exactly the same way as if they were part of the BASIC programming language. This opened the way to the commercial offering of ready-made libraries, more often called toolboxes. They give you windowing, fast communications, and so on—just like a real programming language.

Moreover, language extensions for BASIC are now available that give the programmer database structures (e.g., dBASE, dbVista, and B-tree) that are readily available in a few commands and very adaptable to boot.

Of course, there's nothing new here for C programmers—it just means that, one by one, the disadvantages of BASIC disappear, while the advantages stay with us. Incidentally, I sometimes hear BASIC being criticized because it can handle only a limited amount of data. This may indeed be a handicap for some applications, but on the whole this point seems to me rather academic. How many professional programmers nowadays would practically consider building a structure that handles large amounts of data, from scratch?

Of course I use toolboxes and language extensions where available. It's only the few people developing these tools who have to worry about this shortcoming of BASIC—but they don't write in BASIC, anyway.

If it's all so wonderful, why don't I write commercial programs in QuickBASIC 4.0? Good question. Here are some reasons:

1. A QuickBASIC program cannot be larger than 256K bytes, a limitation discussed nowhere in the manual but mentioned on the back of the packing. And 256K bytes is not enough. Were it 640K bytes, it still would not be enough. Since the beginning of computer times, this dilemma has been resolved by means of overlays—the technique of keeping the most often used functions in memory and reserving space to load less often used functions from disk as needed.

QuickBASIC 3.0 was capable of using
continued

C_talk™ The Practical Union of C and Smalltalk

Add a new dimension to your C compiler.

From C:

- Ease of application delivery – portability
- Performance – speed and efficiency of C
- Familiarity of C – use all your existing C code

From Smalltalk:

- Data abstraction – data hiding/encapsulation
- Full object inheritance
- Polymorphism – message sending with dynamic binding

Boost Your Productivity! C_talk's practical approach to object-oriented programming in C allows you to realize substantial productivity gains using these tools:

- C_talk's *Browser* – a powerful Smalltalk-like browser for building software objects
- An automatic *Make* utility – for building applications
- A *Preprocessor* – for converting objects into C source code.
- A set of *Foundation Classes* – to use as basic building blocks.

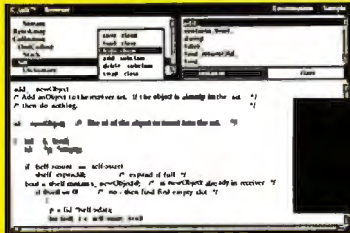

\$149⁹⁵

Why C_talk?

C_talk has been proven successful in delivering several large-scale systems in demanding realtime environments. It's concise, easy to learn and use. It's programming in C (not a new language), while adhering to the Smalltalk paradigm.

C_talk is the practical, and affordable, union.

C_talk is designed to operate with MSODS on IBM or compatible computers. At least 512K of memory, a hard disk and mouse are recommended.

Order today!

Call or write:
CNS, Inc.
Software Products Dept.
7090 Shady Oak Rd.
Eden Prairie, MN 55344
Tel: (612) 944-0170
Fax: (612) 944-0923

Add for shipping \$5 US, \$25 Int'l.
(30-day money-back guarantee)



*...providing and advancing
object-oriented methodology.*

C_talk is a trademark of CNS

CNS is a registered trademark of CNS, Inc.

Verbatim
Minidisks
2S/2D
MD 2
40 tracks/side at
48 TPI

Verbatim
A Kodak Company

DataLife

10 Minidisks
2S/2D
MD 2

DataLife

DataHold
anti-static liner
Lifetime Warranty

Verbatim
A Kodak Company

DataLifePlus

10 Minidisks
2S/2D
Manufacturer's
Lifetime Warranty

Teflon® Protection
on Recording Surface
Lifetime Warranty

Verbatim
Minidisks
2S/2D
40 tracks/side at
48 TPI

For People Who Put A Premium On Performance. And Protection.

The more invaluable your data is to you, the more you'll value Verbatim® floppy disks. Because when it comes to high performance and data protection, Verbatim has the winning combination no other floppies can copy.

You expect high performance from Verbatim, so it's no wonder that all our DataLife® floppies are engineered to perform an average of 50 million revolutions. That's fifteen times the industry standard.

Setting new standards in data protection is another Verbatim advantage. After all, nearly 50% of all computer users have experienced data loss. Which directly translates into lost time, productivity and money. That's why Verbatim offers advantages like DataHold™ and DataHold II anti-static liners. So static charges are dispersed before they ever have a chance to build up.



For the world's ultimate data protection, DataLifePlus™ floppies have an exclusive DuPont Teflon® coating. So fingerprints, coffee, soft drinks, and even greasy foods can be easily wiped from the recording surface. To virtually eliminate data loss.

What's more, Verbatim DataLifePlus and DataLife HD 5¼" floppy disks are preformatted. Another Verbatim advantage. And of course, all Verbatim floppy disks are tested to be 100% error free and are backed by a lifetime warranty.

Verbatim data cassettes and cartridges, 8", 5¼" and 3½" diskettes. The only clear choice for people who put a premium on performance and protection.

For more information on the full line of high quality Verbatim products, call 1-800-538-8589.

® Teflon is a DuPont registered trademark.

 **Verbatim**
A Kodak Company

DOING MORE FOR THE DATA PROCESS™

overlays, albeit in a nonstandard way. This idiosyncrasy has disappeared in version 4.0. But do you think Microsoft gave us the standard way of making overlays in return? Not at all. Version 4.0 cannot use overlays (nor can Bascom 6.0, for that matter). Worse, if the linker finds one BASIC module in the row, it refuses to make correct overlays even when these have nothing to do with the BASIC module—and it doesn't even give you an error message. This limitation is not

mentioned in the documentation.

Exit QuickBASIC 4.0 for two-thirds of professional programming. BASIC users, unite! Let's all write a letter to Microsoft about this, and let's do it now!

2. BASIC is not portable to, say, Xenix. Why not? Because it is not a professional programming language. At least that's what I suspect, since I cannot find any technical reason for this.

3. Intel's way of addressing—and, consequently, memory models—are the

bitter fruit of the need for compatibility, way back when it all started. Yet we in microcomputerworld are stuck with them and will be for some time to come. BASIC knows only one memory model (medium). For many applications, that's no problem: We just buy a database toolkit or language extension. But sometimes it just isn't enough.

Sorry, I'll have to stick to C for the time being. But, OK, let's drop Pascal—it has more than served its function.

Hans Mabelis

Amsterdam, The Netherlands

Getting Real

In the September 1988 issue, Daniel J. Bernstein states in his letter ("Recursion vs. Iteration") that "any recursive routine can be written iteratively."

This statement is highly misleading. It is true that it follows from a theorem of Kleene that every computable function can be programmed using a single WHILE loop, together with some more elementary aids, such as substitutions, but there is no known practical way of doing this in general. The method used for proving this theorem is unbelievably inefficient and totally impractical. Let Mr. Bernstein write an iterative program for the well-known Ackerman function! This has, in fact, been done, and the solution was sufficiently interesting to have been published.

There is, of course, another way to avoid recursive function calls, and that is by mimicking this whole apparatus, using stacks, but this cannot be regarded as an iterative solution.

In practice, therefore, the ability to call functions recursively is one of the most essential and powerful methods available to the programmer.

Ivan Danicic
London, U.K.

Old Hoc

Jud McCranie (Letters, October 1988) suggested that the acronym spool (standing for "simultaneous peripheral operation on-line") was a recent ad hoc creation. Since I remember this acronym being in use when IBM introduced the original System 360, I decided to check my now-ancient manuals.

It seems the acronym was first used by IBM for its 7070 computer, the predecessor of the more famous 7090/7094 machines. The date was 1962 or 1963. So, for the record, the term is certainly not recent, though it may well be ad hoc.

Robert L. Milton
Agoura Hills, CA ■



Power. Speed. Performance.

We listened to you and added hundreds of features to PC-Write.

Larger Files—Break the 60K file limit! Use all available DOS memory to edit large documents. Rapidly search and switch between related files. Lock files on a network.

More Formats—Edit multiple columns on-screen. Or mark text as a box, then position and format it. Create tables and scripts faster.

Easier To Use—Stay on track with on-screen "reminder" lines. Select page layout and fonts with new menus. Fix typing mistakes with our improved spelling checker.

New catalog adds value.

We offer popular products that work well with PC-Write.

New Capabilities—Choose products such as InSet™ graphics, WordFinder™ thesaurus, or popular soft font, grammar checker, foreign language, and scientific packages.

Special Discounts—Registered PC-Write users get phone support and reduced prices for all products.

Still only \$89.

The \$89 registration fee gives you software, user's guide with tutorial, phone support, two free updates, and our newsletter. PC-Write 3.0 is still shareware, so you can give copies to others to try, free!

Order PC-Write 3.0 today.

Call 1-800-888-8088 BYT1

90-day money-back guarantee

PC-Write is not shareware outside the U.S. and Canada. PC-Write™, Quickssoft, WordFinder™, Microlytics, InSet™, Inset Systems, Quickssoft, Inc., 219 First Ave. N #224-BYT1, Seattle, WA 98109. 206-282-0452.

Quickssoft

Circle 228 on Reader Service Card

Compaq introduces
a revolutionary

new personal computer.

With new display technology.

Breakthrough graphics technology.

Advanced storage technology.

New expansion technology.

Innovative modem technology.

New keyboard technology.

New surface mount technology.

Advanced network technology.



And a battery.



Introducing the new
COMPAQ SLT/286 Personal Computer.
The first PC that puts true
desktop performance in your lap.



When you there's

Before a laptop PC
mea could live
without manageable size. Battery. Power. Speed. Screen quality. Full-size keys.

We've changed that, with the new COMPAQ SLT/286. It's the first laptop from the company that set the standard in portable computing. And the first laptop to give you everything you want. Without compromise.

Creating a new high-performance PC this small was no small feat. It took a series of



The COMPAQ SLT/286 snaps



with standard spacing.

desktop—on battery power.

From its compact size to its high-performance components, you'll see that your needs shaped our thinking.

First of all, we knew you wanted to wield a lot of power, without throwing around a lot of weight.

The new COMPAQ SLT/286 weighs in at just 14 lb., with a space-saving footprint. That means

shades of gray. Now resolution with eight-bit screen technology produces text and graphics with higher contrast on a 10" diagonal screen. So things are easy to read.

Now let's take an inside look. The COMPAQ SLT/286 is powered by a 12-MHz

airline tray table—

to spare. You're on the r

you stranded, eit

COMPAQ SLT/286 uses innova-

tive battery technology

for over three hours of

operation. The battery is small, so

spare is no problem

ent and recharge

is easy.

What's amazing ab

out the battery is everything that

runs on it. Every component is

optimized to save battery life.



A small wonder. Compared to other laptops, the COMPAQ SLT/286 gives you more PC in less space.

The first laptop from the company that set the standard for portable PCs.

It simply works better.

function PC this small, for compromise.

80C286 microprocessor that drives software 20% faster than most 10-MHz 80286-based PC's. You get the capability to run the world's largest library of software with MS-DOS®. Plus Microsoft® Operating System/2.

Flexibility is built in. You can choose a high-speed 40- or 20-MB fixed disk drive to complement the standard 3 1/2" 1.44-MB diskette drive. Plus you can easily expand the 640K of standard memory to 3.6 megabytes internally.

You'll find our keyboard is just your type. It has full-size keys, spaced just like the keys on a desktop PC. The keyboard is removable, so it adjusts to the way you work. You get all 12 function keys and an embedded numeric keypad. Or if numbers are your life, add a separate numeric keypad as an option.

Other creature comforts are also on board. Like an optional internal 2400-baud modem. Room for two internal storage devices. Ports for a printer, external VGA monitor and other periph-



Its footprint is small enough to fit on an airline tray table, with room to spare.

erals. You can even add a 12-MHz 80C287 coprocessor as an option to speed number crunching.

At this point you may be thinking that the COMPAQ SLT/286 does everything a desktop can do. You're right. In fact you can even do more at the office with its optional Desktop Expansion Base.

Unlike competitive expansion units, ours wasn't an afterthought. Its integrated design gives you two industry-standard expansion slots along with duplicate interfaces for your peripherals. The expansion unit even recharges the battery for you.

Best of all, the COMPAQ SLT/286 just snaps right into the Desktop Expansion Base. No cord. No wires. No hassle.

With all these innovative features, you can see that the new COMPAQ SLT/286 leaves absolutely no room for compromise. It's simply high-performance personal computing in its most concentrated form.



Internal 2400-baud modem optional.



Battery included for over three hours of power.

COMPAQ

We have the world's best handle on portable computing.



In 1982, Compaq introduced the world to the power of portable personal computing with the COMPAQ Portable.

Since then we've consistently delivered new levels of performance in consistently smaller packages.

Today we offer the world's highest-performing portable personal computers. COMPAQ products consistently earn the industry's highest ratings for quality and user

satisfaction. And that's an achievement that stands unchallenged.

You'll find that we've built these same uncompromising standards into the new COMPAQ SLT/286.

To get a handle on more information, including a free brochure and the location of your nearest Authorized COMPAQ Computer Dealer, call 1-800-231-0900. Ask for Operator 71. In Canada, 1-800-263-5868, Operator 71.

COMPAQ is a trademark of Compaq Computer Corporation. Microsoft, MS and MS-DOS are trademarks of Microsoft Corporation. MS OS/2 is a product of Microsoft Corporation. Product names mentioned herein may be trademarks and/or registered trademarks of their respective companies. Registered U.S. Patent and Trademark Office. ©1988 Compaq Computer Corporation. All rights reserved. Use of electronic equipment on board commercial aircraft is at the discretion of each airline.

COMPAQ

It simply works better.

CHAOS MANOR MAIL

*Jerry Pournelle answers questions about his column
and related computer topics*

The Care and Feeding of Dinosaurs

Dear Jerry,
I couldn't help but chuckle when I read the letter from John Boddie (June 1988). As a dinosaur keeper myself (a "thecodont" system 36 rather than a "sauropod" mainframe), I will agree that many corporate MIS departments are ponderous. I am amused, though, at all the squealing little proto-rats from sales, accounting, and everywhere else who think they can do a better job.

I've dined many times on these mammals that have spent weeks "developing applications" in Lotus 1-2-3 that still have a few bugs in them when the president wants the information, so they rush to the MIS department and I write a quick RPG (excuse my language) program and get the answer in 2 minutes.

I'm not completely heartless, though. Many times I've lent my shoulder to a whimpering mammal that didn't want to be locked into a daily routine like backing up his spreadsheets until after they were accidentally deleted. And then there's always the problem of negotiating the "cretaceous swamp" of information. Little mammals tend to squeal when their data doesn't match the data in the dinosaur—usually because they "don't have time" to follow standard procedure and verify what they've punched.

In short, mammals are cute and they make nice pets. I think every sales department should have one out in West Fencepost. But when it comes down to devouring the volume of information that most companies generate on a daily basis, give me a good old tyrannosaurus any day. Perhaps this sounds a little cold-blooded, but when it comes down to it, "survival of the fittest" is the order of the day, and barring an asteroid striking the earth, I doubt that dinosaurs will become extinct again soon. But keep the mammals coming: They make great meals for newly hatched dinosaurs.

Don Varney
New Bedford, MA

Well, I'm glad things work out well in your shop. Some of us have had different

experiences; as you say, survival of the fittest will determine who's right.

I'm sure there are lots of good reasons to keep dinosaurs. I'm also certain there are lots of people who can't afford to feed a tyrannosaurus.—Jerry

Beware of Cheap Clones

Dear Jerry,

Since you get lots of high-quality hardware direct from high-end vendors, you probably don't realize how bad the cheapest stuff being sold is nowadays. I didn't, either. I bought my Taiwan special IBM PC XT clone a few years ago, use it a lot, and haven't had any problems beyond what I consider to be normal wear and tear. It even came with documentation that included schematics that weren't too wrong for most of the components.

However, we bought some clone kits for work recently. Wow! Two out of five motherboards failed. One video card literally exploded (it wasn't dangerous, but it was showy). Three keyboards failed within 2 months. It took six hard disk drives to come up with three that worked reliably. One monitor was too jittery to work with. We even got one case with the card slot bracket mounted at enough of an angle that the cards don't sit securely in the left-hand slots.

The only things we haven't had trouble with are the power supplies and the floppy disk drives. I won't even talk about the quality of the documentation, and lots of parts didn't come with any documentation at all. Clearly, some of the cost reduction in hardware lately has come at the cost of product quality.

To their credit, the dealers involved have been very responsive. We finally got everything working. But it took time

continued

Jerry Pournelle holds a doctorate in psychology and is a science fiction writer who also earns a comfortable living writing about computers present and future. He can be reached c/o BYTE, One Phoenix Mill Lane, Peterborough, NH 03458, or on BIX as "jerryyp."

Three ways to build better programs...

**POWER
SCREEN** **\$129**

**NOW
For
Turbo
Pascal
5.0
&
Turbo C
2.0!**

Screen I/O manager.

Features: ♦ screen painter ♦ virtual screens
♦ data validation ♦ context sensitive help
♦ unlimited screens ♦ definable keys
♦ & much more!

**POWER TOOLS
PLUS** **\$129**

**NOW
For
Turbo
Pascal
5.0 & 4.0!**

Full featured function library.

Features: ♦ TSR support ♦ direct video
access ♦ VGA and EGA support ♦ windows
and menus ♦ DOS memory allocation
♦ interrupt service routines
♦ & much more!

**ASYNCH
PLUS** **\$129**

**NOW
For
Turbo
Pascal
5.0 & 4.0!**

Asynchronous communication manager.

Features: ♦ speeds to 19.2K baud
♦ XON/XOFF protocol ♦ hardware
handshaking ♦ XModem file transfer ♦ I/O
buffers up to 64K ♦ & much more!

We're Blaise Computing, manufacturers of high quality function libraries designed to reduce the time and technical expertise required for serious applications development.

All of these packages include Peter Norton's On-line Instant Access Program, a comprehensive user reference manual with extensive examples, and full sample programs.

Satisfaction guaranteed or return within 30 days for a full refund.

We have a full line of products for C and Pascal. For a free brochure or to order call

800-333-8087!



BLAISE COMPUTING INC.

2560 Ninth Street, Suite 316 Berkeley, CA 94710 (415) 540-5441
JANUARY 1989 • B Y T E 33

and a fair number of trips to the shops to do it.

Until this experience, I would have told anybody looking for low-end equipment to buy from the cheapest supplier. Now I'm not so sure. I guess my advice would be, "buy cheap, but remember that it may not work." All other things being equal, you may be better off buying from a supplier 3 blocks away than from one 15 miles away who is \$20 cheaper and buying from just one supplier at a time.

Donald Kenney
San Diego, CA

I have noticed the problem, and one day I ought to do a larger treatment of the subject. There was a time when all clones were nearly equal, and all pretty good. No longer.

Pournelle's Rule still applies: "If you don't know what you're doing, deal only with people who do."—Jerry

Don't Trash That Software!

Dear Jerry,

I read with great dismay that you have so much software that you're forced to throw away a great deal of it unopened. This is indeed a terrible situation. I'd like to suggest that instead of throwing away this valuable resource, you send it to some poor computer user. I think I qualify for such a donation, since I have a Corona IBM PC-compatible but only four pieces of software—one is a utility, two are languages that I need for school, and the last is Electric Desk, an integrated word processor. Unfortunately, I don't have the resources to purchase any more software. If you decide to make any donations, I'll be happy to pay for the shipping and handling.

I'm writing this letter somewhat tongue-in-cheek. While I would appreciate any software you could spare, you might suggest in your column that any institution or large user group donate its older software to organizations trying to spread computer literacy. As our knowledge base grows, those outside the mainstream of education will fall further and further behind until a new class emerges, the functionally computer illiterate.

Imagine how much good all those old Osbornes, Kaypros, and Tandys could do in inner-city or nonaffluent areas, both in and outside the U.S. In teaching the people of undeveloped nations to use microcomputers for such basic needs as civic and resource planning, health care, education, government and police record keeping, and even cultural preservation,

we would be providing a program that could far exceed the limited success of programs like the Peace Corps.

James Carroll
North Lauderdale, FL

Yours is one of many letters suggesting that I donate unwanted software to clubs, educational institutions, or other worthy causes.

I completely agree—that would be a good idea, and I'd really like to do it. Alas, I don't own the software sent to me for review, and unless it's accompanied by a letter specifically authorizing me to donate it to a good cause—or unless, like Borland, the publisher has given me blanket permission to do so—I have no ethical alternative to destroying it.

I do like your notion that user groups and other publishers help expand the computer literacy base.—Jerry

Manipulating Turbo C

Dear Jerry,

After I finished reading Walter K. MacAdam's letter (June 1988), I couldn't help but reply. Screen manipulation is indeed possible in Turbo C, though it's a bit esoteric.

I have no intention of coming to Turbo C's defense. In fact, I prefer QuickC to it—primarily for the larger number of run-time routines QuickC comes with. However, there is a simple way of getting around some of Turbo C's shortcomings in this area without resorting to assembly language. I find it ludicrous that, rather than pointing these methods out to Mr. MacAdam, Borland suggested he buy such routines from another dealer.

Turbo C has several routines that let the user generate ROM BIOS interrupts. Int86, the least complex, can be used for scrolling, clearing the screen, and getting and setting the cursor position, among other things.

Int86 utilizes three parameters, commonly denoted INTNUM, INREGS, and OUTREGS. INTNUM is the number of the interrupt to be used. INREGS and OUTREGS are unions of type REGS, defined in the DOS.H include file, which describes the system registers.

When a call to INTDOS is made, an interrupt 0x21 is generated; the contents of INREGS are copied to the registers; the value of INTNUM invokes the interrupt; the function, defined in INREGS.H.AL, is executed; and the (new) register values are copied to OUTREGS. This entire, mind-boggling process is described in detail in the *Turbo C Reference Guide* on page 131.

The only catch is that you must know what to put in which registers before you call Int86. (The Turbo C books assume the user already has knowledge of the subject. Not for beginners, eh?) However, a partial list can be found in the wonderful book *C: The Complete Reference* by Herbert Schildt (Osborne-McGraw-Hill, 1987).

A clear-screen interrupt is generated by doing the following:

```
INREGS.H.AH = 6;
/*screen scrolling function*/
INREGS.H.AL = 0;
/*number of lines to scroll; '0'
clears screen*/
INREGS.H.CH = 0;
/*row starting position*/
INREGS.H.CL = 0;
/*column starting position*/
INREGS.H.DH = 24;
/*row ending position*/
INREGS.H.DL = 79;
/*column ending position*/
INREGS.H.BH = 7;
/*blank line's color*/
INT86 (0x10, &INREGS, &OUTREGS);
```

Determining the cursor position is even simpler. Generate the cursor location interrupt, and the *x* value (row) comes back in OUTREGS.H.DH, while the *y* value (column) is in OUTREGS.H.DL. Here's an example:

```
INREGS.H.AH = 3;
/*cursor location function*/
INREGS.H.BH = 0;
/*video page*/
INT86 (0x10, &INREGS, &OUTREGS);
PRINTF ("Cursor was just at %d, %d\n",
OUTREGS.H.DH, OUTREGS.H.DL);
```

As for setting the cursor location, that's a given; it's illustrated in the Int86 example in the *Turbo C Reference Guide* on page 132.

Granted, Turbo C doesn't exactly roll over, play dead, and fetch the newspaper in the morning. But screen manipulation is available, and even easy to use, once you've done it a few times. By making a procedure out of such processes, as well as other useful screen functions executed similarly, you could make a custom user library. This would obviate the need for purchasing a separate C library, as Borland suggested.

S. Y. Walters
Tempe, AZ

Thank you. I'm no expert on any kind of C, so I have to depend on reports from readers.—Jerry ■

Proof is in the Performance

db_FILE™ provides faster file management for C programmers

Proven performer

db_FILE™ from Raima is the only file manager you'll ever need. Other file managers deliver B-tree/ISAM capabilities, but they slow down as the application increases in size or complexity. Only db_FILE combines B-tree/ISAM capabilities with full network model database capabilities. The result: *You get more file management for less!* Thousands of C programmers in over 50 countries worldwide use db_FILE. *And, it's fast, 100% faster than the closest competition.* So, for building applications that feature fast data access, whether simple or complex, db_FILE is the proven performer.

Proven portability

db_FILE is written entirely in C for optimum portability. Unlike others, db_FILE is not limited to MS-DOS, so your db_FILE applications will run in any environment that supports the C language. Source code is available, allowing you to optimize performance or port to new environments yourself.

More proof - db_RETRIEVE™ SQL-based Query
You can add even more performance with db_RETRIEVE™. It provides the familiar relational view, through SQL, of a db_FILE network model database...*without sacrificing the performance!* Source code is also available.

Final proof - the price.

You can't buy this much power for less!
Both db_FILE and db_RETRIEVE feature free lifetime support. Plus, applications developed using db_FILE and db_RETRIEVE are royalty-free, so the savings go on and on.
Call us today, and prove it to yourself!

	db_FILE	db_RETRIEVE
Single-User Object	\$ 395.00	\$ 395.00
Single-User Source*	\$ 495.00	\$ 495.00
Multi-User Object	\$ 595.00	\$ 595.00
Multi-User Source*	\$ 795.00	\$ 795.00

*Source code may only be purchased by registered owners or purchasers of compatible object code.

For the name of your db_FILE distributor.

CALL: 1-800-db-RAIMA
(that's 1-800-327-2462)

Ask about the many other products and services Raima Corporation offers, including consulting, application development services, and training.

RAIMA™
CORPORATION

BY19

File Structure:

Based on B-tree indexing and network database model. Both access methods may be used independently or in combination for real power.

Data Types Supported:

Standard C data types plus *db_addr* for user created structures

Transaction processing supported

Not RAM resident

Operating Systems Supported:

UNIX, XENIX, MSDOS, Macintosh; Microsoft Windows compatible

C Compilers Supported:

UNIX, XENIX, Microsoft, Lattice, TurboC, LightspeedC, MPW

Hardware Independent

Major LANs Supported

db_FILE is upwardly compatible with Raima's db_VISTA III Database Development System.

Power



T5200: 20MHz 386 processor, 2 internal IBM[®]-compatible expansion slots, VGA gas plasma display with VGA monitor port, 40MB or 100MB hard disk, 2MB RAM standard expandable to 8MB, 1.44MB 3 1/2" diskette drive.

At Toshiba, we're not only committed to making computers more portable, but also to making portables more powerful.

Which is why, in our effort to constantly improve and refine our machines, we've added three new computers to what is already the most complete family of truly portables available.

Each designed to be powerful enough to take on the increasingly complex tasks that face today's sophisticated PC users.

First, the T1600 which weighs under 12 pounds and which is the fastest battery-

powered computer we've ever made.

Second, the T3100e, the successor to our most popular machine—the T3100/20. We've made it over two pounds lighter and a lot faster—we've even added expansion capabilities. About the only thing we didn't add was more size.

T1600: Battery-powered 286/12MHz, coprocessor socket, 20MB hard disk at 27msec, 1.44MB 3 1/2" diskette drive, 1MB RAM expandable to 5MB, detachable backlit EGA compatible LCD, removable rechargeable battery pack.



Toshiba is the world leader in truly portable PCs and manufactures a complete line of high quality dot-matrix and laser printers. For more information call 1-800-457-7777. All Toshiba PCs are backed by the Exceptional Care program (no-cost enrollment required). IBM is a registered trademark of International Business Machines Corporation.

Surge.



And finally, the T5200, which has enough power to replace virtually any desktop PC.

But we haven't just concentrated on power and portability. We've also constantly looked for ways to make our machines more durable, more reliable, and easier to use—down to the 800 number our customers can call for help with any technical question that might come up.

We figure that's what our users demand.

And it's by anticipating the growing needs of our users that we have continually found ways to make our machines weigh

less and do more. So you can work wherever you want and however you want.

All of which might make it tempting for some people to abandon their desktop for the convenience of portability. Go ahead.

We've given you the power to do it.

T3100e: 12MHz 286 with 80287 coprocessor socket, internal half-length IBM slot, 20MB hard disk with 27 msec access, 1MB RAM expandable to 5MB, gas plasma display, 1.44MB 3 1/2" diskette drive.



In Touch with Tomorrow
TOSHIBA

Toshiba America Inc., Information Systems Division

ASK BYTE

BYTE technical editors answer your questions on microcomputing

Turning Apples to Oranges

I have a Compaq Deskpro 286 in my office for business.

My son, who is 8 years old, is learning about Apple computers at school. Rather than buy two computers, I would like to know what hardware and software are required to make the Compaq Deskpro or IBM PC AT series act like and look like the Apple computers.

Lee Rose
Deerfield, IL

I assume that by "Apple computers" you mean the Apple II series of computers, which have become popular in the classroom. Though I can understand your desire to make your work machine compatible with your child's school machine, such an effort borders on the impossible. Even if you are successful, you might not be acting in your son's best interest.

First, not only are the CPUs different in both machines, the disk formats are also incompatible, as are the video systems and operating-system software. That just about covers it, doesn't it? The best you could do would be to locate one of the peripheral boards that allow a PC to interface to an Apple disk drive, but all that buys you is the ability to transfer data files from one system to another.

Also, it probably wouldn't be a good idea to keep your son tied to the Apple II. Not that I'm passing judgment on that machine, but the situation in the real world today doesn't point to the Apple II as being a major player. Realistically, your son would probably benefit from exposure to the AT computer.

With luck, your son's computer class will focus on languages that are more or less common across all computers. Even if the language of choice is Applesoft BASIC, your son will pick up enough fundamentals to allow him to operate PC BASIC with ease.—R.G.

The Hacker's Mac

A couple of years ago, I heard about Lee Felsenstein's "Hacker's Mac" project, a proposal for the development of an open,

Macintosh-like homebrew system for the hobbyist. I contacted him at Golemic and received a preliminary specification in the mail. I have been unable to contact him again or learn any more about the project. Do you know if this project is ongoing and, if so, how I can get current information?

David Lanznar
Boston, MA

You might check out Max Stax's recent columns in Computer Shopper magazine (beginning in August 1988). His "Hackintosh" may be the answer to your prayers.—R.G.

IN ASK BYTE, BYTE editors answer questions on any area of microcomputing. The most representative questions will be answered and published. Send your inquiry to

Ask BYTE
One Phoenix Mill Lane
Peterborough, NH 03458

Due to the high volume of inquiries, we cannot guarantee a personal reply. All letters and photographs become the property of BYTE and cannot be returned.

Do Get Me Started

Do you have any suggestions for someone who wants to get started designing circuits or putting together a portable IBM PC from parts? Where could I order parts that are found in a Toshiba or Zenith laptop (e.g., a screen, a power supply, a 3½-inch hard disk drive, and a 3½-inch floppy disk drive)?

Walter George
San Francisco, CA

For getting started in digital circuit design, I've always liked Don Lancaster's Cookbook series (this includes The CMOS Cookbook and The TTL Cookbook, both published by Howard W. Sams, Indianapolis, IN), as well as the BugBook series from Blacksburg books. Though they may be difficult to find, a search through a used technical bookstore

would be worth it if you turned them up.

If you want to put together your own personal computer from parts, you should try one of the many computer flea markets that take place monthly around the country. Computer Shopper magazine publishes a schedule of these swap meets in its "Coming Events" section. You should also pick up a copy of one of the following books:

How to Build Your Own IBM PC-Compatible Computer (Comprehensive Guides, 7507 Oakdale Ave., Canoga Park, CA 91306, 1987)

Build Your Own IBM Compatible and Save a Bundle by Aubrey Pilgrim (Tab Books, Blue Ridge Summit, PA 17214, 1987)

Build Your Own 80286 IBM Compatible and Save a Bundle by Aubrey Pilgrim (Tab Books, 1988)

As far as putting together a laptop goes, I suggest you regulate your enthusiasm. You may be able to put together a portable, but the engineering gauntlet you'll have to run to stick a laptop together might be more than you've bargained for.—R.G./S.W.

Who Needs All Those Bits?

Someone once suggested to me that IBM has ever had only one successful personal computer, the original PC. The XT, AT, and PS/2 models are only faster or larger versions of the PC. This is not strictly true, of course, but it fits my understanding of how microcomputers have been used so far and exactly describes what I want: my own computer with a lot of memory and a lot of speed and software that I understand.

The only arguments that I remember hearing (7 years ago) in favor of purchasing an IBM PC instead of an Apple II were the IBM name and increased speed. Speed isn't the only issue, of course, or we might still be using CP/M.

Why doesn't anyone make a fast 8088

continued

The Bus Stops Here!

Introducing Wells American's CompuStar[®] Multi-Bus Business Computers.
The world's first and only multi-processor, convertible bus™ microcomputers.

Ask any computer expert about what type of system you should buy nowadays and you'll likely get a "pass the bus" response. Something like — "Well, uh, the PC/AT* bus is your best buy but, then again, the new PS/2* bus may become the next industry standard." Great advice, right? If trying to decide on a processor weren't tough enough, now you're expected to pick a bus, too.

RELAX, NOW THERE'S COMPUSTAR.

The all new CompuStar[®] from Wells American not only lets you interchange microprocessors, you can also mix and match buses — a PC/AT bus, a PS/2 bus or... both. As your computing needs change, simply snap in a new processor or add an extra bus. You'll never again have to worry about buying the *wrong* computer system!

FOUR COMPLETE SYSTEMS IN ONE.

The CompuStar can be configured with any of four microprocessors — an 8086, an 80286, an 80386SX, or an 80386. The processor and up to 16 megabytes of user memory have all been combined, using the latest VLSI technology, on a single, plug-in CPU module. Plus, any time during the first year of ownership, CompuStar users can "trade-in" the CPU module they initially selected toward the purchase of any of the other more powerful modules. *Nobody* but Wells American gives you this kind of value.

CONVERTIBLE BUS? YOU'RE KIDDING!

No, we're not. In fact, it may well be the most practical microcomputer innovation ever. Say you've selected an AT compatible CompuStar and later want to add PS/2 compatibility. No problem! Snap in a PS/2 Bus and Adapter Module and you can use *both* buses in the same system. Likewise, if you've selected a PS/2 compatible CompuStar and decide you want to add an AT bus, just snap in an AT Bus Module. Depending on configuration, the CompuStar can have up to 13 bus expansion slots — all AT slots, all PS/2 slots or a "split-bus" of AT and PS/2 slots. Best of all, you can reconfigure your CompuStar whenever you want.

\$1995



The CompuStar is also easily expanded. That's because there are seven CompuStar disk/tape compartments — six accessible from the front and an additional full-height bay inside. All this in a sleek, compact tower design that actually leaves *more* room on your desktop than any of the so-called "desktop" models.

A NEW IDEA FROM AN OLD COMPANY.

The CompuStar[®] Multi-Processor, Convertible Bus™ Microcomputer. It's no surprise that our engineers invented it. After all, we've been making microcomputers longer than anyone else... even longer than IBM! And if that kind of experience doesn't impress you, CompuStar's service programs surely will. You can select an optional overnight module swap-out plan or on-site service from General Electric Corporation — one of the most respected names in consumer electronics. And, of course, every CompuStar carries a full one-year factory warranty.

FINALLY, AFFORDABLE TECHNOLOGY.

Think all this technology sounds expensive? It's not. CompuStar 20MHz 80286 systems start as low as \$1995†. There are also inexpensive 8086 and powerhouse 25MHz 80386 systems available. Plus, there is a wide variety of CompuStar display, tape and disk options including a one gigabyte erasable optical disk. You can choose a factory preconfigured CompuStar or custom design one yourself. Just unlock the front panel and literally "snap-in" a bus, CPU or disk module in a matter of seconds. It's system flexibility never before available... at any price.

While one of our competitors (we won't mention any names) threatens you with "missing the bus," most simply *pass* the bus. Our new CompuStar however, *eliminates* the bus problem altogether. Not to mention the processor problem. Even the expansion problem. Prove it to yourself. Call today about our CompuStar 31-day trial offer. Oh, and by the way, the next time anyone asks, tell 'em you know where the bus stops.

 **Wells American**

Corporate Headquarters: 3243 Sunset Boulevard • West Columbia, SC 29169 • 803/796-7800 • TWX510-601-2645

*Personal Computer, AT, AT and PS/2 are trademarks of International Business Machines Corporation. †Photograph depicts optional equipment. Complete price list available upon request. CompuStar 80286 base system (\$1995) includes built-in VGA/EGA display adapter, one diskette drive with controller, two serial/one parallel/one mouse port, keyboard and 220 watt power supply.

ChiWriter

NOW
WITH
MICROSPELL

How are you currently producing your scientific documents? Are you using a "golf ball" style typewriter? A regular word processor, hand lettering the special symbols? Are you fighting against a "what-you-see-is-definitely-not-what-you-get" system with a special command language? Or are you using one of our competitors' expensive and inflexible programs? Find out how ChiWriter can solve your scientific word processing problems.

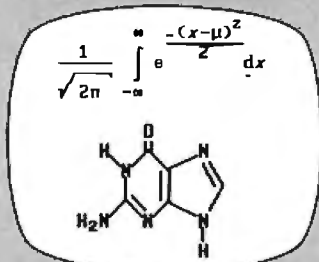

From an actual ChiWriter screen display

Powerful Scientific/Multifont Word Processing at a Reasonable Price

ChiWriter is a complete word processor, designed especially for scientific and foreign language text. Its features include: intuitive formula editing commands, automatic pagination, variable headers and footers, footnotes, box draw mode, a notepad window, and an integrated spelling checker.

Best of all, ChiWriter is completely "what-you-see-is-what-you-get." Even complicated formulas can be entered easily because the screen display corresponds exactly to the printout.

ChiWriter runs on an IBM PC with CGA graphics, 2 floppy or 1 hard/1 floppy drive, and an Epson/IBM compatible 9 pin printer. Hi res screen support (Hercules, EGA, VGA, AT&T), 24 pin printer support, and laser printer support (HP LaserJet, DeskJet, PostScript) are available.

"ChiWriter is a nifty product with a price I defy you to beat and performance I defy you to snub... I know of several \$500 programs that will do the job, but for the same money you could buy ChiWriter and a vacation."

Phil Wiswell, PC Magazine

- | | |
|---|----------|
| <input type="checkbox"/> ChiWriter Program | \$99.95 |
| <input type="checkbox"/> Hi Res Screen Support | \$24.95 |
| <input type="checkbox"/> 24 Pin Printer Support | \$24.95 |
| <input type="checkbox"/> Laser Printer Support | \$59.95 |
| <input type="checkbox"/> International Keyboard Support | \$19.95 |
| <input type="checkbox"/> Chemistry Support | \$49.95 |
| <input type="checkbox"/> Word Perfect Converter | \$49.95 |
| <input type="checkbox"/> Conographic Font Set | \$149.95 |
| <input type="checkbox"/> MergeChi Mail Merge Facility | \$24.95 |
| <input type="checkbox"/> IndexChi Index Generator | \$59.95 |
| <input type="checkbox"/> Shipping & handling | \$ |
- \$5 U.S. & Canada, \$10 Europe, \$15 elsewhere

Name _____

Address _____

City _____

State _____ Zip _____ Country _____

Phone () _____

Payment by Check Purchase Order VISA MC

Card # _____ Exp. / _____



BY1/89

Horstmann Software Design Corporation
140 E. San Carlos St./P.O. Box 5039
San Jose, CA 95150-5039, USA
(408) 298-0828

horstmann software



ASK BYTE

or 8086 computer? Why do we need an 80286 or 80386 to get above 10 MHz? Aren't 8 bits plenty for word processing? We haven't been using the extra memory-addressing abilities of 16-bit and 32-bit buses, so what have we been using? Is there some reason why the 8088 and 8086 are limited in speed?

Perhaps the answer lies in the economics of designing and building computers or is buried in the history of computer developments.

Dennis P. McGuire
Minneapolis, MN

If people used microcomputers only for word processing, 8 bits might be enough. (Even so, a large cut-and-paste operation involves moving blocks of memory around, and if the move can be performed 16 bits [2 bytes] or 32 bits [4 bytes] at a time, the cut and paste will execute much faster.) But the fact is that more than character manipulation occurs out there in the computer world. For example, one of the great attractions of the Macintosh is the alloy of text and graphics it provides, making yesterday's dreams of desktop publishing today's reality. Efficient manipulation of graphics on a par with those of the Macintosh would be prohibitively slow on an 8-bit-wide machine.

Perhaps you haven't been using the extra memory-addressing abilities of 32-bit buses, but I'll wager that a number of 80386-based Unix users have. I submit that they would be rather cool to any suggestion to return to an 8-bit bus. —R.G.

Imagewriter on a Laptop

I'd like to connect a laptop Toshiba T1200 with an Apple Imagewriter I. Because I am using MS-DOS at work and a Macintosh at home, I want to print some work at home, but I wasn't able to find documentation on proper pin arrangement for the ends of the connecting cable. Could you recommend a publication that would help me?

Serge Amoos
Geneva, Switzerland

I have been using an Imagewriter I connected via a T-switch to an Apple Macintosh and a Zenith MS-DOS computer for over a year now with no problem, so you should encounter none. All the documentation you need is in the Imagewriter user's manual (pin-outs for the serial port are in appendix F). Also, there have been a number of replies to letters in recent Ask BYTE columns with detailed connection diagrams for RS-232 products and how to handle the infamous

Table 1: Pin-out for AT-compatible serial port.

Pin	Description
1	Carrier detect
2	Receive data
3	Transmit data
4	Data terminal ready
5	Signal ground
6	Data set ready
7	Request to send
8	Clear to send
9	Ring indicator

"crossover" problem.

Keep in mind that you should use the Toshiba's serial port to connect to your Imagewriter, not the parallel port. The Toshiba's 9-pin serial port should be IBM PC AT-compatible; refer to table 1 for a pin-out of the AT's serial connector. And remember to use MS-DOS's MODE.

—R.G.

Laptop Expansion

For the past year, I have been looking (in vain, it seems) for an external 3½-inch floppy or hard disk drive for my Toshiba T1000. Do you know of such a unit that I could connect to the external drive port on the back of the T1000?

Gary Ridley
Ottawa, Ontario, Canada

I have looked in vain as well. It seems that the only external drive currently available for the T1000 is a 5¼-inch model. I suggest you contact your nearest Toshiba dealer for price and ordering information. —R.G.

Permutations

I have an Apple IIe with 128K bytes of memory. I want to find a program (preferably in the public domain) that will compute and print all possible combinations of any entered group of numbers, letters, or words. For example, I want to find all possible combinations of "Compute with Apple." If I enter the three words in any order, I would like the computer to print out the following:

Compute with Apple
Compute Apple with
with Apple Compute
with Compute Apple
Apple Compute with
Apple with Compute

This appears to be a simple task for a competent programmer. Alas, I am not

continued

INTERACTIVE
386/ix

The Choice is Clear.

UNIX® Checklist

for 386 systems

- Leading Edge Technology:** First to bring UNIX to 386, first to bring MS-DOS to UNIX, first with X Window, NFS and host-based TCP/IP for the 386.
- Optimized For Business:** Mature and popular environment supporting thousands of commercial applications. Backed by comprehensive support and training.
- Standard:** UNIX System V certified. Committed to meet emerging POSIX and X/OPEN standards. MS-DOS® and XENIX® applications run, too.
- Outstanding Industry Track Record:** UNIX technology supplier to IBM, Intel, AT&T, Prime, NCR, Microsoft, Wang, Apollo and others.
- Excellent Price/Performance:** pricing and di

INTERACTIVE

A KODAK COMPANY

1-800-537-5324

INTERACTIVE
Systems Corporation
2401 Colorado Avenue
Santa Monica, CA
90404

UNIX® is a registered trademark of AT&T
386/ix is a trademark of INTERACTIVE
Systems Corporation.
MS-DOS and XENIX are registered
trademarks of Microsoft Corporation.

©1988 INTERACTIVE Systems Corporation.

NOW THERE ARE TO THE POST

PostScript printers and typesetters offer a variety of resolutions, paper handling options and printer speeds, as well as black & white and color output.



In just three years, the PostScript language has been adopted by more than 25 of the world's leading computer equipment manufacturers.

Agfa-Gevaert Apollo Computer
Apple Computer AST Research
Autologic Dataproducts Diconix
Digital Equipment Corporation Fujitsu
General Computer Hewlett-Packard IBM
Linotype Matsushita Monotype NBI
NEC NeXT QMS Quadram
Qume Ricoh R.R. Donnelley
Scitex Texas Instruments
Vartyper Wang



More than 3,000 software programs—for minicomputers, mainframes, workstations and personal computers—support the PostScript language.

THE OUTSIDE. To professionally print words and pictures on the same page, all you need are laser printers and typesetters that speak the right language. The language of PostScript.

As the standard page description language of electronic publishing,



POSTSCRIPT that support PostScript software from Adobe Systems. It's your guarantee of quality and compatibility.

Look for this symbol on computers, printers and other products

PostScript software from Adobe Systems is your key to complete device independence—giving you the freedom to select the right hardware, software and vendors for your needs and budget.

Isn't it time you put the power of PostScript on your side?

Adobe and PostScript are registered trademarks and the Adobe logo, the PostScript logo, and Display PostScript are trademarks of Adobe Systems Incorporated. The logos of the original equipment manufacturers supporting PostScript and the Display PostScript system and the software titles supporting PostScript are the trademarks or registered trademarks of their respective companies. ● 1988 Adobe Systems Incorporated. All rights reserved.

ARE TWO SIDES SCRIPT® STORY.

digital



IBM

*Display PostScript
is already the graphics
standard for a new
generation of computer
and workstation
displays from these
manufacturers.*



*Computers and workstations
with the Display PostScript
system deliver a variety of
screen resolutions in
black & white,
grayscale and color.*



*Taking advantage of
enhanced software portability,
applications with greater
power and potential are
already emerging to support
Display PostScript.*

THE IN SIDE.

Introducing Display PostScript™ from Adobe. With the same imaging standard and language used in PostScript printers, this system software module is now in computer and workstation displays.

And because it's transparently integrated over a variety of operating systems, Display PostScript is your key to hardware compatibility and software portability.

Take advantage of a powerful, new graphics standard for today—and tomorrow. Be sure to insist on the Display PostScript system.

If you'd like more inside information about PostScript software and/or the Display PostScript system, call 800-29-ADOBE.

ADOBE™
SYSTEMS INCORPORATED

POSTSCRIPT

The World's Lowest Price A to D Size Flatbed Plotter.

(8 1/2" x 11" to 22" x 34" plot sizes)

A breakthrough in X-Y positioning gives remarkable performance and low price in the MURAL™ Plotter.

■ **Plots any size from A to D+**

Maximum pen travel is 25" x 34". Pre-printed media is easily registered to this plotter.

■ **Simplified flatbed construction for durability and performance**

Contains a precision molded zero backlash drive chain embodying two steel aircraft cables. Uses no moving electrical components in the pen carriage. Assures virtually perfect repeatability every time.

■ **HPGL compatible**

Works with all software that drive H-P plotters including AutoCAD, VersaCAD, and DesignCAD. Runs on all systems from IBM PC (and compatibles) to Apple and more.

■ **Prints on any media**

Plots on any size media to 1/4" thick, including bond, vellum, mylar, posterboard.

■ **Fits anywhere**

Designed for desktop or space-saving wall mount use.

■ **Satisfaction guaranteed or your money back**

If not completely satisfied, return it within 30 days of purchase for a full refund.

■ **FREE information kit**

Phone or write today for sample plot, brochure, and name of nearest dealer.

800-323-3283 Extension 128
(In MA 413-534-4400)

Mural is a trademark of United Innovations

ONLY \$2,495

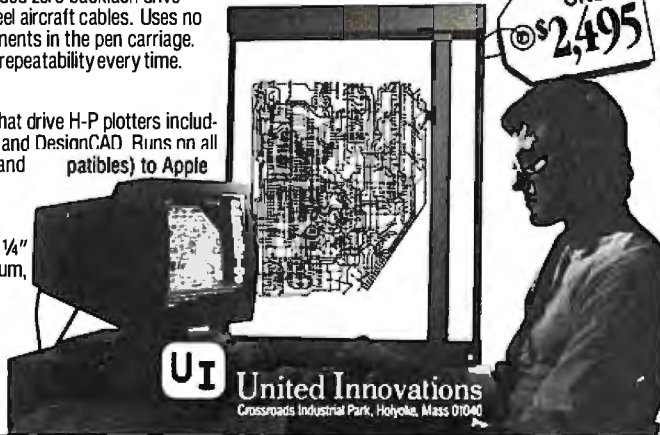

United Innovations
Crossroads Industrial Park, Holyoke, Mass 01040

one. I would use such a program as a code breaker; I could set it up to keep searching until it found a certain code combination.

Roderick I. McNeil
Warner, NH

How do you write a program that can generate all possible permutations of an array of tokens (where the tokens are strings, as in your example)? Thinking about how to solve that problem without the help of a computer is one good way to discover an algorithm that you can then translate into a program. Consider how to permute all the digits in a number. Start with an easy case—the two-digit number 34. Clearly, there are just two permutations:

34
43

What if you're working with the three-digit number 234? Well, there have to be combinations that begin with 2, 3, and 4. How many of each? Two, since when you "freeze" each first digit, what's left is a two-digit number that—like 34—has two permutations. Working step-by-step for each of three possible initial digits, there are two permutations; the total yield is six permutations. A template of the solution looks like this:

2
2
3
3
4
4

When the first digit is 2, the remaining digits are 3 and 4. You know how to permute 3 and 4, so you get

234
243
3
3
4
4

When the first digit is 3, 2 and 4 remain. So you get

234
243
342
324
4
4

You get the idea. Now, what about the continued

UTAH

NEW
VERSION 5.0
\$69.95



For IBM® PC's, XT's, AT's and other DOS machines. Needs only 1 disk drive and 128K memory. This is the one you've heard so much about - with fast compile times, small object code modules, not copy protected, no royalties, and clear error messages. Version 5.0 is based upon ANSI-74 standards with new dynamite features including:

- Nested IF's and nested conditions.
- Indexed files (ISAM) with up to 24 keys (includes START verb). This advanced feature requires the software package Btrieve® which is optionally available.
- ACCEPT (line, column) numerics with decimal point alignment, numeric checking, AUTO-SKIP, SECURITY, LENGTH-CHECK, EMPTY-CHECK, ATTRIBUTE (color), FROM ESCAPE KEY, DAY, DATE, TIME, DAY-OF-WEEK.

- Fast memory mapped DISPLAY's (line, column) ERASE, BEEP, ATTRIBUTE (color). Can display entire screen with one DISPLAY statement.
- Windowing, pop-ups, color and overlays. This advanced feature requires the software package Saywhat?!™ which is optionally available.
- An easy to use, COBOL source code EDITOR with auto line numbering, A-margin, B-margin tabing with full screen cursor control.

Also available: Utah SuperSort®, a fast sort program callable from Utah COBOL; Utah FORTRAN; Utah BASIC; Utah PASCAL; Utah PILOT. Used by 50,000 professionals, students and teachers in 40 countries. 30-day money back guarantee. Discover the ease and simplicity of COBOL, today!

Phone order rushed by UPS 2nd Day Air:
(702) 827-3030



Since 1977
Ellis Computing, Inc.
5655 Riggins Court, Suite 10
Reno, Nevada 89502

IBM is a registered trademark of International Business Machines, Inc. Btrieve is a registered trademark of Novell, Inc. Saywhat?! is a trademark of The Research Group. SuperSort is a registered trademark of Micropro International Corporation. Utah COBOL is a trademark of Ellis Computing, Inc. © 1987 Ellis Computing, Inc.

Now you can grab, store, and process 16 images in Real Time on the PC AT.



The many faces of Fred Molinari, President.

The DT2861 Arithmetic Frame Grabber can process 4 times as many images as any other frame grabber built for the PC AT.

With a built-in processor, the DT2861 also lets you process 4 images in parallel, or switch display instantaneously from as many as 16 images. The DT2861 grabs images off virtually any video source,



including CAT scanners, scanning electron microscopes, line-scan cameras, as well as ordinary video cameras and VCRs. It even ships with IRISstutor™ software - for free!

For more information about the Frame Grabber

that's 4 times better than anything else made for PCs, give us a call today.

Call (508) 481-3700
In Canada, call (800) 268-0427

◀ **DT-Connect™** is an open interface specification which permits the direct connection of stand-alone data acquisition and frame grabber boards to processor boards for greatly accelerated signal (DSP) and image processing.

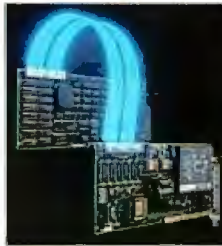

Image Processing Board	Computer	Resolution	Gray Levels	RS-170, NTSC, RS-330, CCIR, PAL Compatible	VCR Compatible	Slow Scan	Number of Video Inputs	Real-Time Frame Grab	On Board 8-bit ALU	Memory-Mapped Frame-Store Memory	Zoom, Pan, Scroll	Software Support	Price
DT2861 Frame Grabber	IBM PC AT	512x512	256	Yes	Yes	0-12 MHz	8*	Yes	Yes	16 buffers 512x512x8 each (4 Mbytes)	Yes	DT-IRIS IRISstutor	\$5995

*With DT2859 1/2 size multiplexer board (\$395).

DATA TRANSLATION®

World Headquarters: Data Translation, Inc., 100 Locke Drive, Marlboro, MA 01752-1192 USA, (508) 481-3700 Tlx 951646

United Kingdom Headquarters: Data Translation Ltd., The Mulberry Business Park, Wokingham, Berkshire RG11 2QJ, UK, (0734) 793838 Tlx 94011914

West Germany Headquarters: Data Translation GmbH, Stuttgarter Strasse 66, 7120 Bietigheim-Bissingen, West Germany 07142-54025

International Sales Offices: Australia (2) 662-4255; Belgium (2) 735-2135; Canada (800) 268-0427; Chile (2) 25-3689; China (408) 727-8222, (1) 868-721; Denmark (2) 274511; Finland (90) 372-144; France (1) 69077802; Greece (1) 951-4944, (31) 527.039, (1) 361-4300; Hong Kong (5) 448963; India (22) 23-1040; Israel (3) 32-4298; Italy (2) 82470.1; Japan (3) 348-8301, (3) 502-5550, (3) 355-1111; Korea (82) 756-9954; Morocco (9) 30-4181; Netherlands (70) 99-6360; New Zealand (9) 504759; Norway (2) 53 12 50; Peru (14) 31-8060; Philippines 818-0103; Portugal 545313; Singapore 7797621; South Africa (12) 8037680/93; Spain (1) 455-8112; Sweden (8) 761-7820; Switzerland (1) 723-1410; Taiwan (2) 918-4740; United Kingdom (0734) 793838, West Germany 07142-54025.

Data Translation is a registered trademark of Data Translation, Inc. Other brands and products are trademarks of their respective holders.

Circle 71 on Reader Service Card

JANUARY 1989 • BYTE 45



Break the 32M barrier without breaking your wallet with **EZ-DOS 4.0**.

EZ-DOS 4.0 was developed by **Digital Research** as an alternative DOS for PCs. As such, EZ-DOS 4.0 allows **512M** partitions and file/subdirectory **PASSWORD** protection. On-line **HELP** is another user-friendly feature.

EZ-DOS 4.0 also comes with **GEM/3 Desktop**, this graphic, windowing user interface:

GEM Desktop™

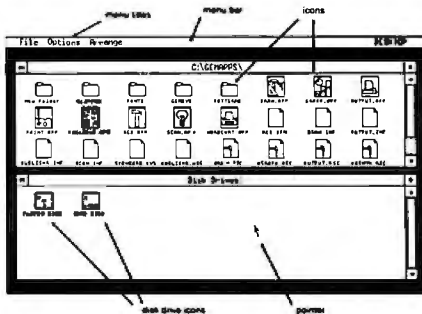

EZ-DOS 4.0 \$79.00
with True BASIC \$99.00

2001 Sales, Inc.

Corp. Headquarters:
16580 Harbor Blvd., Ste. D.
 Fountain Valley, CA 92708
 Tel: (714) 531-6551 Fax: (714) 531-8546

CANADA:
 Tel: (416) 591-6600 Fax: (416) 591-6808

TAIWAN:
 Tel: (02) 542-4575 Fax: (02) 536-3405

HONG KONG:
 Tel: 5-890-3707 Fax: 5-895-6241

Dealer, Distributor & OEM inquiries welcome.
 VISA and Master Card accepted.

four-digit number 1234? You know that there are six permutations of a three-digit number and that you have to solve the three-digit problem four times—once for each possible first digit. Taking it step-by-step, the four-digit template looks like the array in table 2a. Each column now reduces to a three-digit problem, and you can add the appropriate three-digit templates; see table 2b. Now you're back to the degenerate two-digit problem. To complete each number, permute the two unused digits, and you have table 2c.

It's a classic recursive problem. To solve it for *n* tokens, find the solution for *n-1* tokens; keep decomposing the problem until you get to the trivial case of 2 tokens; then let the results percolate back up to the top level.

Now you can express the method in algorithmic terms. A first draft (in pseudocode) is shown in listing 1. For a second draft, use two variable-length arrays called prefix and suffix. The prefix is the part that's fixed, and the suffix is the

part that's variable. For example, when permuting the digits 1234, 1, 2, 3, and 4 will in turn be the top-level prefixes, and 234, 134, 124, and 123 will be the corresponding suffixes. At the next level, the prefixes (for solutions starting with 1) will be 12, 13, and 14, and the suffixes will be 34, 24, and 23. See listing 2.

To start, you need a main program that initializes the prefix to be an empty token array (since nothing is fixed yet) and a suffix that is the array of tokens you want to permute (since at first the whole thing is variable). The pseudocode for the main program is shown in listing 3.

To translate this algorithm into a program, you'll need a language that supports recursion, such as Pascal or one of the more modern dialects of BASIC. If the tokens you're interested in permuting are letters or digits, you can use strings to represent arrays of them. It's best if the language you choose provides intrinsic support for variable-length strings; that

continued

Table 2: Templates for permuting a 4-token entity: (a) The first step (leftmost token), (b) the next step, and (c) the final array.

(a)			
1	2	3	4
1	2	3	4
1	2	3	4
1	2	3	4
1	2	3	4
1	2	3	4
1	2	3	4
(b)			
12	21	31	41
12	21	31	41
13	23	32	42
13	23	32	42
14	24	34	43
14	24	34	43
(c)			
1234	2134	3124	4123
1243	2143	3142	4132
1324	2314	3214	4213
1342	2341	3241	4231
1423	2413	3412	4312
1432	2431	3421	4321

Listing 1: First step in casting the technique shown in table 2 into an algorithm.

For each token of an *n*-token array, append to that token all permutations of the remaining *n-1* tokens.

Listing 2: Algorithm of listing 1, shown now in greater detail.

```

permutate_n(prefix,suffix)
{
  n := count_of_tokens_in
      (suffix)
  for d := 1 to n
  {
    if 2_token(suffix)
    {
      permutate_2_and_print
        (prefix,suffix)
    }
    else
    {
      new_prefix := (prefix +
                    dth_token_of(suffix))
      new_suffix := (suffix -
                    dth_token_of(suffix))
      permutate (new_prefix,
                new_suffix)
    }
  }
}

permutate_2_and_print(prefix,
                      suffix)
{
  print ( prefix +
        1st_token_of(suffix) +
        2nd_token_of(suffix) )
  print ( prefix +
        2nd_token_of(suffix) +
        1st_token_of(suffix) )
}
    
```

SYMANTEC

TIME LINE

KEY FEATURES:

Outline Gantt

Network View (PERT)

May 23, 1988

INFO THE PC NEWS WEEKLY

WORLD

PROJECT MANAGEMENT SOFTWARE • REPORT CARD					
		Harvard TPM II 2.0	Microsoft Project 4.0	Superproject Expert 1.0	Time Line 3.0
Performance	(weighting)				
Features/flexibility	(225)	Good	Good	Very Good	Excellent
Recalculation speed	(75)	Satisfactory	Very Good	Very Good	Very Good
Leveling speed	(50)	Satisfactory	Good	Very Good	Very Good
Documentation					
Ease of learning	(100)	Good	Very Good	Very Good	Excellent
Ease of use					
Ease of use	(125)	Very Good	Very Good	Very Good	Very Good
Error handling					
Data Integrity	(150)	Good	Very Good	Very Good	Excellent
Error messages	(75)	Very Good	Good	Good	Very Good
Support					
Support policies	(25)	Good	Good	Very Good	Excellent
Technical support	(50)	Good	Satisfactory	Very Good	Very Good
Value					
	(50)	Satisfactory	Good	Good	Very Good
	(75)	6.2	6.8	7.2	8.8

THE #1 PROJECT MANAGER IS BEHIND THE BEST COMPARATIVE REVIEW IN THE WORLD.

Just why is Time Line #1, review after review, evaluation after evaluation? Is it our advanced outline structure or true "what-if" analysis using unlimited undo/redo? Maybe it's our completely customizable Gantt charts, PERT charts, and form-driven reports. Could it possibly be the way we handle multi-project scheduling and resource allocation without having to manually link files?

We think Time Line is #1 because of its seamless combination of advanced technology and ease of use. But we're biased. Decide for yourself. Call now for a free Time Line demo disk (you may also qualify for our free corporate evaluation program). You'll see what "the best project manager in the World" can do for you.

The #1 Project Manager

FREE DEMO DISK, CALL (800) 228-4122 EXT. 429Y.



SYMANTEC

*Time Line is the #1 best-selling project manager (survey of National Distributors). It is also the #1 choice of 48 of the Fortune 50. Time Line 3.0 (\$595) received InfoWorld's highest 1988 rating for project management software (S.S). Time Line 2.0 (\$495) was PC Magazine's Editor's Choice in '86 and '87 and was rated #1 by Software Digest in '87. Training and consulting services, and links to CA-TELLAPLAN are available, call (415) 898-1919. © 1988 Symantec Corp, 10201 Torre Ave., Cupertino, CA. (408) 253-9600.

PC MAGAZINE Editor's Choice, '86 and '87

Never buy another ribbon! with MacInker™

over 100,000 sold



Universal Cartridge MacInker **\$68.50**



Imagewriter or Epson MacInker **\$42.00**

Eliminate expensive ribbon replacement with the famous MacInker. The Universal Cartridge MacInker (\$68.50) will re-ink most cartridges with the appropriate adaptor. The Universal Spool MacInker will re-ink all spools. Operation is very simple & automatic. Our extra dark, lubricated ink yields better than new printout quality and its cooling effect extends print-head life. New ink dispenser ensures precise ink metering. Average number of re-inkings/cartridge is 60-100 at an average cost of 5cents/re-inking. We also have dedicated MacInkers for special cartridges. All MacInkers, with appropriate Multicolor Adaptor can re-ink multicolor cartridges (2 or 4 colors). Or use your MacInker to re-ink in 10 different colors: red, green, blue, yellow, purple, brown, orange, gold and silver. Our Customers range from individuals to Fortune 500 Corporations. In 1982 we pioneered re-inking technology and are dedicated to its development. We have a complete range of accessories, heat-transfer re-inking adaptors, special inks and cartridges.

New

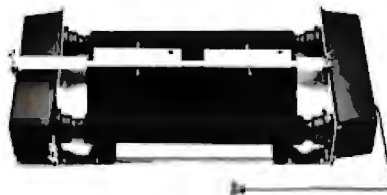

Band Printer MacInker **\$299.00**

Universal Cartridge MacInker	68.50
Multicolor Adaptor (specify printer)	40.00
Imagewriter I/II MacInker mod 234 IM.....	42.00
Epson MacInker mod 271EP	42.00
Universal Spool MacInker	68.50
Heat Transfer Adaptor	40.00
Extra Ink bottle.....3.00 pint	18.50

Call for free catalog

Special Offer

Just say, "I saw it in 'Byte' and get a free mousepad with any order >\$60.00, or free key-beeper & flashlight combination for orders >\$100.00.

Buy the Universal Cartridge & the Universal Spool at the same time and get the second unit for \$50.00

All MacInkers delivered with bottle of ink, ink meter, reservoir, reservoir cover. Black, uninked, colored, special cartridges available. Best ribbon quality at lowest costs.

Multiuser Printer Buffers

Let us configure the most economic & efficient buffer set-up when using two printers with one computer or two computers and two printers. We have the most complete range of buffers, converters, switches, cables & custom cables. Award winning Proteus switches manually or by software between 2 printers. Memory is automatically partitioned & both printers can print simultaneously.

UG-411, 1 comp. / 1 printer	64k	160.00
	256k.....	230.00
UG-402 2 comp. / 2 printers	64k.....	199.00
	256k.....	240.00
PROTEUS, 1 comp. / 2 printers	64k.....	199.00
	256k.....	240.00
UG-403 4 comp. / 2 printers	256k.....	275.00
UG-408 4 comp./ 4 printers	512k.....	375.00
UG-412 Serial buffer card 1 MEG		500.00
CBL-715 Univ. ser-par-ser converter		159.00
CBL-705 Ser-par converter		99.00
Autoscanning switches (4 to 1)		169.00



UG-402



Proteus

Satisfaction or 30 day refund on all products - Immediate shipment - Major credit cards

Computer Friends, Inc. Order Toll Free 1-800-547-3303

14250 NW Science Park Dr.
Portland OR 97229

in Oregon (503)626-2291
fax (503)643-5679 telex 4949559 CF

ASK BYTE

Listing 3: Main routine for calling the permutation function of listing 2.

```
permute
{
  prefix := new_array
  suffix := 1234
  permute_n(prefix, suffix)
}
```

way, you don't have to explicitly manage their length when you append prefixes to suffixes, append tokens to prefixes, and delete tokens from suffixes.—J.U.

Help with Hercules

I have an Epson Equity II IBM PC XT clone with a monochrome monitor. It came with a built-in video board that supports both regular monochrome text mode and Hercules graphics. The GWBASIC that came with it supports monochrome text (mode 7) and Hercules graphics modes. However, my customary programming language is Lahey FORTRAN 77, which provides a convenient subroutine that can be used to perform BIOS or DOS function calls. I have used it to set up my screen I/O, menus, and so on, in text mode.

Now, however, I would like to perform graphics from FORTRAN. I thought mode 6 might support Hercules graphics via the BIOS video services, but it didn't work when I tried it. Perhaps it will be necessary for me to write an assembly language subprogram to do Hercules graphics. Lahey includes a sample that shows how to interface assembly language with his FORTRAN, and I have programmed in assembly language on several machines (although not on an 8086). I expect I can handle it, but I need to know the protocol for manipulating Hercules graphics. Can you tell me where to look? I tried Peter Norton's *Programming Guide to the IBM PC*, but I couldn't find the information I needed.

James C. Wilcox
Palos Verdes Estates, CA

None of the standard IBM video modes will work with Hercules graphics. Writing graphics routines for the Hercules cards requires programming the 6845 graphics controller, but it's not difficult, especially with the proper sources. Two good references are Richard Wilton's *Programmer's Guide to PC and PS/2 Video Systems* (Microsoft Press, 1987) and David Doty's *Programmer's Guide to the Hercules Graphics Cards* (Addison-Wesley, 1988).—S.A. ■

MS-DOS \$99

We call PolyAWK our "toolbox language" because it is a general-purpose language that can replace a host of specialized tools or programs. You will still use your standard language (C, Pascal, Assembler or other modular language) to develop applications, but you will write your own specialized development tools and programs with this versatile, simple and powerful language. Like thousands of others, you will soon find PolyAWK to be an indispensable part of your MS-DOS toolbox. If you don't have enough OS/2 development tools, now it's easy to write your own.

A True Implementation Under MS-DOS & OS/2

Bell Labs brought the world UNIX and C, and now professional programmers are discovering AWK. AWK was originally developed for UNIX by Alfred Aho, Richard Weinberger & Brian Kernighan of Bell Labs. Now PolyAWK gives MS-DOS & OS/2 programmers a true implementation of this valuable "new" programming tool. PolyAWK fully conforms to the AWK standard as defined by the original authors in their book, *The AWK Programming Language*.

A Pattern Matching Language

PolyAWK is a powerful pattern matching language for writing short programs to handle common text manipulation and data conversion tasks. A PolyAWK program consists of a sequence of patterns and actions that tell what to look for in the input data and what to do when it's found. PolyAWK searches a set of files for lines matched by any of the patterns. When a matching line is found, the corresponding action is performed. A pattern can select lines by boolean combinations of regular expressions and comparison operations on strings, numbers, fields, variables, and array elements; patterns may reference properties of the current input line or any other program variables. Actions may perform arbitrary processing on selected lines. The action language looks like C, but there are no declarations, and strings and numbers are built-in data types. You can have multiple input files and output files, regular expressions, user-defined functions, and run other programs.

Saves You Time & Effort

The most compelling reason to use PolyAWK is that you can literally accomplish in a few lines of code what may take pages in C, Pascal or Assembler. Programmers spend a lot of time

writing code to perform simple, mechanical data manipulation — changing the format of data, checking its validity, finding items with some property, adding up numbers and printing reports. It is time consuming to have to write a special-purpose program in a standard language like C or Pascal each time such a task comes up. With PolyAWK, you can handle such tasks with very short programs, often only one or two lines long. The brevity of expression and convenience of operations make PolyAWK valuable for prototyping even large-sized programs.

Very Concise Code

Where program development time is more important than run time, AWK is hard to beat. These AWK characteristics let you write short and concise programs:

- The implicit input loop and the pattern-action paradigm simplify and often entirely eliminate control flow.
- Field splitting parses the most common forms of input, while numbers and strings and the coercions between them handle the most common data types.
- Associative arrays use ordinary strings as the index in the array and offer an easy way to implement a single-key database.
- Regular expressions are a uniform notation for describing patterns of text.



PolyAWK™
The Toolbox Language.™
For C, Pascal, Assembly & BASIC Programmers

OS/2 \$199

- Default initialization and the absence of declarations shorten programs.

Large Model & Math Support

PolyAWK is a large model implementation and can use all of available memory to run big programs or read files greater than 64K. PolyAWK also includes extensive support for math functions such as strings, integers, floating point numbers and transcendental functions (sin, log, etc.) for scientific applications. Conversion between these types is automatic and always optimized for speed without compromising accuracy.

PolyAWK Comes With The Book

When you order PolyAWK you receive a copy of *The AWK Programming Language* written by the authors of the original UNIX-based AWK. The book begins with a tutorial that shows how easy AWK is to use, followed by a comprehensive manual. Because

PolyAWK is a complete implementation of AWK as defined by the book's authors, you will use this book as the manual for PolyAWK.

PolyShell Bonus For MS-DOS!

PolyShell gives you 96 of the most useful UNIX commands and utilities under MS-DOS in less than 20K. You can still use MS-DOS commands at any time and exit or restart PolyShell without rebooting. MS-DOS programmers — discover what you have been missing! UNIX programmers — switch to MS-DOS painlessly! PolyShell and PolyAWK are each \$99 when ordered separately. Save \$50 by ordering the PolyShell + PolyAWK combination package for \$149 (MS-DOS only).

30-Day Money Back Guarantee

You can purchase PolyAWK and the book, *The AWK Programming Language*, for \$99 (MS-DOS) or \$199 (OS/2), or \$249 for both. If you already have the book, deduct \$14. The combination package includes only one book. Order PolyAWK (MS-DOS & OS/2) plus PolyShell (MS-DOS) for \$348.

To Order: 1-800-547-4000

Ask for Dept. BYT. Send Checks and P.O.s To: POLYTRON Corporation, 1700 NW 167th Place, Beaverton, OR 97006, (503) 645-1150 - FAX: (503) 645-4576, TELEX: 325800 POLYTRON. Call About Our OEM/VAR Strategic Alliance Program.

POLYTRON

High Quality Software Since 1982

Circle 211 on Reader Service Card

Finally, a Mouse That Won't Tie You Down.



The New Cordless Manager Mouse

Finally, a mouse that won't hold you back.

Manager Mouse Cordless, the world's first and only cordless mouse.

Better by design, it offers variable resolution, from 10 - 1000 dpi, and the reliable, maintenance-free performance that's become a trademark of the Numonics Manager Mouse line.

Amazingly simple to operate, Manager Mouse Cordless is compatible with virtually all mouse-driven software.

It's one mouse that breaks away from the pack.



NUMONICS

101 Commerce Drive, Montgomeryville, PA 18936
Toll free: 1-800-247-4517 • In PA call collect: 215-362-2766

BOOK REVIEWS

Descartes' Dream

by Philip J. Davis
and Reuben Hersh

Houghton Mifflin Co.,
Boston, MA: 1986, 320 pages,
\$12.95

Reviewed by Mark Bridger

In their first book, *The Mathematical Experience* (Birkhauser, 1981), Philip J. Davis and Reuben Hersh tried to explain, for the nonmathematician, what mathematicians do for a living and what they think about what they do. In addition to providing some interesting descriptions of areas of contemporary research, the authors let everyone in on a secret of which many mathematicians seem to be unaware: Not all mathematicians agree on the scope, validity, or relevance of their field. In *Descartes' Dream*, the authors turn their attention to a fact that is no secret at all: Noteveryone is entirely happy with the way mathematics seems to be applied in the modern world.

The year 1987 marked the 350th anniversary of the publication of René Descartes' celebrated *Discourse*, in which he introduced many of the ideas of what has come to be called Cartesian or analytic geometry. Of equal importance, Descartes also described a way to determine "truth" in the sciences. Loosely speaking, this method consists of 1) assuming only what is intuitively self-evident, 2) arguing from the simple to the complex, by dividing a problem into small enough steps, and 3) carefully checking one's work for correctness. Hardly anyone nowadays would dispute this as a generally reasonable procedure to follow in scientific

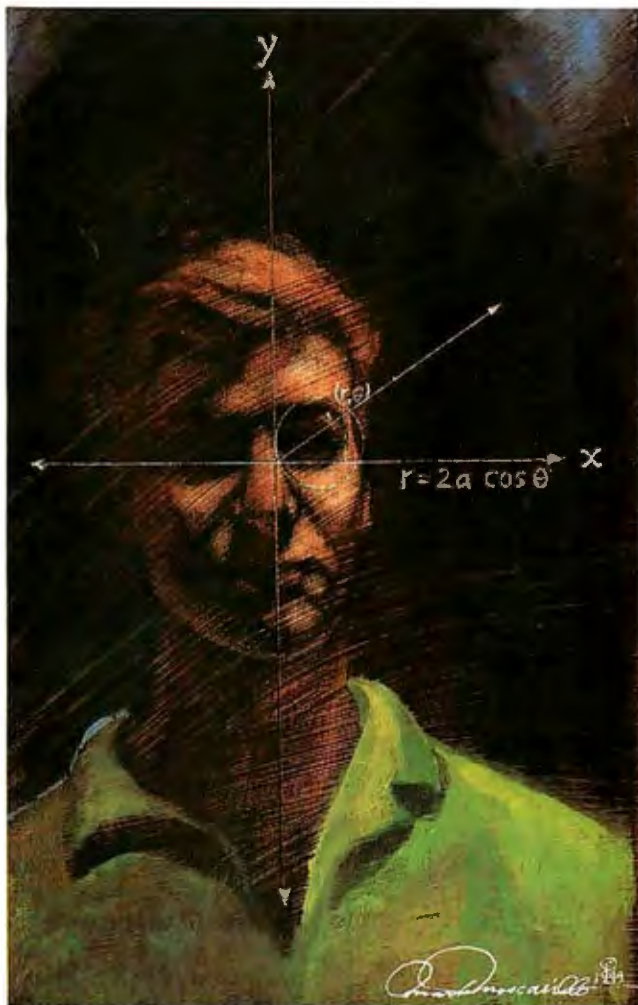

research (although what is intuitive in quantum mechanics, for example, is open to argument). What Descartes provided that was unique was the vision that *this could always be*

made to work; in other words, that you could unravel *any* problem, pure or applied, by following this method. This "revelation" seems to have dated from a series of mystical

dreams that Descartes experienced in 1619 and that provide Davis and Hersh's title.

Descartes had more than a dream to support his optimism. His own research had shown him ways in which problems in geometry could be translated into problems in algebra, hence into numerical calculations. By using geometry to model the physical world, by applying "analytic geometry" to derive algebraic equations, and by solving these equations, you could learn whatever you wanted to know.

The *Discourse* had a very powerful effect on philosophy, logic, science, and mathematics. Fifty years after its appearance came an event that seemed to justify without a doubt Descartes' dream: the publication in 1685 of Newton's *Principia*. Physics and mathematics research, from Newton through Einstein and from Euclid through Hilbert, promised the eventual knowledge of everything. Only in this century, with Godel's theorem and quantum mechanics, have we awakened from this dream of certainty.

The theme for *Descartes' Dream*, then, is the "mathematization" of the modern world, the attempt to apply the tools of mathematics to every facet of our existence. And these tools are not to be taken lightly: algebra, geometry, logic, calculus, probability and statistics, numerical analysis, topology, and . . . computer science. Hersh and Davis devote the first few chapters of their book to a discussion of how and why these techniques came to play roles in our lives. They discuss topics ranging from social structuring to computer dating, from computer art to IQ testing. Their tale is a cautionary one. We

continued

ALSO REVIEWED

Structured Programming Using Turbo BASIC

Programming in ANSI C

Macintosh Family Hardware Reference

Computer Cryptology: Beyond Decoder Rings

Program Design for Knowledge-Based Systems

*Expert Systems in Data Processing:
A Professional's Guide*



MR. BOOKS[®]

asks:

"Did your best friend run off with your wife and your software manuals? And you miss your manuals!" Well, we can help, as we stock the industry's best computer books, and at great discounts!

SAVE UP TO 40% OFF!

No.	BOOK TITLE	PUB.	# OF PAGES	QUAL	GRD.	DISC. PRICE
7266	Build Your Own 80286 IBM Compatible	TAB	208	**		15.93
6090	C Primer Plus, Revised Ed.	SAM	576	**	B/I	21.46
2519	Compl. Hypercard Hndbk 2nd ed	BAN	720	**	I	25.76
5008	Customizing AutoCAD	NRD	560	**	I/A	30.06
5240	dBase III+ Handbook, 2nd Ed.	QUE	519	**	I	17.16
7903	Desktop Publish. w/PageMaker	WLY	289	*		17.16
5002	Inside AutoCAD	NRD	576	**	I	30.06
4300	Inside OS/2	MS	685	***	I/A	17.16
7107	Lotus 1-2-3 Desktop Companion	SYB	976	**	I	19.74
7112	Mastering AutoCAD, 2nd Ed.	SYB	739	**	I	25.76
7114	Mastering Crosstalk XVI	SYB	187	*		14.58
6601	Mastering First Choice	SF	301	**	B	17.24
7012	Mastering Quattro	SYB	576	**		19.32
7023	Mastering Ventura	SYB	547	**	I	19.74
7007	Mastering WordPerfect 5.0	SYB	708	***		18.88
7031	MS-DOS Power User's Gd 2nd Ed	SYB	511	***	I/A	17.16
5255	Norton's Prgmr's Gd to PC&PS/2MS	511	511	***	I	19.74
4249	Prgmr's Gd to PC&PS/2 video sys	MS	544	***	I/A	20.20
4230	Proficient C	MS	512	***	I/A	20.20
2306	Programming in Clipper, 2nd Ed.	AW	728	**		28.32
4279	Programming Windows	MS	852	***	A	21.46
4242	Running MS-DOS, 3rd Ed.	MS	512	**	I	18.59
7053	Understanding dBASE III Plus	SYB	425	***	I	17.78
5282	Using 1-2-3, Special Edition	QUE	905	**	I	20.21
5288	Using Enable, 2nd Ed.	QUE	750	**		19.74
5222	Using WordPerfect, 5.0	QUE	876	**	B/I	18.88
5208	Using WordStar, ver 5.0	QUE	535	**	I	16.30

* GOOD B BEGINNER SHIPPING & HANDLING
 ** VERY GOOD I INTERMEDIATE \$1.60 - 1 BOOK
 *** EXCELLENT A ADVANCED \$1.00 EACH ADD'L BOOK

Call for our 'Catalog on a Disk' of approximately 2,000 of the best computer books, by the best authors in the industry. With mini-reviews of selected titles \$2.50 for shipping & handling.

ORDERS ONLY: 1-800-274-1460; ORDERS ONLY
Questions/Title Searches/Inquiries Call 303-984-2315
MR. BOOKS, INC., 400 N. 7th, New Castle, CO 81647

BOOK REVIEWS

humans are very complex, but we invariably simplify when we try to understand ourselves or our surroundings mathematically. Our computing machines and our science enable us to assign only a few numbers—maybe 1, maybe 1000, maybe 1,000,000—to each of the things we want to study. Even if we assign them correctly, there are almost never enough numbers to describe very important things adequately. Then we compute, average, integrate, take the square root, and end up once again with not enough different numbers to encompass our subject properly. If our scientists and the people they sell their services to would accept this fact humbly and proceed with circumspection and humaneness, all might be well. But that's not the case, as the authors take some care to document.

Descartes' Dream is actually a series of essays, some written for the book and some taken from the authors' lectures, interviews, and other publications. The essays cover a wide range of topics. "Feedback and Control: The Equilibrium Machine" shows how mathematics can model the states of a fairly complicated machine. It also exposes the difficulties of getting both the machine and the model to work correctly in a real-world setting. Another essay, "Mathematics and Rhetoric," points out that even mathematicians sometimes cheat in playing the Cartesian game.

Most of the essays discuss very specific topics relating to mathematics and its applications in the contemporary world. The authors take up the serious charge that success in the study of mathematics is used as a filter to eliminate groups of people from the college or job market. They also have a wonderful example of a physics problem for which half a dozen different pieces of high-powered software yield half a dozen quite different answers. (So much for Star Wars. . .)

The book also contains a fair amount of repetition and some nonsense as well. For example, a "Marxian" analysis of computer professionals as a "class" determined by a "new means of production"—the computer—is a total misinterpretation of what Marx meant by these terms. Actually, he had some penetrating predictions about technology: On one hand, it would be a tool used to increase productivity and to lower wages, and on the other hand, it would provide the levels of production and affluence needed to make a socialist state possible (Marx was hardly a Luddite). In another section of the book, a computer scientist gushes in jargon about microcode, operating systems, compilers, and programs in the context of "meta thinking"—and ends with a flippant toss-off of capitalism and communism; it's a rather tangential excursion.

The authors also seem to devote a lot of space to the concept that mathematics and computers, by assigning numbers to everything, are dehumanizing us and may very well have been an important factor in the Nazi holocaust, among other terrible things. The fact is, mathematics and its applications are created by human beings, who set in motion certain forces and react in turn to them. Mass murder existed before the advent of massive technology. Even when humans were not "reduced to numbers," there was no impediment to torture, murder, and rape—one could always find people to carry out the orders.

Davis and Hersh might more properly have asked why it is that one can always find a scientist or mathematician perfectly willing to work on any sort of project, from the "proof" that some people are genetically inferior to the construction of machines of disease and death. After all, who employs these people, and who determines which of their projects get funded and which

continued

KADAK's
engineers bring
years of practical real-time
experience to this mature

MULTI-TASKING SYSTEM

(version 2.0)

for the IBM® PC, PC/XT and PC/AT

- No royalties
- IBM PC DOS® support
- C language support
- Preemptive scheduler
- Time slicing available
- Source code of the C interface and device drivers is included

- Intertask message passing
- Dynamic operations:
- task create/delete
- task priorities
- memory allocation
- Event Manager
- Semaphore Manager

AMX86™ operates on any 8086/88, 80186/88, 80286 system.

Demo package \$25 US
 Manual only \$75 US
 AMX86 system \$2195 US
 (shipping/handling extra)

KADAK Products Ltd.
 206-1847 W. Broadway
 Vancouver, B.C., Canada
 V6J 1Y5
 Telephone: (604) 734-2796
 Telex: 04-55670

Also available for 8080, Z80, 68000

Compu\$ave

800-877-8855

"Quality Products at Discount Prices since 1985"

BOARDS	COMPUTERS	PLOTTERS	PRINTERS
Advanced Digital Slave 545	Acer 1100 B4 3250	Calcomp 1023GT 3785	Alps Allegro 24 349
Alloy Slave 16 N 605	Acer 20 Mhz CALL	Calcomp 1043 GT 5645	Alps 324 E 745
AST Advantage Premium 299	AST Model 80 1525	Calcomp 1044GT 10,245	Canon BJ 130 665
ATI Rampage 286 - 512k 399	AST Model 300 2777	Calcomp Colormaster 3395	Citizen 120D 149
ATI VGA Wonder CALL	AST Model 340 3999	Houston DMP 52 2399	Citizen 180D 162
BOCA RAM AT 142	AST 3320 6935	Houston DMP 41/42 2110	Citizen MSP 40 312
Genoa VGA HiRes 345	Intel 25 Mhz 3899	Houston DMP 56A 3850	Fujitsu DL3400 525
Intel Above Board Call	Mitsubishi MP286 40Mb 1925	Houston DMP 61 3025	NEC P2200 339
Orchid Tiny Turbo 262	Mitsubishi MP286 Laptop	Houston DMP 62 4249	NEC P5200 515
Orchid Designer 329	w/ 20 Mb Drive 2337	HP 7475 A 1395	NEC P5300 679
Panasonic Fax 642	NEC 386: 2 Mb 2995	HP 7550 A 2895	NEC P9XL 1050
Paradise VGA+ 16 295	NEC EL II 1465	HP 7570 A 3045	Okidata 390 475
Paradise VGA Pro 395	NEC Powermate CALL	HP 7595 7795	Okidata 393 959
STB VGA EM 512K 365	Packard Bell 12 Mhz 1265	Ioline 3700 3065	Panasonic 1080i M2 162
Sigma VGA H 242	Samsung 20 Mhz 2899	Ioline 4000 3995	Panasonic 1091i M2 185
Tops Flashcard CALL	Samsung S500 / 40 Mb 1565	JDL 850 GL 2799	Panasonic 1124 339
Video 7 V RAM 482	Sperry PC IT: 512k/44 M 2795	Roland 885 1095	Panasonic 1524 549
Video 7 Fastwrite 369	Televideo 386 2Mb 2595	Roland 980 1195	Star NX-1000 171
Hercules, Verticom, VMI Western	Toshiba 1000 769	Roland 990 1595	Star NX-1000R Color 299
Digital, Others CALL	Toshiba T1200F 1459	Roland GRX CALL	Star NX-2400 318
	Toshiba T1200HB 2455	Versatec, JDL, Other CALL	Toshiba 321SL 499
	Toshiba 1600 CALL		Toshiba 341SL 635
	Toshiba 3100/20 2995	DIGITIZERS	Toshiba P351SX 965
	Toshiba 3200 3825	Calcomp 12 x 12 348	Canon 811 (Laser) 1565
	Toshiba 5100 4925	Calcomp 44 x 60 3745	NEC LC 890 (Laser) 3165
	Toshiba 5200 CALL	Calcomp 36 x 48 3195	Panasonic Laser Partner 1650
	Wyse 2108 1145	GTCO 24 x 36 1945	HP Laser Jet II SAVE
	Wyse 2112 1659	GTCO 36 x 48 2395	Brother, C.Itoh, Data Products,
	Wyse 2214 CALL	Hitachi 11 x 11 439	Diconix, Epson, Genicom, QMS,
	Wyse 3216 2795	Kurta IS 3 CALL	OTC, Varityper, TI CALL
	Unisys 386 2695	Kurta IS 8.5 x 11 245	
	Zenith Supersport 1625	Kurta IS 12 x 12 309	MONITORS
	Zenith Supersport 286 3475	Kurta IS 12 x 17 535	Amdek 1280 645
	Altos, ITT, Sharp CALL	Summa 12 x 12 + 348	Gold Star TTL 79
		Summa 12 x 18 579	Mitsubishi 1381A 509
	TERMINALS		Mitsubshi 6905TK 2154
	Altos V 485	MODEMS	NEC Multisync II 595
	Adds 1010 299	ATI 2400 ETC. 155	NEC Multisync + 915
	IBM 3151 389	Anchor 2400E 145	NEC Multisync XL 2089
	Kimtron KT-70 PC 359	Avatex 1200 External. 95	NEC Multisync GS 189
	Link MC-5 409	Cardinal 2400 External 139	PGS Ultra Sync 522
	Televideo 905 280	Cardinal 2400 Internal 109	PGS UltraSync 16" 895
	Televideo 955 365	Hayes 1200 279	Seiko 1430 599
	Televideo 965 412	Hayes 2400 415	Samsung TT1 79
	Wyse 30 289	Hayes 2400 B 389	Samtron EGA 359
	Wyse 50 355	Migent Pocket 109	Sigma Laser 19" 1765
	Wyse 60 395	Multitech 224 EH 388	Sony Mutlican 675
	Wyse 85G 379	Multitech 224 EC 305	Tatung Multiscan 475
	Wyse 99GT 469	Practical 12001 65	Wyse 650 VGA 459
	Wyse 150 CALL	Prometheus 2400B/2 129	Wyse 700 678
	Visual, CIE, Qume CALL	Prometheus 2400G 149	Wyse 7190 CALL
		Racal-Vadic 2400VP 388	Zenith 1490 598
		UDS V.32 CALL	
		USR 2400E 345	SCANNERS
		USR Courier 2400 299	Datacube 830 1725
		USR HST 9600 599	Logitech Scan Man 191
		Ven-Tel 2400 (PS/2) 275	Panasonic 505 969
		Zoom 2400 HC 145	PGS LS-300+ OCR 965
		Packard Bell, & Others CALL	PC Hand Scanner & Others Call

HOURS: MON-FRI 7 AM-6 PM, SAT: 9 AM- 2 PM. Mail Address: 4207 S. 37th Street - Dept B1 - Phoenix, AZ 85040

Prices reflect cash discounts and are subject to change without notice. We do not guarantee compatibility. DOA's are replaced or repaired, an RMA is required for any return. Major credit cards and preapproved PO's are accepted. INTERNATIONAL SALES (602)437-4855 - FAX (602)437-9685 - SERVICE (602)437-4856.

International Orders, Bids and Government P.O.'s are Welcome



FORTRAN for the 80386 The Real World Solution

- Supports Intel 80287/80387 & Weitek Coprocessors
- 100% Royalty Free License on Developed Software
- Free DOS Support Library with Source Code
- Accesses up to 16 MBytes of Memory
- Source Level Symbolic Debugging
- Uses 32-bit Instructions

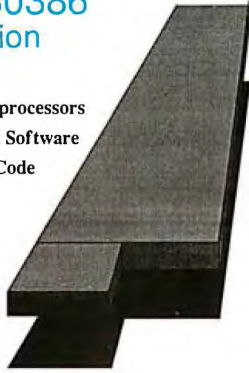

Put the full power of the 80386 into your programs. Using SVS FORTRAN-386 compiler & Phar Lap's 386 Linker you can break DOS's 16-bit instruction and 640K memory limit. With SVS you can cut a typical program's run-time in half, while using up to 16 Megabytes of memory.

Supporting Software Tools: *with Source Code

Scitech Scientific Package (SSP)*
Scitech Plotting Package (SPP)*
Maintainability Analysis Tool (MAT)
MAT analyzes and diagnoses your FORTRAN programs. MAT provides the information you need to make your programs more reliable and easier to maintain.

Prices:

SVS FORTRAN-386.....	\$695
SVS PASCAL-386.....	\$695
Phar Lap-386 ASM/LINK.....	\$495
Scitech Scientific Package.....	\$325
Scitech Plotting Package.....	\$325
Maintainability Analysis Tool.....	\$895

For more information call:
1-800-346-5159
In CA call (415) 960-5931



BOOK REVIEWS

do not? Computers can be used for Star Wars, or they can be used for agriculture. Davis and Hersh perform the admirable task of showing us that mathematics is a human activity, performed by very fallible humans. However, they don't go far enough in pointing out that mathematics doesn't just happen, or happen to us. The whole issue of the economics and politics of science and technology, unfortunately, is left unaddressed.

Whatever its deficiencies in certain areas, *Descartes' Dream* provides a framework for discourse and argument, and it raises, in some form, most of the important issues that we must confront when we apply technology and mathematics to human beings.

After an introductory chapter to familiarize readers with the Turbo BASIC environment, the authors move into lessons describing how to place text and graphics on the computer's screen. This is a refreshingly logical beginning to learning how to write programs. Before they tackle sophisticated algorithms, most programmers just want to be able to see the results of their efforts on-screen. Why more books don't start this way is a mystery.

From learning to master the screen, the lessons move into a discussion of top-down programming using the example of a graphical house. First, you learn to draw the frame, then the roof, and finally the doors and windows. Using graphical examples reinforces the lesson concept visually.

The book continues in this style, using visual examples where possible to illustrate a programming concept.

Structured Programming Using Turbo BASIC is not a comprehensive guide to either BASIC programming or Turbo BASIC. But for the beginning BASIC programmer, it provides a solid foundation on which to build.

—G. Michael Vose

BRIEFLY NOTED

Structured Programming Using Turbo BASIC by Wade Ellis Jr. and Ed Lodi, Academic Press, San Diego, CA: 1988, 337 pages, \$23.95. The Educational Testing Service was recently petitioned by a group including the inventors of BASIC to provide BASIC as well as Pascal versions of the Computer Programming Aptitude Test. The group believes that BASIC is as well-suited a language for students to learn proper programming technique as Pascal.

Authors Ellis and Lodi prove the point that BASIC programs can be well structured, readable, and maintainable. Their book serves as an introduction to BASIC programming but follows the tenets of structured programming technique from beginning to end.

An educated layperson or a student in a formal classroom setting can use *Structured Programming Using Turbo BASIC*. It is liberally sprinkled with exercises for the reader to solve; the solutions can be found in an appendix if you get stuck. An optional companion disk contains all the book's sample code.

Programming in ANSI C by Stephen G. Kochan, Hayden Books/Howard W. Sams & Co., Indianapolis, IN: 1988, 468 pages, \$24.95. Now that an ANSI standard for the C programming language is imminent, books on C will need to follow the standard conventions in describing C programming technique. Stephen G. Kochan vaults to the head of the ANSI-conforming pack with this revision of his 1984 book, *Programming in C*.

With 17 chapters roughly corresponding to the earlier volume, Kochan's book is suitable for a beginning programmer or someone new to C. Kochan thoroughly explains every C operation needed to write a nontrivial program, along with an easy-

continued

Nobody Beats Our Printer Ribbon Prices!

We Meet Or Beat ANY Published Price With A Money-Back Guarantee!

Anadex 9500, 9625B.....	\$3.60	NEC P2200.....	5.50
Apple Imagewriter Nylon.....	2.95	NEC PC8000, PC8023A Nylon.....	2.95
Apple Imagewriter 4-color.....	9.95	Okidata 292... 4.85 292 4-color... 10.50	
Brother 1409.....	4.50	Okidata 293/294.....	5.60
Brother 1509/1709.....	5.50	Okidata 293/294—4-color.....	15.50
Canon AI200, A40, A50, PW250.....	4.50	Okidata 390.....	3.75
Centronics 700 Series—Cartridge.....	4.50	Okidata 393.....	15.15
Citizen MSP10, MSP20.....	2.50	Panasonic KXP 1090/1091/1092.....	4.90
Citizen MSP15, MSP25.....	3.50	Panasonic KXP 11093.....	2.95
Citizen 120D.....	4.50	Panasonic 1524.....	6.95
Cloeco Adam.....	7.95	QUME 4 Sprint 7/8/9/10/11/LQ50.....	2.95
Commodore MPS801.....	3.50	Radio Shack DMP400.....	2.95
Comrex 420, Comwriter 420.....	6.90	Seikosha SP-800/1000.....	3.75
C. ITOH 3500.....	25.00	Seikosha 5300.....	18.95
C. ITOH Prowriter Jr.....	5.95	Star NX1000.....	4.25
DEC LA34, LA38, LA100.....	Just 2.95	Toshiba 1350, 1351, 321, 341, 351.....	3.10
Diablo HyType II.....	2.95	Toshiba 321SL.....	4.95
EPSON MX80.....	2.50	Xerox 850/860.....	3.00 630..... 2.95
EPSON LX80.....	2.50		
EPSON LQ1500.....	2.95		
EPSON EX-1000, EX-800.....	4.20		
EPSON EX-800/EX-1000 4-color.....	15.95		
EPSON FX100, FX286, MX100.....	3.50		
EPSON LX80, LX86, LX90.....	2.50		
Fujitsu 3400.....	7.95		
Fujitsu DPMG/DPL9, DX2100/2200.....	3.95		
IBM 4202, Proprinter XL.....	4.50		
IBM 4201, Prowriter, Proprinter.....	3.75		
Mannesmann/Talley 100 Thru 160.....	3.00		
Mannesmann/Talley MT 85.....	3.95		
Mannesmann/Talley Sprint 80.....	3.50		
NEC Pinwriter P-5.....	3.95		
NEC 2000/3500 Flip M/S.....	5.25		
NEC Pinwriter P1/P2/P16.....	3.60		

PLUS HUNDREDS MORE...
MOST AVAILABLE IN 4-COLOR!

1-800-327-1013

Mr. Megabyte's American Ribbon Co.
1041 W. Commercial Blvd.
Ft. Lauderdale, FL 33309

VISA MasterCard AMEX
FREE With Order Of 12-
Your Choice Of Printer Cover
OR Free Shipping*

*Based on prices listed. Subject to change without notice. Copyright 1988, American Ribbon Co., Inc.

Hands down, the best selling most compatible graphics tablet you can buy.

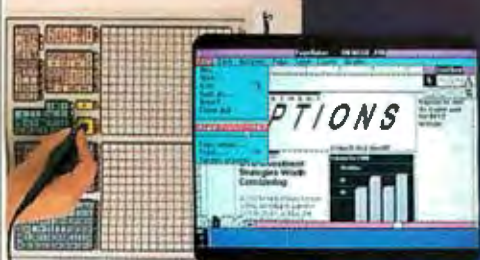

Desktop Publishing

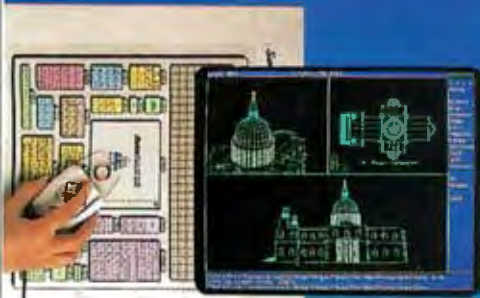

CAD



Universal Mouse Emulator™



Drawing / Tracing

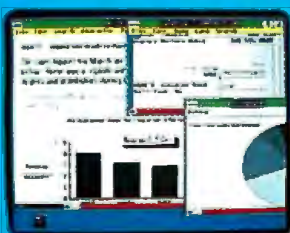

Microsoft® Windows

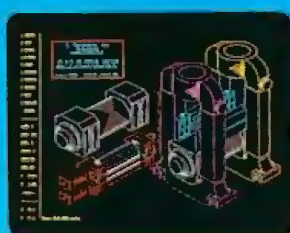

CAM



CAE

SummaSketch® is the world's best selling tablet because it's filled with "Plus's": Like full IBM connectivity with the PC, AT and PS/2. Plus full Microsoft® compatibility through a Universal Mouse Emulator™. Plus a separate tablet driver for Microsoft Windows. Plus a two-year warranty. Add that to our standard features — like high resolution and accuracy with the most software compatibility — and you have the tablet with all the Plus's. The 12" × 12" SummaSketch Plus.

New 18" × 12" Version. Now you can get all these great features in our larger SummaSketch® Professional tablet. All the Plus's, plus more active area to work with!

Summagraphics®

Seymour, CT 06483 • (203) 881-5400

Circle 358 on Reader Service Card

FREE! \$245 TEMPLATE.

Your choice AutoCAD®, VersaCAD®, CADKEY® or Microsoft® Windows tablet template, free. Details inside SummaSketch Plus and SummaSketch Professional boxes.

Send me more information on the AutoEase template offer and on SummaSketch tablets.

Type of industry: _____
Type of application: _____
 I'm interested in OEM information.

Name: _____ Title: _____

Company: _____

Address: _____

City: _____ State: _____ Zip: _____

Mail to: Summagraphics Corporation

60 Silvermine Road
Seymour, CT 06483

© 1988 Summagraphics Corporation. All rights reserved.

Q Why Should I Purchase the SIVA 286/386 System?

Complete 8, 12, 16 and 20 MHz Systems with*

SIVA Systems from VNS America Corp. delivers the uncompromising power you want, plus the hardware/software products you need. Promptly. Courteously.

Enjoy the AT®-compatibility, speed and future upgradeability you would expect from up-to-date premium quality computers. And, enjoy the fast service so many have come to appreciate from VNS America Corp.

About VNS America Corp.

VNS America Corp. and its associate companies pool their expertise and buying power to bring you premium, name brand products at breakthrough prices.

We're bold, colorful and innovative. We have to be to gain your attention in this ultra-competitive industry. But, our products and service are first rate because we need your confidence to succeed.

IBM set the standard... we're just making it affordable to thousands of companies, individuals and industry that want quality at the best prices.

TRY US

Call 1-800-252-4212

VNS America Corp.

Suite 270, 910 Boston Post Road
Marlboro, Massachusetts 01752 U.S.A.
In Massachusetts 508-481-3726
FAX: 508-481-2218

The Powerful SIVA 386 System

Standard 386 Features:

- 32-bit Intel 80386-16 CPU.
- 1MB of 32-bit RAM on board. System expandable to 16MB.
- 8/16/20 MHz Keyboard selectable.
- ST-251-1 Seagate 40MB Formatted 28 ms high speed, with ultra high speed Controller 1:1 interleave.
- 1.2MB High Capacity Floppy Drive.
- Super deluxe heavy duty tower case with 6 half-height drive openings.
- High-resolution 12" Non-Glare Amber Display. Tilt and Swivel base, Hercules-compatible Adapter.
- 101 Key Enhanced Keyboard, Pleasant "Tactile/Click" Feel.
- 80287/387 Math-Coprocessors optional.
- Fully compatible with virtually all XT/AT and 386 software.

\$2495

Upgrades for your 386 System:

- VGA Color Upgrade - add only \$495.
- 20 MHz CPU Upgrade - add only \$195.
- Call for all other options and upgrades.



A You will experience unmatched performance using our hardware/software products. And, you will benefit from breakthrough pricing from VNS America Corp.

Premium Name Brand Peripherals and Software!



The Economical SIVA 286

A Complete 12 MHz High-Speed SIVA 286 System with 40MB (28MS-ST251-1) Hard Disk

Complete System Features:

- 80286 CPU, 8/12.5 MHz Dual Speed, Keyboard Selectable
- High-Speed RAM, 512K Expandable to 4MB on the Motherboard (16MB System Total)
- Phoenix BIOS
- 40MB Hard Drive, 1.2MB Floppy Drive
- Ultra High-Speed/Floppy,/Hard Disk Controller 1:1 Interleave, 800KB/Sec Transfer Rate
- High Resolution 12" Amber Display with Tilt and Swivel Base, Compatible Graphics Controller
- Full 101-Key Enhanced Keyboard, Pleasant Tactile/Click Feel
- Two Serial and One Parallel Printer Ports and One Mouse Port
 - 3-16 Bit and 1-8 Bit Free Expansion Slots
 - Clock Calendar with 10-Year Life Battery Backup
 - 80287 Support, up to 12 MHz
 - Meets FCC Requirements

\$1295

Standard System Including all Standard Features except Hard Disk \$995

Lowest Cost Compilable Upgrader

- Additional 512K Memory for \$195.
- 1.5MB Additional Memory for \$395.
- EGA Upgrade for \$295.

Nine Reasons to Call VNS America Now...

- Produced by High Technology Manufacturing Processes
- FullySurface Mounted Technology
- EGA Controller Standard
- Supports 3.5" and 5.25" Floppy Disks
- 10-Year Battery Life
- Phoenix BIOS
- No Memory Surcharge (We're not opportunists!)
- Same Day Shipment (Competitors often take 4-6 weeks.)
- 100% Compatible with Your Budget

**Complete: includes 12 MHz high-speed SIVA 286 System with 40 MB hard disk drive, monitor and keyboard.*

VNS America Corp.

**Order Now Toll-Free
1-800-252-4212**

**Complete unit includes CPU, monitor, keyboard and 40 MB hard disk drive.*

Circle 293 on Reader Service Card

Want to save Time, Money,
& Headaches?

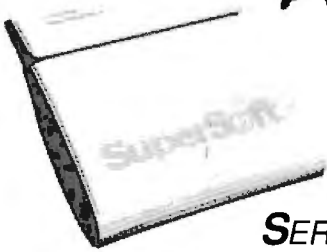

GET SUPERSOFT'S
SERVICE DIAGNOSTICS

All the software, alignment diskettes, parallel/serial wrap-around plugs, ROM POSTs and extensive, professional documentation to provide the most comprehensive testing available for IBM PCs, XTs, ATs and all compatibles under DOS or Stand Alone. No other diagnostics offers such in-depth testing on as many different types of equipment by isolating problems to the board and chip level.

NEW: SuperSoft's ROM POST performs the most advanced Power-on-Self-Test available for system boards that are compatible with the IBM ROM BIOS. It works even in circumstances when the Service Diagnostics diskette cannot be loaded.

NEW: 386 diagnostics for hybrids and PS/2s!

For over nine years, major manufacturers have been relying on SuperSoft's diagnostics software to help them and their customers repair microcomputers. End users have been relying on SuperSoft's Diagnostics II for the most thorough hardware error isolation available. Now versions of Service Diagnostics are available to save everyone (including every serious repair technician) time, money, and headaches in fixing their computers, even non-IBM equipment.

All CPUs & Numeric Co-processors	All Color Graphics & Monochrome Monitors
System Expansion & Extended Memory	Parallel & Serial Ports
Floppy, Fixed & Non-standard Disk Drives	Mono, CGA, Hercules & EGA
Standard & Non-standard Printers	Adapters
System Board: DMA, Timers, Interrupt, Real-time Clock & CMOS config. RAM	All Keyboards & the 8042 Controller

Join the ranks of XEROX, NCR, CDC, SONY, PRIME, ... who have bundled SuperSoft's diagnostics with their microcomputers at no risk because of our 30 day money back guarantee.

Service Diagnostics for PC, PC/XT, and compatibles only.	\$169
Alignment Diskette for PC, PC/XT and compatibles (48 tpi drives).	\$ 50
Wrap-around Plug for PC, PC/XT and compatibles (parallel and serial).	\$ 30
Service Diagnostics for AT and compatibles only.	\$169
Alignment Diskette for AT and compatibles (96 tpi drives).	\$ 50
Wrap-around Plug for AT (serial).	\$ 15
ROM POST for PC, PC/XT and compatible	\$245
ROM POST for AT and compatibles only.	\$245
Service Diagnostics: The KIT (Includes all of the above—save \$502).	\$495
Service Diagnostics for 386 or V2, V30, or Harris, etc. (please specify)	\$195
Diagnostics II is the solution to the service problems of users of all	
CP/M-80, CP/M-86 and MS-DOS computers.	\$125
ROM POST for PS/2 and compatibles only.	\$245
Alignment Diskette for PS/2 and compatibles (3.5 inch).	\$ 50

To order, call 800-678-3600 or 408-745-0234
FAX 408-745-0231, or write SuperSoft.

your microcomputer repair solution

SuperSoft

FIRST IN SOFTWARE TECHNOLOGY P.O. Box 611328, San Jose, CA 95161-1328 (408) 745-0234 Telex 270365

SUPERSOFT is a registered trademark of SuperSoft, Inc.; CDC of Control Data Corp.; IBM PC, AT & XT of International Business Machines Corp.; MS-DOS of MicroSoft Corp.; NEC of NEC Information Systems, Inc.; PRIME of PRIME INC.; Sony of Sony Corp.

to-understand programming example. His lucid explanations of how to perform an operation detail both C keywords and the library functions you need to accomplish a programming task.

All this explanatory material follows the conventions of the ANSI standard. New C programmers using this book to learn the language will therefore automatically use function prototypes, for example, and will understand new ANSI-standard datamodifiers like const, signed, and volatile.

Of course, a consequence of this learned ANSI style may be confusion when a student uses a nonconforming compiler. To help in this situation, Kochan provides an appendix that describes the differences between ANSI C and "old" C. The organization of this appendix matches that of an earlier appendix that describes the ANSI version of the language. So, if you try to use the escape character `\x` to display a hexadecimal number and get a compiler error, you can quickly discover just what syntax is unacceptable to your current compiler.

Another useful appendix describes the standard C library. Although the functions are described only briefly, they are grouped logically—into math functions, dynamic memory allocation functions, I/O functions, and the like—to help you find the library routines you need for a given programming problem.

All in all, *Programming in ANSI C* is a solid and useful volume. —G. Michael Vose

Macintosh Family Hardware Reference by Apple Computer Staff, Addison-Wesley, Reading, MA: 1988, 304 pages, \$26.95 (hardcover). The only hardware folk who will be disappointed with this book will be the ones looking for detailed schematic diagrams of Macintoshes. While block diagrams of various circuits abound, Apple has not put a wiring and parts dia-

gram in here. Pin-outs of the external connectors are provided, though, along with explanations of what the pin-outs mean.

Each of the various Macintoshes (classic, SE, and II) is clearly explained on a subsystem basis (e.g., versatile interface adapters). The writing is crisp, and the organization of topics well thought out. The authors explain the actions and interrelations of the hardware in a no-nonsense manner that flows well from one numbered section to another. They clearly define the signals used in each subsystem and explain their expected values at relevant times.

I highly recommend this book to anyone involved with Macintosh hardware—and to the merely curious as well. It does a fine job of explaining the intricacies of the Mac in a way that does not require an advanced degree in electronics to understand.

—Larry Loeb

Computer Cryptology: Beyond Decoder Rings by Karl Andreassen, Prentice Hall, Englewood Cliffs, NJ: 1988, 268 pages, \$24.95. Before the data encryption standard, public-key cryptography, and zero knowledge proofs, most of cryptography was simpler and not so mathematical. These systems from earlier days are by no means obsolete, and Karl Andreassen's book shows how to use a computer programmed in BASIC to make and break such ciphers. Not to be too presumptuous, Andreassen refers to the field as "amateur cryptography."

The book's main emphasis is on describing such well-known methods as substitution, Vignere, and transposition. BASIC programs are provided for generating each of these, followed by suggestions on ways to break them—what statistical patterns arise from each method and how studying such patterns can provide a hidden prying tool for breaking the cipher. Sev-

continued

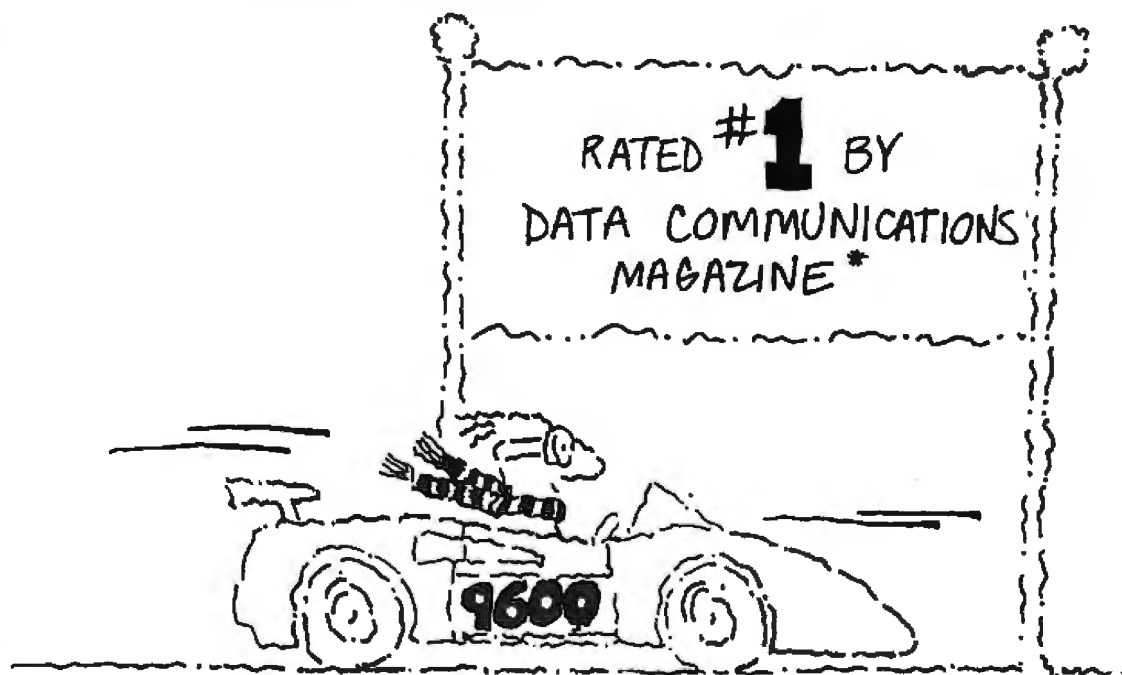

At 17,400 bps and under \$1,000... The new champion is Courier HST.™

The race belongs to the swift and that's why USRobotics' Courier HST is "the champion".

In race after race among high speed modems, the Courier HST outperforms the high-priced competition.

The writers at *Data Communications* and the independent testing laboratory, Telequality Associates, concluded in their head-to-head modem test:

"The USRobotics Courier HST modem, the least expensive of all the modems tested, outperformed all the pseudo-duplex modems on the line simulation tests..."

And *PC Magazine* calls the Courier HST, "the top price-performance ratio at 9,600 bps."



USRobotics:

The secret to our success?

Partly, it's our innovative V.32 asymmetrical data pump with MNP™ Level 5 data compression delivering 17,400 bps... *saving you money on phone line charges.*

Partly, it's our unique automatic fall-back/fall-forward which assures you the fastest speed possible.

But there's even more to being "the champion" than that.

Mostly, it's the security you get from knowing you are buying the #1 rated modem.

If you are considering trading in your current modem for a high speed modem, don't get left in the dust.

Get the new champion—**Courier HST.**

Call 1-800-DIAL-USR

In Illinois (312) 982-5001

USRobotics®

The Intelligent Choice in Data Communications

8100 North McCormick Boulevard, Skokie, Illinois 60076.

*Rated first by *Data Communications* under frequently encountered line conditions. *Data Communications*, May 1988.

USRobotics, Courier and HST are trademarks of U.S. Robotics, Inc. Other computer and software names identified by ® or ™ are tradenames and/or trademarks of their respective manufacturers.

For sales in the United Kingdom, please call Maricom, Ltd., Ipswich, England. Telephone: 0473 233888.



THE INCREMENTAL ASSEMBLER DEVELOPMENT ENVIRONMENT

a Revolution in Assembler Programming

A complete, integrated macro assembler development environment for the 8086 family of processors under DOS. Including a powerful window-oriented source debugger, syntax checking editor, fast linker, and the FIRST INCREMENTAL ASSEMBLER.

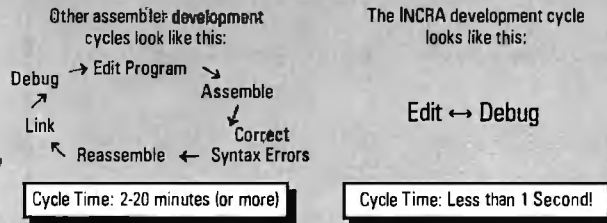

With other systems, the development cycle for large programs can take several minutes involving a lot of tedious hopping from one program to another. The INCRA Assembly development environment is completely integrated, everything you need to develop assembler programs or routines for programs in other languages, is available at the touch of a key. With INCRA you go from program entry and editing to debugging instantly because the INCRA assembler is INCREMENTAL. It updates the executable code as soon as you change the source - in milliseconds. And the powerful INCRA debug window is always available at the push of a key to trace through the program. If you find a mistake, just flip to the editor and correct it, then flip to the debugger and continue testing.

The INCRA editor checks your assembler syntax as you enter, giving intelligent error messages that make it clear what was wrong and how to fix it - you never

have to worry about waiting 5 minutes for a program to assemble, only to find you have to do it all over because you forgot to put in a comma! INCRA also contains a fast, integrated linker that can quickly pull in procedures from other modules and libraries at the push of a button. The INCRA incremental assembler works just as well on linked programs as on single modules, so you can develop large, multi-module programs, and mixed language programs without constantly relinking. And with INCRA, macros expand as soon as you enter them, no need to wait for assembly to see if the macro expanded the way you thought it would! If there's a mistake, just edit the macro call, and the macro will immediately reflect the changes.

If you're a serious programmer working with assembler, INCRA's power and speed will make your life easier. If you're just learning assembler, INCRA's ease of use will make it exciting and fun!

\$180.00 u.s.

DEMO DISK \$5.00 (DEDUCTIBLE FROM PURCHASE PRICE)

If you do any assembler programming at all...

Incra is the tool to use.

Incremental Assembler

- ☆ Complete macro assembler
- ☆ Supports 8086/88, 80186, 80286, 8087, 80287
- ☆ Also operates in batch mode (faster than MASM 5.0)
- ☆ Compatible with MASM 5.0 (will assemble most MASM 5.0 programs without changes)

Editor

- ☆ Full Screen, fully featured
- ☆ Syntax checking
- ☆ Automatic INCREMENTAL assembly
- ☆ Customizable Options
- ☆ Unique line buffer for moving and re-ordering lines
- ☆ Super fast search and page
- ☆ Instantly generates .exe and .obj files
- ☆ Template program files
- ☆ Lots more!

Debugger

- ☆ Window-oriented - see all data, registers, flags, and executing source lines (with comments) at a glance
- ☆ Fully symbolic (no need to declare publics)

- ☆ Single step, multiple breakpoints, conditional breakpoints, check-trace
 - ☆ Highlights changes to registers flags & data at each step
 - ☆ Powerful symbolic data display options
 - ☆ Save and restore data display definitions
 - ☆ Disassemble with symbolic names
 - ☆ Flip to and from your program's display screen
 - ☆ 8087 Window
- Linker**
- ☆ Faster than MASM 5.0
 - ☆ Link .incra files, regular .obj files, and libraries

Macros

- ☆ Full macro capabilities
- ☆ Macros can be instantly expanded in the editor to inspect resulting source
- ☆ Full conditional assembly is supported

Calculator

- ☆ Available at all times
- ☆ Complete set of arithmetic and logical operations

- ☆ All program constant and offset values are available as operands
- ☆ Hex, decimal, octal, binary, ascii results and operands accepted

Options

- ☆ Change environment features such as screen colors, cursor type, tabs, processor type, etc.
- ☆ Save options permanently

Help

- ☆ Pop-up command descriptions available at all times

To order: Call (U.S. or Canada)

1-800-263-5645

or send check or money order to:



25 Warrender Ave., Suite 909
Islington, Ontario Canada
M9B 5Z4
(dealer inquiries welcome)
(416) 234-9347

eral programs are listed that automate the process of gathering the necessary statistical information.

Computer Cryptology: Beyond Decoder Rings makes a good introduction for people who might enjoy recreational cryptography and cryptanalysis. —Peter Wayner

Program Design for Knowledge-Based Systems by *Graham Winstanley*, Halsted Press, New York: 1987, 226 pages, \$29.95. This concise book shows how to develop a knowledge-based system with Lisp as the implementation language. Using a mixture of formal design and rapid prototyping techniques, Graham Winstanley guides the reader from initial concepts and definitions to the development of a complete rule-based expert system. The latter chapters deal with the user interface, testing, and debugging, along with various alternative strategies, their usage, and implications. Winstanley also discusses peripheral issues of the hardware requirements.

Program Design for Knowledge-Based Systems will be useful to programmers who need to upgrade their skills from a more conventional environment. It will also be a valuable reference for system designers with some computing experience who are interested in the new field of knowledge engineering based exclusively on Lisp. In addition to providing a solid foundation in Lisp programming, the book includes details of how to design interfaces, specific examples of expert-system development, and a unique treatment of embedded expert systems. The author is a senior lecturer in electronics and computing at Brighton Polytechnic in England.

—Dong H. Kim ■

is an outstanding introduction to what artificial intelligence in the form of expert systems can accomplish in various data-processing fields. The authors include many examples of how several companies, both large and small, have used the latest advances in expert systems in personnel cost reduction and risk assessment, thus gaining a competitive edge in marketing and sales. After surveying the expert systems that are in current use, they discuss the best ways to choose the profitable area of expert-system application and to avoid many possible mistakes and pitfalls. They also show how to assemble the best team for various applications.

Available programming languages, such as Lisp and Prolog, are also discussed adequately in chapter 5. The next two chapters deal with expert-system shells and how the knowledge engineer should go about choosing tools. After discussing IBM ESE (Expert System Environment) in chapter 9, the authors devote the rest of the book to the actual design and hardware requirements of an expert system.

Expert Systems in Data Processing is well organized and illustrated, and it's written in an easy-to-read, relaxed style with numerous fully coded examples of the many techniques the authors present.

CONTRIBUTORS

Mark Bridger, a professor of mathematics at Northeastern University, lives in Newton Upper Falls, Massachusetts. **G. Michael Vose** is coeditor of *OS Report: News and Views on OS/2*. He lives in Peterborough, New Hampshire. **Larry Loeb** is an engineer-turned-dental-surgeon who lives in Wallingford, Connecticut. **Peter Wayner** is a graduate student in computer science at Cornell University in Ithaca, New York. **Dong H. Kim**, a researcher and consultant, lives in Chapel Hill, North Carolina.

Expert Systems in Data Processing: A Professional's Guide by *Jerome T. Murray and Marilyn J. Murray*, McGraw-Hill, New York: 1988, 237 pages, \$34.95. This

**LAST CHANCE AT
\$99.95**

Expires Feb. 1st
Regular price \$149.95.



WALTER BRIGHT – Programmer

“This is a revolutionary product which reflects the fact that Walter Bright is one of the world’s best programmers.”

Andy Redfern, Personal Computer World

“I find it amazing that Walter continues to find ways to improve his already excellent product.”

Scott Robert Ladd, Micro Cornucopia

C++
FROM ZORTECH INC.

C is great! C++ is better!!

Performance benchmarks

Benchmark	Zortech C	Zortech C++	Turbo C 1.5	Quick C 1.0
Sieve	20.49	20.54	23.62	22.72
Rsieve	20.49	20.54	23.62	22.03
Integer	1.32	1.38	6.31	6.49
Float	0.17	0.22	52.29	51.03
*Float	32.73	37.74	52.39	51.63
Pointer	17.91	17.96	17.13	16.87
Rpointer	17.79	17.91	17.14	16.64
Loop	3.90	3.90	3.90	3.90
Optimize	0.49	0.60	8.46	8.79

Benchmarks were run on an 80286 based IBM compatible at 6Mhz with no 8087.

*The float benchmark was re-run without optimization.

Zortech C++ is the first native-code C++ compiler for MS-DOS compatible machines. This means you don't need to spend a lot of money on a C compiler. In fact, Zortech C++ comes with a C++ compiler, a C compiler, a linker, a librarian, a fully integrated editing environment, context sensitive help and the fastest graphics library you've ever seen!

With Zortech C++, you can mix and match code in C++, C and assembler and link them all together with a single command!

Zortech C++ comes with a complete C++ and C library, including compatibility with the ANSI C draft. Unique to Zortech C++ is support for mice, fast screen writes, re-entrant floating point and speaker support.

Now you can move your Microsoft and Turbo C code over to Zortech C++ – we've included compatible library functions! Also, we have made Zortech C++ compatible with Microsoft's Codeview debugger!

Enter the world of Object Oriented Programming (oops) with Zortech C++!

Sure, C is great – but C++ is better!

NOW AVAILABLE...

Std. Library Source Code

Only \$49.95 * (with C++ Purchase)



YES!

Rush me:

Zortech C++
99.95*

Library Source
\$49.95*

Intro to OOP and C++
\$27.95*

The C++ Programming Language
\$29.95

VISA/MC/COD CHECK ACCEPTED



ZORTECH

Name.....

Address.....

Phone.....

VISA or MC#..... Exp. date.....

To: ZORTECH INC. 366 Massachusetts Ave., Arlington, MA 02174. Tel: 617-646-6703. Fax: 617-643-7969.

CALL THE ORDER HOTLINE 1-800-848-8408

* Please add \$5.05 shipping to your order (UPS Ground)

Programmer's Paradise Stocks *over*



WE'LL MATCH NATIONALLY ADVERTISED PRICES.

	LIST OURS		LIST OURS
ASSEMBLY LANGUAGE		Greenleaf Makeform	125 90
Advantage Disassembler	295 279	HI-SCREEN XL	149 129
MS Macro Assembler	150 99	JAM	750 684
OPTASM	125 105	JYACC FORMAKER	495 453
SOURCER	100 89	PANEL Plus	495 395
w/ BIOS SOURCE	140 125	PANEL/QC	129 99
Turbo Assembler/Debugger	150 105	PANEL/TC	129 99
Visible Computer: 80286	100 89	Vitamin C	225 162
		VCScreen	149 109
BASIC		Windows for C	195 169
db/LIB	139 121	w/Source	390 332
GraphPak Professional	149 127	Windows for Data	295 259
Facelt	99 90	w/Source Code	590 479
MS BASIC/6.0	295 199		
MS QuickBASIC 4.5	99 69	COBOL LANGUAGE	
QuickPak Professional	149 129	Micro Focus COBOL/2	900 733
QuickWindows	79 70	Micro Focus COBOL/2 Toolset	900 733
w/Source	99 90	PC-CICS	149 121
QuickWindows Advanced	139 125	Personal COBOL	900 599
Quick-Tools	130 111	Microsoft COBOL 3.0	995 799
True BASIC	100 80	w/RealMENU	1145 929
Turbo Basic	100 69	RM/COBOL	950 763
SoftCode	79 69		
		COMMUNICATIONS	
C LANGUAGE		Carbon Copy Plus	195 135
ADVANTAGE C + +	495 479	Close-Up (Support)	245 222
C-terp	298 232	Close-Up (Customer)	195 116
Lattice C	450 289	Co/Session (2 user license)	249 227
Microsoft C	450 299	Support	175 157
QuickC	99 69	Application	125 116
w/serial mouse	249 149	RELAY Gold	250 229
RUN/C Professional	250 159	RELAY Silver	150 139
Turbo C v. 2.0	150 105	SideTalk	120 90
Turbo C v. 2.0 Professional	250 175		
Watcom C	295 269	dBASE LANGUAGE	
Zortech C + +	100 90	CLARION	695 599
		Clipper	695 439
C LIBRARIES/UTILITIES		Clear	100 90
C ASYNCH MANAGER	175 137	w/ Laser & 24 pin option	150 129
C TOOLS PLUS/5.0	129 99	dBASE III Plus	695 399
C Utility Library	199 129	dBASE IV	695 399
Essential Communications	185 119	dBASE Graphics for C	90 69
Greenleaf Comm Library	229 169	dBASE ON LINE	69 60
Greenleaf Functions	209 155	dBASE Programmers Utilities	90 79
Greenleaf SuperFunctions	265 189	dBASE Tools for C	90 69
Greenleaf TurboFunctions	109 79	dBASE Tools for Pascal	90 69
PC-lint	139 101	dBFAST	100 75
TimeSlicer	295 279	DEBUG	195 179
w/source	1000 899	dQUERY	150 129
Turbo C TOOLS	129 99	FoxBASE+	395 249
		Flipper	195 182
C GRAPHICS		Genifer	395 259
Essential Graphics	299 219	Integrated Dev. Library	149 135
w/source	595 499	QuickSilver	599 369
GraphiC	395 322	R: Base for DOS	725 529
GSS Graphic Dev. Toolkit	495 409	R & R	150 129
HALO '88	325 229	w/ Clipper/FoxBASE module	199 179
HALO '88 for MS Devel.	595 399	Say What!	50 45
MetaWINDOW	195 162	Scrimage	CALL CALL
MetaWINDOW/PLUS	275 232	SilverComm Library	150 139
TurboHALO	100 80	The Documentor	295 229
		Tom Rettig's HELP	120 CALL
C SCREENS/WINDOWS		Tom Rettig's Library	100 80
C-Scape	299 282	UI Programmer	295 229
C Windows Toolkit	100 90	XDB-SQL	495 419
Greenleaf DataWindows	295 209		

DEBUGGERS

386 DEBUG	195 145
Advanced Trace 86	175 121
Periscope I/512 K	795 636
Periscope II	175 141
Periscope IIX	145 106
Perscope III 10 MHz	1395 1195
Trapper	150 CALL

DESKTOP PUBLISHING

HALO DPE	195 162
MKS SQPS	495 420
Pagemaker	695 532
Ventura Publisher	895 554

DISK/DOS UTILITIES

Command Plus	90 70
Command Tips	90 80
Disk Optimizer	60 55
FANSI CONSOLE	75 66
FASTBACK Plus	189 142
hTest hFormat	90 80
MACE Utilities	99 90
MKS Toolkit	199 169
Norton Commander	89 56
Norton Guides	100 75
Norton Utilities	100 61
Norton Utilities, Adv. Ver.	150 101
Pathfinder	70 65
PC/Tools Deluxe	80 70
Vcache	50 47
Vfeature	80 75
Vfeature Deluxe	120 111
Vopt	50 47
Xtree	70 60
Xtree Pro	129 111

EDITORS

BRIEF	195 CALL
EDIX	195 169
EMACS	295 268
Epsilon	195 151
KEDIT	150 120
MKS VI	149 127
Multi-Edit	99 90
Norton Editor	75 70
PC/EDT +	295 269
Pi Editor	195 155
SPF/PC	245 185
VEDIT PLUS	185 115

FILE MANAGEMENT

Btrieve	245 185
Xtrieve	245 189
Report Option	145 109
Btrieve/N	595 455
Xtrieve/N	595 459
Report Option/N	345 279
CBTREE	159 141
c-tree	395 318
d-tree	495 395
r-tree	295 241
c-tree/r-tree bundle	650 523
CQL Query System	395 332
DBC III	250 CALL
DBC III PLUS	750 CALL
db-RETRIEVE	395 322
db-FILE	395 322
FABS Plus	195 172
Informix ESQL/C	595 535
Informix 4GL	995 895
Informix SQL	795 715
XQL	795 599

FORTRAN COMPILERS

F77L	477 429
Lahey Personal FORTRAN 77	95 89
MS FORTRAN	450 299
RM/FORTRAN	595 479

FORTRAN LIB/UTILITIES

DIAGRAM'er	129 116
DOCUMENT'ER	129 116
Grafmatic	135 119
Plotmatic	135 119
Spindrift Library	149 135
Tekmar Graphics Library	195 169

MODULA-2

JPI Top Speed Modula-2	100 90
LOGITECH Modula-2	
Development System	249 199
Stony Brook Modula-2	
Development Package	345 309

OBJECT-ORIENTED PROGRAMMING

ACTOR	495 423
ADVANTAGE C + +	495 479
Smalltalk/V	100 85
Communications	50 45
EGA/VGA Color Ext.	50 45
Goodies #1, #2 or #3	50 45
Smalltalk/V286	200 169

OPERATING SYSTEMS

Concurrent DOS 386	395 349
Microport:	
System V/AT (complete)	649 549
AT Runtime System	249 209
286 DOS Merge	249 209

LIST OURS

195 145	
175 121	
795 636	
175 141	
145 106	
1395 1195	
150 CALL	

SCO:

XENIX Sys V (comp.)	1295 999
Operating System	595 479

WENDIN:

Operating System Toolbox	99 80
PCNX	99 80
PCVMS	99 80
Wendin-DOS	139 109

OS/2 DEVELOPMENT TOOLS

Btrieve for OS/2	595 455
Epsilon for OS/2	195 151
Greenleaf DataWindows	395 CALL
GSS Dev. Toolkit for OS/2	175 139
LOGITECH Modula-2	349 279
MS Languages	CALL CALL
Panel Plus for OS/2	89 80
Rbase for OS/2	895 CALL
Vitamin C (OS/2)	345 279
Windows for C (OS/2)	295 CALL
Windows for Data (OS/2)	395 CALL

PASCAL COMPILERS

Microsoft Pascal	300 189
Turbo Pascal	150 105
Turbo Pascal 5.0 Professional	250 175

TURBO PASCAL LIBRARIES/UTILITIES

DATABOSS	399 359
DATABOSS TOOLS	99 89
Overlay Manager	45 39
PCX Toolkit	90 80
Pascal ASYNCH MANAGER	175 137
T-Debug Plus V. 4.0	45 40
Turbo Analyst	99 79
Turbo ASYNCH PLUS	129 99
Turbo Geometry Library	150 135
Turbo MAGIC	199 179
Turbo Plus v. 5.0	100 80
Turbo POWER SCREEN	129 99
Turbo POWER TOOLS PLUS	129 99
Turbo Professional	99 80
Turbo Professional 5.0	125 99
Universal Graphics Library	150 121

TRANSLATORS

Bas_C (Economy)	199 179
Bas_C (Commercial)	375 323
Bas_Pas (Economy)	149 129
Bas_Pas (Commercial)	280 242
BASTOC	495 399
Brooklyn Bridge	130 CALL
dB2C	299 272
dBx TRANSLATOR	550 469

XENIX/UNIX SOFTWARE LANGUAGES

ADVANTAGE C + +	695 669
APL*PLUS	995 699
C-terp	498 384
Micro Focus Toolkit	2495 1999
Micro Focus VS/COBOL	1495 1199
Microsoft Languages	CALL CALL
RM/COBOL	1250 954
RM/COBOL-85 (286)	1500 1259
RM/COBOL (386)	1900 1589
RM/FORTRAN	750 553

ADDITIONAL XENIX/UNIX SOFTWARE

Aspen Korn Shell	125 109
Directory Shell (286)	349 299
Directory Shell (386)	495 423

NEW RELEASES

PANEL PLUS II
The latest offering of this reliable, time-tested screen design product includes all new documentation, support for virtual screens, scrolling line windows, a screen editor enhanced by greater use of pop-up dialog boxes, and many new library functions. Call for more information.
List: \$495 **Ours: \$395**

MICROSOFT QUICKBASIC 4.5
Comes with QB Advisor, an on-line reference system that uses hypertext technology, and the Easy Menu option that simplifies the user interface helping new programmers to more quickly become productive.
List: \$99 **Ours: \$69**

VM/386 MULTIUSER
A true DOS multi-user system allowing one 386 PC to act as a host for up to eight PC-compatible terminals. A low cost alternative to networking. Lets you continue to use all the DOS software you already own.
List: \$895 **Ours: CALL**

1,000 Brand Names 1-800-445-7899

January Specials

ESSENTIAL SOFTWARE	LIST	THIS MONTH
C Utility Library	199	129
Essential B-Tree	99	79
w/ source	198	159
Essential Communications	185	119
Essential Graphics	299	219
w/ source code	598	499
!resident C*	99	79
w/ source code	198	159
Screen Star	99	79
w/ source code	198	159

LIST OURS

Brieve	595
FoxBASE+ (286)	795
Informix 4GL	1495
Informix 4GL w/Debugger	2100
Informix SQL	1195
InformixESQL/C	895
Informix 4CL (386)	2495
Informix 4CL (386) w/Debug	3500
Informix SQL (386)	1395
Informix ESQL/C (386)	1095
PC/EDIT+	395
EDIX	275
FORMAKER	895
JAM	1350
PANEL Plus	795
Windows for C	595
Windows for Data	795

386 SOFTWARE

386ASM/LINK	495
386MAX	75
386MAXPROFESSIONAL	CALL
Concurrent DOS 386	395
DESQview	130
F77L-EM/32	895
High C 386	895
Microport	
System V/386 (complete)	899
Runtime System	299
MS Windows/386	195
NDP C 386	595
NDP FORTRAN-386	595
SCO XENIX	
Operating System	695
Sys. V 386 (complete)	1495
VP/IX (2-USERS)	495
VP/IX (unlimited users)	995
VM/386	245
VM/386 Multiuser (unlim.)	895

OTHER PRODUCTS

FLOW CHARTING II	229
Pfinish	395
Source Print	97
Tree Diagrammer	77

BORLAND

Eureka: The Solver	167
Paradox 2.0	725
Paradox Network Pack	995
Paradox 386	895
Quattro	247
Reflex & Reflex Workshop	200
Reflex Data Base System	150
SideKick	85
SideKick Plus	200
Sprint	195
Superkey	100
Turbo Basic	100
Database Toolbox	100
Editor Toolbox	100
Turbo Assembler/Debugger	150
Turbo C 2.0	150
Turbo C 2.0 Professional	250
Turbo Lightning	100
Lightning Word Wizard	70
Turbo Lightning and	
Lightning Word Wizard	150
Turbo Pascal 5.0	150
Turbo Pascal 5.0 Professional	250
Database Toolbox	100
Editor Toolbox	100
Gameworks Toolbox	100
Graphix Toolbox	100
Numerical Methods Toolbox	100
Tutor	70
Turbo Prolog	150
Turbo Prolog Toolbox	100

Greenleaf Functions	209
Greenleaf Comm Library	229
Greenleaf TurboFunctions	109
Greenleaf DataWindows, DOS	295
OS/2 Version	395
Greenleaf Bus, MathLib	325
Greenleaf SuperFunctions	265
Greenleaf MakeForm	125
OS/2 Version	170
Greenleaf DataMath Interface	75

LAHEY	LIST OURS
F77L	477
F77L-EM/16	695
F77L-EM/32	895
A.I. DEVELOPER'S KIT	
OPERATING SYSTEM	495
PERSONAL FORTRAN 77	95

MEDIA CYBERNETICS

Dr. HALO III	140
HALO DPE	195
HALO '88	325
HALO '88 for 2 compilers	475
HALO '88 - MS Developers	595
TurboHALO for C	700

MICROSOFT

MS BASIC/6.0	295
MS BASIC Compiler (XENIX)	695
MS BASIC Interpreter (XENIX)	350
MS C	450
MS COBOL V. 3.0	900
for XENIX	995
MS Excel	495
MS FORTRAN	450
for XENIX	695
MS Learning DOS	50
MS Mach 20	495
MS Macro Assembler	150
MS Mouse Serial or Bus	
w/Paintbrush	150
& Mouse Menus	175
w/EasyCAD	200
w/Paintbrush & Windows	350
MS OS/2 Prog. Toolkit	300
MS Pascal	695
for XENIX	99
MS QuickBASIC	99
MS QuickC	195
MS Sort	99
MS Windows/286	195
MS Windows/386	500
MS Windows Dev. Kit	450
MS Word	149
MS Works	

MORTICE KERN SYSTEMS

MKS Awk	99
MKS Lex: Yacc	249
MKS Make	149
MKS RCS	189
MKS SOPS	495
MKS Toolkit	199
MKS Trilogy	119
MKS Vi	149

PERISCOPE

Periscope I/512K	795
Periscope I/OK	545
Periscope II	175
Periscope IIx	145
Periscope III	1395
Periscope III PLUS/512K	1995
Periscope III PLUS/OK	1745

SOFTWARE BOTTLING

Flash-up	79
Flash-up ToolBox	69
SoftCode	79
Speed Screen	49

WHITewater GROUP

Actor	495
Language Extension I	99

PROGRAMMER'S POLICIES

Phone Orders

Hours 9 AM-7 PM EST. We accept MasterCard, Visa, American Express. Include \$3.95 per item for shipping and handling. All shipments by UPS ground. Rush service available.

Mail Orders

POs by mail or fax are welcome. Please include phone number.

International Service

Call or fax for information.

Dealers and Corporate Accounts

Call for information.

Unbeatable Prices

We'll match nationally advertised

Return Policy

30-day no-hassle return policy. Some

HALO '88

The latest version of the industry standard. Now adds to the library, subroutines and devices which facilitate the development of contemporary applications such as Desktop Publishing, Document Management, Vision, and Imaging. HALO '88's powerful functions reduce development time by offering fast, effective subroutines. And no other graphics library supports more languages, more compilers or more devices.

List: \$325 Ours: \$229



HALO

ACTOR version 1.2



TheWhitewaterGroup

No Microsoft Windows developer should be without Actor. The Whitewater Group's object-oriented programming language. It will cut your design and development time in half. Use Actor to interactively prototype, test and deliver your applications in one integrated, MS-Windows based programming environment, featuring Actor's runtime debugger. In addition, you can incorporate your existing C or Assembler code into your Actor programs.

List: \$495 Ours: \$439

SOFTCODE...

The "Full-Feature" Program Generator

SoftCode is a new kind of program developer that gives you complete control over the type of code generated. It includes a WYSIWYG screen editor that's packed with features to give you fast results. And a fully documented Program Template Language that lets you actually create and modify your own templates. Choose from 4 Template Sets—dBASE, Pascal, BASIC or C—to instantly turn SoftCode into the generator of your choice.



THE SOFTWARE BOTTLING COMPANY

List: \$79 Ours: \$69



LAHEY 386 FORTRAN

F77L-EM/32 is a fast and powerful 32-bit FORTRAN compiler that gives users the ability to write and port programs up to 4 GigaBytes on a 80386. All of the features that have made Lahey the choice of professional programmers have been incorporated into F77L-EM/32: Full 77 Standard, mainframe extensions, fast compilation, excellent diagnostics, and a powerful debugger. Another outstanding product from the FORTRAN experts.

List: \$895 Ours: \$805

In NY: 914-322-4548
Customer Service: 914-332-0869
International Orders: 914-332-4548
Telex: 510-601-7602

Fax: 914-332-4021

Call or Write for Latest Free Catalog!

Programmer's Paradise



How to move a mountain, level a building, rule the world, erase the past, make a million, and draw attention to yourself.



You can draw anything with AutoSketch®. But that's only the beginning. Then, you can move it. Make sure it's level. Scale it to size. Or draw in rules.

Don't like it? Erase it. Want it bigger? Stretch it. Need details? Zoom in. Want more of the same? Duplicate it.

AutoSketch is the precision drawing tool that does amazing things. In up to 10 working layers. And because it's also easy to learn (takes about an hour), you won't have a long, drawn-out start-up process. That makes it the perfect complement to

your word processing or desktop publishing package.

So get AutoSketch for your PC*. For just \$99.95, you'll accomplish things you never thought possible. And who knows what kind of attention that might get you.

To order AutoSketch directly, or for more information, call 1-800-223-2521. For the name of your nearest AutoSketch Dealer, call 1-800-445-5415, ext.1, or write to AutoSketch, 2320 Marinship Way, Sausalito, CA 94965. **AUTODESK, INC.**

*AutoSketch runs on IBM PC/XT/AT and 100% compatible computers, and supports IBM's PS/2. AutoSketch is registered in the U.S. Patent and Trademark Office by Autodesk, Inc. IBM and Personal Computer AT are registered trademarks, and Personal Computer XT and PS/2 are trademarks, of International Business Machines Corporation.

PRODUCTS IN PERSPECTIVE

- 67 **What's New**
- 97 **Short Takes**
Extend
Irwin Model 5080
Jumbo
dBASE IV
For the Record
- Reviews**
- 162 21 IBM PC-compatible
digitizing tablets
- 179 The IBM PS/2 Models
70-E61 and 70-121
- 189 Dolch's P.A.C. 386-20C
- 195 Intel's Connection CoProcessor
- 201 IBM 8514/A and Control
Systems Artist 10 MC
graphics coprocessor boards
- 213 IntegrAda
- 223 QuickBASIC for the Mac
- 233 Opus I
- 239 Mathematica



IT'S TIME TO DO SOME SERIOUS 386 BUGBUSTING!

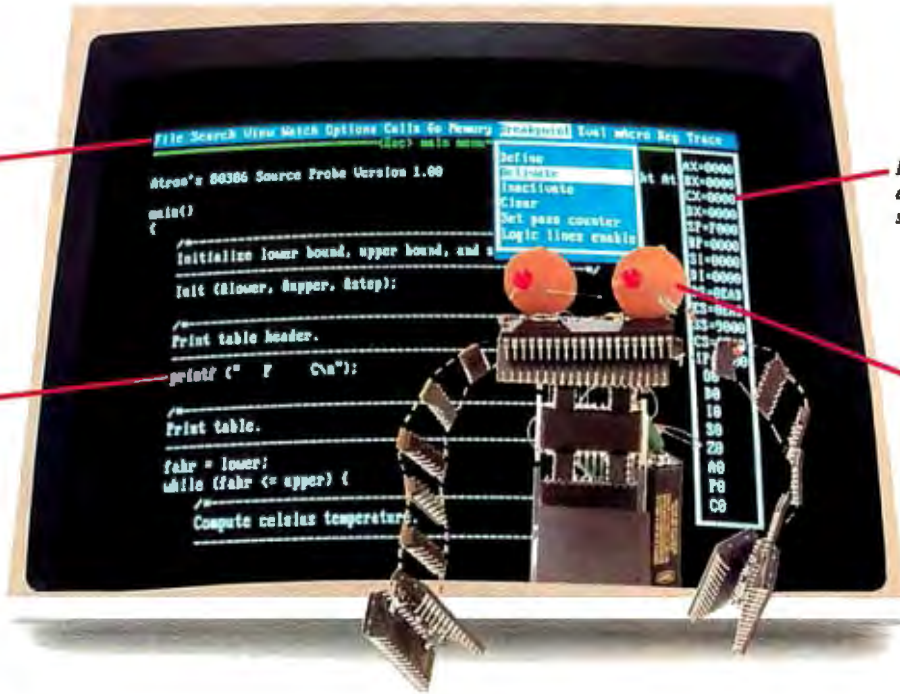

PROBE's menu bar and pull-down menus set a new standard for debugger interfaces.

PROBE has source-level debugging to let you "C" your program.

POP registers up and down with a single key.

This is an out-of-range memory-overwrite bug. Since it is interrupt related, it only appears in real time.

Welcome to your nightmare. Your company has bet the farm on your product. Your demonstration wowed the operating committee, and beta shipments were out on time. Then wham!

All your beta customers seemed to call on the same day. "Your software is doing some really bizarre things," they say. Your credibility is at stake. Your profits are at stake. Your sanity is at stake.

THIS BUG'S FOR YOU

You rack your brain, trying to figure something out. Is it a random memory overwrite? Or worse, an overwrite to a stack-based local variable? Is it sequence dependent? Or worse, randomly caused by interrupts? Overwritten code? Undocumented "features" in the software you're linking to? And to top it off, your program is too big. The software debugger, your program and its symbol table can't fit into memory at the same time. Opening a handful of files and debugging isn't much

Then, so you can look at the cause of the problem, the 386 PROBE automatically stores the last 2K cycles of program execution. Although other debuggers may try to do the same thing, Atron is the only company in the world to dequeue the pipelined trace data so you can easily understand it.

Finally, 386 PROBE's megabyte of hidden, write-protected memory stores your symbol table and debugger. So your bug can't roach the debugger. And so you can debug a really big program.



WOULD A GOOD NIGHT'S SLEEP PUT YOU IN THE TOP TEN?

Announcing the 386 PROBE™ Bugbuster,* from Atron. Nine of the top-ten software developers sleep better at night because of Atron hardware-assisted debuggers. Because they

can set breakpoints, so the breakpoint triggers only if the events are coming from the wrong procedures. So you don't have to be halted by breakpoints from legitimate areas. You can even detect obscure, sequence-dependent problems by stopping a breakpoint only after a specific chain of events has occurred in a specific order.

debugging time today. of a nightmare right now,



Atron

WHAT'S NEW

SYSTEMS

The Everex for the Masses

If you want the newest model so you're assured compatibility for the future and you don't want to spend a lot of cash, you might consider the 80386SX-based machine from Everex.

The Step 386is is a small-footprint desktop model that's rated at 3.2 million instructions per second. It runs at 16, 8, or 5.3 MHz (no wait states), and you get a megabyte of memory, a 1.2-megabyte 5¼-inch floppy disk drive, and a standard 101-key Enhanced AT-style keyboard.

Especially attractive to software developers is the LED "status diagnostic display" that shows in real time which head, cylinder, and drive is being accessed. Other LEDs on the front panel indicate how fast your microprocessor is running, and a speed switch on the front panel lets you power down or up.

MS-DOS 3.3 and GW-BASIC are bundled with the system. The chassis contains two 8-bit and six 16-bit AT-type expansion slots.

Price: \$3299.

Contact: Everex, Computer Systems Division, 48431 Millmont Dr., Fremont, CA 94538, (800) 356-4283.

Inquiry 861.

A Desktop in Your Laptop

The ProSpeed 286 laptop from NEC Home Electronics might make you wonder why anyone would need a desktop computer.

Here you've got a 16-MHz 80286 with a 640-by-400-pixel



Everex's Step 386is is built around Intel's 386SX.

monochrome backlit liquid crystal display (LCD), up to 100 megabytes of hard disk storage capacity, a megabyte of system RAM (expandable to 5 megabytes), and three expansion slots.

If you want a VGA monitor, you can add one through the port on the back of your laptop.

Provided in the base package is DOS 3.3, an 82-key PS/2 keyboard, the 640-by-400-pixel monochrome screen, one 1.44-megabyte 3½-inch floppy disk drive, a standard 20-megabyte hard disk drive, a 2-to-4-hour nickel-cadmium battery, and password security software.

On the back panel are ports for a serial connection, a parallel connection, floppy disk expansion, RGB video output, an external keyboard, an RJ-11, and direct current power. The ProSpeed has an internal general-purpose lap-

top expansion (LTX) slot, along with two slots designed for memory and modem.

Price: \$4999.

Contact: NEC Home Electronics (U.S.A.), Inc., 1255 Michael Dr., Wood Dale, IL 60191, (312) 860-9500.

Inquiry 860.

Average Users Unite!

QIC Research's latest is a 16-MHz 80286-based machine you might want for your average home.

This basic unit includes a 1.2-megabyte floppy disk drive and not much more. But it's packaged for expansion. There's a floppy/hard disk drive controller, an 80287 math coprocessor socket, two eight-bit and six 16-bit expansion slots, a serial port, a parallel port, and a game port.

SEND US YOUR NEW PRODUCT RELEASE

We'd like to consider your product for publication. Send us full information, including its price, ship date, and an address and telephone number where readers can get further information. Send to New Products Editor, BYTE, One Phoenix Mill Lane, Peterborough, NH 03458. Information contained in these items is based on manufacturers' written statements and/or telephone interviews with BYTE reporters. BYTE has not formally reviewed each product mentioned. These items, along with additional new product announcements, are posted regularly on BIX in the microbytes.sw and microbytes.hw conferences.

Standard memory is 512K bytes of RAM on the motherboard, which is expandable to 4 megabytes.

Price: \$1449.

Contact: QIC Research, Inc., 1961 Concourse Dr., Suite C, San Jose, CA 95131, (408) 432-8880.

Inquiry 863.

Sharp's Hand-Held PC Connects to Desktop PCs

Sharp's 8-ounce "pocket PC" is designed as a hand-held organizer. The Wizard has been in production since 1987 but has been available only in Japan.

The Wizard will have seven basic functions, including an appointment diary, a 200-year calendar, a 600-entry phone directory, a notepad function that stores up to 16 pages of typed information, a calculator, and world and local clocks. The Wizard has alphanumeric keys and an eight-line LCD.

"Smart cards" containing time-budgeting software, a thesaurus/dictionary, and a language translator are also available.

Cabling through an RS-232C port allows you to transfer data between two Wizards, from a Wizard to a desktop, or from a Wizard to a small printer.

Price: The Wizard, \$299; time expense manager, \$119.99; thesaurus/dictionary, \$129.99; language translator, \$99.99.

Contact: Sharp Electronics Corp., Sharp Plaza, Mahwah, NJ 07430, (201) 529-8874.

Inquiry 862.

continued

Hard Disk Drives with Removable Storage

The Disk Pack drive is an external box with two slots for removable hard disk drives called Disk Pack modules. The SCSI port to the Disk Pack drive makes it compatible with many computers, including the Macintosh.

Mega Drive Systems is marketing the products in standard-size modules, ranging in capacity from 20 megabytes to 120 megabytes.

Access time for a single 20-megabyte drive is 65 milliseconds, but it's reduced on the 40-, 80-, and 120-megabyte modules to 19, 19, and 18 ms., respectively. Each module weighs 2½ pounds.

SCSI kits for the IBM PC XT, AT, PS/2s, and compatibles are optional.

Price: Two-slot drive, \$799; 20-megabyte module, \$899; 40-megabyte module, \$1299; 80-megabyte module, \$1699 (pricing not set on 120-megabyte version); XT/AT SCSI kit, \$299; PS/2 SCSI kit, \$579.

Contact: Mega Drive Systems, Inc., 1801 Avenue of the Stars, Suite 507, Los Angeles, CA 90067, (800) 322-4744; in California, (213) 556-1663.

Inquiry 866.



Mega Drive's box can hold two removable disk drives.

Mass Storage to the Max

A modular storage chassis with a single SCSI access to CD-ROM drives, hard disk drives, WORM (write-once-read-many) drives, and tape backup drives is now available from Online Computer Systems.

The Multimedia Data Storage Unit series comes in packages designed for desktop publishing, workgroup publishing, education, and resource configuration for file servers. The standard chassis contains eight slots—WORM and large hard disk drives require two slots, while smaller hard disk drives and tape car-

tridges need only one.

The desktop publishing package contains two Sony CD-ROM drives and a Panasonic WORM drive. Also included is a Panasonic WORM disk, a SCSI host adapter, and Microsoft extensions.

The CD-ROM drives will act as mechanisms to access "image libraries" stored on CD-ROM disks. You can sort through those images and store them on WORM drives in particular sequences for certain publishing projects.

One file server configuration includes three 676-megabyte hard disk drives, a 400-megabyte WORM drive, a Maxtor OM-800 disk, and a SCSI host adapter.

Price: \$6000 to \$20,000.

Contact: Online Computer Systems, Inc., 20251 Century Blvd., Germantown, MD 20874, (800) 922-9204; in Maryland, (301) 428-3700. **Inquiry 864.**

Presentation Hardware for Your Macintosh

Manipulating computer graphics on-screen while you're making a presentation is the chief function of the Kodak Datashow remote for the Macintosh. It's an infrared remote-control device much like the one you use to switch channels on your television, and it works through the Apple Desktop Bus architecture incorporated on the Macintosh SE, II, and Apple IIGS. In other words, it's a slide projector remote control, except that the slide projector is the Macintosh monitor. It plugs into either the keyboard port or the mouse port.

The remote's infrared beam can send signals to a receiver up to 35 feet away. If you add a mouse extender, it will reach another 16 feet.

The remote's signals conform to keyboard equivalents used by Kodak and presentation package software manufacturers.

Standard features include forward, reverse, skipping to particular frames, reversing screen tones, inverting the image, and blanking out the image (to focus attention away from the screen).

Price: Remote, \$245; mouse extender cable, \$49.

Contact: Eastman Kodak Co., Motion Picture and Audio/Visual Product Division, 343 State St., Rochester, NY 14650, (800) 445-6325, ext. 883; in New York, (716) 724-3169.

Inquiry 865.

continued

Removable Cumulus Disk

The Cumulus Classic is a removable 5¼-inch half-height hard disk drive that stores 44 megabytes on a half-pound disk with an average access time of 25 milliseconds.

This SCSI-based drive comes with software drivers that provide backup features for your system's hard disk drive. Besides providing for incremental and scheduled backups, a memory-resident

program allows the removable disk to "shadow" or "mirror" your system's hard disk.

In the event of a hard disk failure, the system will automatically change over to the removable media. The software has a windows-oriented interface that lets the user manipulate any combination of files in a number of ways.

One of the long-time problems with removable storage

media has been keeping the heads clean. Cumulus says it has taken care of the problem by using a fan and centrifugal force from the spinning disk.

Price: Drive and one cartridge, \$1295; extra cartridges, \$149.

Contact: Cumulus Corp., 23500 Mercantile Rd., Cleveland, OH 44122, (216) 464-2211.

Inquiry 867.

NEW!
Advanced Math
and Statistics
Applications Packs

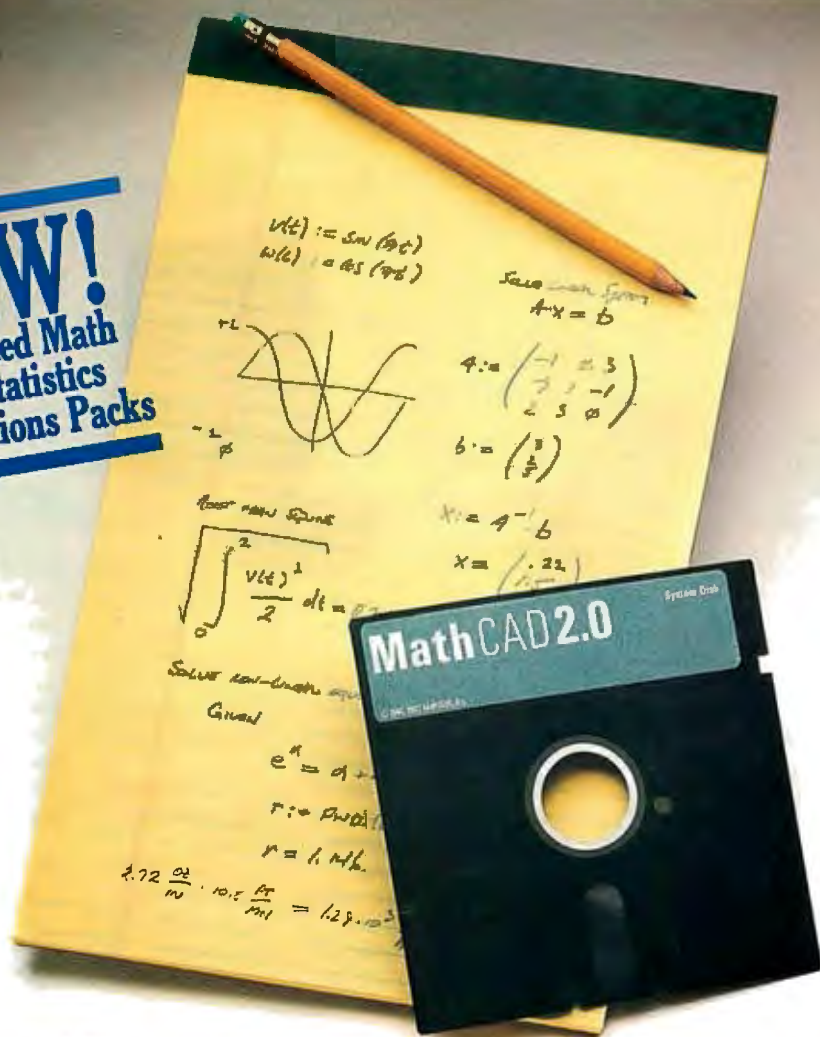

Your pad or ours?

If you perform calculations, the answer is obvious.

MathCAD 2.0.

It's everything you appreciate about working on a scratchpad—simple, free-form math—and more. More speed. More accuracy. More flexibility.

Just define your variables and enter your formulas anywhere on the screen. MathCAD formats your equations as they're typed. Instantly calculates the results. And displays them exactly as you're used to seeing them—in real math notation, as numbers, tables or graphs.

MathCAD is more than an equation solver. Like a scratchpad, it allows you to add

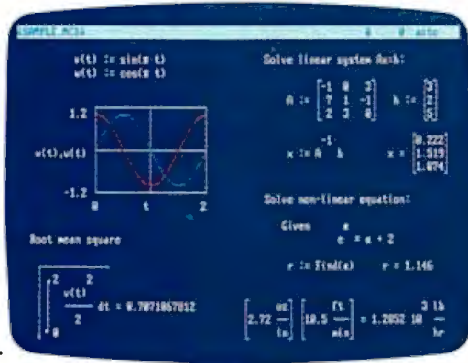

text anywhere to support your work, and see and record every step. You can try an unlimited number of what-ifs. And print your entire calculation as an integrated document that anyone can understand.

Plus, MathCAD is loaded with powerful

built-in features. In addition to the usual trigonometric and exponential functions, it includes built-in statistical functions, cubic splines, Fourier transforms, and more. It also handles complex numbers and unit conversions in a completely transparent way.

Yet, MathCAD is so easy to learn, you'll be using its full power an hour after you begin.

What more could you ask for? How about two new applications packs to increase your productivity?

The **Advanced Math Applications Pack** includes 16 applications like eigenvalues and eigenvectors of a symmetric matrix, solutions of differential equations, and polynomial least-squares fit.

The **Statistics Applications Pack** lets you perform 20 standard statistical routines such as multiple linear regression, combinations and permutations, finding the median, simulating a queue, frequency distributions, and much more.

MathCAD lets you perform calculations in a way that's faster, more natural, and less error-prone than the way you're doing them now—whether you use a calculator, a spreadsheet, or programs you write yourself. So come on over to MathCAD and join 45,000 enthusiastic users.

For more information, contact your dealer or call 1-800-MATHCAD (In MA: 617-577-1017).

Requires IBM PC® or compatible, 512KB RAM, graphics card.
 IBM PC® International Business Machines Corporation.
 MathCAD® MathSoft, Inc.

MathCAD®

MathSoft, Inc., One Kendall Sq., Cambridge, MA 02139

Keep the Debugging Out of the Lower 640K

The Periscope I Revision 3 board keeps debugging out of the lower 640K bytes of DOS memory so you can develop large applications like Microsoft Windows. Its footprint in the first megabyte is only 32K bytes.

For use in the XT, AT, and compatibles, the Periscope I has a wait-state generator that controls how many wait states you insert for memory access.

It also has 512K bytes of write-protected RAM (so run-away programs won't write over it), which can store the Periscope software and all related debugging information, including symbols. You can expand the memory up to 1 megabyte by adding 256K-by 1-byte dynamic RAMs in the 16 empty sockets. The write-protected RAM is managed by a paging algorithm built into the accompanying Periscope 4.1 software.

The 32K-byte footprint is addressed in the system above the lower 640K bytes, but still within the first megabyte.



The Periscope I debugging system.

You can use it in systems with both an EGA (or VGA) card and an EMS card.

Price: \$695.

Contact: The Periscope Company, Inc., 1197 Peachtree St., Plaza Level, Atlanta, GA 30361, (800) 722-7006; in Georgia, (404) 875-8080.

Inquiry 870.

Accelerate Your Mac II to 33 MHz

The DayStar Digital 33/030 Accelerator II will increase the speed of a Mac II by two to five times, the company claims. The speed increases depending on the ap-

plication, with graphics applications generally not as fast as others.

The accelerator is designed around the 68030 processor running at 33.33 MHz. It more than doubles the speed of the standard 15.67-MHz Mac II and is 1.9 to 3.9 times the speed of the new Mac IIx. With the optional 33.33-MHz 68882 floating-point coprocessor, the speed of numerical calculations is increased over that of the standard 68881. But you can use the original 15.67-MHz 68881 coprocessor on the Mac II instead of the 68882.

The accelerator runs with no 68030 wait states, the company claims. This is accomplished with a high-speed

memory cache, which uses 32K bytes of 25-nanosecond static RAM. Existing single in-line memory modules are not affected. The accelerator plugs directly into the original 68020 socket on the Mac II motherboard, instead of requiring a separate NuBus card. DayStar said it's compatible with all standard Mac II software and Apple's A/UX Unix operating system.

Price: \$6000; 68882 coprocessor, \$1000.

Contact: DayStar Digital, 5556 Atlanta Hwy., Flowery Branch, GA 30542; (404) 967-2077.

Inquiry 868.

SCSI Adapter Boots Nonbootable Peripherals

The TMC-841RL from Future Domain is a ROM-less SCSI host adapter that can address CD-ROM players, tape drives, and optical disk drives. Because there is no on-board ROM, this cuts the boot time by up to 35 seconds, the company claims.

Once loaded, the device driver that is supplied with a storage device defines the addresses for the adapter. Each adapter supports up to six disks and one tape drive. It's compatible with the IBM PC, XT, AT, and compatibles and offers an 8-megabit-per-second transfer rate. With appropriate software drivers, the TMC-841RL allows interface to DOS and Xenix operating systems, and to Novell's NetWare, the network operating system. It includes parity, arbitration, reselection, and interrupts.

Price: \$90.

Contact: Future Domain Corp., 1582 Parkway Loop, Tustin, CA 92680, (714) 259-0400.

Inquiry 871.

Memory for Multiple Operating Systems

The OS/RAM4 is a 4-megabyte memory board for Micro Channel computers that automatically configures itself for DOS, OS/2, or Unix.

Software installation takes just four keystrokes. Then special software and a resident BIOS is recognized and run by the system processor before the operating system is loaded—much the same way the IBM BIOS is run by the system processor before the operating system is loaded.

The company claims this

bypasses the catch-22 many people experience with PS/2 Models 50, 60, and 70 running OS/2: They are not shipped with the required 2 megabytes to run OS/2 and subsequently configure memory boards—and you can't configure the memory boards without first having the necessary 2 megabytes of memory.

With the OS/RAM4, a single chip serves as a complete Micro Channel interface and memory support circuit.

OS/RAM4 provides both

extended and expanded memory support when running under DOS and can be partitioned in 512K-byte increments. Expanded memory is handled according to the LIM/EMS 4.0 specification, and the limit of extended memory comes from your particular computer.

Price: \$395 without RAM.

Contact: Capital Equipment Corp., 99 South Bedford St., Suite 107, Burlington, MA 01803, (800) 234-4232; in Massachusetts, (617) 273-1818.

Inquiry 869.

continued

Introducing Turbo Debugger, Turbo Assembler, Turbo Pascal 5, Turbo C 2: The Revolution Continues!

**NOW
SHIPPING!**

TURBO ASSEMBLER® AND TURBO DEBUGGER®

THE NEXT GENERATION

NEW

The new Turbo Assembler lets you write the tightest, fastest code. We used Turbo Assembler to write best sellers such as Quattro® and Turbo Pascal; here's why:

	TURBO ASSEMBLER	Microsoft® Assembler
BGIDEMO BENCHMARK		
Assembly time (seconds)	9.34	27.46
Link time (seconds)	4.15	10.51
FEATURE COMPARISON		
MASM compatible (4.0, 5.0, 5.1)	Yes	No
Thorough type checking	Yes	No
Nested structures and unions	Yes	No
Multimodule cross reference	Yes	No
Assemble multiple files	Yes	No

Run on IBM PS/2 model 60 using Turbo Assembler version 1.0, Turbo Linker version 2.0, Microsoft Macro Assembler version 5.10, Microsoft Overlay Linker version 3.64.

- **Faster than other assemblers**
- **MASM compatible (4.0, 5.0, and 5.1)**
- **Significant new assembly language extensions**
- **Easy interfacing with high-level languages including Turbo C and Turbo Pascal**
- **Full 386 support**

**TURBO ASSEMBLER &
TURBO DEBUGGER
BOTH TOGETHER
ONLY \$149.95**

The Turbo Debugger is truly revolutionary. It's the professional productivity booster that you've been waiting for. Check out the features:

FEATURE COMPARISON	TURBO DEBUGGER	CodeView®
Multiple overlapping views	Yes	No
386 virtual-86 mode debugging	Yes	No
Remote debugging	Yes	No
Data debugging	Yes	Partial
Generalized breakpoints	Yes	No
Session logging	Yes	No
Conventional memory used—80386	Zero K	230K
Conventional memory used—remote	15K	N/A

Turbo Debugger version 1.0, Microsoft CodeView version 2.2.

DATA DEBUGGER

- Follow pointers through linked lists
- Browse through arrays and data structures
- Change data values

BREAKPOINTS

- Actions: stop, run code, log expression
- Break on condition, memory changed
- Software ICE capabilities
- 386 debug register support
- Support for hardware debuggers

DEBUG ANY PROGRAM

- Turbo Pascal, Turbo C, Turbo Assembler
- EMS support
- 386 virtual machine and remote machine debugging
- Supports CodeView® and .MAP-compatible programs

TURBO PASCAL® 5.0

COMPILE, DEBUG AND RUN!

NEW

Turbo Pascal, the fastest programming language around and the worldwide favorite, is now better than ever with a sophisticated debugging environment right at source level, plus a separate command-line compiler.

FEATURE COMPARISON	TURBO PASCAL 5.0	Turbo Pascal 4.0
Integrated debugger	Yes	No
Overlays, including EMS support	Yes	No
8087 floating-point emulation	Yes	No
Turbo Debugger support	Yes	No
Procedural types, variables, parameters	Yes	No
Smart linking of code and data	Yes	No
Constant expressions	Yes	No
EMS support for editor	Yes	No

NEW TURBO PASCAL 5.0

- Compile, edit and debug in the integrated Turbo Pascal environment
- Integrated source-level debugger lets you step code, watch variables, and set breakpoints
- Overlays, including EMS support
- 8087 floating-point emulation
- Support for Borland's Turbo Assembler and Turbo Debugger
- Procedural types, variables and parameters
- Smaller, tighter programs: Smart Linker strips unused code and data
- Constant expressions
- EMS support for editor
- Only \$149.95

TURBO PASCAL PROFESSIONAL SERIES: TURBO PASCAL 5.0 PLUS BOTH TURBO ASSEMBLER AND TURBO DEBUGGER—ALL THREE FOR ONLY \$250!

Turbo Pascal 5.0, plus the new Turbo Debugger, the new definition of the state of the art in source-level debugging. And the new Turbo Assembler, the fastest assembler ever, including special directives for easy interfacing to Turbo Pascal. Only \$250.

HOW TO UPGRADE NOW!

TURBO C AND TURBO PASCAL OWNERS UPGRADE NOW!

If you're a registered Turbo C or Turbo Pascal owner, you can upgrade and get the latest version of your favorite language. The upgrade manual plus disks for Turbo C 2.0 and Turbo Pascal 5.0 are yours for just \$49.95 (plus tax if applicable and \$5.00 for handling within the U.S.; \$10.00 in Canada).

CALL NOW AND BE SURE TO HAVE YOUR TURBO C OR TURBO PASCAL SERIAL NUMBER HANDY.
(408) 438-5300

Circle 42 on Reader Service Card
(DEALERS: 43)

BI 1306

NEW

THE PROFESSIONAL'S CHOICE

Turbo C is the professional's no-compromise choice. We at Borland used Turbo C to write industry best-sellers such as Sprint® and Reflex.*

FEATURE COMPARISON	TURBO C 2.0	Microsoft C 5.1
Integrated debugger	Yes	No*
Inline assembly	Yes	No
Auto dependency checking	Yes	No
EMS support for edit buffer	Yes	No
Device-independent graphics	Yes	No
Number of memory models	6	5
Price	\$149.95	\$450.00

*Integrated debugger included with Quick C.

NEW TURBO C 2.0

- Compile, edit and debug in the integrated Turbo C environment
- Supports 6 memory models
- Over 430 library functions, including a complete graphics library
- MAKE facility with automatic dependency checking
- Step code, watch variables, and set breakpoints in the integrated source-level debugger
- Only \$149.95

NEW TURBO C PROFESSIONAL SERIES: TURBO C 2.0 PLUS BOTH TURBO ASSEMBLER AND TURBO DEBUGGER—ONLY \$250!

Professional Turbo C gives you the tools you need to write and debug professional-quality programs in optimized C and Assembly language. You are provided with Turbo C's own integrated development environment, plus Turbo Assembler and the standalone Turbo Debugger. Only \$250.

AVAILABLE AT YOUR LOCAL DEALER
OR CALL (408) 438-5300 TO UPGRADE

Fiber Optics Brings Bit-Mapped Graphics to Multiusers

With the help of optical fiber, the PC LightCard from SunRiver Corp. brings single-user true bit-mapped graphics to multiple users. The difference is that most graphics terminals today are vector-based devices that aren't capable of writing pixel by pixel.

Multiple users means that you and as many as four colleagues with IBM PCs, XT's, AT's, and compatibles can "hot-key" from PC applications to a host 80386 machine into SunRiver's multiuser graphics environment. There you can enjoy 640- by 480-pixel, 16-color (EGA Plus) graphics.

The SunRiver system consists of multiple terminals (the original system uses dumb fiber-optic workstations) connected in star fashion to an 80386-based host PC (through a host adapter) at data rates of 32 megabits per second. The host and PC with a PC LightCard are supported on SCO Xenix System V, which runs DOS under Unix.

Two strands of multimode optical-fiber cabling are connected to each board with ST-type connectors terminating on the cards. Each card has an LED driving light at 850-nanometer wavelengths for distances of as much as 300 meters to a PIN photodiode receiver on another card. A PIN photodiode receiver catches light pulses from other cards on the network.

Features include EGA, CGA, and monochrome graphics options, multiple virtual terminals through the PC function keys, mouse connection through the on-board serial port, file transfer, and local printing of remote host applications.

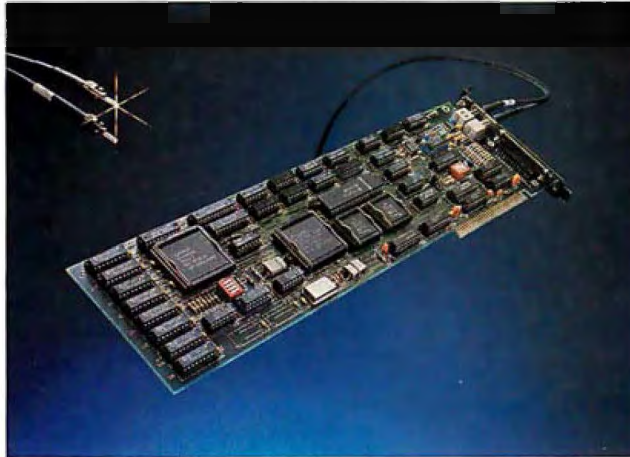

SunRiver's LightCard plugs into fiber optics.

Price: \$899; four-user adapter for host 80386, \$799.

Contact: SunRiver Corp., 108 Business Park Dr., Jackson, MS 39213, (601) 957-0100.

Inquiry 873.

Board Supports Video/Data/Voice

With a PCAT-300 board and a videodisk player, you can store up to 150 hours of audio, up to 221 megabytes of data, up to 54,000 pictures, or any combination. Each video frame can have up to 10 seconds of audio and 4096 bytes of data.

The company claims the main reason the PCAT lets you store so much information so quickly is its use of analog technology (rather than digital). This saves time during the premastering phase because you don't need to keep stopping and starting the disk to modify input to correct for errors. As soon as the PCAT loads information onto the disk through its 500K bytes of RAM, you're ready to make copies.

The PCAT works with IBM PC AT- and PAL/NTSC-compatible video input. The dynamic range is 78 decibels,

and the bandwidth is either 3.4 kHz for voice or 11 kHz for higher fidelity. Signal-to-noise ratio is 40 decibels, and the digital data is 6032 bytes per frame or 325 megabytes per disk. Data transfer is rated at 1.45 megabits per second.

With your own encoder, you prepare audio data on an audio tape with beep tones, and data is supplied on 1.2-megabyte or 360K-byte DOS-compatible disks. You can subsequently add digital data in real time from an encoded disk. You need your own videodisk player and video disks.

Price: \$1984.

Contact: EECO, Inc., 1601 East Chestnut Ave., P.O. Box 659, Santa Ana, CA 92702, (714) 835-6000.

Inquiry 875.

Paradise with a VGA Plus

The VGA Plus 16 Card supports 16-bit video graphics at up to 800 by 600 pixels, and it's compatible with the IBM PC, XT, AT, PS/2 Models 25 and 30, and compatibles.

In its 640- by 400-pixel resolution mode, the Paradise VGA Plus 16 card displays 256 colors out of a palette of 262,144 colors. At 800- by

600-pixel resolution, the card displays up to 16 on-screen colors and 132 columns of text.

The card supports a 16-bit data path and Western Digital BIOS to provide high performance for AT users. It also supports all pre-EGA standards, including Hercules monochrome graphics. The company claims it is 400 percent faster than the IBM VGA card.

Also standard is Western Digital's proprietary AutoSense feature, which checks system bus timing and peripheral and memory configuration to make certain it's safe to run a 16-bit video BIOS in your system.

Price: \$499.

Contact: Western Digital Imaging, 800 East Middlefield Rd., Mountain View, CA 94043, (415) 960-3350.

Inquiry 874.

Turn Your Epson Printer into a Scanner

The SX-1000 Scanning System from Desktop Technology turns your Epson FX, MX, RX, or LQ printer into a scanning system.

Like other scanners, it allows you to digitize hard-copy drawings and photographs onto disk files that can be imported to programs such as Ventura Publisher and Aldus PageMaker. The SX-1000 works with ATs with at least 512K bytes of hard disk memory and a CGA-, EGA-, or Hercules-compatible display and mouse.

Price: \$249.95.

Contact: Desktop Technology Corp., 986 Mangrove, Suite B, Sunnyvale, CA 94086, (408) 738-4001.

Inquiry 888.

continued

The best thing next to an IBM PC. Or any PC.



Model 310/360

The economics of IBM ASCII displays.

The affordable Models 310 and 410, when equipped with cartridges, offer PC terminal function for all multi-user PCs. That includes the IBM® RT-PC™ computer and the IBM PS/2™ family.

What's more, Models 310 and 410 offer many popular emulations. Optional cartridges provide features such as concurrent DEC™ and PC connectivity, and auto dial. Both models come with a 3-year warranty. Add an IBM Maintenance Agreement, and you'll get five years of IBM service for just \$54.



The ergonomics of IBM ASCII displays.

They're not only economically attractive, they're easy to look at. Flat 14" screens offer non-glare viewing. Green or amber/gold short-persistence phosphors produce crisp character resolution. And each model uses the advanced 102-key IBM keyboard.



Model 410/460

Want more information? Just ASCII.

For a free brochure and to find a distributor near you, call 1-800-IBM-7257 ext. 89. Or call your IBM Marketing Representative.



Amí is here. It's about time.



Requires IBM® AT, PS/2 or compatible (30286 or 386 CPU); EGA, VGA, or Hercules compatible displays; MS/DOS 3.0 or higher.

All of us want beautiful, professional-looking results from our word processing.

But who has time for the processing?

Who has time to manipulate columns and margins, align paragraphs, justify lines, tinker with leading, insert graphics and wrap text?

Let's face it. Writing is hard enough without having to struggle with formatting when you're finished.



Well, now you don't have to.

Because now there's a word processor that lets you create your words and your page layouts *at the same time*—as one intuitive train of thought.

While making the entire process easier, friendlier and more accessible than you ever dreamed possible.

Also a whole lot faster.

In fact, Amí™ is designed to save you about three quarters of the time—and effort—you're currently spending on everything from simple letters and memos to presentations, reports and multi-column newsletters.

For people who do Windows. And people who don't.

With its WYSIWYG screen display, powerful use of frames and interactive dialog boxes, Amí looks a lot like a desktop publisher.

But it's actually a serious word processor that makes the most of the Microsoft® Windows environment.

(If you don't have Windows, don't worry. A runtime version is included with Amí.)

Amí gives you everything you need to process words quickly. Like complete and efficient keyboard commands (or mouse, if you insist). A 130,000-word spelling

checker. Search and replace. Cut, copy and paste. Headers and footers. Undo functions. Context sensitive help. And much more.

Amí even gives you a choice of ways to write.

In Draft Mode, you can put your head down, get your words into the computer as fast as humanly possible and worry about formatting later.

Layout Mode, on the other hand, gives you instant onscreen formatting, with automatic spacing, fonts, special effects and all the other things we mentioned at the top of this ad.

If you'd rather not do any designing, you don't have to. Because Amí comes complete with 25 pre-designed style sheets.

You can use them right out of the box. Modify them. Or create your own.

You can integrate text and graphics. Import both from

other programs. And admire your documents from four fully editable page views.

There's no time like the present.

Amí is the next generation in word processing. Yet it sells at a price that would make your grandparents nostalgic.

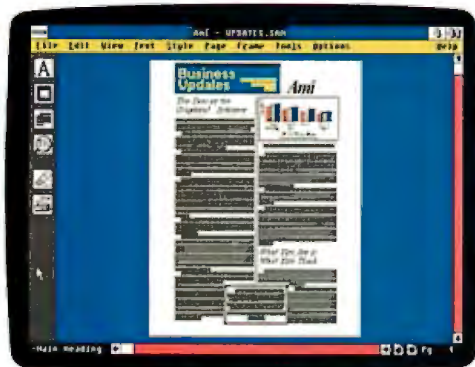
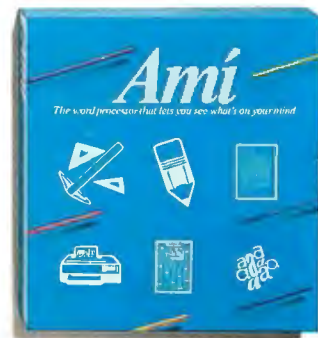
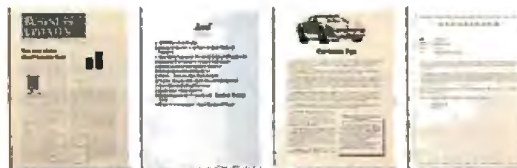

Now you can easily edit text and graphics and see the results onscreen before you print.

Amí comes complete with 25 pre-designed style sheets, so writing and formatting time is reduced to practically nothing.

Just \$199 suggested retail.

Buy it by March 15, 1989 and you'll pay under \$150. No kidding.

We'd be happy to tell you more about Amí and where to buy it.

All you have to do is call.

But hurry. Time's wasting.

**For the dealer nearest you,
call Samna at 1-800-831-9679.**

DEC Connectivity without the Cost

The Netmate/XLS is an 80386-based workstation specifically designed to perform your local data processing and to connect to networking environments like Ethernet and Digital VAX networks.

Booting up is especially easy with DataMedia's Netcard, a credit-card sized ROM card. You insert it into the Netcard slot of the machine, and it provides the boot code for Sun's NFS and for DEC's PCSA.

Once you're booted up, the Netmate/XLS will run multiple MS-DOS and VT-241 sessions in a multi-windowed Windows/386 environment with VGA and DEC VT-340 graphics support. Display resolution is 800 by 480 pixels, with 16 colors.

Performance is rated at 4.66 MIPS (millions of instructions per second), and the standard system comes with an Intel 80385 32-bit cache controller with 32K bytes of static RAM, 2 megabytes of RAM, 128K bytes of ROM, and 256K bytes of display memory.

There are three AT-style slots inside every Netmate/XLS, with a 32-bit slot for up to 6 megabytes of optional memory. Ports for RS-232C communication, your printer, and your mouse are standard—there's an option for an external SCSI port.

Also available as options are an 80387 numeric coprocessor and enhanced VGA color graphics for up to 1024 by 768-pixel resolution.

Three models are available: a diskless version, one with a 1.44 megabyte 3½-inch floppy disk drive, and one with the floppy disk drive and an 80-megabyte hard disk drive (with a 40-megabyte



DataMedia's Netmate connects to Ethernet.

hard disk drive available as an upgrade option).

Price: \$4895 to \$6995.

Contact: Datamedia Corp., 11 Trafalgar Sq., Nashua, NH 03063, (603) 886-1570.

Inquiry 881.

10Net Communications Bridges to Token Ring

The Token Ring Bridge from 10Net Communications allows you to connect all the 10Net networks, both 10 megabit- and 1-megabit-per-second ones, to IBM-compatible token rings.

Like other hardware from 10Net, each board is equipped with software for the company's unique distributed processing environment. For token rings, 10Net offers a 10Net Plus for Token Ring software package.

The Token Ring Bridge is equipped with utilities for recording and viewing performance statistics over the network, and it requires a dedicated IBM XT, AT, or compatible. It also acts as a cluster traffic filter, eliminating cross-bridge traffic.

The next step, say company officials, is a 10Net-compatible LAN Manager network operating system, scheduled to ship this quarter.

Price: Bridge, \$495; 10Net Plus software, \$195.

Contact: 10Net Communications, 7016 Corporate Way, Dayton, OH 45459, (800) 358-1010; in Ohio, (800) 782-1010; in Canada, (800) 544-6105.

Inquiry 877.

FDDI Reaches the Personal Computer

Two 125-megabit-per-second local-area networks (LANs) are designed specifically for 80286- and 80386-based systems, says manufacturer Simple Net Systems.

The company claims that both the LaserLAN and the LaserLAN Plus are compatible with evolving Fiber Distributed Data Interface standards, as drafted by the ANSI X3T9.5 committee. FDDI is to data communications what Integrated Services Digital Networking is to telecommunications—the standard set of specifications for business networking in the 1990s.

Both networks are optical fiber-based systems that allow you to transmit data at more than 10 times the rate of Ethernet-based systems, one of the most popular standard PC-based LANs. This data rate feature has become important in graphics environments. Another valuable asset of optical fiber-based LANs is the fact that transmission distances can be lengthened without the need for repeaters.

LaserLAN is an LED-driven system consisting of a 16-bit full-length board with 128K bytes of RAM, Novell NetWare drivers, and a proprietary NetBIOS interface. Distances between workstations can be up to 500 meters. LEDs drive light through multimode optical fiber at 825-nanometer wavelengths.

LaserLAN Plus is a semiconductor laser-based 16-bit board with a NetWare driver and the same proprietary NetBIOS interface. Because LaserLAN Plus boards use semiconductor lasers to pulse light down single-mode optical fibers at 1300-nanometer wavelengths, distances between workstations can be as much as 1500 meters.

Both boards contain PCO transmitters and receivers and the Advanced Micro Devices chip set that's designed around the evolving FDDI. The topology of FDDI is a counter-rotating token ring. Both LaserLAN and LaserLAN Plus operate under SimpleWare, Simple Net Systems' proprietary network operating system.

Price: LaserLAN, \$4095 per node; LaserLAN Plus, \$5495 per node.

Contact: Simple Net Systems, Inc., 545 West Lambert Rd., Suite A, Brea, CA 92621, (714) 529-8850.

Inquiry 878.

continued

Get out of the danger zone with ORACLE®



Announcing ORACLE Quicksilver

All the database Top Guns are flying SQL, the industry-standard data management language first delivered by Oracle. Now, ORACLE Quicksilver adds SQL and connectivity to your dBASE applications, so you can fly them into the 1990s.

Your ticket to the future

ORACLE Quicksilver is a compiler that turns your dBASE programs into fast, secure, multi-user applications that can access both distributed ORACLE and dBASE data. It delivers all the capabilities of dBASE, plus powerful extensions like windowing, graphics and user-defined functions. You can even add SQL statements to your dBASE programs for more powerful, flexible data access.

ORACLE database included

ORACLE Quicksilver comes with the ORACLE RDBMS. So you can get automatic indexing, comprehensive security, and mainframe-class data integrity.

Why wait until dBASE IV can talk to SQL Server?

dBASE IV doesn't talk to SQL Server yet. When it finally does, it will only talk to SQL Server on OS/2—not on any other operating system. Which means you'll still be isolated from corporate data on minis and mainframes.

Add connectivity to your dBASE applications today

Your ORACLE Quicksilver applications can talk to ORACLE SQL databases on your PC today. And with our optional networking software, you can build distributed databases across ORACLE servers on PCs, minis and mainframes—including IBM DB2 data.

No-risk Money Back Guarantee

Test fly ORACLE Quicksilver now. If you're not out of the danger zone in 30 days, return it for a full refund. **Limited Time Free Offer:** Order now and, for a limited time, you'll receive ORACLE SQL*Tutor—our on-line SQL training program—absolutely free.

*Call 1-800-ORACLE1, ext. 4925 today.
Or fill out and return the attached no-risk coupon now.*



Dear Oracle...

Oracle PC Direct • 20 Davis Drive • Belmont, California 94002
1-800-ORACLE1, ext. 4925

Send me the following ORACLE products for my PC. * Enclosed is my check or VISA MasterCard AMEX credit card number and authorization for:

- \$ _____ ORACLE Quicksilver at \$699 and ORACLE SQL*Tutor free
- \$ _____ ORACLE SQL*Tutor ONLY for \$199
- \$ _____ Please add appropriate state sales tax
- \$ _____ **Total enclosed/authorized.**
I understand Oracle will pay for shipping, and all prices valid in U.S. only.

NAME _____ TITLE _____
COMPANY _____
STREET (no P.O. boxes, please) _____
CITY _____ STATE _____ ZIP _____
PHONE _____
CREDIT CARD NO. _____ CARD EXPIRATION DATE _____
SIGNATURE _____ TODAY'S DATE _____ BYTE _____

*REQUIREMENTS: ORACLE SQL*Tutor, 256K PC and hard disk. ORACLE Quicksilver: To manage only dBASE DBF files and no ORACLE database, you need a 640K PC. To manage an ORACLE database on a remote computer, you need a 640K PC and optional networking software. To build an ORACLE database on your PC, you need a 286 or 386 PC with 640K plus 1MB of extended memory. All configurations require hard disks and DOS 3.0+.

ORACLE®

COMPATIBILITY • PORTABILITY • CONNECTABILITY

Call 1-800-ORACLE1, ext. 4925 today.

Copyright © 1988 by Oracle Corporation. ORACLE is a registered trademark of Oracle Corporation. Also trademarks: dBASE of Ashton-Tate. Quicksilver of Quicksilver Software, Inc. DB2, OS/2 and IBM of International Business Machines. Other companies mentioned own numerous trademarks. TRBA

20 Davis Drive, Belmont, CA 94002 • World Headquarters (415) 598-8000 • ORACLE Canada (800) 387-4407 (except Quebec) • Quebec (514) 337-0755 • ORACLE Systems Australia 61-2-959-5080 • ORACLE Europe 44-1-948-6911 • ORACLE Systems Hong Kong 852-5-266846

Luxury LanProbe LAN Analyzer

The LanProbe and accompanying software allow for network analysis of Ethernet LANs, according to manufacturer Eon Systems. It's a proprietary design; industry experts admit the nearest designed-from-scratch network management software standard is years away.

The LanProbe is designed for network planning, maintenance, and management, and it works on top of Microsoft Windows (version 2.0 or higher) on any IBM AT, PS/2, or compatible with some basic requirements.

LanProbe features a real-time map of the network, cabling diagnostics, a test library, and remote monitoring.

Specifically, functions include monitoring the cable, communications software, traffic load, equipment malfunction, and user error. It performs statistics-gathering, maintains an events log, does cabling testing, performs packet traces, and maintains several segment maps.

The hardware device attaches to the logical end of an Ethernet segment—usually thin or thick coaxial—and it monitors all the traffic. It will work with optical fiber and twisted-pair cabling with the addition of a transceiver.

Network data relating to the segment is then transferred to a workstation running the system's ProbeView software through an RS-232C port, an Ethernet adapter, or a modem connection.

The host computer must also have 450K bytes of free RAM, a floppy disk drive, 2 megabytes of free hard disk space after installing Windows, EGA or VGA graphics, and a mouse.
Price: \$8000; ProbeView

software, \$5000.

Contact: Eon Systems, Inc., 10601 South De Anza Blvd., Suite 305, Cupertino, CA 95014, (408) 252-5440.
Inquiry 882.

Twisted-Pair Ethernet Card Supports the Micro Channel

A new Ethernet card from InterLAN is designed specifically for the IBM PS/2s and uses the same unshielded twisted-pair wiring your telephone company has been installing for years.

Extra pairs of this unshielded twisted-pair wiring are already in the walls of most buildings. Lately, any installation of telecommunications electronics like Private Branch Exchanges has involved the installation of eight pairs.

Unlike some twisted-pair Ethernet cards that need a separate transceiver, the NI9210-UTP includes the SynOptics transmitter/receiver chip that matches the SynOptics transmitter/receiver chip in SynOptics' concentrators, Models 1000, 1010, and 2500, that you put in your wiring closet. Each NI9210-UTP also includes an attachment unit interface connection if you prefer coaxial cabling.

But with twisted-pair wiring, all you do is plug a patch cable with RJ-45 connectors from the wall plug into the card in each office. Then you connect the appropriate wires from the office walls to the wires in the wiring closet.

Each board comes with extras to make installation, testing, and maintenance easier. Each card has 16 megabytes of dual-ported on-board RAM for packet buffering. On-board software helps you configure the board by taking advantage of the PS/2

Adapter Description File.

Diagnostic software is also included so you can diagnose workstation configuration problems. Some cards have to be configured differently with graphics terminals, for example.

There's also support for what businesses are choosing most in network operating systems—Novell's Advanced NetWare, 3Com's 3+, Transmission Control Protocol/Internet Protocol (TCP/IP) workstations, and FTP, Inc.'s PC/TCP.

Price: \$595.
Contact: InterLAN, Inc., 155 Swanson Rd., Boxborough, MA 01719, (508) 263-9929.

Inquiry 879.

All Your Files for CD-ROM

One of the problems with the more than 80 titles currently on CD-ROM is that only one person can use the massive amounts of information at a time—until now.

With CD-Net, all you need is access to a LAN, and you and nearly a dozen friends can use the same disk at the same time. You can set it up as a library of these nonproprietary files, or you can set it up to serve your business's needs with proprietary files on CD-ROM.

CD-Net is a stand-alone CD-ROM read-only network server that includes up to 11 CD-ROM players per unit. It comes standard with the CD-ROM players, a network interface card, cables and connectors, server and workstation software, and an application menu to control switching between databases.

Four standard models support 1 to 100 workstations, with Models 50 and 100 based on 80286 systems and

including an expansion chassis for adding four or six CD-ROM players. The single-user Model 25 includes one to four drives, while Models 50 and 100 are available in one-, two-, or three-drive configurations. The Model 200, a tower 80386, can include from one to five drives. The expansion chassis comes in the single-user Model 10, for up to three drives; a multi-user Model 10s (designed to work with Model 50 and Model 100), which supports up to four drives; and the Model 20 expansion chassis, designed to work with the Model 200 tower to support up to six drives.

It supports simultaneous and independent access of information on the same player and multiple players for any workstation on the network. The resident memory management software recycles the data in RAM on a most-recently used basis—so frequently used information, like directory structures, usually remains in RAM.

Each CD-ROM drive has between 400K bytes and 2 megabytes of memory for caching. On each drive, storage capacity is 633 megabytes, data transfer rate is 153.6 kilobits per second maximum, rotation speed is 200 to 400 rotations per minute, and average access time is 250 milliseconds, non-cached. The CD-Net tower measures 8 by 25 by 16 inches and weighs 32 to 45 pounds.

Price: Model 50 with two drives, \$4145; Model 200 with three drives, \$9695; three-drive expansion chassis for Model 50, \$3195; five-drive expansion chassis for Model 200, \$6450. Add \$1000 for token-ring hardware.

Contact: Meridian Data, Inc., 4450 Capitola Rd., Suite 101, Capitola, CA 95010, (408) 476-5858.

Inquiry 880.

continued

Introducing GTEK's® Family



MODEL 7128

- Compatible with virtually any computer.
- High performance to cost ratio.
- Programs all popular chips, including MPU's.



MODEL 7344 PAL DEVELOPMENT SYSTEM

- Includes programmer, GPC Compiler and communications software.
- Program, secure and functionality test 20 & 24 pin pals.
- Supports MMI, NAT, TI, Cypress Erasable PALS.
- A must for any new cost effective design.



MODEL 705

- Stand alone operation.
- Programs Motorola 68705 Family MPU's.
- One button operation from cycle power to verify.
- Great for production.

MODEL 7228

- Programs all popular chips to 512K.
- Intelligent programming algorithms.
- High performance to cost ratio.

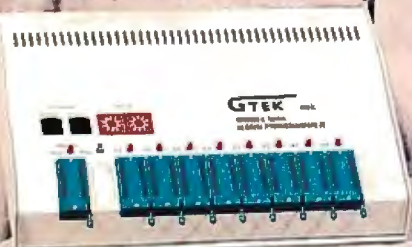

MODEL 9800

- Programs 8 parts at a time.
- Programs all chips, to one megabit, including single chip processors.
- Operates serial to 56Kbps or stand alone.
- Programs 2764 in 5 seconds.
- Ultra fast communications software.



MODEL 9000

- Fastest programmer on the market.
- Quick & Intelligent programming algorithms.
- Programs all chips, to one megabit, including single chip processors.
- Programs largest variety of chips incl. Prom replacements, Eproms and EEPROMs.



MODEL 7956

- Programs 8 eproms at a time.
- Programs chip to 512K, including single chip processors.
- Operates serial or stand alone.
- Switch selectable part selection.

MODEL RDMX-2XL EPROM EMULATOR

NEW!



- Emulates 2716-27010 eproms.
- 256K to 1024K memory available.
- Battery backed up, auto emulate on power-up.
- Low-cost, pays for itself on first project.
- Free 19.2K Serial Communications Software.

- PCSS-8I INTELLIGENT SERIAL BOARD
- 8 interrupt driven RX/TX channels/card.
- 1-8 cards per computer.
- BIOS Enhanced Software incl.
- Reduces host processor overhead.
- 32-128KByte buffer memory.
- May be used stand alone in custom appl.

NEW!



- MODEL 2010 SINGLE BOARD COMPUTER
- 2010B: Intel 8052AH - Basic V1.1 Solid State EProm Disk System.
- 2010M: Machine Language with built-in assembler/disassembler.
- 64KByte RAM, 40 bit programmable I/O lines.
- RS232 & expansion interface.

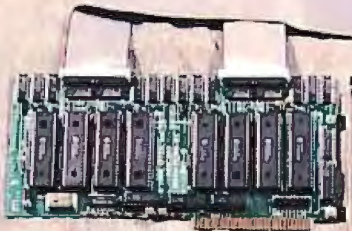
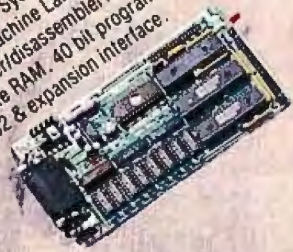

PCSS-BX SERIAL BOARD

- Eight RS232 ports per card (optional 4 port)
- All eight ports 100% DOS compatible.
- 32 ports may be added to a PC.
- Optional RS422 to 4000 ft.
- Interrupt driven BIOS Enhancement Software included free.



All GTEK products are manufactured by GTEK in the U.S.A., are fully warranted for 1 year and offer free technical support.

Intel is a registered trademark of Intel Corp.
MMI & PAL is a registered trademark of MMI Corp.
TI is a registered trademark of Texas Instruments Corp.
Cypress is a registered trademark of Cypress Semiconductor
Motorola is a registered trademark of Motorola Corp.
GTEK is a registered trademark of GTEK, Inc.

GTEK INC.

Development Hardware & Software
P. O. Box 2310
Bay St. Louis, MS 39521-2310
Order Toll Free 1-800-255-GTEK (4835)
Fax: 1-801-467-8935 Telex 315814 (GTEK UD)
MS & Technical Support 1-801-467-8048

Circle 120 on Reader Service Card (DEALERS: 121)

Cool Your Chips, Buster

A heat sink kit from Scitech reduces microprocessor and coprocessor chip temperatures by as much as 30° Fahrenheit, the company claims.

Two versions are available, based on the dimensions of the chips. Model 1 works with 80286, 80386, and 80387 square chips. Model 2 works with the 80287, 8088, 8086, 8087, and V20.

You simply apply the conductive adhesive to the top of the chip and add the tiny aluminum heat-dissipation device. **Price:** \$10 for Model 1; \$5 for Model 2.

Contact: Scitech, Inc., P.O. Box 334, Groves, TX 77619, (409) 962-3176. **Inquiry 884.**

Pentax Scanner for Desktop Publishing

The SB-A4301 Image Scanner is a 16-level gray-scale flatbed scanner with 300-dot-per-inch resolution.

It works with the IBM XT, AT, and compatibles with at least 640K bytes of RAM and 10 megabytes of hard disk space. The IBM interface board allows for direct memory access to speed image transfer between the scanner and the computer.

The scanner is designed to be used in a desktop publishing or optical-character-recognition (OCR) environment. Each device contains a charge-coupled device (CCD), an advanced controller chip, and a folded-path optical system.

The folded-path optical system includes the flatbed scanner concept (to make it easier to scan thick books, for

example) and the specific light path from the CCD element. The illumination source is a high-luminosity fluorescent lamp.

Resolution is variable from 39 to 300 dpi in 3-dpi increments. Contrast has 10 selectable levels, and there are three settings for handling image density.

Each scanner comes bundled with three desktop publishing interfaces: GEM Desktop (an icon-based overlay for DOS); GEM Scan, for setting scan variables and editing a scanned image prior to its transfer to desktop publishing packages like Ventura Publisher and Aldus PageMaker; and an OCR package that can learn different typefaces. GEM Desktop and GEM Scan are from Digital Research, and the OCR program is from Citadel in the U.K.

Price: \$2195.

Contact: Pentax Technologies, 880 Interlocken Pkwy., Broomfield, CO 80020, (303) 460-1600. **Inquiry 887.**

Joystick for Any Computer

A joystick-like cursor-positioning tool offers you an easier way to move the cursor on the screen without special software.

It attaches on the outside of any keyboard that has the cursor keys in the 2, 4, 6, and 8 positions, and you move the knob like a joystick in the direction you want to move. You can also move the joystick to page up, page down, or set a macro on the 5 key and access that by pressing down on the joystick.

Price: \$29.95.

Contact: Interlock, Inc., P.O. Box 2160, Castro Valley, CA 94546, (800) 541-2429; in California, (800) 643-6100. **Inquiry 886.**

This Laptop's a Reader, Too

A stand-alone CD-ROM reader called DynaBook is the first CD-ROM reader that is also a personal computer. It's basically a self-contained laptop computer with a CD-ROM drive and a touchscreen, but no keyboard.

The 16-pound DynaBook has many of the standard features of an AT-compatible laptop, such as a 10-MHz 80286 processor, 640K bytes of RAM, a 3½-inch floppy disk drive, and serial and parallel ports. The system also has a paper-white LCD screen with 720- by 400-pixel resolution and a transparent touchscreen with a resolution of 25 dots per inch and 16-level pressure sensitivity. It also has a two-channel headphone connector.

Although the system does not come with a keyboard, a keyboard port is available for users who need one.

Scenario officials claim that when you add a keyboard, all standard CD-ROM applications will run as usual. A set of development tools is also available for applications developers.

Price: \$4995.

Contact: Scenario, Inc., 235 Holland St., Somerville, MA 02144, (617) 625-1818. **Inquiry 883.**

Enhance Your AT Keyboard with CAD Macros

The AutoKey 20/20 from Mextel is a keyboard attachment that allows you to add as many as 400 macros to many standard keyboards

using about 20 macro keys.

You get access to 20 different menus, each containing 20 user-programmable function keys. You can organize menus on 20 flip-down pages that attach to the AutoKey. Each unit also contains 8K bytes of CMOS RAM to store up to 8000 keystrokes, with a 32K-byte RAM chip available as an option.

With the AutoKey, there's no software to load. You work through the keyboard cable. But keyboard cables are different. Anything IBM-compatible will probably work through the standard 5-pin DIN connectors that have the pins organized in a half-moon pattern and a notch on the bottom. Other computers have proprietary connectors. **Price:** \$179.

Contact: Mextel, Inc., 159 Beeline Dr., Bensenville, IL 60106, (800) 888-4146; in Illinois, (312) 595-4146. **Inquiry 889.**

PC Security Brings New Meaning to Charge Cards

Harcom Security Systems is betting that the use of personal credit cards will be the PC-security access method of the future.

With the PC-Watchman, you can control both general access and access to high-security files. Each unit consists of software and a half-length card for the IBM XT, AT, and compatibles. Once installed, PC-Watchman uses a magnetic reader interface that reads your credit card and tells the system whether or not to lock out the keyboard, for example. An alarm is optional.

Price: \$495.

Contact: Harcom Security Systems Corp., 130 William St., New York, NY 10038, (212) 766-1802. **Inquiry 885.**

continued

Rack and pinion for your PC.



The HiREZ™ Mouse. You can feel on your first lap around the screen. responds more crisply to your

the difference. The cursor control, moving

*320 pixels for every
versus 200
ballistic*

*inch on the desktop,
for ordinary mice. Built-in
tuning and 30% less weight enable it
to go the distance without dragging its
tail, so you can cruise through your work
in less time and desk space.*



*The feeling of
a sportscar instead
of a station wagon.*

*HiREZ travels
less distance
to complete
the same task.*

*HiREZ brings high performance to all
your favorite PC software. And the Logitech name
on the hood means you can count on what's inside.*

*After all, we build mice for companies
like Apple, AT&T, DEC, and H-P.*

*All this mousepower
comes with the
ordinary sticker
price of \$149.00.*

*Because it requires less
motion, HiREZ uses 62%
less desk space.*

*For the name
of your nearest
dealer, call*

800-231-7717.

In California: 800.

552-8885. In Europe:

++ 41-21-869-96-56.



LOGITECH

Personal Peripherals. Worldwide.

Circle 157 on Reader Service Card (DEALERS: 158)

EVERYBODY

But they're not all switching to the database management system you might expect.

In a recent industry survey,* two-thirds of the respondents who intended to buy a DBMS did not intend to buy dBASE.

And, perhaps coincidentally, two-thirds of recent R:BASE® buyers have used another DBMS before.

Why are they switching to R:BASE?

Because nobody really needs a DBMS: they only need what a DBMS can do.

And users find that the friendly facade of other software is fine for questions. But R:BASE has the right answers for their information management needs.

With R:BASE, you can handle all your data management (not just queries) without learning a single command. Our Prompt By Example (PBE) lets you point-and-pick, then R:BASE does the work.

When you find that you're repeating yourself, you automate simply by recording your actions in a macro file.

Or use our application generator to quickly create complete, correct business programs without touching a line of program code.



**Data is data, but
information is power.**

R:BASE gives you that power. And even impartial judges seem to agree: *PC Magazine*, *Software Digest*, *Datapro* and *InfoWorld* all just gave

IS DOING IT.

R:BASE their highest marks.

Because to its ease-of-use, R:BASE adds speed, functionality and data integrity in a combination you don't get with dBASE, Paradox, DataEase, Oracle or any of the other contenders.

R:BASE is optimized for speed, with an intermediate code compiler that makes your applications sing. And a true compiler is on its way.

You can use its English-based language in command mode, to modify programs R:BASE writes for you, or to write your own solutions from scratch.

Simple menus, prompts and our "paint-the-screen" techniques make

sophisticated screens, forms and reports quick and easy to create. With R:BASE forms, you can view and update data from several tables at the same time. Create computed fields. Include scrolling regions so you can work with all the data from other tables. Add rules for data integrity.

And R:BASE is relational, so your rules stay with the tables—applications can't avoid or change them. And forms can be set up to cascade changes through related tables. So you can trust the information you get.

We also give you an SQL implementation that even novices can use to create simple yet powerful queries.



And networking is free for up to three users. It's also easy, so any single-user application can be run on a multi-user LAN with a single command. And our advanced concurrency control, unlike

earlier-generation auto-refresh in other DBMSs, won't bring your network to its knees when you expand with our Six-Pack or Network Unlimited versions.

Applications that just won't quit.

R:BASE is the second-largest selling PC DBMS in the world, and it's backed by all the training, service and third-party support you'll ever need.

It's providing end-users with the information they need in large businesses and small. On stand-alone PCs and in networks sharing data with minis and mainframes. In insurance and real estate companies, factories and universities, government offices and the storefront down the street.

Check out what R:BASE can do for you with your local dealer, or write: Microrim, Inc., P.O. Box 97022, Redmond, WA 98073, 9722.

DO IT.

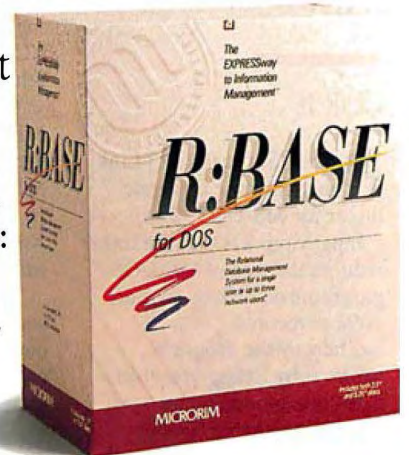

Call 1-800-624-0810 today.

*Computer & Software News, 9/5/88. Microrim and R:BASE are trademarks of Microrim, Inc. Other products and services mentioned are not. © Microrim, Inc. 1988.

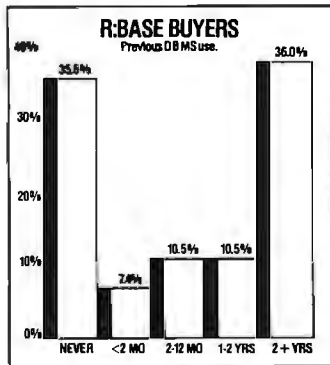

New Actor Does Windows

Version 1.2 of The Whitewater Group's Actor takes advantage of 500K bytes of RAM under the Lotus/Intel/Microsoft Expanded Memory Specification (LIM/EMS) 4.0. It also supports Windows 286 and Windows/386 version 2.1.

Actor is an object-oriented programming language and environment that runs under Microsoft Windows. It produces stand-alone Windows applications.

Version 1.2 offers more Windows error checking, multiple applications sessions within the limits of available memory, horizontal scrolling and support for cursor keys on edit windows, and a larger symbol table.

Actor 1.2 runs on the IBM PC, XT, AT, and PS/2s with at least 640K bytes of RAM, a mouse, and a graphics card. Actor 1.2 also requires Windows.

Price: \$495.

Contact: The Whitewater Group, 906 University Place, Evanston, IL 60201, (312) 491-2370.

Inquiry 1139.

Link It

Pocket Soft calls .RTLink the first true dynamic linker for MS-DOS. The company reports that the linker reduces the size of MS-DOS programs on disk by as much as 92 percent.

The way the program works is by letting you eliminate code redundancies among executable files by sharing language library and user-written routines at run time. Your combined code is placed in a single run-time library with an .RTL extension.



The Whitewater Group's Actor 1.2.

The program works with any compiler or assembler that produces .OBJ files in Intel or Microsoft format, Pocket Soft reports. Borland's Turbo C does not work on the system.

Price: \$495.

Contact: Pocket Soft, Inc., P.O. Box 821049, Houston, TX 77282, (713) 460-5600.

Inquiry 1136.

Pascal on the Mac

TML Pascal II combines TML Pascal and MPW (Macintosh Programmer's Workshop). The updated program is designed for creating MPW tools, HyperCard XCMDs and XFCNs, and other programs.

Pascal II runs under the MPW shell and supports Object Pascal, MacApp, and 68020/68881 code generation. In fact, it's the first non-Apple product that can compile MacApp code.

You can generate assembly source code and object code output, as well as integrate its code with other MPW languages, including MPW C and Assembler. Included with the program is the TML Pascal compiler, a Pascal Source formatting tool, a cross-ref-

erence tool, and example programs on disk. MPW version 2.0.2 software and documentation are also included.

The standard source code library is also upgraded, with new examples covering QuickDraw, serial drivers, HyperCard, and XCMDs.

TML Pascal II requires a Mac Plus, SE, or II with a 3 1/2-inch floppy disk drive and a hard disk drive.

Price: \$125.

Contact: TML Systems, Inc., 8837-B Goodbys Executive Dr., Jacksonville, FL 32217, (904) 636-8592.

Inquiry 1135.

A C Source Generator

Pro-C 1.2 is a C source code generator that doesn't require a run-time environment, according to Vestronix. It will generate C code for applications under MS-DOS, QNX, Xenix, and Unix.

The program is made up of menu-driven interrelated modules that support record definition; menu, screen and report generation; and update processing. The latest version of Pro-C offers control over screen layout and a post-generation procedure.

The program supports Microsoft C 5.x, Turbo C 1.x, Lattice C 3.21, and Zor-

MS-DOS Virtual Memory

Running on top of Phar Lap's 386|DOS-Extender, 386|VMM lets you create applications for 80386-based systems. Phar Lap reports that applications can be many megabytes, expanding beyond available RAM.

The virtual memory system uses the demand-paging hardware that's built into the 80386 central processor. The program automatically swaps code and data as needed to a standard MS-DOS file.

Phar Lap's 386|DOS-Extender is a run-time system for executing protected-mode applications on 80386 machines. If you're already running some applications under 386|DOS-Extender, you can upgrade them to use the Virtual Memory Manager with little or no source code.

Price: \$295.

Contact: Phar Lap Software, Inc., 60 Aberdeen Ave., Cambridge, MA 02138, (617) 661-1510.

Inquiry 1134.

continued

tech C. C-ISAM, C-Tree, and Btrieve file managers are also compatible.

Pro-C runs on the IBM PC, XT, AT, and compatibles with at least 512K bytes of RAM, DOS 2.0 or higher, and a hard disk drive.

Price: DOS version, \$495; QNX version, \$495 and up; Xenix and Unix versions, \$995 to \$1500; Pro-C Workbench source code libraries, \$245.

Contact: Vestronix, Inc., Allen Square, 180 King St. S, Suite 230, Waterloo, Ontario, Canada, N2J 1P8, (519) 745-2700.

Inquiry 1137.



QNX vs. OS/2 UNIX

QNX®: Bend it, shape it, any way you want it.

ARCHITECTURE If the micro world were not so varied, QNX would not be so successful. After all, it is the operating system which enhances or limits the potential capabilities of applications. QNX owes its success (over 70,000 systems sold since 1982) to the tremendous power and flexibility provided by its modular architecture.

Based on message-passing, QNX is radically more innovative than UNIX or OS/2. Written by a small team of dedicated designers, it provides a fully integrated multi-user, multi-tasking, networked operating system in a lean 148K. By comparison, both OS/2 and UNIX, written by many hands, are huge and cumbersome. Both are examples of a monolithic operating system design fashionable over 20 years ago.

MULTI-USER OS/2 is multi-tasking but NOT multi-user. For OS/2, this inherent deficiency is a serious handicap for ter-

minal and remote access. QNX is both multi-tasking AND multi-user, allowing up to 32 terminals and modems to connect to any computer.

INTEGRATED NETWORKING Neither UNIX nor OS/2 can provide integrated networking. With truly distributed processing and resource sharing, QNX makes all resources (processors, disks, printers and modems anywhere on the network) available to any user. Systems may be single computers, or, by simply adding micros without changes to user software, they can grow to large transparent multi-processor environments. QNX is the main-frame you build micro by micro.

PC's, AT's and PS/2's OS/2 and UNIX severely restrict hardware that can be used: you must replace all your PC's with AT's. In contrast, QNX runs superbly on PC's and literally soars on AT's and PS/2's. You can

run your unmodified QNX applications on any mix of machines, either standalone or in a QNX local area network, in real mode on PC's or in protected mode on AT's. Only QNX lets you run multi-user/multi-tasking with networking on all classes of machines.

REAL TIME QNX real-time performance leaves both OS/2 and UNIX wallowing at the gate. In fact, QNX is in use at thousands of real-time sites, right now.

DOS SUPPORT QNX allows you to run PC-DOS applications as single-user tasks, for both PC's and AT's in real or protected mode. With OS/2, 128K of the DOS memory is consumed to enable this facility. Within QNX protected mode, a full 640K can be used for PC-DOS.

ANY WAY YOU WANT IT QNX has the power and flexibility you need. Call for details and a demo disk.

THE ONLY MULTI-USER, MULTI-TASKING, NETWORKING, REAL-TIME OPERATING SYSTEM FOR THE IBM PC, AT, PS/2, THE HP VECTRA, AND COMPATIBLES.

Multi-User	10 (32) serial terminals per PC (AT).	C Compiler	Standard Kernighan and Ritchie.
Multi-Tasking	64 (150) tasks per PC (AT).	Flexibility	Single PC, networked PC's, single PC with terminals, networked PC's with terminals. No central servers. Full sharing of disks, devices and CPU's.
Networking	2.5 Megabit token passing. 255 PC's and/or AT's per network. 10,000 tasks per network. Thousands of users per network.	PC-DOS	PC-DOS runs as a QNX task.
Real Time	3,200 task switches/sec (AT).	Cost	From US \$450. Runtime pricing available.
Message Passing	Fast intertask communication between tasks on any machine.		

For further information or a free demonstration diskette, please telephone (613) 591-0931.

Quantum Software Systems Ltd. • Kanata South Business Park • 175 Terrence Matthews Crescent • Kanata, Ontario, Canada • K2M 1W8

QNX is a registered trademark of Quantum Software Systems Ltd.

UNIX is a registered trademark of AT & T Bell Labs. IBM, PC, AT, XT and PS/2, PC-DOS and OS/2 are trademarks of International Business Machines. HP and Vectra are registered trademarks of Hewlett-Packard Company.

Circle 226 on Reader Service Card

Thermal Analysis

Thermal Analyzer is a three-dimensional thermal-analysis package. You can use the program to check your circuit board designs for potential thermal problems. It models component conduction, convection, and radiation characteristics, and it lets you predict thermal distributions and locate thermal problems in your designs after placing components.

By extracting information from the EE Designer III system database, Thermal Analyzer takes into consideration board size, density package type and orientation, copper density areas, and heat dissipation values. You can specify environmental parameters such as temperature and humidity, and the program uses three-dimensional modeling that simulates heat flow and thermal fields.

A component library is included, which you can add to and edit.

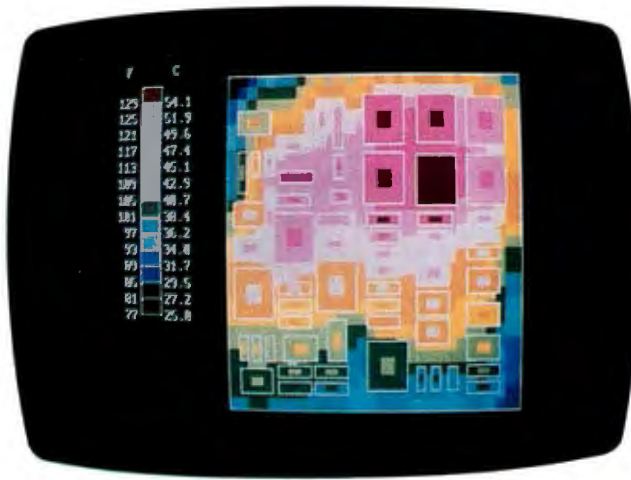

The 3-D Thermal Analyzer.

Thermal Analyzer runs on the IBM PC, XT, AT, PS/2s, and compatibles with at least 640K bytes of RAM, color graphics capability, a hard disk drive, and a mouse. It works with the EE Designer III electronic design system from Visionics.

Price: EE Designer III, \$3995; Thermal Analyzer, \$1000.

Contact: Visionics Corp., 343 Gibraltar Dr., Sunnyvale, CA 94089, (800) 553-1177; in California, (408) 745-1551. **Inquiry 1143.**

Mac in the Lab

A program from GW Instruments turns a Mac II or SE into an oscilloscope, chart recorder, scrolling-strip chart recorder, or scan-line recorder.

MacInstruments turns the Mac into one of these while also offering the benefits of a computer-based system, such as mouse control, printing and storing functions, and export capabilities. You can

zoom or pan through waveform data after sampling, or obtain simple statistics.

GW Instruments reports that MacInstruments samples data at high speeds because of its TurboDriver software. You can connect it with the MacAdios II data-acquisition system from GW instruments.

The TurboDriver software supports interrupt-driven background tasks, spooling to hard disk, and a variety of trigger and display options.

Price: \$790.

Contact: GW Instruments, 35 Medford St., Somerville, MA 02143, (617) 625-4096. **Inquiry 1142.**

Math on a Mac

Mathematical expression evaluation, plotting, and table generation is available in a \$50 desk accessory for the Macintosh from Spectra Blue.

The program daMath, (pronounced "D.A. Math"), lets you evaluate mathematical expressions with up to three variables. You can make line graphs of the expressions over any range of x values. You can overlay multiple plots and make tables of function values that you can view and edit in a spreadsheet-like window.

Cut and paste is supported via the Clipboard, so you can use a page-layout or drawing application's graphics tools to modify daMath's graphics. You can also paste a table of data from daMath into a spreadsheet, word processor, or other application.

The program runs on the Macintosh Plus, SE, and II. **Price:** \$50.

Contact: Spectra Blue, Inc., 5225 East Pima, Suite 2A, Tucson, AZ 85712, (602) 327-4686.

Inquiry 1140.

continued

National Instruments Upgrades Measure

National Instruments acquired rights to Measure from Lotus Development in April 1988 and has recently enhanced the data-acquisition and control program.

Measure consists of a set of data-acquisition drivers for Lotus 1-2-3 or Symphony for acquiring, formatting, and storing data directly into a spreadsheet. It acquires data using GPIB, RS-232C, and A/D interfaces.

Version 2.0 of Measure runs on the IBM PS/2 Models 50, 60, 70, and 80 and supports the company's new general-purpose interface bus (GPIB) boards and multifunction analog, digital, and timing I/O boards

for the AT bus and PS/2 Micro Channel.

The AT-MIO-16 and the MC-MIO-16 are the new I/O boards from National Instruments. They feature programmable gain, a 12-bit A/D converter with 16 single-ended analog inputs, two 12-bit D/A converters, eight TTL-compatible digital lines, and three 16-bit counter/timer channels. The company claims that when Measure 2.0 is coupled with one of these new boards, you can acquire data 30 times faster on the AT or PS/2s.

Using Measure 2.0 with the AT- or the MC-GPIB boards, you can monitor, control, and communicate with IEEE-3488 bus-com-

patible engineering, scientific, or medical instruments in laboratory testing, production testing, and process monitoring and control applications.

National Instruments reports that the software user interface is unchanged in the updated version of Measure. If you've developed worksheets and macros under the original Lotus version, they will run on both the PC and PS/2s with Measure 2.0.

Price: \$495.

Contact: National Instruments Corp., 12109 Technology Blvd., Austin, TX 78727, (800) 531-4742; in Texas, (800) 433-3488; in Canada, (800) 443-4484.

Inquiry 1141.

WHEN THEIR CUSTOMERS DEMANDED UNIX SYSTEM V SOLUTIONS, THESE INDUSTRY LEADERS CAME TO SCO

Standards are made, not born.

The leading UNIX[®] System on three generations of PCs, SCO[™] XENIX[®] System V has revolutionized the way people look at both the UNIX System and PCs by revealing the amazing hidden potential of these standard hardware platforms.

In the process, SCO XENIX has become a true standard in UNIX System V software.

And like a true standard, SCO XENIX has opened up entire new markets of opportunity that have never before existed for micro-processor-based computers.

Teamed with the latest generation of 80386-based machines, SCO XENIX 386 allows systems created from the widest range of hardware choices to surpass the multiuser, multitasking performance of minis or even mainframes—at a fraction of the cost.

SCO XENIX can be found running thousands of XENIX- and UNIX System-based vertical applications on powerful business systems supporting 16, 32, or even more users. And on graphics workstations running advanced engineering and scientific applications.



And, of course, on personal computers, running multiple DOS applications concurrently, or networking XENIX and DOS systems together.

Today, more and more end users are demanding the power that only UNIX System V software can bring to their standard hardware platforms.

And when leading developers, resellers, and computer manufacturers who serve these users want to make sure they're working with a partner who's the UNIX System software leader—for now, and long into the future of UNIX System standards—they come to SCO.

They know that SCO will provide them with the most comprehensive environment for UNIX System applications, technical and marketing support, training, and documentation in existence.

And they know they can trust SCO UNIX System software to be the most complete and reliable anywhere in the world, because it comes from the most complete and reliable UNIX System software company in the world.

The UNIX System software leader—SCO.



The UNIX System Software Leader Worldwide

(800) 626-UNIX (626-8649) • (408) 425-7222 • FAX: (408) 458-4227 • TWX: 910-598-4510 sco sacz • E-MAIL: !uunet!sco!info info@SCO.COM

UNIX is a registered trademark of AT&T. SCO and the SCO logo are trademarks of The Santa Cruz Operation, Inc. XENIX is a registered trademark of Microsoft Corporation. © 1988 The Santa Cruz Operation, Inc., 400 Encinal Street, P.O. Box 1900, Santa Cruz, CA 95061 USA. The Santa Cruz Operation, Ltd., Crazley Centre, Hazlers Lane, Walsford WD1 8YN, United Kingdom, +44 (0)923 816344. FAX: +44 (0)923 817781. TELEX: 917372 scozou g 8/88

PC-Outline Gets a Boost

PC-Outline version 4.0 now has an 80,000-word dictionary and thesaurus from Proximity, multiuser capability, support for desktop publishing fonts, color capability, and support for a variety of printers and plotters.

PC-Outline 4.0 runs on the IBM PC or compatibles with 256K bytes of RAM and DOS 2.0 or higher.

This version of PC-Outline is not a shareware product.

Price: \$195.

Contact: Brown Bag Software, Inc., 2155 South Bascom Ave., Suite 114, Campbell, CA 95008, (800) 523-0764; in California, (800) 323-5335.

Inquiry 1148.

What's the Big Idea?

This idea generator is designed to help you brainstorm, solve problems, and make plans using seven idea-generation techniques. The program provides links to Lotus Agenda.

The Idea Generator Plus helps you focus thoughts, stimulate ideas, and identify the best ideas and prepare them for use with Agenda, Think-Tank, or other outliners, or as DOS text files for use with a word processor.

The program encourages you to define your situation or problem, list goals, prioritize goals, and list the people involved. Then it provides seven techniques for generating ideas: focusing your



A sample outline from Brown Bag's PC-Outline.

goals one by one, reversing your goals, applying lessons learned from previous situations to current ones, searching for parallels between familiar activities and the situation at hand, showing other possible perspectives, focusing on the people involved, and making the most of your ideas.

You can print your idea files to your computer screen or printer, or prepare the files to link with other programs. A hot key converts idea files to Agenda's .STF file format, so you can ex-

port the files into Agenda views.

The Idea Generator Plus runs on the IBM PC and compatibles with at least 256K bytes of RAM, DOS 2.0 or higher, and two floppy disk drives or one floppy and one hard disk drive. The program is available on 5¼- or 3½-inch disks.

Price: \$195.

Contact: Experience in Software, Inc., 2039 Shattuck Ave., Suite 401, Berkeley, CA 94704, (800) 678-7008; in California, (415) 644-0694.

Inquiry 1147.

Accounting Through Windows

Accounting by Design calls its first product the first accounting program that runs under the Microsoft Windows environment. Accounting by Design, which the company has dubbed "client write-up software," offers reports such as a current-period and year-to-date general ledger, and journals.

It includes a report generator that uses Windows graphics to show lines of reports on-screen. The program also has an integrity checker that lets you verify that accounts are correct and complete.

The program runs on any system that supports Microsoft Windows 286. A hard disk drive and printer are required; a mouse is recommended.

Price: \$1000.

Contact: Accounting by Design, Inc., 2931 Shattuck Ave., Suite 103, Berkeley, CA 94705, (415) 845-4716.

Inquiry 1149.

continued

Check it Out

You'll never have to write another check, according to Checkfree Technologies, if you use its new check-writing program. The program removes funds from your account electronically and transfers them to institutions to which you make regular payments.

CheckFree keeps track of the account, transactions, balance, and budgets. The payments appear on your monthly bank statement, so you can verify that they are being made. The program has a check register on-screen with payments that the program has made automatically recorded and your balance adjusted for each

bill paid or deposit made.

Each CheckFree customer has a personal account number for security. You enter data off-line, and transmissions to the processing center are encoded for added security. The program processes payments through the Federal Reserve bank network and never actually accesses your account, according to the company. At any time you have the ability to review, change, or cancel transactions, the company reports.

To use CheckFree, you purchase the start-up kit and fill out two registration forms. The company sends you a special account num-

ber, and you provide the company with your payment information.

CheckFree runs on the IBM PC and compatibles with 256K bytes of RAM, DOS 2.1 or higher, and a Hayes-compatible modem.

It also runs on the Mac 512K and up and the Apple II with 128K bytes of RAM; with either, you'll need the Hayes-compatible modem.

Price: Monthly service charge, \$9 for about 20 transactions; start-up program, \$19.50.

Contact: Checkfree Technologies, P.O. Box 897, Columbus, OH 43216, (614) 898-6000.

Inquiry 1146.



**Make your
point without
a trace of
doubt.**

**With the new
HIPAD PLUS
series.**



If you've ever used a digitizer, you probably were surprised that it didn't do what you thought it would. You assumed that whatever you picked or moved or drew on the tablet would be accurately displayed on the screen and precisely reflected on output. In spite of its straight-forward appearance, it didn't take you long to learn that all digitizers were not created equal, or accurate, or even easy to use.

Today there's a new line of digitizers that can meet your expectations. It's the new HIPAD Plus™ series. With sizes ranging from a compact 12" x 12" to a drafting-size 44" x 60," each model reflects HI's tradition of price/performance excellence.

Compare, for example, the sleek 9012 and 9018 models (shown below) which contain HI's exclusive tilt-correction feature. This unique feature lets you use the stylus like a pencil—no need to hold it in an awkward perpendicular position. HI's tablet captures only the points touched by the tip of the stylus, so you can make menu selections, create freehand drawings, move the screen cursor, or edit pixel-by-pixel—without a trace of doubt.

If you prefer a handheld cursor, you'll find HI's new four-button cursor has the same pin-point precision. (You'll also like the way it feels in your hand.)

The HIPAD Plus digitizers are compatible with both your CAD and graphics systems. Each model processes coordinates rapidly (up to 200 pairs per second) and has a resolution of up to 2,540 lines per inch. This all adds up to high performance and accuracy—and it means you won't be replacing your tablet to meet the high-resolution demands of the future.

And, with prices like \$495* for the 12" x 12" tablet and \$795* for the 12" x 18" tablet, HIPAD Plus is affordable. Make your point without a trace of doubt. For details, call 1-800-444-3425 or 512-835-0900.

**HOUSTON
INSTRUMENT**
A DIVISION OF **AMETEK**

8500 Cameron Road, Austin, TX 78753

*U.S. suggested retail prices. HIPAD Plus and Houston Instrument are trademarks of AMETEK, Inc.

Circle 133 on Reader Service Card

IBM[®]ers. HP[®] folk. Mac fanatics. How will you ever find one printer that pleases them all?

Easy.

With Fujitsu's new, very personal page printers, the RX7100 series.

To begin with, the economical RX7100 model gives you HP LaserJet™ Plus emulation, dual paper bins and a one-piece toner and drum cartridge for ease of replacement. Talk about paper handling—the RX7100 can automatically feed anything from envelopes to legal size paper from the same bin.

The RX7100PS+ offers Adobe[®] PostScript[®], 35 resident fonts, expanded memory, HP LaserJet Series II[®] emulation with AppleTalk[®], plus parallel and serial interfaces, to fill all your desktop publishing needs.



One last thing—a simple upgrade is all it takes to turn the RX7100 model into the RX7100PS+. So you can start small and add more features later, when you need them. Want to know more? Call 1-800-626-4686.

Personally, you'll be doing yourself a favor.

Fujitsu RX7100. The Personal Page Printer.



FUJITSU AMERICA
Computer Products Group

"Personally, if I had to keep as many people happy as you do, I'd go with Fujitsu. You get laser quality, Adobe PostScript, upgradeability... and a price you wouldn't believe."

Circle 111 on Reader Service Card (DEALERS: 112)

Presentations with More Pizzazz

Lotus redesigned many of the Freelance Plus utilities and added some new features in version 3.0 of the business graphics package. New features include a portfolio for creating presentations, a screen utility for displaying presentations, and other new drawing and editing tools. The charting module is redesigned, offering 12 chart formats, the ability to control the style elements of large numbers of charts, and data-import capabilities.

The new portfolio lets you plan your presentation from start to finish and lets you generate black-and-white handouts from color presentations.

Using Screen Show, you can use special effects such as fade, wipe, split, scroll, and spiral. And you can save your creations for use on compatible systems, even if those systems don't have Freelance Plus.

Enhancements such as those made to Freelance's drawing and editing capabilities simplify the creation of diagrams, flowcharts, illustrations, and other business graphics. You can also incorporate existing line art and photos into your graphics. Version 3.0 offers you the additional capability of importing and exporting a wider range of file formats, including the Lotus 1-2-3 release 3 WK3 file format, along with Symphony, dBASE, SYLK, TIFF, ASCII, and other file formats.

Lotus reports that Freelance Plus 3.0 drives a variety of dot-matrix and laser

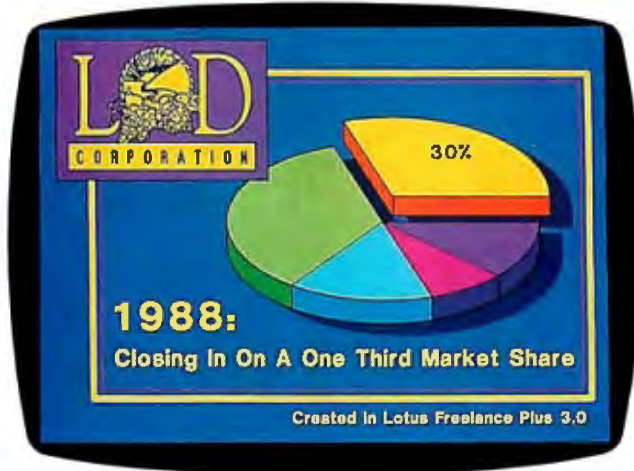

Business graphics with Freelance Plus 3.0.

printers, including those that support PostScript. The program runs on the IBM XT, AT, 3270 PC, PS/2s, and compatibles. It requires 640K bytes of RAM, a hard disk drive, DOS 2.0 or higher, and a Hercules, CGA, EGA, VGA, or compatible graphics card.

Price: \$495.

Contact: Lotus Development Corp., 55 Cambridge Pkwy., Cambridge, MA 02142, (617) 577-8500.

Inquiry 1128.

The Plot Thickens

If you need to view and edit HPGL (Hewlett-Packard Graphics Language) format plot files, you can use Plotview from Ajida. The program runs under Microsoft Windows, enabling you to view HPGL plot files while running other applications.

When editing or viewing the plot file, you can select from features such as scaling, pan, rotation, zoom, or cut and paste.

The program is compatible with any standard output device supported by Microsoft Windows, according to Ajida.

Price: \$59.

Contact: Ajida Technologies, Inc., 613 Fourth St., Santa Rosa, CA 95404, (707) 545-7777.

Inquiry 1131.

You Can Call Me Ray

LazerRays is a ray-tracing program that lets you create images on the IBM PC, XT, AT, or 80386 machines without a coprocessor. You can model scenes with reflections, refractions, transparency, and sharp and soft shadows—all with 32-bit floating-point accuracy, according to Lazerus. Two- and three-dimensional textures are also possible.

LazerRays requires an EGA, VGA, Targa, Vista, or Lazerus board.

Price: IBM PC, XT, or AT version, \$399; 80386 version, \$699.

Contact: Lazerus, 2821 Ninth St., Berkeley, CA 94710, (415) 845-1237. **Inquiry 1130.**

Attention Amiga Artists

Modeler 3D is an object-generation program for the Amiga that lets you create simple three-dimensional geometric shapes or complex objects in a CAD-like environment, according to Aegis.

You can create drawings with the other Aegis design programs, load them into Modeler 3D, and extrude a third dimension with just one command. Then you can add points, polygons, and different colors and shadings—treating the design like any other object.

To use Modeler 3D, you need an Amiga with at least 1 megabyte of RAM and one floppy disk drive, although Aegis recommends more memory and a hard disk drive.

Price: \$99.95. **Contact:** Aegis Development, Inc., 2115 Pico Blvd., Santa Monica, CA 90405, (800) 345-9871; in California, (213) 392-9972. **Inquiry 1133.**

continued

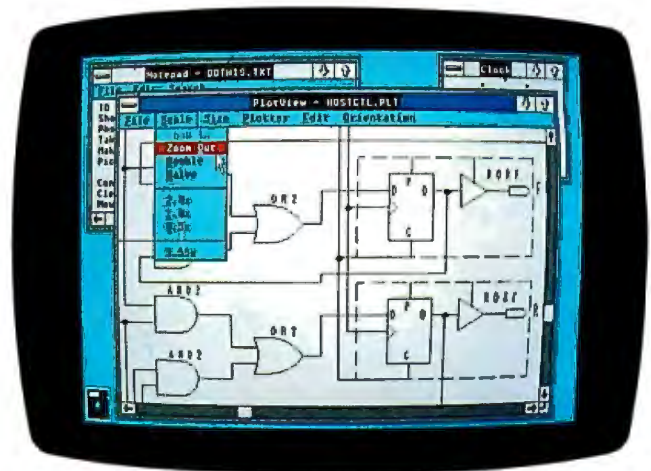

View and edit HPGL files with Plotview.

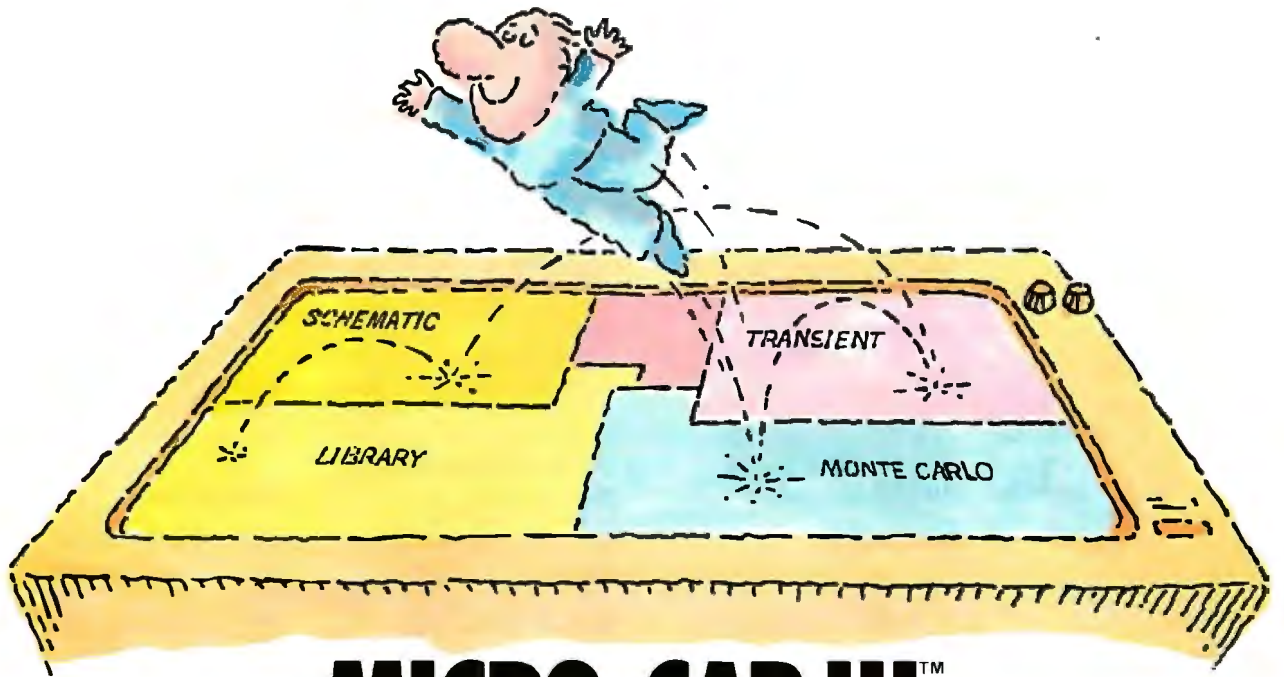

MICRO-CAP III.™ THIRD-GENERATION INTERACTIVE CIRCUIT ANALYSIS. MORE POWER. MORE SPEED. LESS WORK.

MICRO-CAP III,™ the third generation of the top selling IBM® PC-based interactive CAE tool, adds even more accuracy, speed, and simplicity to circuit design and simulation.

The program's window-based operation and schematic editor make circuit creation a breeze. And super-fast SPICE-like routines mean quick AC, DC, Fourier and transient analysis — right from schematics. You can combine simulations of digital and analog circuits via integrated switch models and macros. And, using stepped component values, rapidly generate multiple plots to fine-tune your circuits.

We've added routines for noise, impedance and conductance — even Monte Carlo routines for statistical analysis of production yield. Plus algebraic formula parsers for plotting almost any desired function.

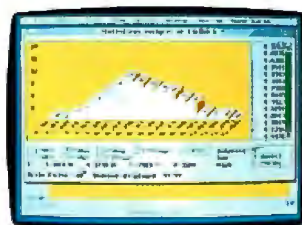
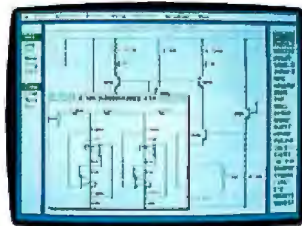
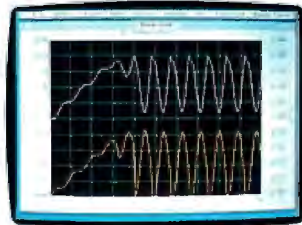

Monte Carlo analysis

Modeling power leaps upward as well, to Gummel-Poon BJT and Level 3 MOS — supported, of course, by a built-in Parameter Estimation Program and extended standard parts library.

There's support for Hercules®, CGA, MCGA, EGA and VGA displays. Output for laser plotters and printers. And a lot more.

The cost? Just \$1495. Evaluation versions are only \$150.

Naturally, you'll want to call or write for a free brochure and demo disk.

SPECTRUM

1021 S. Wolfe Road,
Sunnyvale, CA 94086
(408) 738-4387

MICRO-CAP III is a registered trademark of Spectrum Software.
Hercules is a registered trademark of Hercules Computer Technology.
IBM is a registered trademark of International Business Machines, Inc.

Networking XyWrite

XyWrite III Plus is a network version of the word processing program for the IBM PC and compatibles. It offers multiuser redlining that tracks editing remarks by log-in, date, and time.

The program supports DOS 3.0 file locking and access restrictions for specified network drives. It has a read-only feature that lets users review only the last stored version of any file.

System administrators can customize XyWrite with formatting standards. They can also modify files that check spelling, customize keyboards, and control fonts.

XyWrite III Plus supports network operating systems from AT&T, 3Com, Novell, IBM, and Banyan. You'll need

an IBM PC or compatible with at least 384K bytes of RAM and DOS 3.0 or higher.

Price: \$795 for file server; \$195 per node.

Contact: XyQuest, 44 Manning Rd., Billerica, MA 01821, (508) 671-0888.

Inquiry 988.

Faxing in the Background

Macintosh users can send and receive facsimile transmissions with BackFAX while another application is running in the foreground. It runs with or without MultiFinder and requires an AppleFax modem and at least 1 megabyte of memory on any Mac.

You can keep an address book of the fax numbers that

you use, along with instructions on how and when to deliver the message. The program also has a feature that keeps track of what documents you need to send and will send them at the appropriate time. It will even retry busy numbers as many times as you specify.

To use BackFAX, you choose the BackFAX icon in the Chooser desk accessory and print the document to the BackFAX outbox. Then, using the BackFAX management application, you choose the send options you want, enter the address or retrieve it from the address book, and BackFAX will take it from there.

The program has some graphics capabilities that let you send your company logo on a cover page before your document. You can also incorporate complex graphics

documents designed with PageMaker or MacDraw II. **Price:** \$245.

Contact: Solutions International, 30 Commerce St., Williston, VT 05495, (802) 658-5506.

Inquiry 986.

Cutting the Cost of File Transfer

Thompson Computing is cutting the cost of transferring files on IBM PCs and compatibles with two new file-transfer utilities. 2PC is the full-blown version that costs only \$55. The program features a split-screen format to display files on both machines, and it sends files at 115,200 baud, the company reports.

Other features include pull-down menus, help screens, directory trees, chat mode, and the ability to tag files, view them, and delete them from a directory by wild cards or by selecting them individually. You can sort files by name or extension. The program also offers a print facility and lets you execute DOS commands.

2PC comes with a universal cable that connects to 9- or 25-pin serial ports.

2PCLite is a \$40 version that also transfers files at 115,200 baud and offers a split screen. It uses single-key-stroke commands rather than menus, and it doesn't have a chat facility.

The 2PC programs run on the IBM PC and compatibles with DOS 2.0 or higher and at least 256K bytes of RAM. **Price:** 2PC, \$55; 2PCLite, \$40.

Contact: Thompson Computing, 587F North Ventu Park Rd., Suite 306, Newbury Park, CA 91320, (805) 498-7653.

Inquiry 987.

continued

Managing Networks under 3 + Open

On the same day that 3Com announced shipment of its 3 + Open LAN Manager, the company introduced two network management products that run under 3 + Open.

3 + Open is an OS/2-based network operating system for computer networks that support DOS, OS/2, or Mac workstations.

3 + Open LAN View and 3 + Open LAN Secure enable the network administrator to control and secure resources on 3 + Open networks. They take advantage of named pipes, which is an industry-standard interface for LAN communications.

The LAN View application offers you a graphical view of server statistics regarding performance, utilization, and security, in addition to network errors. You can view the statistics as they occur or from a file. The ap-

plication also converts the stats into a data interchange format (DIF).

On-screen windows show an audit trail of network information, including time of errors. A click and zoom capability lets the network administrator select and expand the windows to help isolate trends and prevent network problems.

The LAN Secure application offers security through enhanced password and resource management. The network administrator can design customized password-control programs that make users change their passwords.

The security application also tracks and logs network resource access and use, so the administrator can monitor events such as invalid log-on attempts and printer use. You can also use the LAN Secure application to con-

vert LAN Manager audit trail data into alternate formats.

To run 3 + Open under DOS, you need an IBM PC, XT, AT, or PS/2 with at least 512K bytes of RAM and DOS 3.1 or higher.

Under OS/2 you need an 80286- or 80386-based IBM AT or PS/2 Model 50, 60, 70, or 80 with at least 2 megabytes of RAM and OS/2 1.0 or higher.

On Macintosh workstations you'll need 3Com 3+ for the Macintosh.

Price: LAN View, \$495 per server; LAN Secure, \$995 per network; LAN Manager Entry System (up to five users), \$995; LAN Manager Advanced (more than five users), \$2995.

Contact: 3Com Corp., 3165 Kifer Rd., Santa Clara, CA 95052, (800) 638-3266; in California, (408) 562-6400.

Inquiry 985.

ONCE IN A BLUE MOON...COMES A STROKE OF GENIUS.

SCANMAN™ HANDHELD SCANNING FOR \$299.

Pop any image up to 4" x 11" straight into your PC. Clip it, crop it, color it. Resize and rotate it. Merge, save, and store it.

Choose between high contrast or high detail. Import images into any best selling publishing application—PageMaker™, Ventura™ and many more. All you need is \$299, an IBM PC, XT, AT or PS/2 (or compatible) with a spare slot, and five minutes to set up.



Scan directly into graphics editor for a full range of paint utilities.



TO ORDER—or for the name of your nearest dealer—CALL: 800-231-7717, IN CALIFORNIA CALL: 800-552-8885.

Or fill in the coupon: BY

Name _____

Address _____

City/State/Zip _____

Phone _____

Send to: LOGITECH, 6505 Kaiser Drive, Fremont, CA 94555
 © 1988 Logitech. PageMaker and Ventura are trademarks of Aldus and Ventura Software, respectively.

ScanMan™
 The Hand-Held Scanner.



LOGITECH

Personal Peripherals. Worldwide.

Circle 159 on Reader Service Card (DEALERS: 160)

PC Tools Upgraded

PC Tools now runs on the Macintosh as well as the IBM PC. The IBM PC program has been upgraded to version 5.0 and has a new user interface with pull-down windows and support for a Microsoft Mouse. It also offers a superset of the DOS 4.0 shell, a desktop manager, a file encryption and compression program, and a backup program.

The Macintosh version offers a desk accessory, a backup utility, a file undelete feature, an unfragmenter, a recovery utility, and the ability to encrypt and compress files. **Price:** \$79.

Contact: Central Point Software, Inc., 15220 Northwest Greenbrier Pkwy., Suite 200, Beaverton, OR 97006, (503) 690-8090. **Inquiry 993.**

The DataShuttle is Launched

If your database, spreadsheet, and word processing programs are incompatible, DataShuttle can come to the rescue. It is a data retrieval



PC Tools now runs on the Mac.

and transfer program for updating databases and spreadsheets. You can convert files between most commonly used formats, such as ASCII, dBASE, SYLK, SIF, DIF, and Lotus formats.

You can select fields and rows to be processed and specify conditional transfers by comparing fields to alphanumeric values or cells.

DataShuttle runs on the IBM PC, XT, AT, PS/2s, and compatibles with DOS 2.1 or higher.

Price: \$129.95. **Contact:** Softway, Inc., 500 Sutter St., Suite 222, San Francisco, CA 94102, (800) 338-2852; in California, (415) 397-4666.

Inquiry 995.



DataShuttle's main menu.

Be Healthy and Happy

Designed for doctors, dietitians, and nutritionists, Two-Minute Nutrition Manager is a nutrition planning, tracking, and reporting program.

Registered dietitians helped design the program, which analyzes food items, recipes, meals, menus, and journals. It contains a 4500-item database and analyzes up to 73 nutrients. The program also has Food Management, Menu Planning, Preferred Meals, Food Exchanges, and Daily Journal modules. You can set up goals, and graphs will show you how close your actual food intake comes to meeting your goals. The program can even generate a shopping list of the foods it recommends.

Consumer and professional models are available. The consumer models have fewer foods and nutrients in the databases, and the professional models offer more extensive information plus the ability to personalize programs with on-line help.

The program is menu-driven and runs on the IBM PC, XT, AT, 80386-based systems, and the PS/2s with at least 2 megabytes of RAM, DOS 2.0 or higher, and a hard disk drive. There is also a version for the Macintosh II, Plus, and SE.

Price: Consumer models range from \$69 to \$149; professional models range from \$295 to \$695.

Contact: DPEX, 3333 Bowers Ave., Suite 190, Santa Clara, CA 95054, (800) 727-3438; in California, (408) 727-7121.

Inquiry 997.

Keyboard Help

Physically challenged persons who have trouble using the computer keyboard will find that the keyboard utility program Peck offers them easy access.

Peck is a RAM-resident program that lets you press keys sequentially instead of in combination. For instance, when you would need to press Control, Alt, and Delete at the same time, you can press one after another. The company reports that the program works with virtually every program written for the IBM PC family.

Peck is available alone, but it is also bundled with PRD+, a software program from Productivity Software that boosts your typing speed and increases accuracy.

Peck uses less than 1K byte of RAM and does not require PRD+. Both Peck and PRD+ require an IBM PC or compatible with DOS 2.0 or higher. PRD+ requires at least 55K bytes of RAM.

Price: Peck, \$9.95; PRD+, \$89.95.

Contact: Productivity Software International, Inc., 1220 Broadway, New York, NY 10001, (800) 533-7587; in New York, (212) 967-8666. **Inquiry 994.**



BYTE

The PERFECT Gift

REWARD THE COMPUTER ENTHUSIASTS ON YOUR GIFT LIST WITH A YEAR'S SUBSCRIPTION TO BYTE – THE DEFINITIVE GUIDE TO PERSONAL COMPUTING.

EACH GIFT WILL INCLUDE 12 ISSUES, PLUS A BONUS ISSUE DEDICATED TO IBM PC'S. YOUR FIRST GIFT WILL COST ONLY \$22.95 WITH ADDITIONAL GIFTS COSTING EVEN LESS; ONLY \$19.95 EACH – BOTH GREAT MONEY SAVING RATES WHEN YOU CONSIDER THAT ONE YEAR OF BYTE PURCHASED AT THE NEWSSTAND WOULD COST \$42! (CANADA: FIRST GIFT \$25.95, ADDITIONAL GIFTS \$22.95 EACH.)

DON'T GET CAUGHT IN THE HOLIDAY RUSH, SEND US YOUR GIFT LIST TODAY AND WE'LL DO THE REST.

YES! I want to send gift subscriptions to the following people and save money off the newsstand price!



TO: (1st Gift-\$22.95; Canada \$25.95)

IBD0086

Name _____

Address _____

City/State/Zip _____

(Each additional gift-\$19.95; Canada \$22.95 each)

Name _____

Address _____

City/State/Zip _____

Name _____

Address _____

City/State/Zip _____

Name _____

Address _____

City/State/Zip _____

FROM:

Name _____

Address _____

City/State/Zip _____

Payment enclosed* Bill me

Charge to: VISA MasterCard

Acct. # _____ Exp. date _____

Signature _____

*Please send this order card with payment in an envelope to: P.O. Box 550, Hightstown, NJ 08520-9893

FREE BONUS – A gift announcement will be sent in your name to the recipient.

Please allow 6-8 weeks for processing.



BYTE The PERFECT Gift

REWARD THE COMPUTER ENTHUSIASTS ON YOUR GIFT LIST WITH A YEAR'S SUBSCRIPTION TO BYTE – THE DEFINITIVE GUIDE TO PERSONAL COMPUTING.

EACH GIFT WILL INCLUDE 12 ISSUES, PLUS A BONUS ISSUE DEDICATED TO IBM PC'S. YOUR FIRST GIFT WILL COST ONLY \$22.95 WITH ADDITIONAL GIFTS COSTING EVEN LESS; ONLY \$19.95 EACH – BOTH GREAT MONEY SAVING RATES WHEN YOU CONSIDER THAT ONE YEAR OF BYTE PURCHASED AT THE NEWSSTAND WOULD COST \$42! (CANADA: FIRST GIFT \$25.95, ADDITIONAL GIFTS \$22.95 EACH.)

DON'T GET CAUGHT IN THE HOLIDAY RUSH, SEND US YOUR GIFT LIST TODAY AND WE'LL DO THE REST.



NO POSTAGE
NECESSARY
IF MAILED
IN THE
UNITED STATES

BUSINESS REPLY MAIL

FIRST CLASS MAIL PERMIT NO. 42 HIGHTSTOWN, NJ

POSTAGE WILL BE PAID BY ADDRESSEE



Computers and Communications Information Group

P.O. Box 550

Hightstown, NJ 08520-9893

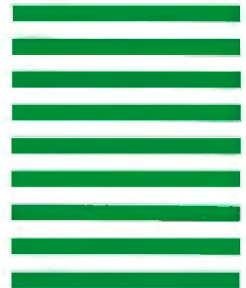

For Anyone Who Considers Code A Four Letter Word.

If you think writing program code is a dirty business, we have something to help you clean up your act.

It's called Matrix Layout. Layout lets you create programs that do exactly what you want, quickly and easily—without writing a single line of code. Layout does it for you automatically, in your choice of Turbo Pascal, Turbo C, Microsoft C, Quick-Basic or Lattice C. And if you're not a programmer, you can even create programs that are ready-to-run.

As the first true CASE (Computer Aided Software Engineering) development tool for the PC, Layout lets you write your programs simply by drawing an icon-based flow chart. They'll have windows, icons, menus, buttons, dialog boxes, and beautiful graphics and text. Like the Macintosh and the OS/2 Presentation Manager.

And because Layout is so efficient, everything you create will work incredibly fast, even on standard PC's with 256K and only one disk drive. To top it off, all your programs will feature Layout's automatic mouse support, sophisticated Hypertext functions, and decision handling.

The full Layout package also

comes with three additional programs:

Matrix Paint is a professional paint program that comes with a full palette of high-powered graphics tools, plus scanner support. And any picture or symbol that you draw or

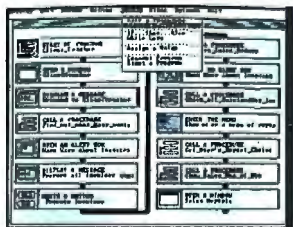

1. Draw a flow-chart.
2. Matrix Layout creates the program code.
3. Your program is complete.

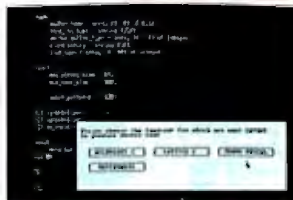

scan into Paint can be included in your program.

Matrix Helpmaker allows you to include an electronic manual in all your programs. Context-sensitive help windows, a table of contents, indexing, and the convenience of Hypertext functionality can now become a part of everything you create.

Finally, Matrix Desktop gives you the ability to organize your files and disks in a very Macintosh-like easy to see, easy to use way.

What's the cost? At just \$149.95 for the entire package, Layout speaks in a language you'll love to hear. Especially with our free customer support, no copy protection, and a 30-day, money-back guarantee.

Video Tape Offer

Our new demonstration videotape graphically illustrates how the many features of Matrix Layout will make a difference in your life. Call **1-800-533-5644** and order your VHS copy now (just \$9.95 for shipping and handling, credited against your purchase). In Massachusetts, call (617) 567-0037.

Do it today. Because once you see what Layout can do for you, we think you'll swear by it.

MATRIX
LAYOUT

Circle 529 on Reader Service Card

Matrix Software Technology Corporation • One Massachusetts Technology Center • Harborside Drive • Boston, MA 02128 • (617) 567-0037

Matrix Software/UK • Plymouth, England • 796-363 • Matrix Software/Belgium • Geldemaaksebaan 476 • 3030 Leuven • 016202064

The following are registered and unregistered trademarks of the companies listed: Matrix Layout, Matrix Paint, Matrix Helpmaker, Matrix Desktop, Matrix Software Technology Corporation, Macintosh, Apple Computer, Inc., OS/2 Presentation Manager, International Business Machines Corporation.

WHAT'S NEW

PACIFIC

The Portland Macintosh Users Group

The Portland Macintosh Users Group sponsors a series of eight classes for Macintosh beginners and a semiannual 2-day camp that is, according to its cosponsors, an opportunity to live, eat, and breathe Macintosh.

The 2-day Fall MacCamp focused on Tools and Techniques, including audio and video digitizing, laser printers, and mass-storage management. It also covered an introduction to macros, networking, disk recovery, viruses, the basic file system theory, adding commands to menus, and installing and using fonts, accessories, and function keys.

The Spring MacCamp, according to President Brian Seligmann, will focus on business productivity, including applications and accounting on the Macintosh.

PMUG College is the series of eight classes, one per week, that cover the desktop, graphics, the system, HyperCard, hard disk management, communications, fonts and desk accessories, and HyperCard authoring. Each course is held starting at 7 p.m. every Wednesday. PMUG also sponsors other workshops through its special-interest groups. SIGs at PMUG include professional production, 4th Dimension, public domain, advanced HyperCard, operating systems, and graphics.

PMUG has its own store located at the PMUG office on the fifth floor of the Gal-

leria. PMUG has about 1100 members and publishes a newsletter, *PMUG Mouse Tracks*.

Price: Annual dues, \$36.

Contact: The Portland Macintosh Users Group, Inc., P.O. Box 8895, Portland, OR 97207, (503) 228-1779.

Inquiry 1083.

Unix Classes for Programmers

Several classes for people with Unix experience are available through Specialized Systems Consultants. A class on applications of Unix utilities, which discusses data selection, cut and paste, file comparison, combining two tabular data files, file splitting, line number filtering, and

other Unix file management commands, will be held February 9. The class requires knowledge of the Unix basics and a Unix text editor.

Hands-On for Unix Programmers will cover the fundamentals of the Unix shell, file systems, managing processes and the environment, communication, language processing, report generation, programmers' utilities, and more. It will be held from February 15 to 17. The class is for people with a technical background, but not necessarily in Unix.

In March, SSC will sponsor a workshop in C programming. The class, which will run from March 13 to 17, is for programmers who want to learn how to write efficient structured programs in C.

continued

Major savings on Major brands

ALR Advanced Logic Research

ALR 386/220 #10 20MHz, 1MB, S/P\$2300
FlexCache 20388 #150 20MHz, 2MB, 150MB\$5350
FlexCache 25386 #150 25MHz, 2MB, 150MB, VGA\$6900

Apple Macintosh II\$3479
Macintosh SE\$2350
Laserwriter II NT\$3600

Archive
Tape 60M Internal\$ 550

AST Premium Computers
286 Mod 60 10 MHz, 512K, P/S\$1485
385 Mod 300 20MHz, 1MB, P/2S\$2935

AutoCAD v.9.0\$1925

Compaq
286 Mod 1\$1676
386-20 Mod 60\$5310
386-25 Mod 110\$6995

Epson Printers
FX850 9 pin. 264/55 cps\$ 365
LQ500 24 pin. 160/60 cps\$ 385
LQ850 24 pin. 264/88 cps\$ 540

Epson Computers
Equity 1+ w/floppy\$ 755
Equity 1+ w/floppy, 1-20 MB hard\$1175

HP
Deskjet\$ 675
Laserjet I w/toner\$1625
Scanjet w/interface\$1150

Microsoft Word 4.0\$ 265

NEC Laser Printer
LC #890 Postscript, 3MB, 35 fonts\$3150

Novell 4-user ELS\$ 425

Chips

256K-10 256K x 1 DRAM, 100ns\$1150
256K-12 256K x 1 DRAM, 120ns\$10.50
1MB SIMM\$Call
60387-25 Math coprocessor, 25MHz\$ 570

SAMSUNG Samsung Computers Best Buy

S-5000 XT, 8MHz, 512K RAM, Hercules graphics, P/S,\$ 670
DOS 1 - 360K floppy

S500 286, 10MHz, 612K RAM, Hercules graphics, P/2S,\$1060
DOS, 1 - 1.2MB floppy

S-800 80386-20 MHz, desktop model; includes 2 MB RAM, ..\$2675
EGA video interface

S-5000 60286-10 MHz, laptop; includes 20 MB hard disk,\$2150
supertwist LCD display (600 x 400)

Skyworld

4-1/2" wide, hand scanner w/OCR\$ 750

Seagate Hard Disks

ST238 w/XT controller 30MB\$ 305
ST251-1 40MB, 28ms\$ 405
ST277R-1 65MB, 28ms, RLL\$ 465

Toshiba Laptop Computers

T1000 512K, LCD, 1-720K\$ 745
T1200-H 1M, LCD, 20M\$2140
T3100-20 640K, Plasma, 20M\$2855
T3200-40 1M, Plasma, 40M\$3425
T5100-40 2M, Plasma, 40M\$4450

Ventura

Ventura Publisher v.2.0\$ 449

Video Seven

FastWrite VGA VGA video card.\$ 375

Severe Discount Computers, 14098 E. Firestone Boulevard, Computer City, CA 90670
(213) 802-7470 FAX #(213) 921-9597

California orders add sales tax. Call to confirm price and availability.

SEVERE

DISCOUNT
COMPUTERS

NEW!

Turn Your PC Into A Duplicating Machine!



Duplicating is a *snap* with THE DUPLICATOR TOOLKIT! Whether you need to make one copy or 100, this program is for you. It begins where DISKCOPY leaves off!

SUPER SPEED. Copy, compare, verify and format in *less* time than it takes to just copy with DOS!

NO DISKETTE SWAPPING. Make only one copy of the source diskette in RAM while you are duplicating or conveniently store and retrieve it from the hard disk for future duplication.

SUPPORT TWO DISK DRIVES. THE DUPLICATOR TOOLKIT switches from "A" to "B" drives on dual floppy systems for *even faster* copies!

EVERY COPY'S AN ORIGINAL. Multiple verification settings let you choose the level of data checking to ensure reliable copies.

MAKES LABELS TOO! You can even generate labels for each diskette. Optional serialization is included.

YOU'RE KEYSTROKES AWAY FROM PERFECT COPIES! If even a quick guide is too much to read, this is the program for you. Easy on-screen prompts will have you duplicating in *seconds*.

Get the *power* DISKCOPY can't give you. Order today!

MINIMUM SYSTEM REQUIREMENTS: IBM PC, XT, AT or compatible and 256K Ram. PC or MS DOS 2.0 or higher. Hard disk recommended. Not copy-protected.

THE DUPLICATOR TOOLKIT and Copy Technologies are Trademarks of Copy Technologies.

COPY TECHNOLOGIES

14252 Culver Drive, Suite 323
Irvine, CA 92714
(714) 975-1477

Circle 522 on Reader Service Card (DEALERS: 523)

I've had it with DISKCOPY! turn *my* PC into a Duplicating Machine! Please send me:

_____ copies of THE DUPLICATOR TOOLKIT at \$79.95 each plus \$4.50 shipping (\$10.00 Canada and outside U.S.). CA residents please add 6% sales tax.

NAME _____

ADDRESS _____

CITY _____ STATE _____ ZIP _____

Check/Money Order Visa Master Card

Account Number _____ Exp. date _____

mail coupon to: **COPY TECHNOLOGIES**
14252 Culver Drive, Suite 323
Irvine, CA 92714

The class requires a Unix editor.

Price: Hands-on Unix for Programmers, \$450; Applications of Unix Utilities, \$150; C Programming Workshop, \$750.

Contact: Specialized Systems Consultants, Inc., P.O. Box 55549, Seattle, WA 98155, (206) 527-3385. **Inquiry 1080.**

Conferences in the Sun

Scientific visualization, industrial/graphics design, CAD/CAM, input devices, and true three-dimensional and factory-floor graphics are some of the topics scheduled for the 11th annual Computer Graphics:

Assessment and Forecast conference, which will be held at the Sheraton Grand on Harbor Island in San Diego. Mergers, acquisitions, and other business realignments will also be covered.

Speakers from the following companies have been scheduled to speak at the conference, which will run from January 11 to 13: Prime Computer, Intecolor Corp., Cricket Software, Versatec, Summagraphics, Digital Equipment Corp., Versacard Corp., AutoDESK, Hughes Aircraft, and more.

Price: \$945 for first attendee; \$845 for each additional attendee. **Contact:** Frost and Sullivan, Inc., 106 Fulton St., New York, NY 10038, (212) 233-1080. **Inquiry 1081.**

The Usenix Association, a nonprofit group that promotes Unix, Unix-like systems, and C, is sponsoring its Winter 1989 Technical Conference of tutorials and technical sessions in San Diego from January 30 to February 3.

The conference will be held at the Town and Country Hotel in San Diego. Usenix also publishes *login*, a bi-monthly newsletter, and *Computing Systems*, a technical quarterly.

Price: Technical sessions: \$150 for Usenix members, \$195 for nonmembers (before January 9). Tutorials: \$225 for one, \$395 for two. **Contact:** Usenix Conference Office, P.O. Box 385, 16951 Pacific Coast Hwy., Sunset Beach, CA 90742, (213) 592-1381 or (213) 592-3243. **Inquiry 1082.**

Getting Software Out on Time

Completing a major software project is one thing—getting it done on time is quite another. Capers Jones, founder of Software Productivity Research, is conducting a seminar for vice presidents and other managers who manage software projects. Topics will include the metrics of project management and the impact of factors on productivity.

The seminar will be held at the Los Angeles Airport Marriott on February 2 and 3. **Price:** \$765. **Contact:** Digital Consulting, Inc., 6 Windsor St., Andover, MA 01810, (508) 470-3880. **Inquiry 1079.**



ALTEC ZIP-386
\$1,995

- * Intel 80386 microprocessor
- * 1M high speed memory installed
- * Expandable to 10 MB
- * Phoenix 386 BIOS or Award 386 BIOS
- * 4 speed (4.77/6/8/16 MHz)
- * 200W power supply
- * Case with re-set button
- * Enhanced keyboard
- * Hard disk/floppy disk controller card
- * 1.2M floppy disk drive
- * Monochrome/Graphics card with printer port
- * HI-RES Monochrome Monitor
- * User's manual
- * 1 year warranty



ALTEC-286 Enhanced System
\$995

- * Intel 80286-10 microprocessor
- * 512K RAM
- * Dual speed 6/10 MHz
- * 200W power supply
- * AT style case
- * Enhanced keyboard
- * Hard disk/floppy disk controller card
- * 1.2 M floppy disk drive
- * Monochrome/Graphics card with printer port
- * HI-RES Monochrome Monitor
- * Phoenix BIOS
- * User's manual
- * 1 year warranty



ALTEC-XT Turbo System
\$675

- * 8088-1 microprocessor
- * 4.77/10 MHz
- * 640K RAM
- * 150W power supply
- * AT style keyboard
- * Floppy controller card
- * 360K floppy disk drive
- * Monochrome/Graphics card with printer port
- * HI-RES Monochrome Monitor
- * Phoenix BIOS
- * User's manual
- * 1 year warranty



ALTEC-286jr System
\$975

- * Intel 80286-10 microprocessor
- * 512K RAM
- * 200W power supply
- * ATjr style case
- * AT style keyboard
- * Hard disk/floppy disk controller card
- * 1.2M floppy disk drive
- * Monochrome/Graphics card with printer port
- * HI-RES Monochrome Monitor
- * User's manual
- * 1 year warranty

ADDITIONAL FEATURES	ADD	
Color System	-\$200.00	
EGA System	-\$400.00	
20M hard disk	-\$205.00 (386 & 286)	\$265.00 (XT)
40M hard disk	-\$355.00 (386 & 286)	\$425.00 (XT)
360K floppy disk drive	-\$80.00	
720K 3 1/2" floppy disk drive	-\$80.00	
1.44M 3 1/2" floppy disk drive	-\$125.00	



ALTEC Technology Corporation
5751 Rickenbacker Road, Los Angeles, CA 90040
Tel: 1-213-888-9100
Order Desk: 1-800-255-9971

* Intel is registered trademark of Intel Corporation.
* Phoenix is registered trademark of Phoenix Technologies Ltd.
* Award is registered trademark of Award Software Inc.
* AT is registered trademark of IBM Corporation.

Important TIPS* for BYTE Subscribers: Receive Product Information 10 Days Earlier!

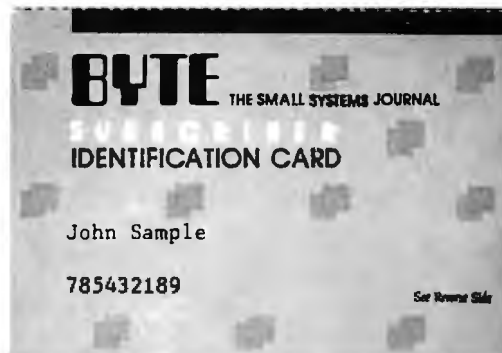

All you need is a touch-tone telephone and your subscriber I.D. number. See instructions facing the Reader Service Index in the back of this issue for outrageous time-saving opportunities!

*BYTE's Telephone Inquiry Processing Service

Enhance!TM makes DOS perform like an operating system should!

Enhance!TM takes many of the powerful features of **UNIXTM**, **VMSTM**, and **OS/2TM** and adds them to DOS. Features like selecting files, *any way you want* when listing, deleting, copying, and even moving them, sorted directory listings, and the ability to assign commands to symbols. All of this from your familiar DOS prompt (no menu selections to slow you down).

All existing DOS commands and features are still available. The COMMAND.COM shell is **enhanced**, becoming a **Super-Shell**, rather than bypassed.

Enhance! works with all DOS versions since 2.0 (including 4.0) and comes with a well-structured and complete manual. Enhance! is fully RAM resident, and may load and run in normal or expanded memory.

Enhance! is a trademark of Cortex Computing Corporation. All other products referenced are trademarks of their respective companies.

IT'S NOT ON THE MENU!!

From your DOS prompt, **Enhance!** lets you do many powerful things with just one command, like:

- **LIST** alphabetically all filenames in all directories that start with "A", end with "Z", and have a vowel somewhere in between.
- **MOVE** multiple files... and directories.
- **COPY** all files modified *this week*, *except* those with .BAK extensions.
- **CHANGE** the time and date of any file to anytime you want.
- **REALLY DELETE** a file so it can't be "undeleted" later.

In addition to this robust file management, **Enhance!** gives you:

- **FULL SYMBOL/ALIAS** defining and processing, including abbreviations.
- **RETRIEVE** previously entered commands.
- **POWERFUL EDITING** of your command line.
- **ENTER** several commands at a single DOS prompt.
- **SAVE** your current drive and directory location and **RETURN** to them later.
- **AND MUCH, MUCH MORE!**

ORDER BEFORE JAN. 15, 1989 and **SAVE \$30**. REGULARLY \$79.95. NOW FOR A LIMITED TIME ONLY \$49.95 plus \$4 shipping & handling. - Texas residents please add sales tax.

CORTEX
computing corporation

1-214-492-5124
P.O. Box 116788 • Carrollton, TX 75011

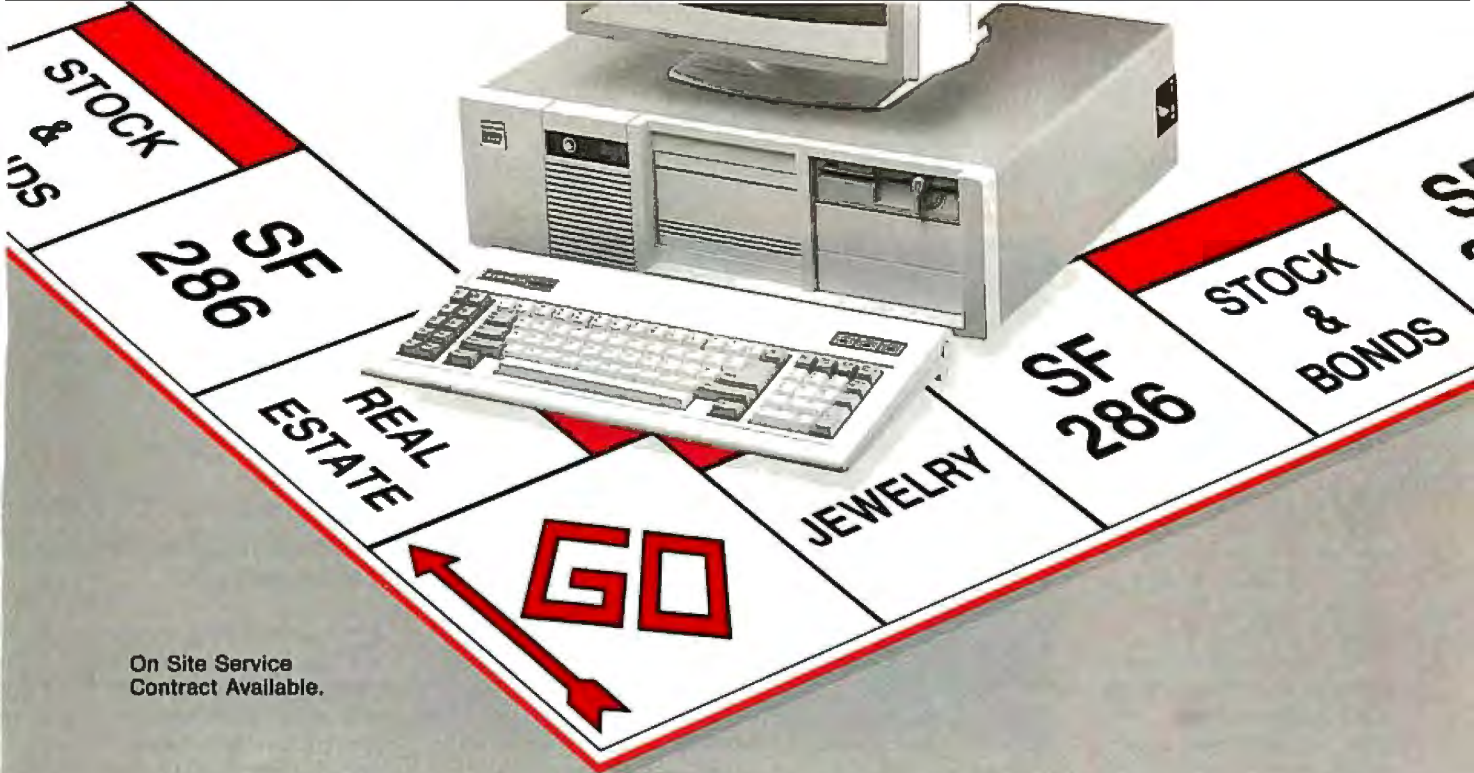

On Site Service
Contract Available.

Don't Just Buy a Computer Invest in a SF-286

SF-286 (Hard Drives Optional)	8MHz	10MHz	10MHz (0 WS)	12MHz (0 WS)	16MHz (386)
Mono System	\$995	\$1119	\$1349	\$1499	\$2050
EGA System	\$1369	\$1569	\$1720	\$1870	\$2349

Basic System Features:

80286-16 bit CPU, 80287 socket, 512K RAM expandable to 1MB, fully compatible AMI BIOS, 1.2MB Floppy Disk Drive, combined floppy/hard disk controller, Keytronics 101 enhanced keyboard, clock/calender with battery backup, 195 watt power supply, 48 hour burn-in testing, operations manual, one year limited warranty and optional on-site maintenance agreement.

SF-286-8MHz 20Mb Mono Special.....\$1249

Basic System features plus: Monographics board with printer port, Samsung 12" amber mono monitor and Seagate 20Mb hard drive.

SF-286-8MHz 20Mb EGA Special.....\$1599

Basic System features plus: Everex EGA graphics board, Evervision EGA color monitor and Seagate 20Mb hard drive.

SF-286-8MHz 20Mb VGA Special.....\$1839

Basic System features plus: Everex EVGA graphics board (640x480, 800x600, up to 256 colors), Evervision multisync color monitor and Seagate 20Mb hard drive. Add \$60 for upgrade to Mitsubishi Diamond Scan Monitor.

SF-286-12MHz 20Mb Mono Special.....\$1749

Basic System features plus: Monographics board with printer port, Samsung 12" amber mono monitor and Seagate 20Mb hard drive.

Upgrade to 40Mb Seagate hard drive, Add \$160
Upgrade to 80Mb Seagate hard drive, Add \$449

Circle 532 on Reader Service Card

EGA Bundle.....\$479

Everex EGA autoswitch graphics board and Evervision EGA color monitor.

Super EGA Bundle.....\$579

Everex EGA Deluxe autoswitch graphics board (640x480, 752x410), and Evervision multisync color monitor. Add \$60 to upgrade to Mitsubishi Diamond Scan Monitor.

Super VGA Bundle.....\$709

Everex EVGA graphics board (460x480, 800x600, up to 256 colors) and Evervision multisync color monitor. Add \$60 to upgrade to Mitsubishi Diamond Scan Monitor.

Hard Disk Specials (for PC)

Seagate ST225 20Mb + Controller.....\$265
Seagate ST125 20Mb + Controller.....\$329
Seagate ST238 30Mb + Controller.....\$289
Seagate ST251 40Mb + Controller.....\$449

Hard Disk Specials (for AT)

Seagate ST125 20Mb (40ms).....\$269
Seagate ST138 30Mb (40ms).....\$339
Seagate ST251 40Mb (40ms).....\$369
Seagate ST251-1 40Mb (28ms).....\$429
Seagate 4096 80Mb (28ms).....\$649

Everex Modems

Everex Evercom external and internal modems (fully Hayes compatible) with Bitcom communications software.

Internal 1200 Baud Modem.....\$80
External 1200 Baud Pocket Modem.....\$139
Internal 2400 Baud Modem.....\$149
External 2400 Baud Modem.....\$199

Misc. Specials

Mini I/O (PAR, SER, CLK, CAL).....\$55
Mini I/O with Game Port.....\$65
Mini I/O + Logitech C7 serial mouse.....\$119
Teac 3.5" 720K floppy drive.....\$99
Teac 3.5" 1.4Mb floppy drive.....\$129
150 Watt Power Supply.....\$49
200 Watt Power Supply.....\$79
MS Dos 3.3 with GW Basic.....\$90
3Mb EMS memory board w/ OK (AT).....\$99

Seagate, Samsung, Everex, Evervision, Mitsubishi, Hayes, Bitcom, Logitech, are trademarks or registered trademarks of their respective companies.

SFMCRO5 V.1 10/11/88



1825 Lombard Street
San Francisco, CA 94123

California Orders, Information
(415) 929-1505

National Order Desk (800) 237-5631
Technical Support (415) 929-1607

Hours: M-F, 9 to 5 (PST)
University P.O.'s and Dealer
Inquiries are Welcome

TERMS: We accept MasterCard, VISA (no surcharge), American Express, COD's (Certified Funds) and approved company P.O.'s. California residents please add sales tax. 10% fee for unauthorized returns (call for PMA number). Returns must be shipped freight prepaid by customer. Prices are subject to change without notice. We reserve the right to substitute equivalent items. We are not responsible for typographical errors.

Laser Printer Does Graphics, Text on Both Sides

With Hewlett-Packard's LaserJet IID printer, you can print text on both sides of a page at 7.4 pages per minute in 300- by 300-dot-per-inch resolution. The printer comes with 14 internal fonts, an S2 font cartridge that has 10 proportional fonts, and 640K bytes of standard memory, expandable to 4 megabytes.

The printer holds up to 200 sheets of paper in each of two bins, and you can print documents so that you can bind them on the left (book-style) or on the top (calendar-style). With an optional envelope feeder, the LaserJet IID can pull paper from both paper trays and the envelope feeder, resulting in presorted, ready-to-mail documents. The envelope feeder holds up to 50 envelopes.

The LaserJet IID works with the IBM PC, XT, AT, PS/2s, and compatibles. **Price:** \$4295; \$350 for the optional envelope feeder. **Contact:** Hewlett-Packard, Inquiries, 19310 Pruneridge Ave., Cupertino, CA 95014, (800) 752-0900. **Inquiry 1084.**

Send Your Child to the Right School

The College Explorer is a program that can help you organize and rate prospective colleges and universities. You can use it to sort colleges on the basis of enrollment size, cost, acceptance rate, freshman test scores, and minimum qualifying grade on the Advanced Placement exams.

You can also tailor the program to rate college features such as majors, location, and activities by level of impor-



LaserJet IID can have up to 4 megabytes of memory.

tance to the student before you search its file of 2800 colleges and universities. Based on your ratings, the program will provide two lists: An A list that contains those institutions that match all the desired features, and a B list that contains schools that match the necessary features.

The program's catalog of college characteristics includes financial aid and a freshman class profile, including the grade-point average, high school class rank, and admission test scores. Other categories include degree level, majors offered, location, enrollment size, housing, athletics, student activities, and religious affiliations.

Two versions are available: One works with the Apple IIc, IIe, and IIGS, and the other works with the IBM PC, XT, AT, and compatibles. The Apple IIe requires an 80-column extension card. The IBM PC requires 256K bytes of RAM and DOS 2.1 or higher. **Price:** \$49.95. **Contact:** The College Board, 45 Columbus Ave., New York, NY, 10023, (212) 713-8000. **Inquiry 1085.**

Color Video System for the Mac II

A color video system from Nutmeg Systems uses a processor-less design that lets it display color faster and with more clarity than other conventional video boards, the company reports. The Nutmeg UltraView Video System increases the data transfer rate of the Mac II to a video card by using a block transfer method between cards on the Mac's NuBus. The card can also transfer via serial method.

The key to the system is the Nutmeg 256 color video interface, a 1-, 2-, 4-, or 8-bit selectable interface card that includes an expansion slot for video memory and a second slot for video performance peripherals.

The system is bundled with a 19-inch landscape monitor from Mitsubishi Electric Corp. that offers 72-dot-per-inch resolution on a 1024- by 768-pixel display, with a 79-Hz refresh rate for a flicker-free image. **Price:** \$5798; \$3999 for the monitor alone; \$1799 for the Nutmeg 256 interface. **Contact:** Nutmeg Systems, Inc., 25 South Ave., New

Canaan, CT 06840, (800) 777-8439; in Connecticut, (203) 966-3226. **Inquiry 1086.**

Alternative to Dedicated Serial-Data Analyzers

Serialtest is a software solution to monitoring and troubleshooting problems in serial-data communications. The program lets you use your PC-to-monitor communications between two devices or on your local-area network.

Serialtest has two modes. In monitor mode, you can eavesdrop on one or both sides of your data flow; in source mode, you can send data from one side of the communications link, sending from your keyboard, from a file, or from both simultaneously.

You can use the program to observe data and control signal changes as they occur; create and manage triggers that control the monitoring and capturing of the data; and select device titles, parity, word length, and stop bits. You can view each byte in ASCII, extended binary-coded decimal interchange code, hexadecimal, binary, octal, and decimal form. Serialtest lets you specify the size of the capture—you're limited only by the amount of the system RAM.

The program works with the IBM PC, XT, AT, and compatibles with one or two serial I/O adapters, 300K bytes of RAM, and DOS 2.0 or higher. A hard disk drive is not required. **Price:** \$495. **Contact:** Advanced Computer Consulting, Inc., 700 Harris St., Suite 101, Charlottesville, VA, 22901, (800) 562-8378; in Virginia, (804) 977-4272. **Inquiry 1087.**

UNDER-WARE ELECTRONICS

JUST IN!
SMITH-CORONA
GREEN COMPOSITE
MONITORS.

\$44.00
REMANUFACTURED
FULL WARRANTY

**UNDER-PRICED HARD-WARE &
UNDER-PRICED SOFT-WARE**

**ALL
MERCHANDISE
GUARANTEED**

IN BUSINESS FOR OVER TWELVE YEARS

SAVE MORE! DESIGN YOUR OWN SYSTEM

ITT XTRA XP

XT-286 SYSTEM

80286 PROCESSOR, 4.77/6.0 MHZ
512K RAM, SERIAL AND PARALLEL,
FLOPPY DRIVE CONTROLLER,
KEYBOARD, USER GUIDE.

ORIGINAL LIST \$1,995.00

**SYSTEMS START
AS LOW AS
\$499.00**

**FREE
DOS 3.1
W/ GW BASIC**
WITH PURCHASE

PERIPHERAL CHOICE / DRIVE CHOICE	WITHOUT VIDEO AND PRINTER	MONO MONITOR & CARD	COLOR MONITOR & CARD	* MONO MONITOR, CARD & DIABLO 630 PRINTER	* COLOR MONITOR, CARD & DIABLO 630 PRINTER
NO DRIVES	\$499.00	\$579.00	\$679.00	\$879.00	\$979.00
360K FLOPPY & 20 MB HD	\$799.00	\$879.00	\$979.00	\$1179.00	\$1279.00
360K FLOPPY & 30 MB HD	\$899.00	\$979.00	\$1079.00	\$1279.00	\$1379.00
360K FLOPPY & 40 MB HD	\$1099.00	\$1179.00	\$1279.00	\$1479.00	\$1579.00

TO CHOOSE THE CONFIGURATION YOU WANT, SIMPLY LINE UP YOUR CHOICE OF DRIVES WITH YOUR CHOICE OF MONITOR AND PRINTER.

• BEST VALUES

DIABLO

630 ECS/API

40 CPS DAISYWHEEL PRINTER

\$349.00

ORIGINAL LIST: \$2,295.00

(API/IBM CABLE FREE)

•••••
TRACTOR FEED
FOR DIABLO 630

\$89.00

QUANTITIES LIMITED. ALL MERCHANDISE AVAILABLE ON A FIRST COME, FIRST SERVE BASIS. ALL MERCHANDISE GUARANTEED. 15 DAY RETURN PRIVILEGE WITH RMA. RESTOCKING CHARGE ON RETURNS. NO SURCHARGE FOR MC, VISA, OR DISCOVER-CARD. COD ORDERS ACCEPTED WITH CASH OR CASHIERS CHECK.

UP TO 82% OFF!! THOMSON MONITORS

COLOR LIST OUR PRICE

14" COMPOSITE.....\$595.00 \$99.00

14" RGBI CGA.....\$499.00 \$199.00

MONOCHROME

12" GREEN TTL.....\$199.00 \$69.00

12" GREEN COMP.....\$134.00 \$49.00

12" AMBER COMP.....\$169.00 \$59.00

FULL FACTORY WARRANTY
FACTORY REFURBISHED

800-442-1408

IN KS 316-942-9797

FAX 316-942-9816

UNDER-WARE

ELECTRONICS

1970 S. WEST ST. #365

WICHITA, KS 67213

NEC MULTISPEED-EL

4.77/9.54 MHZ, 640K RAM,
DUAL 720K DISK DRIVES,
PARALLEL & SERIAL PORTS,
RGB MONITOR PORT,
ELECTRO-LUMINESCENT
BACKLIT SCREEN.

DOS 3.2, POP-UP SOFTWARE.
NI-CAD BATTERY PAK &
A C ADAPTER INCLUDED.

\$1,199.00

ORIGINAL LIST: \$2,495.00

PLUS

FREE CARRYING CASE

DELUXE SEMI-RIGID, BLACK CASE
WITH SHOULDER STRAP
\$129 RETAIL... FREE WITH PURCHASE

PROCORP MOUSE

W/ DR. HALO III

ONLY \$59.00

DATAPRODUCTS 8072

400 CPS DOT-MATRIX PRINTER,
100 CPS LETTER-QUALITY,
18-WIRE HEAD, WIDE CARRIAGE,
COLOR PRINT OPTION,
BUILT-IN TRACTOR FEED,
1 YEAR WARRANTY.

\$599.00

ORIGINAL LIST: \$2,099.00

CANON LASER PRINTER MODEL LBP-8A1

8 PAGE PER MINUTE,
CANON CX ENGINE

\$899.00

ORIGINAL LIST: \$3,000.00

1,000 PLUS ITEMS IN STOCK.
PRINTERS, SOFTWARE, DRIVES, ETC.
ALL UNDER-PRICED
CALL AND TELL US WHAT YOU NEED

Host Adapter for the IBM PC AT

Future Domain Corporation's TMC-881 is a mass-storage small-computer-system-interface (SCSI) controller that supports up to six drives on the IBM PC AT or compatibles. The product includes a full-length board and software drivers for DOS, Novell, and Xenix.

According to Future Domain, the board's driver for Novell Advanced NetWare 286 version 2.1 provides you with twice the throughput of conventional AT controllers and includes overlapped I/O between multiple drives.

The TMC-881 supports most SCSI-based disk drives, tape drives, optical disks, and CD-ROM players.

Price: \$355.

Contact: Future Domain Corp., 1582 Parkway Loop, Tustin, CA 92680, (714) 259-0400.

Inquiry 1063.

Create 3-D Graphs in FoxBase Plus

Fox Software has released a graphics development software package that can create two- and three-dimensional business and scientific graphs with FoxBase data files. The program can also create what Fox calls four-dimensional graphs, a form of stacked three-dimensional graph that displays four parameters.

FoxGraph's data management system can support up to 16,000 pages, rows, and columns. You can create plots of up to 36 by 48 inches on most plotters and Presentation Technologies' Image slide maker. The program can also create

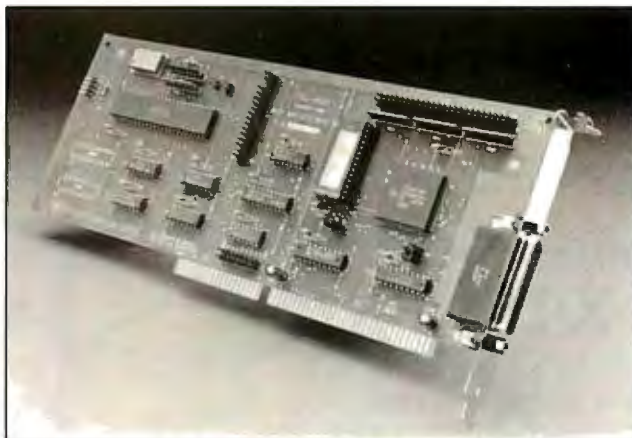

The TMC-881 is designed for IBM PC ATs and compatibles.

IMG (image) files for Ventura Publisher and Tag Image File Format files. The program works with a host of laser printers and supports PostScript output devices.

FoxGraph works with FoxBase Plus 2.10, FoxBase Plus/386, and FoxBase Plus/LAN. FoxBase Plus 2.10 works on the IBM PC, XT, AT, PS/2s, and compatibles and requires DOS 2.0 or higher with FoxBase Plus 2.10, and DOS 3.1 or higher in the 80386 and LAN versions. FoxBase Plus/386 requires 2 megabytes of extended memory and a math coprocessor. FoxGraph supports CGA, EGA, VGA, and Hercules monochrome boards and requires 640K bytes of RAM. A hard disk drive is required.

Price: \$295.

Contact: Fox Software, Inc., 118 West South Boundary, Perrysburg, OH 43551, (419) 874-0162.

Inquiry 1062.

Routines for QuickBASIC Programmers

To help prevent QuickBASIC programmers from reinventing the wheel, Project X Software Development has released more than 350 routines and several add-on programs, including an object screen generator, a library

manager, and a source code formatter.

The Object Screen Generator lets you create any free-form screen, generate code for the screen, and modify it at a later date, the company reports. You can use the Library Manager with QBTools, QuickBASIC 4.0, and Bascom 6.0. The manager is designed to manage object files as they are switched in and out of libraries. When it creates a LIB file, the manager automatically resolves all external calls for you. An Include manager can build files that include only the routines that are specific to a program.

Routines in the program include B-tree indexing, spooler control, screen and window management, input routines, pull-down menus, dialog boxes, scroll and list boxes, mouse control, low-level file access, sorting, searching, keyboard status, bit manipulation, and more.

The program works on the IBM PC, XT, AT, PS/2s, and compatibles with DOS 3.0 or higher and 512K bytes of RAM.

Price: \$89.95.

Contact: Project X Software Development, Inc., 1257 Marlyn Rd., Philadelphia, PA 19151, (800) 678-2112; in Pennsylvania, (215) 922-2557.

Inquiry 1059.

Running MS-DOS on Your Macintosh

PerfecTEK's MS-DOS coprocessor board for the Macintosh II lets you run MS-DOS software on your Macintosh and attach peripherals for both operating systems on one machine, the company reports.

Based on the Intel 80286 processor and running at 10 MHz, the Mac/DOS II board provides IBM-compatible parallel and serial ports; Macintosh font, style, and size selection in DOS applications; and WYSIWYG printing from DOS applications on the Imagewriter and LaserWriter series of printers. The board can also provide 1 megabyte of expansion memory when you're not using it to run MS-DOS applications.

The Mac/DOS II hardware consists of a 32-bit board that fits into a single Macintosh II slot. It has a socket for an optional 80287 math coprocessor. Included with the package are file transfer utilities and a cable that you can use to directly transfer files from the PC to the Mac without buying an external 5¼-inch floppy disk drive for the Macintosh II. An MS-DOS hard disk drive can be emulated on any Macintosh-compatible hard disk drive. You can select the size of the virtual disk drive from 1 megabyte to 32 megabytes.

The board and software require a Macintosh II running System 4.0 and Finder 5.4 with 1 megabyte of memory. To run MultiFinder 1.0 effectively, 2 megabytes are required, the company reports. The package supports MS-DOS 3.2 or higher.

Price: \$1495.

Contact: PerfecTEK Corp., 1455 McCarthy Blvd., Milpitas, CA 95035, (408) 263-7757.

Inquiry 1061.

WAREHOUSE'S PRICE TO THE PUBLIC

Is Your PC or XT System Slowing You Down?

Is NEW Software forcing you to look at Expensive New 80286/386 Hardware?

Look no further, and SAVE your money for your next generation computer system.

Upgrade your PC or XT system to a true AT 80286 Processing Power for only \$199 with the Tiger 286 AXT Mother Board.

Use all existing software and hardware - 100% compatible

No hidden costs - Use Your Existing 150ns Memory, Keyboard, Hard Disk, Floppies and Controller even the same Case and Power Supply(*).

*PC-1 Users with 5 slot mother board may require new case and power supply changes.

- Excell User Says "The Tiger 286 is \$200 Solution To A \$2k Problem."
 Lotus User Says "Now My Home Computer Matches The Speed Of My \$1800 Office AT System."
 Engineering User Says "The Best And Most Cost Effective Upgrade I Have Ever Put In My Computer."
 AutoCAD User Says "Inexpensive Hardware Upgrade That Decreases Regeneration Time And Increases Productivity."
 C Programmer Says "My 10 Minute Compile On My Old 10 Mhz TurboXt Now Only Takes 1 Minute And 24 Seconds. What A Difference."



TIGER 286 MOTHER BOARD

The ultimate Low Cost, High Performance, 80286 replacement Mother Board specifically designed to use in a low cost XT system with existing peripherals and existing memory.

The secret is a 80286 CPU running at 8 MHz and up to 1 MB of zero wait state on-board 16 Bit DRAM. Directly replacing the 8080 CPU Mother Board with a compatible 80286 board is the only way to achieve maximum XT Performance without sacrificing compatibility.

FUNCTIONAL SPECIFICATIONS

- CPU: 80286-8 Microprocessor
- Coprocessor: 80287 Numeric Processor Soc (80287 optional)
- Up to 1 MB of Parity Checked RAM on Board
- High Performance 0 wait state bus controller
- 16 bit system bus to XT I/O Channel Bus Interface Unit (8 XT 8 Bit Slots)
- 100% Software Compatible
- Award BIOS

PHYSICAL SPECIFICATIONS

- Size: 12"x8.5"
- PCB Layout: 16 Pin and 1 Gi
- Power: AT PC Power

Price Performance Leader - TIGER 286

System	Processor	Speed	Price
XT	8086	4.7Mhz	\$90
XT V20	80286	10Mhz	\$120
TIGER 286	80286	8Mhz	\$199
AT	80286	8Mhz	\$250(*)
TIGER 286	80286	10Mhz	\$249

Conversion Cost to Replace Mother Board
 * Plus New Case, Power Supply, Controller

\$199

Complete Mother Board - Memory not included
 (800) 548-2644 - Toll Free Order Only Hot Line

Advanced Computer Products
 1630 Oakland Road, Suite 100A
 San Jose, California 95131
 (408) 437-1003
 (800) 548-2644 (Orders Only)

\$425

COMPLETE SYSTEM WITH SWIVEL BASE MONITOR

8/4.77 MHz TURBO MOTHERBOARD
 256K RAM EXPANDABLE TO 640K
 150 WATT POWER SUPPLY
 360K FLOPPY CONTROLLER
 360K FLOPPY DRIVE
 AT TYPE KEYBOARD
 MONOGRAPHS/PRINTER CARD
 HI-RES MONO AMBER MONITOR
 ★ 10 Mhz System add \$18.00

\$799

COMPLETE SYSTEM WITH SWIVEL BASE MONITOR

10/6 MHz MOTHERBOARD
 512K RAM EXPANDABLE TO 1MB
 200 WATT POWER SUPPLY
 1.2MB FLOPPY DRIVE (CONTROLLER)
 ENHANCED KEYBOARD (101)
 MONOGRAPHS/PRINTER CARD
 HI-RES MONO AMBER MONITOR
 ★ 12 Mhz System add \$20.00

COME WITH ONE FULL YEAR WARRANTY

FLOPPY CONT \$19
MULTI I/O CAR \$49
AT I/O CARD \$45
DTX/WD AT	
FD/HD CONTROLLER	\$105/112
MONOGRAPHS CAR	
COLOR GRAPHIC W/P	
EGA (640 - 350)	
VGA (600 - 800)	\$75
1200/2400 INT. M	
PC MOUSE COM	

4.77/10 MHz TURBO MOTHER BOARD	\$79
4.77/8 MHz TURBO MOTHER BOARD	\$69
288 8/10 MHz MOTHER BOARD (OK)	\$235
288 6/8/10/12 MHz MOTHER BOARD (OK)	\$245

INTEL EISA (CARD) 10/6	
OT MATRIX PRINTER	FROM \$145
OWER STATION (WITH S \$18
OWER STRIP \$8.00
50W/200W POWER SUPPLY \$42/60
360 (AT-XT SWITCHABLE) KEYBOARD \$30
NHANCED (AT-XT SWITCHABLE)	
EYBOARD \$42
CABLES (ALL	OM MADE

HI-RES AMBER M	
COLOR MONITO	
EGA MONITO	
MULTISYNC	

HARD DISK

ST 125 Kit	\$290
ST 225 Kit	\$249
ST 251 Kit	\$395
ST 251 - 1	\$385
60MB Fast Hard Disk	\$499
85 MB Fast Hard Disk	\$559

WE WHOLESALE PRODUCTS
 WE UPGRADE & REPAIR COMPUTERS
 CALL FOR YOUR FREE ESTIMATE
 WE DEVELOPE QUALITY SYSTEMS AT A REASONABLE
 RATES
 ALL TYPES OF PROGRAMMING AVAILABLE
 SPECIALIZING IN DATABASE
 HARDWARE/SOFTWARE INSTALLATION
 TRAINING AND SUPPORT
 CALL FOR APPOINTMENT

WE CARRY TOO MANY ITEMS TO LIST FULLY
 Please call for products not listed
 PRICES SUBJECT TO CHANGE WITHOUT NOTICE.
 SALE PRICES APPLY TO STOCK ON HAND

OWNED & OPERATED BY ENGINEERS

COMPUTERS - ELECTRONICS

Wholesales • Retail • Service

98 S. Abel St., Milpitas, CA 95035
 Sale : (408) 263-6066
 Tech. Hot Line : (408) 263-6067 Fax : (408) 263-8385

★ Ask us about how to use your computer to send Telex & Telegram at low price

Say It, Don't Type It

Covox's Voice Master Key is a memory-resident program that lets you substitute voice commands for keyboard commands, the company reports. For example, if you're working in a DOS-based CAD program and you want to zoom, you say "zoom" instead of moving the cursor to the appropriate icon and clicking the button. You can also use the program to replace commands for underline, bold, and other word processor commands; to change fields or scan records in a database; or to perform macros in a spreadsheet.

When you want to add a voice command, you press the hot keys, and an editing menu pops up. You type in the word you want the program to listen for, say it twice into the included microphone, and then type in the desired keyboard response. Depress the Escape key, and you're back in your application. You can adjust the program for background noise and sensitivity. Voice Master Key provides for up to 256 voiced inputs in 16 levels. You can also tell the program to display along the top or side of your screen all words that are "waiting" to be recognized.

The package includes a half-length board, a microphone headset, and software on a 5 1/4-inch floppy disk. Voice Master Key requires 64K bytes of memory and works on the IBM PC, XT, AT, PS/2 Models 25 and 30, and compatibles with DOS 2.1 or higher.

Price: \$129.95.

Contact: Covox, Inc., 675-D Conger St., Eugene, OR 97402, (503) 342-1271.

Inquiry 1058.



You can also use Voice Master with computer adventure games.

VGA-Based Photo Image Editing

Microtek Lab is marketing a gray-scale picture editor for VGA-based systems that supports the inclusion and manipulation of photographic images to create camera-ready documents. Called Picture Publisher, the program lets you display and manipulate up to 256 levels of gray and accepts photographic scanned images in Tag Image File Format (TIFF). It can also export encapsulated PostScript files.

Developed by Astral Development, Picture Publisher also lets you manipulate multiple images simultaneously, which is a handy feature if you'd like to create a montage of photographs for a document. The program can also manipulate gray levels of contrast and brightness; create and store gamma curves to adjust photographic highlights, midtones, and shadow areas; clone, opaque, smooth, and sharpen images; and crop, size, scale, rotate, and mirror images with precise registration.

According to Astral Development, you can edit any picture of any size or resolution by using the Astral Image Cache. You can also scan any size image up to the capacity

of the hard disk drive.

Picture Publisher works on the IBM PC, XT, AT, PS/2s, and compatibles. It requires a VGA card, an analog monitor, Microsoft Windows 2.03 or higher, a Microsoft or compatible mouse, 640K bytes of RAM, a 20-megabyte or larger hard disk drive, and DOS 2.0 or higher.

Microtek Lab is marketing Picture Publisher with its line of gray-scale scanners.

Price: \$595.

Contact: Microtek Lab, Inc., 680 Knox St., Torrance, CA 90502, (800) 654-4160; in California, (213) 321-2121. **Inquiry 1055.**

Convert Graphics Files in Windows Environment

Easel 4.0 is a file conversion program that works in the Microsoft Windows environment and supports MacPaint, PC Paintbrush, Microsoft Windows Paint, Macintosh StartUp screens, and CompuServe's GIF format. All the formats can be read in and written out to any of the other formats, according to Synergistic Enterprises, the program's developer.

The program can create

(but not read) Hewlett-Packard LaserJet PCL-format output files. The PCL files can be set up as macros or overlays.

Easel 4.10 works on the IBM PC AT, PS/2s, and compatibles with Windows 286 or Windows/386 2.03 or higher, DOS 2.0 or higher, an EGA or VGA card, and 640K bytes of RAM. Additional Expanded Memory Specification (EMS) or enhanced EMS memory is recommended. The program's shareware version does not support the PCL output format.

Price: Shareware version, \$20; commercial version, \$40. **Contact:** Synergistic Enterprises, Inc., 8033 Sunset Blvd., Suite 975, Los Angeles, CA 90046, (213) 655-8894.

Inquiry 1056.

Use PostScript Printers with Non-PostScript Software

LaserTools' Trading Post is a utility that lets you use your PostScript printer as if it were two printers on two separate printer ports, allowing you to use non-PostScript programs with your PostScript printer. After you install an application that prints the program to its appropriate port, Trading Post automatically translates all non-PostScript print jobs.

Trading Post works on the IBM PC, XT, AT, PS/2s, and compatibles with 9K bytes of RAM and DOS 2.0 or higher. The program is also compatible with any network that can create a virtual printer port, including networks from IBM, Novell, and 3Com.

Price: \$79.

Contact: LaserTools Corp., 3025 Buena Vista Way, Berkeley, CA 94708, (800) 346-1353; in California, (415) 843-2234.

Inquiry 1051.

What DOS interface makes your PC® more intelligent than a Macintosh® or a PS/2® with PM®?

DOSTALK™ version 2.1

Artificially
Intelligent



What is DOSTALK?

DOSTALK is the first and only English Language Interface to the MS-DOS® operating system. Using DOSTALK is very much like communicating with an MS-DOS expert. In plain English, just tell DOSTALK what you want and it will take care of everything. DOSTALK will translate English language into the MS-DOS language. DOSTALK will also add to the translation information which might have been left out, such as the exact location of file(s) and/or directories, if the instructions are ambiguous/incomplete, DOSTALK will engage you in conversation until it has gathered the missing pieces of information. In other words, DOSTALK provides you with the most intelligent environment for using DOS—the environment of the decision maker.

Why DOSTALK?

A Natural (English) Language Interface is the most intelligent interface that a software product can ever have; it is substantially more intelligent than the Icon-based interface of Macintosh® or the Window-based interface of OS/2®. So if you want an intelligent personal work station, the choice is simple: either spend a couple of thousand dollars for a Macintosh or a PS/2 with presentation manager or acquire the more intelligent environment of DOSTALK.

SAK Technologies™ Inc.
1600 North Oak St., Suite 931 W,
Arlington, VA 22209
Phone: (703) 522-6425
Fax: (703) 276-9456

DOSTALK Requires:

An IBM PC/compatible 300K RAM, DOS 2.1 or above with 3.0 and above recommended, a hard disk and one floppy drive.

*Customer satisfaction is our main and only goal, if within 30 days of purchase this product does not perform in accordance with our claims call our customer service for a full refund. DOSTALK, SAK Technologies and the half diskette symbol are trademarks of SAK Technologies Inc. Other brand and product names are registered trademarks of their respective holders.

Copyright © 1988 SAK Technologies, Inc.

Some Talk About DOSTALK:

"DOSTALK is a program that most computer users should consider acquiring. The program does exactly what it says, and does it well. It could be the start of a whole new genre."

Dr. Michael Ecker,
PC Clones Magazine

"DOSTALK... clearly what is needed and wanted."

Michael Tucker,
Computer World Focus

"DOSTALK doesn't only let you command the DOS operating system in plain English. It adds some very nice features of its own... DOSTALK does what it promises in a smooth, bug-free manner..."

Sheldon Richman, Washington Times

"DOSTALK, an innovative program that turns the user's frustrating monologue into productive dialogue. Instead of limiting the user to a set of menu choices, it provides a responsive and flexible English language interface."

Sally Smith, Capital Computer Digest

Talk with DOSTALK:

- put the Smith file in Office directory
- is there a file X.txt on C disk?
- make a backup copy of current directory
- list files with extension Exe sorted
- make a duplicate of disk A
- are the B disk files equal to the files in A
- send X.txt to be printed
- prepare A disk
- move X.txt from the A disk into B disk
- empty the directory
- Supply
- remove X.txt
- make a new file
- start Wordperfect®
- run Spreadsheet-by-Lotus®
- execute 123®
- goodbye
- etc.

Additional Features:

- DOSTALK provides you with many DOS utility features which you will find highly valuable, whether you are an advanced or a novice PC user:
- Undo
 - Assign files' names with more than eight characters
 - Ideal DOS tutor—the translation of each request is displayed prior to execution
 - Automatic search and locate of all files and directories—no need to memorize your hard disk
 - Input history buffer for the last ten commands
 - Selective Erase/Copy
 - Invoke DOSTALK by push of a hot key
 - Only 5K of the program stays resident
 - Fully automatic installation
 - An Editor for inputting your requests
 - Submit DOS commands directly from inside DOSTALK
 - And more...

Not Copy Protected
Suggested retail \$129.95

LIMITED OFFER
\$59.95

30-Day Money-back Guarantee*
Dealers and OEMs Welcome!

Yes! I want to increase my productivity with DOSTALK

Send me _____ DOSTALKs (New Version 2.1) at \$59.95 \$ _____

Add \$3.50 for each shipping (outside USA add \$8.50) \$ _____

Virginia residents please add 4.5% sales tax \$ _____

TOTAL\$ \$ _____

Company _____

Name _____

Address _____

City _____ State _____ Zip _____

Phone (_____) _____

Payment Method: Check COD* AMEX

Signature _____

Account No. _____ Expiration Date _____

*Add an additional 6% for COD orders

SERIOUS DEBUGGING *at a* REASONABLE PRICE

All the speed and power of a hardware-assisted debugger at a software price



Hardware-level break points

REAL-TIME break points on memory locations, memory ranges, execution, I/O ports, hardware and software interrupts. More powerful break points than ANY software-only debugger on the market. Soft-ICE gives you the power of an in-circuit emulator on your desk.

Break out of hung programs

With a keystroke - no external switch necessary. Even with interrupts disabled.

Breaks the 640K barrier

Soft-ICE uses ZERO bytes of memory in the first 1MB of address space. This is especially useful for those subtle bugs that change when the starting address of your code changes. With Soft-ICE your code executes at the same address whether the debugger is loaded or not.

Works with your favorite debugger

Soft-ICE can be used as a stand-alone debugger or it can add its powerful break points to the software debugger you already use. You can continue to use your favorite debugger until you require Soft-ICE. Simply pop up the Soft-ICE window to set powerful real-time break points. When a break point is reached, your debugger will be activated.

Solve tough systems problems too

Soft-ICE is ideal for debugging TSRs, interrupt handlers, self booting programs, DOS loadable device drivers, non-DOS operating systems, and debugging within DOS & BIOS. Soft-ICE is also great for firmware development because Soft-ICE's break points work in ROM.

How Soft-ICE Works

Soft-ICE uses the power of the 80386 to surround your program in a virtual machine. This gives you complete control of the DOS environment, while Soft-ICE runs safely in protected mode. Soft-ICE uses 80386 protected mode features, such as paging, I/O privilege level, and break point registers, to provide real-time hardware-level break points.

"Soft-ICE is a product any MS-DOS developer serious enough to own a 386 machine should have."

Dr. Dobh's Journal — May 1988

Both require 80386 AT compatible or IBM PS/2 Model 80. MagicCV requires at least 384K of extended memory. CodeView is a trademark of Microsoft Corporation.

RUN CODEVIEW IN ONLY 8K!



CodeView is a great integrated debugger, but it uses over 200K of conventional memory. MagicCV uses advanced features of the 80386 microprocessor to load CodeView and symbols in extended memory. This allows MagicCV to run CodeView using less than 8K of conventional memory on your 80386 PC.

Don't let 640K be your limit!

If you are closing in on the 640K limit and would like the power of CodeView, MagicCV is for you.

Don't let the debugger hide the bug!

Even if you're not closing in on the 640K limit, running CodeView with MagicCV makes your debugging environment much closer to the end user's program environment. You can use CodeView to locate subtle bugs that only occur when there is plenty of free memory, or those difficult bugs that only occur when your program is running with a couple of TSRs loaded.

How MagicCV works

MagicCV uses the 80386 to create a separate virtual machine for CodeView. MagicCV uses between 4K & 8K of conventional memory as a bridge between the DOS environment and CodeView.

MagicCV is easy to use

If you are a CodeView user, you already know how to use MagicCV too. Just type MCV instead of CV; everything else is automatic.

Save \$86

MagicCV \$199
Soft-ICE \$386

Buy Both and Save \$86!

CALL TODAY
(603) 888 - 2386

or FAX (603) 888 - 2465

30 day money-back guarantee
Visa, Master Card and AmEx accepted

NU-MEGA TECHNOLOGIES

P.O. BOX 7607 • NASHUA, NH 03060-7607

MagicCV with Soft-ICE

Using Soft-ICE with CodeView gives you the features necessary for professional level systems debugging. MagicCV and Soft-ICE can work in concert with CodeView to provide the most powerful debugging platform you will find anywhere.

DISKAT™ The dual-pocket vinyl disk sleeve.

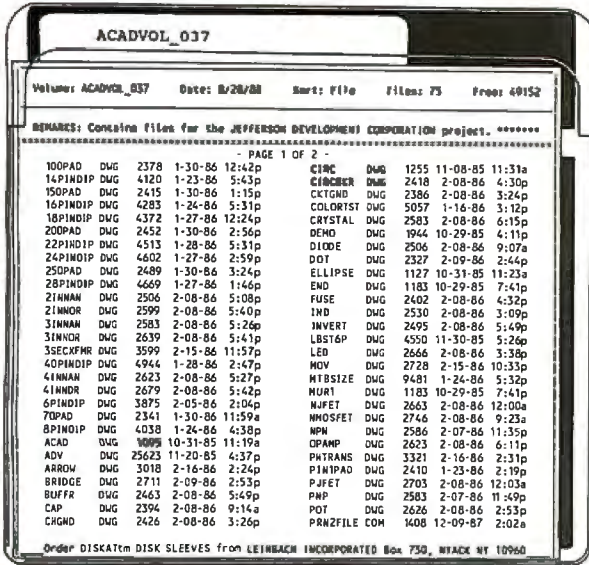

USE A DISKAT™ !

Dual-pocket "see-thru" vinyl disk sleeve.

- Front pocket holds disk directory PRINTOUT.
- Rear pocket holds 5¼" FLOPPY DISK.

ORGANIZE YOUR FILES AND GET TOP DISK PROTECTION

PRODUCT DESCRIPTION

- **DISKAT™ VINYL DISK SLEEVES**
Heavy duty "see-thru" anti-static vinyl material. Heat sealed. Unique dual-pocket design. Front pocket holds disk directory printout, rear pocket holds 5¼" floppy disk.
- **DIRECTORY SOFTWARE (New Version 2.50)**
Prints out disk/file data. Sorts by filename, extension, size, or date. Lists volume name, current date, free disk space and remarks. Runs on all MS-DOS or PC-DOS computers. Self installs all printers.

INTRODUCTORY OFFER

DISKAT™ "50 PACK"
● 50 DISKAT sleeves PLUS **\$49.95**
● DISKAT Directory Software Add \$4.00 shipping

NO RISK 30 DAY MONEY BACK GUARANTEE

C.O.D.s/Purchase orders/Inquiries/Sample Sleeve:

CALL TOLL FREE: 800-544-0789

Send check with order to:

Leinbach Incorporated (914) 353-0990
9 Central Avenue, South Nyack New York 10960

AFFORDABLE NEURAL COMPUTING

Powerful Neural Network software and hardware tools are now affordable. And fully compatible with your PC/XT/AT.

If you depend on the latest advances in computing, you need affordable access to Neural Network technology — to tools that let you research existing neural network models or develop your own. Our NEURAL-NET™ software package does just that. And the price tag is only \$49. For \$49 you can start working with Neural Networks today. Whether you're a scientist, developer, or student, NEURAL-NET™ is a lot less expensive than the cost of staying in the dark about neural computing.

You could spend \$1500 or more on Neural Network software. And you could get conventional algorithmic technology, or a package that ignores first principles of neural computing. But for a reliable introduction to neural computing and a powerful research tool the value alternative is NEURAL-NET™. Just \$49 for the complete package including program disk, sample programs, and User's Guide.

Sure there's a catch. We offer a whole line of inexpensive neural computing products. When your Neural Networks need greater speed and capacity than a software simulation can provide, call us for the best price/performance ratios available. Plug our NEURAL-NET™100 co-processor board into any PC, XT, or AT compatible and get 100 times the speed and performance of any software simulation. The NN-100 costs only \$495.

And for those who demand technical excellence as well as economy, when you buy from us you get neural network technology . . . not conventional technology under a different name. Better than inexpensive, that's value.

Detailed information about Neural Networks and our line of NEURAL-NET™ products is available free of charge.

CALL 602-967-6424
InTec, P.O. Box 27561, Tempe, AZ 85282

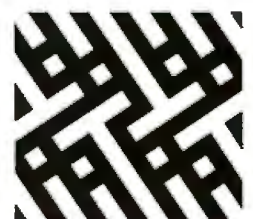

InTec



More than 12 pounds.

Average portable computer

- | | |
|---------------------------------|------------|
| ■ Daily date work organizer | (84.98) |
| ■ Spreadsheet | (495.00) |
| ■ Word processor | (495.00) |
| ■ The average portable computer | (1,500.00) |

Suggested price

\$2,574.98

or,

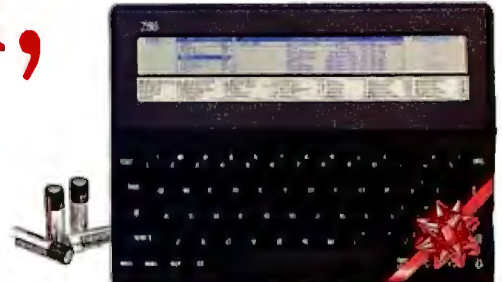

Less than 2 pounds.

Cambridge Z88 portable computer

- | | |
|---------------------------------------|------------|
| ■ Daily date work organizer | (included) |
| ■ Spreadsheet | (included) |
| ■ Word processor | (included) |
| ■ Calendar, alarm clock, calculator | (included) |
| ■ The Cambridge Z88 portable computer | (included) |

Suggested price

\$599.00

The real portable story.

Real portability shouldn't depend how deep your pockets—or how strong you are. With all of the software and peripherals needed to make a portable operate, your original investment skyrockets! It's no surprise that today's definition of a portable is a computer slightly smaller than a desktop PC—with a handle attached.

We have a better answer. The Cambridge Z88, a versatile, hardworking computer that doubles as a portable keyboard. Work you once left behind—or inside a PC—you can now take with you. Like Lotus 1-2-3®, or Wordstar®. Simply transfer the files from your PC to the Cambridge Z88 with a PCLink® cable; then take the Z88 down the hall to a business meeting, or on a trip. When you return, update your PC.

The Cambridge Z88's built-in productivity software includes: spreadsheet, word processor, daily

date work organizer, calculator, calendar and alarm clock.

The Cambridge Z88 is compact—under two pounds, and is the size of a piece of paper less than an inch thick. The Z88 operates for twenty hours on four AA batteries, features a quiet, full size keyboard, and works with almost any printer or modem.

Easy to use, there's no booting, loading, opening, closing, or quitting. Everything operates with a few keystrokes. Move quickly through an unlimited number of tasks. The Cambridge Z88's memory is expandable to over 1.5 megabytes using interchangeable solid-state Memory Cartridges™ of up to 512K bytes—replacing disks.

Test the Z88 for 15 days, and discover the real meaning of portability. If you decide not to keep the Z88, return it for a full refund.



Both the Z88 and your work fit into a briefcase

The Cambridge Z88 computer
Now **\$599.00**

Includes a one year limited warranty, manual, and a lightweight carrying case.

- IBM PCLink \$82.00
- MacLink \$132.00
- Parallel printer cable \$72.00
- 32K EPROM \$49.00
- 32K RAM \$49.00
- Attache case \$28.00

Add \$3.00 per item for shipping

Other Z88 accessories, including a modem, and complete tech support is available upon request.



The Z88 imports/exports work files from both IBM and Macintosh

**CAMBRIDGE
DIRECT**

1419 Lake Cook Rd.
Deerfield, IL 60015
1-312-564-5512

To order, call
1-800-366-0088

For Mail Order, send check or money order to Cambridge Direct, Inc.

SHORT TAKES

BYTE editors' hands-on views of new products

Extend

Irwin Model 5080

Jumbo

dBASE IV

For the Record

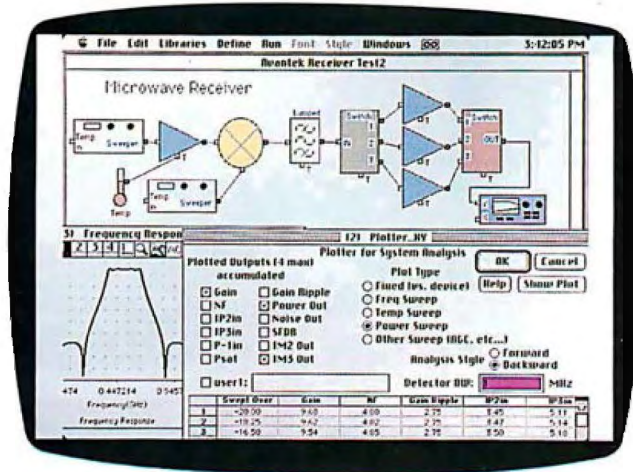

Modeling the Physical World with Blocks

One of the most powerful capabilities of the computer is simulating physical processes and conditions. By simulating a process or design on a computer, designers and engineers can save the time and expense of building and testing physical prototypes. Business and financial analysts can also use simulation programs to model problems.

Extend, from a company called Imagine That!, is a powerful simulation program for the Macintosh that uses block diagrams to model physical systems. Each block in the simulation represents part of the physical process, and each is connected to other blocks with inputs and outputs that represent the physical conditions of the system.

To simulate a home-heating system, for example, you would have blocks representing the furnace, the walls, the roof, the thermostat, and inside and outside temperatures. Variables might include the thickness of the roof or wall insulation and the heat output of the furnace. By varying such system parameters, you can run a variety of "heating tests" to see how much time and energy are required to heat the house under various

environmental conditions. The independent variables (like temperature and energy) tested in the simulation are plotted as a function of time.

Extend is a complete system for developing simulation block diagrams. You start with a blank worksheet and build blocks and connections using the design tools. You can set up dialog boxes and help files for blocks that require user input for modifying the parameters of the simulation. The blocks ultimately connect to a plotter block, which can have up to four inputs. When you run the simulation, the inputs are plotted on the screen. A table at the bottom of the plot lets you read the plot values at any time simply by moving a vertical pointer to the appropriate time on the plot.

The heart of the system is its ModL "simulation scripting

language" for writing scripts that define the function of each block. ModL is a C-like language that includes a large library of mathematical functions and operators for defining block equations and plotter functions. The language has queuing and delay line functions, fast Fourier transforms, integration, random-number generation, financial and statistical functions, and a set of power and trigonometric functions. ModL supports real, integer, and string data types, as well as fixed and dynamic arrays of up to five dimensions.

ModL includes system messages that are sent to blocks during the simulation. For example, a system message might be "ON CHECK-DATA," which tells the block to validate its data. Extend also has a set of system vari-

ables, like "DeltaTime," so that the block equations can dynamically change their values over time.

You can save blocks in libraries for using repeatedly in other simulations. Extend comes with a collection of blocks for electronics and digital simulation. Some of these provided blocks have several hundred lines of code. The company is also working on libraries for other disciplines, like mechanical engineering.

Creating working simulations of real physical processes is not a trivial exercise, and it requires knowledge of the physical process you're simulating. If it's an electrical circuit, for example, you have to know the equations that represent the behavior of the circuit.

Extend is a powerful system, and it is not easy to learn. The tutorial is brief and provides little guidance in writing block scripts. The 216-page user's manual is comprehensive. You can study the example simulations to see how the system works.

One comparable IBM PC program, TutSim, uses block diagrams. However, rather than providing a complete programming language like Extend's ModL, TutSim provides a large library of programmable blocks. Other than plotting, TutSim does not have the graphics capabilities inherent in a Macintosh package. With Extend, you can not only plot the simulation, you can also build the model visually with the block design tools.

At the time of this writing, Imagine That! said it would soon release version 1.1 of the software. The new version will allow file and serial port I/O, so that you can hook up Extend to laboratory equipment or use external data files.

—Nick Baran

continued

THE FACTS

Extend 1.05
\$495

Imagine That!
7109 Via Carmela
San Jose, CA 95139
(408) 365-0305
Inquiry 1015.

Requirements:
Mac Plus, SE, or II
with a hard disk drive or
two floppy disk drives;
System 4.2 and Finder
6.0 or higher.

With Tape, Backing Up's Not Hard to Do

Cher's Law of Exercise can be adapted to backing up hard disks. If we don't back up our hard disks at least once a week, we feel the way Cher does if she doesn't exercise every day: guilty. We know the crash is coming, and we know we have to prepare by storing copies of all those files in a safe place. Still, doing backups is like doing push-ups: drudgery.

The Irwin Model 5080 tape system for the Macintosh not only makes backups painless, but it puts 80 megabytes of data into a ¼-inch DC-2000-style tape cartridge. Irwin's AccuTrack minicartridges (they look like squat audiocassettes) come preformatted, so you can pop them right in and write away, which in itself is good reason to use these tapes.

Although the Model 5080 employs a proprietary recording format, that might be a fair price to pay for the single user, considering that formatting a cartridge can take as long as half an hour with some systems. Irwin claims its tapes are highly reliable because of servo signals embedded along each tape track; these signals keep the read/write head accurately centered over the track it's looking at.

Hooking the subsystem to the Mac is simple, as long as you have the right cable. The tape box plugs into the Mac's small-computer-system-interface (SCSI) port or into another peripheral, like an external hard disk drive. If you want to hook it up directly to the Mac, you need a cable with a 25-pin connector on one end and a 50-pin connector on the other end. Before you even unpack the Model 5080, go buy one of these MCAB25 cables, because Irwin doesn't provide one.

But, oddly enough, the company does provide a cable



THE FACTS

Irwin Model 5080
\$1695

Requirements:

Mac with at least 1 megabyte of RAM, at least 128K bytes of ROM, a SCSI port, and a 25-pin/50-pin SCSI cable (50-pin/50-pin cable for daisy chaining with other peripherals).

with a 50-pin connector on each end. This cable is fine for stringing the tape system to another SCSI peripheral, but I'd bet most users will want to hook it directly to the Mac. Besides making the connection, the only other thing you have to do is set the address selection, done by turning a little dial.

Making a backup is about as easy as it can be. Irwin's EzTape Iconographic program, which runs under Finder and MultiFinder, is refreshingly stripped down and straightforward. It makes for a stymie-free trip through the backup process. Our unit came without a manual, but that turned out to be no problem because the software is so clear. You just click on a few menu choices to specify what kind of backup you want to do (or mark the files you want to back up) and get the process going. Irwin has an update to

Irwin Magnetic
Systems, Inc.
2101 Commonwealth
Blvd.
Ann Arbor, MI 48105
(313) 996-3300
Inquiry 1016.

EzTape Iconographic that lets you set up automated backups, but we couldn't get that update in time for this report.

I timed some random backups and found that the Model 5080 is acceptably quick, es-

pecially compared to some other tape drives. It took a fast 5 minutes to copy and verify 10 megabytes from a Mac II 40-megabyte hard disk.

Wanting to see the drive handle individual files, I had it back up some PageMaker documents. It took about 2½ minutes to copy a 264K-byte file to tape, update the tape directory, update the tape header, and verify the data. Restoring such a file to the hard disk took about 45 seconds. Most users in the real world will be doing global backups about once a week, so that's the speed that's most important, and on that count, the Model 5080 will be acceptable to all but speed freaks.

If you're looking for a secondary storage device that makes backups painless, the creatively named Irwin Model 5080 tape system is a definite must to checkout. And there's something nice about being able to pack 80 megabytes of data on a tiny tape (that costs about \$30). My only beef is with the folks at Irwin who decided not to throw the appropriate SCSI cable into the box. They format the tapes, and they make the software easy to use; but they also make their customers go out and buy a cable before they can find out just how nice the tape drive is.

—D. Barker

Jumbo Works for Peanuts

Behonest now. When's the last time you backed up the data on your hard disk? If you're like over 90 percent of microcomputer users, you seldom (if ever) do. And it will take a catastrophic disk crash to shame you into it.

No matter how easy today's backup programs are to use, it's still a royal pain to sit there and swap floppy disks, especially with large-capacity hard disk drives. Tape backup units, which pack 40 or more megabytes onto a single cartridge, are far and away the

easiest way to back up data. But they've been expensive, averaging in the \$600 to \$700 range in the IBMPC-compatible world.

Colorado Memory Systems has decided to do something about that expense with a tape backup unit it has aptly named **Jumbo**. When compared with its competitors, Jumbo's \$399 list price is peanuts. Colorado Memory Systems developed the QIC-60 tape drive, which became an industry standard when Tecmar licensed it and

continued



Embedded systems designers have already used CrossCode C in over 291 different applications.

CrossCode C has twelve important features to help you program your 68000-based ROMable applications

It's the one 68000 C compiler that's tailor-made for embedded systems development

CrossCode C is designed specifically to help you write ROMable code for all members of the Motorola 68000 family. It comes with these twelve special features to help you get your code into ROM:

- 1. A 100% ROMable Compiler:** CrossCode C splits its output into five memory sections for easy placement into ROM or RAM at link time.
- 2. Integrated C and Assembler:** You can write your code in any combination of C and assembly language.
- 3. Readable Assembly Language Output:** The compiler generates assembly language code *with your C language source code embedded as comments*, so you can see each statement's compiled output.
- 4. Optimized Code:** CrossCode C uses minimum required precision when evaluating expressions. It also "folds" constants at compilation time, converts multiplications to shifts when possible, and eliminates superfluous branches.
- 5. Custom Optimization:** You can optimize compiler output for your application because *you* control the sizes of C types, including pointers, *floats*, and all integral types.
- 6. Register Optimization:** Ten registers are reserved for your register variables, and there's an option to automatically declare all stack variables as *register*, so you can instantly optimize programs that were written without registers in mind.
- 7. C Library Source:** An extensive C library containing over 47 C functions is provided in source form.
- 8. No Limitations:** No matter how large your program is, CrossCode C will compile it. There are no limits on the number of symbols in your program, the size of your input file, or the size of a C function.
- 9. 68020 Support:** If you're using the 68020, CrossCode C will use its extra instructions and addressing modes.
- 10. Floating Point Support:** If you're using the 68881, the compiler performs floating point operations through the coprocessor, and floating point register variables are stored in 68881 registers.
- 11. Position Independence:** Both position independent code and data can be generated if needed.
- 12. ANSI Standards:** CrossCode C tracks the ANSI C standard, so *your* code

will always be standard, too.

There's More

CrossCode C comes with an assembler, a linker, and a tool to help you prepare your object code for transmission to PROM programmers and emulators. And there's another special tool that gives you symbolic debugging support by helping you to prepare symbol tables for virtually all types of emulators.

CrossCode C is available under MS-DOS for just \$1595, and it runs on all IBM PCs and compatibles (640K memory and hard disk are required). Also available under UNIX & XENIX.

CALL TODAY for more information:

1-800-448-7733

(ask for extension 2003)

Inside Illinois or outside the United States, please dial

PHONE: 1-312-971-8170

FAX: 1-312-971-8513

SOFTWARE DEVELOPMENT SYSTEMS, INC.
DEPARTMENT 23
4248 BELLE AIRE LANE
DOWNERS GROVE, ILLINOIS 60515 USA

CrossCode™ is a trademark of SOFTWARE DEVELOPMENT SYSTEMS, INC. MS-DOS® is a registered trademark of Microsoft. UNIX® is a registered trademark of AT&T. XENIX® is a registered trademark of Microsoft.

"INVADING THE COMPUTER WORLD"

4 GUYS Computers

IN NYS (212) 643-3900 ON SAT (212) 239-4350
HOURS: MON-SAT 10-7/SUN 10-6

FOR PHONE ORDERS **1-800-242-4GUY**

CORPORATE ACCOUNTS WELCOME

AT&T
Apple
SHARP
COMPAQ

AST
ZENITH
CITIZEN
brother

IBM
AMIGA
Sitara
NEC
Commodore

CALL FOR LOWEST PRICES IN THIS MAGAZINE

CALL THE OTHER STORES FIRST, GET YOUR BEST PRICE ON ANY NAME BRAND COMPUTER, PRINTER, MONITOR, MODEM, FAX MACHINE, SCANNERS, OR FAX CARD—THEN CALL 4 GUYS... AND WE'LL TRY TO BEAT IT!

<p>ZENITH 184 20MB H.D. \$1995</p> <p>NEC CALL</p> <p>COMPAQ DESKPRO 286 12MHz 1.2Floppy \$1975 Drive 40MB H.D. DESKPRO 386.25.....CALL</p> <p><small>ALL AMIGA AND MODELS IN STOCK! w/ Purchase of 2nd Drive and Monitor</small></p>	<p>LEADING EDGE Model D1 512K 1 Floppy Des 3.2 Keyboard</p> <p>CALL</p> <p>HYUNDAI XT 400K 1 Drive</p> <p>HYUNDAI 286C All Compatible 10MHz EGA 006 30MBHD w/ Monitor Purchase</p> <p>\$1399</p> <p>AMIGA SPECIAL: DE FLS & REDATE commodore CQLT</p>	<p>LEADING EDGE D2 AT Compatible 66286 Processor 640K Memory 1 2MB Floppy DOS 3.2 & GW Basic XT 101 Keyboard Leading Edge Word Processor Incl.</p> <p>\$1199</p> <p>SPECIAL EPSON APEX 100% IBM XT COMPATIBLE Complete with MS DOS BASIC PFS etc CHOICE AND MORE! CALL OR COME IN</p> <p><small>IF YOU DON'T SEE WHAT YOU WANT ASK! Printers Modems Laptops Monitors Copiers Fax</small></p>
---	---	--

FULL ON-LINE TECHNICAL SUPPORT

ALL OUR PRODUCTS ARE FACTORY FRESH WITH FULL WARRANTY. NOT RESPONSIBLE FOR TYPO ERRORS. ALL PRICES IN THIS MAGAZINE BY 10:00 AM ON SATURDAY. ALL ORIGINAL PACKAGING AND RETURN AUTHORIZATION. SHIPPING AND HANDLING EXTRA. THE HIGHEST QUALITY ALL OTHERS ARE. PRICES SUBJECT TO AVAILABILITY.



THE FACTS

Jumbo
\$399

Colorado Memory Systems, Inc.
800 South Taft Ave.
Loveland, CO 80537
(303) 669-8000
Inquiry 1017.

Requirements:
IBM PC, XT, AT,
PS/2, or compatible with
384K bytes of RAM and
MS-DOS 2.0 or higher.

IBM sold the drive as an option for PCs.

Jumbo uses the QIC-40 standard, which puts up to 40 megabytes on a small DC-2000 tape cartridge. I've reviewed other tape backup units, and many of them are a pain to install and set up. There are different models for different computer systems, not to mention DIP switches and jumpers to puzzle over.

But Jumbo is a refreshing exception. After removing the cover of my AT, all I had to do was slide the tape unit into the empty space under my 1.2-megabyte floppy disk drive, hook up power and the extra floppy disk ribbon connector, and put the cover back on. Then I copied the supplied software to my hard disk, started it up, and it worked. (For those of you with non-standard disk setups, there is a disk-select jumper.)

This drive is a good example of what's happening in the world of hardware, where lower prices don't necessarily mean shoddy merchandise. Application-specific inte-

grated circuits and surface-mount construction have resulted in low part counts. Jumbo has only four ICs and no adjustments for the electronics. It's simple and rugged, and it should last a long time.

There's an optional mounting kit available for the IBM PS/2 line. There's even an external cabinet if you've run out of room in your system case. Jumbo's circuitry automatically senses whether it's hooked up to an XT or an AT, and it sets its data transfer speed accordingly: 250K bytes per second for regular PCs and 500K bytes per second for ATs.

The backup software that comes with Jumbo is sophisticated and easy to use. In truth, I never opened the software manual because using the backup system is a simple matter of reading the screen. Like any good backup software should, it gives you the option of doing the backup immediately or automatically at a pre-determined time—like in the

continued

PRICE SLASHED!

FREE Software!

SONY Quality

THE 3.5" CONNECTION!

The perfect solution for upgrading your existing PC/XT/AT to "State Of The Art" 3.5" floppy disk technology! The Model 853W (720K) and Model 873W (1.44MB/720K) 3.5" drives are "drop-in" replacements for 5.25" drives! Disk format is fully compatible with popular Laptops (IBM, Toshiba, Zenith, etc.) and the new IBM PS/2 models. Both units come completely assembled and contain everything that you need, including Premium SONY drive, interface adapters, software device drivers and complete documentation. These drives utilize your existing controller so no additional slots are required (1.44MB requires AT class controller or special PC/XT High-Density Controller available from Tigertronics). Available with gray or black bezel (specify).

<p>Model 853W (720K) \$159.95 \$129.95</p>	<p>Tigertronics INCORPORATED</p> <p>400 Daily Lane • P.O. Box 5210 Grants Pass, Oregon 97527</p>	<p>Model 873W (1.44MB) \$229.95 \$159.95</p>
--	---	--

IMMEDIATE DELIVERY!
Call 503 474-6700 or 503 474-6701
FAX 503 474-6703

The Power Of Choice.

AST Premium Workstation/286
16 MHz, 286 CPU. Sleek, all-purpose office AT-compatible

AST Premium/286
10 MHz, 0 wait-state, 286 CPU. Top-rated AT-compatible performance

AST Premium Workstation/386SX
16 MHz, 386SX CPU. Powerful, cost-effective desktop computing

AST Premium/386C
20 MHz, 386 CPU. High-speed, 32-bit caching architecture

AST Premium 386/25
25 MHz, 285 CPU. Fastest 386 system available

When it comes to selecting name brand computers that satisfy a wide range of power requirements, AST makes your job simple.

First, for CAD/CAE, LAN, multi-user and other applications requiring the most powerful personal computer available, AST provides the 25 MHz, AST Premium® 386/25. Based on the Intel® 386 chip with an integrated cache architecture, the AST Premium 386/25 provides the ultimate solution for sophisticated processing.

For those who don't need quite so much power, AST offers the 20 MHz, AST Premium/386C with cache memory and the slim-line, 16 MHz AST Premium Workstation/386SX. Both allow you to use your current MS-DOS® applications. And take advantage of the next-generation, 32-bit operating systems and environments, including Microsoft® Windows/386, UNIX® System V/386, OS/2™ and more.

Of course, not every application requires 386 architecture. For word processing, spreadsheets or desktop publishing, the award-winning AST Premium/286 is the power of choice. Built with FASTslot™ technology and unbeatable compatibility, the AST Premium/286 provides built-in 386 CPU upgradeability when you need it.

And for extra value in a 286 PC that looks like it belongs in the executive suite, choose the AST Premium Workstation/286. As industry critics say, "This is one slick, attractive machine... like other AST machines, it's built like a tank."

In fact, AST's reputation for providing high-quality, top-value products extends throughout our leading board-level enhancements and connectivity solutions.

So, give yourself the power of choice—AST Premium Computers. For more information, call (714) 863-0181, ask for operator AA89.

Please send me more information on the AST family of Premium Computers.

Please have an AST representative call me.
I am an end user a reseller.

Name _____

Title _____

Company _____

Address _____

City/State/Zip _____

Phone (____) _____

Send to: AS Research, Inc. 2121 Alton Avenue,
Irvine, CA 92714-4992. **BYTE 1/89**

AST markets products worldwide—in Europe and the Middle East call 44 1 568 4390; in Japan call 813 447 8303; in the Far East call 852 5 717223; in Canada call 416 626-7314. AST, AST logo and AST Premium registered trademarks AST Research, Inc. 80386 and 80386SX trademarks Intel Corp. All other product and brand names are trademarks and registered trademarks of their respective companies. Copyright © 1988 AST Research, Inc. All rights reserved.

AST
RESEARCH INC.

Times Have Changed.

Circle 25 on Reader Service Card
(DEALERS: 26)

IF YOU DESIGN ADD-IN BOARDS FOR THE NEW
IBM PS/2 SYSTEM YOU NEED OUR

MICROCHANNEL 4860 C INTERFACE CHIP

Just some of the Functions implemented:
Program. Option Select * 32 Bit Data Bus Contr.
Multi Device Arbitration * Channel Check Indicator
Memory and I/O Transfer contr. * Wait State Log.
16 Programmable Address Levels.

It comes in a 68 pin PLCC and is fabricated in 1.5u CMOS, only consumes 150mW. You can replace 10 to 20 TTL devices, a board real estate saving of 20 to 65 sqcm. A reduction of board development time of some weeks is realistic. Only requires 2 additional 74LS245 for 16 bit systems, or 4 for 32 bit systems. The chip costs US\$ 15,- in quantities of 5000 and is available now.

EDC GmbH, Taurusstr.51
8 MUNICH 40 W. GERMANY

Tel. (89) 3507076

Fax. (89) 3596180

Tx. 5212599

IBM, PS/2 and Micro-
channel are registered
trademarks of IBM

Dealer inquiries invited

SHORT TAKES

middle of the night. And it will also back up all files on Novell and 3Com networks.

Makers of tape backup units are fond of backup benchmarks. But think about it: A few seconds plus or minus don't mean much if your system is doing the backup when you're not around. However, if you must talk numbers,

Jumbo is no slouch. It took 12:57 to back up 1296 files on my hard disk, a total of over 28 megabytes of data.

Jumbo is inexpensive, easy to install and use, and well built. It brings secure data backup within the reach of nearly all PC users. Now, what's your excuse?

—Stan Miastkowski

dBASE IV: Setting the New Standard?

After many months of speculation both about the product and when it would finally arrive, **dBASE IV version 1.0** is here. It represents a quantum leap over dBASE III Plus in functionality, power, and ease of use.

The first difference that you notice between the two is size. While dBASE III Plus would run in 256K bytes with two floppy disk drives, dBASE IV needs 640K bytes (or more) and a hard disk drive.

The number of fields per record has been increased from 128 to 255. The maximum number of keys (indexes) per table has been raised from 7 to 47. Using DOS 3.1 or higher, dBASE IV will support up to 99 open files at any one time (but still only 10 data tables). Field length and the maximum size of the command line have both been raised from 254 to 1024 characters. The maximum number of memory variables has been raised from 256 to 15,000, freeing developers from one of the most irksome constraints of dBASE III Plus.

Indexing is a major improvement in dBASE IV. With dBASE III Plus, you could have up to seven indexes (each costing a file handle) open for a single data table. With dBASE IV, you can have up to 47 index files open inside a Master Index File (.MDX) that takes up only a single file handle.

While dBASE III Plus al-

lowed for a single parent-child relationship to be active, dBASE IV allows multiple children related by different keys to a single parent. In many instances, this allows for a substantial reduction in code size and complexity.

Finally, dBASE IV has a significantly higher execution speed than dBASE III Plus. This increase in speed comes because dBASE IV preparses code to save execution time. It compiles dBASE programs into intermediate code, checking for syntax errors while assembling code tokens for execution. The resulting code requires dBASE IV or dBASE Run Time to execute.

You might find that your dBASE III Plus code generates compiler errors when first run under dBASE IV. As an interpreter, dBASE III Plus simply executes the first line of code that meets the specified condition of an IF/ELSE/ENDIF or a DO CASE structure. If there's no ENDIF or ENDCASE statement, it doesn't matter because the interpreter never reaches that line. This makes a difference with dBASE IV, however, so you'll be finding out all about your bad coding practices.

Some commands in the new program are different from those used in competing products, such as FoxBASE and Clipper. The menu commands are a good example. But the changes have improved the dBASE language.

This new version of dBASE adds many enhancements and new features to the language while retaining compatibility with dBASE III Plus. Detail-

continued

New!
WINDOWS development
tool for dBASE III Plus!

**Create or enhance
dBASE applications under
Windows!**

Then port to MAC and back!

\$249
Suggested Retail Price

Introductory Price
\$199



dBFast/Windows is an interactive editor/compiler and runtime system which allows a fast, efficient implementation of dBASE III Plus under Microsoft Windows. You easily design multiple, moveable windows, menus, buttons, and other graphic features. Create, compile and edit in a single screen! No need to buy dBASE III Plus! Port data and program files between IBM and MAC without modification! Save time and money by sharing your applications across platforms!



Bumblebee Software, Inc.
 1715 114th Ave. SE - Woodridge Bldg. #120
 Bellevue, WA 98004 USA
 (206) 462-0130 FAX: (206) 454-3577

MINUTEMAN[®]

UNINTERRUPTIBLE POWER SUPPLIES



"More Powerful Than Ever!"

INTRODUCING
THE NEW
900 WATT
MODEL
120 VOLT

TOTAL POWER PROTECTION

- BLACKOUTS** Enables user to operate during complete loss of power.
- BROWNOUTS** User is protected from low AC voltage below 102 volts.
- OVERLOADS** Automatic shutdown in overload situation to protect UPS from inverter burnout.
- OVERVOLTAGE** UPS runs on inverter (117 volts) when AC voltage exceeds 132 volts.
- SURGES/SPIKES** Clamps transients above 200 volts with an energy rating of 100 joules or less.
- EMI/RFI** Three stage filtering for clean AC power.



- **FULL ONE YEAR WARRANTY**
- **ORDER-SHIP SAME DAY**
- **1 MILLISECOND TRANSFER TIME***
- **SYNCHRONIZED SINEWAVE***

*250 watt and 500 watt units offer 4 msec transfer time, PWM waveform

PARA SYSTEMS, INC.

1455 LeMay Dr.
Carrollton, TX 75007

Telephone:
(214) 446-7363

1-800-238-7272

FAX: (214) 446-9011 TELEX: 140275 OMEGA

Power Output	120 Volt Models	230 Volt Models
250 WATT	\$ 379.00	\$ 429.00
300 WATT	\$ 549.00	N/A
500 WATT	\$ 699.00	\$ 799.00
600 WATT	\$ 899.00	\$1049.00
900 WATT	\$1249.00	N/A
1200 WATT	\$1499.00	\$1749.00
1600 WATT	\$1999.00	\$2299.00

Suggested Retail



Optional Battery Packs Not Shown



MORE dBASE POWER!

FOR ONLY

\$189.95!



dBMAN V: A database manager for your PC that has dBASE III+ power, Report Writer, and Compiler all in one package! Now you can buy a powerful dBASE III+ work-alike that includes more features and power than any other competitive product on the market, at a fraction of the cost!

"dBMAN competes directly with dBASE III+, it runs many operations much more quickly and costs less than half the price." Bruce Brown, PC Magazine.

Unlimited Power. We extended the dBASE III+ language to bring you to a new level of programming power and versatility.

Reports without programming! With our Report Writer you can easily create invoices, sales statements, form letters, employee lists, multi-lined and columnar reports, and more. All without programming!

Speed unequalled in performance. dBMAN V's Greased Lightning! Compiler executes dBASE applications up to 16 times faster than dBASE III+, and comes with an unlimited distribution runtime license at no extra cost!

We are offering a 30 day money back guarantee if not fully satisfied. (When purchased from a VersaSoft authorized dealer.)

And, our multi-user version of dBMAN for Novell, IBM PC Net retails for only \$499.95!

Just compare our price with the competition:

Program	Interpreter	Compiler	Report Writer	TOTAL
dBMAN V	\$189.95	included	included	\$189.95
FoxBASE	\$395.00	\$495.00	\$149.95*	\$1039.95
Clipper	N/A	\$695.00	\$149.95*	\$844.95
QuickSilver	\$199.00	\$599.00	\$149.95*	\$947.95
dBASE III+	\$795.00	N/A	\$149.95*	\$944.75
dBASE IV	\$1295.00	included	included	\$1295.00

* Suggested retail price for comparable relational full-screen report writer.

dBMAN Highlights:

- dBASE II and dBASE III+ compatibility
- 320 extended commands and functions
- Password protection and data security at file level
- BCD numbers
- Single command menus: vertical, horizontal, scrollable and pull down menu
- Program debugger/editor

Report Writer Highlights:

- User defined pop-up windows and more...
- 9 group levels
- Conditional printing of any items
- Compute running sums, counts, averages, minimums and maximums
- Relate and report from up to 9 database files with lookup (one to one) and scan (one to many) relations and more...

Multi-User Version:

- Locks records and files as a set to prevent deadlock
- Supports transaction update and roll back (Novell TTS system) and more.
- Available for Novell Network, IBM PCNet, Xenix, UNIX and other major operating systems.

Call today to order your copy of dBMAN V!

VersaSoft Corporation

4340 Almaden Expwy, Suite 250
San Jose, CA 95118
Phone: 408-723-9044
Telex: 650-263-5806
Fax: 408-723-9046



dBASE III+ and IV are trademarks of Ashton-Tate. FoxBASE is a trademark of Fox Software. Clipper is a trademark of Nantucket. QuickSilver is a trademark of WordTech Systems. Novell Network, IBM PCNet, Xenix, UNIX are trademarks of Novell. IBM, Microsoft, AT&T Bell Laboratories respectively.

SHORT TAKES

ing the differences and additions to the commands and functions available (a total of 310) is the subject of a good-size book. Many have been improved, and new ones will keep even expert developers busy for quite a while. Some of the more interesting command sets include commands for creating Lotus 1-2-3-like menus, a real BROWSE command, windowing, and two-dimensional arrays.

What is truly extraordinary about dBASE IV is that much of its power is also available to the nonprogrammer through the task-oriented nonprocedural Control Center. The Control Center is to dBASE IV what the ASSIST mode is to dBASE III Plus. All similarity ends there. The Control Center is a powerful shell that lets you develop real customized applications without having to write a line of code.

The Control Center is a collection of well-thought-out work surfaces that let the nonprogrammer (and the programmer) define data tables, screens, reports, and labels, and finally tie them together through the application generator. The work surfaces are intuitive in nature, and, with only a little experience, a *confident* beginner will be able to design functional programs.

As for this year's hot database topic, dBASE IV sort of does SQL. Well, actually, dBASE IV emulates SQL using dBASE data tables. It lets you use a set of SQL commands inside dBASE when you SET SQL ON. When you do this, you deactivate dBASE IV commands that are in conflict with SQL.

This is an overwhelming product. A new era has finally dawned for the dBASE language. Thanks, Ashton-Tate.

—Anne Fischer Lent and Malcolm Rubel

THE FACTS

dBASE IV version 1.0
Standard Edition, \$795;
Developer's Edition,
\$1295

Requirements:

IBM PC or compatible with 640K bytes of RAM, a hard disk drive, and DOS 2.0 or higher (DOS 3.1 or higher for extended file support).

Ashton-Tate, Inc.
20101 Hamilton Ave.
Torrance, CA 90502
(213) 329-8000
Inquiry 1018.

Database of the Dead

Getting organized for dying isn't exactly a happy subject, but unless you've got plans for fooling the Grim Reaper, it's something you have to think about. For the Record is a Macintosh program that helps you organize your important personal information and store it electronically in one place. Of course, you don't need a computer program to do this; a ledger or notebook could serve the same basic purpose. But this program does more than just serve as a computerized cigar box.

guide you through the process of setting down all the bits of personal, financial, and legal information your family or friends will need to take care of your posthumous affairs. It's basically a database program, where you record your significant details by filling out forms. Rather than having a big stack of forms to sort through, the program fetches the appropriate paper when you select the category of information you want to record.

Let's say you want to note the worth and location of your valuable objects. After picking

What For the Record does is

continued

ATTENTION ROM DEVELOPERS!

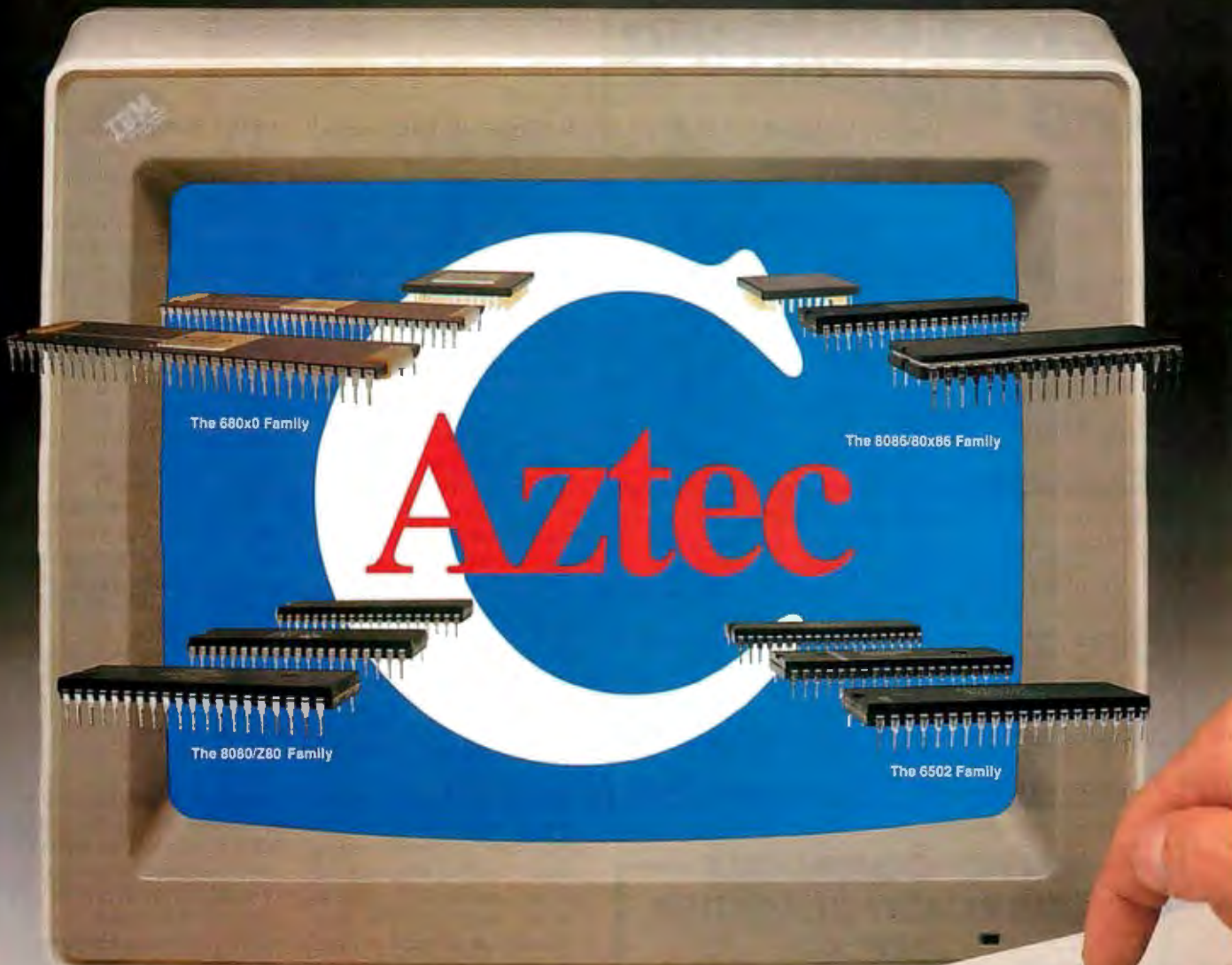

Aztec C ROM Cross Development Systems Produce Fast, Tight C Code with Less Effort

Aztec C ROM Cross Development Systems give you the best results — clean, tight and fast running code. Aztec C systems are available for a variety of targets and for both MS-DOS or Apple Macintosh hosts! And, Aztec C systems come complete with all the tools to edit, compile, assemble, optimize and, now, *source debug* your C code in less time and with less effort.

Quality, tight code that's fast and efficient. An abundance of tools to produce better results in less time. That's why Aztec C

systems are the choice of more professional ROM developers.

So when you're looking for the best results, insist on Aztec C ROM Cross Development Systems. Call today and find out more about our complete line of Cross Development Systems.

Supported targets include: the 68xxx family, the full 8086 family, the 8080/280 family and the 6502 family of microprocessors.

1-800-221-0440 (outside NJ)

(NJ and Outside U.S.) **1-201-542-2121** Telex: 4995812MANX Fax: 201/542-8386

MS-DOS is a registered trademark of Microsoft Corporation
Apple and Macintosh are registered trademarks of Apple Computer Corporation.

Aztec by MANX
SOFTWARE SYSTEMS
P.O. Box 55, Shrewsbury, New Jersey 07702

Custom Key Imprints

Create a keyboard so easy to use, costly train: into instant productivity!

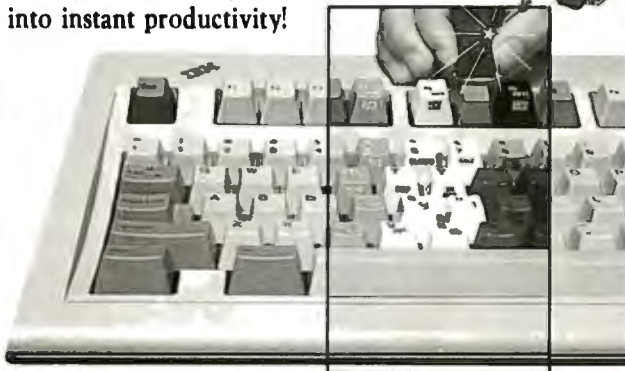

Custom Keys and Snap-On IBM KeyCaps: Available in a wide variety of colors and imprinted in your choice of colors and fonts. Keypop and Keyfront Labels: Supporting emulation, word processing or custom made to your specs. Won't wear out or come off keys until intentionally removed. FlexShield Keyboard Protectors: Extend keyboard life. Protect from dirt, liquid and damaging environments without restricting keyboard operation. Call for your **FREE CATALOG** of Custom Keyboard Enhancements.

CATALOG HOTLINE: 800 628-2828, Ext. 650

Hooleon CORPORATION For orders or custom info, call: **602 634-7515** FAX: 602 634-4620

P.O. Box 201, Dept. BYTE, Cornville, AZ 86325

IBM COMPATIBLE SINGLE BOARD COMPUTER

Quark/PC[®]+

4" x 6"



From **\$325.** quantity one

- Low Power — Less than 3 Watts
- Optional on-board Video LCD Driver
- Ideal for any PC compatible OEM product which is not a personal computer

Includes: 1. Powerful V40[®] CPU (Faster than a PC) 2. Math Co-Processor Socket 3. 5 Volt Only Operation (3 watts) 4. Speaker Port 5. Keyboard Port 6. Parallel Printer Port 7. PC Bus 8. PC Compatible BIOS ROM 9. 1 Serial Port

On board Options include: 1. 5 Mode Video Controller Option (Monochrome, Hercules[®] Graphics, CGA, High Res CGA, LCD Driver) 2. Floppy Disk Controller (3.5"/5.25", 360K/720K/1.2 MB) 3. SCSI Bus Interface (Hard Disk etc.) 4. Up to 768K RAM 5. Battery-Backed-up Real-Time-Clock 6. 2 Additional RS232C Serial Ports

To order or enquire call us today.
Megatel Computer Corporation
 (416) 745-7214 FAX (416) 745-8792
 174 Turbine Drive, Weston, Ontario M9L 2S2
 U.S. Address: 1051 Clinton St., Buffalo, N.Y. 14206

Distributors:

Germany: V&C Computers (06071) 25666 FAX (06071) 5863
 Italy and Southern Europe:
 NCS Italia (0331) 256-524 FAX (0331) 256-018
 U.K.: Densitron (0959) 76331 FAX (0959) 71017
 Australia: Asp Microcomputers (03) 500-0628 FAX (03) 500-9461
Quark is a registered trademark of F&K Manufacturing Company. Hercules is a registered trademark of Hercules Corporation. V40 is a registered trademark of NEC Corp. IBM PC is a registered trademark of IBM Corporation.

megatel

the Objects of Value category from one side of the screen, you get on the other side a window of subcategories, like precious metals, art, stamps, and computers. Selecting the subcategory takes you to the related screen form, where you type in the name of the object, a description, what it's worth, when and where you got it, its serial number, and whereabouts of ownership papers.

A category called Emergency Information is where you record vital data like how to reach your children's appointed guardian, who to notify of your death, who has power of attorney, and other items that your survivors will need after you've become a decedent. Likewise, there are categories covering sources of income, sources of debt, securities, vehicles, insurance policies, business interests, tax records, medical information, personal documents, memorabilia, what you want done with your body after you no longer need it, biographical notes, and hiding places (where you divulge the location of treasure maps or proof that Elvis is alive or whatever it is you've been hiding from your loved ones).

If you wanted to get all this business in order, you could probably do so in a day using For the Record, assuming you had all the information accessible. The program is set up nicely; you can start with the first category and work your way through the entire database, filling out the forms related to each subject.

The Nolo Press folks, who brought us WillWriter, have thought of pretty much everything. Thus, by the time you've used the program, you have a thorough record of all your personal information. This package can save you lots of time and even some lawyer's fees. The disk holding your records isn't a legal substitute for the records, but it sure will help your survivors find what they need to find when the time comes.

The program has some nice

touches that facilitate filling out the forms, including an icon that sends you into a clean entry sheet or the next screen. And if a particular form doesn't allow space for all the things you want to record, you can use the program's notes feature, which lets you attach a page of notes to any record (when I was using the program, I came across a notes page that apparently a Nolo programmer had left there, containing the lyric to "Mary Had a Little Lamb").

For the security-minded, there's a way to lock any or all categories; this uses a simple password scheme that, as Nolo admits, a competent hacker could figure out, but it will thwart the casual snoop from getting to your information.

This is a dandy little package for collecting all your records and data—and even bits of autobiography—in one place. Just be sure your executor knows how to boot up a Mac; he or she will probably not have much trouble working through the program to retrieve the information, but the executor has to know how to get in there to start. The inch-thick manual that comes with the program is only part manual; it's mostly a helpful adviser on getting your affairs in order. As the folks at Nolo Press say, you can't take it with you, but you can at least let someone know where you left it.

—D. Barker ■

Mac 512KE or higher with at least one double sided floppy disk drive System 6.0 or higher recommended

Berkeley, CA 9
 (415) 549-1976
 Inquiry 1019.

Seagate's 80MB ST4096

The capacity is high. The price is not.

If you have a voracious appetite for computer storage, Seagate's ST4096 is the drive for you.

This full-height 5.25" drive features a full 80 megabytes of formatted storage capacity, compared to other drives that format down to 72MB. With capacity this high, the ST4096 is ideal for heavy database or spreadsheet applications.

If it's a multiuser system you have in mind, the ST4096 offers a speedy 28ms access time for quick system response.

Every ST4096 we ship comes complete with menu-driven utility software for easy installation, partitioning and data management. It's just the kind of added value you'd expect from the first name in disc drives.

To find out more about reliable disc drives with high capacity and low price, contact your authorized Seagate Distributor, or call us directly at 800-468-DISC.

 **Seagate**

The first name in disc drives





The Only Character Recognition System That Outperforms Ours.

Consider the facts:

Nature's character recognition system can be trained to read all characters and languages it sees. **SPOT** (Flagstaff Engineering's Optical Character Recognition program) is trainable too. It reads most printed documents in English and more than 130 other languages.

Like nature's original, **SPOT** is very discerning. It can glance over an entire page or zoom in on a few lines of text. **SPOT** can read newspapers, magazines, books, manuals, invoices, contracts, government documents and much, much more.

Your eyes are teamed up with that marvelous computer, the brain. **SPOT** uses the latest man-made personal computers in conjunction with the

most popular low-cost scanners, and requires no additional hardware.

SPOT's advanced logic closely approximates what the human eyes and brain do. That's why **SPOT** will continue to be *the leader in OCR* ... with an intuition inspired by the original.

Seeing is believing. Since 1982, Flagstaff Engineering has helped thousands of international customers read information from various computer and printed media. Demonstration programs are available. Call today.



Helping People Read a World of Information

1120 Kaibab Lane • Flagstaff, AZ 86001
602-779-3341 • FAX 602-779-5998



Circle 105 on Reader Service Card
(DEALERS: 106)



TO THE STARS

Jerry ponders on portables and, laid low by the flu, examines game designs

Last week I went to Washington, DC, to participate in NASA's posthumous presentation of the Distinguished Public Service Medal (NASA's highest award) to my friend and mentor Robert A. Heinlein. Appropriately, the ceremony was held in the Air and Space Museum of the Smithsonian Institution, and it was nicely done. The medal was appropriate, too; Robert Heinlein's stories of what we can do if only we have the nerve have had a profound and beneficial effect. I only wish they'd got around to giving it to him in his lifetime.

I also talked to some people about the space program and what they want me to do. Depending on the outcome of next month's election, which you'll know by the time you read this, I may be a bit more involved than I am now.

On that score: the Lunar Society, an outfit mad enough to think we might be able to put a colony on the moon well before the end of this century, needs a science education coordinator. Dozens of low-cost experiments, ranging from computer simulations to simple chemical analyses, will have to be done. Most are within the capability of a good high school science laboratory, and many would make excellent Science Talent Search (STS) projects. As an example: we don't really need to spend millions of dollars developing "space-rated" items. Many everyday objects will work fine. Unfortunately, some won't: ordinary felt-tip pens, for example, give off some pretty noxious fumes when exposed to vacuum or low pressure (and worse when burned).

One good STS project would be to take items like standard electric power outlets, put them in a vacuum for a few weeks, and analyze the resulting gases. Another experiment would be to take what's outgassed from such items and pump the gas in a closed cycle through a water bath, extremes of cold and heat, and into a tub full of algae. A high school lab isn't likely to have a gas chromatograph to analyze the results (although some do), but nearly any university should be willing to cooperate. There are literally dozens of potential projects like that; the problem is coordinating the work. Any volunteers?

The Portable Wars

I do more traveling than I like—for all the mess, Chaos Manor is a pretty comfortable place—but there is one advantage. No one has yet found a way to telephone me on a train or in flight. Alas, I suppose it's just a question of time: Mr. Heinlein's *Between Planets* has teenagers carrying personal telephones on backpacking expeditions, and Geoff Goodfellow has been carrying a personal telephone to the Hackers' Conference deep in the Peninsula Hills for several years; someday, I just know I'll get saddled with one. For the moment, though, long flights are a good time to get some work done, provided you have the proper tools.

The question is, what are the proper tools?

What I've been carrying lately is the Zenith SupersPort 286. This is a machine that grew out of the Zenith Z-18x series of portables, and it is a full 80286 machine complete with a 20-megabyte hard disk drive. The Zenith backlit screens are wonderful: you can read them in just about any light conditions. If the room light is bright enough, you can dim or even turn off the backlighting to save battery power.

Unlike the earlier Z-18x series, the SupersPort's screen will tilt to any angle,

including flat horizontal, which makes it much easier to set up an optimum combination of tilt, brightness, and contrast. About the only time I've ever had trouble with the SupersPort has been when I was inside in dim light with bright windows all around me. That happened once on a train in the Arizona desert, and once on the porch of a Zurich restaurant facing the lake. Even then, I could read the screen; it just wasn't comfortable—but no other portable would have been better under those conditions, and many of them would have been plain impossible.

Like its Z-18x predecessors, this would really be good enough to be your only machine, depending, of course, on just what you do with computers. The SupersPort doesn't have color, but it is Hercules-compatible, and for that matter, unlike some of the Z-18xs, the SupersPort's EGA video output jack really works. There aren't any slots, but you can install an internal modem.

There's provision for additional memory and a math chip. (If you do any calculations at all and you don't have a genuine Intel math chip for your computer, go get one. They're simple to install and the most cost-effective speedup device I know of.) The keyboard is a bit small, but it doesn't take long to get used to it. I'm told there is (but don't yet have) a tiny memory-resident program to swap the Caps Lock and Control keys to make typing easier. In other words, the SupersPort really is a full IBM PC AT-type computer.

It's also heavy.

I like to avoid checked luggage whenever possible. This means I get on an airplane carrying a briefcase, a garment bag, and a computer. Sometimes, after COMDEX for instance, I also have several canvas book bags of stuff I collected at the show. (Some airlines have begun to get sticky about the "two carry-on items" rule; when they do, I tell them my briefcase is my purse and point to all the

continued

integrated,

**Introducing
BRIEF v2.1**

Over 5,000 of you were forced to make sacrifices to use BRIEF, The Programmer's Editor. Advanced compilers and new programming environments, like Turbo C and QuickBASIC, took up so much RAM that BRIEF could not fit in the same 640k.

If you wanted to retain BRIEF's uniquely powerful features¹ while working with larger programs, you had to sacrifice speed and continuity. Instead of a tight Edit-Compile-Edit loop, you had to slog through an obsolete Edit-Exit-Compile-Exit-Edit loop.

Now you no longer have to make that sacrifice.

You can enjoy the features¹ that have made BRIEF the best-selling and the best regarded² programmer's editor without sacrificing environment integration.

Version 2.1 of BRIEF can be swapped in and out with a single keystroke ng immediate compilation with even the largest compilers: Microsoft C5.0, QuickC, Turbo C, Lattice C, dBXL, FoxBASE+ v2.0, Clipper, etc.

¹ For example: real multi-level Undo (not simply Undelete), flexible windowing, unlimited file size, unlimited number of simultaneous files, automatic language sensitive indentation.

² For example:
"The quintessential programmer's editor." — *Dr. Dobbs's Journal* "Right out of the box, it's a versatile, **extremely powerful** editor that handles most any programming task with aplomb." — *Computer Language* "Simple to learn and use and extremely sophisticated. Strongly recommended." — *PC Magazine* "Not only the best programmer's text editor I've ever seen, but it is also a **tour de force** in the way it was conceived and implemented." — *Computerworld* "So far surpasses users' expectations that it is **revolutionary**." — *MicroTimes Magazine* "BRIEF is truly outstanding." — *Microsoft Systems Journal*

Current BRIEF Users:

Call Ann for details on 4 other important enhancements. Registered users of versions 2.0 or 2.01 update for only \$35.

Haven't tried BRIEF yet?

BRIEF retails for \$195. Call Ann today for a no-risk, 60-day trial with a full, money-back guarantee.

**Call toll-free today
800-821-2492**

**Solution
Systems**

**541 Main Street, Suite 410
South Weymouth, MA 02190
617-337-6963**

women with purses in addition to two tams. So far, no one has bothered me on flights out from COMDEX.) Anyway, I generally have plenty to carry; and when you change planes, your flight will inevitably come in at gate 3 to connect with one at gate 37 leaving in 10 minutes. I think they run a linear programming model on a Cray to achieve that.

The result is that every trip I feel the weight of the SupersPort's shoulder strap. "Never again," I mutter as I scurry down the corridors of the Dallas airport. "Next time I swear I'm taking a lighter machine."

The problem is, which one?

The lightest of all are the TRS-100 and NEC PC-8201 laptops. These are pretty good little computers. There's no backlighting, but they're surprisingly readable, even in fairly dim light. I've been able to work with the PC-8201 in the darkened cabin of an overnight flight to Europe. These two machines have BASIC and quite a good text editor in ROM; longtime readers will recall I used the PC-8201 to write this column while I was in Liechtenstein.

The "normal" screen of 8 lines of 40 characters is impossible, but Traveling Software's Ultimate ROM II (isn't being twice ultimate a bit like being "very unique"?) lets you have 8 lines of 60 characters, which isn't enough, but it's better than working with a typewriter. If all you're doing is making notes and writing short articles, these machines are pretty good.

There are some problems. On my last trip, I took copies of *Strategy of Technology*, *Prince of Mercenaries*, and a new book Larry Niven and I are working on called *A Labor of Moles*. I had them all on the SupersPort's hard disk, and I managed to get some work done on each of them. I couldn't have done that with the PC-8201. While Traveling Software's LapDOS will let you couple a battery-powered 3½-inch floppy disk drive to a PC-8201 or TRS-100, it's quite slow; changing from book to book would not have been so easy.

On the other hand, it would have been possible. There are still situations where the TRS-100 and the PC-8201 make a lot of sense, especially if they're jazzed up with some items from Traveling Software's catalog: a spelling checker in ROM, a way to add a megabyte of memory to the TRS-100, and programs to squirt text from the laptop to a DOS machine. Given the light weight and low price, the older laptops aren't dead yet.

The next step up is the Toshiba T1000. This little gem has DOS in ROM (alas,

version 2.2, but you can boot it with 3.x if you need DOS 3 features). There's one floppy disk drive, and it has no backlighting. Unlike the TRS-100 and PC-8201 laptops, the memory is volatile. In a word, it's your basic unadorned PC-compatible laptop. It also weighs about 5 pounds, compared to my SupersPort's 15+ pounds. (Part of the SupersPort's weight is the bag, a large power converter, and other auxiliary stuff that could go in checked luggage but never does.) Many writers swear by the T1000. David Drake loves his; he often works outside in his backyard and considers the T1000 ideal for that.

The T1000 is a "full PC," meaning you can run your favorite word processor and other DOS software; one friend with back problems has hers set to play mah-jongg while she lies flat. It also has a full screen. It doesn't weigh much more than the PC-8201 and the TRS-100. It costs more, but on balance you get quite a lot for the added weight and price.

If you want to spend more money, you can add a 768K-byte nonvolatile RAM disk. This should be really handy, since it speeds up disk operations, and being nonvolatile, it is safer than a hard disk.

For communications, get a WorldPort 300-/1200-bit-per-second modem; it's about the size and weight of a pack of cigarettes and works very well. I'm told you can also buy a gadget that backlights the T1000's screen.

All told, the T1000 is extremely tempting and definitely preferable to the smaller laptops. In my judgment, the real battle of the laptops is between the T1000 and the SupersPort. (A number of other laptops have hard disk drives, but the SupersPort's batteries—provided you deep-discharge them at regular intervals—last over 3 hours, which is a good bit longer than any other machine I've tested or even heard of.)

I haven't really made up my mind on which to take on trips. When I'm humping baggage through airports, I swear I'll never carry the SupersPort again; but when I actually sit down on the plane or in my hotel room, I'm mighty glad I have the full machine.

Usually what happens is that the night before a trip I dither, and finally decide to carry the SupersPort. Then I mutter curses at it in airports.

There are several reasons for that choice. First, I sometimes do programming on trips; and since I can't carry the reference documents, it's important to have all the help files instantly available on the SupersPort's hard disk. I have to

continued

"TOPSPEED EARNS A STANDING OVATION!"

—Kent Porter, Dr. Dobbs Journal



TopSpeed's seamlessly integrated environment.



VID (Visual Interactive Debugger): power without complexity.

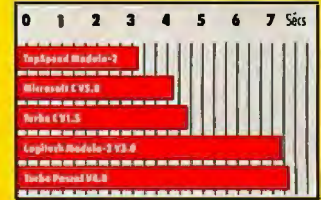

Siege benchmark measured by the British Standards Institution (BSI)—25 iterations on an 8MHz AT.

"...TopSpeed is surely one of the finest new products introduced to date in the PC arena...DDJ doesn't give unqualified raves very often, but there's no question about it in this case; JPI's TopSpeed Modula-2 is first-rate."

Kent Porter
Dr. Dobbs Journal

"JPI Modula-2 looks like another classic in the making. It generates code as good as or better than leading C compilers and the programming environment is a genuine pleasure to use."

Dick Pountain
BYTE Magazine
August '88, pg. 88IS-3

"I liked all of the hard-disk space that was recovered after I deleted my BORLAND, MICROSOFT, and LOGITECH compilers, because with TopSpeed Modula-2 all the rest are obsolete."

Robert D. Randall
Donnelley Marketing

In England and Europe contact:
Jensen & Partners UK Ltd., 63 Clerkenwell Road, London EC1M 5NP. Phone: (01)253-4333.
Compiler Kit: £39.95, TechKit £34.95, VID £34.95, DOS 3-Pack £119.95

Handling charges: In UK please phone for VAT and P&P. In Europe, add £6 for up to 3 products. £2 for each add'l product.

The successor of Pascal: JPI TopSpeed™ Modula-2 produces better code than Microsoft C, Turbo C, Logitech Modula-2 and Turbo Pascal 4.0.

Debug with VID: The easy-to-use, source-level debugger. Single-step and trace through source in multiple modules. Examine and modify all variables in symbolic form, including arrays, records, enumerated types and pointers. Point and shoot breakpoints including "One-shot," "Sticky," "Delayed," and "Monitor." Watch both variables and Modula-2 expressions during execution. Automatic variable trace of all variables accessed, and assembler, registers and procedure call-stack trace windows. Package includes symbolic disassembler and execution profiler. 72-page manual.

The Compiler Kit includes: High-speed optimizing compiler (3,000-5,000 lines/min. on a PC AT 8MHz), integrated menu-driven environment with multi-window/multi-file editor, automatic make, fast smart linker. All Modula-2 sources to libraries included. BONUS: Complete high-speed window management module included with source. 258-page User's Manual and 190-page Language Tutorial.

The TechKit™ includes: Assembler source for start-up code and run-time library, JPI TopSpeed Assembler (30,000 lines/min.), TSR module, communications driver, PROM locator, dynamic overlays, and technical information. 72-page manual.

System Requirements: IBM PC or compatible, 384K available RAM, two floppy drives (hard disk recommended).

Compiler Kit \$99.95
TechKit \$59.95
VID \$59.95

DOS 3-Pack \$199.95
(Compiler, TechKit & VID)

To Order:
In the US, call:
1-800-543-5202
In Canada, call:
1-800-543-8452

Or mail us your order with a check, money order, or VISA/MC information. 30-day unconditional money-back guarantee.

Shipping & handling charges:
In North America: add \$5, plus \$2 for each add'l product. CA residents please add applicable sales tax. Overseas: add \$20, plus \$8 for each add'l product.

 Jensen & Partners International

1101 San Antonio Rd.
Suite 301
Mountain View, CA 94043
Phone: (415)967-3200

TopSpeed and TechKit are trademarks of Jensen & Partners International. Other brand and product names are trademarks or registered trademarks of their respective holders.

THE PROGRAMMER'S SHOP

helps save time, money, and cut frustrations. Compare, evaluate, and find products.

NEW Catalog!

Our new, colorful, completely updated catalog lists over 700 of the most popular, cutting-edge programmer's tools, clearly organized into intuitive function categories. Completely indexed by product and manufacturer plus helpful notes on every item listed, common questions and answers. Yours FREE when you call.

Assemblers

	List	Ours
MS Macro Asm	150	105
Turbo Assembler/Debugger	150	105
Visible Computer 80286	100	89

AZTEC C86 - Commercial	499	Call
High C-286 - by MetaWare	595	Call
Lattice C - V3.3	450	289
Microsoft C 5.1 - w/CodeView	450	299
Microsoft QuickC	99	69
Turbo C - by Borland	150	105
Watcom C6.5 - highly optimized	295	269

Dbase & Tools

CLEAR+ for dBASE	200	159
Clipper Summer '87	695	449
dBASE IV	795	529
dBRIEF w/BRIEF	275	Call
dBug - source debugger	195	179
Documentor	295	239
DBXL Interpreter	199	149
FoxBASE+ - V2.1	395	259
FoxTool Box	295	279
Genier - code generator	395	259
R&R Relational Report	149	139
R&R Clipper & FoxBASE	55	45
Quicksilver Diamond	599	369
UI Programmer	295	249

New Discovery

Microsoft Programmer's Library

48 references on CD-ROM disk include Windows and OS/2 development kit manuals, Microsoft Press books, most Microsoft language manuals, and 20 floppies' worth of indexed sample code. Indexed and cross-referenced. \$329. Additional network nodes \$59.

Debuggers

	List	Ours
Periscope II - breakout switch	175	139
Periscope III - 10 MHz version	1395	1129

BRIEF	195	Call
COMPEDITOR	175	165
Edix	195	159
Epsilon - like EMACS	195	159
KEDIT - like XEDIT, V.4	150	129
Personal Rexx	125	109
ME Macro Editor - Source	189	159
MKS VI	75	69
EDT + 4.0 - like VAX EDT on PC	295	269
SPF/PC - V2.0	245	189
Vedit Plus	185	135

Text Screen Addons

C Worthy w/forms with source	295	Call
Curses - by Aspen Scientific	495	Call
Greenleaf DataWindows	119	109
PowerScreens - by Blaise	295	229
Windows C - source, menus	129	99
Vitalm C - source, menus	225	169
Windows for Data	295	265

Note: Mention this ad. Some prices are specials. Ask about COD and POs. Formats 3" laptop now available, plus 200 others. UPS surface shipping add \$3/per normal item. All prices subject to change without notice.

Established 1983. We carry over 1,100 different products. Call today for complete technical information and advice, our catalog, literature, and solid value.

518 Pond Park Road
Higham, MA 02043
Mass 303/442-8070
or 617/240-2510/11044
Telex: 671 5344
FAX: 749-2818

800-421-8006

HOURS:
M-F 9:30-8:00
Sat. 10:00-4:00

Some Things Never Change



WELTEC introduces their new 525 external floppy drive subsystem - the easy way to use 5 1/4" data with your 3.5" format laptop computer. The 525 subsystem is simple to setup, easy to use, and supports a wide variety of laptop and desktop systems.

For more information on the 525 subsystem write or call:

800-333-5155



WELTEC digital, inc.

17981 Sky Park Circle, Suite M, Irvine, CA 92714
Phone: 714-250-1959 • Telex: 3728057 • FAX: 714-250-1964

confess, though, I do less and less programming all the time.

Second, it's very nice to have several books all instantly available. The SupersPort does really rapid disk accesses, making it simple to switch from one chapter to another, or even from one book to another. Whether that's sufficiently convenient to warrant making me a beast of burden is another matter.

The latest reason I put up with the SupersPort's weight is Symantec's GrandView. This program is so neat I can't see how I ever lived without it. It's actually worth humping baggage to have it.

GrandView is the logical successor to ThinkTank: an outline processor with a good text editor. The editor is really good enough to write columns with—I know at least one columnist who uses nothing else—and since GrandView has the capability for multiple windows, I can do about half my trip work without ever leaving it. GrandView, alas, really needs a hard disk.

There's one more possibility I haven't tried: the T1000 with the additional 768K-byte RAM disk. I'm told that GrandView operates very well with a RAM disk. That could make the T1000 a really powerful contender, and it would be a great deal lighter than the SupersPort. We'll see. I suspect, though, that when all the tests are over, I'll still be lugging the SupersPort and muttering curses.

Game Designs

I came back from Washington, DC, with a sore throat that soon developed into a cold and went from there to a full case of the flu. I'm basically pretty healthy—megavitamins seem to help keep my immune system in good shape—but even so, I was sick enough that I didn't much feel like working. The upshot was that I spent a few days mucking about with new computer games.

They're getting pretty good. Some, like Wall Street Raider, are educational to boot: Raider is a detailed simulation of corporate finance. Playing one against the computer isn't a lot of fun—the computer isn't too sophisticated—but if you get three other people, you can really learn something about stocks, mergers, takeovers, and the general world of finance, and have a whacking good time in the bargain.

However, it's no game to play when you're nursing a cold. I've found by and large that when the flu gets you, the best thing to do (other than go to bed, which is boring) is to go conquer something.

continued

If your idea of Romance Languages includes BASIC and C, then we have a great deal for you.



- U.S.A \$24.95 for 1 year
- Canada \$26.95 U.S. for 1 year
- Bill me
- Payment enclosed
- Charge to my () VISA () MasterCard
- Account # _____
- Expires _____
- Signature _____
- This is a renewal order.

Packed with in-depth information on the latest in microcomputing, BYTE magazine is written to stimulate the minds of almost half a million personal computing experts. Now, you too can enjoy BYTE each month at our special introductory rate.

Subscribe now and save \$17 off the newsstand price...12 issues for \$24.95 instead of \$42.00...and \$5.00 off the regular subscription rate of \$29.95. You'll also receive our special IBM PC issue as part of your subscription!

IBJ0378

Name _____
(Please Print)

Company _____

Address _____

City/State _____

Country _____ Code _____

For direct ordering, call toll free 1 800 257-9402 weekdays
9:00 AM-5:00 PM EST. In New Jersey, call 1 609 426-5535.

Please allow 6-8 weeks for processing your subscription.

BYTE



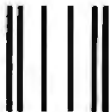

NO POSTAGE
NECESSARY
IF MAILED
IN THE
UNITED STATES

BUSINESS REPLY MAIL

FIRST CLASS MAIL PERMIT NO. 42 HIGHTSTOWN, NJ

POSTAGE WILL BE PAID BY ADDRESSEE

BYTE

Subscription Department
P.O. Box 558
Hightstown, N.J. 08520-9409



THE NEW STANDARD FOR HIGH PERFORMANCE STATISTICAL SOFTWARE

CSS

COMPLETE STATISTICAL SYSTEM

WITH DATA BASE MANAGEMENT

AND GRAPHICS

A powerful, comprehensive, elegant, and super-fast statistical package for IBM (PC, AT, PS/2) and compatible computers. ■ The CSS optimized user interface with fast hierarchical menus incorporates elements of artificial intelligence; even complex analyses require only a few keystrokes (batch processing is also supported). ■ CSS features comprehensive, state of the art implementations of: *Basic statistics, Multi-way frequency tables, Nonparametric statistics, Exploratory data analysis with analytic graphs, Multiple regression methods, Time series analysis with modeling and forecasting (incl. full ARIMA), General ANOVA/ANCOVA/MANOVA, Contrast analysis, Discriminant function analysis, Factor analysis, Principal components, Multidimensional scaling, Item analysis/Reliability, Log-linear analysis, Cluster analysis, Non-linear estimation, Logit/Probit analysis, Canonical analysis, Survival and Failure Time analysis (Censored data), Quality Control analysis, and much more.* ■ All statistical procedures are integrated with fast data base management and instant, presentation quality graphics (over 100 types); full support for all mono and color graphics boards (incl. VGA) and over 100 plotters and printers (incl. the HP and Postscript standards). ■ All CSS screen output is displayed via customized Scrollsheets™ (i.e., dynamic, user controlled, multi-layered tables with cells expandable into pop-up windows); all numbers in a Scrollsheet™ can be instantly converted into a variety of presentation quality graphs; contents of different Scrollsheets™ can be instantly aggregated, combined, compared, plotted, printed, or saved. ■ The flexibility of the CSS input/output is practically unlimited: CSS offers an intelligent interface (read/write) to all common file formats (Lotus, Symphony, dBI, dBIII+, DIF, SYLK, ...) and special utilities to easily access data from incompatible programs; graphics can be saved in files compatible with desktop publishing programs (Aldus, Ventura). ■ CSS data files can be as large as your operating system (DOS) allows; OS/2 version coming soon. ■ CSS precision exceeds the standards of all common precision benchmarks. ■ *Technical note: The CSS user interface and all I/O were written in Assembler and bypass DOS; graphics and data management were written in Assembler and C; the computational algorithms were written in Assembler and optimized Fortran.* ■ \$495 (plus \$5 sh/h); 14-day money back guarantee.

Circle 253 on Reader Service Card



StatSoft

2325 East 13th Street ■ Tulsa, OK 74104 ■ (918) 583-4149

Fax: (918) 583-4376

Overseas Offices: StatSoft of Europe (Hamburg, FRG), ph: 040/4200347. StatSoft UK (London, UK), ph: 0438/310056 or 316581. Hearne Software (Melbourne, Australia), ph: 613-497-4276

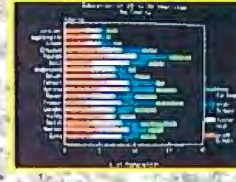
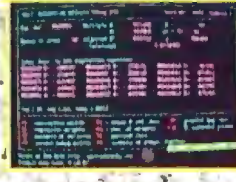
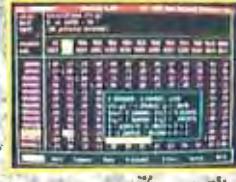
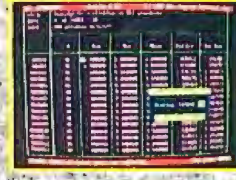
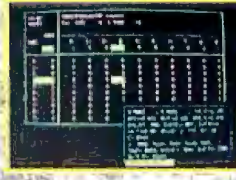
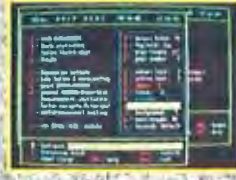
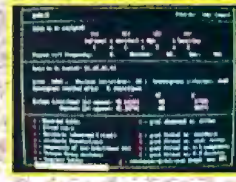
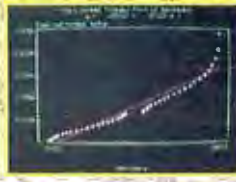
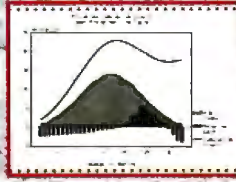
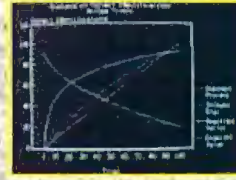
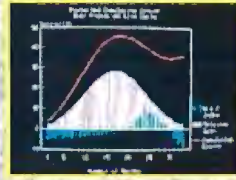
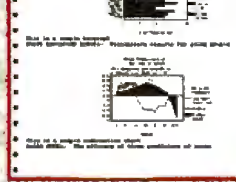
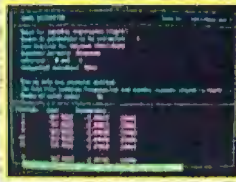
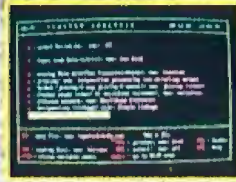
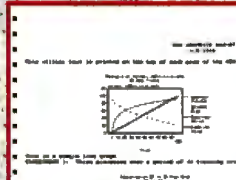
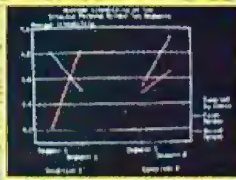
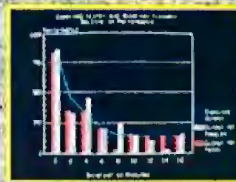
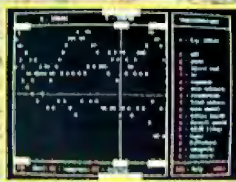
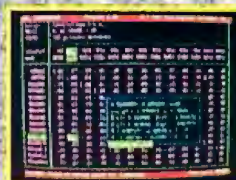
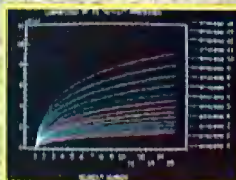
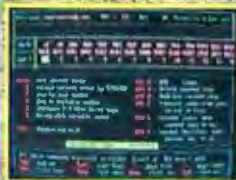
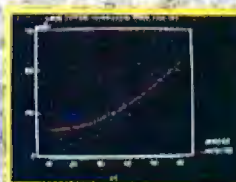
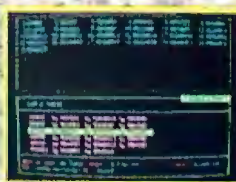
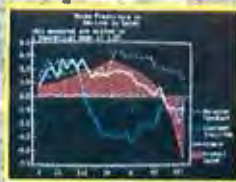



Diamond Scan 14
Auto-Tracking
800 x 600 pixels (digital, analog, monochrome)
330 x 500 pixels (composite NTSC)

Diamond Scan 20A
Auto-Tracking
800 x 600 pixels (digital, analog, monochrome)
1024 x 800 pixels (maximum)

Diamond Scan 16L
Auto-Tracking
1024 x 768 pixels (typical)
1280 x 1024 pixels (maximum)

Diamond Scan 20L
Auto-Tracking
Up to 1280 x 1024 pixels

Actual unretouched screen images
Monitors shown with optional bases

A Clear View To Monitor Quality

CHAOS MANOR

One of the more fascinating war games is *Empire*. This is a PC (IBM, Atari, and Amiga) version of the game that Walter Bright wrote for big minicomputers. It was ported over by Mark Baldwin. *Strategic Conquest* (Macintosh only; a Mac II version has been announced, but I've never seen it) is pretty directly based on the old *Empire*, and it was published before Baldwin got *Empire* converted to PCs.

Empire is published by Interstel. They also do *Star Fleet One* and have announced but never shipped *Star Fleet Two*. Presumably because they began as a space-war-oriented company, they've surrounded *Empire* with a fairly silly scenario shell, something about being dropped onto a planet with a single army and the mission of conquering the whole place. All of that is about as silly as the game's box cover: a drawing of an overdressed chap who looks to be under 20 and has enough gold braid and medals to make any generalissimo proud. More to the point is the warning printed in the manual: "*Empire* has been known to be addictive. Typical battles can take several hours to resolve. Interstel assumes

no responsibility for lost productivity on the part of the players."

The odd part is that they're right. *Empire* is an addictive game, and I've been wondering why.

First, the game is easy to play. Just take the mouse and use it to indicate where your troops should go. If you want to start a battle, try to move where an enemy force is.

Second, it goes in tiny increments. It's easy to make just one more move; and although there are a lot of units, you can give them general orders—such as go this way until you find something, or sit here and wait for something to happen—so you don't have to fool with each unit in each turn.

Third, the conflicts are resolved instantly: you attack, and you find out what happens. Then you move another unit. As with point two, this leaves no clear stopping point. It's always tempting to make just one more move and see what that does.

Fourth, the user interface is intuitive. It's not as good as I'd like. The mouse response can sometimes be annoying. I've sent Baldwin suggestions for new

ways to display needed information. Still it's more than adequate for the job.

Fifth, the game isn't easy to win, but you probably will. The enemy isn't entirely predictable. He can surprise you, and of course you never know what the world map looks like until you've conquered, or at least explored, the territory.

Summing it all up, *Empire* tempts you to play just a little longer and find out what's going to happen next.

Another series of computer war games is based on the old board game *Stellar Conquest*. *Reach for the Stars*, which has been the game of the month here a couple of times, is certainly the best implemented of these; alas, it's available only for the Mac, which is probably not a coincidence since it's the Mac interface that makes it so easy to play. *Stellar Crusade* is another; this one is available for the Atari ST and the IBM PC (and probably some other machines). The user interface isn't anywhere near as nice as that of *Reach for the Stars*, but *Stellar Crusade* does try some innovations.

The one I've spent the last 2 days mucking about with is *Anacreon*, which is published by an outfit called TMA

Only one supplier of color monitors offers the widest selection of features and operating flexibilities in the market today.

That company is Mitsubishi Electronics.

Mitsubishi® delivers the reliability and performance that can meet your color information display requirements today as well as tomorrow. Larger screen sizes, truer colors, and optimum resolutions make your work easier—and far more productive.

Whether your requirements call for fixed-frequency graphics standards, like EGA and VGA, or multiple-frequency performance, Mitsubishi has the color monitor

with the resolution and size to fit your specific needs. This includes the Diamond Scan Series of 14", 16" and 20" auto-tracking monitors, some with microprocessor-enhanced programmable display settings. All at very competitive prices.

To get a clear view of monitor quality and value, look to Mitsubishi.

For product information or nearest authorized Mitsubishi Electronics sales representatives, please call 1-800-556-1234, ext. 54M. In California, call 1-800-441-2345, ext. 54M. Mitsubishi Electronics America, Inc., Computer Peripherals Division, 991 Knox Street, Torrance, CA 90502, (213) 217-5732.

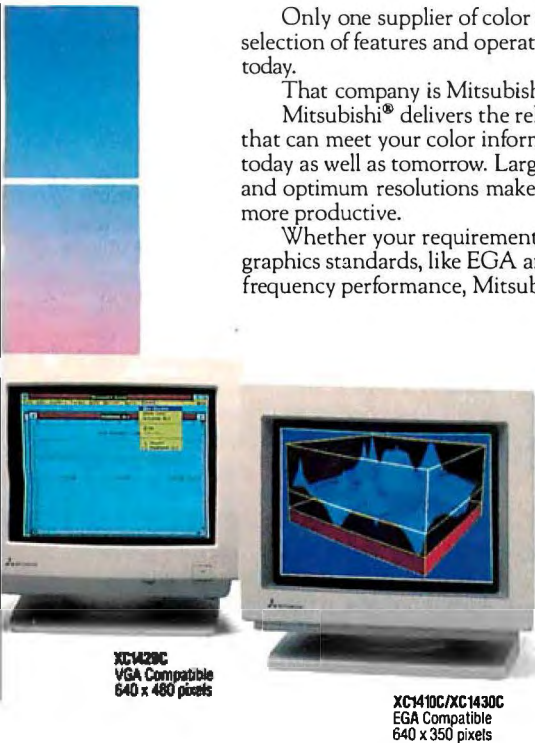

Mitsubishi Model	Screen Size (Inches)	Horizontal Scan Frequency (kHz)	Mask Pitch (mm)	Compatibility/Resolution							
				NTSC	CGA	EGA	VGA		Apple Mac II	1024 x 768	1280 x 1024 (24 bits)
							Std.	Ext.			
Diamond Scan 14 (AUM1381A)	14/13V	15.7 - 36 auto-tracking	0.31	•	•	•	•	•			
Diamond Scan 16L* (HL6605TK)	16/15V	30 - 64 auto-tracking	0.31				•	•	•	•	
Diamond Scan 20A (HA3905ADK)	20/19V	15.7 - 36 auto-tracking	0.31		•	•	•	•	•		
Diamond Scan 20L* (HL6905TK)	20/19V	30 - 64 auto-tracking	0.31				•	•	•	•	
XC1429C	14/13V	31.5	0.28				•				
XC1410C	14/13V	22 or 15.75	0.40		•	•					
XC1430C	14/13V	22 or 15.75	0.31		•	•					

*Microprocessor-enhanced programmable display settings



© 1988 Mitsubishi Electronics America, Inc. Mitsubishi is a registered trademark of Mitsubishi Electric Corp., Tokyo.

Screen images produced with permission from the following companies (trademarked software package name follows company name): Autodesk, Inc. (AutoShade); Computervision Corporation (Personal Designer); Computer Friends, Inc. (Modern Artist); SuperMac Software (PixelPaint); Three-DI Graphics, Inc. (Perspective); Microsoft Corporation (Excel Version 2.0).

And Value.

CHAOS MANOR

(undoubtedly the author, George Moromisato, in another guise). The manual is thick and informative and full of good ideas, but, alas, doesn't give the address of the company! That's actually not surprising: the whole game is filled with excellent ideas, mostly well implemented, and then spoiled by inattention to some vital detail.

I am about to be more critical of Anacreon than the game deserves; most of its sins are committed by one or another start-up software publisher, and indeed, it's their very generality that tempts me to discuss them. Then, too, I've just spent the last 2 days (and nights) playing this thing, so I've given it a lot of thought. Incidentally, you should note that I have been playing the game. True, it was mostly a way to be distracted from my flu, but I've got plenty of other games here, or for that matter there are a lot of new science fiction novels I haven't read. It says a lot for Anacreon that although it was pretty frustrating at the beginning, I did keep at it.

Anacreon (the name is based on one of the barbarian kingdoms in Isaac Asimov's *Foundation* series), like all the

Stellar Conquest derivatives, is a kind of super Hammurabi, with provision for rather simple combat thrown in. Hammurabi, for those who came late into the computer revolution, is one of those early BASIC games that appeared early on, just after the MITS Altair computer came on the market.

Half the people I know wrote a Hammurabi program back in the 1970s; for many, it was the first program they'd ever written in their lives. It was a game of allocation of resources. How much wheat do you feed the peasants as opposed to how much to save as seed corn? Do you borrow money from Gonzor the Toothless (who wants exorbitant interest) or neglect to buy a new grindstone? And so forth. The Stellar Conquest derivatives are much more sophisticated now, but they still require you to make economic decisions.

This is all right when you're working with half a dozen planets, but after the game gets going and you have 40 or so places to worry about, it becomes tedious in the extreme. Anacreon tries to handle this in a fairly novel way: you don't issue detailed orders to your planets, you des-

ignate what that planet will concentrate on making. After that, it will take care of itself, notifying you if it's out of some raw material it needs.

So far, so good; but once again, after 30 or 40 turns, you are bogged down in details. Stellar Conquest games all have the feature that the only way to win is to build enormous fleets; but since your empire is scattered all to heck and gone, you get tiny forces on each planet. Then comes the task of concentrating those—and very few of the silly games have any automatic provision for doing it!

Empire solves much the same problem by letting you set flight paths: aircraft produced by rear-area cities can be automatically sent to some convenient forward area without your having to notice them. Stellar Conquest games desperately need that kind of feature: a way to order a planet to send each type of force it produces to some designated place or places (there are several kinds of warships, and you generally don't want to mix them in one fleet), and keep doing that until further notice.

Now since the need for this feature is

continued

so obvious, and so few games of this kind have it, one wonders why this happens; and I suspect it's because the game designer has long since stopped playing the game to its conclusion—and may well be sick of it. In any event, the designer is “testing” it rather than playing it. This probably happens to designers of other types of software as well: it's “tested” but not *used*, so that each individual feature works fairly well, but crying needs that don't arise until things get compli-

cated just aren't seen.

Anacreon's next problem is in the user interface. While portions of this are quite good, some are just annoyingly buggy, and much of it is incomplete. Bugs include one routine in which the system will accept a character input; but if you insert a number, it gives an error message and makes you start over (after which it accepts the number it previously rejected). You can designate planets either by their names or their numerical

coordinates. The routine in question allows, among other things, the naming of the planets—which must be identified by their numerical coordinates before you can name them. Since I can't recall all those numbers, I have to look at the screen map to see what the coordinates are—and doing that triggers the bug. This is a trivial bug, but it's annoying, and I do wonder why it wasn't fixed.

However, fixing that bug isn't what's really needed. What Anacreon really needs is a way to let you point and shoot: use either the mouse or the cursor keys to designate which of the doggone planets you're trying to name, or go to, or attack. Anacreon was written in Turbo Pascal 4.0, and about half the game inputs *can* be done with menu bars and the cursor keys; the other (and most often used) inputs have to be laboriously typed in, even though right there on your screen is a list of the items you have to type in. It's clear that Anacreon, again like a lot of self-published software, was rushed into production before it was really finished.

One wonders why this should be so. Start-up companies are at a horrible disadvantage. They have no advertising budgets, no mailing lists, no word-of-mouth reputation. They're a bit like beginning actors.

Charlton Heston once told me that getting ahead in acting was more a matter of luck than talent and skill; but then he hastily amended that. “What I meant,” he said, “was that there are a lot of skillful and talented people out there, far more than the industry can absorb, so that it takes luck, at least one good break, to rise above the crowd. However, if you haven't done your homework and developed your skills, one good break won't do you any good because you won't be able to exploit it.”

It seems to me that software start-ups are in the same position. There are a lot of good programmers out there. A lot of them have good ideas. Many of them go on to develop their ideas, and a surprisingly large number then try to publish their stuff. I must get 100 such attempts each month, and I probably don't get them all. I look at perhaps 10 of those, and I'll be the first to admit that luck has a lot to do with it. A good cover letter explaining just why this is different from all the “yet anothers” helps a lot, but in the last analysis, I look at stuff by whim.

Since there is so much unexamined software lying around Chaos Manor, I'm not going to spend a lot of time with anything that's confusing, or contains annoying bugs disguised as features. I've

continued

Write Better Turbo 4.0 Programs...

5.0

Or Your Money Back

You'll write better Turbo Pascal 5.0 programs easier and faster using the powerful analytical tools of Turbo Analyst 5.0. You get an integrated development environment with • Pascal Formatter • Cross Referencer • Program Indexer • Program Lister • Execution Profiler • Includes complete source code. + a new execution timer!

“Turbo Analyst...a valuable tool for every Turbo Pascal programmer. The Program Structure Analyzer... a timesaver. The integrated environment...impressive.”

Namir Shammass, Turbo Tech Report, July/Aug. 1988

Turbo Analyst 5.0 is only \$99.

Now with data entry screens!

A Library of Essential Routines

Turbo Professional 5.0 is a library of more than 500 state-of-the-art routines optimized for Turbo Pascal 5.0. It includes complete source code, comprehensive documentation, and

powerful and useful demo programs. You get • TSR management • Menu, window, and data entry routines • BCD • Large arrays and more.

“Turbo Professional...a superbly crafted toolbox... [makes] the hard stuff so easy.”

Kent Porter, Dr. Dobb's Journal, April 1988

Turbo Professional 5.0 is only \$125.

Call toll free for credit card orders.

1-800-538-8157 ext. 830 (1-800-672-3470 ext 830 in CA)

For upgrade or other information, call 408-438-8608.

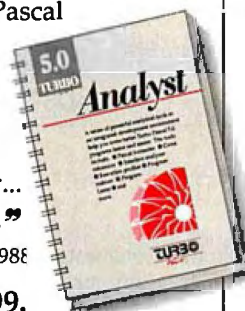

Satisfaction guaranteed or your money back within 30 days. Turbo Pascal 4.0 or 5.0 is required. Shipping & taxes prepaid in U.S. & Canada. Elsewhere add \$15 per unit.



TurboPower Software
P.O. Box 66747
Scotts Valley, CA 95066-0747

STOP

and compare our quality and prices! *Our Standards Are Their Options...*

42+ Meg 12 MHz 286 EGA Color System **\$1850**

- Samsung 14" EGA Color Monitor
- 12 MHz PC-AT Computer
- Baby AT Case with Key Lock, Turbo, Power and Hard Drive LEDs
- Everex Enhanced Auto Switch EGA Card 640 x 480
- Intel 80286 CPU
- Multi-speed 6/8/10/12 MHz
- Keytronics 101 Enhanced Keyboard
- 640k Memory Expandable to 1 Meg
- 200 Watt Power Supply
- Seagate Model ST251 42+ Meg Hard Disk Drive
- 5¼" 1.2 Meg Floppy Drive
- Western Digital 2 Hard Disk and 2 Floppy Controller with Cables
- Serial/Parallel & Game Port
- 80287 Math Co-Processor Slot
- Complete Operations Manual
- One Year Warranty

With EGA Multisync (Analog) 800 x 560 **\$2045**
 With Monochrome + 40 Meg (ST-251) **\$1495**



286 16 MHz 0 Wait State Running at 21.0 MHz

42+ Meg 16 MHz 286 EGA Color System **\$2250**

Same System as Above with the Following Differences:

- Running at 21 MHz
- 0 Wait State
- 16 MHz PC-AT Computer
- Multi-speed 8/16 MHz
- Landmark Test of 21 MHz
- 1 Meg Memory Expandable to 8 Meg on the Motherboard

With EGA Multisync (Analog) 800 x 560 **\$2445**
 With Monochrome + 40 Meg (ST-251) **\$1895**

42+ Meg 20 MHz 386 EGA Color System **\$2995**

- Samsung 14" EGA Color Monitor
- 20 MHz 0 Wait State Computer
- Everex Enhanced Auto Switch EGA Card 640 x 480
- AT Case with Key Lock, Turbo, Power and Hard Drive LEDs (Tower Case available)
- Intel 386-20 CPU (not a 386-16)
- Keytronics 101 Enhanced Keyboard
- 1 Meg Memory
- 220 Watt Power Supply
- Seagate Model ST251 42+ Meg Hard Disk Drive
- 5¼" 1.2 Meg Floppy Drive
- Western Digital 2 Hard Disk and 2 Floppy Controller with Cables
- Serial/Parallel & Game Ports
- Math Co-Processor Slot
- Complete Operations Manual
- One Year Warranty

With 386-20 MHz EGA Multisync (Analog) 800 x 560 **\$3190**

DOS 3.3 — \$79
DOS 4.0 — \$109

To Order, Call

1-214-931-3777

ieee, inc. 17120 DALLAS PARKWAY • SUITE 212 • DALLAS, TEXAS 75248

ALL SYSTEMS ALSO
AVAILABLE WITH VGA

TERMS: One year warranty (12 months parts/12 months labor). 30 day money-back guarantee (excluding shipping charge). We accept **Visa, MasterCard, Discover** (add 3% for credit cards), cashier's check, money order, wire transfer and personal checks (personal checks, please allow 10 working days to clear). Shipping and insurance extra. Prices and availability subject to change without notice. IEEE reserves the right to substitute equivalent or better products. No COD's accepted. 15% restocking fee on unauthorized returns. IBM XT/AT are trademarks of IBM Corporation. **HOURS: (Central Time) 9 a.m. to 7 p.m. Monday through Friday, 9 a.m. to 5 p.m. Saturday.**

M E M B E R — D A L L A S C H A M B E R O F C O M M E R C E

BEST BUYS ON THE MARKET!

80286-12 MHz ZERO WAIT STATE

20 COMPLETE MB EGA SYSTEM... \$1595.

- 80286-12 (12/6) CPU
- 512K (EXPANDABLE TO 640K, 1 MEG 2 MEG, 4 MEG ON THE CPU - EXT. OR EMS)
- 20MB HDD (ST-225) • 1.2 MB FDD
- CONTROLLER (2 FDD, 2 HDD)
- EGA CARD w/AUTO SWITCH
- 14" EGA COLOR MONITOR w/TILT & SWIVEL BASE
- SERIAL, PARALLEL PORT
- CLOCK CALENDAR w/BATTERY BACKUP

- TURBO SPEED & RESET BUTTON
- 200W POWER SUPPLY
- 101 ENHANCED KEYBOARD
- 6-16 BIT, 2-8 BIT SLOTS
- 80287 MATH SOCKET
- OS/2 COMPATIBLE
- NORTON V3 SI - TESTED 15.3
- CHOICE OF CABINET
- ★ FULL (21"W x 16.5"L x 6"H)
- ★ COMPACT (14.5"W x 16"L x 7")

2 MHz ZWS SYS	20 MB ST-225 (65MS)	40 MB ST-251 (40MS)	40 MB ST-251-1(28MS)	80 MB
EGA SYS	\$1595.	\$1760.	\$1860.	\$2050.
VGA SYS	\$1840	\$1005	\$2001	\$2285.

TURBO-XT MONO SYSTEM w/20MB HDD \$895.

- 8088-2 8 MHz CPU w/640K RAM
- 20MB HDD w/CONTROLLER
- 360KB FLOPPY DISK DRIVE
- MONO G CARD (720 x 348 RES)
- 12" TTL AMBER MONITOR
- SERIAL, PARALLEL, CLOCK CALENDAR
- 101 ENHANCED KEYBOARD
- FRONT RESET SWITCH
- POWER, TURBO LED

80386 COMPUTER SYSTEM w/40MB HDD \$2785.

- 32 BIT 80386-16 (20 MHz OPTION)
- 1 MEG RAM (80NS)
- 40MB HDD • 1.2MB FDD
- 200W POWER SUPPLY w/DESKTOP CASE
- MONO G CARD w/14" TTL FLAT MONITOR
- SERIAL, PARALLEL, CLOCK CALENDAR
- 32KB (4-8 SRAMs) CACHE MEMORY
- 1-32 BIT (MEMORY), 5-16 BIT & 2-8 BIT SLOTS
- RELOCATABLE EGA & BIOS TO RAM



• 30 DAY MONEY BACK GUARANTEE. Your complete satisfaction is our top priority. Any Suntronics system may be returned within 30 days from the date of shipment for refund less shipping charge. Items returned must be as-new without modification or damage. All manuals and packaging must be included. Return shipping must be prepaid and insured bearing a RMA (Return Material Authorization) on the shipping label.



CALL FOR OTHER CONFIGURATIONS!

SUNTRONICS, INC.
Since 1976

VISA/MASTERCARD ACCEPTED

1-800-545-9777

1 YEAR WARRANTY - PARTS & LABOR
ALL ITEMS IN STOCK!

Prices subject to change without notice. COD requires cash.

MAIN OFFICE (213) 644-1140

12603 S. CRENSHAW BLVD
HAWTHORNE, CA 90250 M-F 8:30-5:30

ORANGE COUNTY (714) 538-0929

108 W. KATELLA AVE
ORANGE, CA 92667 M-F 10-6 SAT 10-5

CHAOS MANOR

said all this before; and since being considered for review in a BYTE column is the equivalent of the actor's one lucky break, you'd think a software author would take a lot of care to see that the product is as solid as possible.

Alas, most of it is likely to be like Anacreon: pretty good if you're willing to spend time mastering it, but hard to get into if you're not an enthusiast.

More examples. Item: The game's Options menu lets you enable or disable the Pause feature. This is important, because the game has a time clock running, and since each move can take half an hour or so, and few of us are immune to dinner announcements, telephone calls, and other distractions, you really *must* be able to halt that clock while doing something else. Alas, it is nowhere explained how to do that. The thick manual has an index, but no entry for Pause.

Item: you can save the game only after you have completed a move. Moves take a long time, especially when you're first learning the game, and particularly during some of the economic phases when you have to collect fleets and send them after raw materials to be delivered to fac-

tory worlds (once again, there is no "automatically trade these materials between these planets" command).

Here you've invested 15 minutes of time making moves and getting everything set, you need to look something up

Start-ups
*aren't the only ones
who can manage to do
things goofy.*

in the manual, and the phone rings. The game clock ticks on inexorably (it updates itself from the system clock, so that even if you use DESQview and stop the thing from running in the background, you can't stop that damned clock). You can't save, you can't pause, and if you move hastily, you'll probably blow the

game. What do you do? Even if you know the secret to Pause, you're still in trouble.

If you're the game developer or one of his close friends, you don't have that problem; you know what you're doing. Besides, you're probably no longer playing the game, you're just "testing" it.

I could go on, but surely the point is made? I get a lot of software like that, and not just games. Anacreon got several lucky breaks. If it hadn't been for the flu, and my particular interest in stellar empires in general and Isaac Asimov's *Foundation* in particular, I'd never have got past its bugs; Anacreon would have ended up with its disks scrubbed and the manual in the Notre Dame paper drive, which would be too bad, because it's really a darned good implementation of the Stellar Conquest idea.

Incidentally, start-ups aren't the only ones who can manage to do things goofy. Interstel, publisher of two of my favorite games, has put out a thing called First Expedition, which manages faithfully to simulate all the long boring aspects of sailing: they make you sit there and steer

continued



Everything you see here...

**12 MHz 80286
AT-Compatible**

1Mb on-board DRAM

Full set of AT-compatible controllers

**EGA/CGA/MDA/
Hercules compatible**

HD/FD controllers

...and more

you see here. THE AMPRO LITTLE BOARD™/286

Big power for smaller systems.

Little Board/286 is the newest member of our family of MS-DOS compatible Single Board Systems. It gives you the power of an AT in the cubic inches of a half height 5 1/4" disk drive. It requires no backplane. It's a complete AT-compatible system that's functionally equivalent to the 5-board system above. But, in less than 6% of the volume. It runs all AT software. And its low-power requirement means high reliability and great performance in harsh environments.

Ideal for embedded & dedicated applications. The low power and tiny form factor of Little Board/286 are perfect for embedded microcomputer applications: data acquisition, controllers, portable instruments, telecommunications, diskless workstations, POS terminals... virtually anywhere that small size and complete AT hardware and software compatibility are an advantage.

Compare features.

Both systems offer:

- 12MHz CPU
 - 512K or 1Mbyte on-board DRAM
 - 80287 math co-processor option
 - Full set of AT-compatible controllers
 - 2 RS232C ports
 - Parallel printer port
 - Floppy disk controller
 - EGA/CGA/MDA/Hercules video options
 - AT-compatible bus expansion
 - A wide range of expansion options
 - IBM-compatible Award ROM BIOS
- But only Little Board/286 offers:**
- 5.75" x 8" form factor

- EGA/CGA/MDA/Hercules on a daughterboard with no increase in volume
- SCSI bus support for a wide variety of devices: Hard disk to bubble drives
- On-board 1Kbit serial EPROM. 512 bits available for OEMs
- Two byte-wide sockets for EPROM/RAM/NOVRAM expansion (usable as on-board solid-state disk)
- Single voltage operation (+5 VDC only)
- Less than 10W power consumption
- 0-60°C operating range

Better answers for OEMs.

Little Board/286 is not only a smaller answer, it's a better answer... offering the packaging flexibility, reliability, low power consumption and I/O capabilities OEMs need... at a very attractive price. And like all Ampro Little Board products, Little Board/286 is available through representatives nationwide, and worldwide. For more information and the name of your nearest Rep, call us today at the number below. Or, write for Ampro Little Board/286 product literature.

408-734-2800

Fax: 408-734-2939 TLX: 4940302

AMPRO
COMPUTERS, INCORPORATED
1130 Mountain View/Alviso Road
Sunnyvale, CA 94089

for long minutes in real time while absolutely nothing happens on-screen. I can't imagine that anyone at the company ever *played* this turkey.

The moral of this is left as an exercise to the reader, particularly those of you who want to publish your own software.

Note on Turbo Pascal

Anacreon was written in Turbo Pascal 4.0. It's a good example of just how complex a program you can write in Pascal. It also stretches the limits of a 512K-byte machine. The author has recently updated to Turbo Pascal 5.0 and reports that although it's not a real problem, he is having some difficulty getting his big program and the debugger going at the same time; its pure size limits are the root of the problem.

Fortunately, Borland's new Turbo Debugger can be run on an external machine, meaning that you can have the debugger in one PC-compatible (it can even be an old PC clone) connected to your AT with a serial cable, and run your program on the large machine. This not only saves memory, but often you can find out a lot from crashes, since you haven't crashed the machine doing the debugging.

Turbo Pascal 5.0 also allows overlays in expanded memory, which is another neat solution to the memory limits of most machines.

It has a great tutorial, and there are scads of Turbo Pascal toolkits, not only Borland's but many developed by third parties. I am more and more becoming convinced that Turbo Pascal is the programming language of choice for people who are more interested in *what* they want the machine to do than in how to make that happen. Turbo Pascal may be neither as elegant nor as portable as C, but it's sure less obscure. I think it may well be the language for the rest of us.

Power Point

The Mac II isn't indispensable, but it's getting close. I still don't use it to write books or to do taxes, or indeed any of the day-to-day stuff, but I could. While I was in Washington, I went to Tom Clancy's house for lunch, and there sat his little Mac Plus, which is still the only computer he has for both writing and database organization. I couldn't write books on the small Mac because I can't see that small screen well enough, but I can see the Mac II just fine—and clearly if Tom Clancy can turn out his blockbusters on a Mac Plus, I ought to be able to do it with a II, especially since I have a Plus networked into the system as well.

It's partly out of habit that I don't con-

centrate on the Mac II and say to heck with everything else. There's also software familiarity: I've got used to PC-compatibles, and there really is a lot more interesting software for PCs than for the Mac. Finally, while MultiFinder doesn't work very well yet, DESQview on a big 80386 machine certainly does, and I've got very used to being able to pop from my word processor to my database, then over to the modem, then into GrandView for notes. . . .

On the other hand, even though I don't use it every day, I'd really *hate* to give up the Mac II. When we do use it, nothing else will do the job half so well.

Even
though I don't use it
every day, I'd really
hate to give up the
Macintosh II.

Microsoft's Power Point is a good example of that. This is a program that lets you organize presentation materials. You can make briefing charts, organization charts, color pictures and maps, and just whole bunches of other stuff, in black and white or in color. To get color pictures from the Mac II's screen onto a projector, you can either get an electronic slide maker or do what we do and shoot the picture with Datacam and use photographic methods. Black and white prints out nicely on the LaserWriter IINTX, of course: if you want ViewGraphs, you print on acetate.

I've only got started with Power Point. As with most modern Macintosh programs, it's easier to *use* than to talk about it; you just sort of noodle around doing what seems obvious, and after a while it clicks.

Of course, you can also read the manual. Power Point's manual is extraordinarily complete, with lots of color illustrations. Much of it consists of descriptions of what the program can do; these are followed by copious examples, in clear and precise language. This is getting close to the model of what a good manual should be. It's also supplemented by pamphlet-format quick reference and template guides. It's this kind of quality

that makes it difficult for small outfits to compete with the Redmond giant.

I could run on at length about Power Point, but I won't; I'll just say that if you're in the business of putting on briefings and otherwise making presentations, you might want to seriously contemplate getting a Mac II just so you can use this program; it's that good. Highly recommended.

MacSpin

People generally aren't interested in statistics. I suppose I am more than most because back when I was in graduate school in psychology, Dr. Aaron Paul Horst insisted that his students go over to the math department and really learn the calculus of probabilities rather than faking it by taking "Statistics for Social Scientists." I can't say I had fun doing that, but the course was worth the effort.

That was just before John Tukey and his students effectively revolutionized the field of statistics. Tukey insisted that you needed more than mathematical models to understand data; that you ought to play about with it, manipulate it, examine it in different ways, rather than mechanically crank out an analysis of variance that would produce a table of "significant" differences without giving much hint of what that meant.

Tukey and others seized upon early developments in computer graphics to make their case and developed novel ways to look at clouds of data points. The programs ran on a computer system that cost the equivalent of a half million 1988 dollars.

MacSpin was written by several of Tukey's graduate students, and it does on a Macintosh what his original programs did on Stanford's large and expensive system back in the 1970s. I was much impressed with version 1 of this program when it came out several years ago; I'm even more impressed with version 2.

Who needs MacSpin? Actually, almost anyone with a Mac will find it interesting. The program comes with a bunch of data sets, all of them rather fascinating. One is a plot of the known galaxies. When you first put it up on the screen it makes little sense, but then as you rotate the image, you see big holes and gaps. Why should that be? Then you see the pattern and realize that it's the Milky Way.

Other canned data sets include hospitals and livability of cities. Use these to get a feel for what the program can do; by then, you may have thought of other things to examine. I'm about to put in the

continued

NEW

THE "DESKTOP PRESENTER PACK"



Everything you need for creating and giving presentations with your PC.

Now, you can make impressive, professional-quality, full-color presentations of any kind right at your desk with The DESKTOP PRESENTER PACK.

Everything you need is included: Colormetric® a high resolution graphics card for your PC, PictureIt™ business graphics software, and PCPrintmaker® desktop printing software.

With The DESKTOP PRESENTER PACK you will turn your personal computer into a full-capability workstation for creating professional-

quality presentations quickly and easily. Then use your PC to give a video presentation in 1000 colors.

Or make high resolution slides, overhead transparencies or hardcopy all in full-color by simply plugging in a SlideMaker® or color printer.

Buy the DESKTOP PRESENTER PACK and make the best presentation of your career.

Call today 800-556-1234, ext. 234.

In Calif. 800-441-2345, ext. 234.

General Parametrics Corporation the makers of VideoShow

Berkeley, CA 415-524-3950

Circle 114 on Reader Service Card

JANUARY 1989 • BYTE 121

Items Discussed

Anacreon \$49.95 TMA 15 Whittier Rd. Natick, MA 01760 (508) 655-5823 Inquiry 1002.	MacSpin \$300 D ² Software P.O. Box 9546 Austin, TX 78766 (512) 482-8933 Inquiry 1006.	SupersPort 286 \$4999 Zenith Data Systems 1000 Milwaukee Ave. Glenview, IL 60025 (312) 699-4800 Inquiry 1011.
Datacam Polaroid..... \$545-\$595 35mm \$875-\$925 Photographic Sciences Corp. 770 Basket Rd. P.O. Box 338 Webster, NY 14580 (716) 265-1600 Inquiry 1003.	OmniKey 102 \$99 Northgate Computer Systems 2905 Northwest Blvd., Suite 250 Plymouth, MN 55441 (800) 328-8907 Inquiry 1007.	T1000 \$1249 Toshiba America, Inc. 9740 Irvine Blvd. Irvine, CA 92718 (714) 583-3000 Inquiry 1012.
Empire \$49.95 Interstel P.O. Box 57825 Webster, TX 77598 (713) 486-4163 Inquiry 1004.	Power Point \$395 Microsoft Corp. 16011 Northeast 36th Way P.O. Box 97017 Redmond, WA 98073 (206) 882-8080 Inquiry 1008.	Turbo Pascal 5.0 \$149.95 Borland International 1800 Green Hills Rd. P.O. Box 660001 Scotts Valley, CA 95066 (408) 438-8400 Inquiry 1013.
GrandView \$295 Symantec Corp. Living Videotext Division 117 Easy St. Mountain View, CA 94043 (415) 964-6300 Inquiry 1005.	Reach for the Stars \$40 Strategic Studies Group, Inc. 1747 Orleans Court Walnut Creek, CA 94598 (415) 932-3019 Inquiry 1009.	Wall Street Raider \$39.95 Oasis Press 720 Hillview Dr. Milpitas, CA 95035 (408) 263-9671 Inquiry 1014.
	Stellar Crusade \$49.95 Strategic Simulations 1046 North Rengstorff Ave. Mountain View, CA 94043 (415) 964-1353 Inquiry 1010.	

data on my books: sales, year published, number of pages, cover price, with or without coauthors, and everything else I can think of, then see if anything interesting pops out. I've also got a couple of other projects in mind.

The MacSpin documents indicate that the program is copy-protected. Weary of that, I used Copy II Mac to put it on my hard disk and get it over with. I have since discovered an undocumented feature: although the documents don't say so, its manufacturer, D² Software, removed the copy protection from MacSpin some time ago.

MacSpin is an excellent program, particularly if you're one of those unfortunate people who hate statistics but are always having them thrown at you. A few hours of hacking about with MacSpin will teach you more about correlations than you ever learned in "Educational Statistics." Recommended.

Northgate Keyboards

Did you like the feel of the old IBM PC keyboard? The one that went "klik-klak!" (Sorry: we just went to opening night of *The Tales of Hoffmann*. Placido Domingo was superb as usual. A new Hoffmann libretto and arrangement based on recently discovered Offenbach notes, but that's another story.) Anyway, if you liked that keyboard, you may be interested in the Northgate OmniKey 102. It has that feel, without the disastrous key layout of the old IBM.

Indeed, the OmniKey 102 has about as good a key layout as any I know, and the feel is quite good. It has the function keys in a group on the left (XT style), rather than across the top. The Escape key is where it belongs, the Backspace and Return keys are oversize, and there are a number of other interesting layout features.

I like this keyboard; whether I like it

more than my DataDesk keyboards is debatable, but I sure do like the feel of the OmniKey 102.

There's one real problem. Northgate sent me four of those keyboards. Three of them have the annoying habit of repeating a letter sometimes (keyboard bounce); one has a sticky 2 key that I can't fix with silicon lubricant. I'm sure these keyboards were just off the assembly line, and it may be they were part of a bad batch; but sending me three mildly defective keyboards out of four doesn't argue well for their quality control. Worse, people for whom I have a great deal of respect tell me that trying to get Northgate to honor a warranty is a very difficult and time-consuming business; they do it, but apparently their system is swamped.

I have discovered that the keyboard bounce happens only when the keyboard

continued

Order Status,
Technical & Other
Info. (602) 246-2222
FAX #(602) 246-7805

Call for programs not listed

WAREHOUSE DATA PRODUCTS

MICROSOFT PC Works
SPECIAL \$83
MICROSOFT PC Excel
SPECIAL \$247
Call on all Microsoft Mouses

TOLL-FREE ORDER LINE 1-800-421-3135

HOLIDAY SPECIAL

**Complete Brand Name Mono Computer System
w/Epson Printer**

8088-10 MHz	\$1249
80286-12 MHz	2369
AT&T 6386 W	2795

HARDWARE

Acc

Copy II PC Delu	\$101
Curtis Ruby +	69
Logical Connecti	429
Mach III Joystick	36
Masterpiece	99
Masterpiece +	
150 Watt Power S	

Hard Cards

Plus 20 MB	\$529
Plus 40 MB	659

Hard Drives

Seagate ST-225 20 MB w/cont	\$256
Seagate ST-238 30 MB w/cont	286
Seagate 40 MB AT 251-0	399
Seagate 80 MB AT	576
Seagate ST-125 w/cont	316
Seagate ST-138 w/cont	396

Boards

AST	Call
Rampage/2	Call
Rampage 286 w/512K	\$399
Rampage 286 PLUS w.	Call
Sixpac Plus w/64K	129
All Other AST Products Call	
EVEREX	
2MB Above PC/XT w/o Mem	70
3MB Above AT w/o Mem	
ORCHID	
Ram Quest Extra PS/2	Call
INTEL	
Above 286 w/512K	375
Orchid Tiny Turbo	289

Monitors

AMDEK	
410 Am	\$145
MAGN	
RGB	
SIGMA	
Laserview + 19"	Call
SAMSUNG	
Flat Amber	
TTL Amber w/tilt	
Color w/tilt	
VIKING	

ACC

Dac Easy Acct'3	w Price
Dac Easy Light	\$39
Dac Easy Payroll	w Price
Dollars & Sense	94
In House Acct.	
Managing Your	
Quicken	

Languages

Microsoft Pascal	\$176
Microsoft Quick Basic 4.0	59
Microsoft Quick C	Call
Ryan McFarlan Fort	
Ryan McFarlan Cob	
Turbo Basic	
Turbo C 2.0	
Turbo Pascal	
Turbo Prolog	

Communication Programs

Brooklyn Bridge Universal	\$75
Carbon Copy Plus	105
Crosstalk XVI	92
Crosstalk MK4	110
Flying Dutchman	64
PC Anywhere III	99

Multi-User Software

Fox Base +	\$299
Microsoft Word	205
Word Perfect 5.0	355
Word Perfect Mn	99

Data Base Managers

Zipper	\$416
Condor 3	325
Data Perfect	Low Price
DBase III Plus	375
DB-XL Diamon	115
Fox Base Plus	189
Genifer	189
Paradox 2.0 Premium	435
PFS: Pro File	Call
Powerbase	169
Q&A 3.0	188
Quicksilver Diamor	329
Revelation Advanc	460
R Base For DBC	425
Reflex	90
Relate 6	112
VP Info	63

Project Manager

Microsoft Project	\$299
Super Project Plus	955
Timeline 3.0	
Harvard Total Project	

EVEREX	
286, 10MHz, 0 Wait	\$1149
286, 10MHz, 1 Wait	999
286, 12.5MHz, 0 Wait	1349
ACER	
710 w/o Monitor	Call
900 w/o Monitor	Call
SHARP	
PC 4501	\$765
PC 4502	Call
PC 4521	Call
AT&T	
6286WGS	1499
6300WGS	899
6386 WGS, 40 MB H.D.	2999
6386, 135 MB H.D.	4599
ZENITH	
Super Sport 286/20MG	Call
Super Sport 8088/2-Floppies	Call
Super Sport 8088/20MG	Call
NEC	
Multispeed-2	Call
All Other	
NEC Pro	Call

S

Lotus 1-2-3	
Microsoft PC	247
Quattro	143
Surpass	329
Plan Perf	Call
	117

CoreFast	75
Copy II PC	\$19
Copywrite	39
Cubit	90
Desqview	
Direct Ac	
Eureka	
Fastback Plus	Call
Formtools	56
Graph in the Bc	Call
Mace	40
Microsoft Window	
Norton Advancc	
Norton Utilities	
PC Tools Deluxe	
Prokey 4.0	
Q DOS II	
Rightwriter	
Sidekick Plus	
Sideways	
SQZ Plus	
Superkey	
Lightning	
XTree	

VGA/EGA Boards

AST VGA + (16 Bit)	\$349
ATI EGA Wonder 800	299
Genoa Super EGA Hi-Res	186
Orchid Designer VGA 800	249
Orchid Pro Designer	299
Paradise VGA Plus	269
Paradise VGA Prof.	
Vega VGA	
All Other E	

Modems

AZ 2400 INT w/o Soft	\$129
Everex 300/1200 w/Soft	69
Everex 2400 EXT. Error Ct	189
Hayes 1200 EXT w/o soft	299
Hayes 1200B INT w/Soft	289
Hayes 2400 EXT w/o Soft	435
Migent Pocket Modem	114
U.S. Robotics 2400 w/o Soft	335

C

Boeing Graphi	\$200
Chartmaster	199
Design Cad 2D 8	148
Diagram Master	199
Easy Cad	109
Generic Cad	49
in-A-Vision	270
Microsoft C+	225
Newsroom F	65
Printshop	

Casper	
Princeton Ultra Scan	
Mitsubishi Diamond I	
NEC - Multisync II	
Zenith 14" Flat Sereel	

Logitech	\$68
Microsoft	92
Microsoft	92

I

Ability Plus	\$145
Enable	352
Microsoft Works	83
PFS 1st Choice	79
Smart System	380
Symphony	465

Word Processing

Grammatic	\$49
Microsoft Word 4.0	106
Multimate Advantage	
Q and A Write	
Rightwriter	
Webster Spellcheck	
Word Perfect Ver. 5.0	
Word Perfect Executive	124
Word Perfect Library 2.0	65
Wordstar Pro 5.0	239
Wordstar 2000 +	205

FREE SOFTWARE!

Purchase over \$100 and receive one of these disks absolutely FREE! Purchase over \$250 get two free disks, over \$400 get three, or get all four disks when your purchase is over \$500!
1) MIXED BAG. 2) PC-WRITE. 3) FONT-SET. 4) DR. DATA LABEL.

TERMS: Shipping minimum is \$5.00. AZ orders + 6.7% sales tax. Personal check/company check - allow fourteen (14) days to clear. We accept purchase orders from authorized institutions for 3.5% more than cash price. All returns are subject to our approval. There will be a 20% restock fee. Minimum phone order \$50. All prices are subject to change. Due to copyright laws we cannot take back any open software.

WAREHOUSE DATA PRODUCTS

2727 West Glendale Ave. • Phoenix, AZ 85051

We do not guarantee compatibility



No Charge for MasterCard or Visa

Servicing our PC buyers with low pricing and technical experience since 1979.

Phone Hours:
Monday thru Friday 6:30 am-9:00 pm.
Saturday 9:00 am-5:00 pm MST.

is used with a very fast 80386 machine; with normal AT and XT machines, you will never see it.

For all that, I do like the darned keyboard, and I have been oddly reluctant to change it, even if every now and then I have to correct "annnd" or "kkeeeep." The bounce doesn't happen very often, the spelling checker generally finds all those cases anyway, and—and besides, I guess I really do like to hear the keys go klick-klak!

Winding Down

I'm out of space, and as usual there's an enormous pile of good stuff in the ready line. Broderbund has a new Macintosh HyperCard program called DTP Advisor; it's a tutorial and management system for people interested in desktop publishing, and you really can learn a lot by using it. There's askSam. I am getting seriously annoyed at companies that use odd orthography for product names, and I often swear I will never review another,

but in fact this is a darned good free-form database program, easy to learn and easy to use, just the sort of thing the casual user needs; it hasn't yet got a permanent DESQview window on my system, but by next month it may.

There's Stephen Manes's *Complete MCI Mail Handbook* (Bantam, 1988). I find MCI Mail indispensable, but their user manuals suck green turtles; Bantam's new book is both an introduction and a reference, and it's excellently done. There's also Que's new *HyperCard Quickstart*, an excellent tutorial to getting started with Macintosh HyperCard: how to use it, and also how to author your own card stacks. If you've been curious about what HyperCard is all about, this is the book to get.

We've also got Gofer for the Mac. Gofer, for those few who don't know, is a program that searches all over your hard disk to find files containing the stuff you've asked it to look for. It works intuitively, it's very fast, and if you've got stuff scattered all over the place the way I do, you really have to have this program for the PC. I haven't done much with the Mac version, but given my 330-megabyte Priam MacDisk, I expect to use it a lot.

The book of the month is Michael Wood's *In Search of the Dark Ages* (Facts on File, 1987); it will tell you more about Alfred the Great and Athelstan than you thought you wanted to know. Wood shares that with Tom Clancy's *The Cardinal of the Kremlin* (he told me he wouldn't give me the antidote to what he put in the lunch if I didn't say that).

The game of the month is clearly Anacreon; despite its problems, it's playable and the flavor is good, much like Beam Piper's old Space Viking series. Also, the author is busily fixing bugs even as I write this. (I called him a few minutes ago and read him what I've said.)

I've just read this over, and it's interesting that I find myself thinking up excuses for not using the Mac II more. You can make whatever you want to of that. ■

Jerry Pournelle holds a doctorate in psychology and is a science fiction writer who also earns a comfortable living writing about computers present and future. Jerry welcomes readers' comments and opinions. Send a self-addressed, stamped envelope to Jerry Pournelle, c/o BYTE, One Phoenix Mill Lane, Peterborough, NH 03458. Please put your address on the letter as well as on the envelope. Due to the high volume of letters, Jerry cannot guarantee a personal reply. You can also contact him on BIX as "jerry."

ARE YOU STILL DRAWING FLOWCHARTS BY HAND?

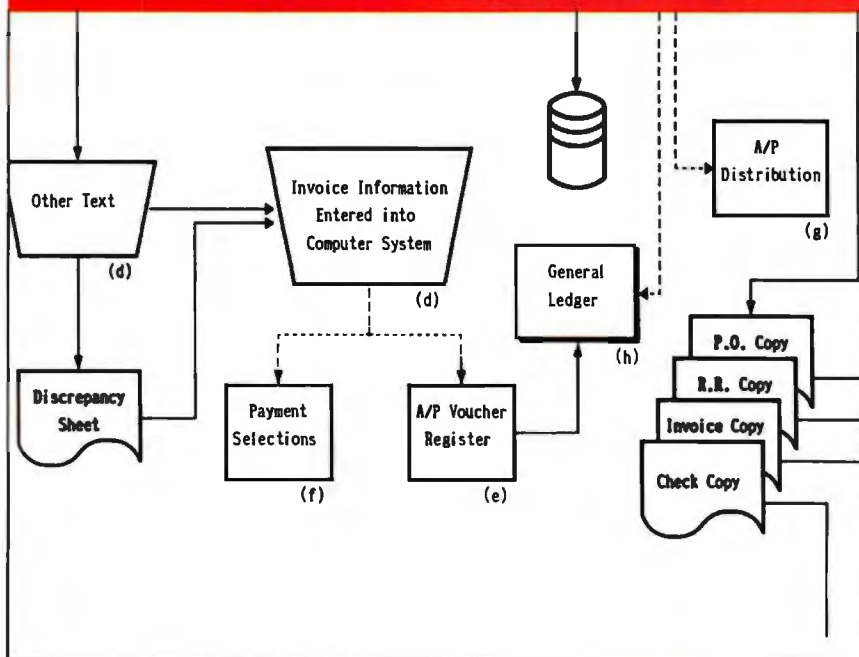

FLOW CHARTING II+

Flow Charting II+ will *amaze* you with its speed, power and simplicity.

- Update and print charts as fast as the situation changes
- See your revisions right away—no long wait for charts to be hand drawn
- Select 26 standard shapes; 10 text fonts
- Tutorial manual makes learning easy
- Runs on IBM or compatibles
- Produces excellent organizational charts!
- Only \$229!

PATTON & PATTON

Software Corporation

Excellence in charting the flow of ideas

For more information, see your local retailer or call
 1-800-525-0082, ext. 47 (outside Calif.) 408-629-5376 (Calif./Int'l.)
 81 Great Oaks Blvd., San Jose, CA 95119

UserSoft/C Means Business

UserSoft Business C is the financial C compiler that makes sense to both clients and programmers. It is *not* just another C compiler.

Business C Development Tools™, consists of SCREEN™, S/AM™ and SUPERIOR™, regular price at US\$299.95. **Comdex '88 special at US\$199.95.** System Requirements for the IBM PS/2™ and the IBM® family of personal computers and all 100% compatibles. PC-DOS (MS-DOS) 2.0 or later. 384K RAM. **Compiler Library Models** SMALL to HUGE.

Commercial C Development Tools™, consists of S/AM™ and SUPERIOR™, regular price range from US\$499.95 to US\$999. **Comdex '88 special at US\$399.95.** Commercial Development Tools are currently available for UNIX (Sun, VAX), and other systems. Versions for Macintosh™, IBM/VS™ and XENIX™ will be released early in 1989.

S/AM—the revolutionary database management system that gives you **unlimited growth and ease of usage.** There are no limitations on any of the following features: key types (alpha-numeric, integer, float & image), # of key parts, # of data fields, size of any key and/or data, and # of alternative keys. Other features include automatic management of alternative key files (virtual tables); encryption on file, record, datafield or even a byte; privacy prevention option (in the event of three or more illegal attempts to access the file, future access to that level will be prohibited until reset); high-language access for non-image data; mixed (fixed and variable) data field/key length for storage compression & for special applications.



USERSOFT

If within 60 days of purchase, this product does not perform in accordance with our claims, call our customer service department and we will arrange a refund.

All UserSoft products are trademarks or registered trademarks of UserSoft Systems Limited. Other brand and product names are trademarks or registered trademarks of their respective holders. Copyright© 1988 UserSoft Systems Limited

SCREEN is a superset of UNIX curses; supports large window buffer with scroll, wrap, horizontal scroll etc.; has multiple windows & sub-windows, direct screen read/write and auto CGA/monochrome capabilities. Optimized for developing spreadsheet and word processing programs.

SUPERIOR—the world's first breakthrough in making C "The language for developing business application programs". It is capable to manipulate the format for inputting or outputting values with just one statement which could not be done by any of the other languages from BASIC, conventional C, COBOL, FORTRAN, SNOBOL to 4GL. It includes functions for strings manipulation, conversion, business calculation such as regression, standard deviation, innovative complex matrix operations, and most built-in functions compatible to those of WANG™ BASIC/2, IBM™ PL/1 subset G and THEOS™ BASIC.

Our September and October ads in BYTE give detailed comparison of the functions, portability, documentation, product and price.

Why do project managers buy? UserSoft's Tools minimize training costs, increase productivity, reduce stress and development time; and eliminate complexities of project through "programming compression™", also provides privacy to information.

Why do COBOL programmers buy? It has superpowerful routines for screen handling, flexible and unique input/output formatting, easy-to-use BASIC and PL1 functions. It, increases project performance and software portability, makes C easier to use than COBOL & other languages.

UserSoft Systems Limited
Suite 1512, 409 Granville St
Vancouver, BC, Canada V6C 1T2
Telephone 604/681.8872

Power C is a trademark of Mix Software
MS-DOS, Microsoft C is a registered trademark of Microsoft Corporation
Turbo C is a registered trademark of Borland International
IBM, MVS and VSAM are trademarks of International Business Machine
Sun is a trademark of Sun Microsystems
DEC, VMS and VAX are trademarks of Digital Equipment Corporation
UNIX is a trademark of Bell Laboratory
VS is a trademark of WANG Laboratory

Why do C programmers buy? It reduces coding, debugging, testing and programme maintenance time. It provides easy portability and conversion to other systems. It is the most complete, powerful and flexible set of tools ever required for software development.

Why do educational institutes buy? It is the world's most versatile Data Management system yet practical and easy to be taught. UserSoft Development Tool is the possible replacement of COBOL, PL/1, FORTRAN, BASIC. It prepares student to be highly productive and competitive in the industry.

Can you afford to wait? Many with no computer experience have already claimed to have **acquired C programming skills in just one week.** Business C Development Tools™ could make you more competitive increasing productivity manyfolds.

This special offer must be posted before December 31, 1988.
YES... Please Rush me _____ copies of the following products.
Business C Development Tool ■ US\$199.95 (includes S/AM, SUPERIOR and SCREEN - PC/XT/AT only)
Commercial C Development Tool (includes S/AM and SUPERIOR)
For non-PC product please call (800) 663-0322
UNIX (reg. \$499-\$1999) ■ US\$399.95
 Apollo Honeywell Sun VAX
 UNISYS Wang/INEX
WANG/____VS (reg. \$1499) ■ US\$399.95
OTHER (reg. \$999-\$1999) ■ US\$999.95
 VMS MVS PRIMOS VS/VS1
Individual Tools for PC only:
 S/AM US\$99.99 SUPERIOR US\$99.99
 SCREEN US\$69.99
Circle for my: MicroSoft-C/Turbo-C/Lattice-C/Advanced-C+ +/- _____
 5 1/4" disk (360k/1.2M) or 3 1/2" disk
I'll like to have more information for _____ system.

NAME _____
ADDRESS _____
CITY/STATE _____
ZIP/PHONE _____
CARD # VISA MASTERCARD AMX CHQ.
EXPIRATION DATE _____

To order Call: 1-800/663-0322

Shipping and Handling:
North America (US\$10 UPS; \$20 Air);
Overseas US\$50.

General: (604) 681-8872, or
FAX (604) 685-1207/Telex 04-508312
VCR ATTN USERSOFT

All dealers/wholesalers/educators are welcome, call Mr. S. Chetty (604) 681-8872

The DXY Series—The Tops in Desktops

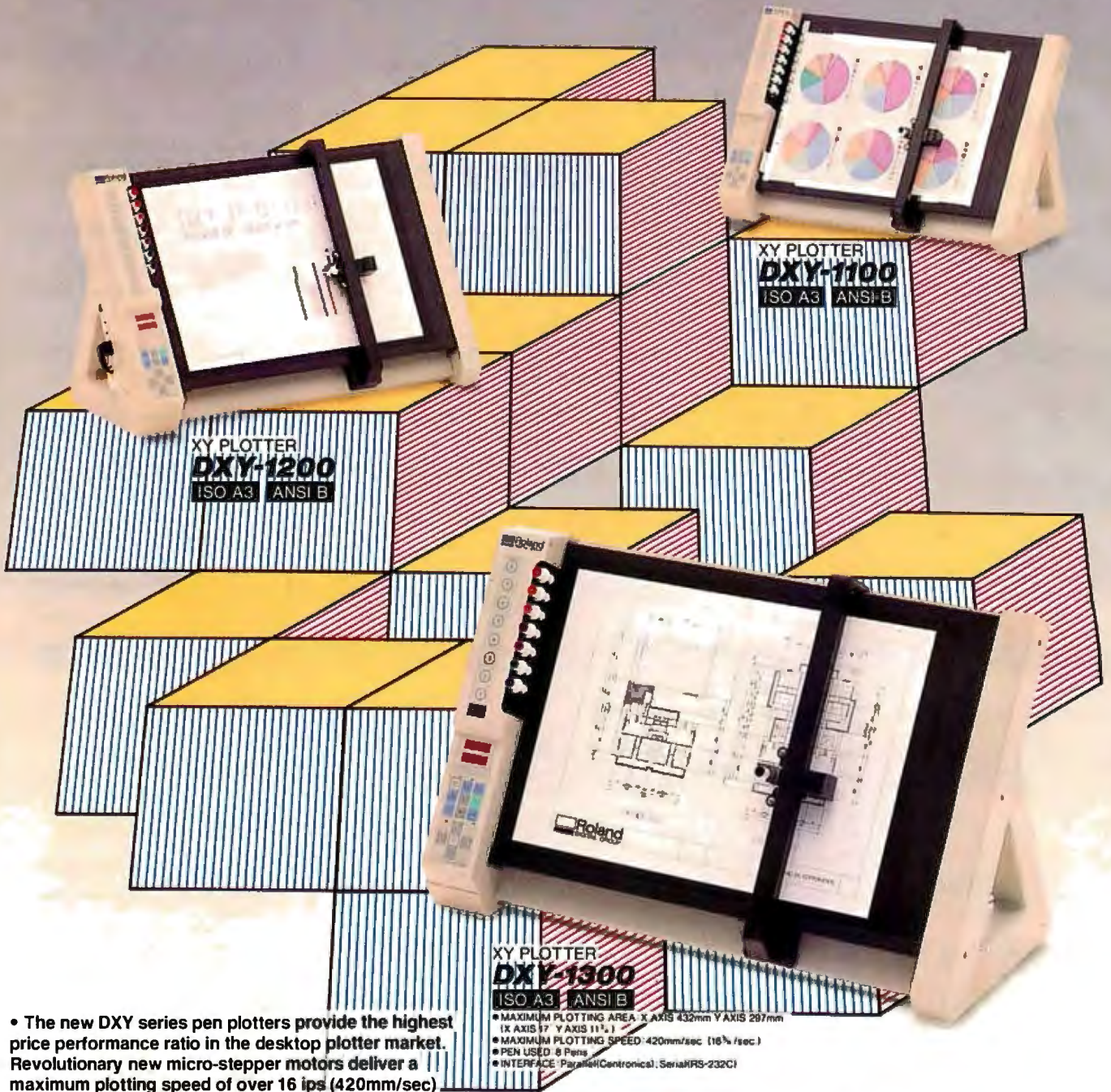

- The new DXY series pen plotters provide the highest price performance ratio in the desktop plotter market. Revolutionary new micro-stepper motors deliver a maximum plotting speed of over 16 ips (420mm/sec) while maintaining superior resolution of 0.0004"/step (0.0125mm/step). With new vertical and horizontal pen arm supports, excellent plot quality is assured.
- Full software support is guaranteed since the new DXY plotters use both Roland's original DXY-GL and the RD-GLI, emulation of Hewlett-Packard's HP-GL.
- To free computer time, a large 1Mbyte buffer is standard in the DXY-1300.
- A soft pen landing mechanism minimizes noise and allows for the use of all types of plotter pens- including liquid ink.
- A detachable stand enables plotter operation at a 60° angle minimizing the space requirements.

- MAXIMUM PLOTTING AREA: X AXIS 432mm Y AXIS 297mm (X AXIS 17" Y AXIS 11 3/4")
- MAXIMUM PLOTTING SPEED: 420mm/sec (16 1/2"/sec.)
- PEN USED: 6 Pens
- INTERFACE: Parallel/Centronic/Serial(RS-232C)

Roland
DIGITAL GROUP

ROLAND DG CORPORATION

1227 Ohkubo-cho, Hamamatsu-shi, Shizuoka-ken 432, Japan
Phone:(0534)85-3177 Fax:(0534)85-2735 Telex:4225070 ROLDG J

INTERNATIONAL DISTRIBUTORS

- | | | | | |
|--|---|---|---|--|
| U.S.A.:
Roland Corp US
Phone:(213)685-5141 Telex:674489 RCUS LSA | CANADA:
Roland DG Canada Inc.
Phone:(604)273-4453 Fax:(604)270-7150 | AUSTRALIA:
Roland DG Australia Pty Limited
Phone:(03)241-1254 Fax:(03)241-1257 | BENELUX:
FRANCE:
W. GERMANY: PORTUGAL:
Roland DG Europe N.V.
Phone:(014)58 45 35 Telex:71046 R08NL B | AUSTRIA:
SWITZERLAND:
ROLAND DG EUROPE N.V. |
| ENGLAND:
Roland (UK) Ltd.
Phone:(0118)47-5665 Telex:934470 ROLAND G | SCANDINAVIA:
Roland Scandinavia A/S
Phone:(01)32 47 22 Telex:19720 ROLAND DK | NEW ZEALAND:
Roland Corporation (NZ) Ltd.
Phone:(09)398-104 Fax:(09)391-065 | | |

■ If the above doesn't cover your inquiries, please contact Roland DG Corporation, Japan.

Circle 234 on Reader Service Card



THE BLIGHT OF BLOATED SOFTWARE

WordStar 5.0 is a fine new version of a classic, but it's no longer lean and mean; are word processors getting too big?

Lately, I've been doing some hard thinking about the nature of word processors and word processing in today's computing environment. We've reached a technological bottleneck of sorts, and I'm not sure I like what's happening as a result. The problem lies in the rapid proliferation of laser printers and their effects on the design of software interfaces.

A few years ago, before laser printers had gained widespread acceptance, there was a direct correspondence between screen displays and output devices. Computer monitors and printers (dot-matrix and daisy-wheel) were standardized on 80-character monospaced lines. What you saw on the screen was what you got on the printer; true WYSIWYG was the order of the day.

Laser printers with scalable typefaces are now destroying the standard of 80 characters per line and 66 lines to a page. Software developers are faced with the necessity of tracking font usage and devising methods for depicting that information on the screen. In the MS-DOS world, largely bound to 80-character display devices, WYSIWYG has become an impossibility. We've been left with cumbersome word processors that embed complex font commands in text and interfaces that are relatively hostile to the user, if only due to the requirements of formatting.

Over on the Macintosh side, with bit-mapped displays and an operating system



designed to manipulate fonts, there has been little hassle. But MS-DOS users will need to switch to Windows, the OS/2 Presentation Manager, or one of the Unix windowing shells before they can play with fonts without having to master arcane and mystifying command systems. Most of today's state-of-the-art word processors are transitional programs, trying desperately to bridge the gap between 80-character screens and proportional-spacing laser printers.

I don't know if everyone needs the program overhead this causes. Business letters, report drafts, and college papers don't require the quality of laser-printer output, and expensive laser printers are beyond the reach of many single users and small businesses. Why clutter up disks with fat programs and umpteen support files? Why slow down performance with features that may not be used?

I'd like to suggest to the manufacturers of word processing packages that they consider releasing "junior" versions of their programs, stripped of the laser-printer stuff but retaining all the other

power features of their top-of-the-line software. Let's retrieve a little of yesterday's compactness and ease of use in today's products.

WordStar Gets Bigger

What brought all this nattering about WYSIWYG to mind was a month with WordStar Professional 5.0 (MicroPro, \$495). The program is certainly ready at last to take its place among the leading word processors of the day; WordStar users no longer need to make embarrassed noises when they mention the product. But WordStar now suffers from some of the bloat associated with supporting the newer output devices, so it's no longer lean and mean, and not all the new features are as smooth as they should be. MicroPro has made literally hundreds of changes to the program; I'll sketch the most significant ones.

To begin with, WordStar can now reformat paragraphs automatically. This is considered to be a minimum requirement for a modern word processor, and its absence relegated earlier versions to in-

continued

Paul Mace
SOFTWARE

hTEST hFORMAT

... Can double your
hard disk performance.

Experience has shown most hard disks are set up wrong . . . which means the interleave is probably wrong and *you are being penalized anywhere from 50 to 600% in performance.*

Included in the hTEST · hFORMAT package is an interleave optimizer, hOPTIMUM. It calculates the optimum value for interleave, then resets the disk, automatically, for peak performance.

The second casualty to improper setup is your data . . . because some hardware vendors take the easy route. They skip low-level testing and entry of manufacturer's bad-track information.

hTEST finds those marginal regions on the disk before they cost you time and information. hFORMAT lets you enter the manufacturer's test information and certify for yourself that the disk is properly initialized for reliable service.

When the worst happens . . . and you lose data, hFORMAT will help recover your disk—even from that ultimate disaster: "Invalid Drive Specification."

hTEST · hFORMAT: for IBM PC, XT, AT and compatible computers. Requires 64K, DOS 1.1 or higher.

**Advanced Hard Disk
Diagnostics designed by
Kolod Research . . . \$89.95**

Paul Mace Software, Inc.

400 Williamson Way
Ashland, OR 97520

(800) 523-0258

(503) 488-2322

(COD's, PO's add \$5.00)

(Foreign orders add \$10.00)

h-Test h-Format is a trademark of Kolod Research Inc.

CONVINCE YOURSELF!
Send us \$1. We'll send you
an interleave test disk.

APPLICATIONS PLUS

Items Discussed

Canon Cat.....\$995
includes Canon 180 printer
Canon U.S.A., Inc.
One Canon Plaza
Lake Success, NY 11042
(516) 488-6700
Inquiry 1000.

WordStar Professional 5.0....\$495
MicroPro International Corp.
33 San Pablo Ave.
San Rafael, CA 94903
(415) 499-1200
Inquiry 1001.

famy. I found the program as shipped just a hair too slow for my taste, especially compared to speed demons like XyWrite. However, it turns out that you can set the speed to your taste using WordStar's modification utility. After a bit of tinkering, I got it nicely tuned to my preference.

Next, WordStar's Control-key menus are no longer the only interface available. If you like, you can opt for pull-down menus that conform to IBM's Systems Application Architecture guidelines. For old WordStar hands, the new menus are disconcerting—it's particularly odd to select a menu item and watch the program insert an old-style dot command into text—but they do provide a simpler form of access for novices struggling to master the program. If you're already trained in WordStar, you can turn off all the menus and rely instead on your memory of the keystroke sequences.

Windowing has been added, but of a limited sort; you can open only two views. MicroPro claims that its research indicated that this is what the majority of users wanted, but I wonder if it's enough. I'd be happier with three views and could see use for more.

There's an undo command, macros, support for laser printers (including PostScript devices), direct import of dBASE and Lotus 1-2-3 files, a text-search utility that lets you locate files by words or phrases in them rather than having to find them by filename, and a thesaurus that actually provides short definitions of words. The spelling checker is one of the best I've ever used.

By far the most impressive new feature, though, is a page-preview mode that

lets you see documents as they will appear when printed. It's unquestionably the most elegant preview on MS-DOS machines, and it's good enough to rival most Macintosh word processors. On an EGA monitor, you can display a full page at a time, zoom down to tighter magnification of smaller regions, or zoom back out to a thumbnail view showing up to 32 pages at a time. All this is done in actual fonts, and graphics—even color graphics—appear in position in any view.

The documentation is up to MicroPro's usual high standards, and it's arguably the best in the product category. The automatic installation procedure, however, is an abomination. . . because there is none. When a program comes on 12 disks, it's unconscionable not to give users at least a batch file to help them get the program loaded and configured.

On the whole, though, I was pleased with the changes to WordStar, rough edges and all. If you're looking for a new word processor, add WordStar Professional 5.0 to your comparison shopping list. And if you currently use WordStar, an upgrade is in order.

Off to Buy a Cat

Though a leopard can't change its spots, a Cat can lower its price. The Canon Cat, a writing machine that is based on technology developed by Jef Raskin at Information Appliance, has been reduced from the \$1495 at which it was introduced last year to a mere \$995. This buys you both the Cat itself and the Canon 180, an 18-character-per-second daisy-wheel printer. That's finally a reasonable price. I've been lusting after this baby ever since Jef showed me a prototype of the Information Appliance software about 4½ years ago, and tomorrow I'm going to rush out and purchase one. I'm as excited as I was the day before I bought my first Macintosh.

I've always been intrigued by this machine's minimalist approach to computing. It strikes me as a closer equivalent to a notebook than anything else anyone's got, with enough software smarts to make sense out of randomly entered pieces of text. The Cat is an unusual computer, unlike any other machine on the market, conceptually positioned someplace between a full-blown computer system and a pocket calculator.

The Cat is a small unit with a 9-inch black-on-white monitor, a single 3½-inch floppy disk drive, and an attached Selectric-style keyboard. The footprint is roughly 13 by 18 inches. For those of you who remember the dark ages, the Cat

continued



Select
5 Books
for only \$3⁹⁵

ENROLLMENT
APPLICATION

Please accept my membership in The **Computer Book Club**® and send the 5 volumes listed below, billing me \$3.95 plus **shipping** and handling charges. If not satisfied, I may return the books within ten days **without** obligation and have my membership canceled. I agree to purchase at least 3 books at regular **Club Prices** (plus **shipping/handling**) **during** the next 12 months, and may resign any time thereafter.

Write your selections here:

Name _____

Address _____

City _____

State/Zip _____ Phone _____

Signature _____

Signature of parent or guardian required for all new members under 18 years of age.

BY189

Valid for new members only. Foreign applicants will receive special ordering instructions. Canada *must* remit in U.S. currency. This order subject to acceptance by The Computer Book Club®.



Select
5 Books
for only \$3⁹⁵

ENROLLMENT
APPLICATION

Please accept my **membership** in The **Computer Book Club**® and send the 5 volumes listed below, billing me \$3.95 plus **shipping** and handling charges. If not satisfied, I may return the books **within** ten days **without** obligation and have **my** membership canceled. I agree to purchase at least 3 books at regular **Club Prices** (plus **shipping/handling**) **during** the next 12 months, and may resign any time thereafter.

Write your selections here:

Name _____

Address _____

City _____

State/Zip _____ Phone _____

Signature _____

*Signature of parent or guardian **required** for all new members under 18 years of age.*

BY189

Valid for new members only. Foreign applicants will receive special ordering instructions. Canada *must* remit in U.S. currency. This order subject to acceptance by The Computer Book Club®.



NO POSTAGE
NECESSARY
IF MAILED
IN THE
UNITED STATES



BUSINESS REPLY MAIL
FIRST CLASS PERMIT NO. 9 BLUE RIDGE SUMMIT, PA 17214

POSTAGE WILL BE PAID BY ADDRESSEE

The Computer Book Club®
Blue Ridge Summit, PA 17214-9988



NO POSTAGE
NECESSARY
IF MAILED
IN THE
UNITED STATES



BUSINESS REPLY MAIL
FIRST CLASS PERMIT NO. 9 BLUE RIDGE SUMMIT, PA 17214

POSTAGE WILL BE PAID BY ADDRESSEE

The Computer Book Club®
Blue Ridge Summit, PA 17214-9988



SELECT 5 BOOKS for only \$3⁹⁵

(values to \$208.75)

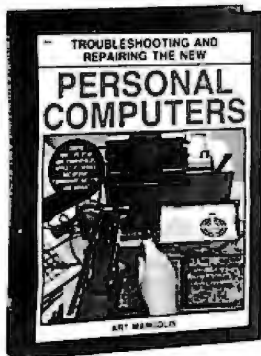

2809 \$26.95
Counts as 2



3019 \$39.95
Counts as 2



3030P \$17.95



2891P \$19.95



2997 \$25.95



2968 \$19.95



2892P \$16.95



2978P \$17.95



2690P \$16.95



2870 \$24.95



9826P \$16.95



2907P \$19.95

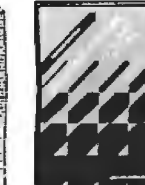

9806 \$34.95



9083 \$29.95
Counts as 2

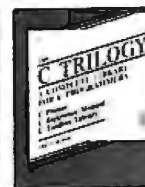

2890 \$32.95
Counts as 2

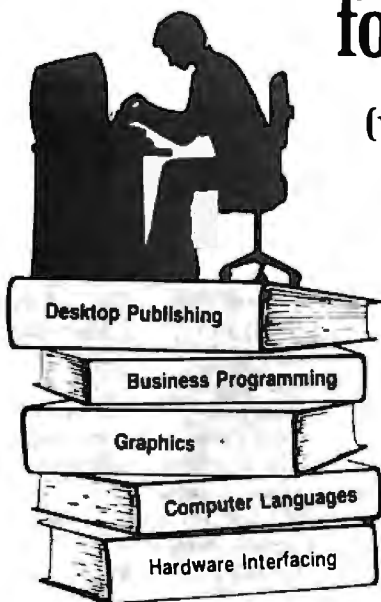

3116 \$27.95
Counts as 2

When it's new and important in business or personal computing, The Computer Book Club® has the information you need . . . at savings of up to 50% off publishers' prices!



9785 \$86.95

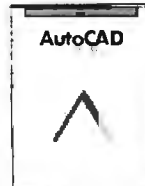

2989 \$29.95
Counts as 2



2050P \$16.95



2929P \$15.95



1860P \$16.95



9783P \$34.95



2859P \$20.95



3111 \$27.95
Counts as 2



9779P \$22.95

All books are hardcover unless numbers are followed by a "P" for paperback. (Publishers' Prices Shown)



The Computer Book Club®

Membership Benefits • Big Savings. In addition to this introductory offer, you keep saving substantially with members' prices of up to 50% off the publishers' prices. • **Bonus Books.** Starting immediately, you will be eligible for our Bonus Book Plan, with savings of up to 80% off publishers' prices. • **Club News Bulletins.** 14 times per year you will receive the Book Club News, describing all the latest selections—alternates, extras—sales—hundreds of titles to choose from. • **Order** the membership selection, do not and it will be sent to you. • **Prefer another selection, or no book at all, simply indicate your choice on the reply form provided.** As a member, you agree to purchase at least 3 books within the next 12 months and may resign at any time thereafter. • **Ironclad No-Risk Guarantee.** If not satisfied with your books, return them within 10 days without obligation! • **Exceptional Quality.** All books are quality publishers' editions.

If card is missing, use this address to join: ©1989 THE COMPUTER BOOK CLUB®
Blue Ridge Summit, PA 17294-0820

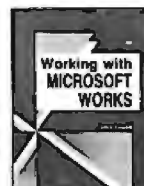

0119P \$21.95



0782P \$31.95



2841P \$15.95



3031 \$24.95



3045P \$19.95



2961P \$17.95



3047 \$34.95
Counts as 2



2856P \$18.95



3127P \$16.95



2820 \$25.95



2637 \$22.95

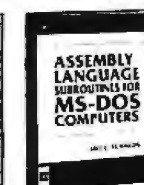

2787P \$18.95



2852P \$17.95



9200P \$24.95
Counts as 2

looks like a scaled-down, redesigned version of the old Intertec SuperBrain, though the Cat's muted gray/beige color is far more at home in today's office environment than the garish red, white, and dark gray of the SuperBrain.

Its unique software is what makes the Cat special. It's a full word processing and data management system in ROM that lets you create a huge scroll of text that can be broken into pages for output; there are no files per se. You find your way through this collection of information by using two keys at the top of the keyboard to initiate forward and backward searches. When you keep pressing one of these keys, each letter you type becomes part of the search string. As the Cat moves its cursor after each key-stroke, rather than at the end of your entry, you rarely have to type an entire word to reach its next occurrence.

Highlighted blocks can be copied, moved, deleted, or sent to the printer. If the block is made up of numbers or a mathematical formula, the Cat will calculate the result. You can also enter programs in either Forth or 68000 assembly language, and the Cat will execute them.

There are other goodies, too: a simplified system for disk operations, an internal 300-/1200-bit-per-second modem, and a 90,000-word spelling checker.

You haven't heard much about the Cat because Canon doesn't seem to want to let you know that it's a computer. Canon has been marketing the product as a competitor to memory typewriters and dedicated machines like the Magnavox VideoWriter. So you can't find the Cat in computer stores; you can get one only through office equipment dealers.

I suppose that if you see the Cat as a piece of office equipment, the bundling of a daisy-wheel printer is a logical idea. I, however, have no desire to acquire a device that sounds like a pneumatic drill. And the Cat has built-in drivers for Epson/IBM printers, the Canon Laser Beam Printer, the Bubble-Jet, and other Canon printers, so the daisy-wheel printer is not an essential item. When I called Canon to ask if it was possible to buy the Cat minus printer, I was told that any decision to break up the bundle was "up to the dealer" and that there is no official Canon price for a solo Cat.

Canon's California office gave me the

names of two stores in my area, and I called both to see what they would do for me. The first refused to split up the bundle and tried to convince me that the daisy-wheel printer was a marvelous bargain. I didn't dispute that, but I still didn't want one. The second outfit was quite amenable to selling a printerless Cat, and it quoted me a list price of \$799. I don't know if the same 50 percent success rate would apply nationwide, but I'm fairly confident that you can find a Cat by itself if you want one.

It could be that the Cat is the perfect writer's tool. I don't know if my initial admiration will hold up after extended use. I'll report next month on my reaction to running the Cat for day-to-day tasks. ■

Ezra Shapiro is a consulting editor for BYTE. You can contact him on BIX as "ezra." Because of the volume of mail he receives, Ezra, regretfully, cannot respond to each inquiry.

Your questions and comments are welcome. Write to: Editor, BYTE, One Phoenix Mill Lane, Peterborough, NH 03458.

The facts on deterministic fractals. By the expert in the field.

FRACTALS EVERYWHERE

by

Michael Barnsley

Michael Barnsley is inventing the future of deterministic fractal geometry. You have read about his exciting work in publications such as *IEEE Spectrum*, *Byte*, and *Scientific American*. Now you can read his new authoritative book on the subject of fractals, describing revolutionary applications in:

- ▲ image compression
- ▲ satellite reconnaissance and imagery capabilities
- ▲ computer-aided design
- ▲ flight simulation
- ▲ cinematic special effects

Handsomely illustrated, including 32 full-color plates, this innovative work is your key to mastering fractal geometry.

1988, 424 pages, \$39.95/ISBN: 0-12-079062-9



ACADEMIC PRESS Harcourt Brace Jovanovich, Publishers
Book Marketing Department #27128, 1250 Sixth Avenue, San Diego, CA 92101

Credit Card Customers Call Toll Free 1-800-321-5068



BOFFIN

LIMITED

2500 WEST COUNTY ROAD 42 • #5 • BURNSVILLE, MN 55337 • (612) 894-0595

A Small Case For BIG Performance!!!

TOSHIBA



CALL
T1000
T1200F
T1200H
T3100
T3200
T5100

CALL

SUPERSPORT



Dual Floppy
CALL
20 MB HD
CALL
SUPERSPO

MITSUBISHI

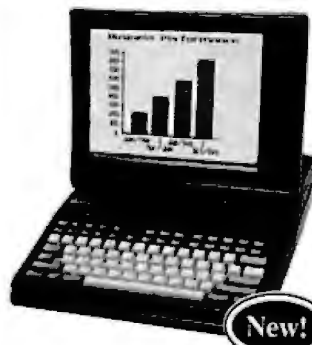

MP286L/20

- 11" Diagonal Black & White Display
- 20 MB Hard Disk
- 12 MHz 80286
- 1.4 MB Floppy Drive

\$2695.00

Dual Floppy (1.4 MB) Model

\$2195.00

New!

From

Easy Talk 3270

3270 Emulation Card for Toshiba Laptops; Fully supports IRMA & IBM Emulation. Auto-Config. - No Jumper Changes required. Includes software for 3270 and IND/FILE Transfer Support

\$599.00

Easy EGA

EGA Card for Toshiba T1200 and T3100 Laptops. Supports MDA, HGC, CGA & EGA

\$299.00

Easy Talk E2400

2400 Baud Modem for the Epson Equity LT

\$239.00

Weltec . . .

External 5.25" FDD

\$199

Specify TOSHIBA, ZENITH or NEC*

*No cable w/NEC Drive - Cable included in NEC Laptop Box

MHz INTERNAL MODEMS

1200 Baud \$139 2400 Baud \$239

Specify:

Toshiba, NEC EL/HD,
Zenith 181/183 or SupersPort

WonUnder

Single card expansion slot for **\$299**
ie T1100+, T1200, T3100/20 & T5100

mix 150P Portable Printer **\$299**
ink Plus **\$79**

When Purchased with any Laptop

- Competitive Price
- Corporate Volume Discounts
- Net Terms to Qualified Corporate Accounts

Prices Subject to Change Without Notice

To Order Call:

FAX Number: 894-6175

(800) 255-4012

IN MN: (612) 894-0595

The Ultimate Business Machines

In just three years, CLUB American Technologies has grown into a multi-million dollar computer manufacturer. What's the secret to our success? The answer is simple, CLUB delivers solidly designed systems which are famous for high performance and superior quality. That's why so many fortune 500 companies depend on us. Additionally, CLUB's on-line engineers are available to support you every business day with optional on-site service available.

CLUB Model 200 Series

The Model 200 Series are OS/2 compatible, 80286 based systems. They are available in either 8 or 10 MHz versions to fit your specific needs. These economical, yet full featured AT compatibles are perfect for any applications such as spreadsheets and word processing.



Model 200 Series Features & Pricing

Intel 80286 CPU -208/208S-6/8MHz, 210/210S-8/10MHz, 211-8/10MHz '0' wait state, 512K DRAM, 1.2MB Floppy Disk Drive, 80287 Math Coprocessor Socket, HD/FL Controller (controller is built-on motherboard for 'S' Models) Keyboard Speed Switchability ('S' Models), 2 Serial/1 Parallel Ports (211), 192 Watt Power Supply, 101 Key Enhanced Keyboard, Documentation and more.

200 Series with Monitor and Adapter

Model with Hard Disk	Mono	EGA	VGA
208 or 208S with 20MB	\$1275	\$1625	\$1875
208 or 208S with 40MB	\$1420	\$1770	\$2020
210 or 210S with 20MB	\$1705	\$2065	\$2305
210 or 210S with 40MB	\$1850	\$2210	\$2450
211 with 20MB	\$1805	\$2165	\$2405
211 with 40MB	\$1950	\$2310	\$2550

CLUB Model 212 Series

With an effective throughput of 16 MHz, the Model 212 Series is as fast as many 386 machines at a fraction of the price. Compatibility with the existing AT standard ensures that the Model 212 will run your large databases, and complicated financial software today, as well as OS/2 applications tomorrow.



Model 212 Series Features & Pricing

Intel 80286-8/12, 1MB of DRAM, 1.2MB Floppy Disk Drive, 1:1 Interleave HD/FL Controller, 80287 Math Coprocessor Socket, Clock/Calendar/Configuration with Battery Backup, Reduced Chassis (212D), 192 Watt Power Supply, 101 Key Enhanced Keyboard, Complete Documentation, and more

212 Series with Monitor and Adapter

Model with Hard Disk	Mono	EGA	VGA
212 with 40MB	\$2250	\$2615	\$2850
212 with 70MB	\$2505	\$2870	\$3105
212D with 40MB	\$2190	\$2550	\$2790
212D with 70MB	\$2445	\$2805	\$3045



CLUB Model 300 Series

The Model 300 Series 80386 microprocessor's state of the art design brings mainframe capability to the desktop at a vastly lower cost per seat. Complete compatibility with OS/2 and Unix give the Model 300 Series the ability to meet the most demanding multi-user and multi-tasking applications. Let CLUB give you the key to increased productivity in today's complex office and engineering environments.

Model 300 Series Features & Pricing

Intel 80386 CPU - 8/20 (320), 8/16 (316S), 1MB 32-bit DRAM (320), 1MB DRAM (316), 1.2 MB Disk Drive, 1:1 interleave HD/FL Controller (320), HD/FL Controller (316S), 80387 Math Coprocessor Socket (320), Weitek Support (320), 80287 Math Coprocessor Socket (316), 8 expansion slots, Clock/Calendar/ Configuration w/battery backup, 192 Watt Power Supply, 101 Key Keyboard, Documentation, and more.

300 Series

with Monitor and Adapter

Model with Hard Disk	Mono	EGA	VGA
316S with 40MB	\$2690	\$3050	\$3420
316S with 130MB	\$4060	\$4420	\$4790
320 with 70MB	\$4005	\$4330	\$4675
320 with 130MB	\$5120	\$5445	\$5790

CLUB Model 110

The Model 110 is an affordable entry level computer. It's perfect for general business applications and for low cost network nodes.

Model 110 Features & Pricing

Intel 8088 CPU-4.77/10 MHz, 256K RAM Maximum 640K, Floppy Disk Drive and Controller, 8 Expansion Slots, 150 Watt Power Supply, 101 Key Keyboard, Documentation and more

100 Series

with Monitor and Adapter

System & Hard Disk	Mono	EGA	VGA
110 with 20MB	\$895	\$1255	\$1495
110 with 40MB	\$1080	\$1440	\$1680



Circle 49 on Reader Service Card

Peripherals

For your convenience, we offer the latest peripherals to enhance your systems. Our manufacturing facilities are geared to build systems the way you want them. Call and tell us what you need. Here's a list of just some of the products we carry.

Storage

Floppy Drives: 5.25" - 1.2MB \$95
5.25" - 360K \$85
3.5" - 1.44MB \$120
3.5" - 720K \$105
Tape Backups: Internal: 40MB \$580
60MB \$650
125MB \$995
External: 40MB \$620
60MB \$690

Multifunction & Memory

(all prices with OK)

384K memory card for XT \$99
576K memory card for XT \$42
2MB multifunction card for AT \$110
3MB extended memory card for AT \$110
10MB EMS card for AT \$150
2MB EMS card for AT \$110
Mini I/O for XT and AT \$75
Mini I/O w/ floppy controller for XT \$85
80286 accelerator card for XT \$299

Modems

1200/300 Baud rate internal \$99
2400/1200/300 Baud rate internal \$175
2400/1200/300 Baud rate external \$210
1200/300 Baud pocket Mini Modem \$139

* All modems come with Bitcom software

Printers

Star Micronix NX 1000 9 pin \$199
Star Micronix NB-24-10 24 pin \$493
Epson FX 1050 \$595
HP Laser Jet \$1815

Products for PS/2

RAM 4000 (EMS) card OK \$399
60MB Tape backup internal \$1095
60MB Tape backup external \$1285
120MB Tape backup external \$1595
PS/2 modem 2400 baud internal \$299

Others

80287-8 \$230
80287-10 \$279
80387 Call
Ram chips Call
Logitech Mechanical mouse \$79
Optical mouse \$75
DCS 3.3 \$95

To Order:

Continental USA, Hawaii, Alaska:

Call (415) 490-2201

In Canada Call PC Centre,

Call (416) 470-0560

International

Call (415) 683-6623

Customer Support &
Technical Hotline

Call (415) 683-6580

Corporate, University and
Government P.O.'s Welcome

All prices are subject to change and quantities may be limited. We reserve the right to substitute equivalent items.

OS/2, MS DOS, Unix, IBM PS/2, PC, XT, AT, Bitcom, Star Micronix, NX-1000, NL24-10, Epson FX-1050, HP Laser Jet, Logitech Mechanical Mouse, Intel, VGA, EGA are the trademarks or registered trademarks of their respective companies.

CLUB V v.1 8/23/88

CLUB

American Technologies, Inc.

3401 W. Warren Ave., Fremont CA 94539

See DOS run.



Look at DOS. It looks back at you. It makes you do all the work. You need the Norton Commander.



See this user-defined menu. It runs your favorite programs and routines at a keystroke.



View two directories—from one or two disks—at once. And move your files around quickly.

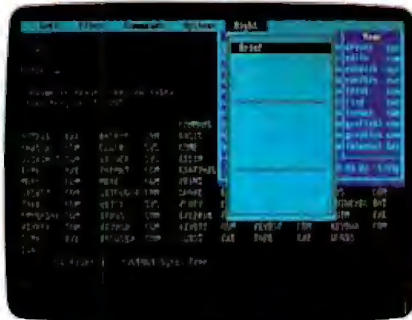

Pull down a menu for quick, easy access to the full power and features of the program.



Want a tree view? Just pop up a window. You can scroll, mouse or Speed Search for directories.



To see your files, pick a directory on the left and see the contents on the right.



Remember your last 15 commands? Our Command History does. Take your pick and run them again.



View your dBASE® II or III data without having to run dBASE. It's as close as a keystroke.

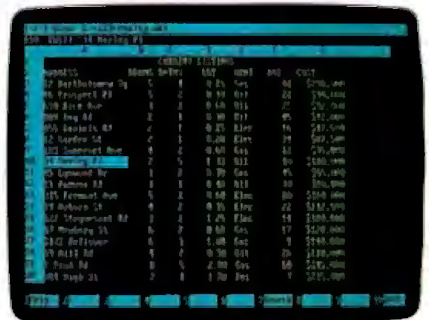

Another keystroke shows Lotus® 1-2-3® or Symphony® files—with-out running 1-2-3 or Symphony.

See DOS run like you've never seen it before. Like you won't see it run with any other DOS enhancement shell. See version 2.0 of the Norton Commander™—a dramatically advanced version of the program *Infoworld* called "tops in its class...a new level of convenience for MS/DOS users." The new Norton Commander combines the functions of a hard disk manager with all the features you need to support and enhance the DOS command line. Yet it's flexible enough to get out of your way when you don't need to see it. Novice or expert, you'll want to see your dealer right away. And see how fast DOS can run.

Peter Norton
COMPUTING

NORTON
COMMANDER

Circle 359 on Reader Service Card (DEALERS: 360)

Designed for the IBM® PS/2® and PC families, and 100% compatibles. Available at most software dealers, or direct from Peter Norton Computing, Inc., 2210 Wilshire Blvd. #186, Santa Monica, CA 90403. 213-319-2000. Visa and MasterCard welcome. ©1988 Peter Norton Computing.





SO, MAYBE YOU DO NEED A LAN

If you have to do more than share a laser printer, a LAN may be just what you need

Last month, I wrote about Bill Miller, an Oklahoma patent attorney who needed to share a laser printer. It looked then like he probably didn't need a LAN. Why? Because the only thing he really needed to share was the printer, and there were easier and less expensive ways to do that. There is, however, more to life than laser printers.

For example, there's the case of the contract office in a small government agency in Washington. I'm not allowed to say which agency, but it has a problem that's not unlike those in private industry. Documents are generated by members of the 10-person staff, and they have to be approved by more senior members. When the approval is finished, the document has to be printed on a laser printer and stored somewhere safe.

This office generates modestly sized documents, often less than 20 pages and always less than 100 pages. In addition, members of the staff need to have access to common spreadsheets and to be able to print them. The staff currently has no need to use any outside services.

Unlike the legal office in last month's example, the people in this government contract office are not saddled with old, unsupported computers. Instead, they have a group of Zenith Z-248 computers purchased under the military's arrangement with Zenith Data Systems. These are AT-compatible computers that will work with readily available network hardware.

Let's take a look at whether or not this office needs a LAN.



Sharing Information

What this office needs is to share information. While most users think of local-area networks in terms of sharing scarce peripherals such as laser printers, you should realize that sharing information is at least as important. The key to the value of your network is sharing.

The kind of network you need, and the capacity of your network, depend on exactly what you need to share and how much there is of it. In the case of the government office in this example, there are a number of documents that vary in size from about 20K bytes to about 200K bytes. In most cases, the sharing doesn't take place until one user is finished with the file and notifies the next one that he or she can have it. At that point, the next user can move the file to his or her machine and continue work.

As you can see from the example so far, this is an office where the files are fairly small, as is the volume of transfers. The users need some way to send

notes to each other, and they do need the ability to share the laser printer when the time comes to print out a draft or a final copy of the documents.

Which One to Use?

Here is one of those examples that have many possible solutions. The office could go with a LAN that has a dedicated file server. That would give the staff access to common files on the server, as well as other network services such as electronic mail. Another option, and the one they chose, is to go with a peer-to-peer network, in this case DCA's 10Net.

The decision makers chose 10Net partially because of its relatively low cost per workstation and partially because it is relatively easy to install and maintain. It doesn't have the speed and capacity of a huge file server, but it doesn't have the cost associated with one, either. Instead, each workstation can share a portion of its hard disk with the others. Each can

continued

Twisted-pair network card ...\$495

(with software and hardware)

Fiber-optic network card\$795

(with software and hardware)

10 megabit-per-second fiber-optic card.....\$

(with software and hardware)

10Net Communications

7016 Corporate way

Dayton, Ohio 45459

(513) 433-2238

Zenith Z-248..

Zenith Data Sys.

1000 Milwaukee

Glenview, IL 6

(312) 699-4800

Inquiry 951.

also make peripherals available for sharing with other network users, so the workstation with the laser printer can act as a print server for the entire network.

A Look at 10Net

Digital Communication Associates' 10Net has been quietly growing in acceptance. Its stronghold was once in Europe, but the company has shown significant growth in the United States and Asia. One of the major reasons for this growth is that 10Net is relatively inexpensive to install and use. Another is that 10Net is available in a fiber-optic version that has become quite popular with U.S. and Soviet intelligence and diplomatic communities—a fact that demonstrates it can work in a secure environment.

In its most basic form, 10Net is a twisted-pair network that transmits information at 1 megabit per second. This means that it uses cable very similar to telephone wire and will transmit a typical document file in a second or two. The network is cheap to install, and it's fast enough for most uses.

Its easy installation is one of 10Net's major points. All that is required is to

connect the twisted-pair cable to a pair of screw terminals. You run the cable from one workstation to the next, and when you have connected all the workstations, your network is complete. Installing the network interface card is also easy; you just insert it into an expansion slot inside your computer.

Relatively little maintenance is required with this type of network. Because each user controls the hard disk drive on his or her individual computer, and because there is no file server, a network administrator has little to do. The greatest problem with this sort of network is that you can only access files on other users' hard disk drives if they have their computers turned on. This can be a problem if there is likely to be much need to use the network at odd hours when the other computers will be turned off.

Real Life Use

In actual use, users share portions of each other's disk drives and share designated peripherals. Which ones they have access to depends on parameters that can be controlled by the person using the

continued

Computers For The Blind

Talking computers give blind and visually impaired people access to electronic information. The question is how and how much?

The answers can be found in "The Second Beginner's Guide to Personal Computers for the Blind and Visually Impaired" published by the National Braille Press. This comprehensive book contains a Buyer's Guide to talking microcomputers and large print display processors. More importantly it includes reviews, written by blind users, of software that works with speech.

This invaluable resource book offers details on training programs in computer applications for the blind, and other useful information on how to buy and use special equipment.

Send orders to:

National Braille Press Inc.

88 St. Stephen Street

Boston, MA 02115

(617) 266-6160

\$12.95 for braille or cassette, \$14.95 for print. (\$3 extra for UPS shipping)

NBP is a nonprofit braille printing and publishing house.

TAKE CHARGE!® DOES WHAT ALL THESE DO AND MUCH MORE... INCLUDING TASK SWITCHING

SIDEKICK PLUS \$199.95 72K	DISK OPTIMIZER \$69.95 256K	AUTOMENU \$50.00 30K	PC TOOLS DELUX 5.0 \$79.00 40K	DIRECT ACCESS \$89.95 256K
CRUISE CONTROL \$59.95 4K	METRO \$85.00 64K	Q DOS \$79.95 128K	XTree professional \$129.00 100K	NORTON UTILITIES ADVANCED \$150.00 256K
SOFTWARE CAROUSAL \$79.95 32K	NORTON COMMANDER \$89.00 145K	COMMUNICATIONS \$100.00 100K	MACE \$99.00 192K	Take Charge! \$139.95 20K

IN ONLY 20K OF RAM!

This power packed integrated program lets you Take Charge! of your PC with every memory resident program you will ever need, plus Configure-IT, the Take Charge! Task Switching Manager. Lets you run your favorite programs as pop ups from within another running application program with the use of a hot key. Pop up word processing from within your Data Base Management program. Go from Lotus 123 to any other program and back, all within 20K of RAM. While using such Take Charge! features as a Full featured **Menu System** that enables you to run all the software on your PC with just one key stroke. A **Disk Optimizer** to speed up your hard disk. **Undelete** for files accidentally deleted. **Format Recovery** for those accidentally re-

formatted hard disks. **File Locator** to quickly find any file anywhere on the hard disk. A complete **Communications package** for communicating with other PC and BBS. View and work in multiple directories with **Split Screen** facility. A full featured **Dos Shell** with **Graphic Tree Directory** display. Copy, move and delete files quickly. Pop up **Calculators**, full screen **Editor** with unlimited file size, **Notepad/clipboard**, **ASCII**

Take Charge!
LIKE NOTHING IN RECENT MEMORY

table, **Rolobase** with autodialer, **Appointment book** and **calendar**. **Cut-and-paste** between applications. Set the **Alarm** clock to remind you of appointments. Lock your **Keyboard** with your own security code. Set the **Clock** to display on the screen. Set the **Screen Saver** to automatically turn off the CRT display. Change on screen colors. Redirect printer output. Use the **Speed Key** to increase cursor speed. Plus **Disk Test**, **Disk Map**, **Directory Editor**, **Hex Editor**, **Directory Sort**, **DOS 4.0** and **Compaq DOS 3.31** support. **\$139.95**

HOLIDAY SPECIAL \$49.95

Offered through manufacturer only, with proof of purchase of any of the above disks. Offer expires Jan. 31, 1989.

Call your local Dealer, or write: Departmental Technologies, Inc /13 Kilroy Rd., Newton, NJ 07860
Tel: (201) 786-6878 / FAX: 201-786-5868 / Major Credit Cards Accepted, Dealer Inquiries Welcomed

System Requirements: IBM™ PC, XT, AT, PS/2, or 100% IBM compatible. Requires hard disk. MS/DOS 2.0 or greater. 320 K minimum. Network compatible. Product RAM estimated. All product names are trademarks of their manufacturers. Copyright 1988. Departmental Technologies, Inc. All rights reserved.

Circle 80 on Reader Service Card

workstation. This means that people on the network can't read what's on your computer unless you want them to.

To the users, the disk drives on the network look like disk drives on their own computers. Likewise, the network printer seems to be just like a printer connected to their own computers. You control this setup through a series of commands normally loaded with a batch file.

In the office in this example, when the initial draft of the document is ready for

the next person, it would simply be copied to his or her computer. This could be done by either person involved, with an E-mail note telling the other that it has happened. Once the next person is finished, the document is moved along to its subsequent location. At any point in this chain, it can be sent to the laser printer.

Other Choices

There are, of course, other choices in low-cost, peer-to-peer networks. TOPS

is also a twisted-pair network that will let you work with Macintosh computers as well as IBM PC compatibles. Another choice is LANtastic, which Jerry Pournelle tells me is nothing short of wonderful. I understand that he even managed to network his Amiga with this product.

How Do You Decide?

Last month you saw that some small offices may have a few of the needs normally associated with a LAN but really don't need one. A printer server was all they needed. This time, we see that there are low-cost, easy-to-implement solutions to true local-area networking. There is, of course, a wide variety of server-based LANs. How do you decide which one is right for your business?

The key to deciding is to determine what your needs actually are, as well as to make a realistic appraisal of your needs for the next few years. To do this, consider these points:

- What do you actually need to share? Is it a single peripheral, such as a laser printer? Is it information? Is it many peripherals?
- What is the nature of the information you need to share? Is this a system that is primarily handling E-mail? Will you transfer documents? Will you need to move extremely large files (e.g., CAD files)?
- How big will the network be? How many people will use it? How much distance must be covered?
- Do you need a central storage area for files? Do you need some other sort of centralized service (e.g., a wide-area network gateway)?

Answers to these questions will give you a more thorough knowledge of your networking needs. While there are no magic numbers that automatically indicate one network over another, the answers will give you the information you require to begin specifying your network. You can find the right network by realistically looking at your needs and applying those needs to the solution. ■

Wayne Rash Jr. is a consulting editor for BYTE and a member of the professional staff of American Management Systems, Inc. (Arlington, VA). He consults with the federal government on microcomputers and communications. You can reach him on BIX as "waynerash."

Your questions and comments are welcome. Write to: Editor, BYTE, One Phoenix Mill Lane, Peterborough, NH 03458.

IF DESKTOP PUBLISHING WERE A BUICK, PCT_EX WOULD BE A LAMBORGHINI.

You'd expect us to say PC T_EX is hot—so don't take our word for it. In their desktop publishing systems category, INFOWORLD rated PC T_EX #1. They said:



"...No non-T_EX-based program has such typological aesthetics...enormously flexible and offers complete control over the output of your printer..."

And from PC MAGAZINE: "...PC T_EX offers ample rewards. You can achieve incredible precision in formatting text, especially mathematical expressions."

TRY THIS!

with a standard desktop system and you'll see that for complex scientific and mathematical formulation and notation, PC T_EX leaves the others back in the dust.

FORMATTING with textbook quality, and unsurpassed placement of

TYPE that rivals professional typesetting: all yours. Pick the type you like from 30+ Bitstream font families.

FLEXIBILITY Camera-ready, publisher-ready manuscripts are fast and easy. Author to printed piece time reduces, author control increases.

That's flexibility—that's PC T_EX.

$$\int_{-\infty}^n \frac{X^Z \cdot Y \cdot Z dt}{X - tY} = \sum_{i=1}^n \left(\frac{(x^4 - i)^3}{\sqrt{Z^3 + y^{10}}} \right) / (Z - X^5 Y)$$



TEST DRIVE IT.

For a free PC T_EX demo diskette, the new PC T_EX 88 product catalog and information on a PC T_EX configuration for your system, give us a call at **415-388-8853**



12 Madrono Ave. Mill Valley CA 94941

VOR O O O O O M !

PC T_EX is a registered TM of Personal T_EX, Inc. T_EX is an American Mathematical Society TM. Manufacturer's product names are their TMs. Inquire about PII distributorships. Site licenses available to qualified organizations. This ad was typeset using PC T_EX and Bitstream fonts.

TimeWand[®] - Gathering Information



The TimeWand



Scan Part Number



Qty.- 4

Scan Quantity



Transfer Scan Data

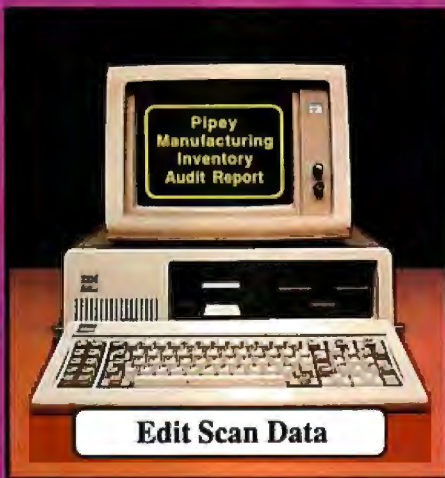

Edit Scan Data

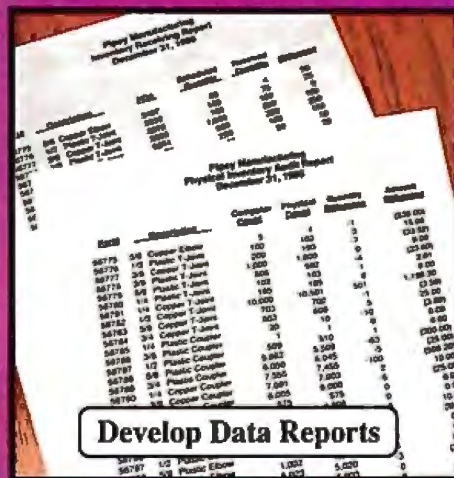

Develop Data Reports

Bar Codes, Computing, and the TimeWand... a Closer Look.

"A successful business runs on accurate, timely information." An obvious statement perhaps, but one that every personal computer user must keep in mind. In order to get the reports we require, we must ensure that the information on which we base our decisions is as up-to-date as possible. This is where a bar code reading system such as the TimeWand can be used to improve efficiency in the office or workshop. The TimeWand provides a convenient way to ensure that your computer has all the facts, all the time.

Let's use inventory control as an example. Once an inventory system is set up on the computer, you are faced with the important task of keeping the inventory up to date. The TimeWand gives you a quick and efficient method of getting information into your computer system. To enter an item into inventory (such as the copper elbows shown above), all you need to do is scan the item, the quantity, and transfer the data to your computer. By using TimeWand, you bypass the time-consuming steps of writing down every transaction, deciphering hand-written notes, typing in each inventory transaction by hand, and searching for transcription errors that might have occurred. The TimeWand is an ideal tool for gathering information for use in your business.

From time-billing to tracking work orders to monitoring security, the TimeWand provides an inexpensive solution for your data collection needs. Call or write Videx today for more information about how the TimeWand can help in your business.

TimeWand (8K version) - \$248
Recharger and Cable - \$149
TimeWand Communication Software (IBM) - \$299

Software available for the Macintosh, Apple // family, and Tandy (Model 100 and 200).



1105 N.E. Circle Blvd., Corvallis, OR 97330-4285
 503-758-0521

TimeWand and Videx are registered trademarks of Videx, Inc.

JANUARY 1989 • B Y T E 139

DAZZLING PERFORMANCE.



'286/SS

COMPLETE 12MHz '286 WITH 32MB HARD DRIVE ONLY \$1295.00

- 80286 CPU, 6/12 MHz Dual Speed, Keyboard Selectable.
- Zero-Wait State RAM, 512K expandable to 4MB on the motherboard (16MB System Total).
- 32MB Hard Drive, 1.2MB Floppy Drive.
- Ultra high speed Hard/Floppy controller. 1:1 interleave, 800 KB/sec transfer rate.
- High Res 12" Amber Display with Tilt and Swivel Base. Compatible graphics controller.
- ZEOS Enhanced Keyboard, Pleasant Tactile/Click Feel.
- Serial and Parallel Printer Ports.
- Clock/Calendar with Battery Backup.
- 6-16 and 2-8 bit expansion slots.
- 80287 support, up to 12 MHz.
- Space Saver Case with Security Lock, LED indicators.

12MHz, 16MHz and 20MHz '286 HARD DRIVE SYSTEMS

As high as 20MHz! Dazzling performance is yours with one of these high performance full size ZEOS '286 Systems.

Each comes *complete* with our standard features including drives, monitor, high speed controller, etc. Our full size case features room for up to 5 half-high drives, two of which are internal. Incredible values.

■ **286/12**—Complete 12 MHz System with 512K of Zero-Wait RAM, High Speed 32MB Hard Drive and all the standard ZEOS goodies. **ONLY \$1395.00**

■ **286/16**—Complete 16MHz system with 1MB RAM on board and High Speed 32MB Hard Drive. *Faster than a '386 16MHz* when running 16-bit software!

ONLY \$1895.00

■ **286/20**—At 20MHz, it's the fastest. Complete with our 32 MB, High Speed Hard Drive and 1MB RAM. This is what Dazzling Speed is all about. **ONLY \$2095.00**



'286/FS

DAZZLING PERFORMANCE. INCREDIBLE PRICES.

Can you believe it? *Yes, you can!*

We've proven it to thousands and we would like to prove it to you. ZEOS® systems are sold *complete*, ready to plug in and fly right out of the box. And the quality

and prices are incredible.

How is it possible? Because your ZEOS computer comes to you *factory direct*, fully assembled, burned-in and tested in our own laboratories. Every system is built to order. Custom built actually, right to your own specifications.

And our quality and performance are second to none.

We don't just say it. We guarantee it. That's why your new ZEOS system comes with a Full One Year Limited Warranty and our 30 day Full Refund Satisfaction Guarantee.

So pick out your dream

INCREDIBLE PRICES.



'386/55

COMPLETE 16MHz '386 DESKTOP WITH 32MB HARD DRIVE.

ONLY \$2495.00
(20MHz add \$500)

- Genuine 32-bit Intel 80386, 16 or 20MHz parts.
- 1MB of RAM Expandable to 16MB.
- 32MB, High Speed Hard Drive, 1.2MB floppy drive.
- *Ultra high speed* Hard/Floppy controller. 1:1 interleave, 800 KB/sec transfer rate!
- High Res 12" Amber Display with Tilt and Swivel Base. Compatible graphics controller.
- 101 Key ZEOS Tactile Click keyboard.
- Serial and Parallel/Printer Ports.
- Clock/Calendar with Battery Backup.
- 2-32, 4-16 and 2-8 bit slots.
- 80287 and 80387 support.

machine and order it now with confidence. Dazzling performance and incredible prices await you. *Guaranteed.* Order now by calling 800-423-5891.

Other ZEOS Options Include:

- Basic Configurations: Call for prices on systems

without drives, etc.

- EGA/VGA Upgrades. 14" EGA color monitor with EGA card, add \$495. 14" VGA system, add only \$695
- High Capacity Drives. Many other drives and options are available. Call Toll Free for details, 800-423-5891

COMPLETE '386 VERTICAL SYSTEM. 64MB DRIVE!

ONLY \$2995.00
(20MHz add \$500)

Acknowledged worldwide as the highest performance value anywhere. Same great standard ZEOS features found on our other complete systems plus:

- 64KB Zero-Wait CACHE using 64K of SRAM.
- 1MB of 32-bit RAM system expandable up to 16MB.
- 65MB High Speed Seagate Hard Drive.
- 80287 and 80387 optional.
- Heavy Duty Vertical Case.

Call about our new **25MHz** systems. Now Shipping!



'386/V

**ORDER NOW TOLL FREE
800-423-5891**

FAX Orders Dial: 612-633-2310

In Minnesota Call: 612-633-4591

530 5th Ave. NW, St. Paul, MN 55112

Open days, evenings and weekends.

MasterCard, VISA and C.O.D.

Se habla Español.



We've Invented the Future of Instrumentation Software . . . Twice.

With Words

With Pictures

Acquisition

Integrated libraries for GPIB, RS-232, A/D-D/A-DIO plug-in cards, and modular instruments.

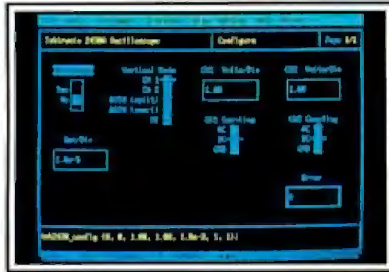

Intuitive character-based function panels that automatically generate source code.

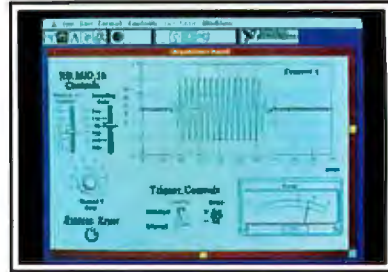

Front panel user interface with virtual instrument block diagram programming.

Analysis

Extensive libraries for data reduction, digital signal processing, and statistical analysis.

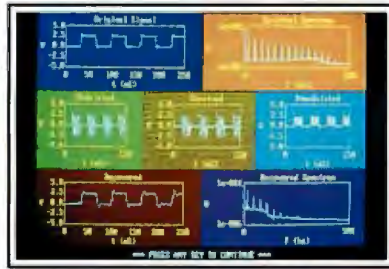

Over 100 analysis functions plus all the built-in functions of your language.

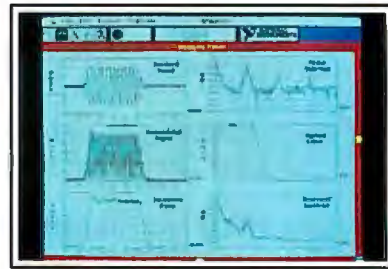

Over 250 icons for computation and analysis.

Presentation

Flexible high-performance graphics and report generation.

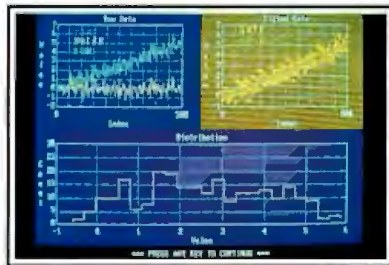

Extensive graphics support for CGA, EGA, MCGA, VGA, and Hercules.

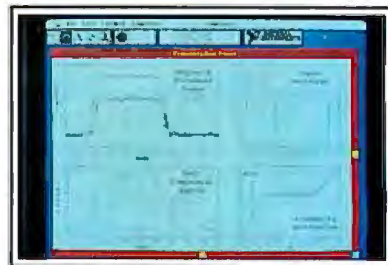

Macintosh Desktop Publishing compatibility.

The Software is the Instrument

LabWindows™—
for the DOS-based PC and PS/2,
with Microsoft QuickBASIC or C.



12109 Technology Boulevard
Austin, Texas 78727-6204
800/531-4742 512/250-9119

LabVIEW®—
for the Apple Macintosh

Circle 351 on Reader Service Card for LabWindows.
352 for LabVIEW.



HOOKED ON SMALLTALK-80 FOR THE MAC

A new implementation of this language makes it a winner

In the past few months I've been sold on the virtues of object-oriented programming. I've toyed with the AT&T's C++ preprocessor on Unix, the object extensions to MacForth on a Mac II, the MacApp program shell that runs under MPW (Macintosh Programmer's Workshop), and the Extend simulation system from Imagine That!, a simulation-design system that adopts certain object-oriented programming concepts.

But the system that's really brought the practical power of object-oriented programming home to me is Smalltalk-80. In fact, I think I've become a Smalltalk-80 addict—so much so that I'm working on a new short course for next year that focuses on Smalltalk-80 and object-oriented programming.

It didn't used to be that way. I've toyed with Smalltalk-80 before, using the early beta 0.4 release available from the Apple Programmers and Developers Association (APDA) for \$75. This release was incomplete, it was a little flaky, it provided only a byte-code interpreter, and it was poorly documented. With these shortcomings, I gave up using the language on a Mac until I found out about the full release from ParcPlace Systems.

Its Smalltalk-80 system is not limited to the Mac; in fact, there are versions that run on Sun 2, 3, and 4 workstations, Hewlett-Packard 9000s, and Apollo 3000 and 4000 workstations running some flavor of Unix. A DOS-based version for 80386 machines is also due out soon. It would be hard to imagine, however, that these Smalltalk-80 implementations could work any more smoothly than the one I've been using on a Mac II.



Still, the system operates nearly identically across processors, which gives it a big advantage in terms of program development and transportable code.

The reason for this coherent implementation across processors and operating systems is the system's structure. Smalltalk-80 consists of two functional parts: a virtual image and a virtual machine. The virtual image contains the Smalltalk-80 language and compiler, the run-time system, graphical system libraries, and a whole slew of program-development tools. The virtual machine links the operating system and hardware of a particular computer to the virtual image.

Smalltalk-80 is a pure object-oriented system. Unlike more traditional procedural languages and systems that approach data and algorithms separately, Smalltalk-80 considers them together, as objects. Where procedural languages like C derive their power mostly from algorithm composition and data typing,

pure object-oriented languages (like Smalltalk) dispense with this data/algorithm dichotomy.

Everything in Smalltalk-80 is an object. Once you understand how an object is created, you've grasped the essentials. The agents that act upon those objects are called *methods* (corresponding to a function or procedure in a procedural language), while a message is the way in which one object communicates with another (akin to a function or procedure call). Indeed, all the actions that take place in Smalltalk-80 are the result of objects messaging other objects.

Object-oriented programming systems also support sophisticated object-ordering methods, called object *classes*, so that you can assign similar properties (behaviors) to a group of objects (individual objects in a class are called *instances*) and work with them as a class.

As a full object-oriented system, Smalltalk-80 also supports object *inheri-*

continued

AW...WHAT THE HECK!

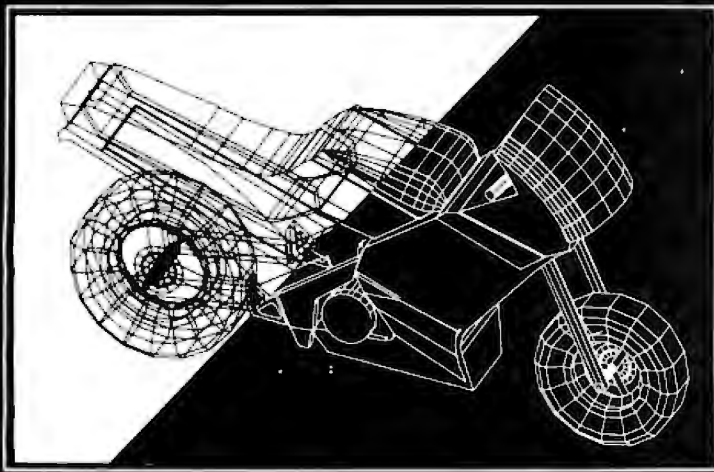

The first question asked by many people is, "Why is *DesignCAD 3-D* priced so low?" The answer? After developing *DesignCAD 3-D* we were unable to decide how the product should be priced. We consulted experts. We used the finest spreadsheets on the market. We took employee polls. We asked our lawyers and accountants for their opinion. We even asked our Mothers, Wives, and childhood Sweethearts! Finally in the greatest American Tradition, we said, "Aw... *What the Heck! Let's see the other guys beat this price!*" *DesignCAD 3-D* sells for \$299 complete. No add-ons, nothing else to buy!

DesignCAD 3-D is a complete 3-Dimensional CAD system. It offers most, if not all, the features found on programs costing more than \$3000! In fact, *PC Magazine* says, "For a low-cost, self-contained 3-D package *DesignCAD 3-D*'s range of features steals the show. The package offers more than adequate features for a wide range of professionals and hobbyists alike."

Once again, American Small Business Computers has proved that you don't have to spend a lot of money to get quality software. *DesignCAD 3-D* provides features such as Shading, Solid Object Modeling, Hidden Line Removal, Cross Sectioning capability, ability to output shaded drawings to laser printers, dot-matrix printers, or pen plotters, extensive file transfer capability, *all for only \$299!* No other 3-Dimensional CAD system can come close to providing the price/performance of *DesignCAD 3-D*.

There is a very important reason to buy *DesignCAD 3-D* other than price: PERFORMANCE! *DesignCAD 3-D* provides complete 3-Dimensional drawing capabilities. It's not a "warmed-over" 2-D program. *DesignCAD 3-D* allows you to draw any entity in 3-D space. This means, for example, that you can draw a curve in the shape of a spring. You can draw a circle or arc at ANY angle on ANY plane.

DesignCAD 3-D allows up to 4 simultaneous views - any angle or perspective - on the screen. *DesignCAD 3-D* also provides complex extrusions—linear, scalar, and circular. Extensive 3-D text capabilities and auto-dimensioning are provided, *at no extra charge, of course!*

DesignCAD 3-D almost certainly is compatible with the computer system you now own. *DesignCAD 3-D* supports more than 200 dot-matrix printers, at high resolution. *DesignCAD 3-D* supports more than 80 plotters, and most digitizers, mice, and graphics adapters available for "PC and PC Compatible" systems. Shaded and wireframe models can be output to the printer or plotter YOU own.

DesignCAD 3-D provides the capability to read drawings from most other CAD systems (*DesignCAD/ProDesign II*, *AutoCAD's DXF*, *Hewlett Packard's HPGL*, and *IGES*). *DesignCAD 3-D* will also write *GE*, and *POSTSCRIPT* files. This file exchange utility is included at no extra charge, of course.

DesignCAD 3-D does not require expensive graphics adapters and monitors - even shading can be done on ordinary displays, such as the Enhanced Graphics Adapter (EGA), Color Graphics Adapter (CGA) and Hercules Monochrome Adapter. *DesignCAD* also supports many of the ultra high resolution graphics adapters, with more hardware being supported daily.

However, the best reason to buy *DesignCAD 3-D* is not the low price. It's not the outstanding performance. It's not the extensive hardware compatibility. *The best reason to buy DesignCAD 3-D is for its amazing ease of use!*

What else do you need to know about *DesignCAD 3-D*? Only this: "Included at No Extra Charge." What is included at no extra charge? EVERYTHING! \$299 BUYS IT ALL!

\$299

DesignCAD 3-D

Oh yes, we also market a 2-Dimensional version of *DesignCAD 3-D* with special drafting and design functions. Can they work together? Naturally... Our Mothers, Wives, and childhood Sweethearts would see it no other way! The price?... \$299, of course!

How do you get one? See your local computer store or dealer, or contact:

To quote *PC Magazine*...

"DesignCAD 3-D, the latest feature-packed, low-cost CADD package from American Small Business Computers, delivers more bang per buck than any of its low-cost competitors and threatens programs costing ten times as much."

American
Small Business Computers, Inc.

327 So. Mill Street • Pryor, OK 74361
Phone: (818) 825-4844 Fax: 01-918-825-6359
Telex: 9102400302

Write or phone us for FREE DEMO DISK and information on *DesignCAD 3-D* and *DesignCAD 2-D* products.

tance. Inheritance allows instances of the same class to inherit properties or behaviors from all those classes that precede it in the object classification scheme. Inheritance permits a great savings in repetitive coding, helps simplify overall application design, speeds up compilation, and allows you to concentrate on creating your application rather than concentrating on the development environment.

Smalltalk-80 version 2.3 comes on six disks and contains the complete system. It incorporates a compiler, a symbolic debugger, object browsers, inspectors, a basic text editor, full support for displaying information, and the visual interface. It costs \$995, which is expensive, but considering everything the package includes, it's not unreasonable.

The hardware requirements for version 2.3 for the Mac aren't excessive, but the system certainly behaves better if you pile on the memory and disk space. You'll need a Mac Plus, SE, or II with at least 2 megabytes of RAM and 10 megabytes of hard disk space. If you plan to use the system for major development efforts, a Mac II with 8 megabytes of RAM

Item Discussed

Smalltalk-80 version 2.3\$995
ParcPlace Systems
 2400 Geng Rd.
 Palo Alto, CA 94303
 (415) 859-1000
Inquiry 999.

and a big, fast hard disk drive will make the process considerably smoother (but that's also true with any Mac development system).

What makes ParcPlace's Smalltalk-80 such hot stuff? It's really a combination of two factors. First, Smalltalk-80 is a mature object-oriented system. The Smalltalk language, of course, is object-oriented, but so is the development environment. Objects, classes, behaviors (or properties), inheritance, messages, and browsers are all integral to the complete Smalltalk-80 system, not grafted on as in

some other Mac development environments (like MacForth).

Second, this basic object orientation fosters strong program modularity and subsequent refinement; sort of the ultimate in black-box coding. By definition, Smalltalk-80's objects are modular. With Smalltalk-80, if you're not satisfied with the behavior of a specific object, you can refine it on the fly. There's no need to start at square one. If you're an old died-in-the-wool FORTRAN or Pascal programmer like me, the first few times you try Smalltalk-80 on your Mac, you'll shake your head at how easy it is to modify a project under development and investigate a new angle to a particular problem.

As the list above hints, ParcPlace's Smalltalk-80 includes everything you need for program development. Everything. And all the goodies are honest-to-God fully integrated.

You move easily about the system creating and editing code, compiling, debugging, browsing objects, borrowing from libraries, and popping up menus right and left. The power of Smalltalk-80

continued

A MESSAGE TO OUR SUBSCRIBERS

FROM TIME TO TIME WE MAKE THE BYTE subscriber list available to other companies who wish to send our subscribers material about their products. We take great care to screen these companies, choosing only those who are reputable, and whose products, services, or information we feel would be of interest to you. Direct mail is an efficient medium for presenting the latest personal computer goods and services to our subscribers.

Many BYTE subscribers appreciate this controlled use of our mailing list, and look forward to finding information of interest to them in the mail. Used are our subscribers' names and addresses only (no other information we may have is ever given).

While we believe the distribution of this information is of benefit to our subscribers, we firmly respect the wishes of any subscriber who does not want to receive such promotional literature. Should you wish to restrict the use of your name, simply send your request to the following address.

BYTE MAGAZINE
 ATTN: SUBSCRIBER SERVICE
 P.O. Box 7643
 TEANECK, NJ 07666-9866



**"TURN MY PC INTO A
 PROTOCOL ANALYZER
 FOR UNDER \$400?
 ...SHOW ME!"**



If you're involved in data communications, the PC Comscope can give you data line monitor capabilities at a fraction of the cost using your PC. Making use of pull down menu's and built-in help screens provides true operator simplicity. The combination of these features and price make this an extraordinary buy.

You can view the bidirectional data and control signals of any RS-232 link.

The PC Comscope capabilities include:
 ASYNC; SYNC; HDLC; TIME STAMPING;
 SOPHISTICATED TRAPPING; STORE DATA ON DISK;
 ASCII; EBCDIC; IPARS... Telebyte does it again!

PC Comscope for under \$400.

TALK TO **TELEBYTE** 270 E. Pulaski Rd. Greenlawn, NY 11740
 (516) 423-3232 / 385-8080 or 1-800-835-3298
 FAX: (516)385-8184

A Wealth of Knowledge.

We, the Murphys, believe we can help **peace officers, sales persons, attorneys, editors, social workers, secretaries, personnel managers** and anyone else who deals with or needs to *keep track of a variety of people.*

We've crafted a *personal information manager* that handles mundane yet important tasks such as billing and client tracking easily and efficiently. So you can better use the information you have pertaining to the people important to you.



Easy Billing and Time Keeping. Maintain your time and job records with our program. Invoices and time reports can be created automatically.

Personal Information Management. Organize clients, contacts, phone numbers, etc. Keep extensive notes for each entry (great for callback information and call history). Cross reference the entries with user-definable relationship links.

Print mailing labels/merges, rotary index cards, telephone lists and more.



The REGISTER Program

\$79.95

+ \$2.50 s/h

Available for IBM PC's
MS-DOS 2.0 or better, 512 Kb
30-day money back guarantee

Orders 1-800-548-7465
Information (206) 226-0765
Fax (206) 235-8368



The Murphys

**Applied Computing
Services**

14410 S.E. Petrovitsky Rd., Suite 203, Renton, WA 98058

comes from this modelless environment and visual interface. You're never "in" the editor or "in" the compiler, per se. Everything's available to you all the time. The interface is the one developed at Xerox Palo Alto Research Center (PARC, from whence comes the name for ParcPlace, a Xerox spinoff company), which spawned the Xerox Star and later the Apple Lisa and Mac. This means windows galore, a mouse, pull-down and pop-up menus, and the rest. Each of the development facilities can be used anyplace in the system, including text editing, debugging, performance monitoring, version management, system updating, and a bunch more.

Other development tools include inspectors, an impressive set of context-sensitive browsers, and some special cross-referencing tools that can access all system code and any reusable code module. You can also define primitives easily and use them to call and link external routines written in other languages, like C (the system is MPW C compatible), so you need not toss out any of your current favorite routine libraries when you migrate to Smalltalk-80.

The system also supports all the Mac-specific functions you need for program development. You can access the Mac's serial ports and use color directly. Smalltalk-80 permits Clipboard and Desk Accessory access. It is compatible with the MultiFinder (including background processing), supports TOPS and AppleShare, provides PostScript printing using the Print Manager, and gives you access to the Mac Toolbox through user-defined primitives. If you run version 2.3 on a Mac II, you'll also get support for the 68020 instruction set and the 68881 math coprocessor.

It is fairly easy to get started learning the system, since it includes some built-in applications that you can browse through, plus good documentation and on-line help. Of course, the best help comes from the user interface itself. Smalltalk-80 constantly gives you visual feedback for every action you take. All the object definitions that make the Smalltalk-80 environment so rich for development can also be included in the applications you're building. You can incorporate these library objects directly into your code or refine them as needed, making for a rapid development process.

Development is also enhanced by the quick access to system-level functions that's provided. The pop-up System Menu is just an option key or mouse click away regardless of what you're doing when you need it. From this menu you

can create a new System Browser that presents information (displayed hierarchically) about the Smalltalk-80 system itself. Garbage collection, which the system does automatically (as it does reference-counting and memory compaction), can also be invoked manually from the System Menu. This mark-and-sweep collection routine cleans things up nicely when you've been coding for a while, especially if you've created some circular structures.

The System Menu also controls workspace creation (for editing code), file listings, specific project views, a running system console window (called the system transcript), and a command to suspend the system and return to the Finder, leaving Smalltalk-80 in the background under MultiFinder. These views and commands just scratch the surface of this complete programming environment.

I've been so taken with ParcPlace's Smalltalk-80 system that I'm spending time developing personal applications that I wouldn't have bothered with before, when I was using Lightspeed Pascal (my usual development environment), because the effort needed just wasn't rewarded by the results.

Smalltalk-80 encourages you to pull together quickie applications because it's so easy to grab and modify the basic objects they require. And if you're not quite satisfied with the results, no problem: You can dip into the library of objects for another stab at it. This system is the first programming environment I've used on the Mac that actually made me *want* to develop software.

If you, too, want to get started with Smalltalk-80 on the Mac but need some background information about object-oriented systems, you should dig out your August 1981 and August 1986 issues of *BYTE*. These two issues covered, respectively, the Smalltalk-80 system and object-oriented programming.

Adele Goldberg's Smalltalk-80 book is also a good place to get started (*Smalltalk-80: The Language and Its Implementations*, Reading, MA: Addison-Wesley, 1983; written with David Robson). Have fun with Smalltalk-80 on the Mac. I sure do. ■

Don Crabb is the director of laboratories and a senior lecturer for the University of Chicago. He is also a consulting editor for BYTE. He can be reached on BIX as "decrabb."

Your questions and comments are welcome. Write to Editor, BYTE, One Phoenix Mill Lane, Peterborough, NH 03458.

Over The Years, We've Developed The Best Image In Monitors.



Ultra Vision 1000. A 19-inch analog multi-sync with VGA and up to 1600 x 1200 resolution.



MultiVision 770+. A 14-inch multi-sync with CGA, EGA, VGA and up to 800 x 600 resolution.



Crystal View 1901. A 19-inch system with Enhancement Filter, built-in CGA, and up to 1280 x 960 resolution.

We made the first amber monitor for the IBM PC.[®]

And the only 19-inch, multi-sync monitor to meet both IBM[®] and Apple[®] graphic standards.

Now, we're offering a family of high-resolution, monochrome and color IBM graphic standard monitors.

The 19-inch Ultra Vision 1000 offers extremely high resolution. Brilliant life-like colors. And the widest frequency range of any multi-sync monitor its size — so it works with virtually all graphic standards and resolutions.

The 19-inch Crystal View 1901 features our exclusive non-glare filter. It's a high-resolution, monochrome system that handles two 8½" x 11" pages of text or a B-size CAD drawing without scrolling or shrinking. Voted PC Magazine's "Editor's Choice."

The 14-inch, color MultiVision 770+. A multi-sync monitor with more image controls for maximum user comfort than any monitor its size.

Coming soon, the Super Vision VGA: the best VGA monitor you're likely to see.

PRODUCT	CAD/CAM/CAE	Presentation Graphics	Desk Top Publishing	Word Processing Spread Sheet
Ultra Vision 1000	✓	✓	✓	✓
MultiVision 770+		✓	✓	✓
Crystal View 1901			✓	✓
Super Vision VGA				✓

What you see here is only part of the picture. We have everything from 12-inch monochrome to 19-inch, high-resolution color monitors. All with special non-glare filtering,

superior brightness, and sharp focus across the entire screen.

That's important. Since OSHA found 91% of the people using computer displays suffer from eye strain. Prompting state and local governments to respond with new work rules.

With Taxan, the leader in meeting these new health requirements, you're already protected.

Call 800-544-3888 for sales information and your nearest authorized Taxan dealer. Taxan USA Corporation, 161 Nortech Parkway, San Jose, CA 95134, (408) 946-3400.

See why, in IBM monitors, one brand is clearly superior.

TAXAN
A Revolution in Graphics



The idea from the first has always been simple. To provide people with the easiest way possible to access the most power possible in a database management system.

So that the process of working with information becomes the means, and not the end, of the job at hand.

Welcome to dBASE IV™

IT'S NEVER BEEN EASIER.

dBASE IV is built around an all-new Control Center—a single, understandable window from which you perform all of your key database operations. By using simple-to-use, pull-down menus.

And no programming at all.

Unless, of course, you want to. Because whether you write a program yourself, or use the Applications Generator to do it for you, dBASE IV gives you access to 310 powerful new or enhanced commands and functions. All while running significantly faster than its predecessor

dBASE III PLUS.*

And, since many people will need to share information in a **workgroup**, dBASE IV gives you all the **tools** you'll need to **build** connections. Like our dBASE IV LAN PACK, which lets multiple users share files and programs.

A VERSION FOR DEVELOPERS.

If you build heavy-duty applications, the special dBASE IV Developer's Edition is just for you.

With the Developer's Edition (sold

Introducing dBASE IV.

What we put in is nothing compared to what you'll get out.



separately), you get a complete development, test, and distribution environment for both stand-alone and multiuser applications. In addition to the complete dBASE IV software, the Developer's Edition includes special tools such as the Professional Compiler; as well as utilities, programming documentation, and a royalty-free, application distribution module.

And one other thing, which also comes with every other dBASE® product.

A COMMITMENT TO SUPPORT.

With over two million current dBASE users, we at Ashton-Tate have an obligation to provide the best support, service, and training in the industry. So we do.

We back an extensive network of knowledgeable dealers. And we guarantee fast, reliable technical support. As well as encourage separate, third party resources in a variety of complementary areas.

All of which means that dBASE IV is not only the most advanced PC database environment you can find.

It also means it's the easiest to find. Just give us a call at 800-437-4329 ext. 2928 for more information, including details about upgrading from dBASE III PLUS. Or simply stop by your nearest Ashton-Tate dealer for a revealing look at dBASE IV.

You won't believe what we put into it.

 ASHTON·TATE®

Circle 23 on Reader Service Card
(DEALERS: 24)



Because Resources Should Be Shared



BayTech engineers Printer Sharing.

Make the most of your investments in valuable printers, computers, plotters, modems, and other resources with a printer-sharing device from BayTech. We manufacture a diverse product line engineered for flexibility and speed that lets you share your resources and maximize your investments.

From simply sharing one or more printers between computers, to creating a complete network for printer sharing and computer-to-computer communication, BayTech has a device designed to meet your specifications.

Call toll free today to learn more about maximizing your resources.

Circle 36 on Reader Service Card

BayTech



*Bay Technical Associates, Inc.,
Data Communications Products Division
200 North Second St., P.O. Box 387,
Bay Saint Louis, MS 39520 USA
Telex: 910-333-1618 BAYTECH.
Telephone: 601-467-8231 or toll-free
800-523-2702, EXT 981*



1988 IN REVIEW: OS/2'S FIRST YEAR

For an operating system less than a year old, OS/2 is doing well

It will be late December by the time you read this, so Merry Christmas to all. For IBM PC programmers, Christmas came early this year. OS/2 is chock full of nifty toys—things like dynlink libraries, threaded multi-tasking, virtual memory, and, yes, even the flawed first cut at the Presentation Manager. It all adds up to a much more ambitious operating system than we expected DOS 5.0 to be.

For PC users, though, OS/2's arrival sometimes seems more like Halloween: Version 1.0 is big, scary, and crawling with bugs. But rest assured that programmers are busily unpacking their new toys and learning how to use them.

For an application platform in its first year, OS/2 is doing very well. Virtually all major PC software vendors have released (or, more likely, have pledged to release soon) OS/2 versions of their current DOS programs. Given the marketing power behind OS/2—IBM—it will almost certainly be a major operating system, and more likely *the* operating system of choice on PC compatibles of the mid to late 1990s.

However, OS/2 will also succeed on its technical merits. It does what an operating system must do: manage raw machine resources in a secure and fundamentally consistent manner. Application programmers who have until now struggled to overcome the limitations of DOS can get out of the operating-system business and concentrate on the business of writing applications.

Background Telecommunications

We don't have to wait for everything. An asynchronous communications program

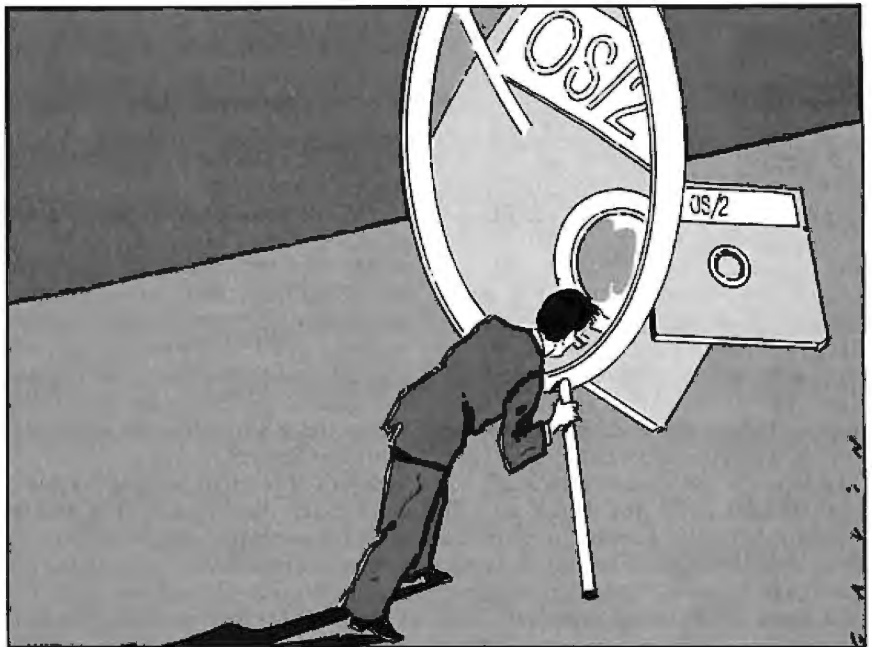

is one of the mainstays of every PC user's arsenal, and two Canadian programmers—T. Blahovici and E. Zuck—are first out of the gate with one that runs under OS/2. It's a shareware program called Logicom, and it closely resembles the popular DOS shareware program Procomm. There's one crucial difference: Logicom, being an OS/2 program, can run in the background.

I can start a BIX session, use Logicom to initiate a lengthy download, then just flip it into the background and continue working on some other task in the foreground—like writing this column. Logicom works well. It doesn't drop so much as a bit while in the background, even when set to regular priority. (There are regular and high priorities; when you turn high priority on, Logicom gets more cycles when it runs as a background task.)

Its major downside is that there is, currently, no scripting feature. You can get Logicom from Logistique LMM (1550

Barre St., Montreal, Quebec, Canada H4L 4M6, (514) 748-9192). The authors ask \$30 for it.

Software Development, OS/2 Style

People often ask me what they'll need to start doing development in OS/2. I tell them to learn C, if they haven't already done so. Whether you love it or hate it, C is to OS/2 what it is to Unix—the language the system was written in, and therefore the one for which tools exist.

Microsoft's C Compiler is an industry standard: It's fast enough, it's comprehensive, and it generates excellent code. A companion debugger, CodeView, represents another industry standard. It supports source code-level debugging, interactive evaluation of C (or FORTRAN or BASIC) expressions, and watchpoints that let you view the contents of changing variables.

OK, so you've got the dynamic duo, Microsoft C and CodeView. How do you

continued

go about writing an OS/2 application? Applications use the services that OS/2 provides by calling points of entry called APIs: Application Program Interfaces. There are hundreds of APIs, organized into groups according to the kind of machine resource they control: processes, memory, disk files, the mouse, or the screen.

Using an API is just like calling a function; you write its name and follow that with a list of arguments. For instance, to find out what my program's process ID is, I would use the API called `DosGetPid`. The following fragment shows how:

```
ret_code = DosGetPid(&MyPID);
if ret_code
    printf("Process ID=%d\n",
        MyPID);
else
    printf("DosGetPid failed: %d\n",
        ret_code);
```

If you don't speak C, here's a paraphrase: "First, call the get-the-process-ID API. Check its return code. If the return code is zero, the call worked out fine. The process ID is in `MyPID`, so print it. If the return code is *not* zero, the call failed; print the return code so I can look it up and see what went wrong."

How did I know that there's an API called `DosGetPid`? I looked it up in the *OS/2 Programmer's Reference*. It names each API function, details the number and types of arguments required, and says something about when and how to deploy each function. You'd be completely lost without that kind of information. The only fly in the ointment is that you can't buy just the *Reference*. Until recently, it came only with the \$3000 Software Development Kit (SDK). But the situation is improving.

Microsoft now offers a Programmer's Toolkit that is available for about \$350. For a while, the Toolkit even came with Norton Computing's *On-Line OS/2 API Guide*. Norton offers guides for a number of languages, and the *OS/2 API Guide* is priced at \$150 separately. (Those of us who shelled out \$3000 for the SDK don't get the Norton guides.) And several substitutes for the *OS/2 Programmer's Reference* are also available, notably Ed Iacobucci's *OS/2 Programmer's Guide*.

So to start out in OS/2 programming today, you'll need to spend the better part of a thousand bucks for OS/2 itself, the necessary tools, and the necessary documentation. Will it get cheaper? Certainly, in time. When an inexpensive

language product such as Microsoft's QuickC or Borland's Turbo C becomes available for OS/2, protected-mode programs will litter the landscape.

While You Wait

Until OS/2 applications do start to litter the landscape, we've got lots of things that run best under DOS. Unfortunately, DOS is a single-user, single-tasking system. The 80386 chip can do better than that with its built-in virtual 8086 (V86) capability, which permits multiple DOS programs to run concurrently on an 80386 machine.

There are several V86 manipulators, and I'll discuss them in a future column. But I find myself using IGC's VM/386 more than the others (believe me, I've got them all) for several reasons: It's bulletproof, it's flexible, and the technical support is top-notch.

VM/386 actually *boots* separate sessions. It creates separate virtual machines, each with its own `CONFIG.SYS` and `AUTOEXEC.BAT`. As the burden of the multitasking rests on the V86 hardware support, VM/386 can be fairly bulletproof. One (unfair) test of multitaskers is a game from Electronic Arts called *Skyfox II*, a game like the circa-1978 Atari *Star Raiders*.

Skyfox II is unfair because it's one of those games that bypasses DOS and the BIOS for *everything*. It kills most multitaskers, makes OS/2's compatibility box die, and gives `DESQview` fits. But VM/386 just takes it in stride. Just don't forget to leave the game in pause mode while it's in the background, or the Xenos will merrily destroy all your starbases while you Excel in the foreground. And when you are completely stuck (with VM/386, not *Skyfox II*), IGC employs friendly, helpful support people.

No, it's not OS/2, but it will do, at least until OS/2 is OS/2.

OS/2 Tip of the Month: Neat Features and Subtle Changes

It's nice that OS/2 does have commands like the familiar DOS commands `COPY`, `DIR`, and `DISKCOPY`—the vast majority of OS/2 commands act just like their DOS counterparts. Thus, I tend to avoid the manual and use them just as I did under DOS.

Big mistake, for some commands. For example, if you're using `MODE` to control your screen, `MODE BW80`, `MODE MONO`, and `MODE CO80` behave as before, but they also can optionally be invoked with a second parameter, the number of lines on the screen. You can tell your EGA monitor to show 43 lines with

`MODE CO80,43` or tell your VGA monitor to show 50 lines (in glorious Squint-O-Vision, as my father—who is a recent convert to PCs—would say) with `MODE CO80,50`.

`MODE` also now enables an option to verify any writes to a floppy disk. The command is `MODE DSKT VER=ON`, and it's more powerful than the `VERIFY ON` command. It actually reads back data written to a floppy disk and compares it to what it is supposed to be. Very thorough, but obviously slower: A series of floppy disk writes that normally took 24 seconds went to 37 seconds when `MODE DSKT VER=ON` was invoked.

You may be accustomed to using the DOS 3.3 `APPEND` command. More likely, you're not—it's an obscure way to create a search path for data files. And that's just as well, because it's available under OS/2 only in the compatibility box, and—as of version 1.0 of OS/2—it doesn't even work there.

Happily, OS/2 provides a superior alternative, a near-identical command for use in protected mode called `DPATH`. Put simply, `DPATH` tells D system where to find D data. If an application can't find a requested file in the current subdirectory, it looks in other subdirectories named in the `DPATH` command. Why the new name? `DPATH` is a different approach. It is, for one thing, an internal command, unlike `APPEND`, which is external. And unlike `APPEND`, `DPATH` records the data path in an environment string. You can see environment strings under DOS or OS/2 by typing the command `SET`. You'll see a result like

```
COMSPEC=C:\COMMAND.COM
PATH=D:\DOS;D:\XDOS;D:\WP
DPATH=D:\WP\MEMOS
```

In this example, the environment string `COMSPEC` contains the value `C:\COMMAND.COM`. As you would imagine, `COMSPEC` tells the system where to find `COMMAND.COM`. The `PATH` string is connected to the `PATH` command, and likewise for the `DPATH` command. Environment strings are a sane way to simplify the task of modifying system parameters on the fly. ■

Mark Minasi is a managing partner at Moulton, Minasi & Company, a Columbia, Maryland, firm specializing in technical seminars. He can be reached on BIX as "mjminasi."

Your questions and comments are welcome. Write to: Editor, BYTE, One Phoenix Mill Lane, Peterborough, NH 03458.

Discover Parallel Processing!



Monoputer/2™

*The World's Most Popular
Transputer Development System*

Since 1986, the MicroWay **Monoputer** has become the favorite transputer development system, with thousands in use worldwide. Monoputer/2 extends the original design from 2 to 16 megabytes and adds an enhanced DMA powered interface. The board can be used to develop code for transputer networks or can be linked with other Monoputers or Quadputers to build a transputer network. It can be powered by the 20 MHz T414 or T800 or the new 25 MHz T425 or T800.

Parallel Languages

Fortran and C Make Porting a Snap!

MicroWay stocks parallel languages from 3L, Logical Systems and Inmos. These include one Fortran, two Cs, Occam, Pascal, and our own Prolog. We also stock the NAG libraries for the T800 and Rockfield's structural and thermal finite element package. A single T800 node costs \$2,000, yet has the power of a \$10,000 386/1167 system. Isn't it time you considered porting your Fortran or C application to the transputer?

For further information, please call MicroWay's Technical Support staff at (508) 746-7341.

Quadputer™



*Mainframe Power
For Your PC!*

MicroWay's **Quadputer** is the most versatile multiple transputer board on the market today. Each processor can have 1, 4 or 8 megabytes of local memory. In addition, two or more Quadputers can be linked together with ribbon cables to build large systems. One MicroWay customer reduced an 8 hour mainframe analysis to 15 minutes with five Quadputers, giving him realtime control of his business.

Micro Way

World Leader in PC Numerics

P.O. Box 79, Kingston, MA 02364 USA (508) 746-7341
32 High St., Kingston-Upon-Thames, U.K., 01-541-5466
USA FAX 617-934-2414 Australia 02-439-8400 Germany 069-75-1428

In 1988, \$3.5 billion in micro-computer software will be sold worldwide. During that same time, another \$3.0 billion in sales will be lost to free distribution — better known as software piracy. And right now, Rainbow Technologies' Software Sentinel™ is protecting close to \$1.0 billion in software for developers who never wanted to be part of the free software distribution network in the first place.  The Software Sentinel hardware key is “execution control” software protection. It ships with the software and simply plugs into the PC's parallel port hundred percent invisible to both user and software. Users can make as many copies as they want. Make working submasters. Use a hard disk. Virtually anything that can be done with unprotected software. Except start freely distributing that software to other users.  The family of Software Sentinel products. Selected by the very big to the not-so-big developers of DOS, OS/2 and Xenix software in worldwide markets. To the tune of close to a billion dollars. So far.

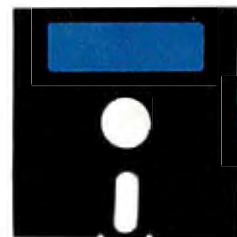

Come see us at COMDEX, Booth W747.



RAINBOW TECHNOLOGIES

18011-A Mitchell South, Irvine, CA 92714 • (714) 261-0228 • TELEX: 386078 • FAX: (714) 261-0260

Rainbow Technologies, Ltd., Shirley Lodge, 470 London Rd., Slough, Berkshire, SL3 8QY, U.K., Tel: 0753-41512, Fax: 0753-43610

Copyright ©1988 Rainbow Technologies, Inc. Software Sentinel and SentinelPro are trademarks of Rainbow Technologies, Inc.

Xenix is a trademark of Microsoft Corporation. OS/2 is a trademark of International Business Machines Corporation.



MAKING APPLICATIONS TALK

With a few enhancements, the Communicating Applications Specification could take the pain out of file transfers

If you've ever exchanged computer files by modem with a friend or co-worker, you know firsthand what a trying and time-consuming process it can be. In most cases, you both stop what you're doing at the moment, run modem programs, configure your systems, make a connection, and manually start a file transfer between the two machines. Alternatively, you can use a bulletin board or electronic-mail service as an intermediary, incurring both costs and delays.

Last September, Intel and Digital Communications Associates, Inc. (DCA), jointly announced a potential solution to this problem: the Communicating Applications Specification (CAS). The goal of CAS, according to the specification, is to "allow software developers to easily integrate communications into their applications."

In theory, CAS will let you send or receive information from *within* an application just as if you were accessing, say, a printer—and it can deliver the data either in ASCII form or as a facsimile that any CCITT Group III fax machine can receive.

Intel and DCA are promoting CAS as a universal standard, although it is currently implemented only for Intel's Connection CoProcessor board (an intelligent fax modem card). Let's take a look at CAS version 1.00A, both as an interface to this specific board and as a stan-

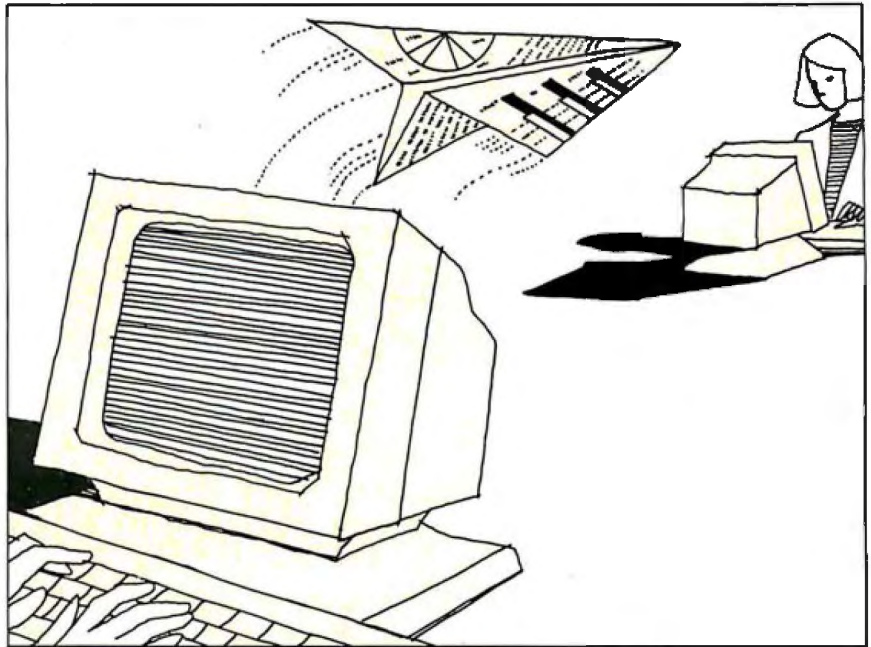

dard for microcomputer communications in general.

What Is CAS?

CAS is an application program interface (API) that lets a program send and receive files without "knowing" the characteristics of the underlying hardware. Using CAS function calls, a program can start a file transfer (or schedule it to occur later) by issuing a single command. The transfer takes place in the background while other work continues.

Using CAS, an application could let you send documents as ASCII text files (using a special transfer protocol designed by Intel for fax modems) or as faxes with 80 by 66 or 132 by 88 characters per page. You could also send and receive files in the PCX or DCX graphics format (generated by programs such as Z-Soft's PC Paintbrush) or exchange those files with fax machines.

It's important to understand at the outset that CAS is not designed to handle

every computer communications need. It's not suitable, for instance, for use as part of a "live" terminal emulation program, so it does not address the long-standing problem of having to access the hardware directly to do interactive serial communications on IBM PC-compatible computers. Instead, it focuses on doing one thing well: providing hassle-free background file and image transfers.

Inside CAS

The basic architecture of CAS is shown in figure 1. One or more applications make requests of a terminate-and-stay-resident (TSR) program called the Resident Manager, which in turn uses a Transfer Agent to send or receive the file. Each type of communication hardware (e.g., fax and mainframe link) has its own hardware-dependent Transfer Agent to deal with transmission of data over the associated medium.

For example, the Intel board comes

continued

with a Connection CoProcessor Application Manager (CCAM) that contains both the Resident Manager and the Transfer Agent. Processing is distributed between

the host CPU and a dedicated 80186 CPU on the board. In theory, you don't have to have an intelligent peripheral board to run CAS. The coprocessor on

the Intel board helps with high-speed fax operations, but other kinds of transfers (e.g., exchanging files via conventional modems) might be handled entirely as "background" tasks on the host CPU.

The Resident Manager handles five categories of CAS events:

- **Send:** The local computer sends data to a remote machine (e.g., a computer or fax machine).
- **Receive:** The local computer receives data from a remote machine (transfer initiated by the remote agent).
- **Polled send:** The local computer prepares for a remote machine to call and sends data when the call comes in.
- **Polled receive:** The local computer calls a remote machine and retrieves data from it.
- **Log:** The local computer makes a record of a communication attempt.

An application program can initiate three of these events: a polled send, a polled receive, or a send. These events are called *tasks*, and you can schedule them to happen at a future date or time (so that, for example, file transfers can

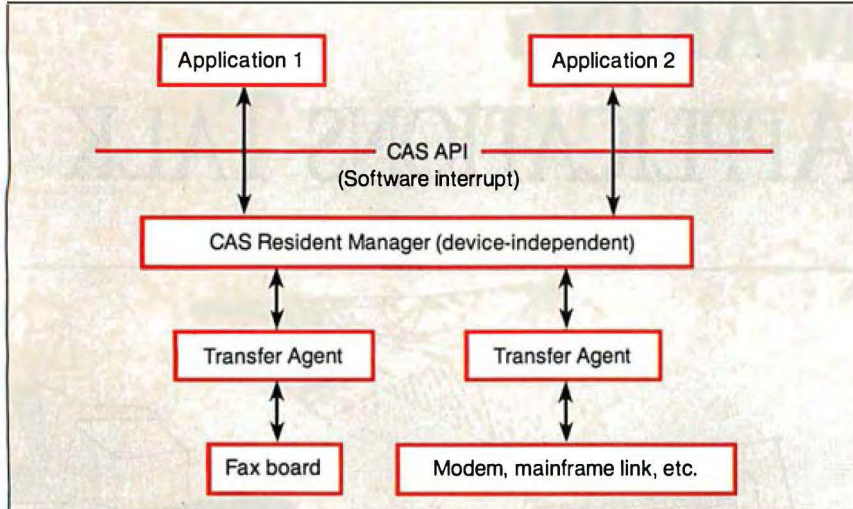

Figure 1: One or more applications make requests of the Resident Manager, which in turn uses a Transfer Agent to send or receive the file. Each type of communication hardware (e.g., fax board or mainframe link) has its own hardware-dependent Transfer Agent to deal with transmission of data over the associated medium.

How the competition stands

Introducing the modem with a sleek new stand-up* design. Telebit's new T1000 Multi-Speed modem. The modem that not only looks different, but is different. With more features. More performance. And a surprisingly low price.

More modem for less money.

What makes the T1000 so different? For one, you get a choice of more speeds. The T1000 can send and receive data at 300, 1200, 2400, or 9600 bps using ordinary dial-up phone lines.

So the T1000 can talk to your installed base of low-speed modems, plus the large installed base of Telebit® and other PEP™ high-speed modems.

But it costs about the same as a

2400 bps error-free modem.

Another difference? The T1000 runs at 9600 bps with any type of data—without compression. Error free. With MNP and PEP error detection and correction.

The T1000 fits right in.

The T1000 Multi-Speed modem even talks Hayes—right from the box. And if you're using the AT command set or even Smartcom III software, we're compatible. You won't need new software. And you won't need new commands.

The T1000 also has internal support for the most widely-used communications protocols—Kermit, Xmodem, Ymodem and UNIX's UUCP. So you can transfer files up to 3 times faster than any other modem.



occur in the middle of the night, when rates are low). The other kinds of events happen as a result of the activities of the Resident Manager and/or remote machines calling in.

The Resident Manager keeps information about events in *queues*, which consist of groups of DOS files on the local disk.

Using CAS from Within an Application

An application interacts with CAS in the same way that it interacts with MS-DOS: through a software interrupt called the *multiplex interrupt*. The application invokes CAS functions by placing values in specific CPU registers and invoking interrupt 2F hexadecimal; the results are returned either in registers or through memory. A complete description of each function is beyond the scope of this article, but table 1 gives you a general idea of the facilities available to an application in the initial version (1.00A) of CAS.

Because all CAS functions are available through the set of function calls listed in table 1, any application can provide a "front end" for CAS. Presumably,

an application will let you earmark data for transmission, pull up a phone book, select a person or persons to receive the data, and start the transfer process. This same "front end" should also be able to let you examine information that has come in from other machines and bring it into the application.

Limitations of CAS 1.00A

The current implementation of CAS appears to work well for its original application: sending and receiving faxes and files using Intel's Connection CoProcessor software and other applications designed to work with that specific board. However, the initial version of CAS has limitations of which users (and software developers) should be aware.

First, CAS offers few provisions for security. If your CAS board is configured to answer the phone, there's no way to prevent fax "junk mail" from quickly filling up your hard disk. By the same token, if your system is waiting for another system to call for a file, there's no way to make sure that only the intended recipient (rather than some other caller)

continued

Table 1: Functions available to applications in the initial version (1.00A) of the Communicating Applications Specification.

- Abort the Current Event
- Delete a File
- Delete All (Queue) Files
- Find First Entry in Queue
- Find Next Entry in Queue
- Get Event Data
- Get Event Status
- Get Event Time
- Get External Data Block
- Get Hardware Status
- Get Queue Status
- Get/Set Autoreceive State
- Move Received File
- Open a File
- Run Diagnostics
- Set Task Date
- Set Task Time
- Submit a Single File to Send
- Submit a Task

up to Telebit's newest modem.

And here's another big difference. Since the T1000 runs the most popular communications software at the highest possible speeds. You can take full advantage of packages like HyperACCESS, Crosstalk-Fast, MicroPhone II, and Acknowledge.

Just plug us in, and the T1000 will fit right in. No matter what your environment.

Remote management for ease of use.

Here's the final difference. The T1000 offers a host of remote management features. Including remote access, remote configuration and remote diagnostics.

So get the modem that's head and shoulders above the rest. In features and performance. At just the right price. Telebit's new

T1000 Multi-Speed Modem.

Call 1-800-TELEBIT or (415) 969-3800, today.

Or write Telebit at
1345 Shorebird Way, Mountain View, CA 94043-1329.

Fax: (415) 969-8888.

Because no one gets the message through like Telebit.

T1000.



© 1988 Telebit Corporation. Telebit is a registered trademark and PEP is a trademark of Telebit Corporation. Other brands or product names are trademarks of their respective holders.

*optional

Circle 266 on Reader Service Card



The \$4,500⁰⁰ Sun[™]/Apollo[™]/VAX[™]

(Only faster—and it's all yours!)

Suddenly your PC/XT/AT has the computing power of a mini or technical workstation.

Definicon's coprocessors are single-board computers that slip into one expansion slot of any IBM-compatible—and turn it into your personal, desktop, 32-bit *power* machine. You can choose clock speeds from 12.5 to 25 MHz, with 1 to 16 megabytes of RAM.

That means the exact, cost-efficient power you need—for single units or whole systems—at prices from only \$1,349 to \$15,920.

We also offer boards for parallel processing and graphics. Plus software. And all combine the user-friendly MS-DOS advantages of your PC with supercharged power that's yours alone, shared with no one.

If you, or those you manage, have a voracious need for computing power, you *must* get the whole story. Call Darby Liddin at Definicon right now.

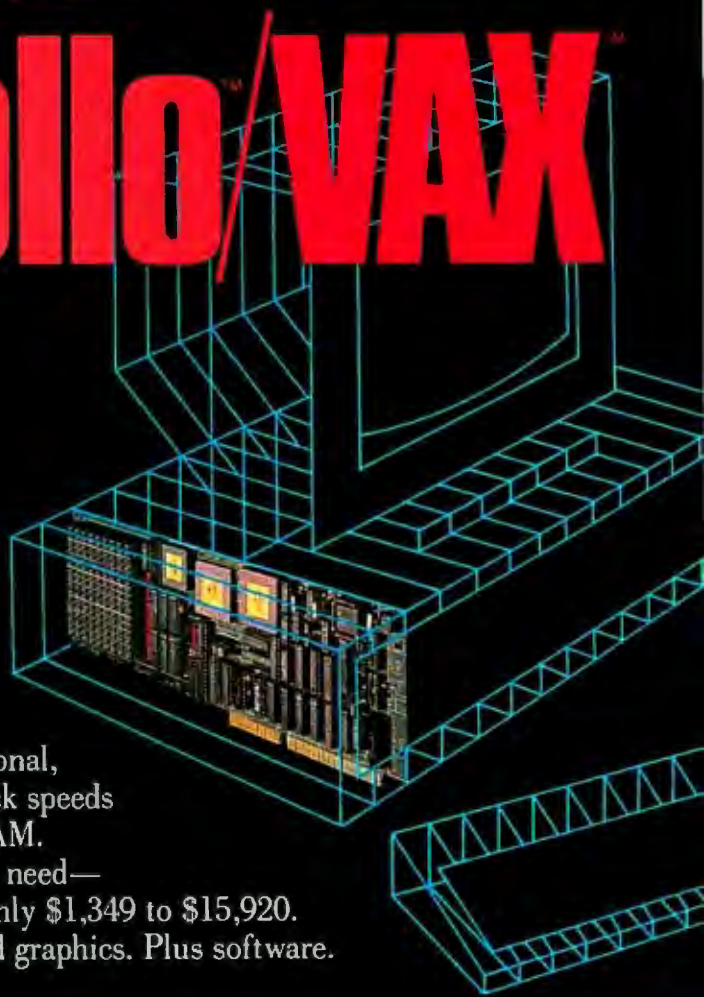

DEFINICON

Get Aboard Tomorrow

Circle 76 on Reader Service Card (DEALERS: 77)

Definicon Systems, Inc.
1100 Business Center Circle
Newbury Park, CA 91320
(805) 499-0652

UK: 1-498-0701 France: 1-69-307000 Germany: 49-89-572062

NATURAL LANGUAGE INTERFACE



THE COMPUTER CHRONICLES MAKES KEEPING UP WITH THE INFORMATION AGE EASY

Stewart Cheifet and Gary Kildall are your co-hosts for a weekly half-hour television program aimed at computer users, owners, educators and computer industry professionals. If you're looking for help in finding out what's new and what's news, tune in to **THE COMPUTER CHRONICLES** every week on your local public television station.

Regular commentators are Jan Lewis, President of Lewis Research Corporation and publisher/editor of



JAN LEWIS



GEORGE MORROW

*The Computer Chronicles is funded in part by McGraw-Hill's **BYTE** magazine. The Computer Chronicles is a co-production of WITF/Harrisburg and KCSM/San Mateo.*

HyperAge magazine, and George Morrow, founder of Morrow Designs.

Topics this season include: CDROMS — Shareware — Multitasking — Business Graphics — Investment Software — PC Imaging — PC Networks — Decision Support Software — Laser Printers — Hypercard — Input Devices — and MUCH MORE.

Each week **THE COMPUTER CHRONICLES** looks at the top stories of the week in Random Access, a news segment designed to keep you informed about the latest developments in the computer industry.

THE COMPUTER CHRONICLES, a weekly half-hour of public television that just might be the help you need.

THE COMPUTER CHRONICLES IS NOW ON BIX

Bix, the Byte Information Exchange, now has a conference for the Computer Chronicles.

Now you can communicate directly with the staff of the Computer Chronicles to suggest topics for future shows or to request information or details on past shows.

Once on Bix, just type "join comp.chron" at the colon (:) prompt.

**\$17
OFF**

INTRODUCTORY OFFER

**\$17
OFF**

Enjoy BYTE magazine's in-depth information on all the latest in personal computing each month at our special introductory rate!

Subscribe now and save \$17 off the newsstand price—12 issues for \$24.95 instead of \$42.00... and \$5.00 off the regular subscription rate of \$29.95. You'll also receive our special IBM PC issue as part of your subscription.

U.S.A. \$24.95 for 1 year Canada/Mexico \$26.95 U.S. for 1 year

Bill me

This is a renewal order.

Payment enclosed

Name _____

Charge to my

(Please Print)

MasterCard

VISA

Company _____

Account # _____

Address _____

Expires _____

City/State _____

Signature _____

Country _____ Code _____

For direct ordering, call toll free 1 800 257-9402 weekdays
9:00 AM-5:00 PM EST. In New Jersey, call 1 609 426-5535.

BYTE

Please allow 6-8 weeks for processing your subscription.

IBJ0345

**\$17
OFF**

LOWEST RATES

**\$17
OFF**

SPECIAL SAVINGS

SPECIAL SAVINGS



NO POSTAGE
NECESSARY
IF MAILED
IN THE
UNITED STATES

BUSINESS REPLY MAIL

FIRST CLASS MAIL PERMIT NO. 42 HIGHTSTOWN, NJ

POSTAGE WILL BE PAID BY ADDRESSEE

BYTE

Subscription Department
P.O. Box 558
Hightstown, N.J. 08520-9409

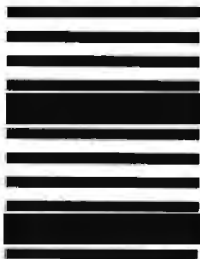

THERE ARE FOUR WAYS TO MEASURE THE SPEED OF A LAN.



Ours only wins in three of them.

1. How fast does it install.

We have no competition in this category. LANLink 5X installs in about fifteen minutes, and it doesn't take a technician to do it. Since LANLink 5X uses standard parallel or RS-232 serial ports, installing a network means little more than connecting the cable and loading the software.

With hardware LANs, installation can easily take two days—one to set it up and one to tweak it. And it also takes someone who really knows what he's doing. That is, someone expensive.

2. How fast does it transmit.

Okay, this is the category we don't win; the hardware LANs are generally a little quicker. At least, they are under optimal conditions, which is how they rate themselves.

But LANLink 5X is pretty quick, too. At half a megabit per second, it's way out ahead of any other software LAN, and right at the heels of the hardware types. Which, of course, are far more expensive.

3. How fast does it maintain.

The real cost of a network is not so much the initial price as it is the continuing outlay for maintenance—adapting it to changing needs. That's something LANLink 5X does practically on its own.

Running under PC-MOS/386[™] or PC-DOS, it turns your server PC into a multi-tasking controller, driving a truly expandable LAN that is easily and quickly upgradable.

A hardware LAN, on the other hand, becomes obsolete as new technology is introduced. And, to keep the network up and running as applications change, you need the attentions of a technician, on a continuing basis. A very well-paid technician.

4. How fast can you pay for it.

Now we've arrived at the bottom line, where LANLink 5X is toughest to beat. You can install a five-user LANLink network for about the same cost as the LAN board in a board-driven network. On top of that, factor in what you save on installation and maintenance time, and the difference is pretty dramatic.

LANLink 5X is available immediately, and it comes with a money-back guarantee. Its price of \$595 includes a server and a satellite module plus the network operating system. Additional satellites are available for \$125.

For complete details on the fastest software-driven network available, call 800-4 1-LINK.

LANLink 5X. Because three out of four ain't bad.

3577 Parkway Lane, Norcross, GA 30092 (404) 448-5465 FAX (404) 263-0474

LANLINK 5X

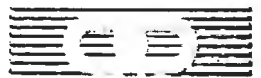



Graphic Details

BYTE's testing editors compare 21 high-end, IBM PC-compatible digitizing tablets

Stanford Diehl
and Steve Apiki

For obtaining accurate graphics input, the digitizing tablet is more powerful than the mouse. Digitizing tablets are more precise and sample faster. Also, the stylus and fixed surface provide for a more natural drawing motion.

You pay a price for increased performance: The average cost of a digitizing tablet is about \$800, versus only \$150 for a mouse. But with system performance spiraling upward—and CAD, desktop publishing, and graphic design now everyday applications in the DOS world—more users are finding these devices a worthwhile investment.

Digitizing tablets provide a range of features that make them attractive to artists and designers. Most tablets offer a choice of pointing devices. These include a pen or stylus, which are both easy to handle, and a cursor (also called a puck), which provides pinpoint accuracy. The tablet's fixed drawing reference makes it possible to digitize older, paper-based designs and bring them up to date. Many manufacturers have added versatility with multibutton cursors and menu templates that offer realistic alternatives to keyboard command entry.

Making a Point

Like a mouse, a digitizing tablet acts as an input device for your microcomputer.

It usually includes a tablet and some type of pointing device, called a transducer. The tablet has a flat surface with a defined space, or active drawing area, where you can place a map, a drawing, or a menu overlay. You then point to areas within the work space, and the tablet sends coordinate data to the application you're running (like AutoCAD) that corresponds to the location of the transducer. While a mouse reports a relative position based on the last known position of the mouse, a digitizer returns an absolute location regardless of the last known position of the transducer.

The cursor is a flat rectangular device with a cross-hair sight for pinpointing a location. Most cursors have four buttons. Though the cursor is a more accurate pointing device, the pen or stylus lets you input data more naturally. The only difference between the pen and stylus is that the former contains an ink cartridge, while the latter does not.

To activate the pen or stylus, you press down on the tip. The tip button on the stylus and the puck's pick button act much like the left button on a mouse. For instance, in AutoCAD's sketch mode, you press the stylus's tip button to begin drawing. The AutoCAD screen then displays a line as you trace it across the pad. Pressing the tip button again deactivates the transducer. For additional functionality, some styli and pens include a button on top of the barrel.

Many applications, especially CAD and drawing software, include driver software for a variety of digitizing tablets. Vendors provide additional compatibility by emulating other popular tablets, like the Summagraphics Bit Pad and MM Digitizer Series, which has become the industry standard.

Tablet Technologies

Digitizers employ a variety of technologies. Most common is the antenna-transmitter technique, in which evenly spaced horizontal and vertical wires

within the tablet represent an x, y coordinate grid. The internal wires sense the magnetic (or electric) field emitted by the transducer. The horizontal wire closest to the transducer coil, registering the strongest signal, reports the x -axis data, while the closest vertical wire returns the y -axis data. Together, they represent the coordinate location of the cursor or stylus coil. The more closely spaced the wires, the higher the resolution.

Some systems energize the grid instead of the cursor or the stylus. Each internal wire holds a known signal. The pointing device picks up the signal of the closest horizontal and vertical wire, returning the resultant coordinate pair.

All the digitizers we tested used one of these techniques. However, some non-standard technologies also digitize and input information (see the text box "Digitizers with a Twist" on page 169).

Performing Arts

The specifications commonly used to define a digitizing tablet's precision are found in table 1. Resolution tells you how many distinct points a digitizer can distinguish within the drawing area. If the vendor claims resolution of 200 lines per inch (lpi), a tablet with a 12-inch by 12-inch work space will recognize ordinate points from 0 to 2400 along both axes. The cursor must then move at least $\frac{1}{200}$ inch before it can report a new position.

Accuracy measurements tell you how closely the digitizing tablet can approximate a known standard. Theoretically, a digitized line will deviate from its actual length by only as much as the accuracy figure. Accuracy measurements provided by the vendors range from 0.001 to 0.035 inch, with 0.01 being the norm.

Stylus proximity defines how far the transducer can move from the tablet before it stops transferring coordinate data. Some tablets require the cursor to contact the pad, while others continue to report cursor position even with the transducer an inch or more away from the drawing

surface. The larger the distance between cursor and pad, however, the more accuracy suffers.

Accuracy figures usually refer to operation with a cursor. A stylus can't maintain the same level of precision because the cursor provides a more stable pointer at a uniform height above the pad. Furthermore, the stylus coil, housed in the body of the device, may not report the true position of the tip. This is because orienting the pen at a comfortable angle for drawing introduces a tilt error. We tested for both stylus proximity and stylus error as part of our benchmark tests (see the text box "Digitizing by Numbers" on page 170).

The 21 digitizing tablets selected for this Product Focus represent a variety of devices available for the IBM PC and compatibles. All tablets have either a 12-inch by 12-inch or a 12-inch by 18-inch active drawing area, and they use standard antenna-transmitter or energized-grid technology. Individual descriptions

continued



Table 1: Features and testing information for the 21 digitizing tablets reviewed.

Digitizing tablet	Price ¹	Active area (Inches)	Resolution (lpi)	Accuracy (Inches)	Max. output rate (points/second)	Emulations	Pointing devices available
CalComp 23120 (Drawing Board)	\$625 ²	12 x 12	1016	0.025	144	CalComp 2000, HI ³ , Hitachi ³ , GTCO ³ , Summagraphics, Mouse Systems Mouse	Stylus, 4-button and 16-button cursors
CalComp 23180 (Drawing Board)	\$1125 ²	12 x 18	1016	0.025	144	Same as 23120	Same as 23120
CalComp 25120	\$915 ⁴	12 x 12	1280	0.025	125	CalComp 2000, 2200 ³ , 3000 ³ , and 9100; GTCO ³ , Hitachi ³ , HI ³ , Kurta ³ , Numonics ³ , Summagraphics ³	Stylus, pen, 4-button cursor
Hitachi HDG-1111C (Tiger Tablet II)	\$998	11 x 11	1000	0.02	150		1- or 3-key stylus, 4- and 12-button cursor
Hitachi HDG-1212D	\$599	11.7 x 11.7	1000	0.02	150		1- or 2-key stylus; 1,3,4,
			1016			Kurta Series One, Series Two; Microsoft Mouse, Summagraphics, GTCO	1- or 2-switch stylus, 4- or 12-button cursor, cordless stylus and cursor
			1016				
Penpad 300	\$695	11 x 11	1000	0.001	150	Summagraphics ³ , Hitachi ³ , GTCO ³ , CalComp 2000 ³ , Numonics, Microsoft Mouse, Mouse Systems Mouse	Stylus, 4- or 16-button cursor
Penpad 320	\$1095	11 x 11	1000	0.001	150	Same as 300	Same as 300
SummaSketch Plus			1016				
Summagraphics SummaSketch Pro	\$999 ⁵	12 x 18	1016	0.025	121	Same as Plus	Same as Plus

¹ Except where noted, price includes tablet, power supply, interface, and 4-button cursor.
² Choice of 16-button cursor or stylus and 4-button cursor.
³ Output format only; input commands not supported.
⁴ Cursor and stylus are optional.

⁵ Also includes stylus.
⁶ Includes corded 4-button cursor.
⁷ Tests run with corded stylus.
⁸ Optional emulation; requires firmware replacement.

of the tablets follow. Because of similarities between products distributed by each company, we grouped the tablets by company name.

CalComp

The CalComp 23000 Series combines ease of use with diverse emulations and

an ergonomic design. Most applications support the CalComp format. But for those that don't, Summagraphics emulation ensures a wide range of software compatibility. The 23120 (\$625) provides a 12-inch by 12-inch drawing surface, while the 23180, at \$1125, has a 12-inch by 18-inch work area. Both

models offer 1016-lpi selectable resolution and a mediocre accuracy of 0.025 inch.

A proximity light reports when the cursor is within the active area. Our tests revealed an impressive proximity range of 0.875 inch for all the CalComp models (see the BYTE test results in table

Interface	Software	Documentation (pages)	Dimensions (Inches)	BYTE tests (all values in inches)			
				Horizontal error	Vertical error	Stylus proximity	Stylus error at 45 degrees
RS-232C	None	41	2.5 x 15.9 x 14.9	0.0208	0.0062	0.875	0.0207
RS-232C	None	41	2.5 x 16.4 x 20.5	0.0124	0.0034	0.875	0.0205
RS-232C	None	106	2.5 x 16 x 21	0.0179	0.0237	0.875	0.0116
PC card	Windows, ADI driver	56	2.1 x 15.6 x 15.6	0.0037	0.0064	0.75	0.0033
PC card	Windows, ADI driver	56	2.1 x 15.6 x 21.6	0.0059	0.0088	0.75	0.0079
RS-232C	Windows, ADI driver	44	0.8 x 17.9 x 15.6	0.0278	0.0005	0.692	0.2631
RS-232C	Hitachi mouse driver	10	2 x 16 x 17	0.0030	0.0040	0.192	0.0512
RS-232C	Hitachi mouse driver	14	1.1 x 15.7 x 16	0.0153	0.0050	0.25	0.0457
RS-232C	None	49	1.2 x 16.9 x 15.2	0.0185	0.0082	0.5	0.0041
RS-232C	None	42	1.3 x 16.8 x 21.3	0.0039	0.0011	0.5	0.0028
RS-232C	ADI, mouse drivers, setup utilities	118	2.8 x 16 x 15	0.0265	0.0478	0.25	0.0797 ⁷
RS-232C	Same as 12 x 12 model	118	2.8 x 16 x 20	0.0530	0.0274	0.375	0.0716 ⁷
RS-232C or IEEE-488	None	35	0.8 x 16.1 x 16.1	0.0080	0.0090	0.875	0.1320
RS-232C or IEEE-488	None	35	0.8 x 16.1 x 20.8	0.0052	0.0022	0.875	0.1019
RS-232C	Mouse drivers; setup and diagnostics	12	0.5 x 15.8 x 16.8	0.0098	0.0044	1	0.0858
RS-232C	Mouse driver, setup utilities	34	0.5 x 16 x 17	0.0018	0.0016	1	0.0025
PC card	Driver, test, and setup utilities	176	0.5 x 16 x 17	0.0076	0.0024	1	0.0065
RS-232C	Mouse, ADI driver; setup and diagnostics	37	0.9 x 16 x 16	0.0043	0.0012	0.5	0.0348
RS-232C	Same as DT-3503	37	0.9 x .23 x 19.1	0.0094	0.0027	0.5	0.0144
RS-232C	Mouse, Windows, ADI driver; self-test and reset program	45		0.0166	0.0035	0.5	0.0292
RS-232C	Mouse, Windows, ADI driver; self-test and reset program	50	1.3 x 17 x 22.5	0.0086	0.0074	0.5	0.0102

1). Horizontal and vertical error were better than expected, given average resolution specifications.

The tablets smoothly stepped through our compatibility tests. PC Paintbrush defaulted to a Summagraphics driver even when we chose the CalComp configuration option, but the program

booted without a hitch. The tablets displayed reliable, efficient operation.

The CalComp cursor slides cleanly across the pad, and the fine cross hairs allow pinpoint cursor positioning. Unlike most stylus models, the CalComp offering does not include a push button on its barrel. If you need a button on the

barrel, CalComp sells a 2-button stylus alternative for \$115. The company also offers a 16-button cursor. You can substitute the 16-button model for the standard stylus and 4-button cursor.

The CalComp 25120 (\$915) uses the same cursor and stylus on a molded

continued

frame and a darkened 12-inch by 12-inch work space. The design results in a small footprint and a clearly defined drawing area. You configure the 25120 by setting a series of software switches for each emulation and application. A row of LEDs above the active boundary tracks the status of your parameter selections. The menu strip replaces cumbersome DIP switches, letting you step through the configuration by touching selected blocks with the stylus. You can also select eight modes of operation, data output rates, and bit rates via menu soft keys.

The 25120 offers better resolution (1280 lpi) than the 23000 series, while posting identical 0.025-inch accuracy. The \$915 price is steep, though, especially since it doesn't include a cursor or stylus.

GTCO

GTCO's digitizers fall into two product groups: the Digi-Pad PC, which features excellent accuracy at a good price, and the less expensive and less powerful Micro Digi-Pad 1212. The 11-inch by 11-inch Digi-Pad PC (the 1111A) is priced at \$599, and the 11-inch by 17-inch version (the 1117) is \$839.

The Digi-Pad PC's most unusual feature is its reliance on a dedicated PC bus controller card rather than the RS-232C interface favored by most other models. The unit draws power from the bus, eliminating the need for an external power supply.

You can set communications parameters, output mode, and format via three banks of DIP switches at the top of the controller. It's also possible to set the port address with a few jumper selections. Output format is limited to GTCO; no emulations are supported. In addition to the switch settings, you can set options by remote commands sent to the card's port address.

GTCO drivers come with almost every major application package, so the lack of emulations isn't a serious concern. The Digi-Pad PC comes bundled with Windows and an ADI driver. While AutoCAD includes a GTCO driver, GTCO's ADI driver supports a four-button cursor and in general seems to perform better and with fewer hitches than the AutoCAD 2.52 driver.

While both versions of the Digi-Pad PC were able to run through our compatibility tests, we did have some trouble coming up with the correct parameter settings; the documentation includes switch settings for AutoCAD only.

The tablet's average resolution and

good accuracy specifications were borne out in our horizontal and vertical error tests. Our only serious problem in using the Digi-Pad PCs was with the rough cloth bottom on the cursor. While the cursor was fine on the hard, smooth surface of the tablet, it tended to grab paper we taped to the pad, resulting in a jerky, inaccurate movement. Nevertheless, the errors were small (less than 0.01 inch), putting the device in a league with digitizers costing far more. Perhaps most impressive, the stylus angle error approached zero.

The HiPad Plus tablets set the standard for resolution at 2000 lpi.

GTCO's low-end model, the 12-inch by 12-inch Micro Digi-Pad 1212 (\$540) was far less powerful than the Digi-Pad PC, but it offers simplicity and good performance for its price range.

The unit has no switches; to get up and running, you simply hook up the external power supply and plug the interface cable into a serial port. The power and cursor sockets are even interchangeable, making the configuration completely idiotproof. If you need to change parameters, you can set jumpers located inside the tablet.

The tablet worked flawlessly with all the applications we used for compatibility tests. ADI and Windows drivers are provided with the hardware.

Though the Micro Digi-Pad's simplicity is appealing, it lacks some basic features. The tablet has no markings to indicate where on the 17.9-inch by 15.6-inch surface the 12-inch by 12-inch active area lies. There's also no provision for raising one side of the tablet for a better working angle, a feature found on most other tablets.

Not surprisingly, this low-cost product also has the worst resolution specification at 200 lpi, and its 0.025-inch accuracy is average. Our digitizing accuracy tests showed mixed results, with the horizontal error near what the vendor's accuracy specifications would indicate (0.0278 inch), but the vertical error was virtually zero (0.0005 inch). The verti-

cal error was less than the resolution of the tablet, and we attributed this to a small calibration error and round-off error in the software distance calculation.

These results point out that it's possible to get excellent results even with poor specifications. However, even if we hadn't been lucky enough to align the paper on a sensing point and hit the same point twice, the 0.005-inch minimum resolvable distance is close to the limits of the human ability to resolve lines, so the tablet is suited for most applications.

Hitachi

The Hitachi Tiger Tablet series has enjoyed a good reputation for nearly 5 years, an eternity in the fast-moving peripherals industry. Hitachi's newest Tiger Tablet, the HDG-1111C, adds capability to this venerable line by maintaining compatibility with older models and adding emulations.

The \$998 11-inch by 11-inch tablet has a built-in power supply and three banks of DIP switches. Although the system is versatile, you may have a tough time setting it up, because the documentation for the switch settings is very poor. Luckily, Hitachi's technical support is good.

Hitachi provides full firmware emulation for the Summagraphics MM and Bit Pad Series, in addition to the native Tiger Tablet mode. The emulations broaden software support considerably, though the Hitachi output format is compatible with AutoCAD and other major packages. We were able to run AutoCAD using the Tiger Tablet driver and PC Paintbrush with the digitizer in Summagraphics MM mode. Windows applications were not supported, but Hitachi says it will be shipping a Windows driver with the tablets by the time you read this.

Small error values on our horizontal and vertical line tests indicate the system is well suited for precise digitizing. There was a noticeable error caused by holding the pen at an angle less than vertical, but this was small enough to be attributed to pen slippage. One disturbing problem was the tendency of the stylus to send wildly offset points to AutoCAD while tracing, resulting in circles with large "horns." Hitachi assured us that the problem was atypical, and it didn't occur when we used the cursor.

The second Hitachi tablet, the HDG-1212D, supports the same Summagraphics emulations as the HDG-1111C, but it has slightly fewer features and sells for less at \$599. The HDG-1212D comes with an outstanding 10-year warranty

continued

MAXXICAD

True
3-D

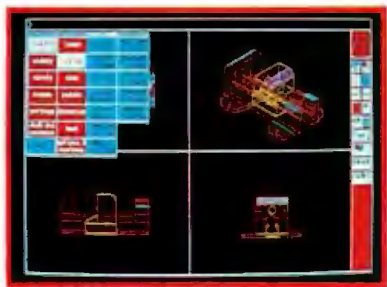
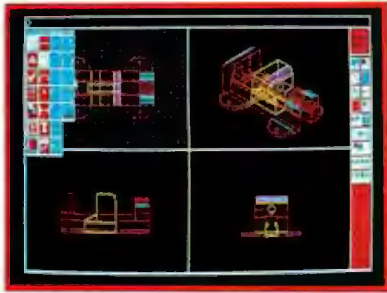

- Model mode (3D) or picture mode (2D) selectable at any time
- Optional "pop-up" icon or text command structure
- A dynamic on screen example available for each of 200+ commands
- Displays up to 14 active views simultaneously
- Dynamic rotation and translation of views
- Modification of entities
- Complex surfaces
- Dimensioning and tolerancing includes 18 options
- Multiple utility commands available during sessions
- Efficient file storage, security, back-up and recovery
- Three levels of documentation
- 24 hour telephone availability

"Maxxicadd stands as one of the most promising CAD products in today's market."

"Maxxicadd's remarkably simple user interface and on-line animated help facility is a dealer's dream come true. Within a day, any dealer (or, for that matter, user) can learn enough of the package to be giving demonstrations."

- Reprinted from Computer Graphics Today, August, 1988

"Engineering Tools For The Twenty First Century"



CRTC

COMPUTER RESOURCE TECHNOLOGY CORP.

2164 East Broadway Road, Suite 310

Tempe, Arizona 85282

(602) 921-9638

Call toll-free for more information and a demonstration disk.

1-800-628-2828, Ext. 923



Photo 1: Having the lowest price didn't stop the Houston Instrument HiPad Plus 9012 (left) from turning in an excellent performance. The configuration menu on the tablet also makes the unit easy to use.

Photo 2: A cordless cursor option and programmable function switches distinguish the Kurta IS/One (below) from the rest of the pack.



(the HDG-1111C carries a more typical 1-year warranty).

Summagraphics emulation is the default mode, and the HDG-1212D has only one switch bank for changing settings. It also has a native Hitachi mode, compatible with the HICOMSCAN digitizer series. Application support for the two tablets is similar.

PC Paintbrush ran in MM mode without difficulty. Software shipped with the tablet includes a generic mouse emulator that's compatible with most applications.

We ran the HDG-1212D with AutoCAD using AutoCAD's HICOMSCAN driver and had one problem when using the tablet for CAD. The 12-button cursor Hitachi provides has the pick button mapped to the zero key, laid out where it would be on a telephone keypad. The design means that most operations require pressing a button on the back of the cursor, away from the operator's eyes and index finger. Hitachi plans to provide an ADI driver that will correct the problem.

Error test results were only fair, and they were slightly poorer than those for the HDG-1111C. The results are relatively consistent with the two tablets' accuracy specifications.

Houston Instrument

Houston Instrument adds a new series to the field of digitizing tablets by introducing the HiPad Plus 9012 and the HiPad Plus 9018. The company, an established player in the digitizing industry, offers a pair of tablets that deliver impressive performance at a minimum price.

The HiPad Plus 9012 has a 12-inch by 12-inch drawing area, and the \$495 price includes a stylus, power supply, and interface cable (see photo 1). The HiPad Plus 9018's \$795 price tag includes a stylus and a cursor in addition to the power supply, cable, and pad, and its drawing area measures 12 inches by 18 inches.

Both tablets set the standard for resolution at 2000 lpi, and only the Pencept models surpass their 0.01-inch accuracy figure. These tablets pack tilt-correction firmware that supposedly rivals a cur-

sor's accuracy. Our test results show excellent tilt correction, but a cursor is still the more accurate pointing device. We measured a proximity range of 1/2 inch for both tablets. The horizontal and vertical errors were low, but not as good as you might expect, given the resolution specification the company provides.

You can set configuration parameters by selecting items from a menu overlay. No software is required. You simply press a button at the rear of the pad before clicking the pointer over a desired item. For quick-and-dirty configuration, you can select from a list of popular emulations at the bottom of the menu. You can also set individual parameters such as binary or ASCII formats, data transfer rate, transfer modes, resolution, and calibration points.

The tablets default to Summagraphics mode, and our compatibility tests verified the emulation. However, only partial emulation is provided for the Hitachi HDG-1111C, the Kurta Series I and IS/One, and the GTCO Digi-Pad 5. Houston Instrument plans to ship a mouse driver with the HDG-1212D.

Kurta

The Kurta IS/One stands out for ease of use and superior ergonomic features. Both the 12-inch by 12-inch (\$645) and 12-inch by 17-inch (\$995) versions offer full programmability, function pads, and well-designed cursors and styli (see photo 2).

The standard IS/One configuration includes the tablet, a four-button cursor, and IS/Pensmith driver software. A wealth of options is available, including a cordless cursor and stylus and template software for AutoCAD and Windows.

IS/Pensmith, the standard Kurta driver package, includes ADI and mouse drivers and several useful utilities. The ADI driver is programmable, so you can define tablet areas for menu templates and areas for input. Once you have these set up, you can switch from full tablet mode to menu and input area mode without leaving the application. Other utilities redefine the cursor buttons and link the tablet function keys to keyboard macros. In addition, a save utility stores macros and configuration information to disk, and a setup utility lets you modify driver settings on the fly.

The tablet has an imposing array of three DIP-switch banks, but the tablet is fully programmable, so you'll probably never need to change them. You can activate five soft switches at the top of the tablet with the stylus or the cursor. Each of these change the tablet parameters to

Digitizers with a Twist

Two new ideas are putting a spin on the traditional digitizer concept: The first involves taking the technology a step further, and the second is to find unusual applications for the current technology.

A series of sonic digitizers from Scientific Accessories is an example of the former. Because coordinate information is calculated using sound information, the stylus requires no special writing surface. The units consist of a cursor and a receiving box that you connect to your system. The cursor generates sound waves; two microphones in the receiver calculate the position of the cursor by triangulation based on the time it takes for the wave front to reach the unit. The GP-7, which has the smallest imageable area at 18 by 24 inches, sells for \$1696.

Digitizing in three dimensions is the focus of the Polhemus 3space Digitizer. Using an electromagnetic source, this high-end, \$13,900 system is able to accurately digitize solid models. Polhemus uses similar technology to create a tracker capable of analyzing motion in 6 degrees of freedom.

Other firms have opted to take current technology and widen its applications. The ScriptWriter from Data Entry Systems adds character-recognition capability to a portable digitizer tablet to create a clipboard-like data recorder. It's available directly from the company for \$1595.

The portable, 4-pound ScriptWriter operates on a 10-hour rechargeable battery. The impedance-sensitive writing surface is configured according to a number of standard forms. You write characters onto the form with a pen, and the device reads the characters into its 96K-byte memory buffer. You can also set up sections of the surface to accept graphics input, like signatures, but the 96K bytes doesn't go far when recording graphics. The RS-232C interface lets you dump data to a microcomputer for further processing.

Jandel Scientific's Sigma Scan is a system for scientific data manipulation. The package includes a digitizing tablet and sophisticated software for calculating and interpolating values based on graphics input. Prices range from \$1195 for a 12-inch by 12-inch tablet to \$4595 for a 36-inch by 48-inch version. The software is available separately for \$495.

Using a cursor, you are able to trace images from sources traditionally requiring graphical analysis, like strip-chart recordings, spectrographs, photos, or x-ray images. Once the data is recorded, it can be transformed mathematically with user-defined equations. Nonlinear interpolation allows the software to transform input points based on previously received data stored in look-up tables. The software automatically calculates statistical descriptions of the input.

activate emulations or other predefined settings. The documentation includes a full list of DIP-switch settings and soft-key settings for most of the applications that the IS/One supports.

Besides the soft keys for configuration changes, the tablet has several definable function switches that you can use to play back keyboard macros. The number of switches varies with the size of the tablet; the 12-inch by 12-inch version has 13 switches, and the 12-inch by 17-inch version has 23.

Optional cordless, battery-operated pointing devices function almost as well as their corded cousins, and they are far easier to manipulate. They cost about \$80 more than the standard version. The cordless stylus allows more natural writing and drawing than any other input device. Stylus angle tests resulted in an average error when the stylus was held at

a less than vertical position.

The Kurta's excellent features don't, however, guarantee smooth operation. One problem is the sheer volume of emulations: We were able to use the ADI driver with AutoCAD but could access only a 12-inch by 12-inch square on the 12-inch by 17-inch tablet; Kurta recommended using the AutoCAD Series One driver and Series One emulation. When we did so, the problem disappeared.

PC Paintbrush ran without a hitch using Series One emulation, but when we failed to reconfigure the tablet before using the optional Windows driver, our Windows pointer ran upside down. After a few tries, we were able to get all our compatibility test software up and running smoothly.

In the error tests, the Kurta tablets fared poorly. This points out the impor-

continued

Digitizing by Numbers

As testing editors, we're accustomed to generating benchmarks that yield hard numbers. We like to see a product's performance boiled down to a few critical values that let you make clear, across-the-board comparisons. Digitizing tablets, however, don't readily lend themselves to such tests. Furthermore, as a user interface, the wealth of features offered by most designs simply outstrips human capability, making the user the ultimate limitation in performance.

A good example is resolution. While specifications ranged from a low of 200 lines per inch to a high of 2000 lpi for the tablets we tested, we were unable to distinguish distances of less than about 0.005 inch. Your eyes may be more discerning, but our experience points up the difficulty in testing most of these devices at the limits of their capability.

In the digitizer industry itself, there are no standard tests. Short of test rigs using robotic arms to gauge precision, there's no clear-cut method for testing these devices. Our tests attempted to examine the interaction of the system as a whole: tablet, monitor, applications software, and user. As much as possible, we tried to keep the digitizer the only variable factor.

Line Error

We created four tests that measure horizontal error, vertical error, stylus error, and stylus proximity. Our test system consisted of a Compaq 386/20 with a high-resolution NEC MultiSync monitor and adapter card in a typical PC CAD configuration. Then, running AutoCAD 2.52, we digitized a standard test pattern and printed it on a 300-dot-per-inch laser printer, which gave us line resolutions of about 0.01 inch. The test pattern included two calibration points that ensured that tablet and software dimensions were equivalent.

Each pattern had two horizontal and two vertical lines. We digitized the endpoints of each line and used AutoCAD

to tell us the distance between each point. Our horizontal error measurement is the average difference between the known lengths of the two horizontal lines and their digitized images. We recorded only the distance along the x axis. Similarly, our vertical error measurement characterizes the differences we found in digitizing vertical lines of known length. These accuracy tests include errors generated in every part of the digitizing subsystem; cursor cross-hair thickness and surface friction contributed inaccuracies not accounted for in rated resolution specifications.

Stylus Error

The stylus, though a natural interface, is often less accurate than the flat, steady cursor. We measured the offset caused by using a stylus at a 45 degree angle by tracing two lines on the test pattern, one with the stylus held vertical and one with the stylus at 45 degrees. We compared these images with lines digitized by the cursor, again using an AutoCAD function to compute the distances. Both stylus lines were slightly off the cursor lines; the difference between the vertical offset and 45 degree offset was reported as 45 degree error.

As an additional stylus test, we measured the maximum distance you could move the stylus away from the tablet and still have it function. Some vendors list this value as stylus proximity. Tablets with a high rating for stylus proximity are useful in digitizing patterns from thick media.

Our test pattern also included a circle that we traced with a template as a qualitative test for measuring overall distortion. Finally, we tested compatibility with five popular applications that rely heavily on graphics input: AutoCAD, PC Paintbrush, Microsoft Windows, PageMaker, and Microsoft Excel. Our tests confirmed the manufacturers' compatibility claims and gave us a feel for the tablets' performance outside the traditional CAD environment.

Numonics

We tested two 2200-series tablets from Numonics: the \$964 11.8-inch by 11.8-inch version (the 2200-1212) and the \$1155 11.8-inch by 17.7-inch version (the 2200-1217). Both tablets support the Summagraphics MM standard as their main mode of operation. We also tested

the 2207, a low-end tablet that's in a class by itself.

Emulations are built into the firmware of the 2200-series tablets. Changing command sets or output formats (beyond switching between ASCII and binary) requires changing a PROM. The units that we tested were configured to operate in MM mode only, and they behaved to the applications software exactly like a SummaSketch tablet.

One DIP switch allows changes in communications parameters, mode, and ASCII and binary formats. Host commands for remote parameter setting are also supported. Both units provide two sockets for pointing devices, one each for the stylus and the cursor, so you can use both at the same time. Another interesting feature is that the tablets' surfaces are flat, rather than slightly inclined.

Both AutoCAD and PC Paintbrush ran using the Summagraphics MM driver provided with each application. There is no Windows support.

The 2200-series tablets' good accuracy rating contributed to a better-than-average performance on our horizontal and vertical error tests, putting the tablet on a par with other digitizers with the same performance specs. On the other hand, stylus angle performance was unusually poor, displacing the line by over 0.1 inch for tablets of both sizes.

Our third Numonics unit, the 2207, looked at first to be a stripped-down, low-cost alternative to the 2200-series line; but that's not the case. In addition to Summagraphics output format emulation, the tablet comes with a mouse driver, and Numonics plans to ship a Windows driver. Macintosh support software is also included as a part of the standard package.

An additional software utility lets you set communications parameters and output format. On the outside, the tablet is remarkably thin and easy to handle, with a height of only 1/2 inch.

As with the 2200-series tablets, we were able to run AutoCAD and PC Paintbrush using the MM output format. Windows applications aren't supported.

The 2207 turned in good numbers on both our horizontal and vertical error tests. Stylus angle error was slightly worse than average, but not as bad as that of the 2200 series.

Considering the power, versatility, and convenience of the 2207, it's hard to understand why it's priced so far below the 2200 series at \$595. While the 2200 tablets boast better input speed and accuracy specifications and have more interface and pointing device options, the

tance of the accuracy specification: The IS/One had the worst rating at 0.035 inch. Though that didn't affect the benchmark results, the tablets seem to be unusually sensitive to electromagnetic interference; any metal object (including drafting equipment) near the pointers made them unreliable.

Photo 3: *The performance crown goes to Pencept's Penpad 320 (right), which also boasts character recognition and a sophisticated macro capability.*

Photo 4: *The Summagraphics SummaSketch Plus (below) makes system setup a plug-and-go proposition.*

2207 turns in a performance that makes it nearly as well suited for high-precision applications.

Pencept

The Penpad 320 takes digitizing tablets to a new level of performance. While the Penpad 300 is a solid product, it's the Penpad 320 that affirms Pencept as the digitizer technology heavyweight.

Both Pencept models use the same tablet, a 16-inch by 17-inch pad with an 11-inch by 11-inch drawing area. The Penpad 320 draws its performance punch and its AC power from a full-length interface card that slides into your PC (see photo 3). The Penpad 300 uses a standard AC power adapter. In our tests, the stylus registered a full inch of proximity range, though the pen tip did seem too sensitive at times. Using it can get frustrating if you inadvertently activate or deactivate the tip while trying to draw. The design demands an easy touch.

The Penpad 300 looks bland when compared to its glamorous cousin. But when compared with other digitizing tablets of its class, the Penpad 300 stacks up very well. At \$695, it offers average 1000-lpi resolution and outstanding accuracy at 0.001 inch. Our tests show an exceptional proximity range and effective tilt correction. In fact, the Penpad 300's pen posted the lowest error at a 45 degree angle, and the ASCII format can include numeric data to further compensate for stylus tilt. Emulations abound, covering the CalComp 2000, GTCO Digi-Pad 5, Hitachi Tiger, Microsoft Mouse, Mouse Systems Mouse, Numonics 2200, and Summagraphics Bit Pad One.

To create the \$1095 Penpad 320, Pencept built upon the Penpad 300's impressive specifications by adding some unique features, like character recognition and a liberal dose of application-specific macros. The result is a digitizing tablet in a realm all its own. You've got to open your PC to install the interface card, and the special features require some practice, but a disk-based tutorial and clear documentation guide you along.

continued

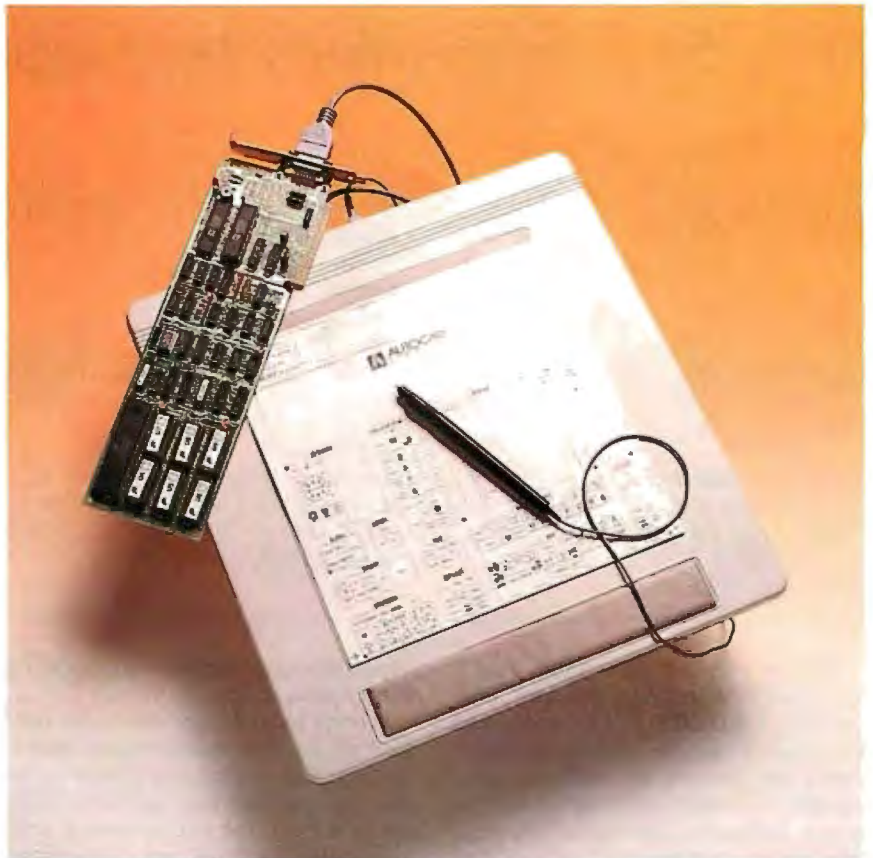

Company Information

CalComp

2411 West La Palma Ave.
Anaheim, CA 92801
(800) 225-2667
(714) 821-2000
Inquiry 1020.

GTCO Corp.

7125 Riverwood Dr.
Columbia, MD 21046
(301) 381-6688
Inquiry 1021.

Hitachi America, Ltd.

950 Benicia Ave.
Sunnyvale, CA 94086
(408) 773-8833
Inquiry 1022.

Houston Instrument

8500 Cameron Rd.
Austin, TX 78753
(800) 444-3425
Inquiry 1023.

Kurta Corp.

3007 East Chambers St.
Phoenix, AZ 85040
(800) 445-8782
Inquiry 1024.

Numonics

101 Commerce Dr.
Montgomeryville, PA 18936
(800) 247-4517
Inquiry 1025.

Pencept, Inc.

460 Totten Pond Rd.
Waltham, MA 02154
(617) 890-8877
Inquiry 1026.

Seiko Instruments U.S.A.

1130 Ringwood Court
San Jose, CA 95131
(800) 255-7617
Inquiry 1027.

Summagraphics Corp.

60 Silvermine Rd.
Seymour, CT 06483
(203) 881-2000
Inquiry 1028.

Pencept provides some highly useful templates for AutoCAD, Windows, VersaCAD, CADKEY, CADvance, and Freelance Plus. The templates include predefined macros for common tasks. An IBM PC Command template lets you access 10 function keys that let you negotiate cursor movement and process control sequences directly from the pad. Other touch blocks trigger calibration routines and changes to the character set. A 10-character scratchpad enables printed DOS commands. The Penpad 320 almost makes your IBM keyboard obsolete. You can also create your own macros or design your own template.

For the Penpad tablets to recognize characters, you must print them in a specific way; for instance, zeros require slashes through them. But once you master the technique, a single traced character can generate a powerful series of commands. From AutoCAD, you can enter sketch mode by holding down the stylus button and drawing a dollar sign anywhere on the tablet. The Pencad software makes this possible. Pencad, a Pencept utility program, expands the functionality of many popular CAD packages. It also includes a facility for creating your own macros, and when you leave the facility, you can automatically update your Pencad template with the new macro definitions. This lets you automate a full range of common tasks.

Another software offering, Penform, delivers a utility for creating customized forms. Penform can then pass any data written on the form directly to a database. In businesses that still require data entry from hard-copy forms, you skip a

step, thereby saving time and avoiding transcription errors.

Pencept includes any one of the software programs with the Penpad tablets. Additional programs are optional. The standard package also includes DOS, mouse drivers, the tutorial, and a software toolkit for developers. The Penpad 320 attains top-of-the-line status by combining adequate resolution, outstanding accuracy, and a wealth of powerful features. In a field where innovation is the exception, Pencept steals the show.

Seiko

Seiko's Screenplay tablets are another group that rely heavily on Summagraphics emulation to provide application support. While a standard Seiko data format exists, few application packages provide compatible drivers. The 11-inch by 11-inch tablet (the DT-3503) sells for \$599; the 11-inch by 17-inch tablet (the DT-4513) sells for \$999.

Both tablets feature a switchable, external power supply and configuration DIP switches. The total package includes an ADI driver and a generic mouse driver; Seiko plans to ship additional menuing software as an enhancement.

The Summagraphics-emulation mode worked as expected with PC Paintbrush. AutoCAD ran just as well with either Summagraphics MM emulation or the supplied ADI driver. We also tried to run the mouse driver to see how well it worked: The driver's installation program locked the system. Putting the driver's .SYS file into CONFIG.SYS made the system refuse to boot from the hard disk. LCS Telegraphics, which

writes driver software for Seiko, attributed the problem to a bad batch of software it had shipped. LCS sent us a new driver that functioned properly.

Cursor design was excellent. Its outlined, rather than filled, cross hairs made it possible to accurately choose a fine point. The buttons were also positioned comfortably. Cursor performance was a deciding factor in the tablet's outstanding error test results; the numbers were far better than those for similar tablets with 1000-lpi resolution and 0.01-inch accuracy.

While the cursor enhanced the tablet's overall capability, the stylus detracted from it. The tip switch, which is far too sensitive, sent spurious "pen up" and "pen down" messages to the system while the pen was in contact with the tablet. There was also no tactile response whatsoever from the stylus, so it was impossible to tell by feel whether the switch was activated or not. The problem occurred in styli sent with tablets of both sizes. Our 45 degree error measurement, though average, would have been far better if it weren't for the great inaccuracies caused by the temperamental stylus.

Summagraphics

A pioneer in the digitizer field, Summagraphics remains an omnipresent standard. For a setup routine, you just plug it in and go at it: It's that simple. You'll still have to configure your applications software, but if it supports digitizing tablets, it will support Summagraphics. Hardware switches set the configuration parameters.

continued

Princeton's UltraSync. The clear winner!



**Editor's
Choice
Winner***
May 31, 1988*
Dec. 22, 1987

“...the UltraSync has the edge in brightness and sharpness over the (NEC) MultiSync, making its text easier to read... the UltraSync's sharp display topped the fuzzy (IBM) 8513 display hands down... display image is as sharp as a stiletto and as bright as an arc lamp... Even as the brightness is turned up... the characters displayed on the... screen remain clear and sharp... excellent video qualities.”



May 1988

“Picture quality was excellent, and results for features available were far above average... Colors maintain their consistency and sharpness over the whole screen... has excellent placement of controls... widest combination of vertical scan rates... takes up little space on a desk... the top multiscanning monitor in our ratings.”

**Supports CGA, EGA, PGC, MDA, Hercules, MCGA, VGA and more.

Circle 214 on Reader Service Card



.28mm dot pitch, 800x600 resolution.

When it comes to high-resolution autosynchronous color monitors that are IBM PC, PS/2, Apple Mac II and SE Series compatible, the experts point to UltraSync.

Why? UltraSync's brilliant color display and superb high-resolution, for starters. Also because UltraSync offers extensive graphics standards** compatibility due to its wide autosynchronizing frequency ranges. It adjusts automatically to practically any standard. Then there's UltraSync's automatic picture sizing. Built-in text switch. Ergonomic design. And its affordable price (\$849).

But don't take our word for it. Read what the experts have to say. UltraSync, the only real choice. For more information, contact Princeton Graphic Systems, 601 Ewing Street, Building A, Princeton, New Jersey 08540, (609) 683-1660.

PRINCETON
GRAPHIC SYSTEMS
AN INTELLIGENT SYSTEMS COMPANY

THE VISIBLE EDGE

INFO WORLD

August 22, 1988

“...its finer dot pitch produced crisp images with none of the graininess found on some monitors... produced some of the brightest and clearest colors we saw... Ease of use rates a good score... outperforms many competing monitors in both color duplication and text clarity... a very good buy.”

FAMILY & HOME OFFICE COMPUTING

August 1988

“...easy on the eyes and sharp enough in the text mode for long, eye strain-free word processing... colors are bright and rich, and the display seemed sharp from corner to corner... the quality is superior... the Princeton UltraSync is one of the best monitors available for less than \$1,000... a superlative buy.”

PC Resource

September 1988

“...very crisp display... its colors are better than those on NEC's Multisync II.”

DIGITIZING TABLETS

Finally . . . a low cost, high speed copier for 5¼ and 3½ inch diskettes!

Attach a Victory V3000 Autoloader to your IBM/PC or Apple/Macintosh, enter one or more copy jobs, and walk away! The system automatically copies 5¼ or 3½ inch diskettes—up to 180 per hour. Switching the copy drive takes less than two minutes.

Copy Formats Flawlessly.
Victory's Auto-Dup™ software copies different formats or you can

build your own format. Auto-Dup tests the quality of each copy, sorting diskettes into one of two output bins.

Do-It-Yourself Servicing.
The Autoloader's simple component design and diagnostics for checking drive alignment and speed allow you to maintain the system without outside service.

Call (800) 421-0103. And ask about Victory's family of affordable Autoloaders that support

Hard Drive Back-Up, Serialization, and Custom Label Printing.



VICTORY ENTERPRISES
Technology, Inc.

Victory Plaza
1011 E. 53½ Street
Austin, TX 78751-1728
(512) 450-0801

In Europe call BFI: Paris (33-1) 45330137, Frankfurt (49-6074) 27051, London (44-1) 941-4066, Milan (39-2) 33100535, Stockholm (46-8) 7547460, Madrid (34-1) 2559503.



The \$599 SummaSketch Plus has a 12-inch by 12-inch drawing area with 1016-lpi resolution and 0.025-inch accuracy (see photo 4). The SummaSketch Professional sells for \$999 and shares the basic specifications of the Plus. Both support a two-button stylus and a four-button cursor. Unfortunately, the cursor's rough underside sometimes causes jerky movement across the pad, which prevents you from consistently pinpointing a desired position.

Our compatibility tests just barely scratched the surface of available applications software for the Summagraphics line. Our other tests revealed an adequate proximity range and above-average tilt correction. Accuracy measurements were average. The included software provides a generic ADI driver, a mouse driver, and Windows drivers. All worked flawlessly. The Windows driver adds a facility for mapping the tablet to the entire screen or to a designated portion. A third option matches a region of the drawing area to the screen while maintaining a uniform aspect ratio. A batch file can automatically load terminate-and-stay-resident drivers for AutoCAD and for Microsoft Mouse emulation.

Summagraphics also throws in a few useful utilities. One program resets the digitizer; another displays the complete set of data compiled by the tablet.

The Last Word

In general, the digitizing tablets we tested are consistent and reliable. The new Houston Instrument series breaks from the pack with considerable performance at the lowest price. The HiPad Plus tablets offer the best resolution of all the products reviewed, excellent accuracy specifications, and a hassle-free set-up routine using a menu template—all at a price lower than those of tablets offering half as much.

But if you crave the very best or desire the full complement of state-of-the-art features, Pencept's Penpad 320 stands alone. The tablet can compete against the others on the merits of its specifications, and our tests confirmed its stellar performance. Add to that a bundle of extras like character recognition, data-entry forms, a variety of applications templates, a DOS interface, predefined macros, and highly useful software, and you end up with a digitizing tablet that no other vendor can match. ■

Stanford Diehl and Steve Apiki are BYTE Lab testing editors. They can be reached on BIX as "sdielh" and "apiki."

A Brand New Resolution The Handy Scanner HS-3000

Free HALO DPE™

The handiest little scanner in the world just got even better. The Handy Scanner 3000 from DFI offers you clarity and versatility in a little package. Like our other Handy Scanners, the Handy Scanner 3000 for the IBM PC, PS/2, and compatibles can handle almost all the jobs the desktop model can, but it's smaller and easier to use.

We give you the features you need the most in a Handy Scanner. The new 4-1/8" scanning width makes sheet work of the biggest pictures. You can switch the scanner between 400/300/200/100 DPI. For those really important pictures, the Handy Scanner 3000 lets you have it all with 400 DPI resolution. The real-time screen display lets you instantly see your scan, so you can quickly make scanner adjustments as necessary. With adjustable half-tones and contrast, you get a clean, clear picture. To watch

ors, not one, are used to scan images, graphs, or art objects such as red or pinkish blue lines can be scanned without losing detail.

The Handy Scanner 3000 comes complete with fully featured, powerful software for scanning, editing, and integrating text with your graphics. Several font files are compatible with almost all graphics software, including PageMaker, Ventura, WordPerfect 5.1, and many others. The package includes the scanner, interface card, the HALO DPE software publishing software package (worth \$195), a utility diskette, and an instruction manual.

The Handy Scanner 3000 is a little wonder that does a lot, and now it does it even better.

\$299.95

ADDED SPECIAL NOW OCR SOFTWARE AVAILABLE

Converts scanned images from scanner into ASCII text for use with word processors, data bases, etc.

Reg. \$199.95 if purchased with HS-3000 ONLY

\$79.95

LOGITECH SCANMAN

- 200 dpi
- 4" scanning width
- IBM, PC, XT, AT, PS/2 (25 & 30)

Complete with Logitech™ "Scanware"™ Software

\$189.95

QUALITY CUSTOMER SERVICE
508-278-6555

TECHNICAL ASSISTANCE
508-278-6556

TOLL FREE ORDER LINE
1-800-635-0300
TRUE DATA PRODUCTS
115 MAIN ST., P.O. BOX 347
UXBRIDGE, MA 01569
508-278-6555
HOURS: MON-FRI 9-6, SAT. 10-4 (EST)

CORPORATE P.O.'S WELCOMED

ALL PACKAGES SHIPPED UPS EXCEPT CANADA AND A.P.O.'S
C.O.D.'S ADD \$2.30
MASTER CHARGE/VISA ADD 3%
1 YEAR WARRANTY UNLESS OTHERWISE NOTED
PRICES TERMS CONDITIONS SUBJECT TO CHANGE WITHOUT NOTICE

TAKE ONE AND YOUR HEADACHES ARE GONE.

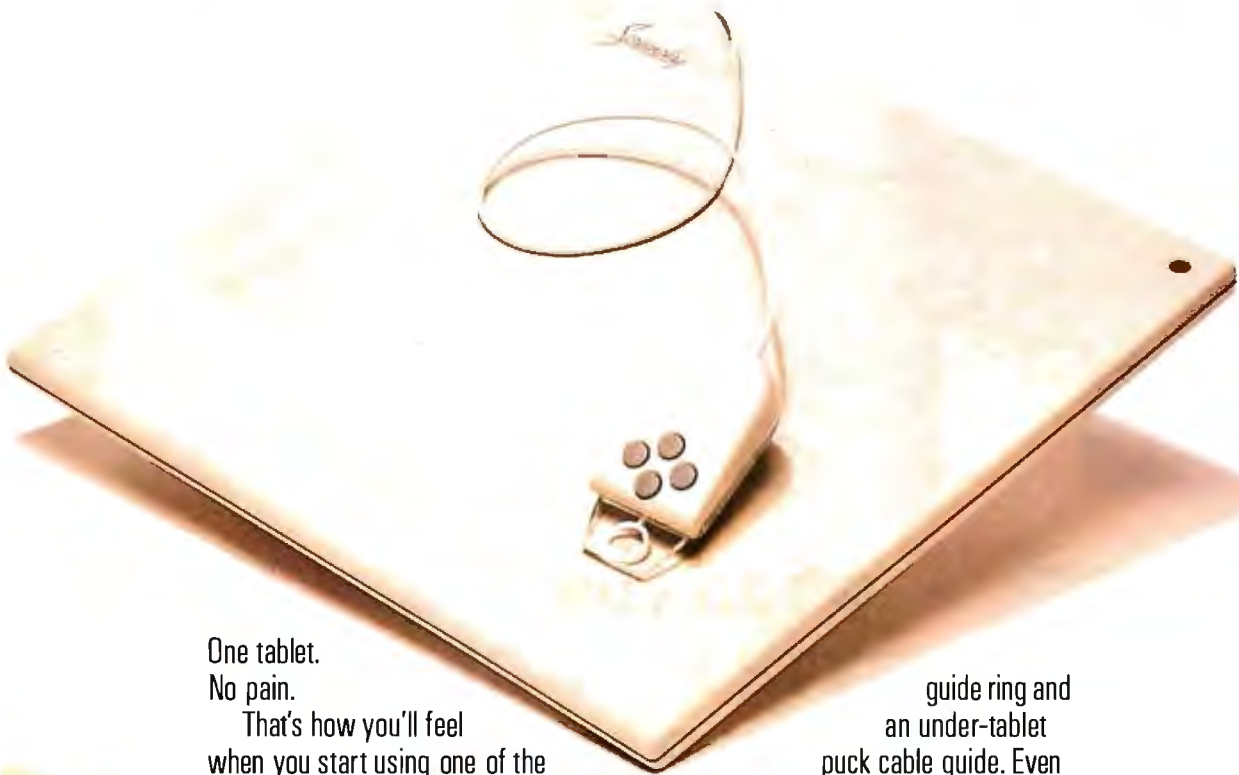

One tablet.
No pain.

That's how you'll feel when you start using one of the new Screenplay Tablets from Seiko.

Because for the first time, you can get the quality and reliability that used to be reserved for big spenders. Without spending big dollars.

Screenplay gives you unprecedented accuracy, resolution, repeatability and speed. Our patented double-loop sensing technology eliminates dead spots and edge problems. So what you draw is flawlessly represented on screen. In fact, you'll get (or exceed) the accuracy found in tablets costing twice as much.

Plus, using Screenplay is a joy. The pen is a true drawing instrument. Solid. Built for years of hard duty. With a brass barrel and tip. Pucks are designed for right or left-handed people. And the tablet itself is designed for neat, tangle-free operation. There's a pen cable

guide ring and an under-tablet puck cable guide. Even the connectors are recessed to prevent snarls. While the function controls are easily accessible without having to dig inside the tablet.

And best of all, you can get Seiko quality and reliability in the size you want: 8x12, 11x11, 15x15, 12x18, 17x24 and 18x25 inch Screenplay tablets; 30x40, 36x48 and 42x60 Screenplay tables.

So stop by your local computer dealer to see Screenplay in action. It's the one tablet that'll make your input headache go away forever.

Dealer Inquiries: Call Mark Davis at (408) 943-9100.

SEIKO I ●
Seiko Instruments USA

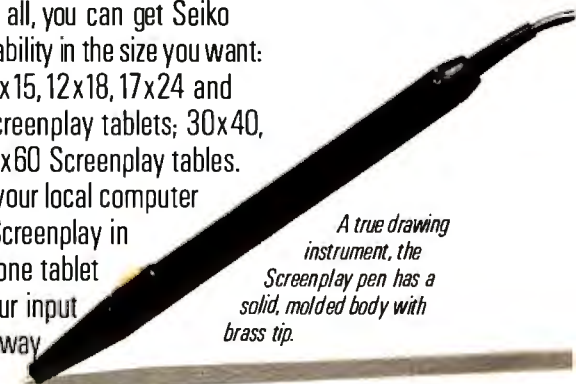

A true drawing instrument, the Screenplay pen has a solid, molded body with brass tip.

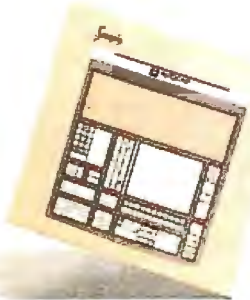

With your AutoCAD Template, Screenplay speeds you through screen manipulations.

Take any 3 books for only \$1⁰⁰ each



when you join BYTE Book Club[®] VALUES UP TO \$135.95

OS/2 PROGRAMMER'S GUIDE. By E. Iacobucci. 1100 pp., illus., softbound. "Byte" magazine called it "a necessity." This giant reference explains all the basic functions you'll need, with emphasis on such new or different functions as multitasking and memory management.
881300-X Pub. Pr., \$24.95

UNIX UTILITIES. By R.S. Tare. 352 pp., illus., softbound. This practical manual shows how to make the best use of UNIX utilities. It covers more utilities than any other book of its kind and provides numerous examples of real applications.
628/84X Pub. Pr., \$24.95

dBASE POWER: Building and Using Programming Tools. By P.L. Olympia, R. R. Freeland, and R. Wallin. 380 pp., illus., softbound. This practical guide shows the experienced dBASE III or dBASE III PLUS programmer how to use to the fullest such features as RUN and CALL/LOAD, as well as how to write C and assembly language programs that perform dBASE functions for you.
584696-9 Pub. Pr., \$29.95

A PROFESSIONAL'S GUIDE TO SYSTEMS ANALYSIS. By M.E. Modell. 307 pp., illus. Detailed coverage of what you need to know — what questions to ask, how to conduct a cost-benefit analysis, how to document and validate your findings — to design the best systems for your user's needs.
426/325 Pub. Pr., \$34.95

ADVANCED GRAPHICS IN C: Programming and Techniques. By N. Johnson. 430 pp., illus., softbound. Now C programmers can write crisp graphics programs for the IBM-PC using the IBM EGA (Enhanced Graphics Adaptor) or the AT&T Image Capture Board (ICB). Includes GRAPHIQ, a complete C graphics toolkit.
881257-7 Pub. Pr., \$22.95

A COMPREHENSIVE GUIDE TO AI AND EXPERT SYSTEMS: Turbo Pascal Edition. By R.I. Levine, D.E. Drang, and B. Edelson. 256 pp., 99 illus. A must for everyone who wants to understand and utilize artificial intelligence for commercial, military, scientific, or educational applications. It's all in clear, simple language with many illustrations and sample programs.
374/708 Pub. Pr., \$22.95

IBM® PC AND MACINTOSH® NETWORKING. By S.L. Michel. 296 pp., illus., softbound. This state-of-the-art guide shows how to painlessly network your PC's and MAC's so that they share files, storage, and printers. Full descriptions of TOPS™ and AppleShare™ allow you to choose the solution that's right for you and implement it for greatest advantage.
584658-6 Pub. Pr., \$21.95

ADVANCED 80386 PROGRAMMING TECHNIQUES. By J.L. Turley. 509 pp., illus., softbound. Offering advanced techniques for serious programmers, this hands-on-guide covers advanced memory segmentation, the internal four-level protection hierarchy, multitasking, demand paging, system security, 8086/80186/80286 emulation, and intertask communication.
881342-5 Pub. Pr., \$22.95

THE WAITE GROUP'S MS-DOS BIBLE, Second Ed. By S. Simrin. 522 pp., illus., softbound. Shows you how to start up your system, create and manage files, customize your keyboard, and become proficient in such advanced MS-DOS features as LINK, DEBUG, TSR programming, and device drivers.
584702-7 Pub. Pr., \$22.95

ADVANCED TURBO C.® By H. Schildt. 397 pp., illus., softbound. Complete Turbo C mastery can be yours—from stacks, queues, linked lists and binary trees, to operating system interfacing, porting, debugging, and much more. Fully explains how to get the most from the power and speed of Turbo C.
881280-1 Pub. Pr., \$22.95

DATABASE SYSTEM CONCEPTS. By H. F. Korth and A. Silberschatz. 546 pp., illus. From fundamental concepts to advanced problem solving, this book provides a clear understanding of the design and use of database systems. Also demonstrates the best ways to protect data from unauthorized access and malicious or accidental alteration or destruction.
447/527 Pub. Pr., \$42.95

ARTIFICIAL INTELLIGENCE USING C: The C Programmer's Guide to AI Techniques. By H. Schildt. 412 pp., 37 illus., softbound. This hands-on guide shows you how to create your own AI applications and systems using C. After an introductory overview it provides coverage of expert systems, logic, natural language processing, machine learning, pattern recognition, and more, with ready-to-run programs illustrating each topic.
881255-0 Pub. Pr., \$21.95

PROGRAMMING USING THE C LANGUAGE. By R.C. Hutchison and S.B. Just. 519 pp., illus. Whether you want to understand programs in C written by others, or write better C programs of your own, this practical, authoritative book gives you the tools and guidance you need. Coverage includes program organization, sorting algorithms, recursion, linked lists, and more — with many sample programs.
315/418 Pub. Pr., \$28.95

HARD DISK MANAGEMENT with MS-DOS and PC-DOS. By D. Gookin and A. Townsend. 307 pp., illus. Shows you how to make the best use of your hard disk for all types of programs, with an emphasis on organization, data security, and enhancing performance. Easy enough for novices, yet sophisticated enough for power users, it's packed with helpful hints, proven shortcuts, and clear explanations.
583954-7 Pub. Pr., \$26.95

TRICKS OF THE UNIX MASTERS. By R.G. Sage. pp. illus. Many of UNIX's most interesting features have virtually been kept secret from users — until now! This master guide goes beyond the basics to show you the shortcuts, tools, tips, and tricks it could take years to discover on your own.
584637-3 Pub. Pr., \$22.95

BYTE BOOK CLUB[®]

Membership Order Card

Please enroll me as a member and send me the three choices I have listed below. Bill me only \$3.00, plus local tax, postage and handling. I agree to purchase a minimum of two additional books during my first year as outlined under the Club plan described in this ad. Membership in the club is cancellable by me any time after the two book purchase requirement has been fulfilled. A shipping and handling charge is added to all shipments.

Indicate below by number the books you want. A few expensive books (noted in the descriptions) count as more than one choice.

<input type="text"/>	<input type="text"/>	<input type="text"/>
----------------------	----------------------	----------------------

Signature _____

Name _____

Address/Apt.# _____

City, State, Zip _____

Corporate Affiliation _____

This order subject to acceptance by McGraw-Hill. All prices subject to change without notice. Offer good only to new members. Foreign member acceptance subject to special conditions.

BYTE BOOK CLUB[®]

Membership Order Card

Please enroll me as a member and send me the three choices I have listed below. Bill me only \$3.00, plus local tax, postage and handling. I agree to purchase a minimum of two additional books during my first year as outlined under the Club plan described in this ad. Membership in the club is cancellable by me any time after the two book purchase requirement has been fulfilled. A shipping and handling charge is added to all shipments.

Indicate below by number the books you want. A few expensive books (noted in the descriptions) count as more than one choice.

<input type="text"/>	<input type="text"/>	<input type="text"/>
----------------------	----------------------	----------------------

Signature _____

Name _____

Address/Apt.# _____

City, State, Zip _____

Corporate Affiliation _____

This order subject to acceptance by McGraw-Hill. All prices subject to change without notice. Offer good only to new members. Foreign member acceptance subject to special conditions.

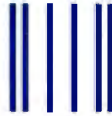

NO POSTAGE
NECESSARY
IF MAILED
IN THE
UNITED STATES

BUSINESS REPLY MAIL

FIRST CLASS MAIL PERMIT NO. 42 HIGHTSTOWN, NJ

POSTAGE WILL BE PAID BY ADDRESSEE

McGraw-Hill Book Clubs

P.O. Box 582

Hightstown, NJ 08520-9959

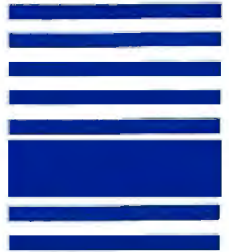

NO POSTAGE
NECESSARY
IF MAILED
IN THE
UNITED STATES

BUSINESS REPLY MAIL

FIRST CLASS MAIL PERMIT NO. 42 HIGHTSTOWN, NJ

POSTAGE WILL BE PAID BY ADDRESSEE

McGraw-Hill Book Clubs

P.O. Box 582

Hightstown, NJ 08520-9959

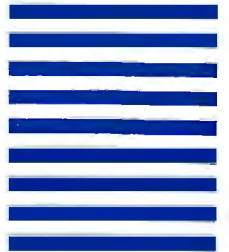

SADT: Structured Analysis and Design Technique. By D. Marca and C. McGowan.
402/353 Pub. Pr., \$44.95

PROGRAMMING WITH TURBO PASCAL. By D. Carroll
852908-5 Pub. Pr., \$39.95

HIGH-SPEED ANIMATION & SIMULATION FOR MICROCOMPUTERS. By L. Adams
583855-9 Pub. Pr., \$20.95

PROGRAM TRANSLATION FUNDAMENTALS: Methods and Issues. By P. Calingaert.
584589-X Pub. Pr., \$36.95

PRINCIPLES OF PARALLEL AND MULTI-PROCESSING. By G.R. Desrochers.
165/793 Pub. Pr., \$49.50
(Counts as 2 of your 3 books)

UNDERSTANDING & USING dBASE III® PLUS. By R. Krumm.
583940-7 Pub. Pr., \$22.95

32-BIT MICROPROCESSORS. Edited by H.J. Mitchell.
425/85X Pub. Pr., \$45.00

THE DATABASE EXPERTS' GUIDE TO DATABASE 2. By B. Larson.
232/679 Pub. Pr., \$24.95

NETWORKING SOFTWARE. By C. B. Ungaro.
606969-9 Pub. Pr., \$37.95

THE DATABASE EXPERT'S GUIDE TO SQL. By F. Lusardi
390/061 Pub. Pr., \$24.95

PRINCIPLES OF ARTIFICIAL INTELLIGENCE AND EXPERT SYSTEMS DEVELOPMENT. By D.W. Rolston
536/147 Pub. Pr., \$39.95

HOW TO WRITE COMPUTER DOCUMENTATION FOR USERS, 2nd Ed. By S.J. Grimm
583783-8 Pub. Pr., \$29.95

DATA STRUCTURES USING PASCAL, 2nd Ed. By A. M. Tenenbaum & M. J. Augenstein
583738-2 Pub. Pr., \$46.00

MICROCOMPUTER LANS: Network Design and Implementation. By M.F. Hordeski
584580-6 Pub. Pr., \$28.95

OPERATING SYSTEMS. By M. Milenkovic
419/205 Pub. Pr., \$40.95

CIARCIA'S CIRCUIT CELLAR, Volume VI By S. Ciarcia.
109/680 Pub. Pr., \$19.95



Any 3 books for \$1.00 each... if you join now and agree to purchase two more books — at handsome discounts — during your first year of membership.

COMPUTER ORGANIZATION. By M. Andrews.
584588-1 Pub. Pr., \$39.95

PROGRAMMING IN C, Revised Ed. By S.G. Kochan.
584701-9 Pub. Pr., \$24.95

CIARCIA'S CIRCUIT CELLAR, Volume V. By S. Ciarcia
109/672 Pub. Pr., \$21.95

HANDBOOK OF SOFTWARE MAINTENANCE. By G. Parikh
583639-4 Pub. Pr., \$35.95

THE C PRIMER, 2nd Ed. By L. Hancock & M. Krieger
259/95X Pub. Pr., \$19.95

DATA TYPES AND DATA STRUCTURES. By J.J. Martin
583689-0 Pub. Pr., \$45.00

TROUBLESHOOTING AND REPAIRING THE NEW PERSONAL COMPUTERS. By A. Margolis.
583871-0 Pub. Pr., \$17.95

ADVANCED TURBO PASCAL: PROGRAMMING AND TECHNIQUES. By H. Schildt.
583761-7 Pub. Pr., \$18.95

DESIGNING USER INTERFACES FOR SOFTWARE. By J.S. Dumas.
584641-1 Pub. Pr., \$31.00

68000 ASSEMBLY LANGUAGE PROGRAMMING, 2nd Ed. By L. Leventhal; D. Hawkins; G. Kane & W. Cramer
583817-6 Pub. Pr., \$28.95

ADVANCED COBOL, 2nd Ed. By A. S. Philippakis and L. J. Kazmier.
498/13X Pub. Pr., \$37.95

HARD DISK MANAGEMENT IN THE PC & MS-DOS ENVIRONMENT. By T. Sheldon
565/562 Pub. Pr., \$24.95

FILE ORGANIZATION FOR DATABASE DESIGN. By G. Wiederhold.
701/334 Pub. Pr., \$40.95

USING TURBO C. By H. Schildt
881279-8 Pub. Pr., \$19.95

More Books to Choose from

123: THE COMPLETE REFERENCE. By M. Campbell.
881005-1 Pub. Pr., \$22.95

QUICK C PROGRAMMING FOR THE IBM. By C. Townsend.
584659-4 Pub. Pr., \$22.95

HOW TO BE A SUCCESSFUL COMPUTER CONSULTANT. By A. R. Simon
572/968 Pub. Pr., \$19.95

MS-DOS BATCH FILE PROGRAMMING ... including OS/2. By R. Richardson.
584710-8 Pub. Pr., \$17.95

INTRODUCING PC-DOS AND MS-DOS: A GUIDE FOR BEGINNING & ADVANCED USERS. By T. Sheldon
565/597 Pub. Pr., \$24.95

APPLYING EXPERT SYSTEMS IN BUSINESS. By D. N. Chorafas
108/803 Pub. Pr., \$29.95

STRUCTURED COBOL: A STEP BY STEP APPROACH. By C.R. Litecky and G.B. Davis.
157/88X Pub. Pr., \$30.95

TELECOMMUNICATIONS AND DATA COMMUNICATIONS FACTBOOK. By J. Abbatiello and R. Sarch
606965-6 Pub. Pr., \$39.95

DESIGN OF DISTRIBUTED OPERATING SYSTEMS. By P. J. Fortier
216/215 Pub. Pr., \$42.95

WORDPERFECT®: THE COMPLETE REFERENCE. By K. Acerson.
881312-3 Pub. Pr., \$27.95

PROGRAMMER'S CHALLENGE: 50 Challenging Problems to Test Your Programming Skills. By S. Chen.
583883-4 Pub. Pr., \$29.95

Here's how Byte Book Club® works to serve you:

- **Important information... we make it easy to get!** Today, professionals who perform best are those who are best informed. For reliable, hands-on information, turn to the Byte Book Club. Every 3 or 4 weeks (12-15 times a year), members receive the Club Bulletin offering more than 30 books — the best, newest, most important books from all publishers.
- **Dependable service... we're here to help!** Whether you want information about a book or have a question about your membership, just call us toll-free or drop us a line. To get only the books you want, make your choice on the Reply Card and return it by the date specified. If you want the Main Selection, do nothing — it will be sent to you automatically. (A small shipping and handling charge is added to each shipment.)
- **Club convenience... we do the work!** You get a wide choice of books that

simply cannot be matched by any bookstore. And all your books are conveniently delivered right to your door. You also get 10 full days to decide whether you want the Main Selection. (If the Club Bulletin ever comes late and you receive a Main Selection you don't want, return it for credit at our expense.)

- **Substantial savings... and a bonus program too!** You enjoy substantial discounts — up to 40%! — on every book you buy. Plus, you're automatically eligible for our Bonus Book Plan which allows you savings up to 70% on a wide selection of books.
- **Easy membership terms... it's worthwhile to belong!** Your only obligation is to purchase 2 more books — at handsome discounts — during the next 12 months, after which you enjoy the benefits of membership with no further obligation. You or the Club may cancel membership anytime thereafter.

Fill out the card and mail today! If the card is missing, write to:

BYTE BOOK CLUB®, P.O. Box 582, Hightstown, New Jersey 08520-9959
For faster service in enrolling, call 1-800-2-MCGRAW

BEST



NEW MINI PORTABLE BEST-286 LCD

- 10 MHz 0 WAIT (12 MHz Option)
- 512 K RAM
- 1.2 M. Floppy Drive
- 30 MB Hard Disk (ST-138)
- 200 W DC Fan Power Supply
- Serial & Parallel
- Non-Glare LCD Screen
- Super Twist
- Built-In Back Light
- 640 x 200 Dots
- Weight 22 lbs
- Padded Soft Carry Bag
- Dimension 16" x 8" x 9"

\$1600



VTI-33 SYSTEM

- 8088-2 10 MHz
- 640 K RAM**
- 2 360K Floppy Drive
- Serial, Parallel Port
- Clock, Calendar
- AT Style Keyboard
- Build in Mono/Color Graphic
- MONO MONITOR**
- MS-DOS 3.3, GW Basic

\$749

COLOR SYSTEM \$919



BEST-286 PORTABLE

- 10 MHz
- 512 K RAM
- One 1.2 MB Floppy Drive
- 7 Expansion Slots
- 200 W DC Fan Power Supply
- 9" Dual Amber Screen
- Mono or Color Graphic Card
- Serial & Parallel Port
- 84 Key Soft Tough Key Board

\$1115

BEST-88 PORTABLE \$845

386 SYSTEM

- 16 MHz 80386 CPU
8/16MHz
- 20 MHz (Option)
- 80287 & 80387 Socket
- 1 M RAM
- One 32-bit, Five 16-bit,
Two 8-bit Expansion Slots
- 1.2 M Floppy Drive
- WA2 or NCL Control Card
- 3.5" Drive (Option)
- Vertical Chassis

\$1995



Same Day Shipping

VTI-55 SYSTEM

- 80286 12 MHz
- 640K
- 1.2 MB Floppy Drive
- 30 MB Hard Disk (28 ms)**
with NCL Controller
- 2 Serial 1 Parallel
- Clock Calendar
- 101 Enhance Keyboard
- ATI EGA Wonder Card
- EGA MONITOR**
- MS-DOS 3.3, GW Basic

\$1699

MONO SYSTEM \$1399

286 BABY MOTHER BOARD	PORTABLE CASE
10 MHz \$265	9" Dual Amber Monitor
12 MHz \$295	200 W Power Supply \$349
8088 Mother Board \$95	LCD CASE
Mono Monitor \$79	640 x 200 Dots \$549
Fujitsu 101 Enhance Keyboard \$45	ATI EGA WONDER \$175 (640 x 480)
EGA PLUS 640 x 480 (Paradise Compatible)	\$139

CALL FOR QUANTITY PRICE

BEST

COMPUTER INC.
5017 Telegraph Road
Los Angeles, CA 90022

Tel: (213) 265-0900
Tech: (213) 265-0300
Fax: (213) 265-4234
Toll: **(800)634-7920**
Outside Cal.



MON - SAT 9:00 - 6:00 PACIFIC TIME
PRICE ARE SUBJECT TO CHANGE WITHOUT NOTICE

Circle 37 on Reader Service Card
(DEALERS: 38)

Credit Card Purchase Subject to Service Charge.



Strengthening the Lineup



The new IBM PS/2 Models 70-E61 and 70-121 mean more support for the Micro Channel architecture

Caroline Halliday

Aside from their smaller size and weight, the PS/2 Models 70-E61 and 70-121 seem to fit right in with their older siblings; there is little difference between the machines. The Model 70s are equivalent in performance to the Model 80-071 and Model 80-111, respectively, and act as desktop equivalents of these floor-mounted machines.

Family Resemblance

The Model 70 machines, in their various versions, provide 32-bit processing power on the desktop. The Model 70-E61 (\$5995) is a 16-MHz 80386-based machine with a 60-megabyte enhanced-small-device-interface hard disk drive and 1 megabyte of system-board RAM in its standard configuration. The Model 70-121 (\$7995) runs at 20 MHz and has a 120-megabyte ESDI hard disk drive and 2 megabytes of system-board RAM as standard. These prices are, surprisingly

for IBM, very competitive. A comparably equipped 20-MHz 80386-based Compaq Deskpro 386/20e with a 110-megabyte hard disk drive and 2 megabytes of RAM has a list price of \$9397, and the closest equivalent AST Premium/386 is \$9795.

The reviewed systems were the standard configuration with the optional 16-MHz (\$795) and 20-MHz (\$1195) 80387 math coprocessors installed in the respective machines. I used the 8514 (\$1550) and 8513 (\$750) color displays with the reviewed systems.

Aside from the size of the hard disk drive, the processor speed, and the standard quantity of RAM, the different versions of the Model 70 are physically similar. The 101-key Enhanced keyboard is supplied with the system unit. The VGA display subsystem is an integral part of the system board. The machines have a single 1.44-megabyte 3½-inch floppy disk drive, with room for a second drive. The system board can accommodate up to 6 megabytes of RAM, and total system memory can be as much as 16 megabytes. The large amount of system-board RAM is one of the major selling points of this machine.

RAM to Spare

Until recently, the IBM personal computers have usually been in single-tasking environments with DOS as the dominant operating system. This has changed with the coming of OS/2 and renewed interest in other multitasking operating systems. As the operating systems become more sophisticated, they need more RAM to support the multiple tasks. The Model 70's 6 megabytes of system-board RAM should be an ample amount for OS/2-based applications.

The system-board memory is paged, as on the 20-MHz Model 80. For successive memory accesses within the 2K-byte page, the memory is accessed at zero wait states. Accesses outside the current

continued

REVIEW
STRENGTHENING THE LINEUP

	Model 70-E61	Model 70-121	Model 50 Z
Company	IBM Corp. 900 King St. Rye Brook, NY 10573 (800) 426-2468	IBM Corp. 900 King St. Rye Brook, NY 10573 (800) 426-2468	IBM Corp. 900 King St. Rye Brook, NY 10573 (800) 426-2468
Components	Processor: 16-MHz 32-bit 80386; socket for optional 16-MHz 80387 math coprocessor Memory: 1 megabyte of 85-ns RAM, expandable to 6 megabytes maximum on system board and 16 megabytes maximum in the system Mass storage: One 1.44-megabyte 3½-inch floppy disk drive; 60-megabyte hard disk drive Display: VGA as integral part of system board; optional displays Keyboard: 101-key Enhanced keyboard I/O interfaces: One DB-25 parallel port; one DB-25 serial port; one 6-pin DIN mouse port; two 32-bit MCA expansion slots and one 16-bit MCA slot	Processor: 20-MHz 32-bit 80386; socket for optional 20-MHz 80387 math coprocessor Memory: 2 megabytes of 85-ns RAM, expandable to 6 megabytes maximum on system board and 16 megabytes maximum in the system Mass storage: One 1.44-megabyte 3½-inch floppy disk drive; 120-megabyte hard disk drive Display: VGA as integral part of system board; optional displays Keyboard: 101-key Enhanced keyboard I/O interfaces: One DB-25 parallel port; one DB-25 serial port; one 6-pin DIN mouse port; two 32-bit MCA expansion slots and one 16-bit MCA slot	Processor: 10-MHz 16-bit 80286; socket for optional 10-MHz 80287 math coprocessor Memory: 1 megabyte of zero-wait-state, 85-ns RAM, expandable to 2 megabytes maximum on system board and 16 megabytes maximum in the system Mass storage: One 1.44-megabyte 3½-inch floppy disk drive; 30-megabyte hard disk drive on Z-031 (review system); 60-megabyte hard disk drive on Z-061 system Display: VGA as integral part of system board; optional displays Keyboard: 101-key Enhanced keyboard I/O interfaces: One DB-25 parallel port; one DB-25 serial port; one 6-pin DIN mouse port; three 16-bit MCA expansion slots
Size	5½ × 14 × 16½ ins.; 21 lbs.	5½ × 14 × 16½ ins.; 21 lbs.	5½ × 14 × 16½ ins.; 21 lbs.
Options	PC-DOS 3.30: \$125 IBM OS/2 Standard Edition: \$340 IBM OS/2 Extended Edition: \$830 IBM Advanced Interactive Executive (AIX) PS/2 Operating System: \$624 8503 monochrome display: \$275 8512 color display: \$595 8513 color display: \$750 8514 color display: \$1550 2- to 8-megabyte memory-expansion option: \$1695 1-megabyte memory module kit: \$695 2-megabyte memory module kit: \$1395	PC-DOS 3.30: \$125 IBM OS/2 Standard Edition: \$340 IBM OS/2 Extended Edition: \$830 IBM Advanced Interactive Executive (AIX) PS/2 Operating System: \$624 8503 monochrome display: \$275 8512 color display: \$595 8513 color display: \$750 8514 color display: \$1550 2- to 8-megabyte memory-expansion option: \$1695 1-megabyte memory module kit: \$695 2-megabyte memory module kit: \$1395	PC-DOS 3.30: \$125 IBM OS/2 Standard Edition: \$340 IBM OS/2 Extended Edition: \$830 IBM Advanced Interactive Executive (AIX) PS/2 Operating System: \$624 8503 monochrome display: \$275 8512 color display: \$595 8513 color display: \$750 8514 color display: \$1550 2-megabyte memory module kit: \$1395
Documentation	PS/2 Model 70 Quick Reference and Reference Disk	PS/2 Model 70 Quick Reference and Reference Disk	PS/2 Model 50 Quick Reference and Reference Disk
Price	\$5995	\$7995	Model 50 Z-031: \$3995 Model 50 Z-061: \$4595
	Inquiry 851.	Inquiry 852.	Inquiry 853.

page require two wait states. On the Model 70-E61, this corresponds to two and four 62.5-nanosecond clock cycles (125 ns and 250 ns) for read accesses in and out of the page, respectively. On the Model 70-121, the corresponding cycle times are 100 ns and 200 ns. In a typical application, this paged-memory arrangement gives a performance improvement over more conventional linear memory,

as memory accesses are more often sequential or closely clustered rather than random. The paged-memory system improved the performance of the Model 70 in the CPU portion of the benchmark results.

In addition, the Model 70 can copy the ROM BIOS to 32-bit RAM. ROMs are slower devices compared to high-speed RAM, but because the BIOS is copied to

RAM, the ROMs are accessed only during the power-on self test (POST), when the copying occurs. This "shadow RAM" method is used by other manufacturers, including Compaq and AST.

The spare 384K bytes from the 1 megabyte of system-board RAM is addressed immediately below the 16-megabyte system limit. The top 128K bytes of

continued

Revamped PS/2 Model 50 Z

Early assessments of the PS/2 family were quick to criticize the slow hard disk drive on the Model 50. It was so slow that the mediocre performance of the rest of the machine was overshadowed. Many PC AT-compatible machines had higher performance and a better price. The introduction of the Model 50 Z with its zero-wait-state memory and reasonably fast hard disk drive may assuage some of the critics, but not all.

The Model 50 Z is available in two standard versions. The Z-031 (\$3995) has a 30-megabyte hard disk drive (as reviewed), and the Z-061 (\$4595) has a 60-megabyte hard disk drive. Except for the variation in hard disk capacity, the machines have similar characteristics.

The Model 50 Z uses a 10-MHz 80286 microprocessor with a socket for an optional 80287 math coprocessor. The 1 megabyte of 85-nanosecond RAM on the system board can be upgraded to a maximum of 2 megabytes on the system board and up to 16 megabytes using the expansion slots. The system-board memory can run at zero wait states, which greatly improves the Model 50's performance.

The 50 Z has a single 1.44-megabyte 3½-inch floppy disk drive as standard, and there's room for a second. The system includes many features found on other PS/2 machines, such as a parallel port, a serial port, and a mouse port. The VGA is an integral part of the system board. A 101-key Enhanced keyboard comes with the system.

Three 16-bit Micro Channel architecture (MCA) expansion slots are available on the system board; one has a video extension connector for installing an alternate video board.

Internal Image

The styling of the Model 50 Z is identical to that of the Model 70 machines; the case is approximately 35 percent smaller than the IBM PC AT. As on other PS/2 machines, the power switch and disk drives are all located on the front panel. A small touch that system managers will appreciate is that the model number is also on the front panel.

The cover is held on with two thumb-screws at the rear. The interior is similar to the Model 50's. Only one cable is used in the Model 50 Z system, linking the speaker assembly to the system



board. This modification is necessary since the system board itself is only two-thirds the size of the original Model 50 and is located in the rear of the case. The rest of the system elements are linked to the system board via circuit-board edge connectors.

The plastic frame over the Model 50 Z system board holds the disk drives and the speaker assembly. The hard disk drive includes the disk controller, so the circuit board used to link it with the system board is only a physical adapter (unlike the Model 50's circuit board, which is a disk controller). The floppy disk drives are linked to the system board via another circuit board sitting centrally in the rigid frame.

Access to the system-board RAM is not as easy on the Model 50 Z as on the Model 70. The whole mounting frame has to be removed (along with the clock battery). Once removed, the 1-megabyte single in-line memory module standard memory can be replaced with a 2-megabyte SIMM. Additional memory must be added to the MCA expansion bus; it will operate more slowly due to bus restrictions, and it will reduce the number of available slots. There are only three expansion slots to start with, and the system-board capacity of 2 megabytes of zero-wait-state RAM is not extensive.

Measuring Up

The Model 50 Z improves on the performance of the Models 50 and 60, but only enough to make it competitive with other high-quality 80286-based machines. The full suite of BYTE benchmarks were run on the Model 50 Z. The

results show the Model 50 Z performing as its architecture would predict: at the high end of the AT class of machines, but not as well as an 80386-based machine. The improvement in the hard disk drive is obvious from the Disk I/O results. There is approximately a 25 percent improvement in performance over the IBM PC AT, and an even more substantial improvement over the Model 50 with its notoriously slow hard disk drive.

The effect of the zero-wait-state RAM is evidenced throughout the rest of the low-level benchmarks. The CPU tests give a 30 percent improvement over the Model 50, which runs with one wait state. The marginal improvement in floating-point and video results is also attributable to the RAM architecture. The actual timing differences measured on the floating-point and video tests are on the order of 1 second, so no significant difference between the Model 50 and Model 50 Z is apparent.

The improvement in the floating-point performance of the Model 50 over the AT is due to the speed of the coprocessor. On the Model 50, the 80287 runs at 10 MHz—the CPU speed; on the AT, the coprocessor runs at only 5.33 MHz—two-thirds the CPU speed. This small architectural difference has a substantial effect on performance.

The applications portion of the benchmarks reflects the results of the low-level tests. The zero-wait-state RAM has a dramatic effect on the scientific/engineering results and is also seen in the spreadsheet tests. The faster hard disk drive affects the database results in particular, as well as improving the spreadsheet index.

Old Bottle, New Wine

As would be expected, the Model 50 Z is a fully software-compatible AT-class machine. Its 10-MHz, zero-wait-state architecture gives it a zippy performance for its class, but its \$4000 price tag may be too high for some. The MCA expansion slots and the use of 3½-inch disk drives may be a major factor in its suitability for a particular environment.

Overall, it is a well-engineered machine with a strong heritage. The Model 50 Z provides ample computing power for many applications, but it suffers from limited memory and expansion capabilities.

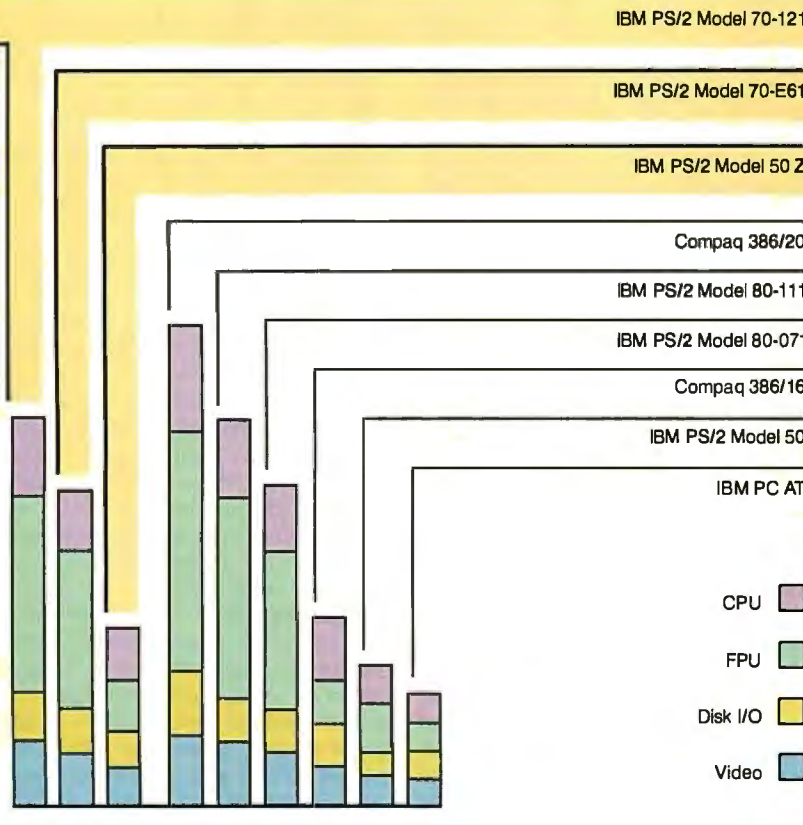
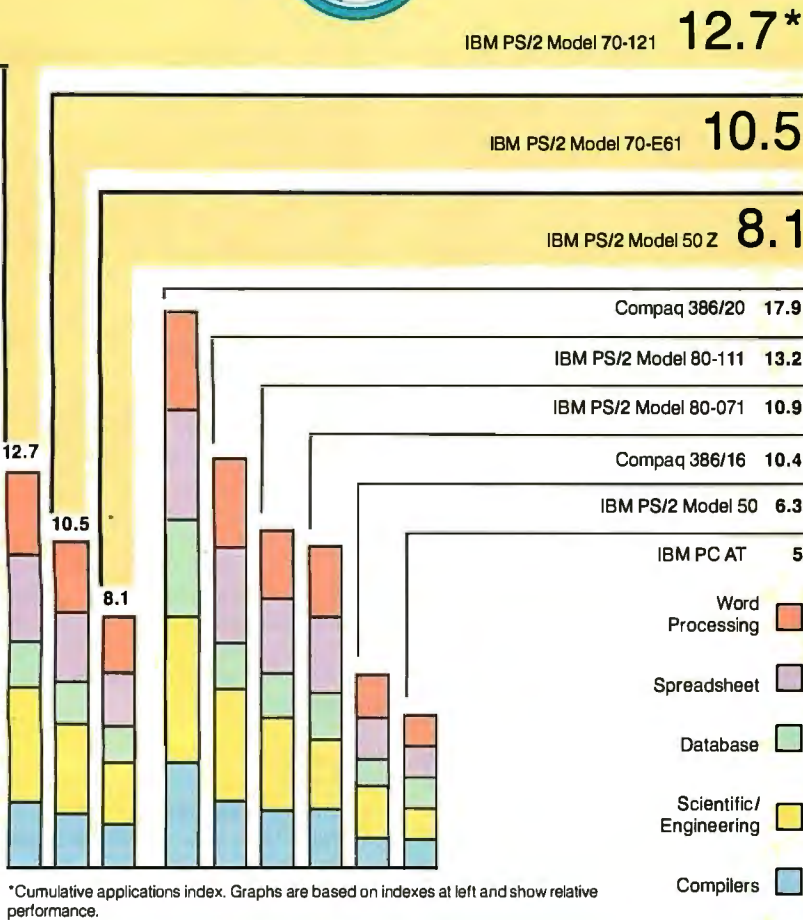

this memory is normally remapped to create a write-protected copy of the ROM BIOS at the appropriate address for DOS, just below the 1-megabyte point.

The disadvantage of this shadow RAM method is that with 128K bytes of RAM set aside for the BIOS, only 256K bytes remains besides the 640K-byte base DOS memory for any disk-cache program, RAM disk, or extended-memory needs. Adding a second megabyte of memory is highly desirable even if OS/2 isn't going to be used.

Video Capabilities

The VGA display subsystem is an integral part of the system board. The review units came with the 8513 and 8514 color monitors. The 8513 unit displays a crisp image on a 14-inch screen. The 8514 monitor, when used in association with the 8514/A Display Adapter, can display a resolution of 1024 by 768 pixels.

An optional 8503 monochrome monitor can display text and graphics in green on a black background. The 256 color modes possible on the VGA are displayed as 64 shades of gray.

The VGA itself can be considered an extension of the EGA standard. The CGA and EGA video standards are fully supported, and as a consequence, the MDA is supported via EGA emulation. Additional modes are offered on the VGA, including a 320- by 200-pixel, 256-color graphics mode; a 640- by 480-pixel, 16-color graphics mode; a 720- by 400-pixel mode in 16 colors or monochrome; and a 360- by 400-pixel, 16-color text mode.

The compatibility of the VGA implementation on the Model 70 is perfect. However, other manufacturers, such as Paradise Systems, Compaq (using the Paradise chip set), and Video Seven, have implemented a 16-bit version of the VGA that provides better performance in many circumstances than the 8-bit IBM version.

Micro Channel Architecture

The Model 70 includes two 32-bit Micro Channel architecture (MCA) expansion slots and a single 16-bit slot. The 16-bit slot has the video extension portion in addition to the standard 16-bit connections. An additional video board can use this extension to, for example, enable and disable the VGA on the system board, or to gain access to the VGA's video DAC (D/A converter). The 8514/A PS/2 Display Adapter uses this extension to route the output from the VGA to the 8514/A's external connector, allowing

continued

DADiSP..

Let Your Instruments
Do The Talking.™



Talk to your instruments with DADiSP-488. Use over 150 functions to display and analyze your waveforms, as easy as typing a name. Run external data acquisition software, or your own analysis programs. Create new functions with DADiSP Macros.



the First Spreadsheet
designed exclusively for
Scientists and Engineers.

(617) 577-1133

Ask about DADiSP for IBM-PC/XT/AT, DEC MicroVAX, HP9000, Masscomp 5000, and Sun Workstations. For further information write DSP Development Corporation, One Kendall Square, Cambridge, MA 02139, (617) 577-1133

Mention this magazine and receive an Evaluation Disk FREE. A \$20 value.



the user to switch between the two display systems.

The 32-bit slots include the Matched Memory cycle (MMC) extension found on the Model 80. A 16-MHz Model 80 can use this extension to allow a memory board to request a faster bus cycle, thus speeding memory accesses from the expansion bus. However, as on the 20-MHz Model 80, this extension is not used on the Model 70s and is a physical connection only. Only the -MMC CMD signal line is driven by the system board; it is the same as the -CMD signal on the 16-bit section of the expansion channel. Boards that request an MMC will operate, but not at the faster rate.

Physical Attraction

The Model 70s are packaged in a compact, if slightly too deep, system unit that measures 5½ by 14 by 16½ inches. A slightly wider machine that was not as deep would help economize on space in modular computer furniture, allowing more room for the keyboard.

Setting up a new machine is relatively easy: Simply plug in the display, keyboard, and power cables, and turn it on. You use the Model 70/80 Reference Disk to run the Setup program to configure the system.

Installing additional expansion boards or other options is also easy in the Model 70. Turn two thumbscrews to release the cover. Slide it forward about an inch before you lift it off. The expansion slots are on the left side of the unit, as is the math coprocessor socket. You may need to temporarily remove any installed expansion boards to insert the math coprocessor, but otherwise installation is straightforward.

An expansion board may include adapter description files as part of its configuration requirements. These files, which are supplied on a disk with the expansion option, should be copied to the working copy of the Reference Disk.

The inside of the Model 70 is similar to that of the original Model 50; there are no cables linking the system elements. The power supply is on the right side, the system board lies on the bottom of the case, and the hard disk drive, floppy disk drive, and speaker assembly are all mounted on a rigid frame over the system board.

The mounting frame is sturdy, molded plastic with mounting rails for the disk drives. A single printed circuit board mounted vertically contains the connectors used to link the disk drives to the system board. On the Model 50 and Model 50 Z, two circuit boards are used.

The hard disk drives in the review units are impressive. Despite their large capacity (60 megabytes and 120 megabytes), each has only 3½-inch diameter platters, instead of the more typical 5¼-inch. The rails in the molding suggest that a 5¼-inch version could be accommodated, however. As the hard disk controller is also an integral part of the hard disk drive, this may allow a larger-capacity hard disk (as yet unannounced) to be installed at a later date.

The system RAM is mounted on the system board via single in-line memory module connectors located under the disk drives. You can install or remove RAM by removing the second disk drive (if installed) and plugging in the SIMMs. The system can use either 1- or 2-megabyte SIMMs. Each Model 70 has three memory connectors. Six megabytes of system-board memory requires three 2-megabyte SIMMs, so upgrading the 70-E61 requires removing the standard 1-megabyte SIMM.

Sitting on the Bench

I tested the Model 70s with all the BYTE benchmarks. As expected, I found no incompatibilities with the IBM standard.

I compared the 16-MHz Model 70-E61 to the IBM PC AT, PS/2 Model 80-071, and Compaq 386/16. No software disk cache was installed on any of the machines. The Model 80-071 had a 70-megabyte ESDI hard disk drive, and the Compaq 386/16 had an 80287 math coprocessor rather than an 80387.

I compared the Model 70-121 with the IBM PC AT, the PS/2 Model 80-111, and the Compaq 386/20. Again, no software disk cache was installed on any of the machines. The Model 80-111 had a 115-megabyte ESDI hard disk drive.

The low-level benchmark results from the 16-MHz machines were most interesting in the CPU area. The difference between the paged-memory subsystem and a linear approach were obvious when I compared the Model 70-E61 and the Model 80-071. The byte-wide and word-wide String Move tests took similar amounts of time on the linear system (Model 80-071), whereas the Model 70-E61 showed improvement in performance of fetch in and out of a page. The Compaq 386/16 gave results very similar to those of the Model 70-E61, showing its similar paged-memory system. The effect of using a different math coprocessor was also apparent in the floating-point results, where the 80387 in the Model 70-E61 gave over three times the performance of the Compaq's 80287.

continued



COMPUTERS FROM IOWA SURPASS ALL OTHERS!

We at Gateway 2000 firmly believe that we are the best source for computers in the nation. We have over 2000 configurations available, all priced incredibly low and all backed by our unsurpassed service.

"We are very happy that our system is at the top of the stack in both price and performance, but it is your courteous service that is uncontested by the competition."

— Pierce Haviland — Kingston, NY

"Overall, I feel that your product is outstanding and your service has been excellent."

— Eric Snogren — Stonington, CT



12Mhz 286 EGA

- 512K Ram
- 1.2 Meg 5 1/4" Drive
- 1.44 Meg 3.5" Drive
- 40 Meg Hard Drive (28 MS)
- 1 to 1 Interleave
- Paradise EGA 480
- 14" EGA Monitor
- 1 Parallel / 2 Serial Ports
- 101 Key Keyboard
- MS DOS w/GW Basic

\$1895.00

16 Mhz 286 EGA

- 1 Meg 70NS Ram
- 0 Wait State (S.I. 17.3)
- 1.2 Meg 5 1/4" Drive
- 1.44 Meg 3.5" Drive
- 40 Meg Hard Drive (28 MS)
- 1 to 1 Interleave
- EVEREX EGA Board
- 14" EGA Monitor
- 1 Parallel / 2 Serial Ports
- 101 Key Keyboard
- MS DOS w/GW Basic

\$2395.00

New

386 SX \$2695.00

(Same configuration as above)



25 Mhz 386 VGA

- 1 Meg 60NS Ram
- Expandable to 8 Megs on MB
- 32 Bit Slot Open
- 1.2 Meg 5 1/4" Drive
- 1.44 Meg 3.5" Drive
- 80 Meg Hard Drive (28 MS)
- 1 to 1 Interleave
- 16 Bit PARADISE VGA Board
- NEC MULTI SYNCH II
- 1 Parallel / 2 Serial Ports
- 101 Key Keyboard
- MS DOS w/GW Basic
- 80387 and Weitek Sockets
- Vertical Style Case

\$3995.00

Same 386 as shown but 20 Mhz mono desktop.

\$2795.00



Steve Apiki & Stanford Diehl
Oct. 1988, **BITE**
Review of 20 386's

- "Emerging as truly exceptional..."
- "The Gateway delivers speed without sacrificing features."
- "The system ran without a glitch."
- "We were truly surprised to see a system of this caliber selling for less than \$3000."
- "When evaluating the whole package, The GATEWAY 386 surpasses all the others!"



Gateway 2000 • P.O. Box 2000 • Sgt. Bluff, IA. 51054

800-233-8472 / 712-943-2000

All systems have a 30 day Money Back Guarantee and 1 Year Warranty.
Due to the Volatility in the DRAM Market all prices subject to change.

The 16-MHz Model 70-E61's performance on the application benchmarks showed slightly slower performance than the 16-MHz Model 80-071, due to slight differences in the hard disk performances. The data transfer rate of the 60-megabyte drive in the Model 70-E61 is 8.4 megabits per second with an average access time of 27 milliseconds, and the Model 80-071's drive had a data transfer rate of 10 Mbps. This was especially noticeable in the spreadsheet and database

tests, which are disk I/O-intensive. The difference in the compiler index was not as significant as the index numbers would indicate because the actual timing difference between the two machines was only 1 second.

The performance differences between the Compaq Deskpro 386/16 and the Model 70-E61 were due to the Compaq's faster hard disk drive, reflected in the database results, and the Compaq's 80287 math coprocessor, reflected in the

scientific/engineering results.

The comparison of the 20-MHz machines showed a difference between the IBM MCA and the Compaq architecture. The memory cache controller on the Compaq Deskpro 386/20 gave dramatically faster results for the CPU test than either the Model 70-121 or the Model 80-111. The faster hard disk drive of the Compaq machine was also evidenced in the Disk I/O tests.

When the 20-MHz machines were compared using application benchmarks, there was little difference in the performance of the IBM machines. The difference in the timed results was on the order of only 1 second, with the particular Model 80 tested being the marginally faster machine. The Compaq 386/20 outperformed the Model 70-121, however, due to its memory cache controller system and faster hard disk drive. The Model 70-121's hard disk drive has a data transfer rate of 10.2 Mbps with an average access time of 23 ms. The Compaq 386/20 was over 35 percent faster in the application tests. The difference in architecture was particularly apparent in the disk-intensive tests.

The use of a software disk cache, which is supplied as standard with both the IBM and Compaq machines, will further improve their performance.

Down-Sized Model 80

The Model 70 is a much smaller system than the Model 80 and has fewer expansion slots. This might not be a penalty since the system unit has a serial port, a mouse port, and a parallel port as standard. The disk controller and the VGA are integral parts of the system board. Expansion slots might be needed for connectivity purposes—for example, network boards or internal modems. But unless you need large amounts of RAM (over 6 megabytes), the Model 70 has adequate expansion capacity with its two 32-bit and single 16-bit MCA slots. The 3½-inch floppy disk drives may be a disadvantage to some users.

The Model 70s are truly competitive machines in terms of price and performance. They offer good performance compared to other machines in their class. Their small size makes for a convenient desktop package. Overall, these machines are worth considering. ■

Caroline Halliday owns High Tech Aid, a consulting firm in Ellicott City, Maryland, that specializes in technical documentation and teaching for the PC environment. She can be reached on BIX c/o "editors."

FAX it HOLMES

Introducing FAX 'EM,™ the First Laptop Modem/Fax Card Combination

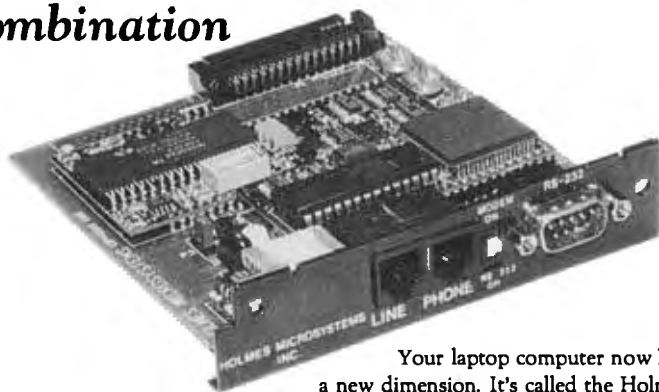

Your laptop computer now has a new dimension. It's called the Holmes

FAX 'EM,™ and it enables your laptop computer to work together with all Group 3 FAX equipment. Now you'll not only be able to send information from your laptop to a computer, but also to a FAX machine that will produce hard (printed) copy. Likewise, you can receive long distance information on your laptop screen from another computer or FAX machine and then turn that information into hard copy on any simple Epson™ compatible printer.

You have access to any document in your office file while you're away from the office. A salesman on the road can speed up ordering by instantly sending purchase orders, checking inventories, confirming bills of lading, etc.

Holmes is putting the electronic world's technology right in your lap—ready to use. If you would like to find out more about what the Holmes FAX 'EM™ can do for you, please contact your nearest Holmes dealer or call us toll free.

HOLMES
MICROSYSTEMS, INC.

2620 South 900 West
Salt Lake City, Utah 84119
1-801-975-9929

1-800-443-3034

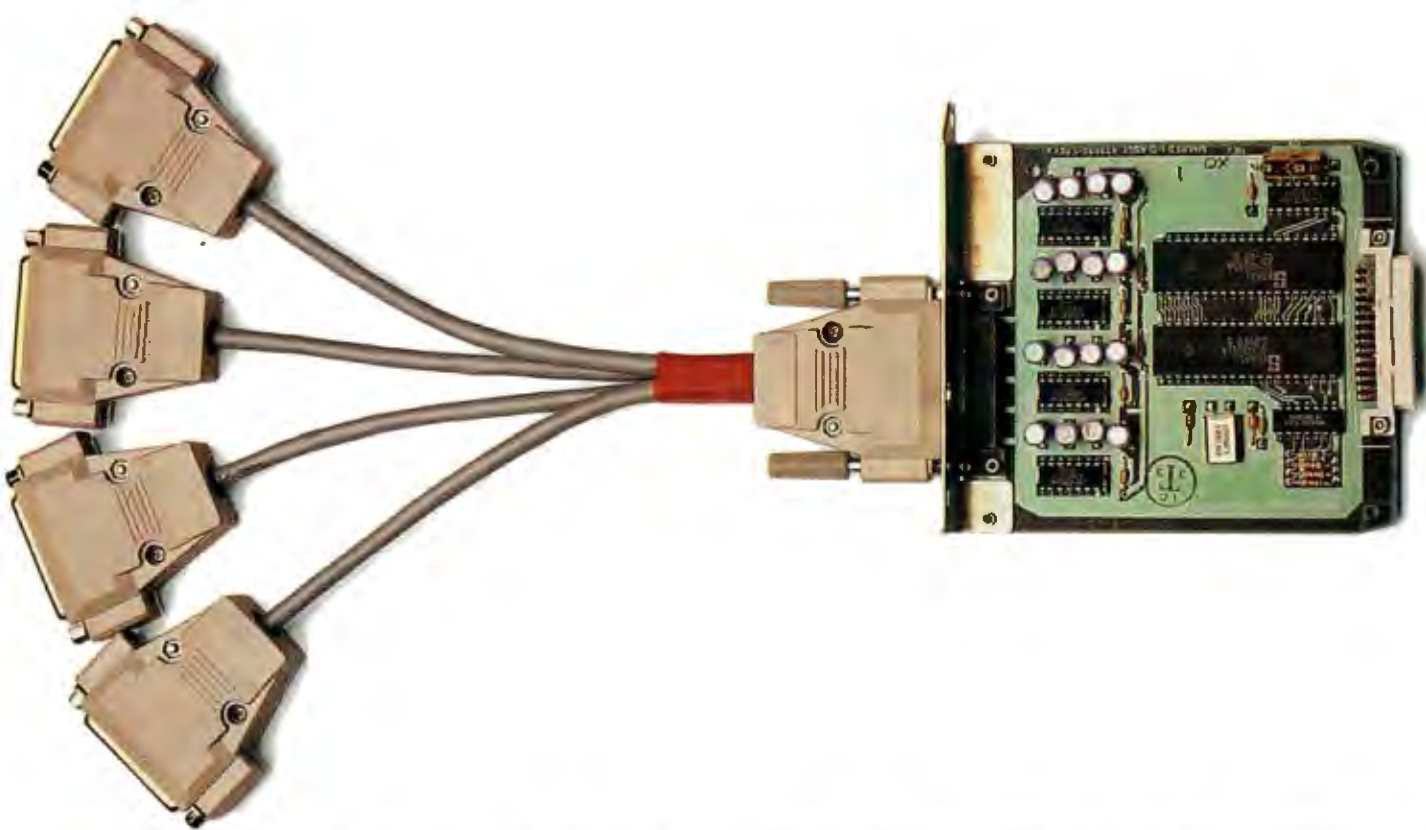

NOW YOU CAN CONNECT FOUR USERS TO ONE LASER PRINTER.

With the Mannesmann Tally® MT910 Laser Printer and its Multiuser Interface option, you can connect four users for just \$1050 each.

Each of you will have your own I/O port, programmable for your own protocol and emulation. Laser-crisp text and graphics at 300 dpi. All the specs you see in the center. And with an optional 5-bin sorter, even your own output bin.



THIS ONE.

- Speed: 10 pages-per-minute
- Dual paper cassettes standard, 250 sheets each.
- Dual output bins standard, 250 sheets each.
- Memory: 500K; 400K available to print graphics or download additional fonts.
- Manual feed handles single sheets, envelopes, transparencies, and labels.
- Emulations: Diablo® 630, Epson® FX, IBM® Proprinter™, HP® LaserJet Plus™, and Qume® Sprint II.
- Workload: 10,000 pages-per-month.
- Standard fonts: Courier 10. Prestige Elite 12 Letter Gothic 16.6 bold, italic, condensed, and expanded.
- Options: 4-user I/O extensive library of optional fonts in cartridge or downloadable formats 1.5 Mg RAM upgrade 5-bin sorter.

So call the number below for more information or to connect with your nearest dealer.

And he'll connect you with the only out-of-the-box laser printer on the market today that gives you so much for just \$1050 per user.

A Mannesmann Tally.

**MANNESMANN
TALLY
1-800-843-1347**

Ext. 187

Concurrent DOS 386

Think small in a big way

When you think multiuser/multitasking, think Concurrent™ DOS 386, the big name in small systems from Digital Research®, architects of the first standard operating system for personal computers. Now, Concurrent DOS 386 allows multiple users to share peripherals, files and applications, using serial terminal workstations linked by RS-232 cables to the system. It's fast, reliable and economical.

The big news today is small systems

Concurrent DOS 386 meets the increasing demands placed on small systems by supporting multiple DOS programs on both the system console and attached terminals. You can run popular programs such as Lotus® 1-2-3®, dBase® III, WordPerfect® and many more, with full math coprocessor support. The system runs up to 255 tasks simultaneously, with full intertask communications and byte-level record, file and device locking.

For people who hate waiting in line

Concurrent DOS 386 brings you all the remarkable speed and power of the Intel® 80386 processor. A prioritized pre-emptive scheduler allows task execution

and intertask communication by several users at near full processor speed while letting some tasks "interrupt" others according to the needs of each user.

A small system with a big memory

Concurrent DOS 386 gives you access to four gigabytes of linear physical memory. Its powerful memory paging capability fully supports the Expanded Memory Specification with no additional hardware or software.

Menus at a touch

Now you can create and customize menus, while programmable function keys let you condense complex commands to a single keystroke. The file manager runs standard operating system functions, plus you have an on-line help facility, text editor and support for DOS-based device drivers.

Multiuser color graphics

Now with the introduction of the newest member of the Concurrent DOS family, Concurrent DOS 386/Multiuser Graphics Edition, your demands for high-resolution EGA bit-mapped graphics in the workstation environment can

be met. Take advantage of advanced technology allowing you to run popular DOS-based graphics programs on individual workstations as well as on the system console without sacrificing system performance. Ask us about this exciting new version of Concurrent DOS 386.

All you have to remember is Concurrent DOS 386

Concurrent DOS 386 from Digital Research is the name to remember when it comes to 386 technology. The power and versatility of Concurrent DOS 386 are giving a new meaning to the word multiuser.

**CALL DIGITAL RESEARCH AT
1-800-443-4200 AND ASK FOR OUR
CONCURRENT DOS PROGRAMMER
INFORMATION KIT.**

**CONCURRENT DOS 386:
SHARING THE SYSTEM AFFORDABLY**

Digital Research and the Digital Research logo are registered trademarks, and Concurrent is a trademark of Digital Research Inc. Other product names are registered trademarks or trademarks of their respective owners. Specifications are subject to change without notice. Copyright © 1988, Digital Research Inc. All rights reserved.

 **DIGITAL RESEARCH®**



A Portable with Punch



Quick and expandable, Dolch's P.A.C. 386-20C strives to be the premier "luggable"

Mark L. Van Name

For a long time, Compaq's Portable 386 was the most powerful of the "luggable" portable PCs. Now a new contender, the Dolch P.A.C. 386-20C, has stolen the performance crown from Compaq. The unit needs some refining, however, before it

can match Compaq's overall quality.

The Dolch P.A.C. (for Portable Add-in Computer) 386-20C, like the Compaq Portable 386, has a 20-MHz 80386 CPU. Unlike the Compaq, however, the 386-20C has a cache: 64K bytes of 35-nanosecond static RAM (SRAM) that lets the 80386 run without wait states over 90 percent of the time. Dolch uses a combination of an Austek cache-controller chip and some other support logic to control this cache, rather than the more common Intel 82385 cache controller, but this cache system still increases the system's performance noticeably.

Dolch delivers all this performance in what looks like a gray lunch box. Standard equipment includes the 20-MHz 80386, the SRAM cache, a socket for a 20-MHz 80387, 1 megabyte of 100-ns dynamic RAM (DRAM), a 1.2-megabyte 5¼-inch floppy disk drive, a 20-

megabyte hard disk drive, two serial ports, one parallel port, and an electro-luminescent (EL) CGA-compatible display.

My evaluation unit also included some extras: a 20-MHz 80387, a second megabyte of memory, a 40-megabyte hard disk drive, and an internal 300-/1200-bit-per-second modem. To use it, you also need MS-DOS; Dolch sells version 3.30. My unit also came with a carrying case, which is almost de rigueur for portables.

The 386-20C's power doesn't come cheap: At \$7995, the standard 386-20C costs more than many desktop systems and slightly more than Compaq's Portable 386. My review system, with all the goodies, lists for \$10,840: a portable in five figures.

Dolch offers two slower versions of the Dolch P.A.C. for those with less cash. The Models 386-16 (\$6495) and 386-20 (\$6995) use a 16-MHz and 20-MHz 80386, respectively, but without the SRAM cache. Otherwise, all three models are similarly equipped.

Room to Grow

The 386-20C also includes a welcome treat in any portable: six expansion slots, two of which are empty in the standard unit. You get to these slots by removing the rear cover of the machine. One slot is dedicated to the system's 32-bit memory board. Four others accept standard AT-style expansion cards, although only two have room for full-length cards. The remaining slot can hold a half-length, XT-style expansion card.

If that's not enough growth space, Dolch will also offer an optional Back-Pac expansion chassis. Though the chassis is not yet available, Dolch says it will connect to an edge connector underneath the rear cover of 386-20C production systems. The Back-Pac chassis will include its own power supply and fan, and it will be able to hold up to three AT-style expansion cards.

continued

Dolch P.A.C. 386-20C

Company

Dolch Computer Systems
(a division of Dolch American
Instruments, Inc.)
2029 O'Toole Ave.
San Jose, CA 95131
(800) 538-7506
(800) 223-2077 (in California)

Components

Processor: 20-MHz 32-bit 80386 with compatibility speed of 6 MHz; socket for 20-MHz 80387 coprocessor
Memory: 1 megabyte of 32-bit 100-ns DRAM on system memory board or expansion card, expandable to 10 megabytes; 64K bytes of 35-ns SRAM cache; 256K bytes of BIOS ROM
Mass storage: 1.2-megabyte 5¼-inch floppy disk drive; 20-megabyte hard disk drive

Display: Electroluminescent CGA-compatible with four gray scales

Keyboard: 86-key modified PCAT-type layout; indicator lights for Caps Lock, Num Lock, and Scroll Lock

I/O interfaces: RS-232C serial port with DB-9 connector; DB-25 parallel port; RGB monitor port with DB-9 connector; DIN external keyboard connector; 32-bit expansion slot for proprietary system memory card; one 8-bit half-size expansion slot; two 16-bit full-size expansion slots; two 16-bit half-size expansion slots

Size

15½ × 8 × 9½ inches; 22 pounds

Software

None

Options

2-megabyte RAM expansion: \$995
6-megabyte RAM expansion: \$3795
10-megabyte RAM expansion: \$5995
20-MHz 80387 math coprocessor: \$1195
40-megabyte hard disk drive: \$225
80-megabyte hard disk drive: \$995
170-megabyte hard disk drive: \$2495
Substitute 1.44-megabyte 3½-inch floppy disk drive: \$50
Internal 1200-bps modem: \$130
Internal 2400-bps modem: \$240
Carrying case: \$150
MS-DOS 3.30 with GWBASIC: \$150
EGA resolution subsystem: \$995

Documentation

50-page operation manual

Price

P.A.C. 386-16: \$6495
P.A.C. 386-20: \$6995
P.A.C. 386-20C: \$7995
System as reviewed: \$10,840

Inquiry 854.

If that's still not enough space, you can chain up to five of these Back-Pac chassis together for a total of 17 possible expansion slots. But each expansion chassis will weigh about 5 pounds without any cards in it, so you aren't likely to carry them around.

The 386-20C is also expandable in other ways. You can add memory to its system memory board via daughterboards, up to the current system maximum of 10 megabytes. You can also replace the standard 20-megabyte hard disk drive with optional 40-megabyte, 80-megabyte, or 170-megabyte drives.

By combining these expansion options with the expansion chassis, you can have a PC that you can take on the road and that still has enough power to be your main desktop system.

Using It

Part of the appeal of any portable is that you can take it with you. But you pay a price for all the 386-20C's power when you take it on the road: It's heavy. The evaluation unit weighed a hair over 22 pounds, 2 pounds more than the Compaq Portable 386. The carrying case adds a couple more pounds.

Once you've got where you're going, however, the system's display and keyboard have to be reasonable to use. Overall, although its keyboard leaves something to be desired, the 386-20C is more than acceptable.

A big attraction is its screen, which offers a 9¼-inch diagonal viewing area and a backlit EL display that shows yellow characters on a dark gray background. The EL technology gives a contrast ratio of up to 20 to 1, so the screen is readable in any light. The display simulates CGA colors with four gray scales, and the screen tilts to give you a comfortable viewing angle. You can flip a switch on the screen to reverse the colors, but I thought the yellow background was too strong.

About the only thing wrong with this display is that its aspect ratio is slightly off, so true circles, like pie charts, appear a bit oval. On balance, however, EL technology is a step forward from the current portable liquid crystal display and gas-plasma standards. You can probably expect to see many other portable manufacturers adopt it in the future.

The card that controls the EL screen will also support an external CGA or monochrome monitor. You even get Hercules emulation with a monochrome monitor, and an EGA option will work with both the internal EL screen and any EGA-compatible external monitor.

Unlike the display, the keyboard is

nothing special. On the good side, it detaches from the front of the unit, where it protects the screen, and it's nearly full-size. The 86 keys are in the standard AT arrangement, except that there are 12 function keys, not 10, and they run across the top of the keyboard rather than down the left side.

The real problem with this keyboard is its feel. It seems insubstantial, almost as if the keys are hollow. Fortunately, it plugs into a standard keyboard connector that will work with any AT-compatible keyboard. I suggest buying a keyboard you like for desktop use and putting up with this one when you're on the road.

Fastest Portable

Once you're past the keyboard and display, the main issues for a portable are the same as for any desktop system: speed and compatibility.

The 386-20C wins the portable speed race—at least for now. With the exception of the Graphics and Floating-Point tests, the 386-20C surpassed the Compaq Portable 386 in BYTE's low-level benchmarks, and its overall application index is about 7 percent faster.

Regarding compatibility, on the software side, the news is good. I threw a lot of programs at the 386-20C, including Borland's Reflex 1.14, SideKick Plus 1.0, SuperKey 1.16A, Turbo Basic 1.1, Turbo C 2.0, and Turbo Pascal 4.0; Digitalk's Smalltalk/V 1.2; Kermit 2.30; Lotus 1-2-3 version 2.0; MicroPro's WordStar 3.3 and 4.0; Microsoft's PC Paintbrush 2.0, Windows/386 2.03, and Word 4.0; Norton Utilities 3.0; Quarterdeck's DESQview 2.0, with its Expanded Memory Manager 386 version 1.10; and Symantec's Q&A 1.1. They all worked.

However, I did encounter two minor problems during the software tests. The first occurred when the 386-20C would not pass 1-2-3's keydisk copy-protection check. I had to slow the system to its compatibility speed of 6 MHz before I could run 1-2-3, something that happens fairly often with the newer high-speed PCs. Unfortunately, the only way to slow the unit was with a SETSPEED program that I could invoke only from MS-DOS.

A call to Dolch revealed that the company was replacing my test machine's ROM BIOS (Phoenix ROM BIOS 1.10 B2) with the AMI ROM BIOS 5.0, which lets you change processor speeds from the keyboard. The ROM BIOS wasn't the only component that Dolch was changing; the I/O board, keyboard controller, and internal modem were all different.

continued



Dolch P.A.C. 386-20C

APPLICATION-LEVEL PERFORMANCE

Dolch P.A.C. 386-20C **13.6***

WORD PROCESSING

XyWrite III+ 3.52	Medium/Large
Load (large)	:11
Word count	:02/:16
Search/replace	:05/:21
End of document	:01/:13
Block move	:10/:10
Spelling check	:08/:50

Microsoft Word 4.0

Forward delete	:11
----------------	-----

Aldus PageMaker 1.0a

Load document	:12
Change/bold	:24
Align right	:17
Cut 10 pages	:15
Place graphic	:04
Print to file	1:54

□ Index: **2.96**

SPREADSHEET

Lotus 1-2-3 2.01

Block copy	:03
Recalc	:01
Load Monte Carlo	:17
Recalc Monte Carlo	:04
Load rlarge3	:04
Recalc rlarge3	:01
Recalc Goal-seek	:07

Microsoft Excel 2.0

Fill right	:04
Undo fill	1:29
Recalc	:02
Load rlarge3	:19
Recalc rlarge3	:01

□ Index: **2.78**

DATABASE

dBASE III+ 1.1

Copy	:50
Index	:21
List	1:51
Append	:46
Delete	:02
Pack	1:16
Count	:18
Sort	1:18

□ Index: **1.68**

SCIENTIFIC/ENGINEERING

AutoCAD 2.52

Load SoftWest	:44
Regen SoftWest	:33
Load StPauls	:10
Regen StPauls	:05
Hide/redraw	9.22

STATA 1.5

Graphics	:23
ANOVA	:18

MathCAD 2.0

IFS 800 pts.	:15
FFT/IFFT 1024 pts.	:15

□ Index: **3.79**

COMPILERS

Microsoft C 5.0

XLisp compile	3:58
---------------	------

Turbo Pascal 4.0

Pascal S compile	:05
------------------	-----

□ Index: **2.37**

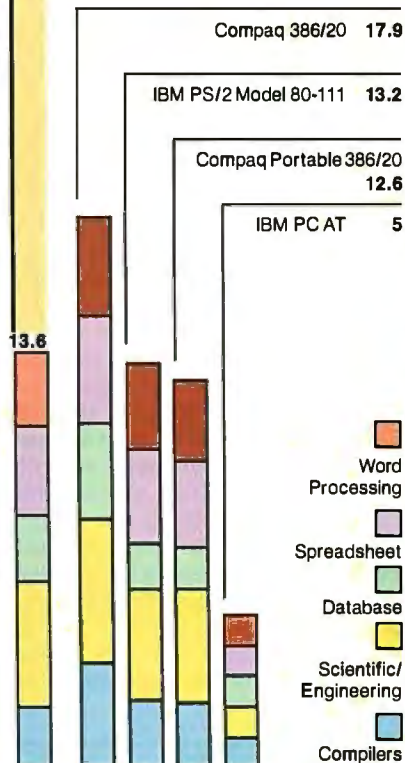

* Cumulative applications index. Graphs are based on indexes at left and show relative performance.

All times are in minutes:seconds. Indexes show relative performance; for all indexes, an 8-MHz IBM PC AT=1.

LOW-LEVEL PERFORMANCE¹

Dolch P.A.C. 386-20C

CPU

Matrix 3.55

String Move

Byte-wide 31.36

Word-wide:

Odd-bnd. 31.25

Even-bnd. 15.69

Doubleword-wide:

Odd-bnd. 23.45

Even-bnd. 7.86

Sieve 18.84

Sort 14.34

□ Index: **3.30**

FLOATING POINT

Math 12.08

Error² 0.00E+00

Sine(x) 2.80

Error 2.00E-09

π³ 3.09

Error 1.00E-09

□ Index: **5.35**

DISK I/O

Hard Seek³

Outer track 3.27

Inner track 3.35

Half platter 10.00

Full platter 16.64

Average 8.32

DOS Seek

1-sector 15.16

32-sector 44.56

File I/O⁴

Seek .08

Read 1.07

Write .97

1-megabyte

Write 6.12

Read 7.25

□ Index: **1.41**

VIDEO

Text

Mode 0 6.22

Mode 1 6.26

Mode 2 7.91

Mode 3 7.91

Mode 7 N/A

Graphics

CGA:

Mode 4 1.65

Mode 5 1.64

Mode 6 1.76

EGA:

Mode 13 N/A

Mode 14 N/A

Mode 15 N/A

Mode 16 N/A

VGA:

Mode 18 N/A

Mode 19 N/A

Hercules N/A

□ Index: **2.23**

CONVENTIONAL BENCHMARKS

LINPACK 243.96

Livermore Loops⁵

(MFLOPS) .09

Dhrystone (MS C 5.0)

(Dhryst/sec) 5952

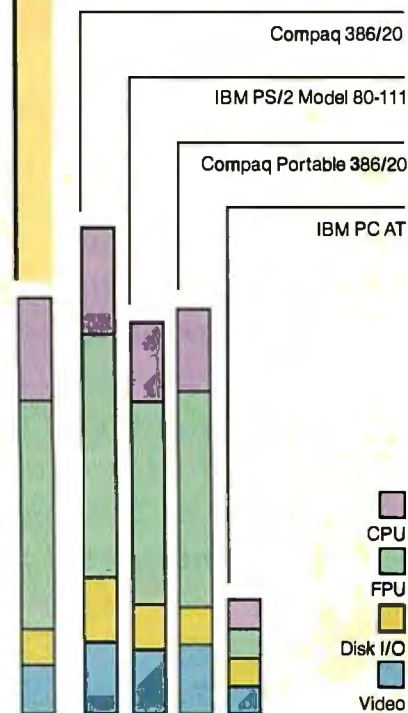

N/A=Not supported by graphics adapter.

¹ All times are in seconds. Figures were generated using the 8088/8086 and 80386 versions (1.1) of Small-C.

² The errors for Floating Point indicate the difference between expected and actual values, correct to 10 digits or rounded to 2 digits.

³ Times reported by the Hard Seek and DOS Seek are for multiple seek operations (number of seeks performed currently set to 100).

⁴ Read and write times for File I/O are in seconds per 64K bytes.

⁵ For the Livermore Loops and Dhrystone tests only, higher numbers mean faster performance.

The company sent a new unit, which the BYTE Lab benchmarked for this review.

My other software problem was inherent in the system's use of gray scales to mimic colors. Some products that make extensive use of colors in their operational displays, such as Borland's compilers, often produced barely readable screens. Dolch says that you can get around this problem by getting the offending software to use different colors, but that's a less-than-ideal solution. Another option is to buy the EGA option, but that further runs up the cost of an already expensive machine.

In my hardware tests, the machine didn't fare as well. My Microsoft Serial Mouse and Everex Evercom II internal 2400-bps modem worked fine, but I had problems with the modem that came with the unit and with an Intel Above Board AT memory-expansion board. Dolch says it has switched to Everex internal modems, and the modem in the updated machine functioned properly. The company was unaware of any problems with the Intel Above Board, and I was unable to test it in the new machine in time for this review.

Far more annoying was that the evaluation unit lost track of its keyboard just about every time I rebooted. The only way to get it to recognize the keyboard was to reboot over and over until the keyboard started working. I guessed that a faulty Phoenix keyboard controller was responsible, as did a Dolch spokesperson. The second unit, with its new keyboard controller, had a similar problem after the BYTE testing editors loaded a file in AutoCAD 2.52, but otherwise it worked satisfactorily.

Follow-up

While investigating these problems, I had several long chats with Dolch's support people, who were always cheerful, knowledgeable, and helpful. Dolch prefers that you call your dealer for support. But if you must call Dolch, the company has a toll-free number.

In contrast to Dolch's technical support, the 386-20C's documentation was nearly useless. If you're a novice user, you might like the MS-DOS introduction and beginner's glossary, but how many novices are going to buy a portable computer at this price? Most users will find

the slim 50-page manual sorely lacking.

If you have a problem that neither the documentation nor Dolch's support group can solve, you can take advantage of the 386-20C's 1-year parts and labor warranty. You pay shipping to San Jose, and Dolch pays for the return trip.

Power to Go

On balance, I liked the 386-20C. It offers a lot of power and room to grow in a package that's heavy but still luggable. Unfortunately, my evaluation unit seemed less than finished. It had several hardware problems, and Dolch was replacing the keyboard controller, I/O board, ROM BIOS, and internal modem as this review went to press.

I also disliked the keyboard, but the EL screen is great. And the 386-20C sure is fast. If Dolch stabilizes this machine, it could be a good alternative for those who want a luggable—and are willing to pay for it. ■

Mark L. Van Name is a freelance writer and computer consultant living in Durham, North Carolina. He can be reached on BIX c/o "editors."

Subscription Problems?

We want to help!

If you have a problem with your BYTE subscription, write us with the details.

We'll do our best to set it right. But we must have the name, address, and zip of the subscription (new and old address, if it's a change of address). If the problem involves a payment, be sure to include copies of the credit card statement, or front and back of cancelled checks.

Include a "business hours" phone number if possible.



BYTE

Subscriber Service, P.O. Box 7643, Teaneck, NJ 07666-9866





PS/2 model 30/20 meg	1775
PS/2 model 50/20 meg	2595
PS/2 model 60/40 meg	3395
PS/2 model 60/71 meg	4100
PS/2 model 80/40 meg	4595
PS/2 model 80/115 meg	6295

Call for other models

COMPAQ

386 S 40 meg	3695
386 130 meg/20 MHz	6295
286 40 meg	2295
386 110 meg/25 MHz	7495
386 60 meg/20 MHz	5295
Portable III 40 meg/12 MHz	4095

CARD & MONITOR EXTRA

Call for other models

Macintosh

Mac-SE/20 Meg	2849
Mac-II/40 Meg	4249
Mac-SE12 Drive	2295
Call for 60 and 100 Meg	
Lazer NT	3695
Lazer NTX	5295

LOW PRICE LEADER

SINCE 1983

LAP-TOP

Compaq SCT 286-20	Call
SLT 286-40	Call
Toshiba T1000	769
T1200F	1395
T1200HB	2395
T3200-40 Meg	3595
T5100	4695
Zenith Supersport	
286-20 Meg	3195
286-40 Meg	3695
8088-20 Meg	Call
Epson LT	Call
NEC	Call
Mitsubishi 286-20	2595



Everex

Step 286 - 12 & 16 MHz & 20 MHz
1 Meg RAM
Set up utility in ROM
S/P, C/C
Enhanced keyboard
1.2 MB floppy
DOS/BASIC

Call! for your configuration

Everex

Step 386-20 MHz & 16 MHz & 25 MHz
256K cache of very high speed RAM
2 Meg RAM, expandable to 16 Meg
S/P, C/C
Enhanced keyboard
1.2 MB floppy
DOS/BASIC
Everex 1800 Available

Call!

AST

AST 386 40 Meg	3495
AST 286 model 80	1595
AST 286 model 120	Call
AST 286 model 140	2595

CARD & MONITOR EXTRA

WE STOCK

CITIZEN
OKIDATA
EVEREX
GOLD STAR

TOSHIBA
NEC
WYSE
HITACHI

PRINCETON GRAPHICS
SONY
ACER
HOUSTON INSTRUMENTS

AMDEK
HAYES
SAMSUNG
CALCOMP

PC MOUSE
MICROSOFT MICE
LOGITECH
MITSUBISHI

IRWIN & ARCHIVE
TAPE BACK
TAXAN
MAGNOVOX

BOARDS

Paradise VGA	285
Vega VGA	279
Everex EVGA	265
Everex EGA	145
Tatung 16 bit	275

SOFTWARE SPECIALS

dBase IV	455
Wordperfect	218
Aldus Pagemaker	450
Ventura Publisher	475
Clipper	415
Quatro	145



NOVELL
Authorized Dealer

PRINTERS

EPSON

LX-800/LQ-500	195/315
LQ-850/1050	535/735

OKIDATA

320/321	335/460
390/391	460/635

TOSHIBA

321-SL/341-SL	485/595
351-SX 350 CPS	945

BROTHER

1709-9 PIN	425
1724-24 PIN	595

LASER PRINTERS

HP Laser II	1695
HP Desk Jet	675
Panasonic 4450	1549
Brother HL-8	1895
Nec LC 890	3295
PageLaser 12	\$\$\$\$

MONITORS

Nec Multisync II	575
Nec Multisync Plus	875
Nec Multisync XL-19"	1995
Samsung EGA	335
Goldstar VGA	375

FAX MACHINES

Sharp FO 220	950
Sharp FO 420	1195
Canon	Call
Minolta	Call
Brother	Call
Richo	Call

Intel Coprocessors

8087-3	105
8087-2	145
80287-6	175
80287-10	285
80387-16	485
80387-20	595
80387-25	695

MODEMS

Everex 1200 Int	89
Everex 2400 Int	149
Hayes 1200 B	275
More in Stock	Call

WE ACCEPT LC, CASHIER CHECKS, MONEY ORDERS, VISA, MC, AmEx
3% charge on VISA, MC & 5% on American Express

EXPORTS Available

COMPUTERLANE

HOURS:
M-S 9-6

1-800-526-3482 (Outside CA)
(818) 884-8644 (In CA)
(818) 884-8253 (FAX)

22107 ROSCOE BLVD.
CANOGA PARK
1/2 BLOCK W. OF TOPANGA
CA 91304

CORPORATE ACCOUNTS WELCOME
CALL FOR VOLUME DISCOUNTS
CONSULTANTS CALL FOR PRICING

Prices subject to change without notice

Compaq is a Registered Trademark of Compaq
IBM is a Registered Trademark of International Business Machines



"The Dataworld 286 [12MHz] AT compatible... [is]... the fastest machine of the nine tested in that review [July 1988]."

and
... speed and excellent compatibility... hundreds of dollars less expensive than other AT compatible.



EDITOR'S
CHOICE

NOW!
20MHz 286
SI = 22.5

"Marvelously cheap, powerful alternative ... outperformed the other 286's ..."

(October 11, 1988)



DATA-286 12MHz

80286 running at 8/12MHz, 0/1 wait state
Phoenix BIOS std. (Award BIOS opt.)
512KB of RAM, expandable to 1MB on board
Socket for 80287-8, -10
200W power supply
Real-time clock with battery backup
1.2MB floppy disk drive
Floppy/hard disk controller
(1:1 interleave controllers available)
101-key keyboard with "click"
Mono card w/parallel port (720x348)
TTL monitor with tilt/swivel base

\$1195



Portacomp II

80286 running at 8/12MHz, 0/1 wait state
Phoenix BIOS std. (Award BIOS opt.)
512KB of RAM, expandable to 1MB on board
Socket for 80287-8, -10
Real-time clock with battery backup
1.44MB 3.5" floppy disk drive
20MB, 39ms, self-parking hard drive
102-key keyboard with "click"
Supertwist backlit LCD, 640x400 res.
RGB/monochrome output port
Weighs under 20 Lbs.
1.2MB external floppy drive opt.
Carrying case available

\$1975



DATA-286 20MHz

80286 running at 10/20MHz
AWARD BIOS std.
1MB of RAM, exp. to 2MB on board
EMS 4.0 support for memory over 1MB
Socket for 80287
200W power supply
Real-time clock with battery backup
1.2MB floppy disk drive
1:1 interleave floppy/hard disk controller
101-key keyboard with "click"
Mono card w/parallel port (720x348)
TTL monitor with tilt/swivel base

\$1555

COMPLETE 10MHz DESKTOP SYSTEMS FROM \$945.00



Vertical Case

Front panel on/off switch
220W power supply
6 half-height drive bays
Dimensions: 16 3/4" (D) x
7 3/8" (W) x 25 5/8" (H)
Available for 286-/386- models



DATA-386

4.77/6/8/16MHz (20MHz opt.)
1MB of RAM, exp. to 10MB
Phoenix BIOS std. (Award opt.)
220W power supply
1.2MB floppy disk drive
Floppy/hard disk controller
101-key keyboard with "click"
Five 16 and two 8-bit slots
Mono card and monitor **\$1995**



Portacomp I

80286 8/12MHz, 0/1 wait
Phoenix BIOS std. (Award opt.)
512K RAM (exp. to 1MB)
200W power supply
1.2MB 5.25" floppy drive
20MB hard disk drive
Supertwist backlit LCD
RGB output port
5 expansion slots
1 parallel, 2 serial ports **\$1875**



Dataworld Keyboard

101-key enhanced layout
L-shaped large return key
Integrated dust cover (paper rest)

\$89



Color-coded key set for
WordPerfect available



Prices subject to change. No charge for credit card, check, C.O.D. 30 day moneyback guarantee (Shipping charges non-refundable).

Dealer/overseas inquiries welcome

In-Calif. 1-800-722-7734 INFO: (213) 695-3777

Out-Calif. 1-800-722-7702 TECH: (213) 699-8250

Monday through Friday, 7 A.M. to 6 P.M. Saturday 9 A.M. to 3 P.M. PST.

3733 San Gabriel River Parkway, Pico Rivera, CA 90660-1495

A PREFERRED COMPUTER SYSTEM





A Great Communicator

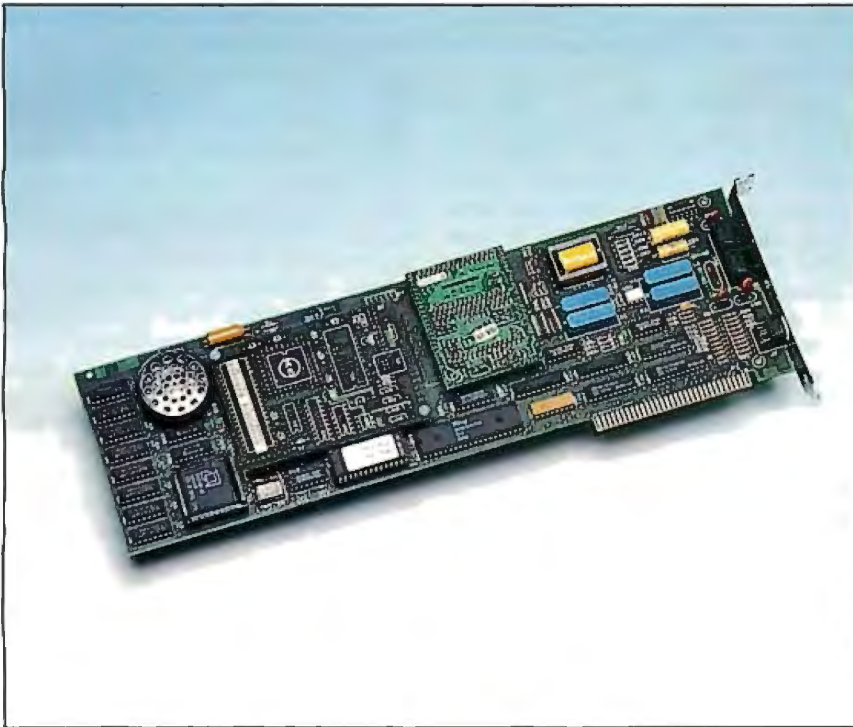

Intel's Connection CoProcessor offers fax, file transfer, and E-mail capabilities on one board

Nick Baran

Intel may be a little late to the party with its Connection CoProcessor PC facsimile board, but it has delivered a solid product. This \$995 full-length add-on fax board features a 10-MHz 80188 microprocessor, 256K bytes of memory, and an expansion socket for adding an optional 2400-bit-per-second Hayes-compatible modem card.

The board's most powerful feature is its on-board microprocessor, which can send or receive fax images, text, or binary files in the background while you continue working in other applications. But the board is also of interest because it supports the new Intel/DCA Communicating Applications Specification.

CAS is an application-programming interface that Intel hopes software developers will use to provide transparent fax communications via the Connection CoProcessor from within their applications.

Intel provides the underlying hardware and software to support the interface. Users will then be able to send and receive files or faxes without leaving their current application. Intel says that several developers, including WordPerfect, Microsoft, and Symantec, plan to incorporate CAS into their applications, but no products were available in time for this review.

The CoProcessor supports Group III fax and binary-file transmission between CoProcessor boards at 9600 bps. While fax transmissions support the CCITT Group III standard, high-speed binary-file transfers require a Connection CoProcessor on each end.

The CoProcessor's Connect software accepts PCX, DCX, and PIC graphics files (when incorporated into DCX files) for faxing. The software stores incoming fax transmissions in PCX format. You can view or print these images, or save them for use with the CoProcessor's graphics editor, which is a version of Z-Soft's PC Paintbrush.

From Fax to E-Mail

Connect, the CoProcessor's menu-driven communications software, lets you send and receive files, faxes, and electronic mail messages, and a set of utilities lets you edit PCX files, maintain phone books, log transmissions and events, poll other CoProcessors, and maintain files. The main menu also displays information on how many faxes, files, or E-mail messages are waiting.

Connect's Mail module is actually a file-transfer utility that lets you create, edit, and send text messages between CoProcessors. You can also attach binary files to a mail message. The Mail function works only with other CoProcessor boards, however.

If you have a scanner, Connect has an option for loading scanned files for use in fax or file transmissions. However, it doesn't include optical character-recog-

continued

Connection CoProcessor

Type

Add-on fax board and software

Company

Intel PCEO
5200 Northeast Elam Young Pkwy.
Hillsboro, OR 97124
(800) 538-3373

Features

On-board 10-MHz 80188 microprocessor with 256K bytes of RAM; Group III fax transmission or 9600-bps half-duplex file transfers between CoProcessors; menu-driven Connect software with fax, E-mail, and file-transfer modules; graphics editor based on PC Paintbrush; software available on four 5¼-inch or 3½-inch floppy disks

Hardware Needed

IBM PC, XT, AT, or compatible with 640K bytes of RAM, graphics adapter and monitor (CGA, EGA, or VGA), and hard disk drive; mouse recommended

Software Needed

MS-DOS 3.0 or higher

Option

2400-bps modem daughterboard: \$295

Documentation

Installation booklet; 100-page User's Manual; 100-page Graphics Editor Manual

Price

\$995

Inquiry 856.

nition software for converting text-based fax images to ASCII text format. As a result, you're limited to viewing and editing them with the graphics editor.

Intel says it's working with OCR vendors and will eventually provide upgraded software that will let you edit faxed documents as text files. In the meantime, the best alternative is to simply print out fax documents. To do so, however, you'll need a graphics-mode printer.

Setup's a Snap

I tested the Connection CoProcessor with the 2400-bps modem option on an IBM PC XT with an 80286 accelerator card, EGA graphics, an expansion unit, and an Above Board with 1.5 megabytes of expanded memory, which the CoProcessor automatically uses. The software

that I used was version 1.0.

The Connection CoProcessor comes with a separate installation guide and two spiral-bound manuals—a general user's guide for the board and Connect software, and a guide for the graphics editor. As with other Intel products I've used, the installation documentation and procedures were easy to follow and straightforward. You install the modem card in the expansion socket on the CoProcessor board, set a DIP switch on the board specifying the serial port number (COM1 or COM2), and plug the board into the PC. There are also DIP switch settings for changing the I/O address for the board, but most users won't have to adjust them.

After installing the board, you plug the RJ-11 cables from the telephone and the phone-line wall outlet into the CoProcessor. This arrangement lets you use the same phone line for both your telephone and the CoProcessor. It also makes it possible to send files between CoProcessors during a voice-initiated call, although the procedure is rather involved.

Since I was using an expansion unit, I didn't have to worry about overloading the power supply. The CoProcessor consumes close to 3 amps at 5 volts, however, and the installation guide warns that the power supply on an old IBM PC or Compaq portable may not be adequate. If you have a machine with a 60-watt power supply, you may need to upgrade to a heftier power supply when you install the CoProcessor.

Software installation involves following a menu-driven installation program that updates your AUTOEXEC.BAT and CONFIG.SYS files and lets you configure the CoProcessor for your printer, graphics display, and input device. The CoProcessor software works fine with just the keyboard, but you should have a mouse for use with the graphics editor. The installation procedure also provides options for changing the communications parameters (e.g., number of rings or number of dialing attempts), but most users won't need to alter these settings.

Sending a Fax

Once the Connection CoProcessor is installed, you're ready to send your first fax. Sending faxes and files is simple. First, you execute the Connect program, which brings up the main CoProcessor menu. You select Fax from the main menu if you want to send faxes, or Transfer if you want to send files to other CoProcessors. Then you select the phone number (or a group of phone numbers)

from your phone directory, select the file (or files) to send, and then either start the transmission immediately or specify the time at which you want it to occur. You can then exit from the program, and the CoProcessor takes care of the rest automatically.

In automatic answer mode, the CoProcessor is ready at any time to receive file or fax transmissions. You may be working away in your word processor, for example, and hear a beep signaling that the CoProcessor has received a call. As you work, the hard disk drive light will come on as the CoProcessor saves the file or fax. Later, you can execute Connect and view the received file.

Connect's menu-driven interface is easy to use and consistent: You simply move the cursor to the desired item and select it with the mouse button or Return key. When you first invoke Connect, it reports how many unread faxes, files, and mail messages you've received. Connect stores received files in a special directory, where you can view, print, delete, or save them. This is a temporary storage area, however, so you must select Save for all files you want to keep. If the received file is a text or binary file, you must save it before you can use it with other applications software (or before you can run it, if it's an .EXE file). If the received file is a fax image, saving it makes the file available for use with the graphics editor.

Connect maintains an internal log of files it receives, so you should always use Connect's file management utilities when deleting received files. If you fail to do this, you may have to completely reinstall the software.

One problem with Connect is that it's extremely slow when calling up a received fax image for viewing or editing; the process can take a couple of minutes for a complex image. An Intel spokesperson said that the company plans to address this problem in its next release.

Also, since there's more than one way to feed an image into a stand-alone fax, you may receive images upside down. You can use the graphics editor to rotate the image, but this takes time to accomplish and only works if the entire image fits on one screen. There is a similar problem with faxes that are oriented horizontally (landscape orientation). The only way to properly view such fax images is to print them.

You can also use the graphics editor to design cover pages for your fax transmissions or to create graphical images for conversion to fax image format. The edi-

continued

Compuclassics

WE WELCOME INTERNATIONAL ORDERS

1 818 705-4885 FAX

SOFTWARE

ALDUS	
Pagemaker 3.0.....	539.00
AMERICAN SMALL BUSINESS	
Design Cad.....	159.00
Design Cad 3D.....	159.00
ASHTON TATE	
Multimate II.....	279.00
Dbase IV.....	489.00
Rapidfile.....	195.00
Framework II.....	429.00
Chartmaster.....	229.00
Master Graphics.....	299.00
ASK SAM SYSTEM	
Ask Sam.....	235.00
AUTODESK	
Autosketch Enhanced.....	65.00
BLOC DEVELOPMENT	
Formtool W/Greatest Hits.....	59.00
BOEING COMPUTER SERVICES	
Boeing Graphics (3D Color).....	209.00
BORLAND	
Sprint.....	125.00
Sidekick.....	55.00
Sidekick Plus.....	125.00
Eureka.....	99.00
Quattro.....	149.00
Turbo Database Toolbox.....	62.00
Turbo Graphix.....	62.00
The Developer's Library.....	235.00
Turbo Lightning.....	62.00
Reflex.....	90.00
Superkey.....	62.00
Turbo Prolog.....	62.00
Turbo Basic.....	62.00
Turbo C 2.0is95.00.....	
Paradox V 2.0.....	429.00
Turbo Pascal 5.0.....	95.00
Turbo Tutor 4.0.....	45.00
BRIDGEWAY PUBLISHING	
Fasttrax.....	49.00
BRODERBUND	
Print Shop.....	35.00
Memory Mate.....	45.00
BUTTONWARE	
PC File +.....	45.00
CENTRAL POINT	
Copy II PC.....	25.00
Copy II PC Option Brid Dix.....	109.00
PC Tools Deluxe.....	39.00
CHROMOS	
Who What When.....	149.00
COMPUTER ASSOCIATES	
Supercalc IV.....	299.00
Superproject Expert.....	445.00
ACCPAC BPI.....	275.00
Silverado.....	99.00
CONCENTRIC DATA SYSTEMS	
R & R Relational Report.....	109.00
CORE INTERNATIONAL	
Corefast.....	89.00
DAC	
Easy Accounting 3.0.....	59.00
Easy Payroll 3.0.....	59.00
Bonus Pack 3.0.....	115.00
UTILITIES	
Org Plus.....	59.00
1 Dir PLUS.....	55.00
Duet.....	49.00
Direct Access.....	55.00
Grammatik III.....	55.00
X Tree.....	37.00
X Tree Pro.....	69.00
Sideways.....	40.00
Max Think.....	45.00
Tomado.....	59.00
Graph-In-The-Box.....	55.00
Mace Utilities.....	55.00
Norton Utilities.....	50.00
Norton Utilities Advanced.....	79.00
Norton Commander.....	49.00
Disk Technician.....	59.00
Disk Technician Plus.....	79.00
Copywrite/Zerodisk.....	CALL
Desqview 2.01.....	75.00
Rightwriter.....	59.00
Mirror II.....	35.00
Flash 5.6.....	49.00
Laplink Plus.....	85.00
Note-It-Plus.....	49.00
SOZ Plus.....	59.00
Cambridge Spreadsheet Analyst.....	89.00
The Documentor.....	179.00
dFlow.....	89.00

DATAFORM	
Procomm Plus.....	52.00
DBFAST	
Dblast.....	62.00
DIGITAL RESEARCH	
Gem Desktop.....	32.00
Gem Draw Plus.....	179.00
Gem 1st Word Plus.....	115.00
Gem Word Chart.....	115.00
Presentation Team.....	285.00
Desktop Publisher.....	179.00
DIGITALK	
Smalltalk V.....	75.00
Smalltalk V 286.....	145.00
FIFTH GENERATION	
Fastback.....	79.00
Fastback Plus.....	99.00
FORMWORX	
Formworx w/Fill & File.....	89.00
FOX SOFTWARE	
Foxbase Plus.....	199.00
Foxbase Multi-user.....	299.00
Foxbase Runtime Unlimited.....	265.00
FUNK SOFTWARE	
Always.....	89.00
GENERIC SOFTWARE	
Generic Cad 3.0.....	55.00
Dot Plot.....	27.00
Auto Convert.....	27.00
Auto Dimension.....	27.00
3D Solid Modeling/Rendering.....	179.00
GIBSON TECHNOLOGY	
Spinwrite.....	55.00
GOLDEN BOW	
V Feature Deluxe.....	85.00
V Cache.....	45.00
HAVENTREE	
Interactive Easyflow.....	129.00
HAYES	
Smartcom III.....	149.00
HILGRAVE	
Hyper Access.....	89.00
IBM	
Displaywrite IV.....	299.00
DOS 4.01.....	95.00
INTUIT	
Quicken.....	39.00
LATTICE	
Lattice C Compiler.....	229.00
LEADING EDGE	
Word Processor W/Spell/Merge.....	59.00
Word Processor V1.5.....	89.00
LOTUS DEVELOPMENT	
ALL PRODUCTS.....	CALL
MATHSOFT	
Mathcad 2.0.....	225.00
MECA	
Managing Your Money 4.0.....	125.00
MERIDIAN TECHNOLOGY	
Carbon Copy Plus.....	109.00
MICROGRAFX	
Designer.....	465.00
MICROLYTICS	
Gofor.....	42.00
MICROPRO	
Wordstar Professional 5.0.....	249.00
Wordstar 2000 Plus.....	239.00
MICRORIM	
Rbase for Dos.....	475.00
MICROSOFT	
Pageview.....	35.00
Quick C.....	67.00
Word.....	225.00
Quickbasic.....	67.00
C Compiler.....	299.00
Fortran Compiler.....	299.00
Cobol Compiler.....	599.00
Macro Assembler.....	99.00
Learning DOS.....	35.00
Fight Simulator.....	35.00
Excel.....	309.00
Windows 386.....	129.00
PC Works.....	129.00
MICROSTUF	
Crosstalk XVI.....	99.00
Crosstalk Mark 4.....	125.00
NANTUCKET	
Clipper.....	439.00
NASHOBA	
Nutshell Plus.....	185.00
NORTH EDGE SOFTWARE	
Timeslips III.....	115.00
PAPERBACK SOFTWARE	
VP Info.....	65.00
VP Planner.....	55.00
VP Planner Plus.....	129.00

PATTON & PATTON	
Flowcharting II Plus.....	145.00
PC SUPPORT GROUP	
Lightning.....	55.00
Lucid 3D V 2.0.....	89.00
PEACHTREE	
Complete Accounting II.....	159.00
Complete Accounting with Data Query.....	239.00
PERSOFT	
Smartterm 240.....	209.00
Referee.....	45.00
SANTA CRUZ OPERATION	
Xenix 286 Operating Sys.....	469.00
Xenix 286 Development Sys.....	469.00
Xenix 386 Operating Sys.....	539.00
Xenix 386 Development Sys.....	539.00
SCITOR	
Project Scheduler Network 4.0.....	449.00
SIMON & SCHUSTER	
New World Writer II.....	99.00
Typing Tutor IV.....	32.00
SOFTLOGIC SOLUTIONS	
Disk Optimizer.....	42.00
Cubit.....	42.00
Double DOS.....	42.00
@ Liberty.....	115.00
Magic Mirror.....	59.00
SOFTWARE PUBLISHING	
PFS First Publisher.....	79.00
Professional Write.....	119.00
Professional File 2.0.....	179.00
PFS Professional Plan.....	59.00
PFS First Choice.....	89.00
Harvard Total Project II.....	379.00
Harvard Graphics.....	299.00
STORAGE DIMENSIONS	
Speedstor.....	49.00
SYMANTEC	
Timeline V 3.....	329.00
Grandview.....	159.00
TRANSEC SYSTEMS	
Masterkey Unlock.....	109.00
dAnalyst.....	135.00
TURBO POWER	
TDebug.....	35.00
Turbo Professional.....	65.00
UNISON WORLD	
Printmaster Plus.....	32.00
Art Gallery I & II & III (Each).....	19.00
Newsmaster II.....	49.00
WISEWARE	
Prime Time.....	65.00
WORD PERFECT CORPORATION	
Word Perfect 5.0.....	239.00
Word Perfect Network Server.....	349.00
Word Perfect Network Add-On.....	75.00
Plan Perfect.....	195.00
Data Perfect.....	299.00
Word Perfect Executive.....	125.00
Word Perfect Library.....	65.00
WORD TECH	
DBXL Diamond.....	115.00
Quicksilver Diamond.....	345.00
XEROX	
Ventura Publisher 2.0.....	519.00

FIFTH GENERATION	
Logical Connection 256K.....	429.00
HAYES	
Smartmodem 1200.....	299.00
Smartmodem 1200B W/Software.....	299.00
Smartmodem 2400.....	465.00
Smartmodem 2400B W/Software.....	465.00
HERCULES	
Hercules Monochrome Plus.....	189.00
HEWLETT PACKARD	
Laserjet II.....	1849.00
Fonts/Cartridges for Laserjet II.....	CALL
INTEL	
Above Board 286 W/512K.....	429.00
8087-3 (5MHZ).....	109.00
8087-2 (8 MHZ).....	159.00
80287 (8 MHZ).....	175.00
80827 (8 MHZ).....	250.00
80287 (10 MHZ).....	319.00
Inboard 386 PC or 386 AT.....	899.00
1 MB Exp for 386 Inboard.....	675.00
INTERNATIONAL BATTERY	
AT Replacement Battery.....	19.50
AST Six Pack Battery.....	3.50
INTEL	
Inboard 386 PC or 386 AT.....	1099.00
1 MB Exp for 386 Inboard.....	675.00
IBWAIN MAGNETICS	
120 XT 20MB Internal.....	339.00
125 AT 20 MB Internal.....	339.00
KENSINGTON	
Masterpiece.....	89.00
Masterpiece Plus.....	105.00
Masterpiece Remote.....	115.00
LOGITECH	
Logimouse C7.....	75.00
Logimouse H1 Rez.....	99.00
Logimouse C7 + Paintbrush.....	95.00
Logimouse W/Cad/Paint.....	125.00
Publisher Mouse.....	125.00
Scan Man.....	199.00
MICROSOFT	
BUS Mouse W/Paintbrush.....	109.00
BUS Mouse W/Windows.....	145.00
Serial Mouse W/Paintbrush.....	109.00
Serial Mouse W/Windows.....	145.00
MICRO SPEED	
Fast Trap.....	95.00
MIGINT	
Pocket Modem.....	115.00
MOUSE SYSTEMS	
PC Mouse BUS Plus.....	95.00
PC Mouse Serial Plus.....	95.00
NEC HOME ELECTRONICS	
Multisync II.....	629.00
NEC INFORMATION SYSTEMS	
P2200 80 COL.....	379.00
P5200.....	569.00
P5300.....	769.00
PANASONIC	
KX-P10911.....	209.00
KX-P1595.....	479.00
KX-P1524.....	649.00
KX-10921.....	365.00
PARADISE	
Autoswitch 480.....	189.00
VGA Plus.....	279.00
PLUS DEVELOPMENT	
Hardcard 20 MB.....	569.00
Hardcard 40 MB.....	709.00
POLAROID	
Polaroid Palette.....	1499.00
Polaroid Palette Plus.....	2399.00
PRACTICAL PERIPHERALS	
Practical Modem 1200 Internal.....	69.00
Practical Modem 1200 SA.....	109.00
Practical Modem 2400 INT.....	155.00
Practical Modem 2400 SA.....	185.00
SAMSUNG	
Amber Monitor.....	85.00
SEAGATE TECHNOLOGY	
ST 251 40MB No Controller.....	389.00
ST 225 20MB W/Controller.....	295.00
ST 238 30MB W/Controller.....	319.00
ST 251-1 No Controller.....	445.00
SUMMAGRAPHICS	
Summasketch 1201 Plus.....	389.00
SYSEN	
Ext 5 1/4" Drive.....	289.00
TOUCHBASE	
Worldport 2400 Modem.....	269.00
Worldport 1200 Modem.....	159.00
TOSHIBA	
T 1000 Laptop.....	875.00
T 3100-20 Laptop.....	3415.00
P321 SL Printer.....	549.00
P341 SL.....	759.00
P351 SL.....	1175.00

ADVANTAGES

- We welcome corporate accounts
- Immediate replacement of defective goods.
- Bulk discounts
- Immediate shipment on purchase orders from qualified government institutions

(schools and universities included)
 •No hidden charges.
 •No minimum.
TERMS:
 All prices are subject to change without notice. We

do not guarantee compatibility. No surcharge for VISA or MasterCard. 2% surcharge American Express. No returns without RMA. Short shipments must be notified within 48 hours. 15% restocking fee on non-defective goods: \$3.50 C.O.D. charge. Shipping \$4.50 minimum per item, less on bulk orders. (\$8.50 Blue Label.) (Higher for some software or hardware items.)

Call for prices for any software item not included in this price list.
 Order desk & technical support open 7 a.m. to 6 p.m. Monday-Friday (PST)
 10 a.m. to 2 p.m. Saturday (PST)
P.O. BOX 1588
 6934 Carby St., Suite #109-110
 Reseda, CA 91335
 Telex 592413COMPU UR/Fax 818-705-4885

WE WELCOME INTERNATIONAL ORDERS

1 818 705-1895 US

1 800 231-6603 CA

1 800 328-4473 US

tor, which is a version of PC Paintbrush, has features for zooming, changing font styles, cutting and pasting, drawing patterns, and so on. The editor can also merge PIC files so that you can include Lotus or Symphony graphs in your documents.

The Phonebook utility is convenient for maintaining numbers of other fax machines. You can specify a group of phone numbers to which you want to send a fax, which is handy if you regularly send the same fax to several other fax machines. You can also create multiple phonebooks, though most users will probably require only one.

Other utilities include polling, which lets your CoProcessor automatically call other CoProcessors or fax machines to request file or fax transmissions. The polling feature conforms to the Group III standard, so you can use it with virtually any fax machine that supports polling. Polling lets you receive files at night when phone charges are lower, or receive a batch of daily transmittals from other offices at a specified time. You can also configure your CoProcessor to send a fax when polled by another fax machine.

The Hayes modem option includes an installation guide and a Hayes modem guide. It works like any other 2400-bps Hayes-compatible modem, but it fits onto the CoProcessor board instead of taking up an extra slot in your PC. You can't connect an external modem to the CoProcessor board, however.

Comparative Worth

The advantage of the Connection CoProcessor and other fax boards is their ability to fax text or graphics to offices that may not have a computer and modem but do have a fax machine. An additional benefit is that faxes received directly from a computer are much more readable than faxes sent from one fax machine to another, because they eliminate the need to print and scan an image into a fax machine before sending it.

The Connection CoProcessor is a well-designed and useful product. At \$995, it's priced competitively with other fax boards that include a microprocessor, such as Panasonic's Fax Partner. If your remote offices have a CoProcessor, the 9600-bps binary-file transmission and E-mail capabilities are

handy, and the board's optional 2400-bps modem saves valuable slot space.

The CoProcessor is also a good choice if you plan to use it extensively in background mode and can't afford any degradation in your system's performance. On the other hand, the CoProcessor accepts only PCX and ASCII text for faxes. If you want to fax TIFF, Dr. HALO, Microsoft Windows, Paint, or AutoCAD files, you'll have to look elsewhere (see "Fax Board Faire" by Brock N. Meeks, September 1988 BYTE).

If CAS becomes widely supported, it could eventually be a strong plus for the Connection CoProcessor. Intel has lined up several major software vendors who plan to incorporate it into their applications. But the specification's success also depends on whether Intel opens CAS to other hardware developers.

CAS aside, however, the CoProcessor holds its own against other fax boards. It's elegantly designed and competitively priced, and it performs well. ■

Nick Baran is a BYTE senior technical editor based in San Francisco. He can be reached on BIX as "nickbaran."

Outline: The infinite font-cartridge.

Imagine: You have a font-cartridge for your laserprinter: You need more fonts. You can tell this cartridge to do it and use them immediately in your textprocessor.

Large fonts, small fonts, decorative fonts, shadow fonts...

You want to change something? Just tell your font-cartridge. The font change is made in the font selection menu automatically.

You want a new cartridge? Save the old and select the fonts for a new one.

As many times as you want. An infinite number of soft-cartridges. An infinite number of fonts.

THAT'S OUTLINE.

s.a.x. software

Roonstr. 32 • D7500 Karlsruhe • Tel. 01049/721/814078

Outline supports all HP and compatible laserprinters.
Outline supports MS Word*, WordPerfect*, Windows*, PageMaker*, Excel*.
* registered trademark

Please contact in USA:
Digital Type Systems Ltd
38 Profile Circle, Nashua NH 03063
Tel. (603) 880-7541



Time 00:49/911/27:00:87

Leprecard Hard Disk Cards

Leprecards feature components utilizing the latest technology. Low power drives mean less strain on your systems, lower operating temperature, and longer component life. You get a 1 year warranty, unlimited technical support, and our illustrated installation and user's guide. Models available for IBM PC/XT and compatibles, as well as TANDY 1000/A/SX/IX/TL/SL.

FREE SOFTWARE Including TakeTwo, the backup utility PC MAGAZINE named Editors Choice in 1986 & 1987, and PC-KWIK disk caching from Multisoft.

21MB 48ms \$299	32MB 48ms \$339	32MB 40ms \$389	49MB 28ms* \$549	65MB 16ms* \$649
------------------------------	------------------------------	------------------------------	-------------------------------	-------------------------------

* Average access speed per partition
Tandy 1000/A/SX/IX/TL/SL Leprecards add \$20

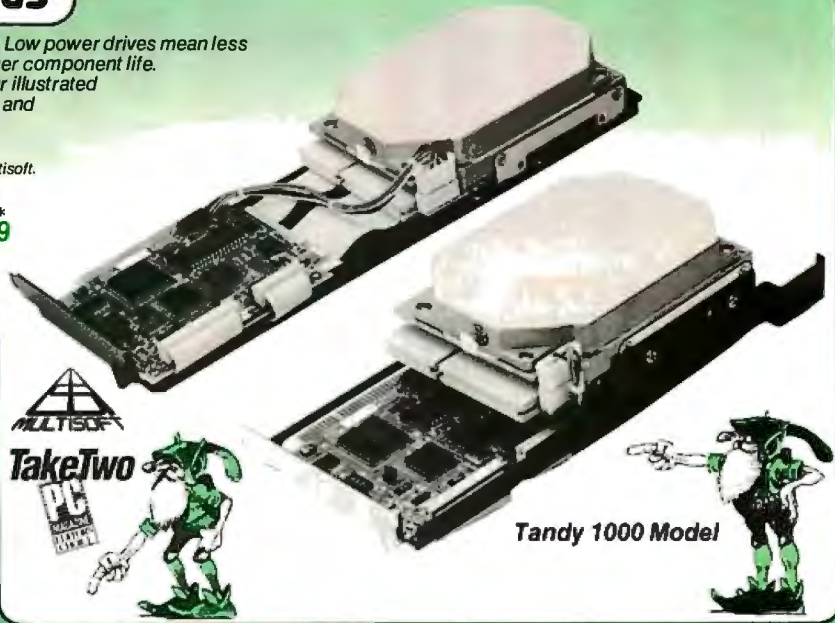

Tandy 1000 Model

3.5" Floppy Kits

Internal kits for PC/XT/AT computers include 5 1/4" mounting brackets, black & gray face plates, and AT rails. 1.44MB for PC/XT includes high speed Western Digital controller.



FREE TAKE TWO floppy backup software.

720 Kit \$109	1.44MB for AT \$139	1.44MB for PC/XT \$199
-------------------------	-------------------------------	----------------------------------

PC/XT Disk Kits

- Pretested & formatted
- Western Digital short slot controller
- 30 page installation guide & reference manual
- Cables, mounting screws, full & half-height face plates
- 1 year Warranty, 30 Day Money Back Guarantee
- Optional: 150 watt, UL/FCC approved power supply for IBM PC's \$69

20MB KIT \$279	• Seagate ST225 - 2x 4MB/65ms. Half-Height/14.8 watts
30MB KIT \$299	• Seagate ST238 - 32.7MB/65ms. Half-Height/14.8 watts
40MB KIT \$459	• Seagate ST251 42.8MB - Half-Height - 11 watt • pre formatted into a pair of 21MB/28ms partitions.
65MB KIT \$549	• Seagate ST277A 65.5MB - Half-Height - 11 watts • pre formatted into a pair of 32MB/28ms partitions.



Tandy 1000 kits add \$20

FREE SOFTWARE Including TakeTwo, the backup utility PC MAGAZINE named Editors Choice in 1986 & 1987, & PC-KWIK disk caching from Multisoft.

Laser Printer

512K **\$1495**
1.5MB **\$1595**

"One of the Laserjet's strongest competitors"
INFOWORLD October 5, 1987

- Printer utility software
- Serial and Parallel interfaces
- 120 day TRW on site maintenance
- 1 year Warranty
- 100% HP Laserjet. & Laserjet + compatible
- 9 resident & 5 downloadable soft fonts standard
- Options: All HP style font cartridges



Toner Cartridge \$29

AT Hard Disk Kits

- Includes IBM AT rails, and cables.
- SpeedStor or Ontrack large drive software.
- Formatted, Partitioned & Tested.

SIZE	MODEL	SPEED	CAPACITY	PRICE
HH	Seagate ST251	40ms	42MB	\$359
HH	Seagate ST251-1	30ms	42MB	\$449
HH	Toshiba Drive MK134	25ms	44MB	\$499
FH	Seagate ST4096	28ms	80MB	\$599
FH	Maxtor 1140	27ms	117MB	\$1669
FH	Maxtor 2190	30ms	150MB	\$1999

LepreFAX Modems

Internal **\$289**

External **\$359**

- Easy to use POP-up Menus
- Sends ASCII or word processing files
- Internal 4800bps, \$289 9600bps \$559
- Prints on standard dot-matrix or laser printers
- Sends/Receives from any Group 3 fax machine
- Automated sending during low phone rate periods
- Portable external plugs into PC/XT/AT serial port, \$359



4" Hand Scanner with HALO DPE software **\$269**

2400 Modems

with MNP

External **\$239** Internal **\$229**

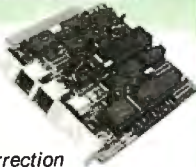

Hayes Compatible, 300/1200/2400 MNP Level 4 error correction
FREE MIRROR II Software, a \$69 value
Internal model \$229, fits in a short slot

2400 without MNP **\$159 Ext \$109 Int**

Orchid

Designer VGA 512K	\$299
Orchid VGA 256K	\$249
Tiny Turbo 286	\$289
Ramquest II 1MB	\$799



\$895

286¹⁰ Computer

80286 processor running at 6/10 Mhz with 0 wait states provides a Norton SI rating of 11.5. 8 slots - Room for 1 full and 3 half-height drives-220 watt power supply - clock/calendar - Choice of 1,2 or 1.44MB floppy drive-Genuine Western Digital combination Hard disk/floppy controller-American made Maxiswitch 84 or 101 key keyboard - 512K RAM standard expandable to 1MB Award BIOS - 1 year warranty - 30 day money back guarantee.

Complete systems with serial & printer ports:

Mono/Graphics Card & Monitor	\$1095	Orchid VGA Card & Multiscan Monitor	\$1595
VGA Card & Mono Monitor	\$1295	Orchid Designer VGA Card &	
EGA Card & EGA Monitor	\$1495	NEC Multisync II Monitor	\$1895



2524B Townsgate Road, Dept. B, Westlake Village, CA. 91361



To order, or get our free catalog call

Toll Free
800 722-AT-XT
California
805-373-7847
FAX
805-379-9345

MEMBER
MMC
MICROCOMPUTER
MARKETING COUNCIL

- No extra for Visa/Mastercard (AMEX add 3%)
- Prices include UPS surface shipping
- Federal Express shipping just \$1.50 per pound
- 30 Day Money Back Guarantee
- Corporate & Institutional PO's accepted

HARD DRIVES

40Mb ST251

Includes ST251 drive, AT mounting hardware, How-To manual & "Disk Manager" partitioning software.

Also available for XT. **\$ 329**

40Mb ST251 \$389 PC/XT KIT

Includes drive, controller, cables, How-To manual, mounting hardware & partitioning software.

Seagate

80Mb ON SALE!

ST4096

Full Height. 28ms access time. Available for XT or AT.

Includes drive, AT mounting hardware & "Disk Manager" partitioning software.

Call for Lowest Price!

65Mb ST277R

40ms access • Half Height Autoparking heads

Includes drive, mounting hardware & "Disk Manager" partitioning software.

\$ 379

This drive requires an RLL controller.

We carry the entire Seagate product line including 3.5" drives

30 Mb GREAT VALUE!

\$ 269

Complete PC/XT KIT includes Seagate ST238R drive, controller, cables, How-To manual & mounting hardware.

High Speed 40Mb

Seagate ST251-1

Half Height • 28ms access time • Available for XT or AT

\$ 399 IT'S FAST!

Includes drive, AT mounting hardware & "Disk Manager" partitioning software.

30 Day "Worry-Free" Guarantee

If for any reason, you are not completely satisfied with any product, simply return it for a prompt and courteous refund!

Card Drive™

Hard Cards

Card Drive 20S 40ms \$319

Card Drive 30S 40ms \$349

Card Drive 50S 40ms \$489

--Features--

- Available for most Tandy models
 - Quality engineered for reliability
 - Super easy installation & setup
 - **ONE YEAR Warranty**
 - Auto park heads
- These Card Drives use quality Seagate Hard Drives

20Mb ST225 KIT

This complete PC/XT KIT includes the Seagate ST225 drive, controller, cables, How-To manual & mounting hardware. Half height • 65ms.

Also available for AT.

SPECIAL! \$ 244

**FACTORY-TRAINED
TECHNICIANS
are on hand
to answer your
questions!**

Never a Surcharge for Visa or MasterCard Orders



All products include our ONE YEAR Warranty and our 30Day "Worry-Free" Guarantee!

Hours: 8am to 7pm Monday - Friday, 12pm to 5pm Sat. MST

HARD DRIVES

International

An IDN Company

To Order:
Call Toll Free

(800) 234-DISK



International Orders: (602) 784-1038
Toll Free Customer Service: (800) 541-8387

Toll Free Order Status: (800) 541-8387

TELEX: 405765 FAX: (602) 829-9193

1208 E. Broadway Rd. #110 • Tempe, AZ 85282 (602) 784-1038



Prices and availability subject to change without notice. All items are NEW. 5% surcharge for American Express and COD orders. P.O.'s accepted NET 20 - subject to 9% surcharge. For EXPRESS MILITARY APO/FPO orders add \$20. 30 Day Guarantee conditions: shipping & handling charge is not refundable; product must be undamaged and in original condition. BYT0189



Pixels on the March

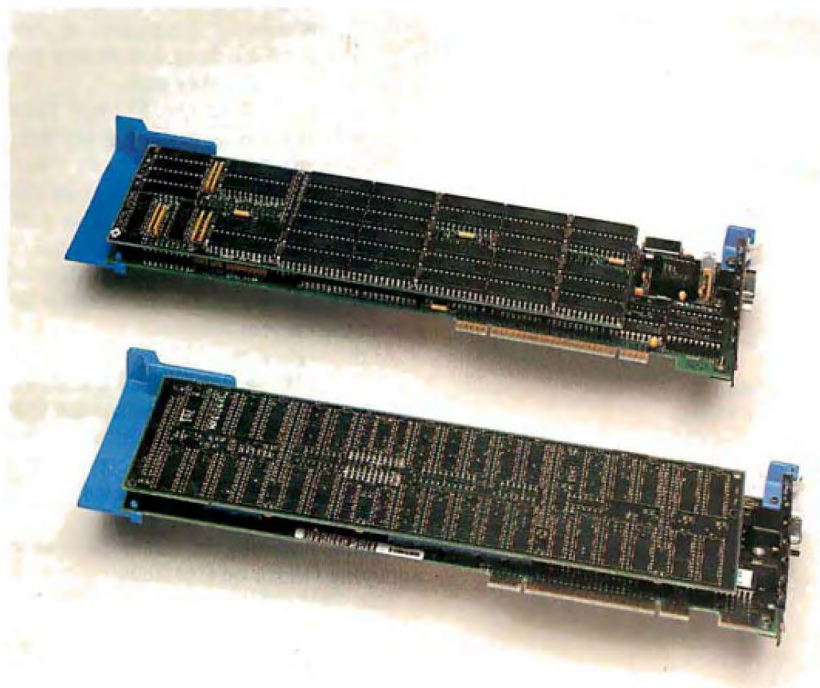

The 8514/A and Artist 10 MC graphics coprocessor boards for the IBM PS/2s

Bradley Dyck Klierer

Fast, high-resolution graphics systems were once the domain of computer-aided drafting and design (CADD) and specialized image-processing workstations for science and engineering. However, the past few years have shown advances in desktop publishing, multitasking systems, and business graphics, and these advances are pushing the limits of personal computer graphics standards. The current set of standard graphics adapters (CGA, EGA, and VGA) requires the software to individually calculate and plot each point (or pixel) on a graphics screen.

At the highest CGA resolutions (640 by 200 pixels), a graphics screen consists of 128,000 pixels—not an unreasonably large number for a reasonably fast computer. But at EGA resolutions (640 by 350 pixels), the number increases to

224,000, and VGA resolutions (640 by 480) have a total of 307,200 pixels. Not only is the pixel count greater, but with the additional colors available on the EGA and VGA, the memory requirements are drastically increased—from 16K bytes on the CGA to nearly 154K bytes on the VGA. Managing this ever-increasing memory load requires ever-greater processing time from the computer's CPU (the 8088, 80286, or 80386 for IBM PC compatibles)—time that is no longer available for other important computational tasks.

Graphics coprocessors (specialized graphics adapters with dedicated graphics microcomputers on-board) can help ease the burden on the CPU. Instead of calculating the position of every point on a line, the CPU tells the graphics coprocessor to draw a line from point A to point B. While the graphics coprocessor calculates and plots the pixels, the CPU is free to continue with other work.

In this review, I'll look at two graphics coprocessors for the IBM PS/2 Micro Channel architecture (MCA) computers. The system I used was a 16-MHz IBM PS/2 Model 80-071 running IBM DOS 3.3. Benchmark programs were written with BYTE's version of Small-C 1.0. I also ran standard BYTE graphics applications when the adapters supported them (since both of these adapters are fairly new, neither one has full support for all graphics-based packages).

8514/A

The 8514/A is IBM's graphics coprocessor board, based on a proprietary IBM chip set. The 8514/A is not particularly powerful, but its low price (\$1350) makes it an attractive entry-level coprocessor. Installation is very easy: Simply plug the card into the correct slot (a special slot is available for video cards in the PS/2s) and run the automatic configuration software. The 8514/A has a piggy-back memory card that makes it thicker

continued

IBM 8514/A

Type

IBM PS/2 graphics adapter

Company

IBM Corp.
900 King St.
Rye Brook, NY 10573
(800) 426-2468

Features

1024 by 768 interlaced pixels with an 8514 color display; 640 by 480 pixels with the 8503 monochrome, 8512 color, or 8513 color displays; 512K-byte graphics memory; 16 colors from a palette of 262,144

Size

11½ by 3½ inches

Hardware Required

IBM PS/2 with Micro Channel bus

Options

Additional 512K-byte adapter memory (brings total colors to 256): \$270
Display Adapter 8514/A Technical Reference: \$10
Display Adapter 8514/A Adapter Interface Application Developer's Guide: \$25

Documentation

16-page Installation Guide

Price

\$1350

Inquiry 857.

than a standard Micro Channel card. A clear plastic sheet covers the back of the piggyback card, preventing short circuits with neighboring cards.

The 8514/A provides four basic coprocessing services: drawing lines (including polylines, polygons, and boxes), filling areas, moving areas (BITBLT), and writing alphanumeric data. Another feature, which OS/2 will probably exploit, is the ability to save the adapter state (e.g., palette, default color, and current cursor position) for several concurrently running programs. With this feature, the adapter can switch the display between programs without side effects.

The adapter does not support circles, ellipses, arcs, or programmable modes. It does support user-defined proportionally spaced character sets. Unfortunately, the characters are not scalable, and you can load only one at a time; this severely restricts its potential for use in desktop publishing systems.

The 8514/A adapter includes 512K

Artist 10 MC

Type

IBM PS/2 graphics adapter

Company

Control Systems
2675 Patton Rd.
P.O. Box 64750
St. Paul, MN 55164
(612) 631-7800

Features

Up to 1024 by 768 noninterlaced pixels; variable scan rate; 256 colors from a palette of 16.7 million; ADI drivers for use with AutoCAD release 9 and AutoShade

Size

11½ by 3½ inches

Hardware Required

IBM PS/2 with Micro Channel bus

Options

Graphics Controller Technical Reference Manual: free if ordered with Artist 10 MC; \$30 if ordered subsequently

Documentation

40-page User's Guide
48-page ADI Drivers User's Guide

Price

256-color version: \$3995
16-color version: \$3695

Inquiry 858.

bytes of graphics memory (unlike memory on the CGA, EGA, and VGA, the computer cannot directly address memory on the 8514/A adapter). With 512K bytes, the adapter supports 16 simultaneous colors at either 640 by 480 pixels or 1024 by 768 pixels. You can add an additional 512K bytes of graphics memory to support 256 simultaneous colors. With either configuration, you select the displayable colors from a palette of 262,144. The 8514/A that I reviewed had a full 1 megabyte of RAM. The adapter also comes with a memory-resident program called the Adapter Interface.

The Adapter Interface permanently occupies 16,320 bytes of RAM. All drawing commands are sent to the Adapter Interface; thus, graphics programming remains independent of the actual hardware configuration. IBM does not publish the hardware interface, forcing developers to use the device driver. However, Microsoft obtained a copy under a special agreement and will

use direct hardware control in its operating-system products. To date, only Microsoft Windows/286 uses the direct hardware interface; an 8514/A driver for Windows/386 was not available as of this writing.

The 8514/A is obviously faster than the VGA, but how you see the improvement may vary. The Small-C programs run much faster. Windows applications also have a slight edge, but the speed difference is much less dramatic. At first I was surprised that Windows did not show substantial improvement, but after I worked with the adapter, it became obvious that Windows' emphasis of bit-mapped graphics does not match the adapter's functions very well.

There is more to the 8514/A than speed; the additional resolution is a welcome enhancement. PageMaker could display two full, readable pages on the 8514 (although the characters were a bit small), and you can see larger portions of Excel spreadsheets (or larger portions of hidden windows if you don't increase the size of the current window).

At the highest resolution (1024 by 780 pixels), the 8514/A sends an interlaced signal to the display. This means that each time the electron beam scans the face of the display, every second line is drawn. On the next pass, the lines missed on the previous pass are filled in. This method of updating the screen can lead to annoying flicker on fine lines.

The IBM 8514 display compensates for the interlace with longer-persistence phosphors. This means that each colored dot on the face of the monitor glows a bit longer than on a typical, noninterlaced monitor—long enough so that it does not fade before the next pass, and the flicker is not noticeable (the phosphors are not as persistent as on the IBM monochrome monitor). Nevertheless, the 8514 display I used did not have a very sharp picture, and viewing it for extended periods became annoying. If I were in the market for an 8514/A, I would shop carefully for a monitor that gives a sharp picture without noticeable flicker.

Programming Video

The function calls are simple to use, thanks to a uniform calling convention, but the 8514/A has a very awkward command set. For example, it makes no provisions for plotting single pixels. Setting the current location or defining a line of a single point will not set a pixel. The only option is to make a 2-pixel line.

Filling areas is also a problem. Rather than selecting a point and filling to sur-

continued

Our Profile Will Make You Smile!

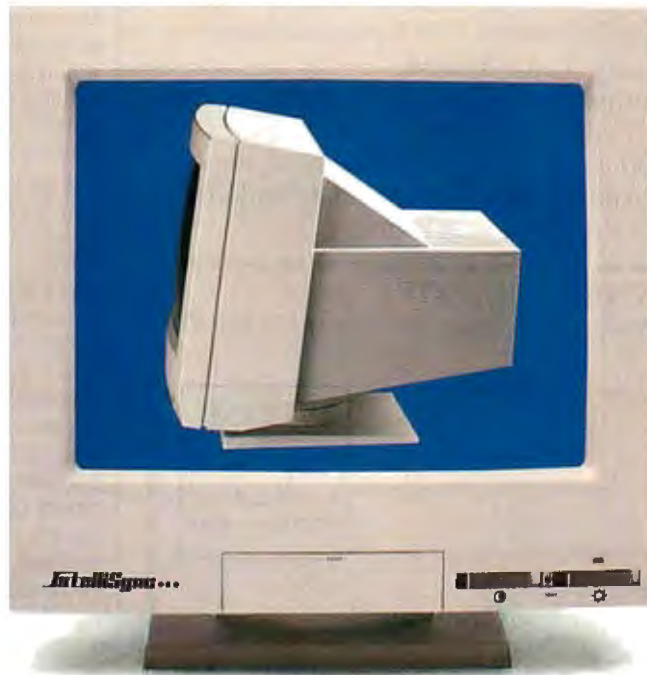

Our Price Will Make You Happy!

Introducing IntelliSync® The New Intelligent Multi-Frequency Monitor From 3LYNX®

It starts with the outstanding design features such as the small foot print, and streamlined profile (even slimmer than single frequency color monitors).

Next the IntelliSync is compatible with the CGA, EGA, VGA, and more, as well as being an excellent companion to all PC/XT/AT*, Apple Macintosh II*, and the new IBM PS/2* systems.

The cost of IntelliSync is nearly 1/3 less than its major competitor. Most impressive is that it is manufactured by 3LYNX, a video display monitor manufacturer producing critical video components for the majority of the top FORTUNE 500 computer companies for years.

For information on the new 3LYNX IntelliSync Monitors call or write today. Call toll free 1-800-243-5969. Or 1-800-24-3LYNX. Fax # (408) 434-0466. International Calls (408) 432-8833.



IntelliSync Monochrome Monitor 15" flat screen with vivid gray scale.

IntelliSync The Best Choice

FEATURES	3LYNX INTELLISYNC	NEC MULTISYNC II*
Size	14"	14"
Front Controls	Yes	Yes
Auto Horizontal Frequencies	15.50-35KHz	15.50-35KHz
Tilt & Swivel	Yes	Yes
Intellisync has incorporated all of the features of Multisync II plus more ...		
Auto Vertical Frequencies	45-120 Hz	50-80 Hz
Inverse Video Option in MDA Mode	Yes	No
Selection of Text Color	Auto	Manual
Color Text Options	7	3
Dimensions (mm)	341(w) 346(h) 386(d)	369(w) 357(h) 406(d)
Weight	29(lbs)	31(lbs)
Suggested Retail Price	\$695.00	\$899.00

3Lynx®

1450 Seareel Lane
San Jose, CA 95131

*Registered trademarks of their respective companies. 3LYNX and IntelliSync are registered trademarks of 3LYNX Technologies Corp.

"IT MAKES C-C-CROSSTALK SEEM T-T-TONGUE-TIED."

If you're talking to a DEC mainframe, no communication software emulates the VT220, VT100 or VT52 terminal more accurately, easily, or eloquently than VTERM. *

Hot keys. Kermit. Automatic reformatting for spreadsheets and databases. VTERM has it all.

Why not join the 60,000 users of VTERM (many of whom moved up from Crosstalk). And try the DEC terminal emulation package that has everyone in the business buzzing.

FREE EVALUATION KIT.

Yes, send me a free time-limited, *full-blown working copy of VTERM/220*, which is mine to keep.

Name _____

Title _____

Company _____

Address _____

Telephone () _____

I am a user dealer . Mail to:

Coefficient Systems Corporation

611 Broadway, New York, New York 10012 (212) 777-6707 BYC 1/89

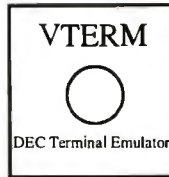

* VTERM refers to VTERM/220, VTERM/4010, etc. products from Coefficient Systems Corporation. Crosstalk is a trademark of Digital Communications Associates, Inc.

Questions? Want faster action? Call (212) 777-6707, ext. 431.

rounding borders, you must send a begin-area command, outline the area, and send an end-area command. This in itself would not be much of a problem, but each polygon or polyline defines an area. You cannot use multiple calls to the line-drawing routine to define a single area.

This created a problem for the circle drawing benchmark. [Editor's note: *The benchmark programs are available in a variety of formats. See page 3 for details.*] To fill the circle, all points have to be calculated, sorted in order around the circumference, and plotted with a single line. Also, filling the area between two concentric circles is very difficult (both circles and a line connecting their circumferences are plotted with a single polyline command). I took a simpler approach (which some might call cheating, but it's the way I would design such an application) by drawing lines across each horizontal chord. By working from the outside circle inward, I could have gotten a doughnut effect, although it would not have affected the times.

In a second test, I modified the circle routine to draw hexagons. This gave me a chance to test the automated filling algorithms against those of the Artist 10 MC. Again, the whole hexagon is filled, rather than the area between the hexagons. This probably explains the better fill times for the 8514/A versus the Artist 10 MC. The two adapters take very different approaches to area fills, making a true comparison difficult.

The Display Adapter 8514/A Technical Reference describes the 59 adapter commands. The manual does not incorporate any examples of program code, although it comes with a demonstration program and C language interface code (including source code for the demonstration program on a disk. Information about the adapter hardware is sketchy; only the software interface is described in detail. The only hardware details given are lists of the memory and I/O addresses, with no indication of function.

The 8514/A passes VGA graphics through to the connected monitor unless an 8514/A program is running. Thus, software written for the EGA and VGA will work on the system. If you connect a second monitor to the VGA output, the VGA display continues normal output during 8514/A graphics execution. I used this feature for very effective debugging sessions (the debugger output continued on the VGA while the graphs were displayed on the 8514/A).

This feature could also be useful for other applications, such as CADD (menus on the VGA, drawing on the

POWER TOOL.

Introducing 4x488™

You get intelligent IEEE-488 and RS232 ports to make instrument programming fast and easy.

You can have up to 4 Mbytes of memory on the same board for your largest programs, RAM disks, and data acquisition tasks.

Compatibility is built-in so you can run your favorite programs or create new ones with our advanced programming tools.



To get your FREE demo disk—call 617-273-1818.

cec Capital Equipment Corp.
Burlington, MA 01803

The bottom line—IEEE-488, RS232, par. port, 4MB EEM LIM, runs DOS and OS/2.

PIXELS ON THE MARCH

8514/A) and spreadsheets (worksheets on the VGA, graphs on the 8514/A). Unlike the old CGA/monochrome combinations, both adapters can use graphics modes simultaneously.

Artist 10 MC

In contrast to the 8514/A, Control Systems' Artist 10 MC is a much more powerful (and, at \$3695 and \$3995, much more expensive) graphics coprocessor for MCA machines. It's based on the Hitachi ACRTC controller. Unlike the 8514/A, versions of the Artist 10 MC are available for PC, XT, and AT compatibles. Although the Artist 10 MC can run at the same resolutions as the 8514/A (in fact, the adapter I received was configured for the 8514 display), it is not compatible with the 8514/A.

With the right monitor, the Artist 10 MC supports 1024 by 768 pixels noninterlaced, and up to 1024 by 1024 pixels interlaced. The adapter is available in two versions: a 16-color 512K-byte model and a 256-color 1-megabyte model (the reviewed configuration). The colors are selectable from a palette of 16.7 million. Control Systems does not make a 16- to 256-color upgrade kit.

At this time, the only software packages the Artist 10 MC supports are AutoCAD release 9 and VersaCAD. According to Control Systems, drivers for Microsoft Windows are under development, but they were not yet available at the time this review was written. The Artist 10 MC is clearly targeted for the CADD market, and its abilities are well suited to the demands of CADD. The complete hardware interface is fully documented in the 300-page Graphics Controller Technical Reference Manual.

Like the 8514/A, the Artist 10 MC has hardware support for lines, area fills, and BITBLT. It also supports zooming, multiple virtual displays with programmable dimensions and bit planes, single pixel plotting, circles, ellipses, and arcs. The Artist 10 MC can also copy memory blocks between the adapter memory and machine RAM via the host machine's direct-memory-access controllers (these DMA controllers can copy memory from one location to another much more quickly than the CPU can).

Installing the Artist 10 MC is a bit more involved than installing the 8514/A. Because the Artist 10 MC is designed to work with a variety of high-resolution monitors, you must make sure the adapter is set properly for your monitor. This involves checking the oscillator crystal frequency (stamped on the metal

continued

"IT MAKES PROCOMM LOOK LIKE AMATEURCOM."

If you talk to a DEC mainframe, no software emulates the VT220, VT100 or VT52 terminal more accurately or professionally than VTERM.*

Hot keys. Kermit. Automatic reformatting for spreadsheets and databases. VTERM has it all.

Why not join the 60,000 users of VTERM (many of whom moved up from Procomm). And try the DEC terminal emulation package that's in a totally different league.

FREE EVALUATION KIT.

Yes, send me a free time-limited, full-blown working copy of VTERM/220, which is mine to keep.

Name _____

Title _____

Company _____

Address _____

Telephone () _____

I am a user dealer . Mail to:

Coefficient Systems Corporation

611 Broadway, New York, New York 10012 (212) 777-6707

BYC 1/89



* VTERM refers to VTERM/220, VTERM/4010, etc. products from Coefficient Systems Corporation. Procomm is a trademark of Datastorm Technologies, Inc.

Questions? Want faster action? Call (212) 777-6707, ext. 441.

People are talking about us.

F77L-EM/32—FAST 32-bit processing on 80386s with programs up to 4GB. \$895

F77L—The compiler of choice among reviewers and professionals. New Version 3.0. \$477

F77L-EM/16—Use extended memory to write 15MB programs on 80286s. \$695

Lahey Personal FORTRAN 77—Full 77 Standard and Debugger. New Version 2.0. \$95



When people talk about FORTRAN the name mentioned most often is



Contact us to discuss our products and your needs. (800) 548-4778
Lahey Computer Systems, Inc. P.O. Box 6091, Incline Village, NV 89450
Tel: (702) 831-2500 FAX: (702) 831-8123 Tlx: 9102401256

Table 1: Benchmark data. All times are in seconds (N/A = not applicable).

	VGA	8514/A	Artist
Resize PageMaker to full screen*	1.44	1.92	N/A
Resize PageMaker to approximately 640 by 480 pixels*	1.44	1.26	N/A
Small-C circles (100 iterations)	430.56	15.27	12.74
Hexagons (100 iterations)	N/A	4.50	11.70

*Timed with stopwatch, average of 10 trials.

package), ensuring the correct programmable-array-logic (PAL) chip is installed (this is an issue with the 8514 display only), and setting a jumper for the location of the SYNC signals. You can also set a jumper for single- or dual-monitor configurations (which allows/disallows VGA signals to pass through to the Artist 10 MC's display). Software can override the jumper settings, but you must make sure the crystal and PAL are correct. Like the 8514/A, the Artist 10 MC also uses a piggyback card. A thoughtful layout keeps the jumpers accessible when

the piggyback card is installed.

Synchronization and scanning frequencies can vary from monitor to monitor, so you must match the setup parameters to your particular monitor; improperly matched parameters can make the display unreadable or off-center. The Artist 10 MC includes 57 monitor initialization files, one for each mode of every supported monitor. Each time you run the supplied demonstration programs, you are prompted for your monitor type and mode (you can restrict the list by deleting unnecessary files). For-

tunately, the Artist 10 MC includes an installation program for AutoCAD that builds a driver file based on one initialization file; this keeps the program from prompting for a monitor every time AutoCAD starts. If you write your own programs, you can also make a more permanent record of the initialization file.

Programming the Artist 10 MC

Control Systems' Technical Reference manual covers its family of Artist 10 Series of graphics controllers. The manual thoroughly covers the hardware details, but it falls short as a programming reference. The only source code in the manual covers DMA transfers with the host system.

The manual's information is sometimes out of date with regard to the Artist 10 MC. For example, the address of the FIFO register (through which all drawing commands and data pass) is incorrect. Fortunately, some portions of the demonstration program loop through hundreds of drawing commands, and I was able to find the correct address with the aid of a debugger.

Control Systems also supplies a handy

DigiChannel/Xi Intelligent Multi-Channel Communications Board doesn't fit your application, read our ad on the right.



Several years ago, we introduced a state-of-the-art intelligent multi-channel communications board. It was 400% faster than basic boards and set new standards for programmability, flexibility and reliability.

Now, with the new DigiCHANNEL/Xi, we've advanced the state-of-the-art again. A 16 MHz 80186 co-processor makes it twice as fast. And plug-in I/O Mate modules make it even more flexible. So does its full

range of drivers, and optional 512K of RAM and 128K of ROM. Plus, a synchronous channel opens a new range of communications options.

In other words, if your multi-user or multi-channel applications call for the last word in speed, configuration flexibility and programmability, call us about the new DigiCHANNEL/Xi.

If not, read our ad on the right.

DigiBoard
Plugging you into tomorrow

Call 1-800-344-4273. In Minnesota, (612) 922-8055.

program called HITDUMP, which dumps the contents of the ACRTC registers. The most reliable method for determining correct mode-parameter settings requires running the demonstration program under a debugger, breaking execution during the drawing commands, returning to DOS, and then running HITDUMP. If you are interested in programming the Artist 10 MC, you may want to have a copy of the BYTE benchmark programs handy to fill in the gaps in the documentation.

Because the adapter has no standard call interface or mode settings, it is the programmer's responsibility to set all the relevant parameters (e.g., starting address, dimensions, and timing data). This makes setting the mode a very complicated task. Fortunately, the monitor initialization files are a handy and easy-to-read source for the required information, but writing the program to set all the registers is still an arduous task.

On the other hand, sorting through all the data is a good learning experience and can reveal interesting details about the adapter. For example, a bit in the operation mode register, normally set only

during initialization, can limit drawing to the horizontal retrace period (a method that eliminates flicker when images are rapidly changing) or allow updates at any time during the display cycle (which speeds operations).

Unfortunately, I was not able to get a copy of AutoCAD release 9 in time to test the drivers. However, I did adapt the BYTE Small-C graphics benchmarks (see table 1). Note the improved time for drawing circles—under the times for both the VGA and the 8514/A. The Artist 10 MC does a true flood fill (the hardware scans for color boundaries while filling), which requires more overhead than IBM's method. But having the circle computations built into the hardware more than offsets the time lost in filling. Support for arcs, circles, and ellipses makes the Artist 10 MC a good choice for CADD applications.

Like the 8514/A, the Artist 10 MC can pass VGA through to the high-resolution monitor. When the Artist 10 MC is in its resident-graphics modes, the PS/2's VGA output continues to display. Once again, I was able to view the debugger on the VGA while running Artist 10 MC

graphics programs (this was even more important on the Artist 10 MC, since getting the mode parameters correct was crucial for obtaining a readable display).

Different Emphasis

Programmers will find either of these cards easier to program than bit-mapped graphics adapters. If you program the 8514/A, you will spend most of your time writing programs that work around its limitations. With the Artist 10 MC, you'll probably find a built-in command that provides the necessary function, but it will be more difficult to implement (of course, you can gradually build a library of functions to support later programs; the BYTE benchmarks might make a good starting point).

Because the Artist 10 MC has no pre-programmed modes, writing the first program is about as difficult as a typical EGA or VGA program. Once you have a library, it's much easier to write code for the Artist 10 MC than for the 8514/A. With either adapter, you should have a second monitor for the VGA.

From the perspective of an end user,
continued

If our Economical New DigiChannel/Xe Intelligent Multi-Channel Communications Board doesn't fit your application, read our ad on the left.



Because of our long experience, we provide engineering and support others can't. What's more, we listen. You've asked for a product that does its job — without all the "extra" features you don't need.

That's why we're introducing the DigiCHANNEL/Xe. Its 8 MHz 80186 co-processor makes it significantly faster than our former model —

yet it costs less. You can still choose between 4 or 8 asynchronous channels, and 64K of SRAM is more than enough for such straight-forward multi-user and multi-channel applications as data collection and office automation. So if the new DigiCHANNEL/Xe sounds like a good fit, call us for more information.

If not, read our ad on the left.

DigiBoard
Plugging you into tomorrow

Call 1-800-344-4273. In Minnesota, (612) 922-8055.

PERMA POWER FIGHTS SURGES TWO WAYS...

OR WE
PULL THE PLUG

Perma Power Surge Suppressors give you peace of mind, knowing that your computer is protected against power line surges and against suppression element failure.

PROTECTION FROM POWER LINE SURGES

Our unique 2-stage circuit uses heavy-duty metal oxide varistors to protect you against high-voltage lightning-induced surges, and high-speed semiconductor devices to protect against frequent fast surges. Only this kind of hybrid circuit can provide the necessary high power dissipation while still providing fast response time and low let-through voltage.

PROTECTION EVEN IF WORN OR BURNED OUT

Any surge suppressor can wear or burn out. With Perma Power you can relax! Power to your system is stopped... as completely as if the plug was disconnected. Other surge suppressors may use a light or buzzer "warning," while they continue to let raw, unprotected power feed directly into the computer. Only with Perma Power's patented Automatic Shutdown* feature is your equipment kept safe from damaging raw power.

Ask for Perma Power Extended Life Surge Suppressors, in 2, 4, or 6 outlets and Power Control Center models to insure your computer is being protected. At office, computer or electronics dealers nationwide.



*Patent #4,578,579

PERMA POWER
Electronics Inc.

5601 West Howard Avenue • Chicago, Illinois 60648
Telephone (312) 647-9414

the IBM 8514/A and Artist 10 MC really seem targeted at vastly different audiences. The 8514/A seems best-suited for budget-conscious people who need a little more resolution or a bit faster performance than the VGA provides. Despite the lack of substantial speed improvements, the 8514/A seems best-suited for Windows applications where lines are straight, boxes are filled, and windows are moved more than average. It does not seem to be designed for CADD applications. Coming from IBM, the 8514/A is likely to set a standard for entry-level graphics coprocessors.

Just as other manufacturers have expanded the EGA and VGA specifications, I expect to see 8514/A-compatible adapters that add to IBM's functions. Again, like the EGA and VGA, probably two levels of compatibility will surface: software interface (which could easily be adapted to many coprocessors currently on the market), and register-level compatibility (which would require a special design effort from the manufacturer).

The Artist 10 MC is clearly aimed at the CADD market. Its two existing drivers are for the best-selling PC CADD programs (and its price brings the entire system into the graphics workstation range). It is also a very well documented adapter, although it would be nice to have a software library, especially for setting the mode. Programmers with large budgets and little concern for PC standard graphics might like this card.

Both adapters allow VGA to pass through to the primary display, and both allow the use of a VGA as a secondary display. This is a significant point, since neither adapter forsakes programs written for the EGA or VGA.

It wouldn't hurt to try running some of your applications on the adapter to see whether it feels any faster or will speed your typical operations. Windows may move around the screen a bit faster, but how often do you move windows? You might also find the added resolution worth the price. With the 8514/A, larger portions of windows are visible, and full, readable pages can be displayed; both could be advantages if you frequently work with large layouts or spreadsheets. However, before purchasing a graphics coprocessor, you should make sure your software supports the adapter. ■

Emergency Power!

Even a "small" brownout can wipe your valuable data clean. Voltage spikes can burn out an entire CPU. Protect your equipment and data with a low-cost battery backup system.

**Battery Back-up Power System — Spike and Surge Protection**

450-watt, 120V power system for up to 2 hrs. (at 80 watt) continuous use during a complete black-out.

\$499⁹⁵

Model BC-450

Line Stabilizer — Voltage Regulation and Surge Suppression

1800 watt power output. Isobar® spike and noise protection.

\$299⁰⁰

Model LC-1800

SCOPE
ELECTRONICS
260 Motor Pkwy, Hauppauge, NY 11788

TOLL FREE
800-648-2626
(NY State 800-832-1446 Ext. 242)



ASK FOR FREE CATALOG Money orders, checks accepted. Please add \$15.00 per item shipping and handling. NYS residents add appropriate sales tax.

Bradley Dyck Kliever is the author of EGA/VGA: A Programmer's Reference Guide (New York: McGraw-Hill, 1988) and owner of DK Micro Consultants, a microcomputer consulting business. He can be reached on BIX as "bkliwer."



Subscribe to BYTE now and save \$17 off the newsstand price of \$42.00... and \$5.00 off the regular subscription rate of \$29.95. You'll also receive our special IBM PC issue as part of your subscription.

- USA \$24.95/1 year Canada \$26.95 U.S./1 year
 Bill me
 Payment enclosed
 Charge to my VISA MasterCard

Account # _____
 Expires _____
 Signature _____

This is a renewal order.

IBJ5302

Name _____
(Please Print)

Company _____
 Address _____
 City/State _____
 Country _____ Code _____

For direct ordering, call toll free 1 800 257-9402 weekdays
9:00 AM-5:00 PM EST. In New Jersey, call 1 609 426-5535.

Please allow 6-8 weeks for processing your subscription.



Subscribe to BYTE now and save \$17 off the newsstand price of \$42.00... and \$5.00 off the regular subscription rate of \$29.95. You'll also receive our special IBM PC issue as part of your subscription.

- USA \$24.95/1 year Canada \$26.95 U.S./1 year
 Bill me
 Payment enclosed
 Charge to my VISA MasterCard

Account # _____
 Expires _____
 Signature _____

This is a renewal order.

IBJ5302

Name _____
(Please Print)

Company _____
 Address _____
 City/State _____
 Country _____ Code _____

For direct ordering, call toll free 1 800 257-9402 weekdays
9:00 AM-5:00 PM EST. In New Jersey, call 1 609 426-5535.

Please allow 6-8 weeks for processing your subscription.





NO POSTAGE
NECESSARY
IF MAILED
IN THE
UNITED STATES

BUSINESS REPLY MAIL

FIRST CLASS MAIL PERMIT NO. 42 HIGHTSTOWN, NJ

POSTAGE WILL BE PAID BY ADDRESSEE

BYTE

Subscription Department
P.O. Box 558
Hightstown, N.J. 08520-9409



NO POSTAGE
NECESSARY
IF MAILED
IN THE
UNITED STATES

BUSINESS REPLY MAIL

FIRST CLASS MAIL PERMIT NO. 42 HIGHTSTOWN, NJ

POSTAGE WILL BE PAID BY ADDRESSEE

BYTE

Subscription Department
P.O. Box 558
Hightstown, N.J. 08520-9409



7.5 good reasons to try ASYSTANT GPIB.

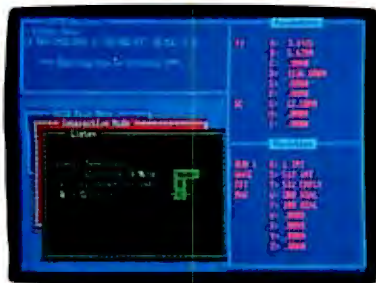

2 No programming required—be up and running from day one.

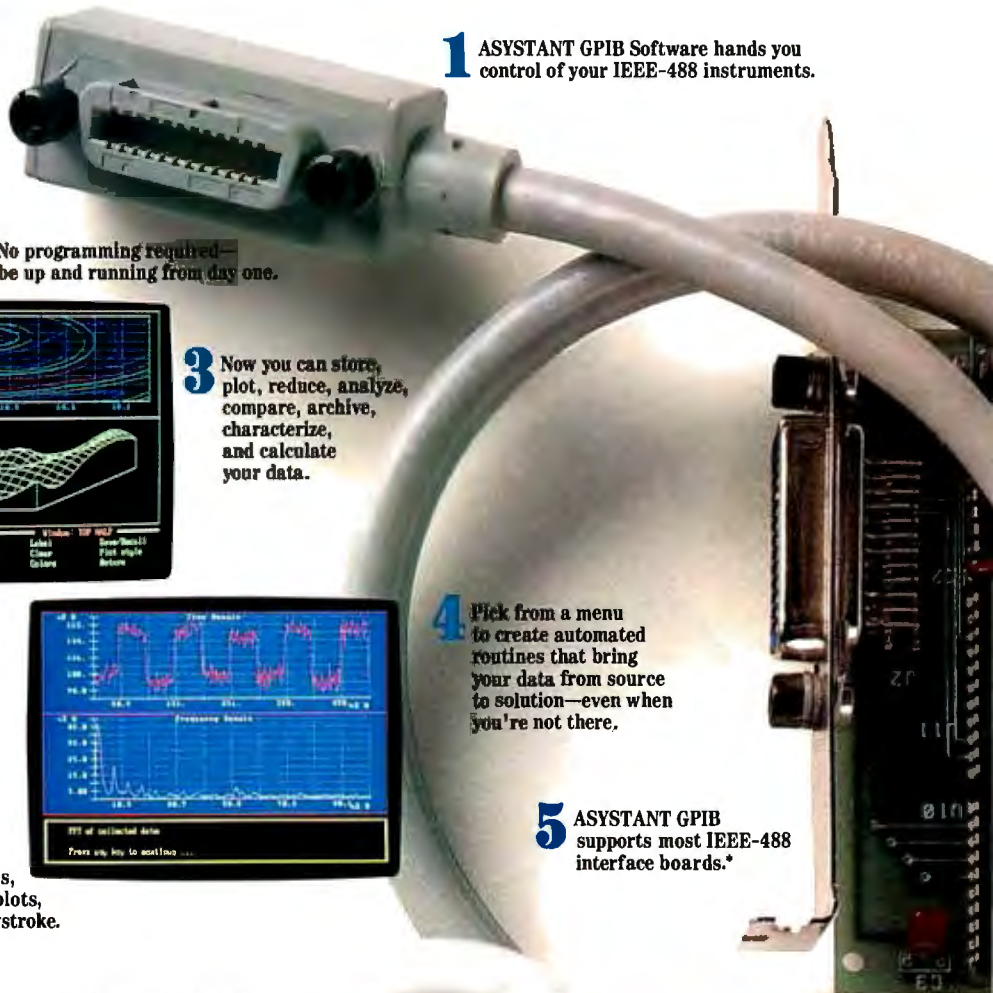

1 ASYSTANT GPIB Software hands you control of your IEEE-488 instruments.

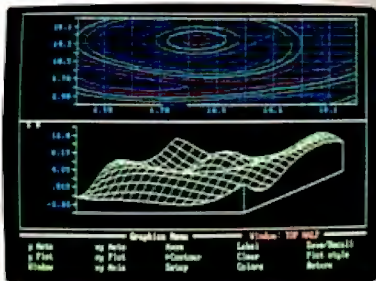

3 Now you can store, plot, reduce, analyze, compare, archive, characterize, and calculate your data.

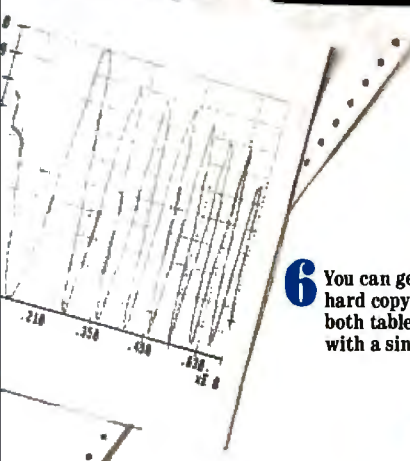

6 You can generate hard copy records, both tables and plots, with a single keystroke.

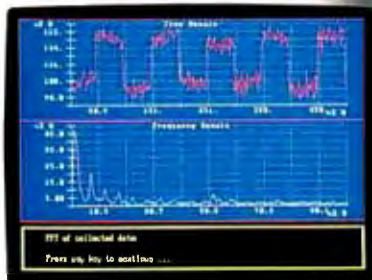

4 Pick from a menu to create automated routines that bring your data from source to solution—even when you're not there.

5 ASYSTANT GPIB supports most IEEE-488 interface boards.*

7 Full technical support is never more than a phone call away.

7.5 30-day money-back guarantee. This is only half a reason, because we know you'll find ASYSTANT GPIB indispensable.

*For the IBM PC and IBM PS/2. ASYSTANT GPIB supports over 20 GPIB interface boards manufactured by:

- | | |
|---------------------------------|------------------------|
| ■ Advantech | ■ ICS |
| ■ B&C | ■ IOtech |
| ■ BBS | ■ MetraByte |
| ■ Capital Equipment Corporation | ■ National Instruments |
| ■ Contec | ■ Qua Tech |
| ■ Hewlett-Packard | ■ Scientific Solutions |
| ■ IBM | ■ Ziatech |

For technical details, call 1-800-348-0033.

New—Call for free demo disk!

ASYST
SOFTWARE TECHNOLOGIES, INC.

100 Corporate Woods
Rochester, NY 14623
1-800-348-0033
(or 716-272-0070)

©1988 Asyst Software Technologies, Inc.
ASYSTANT is a trademark of Asyst Software Technologies, Inc. Other brand and product names are trademarks or registered trademarks of their respective holders.

Circle 27 on Reader Service Card

The ProSpeed™ 386 desktop.

To understand its massive power,



In the past, people who were serious about their computers have had a serious dilemma.

They could either buy a powerful desktop and give up any thoughts of portability. Or get a laptop, and forget about expansion and connectivity capabilities.

But never could they find a computer flexible enough to give them both.

Until now. With the ProSpeed 386 from NEC.

As you'd expect from a powerful 386 desktop, it runs at a swift 16MHz, has a full seven expansion slots and up to four drives. So it can handle anything you throw its way.

And when you want to take it on the road, it's still a high-powered computer. The laptop unit is not only available in both 40 and 100 MB hard disks, it's also battery operated and has up to 10 MB's of memory. There's even a paperwhite monograph screen with EGA

you have
to take it
apart.



resolution that provides the readability and graphics capabilities of a full-sized CRT.

All this and total connectivity capability, too. When you want to turn it back into a desktop, you merely slide the computer into a unique docking station that never

leaves your desk. It contains two standard drive bays as well as the capacity for four full-sized cards. So in a matter of seconds, you're fully integrated back into your office.

No manual reconfiguring. No phone lines to connect. No cable hook ups.

The price isn't a hassle either. So if you'd like us to continue taking the ProSpeed 386 apart, call NEC Home Electronics (USA) Inc. at 1-800-FONE-NEC. Or, if you'd like to dissect it yourself, call for product literature at 1-800-826-2255.

Systat. Because other statistics and graphics packages are not enough.

Systat now offers more statistical graphics than any other PC or mainframe package. And we still give you less bulk with more statistics.

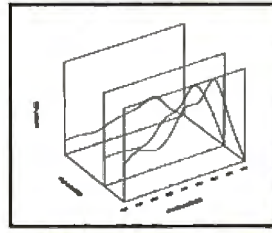
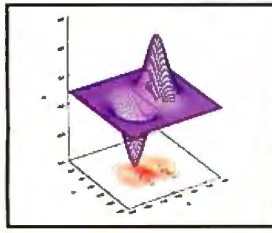
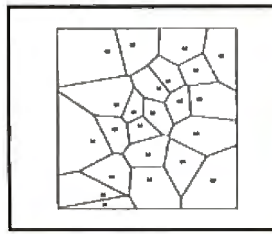
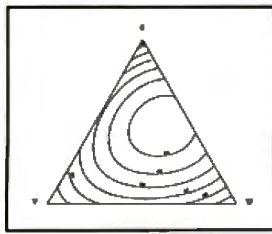
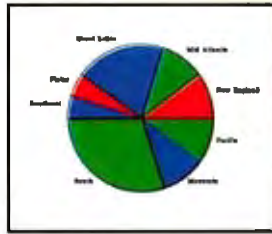
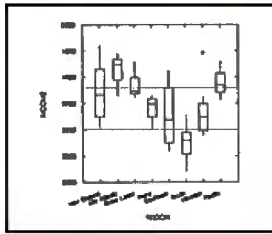
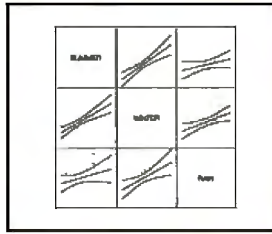
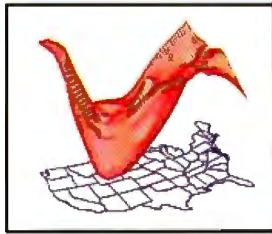
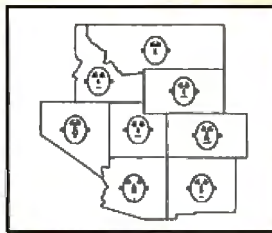
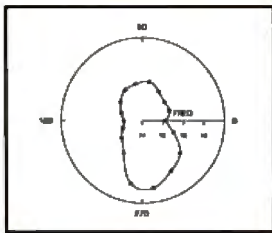
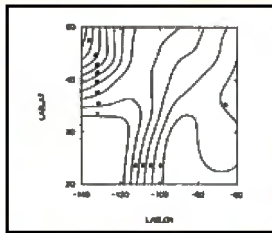
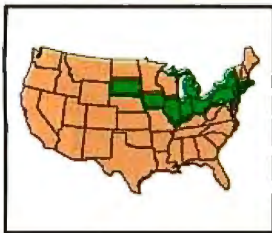

Statistics Basic statistics, frequencies, t-tests, post-hoc tests
 Multiway crosstabs with log-linear modeling, association coefficients, PRE statistics, Mantel-Haenszel, asymptotic standard errors Nonparametric statistics (sign, Runs, Wilcoxon, Kruskal-Wallis, Friedman two-way ANOVA, Mann-Whitney U, Kolmogorov-Smirnov, Lilliefors, Kendall coefficient of concordance) Pairwise/listwise missing value correlation, SSCP, covariance, Spearman, Gamma, Kendall Tau, Euclidean distances, binary similarities Linear, polynomial, multiple, stepwise, weighted regression with extended diagnostics Multivariate general linear model includes multi-way ANOVA, ANOCOVA, MANOVA, repeated measures, canonical correlation Principal components, factor analysis, rotations, components scores Multidimensional scaling Multiple and canonical discriminant analysis, Bayesian classification Cluster analysis (hierarchical, single, average, complete, median, centroid linkage, k-means, cases, variables) Time series (smoothers, exponential smoothing, seasonal and nonseasonal ARIMA, ACF, PACF, CCF, transformations, Fourier analysis Nonlinear estimation (nonlinear regression, maximum likelihood estimation, and more).

Graphics Overlay plots Drivers for most graphics devices
Two dimensional: Error Bars Scatterplots Line and Vector Graphs Vector, Dot, Bubble and Quantile Plots Bar Graphs (single, multiple, stacked, range) Box plots (single and grouped) Stem-and-leaf diagrams Linear, quadratic, step, spline, polynomial, LOWESS, exponential smoothing Confidence intervals and ellipsoids (any alpha value) Smooth mathematical functions Rectangular or polar coordinates Log and power scales ANOVA interaction plots Histograms (regular, cumulative, fuzzy) Stripe and jitter plots Gaussian histogram smoothing Scatterplot matrices Voronoi Tessellations Minimum spanning tree Maps with geographic projections (U.S. state boundary file included) Chernoff faces Star plots Fourier plots Pie charts Contour plots on regularly and irregularly spaced points Control charts and limits
Three dimensional: Data plots Smooth function plots Vector plots Linear, quadratic, spline, least squares surface smoothing Three-dimensional type fonts.

Data Management Import/export Lotus, dBase, and DIF files Full screen data editor Full screen text editor Unlimited cases Missing data, arrays, character variables Process hierarchical, rectangular or triangular files, irregular length records Character, numeric, and nested sorts Merge and append large files Unlimited numeric and character variable transformations Subgroup processing with SELECT and BY Value labels and RECODE Statements Macro processor with programming language, screen control, file manipulation, applications generation, and report writing.



Systat operates on IBM PCs and compatibles, MS-DOS and CP/M machines, several UNIX minicomputers, and the VAX/Microvax. Menu/windowed Macintosh version also available. Single copy price \$795 USA and Canada, \$895 Foreign. Site licenses, quantity prices and training seminars available. No fees for technical support. Statistics and graphics available separately.

For more information, call 312 864.5670 or write Systat Inc., 1800 Sherman Avenue, Evanston, IL 60201.

The following are registered trademarks: CP/M of Digital Research, Inc., IBM PC of IBM, Inc., MS-DOS of Microsoft, Inc., Macintosh of Apple Computer Inc., UNIX of AT&T and VAX of Digital Equipment Corporation.



IntegrAda

An Ada Programming Support Environment for the PC

Karl Nyberg and Jon Udell

IntegrAda from AETECH is a PC-based Ada Programming Support Environment. In a document entitled "Stoneman" (1980), the Department of Defense outlined its vision of an APSE. That document calls for a toolset that supports the complete software life cycle from design to maintenance. A compiler and a linker (binder) are obviously required; additional tools that "Stoneman" calls for include a database, a text editor (preferably Ada-oriented), a pretty-printer (a source code reformatter), a static program analyzer (a cross-referencer), a debugger, and a file administrator.

In comparison, the IntegrAda 4.0 environment features an Ada-oriented editor that constitutes the interface to a compiler, a binder, some of the recommended APSE tools, and a tutorial on Ada programming. The APSE tools include a syntax checker, a pretty-printer, and a library browser.

IntegrAda's compiler is licensed from RR Software, maker of the Janus Ada compiler. The binder and syntax checker are also RR products. AETECH packages these tools with its editor to create an integrated programming environment that invites comparison with the Borland language products in that you can compile, bind, and execute an Ada program without leaving the editor.

IntegrAda will run on any 8086, 80286, or 80386 computer equipped with a hard disk. It requires a full 640K

bytes of memory and needs all of it—you can't run memory-resident utilities while using IntegrAda. The installation program worked smoothly, copying the contents of the eight 5¼-inch floppy disks to directories that it creates on the hard disk. It transfers the files into two directory structures located at the root of directory C:. There's no option to locate these structures in a subdirectory of C: or on another drive. The installed system consumes slightly more than 3 megabytes of your hard disk.

Getting Started

You invoke IntegrAda at the DOS command line with the command `lada`. The editor prompts for your name and the name of a file to edit and then loads that file into a buffer (or presents an empty buffer if the file is new). The basic editing functions are bound to two sets of keys. One set of bindings emulates WordPerfect, and the other (following Borland) emulates WordStar. Unlike the

Borland products, IntegrAda doesn't provide a mechanism for altering the key bindings; unless you're already a WordPerfect or WordStar user, you'll have some learning to do.

A menu-driven help facility attached to F3 documents the basic editing keys and the keys that invoke tools like the compiler, syntax checker, and binder. We loaded TEST.ADA, a demonstration program, and worked through the process of compiling and running it. Control-F4 runs the syntax checker—a parser that can find simple mistakes like missing semicolons and misspelled keywords much faster than the full-blown compiler can. Each time it finds an error, it returns control to the editor; the editor highlights the error, displays an appropriate message, and puts you at the right spot to fix it. We ran the syntax checker a few times to find and fix the errors intentionally placed in TEST.ADA, then tried the pretty-printer at-

continued



IntegrAda 4.0

Type

Ada programming environment

Company

AETECH
380 Stevens Ave., Suite 314
Solana Beach, CA 92075
(619) 755-1277

Format

Eight 360K-byte 5¼-inch floppy disks

Language

Ada

Hardware Needed

IBM PC or compatible with 640K bytes of memory, a floppy disk drive, and a hard disk drive

Software Needed

MS-DOS 2.0 or higher

Documentation

200-page IntegrAda manual; 220-page Ada Language Reference Manual

Price

\$495

Inquiry 1164.

tached to Control-F8.

The pretty-printer supports three styles: Program Structure, MIL-STD-1815A, and First Letter Capitalized. The Program Structure style uses indentation to show logical structure and vertical lines to match the beginning and end of case, if, loop, and record statements. The MIL-STD-1815A style converts reserved words to lowercase and all user-defined identifiers (e.g., procedure and function names, variables) to uppercase. The First Letter Capitalized style, as its name suggests, capitalizes the first letter of all reserved words and identifiers. IntegrAda displays the reformatted text in a separate buffer; in the case of the latter two styles, you can replace the original text with the pretty-printed version.

The pretty-printer didn't work properly on TEST.ADA; it got confused by the task bodies contained in the program and displayed the wrong logical structure. AETECH has acknowledged the bug and promises to fix it in a forthcoming release. We subsequently found that the pretty-printer does work properly on most Ada constructs.

Next we used Control-F6 to invoke the compiler. The program compiled with no difficulty, but we found that the editor/compiler interface has some annoying peculiarities. When the compile finished, the editor told us so but didn't say whether or not there had been errors. We had to use Control-L to view the compiler's output and then had to confirm that TEST.LST was the file we really wanted to view. The editor then displayed a lengthy report from the compiler. At the end of nearly a page of messages from the various phases of the compiler, we found what we were looking for: "Compilation Successful." You can use Control-F5 to locate and fix errors, but it's frustrating to have to view the compiler's output to determine whether or not there are, in fact, errors to fix.

The binder, attached to Control-F7, works like the compiler. It too requires that you view a report to determine whether binding was successful. We ran the binder, checked the results, and then used Control-F9 to run the sample program; it simply echoed some text to the screen.

An Ada-Oriented Editor

The editor has three modes: text, Ada-sensitive, and design. There should be an indication of the current mode somewhere on the screen, but there isn't. In text mode the editor works like a simple text editor—albeit one that doesn't handle lines longer than 80 characters. Ada-sensitive mode—the default—is the standard mode for Ada programming. In this mode the editor adjusts its level of indentation in an attempt to show the program structure. Unfortunately, the results aren't always what you expect.

Listing 1 shows the beginning of TEXT2_IO.ADS, the specification for the alternate TEXT_IO package provided by AETECH. Listing 2 shows what happens when you type that text under control of the IntegrAda editor. The keyword package indents for no apparent reason. The type declarations indent properly, but the extra line between the type and subtype declarations ends the declarative region prematurely; the subtype declarations, which belong logically at the same level as the type declarations, end up flush left. AETECH acknowledged that indentation following a with isn't correct. The problem with the indentation of the subtype declarations was the extra line of space; the editor is sensitive only to a single line of previous context.

A more useful feature of Ada-sensitive

mode is the editor's ability to supply templates for common Ada constructs: packages; all the standard type declarations; procedures; functions; tasks; and loop, if, and case statements. These templates are attached to the Control-F1 and Control-F2 keys. Listing 3 shows what happens when you construct the beginning of TEXT2_IO.ADS using templates for the package specification, the type declarations, and the procedure declaration. For example, to declare the subtype POSITIVE_COUNT, you select derived from one of the template menus and supply the name POSITIVE_COUNT. IntegrAda inserts the declaration and positions the cursor in the right spot for filling in the range constraints. This method works better than manual text entry—there's less typing, and program structure falls naturally into place.

Note that IntegrAda automatically instantiates the appropriate generic I/O package for integer and enumeration types that you declare. That might be useful in some contexts, but in this case the instantiations aren't needed.

The Ada-oriented mode of the editor works in conjunction with a tool that browses through the specifications (.ADS files) in the library (one or more directories on your path). Some background: Ada programs are organized into packages. A package has a specification, which can include what ANSI C calls function prototypes, and a body that implements functions named (exported) in the specification. When you want to write a call to a procedure or function exported by some package in the library, you can review the appropriate specification and capture a portion of it. Say you need to write a call to GET_LINE in the TEXT_IO package. You invoke the browser and select TEXT_IO. The editor splits the screen horizontally and puts your Ada program in the top window and TEXT_IO.ADS in the bottom window.

At this point, you're supposed to be able to use the editor's search function, bound to F2, to locate GET_LINE's declaration. We found that F2 didn't work in this context (AETECH acknowledged the bug and said it will be fixed in a forthcoming release), but we were able to locate GET_LINE by scrolling through the buffer. Once you've found the declaration, you mark its extent, save it to a temporary file with Alt-F10 (which returns you to your original buffer), then recall it with Alt-F10. IntegrAda transforms the declaration into a call, names the formal parameters, supplies TBD

continued

NOW YOU CAN DESIGN JUST ABOUT ANYTHING...INCLUDING YOUR OWN CADD SYSTEM!

PC
MAGAZINE
CADD
3.0



Anyone can produce a computer-aided drafting and design package that sells for thousands of dollars. But creating one that's fast, powerful, and affordable takes real ingenuity.

That's exactly what we've done at Generic Software.™ We sell the most widely used CADD program in the world for under \$500.



PC Magazine ranked it "Editors Choice" in a face off with 17 low-cost CADD packages. "This product is an outstanding value from every point of view and is highly recommended." "A paperback version of AutoCAD", stated PC Week.

And our CADD programs are just part of what we offer. You can start with Generic CADD Level 1,™ then advance to other levels as your needs—and skills—expand.

And you can use our CADD add-ons, Utilities, and symbols libraries to design the CADD system that fits your needs.

You only pay for the functionality you need, and the functionality you get has depth.

Critic tested, market approved. Generic Software offers price, quality, and support. Match our customer support against anyone!

- Unconditional 60-day guarantee on most products
- Unlimited free technical support
- Free monthly newspaper
- Regular updates at modest prices. All adding up to prove that the only thing generic about us is the price.

Call us for a free CADDalog™ or for the name of your local dealer: 1-800-228-3601.

© Generic Software Inc., Level 1 and Generic CADD are trademarks of Generic Software Inc., 11911 North Creek Parkway South, Bothell, WA 98011. Macintosh is a trademark of Apple Computer Inc.

Generic
S O F T W A R E

Circle 115 on Reader Service Card
(DEALERS: 116)



Listing 1: TEXT2_IO.ADS, as supplied by AETECH.

```
with IO_EXCEPTIONS;
package TEXT2_IO is
  type FILE_TYPE is limited private;
  type FILE_MODE is (IN_FILE, OUT_FILE);
  type COUNT is range 0..INTEGER'LAST;
  type TYPE_SET is (LOWER_CASE, UPPER_CASE);

  subtype POSITIVE_COUNT is COUNT range 1..COUNT'LAST;
  subtype FIELD is NATURAL;
  subtype NUMBER_BASE is INTEGER range 2..16;

  UNBOUNDED : constant count := 0;
```

Listing 2: TEXT2_IO.ADS input under the control of the Ada-oriented editor; indentation is inconsistent.

```
with IO_EXCEPTIONS;
  package TEXT2_IO is
    type FILE_TYPE is limited private;
    type FILE_MODE is (IN_FILE, OUT_FILE);
    type COUNT is range 0..INTEGER'LAST;
    type TYPE_SET is (LOWER_CASE, UPPER_CASE);

    subtype POSITIVE_COUNT is COUNT range 1..COUNT'LAST;
    subtype FIELD is NATURAL;
    subtype NUMBER_BASE is INTEGER range 2..16;

    UNBOUNDED : constant count := 0;
```

Listing 3: TEXT2_IO.ADS built from templates. Note the automatic instantiation of TEXT_IO for enumeration and integer types.

```
with IO_EXCEPTIONS;
package TEXT2_IO is
  type FILE_TYPE is limited private;
  type FILE_MODE is (IN_FILE,OUT_FILE);
  package FILE_MODE_IO is new
    TEXT_IO.ENUMERATION_IO(FILE_MODE);
  --use FILE_MODE_IO;
  type COUNT is range 1..COUNT'LAST;
  package COUNT_IO is new
    TEXT_IO.INTEGER_IO(COUNT);
  --use COUNT_IO;
  subtype POSITIVE_COUNT is COUNT range 1..COUNT'LAST;
  subtype FIELD is NATURAL;
  subtype NUMBER_BASE is INTEGER range 2..16;
  UNBOUNDED : constant COUNT := 0;

end TEXT2_IO;
```

Listing 4: Procedure calls captured from TEXT2_IO; indentation is incorrect.

```
procedure FOO is
begin
  GET(FILE => TBD, -- in FILE_TYPE
    ITEM => TBD);-- out CHARACTER
  PUT(ITEM => TBD);-- in STRING

  PUT(ITEM => TBD);-- in STRING
end FOO;
```

(for “to be defined”) in place of the actual parameters, and positions you on the first TBD. All you have to do is fill in the actual parameters to complete the call.

The library browser works nicely, but we had problems with the way IntegrAda formatted the material we captured. Listing 4 shows a sample procedure that contains two procedure calls imported from TEXT2_IO. GET_ITEM indented properly, but IntegrAda should have placed both PUT_ITEM calls directly under GET_ITEM and didn't get either one right. In the first case, it followed the indentation of GET_ITEM's second parameter. In the second—after we added a blank line to kill the association with the previous indentation—we couldn't determine what rule it was applying.

Finally, the editor supports a design mode. It's much like the Ada-sensitive mode, though with a few differences. First, the editor reserves extra commented space in which you're expected to write pseudocode. Second, the Ada constructs that you create from templates include null statements so that you can compile and execute them. IntegrAda's design mode supports the notion of Ada as a design language as well as a programming language. The idea is that you can quickly prototype a first refinement of an Ada system that, although mostly descriptive, has the structural properties of the finished system.

Design mode has one annoying feature. When you're typing a comment and you reach column 79, the editor automatically inserts a linefeed and the characters “-- :” to denote the beginning of a new statement in design language. Unfortunately, this happens even when you are in the middle of a word.

Compiler, Binder, and Library

The IntegrAda compiler is a validated Ada compiler. That's no minor feat: It means that the compiler successfully ran the several thousand tests that constitute the Ada Compiler Validation Capability suite. Both the compiler vendor and a review team acting on behalf of the government run the ACVC tests; validation is important because it ensures that a compiler conforms to the standard definition of Ada and thus enables military software contractors to use the compiler to develop software under the aegis of the Department of Defense.

IntegrAda has a separately validated compiler. That is, AETECH licensed the Janus Ada compiler from RR Software, built an environment around it, then validated the compiler within that environ-

continued



HALO

The Graphics Toolkit for Contemporary Software Developers

Already the fastest and most powerful graphics toolkit on the market, the new HALO[®] delivers subroutines and device support for exciting, contemporary applications in publishing, office automation, vision, and image processing.

HALO '88 is a device independent library of 190 graphics subroutines. It is compatible with 18 programming languages, and over 140 hardware devices such as image scanners; graphics, vision, and imaging boards; printers and plotters; and mice. HALO '88 is designed for the complete IBM compatible microcomputer line including the PS/2 and VGA.

Today's Tools for Tomorrow's Applications

HALO '88 has new subroutines which control scanners and scanned images — even images which are larger than screen resolution and available memory. Extended character set support enables software developers to address IBM's

full 255 characters in graphics and to design foreign language fonts. Among contemporary HALO '88 applications are CAD, Computer-Based Training, Presentation Graphics, Graphic Arts, Mapping, Machine Vision, Silicon Wafer Manufacturing, Sound System Design, Vehicle Scheduling and Routing, and Real Estate.

Join the HALO Family

HALO has an installed base of 60,000+ end-users, hundreds of site-licensed corporations, government agencies, universities, and national laboratories and most importantly, over 220 Independent Software Developers (ISVs) who market applications written with HALO.

HALO '88 provides the software designer with the richest environment of graphics functions; the programmer with reliable and

well-documented tools, and DP managers with continuity of user interface and database format.

Reach for the Future

If you need high performance graphics development software that provides a migration path to OS/2 and other future technology, follow the industry leaders — call (800) 992-HALO (4256).

HALO '88 is just \$325 and includes all device drivers, 20 fonts, your choice of one compiler binding, completely new documentation, an interactive tutorial and free 800# technical support. Update from HALO for \$150.

Ask about the new HALO Programmers' Workbook which provides C program examples for HALO '88 applications developers.

media cybernetics
8484 Georgia Ave.
Silver Spring, MD 20910
(301) 495-3305, (800) 992-HALO

HALO is a registered trademark of Media Cybernetics, Inc. IBM PS/2, VGA and OS/2 are registered trademarks of International Business Machines Corp.



ment. Oddly, the IntegrAda manual makes no mention of RR or its compiler; the only reference to it appears in a copyright notice at the beginning of all the compiler's outputs. AETECH seems to want to hide the identity of the resident compiler. You'd think it would be proud of the foundation of its product—particularly since the Janus Ada compiler, originally criticized for implementing only a subset of Ada, has matured and has recently received good reviews as a credi-

ble, low-cost Ada compiler. At times AETECH's contortions are almost comical, as when the IntegrAda manual defines JRL files (Janus relocatable) as "IntegrAda compiler relocatable."

You can set compiler/binder switches from within IntegrAda. One switch governs the use of a virtual disk, in conjunction with VDISK.SYS. Others govern optimization, generation of debugging code, and the elimination of unused subprograms. You can set the target ma-

chine—it's an 8086 by default, but the compiler can produce 80186-, 80286-, or 80386-specific code. The compiler can generate emulator- or coprocessor-based floating-point code; it's an either/or situation, though, and you can't create a single executable program that will use the coprocessor (if one is present) and emulate otherwise.

A compilation can create three kinds of object files. In general, package specifications produce two outputs: an .SYM (symbol) file that transmits information about the package to other compilation units and an .SRL (specification relocatable) file that contains the specification's code. Package bodies—which other compilation units don't refer to directly—produce code only, in the form of a JRL file. The compiler derives the root name for these files from the name of the package or main subprogram you're compiling.

DOS, of course, limits the filename to eight characters, but Ada imposes no such limitation on the names of Ada entities. The compiler tries to use the first eight characters of an Ada name but in case of conflict will use the first five characters, a dollar sign, and two arbitrary characters. To avoid conflicts, it would probably be best to limit the length of Ada names that will map to DOS filenames.

The binder operates on a file that contains a parameterless main procedure. It collects all objects named in that unit and (transitively) all units on which the main unit depends, then binds them into an executable program. It doesn't use the name of the main procedure's file as the root of the .EXE name that it creates; rather, it prompts for the name of the main procedure. Again, Ada doesn't require that you restrict that name to eight characters, but in practice you probably should.

The IntegrAda implementation of an Ada program library is minimal; the nature of it isn't immediately obvious and isn't spelled out in the manual. The library is simply the collection of .SYM, .SRL, and .JRL files in the directory C:\IADA\COMPILER. The compiler and binder can access the library because the tool that invokes IntegrAda sets a DOS path that includes that directory. That's slightly odd; normal DOS convention is to use the path to name directories that contain programs and to use other environment variables (e.g., lib) to name directories that contain data. To create a new library, you make a directory, add it to the path, and copy compilation results

continued



Discovery Modem

Bell 103/212A
CCITT V21 V22 V23 V22bis
1200, 2400, 1200/75 bps
Auto-Dial, Auto-Answer
Hayes™ Compatible
MNP™ Error Correction
FCC & PTT Approval

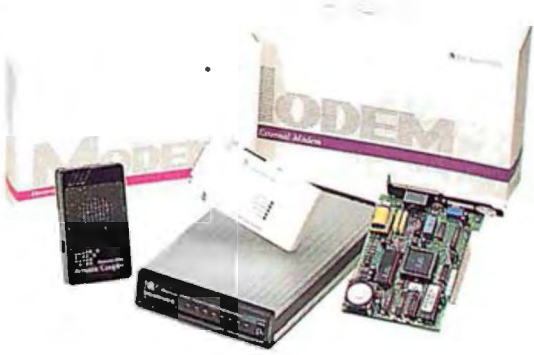

DATATRONICS TECHNOLOGY, INC.

172 Nan-King E. Rd, Sec. 5, Taipei 10572 Taiwan
Phone: (02) 762-3202, 768-6262 Telex: 28440 DTXMODEM
Fax: 886-2-764-0614

U.S.A. Authorized Distributor: Sunhill Inc.
Tel: (800) 544-1361

Hayes is trademark of Hayes Microcomputer Products, Inc. MNP is trademark of Microcom, Inc.

Digitizers

18" x 24" thru 9' x 9' x 9'



We'll cover your digitizer needs with twelve different active areas to choose from. From the GP-7 Grafbar Mark II, ("Flexible, Precise, and Elegant . . .", PC Magazine), all the way through the 60" x 72" GP-8, and of course the user adjustable active volume, (up to 9 ft. cube), of the GP-8-3D. And you can digitize on any work surface.

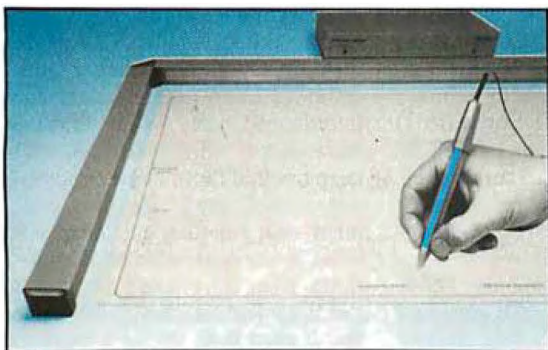

All our digitizers come complete with RS-232 output format, power supply, two-way communications, a stylus, optional one button and four button cursors, a five function menu, and are IBM-PC compatible. So no matter what your size requirements are, we've got you covered; (at low cost too!).

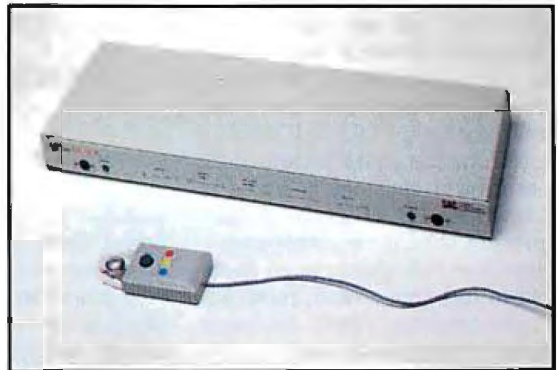

OEM versions available. Directly supported by AutoCAD, ProDesign II, Generic CADD, CADVANCE, CADKEY, Easy Digit, etc. Also, compatible with Lotus Measure.

For more information contact:
Skip Cleveland (203) 255-1526

We've got your size.

SAC[®] SCIENCE
ACCESSORIES
CORPORATION

970 Kings Highway West, P.O. Box 550 Southport, CT 06490 (203) 255-1526 • Telex 964300 FAX (203) 254-7271

to it. There's no mechanism for aggregating the contents of a library into a single object. You can, of course, use an ARC utility to bundle library files for transport, but IntegrAda itself requires loose files.

The notion that such a collection of files constitutes a program library takes getting used to. When we first started using the system, we recompiled the package specification for TEXT_IO. We copied the resulting files to C:\IADA\COMPILER—replacing the originals—then started looking for the library tool. Of course there wasn't one, and we'd just succeeded in corrupting our program library. Here's why. Ada enforces compilation dependencies. The package body (TEXT_IO.ADB) depends on its specification (TEXT_IO.ADS). Since we'd updated the specification, and since the body depends on it, we'd have needed to recompile it too, but we couldn't, because IntegrAda provides source code only for the specifications of library packages, not for their bodies. So we had to retrieve the original TEXT_IO library modules from the installation disk, where, as it turns out, they're stored in ARC format. AETECH should at least write-protect the library modules—which appear at first glance to be modifiable but in fact aren't—and, more important, the company should document its concept of a program library.

IntegrAda provides the source code for specifications solely for use by the library browser. It knows about the directory structure in which the .ADS files are stored and presents a nice menu-oriented interface to them in support of the editor's template-capture facility. Unfortunately, that structure is hard-coded. You can't modify the directory structure that the browser accesses to include new directories with specifications that you write. It will, however, find specifications in your current working directory, and you can also import specifications from a directory that you've named explicitly.

Documentation and On-Line Help

The IntegrAda manual is poorly organized, typographically shoddy, and full of errors. Concepts critical to an understanding of the product—such as Ada design language, program libraries, and template-oriented program editing—are introduced in a roundabout manner or completely ignored. There is no index. Reference and tutorial sections appear in apparently random order. Examples in tutorial sections don't match what you actually see on the screen. The term

"Ada Workstation Environment" appears several times, but the manual never defines what that means. AETECH promises to upgrade the manual in a forthcoming release, but it has a long way to go to meet minimal expectations.

Particularly annoying is the manual's failure to deal accurately with the underlying technology licensed from RR Software. Near the end of the manual, a section explains how to use the compiler and binder in a stand-alone manner, but the documentation of the required switches is incorrect; we had to call AETECH to

The editor's
ability to import
templates is
its strongest asset.

find out how to run the compiler and binder from the DOS command line. And when we invoked a function supposedly bound to Control-F10—which the IntegrAda manual says will enable you to edit a .BAT file that automates stand-alone compilation—nothing happened; as it turns out, the file (COMP.BAT) doesn't exist. The section on manual operation of the binder refers to a linker manual (presumably RR Software's) which, again, AETECH has failed to provide. In another section, there's a reference to CORDER, a compilation-order tool from RR, but AETECH didn't bundle that tool with IntegrAda.

The on-line help is considerably better than the printed manual. You can find out about all the program's functions by poking around in the menu-driven help facility. There's also a tutorial on Ada, called the Ada Training Environment, which presents a series of brief but informative lessons on basic Ada programming concepts. You could easily overlook this tutorial, though; it's not highlighted in the manual, and we just stumbled upon it while poking around in the product.

Ada for the Rest of Us?

IntegrAda aims to do for Ada what the Borland language products have done for Pascal, C, and Prolog—namely, provide an effective integrated programming environment. IntegrAda does implement an

integrated environment, but one that falls far short of the standard Borland has set. The editor is not reconfigurable, so you're stuck with the default key bindings. In Ada-sensitive mode it's often unclear what rules of indentation the editor is applying. The editor's ability to import templates is its strongest asset, but here too you tend to get strangely formatted results. The editor/compiler interface is awkward; you shouldn't have to ask to see the results of a compilation and then have to confirm the name of the file that's about to be presented to you. Some things just don't work—you can't search for text when browsing a specification, for example, and the pretty-printer formats task bodies incorrectly.

Despite these flaws, however, the product can be used to compile, bind, and execute Ada programs in an environment that shields the user from DOS. The syntax checker speeds development significantly. These qualities, in conjunction with a reasonable price and a useful Ada tutorial, may qualify IntegrAda for use in educational settings, particularly when students are new to both Ada and DOS (although AETECH's main competition in this market is, ironically, RR Software).

But the product as it stands has serious limitations. The absence of a compilation-order tool (which the manual frustratingly alludes to but AETECH didn't license from RR) is one major drawback. Unlike other languages, Ada requires that you submit compilation units to the compiler in an order that reflects their interdependencies. When an Ada system grows to any substantial size, it's hard to keep track of those dependencies. That's why "Stoneman" recommends (and other Ada vendors, including RR, provide) a configuration manager—something like Unix make or the Borland project feature, but more complex in that it must both derive a legal compilation order for a group of units and then execute a script that compiles them. The minimalistic program library is another big drawback; "Stoneman" calls for a database more sophisticated than the DOS file system. Because IntegrAda doesn't provide these kinds of APSE tools it's a poor choice for large Ada programming projects. ■

Karl Nyberg is founder and president of Grebyn Corp., an Ada and Unix consulting firm in Vienna, Virginia. You can reach him on BIX c/o "editors."

Jon Udell is a technical editor for BYTE. He can be contacted on BIX as "judell."

One of the most important reasons
for buying our new LaserJet IID printer
is on the other side of this page.

One of the most important reasons
for buying our new LaserJet IID printer
is on the other side of this page.



latest member

LaserJet printer family prints on
both sides of the paper. But
that's just the icing on the cake.

The LaserJet IID printer is full
of new ideas for making paper-
handling easier and more
efficient.

An envelope feeder accessory,
for one. Instead of having to feed
envelopes manually, our new
printer does it automatically.

You wanted more paper trays.
So the LaserJet IID printer
has two of them, each with a
200-sheet capacity. Give us more
fonts, you said. And LaserJet

Series II compatibility. Done!

So now you have a choice of
two HP LaserJet printers. Both
with that superb quality for
text and graphics you've come
to expect from Hewlett-Packard.

All good reasons to call **1-800-
752-0900, Ext. 297A** for the
name of your nearest dealer.



**HEWLETT
PACKARD**

QuickBASIC Comes to the Macintosh

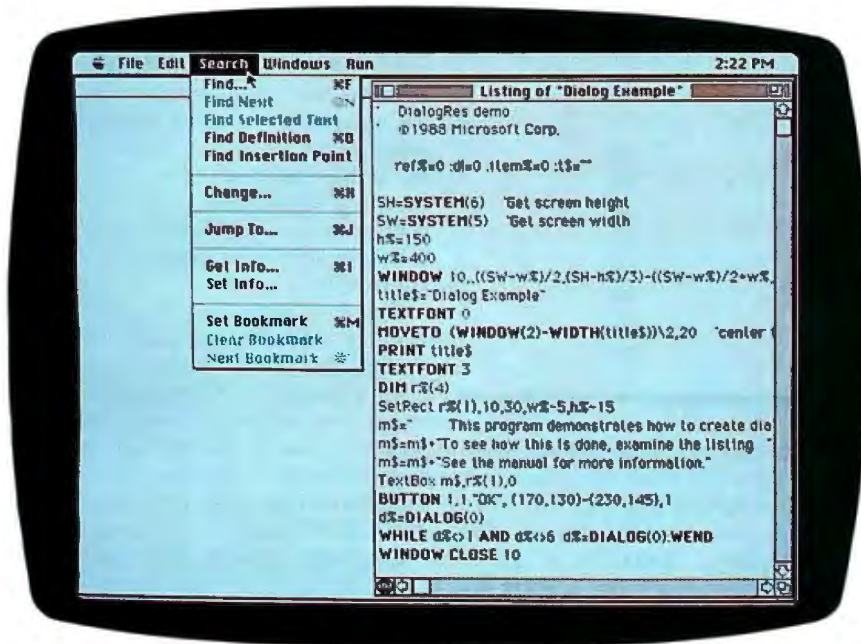
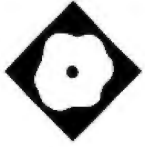

A handy tool for exploring the Toolbox and building Macintosh applications

Namir Clement Shammas

Microsoft has united two popular Macintosh language products—its BASIC interpreter (version 3.0) and its BASIC compiler (1.0)—to form an integrated environment for programming the Mac. The result: QuickBASIC for the Macintosh (\$99).

But don't confuse this BASIC with its IBM PC cousin, QuickBASIC 4.0. The

two BASICs differ in fundamental ways. Applications written in one dialect aren't likely to port to the other without extensive recoding. And the Mac version of QuickBASIC I tested here implements a less sophisticated dialect of BASIC than does the PC version.

However, once you've sorted out its lineage, Macintosh QuickBASIC 1.0 emerges as a fast and flexible tool for building real Macintosh applications. To use it, you'll need at least a Mac Plus. Microsoft provides two versions of the program. One supports binary arithmetic, and the other supports slower but more precise binary-coded decimal (BCD) arithmetic.

Not Created Equal?

There are many implementations of BASIC. To give you a feel for this one, I'll enumerate some of its features; check table 1 for a feature-by-feature comparison of the Mac and PC QuickBASICs.

Macintosh QuickBASIC supports

strings, integers, long integers, and both single- and double-precision reals. It doesn't support constants, though you can emulate a constant with a function that simply returns the desired value. You use DIM to dimension an array, or you can use an array variable that you haven't explicitly created by simply referring to it—QuickBASIC automatically allocates 10 elements per dimension.

The OPTION BASE (lowest array index) is 0 by default; you can change it to 1. The predefined functions LBOUND and UBOUND return the lower and upper boundaries of a specified dimension of an array.

Branching constructs are single-line IF, multiline IF (with optional ELSEIF clauses), and SELECT CASE. With SELECT CASE, a CASE label can take an individual constant (e.g., CASE 1), a range of constants (e.g., CASE 1 to 4), or a list of constants and ranges (e.g., CASE 1 to 4, 5, 7 to 9). The looping constructs are FOR...NEXT and WHILE...WEND.

There are three calling mechanisms: functions, subroutines you can branch to, and subroutines you can call. DEF FN creates a one-line function. The GO-SUB...RETURN pair implements the classic BASIC subroutine—a branch to a label (or line number).

SUB, END SUB, EXIT SUB, and CALL implement a true structured subroutine capability. SUB and END SUB define the extent of a subprogram. EXIT SUB effects a return. CALL invokes a subprogram (actually, it's optional; CALL SQUARE(X) and SQUARE X are equivalent).

QuickBASIC passes arguments by reference, so a called subprogram can alter its arguments. You can get call-by-value by wrapping parentheses around an argument; that transforms the argument into an expression and forces QuickBASIC to send the subprogram a copy of it. To protect a number from an errant SQUARE

continued

Table 1: A comparison of Macintosh QuickBASIC 1.0 and IBM PC QuickBASIC 4.0. The IBM PC version of QuickBASIC provides many advanced features that you won't find in the Macintosh version.

Language feature	Macintosh QuickBASIC	IBM PC QuickBASIC
Long integers	Yes	Yes
User-defined structures	No	Yes
Constants	No	Yes
Static/dynamic arrays	Yes (compiler)	Yes
Loops		
FOR...NEXT	Yes	Yes
WHILE...WEND	Yes	Yes
DO...LOOP	No	Yes
DO WHILE...LOOP	No	Yes
DO...UNTIL	No	Yes
Decision making		
Multiline IF	Yes	Yes
SELECT CASE	Yes	Yes
CASE with expressions	No	Yes
Multiline DEF FN	No	Yes
FUNCTIONs	No	Yes
CALLable SUBs	Yes	Yes
LBOUND and UBOUND	Yes	Yes

function, you could write `CALL SQUARE(X)`.

QuickBASIC supports sequential and random-access file I/O. Filenames must follow the Hierarchical File System (HFS) naming convention. Predefined I/O devices include `SCRN:`, `KYBD:`, `LPT1:`, `COM1:`, and `CLIP:` (the Clipboard). The Clipboard is particularly interesting. You can use it to write QuickBASIC programs that export text or graphics for use by other applications or that import text or graphics for their own use.

In QuickBASIC you gain access to external libraries using the `LIBRARY` statement. You can use up to eight external libraries at once and `CLOSE` them when they're no longer needed. The manual does a good job of describing how to create your own libraries in C or assembly; the distribution package includes sample library material written in MPW C, Lightspeed C, MPW Pascal, and assembly language. QuickBASIC provides a collection of support routines for developing external libraries; they facilitate, among other things, the communication of arguments between QuickBASIC and your routines.

The QuickBASIC Environment

When you launch QuickBASIC from the Macintosh desktop, you enter the inter-

preter. Its top-level menu contains, in addition to the standard File and Edit selections, Search, Windows, and Run selections. Two windows appear. The active window is connected to QuickBASIC's built-in editor; that's where you write, edit, and debug your program. The other window—at first inactive—is the one that receives your program's output.

You can open a third window by way of the Windows selection on the menu bar; it contains a command line that you can use to interactively execute single BASIC statements.

The editor is syntax-oriented—which here means that it maintains your current level of indentation within blocks and displays BASIC keywords in boldface. When you're editing a program, the Search menu supports a variety of navigational aids. You use Find and Find Next to locate a text string. If you're positioned on a call to a subroutine, you can use Find Definition to locate that subroutine's definition, and Find Insertion Point to jump back to your original position. Jump To takes you to a specified line in your file. Finally, you can use Set Bookmark to mark places in a file that you can then jump to with Next Bookmark.

QuickBASIC provides an interesting form of on-line help. If you're positioned

on a BASIC keyword (a language construct like `WHILE`, or a library routine like `CIRCLE`), you can use another selection on the Search menu, Get Info, to view a short description of the term. It's particularly useful as a quick way to find out the order and types of arguments to library functions.

However, I'd like to see more information; function prototypes are helpful, but examples would be a welcome addition. You can extend the help system with Set Info, adding one-line descriptions of your own BASIC subroutines. It's a nice feature, though I'd like to be able to write longer descriptions.

Once you've written your code, you can invoke the QuickBASIC interpreter from the Run menu. If there's an error, the interpreter and editor conspire to locate it, frame it, and position the text cursor at the right spot to fix it. Otherwise the program simply runs—slowly, of course, since QuickBASIC must interpret it—and its output appears in the output window.

The Run menu provides several debugging tools. Run Program does what I've just described. Step frames and executes a single BASIC statement. If you toggle Trace All on, the interpreter runs your program in slow motion, framing each statement it executes; you can stop things with Command-Period and toggle Trace All off again. Finally, you can set breakpoints. You do this with Breakpoint On/Off on the Run menu; clicking on it makes a Stop icon appear or disappear at the beginning of the current line. Alternatively, you can drag a copy of the Stop icon that lives at the bottom of the edit window to the line at which you want to break. When execution reaches the breakpoint, the interpreter sounds an alert and frames the breakpoint icon. You can select Continue from the Run menu to proceed to the next breakpoint.

QuickBASIC doesn't support watch variables, but you can use the command window to examine variables. Whenever the program is quiescent—that is, you've explicitly stopped it, it's between steps in single-step mode, or it's halted because of a breakpoint—you can open the command window (or bring it to the foreground if it's open but not active) and use BASIC's `PRINT` statement to print the value of your variable. Since you're inserting the `PRINT` statement into the flow of your program, the output goes to the same window that your program is using and can cause a conflict.

But the command window is a powerful tool. From it, you can execute any

continued

6 Compact Discs FOR THE PRICE OF 1

...with nothing more to buy ever!

YES, please accept my membership in the BMG Compact Disc Club and send me the four CDs I have indicated. I understand that I may listen to my four introductory CDs first. Then, at the end of ten days—return them with no further obligation—or keep them for just shipping & handling under the terms in the ad. I need buy just one CD at regular club prices during the next year—after which I will choose another CD as a bonus. That's 6 CDs for the price of one...without obligation to buy anything further! (Shipping & handling added to each shipment.)

Limited to new members, continental USA only; one membership per family. We reserve the right to request additional information or reject any application. Local taxes if any, will be added.

Rush Me These 4 CDs NOW (Indicate by number)

D	D	D	D
---	---	---	---

My Major Listening Interest Is (Check one only, but you may always mix.)

- A **Easy Listening** (Instrumental/Vocal Moods) B **Country**
 C **Hard Rock** D **Pop/Soft Rock** E **Classical**

MR.
 MRS. _____
 MISS _____

First Name Initial Last Name (PLEASE PRINT)

Address _____ Apt. _____

City _____ State _____ Zip _____

Telephone (_____) _____
Area Code

YATAE 

Signature _____

CD687



NO POSTAGE
NECESSARY
IF MAILED
IN THE
UNITED STATES

BUSINESS REPLY MAIL

FIRST CLASS PERMIT NO. 5071 INDIANAPOLIS, IN

POSTAGE WILL BE PAID BY ADDRESSEE

BMG COMPACT DISC CLUB
P.O. Box 91412
INDIANAPOLIS IN 46209-9976

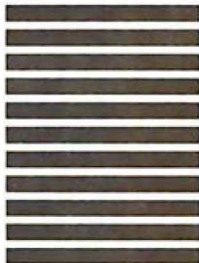

The ultimate in sound... The ultimate in savings...



GET 6 COMPACT DISCS FOR THE PRICE OF ONE

...with nothing more to buy ever!

And...take advantage of our **INSTANT HALF-PRICE Bonus Plan!**

SAVE 50%

Unlike other clubs, you get 50%-off Bonus Savings with every CD you buy at regular Club prices, effective with your first full-price purchase!

200583. John Lennon: Imagine/Soundtrack. Jealous Guy, Mother, more. (Capitol)
 174328. George Harrison—Cloud Nine. Got My Mind Set On You, more. (Dark Horse)
 134347. Huey Lewis: Small World. Latest good time rockers include Perfect World, more. (Chrysalis)
 115356. Vivaldi, The 4 Seasons—Trevor Pinnock. (Archiv DIGITAL)
 180187. Bruce Hornsby & The Range: Scenes From The Southside. The Valley Road, more. (RCA)
 100008. Randy Travis: Old 8x10. Honky Tonk Moon, Deeper Than The Holler, more. (Warner Bros.)
 125179. Tchaikovsky, 1812 Overture; Nutcracker Suite; more—Solti. (London DIGITAL)
 163629. Whitesnake. Still Of The Night, Give Me All Your Love, more. (Geffen)

 100517

200596. U2: Rattle & Hum. Live set includes I Still Haven't Found What I'm Looking For, Desire, more. (Island)
 182522. Dirty Dancing/Original Soundtrack. (I've Had) The Time Of My Life, more. (RCA)
 200478. Metallica: And Justice For All. One, Blackened, title song, more. (Elektra)
 100603. Kenny G: Silhouette. We've Saved The Best For Last, more. (Arista)
 154404. Chicago 19. Don't Wanna Live Without Your Love, Heart In Pieces, etc. (Reprise)
 115457. Itzhak Perlman: French Violin Showpieces: Carmen-Fantasy; Havanaise, more. (DG DIGITAL)
 144578. The Judds: Greatest Hits. Give A Little Love, Mama He's Crazy, etc. RCA
 223559. Beach Boys: Endless Summer. 20 Greatest Hits.
 115306. Handel, Water Music—Trevor Pinnock. (Archiv DIGITAL)
 100601. Squeeze: Classics. Take Me I'm Yours, Striking Matches, Tough Love, more. (A&M)
 104898. Cream: Disraeli Gears. Sunshine Of Your Love, more. (Polydor)

173233. James Galway: Greatest Hits. (RCA)
 154633. Steve Winwood: Roll With It. Don't You Know What The Night Can Do?, Holding On, etc. (Virgin)
 100470. Vangelis: Direct. (Arista)
 153582. Tracy Chapman: Fast Car, Talkin' Bout A Revolution, Baby Can I Hold You, etc. (Elektra)



152854. Whitney Houston: Whitney. Didn't We Almost Have It All, etc. (Arista)
 150913. Van Halen: OU812. (Warner Bros.)
 134073. Richard Marx —Hold On To The Nights. Endless Summer Nights, Should've Known Better, etc. (EMI)
 163579. Segovia Plays Ponce, Rodrigo & Torroba (MCA)
 100579. K.T. Oslin: This Woman. Money, title song, Hey Bobby, etc. (RCA)

100035. Robert Palmer: Heavy Nova. Simply Irresistible, etc. (EMI-Manhattan)
 120768. 20 Greatest Love Songs Of The 50s & 60s. (Laurie)
 123721. Jimmy Page: Outrider. (Geffen)
 134321. Led Zeppelin. Houses Of The Holy—The Song Remains The Same, more. (Atlantic)
 105392. Pops In Space—Boston Pops/Williams: Star Wars, Superman, more. (Philips DIGITAL)
 173406. Jazz CD Sampler. 15 performances from Louis Armstrong, others! (PolyGram)
 123790. James Taylor's Greatest Hits. Fire And Rain, Sweet Baby James, more. (Warner Bros.)
 154537. Carly Simon: Greatest Hits Live. Anticipation, You're So Vain, more. (Arista)
 115541. Bach, Brandenburg Concertos 1-3—Pinnock. (Archiv DIGITAL)
 172190. Elvis Presley: 18 No. 1 Hits (RCA)

134267. Mozart, Overtures, Marriner. (Angel DIGITAL)
 100591. Steve Miller: Born To Be Blue. Ya, Ya, more. (Capitol)
 273965. Sting: Nothing Like The Sun. We'll Be Together, more. (A&M)
 134647. J. R. Baker: Rhapsody In Electric Blue. Gershwin on synthesizer! (Newport Classic DIGITAL)
 244006. Simon & Garfunkel: The Concert In Central Park. [1 disc] (Warner Bros.)
 124705. Jethro Tull: Aqualung. (Chrysalis)
 134408. David Sanborn: Close-Up. Siam, You Are Everything, Way, etc. (Warner Bros.)
 153606. INXS: Kick. Need You Tonight, New Sensation, etc. DIGITAL (Atlantic)
 153621. Beethoven, Symphony No. 7; more. Royal Phil. Previn. (RCA DIGITAL)

164165. Bobby McFerrin: Simple Pleasures. Don't Worry Be Happy, All I Want, etc. (EMI)
 125264. Horowitz in Moscow—Scarlati, Mozart, Rachmaninov, others. (DG DIGITAL)
 144313. Classic Rock: Vol. 1. Elton John: Bennie & The Jets, more. (MCA)
 170348. Guns 'N' Roses: Appetite For Destruction. Welcome To The Jungle, It's So Easy, etc. (Geffen)
 163322. Elton John: Greatest Hits, Vol. 1. Your Song, Daniel, others. (MCA)
 160027. Alabama: "Live". Love In The First Degree, There's No Way, Dixieland Delight, etc. (RCA)

 100516

130230. Crosby, Stills, Nash & Young: So Far (Greatest Hits). Suite: Judy Blue Eyes, more. (Atlantic)
 124546. The Moody Blues: Sur La Mer. I Know You're Out There Somewhere, No Lies, etc. (Threshold)
 143293. Glenn Miller Orchestra: In The Digital Mood. (GRP)
 114780. Cinderella: Long Cold Winter. Gypsy Road, Don't Know What You Got (Till It's Gone), etc. (Mercury)
 154358. Slatkin Conducts Pictures At An Exhibition, more—(RCA DIGITAL)
 144659. The Best Of The Spencer Davis Group. Steve Winwood & Co. on Gimme Some Lovin, etc. (EMI)
 100352. Diane Schuur: Talkin' 'Bout You. Title song, Funny (But I Still Love You), etc. (GRP)
 104857. Benny Goodman: Sing, Sing, Sing. Title song, more. (RCA)

START NOW WITH 4 COMPACT DISCS!

Yes, pick any 4 compact discs shown here! You need buy just one selection at regular Club prices (usually \$14.98–\$15.98)...and take up to one full year to do it. Then you can choose another CD free as a bonus. That's 6 compact discs for the price of 1 and there's nothing more to buy...ever! (Shipping & handling added to each shipment.)

HOW THE CLUB OPERATES

You select from hundreds of exciting compact discs described in the Club's magazine and mailed to you approximately every 3 weeks (19 times a year). Each issue highlights a Featured Selection in your preferred music category, plus alternate selections. If you'd like the Featured Selection, do nothing. It will be sent to you automatically. If you'd prefer an alternate selection, or none at all, just return the card enclosed with each issue of your magazine by the date specified on the card. You will have at least 10 days to decide, or you may return your Featured Selection at our expense. Cancel your membership at any time after completing your membership agreement, simply by writing to us.

FREE 10-DAY TRIAL

Listen to your 4 introductory selections for a full 10 days. If not satisfied, return them with no further obligation. You send no money now, so complete the coupon and mail it today.

BMG Compact Disc Club
 6550 E. 30th St., Indianapolis, IN 46219-1194.

CD688 DIGITAL AUDIO



YOUR SAVINGS START HERE

Mail to: BMG Compact Disc Club
 P.O. Box 91412/Indianapolis, IN 46219

YES, please accept my membership in the BMG Compact Disc Club and send me the four Compact Discs I've indicated here, billing me for just shipping and handling under the terms of this ad. I need buy just 1 CD at regular Club prices during the next year—after which I can choose a FREE bonus CD! That's 6 for the price of 1...with nothing more to buy ever! (Shipping & handling is added to each shipment.)

RUSH ME THESE 4 CDs (Indicate by number):

1 2 3 4

I am most interested in the musical category checked here—but I may always feel free to choose from any (check on only):

1 EASY LISTENING (Instrumental/Vocal Moods)
 2 COUNTRY 3 HARD ROCK
 4 POP/SOFT ROCK 5 CLASSICAL

MR. MRS. MISS

First Name Initial Last Name (PLEASE PRINT)

Address Apt.

City State Zip

Telephone (Area Code)

Signature

Limited to new members, continental USA only. Current CD Club members not eligible for this offer. One membership per family. We reserve the right to request additional information or reject any application. Local taxes, if any, will be added.

Macintosh QuickBASIC 1.0

Type

BASIC interpreter and compiler

Company

Microsoft Corp.
16011 Northeast 36th Way
Box 97017
Redmond, WA 98073
(206) 882-8089

Format

Two 800K-byte 3½-inch floppy disks

Language

Assembly

Hardware Needed

Mac Plus, SE, II, or IIx with one 800K-byte disk drive; hard disk drive recommended

Software Needed

System 4.1 or higher; Finder 5.5 or higher

Documentation

570-page manual

Price

\$99

Inquiry 1200.

BASIC statement—not just PRINT. You can therefore open another window—one that doesn't occlude the output window—and print your output there.

QuickBASIC doesn't update the output window the way typical Mac applications should. For example, while running a window-drag demo, I reduced the size of the output window to a minimum and then expanded it. I ended up with a blank window, even though the program was still running. Actions that bring up a dialog box on top of the output window have the same effect.

Compiler versus Interpreter

Compiling a QuickBASIC program is an easy one-step process. The Run selection in the main menu offers three compiler selections. The first, Options, lets you set compilation switches and run-time options. Among the compile options are those that include the run-time code (and create stand-alone applications), make all arrays static, generate 68020 code, generate calls to the 68881 coprocessor library, create a program list file, create an error list file, and produce a symbol table.

Run-time options enable you to use the

default window and menu, process run-time events, ignore breaks, use long addressing, and disable the File Not Found dialog box. The compiled program appears as a launchable Macintosh application.

The QuickBASIC compiler supports a number of directives (called *metacommands*) that enable you to fine-tune the way the compiler works. You embed these in the source code.

The CHECK metacommand enables or disables the checking of array indexes, file numbers, arguments to the functions ASC() and CHR\$(), arguments to certain Macintosh Toolbox functions, and the arguments to the LBOUND() and UBOUND() functions. IGNORE supports conditional compilation of certain code portions.

INCLUDE permits you to include additional source code from other files. QuickBASIC doesn't support nested INCLUDEs.

The LONG metacommand instructs the compiler to generate long (32-bit) addresses; you won't need to do that unless your program gets very large. PAGE inserts a page break into the listing file.

Because QuickBASIC's compiler and interpreter originated as separate products, there are some significant differences between the two. For example, the interpreter doesn't support static arrays, though the compiler does. The interpreter permits subroutines anywhere in the program's text, but the compiler requires that all subroutines appear either before or after the main program. The compiler supports recursion, but the interpreter doesn't.

The differences aren't crippling, but they do weaken the appeal of QuickBASIC as a fully integrated development system that lets you prototype in an interpretive mode and then seamlessly switch to compiled mode.

Accessing the Macintosh Toolbox

QuickBASIC supports Macintosh-style programming in two ways. A number of the Toolbox routines are implemented as QuickBASIC functions and commands. Those that aren't are accessible by way of the TOOLBOX statement—a direct gateway from QuickBASIC to the Macintosh ROM routines.

All the essential event-handling routines are directly accessible as QuickBASIC functions and statements. These include BUTTON, MENU, MOUSE, DIALOG, and WINDOW. For example, the BUTTON function returns the state of a specified button; the BUTTON statement can display a button at a specific lo-

cation and with a particular message. Buttons, like files, have numbers that act as handles. The BUTTON CLOSE statement enables you to close all the buttons or a specific one. You monitor the user's interaction with buttons with the DIALOG function. Menu interaction works in a similar way. The MENU function returns information about a menu; the MENU statement performs menu-related actions.

The manual outlines two techniques for building a Macintosh-style interface. The first relies on event trapping. For example, you can enable the trapping of menu events with the MENU ON statement. That works in conjunction with the ON MENU GOSUB construct, which you use to build a menu-event handler that evaluates the event and dispatches to an appropriate subroutine.

The second method relies on polling—that is, instead of relying on the system to trap events, you poll for them yourself. Multiple concurrent event traps can cause subtle bugs; in these situations, polling may be preferable.

The event-oriented QuickBASIC constructs work well, but to use them you have to learn a set of nonmnemonic codes. For example, the MOUSE function takes a single integer argument specifying the kind of mouse-related information you need. MOUSE(0) returns a status indicator (itself an integer that you need to decode), MOUSE(1) returns the current x coordinate, and so on.

The same situation applies to the BUTTON, MENU, DIALOG, and WINDOW constructs. I'd much prefer to see descriptive names (for example, mouse-Down) rather than the integer codes that QuickBASIC uses.

One of QuickBASIC's nicest features is the TOOLBOX statement. It takes the trap number of a Toolbox routine, its calling convention (register- or stack-based), and the routine's arguments, and executes the routine. This works especially well in the command window: You can interactively experiment with the Toolbox and very quickly get a feel for its capabilities.

How Quick Is QuickBASIC?

I ran a series of benchmark tests on my Mac Plus; the machine has 1 megabyte of memory, a 20-megabyte hard disk, and internal and external 3½-inch floppy disk drives. QuickBASIC ran from the hard disk. I disabled all forms of checking and made all arrays static.

Table 2 shows the benchmark results for the binary and decimal interpreters.

continued

~~Six~~ Five easy ways to boost your BASIC



PROBAS™ ^{updated} Professional Basic Programming Library

Announcing PROBAS Version 3.0, now with over 335 assembly routines to really kick QuickBASIC and BASCOM into high gear. BYTE magazine calls PROBAS a "Super-charger for QuickBASIC". Thousands of programmers rely on PROBAS to make their life easier and to enhance their programs with features like:

- An 800-page 3-part manual
- Full-featured windowing
- Screen snapshots (Text & Graphics)
- String, array, and pointer sorts
- Lightning-fast file I/O
- Full mouse support

Create dazzling screens in text mode, CGA, EGA, VGA or Hercules graphic modes. Save and restore screen snapshots to arrays, EMS memory or files. Full featured windowing to meet the most demanding jobs. The PROBAS system of virtual screens allows you to draw full or partial screens to memory, and then snap them on in an eyeblink. You can even create virtual screens far larger than the display screen.

Sick of running out of string space? Store hundreds of K in numeric arrays or megabytes in extended or expanded memory. Tired of using a kludgy SHELL to DIR to read a directory or archive files? Scan sub-directories or .ARC files using wild-cards and store thousands of file names, dates, and times. Wish you could drag a window containing text or a menu around the screen with a mouse? It's easy!

PROBAS gives you a complete set of blazingly-fast file routines. Read or write huge chunks of data at a clip, with file locking and error handling so that you can even use them in subprograms. You'll never want to use BASIC's file I/O again! Sort data with lightning fast array and pointer sorts. Search files or arrays at assembly speeds. PROBAS also has over 200 other essential services including handy string, date, time, directory and array manipulation, string, screen and data compression, full mouse support, valuable equipment and input routines and faster replacements for most BASIC commands.

Whether you are a professional or a novice, PROBAS will boost your BASIC in ways you never dreamt possible. PROBAS allows professionals to save time and work and lets novices write professional-quality programs quickly and easily. After all, how much is a few hundred hours of your time really worth?

For all versions of QuickBASIC and BASCOM including BASCOM 6.0 for OS/2. **Just \$135.00!**

PROREF™ On-Line Help For PROBAS

PROREF provides pop-up help for the routines in PROBAS and is an extension of the QuickBASIC programming environment. Find help on any routine with a few key-strokes or mouse clicks. Pop-up an ASCII chart, calculator, scan code module, box diagram, your own help information or almost any DOS program via a hot-key. **Just \$50.00!**

PROSCREEN™ Professional Screen Management System

PROSCREEN is a full-featured screen generator/editor that will save you more design and coding time than you ever thought possible. PROSCREEN treats screens like a word processor treats text to provide complete control over characters, colors, and placement. Design input screens with up to 130 fields and 19 pre-defined and 2 user-defined masks. Use PROBAS or the included BASIC/Assembler subroutines to access the screens. No kludgy code generators here! Comes with subroutine source, extensive on-line help, and a 285 page manual. **Just \$99.00!**

PROMATH™ ^{new!}

PROMATH is a collection of over 150 high-level routines that provide mathematical functions and operations for programmers who often work in mathematics, science, or engineering. Complex variables, real and complex matrices, real and complex trigonometric and hyperbolic functions and their inverses, solution of linear equations, integration, differential equations, Fast Fourier transforms and many other useful routines are provided.

For years Fortran has been the language of choice for scientific and engineering applications, but it lacks many of the useful features of QuickBASIC. PROMATH contains most of the Fortran mathematical and numeric functions and allows you to easily translate Fortran code to BASIC or write new programs in BASIC while retaining Fortran's numerical prowess.

The PROMATH manual is over 200 pages and provides a complete description of each routine, including any algorithm and the mathematical formula the routine uses, shown in standard notation. For QuickBASIC 4 and BASCOM 6 only. **Just \$99.00!**

PROBAS™ TOOLKIT

The TOOLKIT is a collection of assembly and BASIC modules that use the PROBAS library to save you even more hours of grunt work. Why spend hundreds of hours re-inventing the wheel when you can just plug in TOOLKIT modules like:

- Menu Generators
- Fast B-tree indexing
- Mini-editor with word-wrap
- Patch .EXE files
- Protected storage areas
- Julian date routines

The TOOLKIT also includes clock, calendar, windowing, BCD math routines and much more, complete with BASIC source code and a comprehensive manual. The PROBAS TOOLKIT adds capabilities and helps conserve your most valuable asset of all—time! Requires PROBAS. **Just \$99.00!**

PROBAS™ TELECOMM TOOLKIT

The PROBAS TELECOMM TOOLKIT is a collection of high-level communications modules that you plug into your code to provide popular file transfer protocols, terminal emulations, login scripts and baud rates up to 115,200 baud. You get:

- Xmodem/Modem7/Xmodem-1k
- Ymodem (single and batch)
- CRC-16 and Checksum
- VT52, VT100, ANSI BBS etc.
- Auto Dialer & data base
- Documented BASIC source

Why use clumsy SHELLs to complex terminal programs when you can plug just the communications routines you need into your code? Implement just the features and commands you want. Requires PROBAS. **Just \$75.00!**

Our thirty day, money-back guarantee assures you the highest quality and our technical support staff is always ready to help. Try our BBS at (301) 953-7736 or give us a call at:

HAMMERLY
COMPUTER SERVICES, INC.

8008 SANDY SPRING ROAD • LAUREL, MD 20707
INTERNATIONAL CALLS: (301) 953-2191

(800) 343-7484

FAX # 301-725-8147

Add \$5.00 per item (\$8.00 Canada) for shipping per order. Europe: \$39.00 for 1st item plus \$5.00 for each additional item. Visa, M/C, C.O.D. (US Only) checks and approved POs accepted. Trademarks PROBAS, PROREF, PROSCREEN, PROMATH: Hammerly Computer Services, Inc. QuickBASIC, BASCOM: Microsoft Corp.

The table contains only the run times and the ratios between the binary and decimal versions.

The results show—as you'd expect—that the decimal version runs slower than the binary version on tests that involve floating-point calculations. The ratio of the two varies from 1.39 to 3.05 with no math function calls, and from 3.50 to 14.67 with math function calls. So if you need to use the decimal version and the math functions, you'll probably want a

coprocessor. On the other benchmarks, the binary and decimal versions peg about equal.

The results for the binary and decimal compilers appear in table 3. The compilers produce files of equal sizes (rounded to the nearest kilobyte) and take about the same time to compile. As with the interpreters, the math tests are about four times slower when done decimally; other tests come out roughly equal.

QuickBASIC 1.0 for the Macintosh unites the Microsoft BASIC interpreter and compiler into a single integrated environment. It's a first release, and there are some problems that I'd like to see Microsoft fix—notably, the differences between the interpreter and the compiler, the sparse information in the on-line help, the non-mnemonic event codes, and the failure to update the output window.

More generally, I'd like to see Macintosh QuickBASIC support the more advanced language constructs that QuickBASIC 4.0 for the PC provides—constants, user-defined structure types, the DO...LOOP construct, multiline functions, and modules.

The QuickBASIC environment will be especially useful to beginning Macintosh programmers. The many program examples included with the distribution disks are very good; you can use them to learn a lot about BASIC and about how to build Macintosh applications. QuickBASIC's ability to use external libraries developed in other languages makes it suitable for rapid prototyping. I recommend the product and look forward to future improvements. ■

Editor's note: Benchmark listings are available in a variety of formats. See page 3 for details.

Namir Clement Shammas is a freelance writer living in Glen Allen, Virginia. He can be reached on BIX as "nshammas."

Table 2: Benchmark results for the QuickBASIC binary and decimal interpreters. Math and floating-point operations are slower in the decimal version; other operations are about the same.

Test	Iterations	Binary version run time (seconds)	Decimal version run time (seconds)	Decimal/binary ratio
Float	—	21	64	3.05
Inv. matrix	—	38	53	1.39
Math				
SQR	1	3	44	14.67
LOG	—	11	49	4.45
EXP	—	7	32	4.57
ATN	—	8	36	4.50
SIN	—	6	21	3.50
Write	—	15	16	1.07
Read	—	13	14	1.08
Sieve	1	61	60	0.98
Sort	1	151	141	0.93
String	1000	40	40	1.00

Table 3: Benchmark results for the QuickBASIC binary and decimal compilers. Raw times are much faster than with the interpreters. The decimal/binary ratio is comparable.

Test	Binary				Decimal			Decimal/binary ratio
	Source file (K bytes)	Compiled file (K bytes)	Compile time (seconds)	Run time (seconds)	Compiled file (K bytes)	Compile time (seconds)	Run time (seconds)	
Float	2	46	13	4	46	12	32	8.00
Inv. matrix	2	47	11	5	47	13	18	3.60
Math (10 iterations)	3	49	14	—	49	14	—	—
SQR	—	—	—	36	—	—	178	4.94
LOG	—	—	—	65	—	—	330	5.08
EXP	—	—	—	55	—	—	230	4.18
ATN	—	—	—	65	—	—	250	3.85
SIN	—	—	—	42	—	—	210	5.00
Write	2	46	12	15	46	11	16	1.07
Read	2	46	11	18	46	13	19	1.06
Sieve (10 iterations)	2	46	14	8	46	12	8	1.00
Sort (10 iterations)	3	47	13	19	47	12	18	0.95
String (1000 iterations)	2	46	12	16	46	13	16	1.00

We'll take your stats and make you the most valuable player in your league.



★

CHRIS JOHNSON Data Analyst

CAREER HIGHLIGHTS

1983
Proposed remap of sales territories based on SPSS analysis of economic and consumer trends. Increased new-customer revenues 38% in 2 years.

1985
Used SPSS data entry/tabulation system to administer employee benefits more **efficiently**. Eliminated outside costs of more than \$75,000.

1986
Identified current customers likely to need added **services**, increasing average billings by more than 20%.

1988
Rewarded with special corporate recognition and bonus.

★ Another Story in the SPSS SUCCESS SERIES ★

Data analysis software from SPSS® gives your PC a winning advantage.

It doesn't matter which field you play hardball in. The right combination of equipment and ability can make you a hero.

You get that ability with SPSS/PC+,™ the best-selling data analysis software from SPSS. It's designed for the IBM PC/XT,™ PC/AT,™ PS/2™ and compatibles. And with it, you'll turn raw data into real facts, for sound business decisions.

SPSS/PC+ features a base package of numerous statistical procedures. Plus some

powerful options for data entry, advanced statistics, forecasting, graphics, mapping and much more. So you can scrutinize and manipulate your data in countless ways.

SPSS/PC+ also provides a seamless interface with other popular PC software such as dBase™ and 1-2-3,™ to give you complete command of your data. For market research, sales analysis, quality control and much more.

Yet, SPSS/PC+ is designed for ease-of-use. It features a menuing and help system, as well as an on-line statistical glossary that helps you interpret results as you go.

And you'll always have training, support,

and ongoing upgrades from SPSS. The team that's supplied statistical software to over 1 million users since 1968.

For more details on how SPSS/PC+ can help you get the most out of your micro, give us a call at

1-312-329-3315.

We'll show you how to really stand out in your field.

SPSS inc.

Best in the final analysis.

444 North Michigan Avenue • Chicago, Illinois 60611

SPSS is a registered trademark of SPSS Inc. SPSS/PC+ is a trademark of SPSS Inc. IBM PC/XT, PC/AT and PS/2 are trademarks of International Business Machines Corporation. dBase is a trademark of Ashton-Tate. 1-2-3 is a trademark of Lotus Development Corporation.

PRESENTING AMERICA'S HOTTEST NEW CORPORATE JETS.

FIVESTAR'S fleet of powerful business computers have really taken off in the last three years. That's because they're built for corporations that want to get where they're going in a hurry.

We build a full line of high-powered performers that not only provide *total* PC compatibility and advanced business capabilities, but also offer American-made ingenuity, quality and value.

In fact, when you *really* compare, you'll find that FIVESTAR Computers leave the competition far behind.

FIVESTAR 286's. **The performance to fly through heavy workloads.**

FIVESTAR 286's provide the features and performance aggressive companies need to reach higher corporate goals. In fact, they're designed to run future as well as current operating systems.

The 286/10 is powered by an Intel 80286 microprocessor that operates at a fast 10 MHz, with zero wait states. With 640KB memory and 1.2MB floppy disk drive, you'll soar through today's popular business applications. Serial, parallel and game ports, and an enhanced 101-key keyboard, provide in-flight convenience.

The 286/14 is also powered by an Intel 80286 CPU, but operates at 14 MHz (with zero wait states) for even faster performance. It, too, comes equipped with 1024KB memory, 1.2MB floppy disk drive, serial/parallel/game ports and a 101-key keyboard. No doubt about it — it's a hot machine and a dream to fly!

FIVESTAR 386's. **Don't forget to fasten your seat belt.**

The incredible speed and power of FIVESTAR 386's have made them a leading choice of corporations across America for multitasking and sophisticated applications, including CAD. In fact, there's so much performance and value built into our 386's, it can take your breath away.

The 386/16 is fast. Very fast. That's because it features an Intel 80386 CPU operating at 16 MHz, with zero wait states. And its 1024KB memory and 1.2MB floppy disk drive will keep you airborne for long distances. Serial/parallel/game ports and a smooth performing 101-key keyboard are standard equipment.

Prices:

**The 286/10 -
from \$1099.**

**The 286/14 -
from \$1499.**



The 386/20. It's made for those who want to fly to the outer limits. With an Intel 80386 micro-processor operating at 20 MHz (with zero wait states) it'll move through the most complex applications with astounding ease. And you won't have to worry about running low on memory either: It not only features 1024KB of RAM and a 1.2MB floppy disk drive, it also has a 64KB cache memory. Naturally, it comes equipped with serial/parallel/game ports and a 101-key keyboard, too.

Customize your FIVESTAR to meet your own specifications.

All FIVESTAR 286 and 386 Computers are available with hard drives, from 20 to 320 MB, as well as a choice of monochrome, EGA, VGA or super-high resolution paper-white monitors. Whatever the requirement, FIVESTAR can meet it.

Prices:

**The 386/16 -
from \$1999.**

**The 386/20 -
from \$2999.**

**Unmatched reliability.
Unbeatable ground
support.**

Because every FIVESTAR Computer is tested and certified to meet the highest standards of quality, you can count on years of

reliable performance.

Once you've purchased your FIVESTAR computer, you'll get all the support you'll need. Just call our highly-trained service department *toll-free*. Most difficulties can be resolved within minutes.

For companies with critical applications, a comprehensive on-site service contract is available for just \$99. In most cases, service calls are made within 24 hours.

**Order by phone today.
And move your company to higher
levels of performance.**

To order a FIVESTAR 286 or 386 Computer, or for more information about our full line of high-powered computers, call us TOLL FREE. We'll have your hot new corporate jet parked in your hanger in no time!

1-800-752-5555

FIVESTAR
COMPUTERS

Circle 104 on Reader Service Card

America's hottest new corporate jets.

FLEXSCAN™ 9070S, PC Hi-Res That Looks Like a Million.

The FLEXSCAN 9070 Multiple Scan monitor is of course compatible with other multi-scans, but includes improvements that will give you the professional edge which is the mark of a good investment. You can extend your multi-scan range from 20kHz to 50kHz in practical terms. This means that, at the 48-50 kHz range, you can make use of PC CAD/CAE capabilities at a resolution of up to 1024 dots × 768 lines. The FLEXSCAN 9070 takes advantage of non-interlace high resolution signal as high as 1024 × 768 to provide you with a flicker free display at much brightness. You can also use the 9070 with IBM PS/2 or VGA compatible boards at a high resolution mode like 800×600 and 1024×768 (non-interlace). The FLEXSCAN 9070 provides a 16-inch screen, large enough for CAD/CAE and 3-D projections, yet small enough to fit comfortably into your home work space.



1024 dots × 768 lines Graphics (Non-interlace)
AutoCAD

Also, for your convenience, all controls and switches, including the alternate video input, are located within easy reach on the front panel. The FLEXSCAN 9070 is compatible with a wide range of IBM, Apple, and other products, allow you to use all of today's popular programs---at a resolution that looks like a million.

FLEXSCAN™ MODEL 9070S

- IBM VGA(PS/2), 8514/A, PGC, EGA compatible and CAD/CAE use.
- Apple Mac. II and SuperMac Spectrum compatible
- Max. 1280 dots × 800 lines high resolution
- 1024 dots × 768 lines display on Non-Interlace signal delivers flicker-free high-res graphics
- 20kHz to 50kHz horizontal scan automatic adjustment. 50Hz to 80Hz vertical scan automatic adjustment
- 16 inch, 0.31mm dot pitch and newly developed XF(Extended Field) Gun to obtain both brightness and sharp focus.
- Front mounted controls including the input signal select switch between 2 video input.
- Selecting white or Amber displays colored application in shades of gray or amber
- Tilt-Swivel stand standard

NANAO®

NANAO USA CORPORATION

23510 TELO AVE., SUITE 5 TORRANCE, CA 90505
PHONE (213) 325-5202 FAX (213) 530-1679

Specifications are subject to change without notice.

APPLE, Macintosh II are registered trademarks of Apple Computers Inc. ARTIST, ARTIST 1 Plus, ARTIST 10, ARTIST 10/16 are trademarks of Control Systems Inc. IBM, IBM PC, XT, AT and PS/2 are registered trademarks of International Business Machines Corporation. SuperMac is a trademark of SuperMac Technology. SuperEGA HiRes, SuperVGA and SuperVGA HiRes are trademarks of Genos System Corporation. Orchid Designer VGA, Orchid Designer VGA-2, TurboEGA and TurboVGA are trademarks of Orchid Technology. Paradise VGA Professional Card, Paradise VGA Plus Card and Autoswitch EGA are trademarks of Paradise Systems, Inc. Paradise Systems is a registered trademark of Paradise Systems, Inc. VEGA Deluxe and VEGA VGA are trademarks of Video-seven Inc. Methus is a registered trademark of Methus Corporation. Imagraph is a trademark of Imagraph Corporation. AutoCAD is a registered trademark of Autodesk Inc. GEM is a registered trademark of Digital Research Inc. Lotus and 1-2-3 are registered trademarks of Lotus Development Corporation. SigmaVGA and SigmaEGA are trademarks of Sigma designs, Inc. FLEXSCAN is a trademark of NANAO CORPORATION. NANAO is a registered trademark of NANAO CORPORATION.



Opus I

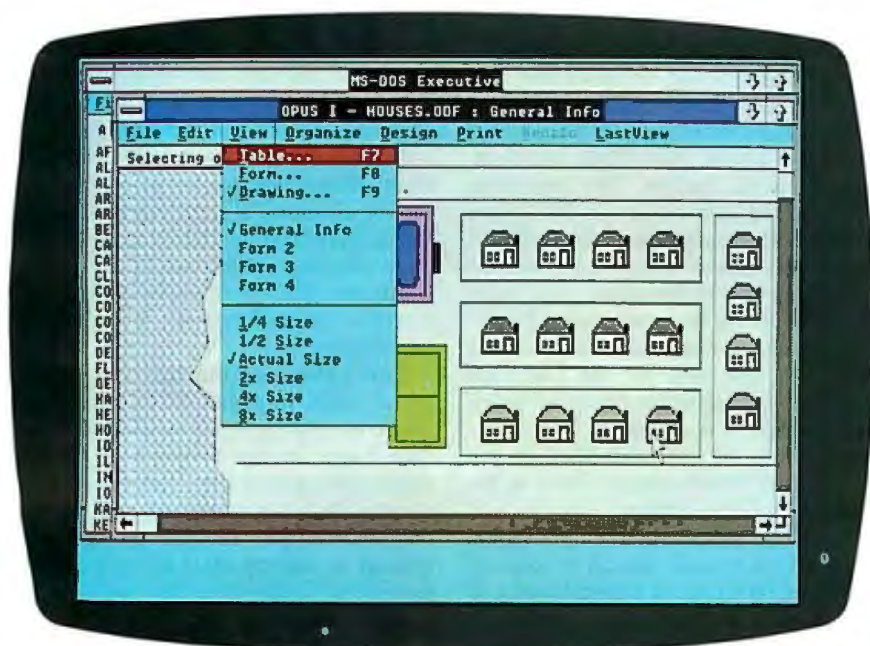

A duet for graphics and data

Phillip Robinson

In the database world, dBASE and its typed text commands still rule. But more databases on the Mac and PC are offering to store graphics information along with more conventional dates, dollars, and text strings.

Opus I is a graphics-oriented database management program that runs under Microsoft Windows. This \$395 "hyperdrawing" program, as Roykore Software describes it, lets you create and manipulate a database using a graphical display. Although Roykore does not position Opus I as a DOS version of HyperCard, the similarities are immediately apparent. The differences soon show when you dig into the program and its accompanying manual.

To gain some insight into what Opus I does on the PC, you have to look at HyperCard on the Mac. HyperCard isn't really a complete database program, but it offers a graphics-based front end and a scripting language for anyone who wants to link graphical pictures, buttons, and

icons to stored information. Opus I is an alloy of graphics and database features that bears a certain similarity to HyperCard. The brass tacks of information are still stored in records and fields, but that same information is linked to, and available from, a graphical display.

A Window on Installation

Opus I requires an IBM PC, PS/2, or compatible; at least 512K bytes of RAM (the main program file is just 256K bytes long); EGA, Hercules, or compatible graphics; a color or monochrome monitor; and DOS 3.x.

Installing Opus I is a breeze, particularly if you already have Windows on your hard disk. Just copy the files from a single 1.2-megabyte floppy disk, and you're ready to run. If you need a 360K-byte or 720K-byte 3½-inch floppy disk, Roykore offers a toll-free number to call for quick delivery.

If you don't already own Windows, Opus comes prepared with its own runtime version of the graphical environment. With that, you'll be able to run Opus under Windows but won't be able to run any other Windows applications. I used Windows/386 running on a PC's Limited 386. Through Windows 2.0 or Windows/386, incidentally, Opus I can take advantage of the Lotus/Intel/Microsoft Expanded Memory Specification (LIM/EMS) 4.0. SYS files for the Intel, AST, and IBM expanded-memory boards are included.

Using Windows without a mouse can be slow and inefficient. I used a Mouse Systems optical mouse for this review. However, a mouse is not essential. The Opus I documentation has descriptions for using all commands with either the mouse or the keyboard.

This review covers version 2.04 of Opus I; version 1.0 was released back in May 1987. Version 2.0 was redesigned with Windows/386 and the Presentation Manager in mind and offers more com-

continued

version

Type

Hyperdrawing program combining simple database with drawing program, allowing direct links between graphical displays and stored data

Company

Roykore Software, Inc.
749 Brunswick St.
San Francisco, CA 94112
(415) 333-7833

Format

Three 1.2-megabyte 5¼-inch floppy disks

Language

Microsoft C

Hardware Needed

Requires IBM PC, PS/2, or compatible with at least 512K bytes of RAM; one floppy disk drive and one hard disk drive; EGA, Hercules, or compatible graphics; a monochrome or color monitor; and DOS 3.0 or higher

Software Needed

Runs under Windows 2.0 or Windows/386 (comes with run-time version of Windows 2.0)

Documentation

80-page tutorial; 190-page user and reference guide; 65-page guide to Windows

Price

\$395; \$40 upgrade from version 1.0

Inquiry 1199.

mands for linking drawings and files together.

Tutorials and Examples

There are two tutorials to choose from in the manual. First is a mouse-based lesson, and that's the one I suggest you use if you can. The second tutorial covers exactly the same ground but from the point of view of a keyboard-only user. Both illustrate the groundwork of Opus by postulating a simple real estate database containing information on houses, owners, prices, sales status, and the like.

The sample database and graphics files for this tutorial are on the Opus disk, along with some other example files. In each example, the first view you

see upon opening the file is a graphical drawing with some typical Windows menus across the top. The drawing can be viewed at anything from ¼ to 8 times the actual size; you choose the size (in inches or centimeters) on a View menu.

Opus I can create drawings of up to 42 by 42 cm. If you experiment with the drawing by pointing the mouse cursor at graphical elements and then clicking the left mouse button, you'll see that some (but not necessarily all) of the objects are "assigned to a record." That note is written just under the Windows menus. Along with it is the number of the assigned record.

In the case of the housing development example, you'll see unpretentious pictures of 17 separate houses, a tennis court, and a swimming pool, all laid out on a set of streets. Each house has an assigned record number. The swimming pool and the tennis court do not. If you double-click on any house, the graphical display disappears and you see a form containing information about that house: ID number, owner, cost, date of sale, sold status, market value, and interest rate. You can then use the LastView menu to pop back to the graphical Drawing Display (this command always returns you to the previous view), or you can use the View menu to move to the Drawing or Table displays.

The Table contains all the information about all the records laid out in columns and rows. With Form Display, you can also inspect the previous or next form (arranged by ID number), edit the information on the form, print the form, and save any changes you make.

The other examples that come with Opus I, by the way, display information about house sites within California, states within the U.S., and the various levels of a company's accounts payable procedures chart.

Seeing, Importing, and Exporting Data

The Table Display is also ripe for any modifications you want to make in the data within a file. You can put Windows' Cut, Copy, and Paste functions to work or use a Delete Record command from Opus itself. There's also an Undo command to correct any mistakes you might make.

Besides the typical Save and Save As commands, Opus I also boasts a Return To command (for switching back to the previous file), a Lock command (to use your own chosen password to protect a file from any changes), and a pair of Import/Export commands. The Import/Ex-

port options let you read or write DIF or delimited files and even offer the flexibility of excluding calculated fields from the export. I was able to move files back and forth from PC Excel to Opus I using these commands.

You can read data into an existing file or create a new file. The Design menu offers separate avenues to creating a Drawing, a Form, a Report, a Mailing Label, or a Field.

For Fields, Opus I presents a dialog box where you choose a Field label and type either text, number, date, or picture. There are three format options for a date field; six format options for a number field (general, currency, business, scientific, percent, and integer); center, left, or right alignment for any field; and cropping or scaling for a picture field.

Calculated fields are easily cobbled from a dialog box that has an editing line for the formula, a scrolling window to select from current field names as formula elements, and a set of arithmetic commands and numerals for making operators. These formulas may contain parentheses.

The Labels option lets you select which field information to enter into which standard line of a mailing address. The Form design consists of taking fields, setting their length (or the number of characters they can hold), and placing them where you want them on the Form Display or tucking them into the hidden part of the form where they won't show during regular processing.

All these design tools are easy to use without much reference to the manual. Opus I also comes with indexed but non-context-sensitive on-line help for all its commands. This help includes references to the pages in the manual if you need further help.

Creating a form and then entering data, either by typing it in or by importing it from some other file, results in a database that can then be searched, sorted, and reported on. Opus I can hold a maximum of 10,000 records per drawing file, 100 fields per drawing file, 1023 characters per text field, 15 decimal places per number field, and 40 characters per field label.

I was disappointed that the error checking on data entry was not very sophisticated. Mistakes such as 4/35/89 are barred, but entering 2/29/89 in a date field prompts no worry at all from Opus.

Designing Reports and Graphics

Designing reports consists of selecting a title, the fields to be printed, statistical

continued

"I brought the excitement back to project scheduling with a product that really works for you!"

ROGER MEADE, PRESIDENT, SCITOR CORPORATION

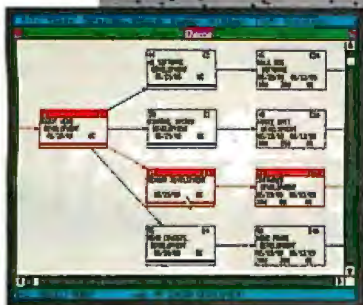

Project Scheduler 4.TM The difference is graphically clear.TM

"Software products claiming to be #1 in project management aren't living up to their boasts. They have evolved by tacking new power features onto outdated versions at the expense of speed and usability. Their basic reports continue to be confusing and unreadable.

"I challenged my development team to reverse this trend and build a totally new product with unmatched speed, power, and ease-of-use. They met this challenge with Project Scheduler 4.

"Project Scheduler 4 is the first PC-based package that integrates high-resolution graphics with all the management tools you need. You understand more because you see more on the screen. At last, PERT and Gantt charts make sense. And responsibilities, deadlines, and resource bottlenecks are all spotted at a glance.

"You see more on paper, too. Project Scheduler 4 gives you beautiful, graphic reports that don't require tedious cut-and-paste assembly. They're instantly understandable. Not to mention simple to

generate for impressive presentations.

"Because scheduling is primarily a visual process, Project Scheduler 4 uses an intuitive, graphic interface that gives you a clear view of the big picture. Gone are hard-to-remember commands and keystroke sequences. Here is the future of advanced productivity tools.

"A project scheduler should help you manage your time, not waste it. Project Scheduler 4 is fast. In fact, it's much faster than most character-

based systems. Its tremendous power is provided with ease and elegance. In other words, it's a project scheduler that really works for you."

When your time is on the line, you should be using Project Scheduler 4. For more information and a free brochure, call 415 570-7700 or write us at 250 Lincoln Centre Drive, Foster City, CA 94404.

 **Scitor**
Corporation



values to calculate and print (total, average, minimum, and maximum), headings, and a single line each for a header and a footer. Reports can be saved to disk for reuse.

Designing a drawing takes you to an entirely new set of menus, really a second program that is tightly linked to the file manager of Opus I. You can use the drawing program to change a variety of foreground and background colors, text sizes (from 6 to 72 points), styles (seven, including bold, underlined, and so on), and fonts.

There is a menu of fill patterns, another of line styles, and a Tool menu with ellipse, pie, polygon, rectangle, line, curve, and freehand commands.

You can also choose to plant a symbol on the display, selecting it from a separate menu of 12 symbol names (e.g., main, airplane, start, PC, car, desk, and arrow) and then positioning it on the screen. Symbols can be renamed or replaced. If you replace a symbol in the symbol set, all the instances of that symbol on the screen will also change.

Once an object is on the display, you can select, move, cut and paste, or re-

shape it (for some types of objects). You can also rotate it, group it with other objects, dissolve the groups, or position the object in front of or behind overlapping objects. You can draw with a grid and rulers for alignment and can snap objects to a grid. From the Drawing Design display, you can print, save, or start on a new drawing.

You can import graphics from other programs via the Windows Clipboard and send Opus I graphics to other programs the same way. Opus stores its graphics as objects, limiting the number of objects in a drawing only by the amount of memory in your PC system. You can use more than one graphics display for a single database file and store these graphics in more than one file on disk.

Connecting the database information and graphics is relatively easy. Just click on an object in the Drawing Design display and choose Assign Objects. A small window pops up that lists all the objects and their numbers in the current drawing. You can assign and unassign records to any object on the screen. Then, when you save these assignments

and return to the standard database Drawing display (not the Drawing Design display), clicking on the object brings up the information from the assigned record. Even if that object is moved to another point on the display, it will still have the same assignment.

Searches and Sorts

Once you have your database all designed and set to go, you'll probably want to browse through it and do some searching or sorting. In any of the main views—Form, Table, or Drawing—you can find a record (by its ID), select records (by entering search values in the fields of a blank form), or sort records.

The selection process can include AND and OR logical operators between fields, and within fields it can use operators such as "match exactly," "begin with," "less than or equal to," "within a range," and so on. It can also use wild-card characters.

The sorting can be done on any field; you click on the fields in the order you want to sort them. Repeated clicks on a field switches between ascending and descending order for the sort.

Every copier company talks We're doing something about

Choosing a new copier isn't easy. You look at copiers, you listen to promises. It all gets very confusing.

Now, you don't have to listen to a lot of talk about promises. You can read ours. Because we put it in writing. If you try to compare it to other copier guarantees, you'll find there's no comparison. Suddenly, a difficult decision becomes a very easy choice to make.

Look at the certificate above. Nobody offers you as good a copier guarantee as Harris/3M. So, while

copier salespeople are all giving you a lot of talk, ours will give you something great to read.

Send in the coupon. Or give us a call at 1-800-TLC-COPY. (In Canada, 1-519-668-2230.) We'll send you our 8-page *Consumer Guide to Copiers*. Then, we can talk about it.



Harris/3M copiers have features for all sizes of offices. That includes the 6070. Seventy copies a minute, guaranteed.

You can highlight or hide either the results of a selection or the unselected members. This is one of the strongest reasons to have a graphical database display, where you can immediately see which members have been ferreted out. In the houses example that comes with the tutorial, for instance, the houses already sold or priced above a certain level can be quickly shown graphically on-screen, or printed for immediate reference by someone who isn't entirely comfortable with tables of data displayed on a computer.

Sophisticated Edge of Opus

The most sophisticated feature in Opus I is the Programmed Links you can create. These give the program more of a taste of "hypermedia," though they are limited in scope compared to the much richer set of commands you'll find in HyperCard.

By holding down the Control button in the Drawing Design display and clicking twice on some drawn object, you bring up a Program Object window. Here, you can tell Opus I to react to a single mouse-click or a double-click on that object (this is called programming a button).

The action Opus takes when it perceives the clicking is up to you. You could tell Opus to bring up another form, to go to another drawing file, or even to start another Windows application program. The Program Object window lets you specify the action—you'll see a scrollable list of 26 commands—and the path names for any files you call up. The command list includes Print Reports, Sort Records, LastView, Highlight, and Find Record.

Unlike HyperCard, Opus has no script language to let you create more commands than these. However, since Excel is another Windows application and has its own macros, including AUTOEXEC macros that run when an Excel window is opened, Opus I can perform some tricky maneuvers using Excel as an agent. With version 2.04 of Opus, you can open multiple Excel spreadsheets without restarting the main Excel program each time, thus saving RAM space.

Drawn Conclusions

Opus isn't HyperCard, mainly because it doesn't have a HyperTalk language to extend its features. Nor does it offer

some of the subtle data-manipulation strengths you'd find in competing and similarly priced database managers or file managers, such as Q&A or Reflex Plus. This is especially true for calculating fields and error trapping, linking data files together, and creating custom data types. Opus doesn't have the features to replace my main database management software or even to transport some of HyperCard's abilities to PCs.

But the ability to link an underlying database directly to a graphical display, along with the built-in drawing tools to create and modify such a display, makes Opus I an important program to consider. That's especially so if you're creating an application for someone who isn't already an experienced database user. You can customize the on-line help files and lock drawings to prevent changes. Opus I can be a great tool for creating simple file management applications in a wide variety of fields. ■

Phillip Robinson is an editor at Virtual Information and lives in Berkeley, California. He can be reached on BIX as "robinson."

about customer satisfaction.

it.



to know more about Harris/3M copiers /3M Copier Promise.
3M, P.O. Box 785, Dayton, OH 45401

COMPANY NAME _____
ADDRESS _____
CITY _____ STATE _____ ZIP _____
PHONE #(_____) _____

ation on your fax machines.

HARRIS/3M

Other restrictions and limitations apply; see your Harris/3M literature. © 1989 Harris/3M Document Products, Inc. Harris is a trademark of the Harris Corporation. 3M is a trademark of the 3M Company.

CLEO is your SNA, BSC and Coax Gateway



VMS
UNIX
XENIX
PC-DOS
Macintosh
NetBios LAN

Sharing Information

Whatever your industry, your computers need to share information with your mainframe. Or, they need to exchange data with other computers. In either case, you need a total communications solution. You need software, hardware interfaces and modems that all work together smoothly. You need CLEO!

CLEO software products allow your computer to communicate with mini-computers and mainframes, and to emulate their workstations. Since 1981, CLEO has provided communications between micros, minis, and mainframes for the automotive, insurance, medical and banking industries. Today over 78,000 CLEO users worldwide are running on all major computer brands. The greatest number of these users run CLEO software on IBM Personal Computers and NETBIOS LANs.

Complete Software/Hardware Package

Every CLEO package contains all the software and hardware accessories you'll need. Your selected CLEO SNA, BSC, or Coax software is packaged with 1) an internal modem card for dial-up applications, or 2) an interface card and cable for use with your existing modem, or 3) a Coax card for local connectivity. There's no waiting for non-CLEO add-ons. And, you get prompt, single-source service.



Package prices range from \$795.00 for most stand-alone packages, up to \$1,995.00 for the 32-user SNA gateway.

Call us today to discuss your application.

CLEO Software
1639 North Alpine Rd.
Rockford, IL 61107
Telex 703639
FAX 815/397-6535

Headquarters:

USA: 1-800/233-2536
Illinois: 1-800/422-2536
International: 815/397-8110

Sales and Distribution:

Benelux: 31 (0) 33-948888
Canada, East: 800/361-3185
Canada, West: 800/361-1210
Canada, Montreal: 514/737-3631
Colombia, S.A.: 12172266
Denmark: 02 94 81 19
England: (0993) 776543
France: 146861136
Italy: (0331) 634 562
Mexico City: 596-5539
Sweden: 468311780

CLEO 



Symbolic Math on the Mac

Mathematica provides powerful problem solving and graphics

Peter Wayner

When I was in high school, my calculus teacher told us we could use computers to do our homework if we chose, but he was sure they wouldn't be much help with the integration and differentiation. That was not very long ago, but he must be more careful with those claims now.

Software that manipulates equations as easily as numbers is not new anymore, and a remarkable new version of the genre, Mathematica 1.0 (\$795), is now available for several different computers, including the Macintosh, Sun386i, Silicon Graphics Iris, NeXT computer (bundled), and IBM RT PC. Its symbolic capabilities are strong, and its user interface is very easy to use.

Most simply, Mathematica tries to be everything to anyone who needs to use mathematics more complex than addition and subtraction. It computes numbers with a precision limited only by the memory of the computer and the patience of the user. Typing $100!$ will return an answer of more than 150 digits. You can also specify any arbitrary precision to save time or screen space.

The program manipulates equations symbolically, solves them for zeros, differentiates them, and integrates them if it can find a way. When you type `Expand [(x+y)2]`, the program returns $x^2 + 2xy + y^2$. Differentiation is as easy, and integration will work for almost any function that can be integrated. If the in-

tegration won't work symbolically, the program performs it numerically. The algebra package arranges the answer in whatever form you desire, and the results can be either completely factored into irreducible polynomials or left expanded.

Another simple command lets you easily turn the data and the equations from these computations into two- or three-dimensional graphs. Axiometric plots and contour graphs of both rectangular and spherical coordinates are easy. You can control the shading with another function or leave it up to the program. The program allows you to place point sources of multicolored light anywhere to illuminate the graph in the best possible way.

When any of the built-in mathematical operations are not enough, you can program Mathematica to do new tricks. The language is an interesting blend of Lisp, Pascal, APL, and Prolog. You can write functions as Pascal-like procedures, Lisp-like functional programs, or Prolog-like rules. The system comes with

many files of programs for handling math like differential equations and Laplace transforms.

Getting to the Core

The program has two parts: the kernel, which does all the mathematical work, and the user interface, which moves the information back and forth. These two parts don't need to run on the same machine, though, and it is possible to run the kernel on a fast machine like the Cray while running the user interface on a Macintosh. The terminal software for handling this remotely is built into the program.

The kernel is written in C and should run exactly the same on all machines. The kernel's main section performs basic numerical computations and algebra of symbolic expressions. The code for more complex operations, like integration, is stored in modules that you load separately. This conserves memory,

continued

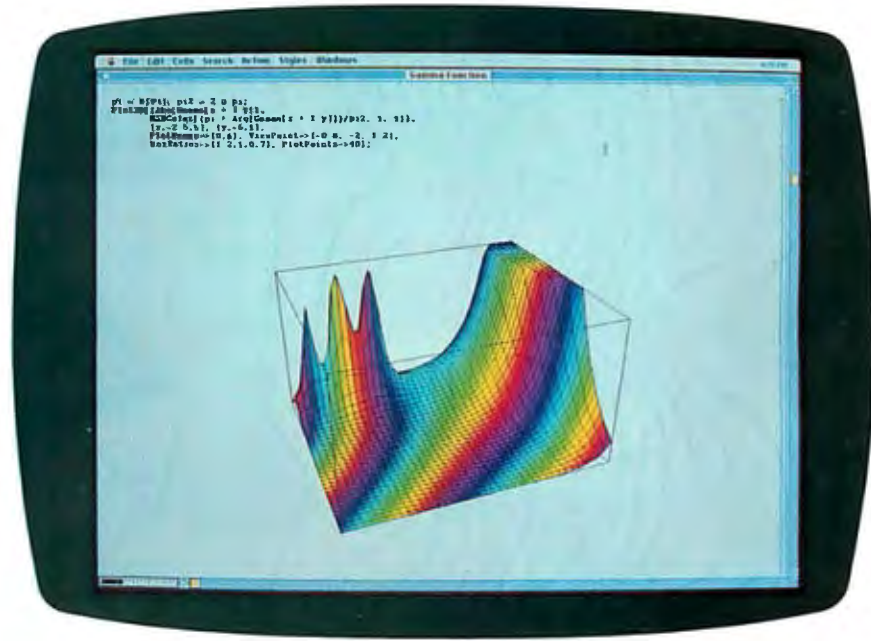

Mathematica 1.0

Type

Mathematics system

Company

Wolfram Research, Inc.
P.O. Box 6059
Champaign, IL 61821
(217) 398-0700

Format

Five 800K-byte disks

Language

C

Computer

Macintosh SE or II with at least 2.5 megabytes of RAM; versions also available for the Sun386i, Silicon Graphics Iris, NeXT computer (bundled), IBM RT PC, and 80386 machines

Documentation

750-page *Mathematica*
125-page book on the Macintosh interface

Price

Mac II version: \$795
Mac SE version: \$495

Inquiry 855.

a scarce commodity with such a large program. The code also frees memory as soon as possible, so you don't have to interrupt computation for garbage collection.

The basic syntax is similar to that of

other symbolic mathematical packages, such as Macsyma or Maple. The input must be an expression of numbers, variables, and functions of other expressions. It's just like typing an equation into a standard computer program. Mathematica parses the expression, places it into its own internal format, and evaluates all the functions until the simplest form possible is uncovered.

The number of different functions is amazing. Hundreds of relatively obscure functions, such as the zeta, the beta, and the gamma (including variants like the incomplete gamma function, the digamma, and the polygamma), are implemented in addition to the old familiar ones like sine, logarithm, and absolute values. The package includes almost every continuous function used for physical modeling that I can think of.

Mathematica can expand a rational function into terms or factor it into the smallest expressions on command. Differentiation is easy to do because its rules are so well defined. Integration is much more difficult, however, since answers are not always known to exist, but Mathematica can usually do as well as any table of integrals that you'll find in a book.

I found a small bug in Mathematica's approach to integrating the difficult Gaussian distribution e^{-x^2} . No closed-form solution exists, but since the integral is so common in statistics, the solution is written as $\text{sqrt}(\pi)/2 * \text{Erf}(x)$, where Erf is the error function circularly defined to be the integral of e^{-x^2} . If I asked for the closed-form answer, Mathematica responded correctly, but if I

asked for the definite integral from negative infinity to infinity, it answered 0 instead of the correct answer, 1.

If symbolic integration is not possible, you can switch to numerical integration by substituting NIntegrate for Integrate in your command. The basic command will not always work if there are singularities in the function, but the manual explains many of the potential traps in numerical integration and possible solutions. This is not a bug in the system. Numerical integration can be tricky and inaccurate if not used carefully.

The syntax can also be a trap for the naive user. When I typed Integrate[Sin(x),x], Mathematica responded $1/2 \text{Sin}(x^2)$. When I typed Integrate[Sin[x],x], the right answer was returned. The difference between the square brackets and the parentheses caused the mistake: In the first case, Mathematica thought Sin was acting as a simple variable, not as a reserved function. Mathematica's lax policy for parsing multiplication symbols compounds the problem: The asterisk is optional, and Mathematica assumes multiplication when no operator is present.

Tailored User Interface

The user interface is different for each computer. All versions display the graphics in some form, but they do not share all the same features. I used a Mac II version that could take advantage of a color monitor. I also ran a version for the Sun386i running Unix.

The most important feature distinguishing the Macintosh version is a very fancy editor called the Notebook. The

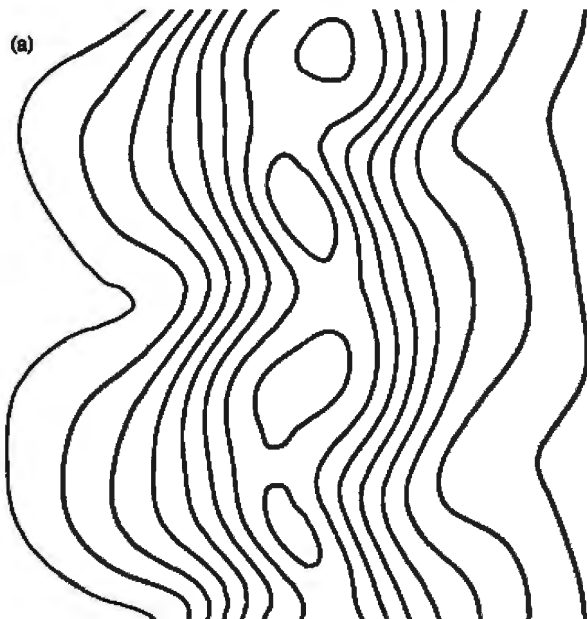
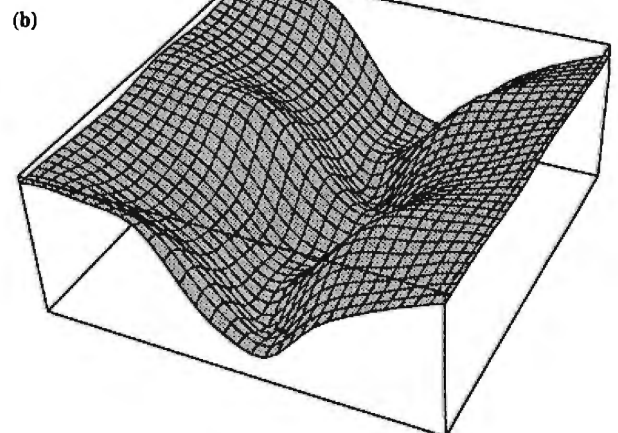

Figure 1: (a) Contour graphics of a simulation of the electrical field in an aurora. The 32 by 32 array of numbers was produced by a FORTRAN program and imported with one command. (b) Three-dimensional plot of the same numbers used for (a).



basic component of the Notebook is a cell that can be simple text, a line of input to Mathematica, the resulting output, or a PostScript graphic. The formatting of all the cells can be easily controlled and switched on and off. The usual Macintosh font commands and styles are all available, as is a large complement of predefined formats for titles, footnotes, and so forth.

You can have the graphics cells displayed in either pictorial form or raw PostScript. You can edit the cell visually with a few commands to change line widths and remove the grid from a function, for example, or you can rewrite the raw PostScript code. Naturally, these graphics look quite nice on the Apple LaserWriters.

The cells can be grouped into various layers like an outline. The right side of the window is dedicated to bracket-like handles for selecting, cutting, pasting, and grouping cells. If you don't want to see the entire cell on the screen, a few clicks reduce it to a small cell displaying only the top line. A few more clicks return the complete cell to the screen. A Notebook with many different levels is easy to maintain.

If the cell is an input cell for the kernel, you can edit it and then have it recalculated. This is a handy feature if you make mistakes while typing in a long expression. The standard Macintosh cut-and-paste operations make this feature easier. If several cells grouped together are steps in a long calculation, you can link them together so a change or recalculation of one would force the recalculation of all of them.

This is probably one of the best implementations I've seen of a hierarchical editor. The brackets marking the ends of cells and groups of cells are easy to understand and manipulate. They are ideal for scientific papers, which usually have a rigidly defined format and a tree-like structure.

However, Mathematica makes several small changes in the Macintosh interface that might confuse a few people. One potential detraction is the use of the preferences file. Apple suggests that every application should create a preferences file if it can't find one. Mathematica doesn't want to do this. It just asked me to look for it on the disk. This problem arose because I set up the preferences file to load the integration functions. Unfortunately, I did this on a 2-megabyte machine without enough memory to hold it all, and the program crashed whenever it tried to follow the preferences file. I threw away the preferences file and then discovered that I needed to dig out the master disks to get everything moving again.

On the plus side, the help system is more sophisticated and includes a new menu selection, "Why the beep," which explains the last error.

The Sun version is much less friendly. The window is essentially a standard terminal. The kernel formats the equations so the output looks exactly like the Macintosh's, but there is no cell structure. The graphics are just as good because there is a PostScript interpreter. The lack of a Notebook doesn't affect the essential function of Mathematica, but you will miss it if you like working on a Mac.

But the Sun version has other advan-

tages, since it is a Unix machine with virtual memory. It has a built-in interface to the Unix pipes that lets it communicate easily with other processes on the machine; another program collecting data can ship it over to Mathematica for processing automatically. The virtual memory uses the disk as additional memory; with it, a Sun machine with 4 megabytes of memory can handle problems many times larger than a Macintosh with 8 megabytes can handle. This makes the machine much more attractive to users who need to compute large programs. I suppose the best compromise would be running the Macintosh front end with a kernel running on a Sun machine, although that could be a rather expensive proposition.

Powerful Graphics

Mathematica's built-in graphics capabilities are its strongest asset. They make it easy to pause for a moment and get a picture of a function without running another software package. Most other mathematical packages don't offer built-in graphics.

While some people might consider it a luxury, there's no question in my mind that the feature is desirable. I like to see functions, even though I know that the picture rarely yields much tangible insight. Simple pen-and-paper mathematics showed me long ago that $y=\log(x)$ grows slower than any polynomial, but I still think of the picture of the curve to convince myself of this.

The kernel handles the plotting and can produce a variety of different graphs.

continued

(c) A different viewpoint of the plot in (b).
 (d) A density plot that assigns each point a shade of gray based on its value.

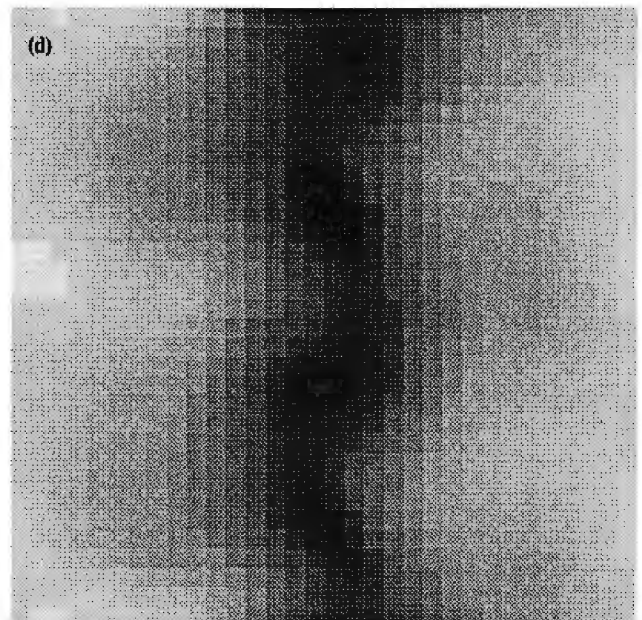
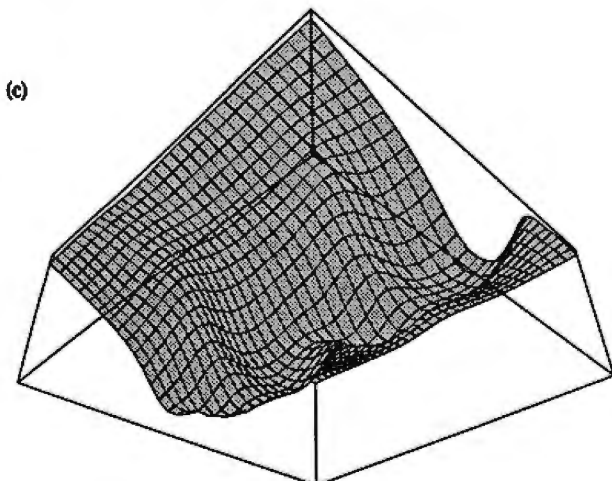

The software can plot both one- and two-variable functions or lists of data in a table with one or two dimensions, with very little help from the user. The computer chooses the scales of the axes, determines a good selection of points, and produces a decent graph with just the function and the endpoints. If there are singularities, Mathematica clips the graph quite well. If the result isn't perfect, you can change the number of points used, plot range, labels, aspect ratio, color, shading, viewpoint, and lighting. (The viewpoint and lighting are only for three-dimensional plots.)

You can choose to plot two variable functions in a three-dimensional perspective, a contour plot, or a density plot. I took an old file filled with a 32 by 32 array of data points in standard FORTRAN form. Mathematica accepted it without any problems. I then made four different plots (shown in figure 1) in about 5 minutes. It's almost impossible for it to be any easier.

The three-dimensional plotting routines are impressive. The graph can be a simple wire-mesh outline, a shaded surface, or some combination. You can specify the shading with another function or leave the shading up to Mathematica. It will use an ambient light or any list of colored point sources around the graph.

Mathematica's graphics are based on PostScript. Each version of the software comes with its own PostScript interpreter for displaying the images on the screen. You can also save the PostScript commands separately into a file, and you can later edit and print them out on a PostScript printer. Using PostScript as an intermediate language is a wise choice because you can customize your graphics on a very detailed level if you want. You can also print them out on a variety of different laser printers.

Mathematica's graphics commands make the system an ideal tool for writing mathematical textbooks and creating slides for talks. Most people just don't want to go to the time and expense of creating plots, but Mathematica destroys that excuse. Graphs come easily from functions.

Building New Functions

No matter how many functions Mathematica included, there would always be a need for more—and that is one of the main reasons for having the package on-hand. You can program new functions in Mathematica's own programming language, which is a mélange of many different features from other languages.

The main structure is Lisp-like. Expressions are just nested layers of functions that are manipulated by other functions. These expressions can be joined in lists, and functions will operate on lists of expressions with ease. The matrix operations borrow their syntax from APL, a language that handles matrices with nimble grace.

You can define functions in a variety of ways. The basic format is a rule-based system similar to Prolog or other logic programming languages. You specify

Some
 programmers may have
 problems remembering
 the syntax.

the function and the pattern of the input variables as a rule. When Mathematica encounters the function again, it tests the parameters against the pattern, and if they match, it executes the function. It always tests the most specific rules first.

A simple example of this method is the program for computing Fibonacci numbers, taken from the manual:

```
fibonacci[n_Integer] :=
    fibonacci[n-1]+fibonacci[n-2]
fibonacci[0] = fibonacci[1] = 1
```

The first two lines state that whenever `fibonacci` is called with an integer, the answer is the sum of the two preceding Fibonacci numbers. The third line establishes the base values for 0 and 1. This puts three rules into the system. When Mathematica encounters the Fibonacci function, it checks the input against the list of rules. If the parameter is 0 or 1, it returns 1. If it is an integer, it recursively calls itself. Otherwise, it does not evaluate the function and returns the expression `fibonacci[...]`.

This rule-matching algorithm lets you "overload" a function and teach Mathematica a variety of ways to handle an operation. I could easily have the Fibonacci function detect if the input was an equation and then do something completely different with the equation. The pattern-matching algorithm would then execute that code. For example, `Plus[2 2] = 5` is a valid line, and whenever Mathematica

needed the sum of 2 and 2, it would evaluate it as 5. In all other cases, it would use the internal routine for addition.

Naturally, these rules don't apply only to numbers. One rule for integration looks something like `Integrate[y_+z_, x_] := Integrate[y_, x_] + Integrate[z_, x_]`. Whenever Mathematica finds `Integrate` called on the sum of two expressions, it moves the addition outside the integral and computes `Integrate` of the two subexpressions. In reality, when Mathematica integrates, it is just searching through a table and repeatedly applying the rules until nothing more can be done.

The internal code for each function is up to the programmer. You can implement IF statements and WHILE loops, and this leaves you several decisions. A function can be implemented with all the special cases filtered by a network of conditionals, or it can be implemented with the special cases as rules. Each might be more efficient for different tasks.

One problem many programmers will find with Mathematica is remembering the syntax. The average user will have very little trouble using the software, because Mathematica's built-in functions have fairly straightforward definitions. You use the complete words "Integrate" or "Expand," for example, although you can create an alias with abbreviations.

The programmer, though, must deal with much more sophisticated problems. There are so many features that each requires its own set of symbols, and there aren't enough keys on the keyboard. There are more than a handful of different assignment operators doing different things. The underscore character, for example, can be used in six different ways to specify the pattern for a rule.

The ">" symbol means "greater than," the ">>" means "save to a file," and ">>>" means "append to a file." The exclamation point after an expression means "factorial"; if it comes before a command, it tells Mathematica to execute the command on the external operating system, but only on some systems; and if there are two exclamation points before a word, it means "display the contents of a file."

These aren't bad features, but they illustrate how complex Mathematica can get below the surface. A beginning and even an intermediate user could use Mathematica without realizing all the underlying depth. Programming it on an advanced level, though, requires a deep understanding of what is going on and an

continued

95% of the Top U.S. Companies Solve Their Complex Numeric Problems with APL ... Shouldn't You?



APL is indispensable in developing mathematical models for pricing financial securities such as options, futures, and bonds. Complex mathematical algorithms are programmed quickly and concisely. And, empirical research is facilitated by APL's unmatched capabilities in manipulating and analyzing arrays of data.

Mark Schroder
Option Research Specialist
Prudential Rache



complex numeric problems are a daily challenge, professionals from all walks of life rely on APL★PLUS®.

Thousands of professionals in a wide range of fields—investment research, insurance, corporate finance, engineering, and science—find APL★PLUS the perfect software for complex problem solving. That's because its natural mathematical orientation and concise code provide the ideal environment for model building, array handling, system prototyping, and matrix manipulation.

Many of our technical professionals are fluent in the use of APL. For us, APL's combination of power, and expressiveness makes it the perfect tool for analysis and visualization of experimental data as well as scientific and engineering computations.

Frederick J. Krambeck
Manager, Process
Development
Mobil Research and
Development Corporation

STSC
STSC, Inc.
2115 East Jefferson Street
Rockville, Maryland 20852
800-592-0050
301-984-5123 in Maryland or
Canada
Telex 898085

Why not give yourself the analytical edge, for only \$695*. Call 800-592-0050 and we'll show you how to put APL★PLUS to work in your specific application.

Each quarter we consolidate and analyze historical data, current data, and forecasts from over 800 entities within GE and then quickly compile into a comprehensive series reports. With APL we get it done in a third of the time it would take us using other methods.

Eric Baelen
Manager, Business Systems
Development
General Electric Company

The APL★PLUS System is available for the mainframe, IBM PC and compatibles, Macintosh, and machines running UNIX and VAX/VMS. The APL★PLUS System may be purchased through dealers and distributors worldwide.

APL★PLUS is a registered trademark of STSC, Inc. UNIX, Macintosh, and IBM are registered trademarks of AT&T Bell Laboratories, Apple Computer, and International Business Machines Corporation, respectively.

Top companies according to the April 17, 1987 issue of *Business Week*.
*U.S. suggested retail for DOS version. International prices slightly higher.



encyclopedic knowledge of many different combinations of symbols. C programmers will feel comfortable, but Pascal programmers like me might be put off by the semantic confusion.

Well-Documented

There are two different types of documentation for Mathematica. The information about the version for your specific computer comes in a separate manual. The manuals for the Macintosh cover the relevant features in such a well-illustrated and excruciatingly detailed way that the package includes a second, thin *Summary for Macintosh Experts*.

The details about the kernel can be found in Stephen Wolfram's 750-page book, *Mathematica* (Addison-Wesley, 1988), which comes with the program. The writing is clear, and the organization is good. The first pages provide a simple overview of all the capabilities. A user interested in just the basic commands need only read the first full chapter. The small details about the structure of the system and about programming it can be found in the other chapters.

At times, I found myself wanting to

know more details about the algorithms Mathematica was using inside; there are many times when it uses automatic settings to get results that can be wrong if used naively. For example, the section on numerical integration sketches possible problems nicely, but it doesn't give very good details about what is going on when it attacks singularities. The entire software system is so complex that 750 pages is only enough for a cursory sketch of many of the less prominent functions.

And the Answer Is...

The user interface on the Macintosh is a big asset and a pleasure to work with after running old symbolic packages on mainframes, though the programming language can be difficult to use. If you want to really use all the capabilities, be prepared to be confronted with many different options. Mathematica has almost too many ways to do things.

There are a few negatives. The program is the largest memory hog since HyperCard. It can run on a Macintosh with 2 megabytes of memory, but not very well. Integration needs at least 2.5 megabytes. I used a 5-megabyte machine

and lived comfortably. If you use the Sun computer, its virtual memory takes care of this problem.

I found several bugs in my early version of the software. The graphics software crashed when I moved the viewpoint of the graph to the origin. Some of the sample Notebooks didn't do everything they said they would. Given the size and the complexity of the program, the bugs were not surprising, nor were they more common than expected. Wolfram Research says it will provide fixes to these bugs in version 1.1, which will be a free upgrade for users.

If you plan to do mathematics—real mathematics, with symbols, not just numbers—then Mathematica might be the one main software package for you. It can do pretty much anything mathematically that you might want a computer to do. Its symbolic powers are strong, and excellent graphics functions are built directly into the software. ■

Peter Wayner is working toward a Ph.D. in computer science at Cornell University. He can be reached on BIX c/o "editors."

	1985	1986	1987	1988
Jan.	\$4.00	\$6.00		\$6.00
Feb.	\$4.00	\$6.00	\$6.00	
March	\$4.00	\$6.00	\$6.00	\$6.00
April	\$4.00		\$6.00	
May	\$4.00	\$6.00		\$6.00
June	\$4.00	\$6.00	\$6.00	\$6.00*
July		\$6.00	\$6.00	\$6.00
Aug.	\$4.00	\$6.00	\$6.00	\$6.00
Sept.	\$4.00	\$6.00	\$6.00	\$6.00
Oct.	\$4.00	\$6.00	\$6.00	\$6.00
Nov.	\$4.00			\$6.00
Dec.	\$4.00	\$6.00	\$6.00	\$6.00

*Overstock Special \$3.00

Check enclosed
Payments from foreign countries must be made in US funds payable at a US bank.

VISA MasterCard CARD # _____ EXP. DATE _____

SIGNATURE _____

The above prices include postage in the US. Please add \$.50 per copy for Canada and Mexico; and \$2.00 per copy for foreign countries (surface delivery). Please allow 4 weeks for domestic delivery and 12 weeks for foreign delivery.

European customers please refer to Back Issue order form in International Advertising section of book.

NAME _____
ADDRESS _____
CITY _____ STATE _____ ZIP _____

BACK ISSUES FOR SALE

SPECIAL ISSUES and INDEX

BYTE '83-'84 INDEX	\$3.00
BYTE 1985 INDEX	\$3.00
BYTE 1986 INDEX	\$3.00
BYTE 1987 INDEX	\$3.00
1985 INSIDE THE IBM PCs	\$4.00
1986 INSIDE THE IBM PCs	\$5.00
1987 INSIDE THE IBM PCs	\$6.00
1988 INSIDE THE IBM PCs	\$6.00
APPLICATIONS SOFTWARE TODAY SPECIAL	\$4.00

Circle and send requests with payments to:

BYTE Back Issues
One Phoenix Mill Lane
Peterborough, NH 03458
(603) 924-9281

Why LAP-LINK Has Connected Over 200,000 Computers.



In less than two years, LAP-LINK has connected over 200,000 computers to become the standard in accessibility software for IBM's and compatibles, laptops, and Apple Macintosh computers.

But outstanding sales aren't the only way to recognize great software. Consider what the experts have to say.

Fast and accurate.

"...LAP-LINK...sets a record for the fastest serial transfer on a P.C." **Howard Marks, P.C. MAGAZINE**—July 21, 1987. And LAP-LINK is not only the fastest, it's also the most accurate. LAP-LINK's error checking system guarantees that all data is transferred with 100% accuracy.

Easy to set up.

"LAP-LINK is the absolute easiest, simplest and most convenient." **Harry Newton, TELECONNECT**—April, 1987. LAP-LINK comes with everything you need to set it up—including 3½" and 5¼" disks, documentation, and Traveling Software's universal cable with both 9-pin and 25-pin connectors.

Easy to use.

"...I don't know if the manual is any good or not: I've never had any reason to open it. LAP-LINK is so thoroughly intuitive, fast and simple to use, the manual is blooming near superfluous." **Jerry Pournelle, BYTE MAGAZINE**—July, 1987. All you need to do is connect our high quality universal serial cable (no need to unplug your printer's parallel cable), type "LL" on both computers and LAP-LINK will automatically connect itself, ready to transfer single files, entire sub-directories, or hard disks.

Award winning.

"If you like a package that's fast, efficient, and easy to use, LAP-LINK is clearly the...program of choice." **M. David Stone, P.C. MAGAZINE**—January 12, 1988. P.C. Maga-

zine was so impressed with LAP-LINK's performance that they gave it their Editor's Choice and "Best of '87" awards.

LAP-LINK

LAP-LINK transfers files between IBM and compatibles, laptops and desktops, including the new IBM PS/2. It installs in seconds, features a split-screen design for showing files in both computers, and transfers data at incredible speeds of over 115,200 baud.

LAP-LINK Plus

With all the simplicity and file transferring capabilities of LAP-LINK, LAP-LINK Plus also offers the option of direct disk drive and printer sharing between any two connected computers. It's like having a two computer network. You can easily switch between local and remote printers using a pop-up window without leaving your application.

LAP-LINK Mac

Everything you need to share files between any model of the Apple Macintosh (512, Plus, SE and Mac II) and an IBM compatible laptop or desktop computer (including the IBM PC, XT, AT, and PS/2). It's easy to use and it's fast, over 57,000 baud. LAP-LINK Mac is also fully compatible with both Macintosh Finder and MultiFinder, as well as AppleTalk, TOPS, and 3Com. **New release 2.0 now includes 14 file translators!**

So for the best Accessibility Software, stop by your local computer or software dealer today. Or call us at: 1-800-343-8080 or in Washington: 1-206-483-8088. Ask about our free catalog.

LAP-LINK is surprisingly affordable at \$129.95, LAP-LINK Plus \$139.95 and LAP-LINK Mac \$139.95 (Suggested retail prices including cable).

Traveling  Software

Traveling Software • 18702 North Creek Parkway • Bothell, WA 98011

Macintosh, AppleTalk, Finder, MultiFinder, and Apple are trademarks of Apple Computer, Inc., IBM is a trademark of International Business Machines Corp., 3Com is a trademark of 3Com Corp., Novell is a trademark of Novell, Inc., TOPS is a trademark of Sun Microsystems, Inc., Traveling Software, LAP-LINK, LAP-LINK Plus and LAP-LINK Mac are registered trademarks of Traveling Software, Inc.

PICK BIX BRAINS

... With a 10 Day Trial Membership

If you've thought about joining BIX before but weren't sure it was what you needed, now is the time to try it. Because now for a limited time, we're inviting you to try BIX for 10 days. If at any time during this 10 day trial period you don't feel BIX has made you a more knowledgeable microcomputer user, we'll refund your entire registration fee. You pay only for time spent on the system.* (See log-on instructions for hourly rates).

Explore BIX in your home or office. Put its power to work for you and unleash your full microcomputer potential — programming, designing, specifying, researching — and more.

Try BIX for 10 full days and see what it can do for you. Explore more than 160 conferences. Access vendor support. Speak to expert consultants. Research new products and systems, and download public domain software.

Prepare yourself for success

It takes a sharp mind and hard work to stay ahead, and having the right tools helps.

Today, you can put one of the most powerful instruments for career advancement to work for you: BIX.

- Learn about new products before they hit the market.
- Get quality marketplace feedback on the products you're thinking of purchasing before you invest.
- Research problems and find the solutions that no one else has been able to render.
- Access some of the most advanced public domain software available in the industry.
- Increase your working knowledge of micros to make more confident purchasing decisions and recommendations.

Join BIX and arm yourself with the latest in microcomputer-related information

BIX's exclusive *Microbytes* newswire gives you complete, daily, up-to-date computer industry information. You'll gain insight from BYTE editors and writers who analyze new products and their potential impact, inform you of the latest mergers and acquisitions, and report late-breaking news from important seminars and conferences.

Talk to colleagues worldwide

You'll stay on top of your company's

business with BIX's electronic mail service.

"Talk" to your east coast, west coast — even European — contacts all in the same day.

Or, simply communicate with other BIX users worldwide. Share information and ideas privately, or in conference.

Choose any option for online access with a one time \$39 membership fee

- Use MasterCard, VISA or American Express and begin your 10 day trial use of BIX right now.
- The 10 day trial also applies if you open an individual pre-paid account on BIX. Trial commences once we open your account and notify you.
- Other billing options including qualified corporate accounts are available. (Sorry, our 10 day trial is not available for these accounts.) Call or write BIX for details.

Use credit cards for immediate access or call the BIX Helpline for information on any other payment option at, 1-800-227-2983 (from U.S. and Canada) 603-924-7681 (in New Hampshire and elsewhere).

Act now! Our 10 day trial offer is subject to cancellation at any time.

*To notify BIX that you wish to discontinue service at any time during the trial period, call the BIX Helpline, and your entire membership fee will be refunded.

**BIX can be accessed via Tymnet throughout the U.S. and Canada. For the Tymnet number nearest you, call the BIX Helpline or Tymnet at 1-800-336-0149.

†If your local Tymnet number is a toll call you will receive additional charges from your local phone company at their prevailing rate.

††Continental U.S. Tymnet rates. Rates from other areas are available from BIX.

BIX is easy to join

To log-on to **BIX**, simply:

Set your computer's telecommunications program for full-duplex, 8-bit characters, no parity, 1 stop bit OR 7-bit characters, even parity, 1 stop bit. Use 300 or 1200 baud.

Call your Tymnet number ** and respond as follows:

Tymnet Prompt	You Enter
Garble or request for "terminal identifier"	a
login:	bix<CR>
BIX logo/name:	bix.038 <CR>

Callers outside the U.S. who have a communicating computer or terminal and a packet switching account with their host country phone system

can reach **BIX** by entering 310690157800. To commence registration, enter the code listed at the **BIX** logo/name: prompt.

After you register, you'll automatically be taken to the **BIX** Learn Conference, an online tutorial that will show you how to begin using the system immediately. Time spent in the Learn Conference is FREE. Complete system documentation will be sent to you within a few days.

Access time will be billed at the following hourly rates.†

Off-Peak Time \$11/hr. (\$9 **BIX**, \$2 Tymnet)††
(7 PM - 6 AM weekdays, all day weekends and holidays)

Peak Time \$20/hr. (\$12 **BIX**, \$8 Tymnet)††
(6 AM - 7 PM weekdays)

BIX

BYTE INFORMATION EXCHANGE

One Phoenix Mill Lane
Peterborough, NH 03458

PC Communications



Introducing:

MIRROR III

Full Spectrum Data Communications

From the occasional user to the experienced professional, today's PC communications software needs to cover the full spectrum.

Pre-programmed access to most popular dial-up information services • "Learn" mode to create your own log-on sequences • Dialing Directory • Installation and System Diagnostics • Comprehensive "HELP" system • 100% Crosstalk® XVI compatibility.

Background mode: Start a file transfer and switch to running another program while MIRROR III handles the transfer behind the scene.

Ultra High-Speed modem support (19,200 bps), or direct connect (up to 115,200 bps).

Host system connectivity with terminal emulations including: DEC VT 100/220 series, IBM 3101 (with block mode), Televideo 925 and Wyse-50.

File transfer protocols: XMODEM, YMODEM, KERMIT, Crosstalk, Hayes, CompuServe-B and ACT CommPressor™ (the latest in data compression).

PRISM: Introducing the most powerful data communications programming language. PRISM provides: Form/Menu generation; real, integer, string, and array variables; File I/O and the ability to integrate MIRROR III with foreground applications. A script file protection/compression utility is also provided.

Put the power of "Full Spectrum Data Communications" to work for you.
Order MIRROR III Today!

To order, Call: 1-800-634-8670
60-Day Money-back Guarantee

\$99.95

SOFTKLONG™

VISA/MasterCard/COD. \$5.00 for Shipping and Handling (\$8.00 for COD orders).
Florida residents add 6% sales tax.

MIRROR III is for use on IBM and 100% compatibles (including the IBM PS/2) running MS-DOS 2.0 or higher.

Crosstalk is a registered trademark of DCA, Inc./CommPressor™ is a trademark of ACT, Inc.

DISTRIBUTING CORP.
327 Office Plaza Drive
Tallahassee, Florida 32301
Telephone: (904) 878-8564
Telex: 6714280 KLON

PC Communications

- 253 Fiber vs. Metal**
by James Y. Bryce
- 259 Looking for Trouble**
by Harry Saal
- 267 The Data Bandits**
*by William M. Adney
and Douglas E. Kavanagh*
- 273 Dialing Up 1990**
by Brock N. Meeks
- 281 Whither the Modem?**
*by John H. Humphrey
and Gary S. Smock*
- 285 OS/2 Hits the Networks**
by Ken Thurber
- 293 When One LAN Is Not Enough**
by William Stallings
- 301 Understanding NetBIOS**
by Brett Glass
- 309 A Logical Choice**
by Ralph Davis
- 317 Making the Connection**
by Ed Tittel

The word “communications” means different things to different people. Depending on context, it can imply talking face-to-face, writing letters, conversing on the phone—even using body language. In any context, it involves the sending and receiving of information.

BYTE’s first expanded In Depth section is devoted to the field of PC communications. It explores various aspects of LAN technology, from cable choices to protocols, from operating systems to programming, and from management to security. It also brings you up-to-date on the current status of dial-up communications software and modem technology.

In our first article, “Fiber vs. Metal,” James Y. Bryce examines the cabling choices currently available, including fiber-optic, twisted-pair, and coaxial. He explains the pluses and minuses of each and describes fiber-optic technology in detail.

In “Looking for Trouble,” Harry Saal gives us guidelines for managing and troubleshooting a LAN. He writes about the logical tools we need to locate a LAN problem and provides a list of some of the physical tools available that can help in “Troubleshooters,” the resource listing. In a similar vein, “The Data Bandits” by William M. Adney and Douglas E. Kavanagh discusses possible security threats to a LAN, including viruses, data theft, and accidental data destruction, and provides direction for how to make your LAN more secure.

While LANs are a major source of excitement—at least in the BYTE office—most of us also still dial up various services and bulletin boards through our modems. In “Dialing Up 1990,” Brock N. Meeks describes the current state of dial-up packages and provides a list of many of the current offerings in the re-

source listing “Communications Programs.” And in “Whither the Modem?” John H. Humphrey and Gary S. Smock provide an update on modem technology and on the rising speeds and falling prices of modems.

In “OS/2 Hits the Networks,” Ken Thurber discusses the role of OS/2 in various network situations and how it interacts with the offerings of the major network companies. He also writes about OS/2 as a distributed-systems platform. You don’t always, however, have a uni-vendor situation. In “When One LAN Is Not Enough,” William Stallings discusses internetwork protocols—how you can establish connections between similar and dissimilar networks to extend your communications ability.

Few of us yet understand the inner workings of NetBIOS, but Brett Glass opens up that complex world and lays it at our fingertips in “Understanding NetBIOS.” Another puzzle lies within the acronyms APPC and LU 6.2. Ralph Davis leads us through this one in “A Logical Choice” and provides the details of the communications protocol used by IBM’s SNA and its connection to distributed processing.

Finally, Ed Tittel shows us how to connect and communicate between PCs, Macs, and VAXes on a single network in “Making the Connection.” He also provides a resource listing of connectivity products.

Altogether, we hope you’ll find this section on PC communications enlightening. We have all learned to use modems and even to become dependent on them by now. And if market trends are any indication, we will all become very familiar with LANs as well in the near future.

—Jane Morrill Tazelaar
Senior Technical Editor, In Depth

Intel announces

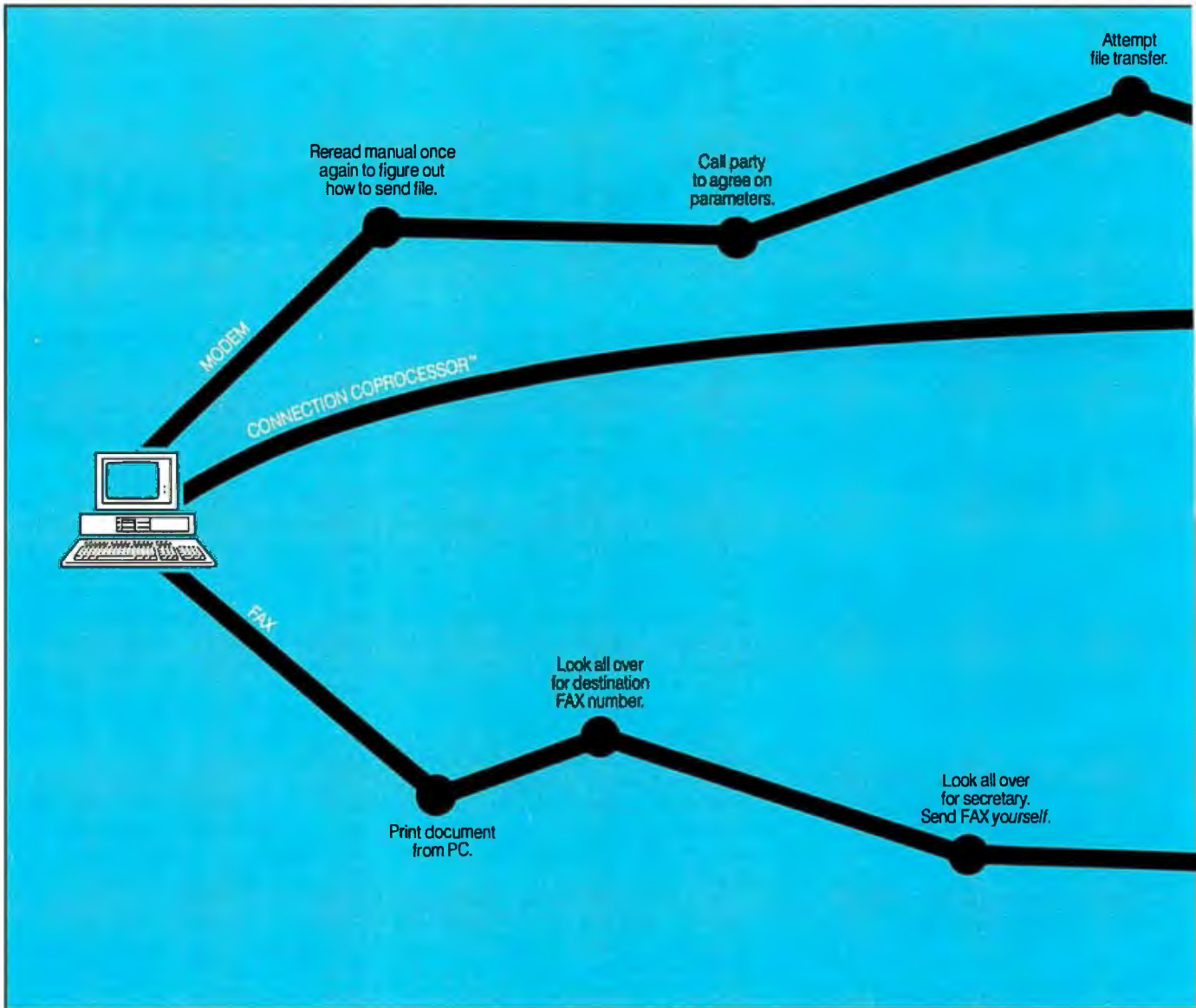

Announcing the first non-stop communications route between businesses anywhere in the world.

Intel's Connection CoProcessor.™

It's a whole new way to send and receive programs, files, text, graphics and electronic messages. Not just between PCs, but with fax machines as well.

The Intel Connection is a new communications coprocessing board that frees your PC from the task of communicating.

Which means you can work on your computer non-stop—even while

sending a document as big as the New York phone book.

Now your faxes or files can fly cross country. And you can still be zooming around in your flight simulator. Or writing that letter to your biggest account. Or recalculating your spreadsheets for tomorrow's meeting. Without interruption or downtime.

And when you fax, there are no more stopovers at the printer, or cooling your heels in line at the fax machine. Because Connection lets you do everything without leaving your PC.

And when you send files directly to



©1988 Intel Corporation. Connection CoProcessor is a trademark of Intel Corporation. WordPerfect is a registered trademark of WordPerfect Corp. Symantec is a trademark of Symantec Corp. Borland is a registered trademark of Borland trademark of Microsoft Corporation. *CAS (DCA/Intel Communicating Application Specification.)

non-stop flights.

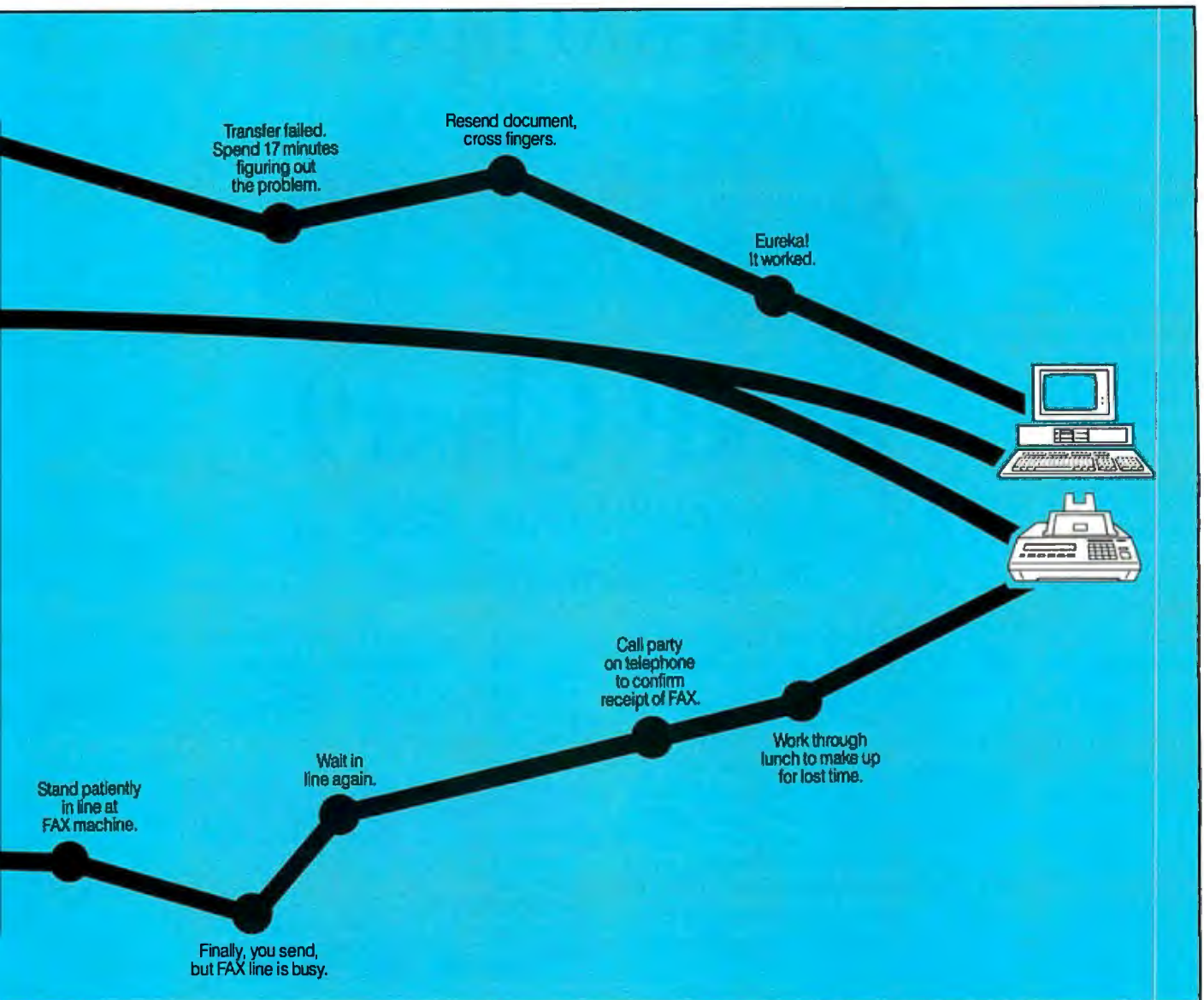

another Connection-equipped PC, you won't have to fiddle around with modem parameters or protocols. Because the Connection CoProcessor sets them for you. At 9600 bps.

Best of all, Connection supports CAS*, a new communication standard that is supported by major software and hardware developers like Symantec,[™] Borland,[®] DCA,[®] Microsoft,[®] and WordPerfect.[®] Which means you can send, for example, a word processing file to your London office, without ever exiting your WordPerfect program.

You just send the document directly from your application. That's it. There isn't any complicated

Corporation. DCA is a registered trademark of Digital Communications Associates, Inc. Microsoft is a registered

communications software to learn.

And everything is backed by toll-free technical support and a five-year warranty from Intel.

So what are you waiting for? Call 800-538-3373 now for a free demo disk.

Because with Intel's Connection CoProcessor, communication is really going to take off.

intel[®]

V.32 at 38,400 bps.



MNP[®] Class 9

Because life is too short
to use a slow modem.

We couldn't make our dial-up modems any more accurate. So we made one twice as fast. And it's available today.

Introducing QX/V.32c, the world's fastest dial-up modem. At 38,400 bps, with full-duplex CCITT V.32 compatibility over dial-up lines. Plus all the added performance and Enhanced Data Compression of MNP[®] Class 9. There's compatibility with V.22bis, V.22, Bell 212A and Bell 103 included, so that QX/V.32c communicates at optimum levels with modems of all speeds. And it can work in synchronous or asynchronous environments.

Speed and performance are not the only powerful features of the QX/V.32c. Its compact design is equally impressive — 1/3rd the size of most competitive modems. And it comes in a rack mount version, as well.

What will you pay for our breakthrough V.32 modem? About the same as modems with only half the error-free throughput. As you can see from the chart, lower phone bills alone could pay for this upgrade.

9600 bps modem\$6.94

QX/V.32c...\$1.74

Comparable costs of sending identical amounts of data over dial-up lines.

Find out how Microcom brought error-free V.32 to 38,400 bps levels. Call toll-free 800-822-8224 today.



Workstation
Connectivity
Worldwide

500 River Ridge Drive, Norwood, MA 02062 617-551-1000 Telex 710-336-7802 MICROCOM NWD
Worldwide Distribution — International FAX: 617-551-1007 USA FAX: 617-551-1006
Toll-free 800-822-8224

MNP is a registered trademark of Microcom, Inc. QX/V.32c and Enhanced Data Compression are trademarks of Microcom, Inc.

Fiber vs. Metal

Mix, match, and choose between fiber-optic and metallic cables

James Y. Bryce

The wait is over. Fiber optics has been considered an exotic animal, a technology that might offer great potential but is too complicated and expensive for routine use. But no more.

Despite repeated bursts of television advertising praising fiber optics in long-distance telephone networks, the computer community still hasn't accepted it for local-area networks (LANs). But careful consideration of fiber optics' costs and performance and that all-important cost-to-benefit ratio often demonstrate it to be the best choice, if not for an entire network, then for significant portions of one.

What Is Fiber Optics?

An optical fiber is manufactured by drawing a large cylinder of glass, called a *preform*, out over a long distance until it is one long piece of pure glass whose diameter is measured in millionths of a meter, or microns. The fiber, just like the preform from which it was made, has two fundamental components that extend along its entire length: the core and the cladding (see figure 1).

The core is the smaller, interior portion of the fiber. It can be anywhere from



5 to 100 microns in diameter. In LAN fibers, the diameters usually range from 50 to 100 microns (very small cores of 5 to 10 microns are reserved for long-distance telephone fibers). Light signals travel through the core.

The cladding also is composed of glass, but it was designed in the preform stage to have a different index of refraction than the core. Although the resulting

fiber is drawn from the same preform, the two components transmit light at slightly different velocities; thus, light is bent, refracted, as it enters the transition between the core and the cladding. You observe the same physical phenomenon when looking through water and trying to spear a fish; the light bends when it passes from air to water. This bending is designed into the fiber and keeps the signaling light within the core.

Various materials are used to encase the fiber. The initial materials are chemical coatings that protect the glass. These are followed with strengthening and protective plastics and even metal sheaths that "harden" the fiber, or more likely the collection of fibers, against environmental damage. Fiber op-

tics is considered so reliable and so secure that military organizations such as the U.S. Army now use fiber for almost all communications—even under battlefield conditions.

Launching the Optical Signal

Two electronic devices are generally used to "launch" the optical signal into a

continued

fiber. Long-distance telephone circuits use lasers because they need power and coherent light for transmission over distances of several tens of kilometers. Computer LANs use LEDs of considera-

bly weaker output powers and incoherent light to transmit signals over distances of only 1 or 2 kilometers.

The end of the fiber is carefully cut, or "cleaved," at a 90-degree angle to its

length; this produces a flat face that is carefully aligned with the LED or laser through connectors. The LED or laser then is pulsed with the electrical signal, and light is transferred to the fiber. In "single-mode" fiber, like that used in long-distance telephony, this light can enter at only one angle and therefore travels through the core in one mode, without significant refractions at the cladding.

In the "multimode" fiber used for LANs, the light can enter at a number of different angles, creating different paths, or "modes," of travel through the fiber. Each mode travels through the fiber, being refracted back and forth from the core's boundary with the cladding or being constantly refocused. Light entering the fiber at a shallow angle is refracted fewer times than that entering at a steep angle. (See figures 1 and 2.)

The different paths resulting have different lengths. These differing lengths ultimately result in data-rate limitations, as the different modes arrive at slightly different times. At extremely high data rates, these different modes cause adjacent optical pulses to merge into one another at the point where the practical data-rate limit for a given length of fiber is reached.

Although data rate is more limited with multimode fiber than with single-mode fiber over LAN distances of usually less than a kilometer, the multimode material can carry data rates substantially greater than 1000 megabits per second. Also, multimode fiber is easier to handle, installing connectors is simpler, and LEDs are far cheaper than the lasers used for single-mode fibers.

Comparing Cables

Fiber optics wins on almost every point when you contrast it with metallic cables (see table 1). The two types of metallic cables most widely used are twisted-pair and coaxial. Twisted-pair cables have been in use the longest and are the most misunderstood. Currently, there is a significant interest in making almost any twisted-pair found in a building carry LAN signals, because twisted-pair cable, especially that already in place, is considerably cheaper than other cable technologies.

The pressure of this idea has been so great that IBM declared an unshielded twisted-pair designated "type 3" as part of the IBM Cabling System. A number of companies have installed the cheaper cable only to discover in mid-1988 that IBM's extension of the Token Ring data rate from 4 megabits per second, which worked over reasonable distances on type

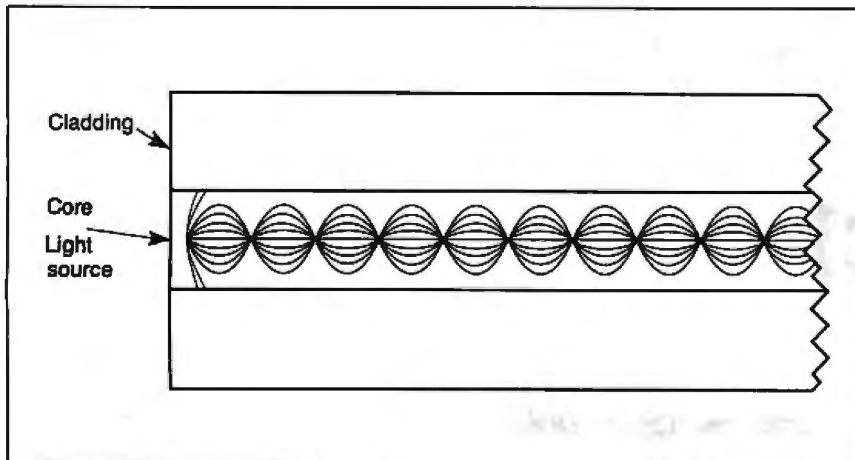

Figure 1: With graded-index multimode fiber cable, light is constantly refocused as it travels through the core.

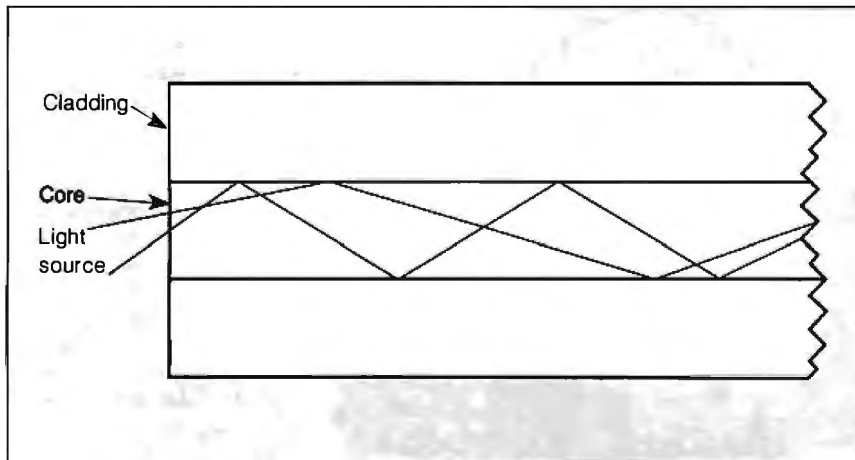

Figure 2: In step-index multimode fiber, light travels through the fiber, being refracted back and forth from the core's boundary with the cladding.

Table 1: Fiber-optic performance as compared with twisted-pair and coaxial.

	Twisted-pair	Coaxial	Fiber
Data rate per kilometer	16 megabits	500 megabits	1000+ megabits
Accessibility to being tapped	Easy	Easy	Difficult
Signal radiation	Yes	Yes	No
Potential for explosion	Yes	Yes	No
Bit error rate	1 in 10 ⁶	1 in 10 ⁶	1 in 10 ⁹⁺
Static problems	Yes	Yes	No
Grounding problems	Yes	Yes	No
Size and weight by data rate	Large	Large	Small

3, to 16 megabits per second meant that it would no longer work. This dilemma is generally true of metallic cables: As the data rate increases, signals degrade more and more over unit lengths of cable.

The problem results from the cable's susceptibility to interference (in metallic cables, this is at least partially protected by shielding) and attenuation of signal levels in a fashion more detrimental to high-frequency than to low-frequency components. The typical digital signal

begins as a square wave. A square wave is a collection, at least theoretically, of an infinite number of sine waves of different frequencies. Cables attenuate the low frequencies the least, the high ones the most. So as the square wave travels down the cable, it begins to decrease in strength and spread out, or round off. Adjacent square waves do the same, and pretty soon the different pulses are running into one another (see figure 3).

The signal must be regenerated in a

device that can tell the difference between the now distorted wave shapes and reconstruct them as new digital ones and zeros—clean square waves. This device is usually called a repeater. In considering any cable, you must consider how much it distorts a signal over a unit distance. For easy comparison, the unit distance usually chosen is 1 kilometer.

In this article, I have considered only cables of high-quality construction and

continued

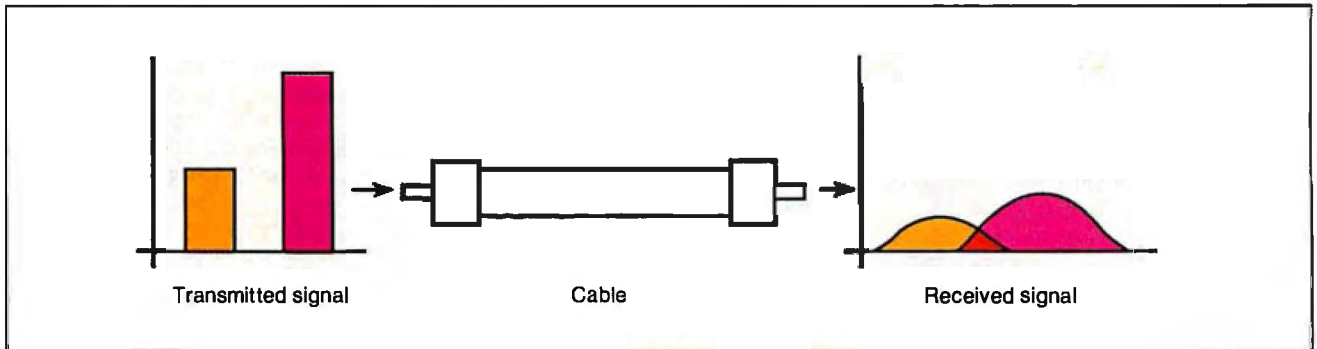

Figure 3: The change in signal levels over metallic cable. Beginning as a square wave, the typical digital signal will weaken and round off as it travels down the cable. As adjacent square waves do the same, the different pulses run into one another.

CarrierNet
Makes Peripheral Sharing
And Office Networking Fast, Affordable,
And "Cableless"

Today's office environment requires a flexible solution for the costly problem of equipment and effort duplication. Carrier Current Technologies, Inc. has the solution, with a line of *cableless* products—The Carrier Office Network. Our expandable, *cableless* network can be used for peripheral sharing, file transfers, network updates, modem sharing and electronic mail service.

The Carrier Office Network features CarrierNET, a *cableless* data transfer system. CarrierNET connects quickly to the serial port of your PC and plugs into the existing electrical wall outlets of your building, turning your office's electrical system into a data transfer network. It does all this without costly, unsightly cables. And, The Carrier

Office Network can be installed, expanded or moved in minutes. Give us a call. And find out just how economical and efficient a Carrier Office *Cableless* Network can be.

CARRIERNET
by Carrier Current Technologies, Inc.
4905 Pine Cone Drive
Durham, North Carolina 27707
919/490-4970

Dealer Inquiries Welcome.

The Future Is Plastics

Traditional twisted-pair and coaxial cables have a few characteristics and tricks left that bear mention, especially in getting from the wiring closet to the machines on the floor. And just around the corner lurks plastic fiber, ready to bring economic light to that last link.

Twisted-pair is so widely installed that a major effort has been under way to use it for ever higher data rates. There are real limits to twisted-pair for the future. Current work to make most reasonably good twisted-pair carry IEEE 802.3 (ISO 8802/3) signals over useful distances at 10 megabits has met with success. Usually, this is called Ethernet on twisted-pair, although the Xerox-developed Ethernet, strictly speaking, is slightly different from 802.3 in details such as preamble, address technique, logical link control, type and length fields, and maximum frame size.

Previous efforts at 802.3 protocol over twisted-pair were limited to 1-megabit data rates and standardized as 802.3 1Base5. Since the newer technologies offer 10 megabits, you should expect such lower data-rate systems to fade into obscurity very quickly. Products of two manufacturers represent somewhat divergent 10-megabit twisted-pair techniques; other companies are also entering the field.

Synoptics Communications of Mountain View, California, offers LattisNet. This system uses two twisted-pairs for a maximum distance of 110 meters, depending on the quality of the wire. Cabling goes back to a concentrator. The product also provides modules for fiber-optic connections among concentrators and to individual devices. Current work by the IEEE 802.3 committee (802.3 10BaseT) is expected to standardize on a scheme very similar to this.

3Com Corp. of Santa Clara, California, has introduced a method that is considered an extension covered by the current standard usually applied to "thin Ethernet" (802.3 10Base2). In this system, devices called PairTamers are attached to thin Ethernet coaxial cable (RG 58 A/U or C/U) on one side and to a single twisted-pair on the other. With good-quality twisted-pair, distances of up to 76 meters can be realized. This is often more than adequate for ordinary building installations.

A single run uses a PairTamer at each end of the twisted-pair. The device simply converts from coaxial cable on one

side to twisted-pair on the other, so no other special electronic equipment is needed. Once the conversion to coaxial cable is made, the standard thin-Ethernet methods of daisy chaining from one machine to the next and so on may be adopted. 3Com provides information for calculating the distance limitations of the combination of twisted-pair and coaxial cables; the company also provides cable-system test equipment and multipoint repeaters as aids in constructing systems.

Thin Ethernet still has some tricks left also. Its standard installation requires that a loop of cable be pulled to each device; there, a tee connector passes the signal by a transceiver tap usually built into the network card inserted into a microcomputer. Multipoint devices such as the DEMPR from Digital Equipment Corp. allow eight runs of thin-Ethernet coaxial cable to daisy chains of machines, converting the usual bus topology into a star.

As Dustin Hoffman learned in *The Graduate*, there is one word that defines the future—*plastics*. Plastic fiber-optic cable is here and has been for quite a while. The primary difficulty with the material has been its narrow bandwidth and high attenuation when compared to glass. Now research is leading to practical and cheap plastic fiber. Hoechst-Celanese of Somerville, New Jersey, and Codenoll of Yonkers, New York, are working together to provide such fibers for local-area networks.

Plastic fibers are 200 to 500 microns in diameter, can be cut with simple and inexpensive tools, and are installed with minimal training using connectors designed to make the job easy. Why is all this so simple and applicable to the wiring-center-to-machine connection? The distances involved are short, 100 meters or less, and many systems contemplate regeneration of the signal, either at the wiring center, the machine, or both; thus, signal-loss budgets of 20 dB usually available in an optic system allow otherwise sloppy, high-loss connections characteristic of the rough techniques developed for plastic fibers.

Watch for plastic fiber over the next year; it will probably be your cable of choice for workstation hookup. It may be offered so cheaply that you will choose to pull it in along with twisted-pair or coaxial cable waiting to install connectors and actually use it when electrical-to-optical conversion costs drop.

standard type; hence, my estimates are at the high end of performance. For twisted-pair in particular, the types found strung throughout buildings after being abandoned by telephone companies are at best only vaguely known and thus not adequately standard to provide a basis for comparison. IBM's full-specification cables, such as "type 2," provide a more predictable base.

How Do They Perform?

Data rate: Twisted-pair is by far the poorest performer in terms of data rate per unit distance. The better grades, such as those that meet IBM's type 2 specification, are good for perhaps 16 megabits per second over a kilometer. Coaxial cable is far better, having a capacity of 300 to 500 megabits per second. But fiber optics is the hands-down winner, being able to carry more than a gigabit (1000 megabits) per second over that same kilometer. We don't make use of those data rates now, but the future holds that prospect.

The most exciting prospect for high data-rate communications is called the fiber distributed-data interface. It's currently in the final stages of specification as a fiber-optic token-passing ring that operates at 100 megabits per second. That rate has a variation to 200 megabits per second, and increases beyond that are anticipated. The FDDI specification will initially furnish the backbone connecting slower LANs, but, as our machines improve in power, we'll need to directly connect such high-speed fiber-optic networks to our mainframes, minicomputers, and even microcomputers.

Security: Security of the cable system has become a major concern of many LAN installations. At the extreme, complex specifications, such as the Tempest rating promulgated by the Department of Defense, are required of electronic cables and gear; a great deal of the Tempest specification deals with shielding. Installations that are even more secure require a fuller complement of cable protection, including encasing cables within thick conduits and blocking all wall penetrations; the Strategic Compartmentalized Information Facility requirements furnish an example.

You can tap metallic cables with rather simple devices; the amount of signal energy removed by such taps is usually too small to be detected by all but the most sensitive instruments located elsewhere on the cable. Fiber-optic cables, however, are very difficult to tap. And if a successful tap is made, the signal drawn from the cable is on the order of a

decibel or more, an amount easily detected by standard optical-measuring equipment.

Metallic cables carry signals that are basically radio waves. The cables act like antennas radiating their signals freely. Good-quality shielding greatly limits this radiation, yet shielding is not perfect. A poor connector may have a great deal of leakage. Fiber-optic cables do not radiate at all.

Explosion potential: Consider a fuel depot, an oil refinery, a chemical plant, an operating room where explosive anesthetics may be used, or a gunpowder plant (I actually designed a fiber-optic system for a gunpowder plant). In each instance, using metallic cables that carry electricity adds to the danger of creating a spark and a subsequent explosion. Fiber-optic cables have no such dangers.

Bit error rate: Tests performed by various laboratories have shown that about one error in every 1,000,000 bits can be attributed to metallic cables. Similar tests on fiber-optic cables show 1000 times fewer errors, or one error in every 1,000,000,000 bits, or better.

Static: The most important instance of

static is lightning. A lightning strike within 100 or so meters of a metallic-cable system can induce a very strong voltage flow in the cable, destroying equipment and, perhaps, endangering people. Since fiber-optic cables need no metal components, lightning can't induce a voltage.

Grounding problems: We've all heard the 60-Hz hum that results when an audio plug is being inserted in an amplifier. That hum occurs when the center pin goes in and the shield is not firmly connected. It reminds us that the earth is the return for all currents, and we are surrounded by a 60-Hz power system inducing current flow in all metal.

If a communications line is slightly less than perfectly grounded, such a "hum loop" may result, with the potential for interfering with signals. Different points within the same building, and certainly between buildings, have different grounding potentials. Equalizing these potentials is often very difficult. At worst, the differences found could be dangerous to people coming into contact with cables connecting two points. Fiber-optic cables have no possibility of

this kind of current flow.

Size and weight: A quick glance at representative cables and their respective data-rate capacities shows that fiber-optic cables are far smaller and lighter than their metallic counterparts. This leads to ease of installation, since less equipment and less labor are required to pull in major cable runs.

But How Much Does It Cost?

OK. You're convinced—fiber optics is the best way to go for performance and for the future. But isn't it prohibitively expensive? See table 2.

Cable cost: Almost everyone thinks that fiber-optic cable is very expensive when compared with twisted-pair and coaxial. However, for quality cable that you would use in a well-designed LAN for a moderate-to-large setup, the basic cable costs are the same: \$0.50 to \$1.00 per foot. Plenum cable for use in areas where air is moving, above the ceiling grid in most recently built buildings, costs about two to three times as much. The cost of the cable itself is a constant.

Installation: Twisted-pair and coaxial

continued

our NEW MODEM s

2400 bps • 1200 bps
stand alone, PC card,
MNP software

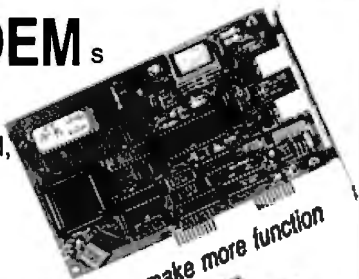

make more function

new **80386-SX** board
P9 daughter board

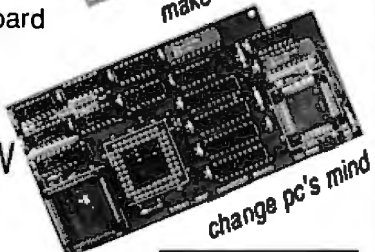

change pc's mind

& WILL BE NEW
9600bps modem
X.25, X.32 **PAD**

WELCOME OEM
AGENT or others

also make
10/6, 12/8 MHz
PC mainboard
20MHz — 386
16MHz — NEAT



ASTA ELECTRONIC SYSTEMS CORP.
ROOM 1000, NO. 432, KEELUNG RD.,
SEC. 1, TAIPEI 10548, TAIWAN, R.O.C.
TEL: 886-2-7551657 (rep.)
FAX: 886-2-7071338



XECOM, INC.'S
XE2400FT FEEDTHRU MODEM

- * Doesn't use a computer slot.
- * Doesn't use up a serial port.
- * Doesn't use computer power.
- * Doesn't require a cable to connect to the computer.
- * Compatible with any standard RS-232 port.
- * V.22 bis modem compatible operation. 2400, 1200 and 300 bit per second data transmission OR full RS-232 signal feed through!



YOU SELECT THE MODE OF OPERATION

Connect a second serial peripheral device to the modem and operate either the modem or peripheral from the same port!

A single port provides both functions!



NewPort modem-internal modem similar to FeedThru-provides V.22 bis modem function AND nine control signals as an additional Asynchronous Communications Adapterport.

XECOM, Inc.
Quality Microcomputer Products
374 Turquoise Street, Milpitas, California 95035
Telephone (408) 945-6640

TECH*GRAPH*PAD

Still
trying to get
Engineering
& Scientific
graphs
from a
Business
program?

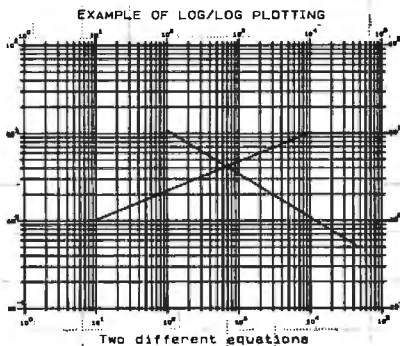
TECH*
GRAPH*
PAD

Easy-to-use technical graphing & plotting software for engineers & scientists. Compatible with Lotus 1-2-3 worksheets, other spreadsheets, PRN & ASCII files, & most data acquisition packages.

Now shipping Version 3.0!

- X-Y, Semi-log, Log/Log, Polar Plots
- Curve Fitting • Data Smoothing
- Labels, Scale, & Color Control
- Multiple X-Y Axes
- Error Bars • Greek Letters
- Laser Printer, Plotter, Printer Output
- IBM PC/XT/AT, PS/2, Apollo, DEC compatible

CALL

(617) 890-1812

Dealer Inquiries Invited

 binary engineering

100 Fifth Ave., Waltham, MA 02154.

Table 2: Fiber-optic costs versus those for twisted-pair and coaxial cables.

	Twisted-pair	Coaxial	Fiber
Cable cost per foot	\$.50-1.00	\$.50-1.00	\$.50-1.00
Installation	1n	1n	2n
Design	1n	1n	2n
Testing	1n	1n	1.5n
Electrical to optical	None	None	+50% to +100%

require about the same amount of labor to install. Fiber-optic cable installation costs about twice as much, due in part to the higher skill level required, but more to the law of supply and demand. Few qualified installers are currently available; thus, they can charge a higher price.

Design: Systems of any size must have qualified designers. You don't just drop a cable system for a particular LAN into a group of multistory buildings; extensive design work must precede installation. Twisted-pair and coaxial designs cost about the same. Fiber-optic design will cost about twice as much, again due mostly to supply and demand.

Testing: Testing twisted-pair and coaxial cables involves well-known techniques and generally available instruments. Since fiber is not so well known and its test instruments are more costly, testing fiber-optic cables costs about half again as much as testing metallic cables.

Electrical to optical: Neither twisted-pair nor coaxial needs any special conversion devices to connect to a computer. Fiber-optic systems require circuits at each device that convert electrical signals to optical signals and vice versa. These circuits can add 50 percent to 100 percent to the price of the network interface. Manufacturers, such as Codenoll of Yonkers, New York, and Siecor of Research Triangle, North Carolina, have been reducing the prices of these conversion devices over the past 2 years.

Where Do You Start?

So, you're convinced. You want to get into fiber and beat the crowd that will finally acknowledge the inevitable 3 to 5 years from now. Where do you start? You start by trying to figure out what the standard fiber is, how to connect it, and where to use it.

Over the past several years, LANs have used a confusing selection of core and cladding sizes. Cores of 50, 62.5, 85, and 100 microns have all found favor at various times. All but the 100-micron core have cladding diameters of 125 microns; the 100-micron core has a 140-mi-

cron cladding. IBM has specified the 100/140 core/cladding cable as "type 5" for its Cabling System. Yet, when connecting to cluster controllers, IBM uses the 62.5/125 cable developed by Western Electric. Most forecasters believe that this will be the dominant fiber size in LANs. Although there are other contenders, the SMA 906 connector is usually the one found on LAN equipment.

Where do you use fiber first? Due to the grounding problems, potential for interference, and ease of installation, connection between buildings is the place to start. Most LAN designs contemplate this (e.g., the use of the fiber-optic "remote repeater" in IEEE 802.3 networks). Next, use fiber optics for the riser cable among floors in multistory buildings. Again, ease of installation and limited numbers of necessary optical-to-electrical conversions make this an appropriate selection.

The last question becomes when to install fiber directly to each workstation on the network. Fiber-optic interfaces are available for this now, but they add to the cost. Installing all the drops to all the workstations could add up to a considerable expense. (For a less-expensive alternative, see the text box "The Future Is Plastics" on page 256.) This step also involves some specialized equipment, such as "star couplers," that replace the usual bus topology if your LAN is based on the IEEE 802.3 contention model. If you use the IEEE 802.5 Token Ring, various manufacturers, such as Proteon of Boston, Massachusetts, already offer appropriate fiber-optic interfaces.

For many installations, adding the workstations may be too expensive or complex at the present time, but within the next few years, fiber will go all the way to the end user's workstation—a workstation that will have a huge appetite for the amount of information that only fiber optics can satisfy. ■

James Y. Bryce is an independent consultant and author living in Austin, Texas. He can be reached on BIX c/o "editors."

Looking for Trouble

If your LAN's performance falters, software may be the culprit

Harry Saal

Sooner or later, every local-area-network manager senses it or starts to hear it from the users: Operations that once seemed fast now take longer. Sometimes a lot longer.

Unfortunately, while a network is fantastic when it works well, it's depressingly complex when you have to decide what needs fixing. It's assembled from many components: workstations, servers, their respective operating systems, cables, cards, LAN management software, standard applications, the users' own applications, plus everybody's batch files and handy utilities.

When something goes wrong, how do you find the problem? Is it the hardware? The cabling? The users? Is it time for an upgrade? (See the text box "Tricks of the Trade" on page 260.) Well, actually, many network problems are software problems—either its design, use, or installation.

Although software snags are often the cheapest and simplest problems to fix, they are often ignored as people search for hardware trouble. In fact, LAN design and management courses often reinforce this hardware bias and give first

priority to the system's physical aspects. Many courses discuss troubleshooting via sessions on how to use a time-domain reflectometer to locate cable breaks or impedance mismatches, or how to locate a card that's jabbering (transmitting non-stop and jamming the network), but none on how to spot a defective routing table or a mistaken bit in a server's access authorization.

Spotting the Problem

Automatic recovery from an error is fundamental to the design of many LAN components. Every time a workstation launches a packet (or frame—the terms are equivalent) onto the network, it has to assume that the packet may not arrive. On a bus system, there may be a collision as two workstations try to transmit at once. On a ring system, there may be a break as another workstation inserts into the ring or drops out. On any of them, the receiver may be busy, or its buffers may overflow. And of course there may be noise or interference so that the packet arrives damaged.

For all these and dozens of other reasons, LAN protocols have a number of provisions for retry and recovery. In the end, the message gets through. Network speeds are high enough to allow many retries; most of the time you won't even notice.

This built-in recovery complicates the task of testing and troubleshooting. When a link is cleanly severed so nothing gets through, you can locate the break relatively quickly. But when there's a partial failure, the system's own recovery

continued



Tricks of the Trade

Having a problems with your LAN? One of these options may help:

- Upgrade your network server's operating system. You may find that features such as backup, shared-file interlocks, and manager maintenance may be more important than gross speed. Probable costs: \$500 to \$5000, times the number of file servers.
- Upgrade the version of DOS for the workstations. DOS is still what directs each workstation's work and redirects requests for network files to the network. Versions differ both in the resources they support and in the way they do it—and in the amount of space they consume. Probable costs: \$50 to \$100, times the number of workstations.
- Switch to different software on your current network hardware. This is a major change. Probable benefits: unclear. Probable costs: Thousands of dollars per file server, bridge, or gateway, plus the costs of the organizational impact of a whole new set of network commands and conventions.
- Upgrade to a faster network technology. This is a big one. There's a factor of 10 difference in the transmission speeds of different cabling systems. But is that where the problem is? To take advantage of a different network technology, you almost have to start over, with a new design for cable layout, new network boards at each workstation and server, and perhaps different servers. Probable costs: Incalculable.
- Split the network into subnets with gateways or routers. Each subnet you create will be freed from other subnet traffic. Each packet that has to traverse the bridge must go through additional processing and transmission time. Probable cost for the installation of a bridge: \$5000 to \$10,000.
- Add another file server. Distributed file servers may ease access, give you redundancy in case of a failure at one of

them, and reduce traffic to each. Adding an extra file server may also introduce new problems of dividing storage between them, assigning users to servers, and finding where anything is. Probable costs: \$3000 to \$9000 for each file server, depending on speed and capacity, plus software and licensing.

- Upgrade your server's CPU speed. There's a range of 5 to 1 in CPU speeds of machines that might be servers. Switching to a faster server CPU might help, or it might do nothing if that's not where the bottleneck is. Probable cost: \$500 (for a turbo board) to \$10,000 (for a suitably equipped top-of-the-line 30-megabyte 25-MHz 80386).

- Upgrade your server's disk speed. There is a range of at least 3 to 1 in the access time of the disk. If requests don't get through to the disk, it may be idle. But if the server is being swamped with needless requests, speeding it up may not help. Probable costs: \$1000 to \$4000, times the number of servers.
- Upgrade server cache memory. If the server doesn't have the memory to stack incoming requests, it may have to discard them, forcing the workstations to retransmit. If it doesn't have the memory to save data that's ready to send, it may have to retrieve it again, requiring new disk accesses. Probable costs: may be zero if you can reallocate cache from

Table A: The 19 adjustable parameters in IBM's PC LAN.

Parameter	Explanation	Default	Min.	Max.
SHR	Number of available network directories	5	1	150
RDR	Number of user workstations served	10	1	29
REQ	Number of network request buffers	2	1	3
RQB	Size of each network request buffer (REQ × RQB may not exceed 48K bytes)	8K bytes	5K bytes	32K bytes
TSI	Time-slice ratio of net and local processing	5-4	0-0	9-9
PRB	Size of print-spooling buffer	5K bytes	5K bytes	16K bytes
PRP	Printing priority vs. other local processing	3	1	3
SHB	Size of buffer for regulating shared R/W	2K bytes	5K bytes	60K bytes
SHL	Number of locked ranges in shared files	20	20	1000
USN	Number of message aliases	1	0	12
MBI	Size of incoming message buffer	1750 bytes	5K bytes	60K bytes
CMD	Number of concurrent NetBIOS commands	8	*	32
SES	Number of concurrent NetBIOS sessions	16	*	*
SRV	Number of servers used	2	1	31
ASG	Number of network devices open	5	1	32
NBC	Number of network buffers	3	1	64
NBS	Size of each network buffer (NBC × NBS must not exceed 32K bytes)	.5K bytes	.5K bytes	32K bytes
PB1...3	Size of buffer for each network printer (Sum of PB1...PB3 may not exceed 16K bytes)	1K bytes	80 bytes	16K bytes

* Depends on server configuration and values of USN and REQ.

ery procedures often overcome the fault and thereby mask a chronic problem.

It's not unusual for a network's speed and resilience to mask a program bug that in any other context would be obvious. Imagine, for example, that someone puts together an electronic mail system in which (because of a programming error) each workstation routinely sends every message 15 times. (Don't laugh; a test

with AND where it should say OR produced this.) Further imagine that each receiving workstation, when it finds it has multiple copies of the same logical message, discards earlier versions and keeps only the last. When the system is tested on a lightly loaded network, each message sent from A to B arrives properly. Network speeds are so high, and there are so many other variables at each

end, that no one notices the 15 repetitions. So the system is installed.

Knowing the length of the average message, the number of workstations, and the number of messages each workstation sends, LAN managers can easily estimate the system's capacity. But as the load grows, those 15 repetitions begin to take their toll. Users begin to complain. Has something broken? Not really. The

existing memory; \$500 to \$2000 per server if expansion memory is required.

- Upgrade workstation speeds. In most environments, the real work is still done at the local workstations. When users complain that response is slow, it's always possible the problem has nothing to do with the network but is entirely within the local workstation. Probable costs: \$500 (for a turbo card on an existing machine) to \$8000, times the number of workstations you upgrade.

- Upgrade workstation cache memory. The approach here is not to speed up transmission through the network, but to reduce the need for network requests. If you have less than 640K bytes of RAM, by all means bring each workstation up to that point. There are numerous ways to use additional RAM beyond that. Probable costs: \$500 to \$1000 per workstation upgraded.

- Upgrade width of data path on network-interface cards. There's variation in the method (and hence the speed) with which cards transfer data from the workstation's main memory and return it. A major consideration is whether the card uses an 8-bit or a 16-bit bus. Probable costs: \$500 to \$800, times the number of workstations upgraded.

- Upgrade the "smarts" of your network-interface cards. A "smart" network card can do much of the network processing (e.g., decoding various levels of network protocols) on the card, while the workstation CPU does something else. A "dumb" card may have to steal processing from the workstation CPU—and that may or may not make a difference in what the user sees. Probable costs: \$500 to \$800.

- Adjust network parameters, an easy and cheap change. Making sense out of which to change is not so easy. Cost: little or nothing in dollars, but lots of time experimenting and figuring them out. As an example, table A lists the adjustable parameters in IBM's PC LAN.

bug was there from the beginning; they just didn't notice it at first. A lightly loaded network usually has so much excess capacity that even gross errors aren't noticed until later when load builds up.

A Troubleshooter's Tools

Simple LAN evaluation devices concentrate on physical measurement, such as bits-per-second transmitted, or bits-per-

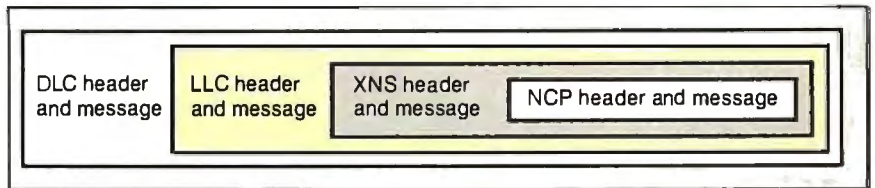

destination accumulated over a sampling interval, perhaps sorting these by the workstation to which they're addressed. These summary tabulations accurately quantify the total flow, but they do little to identify specific software problems.

If you manage a LAN, you must move beyond being able to spot a problem; you must be able to analyze the cause of the problem. Overall statistics let you say, "Yes, indeed, there's a problem," or even "The problem has something to do with workstation X and server Y." But such measurements still give you no idea what they're transmitting or why they're transmitting it.

To look in detail at transmissions, you have to be able to eavesdrop on the network. To understand what you're hearing, it's essential to decode the protocols. You have to be able to work back through the various layers to look at what's being said. This is no simple matter because there are so many layers to decode; a typical packet may contain many levels. The lowest level, data-link control (DLC), specifies the workstation address of the source and destination, the gross length of the packet, and the type of message it contains. That message in turn contains a header and an indicator as to the type of message it contains, and so on for as many levels as the situation requires.

For example, on a token ring running Novell NetWare, an acknowledgment from the file server that a file has been opened typically contains four nested messages (see figure 1). They range from a generic token-ring message at the DLC level, through an indication of the logical destination and protocol (Xerox Network System transport protocol, or XNS), to, finally, the actual message—in this case, in the encoding adopted by Novell.

There are altogether 91 bytes at the DLC level. Of those, 77 are the LLC (logical link control) message, 74 of which are the XNS message. Of those 74, 40 bytes are the Novell NCP (NetWare Core Protocol) message, 12 of which are devoted to the file's name and 6 to its handle. At each level, the length and type of the message is arbitrary, so decoding must thread back from the lowest level to the highest before even establishing the

Figure 1: On a token-ring LAN running Novell NetWare, an acknowledgment from the file server that a file has been opened typically contains four nested messages. They range from a generic token-ring message at the DLC level, through an indication of the logical destination and protocol, and finally the actual message—in this case, in the encoding adopted by Novell.

boundaries of the various messages.

Message interpretation is not self-contained. For example, figure 3 is a reply to an earlier request; interpreting it depends in part on knowing what the request was. All this can be done, but it's far more work than just converting hexadecimal bytes to operation codes or letters of the alphabet.

Once you can read what the machines are saying to each other, many problems become ridiculously simple—and very easy to fix. While the effort or cost of decoding is substantial, the rewards are enormous. That is, if you consider the large potential costs of possible system upgrades, the investment has very high leverage.

A Potent Illustration

The following example illustrates the problems revealed by protocol decoding. Imagine you are a user at a workstation and you want to open a word processor called WP, stored in a public directory of a network file server. When WP was first installed (when network usage was light), you just typed WP and up came the word processor. Now there's a small but irritating delay. Counting frames by destination reveals a surprisingly large burst of packets sent back and forth between the time you ask for WP and the time it's delivered. What's going on?

Putting a protocol analyzer on the case reveals that each successful use of WP is preceded by a string of "file not found" messages. Looking at the details of those messages, you find that whenever the workstation requests the file, it runs through a series of requests in which the file's name is stated with an incorrect path. When it finally asks for the file correctly, the workstation gets it at once.

continued

Troubleshooters

If you are thinking of buying LAN-monitoring devices, the following list may be helpful.

- Software installed to supplement existing hardware. You can install these programs, probably the least expensive and easiest to install of the options, on an existing network workstation.

EtherProbe Network

Analyzer\$995
For workstations using 3Com's Ether-Link Plus network-interface card. Monitors and displays Ethernet XNS and SMB packets.
3Com
3165 Kifer Rd.
Santa Clara, CA 95052
(800) 638-3266
(408) 562-6400
Inquiry 976.

LANWatch \$1200
Works with a variety of Ethernet cards. Useful for studying network traffic.
FTP Software
P.O. Box 150
Kendall Square Branch
Boston, MA 02142
(617) 868-4878
Inquiry 977.

- Special network card and software kit, for installation on an existing PC. Here you can install a vendor- or protocol-specific system instead of a standard network-interface card, permitting a workstation to act as a conventional workstation or as a network analyzer.

LANalyzer EX5300 \$9975
For Ethernet and StarLAN. Install in an AT compatible. Collects and records incoming packets through 16 independently programmable filter channels.

During playback, packets can be displayed in hexadecimal or ASCII, with decoding of DLC and LLC packets and identification of codes in TCP/IP, DECnet, XNS, AppleTalk, MS-NET, ISO, and NetBIOS.

Excelan, Inc.
2180 Fortune Dr.
San Jose, CA 95131
(800) 392-3526
(408) 434-2300
Inquiry 978.

LAN DETECTOR..... From \$10,995
For Ethernet, 10-megabit twisted-pair Ethernet, or StarLAN. Install in an AT compatible. Can be connected on thick, thin, or unshielded twisted-pair cabling. Implements the protocol-interpretation capability designed into The Sniffer.

Interlan, Inc.
155 Swanson Rd.
Boxboro, MA 01719
(800) 526-8255
Inquiry 979.

- Self-contained specialized collector and analyzer. A specialized workstation, including built-in hardware and software for tabulation of summary statistics and filtering of packets to be analyzed.

ISOLAN 1140 \$7950
An independent network workstation with its own Ethernet AUI interface. (Requires a WYSE50 terminal keyboard.) Compiles summary network statistics by workstation. Provides loading statistics by workstation and over time. Development functions for packet analysis also provided. Permits hexadecimal display of packet contents.
BICC Data Network
1800 West Park Dr., Suite 430
Westborough, MA 01581

(508) 898-2422
Inquiry 980.

HP-4972A LAN Protocol

Analyzer\$17,350
Self-contained Motorola 68010-based Ethernet (802.3) analyzer with optional travel pack, with programmable filters, real-time tabulation of traffic by destination, and traffic-generation options.
Hewlett-Packard Corp.
5070 Centennial Blvd.
Colorado Springs, CO 80919
(800) 752-0900
Inquiry 981.

Excelan EX5500\$15,750
A self-contained version of the LAN-analyzer EX5300, installed in a Compaq Portable II.

- Multilevel protocol interpreter. Protocol interpretation decodes the various layers of the received data to reconstruct the logical message contained in the network packets.

The Sniffer..... \$15,750 to \$24,000
A self-contained device installed on several hardware platforms, from laptops to 80386-based machines. Includes interface card for IBM Token Ring, Ethernet, ARCnet, StarLAN, or PC Network broadband. Additional interface cards and software cost about \$5000 each. Interpreters can be purchased for IBM Token Ring, Novell NetWare, XNS/MS-NET, TCP/IP, Sun, ISO/MS-NET, Nestar Plan series, or AppleTalk, at \$995 each, and for DECnet and Banyan VINES at \$1995 each.
Network General Corp.
1945A Charleston Rd.
Mountain View, CA 94043
(415) 965-1800
Inquiry 982.

Why does the workstation go through this sequence of invalid requests each time? Because the network has inappropriately carried something over from the single-machine environment: reliance on the DOS path command to let DOS search directories in which a file might be found. Although the path command still works, it can place a needless load on the network.

Each workstation has access to disk drives of its own and directories on one

or more network file servers. The usual way to refer to the network directories is to assign them letters so they look like virtual drives. A workstation with drives A and C of its own might then configure virtual drives with names somewhere between D and Z as names for network directories.

A Bird's-Eye View

Each workstation starts up with an AUTOEXEC.BAT, which sets various

parameters, starts the network software, and assigns names to network directories. It also sets the path command. This gives DOS a list of drives or directories in which to look for an executable file (i.e., one whose extension is .BAT, .COM, or .EXE).

When you simply type the name of a file (e.g., WP to access your word processing program), DOS always looks first in your current working directory. If there's no executable file of that name

there, it checks a reserved area of memory called the DOS environment for a path statement. The path consists of a list of drives or directories separated by semicolons. DOS searches each of those directories in the order in which they're listed. As soon as it finds an executable file whose name matches, it stops searching and reads and executes the file.

Trying to make things simple and consistent for everyone, LAN managers usually define path so that, on each machine, DOS first looks in the root directory of the workstation's own hard disk, then in a network virtual disk assigned as a private area for the user, then in turn in each of several network directories devoted to different kinds of applications. Each cluster of network directories is assigned to a virtual drive. In IBM's PC LAN, it might look something like this:

```
NET USE F: \\FileServer\NET\
PRIVATE\UserID
NET USE P: \\FileServer\NET\
PUBLIC
```

Each application has a directory of its own. An application package's instructions typically suggest creating an exclusive subdirectory. The manager of the LAN then creates on the server a separate directory for each application. So that each workstation can find any network application, in whatever network directory it may reside, the manager sets each user's path in a way that guarantees that DOS will find the application. The path is something like this:

```
path=\;C:\;F:\;P:\BAT;P:\SPREAD;
P:\ACCTS;P:\MAIL;P:\WORDPROC;\
```

After everyone has installed this setup, a few quick tests demonstrate that it works and is easy to use. But what really happens? Every time you execute WP, the workstation's DOS looks for WP in the current directory and then in the local hard disk. Not finding it in either of those, DOS asks the network file server to look in one of the directories identified in the workstation's path. When the server can't find the file there, the workstation asks for it in the next directory.

Since (in this example) the correct path is the sixth of the network directories, the workstation asks the file server to look in five wrong directories before it hits the right one. Each of those wrong requests generates a directory search at the server and a pair of network messages.

continued

Share Printers

Transfer files and a whole lot more with ManyLink.

ManyLink for PCs is the inexpensive software package that lets two PCs (or a PC and a laptop or PS/2) share printers, transfer files and a whole lot more. Just connect the PCs together with the supplied serial cable, install the software, and you can share any printer connected to either PC. All printing and file transfers are done in the background, so both PC users can continue working even while their files are being printed or transferred.

More than two PCs? *ManyLink for Work Groups* allows up to eight PCs to share printers and transfer files. There's no better way to make your printers and people work more productively.

With *ManyLink for NetWare*, any user can print to any printer cabled to any workstation on the network, saving time wasted trekking to file serve printers.

And users can transfer files from workstation to workstation with a simple "COPY" command.

All ManyLink products allow users to send short messages with a "CHAT" command, and provide security for sensitive files. NetLine's latest product, *ManyLink for ISDN*, lets you use your ISDN telecommunications system to network your computers, share printers and transfer files. So whether you have two computers, a NetWare network, or an ISDN system, when you think of sharing printers, think of ManyLink.

NetLine

2155 North 200 West, Suite 90, Provo, Utah 84604, 801/373-6000
NetWare is a registered trademark of Novell, Inc.

NetLine products are now available through Micro D.

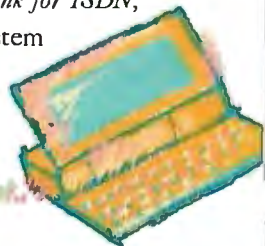
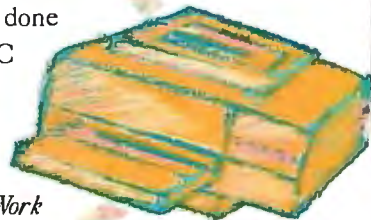
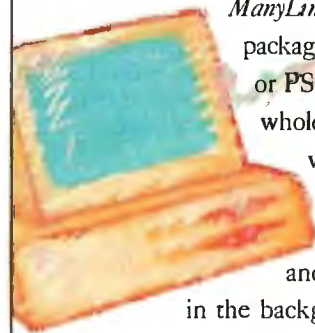

Some Simple Remedies

Several simple remedies will solve problems like the one just mentioned. They all involve less reliance on the path command for finding files.

- *Using synonyms.* Some DOS shells provide a synonym facility in the workstation. When you type a command, the shell looks in a table of synonyms, so that (for example) when you type WP, the shell immediately substitutes

```
\\FileServer\Net\Public\Word-  
Proc\WP
```

in the command that it passes to DOS.

Using synonyms means that each workstation needs a table that pairs the local name for an application with the full network path to it. With the synonym table downloaded to each machine (e.g., at start-up), there is no searching of directories, and the machine can directly transmit a request for the needed file.

- *Centralizing executable files.* Network managers can decrease searching by not creating separate subdirectories for each application and by putting all the applications in one directory, called, for example, APPS or BIN. Then there's only one network directory on everybody's search path.

- *Establishing and enforcing standardized batch files.* Retain separate network directories, but put a common network directory of batch files on everybody's search path. Make sure these batch files don't rely on the path command to locate directories, but instead contain explicit paths. The batch file WP.BAT has to say the following:

```
Z:\WORDPROC\WP.EXE %1 %2
```

If the batch file stipulates the letter for a virtual drive, all users must adopt a common convention for assigning drive names to network directories.

The Importance of Caching

Each personal computer has a CONFIG.SYS file that tells DOS how to set up the machine each time it boots. One of these parameters sets the number of buffers in main memory for reading from the machine's own disks. The disk-read buffers amount to a cache: easily accessible temporary storage for items you're likely to want again.

Caching is based on statistics: When you ask to read part of a file, chances are that in a few milliseconds you will ask for more of the same file. So DOS gambles. When you ask to read just a little,

often it reads not only what you asked for but the following bytes as well. It keeps what it just retrieved in a buffer. Experience shows that's what you're likely to ask for next. When you do ask, it has what you need right there in memory, without requiring another disk access.

When your personal computer serves as a network workstation, it sets up another set of similar buffers, but for caching data received from a network server. Caching at the workstation is important, not so much because it saves transmis-

sions were failing to use it.

On this network, every workstation starts out with a standard menu that it downloads from a central server. First, we recorded the workstation's request for the file and the server's response. To our surprise, the trace of "normal" operations showed 13 consecutive reads and acknowledgments just to get one batch file of 263 bytes. Although the workstation had allocated a cache, clearly it wasn't using it. The workstation was asking the server to send almost the same fragment over and over. Why?

Our next step was to look in detail at the workstation's request to open the file and the file server's reply. Decoding the workstation's first request, we saw the contents of figure 2 at frame 53.

The workstation requested "exclusive read-only" use of the file (hexadecimal 11). Figure 3 is the reply it got from the server. The server opened the file, but rejected the request for "exclusive" use and instead provided "shareable" use. It did that because at the server, the file was flagged "shareable, read-only."

Following normal NetWare rules, a workstation does not buffer a file that is opened as "shareable." Here's the reasoning. "Shareable" permits concurrent access by different users. Some of them may have read-write access. If there's a possibility that someone else may be updating the file, it would be dangerous to read ahead. That's because after your machine reads part of the file into its cache but before you refer to your cache, someone else may update the file, making your cached version obsolete.

At the server, this file is flagged "read-only." There's no way another user could be updating it. Although we knew that, the workstation had no way of knowing. The workstation knew only that when it asked for "exclusive read-only," what it got was "shareable read-only." It couldn't be sure that the file server hadn't opened the file "shareable read-write" for somebody else. To be prudent, in such a situation the workstation never uses its cache.

Our LAN manager had flagged this file incorrectly. It should have been marked "exclusive read-only." Although you might not guess it from the name, this permission allows any number of people to open a file at the same time, provided they all have read-only access.

How did an experienced person like our LAN manager assign the wrong access code to a network application? Well, by reading the network manual that states: "Files flagged Shareable can be read by more than one user at a time.

Caching
*has a price. To the
workstation, it means
setting aside a part of
main memory that
might otherwise be used
for active programs.*

sion time—depending on the disks involved, it may or may not—but because it can greatly reduce the number of requests to a network file server.

Caching has a price. To the workstation, it means setting aside a part of main memory that might otherwise be used for resident software or currently active programs. Occasionally, it means sending a long packet when in fact only a small part of it is used. If you set aside too much space for buffers, you starve the programs that the cache is supposed to serve. The payback is its effect on network traffic, especially on the number of packets transmitted.

To collect an example for this article, we set up a protocol analyzer to report traffic between a workstation and a network server on a Novell token-ring system installed at Network General's headquarters. We had intended to measure the flow with normal caching at the workstation, and then measure again after we deliberately disabled the workstation's cache. In running this simple test, we were surprised to find a nice example of a common problem that we didn't realize we had. Despite the fact that each workstation had allocated a cache, in the sample we observed, the

IF YOU LIKED OUR AD, YOU'LL LOVE THE BOOK.

On the front gatefold of this magazine, you'll find a 4-page ad about our 386™ systems, 286 systems, laser printers, and low direct-from-the-manufacturer prices. And if you

like what you see, we have a 28-page catalog you'll like even more. Just send the card below, and we'll send you a free copy. Or call (800) 426-5150. In Canada, call (800) 387-5752.



© 1988 DELL COMPUTER CORPORATION. 386 is a trademark of Intel Corporation.

GET OUR FREE 28-PAGE CATALOG OF DELL COMPUTER SYSTEMS.

This new catalog is the best place to shop for high performance 386 and 286 systems. We also offer a full line of software, peripherals, enhancement products, and networking solutions. Just send this card, and we'll send you a copy.

Name: _____

Title: _____

Company: _____

Address: _____

City: _____ State: _____ Zip: _____

Phone: _____

Please have a Dell representative call me.

- | | |
|---|---|
| 1. Are you a (select one): | 4. How many PCs do you have installed now? |
| A <input type="checkbox"/> End user | A <input type="checkbox"/> 1-10 |
| B <input type="checkbox"/> Consultant | B <input type="checkbox"/> 11-20 |
| C <input type="checkbox"/> Reseller | C <input type="checkbox"/> Over 21 |
| D <input type="checkbox"/> Corporate Purchaser | 5. How many PCs do you (your company) plan to purchase in the next twelve months? |
| E <input type="checkbox"/> DP/MIS Manager | A <input type="checkbox"/> 1-10 |
| 2. Which products are you most interested in? | B <input type="checkbox"/> 11-20 |
| A <input type="checkbox"/> 286 architecture | C <input type="checkbox"/> Over 21 |
| B <input type="checkbox"/> 386 architecture | 6. Is your requirement: |
| 3. Are you interested in computer products for: | A <input type="checkbox"/> Immediate |
| A <input type="checkbox"/> Home | B <input type="checkbox"/> 1-3 Months |
| B <input type="checkbox"/> Business | C <input type="checkbox"/> Over 3 Months |
| | D <input type="checkbox"/> Info only |

AD CODE NO. 51EA9

GET OUR FREE 28-PAGE CATALOG OF DELL COMPUTER SYSTEMS.

This new catalog is the best place to shop for high performance 386 and 286 systems. We also offer a full line of software, peripherals, enhancement products, and networking solutions. Just send this card, and we'll send you a copy.

Name: _____

Title: _____

Company: _____

Address: _____

City: _____ State: _____ Zip: _____

Phone: _____

Please have a Dell representative call me.

- | | |
|---|---|
| 1. Are you a (select one): | 4. How many PCs do you have installed now? |
| A <input type="checkbox"/> End user | A <input type="checkbox"/> 1-10 |
| B <input type="checkbox"/> Consultant | B <input type="checkbox"/> 11-20 |
| C <input type="checkbox"/> Reseller | C <input type="checkbox"/> Over 21 |
| D <input type="checkbox"/> Corporate Purchaser | 5. How many PCs do you (your company) plan to purchase in the next twelve months? |
| E <input type="checkbox"/> DP/MIS Manager | A <input type="checkbox"/> 1-10 |
| 2. Which products are you most interested in? | B <input type="checkbox"/> 11-20 |
| A <input type="checkbox"/> 286 architecture | C <input type="checkbox"/> Over 21 |
| B <input type="checkbox"/> 386 architecture | 6. Is your requirement: |
| 3. Are you interested in computer products for: | A <input type="checkbox"/> Immediate |
| A <input type="checkbox"/> Home | B <input type="checkbox"/> 1-3 Months |
| B <input type="checkbox"/> Business | C <input type="checkbox"/> Over 3 Months |
| | D <input type="checkbox"/> Info only |

AD CODE NO. 51EA9



BUSINESS REPLY MAIL
 FIRST CLASS MAIL PERMIT NO. 6745 AUSTIN, TEXAS

POSTAGE WILL BE PAID BY THE ADDRESSEE

DELL COMPUTER CORPORATION
 Dept. ME
 9505 Arboretum Boulevard
 Austin, Texas 78759-9969



BUSINESS REPLY MAIL
 FIRST CLASS MAIL PERMIT NO. 6745 AUSTIN, TEXAS

POSTAGE WILL BE PAID BY THE ADDRESSEE

DELL COMPUTER CORPORATION
 Dept. ME
 9505 Arboretum Boulevard
 Austin, Texas 78759-9969



NO POSTAGE
 NECESSARY
 IF MAILED
 IN THE
 UNITED STATES



NO POSTAGE
 NECESSARY
 IF MAILED
 IN THE
 UNITED STATES

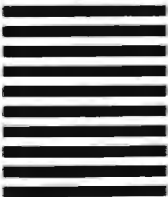

IF YOU CAN'T CALL, WRITE.

On the front gatefold of this magazine, there's a 4-page ad for Dell Computer Systems. It invites you to call our toll-free number, so you can get our free 28-page catalog. But if you'd rather send this catalog, our fine writer just fill it out, and we'll get a catalog to you right away.



This attribute is usually used with the Read-Only attribute." (*SFT NetWare Getting Started: Supervisor's Guide*, pub. 113, rev. 1.00. Novell, November 1987, pp. 5-12.)

Neither of those two sentences is false. But they lead you to believe that "shareable read-only" is just what you want for an application that many people will load from a network server. In fact, such a

file should be marked "exclusive read-only." (Remember, as long as it's read-only, "exclusive" does not prevent multiple users from having the file open at the same time.) We asked the LAN manager to make that change. The effect was dramatic. One request and one reply (see figure 4) did it all.

For this simple 263-byte file: Packets transmitted declined from 26 to 2; bytes transmitted declined from 2558 to 387; and elapsed time declined from 0.163 to 0.003 second.

Tweaking in the Dark

Many network parameters are easy to set but difficult to evaluate. For example, you can set both the size and number of network buffers. Larger buffers can diminish segmentation of file transfers. But larger buffers at the server don't help unless they're matched by the size of buffers at the workstations that use them. If making buffers larger permits fewer of them, that increases the probability that there will be no buffer free to receive a packet, so the packet must be discarded. A discarded packet must be resent.

The sender of a discarded packet decides when to resend it on the basis of a time-out parameter. If the specified time-out is too large, the sender waits idly before replacing a lost packet. If the time-out is too small, the sender worsens the contention for buffers by resending a packet that has been queued rather than lost. How can you balance these conflicting adjustments?

Making the adjustments when all you have to go on is whether or not the network grinds to a halt is so close to flying blind that it's very hard to make a rational recommendation. Listening with a protocol analyzer and making specific observations gives you a basis for noting when you've made things worse and when you've managed to improve them.

Knowing the Problem

Keep in mind three things when you run into network problems. First, you need to identify the problem. Networks are plagued with software errors, many of them trivial to fix but impossible to diagnose by guesswork. Second, you need to acknowledge the painful fact that you—the way you run your network—may be part of the problem. And third, you need to realize that you may be able to fix the problem very simply—but first you have to be able to see what's happening. ■

Harry Saal is president of Network General Corp. in Mountain View, California. He can be reached on BIX c/o "editors."

```

NCP C Open file NG.MNU
NCP: ---- Open File Request --
NCP: Request code = 76
NCP: Dir handle = 07
NCP: Search attribute flags = 06
NCP:
NCP: Desired access rights = 11...
NCP: 000. .... = Not defined
NCP: ...1 .... = Exclusive (single-user mode)
NCP: ....0... = Allow others to open for writing
NCP: ....0.. = Allow others to open for reading
NCP: .....0. = Open for writing disallowed
NCP: .....1 = Open for reading
    
```

Figure 2: In this example, the workstation requested "exclusive read-only" use of the file (11 hexadecimal), which enabled caching; the request was rejected by the server. This action by the server disabled caching at the workstation level, causing the system to complete 13 reads and acknowledgments to receive one batch file of 263 bytes.

```

NCP R F = 10F7 OK Opened
NCP: ---- Open File Reply----
NCP: Request code = 76 (reply to frame 53)
NCP: Completion code = 00 (OK)
NCP: File handle = 00A3 5616 4642
NCP: File name = "NG.MNU"
NCP: File attribute flags = 81...
NCP: 1. .... = File is shareable
NCP: .0. .... = Not defined
NCP: ..0. .... = Not changed since last archive
NCP: ...0 .... = Not defined
NCP: ....0... = Not execute-only file
NCP: ....0.. = Not a system file
NCP: .....0. = Not a hidden file
NCP: .....1 = Read-only
NCP: File execute type = 00
NCP: File length = 263
NCP: Creation date = 15-Jul-88
NCP: Last access date = 26-Aug-88
NCP: Last update date/time = 8-Jul-88 18:53:02
    
```

Figure 3: Here is the reply the workstation received from the server after requesting "exclusive read-only" access to the 263-byte batch file. Although the server opened the file, it rejected the "exclusive" use request and instead provided "shareable" use, because the file was flagged "shareable read-only" at the server. The workstation wasn't using its caching, because under NetWare rules, a workstation doesn't buffer a file that is opened as "shareable."

Rel. Time	Cum Bytes	From Workstation	From File Server
0.000	67	NCP C F = 31F7 Read 512 at 0	
0.003	387		NCP R OK 263 bytes read

Figure 4: By changing a file marker from "shareable read-only" to "exclusive read-only," the packets transmitted for this 263-byte file declined from 26 to 2. Bytes transmitted declined from 2558 to 387, and the elapsed time declined from 0.163 to 0.003 second.

MONTGOMERY GRANT

Retail Outlet: Penn Station, Main Concourse
(Beneath Madison Square Garden) NYC, N.Y. 10001

Store Hours: Mon-Fri 8:30am-8pm/Sat-Sun 9:30am-7pm

FOR ORDERS & INFORMATION CALL TOLL FREE

1-800-759-6565

OR WRITE TO:
Montgomery Grant Mail Order Dept.
P.O. Box 58 Brooklyn, NY 11230

FAX NO. 7186923372
TELEX 422132 MGRANT

OPEN 7 DAYS A WEEK FOR ORDERS: Monday-Friday, 9:00am-7:30pm/Saturday & Sunday, 9:30am-6:00pm (EST)

NO SURCHARGE FOR CREDIT CARD ORDERS / WE INVITE CORPORATE & EDUCATIONAL CUSTOMERS
CORPORATE LEASING AVAILABLE

LAPTOPS



**AMSTRAD
PPC-640 SD**

- 640K
- 720K Floppy Drive
- Built-in 2400 Baud Modem

\$799

AMSTRAD PPC 640 with Two Drives.....\$899
 NEC MULTISPEED EL II.....\$1399
 NEC MULTISPEED HD.....\$2179
 TOSHIBA 1000.....\$749
 TOSHIBA 1200 F.....\$1549
 TOSHIBA 1200 H.....\$2199
 TOSHIBA 1200 HB.....\$2399
 TOSHIBA 3100/20.....\$2929
 TOSHIBA 3200.....\$3669
 TOSHIBA 5100.....\$4649
 ZENITH 184 w/2 FLOPPYS.....\$1469
 ZENITH 184-2w/ 20MB.....\$2199
 ZENITH 184-98 w/20MB, Modem.....\$2299
 ZENITH 286 w/20 MB.....\$3299
 ZENITH 286 w/40 MB.....\$3969
 SPARK EL.....\$1099
 EPSON EQUITY LT.....\$1099

MODEMS, EXTERNAL DRIVES & ACCESSORIES available for all laptops

EPSON

EPSON EQUITY I+
IBM XT COMPATIBLE PKG.

- 640K RAM w/Clock Calendar
- 360K Drive • Keyboard • Serial & Parallel Ports • 12" High Resolution Monitor • MS DOS/GW Basic

\$799

Same w/20 MB Hard Drive.....\$1059
 Same w/30 MB Hard Drive.....\$1099
 Same w/40 MB Hard Drive.....\$1199
 Same w/Two 360K Floppies.....\$879

EPSON EQUITY II+
IBM AT COMPATIBLE
HARD DRIVE PACKAGE

- Keyboard • 640K RAM • 80286 Microprocessor • 1.2 MB Floppy Drive • 20 MB Hard Drive • 12" Monitor • MS/DOS/GW Basic

\$1449

SAME w/30 MB HARD DRIVE.....\$1499
 SAME w/40 MB HARD DRIVE.....\$1599

LOGITECH MOUSE M-7.....\$59.95

EPSON EQUITY III+
IBM AT COMPATIBLE 20 MB HARD DRIVE PACKAGE

- Keyboard • 80286 Processor • 640K RAM • 6/8/12 MHz • 1.2 MB Floppy Drive • 20 MB Hard Drive • 12" Monitor • 8 Expansion Slots • Serial & Parallel Ports • MS DOS/GW Basic

\$1749

SAME w/30 MB HARD DRIVE.....\$1799
 SAME w/40 MB HARD DRIVE.....\$1899

NEC PowerMate 1+

IBM AT COMPATIBLE PACKAGE

- Enhanced Keyboard • 80286 Microprocessor • 12 MHz • 1.2 MB Disk Drive • Serial & Parallel Ports • 12" Monitor • MS DOS • GW BASIC

\$1549

Same w/ 20 MB Hard Drive.....\$1799
 Same w/30 MB Hard Drive.....\$1849
 Same w/40 MB Hard Drive.....\$1949

NEC POWERMATE 386
IBM AT COMPATIBLE 40 MB HARD DRIVE PACKAGE

- Keyboard • 80386 Processor • 1 MB RAM • 1.2 MB Floppy Drive • 40 MB Hard Drive • Serial & Parallel Ports • 12" Monitor • MS DOS • GW BASIC

\$3499

IBM PERSONAL SYSTEM 2

MODEL 50

1 MB RAM • 1.44 MB Floppy Drive • 20 MB Hard Drive

\$2499

Monitor Optional

PS/II Model 30.....\$1299
 PS/II Model 30 w/20MB.....\$1699
 PS/II Model 30/286-002.....\$1549
 PS/II Model 30/286-021.....\$1999
 PS/II Model 50Z w/30MB.....\$2849
 PS/II Model 50-061.....\$3249
 PS/II Model 60-041.....\$3299
 PS/II Model 60-071.....\$3619
 PS/II Model 70-E61.....\$4199
 PS/II Model 80-041.....\$4285
 PS/II Model 80-071.....\$4799
 AMTECH 5.25" 360K External Drive for IBM PS/II/30.....\$169
 PACIFIC RIM 5.25" 1.2MB External Drive for IBM PS/II 50/60/70/80.....\$259
IBM PERSONAL SYSTEM II MONITORS
 6503 Monochrome.....\$239
 8512 Color.....\$449
 8513 Color.....\$549
 IBM ProPrinter II.....\$369

AMIGA 2000

IBM XT COMPAT. RGB COLOR PKG

- A 2000 Computer w/Keyboard • 1 MB Expandable to 9 MB • Built-in 3.5" Disk Drive • RGB Color Monitor • 2088 IBM Compatible Bridge Card w/ 5.25" Floppy Disk Drive

\$2099

FREE MOUSE AND SOFTWARE

AMIGA 500

RGB COLOR PACKAGE

- Amiga 500 w/512 K • Built-in 3.5" Disk Drive • Mouse • RGB Color Monitor • All Power Supplies and Cables • FREE Software

\$759

RGB COLOR SYSTEM

Amiga 500 with 1084S RGB Color Monitor **\$829**

Amiga 500 Computer w/1084S Mon. & 1010 3.5" Floppy Drive **\$1029**

ALL AMIGA COMPUTERS & PERIPHERALS IN STOCK!

SANYO PR 3000

Daisy Wheel Letter Quality

\$59.95

We Can Reconfigure Any Of Our Computer Packages To Your Specifications. Call For Information. We Carry Modems, Drivers, Cards, Color Monitors & All Other Accessories For Your Computer.

SEAGATE 20, 30, 40, 60, 80, MB HARD DRIVES IN STOCK!

COMPAG 286 MODEL 1

IBM AT COMPATIBLE PACKAGE

- 640K • 1.2MB Floppy Drive • 7 Expansion Slots • 8-12 MHz • 12" Monitor • MS DOS & GW Basic

\$1799

C286 MODEL 20 MB PKG.....\$2299
 C-286 MODEL 40 MB PKG.....\$2699

Commodore PC10-1

IBM XT COMPATIBLE PKG.

- 512K RAM • 360K Floppy Drive • 12" Monitor • Serial & Parallel Ports • Keyboard • Box of 10 Diskettes • MS-DOS

\$499

IBM XT Hard Drive Package

- IBM XT Computer • IBM Keyboard • 256K RAM • Expandable to 640K • 360K Disk Drive • 20 MB Hard Drive • Package of 10 Diskettes (Monitor Optional)

\$1199

IBM XT Package with Two 360K Floppy Drives **\$999**

LEADING EDGE MODEL D2

IBM AT COMPATIBLE 20 MB HARD DRIVE PACKAGE

- Keyboard • 640K • 1.2 MB Floppy Drive • 20 MB Hard Drive • 12" Monitor • MS DOS • GW BASIC • Word Processor

\$1449

Same w/30 MB Hard Drive.....\$1499
 Same w/40 MB Hard Drive.....\$1599

AMSTRAD PC1640

- Keyboard • 640K RAM TurboSpeed • One 360K Drive • 12" Monitor • FREE Mouse & Software • MS DOS • GW Basic

\$649

w/20 MB Hard Drive.....\$999

PRINTERS

EPSON	STAR
FX-1050.....\$489.95	NX-1000.....\$218.95
FX-850.....\$339.95	RAMBOW.....\$299.95
LO-500.....\$315.95	NX-1800.....\$188.95
LO-850.....\$329.95	NX-2400.....\$304.95
LO-950.....\$359.95	
LQ-1050.....\$729.95	
LQ-1250.....\$959.95	
LX-800.....\$199.95	

Citizen Printers IN STOCK

TOSHIBA
321-TL.....\$449.95

PANASONIC
OKI-120.....\$189.95
 Okimate 20.....\$119.95
 Okidata 180.....\$239.95
 1080I-II.....\$159.95
 1092I.....\$129.95
 1091II.....\$189.95
 KXP-152.....\$489.95
 KXP-155.....\$409.95
 KXP-4450 Laser.....\$1549
 KXP-1124.....\$319

LEADING EDGE MODEL D

IBM XT COMPATIBLE PKG.

- 512 K RAM Computer • Keyboard • 360K Floppy Drive • 4.77-7.16 MHz • 12" Monitor • 8088.2 Processor • MS DOS/GW Basic

\$699

SAME w/TWO 360K FLOPPIES.....\$769
 SAME w/20 MB HARD DRIVE.....\$949
 SAME w/30 MB HARD DRIVE.....\$999
 SAME w/65 MB HARD DRIVE.....\$1869

Commodore COLT

IBM XT COMPATIBLE PACKAGE

- Keyboard • Two 360K Floppy Drives • Serial & Parallel Ports • 12" Monitor • MS DOS/GW Basic

\$699

OKIDATA

OKI-120.....\$189.95
 Okimate 20.....\$119.95
 Okidata 180.....\$239.95

1080I-II.....\$159.95
 1092I.....\$129.95
 1091II.....\$189.95
 KXP-152.....\$489.95
 KXP-155.....\$409.95
 KXP-4450 Laser.....\$1549
 KXP-1124.....\$319

HEWLETT PACKARD
LaserJet Series II **\$1629**

1 MB Expander \$349 HP DESKJET PRINTER \$689

Commodore 128D PACKAGE

Commodore 128D Computer w/Built-in Disk Drive
 Commodore 1902 Color RGB Monitor
 Commodore Color Printer
 64K PACKAGE **\$699**

Commodore 64K Computer
 Commodore 1541C Disk Drive
 Commodore Color Printer
 12" Computer Monitor **\$389**

Apple PACKAGES

APPLE IIc w/Floppy Drive & 12" Monitor **\$599**
 APPLE IIE w/5.25 DISK DRIVE & 12" MONITOR.....\$749

APPLE IIGS COMPUTER PKG.

- Apple IIGS Computer • 3.5" Disk Drive • Apple RGB Color Monitor • Package of 10 Diskettes • All Cables & Adaptors • Package of 10 Diskettes • Apple Software

\$1399

IMAGEWRITER II Printer.....\$449
 MAC SE Computer w/ Dual Drive.....\$2299
 MAC SE Computer w/20MB APPLE Hard Drive.....\$2749
 APPLE MAC II w/Keyboard.....\$3569

MONITORS

THOMSON 14" CGA Monitor.....\$269
 MAGNA VOX 13" RGB Color Monitor.....\$199
 MAGNA VOX EGA Monitor.....\$339
 w/ EGA Card.....\$450
 MAGNA VOX VGA Monitor.....\$369
 w/ VGA Card.....\$569

NEC MULTISYNC II.....\$579

Rush Service Available
Call For Details

Circle 187 on Reader Service Card

Accepted Checks, Bank Checks, Money Orders, Master and Visa, Amex, Discover, Charge, Discover Card, C.O.D. & APO approved P.O. accepted. No additional charge for credit card orders. Non-credited checks must be 24 hours for clearance. Prices subject to change without notice. Not responsible for typographical errors. Returns or defective merchandise must be prepaid return. Authorization number or return label must be supplied. All items are registered trademarks of International Business Machines Corp. All orders can be shipped Air Express. Call for details. For more information on checks for credit card orders, call 1-800-759-6565.

NO ADDITIONAL SURCHARGE FOR CREDIT CARD ORDERS WE WELCOME CORPORATE & EDUCATIONAL ACCOUNTS

The Data Bandits

*Viruses, theft, and accidental destruction
are all dangerous foes when it comes to network data*

William M. Adney and Douglas E. Kavanagh

Now that your personal computer is part of a local-area network, should you be concerned about the integrity of your data? Well, if you store data on the file server, yes. In fact, you may want to take additional precautions to secure your data.

In many offices that use LANs, a network administrator sets up and maintains data-security policies and procedures. But to rely solely on that person to ensure that your data is secure is neither realistic nor wise. You should do your part as well. After all, it's your information—your spreadsheet, your documents, your time and effort—that must be protected.

Protected from what? There are many potential threats to your network data in today's computing environment, but three are most common: virus programs, accidental destruction, and theft. We'll look at these threats and the countermeasures you can take to reduce or eliminate them.

Computer Viruses

Viruses present a very real problem for computer users, particularly for network



users. Many viruses attach themselves to a file used by the operating system, such as the BIOS (i.e., IBMBIO.COM), the system kernel (IBMDOS.COM), or the command interpreter (COMMAND.COM). The most insidious attach themselves to COMMAND.COM and are passed on to other disks and directories by the DIR command. Unfortunately, the virus is only the latest in a series of

destructive programs that began with the Trojan Horse and the Time Bomb.

The Trojan Horse program looks like it does one thing, but it actually does something else—like destroy a disk directory or scramble a disk's file allocation tables. The significant point about the Trojan Horse is that it always does its vandalism every time it runs. Like the Trojan Horse of ancient Greek lore, the program masquerades as some type of innocuous application; it can be any kind of .COM or .EXE file that purports to display graphics, list a directory, "unerase" files, or just about anything else. The disguise usually doesn't last long.

Trojan Horses can be very destructive. They can do everything from erasing files on a disk to invoking the system's FORMAT program. If the files are only erased, they can generally be recovered by an unerase utility.

If a Trojan Horse invokes FORMAT, your chance of recovery depends on your system. In general, you can't recover files from a reformatted floppy disk because most FORMAT versions actually overwrite everything. On a hard disk—

continued

including the network's file server—the network administrator may be able to recover most files (except for the root directory) with an “unformat” utility. The Mace Utilities package, for example, includes both unerase and hard disk unformat utilities you can use to recover data.

The Time Bomb is even more insidious. It can perform the same kinds of vandalism that a Trojan Horse can, but it usually does so by checking the system date and executing its destructive code on or after a programmed date. As you might guess, the Time Bomb is more difficult to detect and identify because your computer may work correctly for a long period of time—at least until the system date reaches the “bomb date.” Unfortunately, you may not know you have a Time Bomb until it is too late and your data has been destroyed or corrupted.

A virus program may contain destructive code like the Trojan Horse or the Time Bomb, but it has one added feature: It is capable of reproducing itself and usually does so by “attaching” program code to one or more files in the computer system. As a result, it is extremely difficult to “kill” a virus once it is in your system, since this usually requires a detailed examination of all files to be sure that they have not been infected.

It may not be enough to delete a suspected file, because other files may be infected. Many of today's virus programs seem to like to pick the system files, such as the BIOS or the command interpreter, for their free ride into your system, and they do so because nearly all of today's popular computer systems have identical filenames. But a virus can also attach itself to just about any file in your system.

Spotting a Virus

Detecting a virus can be relatively straightforward. The first problem you might notice is that an infected system or network won't perform normally. You may have sudden and unexplainable system freezes while using the same software you have always used. Or you may have problems running the software—it doesn't save or print files properly, it doesn't respond to commands normally, or it simply does strange things.

The second way you can spot a problem is through the drive light on a floppy or hard disk drive. Does it light up every few minutes, indicating some kind of disk activity when you are not using your system? This is not a positive indicator, because some software has an autosave feature that records data stored in memory after a certain number of minutes or

keystrokes. Check your software manual to see if you have this feature; if you don't, you may have a virus in your system.

Another way to spot a virus-infected program is to keep an eye on the date of .COM and .EXE files displayed by the DIR command. In particular, the date of COMMAND.COM shouldn't change unless one of the users has modified the file. Since that requires technical knowledge, you can check the date of COMMAND.COM on your DOS distribution

A virus
is difficult to “kill”
because it can
reproduce itself.

disk, and it should be the same throughout your system on your working disks. Dates for applications software will usually be the date of installation or last upgrade. If you have a directory-listing program that displays the date of system or hidden files, be aware that some programs may update the BIOS file.

One last way you can spot a possible virus is to know which files should be on a disk and which files shouldn't. Unfortunately, it's easy to “hide” files from the DIR command, so you will need some kind of utility program, such as WindowDOS from WindowDOS Associates, that displays all files on your disk. For example, the IBM PC BIOS and system kernel usually have both the System and Hidden attributes set.

In some cases, the files are also read-only. The WindowDOS program displays all filenames—including hidden, system, and read-only files—as well as the size, date, and attributes for each file. You can watch for any unexpected new files or changes in size or date to existing files by periodically running a directory utility program.

In all documented cases, there is only one way to get a virus in your system, and that is to copy an infected file or program. The bad news is that you have much more exposure to a virus, since you may not have any control of the programs and data that are placed on the network. An ounce of prevention is still worth a couple tons of cure. Unfortunately, the

prevention approach presents considerable operational problems. The following three rules can help you prevent a virus from infecting your system:

- Copy program files only from original distribution disks that come in a shrink-wrapped package. This is generally safe, although in at least one documented case a distribution disk actually contained virus code. If everyone follows this rule, it will also aid in the fight against software piracy. In any event, be sure to use a known original source that you trust.
- Don't copy program files from bulletin board systems. This may or may not be a viable option because you probably won't have any control over what other network users do. Unfortunately, some viruses spread through BBSes, and conscientious operators are inventing many ways to cope with the problem. Many of us use BBSes regularly, but you should only use those that are known to be reputable.
- Finally, buy software that helps prevent a virus from attaching itself to your files. Shareware and commercial programs are available, such as the Mace Vaccine program, that intercept and warn you of all attempts to update your system files. Mace Vaccine is a memory-resident program that takes about 4K bytes of memory, and Mace recommends that it be placed first in the AUTOEXEC.BAT file. This and other similar programs can help provide some protection against most of today's virus programs.

Preventing viruses isn't easy. But if you're cautious and vigilant, you can protect your network's health and prevent data destruction or corruption.

Accidental Destruction

Accidental destruction is another threat to your network data. In fact, it is probably the most common threat to data on a file server. A head crash on the network's file server or the electronic failure of a hub communications controller can wipe out a tremendous amount of data. So can power failures.

In fact, mistakes of all kinds can cause catastrophic data loss—for example, accidental use of the dreaded DEL *.* command if you are logged on to the wrong drive or subdirectory. You can counter these threats to preserve your data. Many of these countermeasures apply to most systems even if they are not on a network.

One way to get around the DEL *.* command problem is to provide network subdirectories for each user. If all users work out of their own subdirectories,

only they will have read, write, and delete privileges for files in those directories. Although other network users may have read privileges in other subdirectories, they cannot write files to, or delete files from, a directory not their own. Even so, you should always keep backups of all files in your subdirectory.

You can always opt to store your data on floppy disks in your computer and use the network only to run application programs. While this might also prevent someone from stealing your information off the network, it has the disadvantage of being slower, since floppy disk drives take longer to write data.

If you elect to store your files on the network, the best way to protect them from a head crash or other file-server problem is simply to periodically back up your critical data to a floppy disk on your own system. When you are involved in a complicated project, you should back up often—for example, every time you take a coffee break.

Theft of Information

Theft or compromise of confidential information is another potential threat to using a network. For example, let's say you are a manager using a word processor to write performance reviews on your staff for using a spreadsheet to develop the annual budget, including salaries, for your department. How do you keep that information confidential?

Sometimes, securing confidential information doesn't require a lot of special software or hardware. Since, in most cases, simple precautions are best, just don't keep that information on the network at all. Record all confidential data on floppy disks and lock them in your desk as you would any other sensitive or restricted information.

Remember that the network administrator usually has "supervisor" privileges that, of necessity, permit access to any network drive or subdirectory—but not to your floppy disks. But if you need to store the information on the network, virtually all of today's network software has a variety of internal security features defined and maintained by the network administrator.

Both public and private subdirectories and drives can be defined, and user rights and privileges can be defined for various subdirectories. You should understand what privileges you have for the server areas you use. For example, some public subdirectories (needed by all users) contain various programs you may use, and normally you can read and execute programs in that subdirectory

but not write (or add) programs to it.

Also, typically, at least one public subdirectory or drive includes read/write privileges for all users and is specifically intended to allow transfer and sharing of data among individuals and departments. In addition, each user normally has a private subdirectory with read/write privileges for that single user and with read-only privileges for other users.

Some network software also provides commands that let you define specific

privileges for each file. You may decide to declare a file as private, which means that only you can read or write to it. Keep in mind, however, that the network administrator and other users may have supervisor privileges that allow them to access any file on the network. If a file is really confidential, the easiest way to keep it that way is to store it only on a floppy disk.

Most of the best network software also

continued

the Telcor modem "simply ate up our data."

38.4K
bps



John H. Humphrey and Gary S. Smock
High Speed Modems
June 1988, Byte Magazine

Our patented Model 2496 data compressing modem was the only 2400 bps unit included in this evaluation of 9600 bps dial modems. And it was judged the surprise of the lot!

Just imagine what our 9600 bps modem can do... dial data throughput up to 38,400 bps. What's more, the Telcor Model 2938 also talks to 300, 1200 and 2400 bps modems and fully supports MNP Levels 2-6.

The Telcor Model 2938 outperforms any other dial modem in the world. If

you find that hard to believe, prove it to yourself. Order a pair at \$1195 apiece and try them for thirty days. High speed file transfer software for your PC-AT is included.

Call us toll free in the U.S. at 1-800-826-2938. Elsewhere call 1-508-653-3995. VISA and Mastercard accepted. Also available through local distributors.



TELCOR
SYSTEMS
CORPORATION

*the world's fastest
dial modems*

Network your PC to the world with TCP/IP

- ▶ *PC/TCP is a DOS-based implementation of TCP/IP, the only open standard for communicating*
- ▶ *PC/TCP emulates terminals on local or remote hosts; Transfers files between any host and PC, or between*
- ▶ *PC/TCP has the features you need, as well as speed, reliability, and support when you need it.*

ftp Software.

HOW DO YOU GET A JOB WITHOUT EXPERIENCE? AND HOW DO YOU GET EXPERIENCE WITHOUT A JOB?

Most young people have one answer to this problem. They avoid it until they're out of college. But they could be getting solid work experience while they're still in college. With your company's help. And ours.

We're Co-op Education. A nationwide program that helps college students get real jobs for real pay, while they're getting an education.

But we can't do it without you. Those real jobs have to

come from real companies. Like yours.

For more information on how you can participate in this valuable program, write Co-op Education, Box 775E, Boston, MA 02115.

Not only will you be giving students a chance to earn money and pick up the most valuable kind of knowledge, you'll be giving yourselves a chance to pick up the most valuable kind of employee.

Co-op Education.

You earn a future when you earn a degree.



A Public Service of This Publication ©1987 National Commission for Cooperative Education

includes access-control features that require you to enter a unique user identification (i.e., a log-on ID) and a password when logging on. It's important to choose your password carefully and keep it confidential. And you should change your password periodically—at least once every 2 months—just in case someone else has learned or obtained it.

Modem availability can create another security problem. A major point of vulnerability is a network's dial-up capability. If outside users can access your network, you may want to check with your network administrator to understand what kind of security measures have been implemented to prevent unauthorized access or unauthorized use of a networked modem.

Coping with the Security Problem

You can effectively deal with the two most common network-security problems—accidental destruction and theft of information—by using floppy disks in your system to store all data. This prevents theft of confidential data as long as you keep the floppy disks locked up. It also prevents others from accidentally destroying your data; however, you should make a backup of your original data in case you make a mistake.

Keeping a backup copy of your original floppy disk is also a good idea because it can reduce or eliminate loss of your data if a Trojan Horse, Time Bomb, or virus is introduced into the network. You may also want to keep at least two backup copies of critical files and rotate them as needed so you will have a way to recover that data—just in case.

Preventing data destruction resulting from a virus is difficult for an individual user, but you may want to consider one of the "anti-virus" programs for your individual system. Discuss this idea with the network administrator, because there may be various restrictions about running these programs on the network.

Most of these suggestions can be easily implemented on your own system. More important, you can do something to protect your data when your personal computer has been added to the network. And if you follow these suggestions, you will have taken a major step in protecting your data. ■

William M. Adney and Douglas E. Kavanagh are senior consultants with TAP (Total Assets Protection, Inc.), an Arlington, Texas, consulting firm specializing in strategic information systems and technologically enhanced facilities. They can be reached on BIX/c/o "editors."

The UnVT



The clear alternative to DEC terminals!

If you connect to a DEC VAX, there is a better alternative. The UnVT. KEA Systems' line of DEC terminal emulation products for the IBM PC and successors. Software like ZSTEM 240 with:

- true 132 column support on all adapters
- VT340 color and resolution
- extensive network support

Or for 100% compatibility, the PowerStation. A DEC VT layout keyboard and ZSTEM emulation software. Don't settle for just a terminal. Get The UnVT.

Find out why 65,000 others use the clear alternative.

Call 604-732-7411 or

FAX 604-732-0715 now!



KEA Systems Ltd., 2150 West Broadway, Suite 412, Vancouver, B.C. Canada V6K 4L9 • Order desk 800-663-8702.
DEC, VT and VT340 are trademarks of Digital Equipment Corporation. PowerStation, and ZSTEM are trademarks of KEA Systems Ltd. IBM and IBM PC are registered trademarks of International Business Machines Corporation.



Our Printer Sharing Unit Does Networking!

An Integrated Solution

Take our **Master Switch™**, a sophisticated sharing device, combine it with **MasterNet™** networking software for PCs, and you've got an integrated solution for printer and plotter sharing, file transfer, electronic mail, and a lot more. Of course you can also share modems, minis, and mainframes or access the network remotely. Installation and operation is very simple.

Versatile

Or you can use the Master Switch to link any computer or peripheral with a serial or parallel interface. The switch accepts over 20 commands for controlling the flow of data. It may be operated automatically, by command, or with interactive menus. Its buffer is expandable to one megabyte and holds up to 64 simultaneous jobs. The

MasterLink™ utility diskette for PCs comes with every unit and unleashes the power of the switch with its memory-resident access to the commands and menus.

Other Products

We have a full line of connectivity solutions. If you just want printer sharing, we've got

it. We also have automatic switches, code-activated switches, buffers, converters, cables, protocol converters, multiplexers, line drivers, and other products.

Commitment to Excellence

At Rose Electronics, we're not satisfied until you're satisfied. That's why we have thousands of customers around the world including large, medium, and small businesses, factories, stores, educational institutions, and Federal, state, and local governments. We back our products with full technical support, a one-year warranty, and a thirty-day money-back guarantee.



 **ROSE**
ELECTRONICS

Call now for literature or more information.
(800) 333-9343

Give a Rose to your computer

Dialing Up 1990

*One way to move bits and bytes
from here to there*

Brock N. Meeks

As we approach the 1990s, more people than ever before will be dialing in and logging on. The front-line troops in the current army of communications tools are dial-up communications packages. And the next decade of dial-up software is already upon us.

Software developers are pushing existing technology, anticipating new developments, and improving on tried-and-true techniques. The result is that you have at your fingertips more sophisticated and varied communications options than ever before. Let's look at some of these.

According to Script

Early communications programs had crude scripting capabilities; script files created a few years ago looked more like hieroglyphics than a command file does. And although you had to spend hours creating these nearly incomprehensible scripts, the most advanced applications for them were often no more than automatic log-on and message-retrieval functions. Enter today's command-programming languages.

The programming language found in a top communications package, such as



Smartcom III from Hayes Microcomputer Products, lets you take advantage of the multitasking operating system provided for use with script programs. For example, the Simple Communications Programming Environment (SCOPE) in Smartcom III lets you write a program that will poll an on-line database every hour and download pertinent information. Such a program can run in the back-

ground while it queries the database. If the on-line session should provide some valuable data, the program can sound an alarm to warn you that something urgent has been downloaded.

You can also create "meta-applications," which involve multitasking and interprocess communications. The script language found in Relay Gold and Relay Silver is an excellent example. Relay's script language is built on an Application Program Interface (API) that allows Relay to send and receive commands and data from programs such as Ashton-Tate's dBASE III Plus. A typical application might proceed as follows:

- Your PC is set to automatically receive data from a mainframe, under the guidance of a script program.
- As your PC downloads information, Relay boots up the dBASE API and then initiates another script that sends keystrokes to dBASE to execute report-writing functions.
- The same script can then upload this report to the mainframe.
- As insurance against line noise or other induced errors, Relay can examine

continued

dBASE responses. If there is an error or the data is nonexistent, the Relay script receives the error message, interprets it based on a set of error-trapping routines coded in API, and takes action accordingly.

Such complex scripts often require the knowledge of an experienced programmer, especially if the script language is unlike the traditional programming languages. Fortunately, many of today's scripting languages resemble popular languages. Crosstalk Mk.4 from Digital Communications Associates is one such example; its language, CASL, resembles Pascal. This similarity makes writing complex scripts an easy task for those familiar with Pascal. In addition, functions built into CASL let you exchange messages between script programs that are running simultaneously.

Many of the more sophisticated scripting languages let you automatically write scripts in a "learn" mode. In this application, you log on and perform a typical on-line session while the communications program "watches" or records all your keystrokes. These keystrokes are saved, and when you issue the final command, the program compiles them into a script file. To repeat the on-line session, all you have to do is execute the script file the program has automatically written.

Some scripting languages, such as the one found in Microphone II for the Macintosh, let you write sophisticated modem controls. You can add several different modem scripts to your script file. These scripts let you take advantage of technically complex high-speed modems, such as the Telebit TrailBlazer, a modem notorious for its complexity (see "High-Speed Modems" by John H. Humphrey and Gary S. Smock, June 1988 BYTE). Using the scripting language found in Microphone II, however, controlling TrailBlazer is simply a matter of picking the modem script you want from a menu and placing it in the script you're writing.

Script languages differ greatly in ability and ease of use. In "Communications According to Script" (August 1988 BYTE), Steve Apiki and Stan Diehl supply a chart that outlines 13 top communications programs and shows how many keystrokes each needs to create a BIX script file. The numbers of keystrokes range from a low of 117 to a high of 479.

A Terminal Issue

Depending on your application, terminal emulation is either of the utmost importance to you, or it's a non-issue. Either

you need it, or you don't. There is rarely any middle ground.

Terminal emulation allows a PC to act like a specific terminal attached to a mainframe or minicomputer. It's the method of choice for harnessing the horsepower found in most corporate settings. In an era of connectivity, of using all the computing resources that exist within an organization, terminal emulation is vital. And you are likely to find that you need to access several different types of mainframes or minicomputers, each geographically distributed.

The needs for terminal emulation range from simple data entry to allowing your PC to act with some intelligence. The bottom line for those needing terminal emulation, however, is access to information from a remote host; the hows and whys are unimportant. Since the number and type of hosts may vary, you need a flexible terminal-emulation package—one that can emulate several different brands and models of terminals and cope with various hardware setups, and one that you can upgrade as new protocols are instituted.

The best terminal emulations can download data from a host and then return to the PC's own local intelligence so you can apply whatever application program you need to process the downloaded data. More advanced terminal emulations include data-conversion features that automatically reconfigure downloaded data so it fits easily into the displays of PC-based applications. The file-transfer protocols built into today's dial-up communications packages let you make quick "start-and-stop" mainframe accesses in emulation mode.

Maximum flexibility comes from software packages that let you redesign the keyboard to their preferences or in line with a particular application. Bitcom lets you program in custom-keyboard configurations. For example, you could program the keys that a PC uses for certain commands to have those same meanings under terminal emulation.

Relay Gold has a programmable-keyboard feature that lets you switch among several types of keyboard configurations without having to learn each different one. You have the keys in the positions that are familiar to you, something not possible when switching between stand-alone terminals.

Screen emulation is also of key importance. The ability to display 132 columns is vital to spreadsheet programs. Using a PC for these applications, however, requires more than software-based terminal emulation. For 132-column displays,

you need additional hardware—a plug-in board and a special monitor. Or you could use side-to-side scrolling. This technique displays the standard 80 columns on the screen; to look at the other 52 columns, you scroll right (or left) to bring the "off-screen" characters into view.

Some packages place terminal emulation in the PC's memory so that you can operate it as a terminate-and-stay-resident utility.

Today's dial-up communications products offer a wide variety of terminal emulation. However, of the top-selling communications programs, only three offer IBM 3270-type emulation: Crosstalk Mk.4, Crosstalk XVI, and Procomm Plus. And none of these is a complete emulation in and of itself. The two Crosstalk packages require additional hardware (a plug-in board), and Procomm Plus requires a 7171 protocol converter or its equivalent.

Terminal emulation in the Mac environment is starting to gain some speed, too. As the Mac has moved from a closed system architecture to an open one with the advent of the Mac SE and the Mac II, promising developments have pushed the Mac into view as a viable front-end system for IBM-to-DEC mainframe applications.

Earlier this year, Apple unveiled two promising new development platforms: MacWorkStation and MacAPPC. The MacWorkStation is composed of three main communications modules for sending serial and binary data. High-level programming interfaces allow mainframe applications to exploit Mac features such as menus, windows, and dialog boxes. The result is terminal emulation that melds with the Mac icon-and-mouse user interface. MacAPPC is the Apple implementation of IBM's Advanced Program-to-Program Communications (LU 6.2) protocol (see "A Logical Choice" on page 309).

A Matter of Protocol

File-transfer protocols are the heart and soul of any dial-up communications program. In the beginning, there was X-MODEM, and only XMODEM, which was developed in 1977 by hobbyist Ward Christensen to let one of his computers trade files with another. He placed the protocol in the public domain, and the rest, as they say, is history.

Because XMODEM was the only publicly available file transfer, it quickly became the de facto standard. Today, there isn't a dial-up communications package

continued



WHEN A LAN GOES DOWN DO YOU GO WITH IT?

Business stops when a LAN stops. And so can many a promising career.

Prevention is better than cure – and a whole lot less expensive. Which is why MIS professionals are turning to Spider network monitors to identify problems *before* they come up.

A SpiderMonitor helps you make your LANs work harder: it eliminates bottlenecks, improves resource-sharing, lets you plan for future network demand.

(It also helps you understand all the nuances of your LAN – learning as you work.)

SpiderMonitors are designed for complex multi-vendor environments and support all standard protocols on any IEEE 802.3 Ethernet network. Statistics, Performance, Summary, Test, Development, Traffic Generation: SpiderMonitors are six multi-tasking tools in one. With statistics

for network loading, capacity usage, performance and station activity – all presented in a logical, coherent way.

And all accessed through the friendliest user interface in the industry.

Choose from two models: a board and software kit for an existing AT or XT compatible, or a rugged portable unit.

A SpiderMonitor is a wise investment, fully backed by comprehensive, on-the-spot support. No wonder MIS professionals, installation engineers, software and systems developers rely on SpiderMonitors – worldwide.

To find out more, call us today on (800) 447-7807, for literature and a demo disk.

SpiderMonitors: the friendly, low-cost way to keep LANs up and running.

(And that means you, too.)



Spider Systems Inc., 12 New England Executive Park, Burlington, MA 01803.

Please send me: Full information on SpiderMonitors A 5 1/4" demo disk

A 3 1/2" demo disk Please arrange a live demo on my network

Name _____ Title _____

City _____ State _____ Zip _____ Phone _____

DT 109

SPIDER SYSTEMS
We make networks work

All registered trade marks acknowledged.

Circle 335 on Reader Service Card

JANUARY 1989 • BYTE 275

Communications Programs

- Access**\$250
Runs on the IBM PC, XT, AT, and compatibles
Microsoft Corp.
16011 Northeast 36th Way
P.O. Box 97017
Redmond, WA 98073
(800) 426-9400
(206) 882-8080
Inquiry 952.
- ASCII Pro** \$99.95
Runs on the IBM PC, XT, AT, and compatibles
United Software Industries, Inc.
8399 Topanga Canyon Blvd., Suite 2
Canoga Park, CA 91304
(818) 887-5800
Inquiry 953.
- BackComm**\$149
Runs on the IBM PC, XT, AT, and compatibles
Primary Data, Inc.
5752 Oberlin Dr., Suite 200
San Diego, CA 92121
(619) 546-3996
Inquiry 954.
- BLAST II**\$250
Runs on the IBM PC, XT, AT, and compatibles
Communications Research Group
5615 Corporate Blvd.
Third Floor
Baton Rouge, LA 70808
(504) 923-0888
Inquiry 955.
- Carbon Copy Plus**\$195
Runs on the IBM PC, XT, AT, and compatibles
Meridian Technology, Inc.
7 Corporate Park, Suite 100
Irvine, CA 92714
(714) 261-1199
Inquiry 956.
- Crosstalk Mk.4**\$245
Runs on the IBM PC, XT, AT, PS/2s, and compatibles
Crosstalk XVI.....\$195
Runs on the IBM PC, XT, AT, PS/2s, and compatibles
Remote 2.....\$195
Runs on the IBM PC, XT, AT, PS/2s, and compatibles
Digital Communications Associates, Inc.
1000 Holcomb Woods Pkwy.
Roswell, GA 30076
(404) 998-3998
Inquiry 957.
- Desktop Express (MCI Mail)**\$149
Runs on the IBM PC and compatibles and on the Mac
Dow Jones Software
P.O. Box 300
Princeton, NJ 08543
(609) 452-1511
Inquiry 958.
- Flash** \$29.95
Runs on the Atari ST
Antic Software
544 Second St.
San Francisco, CA 94107
(415) 957-0886
Inquiry 959.
- Freeway Advanced**\$139
Runs on any DOS computer
Freeway \$59.95
Runs on any DOS computer
Kortek, Inc.
460 California Ave., Suite 302
Palo Alto, CA 94306
(800) 327-0310
(415) 327-4555
Inquiry 960.
- HyperACCESS**.....\$149
Runs on the IBM PC, XT, AT, PS/2s, and compatibles
Hilgraeve, Inc.
P.O. Box 941
Monroe, MI 48161
(800) 826-2760
(313) 243-0576
Inquiry 961.
- Instant Terminal** \$95
Runs on the IBM PC, XT, AT, PS/2s, and compatibles
Softronics
7899 Lexington Dr., Suite 210
Colorado Springs, CO 80920
(800) 225-8590
Inquiry 962.
- Lotus Express (MCI Mail)**\$150
Runs on the IBM PC and compatibles
Lotus Development Corp.
55 Cambridge Pkwy.
Cambridge, MA 02412
(617) 577-8500
Inquiry 963.
- MaxOnline**..... \$69.95
Runs on MS-DOS systems
Maxon Systems, Inc.
353 Vintage Park Dr., Suite B
Foster City, CA 94404
(415) 377-0269
Inquiry 964.
- Microphone**\$149
Runs on the Mac
Software Ventures Corp.
2907 Claremont Ave., Suite 220
Berkeley, CA 94705
(415) 644-3232
Inquiry 965.
- Mirror II** \$69.95
Runs on the IBM PC and compatibles
SoftKlone Distributing Corp.
327 Office Plaza Dr., Suite 100
Tallahassee, FL 32301
(904) 878-8564
Inquiry 966.

available that doesn't implement some version of it. I say "some version" because no standards were ever written for implementing XMODEM. As a result, various implementations exist—some good, and some not so good. Now, some 12 years later, there still aren't any stan-

dards for file-transfer protocols, a situation that has led to a variety of them, each satisfying a particular need.

Today, there are at least a dozen different file-transfer protocols in the public domain, as well as a handful of proprietary ones. Most of the top-selling

communications programs have their own protocols, each designed around what its manufacturer considers to be the best method for sending files across the public telephone network.

The trouble is, these proprietary protocols, regardless of how effective they

PFS:Access\$140 <i>Runs on the IBM PC, XT, AT, and compatibles</i> Software Publishers Corp. 1901 Landings Dr. Mountain View, CA 94039 (415) 962-8910 Inquiry 967.	SideTalk\$119.95 <i>Runs on the IBM PC, XT, AT, and compatibles</i> Lattice, Inc. 2500 South Highland Ave. Suite 30 Lombard, IL 60148 (800) 533-3577 (312) 916-1600 Inquiry 972.
Procomm Plus\$75 <i>Runs on MS-DOS systems</i>	Smartcom III\$249 <i>Runs on MS-DOS systems</i>
Procomm\$35 <i>Runs on the IBM PC, XT, AT, and compatibles</i> Datastorm Technologies, Inc. P.O. Box 1471 Columbia, MO 65205 (314) 474-8461 Inquiry 968.	Smartcom II\$149 <i>Runs on the IBM PC, XT, AT, and compatibles and on the Mac</i> Hayes Microcomputer Products P.O. Box 105203 Atlanta, GA 30348 (404) 449-8791 Inquiry 973.
QuickShare\$465 <i>Runs on the IBM PC, XT, AT, and compatibles and on the Mac</i> Compatible Systems Corp. P.O. Drawer 17220 Boulder, CO 80308 (800) 356-0283 (303) 444-9532 Inquiry 969.	Telescope\$125 <i>Runs on the Mac</i> Mainstay 5311-B Derry Ave. Agoura Hills, CA 91301 (818) 991-6540 Inquiry 974.
Red Ryder\$80 <i>Runs on the Mac</i> The FreeSoft Co. 150 Hickory Dr. Beaver Falls, PA 15010 (412) 846-2700 Inquiry 970.	Works for Mac\$295 <i>Runs on the Mac</i>
Relay Silver\$150 <i>Runs on MS-DOS systems</i>	Works for PC\$149 <i>Runs on the IBM PC, XT, AT, PS/2s, and compatibles</i> Microsoft Corp. 16011 Northeast 36th Way P.O. Box 97017 Redmond, WA 98073 (800) 426-9400 (206) 882-8080 Inquiry 975.
Relay Gold\$295 <i>Runs on the IBM PC, XT, AT, and compatibles</i> Relay Communications, Inc. 41 Kenosia Ave. Danbury, CT 06810 (800) 222-8672 (203) 798-3800 Inquiry 971.	

net's X.PC, Microcom's Microcom Networking Protocol (MNP), and Hayes's FAST.

Don't expect any standards to emerge, however. The international standard-making bodies, such as CCITT, ANSI, and IEEE, have avoided trying to develop a file-transfer standard. Protocols like Kermit and XMODEM defy definition. They lump together many layers of the Open Systems Interconnection communications reference model, handling both low-level error-correction and high-level file-handling tasks. Such a melding of OSI "stacks" confounds the standards process.

Hayes's FAST, however, addresses only the upper layers of the OSI model. It offers a file-transfer interface, but no error correction. Similarly, MNP addresses the lower layers of the OSI model, offering only error-correction or data-link levels. Because these two protocols adhere, more or less, to the OSI model, their developers have begun to push for standardization. However, the standard-writing process is slow.

Into the next decade, the three predominant protocols are likely to be XMODEM 1K, Kermit, and ZMODEM.

XMODEM 1K is a substantial improvement over Christensen's original, which transferred files in 128K-byte packets. XMODEM was intended for "short-haul" file transfers between computers in the same local region, and over modems with top speeds of 300 bits per second. When bulletin board systems (BBSes) began to proliferate and file transfers started moving hundreds or even thousands of miles, the original XMODEM failed more often than not. XMODEM 1K is a much more robust protocol. It transfers files in 1K-byte blocks and implements an error-correction scheme much better suited to the inherently noisy public telephone network.

Kermit was developed at Columbia University and is the file-transfer protocol of choice for the many research networks, such as Usenet and Bitnet. The user community has since adapted Kermit for use in dial-up communications packages, and it has proven itself a hardy and reliable protocol.

ZMODEM continues to gain popularity due to its "checkpoint restart" feature. This goes into effect if, for example, your modem becomes unplugged from the phone connection, knocking you off-line in the middle of a file transfer. You simply redial, and ZMODEM's checkpoint restart lets you resume your file transfer from the point of interrup-

continued

are, can't talk to one another. For example, if you're not running Crosstalk Mk.4's DART protocol end-to-end, you can't use DART to transfer files. Thus, in the spirit of reaching most of the people most of the time, the majority of telecommunicators use some form of public

domain file-transfer protocol.

There are two levels of public domain protocols: those like XMODEM and Kermit, ubiquitous among dial-up software packages, and those developed and put into the public domain in hopes that they will become standards, like Tym-

tion instead of making you resend the entire file from block one.

Other file-transfer protocols, such as YMODEM batch and sliding-windows XMODEM, although sturdy protocols, aren't likely to become the protocol of choice. They were originally intended for downloading several files at once, not individually. But with the advent of "archiving" programs, sometimes called "libraries," the need for these protocols is diminishing. Archiving groups several related files into a single "archive," compressed (or squeezed) to save file space, and downloads them as a single file, eliminating the need for batch-file transfers.

In addition, interest in "attached-file" protocols is growing. These protocols are proprietary in nature, and the communications packages that implement them are of little use for general communications needs. Such programs include Lotus Express, a communications package that automates sending and receiving files on the commercial electronic-mail system, MCI Mail. The advantage of a program like Lotus Express is that it lets you attach a binary file to a standard ASCII text file. When you upload your text message, the binary file is "attached" to the text and uploaded along with it. Another user using the same software can then access the system, read your message, and automatically download the binary file (e.g., a program, spreadsheet, or database command file).

Some commercial on-line systems, such as BIX, have also implemented this feature, but it is a function of the system's software, not of the stand-alone dial-up communications program.

And the Band Plays On

As the communications world strives for faster bandwidth and cleaner, more reli-

able file transfers, modems operating at speeds of 9600 bps or higher will become common. With the push among the telephone companies to implement new switching equipment and provide cleaner lines, it won't be long before all serious asynchronous communications are moving at 9600 bps or more.

Today's top dial-up communications packages are capable of handling file transfers at speeds up to 115,000 bps. If the future didn't hold the promise of such high-speed file transfers, we wouldn't find this capability in these packages.

The push for faster bandwidth is driven solely by the emergence of high-speed dial-up modems (see "Whither the Modem?" on page 281). Although BBSes are beginning to creep toward handling file transfers of 9600 bps, the real push is from the world of commerce. Electronic funds transfers along leased phone lines can handle data almost as fast as the technology allows. Banks and multinational corporations need to move megabytes of data several times a day, and in this arena particularly, time really *is* money.

For now, 2400-bps capability is sufficient for commercial information services. Most of the on-line sessions are interactive, and you don't need 9600-bps capability to type in your messages. The market for high-speed, dial-up modems isn't standardized. Implementing speeds higher than 2400 bps would mean subscribers to the service would need to have the same hardware that the service uses. While higher speeds would be nice for uploading and downloading, proprietary hardware would lock out the majority of users.

A Bright Future

The future for dial-up communications software is a bright one. For example,

when scripting languages become more powerful, they will become easier for nonprogrammers to use, thus sparking more sophisticated and complex telecommunications applications.

Beyond software improvements, however, the move to integrate existing and emerging technologies is likely to provide the most exciting advances. The addition of coprocessor boards to take advantage of multitasking; the implementation of gateway services by the telephone companies to allow access to newer, faster forms of information; a public Integrated Services Digital Network service; faster, cleaner, packet-switched networks; the fiber-optic information highway: All these advances will lead to more communications power literally at your fingertips.

The choices for dial-up communications programs are varied, as are the prices. Remember that paying more doesn't necessarily mean you're getting a better program or a more powerful one.

Another long-held telecommunications edict, "People don't change their communications software," also appears to be crumbling. In this day of custom applications and specialized information needs, staying with a single communications package "in spite of the facts" limits your telecommunications ability.

It would be nice to have a single communications package provide all the features you'd ever want. But that package isn't here yet. For now, we have a large variety of products from which to choose: If you look for it, there's a product for every need...and, if you look hard enough, a need for every product. ■

Brock N. Meeks is a San Francisco-based freelance writer who specializes in high technology. You can reach him on BIX as "brock."

Don't buy a "smart" modem that can't talk!

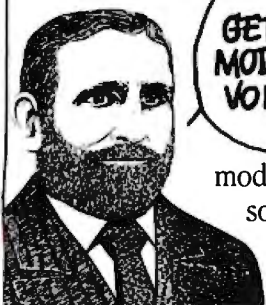

GET WATSON:
MODEM PLUS
VOICE MAIL

Watson is the *real* "smart" modem: it gives you auto-answer, voice mail, speed dial, database access. Plus a full-featured 2400-baud modem. Over 25,000 Watsons have been sold. Voice quality is amazingly life-like, and an optional programmer's kit lets

you build applications. For a phone demo, dial 1 (800) 6-WATSON (in Mass., (508) 651-2186). To order, call 1 (800) 533-6120 (in Mass., (508) 655-6066).

Watson®

Natural MicroSystems Corporation

2400 baud \$299 **NEW!**

BUFFALO® SL

ONLY \$500 PLUS \$100 PER 256KB MEMORY



When you can't afford to buy a laser for each PC, the **Buffalo SL™** is the inexpensive way to let everyone share - not just your lasers, but printers, plotters and modems as well. If you don't need simultaneous access to shared files, the **SL** is also an alternative to a LAN at a fraction of the cost.

The **SL** has four parallel and six serial channels, with all ten being user configurable as either an input or an output, so you can share 1 PC with 9 peripherals, 9 PCs with 1 peripheral, or any combination in between. If you need more than ten channels, you can link several **SLs** together. All channels can be in use at the same time and can rapidly transfer and queue data. The **SL** even allows your PC to send data at 19,200 baud. All memory (user upgradeable up to 4MB) is dynamically allocated and shared as needed.

The **SL** comes with software for menu-driven installation and pop-up menu control selections, but you don't have to be a programmer to use it. Of course, the **SL** works just fine without our software too! The **SL** has many other features so ask us to send you more information.

MORE™ MEMORY

The Memory Extension System™ Board

When 640K just is not enough, you need to add **MORE™ MEMORY**. This **Memory Extension System™ Board** uses only one slot in any 8 or 16 bit bus and can be used as expanded, extended and/or conventional memory (EEMS/EMS version 4.0 software).

2MB-\$1200, 4MB-\$2100, 6MB-\$3000, 8MB-\$3900

MORE MEMORY is compatible with PC/XT/AT computers and supports PC-DOS, MS-DOS, PC-MOS, OS/2, Unix, Xenix, etc. It is easy to install **MORE MEMORY** and it comes with a **5 YEAR WARRANTY**.

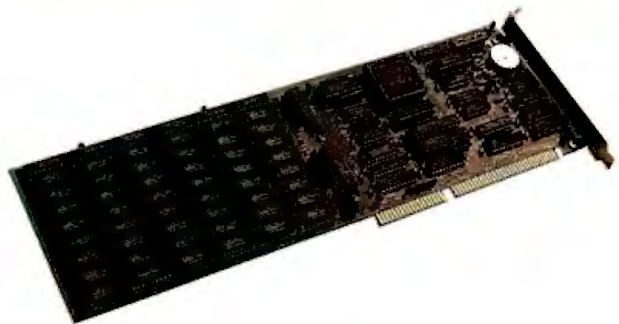

MORE MEMORY has built-in DRAM protection that corrects for any memory errors when you reboot, so you will never have to replace a faulty memory chip. No downtime or costly repairs will ever occur due to a failed memory chip on the **MORE MEMORY** board.

HYPERWARE™ PC productivity boosting software is included **FREE** with each unit. **HYPERDISK™** enables disk drive read/write intensive programs to run 3-10 times faster. **HYPERKEY™** enhances the responsiveness of your keyboard. Sold separately, \$49.95.

Buffalo Products also makes other smaller buffers, automatic switches, and interface conversion devices. All of our products come with a **45 DAY MONEY BACK GUARANTEE**. Call us **TOLL FREE** and talk to one of our friendly application technicians for solutions to your connectivity problems.

(800) 345-2356

Buffalo Products, 2805 19th Street SE, Salem OR 97302 (503)585-3414

DRAFIX CAD ULTRA™ FINALLY FILLS AN IMPORTANT GAP IN LOW-COST CAD.



CADAPULT™ YOUR DRAWING INTO LOTUS 1-2-3 OR DBASE.

Drafix introduces CAD for the real world. Any CAD package lets you create drawings. New Drafix CAD Ultra with CADapult is the first inexpensive CAD software that can turn your drawings into usable database and spreadsheet information.

First, you can give every element in your drawing specific attributes—a name, a part number, a price, for example. Then, with little more than a push of a button, you can convert the data into a spreadsheet, move it into a database or insert it into your drawing.

Suddenly your concept becomes a bill of materials, a component pricing list, an order form, a job estimate.

SIMPLE TO LEARN AND EXTREMELY EASY TO USE.

—PC Week

You'll never find an easier CAD software to use. With Drafix all of the menus are on the screen all of the time—there's nothing to memorize! In minutes you'll create sketches and drawings naturally and effortlessly—drawings that would require weeks of training on other CAD systems.

AMAZING POWER AND SOPHISTICATION FOR ONLY \$395.

All of the drawing, designing and editing functions



demanded by architects, engineers, drafters, contractors and other serious CAD users are included.

- Create your own symbol libraries with attributes or use our pre-attributed, predrawn symbols supplied with the package.
 - Draw lines, arcs, polygons, splines and bezier curves or freehand sketch.
 - Access our full complement of item and grid snaps for superior accuracy.
 - Use our powerful and flexible automatic dimensioning system and crosshatching and solid fill for complex drawings.
 - Take advantage of function key macros for even greater performance.
 - Use the revolutionary word processing window for adding and editing text in drawings.
- Plus much, much more.

EVERYTHING YOU NEED IN A SINGLE PACKAGE.

Other low-cost packages require expensive add-on modules. There's nothing missing from Drafix CAD Ultra. For no extra cost you get:

- DotPlatter™ for high resolution Dot and Laser Printer output.
- General Symbols Library of 450 pre-drawn objects.
- CADapult exchange utility.
- HPGL compatibility with desktop publishing programs and a full range of pen plotters.

CALL US TODAY.

For the name of your nearest Drafix dealer, call us today at 1-800-231-8574.

Ask about Drafix 3D Modeler and Drafix CAD Report too!



FORESIGHT RESOURCES CORP.
10725 Ambassador Dr.
Kansas City, MO 64153
816-891-1040

Circle 107 on Reader Service Card (DEALERS: 108)

Whither the Modem?

*Speed is up and prices are down—
can these trends continue?*

John H. Humphrey and Gary S. Smock

Modems are getting faster, and the sheer volume of personal computer users forces their prices down continually. The technology that once produced 1200-bit-per-second modems for several thousand dollars each has advanced so much that today, a 1200-bps modem can be had for less than \$100. The future of modem technology holds similar promises.

The Past

In the past, the industry concentrated on standardizing and developing modulation technology (the core "engine" of the modem). From the 1960s to the mid-1970s, the marketplace saw intense competition. AT&T's unique modulation methods led the way with international sanction, following in the form of similar CCITT V-series recommendations.

Early core engines presented technically simple modulation technology that embraced frequency-shift keying (FSK) engines serving dial-link usage in the 300- to 1200-bps range (Bell 103/202 and CCITT V.21/23). Leased-line operation, where the variance of channel conditions is more easily constrained,

offered midrange speeds (2400 to 4800 bps) using more sophisticated differential phase-shift keying (DPSK) engines of the Bell 201/208 and CCITT V.26/27 products (see the article "High-Speed Modems" in the June 1988 BYTE).

The late 1970s saw the emergence of more complex modem-engine technology that sported sophisticated quadrature-amplitude modulation (QAM) and

dynamic adaptive equalization. Operating speeds climbed to 9600 bps and above for leased-line use. In the early 1980s, the advent of low-cost microprocessors and switched-capacitor filter technology formed a marriage. This union allowed communications engineers to bring DPSK and QAM technology into low-cost forms that gave dial-network users both a speed boost and an operating-performance surge. These improvements came in the form of Bell 212 and CCITT V.22bis products providing 1200- and 2400-bps data transfer rates.

At the same time, digital-communications technology began to thrive for corporate users with the advent of DDS, T1, and, more recently, Integrated Services Digital Network (ISDN) link technology.

These nonanalog special-network technologies introduced 56,000 bps, 1.544 megabits per second, and discretely quantized 64,000-bps multiple-packet data transmission potential. It looked like digital transmission technology would quickly surface as the long-term winner for all data exchange. However, the dial network is surprisingly resilient.

continued



Dial links are already installed (our parents and grandparents paid the amortized cost of construction). They intermix to effectively connect anywhere in the global village without needing advanced planning and telephone-company installation services. This provides an expedient answer if you want to get up and running without wading through miles of bureaucratic red tape.

The Present

In our ventures into space, we've made use of orbiting satellites to carry communications traffic. Everything from simple dial-link telephony to TV video and sophisticated military communications have become a target for uplink/downlink traffic. This poses new problems, and with them come new solutions.

In conventional terrestrial telephony, impedance mismatches along the routing path serve to generate echoes. At one time or another, you've probably gotten a link where it sounded as if you were in a tunnel. The dial network once solved this nuisance exclusively with echo-suppressor technology. The "tunnel" effect occurs when echo suppressors fail to operate properly.

Echo suppression works on the premise that humans use the telephone lines and that they are half-duplex creatures—one talks while the other listens; both don't talk at once.

Modems are smarter. They talk to each other simultaneously and must do so to maintain the link. To have effective full-duplex modem communication, you must disable the network's echo-suppression feature; this is the purpose of the familiar answer-tone burst you hear from the distant modem when you dial. Answer tone is a signal to the dial network that this is a data call and that it should shut down echo suppression for the duration of the call.

Echo suppressors assume that only one party will talk at a time. The dial-network monitors signal strength in each leg of its four-wire path (me to you and you to me), assuming that the side of the link with the strongest signal is the talker and that the other side can be safely attenuated during talker activity to prevent echoes from flowing back to the talker. When the talker stops, the network releases its attenuation to allow listener response and squelches the opposite path to protect the listener against echoes.

In this manner, the phone lines are actively and selectively silencing one side of the channel in an effort to provide clean, echo-free communications. You can imagine what would happen if the

echo suppressors mistakenly "kicked in" during a data call: One modem or the other could lose the carrier due to the sudden drop in signal strength caused by the echo suppressor. Also, think what would happen if the time delay of the echo were to change radically.

The introduction of satellite communications placed a primary echo-reflection point one-tenth of the way to the moon. Now echoes can flow back to the talker long after the echo suppressor has kicked out and appear during the responding flow of the listener's response. If a call is routed by a multiple-satellite hop (from Omaha to New York, then from New York to Paris), the problem is compounded. Simple suppression of one side of the line based on relative signal strength and fixed time delays breaks down as an effective deterrent.

This situation has spurred research into echo-cancellation (EC) technology. If you know the waveform just issued, you can store it and scan the other side of the line looking for a delayed and attenuated copy—an echo. You can subtract an appropriately scaled and delayed copy of a stored waveform from the inbound path to cancel the echo.

This is how EC technology was born, and today's newest generation of dial-link modems (V.32) make use of EC to achieve full-duplex, 9600-bps communications. Both ends of the link transmit on identical carrier frequencies simultaneously. However, each modem knows the waveforms that it has sent. It uses this information to add an inverted and appropriately scaled and delayed copy of its transmitted data directly into its received signal path, canceling out the effects of transmitter echo. Thus, only the distant modem's inbound signal remains to be processed.

In the early 1980s, work began on what is now the V.32 EC modem engine. By 1984, the CCITT had ratified V.32, and modem manufacturers began the grueling task of designing functional EC modems. To solve the problem, applied mathematicians were put to work in modem development. With them came applied statistics and encryption technologies.

Mathmagic

The industry has learned to use encoding to produce performance gains. *Trellis encoding* is used in today's 9600-bps and higher speed-rated CCITT engines to produce more reliable operation. At first blush, trellis-coded modulation (TCM) looks like pure and simple magic.

First, you add analog horsepower to

complicate the core transmission pattern. Instead of using a simple 16-point constellation, for example, you force the modem to a higher-density 32-point constellation. The 32-point constellation offers higher encoding density with its "quintbits" ($2^5=32$), as opposed to the 16-point constellation with its "quadbit" structure ($2^4=16$).

With a given, fixed baud rate (e.g., 2400 baud), the 16-point constellation can deliver data exchange rates of 9600 bps (2400 baud \times 4 bits per baud). The more complicated 32-point constellation offers an intrinsically higher data rate capacity of 12,000 bps (2400 baud \times 5 bits per baud). It's also more susceptible to channel noise because you have pushed the individual decision points closer together, and any minor noise perturbation is more likely to cause the distant receiver to make a decoding error.

However, instead of using the higher density of the 32-point constellation for speed purposes, suppose you use its added complexity for noise immunity purposes to derive a performance boost. TCM does just that.

Instead of operating at 12,000 bps, V.32 TCM transmission remains at 9600 bps with twice as many constellation points as it needs. The extra constellation points produce a redundant bit. This fifth bit is used as an embedded "checksum" to produce intelligent transmission. Decision rules are used in both the transmitter and the receiver to produce an orderly transmission that is designed to maximize noise immunity.

The redundant bit serves an error-detection function similar to the familiar ninth bit used for parity in 8-bit micro-computer memory systems. The memory-parity bit doesn't prevent errors from occurring; however, it flags them and prevents them from propagating.

With TCM, the fifth bit acts to help the remote receiver make a high-probability choice among possible alternatives when channel noise has distorted the incoming signal. It doesn't absolutely guarantee error-free communication, but it does help by reducing the probability of errors.

The use of redundant encoding techniques like TCM has given rise to faster operating speeds with little, if any, performance penalty. Today's modern leased-line 19,200-bps half-duplex machines churn along rather reliably producing similar noise-immunity characteristics to those of the V.29 9600-bps modems used in the late 1970s.

Along with redundant encoding technology, mathematicians brought encryp-

tion technology to the modem world. The best example is today's 2-to-1 to 4-to-1 built-in data compression. If we can compress the data before feeding it to the modem and expand it once it's received, we can achieve a throughput gain without cost to analog engine complexity.

This is an exciting area of technology, and the CCITT has been working feverishly in recent years to construct a platform for standardizing error-detection, error-correction, and data-compression functions in modems known as V.42. These features exist today on a manufacturer-specific basis. X.PC, MNP, and a myriad of alternatives (e.g., Kermit, XMODEM, and YMODEM) exist to reliably transport data and, depending on protocol, provide a speed boost via data compression.

The V.42 standard sought plenary approval from the CCITT, which met last November. Current V.42 specifications seek to form a standardized platform for the development of these non-engine-related modem attributes. Experts expect quick ratification of the V.42 recommendation that embraces early MNP compatibility (up to level 4) as well as a more advanced form of error correction known as LAPM (link access protocol for modems).

V.42 is expected to serve as a platform on which to build for the future with sophisticated add-on features, such as integral data compression being brought along via incorporation into the flexible LAPM protocol. Since the industry has seen impressive speed boosts of up to four times from today's data-compressing modems (see the Telcor Accelerator 2496MA performance in the article "High-Speed Modems" in the June 1988 BYTE), we can expect a larger selection of standardized, interoperable modem products to emerge in the future thanks to V.42.

The Future

Unfortunately, today's concentration on the fruits of mathematics has taken the focus off core-engine development. In the early 1980s, the industry focused on engine development, and the CCITT promoted EC V.32 in 1984, well ahead of then-current technical practice. This served as a challenge to modem designers. Where is the next advanced-engine specification to challenge us into the mid-1990s? Sadly, the answer is nowhere. Many people expected that the world would suddenly go digital and that ISDN would surface quickly to provide a global communications vehicle that was fast, clean, and omnipotent. This

simply hasn't happened.

Leased-line technology exists based on second-generation, multidimensional TCM that yields solid 19,200-bps core communications speeds. Unfortunately, these machines are large, expensive, and dedicated to corporate leased-line links. What about higher speeds at the personal computer level for dial use?

Even though standards organizations have not promulgated the next-generation engine technology, entrepreneurial design work is alive and well. The 19,200-bps leased-line machines (for which there are no adopted CCITT standards) have improved to the point that core-engine technology now approaches performance levels robust enough to deliver 19,200-bps dial service. In fact, some of the leaders in this area are experimenting by adding dial backup capability to these leased-line products.

The 19,200-bps modems are currently half-duplex in nature, and no error-correction or data-compression protocols have been added as a front-end to the modem's core engine. If you can use echo cancellation at 9600 bps to yield full-duplex, overlapping-carrier operation, why can't you use the same technology at 19,200 bps to produce a full-duplex dial engine that's twice as fast as V.32? The answer is simple: You can.

Already, derivatives of V.32 using integral data compression have been developed that achieve 38,400-bps operation (four times compression on a core 9600-bps engine). By using echo cancellation and data compression, we can envision an 80,000-bps full-duplex, dial-link product made from today's 19,200-bps engines using a four-times data compressor. Such a machine would rival conventional DDS yet have the flexibility of the dial network's extensive existing routing paths. This technology is at hand.

You can use EC to successfully separate transmitted data from received data under spectral-overlapping conditions. Couldn't you also use several echo cancellers in a given modem design to separate multiple overlapped transmitters sharing the same forward channel to create bit-parallel transmission paths? By blending multiple-carrier technology with EC and then introducing the advantages of integral error control and data compression, exotic modems of the future might be able to break the 100,000-bps speed barrier—an exciting prospect.

Certainly, the bandwidth of analog telephony is not infinite, and there are distinct limits as to how fast you can push data through the pipeline. In the late 1940s, Claude Shannon gave us a for-

mula for computing channel capacity that is based simply on the bandwidth and signal-to-noise ratio characteristics of the channel at hand. Using this formula, we computed an upper limit of 30,000 bps for 3-kHz phone lines that typically exhibit signal-to-noise ratios in the 30-dB range. Shannon's law applies to the base data rate of the modem's core engine, and all bets are off if we pre-compress the data stream before handing it to the modem engine for transmission. If we could develop the perfect Shannon engine—today's 19,200-bps machines are homing in—and add a 4-to-1 data compressor to it, 120,000-bps communication should result.

Some people think "anti-Shannon" engines may be feasible—modems that are capable of detecting and canceling noise sources in the phone lines. Such a belief arises from looking at background channel noise as the sum of multiple sources and the idea that some key-noise sources aren't entirely random.

If modems could be made intelligent enough to recognize the discrete contributions of these nonrandom noise sources and act to cancel their effects, significant increases in operating SNR and engine performance would result. Anti-Shannon machines offer the hope of link-performance boosts that are independent of a telephone system's age or quality. Combine such thinking with the continual improvement of the links themselves (use of fiber-optic trunk lines for terrestrial links and the addition of satellite and microwave channels to the mix of channel-routing alternatives), and the belief in continued higher operating speeds continues to brighten.

Dial-link machines aren't expected to rival the 1.544-megabit-per-second rates offered by T1 carrier operation; however, there's some distance to go before modem technology is saturated. By the 1990s, we may realize an order-of-magnitude boost above today's 9600-bps operating speeds.

Price and cost follow the degree of circuit integration and are responsive to sheer volume demand. If enough of us want to transmit the contents of a 10-megabyte hard disk across the country—or across the globe—in less than 2 minutes, it will probably happen. ■

John H. Humphrey and Gary S. Smock are general partners of TeleQuality Associates in Golden, Colorado, where they provide engineering consultation and telecommunications design and product testing. They can be reached on BIX c/o "editors."

VGA

A new way to look at color;
a better way to buy it.

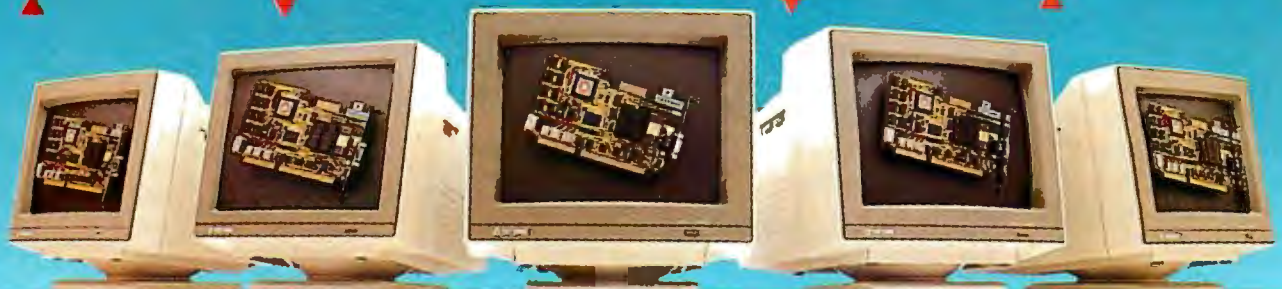

MM 1233 12" analog monochrome Grey scale MM 1433 14" analog monochrome Grey scale CM 1496 14" analog color 31mm dot pitch CM 1497 14" analog color 38mm dot pitch CM 1296 12" analog color 28mm dot pitch

Advantages are enhanced by Tatung VGA provides significantly higher resolution. In fact, image clarity is 37% higher than EGA. And while EGA gives you 16 on-screen colors, VGA puts 256 colors (from a palette of 262,144 colors) on a monitor's screen at a time. Distortion, ghosting, and even eye fatigue is sharply reduced. In text modes, characters (even those with descenders like y, p and g) are more clearly defined thanks to a 9 x 16 dot matrix. But, while the monitor is a vital part of a VGA system, we think the real key is the VGA card that goes with it.

The Tatung VGA card is all performance Ours is a 16-bit graphics array board with a single high speed, register compatible, VGA chip...a graphics controller that's incredibly fast (it has a bandwidth more than 7 times that of other VGA boards)! You can access this speed through the 16-bit data path to display memory, BIOS ROM, and I/O. Our exclusive SwiftWrite makes the wait state virtually non-existent. More? With 16 colors, resolution increases to 800 x 600. On-board is a 256K DRAM; and the card is backward compatible with EGA, CGA, MDA and Hercules graphics standards.

Tatung Monitors deliver the new standard We offer the broadest line of VGA monitors available; 5 newly styled and engineered monitors. Each model provides 640 x 480, 640 x 350 lines of graphics resolution; 720 x 400 lines for text. Tatung's new VGA monitors offer a broad range of features that contribute to their superior value: dark, non-glare CRT's, automatic vertical sizing encoding, multi-color text or reverse video switch, 110/220V switchable power supply, removable tilt/swivel bases...all supported by Tatung's full year warranty.

Tatung bundles provide superior value By bundling VGA monitors and cards, Tatung puts VGA within the reach of everyone. In most cases, the Tatung VGA bundle will cost no more than EGA packages! That's why we believe that feature for feature, dollar for dollar, the Tatung VGA bundle represents incomparable value. The kind of value only the largest manufacturer of monitors in the world can deliver.

In addition, Tatung offers users a huge advantage: a Tatung VGA bundle is 100% IBMTM VGA compatible and more...your investment in software is fully protected.

Tatung offers guaranteed compatibility Whenever a new standard is introduced, system users have a justifiable concern about software compatibility. That's why Tatung offers a unique guarantee*: if you note any software incompatibilities within the 1 year warranty period, Tatung will correct them free of charge within 30 days, otherwise the full value of the Tatung VGA card will be refunded.

That's the Tatung VGA story. It's a story worth seeing. For complete information, specifications, and the name of the Tatung dealer near you, and to arrange for a demonstration, call us today. After all, seeing is believing.



TATUNG

We monitor the world.

In Southern California: (213) 979-7055
In Northern California: (408) 435-0140
Outside California: (800) 421-2929

Tatung Company of America, Inc.
2850 El Presidio Street, Long Beach, CA 90810
Tatung Science & Technology, Inc.
2060 Ringwood Ave., San Jose, CA 95131

Circle 336 on Reader Service Card

IBM PC, XT & AT Systems and their compatibles. Refer to Tatung VGA Card Manual for specific details. All details included with each Tatung VGA card. All names are trademarks of their respective owners.

OS/2 Hits the Networks

*Expect to see the development
of more distributed applications*

Ken Thurber

If you operate a local-area network (LAN) and want to run OS/2, you'll face three different concerns. You'll need to provide OS/2 on user PCs; you'll need to understand distributed applications with OS/2; and you'll need to know how OS/2 operates as a server platform.

The first step you need to take to supply network support to an OS/2-based user PC is to extend the OS/2 environment. Applications running on the PC should be able to access files, printers, and devices located on and shared by servers on the network.

Next, you need to provide OS/2 support for network-wide user and system-administration features for the PC. The third step is to provide a networking system with enhanced communications capabilities so that the OS/2-based PC can access other networking and computer environments.

Distributing the Load

OS/2's support of multitasking and the networking of OS/2 PCs is bound to encourage distributed-applications development. These applications will be designed with a user/server architecture,

where the user portion is oriented toward the user interface and presentation, and the server portion is oriented toward shared-resource management.

Four basic components provide the underlying platform for distributed applications: the operating system on the user PC; the operating system on the server (see the text box "Pieces of the Puzzle" on page 286); the networking protocol

software that enables the PCs and the server to communicate; and the interprocess/intertask communications (IPC) mechanism. (The IPC is implemented on top of the other three components. It handles service requests and replies between the users and the server, respectively.)

OS/2 defines IPC mechanisms for communications between tasks running on the same PC. A particular architecture could extend these mechanisms so that the tasks running on both the user system and the server can communicate.

Besides basic components, a distributed-applications platform needs to provide a distributed naming system that can be used to connect a user to a server transparently. (A naming system can also provide a common view to the

user and the system administrator of distributed applications and network resources.) The platform should also supply an environment that lets you manage the server portion of the application from anywhere in the network.

Since OS/2 is a multitasking operating system, it is one choice for a network-server operating system. It's not your

continued

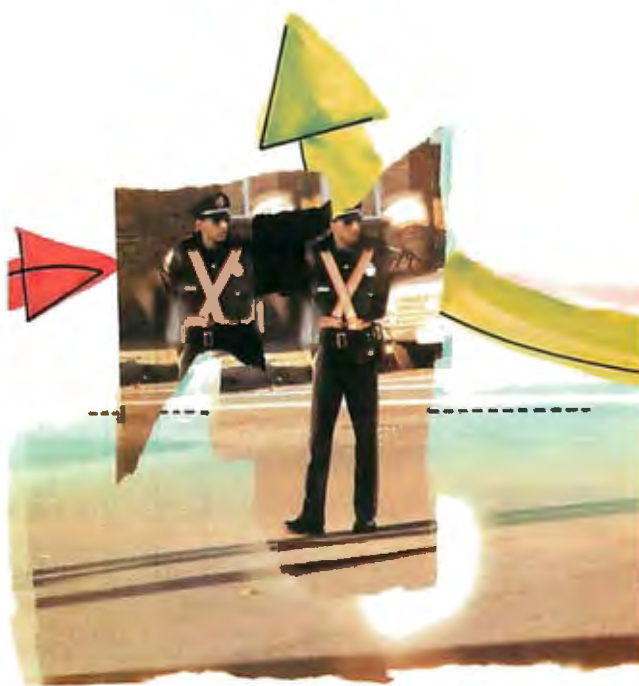

One of the key software components in a PC local-area network is the network operating system. And what is its primary purpose? To provide multi-user capabilities to a collection of single-user workstations.

In fact, LAN operating systems solve multiuser transparency problems, not applications problems. They provide a common syntax as well as error recovery to increase local and remote operation consistency. They also increase the portability of applications across different LANs and promote hardware independence. A LAN operating system's goal, then, is

- Transform a collection of hardware and software resources, namely the LAN and its PCs, into a coherent set of abstract objects or resources.
- Support naming, access, sharing, protection, synchronization, intercommunication, and error recovery.
- Multiplex and allocate these resources among many computations (PCs).

ing systems are not without their problems. For example, none of them addresses the issues of data translation and representation. In other words, most of them support only one type of PC and operating system.

It's also difficult to map a resource such as a file into this network of distributed service and resource structures, and error recovery in an operating system can be complex. Another problem you might notice in distributed systems is that multiple copies of the same software seem to propagate. This is one of the reasons why distributed administrative control in

ment can be a problem. In addition, if your local network operating system isn't efficient, it may become a bottleneck in the system. If the operating system can use only a small portion of the network bandwidth, it may not matter if the LAN is a 1-mega-bit-per-second or a 10-mbps system.

Figure A is a logical model of a LAN

operating system. In most PC LANs, there is actually a communications kernel distributed across all the PCs, regardless of whether the PC is a server, a workstation, or a nondedicated workstation/serve

This model represents a common mechanism of how you, as a LAN user, can communicate with the server. First, you send out a request from a PC or workstation. It goes through a communications kernel on your PC over the network and through the kernel on the server, where it performs a function or an operation. You then receive the server's reply, which travels through the same mechanism. Thus, there's at least one small piece of software, the kernel, that's common to all the ma-

Another common element is the user interface. The ideal user interface in a PC LAN operating system should at the minimum include all the following features:

- A choice between a menu-driven or a command-mode system; you may prefer a menu-driven system if you're a beginner, or a command-mode system if you have more experience
- The ability to set the default boot environment; in other words, a server should be able to download default software every time you log onto a network.
- The ability to execute server commands within turnkey applications; this shields you from mundane network details.
- On-line help not only for an application but for the network, too.
- An elegant way to recover from a crash in the LAN
- A locator to find a resource, cataloged in the

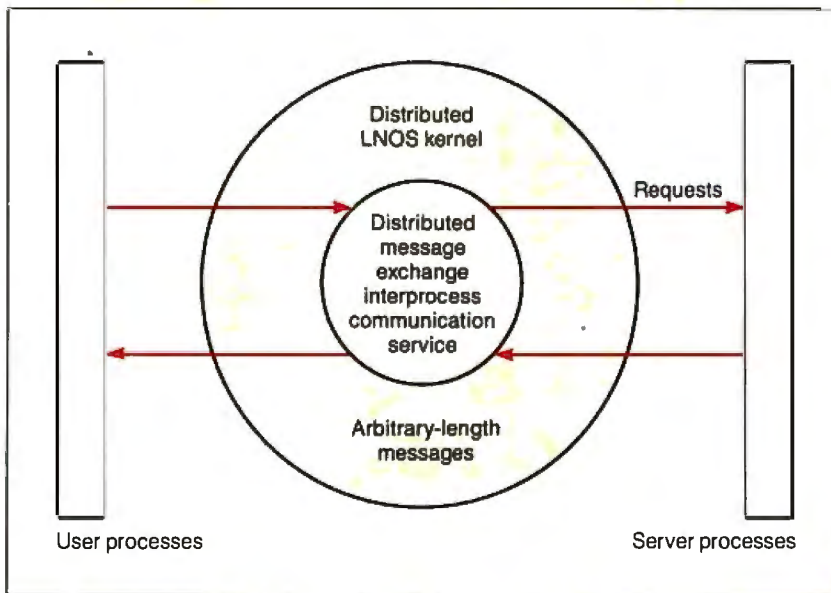

only choice, however. For instance, you could use Unix to provide these same services for OS/2-based PCs. You can also use OS/2 to implement the server portion of a distributed application, but there are other choices as well.

A networking system that includes a solution for OS/2-based servers needs to

provide support for an OS/2-based application server and coexistence with OS/2-based file and print servers.

The discussion that follows compares IBM's OS/2 LAN Server to 3Com's 3+Open operating system and also examines how Novell's NetWare fits into the picture.

Comparing Capabilities

Figure 1 illustrates the architectures of the OS/2 LAN Server, the 3+Open network server (which is based on the Microsoft OS/2 LAN Manager), and NetWare. They all support OS/2 network workstations. And, although it doesn't

continued



2400etc

The Next Generation in Modems

INCREDIBLY POWERFUL. AMAZINGLY AFFORDABLE. AND TOTALLY ERROR FREE.

Imagine a modem so powerful it could deliver twice the throughput of a 2400bps modem. So reliable it would only send 100% error free data. Pick up a 2400etc and experience it.

The 2400etc is a high performance internal modem for the IBM PC/XT/AT and compatible systems. It includes an ATI custom designed digital signal processor which allows the modem to function on extremely noisy lines.



"Smart Idea"

The 2400etc with MNP level 5 guarantees 100% error free data transfer. And, using data compression, provides throughput speeds above 4800bps.

\$239⁰⁰
SUGGESTED LIST PRICE

The 2400etc operates in MNP and non-MNP modes and uses automatic feature recognition to establish a connection at the highest mutual error control level and operating speed.

Other standard features include 100% compatibility with the full standard and extended AT command sets. Adaptive dialing – Tone or Pulse, Automatic dial, redial and answer. Four communications ports 1, 2, 3, 4. Software controlled speaker etc, as ATI proudly calls it.

All this...and a FREE copy of Mirror II communications software.

For use with IBM PC/XT/AT compatible systems.



Technology you can Trust.

ATI Technologies Inc., 3761 Victoria Park Avenue,
Scarborough, Ontario, Canada M1W 3S2.
Tel: (416) 756-0718 Telex: 06-966640 (ATI TOR)
Fax: (416) 756-0720.

ATI is a registered trademark of ATI Technologies Inc. IBM PC/XT/AT are trademarks of International Business Machines. MNP is a trademark of Microcom Corporation. Mirror II is a trademark of Softklone Distributing Corporation.

show in the figure, they are also all compatible with an IBM PC LAN workstation running DOS. In addition, 3+Open can have 3+Open network workstations running DOS.

The figure also shows the Open Systems Interconnection model. If you compare the OS/2 networking architectures to the OSI model, you'll notice the key compatibilities: An OS/2 server is used as the kernel to the network server and the Microsoft Redirector, and thus the server-message-block (SMB) file-system protocol is used.

In addition, IBM and 3Com support the NetBIOS and the data-link-control interfaces. IBM's Advanced Program-to-Program Communication protocol will be supported by the 3+Open server and will use the DLC interface to the physical network connection. Novell's NetWare also supports APPC. In fact, Netware,

along with the 3Com and IBM servers, will be compatible with applications developed by IBM and third-party developers and will adhere to the OS/2 program interfaces.

IBM has already announced several applications as part of its OS/2 Extended Edition. Independent third-party applications developers have announced products with similar functions that will be generally available for OS/2-based network systems.

3Com is expected to offer advanced network-service products, including such office-productivity applications as electronic mail and network management. IBM has not yet announced an intention to provide advanced network services for its OS/2 LAN Server, and Novell seems oriented toward third-party suppliers for development of service products.

Sharing the Work

Today's business applications tend to use the basic file-/print-sharing capabilities of network systems. In these applications, all computing is done at the network workstation. The shared disk of the network server stores data processed at the workstation and sends it to a shared printer for hard copy.

Under OS/2, many applications will be distributed. A distributed application shares computing power among network workstations and network servers. Rather than simply sharing disks and printers, the network server also shares computing power.

For example, in a nondistributed environment, you can sort the data in a database that contains names and addresses and render several different printed reports, depending on your requirements. With a distributed application, one or

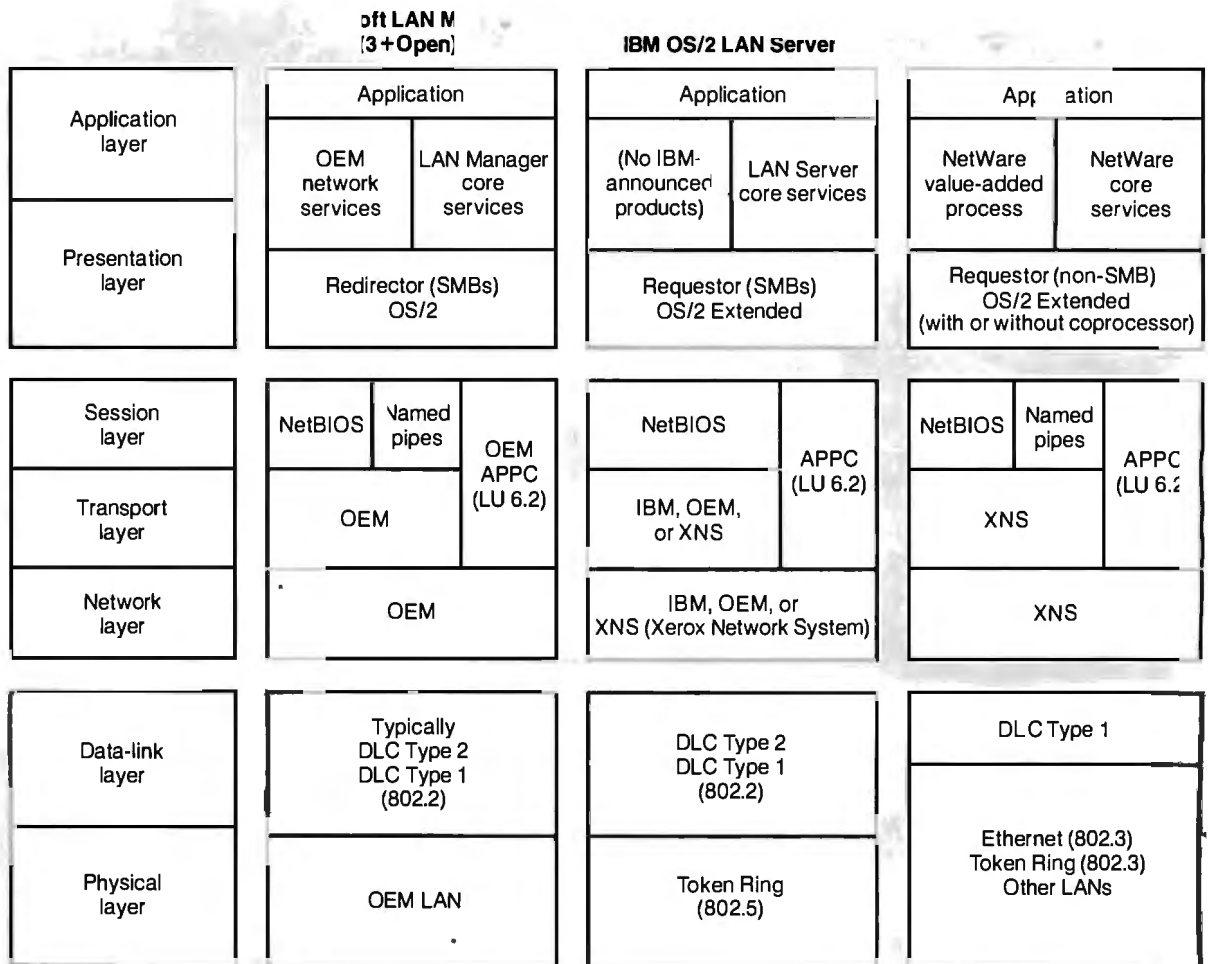

Figure 1: An Open Systems Interconnection and OS/2 architecture summary.

more of the tasks (such as sorting or reporting) would be sent to another computer on the network for processing. Depending on their design, distributed applications may offer many advantages, including efficiency, data security, and a better price/performance ratio for network computing resources.

IBM's OS/2 LAN Server clears the way to create distributed applications that have the potential to improve network workgroup efficiency (see the text box "The OS/2 LAN Server" on page 290). However, implementing the concepts involved will be difficult.

For distributed applications to work, network software must support OS/2 on both the network workstation and the network server. NetWare, 3+Open, and the OS/2 LAN Server all do this. Optionally, with NetWare, the network workstation can communicate to a proprietary

file server that passes OS/2 requests to a coprocessor board that is internal to the server.

VINES and OS/2

Banyan Systems currently supports both DOS-based and Unix-based servers in VINES. In addition, the company is committed to supporting all aspects of OS/2. By supporting OS/2, VINES can extend the services it now offers to include multitasking features for network-based PCs.

Four major categories of services will be available to an OS/2 workstation connected to a VINES network: NetBIOS, OS/2 connectivity, communications, and data management.

VINES will support OS/2 workstations through a Requestor module for file, print, and device sharing. The appropriate module will be invoked when

OS/2 determines that a file, print, or device I/O request is directed toward resources located on the network.

The Requestor module will formulate the request into a protocol packet and communicate with the VINES "socket" interface. VINES will also support the NetBIOS. Figure 2 shows VINES and OS/2 workstation integration.

VINES currently supports a platform for building distributed applications. All services and applications in the VINES product were implemented using this platform. The platform supports DOS clients that can use network-wide IPC mechanisms to communicate with Unix servers. A network compiler technology hides the details of this mechanism.

Banyan plans to extend its distributed-applications platform and will provide full support for IBM OS/2 and OS/2 Ex-

continued

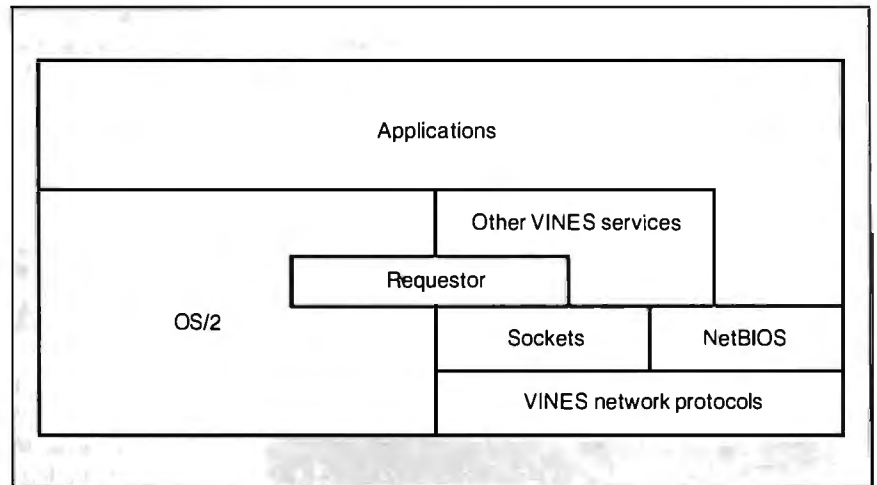
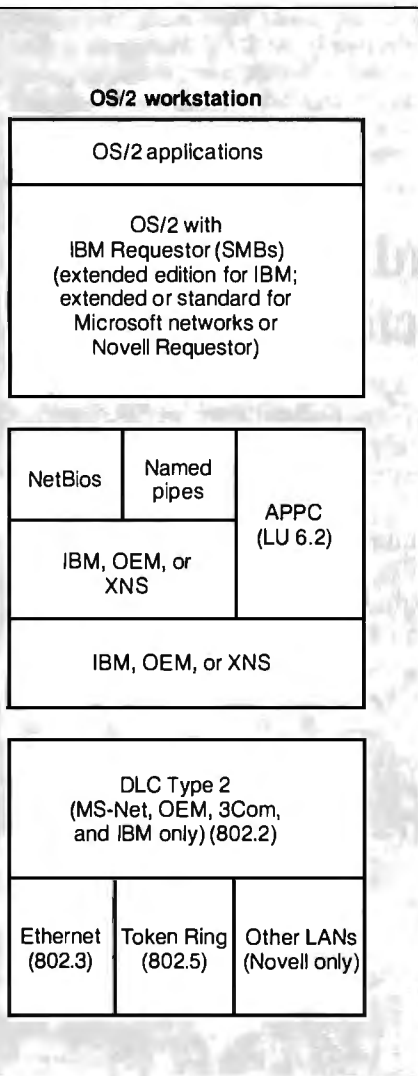

Figure 2: The Banyan VINES and OS/2 workstation architectures.

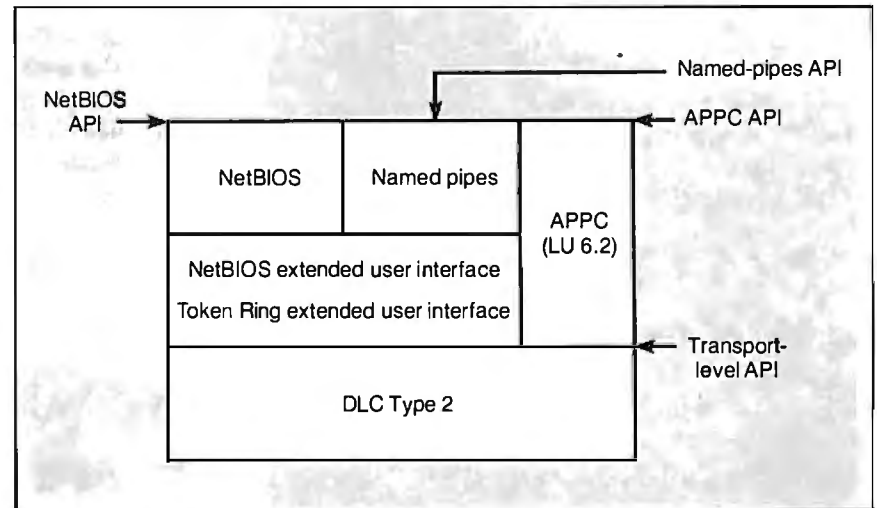

Figure 3: The APPC, NetBIOS, and transport-level APIs.

The OS/2 LAN Server

One good point about IBM's OS/2 announcement was that it helped bury speculation concerning the technologies and architectures to be endorsed for the company's OS/2 network product, OS/2 LAN Server. Based on the announcement, OS/2 LAN Server apparently incorporates key technologies derived from the 3Com and Microsoft joint development of the OS/2 LAN Manager.

Specifically, IBM's announcement reaffirmed that software developers should write to the open programmatic interfaces of OS/2 rather than to propri-

etary systems. It also made clear that IBM endorses OS/2 network servers as a key component of an open-system applications platform for distributed network applications, meaning that OS/2 support on both network workstations and servers is important.

And last, but not least, IBM reaffirmed Advanced Program-to-Program Communication use in the IBM PC LAN Program that uses the Microsoft Redirector, server-message-block protocol, and NetBIOS. These are the same protocols and standards incorporated in the OS/2 LAN Manager.

OS/2 addresses three major needs. It provides protected-mode operation to fully utilize the 16-bit processing and increased memory-addressing capabilities of the newer PCs. It supports multitasking and the necessary intertask communications facilities. And it supports the new generation of hardware system architectures, such as the PS/2s.

When, in the past, MS-DOS dominated the IBM PC and PC-compatible operating systems, the major network operating systems all adopted a DOS-like appearance. With the advent of OS/2, however, this may change.

tended PCs connected to a VINES network. Support for the NetBIOS and APPC interfaces will be provided for both DOS and OS/2. VINES will support all applications interfaces for network and distributed applications as defined by IBM OS/2, OS/2 Extended, and the LAN Server Program.

Microsoft's LAN Manager defines four applications interfaces: OS/2 file, print, and device sharing; the NetBIOS interface; networking extensions to the OS/2 IPC mechanisms; and user workstation and administration interfaces.

VINES will be compatible with the first two interfaces. The third interface

is an alternative network IPC mechanism. Support will be included if there is a strong need. The fourth interface is specific to the LAN Manager's implementation of file, print, and device sharing on an OS/2 server and in Banyan's view is not necessary for OS/2 connectivity or IBM compatibility.



Dennis & Debbie Miller

The Grand Canyon of the Arctic

In Alaska there's a place as magnificent and rare as the Grand Canyon—the Coastal Plain of the Arctic National Wildlife Refuge. Oil companies want permission from Congress to drill there (even though the odds are four in five that no oil exists). That's like damming the Grand Canyon for hydropower.

Approval to drill will destroy what's left of Alaska's north coast and deny future generations the beauty of our most spectacular Arctic wilderness. To learn how you can help us preserve it, write or call: Sierra Club, 730 Polk Street, San Francisco, CA 94109, (415) 776-2211.



SIERRA CLUB



All About Named Pipes

Named pipes are an IPC mechanism supported mainly by the Microsoft LAN Manager and Unix. Named pipes provide an interface that extends the IPC of OS/2 transparently across the network. They offer a higher-level interface to APPC, NetBIOS, or the network-transport layer, so it's easier to create an application that uses remote procedure calls across the network.

Many developers believe that named pipes, a complement to the interprocess pipes used throughout OS/2, enhance productivity and workgroup applications, while APPC is best-suited for program-to-program communications among homogeneous IBM PCs, mini-computers, and mainframes.

Named pipes let an applications developer access a computing resource (which may be located elsewhere on the network) as if it were local. They do this by simplifying the effort of building network-intrinsic applications.

Named-pipe availability, however, doesn't exclude you from developing applications that directly use the APPC, NetBIOS, or transport-level APIs (see figure 3).

Developers of network-intrinsic applications believe this interface is most appropriate for office-productivity applications that don't require access to larger homogeneous IBM systems as their primary function. However, the applications won't function in an IBM OS/2 LAN Server environment.

Keeping a Secret

What no one likes to talk about is why 3Com's and Novell's past approaches have outperformed the IBM PC LAN Program.

The answer is simple: The PC LAN Server uses DOS as its native operating system, while 3Com and Novell designed special high-performance proprietary server operating systems.

But if 3Com and Novell include OS/2 as the server-based operating system, what will happen to their performance? Note that 3Com continually stresses the idea of its "core"; that means either that 3Com will run OS/2 and be saddled with performance comparable to IBM's or that it must enhance the operating system and end up with some level of incompatibility. ■

Ken Thurber is president of Architecture Technology Corp., a consultancy and publisher based in Minneapolis, Minnesota. He can be reached on BIX c/o "editors."

SERIAL COMMUNICATION DATA ACQUISITION IEEE-488 CONTROL INTERFACE CARDS FOR IBM PC AND PS/2



TOLL FREE: 1-800-553-1170

478 E. Exchange St., Akron, Ohio 44304
(216) 434-3154 TLX: 5101012726 FAX: (216) 434-1409

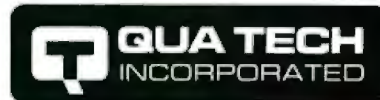

NEW

Control Panel™ makes it easier!

Five major functions in one integrated program
Keyboard or mouse operation

- **Menu Services**
one-touch menu execution of any DOS program without conflict or memory overhead
- **Disk Services**
complete disk management utilities
- **DOS Services**
forget about complicated DOS commands
- **Desktop Services**
calculator, calendar and notepad
- **Communication Services**
integrated voice and data support with scripts, file transfer and terminal emulation
- **Automatic Menu Setup**
sets up menu entries for any of hundreds of popular programs it finds on your disk



For the dealer nearest you call:

(800) 321-9916

Promark, Ltd.

6207 Pan American Freeway, NE
Albuquerque, NM 87109
(505) 345-7701

\$99 special introductory price

Full function 30 day evaluation copy
with complete manual — \$14

*Multi-user, network, OEM and
site license versions available.*

Are you tired of seeing **RED?**

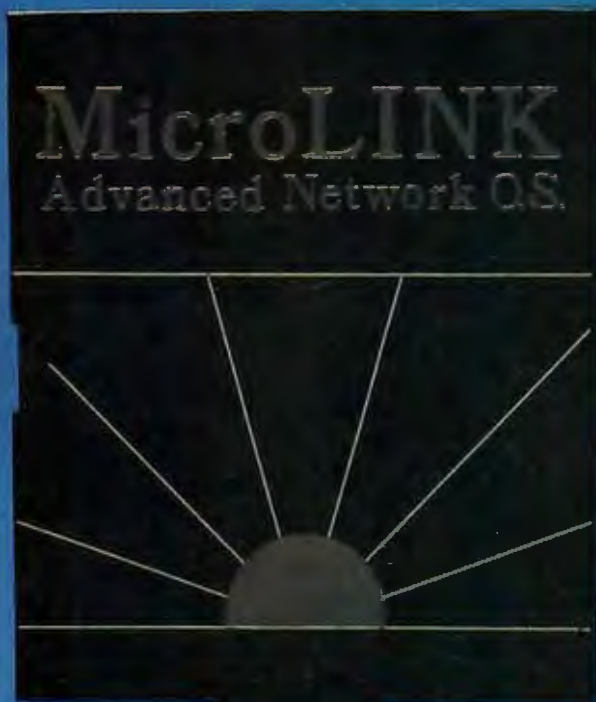

If you are developing a network application for the PC or PS/2, you should consider MicroLINK Network Developer's Kit.

MicroLINK Network Developer's Kit will give you a complete SMB protocol redirector, server and memory management for use on any standard NETBIOS.

Very High Performance

MicroLINK is a very high performance network operating system. In most environments it is 75% faster than the so-called industry leader.

Easy to Implement

MicroLINK comes as stand alone software modules. MicroLINK can be interfaced through MS C or MASM calls.

Low Memory Requirements

MicroLINK requires less than 40k bytes for a user, or 64k bytes for a **nondedicated** server. MicroLINK can also use EMS memory for even lower memory requirements.

Four Nodes Complete

MicroLINK Network Developer's Kit gives you four (4) nodes to develop your applications on. You can easily purchase additional nodes as you need them. You will also receive NETBIOS interfaces for WD8003E and WD8003ET/A ethernet adapters and others. Complete Developer's documentation is included which outlines all network programming interfaces.

For network developing without the headache,
MicroLINK Network Developer's Kit

Available at Programmer's Shop, Programmer's Connection and Programmer's Paradise

Simple NET Systems, Inc. • 545 West Lambert Road • Suite A • Brea, California 92621
(800) 262-8010 • IN CALIFORNIA (714) 529-8850 • FAX (714) 529-2413

MicroLINK is a registered trademark of BESoft Corp. Other brand and product names are trademarks of their respective holders.

When One LAN Is Not Enough

Bridges, routers, and gateways can "network the networks"

William Stallings

The growth of personal computers in the office environment has triggered two dramatic developments in rapid succession. The first was the introduction of personal computer local-area networks. The second was the interconnection of these LANs to each other and to other types of LANs.

A single LAN hardly solves all of a business's interconnection problems. Like it or not, the wide-ranging mix of computers found in typical corporations often requires more than one LAN for service. The word processors in one department, the personal computers in another, and the mainframes in the back room all need their own types of LANs. As a result, LANs of many sorts, using everything from simple twisted-pair cabling to hyperfast optical fiber, have found their way into offices and labs. Internetworking protocols, therefore, are now a necessity.

In fact, the "networking of networks" takes place within single buildings and across continents as corporations attempt to provide company-wide access to electronic files, services, and resources. Electronic-mail systems, for example,

gain value geometrically as new users are brought on-line, a procedure that often requires differing LANs to be linked efficiently and transparently.

Bridges, Routers, and Gateways

Internetworking technology has yielded three types of products: bridges, routers, and gateways (see figure 1 and the text box "Making the Right Decision" on

page 295). In essence, a bridge operates at layer 2 of the Open Systems Interconnection (OSI) seven-layer architecture and acts as a relay of frames between like networks.

A router operates at layer 3 of the OSI architecture and routes packets between dissimilar networks. Both the bridge and the router assume that the same upper-layer protocols are in use. The gateway operates at layer 7 and provides a link between dissimilar architectures (e.g., OSI and Standard Network Architecture) on either the same network or different networks. I'll first look briefly at bridges and then at the functions and standards for routers.

How Bridges Operate

To understand the action of a bridge, consider first how communication takes place among devices attached to a single LAN. For example, on a bus-topology LAN, similar to ring topologies, data on the bus is transmitted in packets. So, if host computer X wishes to transmit a message to host computer Y, X breaks its message into small pieces that are sent, one at a time, in packets.

continued



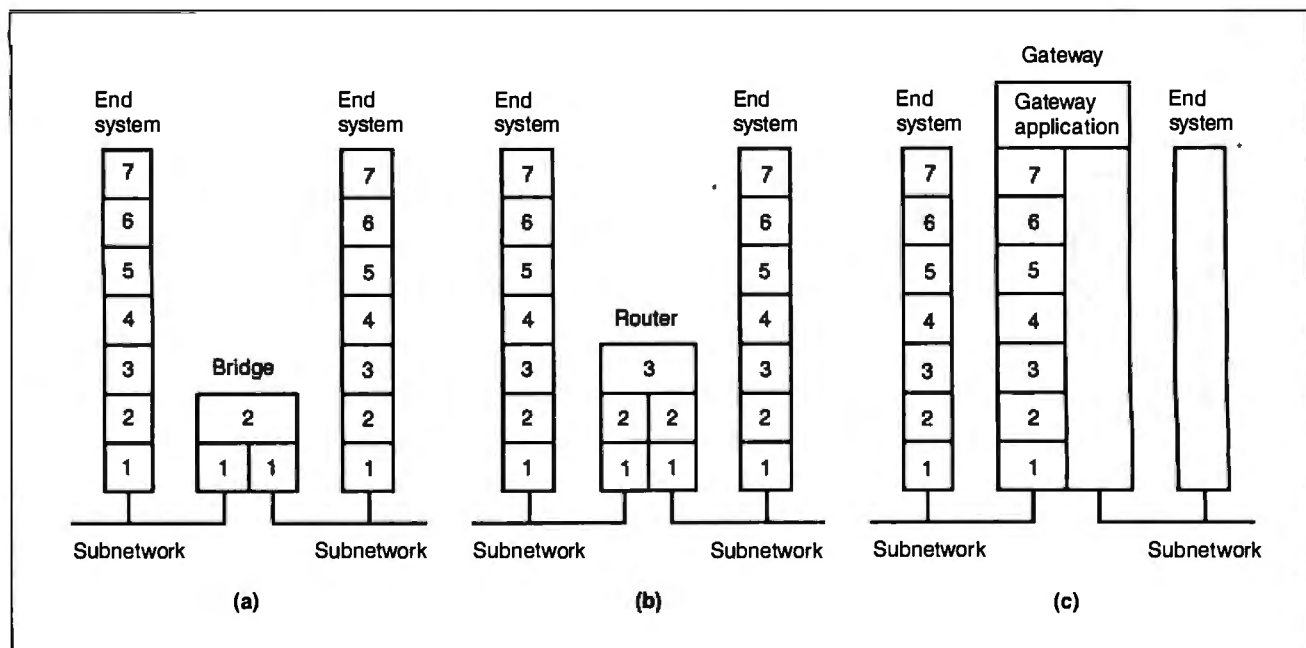

Figure 1: Internetwork devices: (a) bridge, (b) router, and (c) gateway. (The numbers refer to the OSI layers.)

Each packet header includes, among other items of control information, the address of Y. Based on some medium-access control technique (e.g., CSMA/CD or token bus), X inserts each packet onto the bus. The packet propagates the length of the bus in both directions, reaching all other hosts. When Y recognizes its address on a packet, it copies the packet and processes it.

Now suppose you want to link two LANs, A and B, using the same protocols. You can do this using a bridge attached to both LANs (frequently, the bridge function is performed by two "half-bridges," one on each network). The functions of the bridge are few and simple:

- Read all packets transmitted on A and accept those addressed to any host on B.
- Using the medium-access control protocol for B, retransmit each packet on B.
- Do the same for B-to-A traffic.

The bridge doesn't modify the content or format of the packets it receives, nor does it encapsulate them with an additional header. Each packet to be transferred is simply copied from one LAN and repeated with exactly the same bit pattern on the other LAN.

Since the two LANs use the same LAN protocols, it's permissible to do this. The bridge must contain addressing and routing intelligence. At a minimum, the bridge must know which addresses are on each network to know which pack-

ets to pass. Further, there may be more than two LANs interconnected by a number of bridges. In that case, a packet may have to be routed through several bridges in its journey from source to destination.

The bridge provides a transparent extension to the LAN. It appears to all hosts on the two (or more) LANs that there is a single LAN on which each host has a unique address. The host uses that unique address and need not explicitly discriminate between hosts on the same LAN and hosts on other LANs; the bridge takes care of that.

All about Routers

Router operation, as figure 1b indicates, depends on a protocol at OSI layer 3 (network layer), sometimes known as an *internet protocol*. Figure 2 depicts a typical example. Let's say you have a number of PC LANs in your organization; perhaps each supports a separate department. In addition, there's a backbone LAN that links all the PC LANs to each other and also supports minicomputer and mainframe resources that are accessible company-wide.

Figure 2 shows the operation of the internet protocol for data exchange between host A on PC LAN 1 and host B on PC LAN 3 through a backbone LAN. These hosts and the routers must share a common internet protocol, such as the International Standards Organization (ISO) standard protocol for connectionless network service or the Department

of Defense (DoD) standard internet protocol (see the text box "Raising the Standard" on page 297); in either case, this is referred to as IP.

In addition, to communicate successfully, the two hosts must share the same protocols above IP. For example, the two hosts must both have the same transport protocol, such as the ISO standard transport protocol (TP) or the DoD standard transmission-control protocol (TCP).

The IP at A receives blocks of data to be sent to B from the higher layers of software in A. IP attaches a header specifying, among other things, the global internet address of B. That address is in two parts: network identifier and host identifier. I'll refer to this block as the IP datagram. Next, IP recognizes that the destination, B, is on another network. So the first step is to send the data to a router, in this case router α . To do this, IP hands the datagram down to the LAN protocol, which appends a header that includes the address of router α , forming a packet.

Next, the packet travels through LAN 1 to router α . The router strips off the packet header and analyzes the IP header to determine the ultimate destination of the data, in this case B. The router must now make a routing decision. There are two possibilities:

- The destination host B is connected directly to one of the subnetworks to which the router is attached;

continued

Making the Right Decision

The simplest of the internetworking devices is the bridge. This device is designed for use between local-area networks (LANs) that use identical protocols for the physical and link layers. Because the devices all use the same protocols, the amount of processing required at the bridge is minimal.

Since the bridge is used when all the LANs have the same characteristics, why not simply have one large LAN? Depending on the circumstances, there are several reasons for using multiple LANs connected by bridges:

- **Reliability.** The danger in connecting all data-processing devices in an organization to one network is that a fault on the network may disable communication for all devices. By using bridges, the network can be partitioned into self-contained units.
- **Performance.** In general, performance on a LAN declines with an increase in the number of devices or the length of the wire. A number of smaller LANs will often give improved performance if devices can be clustered so that intranetwork traffic significantly exceeds internetwork traffic.
- **Security.** The establishment of multiple LANs may improve security of communications. It's desirable to keep different types of traffic (e.g., accounting, personnel, strategic planning) that have different security needs on physically separate media. At the same time, different users with different levels of security need to communicate through controlled mechanisms.
- **Geography.** Clearly, two separate LANs are needed to support devices clustered in two geographically distant locations. Even in the case of two buildings separated by a highway, it may be far easier to use a microwave bridge link than to attempt to string coaxial cable between the two buildings.

Routers

You can only use bridges to connect similar LANs. Of course, in many cases, you might need access to devices on several types of networks.

A general-purpose device that can be used to connect dissimilar networks and that operates at layer 3 of the Open Systems Interconnection (OSI) model is known as a router. The router must be able to cope with a variety of differences among networks, such as the following:

- **Addressing schemes.** The networks may use different schemes for assigning

addresses to devices. For example, an IEEE 802 LAN uses either 16-bit or 48-bit binary addresses for each attached device; an X.25 public packet-switching network uses 12-digit decimal addresses (encoded as 4 bits per digit for a 48-bit address). Some form of global network addressing must be provided, as well as a directory service.

- **Maximum packet sizes.** Packets from one network may have to be broken into smaller pieces to be transmitted on another network, a process known as segmentation. For example, Ethernet imposes a maximum packet size of 1500 bytes; a maximum packet size of 1000 bytes is common on X.25 networks. A packet transmitted on an Ethernet system and picked up by a router for retransmission on an X.25 network may have to be segmented by the router into two smaller ones.
- **Interfaces.** The hardware and software interfaces to various networks differ. The concept of a router must be independent of these differences.
- **Reliability.** Various network services may provide anything from a reliable end-to-end virtual circuit to an unreliable service. The operation of the routers should not depend on an assumption of network reliability.

There is a place for both bridges and routers in planning the development of an internet. Bridges are easy to configure and have no effect on the host software. In an environment where all the communicating devices are on similar LANs, this is the appropriate solution. If you have a mixed environment, you need the more complex routers. However, even then, you can use bridges to interconnect some of the LANs.

Gateways

You can use bridges and routers to solve internetwork problems in an environment when all the devices implement compatible protocols from the OSI model. This is the ideal situation. However, there will be times when a proprietary network architecture such as Standard Network Architecture (SNA) has already been installed.

Because of the investment in the proprietary system, it's expensive and disruptive to attempt to replace all the communications software with OSI-based software. On the other hand, you want to use OSI to gain access to products from a variety of vendors.

The gateway provides a way to permit the coexistence of OSI-based and pro-

proprietary products and gives you the tool you need to plan and implement a smooth migration to an exclusive OSI strategy. It's a device that connects different network architectures by performing a conversion at the application level. The gateway itself must use all seven layers of the OSI model, plus all layers of the proprietary architecture.

The gateway is used as a staging area for a two-step transfer of data. Consider a file transfer as an example. In the OSI world, the file-transfer standard is file transfer, access, and management (FTAM). Two OSI hosts can exchange files using FTAM. Similarly, two hosts with proprietary architectures can exchange files using the proprietary file-transfer application. If a mixed transfer is attempted from an OSI host to a proprietary-software host, then the sending host automatically (without user intervention) sends the file to a gateway using FTAM. The gateway accepts the file and then transfers it to the intended destination using the proprietary file-transfer protocol. A transfer in the reverse direction proceeds similarly.

Other applications (e.g., electronic mail and document architecture) can also be achieved via gateway. Thus, the gateway must contain both the OSI version and the proprietary version of any application requiring gateway services.

Using a gateway has several key limitations. For instance, the gateway is a potential bottleneck. In an environment where there are large numbers of both types of hosts, there may be considerable traffic through the gateway. To overcome performance limitations, you might need more than one gateway. This complicates the host software, which must now decide which gateway to use for each transfer.

Also, the service provided for a given application is the "least common denominator." For example, FTAM supports the use of priorities. If the proprietary file-transfer protocol does not, then the priority discipline is imposed only between the OSI host and the gateway. From the gateway to the other host, no priority scheme is used.

The market for gateways is projected to grow rapidly. This is because OSI-based products are becoming increasingly prevalent and cost-competitive, while there is and will remain for some time a large installed base of systems based on proprietary communications architectures, especially SNA. While the gateway is not ideal, it provides a way to cope with a mixed environment.

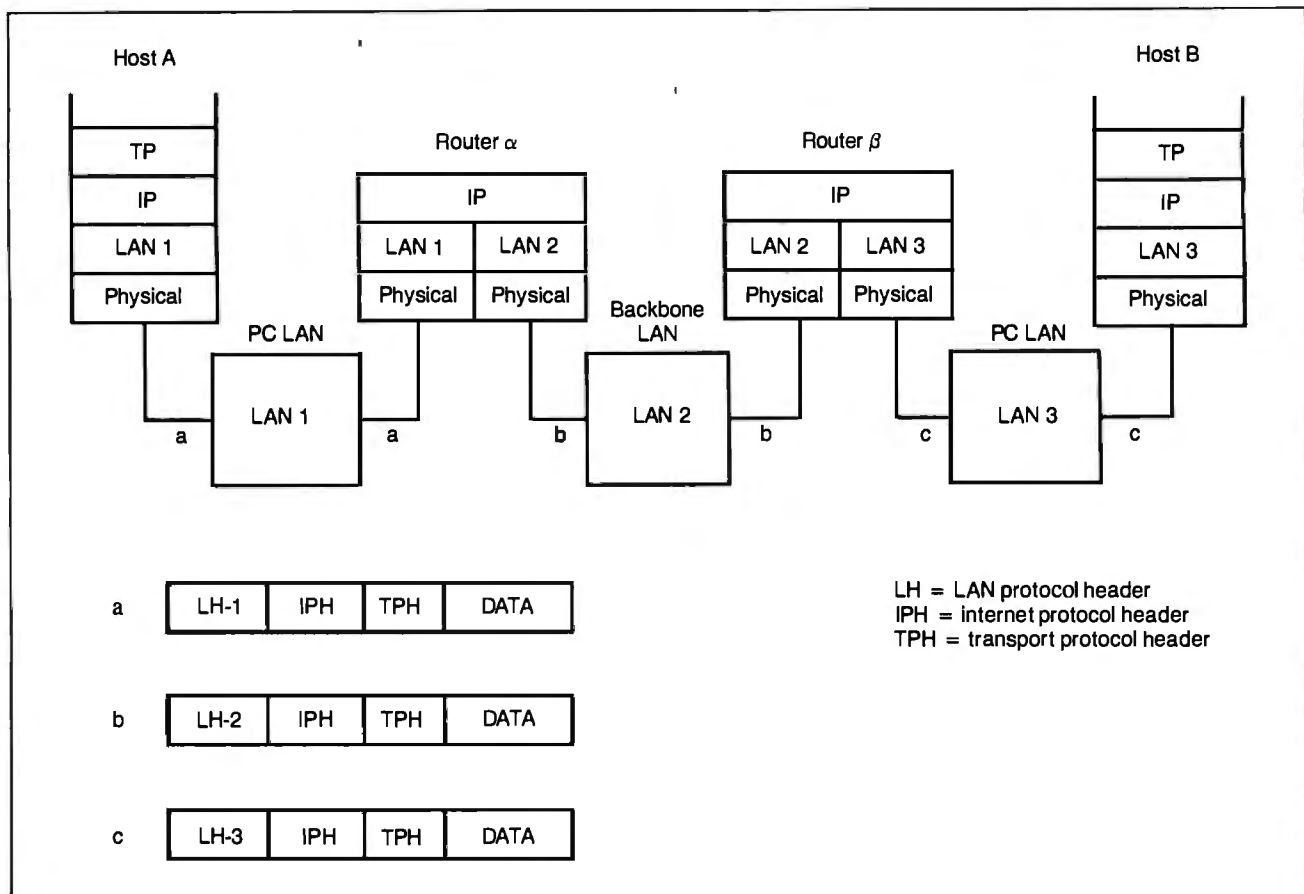

Figure 2: The host machines and routers share the same internet protocols. The hosts also share the same transport protocols.

• or, to reach the destination, the packet must traverse one or more additional routers.

In this example, the data must be routed through router β before reaching the destination. So router α constructs a new packet by appending a LAN protocol header to the IP data unit containing the address of router β . When this packet arrives at router β , the packet header is stripped off. The router determines that this IP data unit is destined for B, which is connected directly to a network to which the router is attached. The router therefore creates a packet with a destination address of Y and sends it out onto LAN 3.

At each router, before the data can be forwarded, the router may need to segment the datagram in order to accommodate a smaller maximum packet size on the outgoing network. In such a case, the datagram is split into two or more segments, each of which becomes an independent IP datagram. Each new datagram is wrapped in a lower-layer packet and queued for transmission. The router may also limit the length of its queue

for each network to which it attaches to avoid having a slow network penalize a faster one. Once the queue limit is reached, additional datagrams are simply dropped.

This process continues through as many routers as necessary for the datagram to reach its destination. The destination host recovers the IP datagram from its network wrapping the same way the router does. If segmentation has occurred, the IP module in the destination host buffers the incoming data until it can reassemble the entire original data field. This block of data is then passed to a higher layer in the host.

The IP doesn't guarantee that all data will be delivered or that the data that is delivered will arrive in the proper order. It's the responsibility of the next higher layer, the transport layer, to recover from any errors that occur. This approach may not be completely reliable, but it provides for a great deal of flexibility.

The IP approach means that each unit of data is passed from router to router in an attempt to get from source to destination. Since delivery is not guaranteed,

there is no particular reliability requirement on any of the subnetworks.

Thus, the protocol will work with any combination of subnetwork types. Since the sequence of delivery is not guaranteed either, successive data units can follow different paths through the internet. This allows the protocol to react to congestion and failure in the internet by changing routes.

But What Is Its Function?

The routing function is typically accomplished by maintaining a routing table in each host and router that gives, for each possible destination network, the next router to which the IP datagram should be sent.

The routing table can be static or dynamic. In the case of a simple configuration, such as a collection of PC LANs and a single backbone LAN, a static table is adequate. For a more complex configuration involving a number of LANs at different locations and perhaps one or more wide-area networks, the static table has several drawbacks. It doesn't allow alternate routing for load leveling, and it doesn't provide for rapid reconfiguration

Raising the Standard

The International Standards Organization (ISO) has issued a standard for an internet protocol, the Protocol for Providing the Connectionless-Mode Network Service (IS 8473), often referred to as ISO-IP.

The protocol is best understood by examining its header format (see figure A). Data to be transmitted is inserted into a datagram with the ISO-IP header with the following fields:

- **Protocol identifier.** When the source and destination hosts are connected to the same network, an internet protocol is not needed. In that case, the internet header is null, except for a special code in this field.
- **Length indicator.** Length of the header in octets.
- **Version.** Included to allow revisions to the standard.
- **PDU lifetime.** This field is used to specify the maximum number of routers a datagram can visit so as to prevent endlessly circulating datagrams. The value is specified in units of 500 milliseconds, but it is generally assumed that each unit represents one "hop."
- **Flags.** The SP flag indicates whether segmentation is permitted. The MS flag is the More flag described in the main text. The ER flag indicates whether an error report is desired by the source host if a datagram is discarded.
- **Segment offset.** Used in the segmentation and reassembly operations.
- **Type.** Indicates whether this datagram contains user data or an error message.
- **Checksum.** Computed on the header at each router for error detection.
- **Options.** Optional parameters include Security, defined by the user; Source Routing, which allows a source host to dictate the routing; Recording of Route, used to trace the route a datagram takes; Priority; and Quality of Service, which specifies reliability and delay values.

The Military Standard

As part of its suite of standards, generally referred to as the TCP/IP protocol suite, the U.S. Department of Defense has issued a standard for an internet protocol. Actually, the DOD-IP predates and is the inspiration for the ISO-IP. Although the formats and details of

DOD-IP and ISO-IP differ, they provide essentially the same functionality.

Because DOD-IP and other military standards have been around longer, they are more widely used than the ISO standards. In particular, a number of vendors provide TCP/IP-based products and routers employing DOD-IP.

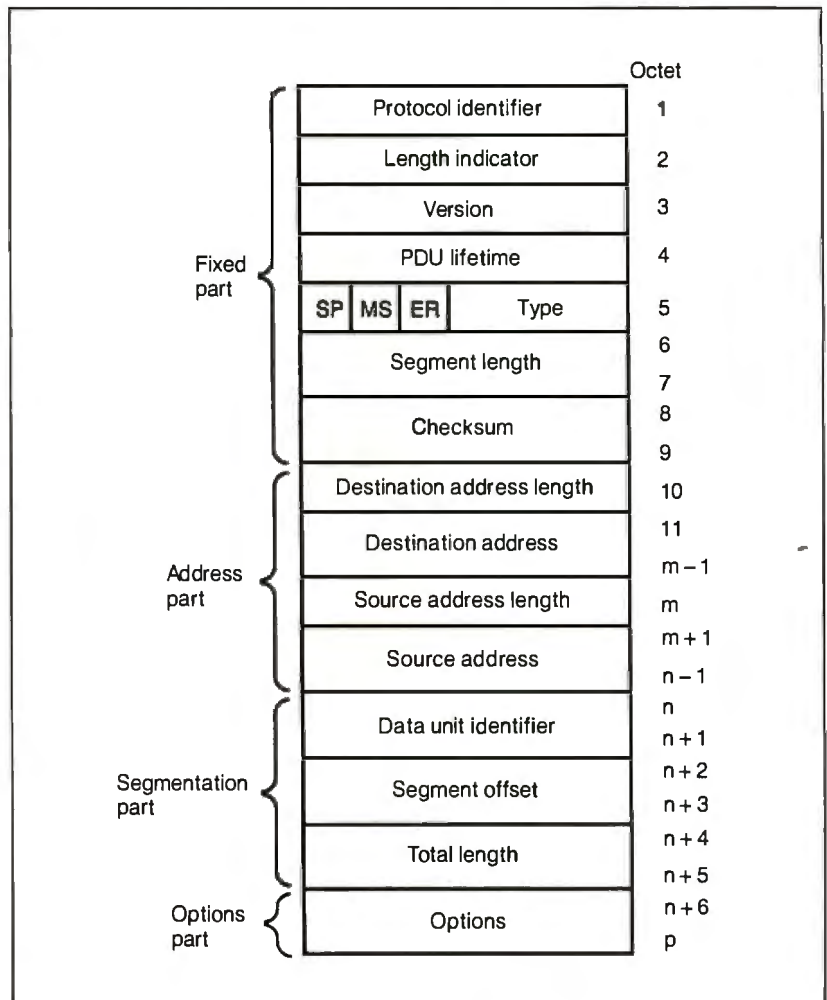

Figure A: The 15-part header format for the ISO-IP, the ISO's standard for an internet protocol.

in the event of a router failure.

A dynamic table is more flexible in responding to both error and congestion events. For this technique, there must be a protocol that will allow the routers to exchange information about congestion and the topology of the configuration. This area is still experimental; the required router-to-router protocols are still evolving.

Achieving Segmentation

Both the ISO and DoD IPs specify the same technique for segmentation. The technique requires the following fields in the datagram header: ID, Length, Offset, and More flag. The protocols use the ID to uniquely identify a host-originated datagram. The ID consists of the source and destination host addresses and a sequence number. The Length is

the length of the user data field in octets, and the Offset is the position of a segment in the original datagram in octets.

The IP layer in the source host creates a datagram with Length equal to the entire length of the data field, Offset = 0, and the More flag set to false. In order to segment a long datagram, an IP mod-

continued

Table 1: The segmentation of a datagram.

Segmentation example		
Original datagram	First segment	Second segment
Length=472	Length=240	Length=232
Offset=0	Offset=0	Offset=240
More=false	More=true	More=false

ule in a router performs the following tasks:

- It creates two new datagrams and copies the IP header fields of the incoming datagram into both.
- It divides the data into two approximately equal portions, placing one portion in each new datagram.
- It sets the Length field of the first datagram to the length of the inserted data and the More flag to true. The Offset field remains unchanged.
- It sets the Length field of the second datagram to the length of the inserted data, and it adds the length of the first data portion to the Offset field. The More flag remains the same.

Table 1 gives an example of the segmentation of a datagram. The procedure can be generalized to an *n*-way split.

To reassemble a datagram, there must be sufficient buffer space at the reassembly point. As segments with the same ID arrive, their data fields are inserted into the proper position in the buffer until the entire original datagram is reassembled; this is achieved when a contiguous block of data is buffered, starting with an Offset of 0 and ending with data from a segment with a false More flag.

Typically, reassembly is done at the destination host, to avoid burdening routers with unnecessarily large buffer space and to permit segments to arrive via different routes.

The Future

The use of internetworking is growing rapidly, and all types of devices will play a role in the future. You can use a bridge primarily to link LANs that use the same networking protocols.

Bridges don't provide links to other kinds of LANs or long-haul networks. You can use a gateway as a special-purpose protocol converter. The only truly general-purpose device of the three is the router.

The international standards are gradually gaining wider acceptance and clearly represent the wave of the future. We can expect to see a rapid increase in ISO-IP-based LANs and routers over the next year or two. ■

Editor's note: This article is based on material in the second edition of the author's Data and Computer Communications (New York: Macmillan, 1988).

William Stallings is president of CompComm Consulting of London, England, and the author of 12 books on data communications topics. He can be reached on BIX c/o "editors."

Important TIPS* for BYTE Subscribers: Receive Product Information 10 Days Earlier!

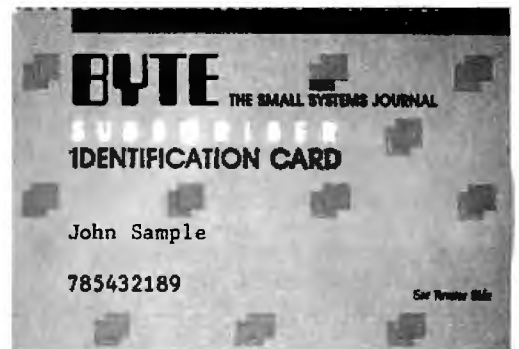

All you need is a touch-tone telephone and your subscriber I.D. number. See instructions facing the Reader Service Index in the back of this issue for outrageous time-saving opportunities!

*BYTE's Telephone Inquiry Processing Service

Knowledge, Experience & Expertise your most valuable resources.

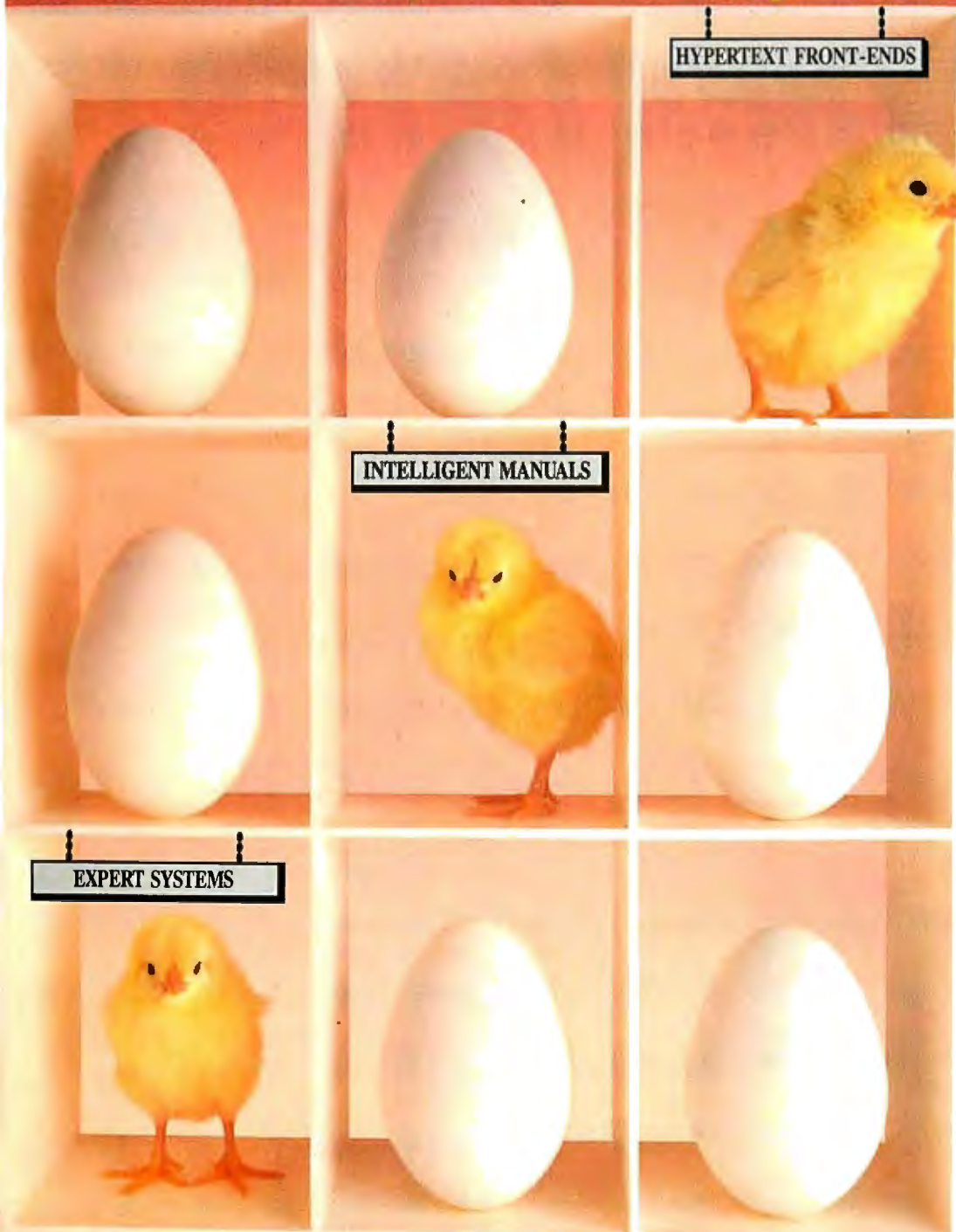

Now available on the IBM PC!

KnowledgePro® is a tool for "explaining things" using a computer. It combines **HYPERTEXT** and **EXPERT SYSTEM** technologies in a high-level language to let you write stand-alone applications or add an intelligent, aesthetic interface to your existing programs.

KnowledgePro stores knowledge in natural "chunks" called topics. It lets non-programmers communicate complex information using simple commands like **SAY**, **ASK**, **IF**, **DO** and **PICTURE**.

KnowledgePro lets you integrate hypertext, rules, math, lists, and logic quickly and easily. With our Database Toolkit you can read Lotus 123 and dBASE III files. The Graphics Toolkit lets you define hypergraphics using PC Paintbrush images. The VideoDisk Toolkit provides complete control of interactive laser video.

KnowledgePro reads, writes and searches text files. You can include routines written in other languages and call other programs.

Your **KnowledgePro** application can ask users for information you need to bring together resources and explanations they need. You can retrieve text, graphics, data, and video information, perform calculations, create text files and run programs based on each user's unique problems, interests and level of expertise. "I recommend that you check out *KnowledgePro*", said Steve Ciarcia of BYTE. "So much fun to work with", said Mickey Williamson in PCWEEK. "I LOVE *KnowledgePro*. It's less like programming and more like writing", said Dan Shafer of PC AI.

KnowledgePro runs on IBM PC XT, AT and PS/2 compatibles with 640k. It costs \$495 plus \$8 shipping (\$58 foreign). There are no run-time charges, so you don't have to pay more to distribute applications. The Database, Graphics and VideoDisk Toolkits cost \$49, \$89 and \$249 respectively. KnowledgeMaker our induction system for creating rules from data costs \$99. Stock Expert, a system for the personal investor, costs \$249. A working demonstration system, with a 100 page manual, is available for \$30 plus \$5 shipping (\$8 foreign) with credit toward purchase of the full system.

Circle 146 on Reader Service Card

Call 518-766-3000

(FAX 518-766-3003)

KnowledgePro
A tool for communicating knowledge
by Bev & Bill Thompson

from



Amex, M/C, Visa, COD or send check to:
Knowledge Garden Inc., 473A Maiden Bridge Rd.
Nassau, NY 12123, USA.
New York residents please add 7% sales tax.

Join us on CompuServe (GO PCVEN user option #8)

KnowledgePro is a trademark of Knowledge Garden. IBM, dBASE III, Lotus 123, CompuServe and PC Paintbrush are trademarks of their respective corporations. Photo Tcherevkoff ©

INTRODUCING THE FIRST LOADER WITH SMARTS!

PROLOADER II

A 3rd GENERATION TECHNOLOGY



A complete package
from \$1,595.⁰⁰

PROLOADER II is CONVERTIBLE

3.5" and 5.25", the same loader does both

Converts from one disk size
to the other in seconds

PROLOADER II is FLEXIBLE

*All disk drive types and
multiple disk formats supported

*Interfaces for IBM™, Apple™ and Macintosh™

PROLOADER II is RELIABLE

*Revolutionary disk loading method
creates a new standard in reliability

VAULT'S PROLOADER II

*Born of a company that has duplicated
over 4,000,000 disks.*

** Designed from experience.*

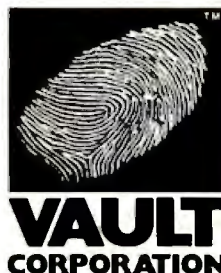

Contact VAULT CORPORATION at
2192 Anchor Court, Unit "C", Newbury Park, CA 91320
or call TOLLFREE
800-445-0193 (Nationwide) or 800-821-8638 (California)

PROLOK™

ROMLOK™

HDPROLOK™

FILELOK™

TECHLINE™

UNILOK™

PROLOADER II IS A TRADEMARK OF VAULT CORPORATION. IBM IS A TRADEMARK OF INTERNATIONAL BUSINESS MACHINES CORP. APPLE and MACINTOSH ARE TRADEMARKS OF APPLE COMPUTER
COPYRIGHT ©1988 VAULT CORPORATION

Understanding NetBIOS

*Hardware and software independence makes this interface
an excellent vehicle for portable network software*

Brett Glass

Whether you're writing a simple database manager or advanced groupware, expect it to at least accommodate a network and, ideally, to use the full potential that a local-area-network environment has to offer. As LANs proliferate, software products will be expected to keep pace by using these fast, convenient connections to good advantage.

For that reason, it helps to understand the IBM NetBIOS—the most widely implemented (and emulated) interface between application programs and LANs in the IBM PC world.

NetBIOS is the Application Program Interface (API) that lets an IBM PC program explicitly access LAN facilities. It's possible, of course, for any program to use the network while making the usual calls to the MS-DOS file system. NetBIOS calls, however, do more: They let you instantly transmit any sort of information to an application on another network machine.

NetBIOS calls are hardware-independent. The same commands that worked with the original IBM PC network (a broadband system made for IBM by



Sytek) work with no changes on Ethernet, ARCnet, Token Ring, StarLAN, and even simple serial-port LANs.

These commands are also largely software-independent. Whether you run Novell's NetWare, 3Com's 3+, Network OS, Banyan's VINES, ViaNet, or any other IBM PC LAN software, chances are it has a NetBIOS API built in or as a no-cost option.

This combination of hardware and software independence makes NetBIOS an excellent vehicle for portable network software. The sample software for this article, for instance, was developed on an ARCnet LAN consisting of an IBM PC AT, an EarthStation I diskless workstation, and Wendy, a "homebrew" AT clone. It then ran on a large Ethernet, with many PCs and different network software, with no changes.

However, NetBIOS doesn't have everything. Novell's NetWare, for instance, has literally hundreds of commands to support user directories, network security, accounting, print servers, and remote job execution; NetBIOS has only 19. But this carefully chosen set of basic functions can handle the needs of sophisticated network applications. (For more details, see the text box "The 19 Commands" on page 303.)

NetBIOS and the OSI Model

The IBM NetBIOS API provides services on two layers of the Open Systems Interconnection (OSI) model: the Data Link Layer and the Session Layer. None of the

continued

other layers are directly accessible to the application (see figure 1).

The Data Link Layer, the lowest layer supported by the NetBIOS API, simply sends packets of data between two stations on the network. The NetBIOS Datagram Support commands operate on this layer. Applications can transmit and receive *datagrams*—small packets of raw information—using these commands. However, the Data Link Layer will not acknowledge receipt of a datagram, or even give any assurance that a program at the receiving end was listening at the time. On the other hand, this mode of communication requires fewer resources from the network adapter and NetBIOS itself.

The Session Layer, a higher and more robust layer of the OSI protocol stack, is

also supported by NetBIOS. The Session Layer coordinates interactions between applications and supports reliable transmission of data between them. When NetBIOS establishes a session between two running programs, each can tell that the other is there and whether or not its messages have been received.

It's up to the application program to provide any higher layers it wishes to use, including the Presentation Layer (which formats data for an application) and the Application Layer (which starts code running to service a request from across the network). When combined with a program such as the IBM PC LAN Program, DOS itself becomes a networked application and can implement features on these two layers.

The IBM PC LAN Program, like

many others, uses NetBIOS as part of the mechanism that lets you share resources, such as disks and printers, across the network. Others, such as Novell's NetWare, use their own proprietary architectures for resource sharing and emulate NetBIOS for programs making NetBIOS API calls. In some cases, the emulation approach makes the network run faster, but it can also cause problems with software compatibility. You should test a program that uses NetBIOS on both types of systems to be safe.

In a Nutshell

Gaining a thorough understanding of LANs can take several years and a lot of effort. One of the advantages of NetBIOS is that it hides much of the LAN's complexity by providing a high-level interface to network functions. To program to NetBIOS, you need only understand a few simple concepts.

A fundamental part of NetBIOS programming is the concept of a *name*. Each LAN adapter card can have up to 17 names, each consisting of 16 bytes. One of these names is the *permanent node name*.

The permanent node name is the physical-adapter card's own unique name. The original IBM LAN Adapter derived this name from a 6-byte serial number written into an EPROM on the card; IBM guaranteed that each adapter had a unique number. Other types of cards may make other provisions to be sure the name is unique. The permanent node name consists of 10 bytes of binary zeros followed by the 6-byte serial number.

Each adapter also uses a *local name table* that holds up to 16 software-selectable names that are recognized on the network. Each may be a *unique name*, which the adapter reserves for its exclusive use on the network, or a *group name*, which other adapters can use. When a name is added to the local name table, the adapter attempts to claim the name by broadcasting its intentions to all other adapters on the network.

If other stations don't reject the claim, the name is registered in the local name table as being associated with that adapter. When a name is added to the name table, NetBIOS returns the number of the slot in which it resides. This *name number* is used by many NetBIOS commands as a quick way of referring to a name that's known to be in the table.

Datagrams

The simplest way that you can communicate through NetBIOS is with the datagram. A datagram is a block of raw data,

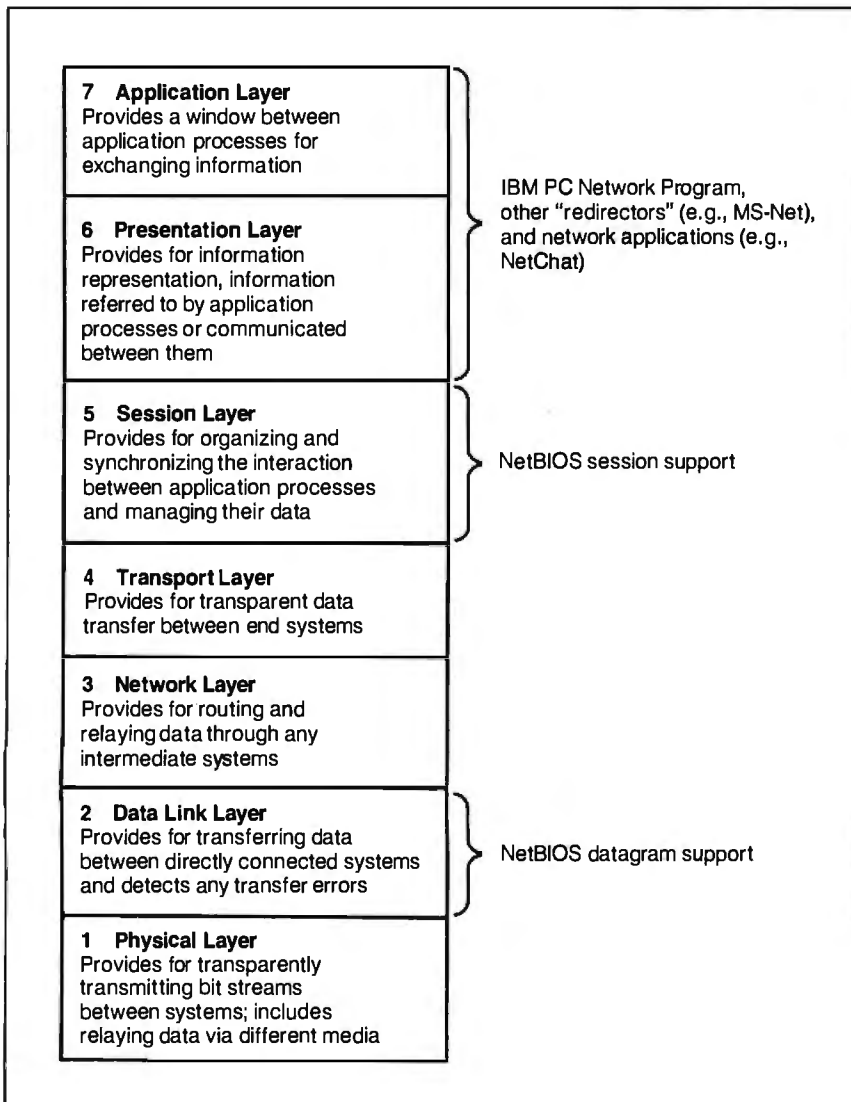

Figure 1: The International Standards Organization OSI model. NetBIOS provides services on both the Data Link Layer and the Session Layer.

The 19 Commands

You can divide the 19 NetBIOS commands into four categories: general-purpose, name support, datagram support, and session support (see table A).

• **General-purpose commands.** The reset command resets the NetBIOS and hardware for one LAN adapter on a PC (the IBM NetBIOS supports up to two). It erases the local name table, aborts all sessions, and sets up buffers to handle specified maximum numbers of active sessions and outstanding commands.

Under normal conditions, you won't want to issue a reset command, since it drops the sessions used by any network program running on your machine and renders any network disks inaccessible. (You may be able to issue this command with impunity in an emulated NetBIOS environment, such as Novell's, but it's not recommended.) If you wish, however, to use a LAN adapter exclusively for your own application, this command frees all available resources for you to use.

The cancel command cancels a command that hasn't completed yet. This is useful when you are using no wait commands.

The adapter status command provides status information on any adapter in the network—not just the local one. Among the items it provides are the 6-byte unit-identification number, jumper status, traffic and error statistics, resource statistics, and the contents of the local name table.

The unlink command is used by a system that has booted from another's disk. During a remote boot, the network adapter intercepts read requests destined for the boot floppy disk and gets the data from a boot server on the network instead. The unlink call ends the boot-disk emulation.

• **Name support commands.** The add name and add group name commands add names to the local name table. An add name command requests exclusive use of a name; it succeeds only if the

name is not already in use. An add group name command succeeds as long as no other station has been granted exclusive use of the name.

The delete name command removes a name from the name table. Pending operations and sessions may need to be terminated when a name is removed.

• **Datagram support commands.** The send datagram and receive datagram commands do the obvious: They send and receive datagrams. The send datagram command sends to a specific name, while receive datagram can receive messages for a specific name or for any name on the adapter. The send broadcast datagram and receive

broadcast datagram commands handle broadcast datagrams.

• **Session support commands.** The call command is a request to initiate a session, and the complementary listen command tells an adapter to accept a call. During a session, you can use the send and receive commands to exchange messages. The chain send command sends a message that is concatenated from two sources—this comes in handy when messages have a header followed by a body. The receive any command receives a message from any name with which you have an active session, and the hang up command ends a session.

Table A: The NetBIOS commands.

Command	Function
General-purpose	
reset	Reset the LAN Adapter, clear name and session tables
cancel	Cancel a pending command
adapter status	Get information about the LAN Adapter, names, sessions, traffic and error statistics, and software version
unlink	Terminate a remote boot operation (end INT 13 redirection)
Name support	
add name	Add a unique name to the local name table
add group name	Add a group name to the local name table
delete name	Remove a name from the local name table
Datagram support	
send datagram	Send a datagram
send broadcast datagram	Send a broadcast datagram
receive datagram	Receive a datagram
receive broadcast datagram	Receive a broadcast datagram
Session support	
call	Attempt to open a session with another name
listen	Listen for a call to come in
hangup	End a session
send	Send data as a message within a specific session
chain send	Concatenate two buffers and send as a message
receive	Receive a message
receive any	Receive a message from any open session
session status	Get information about all sessions associated with a specific name or all names

from 0 to 512 bytes long, that can be sent to a unique name, a group name, or everyone on the network (a broadcast datagram).

Datagrams aren't acknowledged by the LAN card at the receiving end and are lost if the adapter they are intended

for isn't ready to receive them. An application that requires confirmation that the message was received must arrange for the application at the other end to send an acknowledgment.

Broadcast datagrams are received by any station on the network that is listen-

ing for them (i.e., any having a receive broadcast datagram command pending). All other datagrams are sent to a specific name, and any station that has the name in its local name table can receive them.

continued

Listing 1: *The declaration for an NCB for the sample program.*

```

type
  NetName = array [1..16] of Char;
           (Format of a name used in net operations)
  {The following variant record supports the use of the
   callName field of an NCB for either a network name or
   buffer chaining.}
  NameOrBufInfo = record
    case Boolean of
      FALSE: (name : NetName);      (Network name)
      TRUE:  (nextBufLen : Word;    (Length of next
           buffer in a chain)
           nextBufPtr : Pointer)   (Pointer to next
           buffer in a chain)
    end;
  NCB = record
    command,      (NetBIOS command)
    retcode,      (Return code)
    lsn,          (Local session number)

    num : Byte;   (Number of a local name)
    bufPtr : Pointer; (Pointer to message buffer)
    len : Word;   (Message buffer length)
    callName:     (Destination name or info about second)
      NameOrBufInfo; {buffer in a CHAIN SEND}
    name : NetName; {Source (local) name}
    rto,      (Receive timeout in half seconds)
    sto : Byte; {Send timeout in half seconds}
    post : Pointer; {Interrupt completion routine address}
    lana_num : 0..1; {Number of LAN adapter}
    cmd_cplt : Byte; {Command complete flag}
    reserved : array [1..14] of Byte {Internal use only}
  end;

```

Listing 2: *Here, an in-line macro inserts the interrupt instruction directly into the code.*

```

function NetBIOS(var n : NCB) : Byte;
  {Call the NetBIOS with the given NCB. The function
   returns the same value that appears in the retCode
   field of the NCB after the call. Note that commands
   issued with the no-wait option and no interrupt comple-
   tion routine will return their final result codes in
   the cmd_cplt field. A Turbo Pascal in-line procedure issued
   here to generate efficient code.}
  inline($5B          (pop bx)
        /$07          (pop es)
        /$CD/$5C     (int $5C)
  );

```

Conducting a Session

While datagram communications are inherently one-way and unreliable, a *session* is a reliable two-way connection between two names on the network. A node on the network can be involved in more than one session, and the same pair of names can have more than one session running between them. Sessions provide reliable transport by confirming that the receiver is there, the receiver is listening, and each message is received. You can also send longer messages via sessions—from 0 to 65,535 characters.

To understand how a session works, consider this telephone metaphor. The station that initiates the session issues a call command, and the called station responds if it has a listen command pending (i.e., if it's waiting for a call to come in). If all goes well, a conversation is established, and each station can use the send and receive commands to communicate with the other. Like a phone call, the session terminates when one of the stations issues a hang up command.

You can execute many NetBIOS commands concurrently with other parts of

your program if you invoke them with the No Wait option. The original IBM PC LAN Adapter had its own 80188 micro-processor on-board, which made concurrency easy; the adapter simply processed the command and interrupted the PC when it was done. It's not necessary to have a coprocessor to allow concurrent processing, however; NetBIOS implementations for less-intelligent hardware can "borrow" the main CPU during clock ticks and hardware interrupts.

Of the 19 NetBIOS commands, you can execute 16 with the No Wait option. If you do, the Network Control Block (NCB)—the block of memory containing the information about the command passed to NetBIOS—must not be disturbed until the command is complete.

To invoke a NetBIOS command, you must execute a software interrupt (IBM has reserved interrupt number 5C hexadecimal for this purpose) while the CPU's ES and BX registers contain a pointer to an NCB. The NCB is a data structure containing information about the command to be performed.

Listing 1 shows the declaration for an NCB used in the sample program. [Editor's note: *NetChat is a shareware program written in Turbo Pascal. It is available in a variety of formats. See page 3 for details.*] The two subsidiary types, NetName and NameOrBufInfo, build the name and callName fields of the NCB.

The uses of some fields, command and retcode, for instance, are implicit in their names. Some of the others have meanings that vary from command to command and are not 100 percent consistent. The details go beyond the scope of this article, but they are spelled out explicitly in the NetBIOS bible, the *IBM PC Network Technical Reference*.

Invoking Software Interrupts

Once the NCB for a command is filled with the requisite data, it must be passed to the service routine that handles interrupt 5C hexadecimal on your PC. The methods you use to set up the registers vary from compiler to compiler. In Turbo Pascal 4.0 and higher, it's especially easy: You can use an "in-line macro" to insert the interrupt instruction directly into the code. Listing 2 shows the declaration I used.

The function NetBIOS() (in listing 2) is a machine language function that pops the address of the NCB into the ES:BX register pair. It then directly invokes the interrupt via a hard-coded INT 5C instruction. NetBIOS processes the NCB, then sends back a return code in the AL register, which just happens to be where

Turbo Pascal expects the result of a Byte function to wind up. Hence, no further processing is needed.

If you're using a different compiler, you may not have in-line assembly language capability. However, most languages support a function (usually with a name like `Intr` or `Int86x`) that can accomplish the same thing.

How Easy It Is

How simple can a useful NetBIOS application be? The program `NetChat` in listing 3 is only three pages long (not counting the unit that defines the NetBIOS calls), and it's not only useful, it's addictive. `NetChat` implements a CB simulator, similar to `CBIX` or `CompuServe's` CB, over a LAN, and it had the users at my test site typing happily to one another for hours.

The requirements I set for the sample program were as follows. It had to allow any station on the network to talk to any or all other stations; not affect other network functions, such as file access or peripheral sharing; and allow users to come and go at will without halting communications.

The need for any-to-any and any-to-all communications ruled out the use of sessions, which are essentially one-to-one connections. Likewise, sessions would be a poor choice because they would bog down the network. During a session, each message involves exchanging several packets to ensure that it arrives safely. Furthermore, ensuring that each recipient gets a widely distributed message multiplies the overhead by the number of stations involved. Finally, since a session ends when one station "hangs up," maintaining a conversation as a group of sessions would be difficult.

For these reasons, datagrams, which don't incur the overhead of acknowledgment for every message sent, were the clear choice for `NetChat` messages. The remaining choice was whether to use ordinary datagrams or broadcast datagrams for the "party line" traffic. As it turned out, this decision was simple as well. Because broadcast datagrams are often used for other network functions and might interfere with them, I elected to use ordinary datagrams—in combination with an agreed-on group name—for `NetChat` messages.

Join the Club

Each station that participates in a `NetChat` conversation needs to tell its network adapter to listen for `NetChat` messages, while those not involved should

continued

Listing 3: The main `NetChat` loop.

```
(Main loop)
repeat
  if KeyPressed then
    begin
      ch := ReadKey;
      case ch of
        ^C : Halt; {Exit program}
        ^H : {Backspace}
          if Length(editString) > 0 then
            begin
              Write('^H' '^H');
              Dec(editString[0]);
            end;
        ^M : {Send the string}
          with sendNCB do
            begin
              repeat until cmd_cplt <> COMMAND_PENDING;
                {Wait for prev send}
              if cmd_cplt <> GOOD_RTN then
                begin
                  chatError := cmd_cplt;
                  Halt
                end;
              sendBuffer := userName + editString;
                {Add attribution}
              len := Succ(Length(sendBuffer));
                {Size the datagram}
              case NetBIOS(sendNCB) of
                GOOD_RTN, COMMAND_PENDING;; {These codes OK}
              else
                chatError := retCode;
                Halt
              end;
              editString := '';
              ClrScr {Clear the bottom one-line window}
            end;
            #0: ch := ReadKey; {Ignore function keys}

            #1..#31, #127, #255;; {and non-printing characters}
          else
            {Check for full line. Add character if there is room}
            if Length(editString) < Pred(SizeOf(editString)) then
              begin
                editString := editString + ch;
                Write(ch)
              end
            end;
          end;
        for i := 1 to RCVNCBS do
          with receiveNCBs[i] do
            case cmd_cplt of
              COMMAND_PENDING;;
                {Do nothing; no message came in for this NCB}
              GOOD_RTN: {Display a message from the network}
                begin
                  tempBufferPtr := bufPtr; {Get msg address}
                  bufPtr := freeBuffer; {Find the free buffer}
                  len := SizeOf(String);
                    {Set buffer length field back to max length}
                  case NetBIOS(receiveNCBs[i]) of
                    {Immediately start another receive}

                    GOOD_RTN, COMMAND_PENDING;; {These codes OK}
                  else
                    chatError := retCode;
                    Halt
                  end;
            end;
          end;
        end;
      end;
    end;
  end;
end;
```

continued

Integrand's new Chassis/System is not another IBM mechanical and electrical clone. An entirely fresh packaging design approach has been taken using modular construction. At present, over 40 optional stock modules allow you to customize our standard chassis to nearly any requirement. Integrand offers high quality, advanced design hardware along with applications and technical support *all at prices competitive with imports*. Why settle for less?

Rack & Desk PC/AT Chassis



Rack & Desk Models

Accepts PC, XT, AT Motherboards and Passive Backplanes

Doesn't Look Like IBM

Rugged, Modular Construction

Excellent Air Flow & Cooling

Optional Card Cage Fan

Designed to meet FCC

204 Watt Supply, UL Recognized

145W & 85W also available

Reasonably Priced

INTEGRAND
RESEARCH CORP.

Call or write for descriptive brochure and prices:

8620 Roosevelt Ave. • Visalia, CA 93291

209/651-1203

TELEX 5106012830 (INTEGRAND UD)

EZLINK 62926572

We accept BankAmericard/VISA and MasterCard

IBM, PC, XT, AT trademarks of International Business Machines. Drives and computer boards not included.

UNDERSTANDING NETBIOS

```

sendX := WhereX;      {Save location on bottom line}
Window(1,1,80,23);  {Move to the upper window and position cursor}
GoToXY(1,rcvY);
Write('^M^J,tempBufferPtr'); {Write the message}
rcvY := WhereY;      {Go back to the bottom line}
Window(1,25,80,25);
GoToXY(sendX,1);
freeBuffer := tempBufferPtr;
    end
else
    chatError := cmd_cplt;
    Halt
    end
until FALSE
    
```

simply be able to ignore them. To indicate to the adapter that it wants to join the conversation, NetChat uses the add group name command to add a name to the local name table—in this case, the word NETCHAT followed by 11 zeros. It then starts four receive datagram commands and waits for messages.

Why four receive datagram commands? Well, since datagrams are neither acknowledged nor guaranteed to arrive intact, the most likely way for them to be lost is if no receive datagram command is pending when the message comes in. NetChat makes sure that there are always buffers ready for incoming messages by issuing four commands with the No Wait option and checking frequently to see if any of the commands have completed due to an incoming message. If one has, NetChat starts a new command even before it displays the data from the last one. The result is a robust system that isn't likely to lose messages.

While it watches for incoming messages, NetChat also runs a simple line editor in a one-line window at the bottom of the screen. This editor accumulates the characters for an outgoing message until you strike the Enter key, whereupon it issues a send datagram and sends the string as a message to the group.

The sender's name and a colon are prepended to the message so that other participants will be able to identify the source of the message.

When a message goes out to the group, the local adapter receives it just like everyone else. The message is thus interspersed with the incoming messages on the top portion of the screen. The concurrent tasks of editing outgoing messages and displaying incoming ones are handled by a short, straightforward main loop (see listing 3). Most of the code in the loop is involved not with network transactions but with presenting a nice image on the screen. (Listing 3 also

shows you how to fill the required fields for some of the more common NetBIOS commands.)

Shutting Down

When NetChat terminates, it needs to clean up and free the network resources it uses. To shut down all pending operations, NetChat issues a delete name command to delete the group name from the local name table. Since all receive datagram commands must be associated with a name, they terminate instantly when that name is deleted. An outstanding send datagram command will complete quickly.

Our example program uses an "exit procedure" (a procedure that's called when a program halts) to perform the delete name command; thus, the name will be removed (and the space in the name table freed) even if the program terminates abnormally. In NetChat, this procedure is called ExitChat.

A Good Foundation

NetChat is but one example of what an application can do using the resources of NetBIOS. While a factory-control program or a large-scale X.400 electronic mail package will be more complex than my simple CB simulator, the underlying principles are the same.

Regardless of the job at hand, however, the key virtues of NetBIOS—its hardware and software independence and its inherent simplicity—make it a good foundation on which to build any PC application that must communicate over a network. ■

Brett Glass is a freelance programmer, author, and hardware designer residing in Palo Alto, California. He was one of the original architects of the IEEE 802.5 Token Ring LAN and coauthored Living Videotext's ThinkTank 2.0. He can be reached on BIX as "glass."



"THE PC PEOPLE"



MMC

SINCE 1977

Ad Code BI-A

P C SYSTEMS & LAPTOPS

FRC XT'S, Super AT'S, Tower 386 Workstations.....CALL
Nationwide on-site service available!

AST Premium/286 - Model 80CALL
Premium/386 - Model 300CALL

LAPTOPS ZENITH

SupersPort - Dual 720K fply, 640K, 80C88-8 MHz CPU, detach. battery pak, back-lit supertwist screen 640x200, RGB color connector for ext. monitor, clock, ser/par. ports, ext. bus (opt), only 9.7 lbs..... \$1,689
With 20Mb hard drive, 720K floppy \$2,489

SupersPort 286 - 1.44Mb floppy, 20Mb hard dr., 80C286-12MHz, 1Mb, 640x400 8 shades of grey, C,S,P, RGB ports, 14 lbs. with battery pak. \$3,598

MITSUBISHI ELECTRONICS

MP286L 12mhz, 0 wait, 640K, 11" white screen, CGA, HGC Ext Video adptr, 1.44Mb floppy, 20Mb hard drive, 2 ser/1 par, cl/cal, ext floppy ports, 4 proprietary slots, DOS 3.3, GW Basic..... \$2,995
MP286L with 40Mb Drive..... \$3,195

MONITORS & TERMINALS

EGA tilt 'n' swivel, 14" mon... \$359
SAMSUNG 14" tilt 'n' swivel color hi-res... \$239
12" TTL tilt 'n' swivel amber .. \$ 79

TATUNG

CM-1495 OmniScan 14" Multi-freq., 800x600, VGA,EGA,CGA, T'n'S, w/VGA card.....\$729
CM-1496 VGA 14"w/VGA card \$699

MDS

"The Genius" FULL PAGE for PC/XT/ATCALL

MONITERM 19" & 24".....CALL

NEC

MultiSync II (1402) \$599

WYSE

WY-50 green or amber...\$389
WY-60 w/keyboard.....\$425

XTRON

XTRON-Futuristic, flat, & non-glare w/dual mono, EGA, VGA & Multisync modelsCALL

ZENITH

FTM-1490VGA flat screen...\$549

PRINTERS, PLOTTERS & FAX

brother Dot matrix, daisy wheel, laser printers, fax machines .. CALL

Panasonic 1592 132 Col., 190 CPS..... \$429
1080I \$169 1091 Model 2 .. \$ 199
1092 I \$319 1524 \$579

HOUSTON INSTRUMENT PLOTTERS DIGITIZERS

SUMMA SKETCH 12 X 12 \$365
PRO 12 X 18.....\$639 MAC 12 X 12 ...\$389

FAX

Xerox 7007 9600 BPS, 18 second / page, + phone with 99 number auto dial, 10 pg feed, up to 7 day delayed send, 200x400 resolution..... \$1,295
7011, 7018, 7020, 7021, Faxmaster/PC..... CALL

NETWORKING

VAR's...SYSTEM INTEGRATORS... Let us configure a plug 'n' play system - with three of your workstations - delivered to your site!

4-User NOVELL Network System

Server/Work Station:
+ American Research (ARC) - 12.5MHz, 1 wait, 80286, PC/AT 210W power supply, 1 serial, 2 parallel ports, monitor, 1.2Mb floppy, 2Mb RAM, 71Mb hard drive, 60Mb tape drive.
+ American Power Conversion 520 Watt U.P.S.
+ NOVELL: EL5 NetWare 286 Level I (4-users) Network set-up is Menu Driven with "Hot Print" Utilitiial
+ 4 ArcNet cards, 200' cable, 4-port passive hub
+ 3 ARC™ M10 XT's - Each includes: 640K, 4.77/ 10 MHz, 8088-1 CPU, MS-DOS 3.21, RT-style keyboard, amber tilt 'n' swivel monitor.
List Price \$13,995 - Your Cost \$7,895
Lease from \$202. per month.

PC SOFTWARE & MICE

Data Base Management
Ashton-Tate dBase III Plus.....\$368
PFS: Professional File.....\$119
WordTech DBXL (dBASE 3) "Diamond" \$115

Communications
Carbon Copy Plus (Meridian)\$109
Crosstalk XVI (Microstuf) \$ 98

Word Processors
NewWord (WordStar 4.0 clone) \$ 98
WordStar 4.0\$228
Microsoft Word.....\$225
MultiMate Advantage I\$268
PFS: Professional Write.....\$105
Word Perfect\$235

Integrated / Spreadsheets
Enable 2.0 (software group)\$369
Framework II (Ashton-Tate)\$375
Framework III call
Lotus 1-2-3.....\$295
Multiplan 3.0.....\$115
PFS: First Choice.....\$ 85
PFS: Professional Plan\$ 58
Symphony (Lotus).....\$438

Desktop Publishing
PFS: First Publisher \$ 69
PFS: Art Gallery\$ 69
Xerox Ventura 2.0\$489
Aldus PageMaker/PC 3.0.....\$525

Graphics & Mice
Harvard Graphics (for Lotus 1-2-3).....\$248
IMSI OptiMouse Serial\$ 88
IMSI Genius Mouse Serial\$ 59
Microsoft Mouse.....\$ 98
SummaSketch 12x12.....\$365

Project Management
Harvard Total Project Manager\$349

* Compatibility with PC/XT/AT Clones not guaranteed.
* Order Carefully. Opened software not returnable!

POWER ACCESSORIES

330XT\$295
450AT.....\$425
520 ES.....\$495
800RT w/UPS I/F\$795
1200VX w/UPS I/F\$925
Interface Cable\$ 25

Novell U.P.S. Monitor Board Compatible!
* 220 Volt Models Available *

LASER PRINTERS & SCANNERS

Brother HL-8 40 fonts 8PPM 2nd Gen. Canon Engine Emulates Epson, IBM, Diablo 1Mb RAM=Full Pg graphics HP LaserJet Plus compatible



Free font cartridge of your choice!

\$2,995 CALL

AST TurboLaser/PS postscript, ricoh, 3 Mb, 35 fonts, 8ppm, AppleMac/PC CALL
H.P. LaserJet Series II CALL
Panasonic 4450 Laser dual tray, 11 PPM \$1,595
HP ScanJet Scanner with Starter Kit.....\$1,675
HP/Brother Font Cartridges.....FROM.....\$ 119

DRIVES - HARD, FLOPPY & TAPE

EVEREX

Everex 60I - 60Mb internal tape with software . \$ 798
Everex 125Mb Internal Tape.....\$1,088

CDC 90-300Mb SCSI CALL

Maptor XT-1140 140Mb \$1,695

MICROPOLIS 85Mb 28mSEC.....\$ 599
MiniScribe 3053 HH 22mSec 44Mb.....\$449
ScribeCard 30Mb Drive-on-a-card 40mSEC.....\$355

Mitsubishi 44/66Mb (RL) 28mSEC.....\$469

Seagate

Seagate PC 20 Mb with WD Ctrl \$ 269
Seagate PC/XT 30Mb ST-238, ctrl, cable\$289

Floppy Drives

Fujitsu 360K \$75/1.2 Mb \$95/720K \$98/1.44. \$109
Mitsubishi 360K \$89/1.2 \$125/720K\$99/1.44 \$119
Teac 360K CALL /1.2 \$ 99 /720K \$88 /1.44.....\$ 98

MODEMS & BOARDS

ANCHOR

1200 External\$ 98 /1200 Internal. \$ 69
2400 External\$135 / 2400 Internal. \$115

EVEREX

EverCom 2400 Int.....\$139 / 2400E (MNP). \$189

MultiTech Systems Multi-Modems.....CALL

Robotics

US Robotics Courier HST up to 19,200 bps\$629
2400 Ext\$168 /2400 PC.....\$148
1200E\$ 98 /1200 PC.....\$ 68

AST Advantage-Prem-512K, S, P ...\$308
Advantage PS/2 - 512K 2Mb.....\$365
Hot Shot 286-10XT Accel. Bd. \$369
I/O MINI II-XT or AT\$ 75

RAMPAGE 286 - 512K.....\$395

RAMPAGE2 for XT 256K - Model 30\$279

RAMPAGE Plus 256-512K microchannel.....\$509

SIX PAK Plus 64K\$119

VGA PLUS 256K 16bit. \$359 / VGA\$259

XFORMER - AT replacement, for XT's 8 slot MB, 10 MHz "0", 512K, S.P.C, floppy and hard drive controller, EGA, CGA, HGC.....\$629

5251/11 Plus AST Guarantees\$598

Magic I/O AT1-3 S,P,G (170B) . \$ 59

EVEREX Ultragraphics & 19" Monitor . CALL

Floppy I/O S ,P, G, C.....\$ 89

Deluxe EGA 800x600+ prt.....\$159

VGA\$249

intel Above Board/286 -PCMB4020 512K... \$379

80287-8.....\$ 240 /89287-10.....\$289

80387-20 Math Coprocessor\$495

800-378-3136 (toll free) 800-378-3136 (toll free) 800-378-3136 (toll free)
3100 W. Camelback Rd. Phoenix, AZ 85018
TELE: 602/998-7711 FAX: 602/998-7711

Advertised prices are cash, prepaid, Visa or MasterCard Only. Customers using AMEX, COD's or qualifying for terms, calculate additional charges by dividing above prices by .95. Credit card charged after shipment. Special order items require cash prepayment and they are not cancellable / returnable. Shipping first 6 lbs. minimum \$8.00. FREE FEDEX FOR FIRST 9 LBS. ONLY! Sales tax, Arizona residents only. Product returns may be subject to a restocking fee or full credit toward a future purchase. All prices and specifications subject to change without notice.

We Guarantee Good News Every Monday Morning!



In fact, we'll guarantee the best news—100% factual, accurate and unbiased expert analysis of significant developments in the personal computer industry. Just straightforward, no-nonsense professional reporting of industry news, product announcements and key events *as they happen* each and every week.

BYTEweek, McGraw-Hill's new weekly newsletter, is devoted to helping you stay on top of the dramatic changes in the continually-evolving business computing arena. BYTEweek is devoted to reporting and analyzing these changes and developments through its timely, compact, one-stop news format. BYTEweek keeps you on top of significant industry trends and developments through its coverage of the IBM, IBM-compatible, Apple Macintosh and workstation markets. BYTEweek gives you the full details of significant new product announcements with in-depth analysis.

BYTEweek guarantees what no other personal computing publication can by building on two renowned and respected technical resources: the award-winning *Microbytes Daily* on-line news service and the technical expertise of the BYTE Editorial Staff aided by the new resources available to them in the recently expanded BYTE Lab. Through these resources, you are kept on top of issues such as:

- **New data storage techniques**, including CD-ROM, erasable optical and other text, graphics, and video storage technology.
- **Expert systems**, with an examination of both the technical and human aspects of implementation.
- **Bus standards** and the war between IBM and the clone manufacturers—with critically

important user ramifications.

- **Legal skirmishes** and "look and feel" suits, which can put the manufacturer of your favorite software out of business.
- **Software emulation** that will allow new, exotic computer systems to run software written for IBM PCs.
- **LAN system developments**, including all pertinent aspects of connectivity and inter-operability.
- **Network management**, a complex and increasingly important topic for personal computers in both small and large offices.
- **PostScript clones**, which promise faster, lower-cost laser printers with the same capabilities as the Apple LaserWriter.
- **New, easy-to-use programming systems** such as CASE and 4th Generation Languages, that can allow non-programmers to develop powerful applications.

BYTEweek offers you what no other industry publication can: timely news on the rapidly evolving computer industry as *it happens*, framed by interpretation and evaluation that only BYTE's experienced editorial staff can provide.

Subscribe now and take advantage of the special one-year charter subscription rate of \$395 (\$495 outside the U.S. and Canada)—a savings of \$100 off the regular rate. Your subscription to BYTEweek includes 50 issues and a free subscription to BIX, which includes access to the award-winning *Microbytes Daily* on-line news service. Your hourly usage rates will be billed separately.

Don't miss this opportunity! Call BYTEweek's toll-free number:

1-800-258-5485

to order your subscription or request more information and a free sample issue.

BYTEWEEK

One Phoenix Mill Lane, Peterborough, NH 03458

1-800-258-5485

Charter subscription just \$395 for 50 weekly issues



A Logical Choice

APPC, also called LU 6.2, provides a solid foundation for true distributed processing

Ralph Davis

Perhaps one of a kind among communications protocols, Advanced Program-to-Program Communication (APPC), also known as Logical Unit (LU) 6.2, is precisely defined *logically* apart from any of its actual implementations. This is natural for a protocol that is intended to support "any-to-any" communications.

There are many different ways of implementing APPC in the hardware and operating-system software of different systems. However, the completely logical definition of its functionality ensures its uniformity across a variety of platforms.

APPC provides a solid foundation for *true* distributed processing, where programs executing on different machines cooperate in a single distributed transaction. Indeed, its name reveals its purpose: It's intended as a vehicle for programs to communicate with each other.

What Is APPC?

APPC is IBM's strategic protocol for interprogram communication and a central protocol in its Systems Application Architecture (SAA). Although the terms



APPC and LU 6.2 are not exactly synonymous, they are used as if they were. APPC refers to the standard, the overall architecture and design of the protocol, whereas LU 6.2 is the software that actually executes in a network node and gives it access to the communications capabilities defined by the standard. (LU 6.2 also refers to APPC's historical position in the development of IBM's System Net-

work Architecture [SNA] protocols, it being the immediate successor to LU 6.0 and LU 6.1.)

However, since IBM seems to use the two terms interchangeably, it seems unlikely that I'll cause any confusion if I do too.

When viewed from the perspective of concrete implementations, APPC appears to be extremely complex. Many of the verbs require large data structures as parameters. In addition, in its major PC implementations (i.e., IBM's APPC/PC and Novell's NetWare LU 6.2), APPC obliges the systems programmer to write a considerable amount of support code.

Therefore, it's helpful in trying to understand APPC to study its logical definition rather than its implementations. This will also let you

appreciate its true power, as specific implementations may not incorporate all its features.

Intelligent Peers

LU 6.2 is the successor to earlier protocols that supported terminal-to-host communications. When they were developed, terminals were not capable of in-

continued

telligent processing; all the intelligence resided at the host. The terminal, essentially, had only one function—input and output.

As PCs proliferated, users were no longer content with dumb terminals; they wanted intelligent processors on their desks. But those who were already communicating with hosts didn't want to give up this capability. Thus, terminal emulators came along.

Terminal emulators enabled PCs to pretend to be dumb terminals, but they didn't take advantage of the power that intelligent workstations offered. In particular, the terminal emulators still relied on the protocols that assumed an all-knowing host and a helpless terminal. Terminal-to-host protocols didn't offer any capability for peer-to-peer communication; they grew out of a master/slave environment, where the notion of peers was irrelevant.

LU 6.0 and LU 6.1 were early interprogram protocols that introduced many of LU 6.2's features. They allowed one program to load and execute another program through a partner LU and also provided distributed commit-and-rollback capability. However, LU 6.0 was limited to the teleprocessing monitor, CICS (Customer Information Control System), and LU 6.1 allowed communication between CICS and the database-and-communication system, IMS (Information Management System). Both LU 6.0 and LU 6.1 allowed interprogram communication only between one host (PU Type 5) and another.

APPC, on the other hand, assumes that intelligence is distributed around the network. It provides an avenue over which network nodes can communicate with one another without going through a host, and it also provides a solid foundation for true distributed processing. APPC is meant for program-to-program communication.

And that communication is not merely passive. APPC gives programs the ability to load and execute programs on other network nodes, a step beyond other protocols, which are mostly rooted in the Open Systems Interconnection (OSI) session layer or below. They concern themselves with sessions between machines, whereas APPC's realm is conversations between programs. (For a comparison between the OSI layers and the SNA layers, see figure 1.)

A full distributed transaction can involve any combination of participating nodes. Node A, for instance, might allocate a conversation with node B, which in turn allocates conversations with nodes C and D. As part of the transaction, D allocates a conversation between two different programs that it executes concurrently.

At its highest level of error recovery, *syncpoint*, APPC offers full protection for resources involved in a transaction. It implements true two-phase commit protocol, which is essential for distributed database systems. Thus, you don't have to worry about implementing this difficult—and crucial—component of distributed database systems.

Coming to Terms

Before going any further, I want to define some basic terms. A transaction program (TP) is a program executing in a network node that, through LU 6.2, participates in a conversation with a program on another node. A logical unit (LU) is a set of software routines that control the details of creating and managing sessions.

Whereas the LU manages sessions (logical links) between nodes, the physical unit (PU) is software that manages the physical data links between them. LU 6.2 and PU 2.1 go hand-in-hand. Indeed, PU 2.1 was developed to serve as a platform for LU 6.2. Its predecessor, PU 2.0, permitted neither multiple sessions nor peer-to-peer communication.

Conversations (TP to TP) are links between concurrently executing TPs. The programs can reside at the same or different locations on the network. Sessions (LU to LU) are links between LUs over which conversations flow. The session details are transparent to the TPs; their view of sessions is limited to mode names, which are associated with such characteristics as level of data protection, maximum packet size, and so on.

Conversations use sessions. The LU will multiplex conversations over available sessions. Typically, sessions remain in an active state even when there are no active conversations. This ensures that a session will be available when a conversation is requested and improves performance.

Position within Layers

LU 6.2 provides TPs with a high-level interface for program-to-program communication. Because LU 6.2 executes verbs on the SNA presentation-services layer (corresponding to the OSI presentation layer), programs need not trouble themselves with any of the underlying data-link, network, or session protocols.

The presentation-services layer is where many of LU 6.2's most important functions reside. It's responsible for loading and executing ("attaching") programs, converting data records sent on mapped conversations to general-data-stream (GDS) variables, and coordinating error handling with partner LUs.

The term *half-session layer* is another name for the two levels immediately below the presentation-services layer: the data-flow-control and transmission-control layers. It's called "half-session" because it controls the local LU's contribution to a full session, which requires a partner LU. This layer is responsible for the pacing and sequencing of data pack-

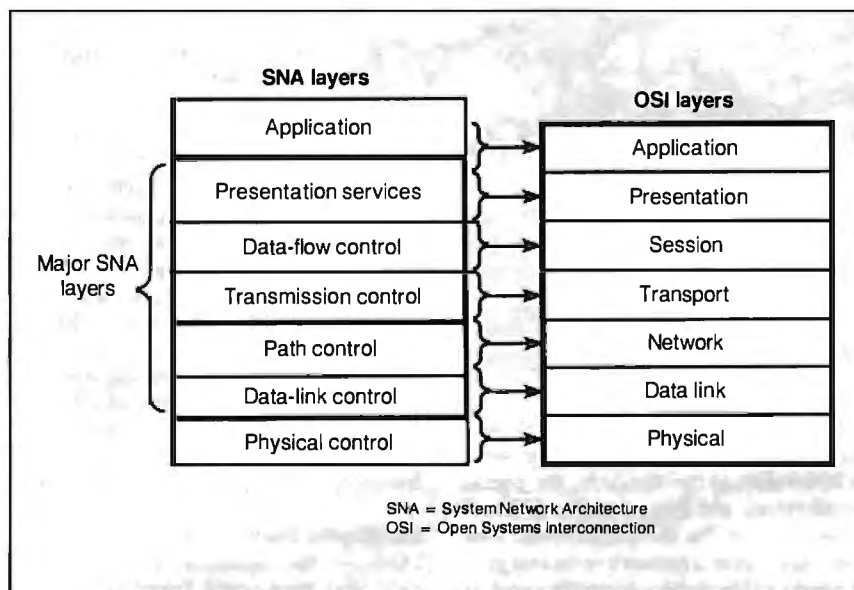

Figure 1: The SNA layers versus the OSI layers. While the correspondences are very close, they are not exact.

ets and for encryption and decryption of data (where these functions are supported).

The Verbiage

The IBM literature identifies two components of APPC: the base set of functions and option sets. All implementations of APPC must include the base set. They don't have to support any of the option sets, but any that they do support must be supported in full.

There are two types of conversation verbs: those that support basic conversations and those that support mapped conversations. There is a one-to-one correspondence between them; the same verbs exist for both conversation types. Their names are the same except that the mapped-conversation verbs are preceded by MC_. Thus, the basic ALLOCATE is the mapped MC_ALLOCATE.

The basic-conversation verbs are lower level than the mapped verbs and frequently require more arguments. They require that you format user data in GDS variables, and they offer less automatic error recovery. They are used primarily by programs that provide network-control services (IBM's service-transaction programs).

Mapped-conversation verbs, on the other hand, offer TPs a somewhat higher level of insulation from the underlying details. Programs only transmit data records; LU 6.2 creates the GDS variables. The LU also offers a high level of error recovery. Mapped conversations also may offer a data-mapping capability whereby you pass user data through a mapping routine that performs transformations on it. Mapped-conversation verbs are used primarily by application programs. Only the basic verbs are required by the APPC specification.

The functions that LU 6.2 implementations must provide, and the basic-conversation verbs corresponding to those functions, are as follows:

- Initiate a conversation with a remote node and then load a TP at that node (ALLOCATE).
- Transmit data to the remote node (SEND_DATA).
- Receive data from the remote node (RECEIVE_AND_WAIT).
- Notify the remote node that an error has occurred (SEND_ERROR).
- Ask the remote node for permission to transmit data (REQUEST_TO_SEND).
- Provide request/response protocol (CONFIRM/CONFIRMED).
- Terminate a conversation (DEALLOCATE).

A variety of other verbs also cluster around certain categories: type-independent verbs, control-operator verbs, and LU-definition verbs.

You can issue type-independent verbs during either a basic or a mapped conversation. Indeed, BACKOUT, SYNCPT, and WAIT can apply to multiple concurrent conversations, without regard to their types.

The control-operator verbs are used to control session parameters, typically by service-transaction programs. The

One of
APPC's strengths is
its multitiered
data-security scheme.

CNOS (change number of sessions) verbs deal, not surprisingly, with regulating the number of active sessions between two LUs. When you use them to define parameters for parallel sessions, they activate a basic conversation between the local node and its partner LU, over which they negotiate the session characteristics.

The LU-definition verbs set parameters for the local LU. They don't involve any exchange with a partner LU. (See table 1 for details on all these LU 6.2 verbs.)

Insulated from the Details

LU 6.2 gives application programs an interface to the SNA presentation-services layer. Because it resides so high in the SNA (and OSI) architecture, it shields programs from any knowledge of the details of communications, such as session initiation, packet creation, data-link control, and so on.

TPs need only concern themselves with allocating and deallocating conversations, sending and receiving data, and reporting success or failure to conversation partners.

Although service programs communicate more directly with the half-session layer and therefore require more knowledge of the underlying details, their sole purpose is control and configuration of the local installation of LU 6.2. Thus, it is possible to concentrate this knowledge in a single person, a systems administra-

tor or systems programmer, and in a few software tools available to that person.

Data Security

One of APPC's greatest strengths is its multitiered data-security scheme, which offers protection for sensitive data (and the option of no protection for data that doesn't need it). All the security features are optional. The components of this scheme are as follows:

- *Data encryption and decryption.* This is available at the session level and is one of the characteristics assigned to session modes. If an ALLOCATE specifies a session mode defined to support encryption (with the DEFINE_MODE verb), the data is encrypted and decrypted automatically. This security option is independent of the others; you may specify it even if you omit all others, and you may omit it even if you specify all others.

- *LU-to-LU passwords.* This is the most basic security level, and it is a prerequisite for all the more specific protection mechanisms. It enables the control operator to require a remote LU to provide a password when requesting a session. You activate it by specifying a password on the DEFINE_REMOTE_LU verb.

- *User IDs, passwords, and profiles.* These require a remote LU to provide user information on allocation requests directed to the local LU. The local LU verifies this information against a list of authorized users, passwords, and profiles, set up with the DEFINE_LOCAL_LU verb.

- *Already verified.* As an additional option, user IDs, passwords, and profiles may be "passed through" when multiple sites are participating in a distributed transaction if the security-acceptance level between two LUs is established as "already verified." For instance, if node A sends an allocation request to node B carrying the user ID "RALPH DAVIS" along with the password, node B may then pass that information through to node C on a second allocation request with an "already verified" indication. The willingness of an LU to accept "already verified" requests from another LU is set by DEFINE_REMOTE_LU.

- *Local restricted access to TPs.* The local LU can also restrict access to TPs. Thus, although you might be able to allocate a conversation with the local LU, you might not have access to all the programs resident at the local node. Those authorized to use a TP are specified with DEFINE_TP.

- *Privilege levels for TPs.* You can also

continued

assign privilege levels to TPs as an argument to `DEFINE_TP`, specifying which, if any, of the control-operator verbs the TPs can issue. This prevents unauthorized programs from changing user-access information.

Data Integrity

LU 6.2 offers two levels of data-integrity protection: `CONFIRM` and `syncpoint`, which means that, at a certain point in a transaction, participating nodes bring their resources into synchronization with each other. No protection (i.e., no automatic protection) is also an option; this requires the participating programs to do their own error checking.

The `CONFIRM` level is essentially a request-and-response protocol. When a

participant sends a `CONFIRM` request to a partner, that partner must respond by issuing either `CONFIRMED` or `SEND_ERROR`. This is all the protection LU 6.2 offers at this level; the TPs must handle any further error recovery. `CONFIRM`-level protection is a required feature.

`Syncpoint` error recovery is an optional feature, and in some respects this is unfortunate. `Syncpoint` protection is one of APPC's most powerful features, and it would be nice if you could assume that it was always available. On the other hand, `syncpoint` protection also addresses the problem of maintaining the integrity of a distributed transaction, a difficult technology to implement.

`Syncpoint` protection provides for the

integrity of data updated at multiple sites. In the terminology of database management, it extends the scope of logical units of work (LUWs) to all the machines involved in a distributed database system. `Syncpoint` protection provides full two-phase commit protocol with rollback and resynchronization capabilities. It thus makes LU 6.2 a solid foundation on which you can build distributed databases.

When `syncpoint` protection is in effect on a conversation, each participating LU keeps a log of its activity on that conversation. LUWs begin when the TPs are loaded and end at each `syncpoint` or when the programs terminate. With a nondistributed DBMS, transaction protection means that the system guarantees that it

Table 1: The LU 6.2 verbs.

Basic Verbs

ALLOCATE (MC_ALLOCATE)

Establishes a conversation between the local node and a partner node and attaches (loads and executes) a transaction program at the partner.

CONFIRM (MC_CONFIRM)

Asks the partner LU to confirm receipt of transmitted data.

CONFIRMED (MC_CONFIRMED)

Confirms receipt of data—issued only in response to `CONFIRM` (MC_CONFIRM).

DEALLOCATE (MC_DEALLOCATE)

Terminates a conversation.

FLUSH (MC_FLUSH)

Forces the local LU to send the data accumulated in its send buffer.

GET_ATTRIBUTES (MC_GET_ATTRIBUTES)

Returns a variety of information pertaining to a conversation, such as the following:

- the names of the participating LUs
- the session mode being used by the conversation
- the synchronization level in effect
- security information
- information used to synchronize or resynchronize participating LUs (if `SYNCPT` is in effect)

POST_ON_RECEIPT (MC_POST_ON_RECEIPT)

Causes the LU to set a flag when the requesting program receives a message on the indicated conversation. After issuing `POST_ON_RECEIPT` or `MC_POST_ON_RECEIPT`, the program must issue a `WAIT` or a `TEST` (MC_TEST) to retrieve the status information.

PREPARE_TO_RECEIVE (MC_PREPARE_TO_RECEIVE)

Forces the local LU into receive state and informs the partner LU that it can enter send state.

RECEIVE_AND_WAIT (MC_RECEIVE_AND_WAIT)

Causes the LU to suspend execution of the transaction program until data arrives on the indicated conversation.

RECEIVE_IMMEDIATE (MC_RECEIVE_IMMEDIATE)

Instructs LU 6.2 to receive any information that is available and to return immediately if no information has been received.

REQUEST_TO_SEND (MC_REQUEST_TO_SEND)

Asks the remote transaction program for permission to enter send state.

SEND_DATA (MC_SEND_DATA)

Places data to be transmitted to the partner LU in the local LU's send buffer. When the buffer becomes full, the LU will transmit it.

SEND_ERROR (MC_SEND_ERROR)

Sends an error indication to the partner LU.

TEST (MC_TEST)

Checks to see whether the indicated conversation has received either data or a request to send.

Type-Independent Conversation Verbs

BACKOUT

Only supported if `syncpoint` error recovery is implemented. A program issues `BACKOUT` during `syncpoint` processing if, in response to a `SYNCPT` request from a partner LU, it detects an unrecoverable error. `BACKOUT` propagates to all participating LUs, so that all stations roll the transaction back to the last successful `syncpoint`.

GET_TYPE

Reports whether the indicated conversation is basic or mapped.

SYNCPT

Requests or confirms commitment of protected resources on all conversations in which a program is participating. `SYNCPT` and `BACKOUT` are part of APPC's `syncpoint` level of data protection, one of its most powerful features.

WAIT

Suspends execution of a program until one of the indicated conversations posts receipt of data. When the program resumes, LU 6.2 returns codes indicating what has been received and the conversation on which it arrived.

will either execute an LUW in its entirety or cancel it in its entirety.

This guarantee is impossible in a distributed system because there are many possible points of failure. Two-phase commit protects against most failures, and for those it can't handle, LU 6.2 offers recovery through resynchronization.

Resynchronization guarantees that if you can't determine the success or failure of a distributed transaction, LU 6.2 will either automatically bring the participants into a consistent state or will offer the control operators the means for doing so.

Two Phases

In two-phase commit protocol, one node, designated beforehand as the transaction

initiator, enters a Prepare record in its log, then sends each participating node a Prepare message. The participants attempt to complete the LUW and write the corresponding log records. If successful, they enter a Request to Commit record in their logs, then send a Request to Commit message back to the initiator. If unsuccessful, they will return an Abort message.

The initiator waits for the responses from the other nodes. If it doesn't receive them within its time-out period, or if any one of them is Abort, it writes an Abort message to its log, then tells all the nodes to abort the transaction. If all expected messages are Request to Commit, it writes a Commit message to its log, then broadcasts a Commit.

Upon receiving the command from the initiator, the participants write a Committed or Aborted record to their local logs, then send an acknowledgment to the initiator. When the initiator receives acknowledgments from all participants, it writes a Completed record to its log.

Syncpoint error recovery implements this protocol transparently to the TPs. But how does it operate in an LU 6.2 transaction?

The initiator issues the SYNCPT verb. This verb has no parameters; it synchronizes all the conversations in which the local LU is involved (i.e., all those conversations that are allocated with a protection level of SYNCPT). Then the LU at the initiator sends a Prepare request

continued

Control-Operator Verbs

CHANGE_SESSION_LLIMIT

Changes the number of sessions of a particular mode allowed between two LUs. It also determines the maximum number of contention-winner and contention-loser sessions. When two LUs simultaneously attempt to allocate a conversation over the same session, LU 6.2 will honor the designated contention winner's request and deny the loser's. In addition, when the contention loser wants to allocate a conversation, it must ask permission from the contention winner. (All this is done automatically by the LUs—transaction programs are not concerned with it.) This verb may result in the activation or deactivation of sessions to accommodate the new limit.

INITIALIZE_SESSION_LLIMIT

Sets the initial maximum number of sessions of a particular mode allowed with a particular partner LU. Also initializes the maximum number of contention-winner and contention-loser sessions. Like CHANGE_SESSION_LLIMIT, INITIALIZE_SESSION_LLIMIT can cause sessions to be activated automatically.

RESET_SESSION_LLIMIT

Sets the maximum number of sessions with a particular partner LU, and the number of contention-winner and contention-loser sessions with that partner, to zero. As a result, it also deactivates all current sessions of the indicated mode or all sessions if no mode is specified.

PROCESS_SESSION_LLIMIT

Used by the service-transaction program that is the target of a CNOS request to cause its LU to negotiate or accept the limits requested by the LU originating the request.

Session-Control Verbs

ACTIVATE_SESSION

Activates a session.

DEACTIVATE_SESSION

Deactivates a session.

LU-Definition Verbs

DEFINE_LOCAL_LU

Establishes the local LU's fully qualified network name; sets the maximum number of sessions it will support with all partner LUs

combined; adds or deletes user IDs, passwords, and profiles; and identifies any data-mapping functions that will be available to transaction programs. The LU name is how other nodes on the network refer to the local LU.

DEFINE_REMOTE_LU

Similar to DEFINE_LOCAL_LU, except that it defines parameters for remote LUs with which the local LU will be communicating. For example, it sets the remote LU's fully qualified network name; its local "nickname"; whether multiple concurrent sessions will be available; an LU-to-LU password for session initiation; and the level of security required by the local LU.

DEFINE_MODE

Defines the parameters for a session mode.

DEFINE_TP

Identifies a transaction program and sets a number of parameters that control its execution during conversations.

DISPLAY_LOCAL_LU

Displays the following parameters relating to the local LU:

- the maximum number of sessions permitted
- the number of sessions currently active
- a list of user IDs, passwords, and profiles
- a list of data maps defined to the LU
- a list of the remote LUs known to the LU
- a list of the known transaction programs

DISPLAY_REMOTE_LU

Returns parameters governing the local LU's sessions with a given remote LU. The parameters include:

- its local "nickname"
- whether multiple sessions are supported
- the security level required by the LUs on incoming allocation requests
- the modes available for sessions between the LUs

DISPLAY_MODE

Reports the parameters assigned to the indicated session mode.

DISPLAY_TP

Reports information pertaining to a given transaction program.

out on all protected conversations.

The participating nodes receive a TAKE_SYNCPT indication. At this point, they can issue only the SYNCPT, BACKOUT, or SEND_ERROR verbs. If the participants are ready to proceed with the transaction, they issue SYNCPT. If they have initiated conversations that are part of the distributed transaction, the Prepare will be propagated down the line. If they haven't, SYNCPT causes the participant's LU to send a Request to Commit message to the initiator.

If any participant can't continue the transaction, it replies to SYNCPT with either BACKOUT or SEND_ERROR. Either of these causes the initiator's SYNCPT verb to return with an error code of BACKED_OUT. If all participants have reported that they are ready to commit, the initiator sends out a Commit command. The participants respond to the Commit with a Forget message, which tells the initiator that it can erase its log records pertaining to the current LUW.

If one of the participants has issued BACKOUT or SEND_ERROR, the initiator receives the BACKED_OUT return code on the SYNCPT verb. At this point, it must issue BACKOUT to propagate the backout to all participating stations. Indeed, any time a TP receives a BACKED_OUT return code on the SYNCPT verb, it *must* issue BACKOUT. BACKOUT, like syncpoint, affects *all* protected conversations in which the local LU is participating.

If a session or conversation failure occurs at some point in the distributed transaction, LU 6.2 will automatically initiate a resynchronization procedure. If the stations can reestablish a session, they will exchange log and status information and attempt to bring themselves back into synchronization. If they are able to, the transaction will complete, and SYNCPT will return OK. If for some reason they can't reestablish the connection, the initiator's SYNCPT will return a code of MIXED_HEURISTIC, indicating that you must undertake a manual resynchronization.

LU 6.2 handles almost this entire complex procedure automatically. The only verbs issued by the TPs are SYNCPT, BACKOUT, and SEND_ERROR.

The syncpoint manager, on the SNA presentation-services layer, handles the rest of the process. It thus offers application programs a significant level of transaction protection accessible through a very simple Application Programming Interface (API) (three verbs).

Transferring Funds

A frequently cited use of distributed processing is the transfer of funds from an account at one location to an account at another. For example, a bank wants to transfer funds between Chicago and New York. A third computer, also located in New York, is coordinating the activities of the two bank computers.

The controlling computer allocates conversations with the other two, then sends them APPC messages indicating the changes they need to make. The pro-

End users
won't actually see
APPC; it will be
transparent.

grams executing at the target computers can either perform the updates when they receive the messages or store the information in arrays until they receive a SYNCPT instruction from the master computer. Assume that they are both using the latter approach.

Because of the number of messages exchanged during syncpoint processing, it would be highly inefficient to do a SYNCPT after each transaction. It makes much more sense to buffer a certain number of transactions and then do the SYNCPT. Assume that after the data for 100 transactions has been sent to the local nodes, the controlling computer issues a SYNCPT. When the local nodes receive it, they take the data accumulated in the arrays and issue update instructions against their local databases. If all the updates are successful, the local node issues its own SYNCPT. If any of the updates fails, the local node rolls back its updates, then issues a BACKOUT or SEND_ERROR.

The initiator's SYNCPT will terminate with a return code of either OK or BACKED_OUT. If the return code is BACKED_OUT, the initiator issues a BACKOUT. The dependent's SYNCPT also returns either OK or BACKED_OUT. If it returns OK, the TP acts to commit (make permanent) the changes it has made to its database. If it returns BACKED_OUT, it rolls back (cancels) its changes.

Suppose that the bank is transferring

\$10 million from 500 accounts in Chicago to 500 accounts in New York. The controlling computer in New York sends the data for the first 100 accounts to the two client computers, then issues a SYNCPT. On receipt of the SYNCPT, Chicago and New York perform their updates. They are all successful, so they both issue their own SYNCPT. At this point, all the SYNCPT requests terminate with return codes of OK.

The central computer now sends out the data for the next 100 transactions, then another SYNCPT. On receipt of the SYNCPT, Chicago and New York issue their updates. This time Chicago succeeds, but New York fails. This means that \$2 million has been removed from the Chicago branch and not deposited in New York. Chicago issues SYNCPT, but New York rolls back its updates and issues BACKOUT. This causes the controlling computer's SYNCPT to return a BACKED_OUT status. It then issues its own BACKOUT, which notifies Chicago that the transaction could not be completed. Chicago then rolls back its updates.

A New Technology

APPC is a new technology. It is also systems software. Thus, before it becomes available to PC users, it must be implemented in PC systems software, and application programs that use the systems software must appear. Remember, end users will never actually see APPC; it will be incorporated into applications software and will remain transparent to them. Users will be aware only of the wider scope of applications software that APPC makes possible.

The first implementation of APPC on the PC was IBM's Advanced Program-to-Program Communication for the PC (APPC/PC). It enables two PCs connected by either an IBM Token Ring Network or a synchronous data-link-control (SDLC) link to communicate using LU 6.2 verbs.

In mid-1988, Novell released NetWare LU 6.2, which is compatible with APPC/PC and intended for PC-based LANs. Thus, the prerequisite systems software on top of which application programs can be built is now in place.

However, there are some problems with APPC/PC and NetWare LU 6.2 that mitigate their effectiveness as platforms for applications. APPC/PC is tremendously expensive in its demands on PC resources—it takes up about half the memory available on a 640K-byte machine. In large database applications, compiled or interpreted, this is a fatal

limitation. Since it's targeted for single-user machines, APPC/PC can't distribute host sessions. Any PC using APPC/PC to communicate with the outside world must have all the necessary hardware and software.

NetWare LU 6.2 corrects these problems for PCs connected in a LAN by implementing a client-server architecture. It requires the presence of a Novell SNA gateway but can support any NetBIOS-compatible network operating system. Under the Novell scheme, a smaller version of the LU 6.2 software, requiring less than 100K bytes, resides in the workstation. The gateway contains the full software.

The workstation passes LU 6.2 verbs received from application programs to the gateway for execution. All the workstations on the LAN can contain LUs; only the gateway functions as an SNA PU 2.1. Workstations can communicate with each other. Also, the gateway distributes host sessions, so NetWare LU 6.2, unlike APPC/PC, permits resource sharing.

Thus, for installations with LANs, NetWare LU 6.2 is a leaner, more efficient implementation. Indeed, APPC/PC's memory demands disqualify it for almost all uses in the DOS environment.

However, both APPC/PC and NetWare LU 6.2 possess an important limitation, particularly as platforms for a distributed database system. Neither of them supports syncpoint transaction protection. This means that database developers are still required to implement their own two-phase commit protocol. In other words, a major feature of systems software that APPC promises remains the responsibility of applications software.

APPC-based applications software for the PC is currently either under development or of minor significance. IBM's Enhanced Communication Facility/Server-Requester Programming Interface (ECF/SRPI), which comes with IBM 3270-emulation software, uses a subset of APPC. ECF/SRPI gives PCs access to IBM's mainframe database systems DB2, SQL/DS, and IMS; host printers, disks, and files; and host programs.

Oracle Corp., developer of the Oracle relational DBMS, has announced plans to support APPC in a future version of SQL*Net, its distributed database software. At present, Oracle doesn't provide multisite transaction capability. In other words, returning to the banking example, it can be guaranteed that all the updates at either site are written as a whole or not at all. But it cannot be guaranteed

that the accounts in Chicago will be debited and the corresponding ones in New York will be credited or that they will all retain their previous values. A version of APPC offering syncpoint protection would be a natural vehicle for this type of transaction.

A Paradoxical Standard

Indeed, APPC is a paradoxical standard. The base set of required features offers minimal functionality. The optional features offer rich functionality, but because they are optional, their presence or absence depends on the particular APPC implementation. And there are so many option sets that a proliferation of totally incompatible implementations is almost guaranteed. Thus, applications developers can't write to "the APPC standard"; they must choose a particular version of APPC and support it.

Serious PC applications are unlikely to appear until the APPC standard matures and its PC implementations become more supple—the support of syncpoint is an absolute must. ■

BIBLIOGRAPHY

An Introduction to Advanced Program-to-Program Communication (APPC).

Document number GG24-1584-01. IBM, 1986.

An Introduction to Programming for APPC/PC. Document number GG24-3034. IBM, 1986.

Ceri, Stefano, and Giuseppe Pelagatti. *Distributed Databases: Principles and Systems.* New York: McGraw-Hill, 1984.

Date, C. J. *An Introduction to Database Systems*, vol. 2. Reading, MA: Addison-Wesley, 1983.

Date, C. J., with Colin J. White. *A Guide to DB2.* Reading, MA: Addison-Wesley, 1988.

LU 6.2 Program Examples. Novell, Inc., 1988.

NetWare LU 6.2 Overview. Novell, Inc., 1988.

NetWare LU 6.2 Technical Reference Manual. Document number 6300-1786-01. Novell, Inc., 1988.

NetWare LU 6.2 Tutorial. Novell, Inc., 1988.

Systems Network Architecture: Concepts and Products. Document number GC30-3072-3. IBM, 1986.

Systems Network Architecture: Transaction Programmer's Reference Manual for LU Type 6.2. Document number GC30-3084-2. IBM, 1985.

Ralph Davis is a senior consultant with ORI/Calculon in Rockville, Maryland. He can be reached on BIX c/o "editors."

90% of the world are still waiting.

What the hell are those importers doing?

Printer Buffer inside cable.

For the average user, most buffers are too complicated. So we designed a buffered cable with 64K or 256K inside.

Just a cable. As easy to use. Nearly as inexpensive.



Battery-operated data buffer

Up to 128K with parallel or RS232-input, will hold data for as long as 3 years. Record and play as often as you like. Carry data to a printer or to another computer.



Share your printer.

Forget these boxes that occupy a lot of your desk space. Forget the times when you had to switch manually. We have a cable that allows two computers to share one printer automatically.



That's what T-switches should look like!

For IBM-compatibles, 2 printers to one computer. Complete set incl. all cables and a small switch-box. **Just a cable.** No bulky box.



Isolating line drivers

If a line driver is not optically isolating, you might face problems arising from different mains supplies. That's why our RS232-drivers are 100% isolated up to 1,000 volts.



Data isolators

Transients on the mains supply or electrostatical discharges can cause erroneous data transmissions and even destruction of computers. We offer optical isolators up to 50kV.



Terminal bus.

Connect up to 16 terminals to one 2-wire bus. Save installation costs and gain flexibility and ease of use. Terminal-Bus-Adaptors includes 1kV optically isolated line drivers.

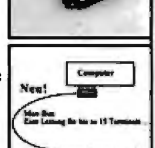

Interfaces.

We have a complete line of interfaces: 20mA, Atari130, C64/128, Centronics, IEEE488, RS232, RS422, RS423 and RS485. (The following are registered trademarks: Atari, C64, C128, Centronics, IBM)

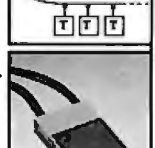

Austria:	Basic, Wien	0222-9505410
Denmark:	Jaloc, Spontrup	06-479139
France:	Noel, Straassbourg	(88) 623752
Singapore:	Overseas Trade	733-4577
Switzerland:	Weber&Co, Zurich	01-9302003
USA:	Tecarna, L.A.	(818) 2853121

Manufacturer and Exporter:

wiesemann & theis gmbh
MIKROCOMPUTERTECHNIK

winchenbachstr. 3-5 phone: ++ 49-202-505077
d-5600 wuppertal 2 telex: 859 16 56
west-germany fax: ++49-202-511050

Making the Connection

Can IBM PCs, Macintoshes, and VAXes harmonize in the workplace?

Ed Tittel

There's a quiet revolution going on all over the desktops of America. Networking technology has become widespread enough to allow individual desktops to stretch their boundaries to encompass corporate resources and provide easy electronic company-wide contact.

The benefits of networking are gospel. It allows everyone to share data and move information around much more easily, quickly, and efficiently than do older methods (see the text box "Connecting . . . Cheap!" on page 318). Network access supports communications applications, like electronic mail, that make people more accessible to each other. And networking applications allow co-workers access to desktops other than their own, that is, to other computers over the network. This means that workers can use the machines best suited for particular activities (e.g., IBM PCs for spreadsheets and business applications, Macintoshes for desktop publishing and graphics, and VAXes for heavy number crunching or large database projects).

The focus of this article is the question of how three popular types of com-



puters—the IBM PC and its many clones, the several varieties of Apple's Macintosh, and the DEC VAX family of mini-computers—can be brought together in order to take advantage of this desktop revolution.

Grafting Apples to Apples

When it comes to hooking computers together, the easiest connections to make

are among like kinds (Macs to Macs, PCs to PCs, and VAXes to VAXes). Of the three, only one comes without some form of built-in networking. Curiously enough, it's also the one most widely used—the IBM PC. This is why the PC supports the largest and possibly the most confusing selection of alternatives for connecting like machines.

Both the Mac and the VAX arrive "network ready" from their manufacturers. The Mac comes with a "plug and play" network that is built around the AppleTalk protocol suite, and a built-in network interface that is ready to use with LocalTalk (a proprietary shielded twisted-pair) or compatible cable. Although you need to purchase one or more network-interface cards for the VAX to actually hook it up

to a network that is its operating system supports the DECnet protocol suite, most commonly found running over Ethernet cable. This means that networking Macs and VAXes is pretty straightforward.

While the built-in network capability of a Mac or a VAX means that "there must be a way" for you to hook up to one of these machines using a network, it

continued

Connecting . . . Cheap!

While it's true that communicating over a local-area network is fast and convenient, it can be overkill in some situations, especially where cost is the most important factor. Here's a look at some less-expensive alternatives to hooking up pairs of machines.

Most of these kinds of connections are temporary; some even require lugging machines around when the distance between them exceeds the length of the cables. The basic requirements are still the same, but they occur in different forms: You need a medium of exchange (not necessarily a cable), some software on one end to create output, and some software on the other end to read that output. Since you're not networking, you no longer need a network interface.

Updating SneakerNet

SneakerNet is a euphemism for walking floppy disks from one machine to another. Obviously, this is easy when both machines are the same, because they can directly share media. Sharing information among PCs, Macs, and VAXes is a little trickier, but the disk (or other magnetic medium) is still the means for moving information between machines.

Another method is media conversion. Because of the increasing popularity of microcomputers, most typesetting companies and service bureaus have conversion equipment that lets them read (and write) disks in a variety of formats. This kind of commercial service can work well for infrequent data moves, but it normally costs about \$15 per floppy disk. These services can also take disks and create VAX-readable tapes, and vice versa; this may be the best approach to moving data between VAXes and PCs or between VAXes and Macs when no other connection is available.

Dayna Communications sells Dayna-

File for moving files between PCs and Macs via disk. DaynaFile is a 360K-byte floppy disk drive (bundled with software) that attaches to the Mac so it can write and read IBM-formatted floppy disks. SneakerNet can then move these disks to a PC to exchange data. Another entry in this field is available on the Mac IIx, which supports IBM's quadruple-density 3½-inch disk formats as well as native Mac formats.

Hold the Phone

The old standby for creating temporary links is connecting computers via modem. This is the most popular way to join remote computers together, but it can also work in any setting as long as each computer has a telephone line and a modem of its own. There are numerous options for all three machines, so there should be no problem getting any two of the three to exchange data with this technology.

If computers are in close proximity, you can use telecommunications software to exchange data over a special cable as well as over the telephone. This cable is called a "null modem" cable; it's a standard RS-232C cable with 25-pin connectors where the DTR (data-terminal ready) and DSR (data-send ready) leads are crossed from one end to the other. This makes one end's send the other end's receive, and vice versa, permitting the cable to act as if a pair of modems were in the circuit (hence its name). These kinds of cables are widely available at computer supply and electronics stores, and they offer one of the cheapest available links between machines (hooking up to the Mac at one end will require a special cable with a standard RS-232C 25-pin connector on one end and a Mac modem connector on the other, or purchasing a 25-pin-to-Mac converter).

In addition to RS-232C cable, you can also find software and cable kits that let you connect pairs of machines on either a permanent or a temporary basis. Since these connections can be permanent, this could be considered a form of networking, but most of these products depend on running special communications software and run at speeds slower than those normally associated with full-fledged network connections.

Lap-Link Mac is a good example of this genre; it consists of software for both ends and a cable to run between a Mac and any IBM PC-compatible computer with a serial port. Its impetus was to let laptop-computer owners move data to and from their Macs, but it will link a Mac and a PC. Unfortunately, nothing similar exists to link the VAX to either microcomputer, but the "null modem" approach will work in a pinch.

Beware the Gotcha

Once you have moved the data from one machine to another, it still may need to be converted. Often, you will need to massage the file format into something recognizable to the software that will manipulate it. Fortunately, file-conversion programs abound that can translate between a wide variety of programs on various machines.

The important thing to remember is that where there's a will, there's a way; even when the means are not adequate to support true networking, there are lots of ways to move data between machines. Consider the frequency of exchange and the amount of data when choosing which method to use, and you'll be able to get the most out of the connections these options permit. Just make sure your target machine can actually read the data when it arrives, and you'll be able to share information among your computers with ease.

doesn't necessarily make finding the right connection simple or easy. Note that while the Mac may come ready to hook up to a network, you'll still need to purchase additional software to use it for distributed processing, E-mail, and so on. That is, you'll need a product like AppleShare, TOPS, or PacerShare to fully exploit the Mac's networking abilities.

Different ways of interacting with networks make different demands on users.

Choosing the method of interaction best suited to your environment often means trading functionality and ease of use for cost.

Network Essentials

Whatever your choice, three constants pertain to networking personal computers: First, you need some form of network interface (most commonly, an add-in card); second, some kind of cable needs to be strung between the machines

you want to connect (and everything from telephone cable to fiber optics is available); and third, you need software that will allow the machines to communicate with each other.

Ultimately, it's the software that defines how you interact with a network and determines how it looks to you from your desktop. The questions of which interface and which medium are resolved, at least in part, when you choose your software. In many cases, the software

MAKING THE CONNECTION

will dictate, or at least limit, the set of possible alternatives.

For the purposes of this discussion, networking software can be divided into three categories: simple network-connection software, operating-system-supported networking, and application-driven networking. Each of these has strengths and weaknesses, advantages and disadvantages, and cost-benefit trade-offs.

Simple Network Connections

In this category, networking software resembles the kind of system you're used to encountering when you use a modem or an RS-232C connection to create temporary links between pairs of machines. The basic applications for this kind of software are file transfer, which lets you move files from one machine to another, and terminal emulation, which lets you establish a session on one machine and work on another as if it were a terminal instead of another computer. Some examples of this genre include the Transmission Control Protocol/Internet Protocol (TCP/IP) Lap-Link PC, applications suite (TELNET, FTP, SMTP, and so on); and a variety of other file-transfer or terminal-emulation programs.

As with the other two categories, simple network connections are established by running particular software applications. In this arena, you need to be aware of the network itself and of the operating systems on both sides of your connection.

For instance, running a file-transfer program means that you have to know the formats for specifying filenames for both operating systems, as well as the commands for running the file-transfer application itself. Likewise, running a terminal-emulation program means that you not only need to know the details of the operating system on the computer that you're using as a terminal, but you also often need to learn how your keyboard maps onto the host's standard keyboard.

This discussion of file transfer applies to all three types of machines, but in looking at terminal-emulation options, I'll consider just Mac-to-VAX and PC-to-VAX connections. Since both the Mac and the PC usually run single-tasking operating systems, I won't discuss emulating a terminal on them (programs like Timbuktu or Carbon Copy Plus, which allow a remote machine to take over a Mac or PC, are more common here).

Since the VAX is a multiuser, multi-tasking machine originally designed for terminal access, it supports a variety of

continued

220 4105

TERMINAL EMULATION

- EM220 \$169
 - KERMIT and XMODEM file transfer
 - Phone directory
 - Scroll memory
 - Hot key
 - Loadable character sets
 - Network support
 - 132 column mode
 - Command (Script) files
- EM4105 \$349
 - TEK 4105 emulation
 - TEK 4010/4014 emulation
 - VT640 emulation
 - VT220 and VT102 emulation
 - High resolution hardcopy
 - Local picture files
 - EGA and VGA support

 Diversified Computer Systems, Inc.
 3775 Iris Ave., Suite 1B
 Boulder, CO 80301
 Telex: 9103800693 (DCSINC)
 (303) 447-9251

Runs on IBM PC, XT, AT, PS/2 and Compatibles

Trademarks: VT102, VT220—Digital Equipment; IBM PC, XT—IBM Corp.; Hercules—Hercules Computer Technology; Kermit—Bell Labs Inc.

QUICK TO FIND FAULT.



"OPEN at 312 feet"

"Network properly terminated"

The new MicroTest Cable Scanner can quickly isolate complex LAN faults. It's a TDR, Network Monitor and Cable Tracer bundled into a compact battery-powered tester. Time is precious. Call or write today for complete details, including good news about the price.

microtest

2920 E. Northern Avenue, Phoenix, AZ 85028 • 1 800 LAN WORK

© 1988 MicroTest, Inc.

C: > ftp vax1	Start up the FTP session; vax1 is a synonym that actually corresponds to a network address.
account name: test password: xxxxxxx	The VAX requires you to have a valid account name and password before it will permit access.
ftp> cd [test.program]	Change to the directory in which to put the file.
ftp> put floalc.dat	Copy the file over the network to the selected VAX directory.
ftp> quit	Exit the FTP application.
c: > telnet vax1	Start up the TELNET session; again, you need to know the name of the network node you want to connect to.
account name: test password: xxxxxxx	The same account and password dialogue as before is needed to log on to the VAX.
\$ set dir [test.program]	The VAX command to change directories is set dir.
\$ program floalc.dat	This sequence will cause the program named program.exe to run, taking floalc.dat as input.
\$ logout	Terminate the VAX session.
telnet > quit	Terminate the TELNET application.

Figure 1: An FTP session. Boldfaced text is what you would enter, and plain text indicates screen information written by the VAX or one of the applications.

terminal emulators for both PCs and Macs. Most of the major terminal-emulation companies—Kea Systems, Walker Richer and Quinn, and Coefficient Systems—support emulators for both PCs and Macs, while a variety of file-transfer applications among any or all of the three machines are also available.

Why bother to approach networking at this level? The greater the burden of managing the network that falls on the user, the easier it becomes to write the software to handle network communications. In a word, this approach is cheap! Because using simple network connections requires the knowledge or ability to work with several operating systems simultaneously, it has been widely used by computer professionals since networking's inception. For the same reasons, however, it isn't the best solution for novices; it burdens them with too many extraneous, unfamiliar details, and network access at this level is murkier than it is transparent.

This approach is best applied when the

need to communicate with other machines is infrequent or irregular and doesn't involve moving large amounts of data. Since you must stop what you're doing, start up a terminal-emulation or file-transfer application, and then perform the operations necessary on the host to complete your tasks, this kind of communicating can be time-consuming. If it needs to be done often, the overhead may consume any productivity gains afforded by the network.

As an example, consider what's involved in running a program on a VAX against some data generated on a PC (based on public domain software from the National Center for Supercomputing Applications [NCSA] TELNET). The applications used are part of the standard TCP/IP applications suite.

The file-transfer application is called File Transfer Protocol (FTP). This application uses a Unix shell-like command set (which brings yet another operating system into the equation) to perform some basic operations. In this example,

the task is to move a spreadsheet file named FLOTBL.DAT over to the VAX for further processing.

The terminal-emulation application is called TELNET, and it provides basic terminal-emulation capabilities (including several varieties of VAX terminals) in addition to its own set of capabilities and commands.

First, you must transfer the file from the PC to the VAX and then log on to the VAX to execute the program. The dialogue in figure 1 shows what you would see at your PC. This dialogue has been trimmed of some screen output (particularly related to logging on to a VAX), but it shows the essential operations that are needed.

Operating-System-Supported Networking

This kind of network software provides extensions to your local desktop that let you access remote resources as if they were local. This is accomplished by building network-access capabilities into the operating system (as has been done with the Mac and the VAX) or by adding software that extends the operating system to include network capabilities. For example, you could use a program such as Microsoft's MS-Net Redirector on PCs to create virtual drives or printers on remote servers. Networked operating systems or system add-ins like TOPS, MS-Net, or AppleShare represent this type of software.

One of the fundamental assumptions behind operating-system-supported networking or its cousin, operating-system-enhancement-supported networking (which applies to more than just the PC), is that the computers running such software are networked. Therefore, the software is set up to support networking much more reasonably than in file-transfer and terminal-emulation applications.

The buzzword for such capability is said to be "transparent" to the user. You don't have to concern yourself with the *how* of networking; you can simply concentrate on *what* you want to perform. Furthermore, transparency means that the activity looks familiar; it doesn't involve using the syntax of the host, just that of the more familiar machine on which you're currently working.

The most common kinds of services provided by networked operating systems or enhancements that support networking are called "distributed file systems." This means that you can see disk drives on file servers or on other ma-

continued

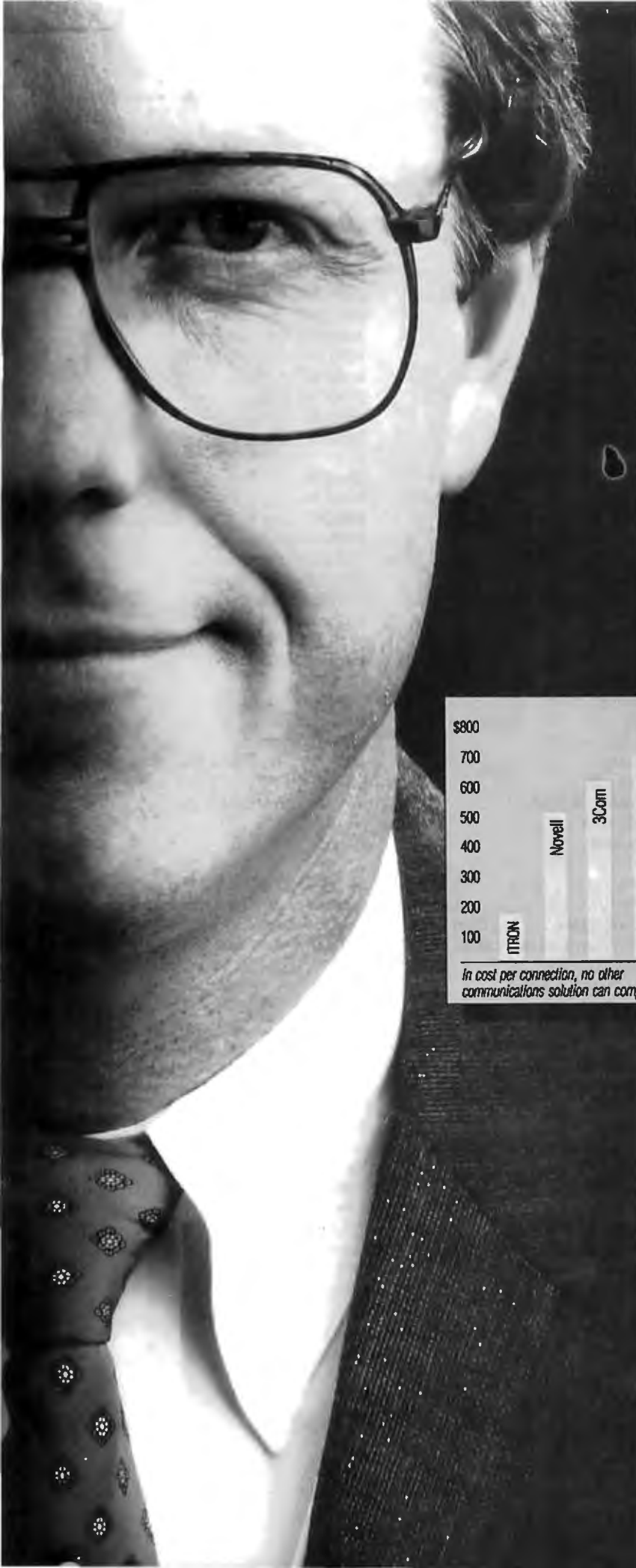

“The work groups in my department need to share printers. They need host connectivity, peer-to-peer file transfer and E-mail...

“But I don't need the complication and expense of a file server.”

Now there's Commix™ 32. For easy, fast communication between PCs, MACs, peripherals and minicomputer hosts. For as little as \$150 per connection.

You'll create a LAN where you can access a printer or modem right from your application program. Where file transfer and E-mail are background tasks. Where terminal emulation is automatic.

A LAN with hardware and software that expands. From a department, to a full-premise Ethernet® LAN, to a LAN/WAN inter-networking solution for ten users or a thousand.

It's not a file server. It's what you need. From ITRON:

800-423-8044

609-722-5575

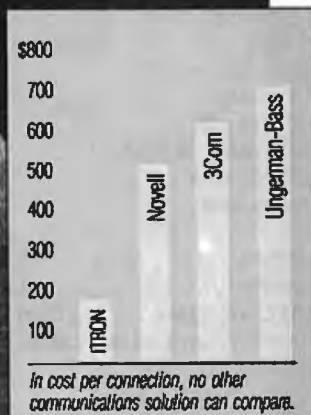

130 Gaither Drive, Suite 116
Mount Laurel, NJ 08054
FAX: (609) 234-0451
BBS: (609) 722-0639 (1200 8NI)
In the U.K.: (01) 735-0731
In Brussels: (2) 725-0770

Circle 320 on Reader Service Card

Connections

Alis Office Automation Package from \$2495
Applix, Inc.
112 Turnpike Rd.
Westboro, MA 01581
(508) 870-0300
Inquiry 1167.

Alisa ADP from \$750
AlisaTalk from \$4700
TSSNet \$495
DEC-to-Mac connectivity products
Alisa Systems, Inc.
221 East Walnut St., Suite 175
Pasadena, CA 91101
(818) 792-9474
Inquiry 1165.

AppleShare PC \$149
AppleShare File Server \$799
Apple Computer, Inc.
20525 Mariani Ave.
Cupertino, CA 95014
(408) 996-1010
Inquiry 1166.

CommUnity-Mac \$495
CommUnity-DOS \$525
Technology Concepts, Inc.
A Bell Atlantic Company
40 Tall Pine Dr.
Sudbury, MA 01776
(800) 777-2323 ext. 221
(508) 443-7311 ext. 221
Inquiry 1187.

DaynaFile 5¼-inch IBM PC-compatible floppy disk drive for Macintosh \$125
Dayna Translation Software \$650
Dayna Communications
50 South Main St., Fifth Floor
Salt Lake City, UT 84144
(801) 531-0600
Inquiry 1170.

DBMS 4GL
for DOS \$995
for Unix or VMS from \$5000
DBMS SQL
for DOS \$795
for Unix or VMS from \$5000
Informix Software, Inc.
4100 Bohannon Dr.
Menlo Park, CA 94025
(415) 322-4100
Inquiry 1173.

Double Helix II \$595
Helix VMX from \$4500
GeoQuery \$349
DataDesk \$495
Odesta Corp.
4084 Commercial Ave.
Northbrook, IL 60062
(312) 498-5615
Inquiry 1179.

Empress-32 relational DBMS from \$1000
For DOS, Unix, and VMS systems
Empress Software, Inc.
Century Bldg.
1100 West St.
Laurel, MD 20707
(301) 953-0049
Inquiry 1171.

EtherLink/NB \$595
SELink/NB \$595
NB5010 \$595
For the Mac and PC
3Com Corp.
3165 Kifer Rd.
Santa Clara, CA 95052
(408) 562-6400
Inquiry 1188.

FastPath \$2495
EtherPort \$695
SCSI Connection from \$1150
Kinetics, A Division of Excelan, Inc.
2540 Camino Diablo
Walnut Creek, CA 94596
(415) 947-0998
Inquiry 1175.

HostShare \$100
HostAccess \$150
Excelan, Inc.
2180 Fortune Dr.
San Jose, CA 95131
(408) 434-2300
Inquiry 1172.

Ingres relational DBMS \$950
Relational Technology, Inc.
1080 Marina Village Pkwy.
Alameda, CA 94501
(415) 769-1400
Inquiry 1182.

Lap-Link Mac \$139.95
Lap-Link PC \$129.95
Lap-Link Plus \$139.95
Traveling Software, Inc.
18702 North Creek Pkwy.
Bothell, WA 98011
(800) 343-8080
(206) 483-8088
Inquiry 1189.

Mac220 \$129
Mac240 \$199
Mac241 \$299
VMacS \$399
VAX terminal emulators
White Pine Software, Inc.
94 Route 101A
Amherst, NH 03031
(603) 886-9050
Inquiry 1191.

MS-Net OEM only
Redirector OEM only
Microsoft Corp.
16011 Northeast 36th Way
P.O. Box 97017
Redmond, WA 98073
(206) 882-8080
Inquiry 1176.

NCSA TELNET Price unavailable
National Center for Supercomputing Applications (NCSA)
University of Illinois
152 Computing Applications Bldg.
605 East Springfield Ave.
Champaign, IL 61820
Inquiry 1177.

NetWare ELS (entry-level system) Level II \$1395
NetWare Advanced \$2695
NetWare SFT (system-fault tolerant) \$4695
NetWare for Mac (per user) \$200
NetWare for VMS from \$5500
Novell, Inc.
122 East 1700 South
Provo, UT 84601
(801) 379-5900
Inquiry 1178.

Oracle DBMS from \$1295
Runs on the Mac, PC, VAX, and Unix machines
 Oracle Corp.
 20 Davis Dr.
 Belmont, CA 94002
 (800) 345-3267
Inquiry 1180.

PacerShare from \$400
PacerLink from \$2000
PacerPrint from \$1000
 Pacer Software, Inc.
 7911 Herschel Ave., Suite 402
 La Jolla, CA 92037
 (619) 454-0565
Inquiry 1181.

Reflection 7 for the PC\$399
Reflection 7 for the Mac\$349
Reflection 4 for PC (VT-241 emulation)\$299
Reflection 2 for PC (VT-220 emulation)\$199
VAX terminal emulators
 Walker Richer and Quinn, Inc.
 2825 Eastlake Ave. E
 Seattle, WA 98102
 (206) 324-0350
Inquiry 1190.

Sybase DBMS for VAX from \$10,000
 Sybase, Inc.
 6475 Christie Ave.
 Emeryville, CA 94608
 (415) 596-3500
Inquiry 1185.

Syntax SMBServer
 for VMS from \$3250
 for Unix from \$5400
 Syntax Corp.
 1501 West Valley Hwy. N
 Suite 104
 Auburn, WA 98002
 (206) 833-2525
Inquiry 1186.

TOPS/DOS\$189
TOPS/Macintosh\$249
 Sun Microsystems, TOPS Division
 950 Marina Village Pkwy.
 Alameda, CA 94501
 (415) 769-9669
Inquiry 1184.

VINES/286 from \$1895
VINES/386 from \$4995
 Banyan Systems, Inc.
 115 Flanders Rd.
 Westboro, MA 01581
 (508) 898-1000
Inquiry 1168.

VTERM/100\$195
VTERM/200\$245
VAX terminal emulators for the PC
VTERM/4010\$249
VTERM/4105\$395
VTERM/4208\$995
VAX terminal emulators with Tektronix graphics emulation for the PC
 Coefficient Systems Corp.
 611 Broadway
 New York, NY 10012
 (212) 777-6707
Inquiry 1169.

Xenix 286\$595
Xenix 386\$695
Xenix-net 286 from \$595
Xenix-net 386 from \$695
 The Santa Cruz Operation, Inc.
 (SCO)
 400 Encinal St.
 Santa Cruz, CA 95060
 (408) 425-7222
Inquiry 1183.

Zstem 220\$150
Zstem 240\$295
VAX terminal emulators for the PC
 Kea Systems, Ltd.
 2150 West Broadway, Suite 412
 Vancouver, BC
 Canada V6K 4L9
 (604) 732-7411
Inquiry 1174.

chines as if they were part of your own desktop. This kind of software also commonly supports such applications as E-mail or message-handling systems.

The VAX comes closest to providing these services at delivery. While the Mac supports communications through its LocalTalk port and the AppleTalk protocol suite, it doesn't come packaged with the ability to access remote file servers and built-in E-mail as the VAX does. None of these features is automatic on the PC.

Paradoxically, the PC has been the major platform for developing network servers and network operating systems. Several software companies have built their businesses around adding transparency to networking to make it easy for users to communicate with each other. These companies have tended to move away from homogeneous computing environments, such as "for PCs only," to heterogeneous ones, and PCs, Macs, and VAXes are the most common systems supported by network operating systems.

Novell, one of the most successful providers of network servers and network operating systems, began with a PC-only environment. Today, Novell's network operating system, called NetWare, includes services for Macs and VAXes, in addition to DOS and OS/2 PCs.

Sun Microsystems acquired the Transcendental Operating System (TOPS) when it bought the Macintosh-oriented company last year; TOPS currently runs on PCs and Macs, with Sun and VAX versions under construction. Banyan Systems' VINES network operating system runs on the PC and the VAX, and support for the Mac has been rumored, but not announced, for most of 1988. Likewise, 3Com's 3+Open network operating system currently supports VAXes and PCs, with Mac support (including full Apple Filing Protocol compliance) just around the corner.

Interestingly, Apple and DEC are also players in this game: They have begun to develop products based on their alliance, which occurred in 1988. For example, both companies have announced operating-system-level support for TCP/IP protocols along with software support for third-party developers. In addition, Apple and DEC both offer hardware and software add-ins to support their proprietary networking protocols and software for the PC.

Apple sells a board designed to plug into standard 8-bit PC buses, called the LocalTalk PC Card, which with its AppleShare PC software permits a PC to

continued

communicate over LocalTalk cable using AppleTalk protocols in an AppleShare environment. Likewise, DEC sells licenses for a product called DOS Services for VMS (virtual memory systems) that lets PCs use the VAX as a file server and execute applications stored on VAX disk drives.

A common tendency with Apple and DEC has been to create interfaces that cause the other computers on the network to look like their own. Apple's PC products are a good example, and there are add-ins for both Macs and PCs that make them look like DECnet computers to a VAX DECnet network as well.

For example, the CommUnity line from Technology Concepts offers products that include the necessary interfaces and software to turn Macs and PCs into DECnet hosts. For the VAX-to-Mac connection, Alisa Systems, Kinetics, White Pine Software, and Pacer Software offer a wide variety of network service applications for various protocols; some of them also offer PC-to-VAX connectivity software as well.

As an example, I'll use HostShare, a PC-based product from Excelan that extends DOS by using the Redirector, software licensed from Microsoft. The Redirector augments DOS so that you can define network devices, primarily disk drives and printers, and give them "normal" device names like F and LPT1.

Once you've performed the setup work to create these definitions (you can do this in the AUTOEXEC.BAT file), you can achieve the same results as the dialogue in figure 1 with this single command:

```
copy c:\data\localc.dat  
f:\test\data
```

For this to work where drive F actually represents a directory on a VAX disk drive, you would also need to purchase software, such as SMBServer from Syntax, for the VAX side. (SMB stands for Standard Message Block, Microsoft's networking protocol for network data transfer that works with the Redirector to support network operations through DOS.)

Even though this example is brief, several things about it are worth noting. First, the command line looks entirely DOS-like. If you didn't know better, you'd think drive F was just another device installed on the PC. Also, notice that the directory specification for the VAX side of the transfer adheres to DOS terminology; the software handles the name translation for you, so you don't

need to know that VAX filenames are delimited with square brackets and that subdirectories are separated by periods (i.e., \test\data on DOS is [test.data] on VMS). If you were talking to a Xenix or Sun server, the notation would be unchanged. (Please note, however, that the terminal-emulation portion of figure 1 would remain the same.)

This transparency comes at a price. It

The age
of distributed
applications is
almost upon us.
Leading this trend
are the DBMS
companies.

often means buying more expensive software to get the increased functionality and buying additional software for servers and other pieces of network paraphernalia that you don't need for simple network communications. It also means that your choices about the kinds of hardware and software you can graft together to make a single, coherent network become more and more limited.

Options in this arena start at about twice the cost per connection when compared to simple network communications software, and they go up from there. For most users, though, the added expense is worth it. The primary additional cost comes from needing to buy a network operating system add-in for each networked computer (e.g., Sun's TOPS); networked server applications (e.g., Syntax's SMBServer) add to that cost as well.

Application-Driven Networking

In this category, you run applications on desktops that access network resources but completely hide the details for managing the access, making it look as if all the data and operations used by the program are local. Such applications are called *distributed* because they essentially run over the network and coordinate multiple resources, both local and remote. Applications belonging to this category include the LANServer

Oracle DBMS and Applix's Alis office-automation package.

Application-driven networking is totally transparent by this definition; you fire off an application on your local computer, and it handles all the processing needed to move files across the network and execute remote programs. Whereas with either simple network connections or operating-system-supported networking, you would have to explicitly move the results back from the VAX, with application-driven networking the results can automatically be reported back to your node and displayed to you as you need them.

Such applications are clearly the most desirable for average users, since they don't need to be aware of the network at all, let alone interact with foreign operating or file systems. However, just as introducing operating-system support for network services limited the options regarding what could safely be put together to build a network, so also does the choice of a distributed application limit what can safely be assembled.

Leading the Way

Fortunately, the age of distributed applications is almost upon us. Leading this trend are the DBMS companies, which currently have the greatest number of products available and which support the largest variety of computers and operating systems.

Many of the relational DBMS companies coming from the Unix world currently offer products that can run on PCs and VAXes, most notably, Ingres, Sybase, Empress-32, and Informix. Oracle is presently alone in offering a DBMS that runs on all three machines, but the others have announced plans to support the Mac within the next year (the introduction of A/UX, the Unix operating system for the Mac II, makes this a necessity). Odesta's Helix VMX covers an interesting subset; it supports VAX servers with Mac clients—and even includes the ability to store and reference Mac graphics files on the VAX.

Another interesting niche in the distributed-applications world is occupied by office-automation packages. Like the early PC network companies, most office-automation companies are growing out of a homogeneous computing environment and are just beginning to grapple with the challenge of supporting multiple computers.

Right now, Applix offers an office-automation package, Alis, that supports Unix or VAX servers for PC clients, and other such packages are under develop-

ment. These promise to deliver on the productivity and communications gains provided by networks by taking basic, everyday work and supporting it over the network. By combining E-mail, word processing, spreadsheets, and other specialized applications into an integrated working environment, these office-automation packages may foreshadow the electronic desktop of the 1990s.

Returning to my example, assume that you want to move a spreadsheet file to the VAX to make use of its more powerful number-crunching capabilities to run a financial forecast involving a number of variables and several thousand data points. If your office-automation package supported a link to a forecasting module on the VAX, all you would have to do would be to prepare your data for the forecast and wait for the results to appear. Everything else—the file transfer to the VAX, running the forecast program, and returning the results to your workstation—would be totally invisible.

The simplicity and power of this approach are appealing, but today's costs can make it somewhat prohibitive. Client copies for all your PCs and Macs will cost from \$200 to \$1000 per node, and the server software for the VAX will run in the tens or hundreds of thousands of dollars. Part of that cost is to fund a still-emerging technology. In a few years, as the technology matures, networking will be more affordable, and offerings will also be better tailored to individual users' and companies' needs.

A Growing Appetite

Networked software is beginning to connect more and more electronic desktops. As users participate in networking more fully, their appetite for the power and synergy provided by shared information and ideas will certainly grow. As the technology to support that appetite also grows, everyone will experience more and more benefits from being linked together.

Don't let the infancy of distributed-application technology deter or delay an investment in networking; the simple communications and operating-system-supported technology currently available is very useful, as are the distributed applications already available. Today's network investment should continue to pay off as networking's uses and the software to exploit them expand to embrace more and more desktops in the future. ■

Ed Tittel is a field applications engineer with Excelan Corp. in Austin, Texas. He can be reached on BIX c/o "editors."



Support America's colleges. Because college is more than a place where young people are preparing for their future. It's where *America* is preparing for *its* future.

If our country's going to get smarter, stronger—and more competitive—our colleges and universities simply must become a national priority.

It's an investment we all share in. Government. Private citizens. And the business community. After all, the future of American business depends on it.

So help America prepare for the future with a corporate gift to the college of your choice—and you'll know your company has done its part.

**Give to
the college of
your choice.**



OUR μ P DEVELOPMENT TOOLS HELP PROJECTS GET ON THEIR FEET.

The "creature" shown above doesn't depict a futuristic lunar landing. Rather, it represents a *polar* landing of a sophisticated weather monitoring device. A new parachute-deployed device that instantly transmits vital environmental data to waiting scientists. And whose Antarctic installation and erection now happen automatically, in a matter of minutes, allowing critical data collection in remote areas that were impossible to reach before.

This "Self-Erecting Weather Station," sponsored by the National Science Foundation and designed and developed by Polar Research Lab, was made possible by Avocet and AVSIM™, Avocet's unparalleled simulator/debugger.

Unequaled capability

Polar Research needed AVSIM's sophistication to control the sensors in the weather station's "legs" and to create its transmitter. AVSIM's detailed on-screen CPU simulation, unlimited breakpoint facility, and unique "undo" capability gave their engineers the ease of use and flexibility that allowed them to *execute and test the software even before the hardware was ready*. Saving crucial time and frustration in both the programming and testing phases of development. And money, too; at only \$379, AVSIM is a fraction of the cost of additional hardware.

Get your own project off the ground; try before you buy

Try the AVSIM demo yourself for 30 days. If you're not satisfied for any reason, return the unopened program disk for a full refund — less \$35 for the demo disk and manual, which are yours to keep.

Free Catalog



Call Toll-Free 1-800-448-8500*

For your free catalog to order, or for more information about AVSIM and other Avocet products.

Complete compatibility: from the ground up

Best of all, AVSIM is completely compatible with our AVMAC™ macro assemblers and AVOCET C™ cross compilers — the ideal combination of tools which gives you a comprehensive development solution.

Call Avocet today and ask about our complete line of affordably priced software and hardware μ P development tools. Discover how we can help you get *your* next project on its feet, too.



The AVSIM Full-Screen Display

AVOCET

SYSTEMS®, INC.

©1988 Avocet Systems, Inc. All rights reserved.

THE SOURCE FOR QUALITY μ P DEVELOPMENT TOOLS

THE BYTE AWARDS

The First Annual BYTE Award Winners



In the course of a year, we see a lot of products at BYTE—the good, the bad, the ugly, the innovative, the inane, and the endlessly delayed. We objectively rate these products in our Products in Perspective section to help you separate the wheat from the chaff.

But of the hundreds and hundreds of products we see, test, and evaluate, only a relative handful are good enough and exciting enough to make an editor go out and get a copy for him or herself. Fewer still ultimately prove to be so useful, trustworthy, and generally handy to have around that they're put into daily use as office workhorses.

Another class of products separates itself from the pack through a combination of factors such as outstanding value, exemplary innovation, and technical elegance. These are the ones that bridge to the future and truly advance the state of the art.

In recognition of these outstanding products, we announce the first BYTE Awards. The awards fall into two categories. First, a BYTE Award of Excellence goes to those products our editors and columnists judge to be the year's most significant and outstanding offerings.

Second, each BYTE Award of Distinction is a personal favorite of some of the BYTE editors and columnists.

For our first year only, we have not limited our choices to products released within the calendar year 1988. A handful of our favorite products from 1987 are still significant and deserve recognition.

Note that we haven't merely based our selection on press releases or on second-hand information from outside reviewers. All our selections are based on personal, in-house evaluations by BYTE editors and expert columnists.

Note also that we've made no attempt to define arbitrary categories, or to force-fit products into some preconceived, predictable, and ultimately indefensible lineup of "the best word processor," "the best spreadsheet," and so on: "best" is simply too slippery a term. But these products—every one of them—are ones we wouldn't hesitate for a moment to recommend.

And now, the envelopes, please.

**EXCELLENCE****A/UX**

A/UX is Apple's version of System V Unix for the Mac II. As such, it signals a new chapter in the history of Unix that may change the development of that operating system forever.

Version 1.0 of A/UX was essentially a plain-vanilla im-

plementation, providing multitasking, virtual memory, and network access, and of course, the ability to run Macintosh programs and access the Mac Toolbox routines. Future releases promise to bring more of the Mac's interface to Unix (e.g., incorporating a Finder to launch applications and manage files). This could help make Unix the multitasking operating system of choice during the next decade, especially if other vendors pick up the basic interface items.

The presence of A/UX will help Unix challenge OS/2 and drive Apple's own native-mode multitasking operating system for the Mac. We find A/UX to be significant because of its potential and the changes it heralds.

EXCELLENCE**Compaq
Deskpro 386/25**

Compaq's 25-MHz Deskpro is the best representative of a fine field of machines that moved the high-speed frontier up another 25 percent in 1988. Though edged out in performance by ALR's entry, the 386/25 combines power with flawless operation and dependability rarely found in systems so close to the forefront of technology.

The 386/25 retains the Flex architecture and hardware cache controller of its outstanding predecessor, the Deskpro 386/20. Peripheral and expansion support is excellent. In addition to the wide range of expansion cards designed for the Deskpro, the system comes with a 16-megabyte memory ceiling and simultaneous support for both the Weitek 1167 and 80387 coprocessors. High-speed ESDI (enhanced small device interface) drives bring the disk performance in line with the rest of the system. For an ideal mix of state-of-the-art performance with proven reliability, the Deskpro 386/25 deserves recognition as the premier DOS system of 1988.

EXCELLENCE**HyperCard**

HyperCard merges the concepts of hypertext and object-oriented programming into a free-form database system that just about any Macintosh user can learn to browse and program. Its strengths are its powerful index-card metaphor, its compact but useful HyperTalk scripting language, and its user interface. Like any first entry, it has some flaws: it can be very slow, it lacks specialized data structures, and it needs a full-blown script editor and a real error handler.

Still, HyperCard opened up a new category of software. It's an outstanding product that really came into its own during 1988. Apple should be applauded for bundling it free with every Macintosh sold.

EXCELLENCE**Microsoft Bookshelf**

Microsoft Bookshelf is the first substantial application of CD-ROM (compact disk read-only memory) technology.

The quantity of information provided by Bookshelf is numbing: A disk the same size as an audio compact disk contains *The World Almanac and Book of Facts*, *Roget's II Electronic Thesaurus*, *The American Heritage Dictionary*, *The Chicago Manual of Style*, *Bartlett's Familiar Quotations*, a spelling checker, a ZIP code directory, and more. It's a writer's El Dorado.

But it's not just the quantity of information that makes Bookshelf work: Considering how many megabytes are on the disk, piles of ASCII text wouldn't cut it. Bookshelf's user interface lets you skip through the references like an electron shot through a card catalog. Best of all, Bookshelf can operate as a terminate-and-stay-resident (TSR) program, so you can conjure it from within your favorite word processing program.

The amount of data stored on Bookshelf is surprising only until you see the amount of *unused* space the disk still has. Microsoft's release of its Programmer's Bookshelf (with electronic versions of most of its programming manuals) proves that the original disk is only a harbinger of personal library systems of the future. If so, we're off to a good start.

EXCELLENCE**NeXT Computer**

The NeXT Computer shows what can be done when a personal computer is designed as a system, and not a collection of hardware elements. It features the latest-generation high-speed components: Motorola's 25-MHz 68030 CPU and 68882 floating-point unit, and a 4-megabyte-per-second SCSI (small computer system

interface) port. A built-in digital signal processor (DSP) chip provides powerful array and signal-processing capabilities. It also has 12 dedicated direct-memory-access channels that move data throughout the system without degrading its performance.

The NeXT Computer is truly innovative in three areas. First, the standard 256-megabyte optical drive eliminates the coming storage crunch that will be brought about by the huge databases we'll be working with in the 1990s. Second,

the DSP lets the NeXT Computer tackle tasks such as voice recognition and synthesis, three-dimensional graphics, real-time data acquisition, and signal processing, plus future applications not yet dreamed of. Third, the object-oriented programming environment, plus kits supplied by NeXT, promise to hide hardware details from the programmer and thus accelerate the development of new applications. The NeXT Computer is worth every penny of its \$6500 market price.



EXCELLENCE

OS/2

OS/2 is today where the Macintosh was in 1984: It's a development platform in search of developers. Naysayers notwithstanding, that's likely to change. For better or worse, DOS and its myriad applications are synonymous with computing for the majority of PC users. Because users require multitasking, virtual memory management, and graphical interfaces (and because DOS doesn't support those things), applications have had to bear the burden. The results have been chaotic.

Under OS/2, developers won't have to play tricks to create the illusion of multitasking, won't have to manage memory, and won't have to invent proprietary and monolithic schemes

for getting applications to exchange data. They can simply develop applications. Programmers now engaged in porting DOS programs to OS/2 report excellent results—a tribute to Microsoft's determined effort to make OS/2 backward-compatible with DOS.

Some planks of the OS/2 platform—Presentation Manager and LAN Manager—are still being hammered into place. When it's complete and bug-free, when it can really use the 80386, and when more desktops sport OS/2-capable PCs, OS/2 will—deservedly—supersede DOS. But even as it stands, OS/2 is a milestone product.

EXCELLENCE

Sun386i

The line between powerful 32-bit personal computers and small workstations has all but vanished. Some 80386-based PCs are starting to take on the duties of more expensive workstations, such as high-resolution graphics and networking capabilities. In an interesting twist, Sun's latest 80386-based workstation, the Sun386i, has taken on some of the abilities of IBM PCs: It can run MS-DOS in one or more windows under SunOS, its Unix multitasking operating system.

This Sun shines best in its ability to run DOS windows as processes under Unix. Each DOS window acts as a virtual PC, and if necessary, it can ac-



cess Unix files on a hard disk or PC peripheral cards in three AT-compatible slots or one XT-compatible slot.

The Sun386i's memory management is excellent: A PC program that runs amok is cleanly killed off by SunOS without disrupting other processes. Sun's efforts to shield the casual user from the intricacies of Unix are good, despite a few gaps. CPU performance in a DOS window is also good, although (as you might expect) PC I/O in the DOS window and peripheral boards lags.

Nevertheless, the Sun386i stands out as an attractive machine in its own right, one that reveals the true potential of the 80386 by running multiple copies of virtual 8086 machines while operating in its protected mode.

continued



EXCELLENCE

The Toshiba T1000

This machine sticks to the basics and takes portability to the limit. If a well-traveled portable-computer user had designed his dream machine, he couldn't have done better.

The designers addressed the one feature that users on



the road value most: convenience. At 6½ pounds and 2 inches thick, the T1000 doesn't even fill a whole briefcase and won't add seriously to

its weight. In addition to being tiny and featherweight, it is as self-contained as you can get and still have a real computer that can handle real-world

workloads. The T1000's 4.77-MHz 80C88 CPU and 512K bytes of RAM can handle any DOS application. DOS is in ROM, so you don't need a boot disk. You can add an internal 1200-bps modem, as well as a 768K-byte nonvolatile RAM disk to carry your applications programs.

The T1000 has a perfectly normal keyboard and a very good nonbacklit LCD display (made even better if you get the backlight retrofit made by Avonix for \$295). The nickel-cadmium battery will run the computer for up to 5 hours.

Finally, though the T1000 lists for \$1249, BYTE staffers have paid as little as \$850 for it through discount outlets. Many of us are in love with this one.

EXCELLENCE

TrueScan

Unless you're willing to spend upwards of \$15,000, the optical scanners available to you can read only a limited variety of documents. Also, these scanners can display them only as bit-mapped images and have little or no ability to convert the scanned image into a file that you can further manipulate with commercial word processing, spreadsheet, or graphics packages. Even many of the most expensive systems have serious limitations.

Calera Recognition Systems has brought forth a solution to this problem called the TrueScan document recognition system.

The top-of-the-line 100-character-per-second version costs \$3500; a second version that reads at 70 characters per second and costs only \$2500 works only with portraits. For these breakthrough prices, you get an IBM PC-compatible add-on board and document-recognition software that interfaces to most low-cost (\$1000 or less) optical scanners.

Among TrueScan's features are the ability to recognize tabular data and convert them into spreadsheets; to scan text only, image (graphics) only, or text and image combined; and in text-and-image-combined mode, to convert the text to ASCII format and the graphics to whatever file format you specify.

TrueScan is indeed an impressive product.

EXCELLENCE

Zenith FTM monitor

The Flat Tension Mask monitor from Zenith Data Systems is the first significant improvement in traditional shadow-mask monitor technology for high-resolution color monitors.

All color CRTs use some form of shadow mask, which is suspended just behind the screen and controls the points where the electron beams strike the surface. The shadow mask will heat and deform under high enough power, making the color become less pure and limiting the levels of brightness that can be displayed.

The Zenith FTM has changed the fundamental design of the shadow mask by putting it under tension and installing it—still under tension—into the CRT. This change creates a front surface that is completely flat. Because the shadow mask is under tension, the heat created when the electron beams strike it does not deform it, and much higher power levels can be used. This improvement permits greater brightness, which in turn permits the use of better antireflective coatings.

The result is an extremely high-resolution monitor with a flat screen that is virtually free from reflections. If there is a problem, it is that users of FTM monitors find it difficult to return to conventional designs.



continued

**New! PCX
MULTI-LINE
VOICE
MAIL**

Just Say NO.*

**To High Prices And Key Pushers*

If you like buying at a discount, but hate dealing with the uninformed key pushers that take your orders, you're ready for an alternative source for quality computer components: the On-Line Store's WHOLESALE + 7% PRICING POLICY.

Offering more than just a good price, the well-informed sales staff at the On-Line Store knows what to ask to make sure the products meet your particular needs.

Key pushers? They just take orders.

In addition, you'll receive unlimited access to their revolutionary multi-line BBS with literally hundreds of free programs—yours for the taking. PLUS you'll find a multitude of other specials too numerous to mention in this ad.

HAYES COMPATIBLE MODEM BUYING MADE EASY

	Internal	External
2400 BAUD • FAST <i>Hayes Compat./2 Year Warranty</i>	\$89*	\$119*
4800 BAUD • FASTER <i>Hayes Compat./2 Year Warranty</i>	\$189*	\$249*
9600 BAUD • FASTEST <i>Famous Brand/Private Label</i>	\$389*	\$439*
IBM PS/2 • 2400 <i>Hayes Compat./2 Year Warranty</i>	\$189*	N/A

Robotics

2400 Internal Modem	\$ 129*
2400 External Modem	189*
4800 Int. LEV 5 MNP	NEW
9600 Courier HST Ext.	Now Low Price 569*

MultiTech Systems

MT 224 EH (4800 w/LEV 5 MNP)	\$ 369*
MT 224 EC (4800 w/LEV 5 MNP)	359*
MT 9600 V. 32 (Industry Standard)	Now 999*
MT 208B (IRS Approved)	CALL

MICROCOM™

AX 9600 + LEV 6 MNP	Closeout \$ 499*
QX/12 w/LEV 7 MNP (12,000 Baud)	569*
QX/32C TRUE V. 32 Modem (32,000 Baud)	SAVE

Many other modems available, including Laptop & Portables. Call for information.

FAX CARDS

JT/FAX By QUADRAM NOW ONLY \$269*



• External Version \$349* • 9600 Baud \$499*
JT/FAX has features such as pull-down windows, multiple scheduling and Broadcast FAX and runs unattended. Input: scanner or word processor. Output: dot matrix or laser printer. Compatible with all Group III FAX. *PC Editor's Choice.*

SCANNERS

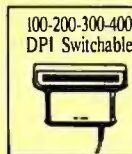

**HI RESOLUTION 4" DPI SWITCHABLE
400 DPI HAND SCANNER & HALO DPE SOFTWARE \$239***
For use with JT/FAX plus scores of desktop publishing applications.

ASCII Conversion Package..... 89*

MULTI-LINE VOICE MAIL CARD

REVOLUTIONIZES PHONE TRAFFIC HANDLING...

PCX is a *real* voice multi-line Telemarketing System and Voice/Mail Exchange with hundreds of features such as call routing, questionnaires, multiple voice messages, autodialing, remote access, and call forwarding. Optional versions allow one PC to accommodate up to 16 phone lines simultaneously.



For a live demonstration of PCX, our Multi-Line Voice/Mail Card, please call 805/654-0721.

From
\$269

AWARD-WINNING SYSTEMS

30 MB HARD DRIVE SYSTEM 286 / AT

- 80286 Intel Processor
- 80287 Co-Processor Slot
- VGA/EGA Graphics Card
- 30 MB Hard Disk
- IBM & OS2 Compat. System
- Choice of Optional Monitors



\$995 Full Cash Price - Financing Available



PORTABLE 286 / 12

Flat Panel LCD Display

\$999 Full Cash Price - Financing Available

New! 386 TOWER

- 80386 Intel Processor
- 80387 Co-Processor Slot
- 1MB Expand to 9MB RAM
- 65 MB Hard Disk

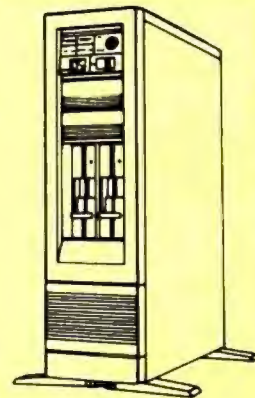

\$1995

Full Cash Price Financing Available

ALL *PRICES SHOWN ARE WHOLESALE AND REFLECT AN ADDITIONAL 3% CASH DISCOUNT. THE ON-LINE STORE'S WHOLESALE + 7% PURCHASERS PAY JUST 7% ABOVE THE WHOLESALE PRICE, PLUS SHIPPING AND HANDLING. Minimum shipping: \$5 per order. International orders: call for rates. Some prices subject to change. Products subject to availability and may be private label versions. WE ALSO SERVE LARGE CORPORATE ORDERS: call for information. This ad supersedes all previous.

BBS 805/650-0193 FAX 805/650-0195



Customer Service
805/650-0188



Mailing Address

3037 Golf Course Drive
Ventura, CA 93003



ACCESSORIES/DISPLAY

1.2 MB 5 1/4" Floppy	\$ 99*
1.4 MB 3 1/2" Floppy	109*
130 MB Hard Disk	Now 899*
Alloy PC/Slave (512K)	599*
Alloy 40 MB Tape B/U	Now Low Price 299*
Quadram 386/16 1 MB	799*
Quadram 386/20 1 MB	CALL
Quadram VGA/EGA 256K	1/2 Off 219*
Video-7 VGA/EGA Card	269*
Genoa EGA/HERC/GEM	Now 189*
Orchid Designer VGA	279*

Some Products In Limited Supply. CALL NOW!

24 Hour Order Line: 805/650-0188



Your Data Communications System Specialist
ASK ABOUT BULLETIN BOARD SOFTWARE



DISTINCTION

Battery Watch

Battery Watch is the first in a new class of software for laptop computers. For the first time, a software product is available that will reliably monitor your use and predict the remaining battery time on a battery-powered laptop. Battery Watch also lets you drain your nickel-cadmium batteries completely, which is the only way to avoid recharging—limiting “NiCad memory.”

Choice Words

Proximity's Choice Words is a hard-disk version of the *Merriam-Webster Dictionary*. It is, in fact, the first major implementation of a dictionary for a hard disk. The program sells for only \$99 and includes pop-up definitions for 80,000 words and a thesaurus. Putting a reference dictionary on a hard disk is such a practical idea that Choice Words may seem less than exciting, but the fact that Proximity has done so in such an easy-to-use way is significant.

**Compaq 386s**

▲ Intel's new 80386SX chip, a less-expensive version of the 80386 with a 16-bit data bus, is used in only one system as of this writing. Not surprisingly, it's a Compaq: the 386s. As the leader, the Compaq 386s will be the proving ground for the new technology that promises to cut costs by reducing power requirements while retaining compatibility.

DESQview 3.0

When people say they want multitasking, often what they really mean is that they want a painless way to go instantly from one program to another. They also want a way to load up machines with memory-resident programs and still have enough room to run large applications.

DESQview accomplishes all that by extending traditional DOS. Unlike OS/2, DESQview lets you run the programs you've already paid for. Add the Phar Lap extension and you can write programs bigger than 640K bytes as well. Many users will find that DESQview is all they need.

Documentor

Documentor is specialized: If you don't do dBASE programming, you don't need it; but if you do program in dBASE, you can't live without it. Documentor makes documenting dBASE programs easier, faster, and better, and does it without muss or fuss. It will save a dBASE programmer many hours a month.

Epsilon Editor

Epsilon is a fast and completely extensible EMACS-like programmer's editor available for both DOS and OS/2. It supports large files, multiple windows and buffers, file- and command-name completion, keystroke macros, regular-expression searching, and syntax-sensitive modes. But the *pièce de résistance* is EEL, a C-like extension language that comes with its own compiler. Lugaru Software has implemented Epsilon's entire user interface in EEL so you can, for example, create your own syntax-sensitive modes or program the help system to browse through your source libraries.

Excel

Excel, Macintosh's extraordinary spreadsheet, has been

ported to the IBM—and it shines. It takes up just about all the 640K bytes of memory on an AT compatible because the program is large and comes with its own run-time version of Windows 2.0. Excel's most impressive feature, its user interface, functions as well as or better than its Macintosh relative.

The spreadsheet's keyboard support lets you access every one of Excel's commands and functions. And if you prefer not to use a mouse, you can do without one with this program. Excel is fast and easy to learn and use.

Fastback Plus

Fastback—a program that backs up your hard disk—is fast, and it is reliable. Now Fifth Generation has improved it. The company fixed the manuals and then put in help files that make the manuals nearly superfluous. Then it added data compression to save disk space and a utility that estimates how many floppy disks and how long the job will take.

With this program, we've copied 38 megabytes of data from one machine to another in 28 minutes (which included formatting the disks). Fastback Plus will also read backup disks made with older versions using an option called Old Restore Program. If you have a hard disk drive, we recommend this package.

Fast Trax

Frequently written files tend to end up scattered around your disk. When you load the file, DOS has to hunt for these fragments, and that can slow you down. Disk defragmenters put the files back together in contiguous blocks, speeding up disk I/O.

And there are a million of them: the Norton Advanced Utilities offers a bulletproof but inflexible defragmenter; DOG, a shareware utility, is flexible but not simple to use; then there's VOPT, the Poly-

boost unfragmenter, SST, and many others—everyone good.

But after trying them all, we've found Fast Trax to be fast, rock-solid, easy to use, and highly configurable—your disk gets organized the way you want it in minutes.

**Gateway 386**

▲ The outstanding value of the Gateway 386 was one of the most pleasant surprises produced by our October roundup of affordable 80386 systems. Selling for \$2995, the Gateway machine combines power and room for expansion at a price that brings the expanded capabilities of the 80386 to individual as well as corporate users. Its 20-MHz performance (though built around a 16-MHz chip), high-speed memory, coprocessor support, and 12-megabyte memory ceiling sets it apart from the rest of the 80386 clones.

GrandView

You could say this is many packages combined into one—word processor, outliner, and project-tracking software. GrandView, a new type of program, is so packed with goodies that you have to really study the manual to see how to get around in this labyrinth. In “document view,” GrandView's outliner is even more powerful in many respects than ThinkTank, and its word processor is complete with spelling checker. In “category view,” GrandView has a feature that lets you attach keywords and priorities to

continued



While dBASE Promises You The Moon, Clipper Delivers.

Right now, while others dream about the database of the future, you can be using it today to create applications of unparalleled sophistication. With Clipper™ — the most powerful and complete database development system for PCs.

Open the Clipper box and you'll find the enhancements dBASE® has been promising. And some it hasn't.

Such as: a remarkable development language that takes you way beyond dBASE® emulation, with enhanced commands and entirely new language extensions. A unique open architecture which gives you the flexibility to create and easily integrate user-defined functions in C, Assembler, Clipper, and still other languages. The speediest-ever dBASE compiler, yielding applications up to 20 times faster. And that's just for starters.

Clipper also provides the most capable menu-driven debugger to be found anywhere, as well as half a dozen modifiable utilities to further reduce development time.

There's source code security, too, plus sophisticated record and file-locking capabilities that make networking

	Clipper® \$695*	dBASE III PLUS™ \$695*	dBASE IV™ Developers Ed. \$1295*
A true compiler	Yes (1984)	No	???
User-defined functions	Yes (1984)	No	Limited
Arrays	Yes (1985)	No	Just Intro'd
VALID function	Yes (1985)	No	Just Intro'd
Improved Execution Speed	Yes (1984)	No	No
Link in Other Languages	Yes (1984)	No	Limited
Null Character Support	Yes (1987)	No	No

*Suggested retail price

applications easier to create.

And once you have created them, Clipper gives you an equal measure of control over distribution by creating .EXE files — there are no runtime modules, licensing or royalty fees, or additional software requirements. You can even add stations to a network without adding to your costs.

All of which adds up to the most powerful and flexible database

development system today.

Why settle for the moon when you can reach for the stars? Call (213) 390-7923 today, and we'll send you a free demo diskette and a very informative booklet, *Developing and Compiling in Clipper*. The dBASE development system that's not just one small step... but a giant leap forward in programming power.

Clipper®

Nantucket Corp., 12555 W. Jefferson Blvd., Los Angeles, CA 90066
 Telex: 650-2574125 Fax: 213-397-5469

Copyright © Nantucket Corporation, 1988. All rights reserved.
 Nantucket and Clipper are registered trademarks of Nantucket Corporation. dBASE is a registered trademark and dBASE III PLUS and dBASE IV are trademarks of Ashton-Tate Corporation.



DISTINCTION

items. While it'll take you a long time to find out all the bells and whistles of this information-management package, we think it'll be worth it.

**HP DeskJet Printer** ▲

If you're looking for a truly silent printer, this HP ink-jet will suit you. The DeskJet's output is close to laser-printer quality at a much more tolerable price of \$995. It comes with 128K bytes of built-in RAM, a 16K-byte buffer, and both parallel and RS-232C input. In draft mode, it runs at 240 characters per second with 300-by-150-dot-per-inch resolution; in letter-quality mode, it does 120 cps at 300 by 300 dpi.

The DeskJet comes with Courier, Courier Bold, and Courier Compressed fonts at 10, 16.67, and 20 characters per inch, and you can make all your font selections from the printer's front panel.

Illustrator 88

Adobe Illustrator was the first of a new class of drawing programs that use PostScript to create artwork made up of lines and Bézier curves. With Illustrator 88, Adobe pulled ahead of its chief competitor, Aldus's Freehand. Illustrator 88 includes a new freehand drawing tool and an automatic tracing tool that makes tracing a rough image fast and painless. Illustrator 88 can now do four-color separations and uses the Pantone palette of colors to let you customize.

If you have a Mac Plus or II and you're ready to move beyond MacPaint, Illustrator 88 can let you create professional-quality graphics.

LANtastic

LANtastic is a half-slot, NetBIOS-compatible networking board for the IBM PC and compatibles. If you need raw speed, other networks are faster, but they cost a lot more and aren't as easy to install and work with. The manufacturer, Artisoft, offers a starter kit that includes two LANtastic cards, cable, bus terminators, and NetBIOS, at a price of \$399. That's a lot of LAN bang for the buck. It also lets you access a CD-ROM drive over the network without DOS extensions in the remote machine. Columnist Jerry Pournelle uses LANtastic (despite the silly name) every day at Chaos Manor.

Lightspeed C

This C compiler for the Macintosh wins our respect because of its powerful features and low price. New features in version 3.0 include Multi-Finder resource and trap support, 68020 and 68881 code generation, and access to Color QuickDraw. A new source code-level debugger gives you windows that track your progress through a program and display the values of selected variables or structures. If you're using a Mac II, you can direct the debugger output to a second monitor. The documentation has been revised and updated. Lightspeed C is compatible with the Mac Plus, SE, II, and IIX.

MacDisk

This 330-megabyte hard disk drive by Priam is a joy to have on a Mac Plus, SE, or II, and it works just as well on other systems such as the Cheetah 386. It's a SCSI device about the size of a shoebox with two lights on the front and a window on the back. In spite of the documentation, which leaves installation in some machines to your imagination, installing it is the simplest thing in

the world. It comes already formatted; it's lightning fast, with an 11-millisecond average seek time; and it's rugged: You can transport it from one machine to another, and you can daisy-chain it with any other SCSI device.

MacInTax

Of the tax-preparation programs we've used, several of us have found MacInTax to be our favorite. You enter information, and MacInTax automatically enters it (and updates it, if you change the value) everywhere else that it's relevant. You can expand lines to allow for multiple entries (such as more than one W-2 form). MacInTax adds the entries and inserts the total on the correct line. The screen display looks just like a real 1040 form, and the printout is perfectly acceptable to the IRS. A must if you're doing your own taxes.

Mark/Release

Mark/Release is a pair of public domain terminate-and-stay-resident programs that let you painlessly manage your other TSRs. You place a "mark" in memory before loading a new TSR program. Later, you can remove any TSR loaded after the mark using "Release." With multiple marks, you can selectively purge and load TSRs to run with various applications you use, or you can instantly clear your RAM of all TSRs with one command. No, it's not the neatest thing since sliced bread, but it's one of those little programs that soon become indispensable. And hey, it's free; how can you go wrong?

Mathematica

Mathematica is another breakthrough Macintosh application. It does for students of calculus, symbolic algebra, and some discrete mathematics what calculators did for those learning arithmetic. Confirmed mathphobic stu-

dents may very well be drawn into Mathematica's impressive displays and its ability to solve equations quickly and display graphical results. It could enable you to absorb the algebra and calculus that seemed impossible to comprehend from a textbook.

Maximum Storage WORM

We have looked at a number of WORM (write once, read many) optical drives. These drives create permanent copies of files. If you change a file, the drive makes a new copy; your old version is safe and can be retrieved—a boon for writers who need archival backup.

With a number of initial problems corrected, we lean toward the system made by Maximum Storage; the drive is simple to install (you modify your CONFIG.SYS file), and the MAXSYS software is easy to use. By default, it displays only the latest version of a file, but it lets you go back and retrieve any version you like. Using the drive is much like using any other hard disk drive; you can even use it to store compilers, word processing programs, and anything else you don't normally write to.

NEC P5XL Printer

In April 1988, we conducted extensive tests of 24-pin dot-matrix printers that produce near-letter-quality output at acceptable speeds. Among the medium-price dot-matrix printers, the NEC P5XL model came out tops in both high-quality text and graphics output. It was also among the quietest of the mid-price printers, though its throughput lagged somewhat behind that of competing models. If printing quality is your prime consideration, the P5XL is a best buy at \$1295.

continued

We couldn't have said it better.



And you can bet they'll be saying it again. **ADVANCED MS-DOS PROGRAMMING**—the preeminent source of MS-DOS information for assembly-language and C programmers—has just been expanded and completely updated. Included is a wealth of new data and programming advice in several significant areas:

- ROM BIOS for the IBM PC, PC/AT, PS/2, and related peripherals including disk drives, video adapters, and pointing devices
- MS-DOS through version 4
- version 4 of the Lotus/Intel/Microsoft Expanded Memory Specification
- writing “well-behaved” vs “hardware-dependent” applications
- compatibility considerations for OS/2

“Advanced MS-DOS PROGRAMMING exemplifies how a highly technical book can be both informative and readable.... Duncan’s strengths include a style that is at once easily read, a thorough coverage of the subject matter heretofore unknown, and the frequent use of examples in the form of assembly language programs and code fragments.”

BYTE magazine
John Unger, IBM Issue 1986

“Makes good reading out of even the most elaborate technical descriptions.”

Online Today

“One of the most authoritative in its field.... The book deserves a place on the shelf of everyone who has ever given a fleeting thought to programming the IBM PC and compatibles.”

PC Magazine

Ray Duncan, DOS authority and noted columnist, explores key programming topics including character devices, mass storage, memory allocation and management, and process management. In addition to his expert advice, he has packed his book with a healthy assortment of updated assembly-language and C listings that range from code fragments to complete utilities. These include a fully functional terminal-emulation program, a nifty DOS shell, and the framework for customized critical-error interrupt handlers.

And the reference section in **ADVANCED MS-DOS PROGRAMMING**, detailing each MS-DOS function and interrupt, is virtually a book within a book.

ADVANCED MS-DOS PROGRAMMING. Your key to fast, efficient, robust programs. **\$24.95**

Microsoft Press *Hardcore Computer Books*

Available wherever books and software are sold.

Or order directly from Microsoft Press. 800-638-3030 (In MD, 824-7300) 8:15 AM to 4:15 PM (EST).

Circle 180 on Reader Service Card (DEALERS: 181)

JANUARY 1989 • BYTE 335



DISTINCTION

The Norton Commander version 2.0

The Norton Commander is a DOS shell program. It simplifies using DOS by providing a convenient user interface that is programmed to automatically do many common tasks. For example, you can view, edit, copy, rename, move, and delete files by simply scrolling through a directory and hitting a function key. You can just as easily create, rename, or remove directories. Navigating through a crowded hard disk is a breeze; just highlight any subdirectory in a tree display to move to that subdirectory.

Norton Utilities version 4.5 and Norton Utilities Advanced Edition version 4.5

The Norton Utilities is an essential first-aid kit for all IBM PC-compatible computers. The package is famous for its program for recovering erased files, and modifying and viewing files. The Advanced Edition features the Norton Disk Doctor, a disk-diagnostics program that can repair damaged boot records, media-descriptor bytes, and file-allocation tables. Both versions include the Norton Control Center, which lets you set screen and color attributes, adjust the keyboard rate, and set other system parameters.

PC Outline

PC Outline is an outstanding example of shareware. It's an outline processor that's functionally equivalent to commercial products such as ThinkTank: a tool for building, rearranging, and selectively viewing an outline. The program features a superior user interface that seamlessly blends pull-down menus (making it accessible to novices) with command keys that experts will prefer.

Brown Bag software, which now owns the rights to PC Outline, is planning a new version called PC Outline Plus. We're looking forward to it.

PageMaker 3.0

PageMaker is still one of the finest desktop publishing packages, and Aldus has continued to improve it. PageMaker 3.0 lets you combine text and artwork created with other programs and integrate them into finished layouts. The new version also lets you automatically do long publications using several design functions at a time instead of one operation at a time. It fully supports style sheets and can exchange named styles with Microsoft Word 3.01.

With PageMaker, you can cut and paste on-screen as you would on an artist's drawing board. PageMaker is the program that showed many of us how to use the Macintosh to its full potential.

PixelPaint

PixelPaint has helped establish the Mac II not only as a machine for engineering and scientific problems, but as a tool for serious graphic art. Its drawing tools are quite similar to MacPaint's and even use some of the MacPaint conventions for copying and constraining the movement of objects that you work with on the screen. However, it does it all in color, and the special-effects capabilities of these tools using blended or shaded colors are simple but well done.

PolyBoost II

PolyBoost II is actually a suite of several programs including a very fast cache for your hard disk, a keyboard enhancer (speeds up keyboard response and includes a command-line editor), a screen speed-up program (for monochrome or color displays), a disk unfragmenter, and several other utilities. The combination of disk, keyboard, and screen speed-

ups is impressive—enough to make your computer feel like a new and faster animal. It will accelerate almost any Intel-based machine and can exploit conventional, extended, or expanded memory. In everyday use, you can figure on an average I/O speedup factor of three or four. At \$80, this is one of the most cost-effective ways to wring extra performance from your PC.

Procomm Plus

There are many communications software camps. The one most of us use here is Procomm Plus. It is rich with features and is easy to crank up and use. The program supports almost any telecomputing application with its 11 standard protocols, 14 terminal emulations, every common data-transfer rate up to 115,200 bps, host mode, split-screen chat mode, an automated phone book, macros, and a good script language. At \$75, the cost/performance ratio is outstanding.

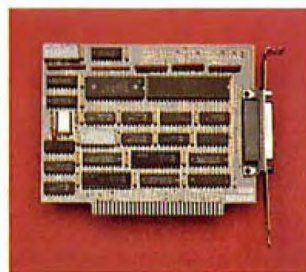
**QuickShare**

QuickShare is one of those products you look at and say, "Of course—why didn't I think of that?" QuickShare gives your Mac Plus, SE, or II another hard disk. Here's the trick: That additional hard disk is in your IBM PC or compatible. The package comes with a TSR that sits inside your PC, watching for requests coming from the Macintosh to

QuickShare's SCSI board in the PC. You create a single large file on the hard disk, to which the QuickShare board maps all Macintosh disk requests; that file on the PC's hard disk now looks like a volume to the Macintosh. QuickShare also features an elegant file-transfer system that makes sending information back and forth between the two machines about as painless as it gets.

SideKick Plus

Talk about bang for the buck. SideKick Plus is jam-packed with useful features. It has nine memory-resident notepads/editors, a calculator, an ASCII table, a disk navigator/manager, a clipboard/cut-and-paste buffer, an outline processor, a calendar/alarm clock and appointment scheduler, and a full-blown telecommunications package that rivals many stand-alone telecomm programs. You can set up SideKick Plus to use Lotus/Intel/Microsoft Expanded Memory Specification (LIM/EMS) or to write to disk to conserve your precious 640K bytes; it can run in as little as 64K bytes.

Soft-ICE

Soft-ICE is an 80386-based debugger that does in software what hardware-based debuggers do: It runs 8086-based programs in emulation mode and can halt and inspect them when they access specified regions of memory or execute specified DOS interrupts. As a bonus, Soft-ICE works with existing debuggers such as CodeView. You can trap an event that your debugger wouldn't have caught, and then transfer control to your debugger and investigate the problem in a familiar environment. If you're developing 8086-based applications on an 80386 machine, this is an essential and affordable tool.

continued

We Just Made Choosing Your Graphics Card



As Easy As 1,2,4.

You've probably seen our TrueVista products, or you've heard about their powerful features like the real-time frame capture, on-board TI 34010 coprocessor, large frame buffer, NTSC/PAL compatibility and more. Recently, we announced several new products in the series, each with unique potential for your

applications from video to digital pre-press to image processing. So now, whether your choice is an AT-class platform or the Macintosh® II, you only need one source for your graphics needs, the TrueVista series. The chart below outlines several key differences in the products.

TrueVista Series

FEATURES	ATVista 1M	ATVista 2M	ATVista 4M	NuVista 2M	NuVista 4M
BUS	AT	AT	AT	NuBus	NuBus
MAXIMUM 32 bits/pixel	512 x 512	1024 x 512	1024 x 1024	1024 x 512	1024 x 1024
ADDRESSABLE 16 bits/pixel	1024 x 512	1024 x 1024	2048 x 1024	1024 x 1024	2048 x 1024
RESOLUTIONS 8 bits/pixel	1024 x 1024	2048 x 1024	2048 x 2048	2048 x 1024	2048 x 2048
VMX EXPANSION	2-10 Mbytes	2-10 Mbytes	2-10 Mbytes	TBA	TBA
PRICE	\$2995.	\$4250.	\$5995.	\$4250.	\$5995.

Now There's Software You Can Count On, Too.

To complete the equation, add in STAGE™, our comprehensive graphics environment for the 34010. Since STAGE is host-independent, it allows you to access the coprocessor directly, regardless of the bus. So your program on the AT can be quickly ported to the Macintosh II. Customers will not be tied to one platform either, as files and programs will be compatible across both hosts. STAGE is currently available for the ATVista series, and will be available soon for the NuVista as well.

With the new members of the TrueVista family and the release of STAGE, you now have everything you need to develop exciting new products for the next generation of computer graphics. And many applications are already appearing to assist you in your immediate needs. Contact us to learn more about our products or our third-party developer program and the support available to you. You'll soon see how you can count on Truevision to provide all your graphics solutions.



TRUEVISION®
INC.

7351 Shadeland Station, Suite 100, Indianapolis, IN 46256 800/858-TRUE

INTERNATIONAL: Canada 416/499-9400 France 33-13-952-6253 Italy 39-2-242-4551 Switzerland 41-1-825-0949
U.K. 44-1-991-0121 West Germany 49-89-612-0010 Other 617/229-6900

Prices quoted are US Domestic suggested retail prices. Macintosh is a registered trademark of Apple Computer, Inc.

Circle 280 on Reader Service Card



DISTINCTION

SpinRite

The Gibson Research people did their homework on this one. SpinRite can repair bad sectors on your hard disk, find your disk's optimum interleave, and reset the interleave via a low-level format while leaving your data intact. All interaction is via an easy-to-navigate window system. The package comes with a 40-page booklet, but the program is so well put together you'll have little need for it. Other packages (such as the new version of Disk Technician, which we've only seen in beta version) may give SpinRite a run for its money in 1989; but for now, SpinRite is our pick.

Sprint

Sprint lets you produce anything from plain-ASCII text files to desktop publishing-style documents with text in snaking columns. Like Microsoft Word, Sprint allows you to manually embed formatting commands or use style sheets to clone formats from one document to another. It lets you have up to 24 documents and up to 6 on-screen windows open at once.

Sprint has a built-in dictionary and thesaurus. It can semiautomatically generate indexes and tables of contents for long documents. It's fast, and it automatically and unobtrusively stores your work every 3 seconds or so to save your bacon in the event of power failure or similar disaster. All it lacks is true WYSIWYG. If you can live without that, Sprint may be all you need in word processing software.



Toshiba T3100/20

While this Toshiba laptop isn't as lightweight as the T1000—it weighs in at 15 pounds—its 16-bit 80286 processor running at 4 or 8 MHz benchmarked faster than some other laptops operating at higher speeds. One of the reasons for its hefty weight is the T3100's 20-megabyte hard disk drive. This is a feature many of us lust over until we've lugged it around for awhile.

The T3100 has an amazingly clear gas-plasma display. The full 25-line by 80-column screen has a resolution of 640 by 400 pixels. It's expensive, almost \$5000, but it has power, speed, a hard disk drive, and a terrific display all wrapped up in a totable package.

Turbo Debugger

A good product sometimes makes you do crazy things. Turbo Debugger is so easy to handle, we've run working programs through it just to see what's going on. If you're used to the menu-driven command system of Turbo C and Turbo Pascal, you can maneuver through Turbo Debugger with rare glances at the manual.

Turbo Debugger is adaptable enough to tackle most errant programs. Its 80386 protected-mode operation stores the debugger above the 1-megabyte limit in shielded memory. It has a remote debugging feature; the debugger runs on one machine and controls the target program via a serial port to another. Throw in its support for math coprocessors and integration with Turbo Pascal and Turbo C so you can do source and object code-level debugging, and you've got a programmer's Swiss army knife.

Turbo C and Turbo Pascal

In a world where language packages get bigger and bigger, it's nice to see the Turbo Pascal and Turbo C getting better and better. The real charm of the Turbo languages springs from two sources. One is the user interface. The other is Borland's philosophy that to improve a language is not simply to tack on support for the latest member of the Intel chip family. These languages were built from the start with an eye for the lowly 4.77-MHz PCs as well as the latest 80386 micros. For rapid prototyping, there's not much better.

Turbo Prolog 2.0

Borland's Turbo Prolog 2.0 may not be what the academic community expected in Prolog, but that may be why it's an exceptional product. In the same way that Borland took the academic Pascal and made a useful and affordable development system, the company has taken the concepts and strengths of a much different language and developed a system for real-world applications programming.

Video Seven VEGA

Though there were some bugs in the first Video Seven VEGA VGA we tested, we kept on trying and found that the VEGA has some very nice features. A half-length card, it is the smallest board of the VGA group we tested. Also, the company furnishes software that can automatically load the ROM code into faster RAM for better performance. At \$499, this is a winner.

Windows/386

Windows/386 was one of the first programs to take advantage of the advanced architecture of the 80386 microprocessor. As such, it is serious competition for OS/2. While OS/2 is held back because it was designed to run on 80286 machines, Windows/386 taps into the power of the 80386 to

support multitasking of DOS applications and break the 640K-byte memory barrier. The graphic user interface of Windows/386 resembles that of Presentation Manager, a benefit for those considering making the switch to OS/2.



Zenith TurbosPort Laptop

Here's a battery-powered portable computer that's easy to be happy with. It has a great display, intelligent power management (IPM), and excellent throughput. The TurbosPort's fluorescent backlit supertwist liquid crystal display produces black-on-white images that are easily readable because of its contrast ratio, 10½-inch diagonal image area, resolution, and gray-scale CGA compatibility.

The IPM reduces recharge time and prevents the power-robbing "NiCad memory" effect. This Zenith runs the 80386 with no wait states at a nonstandard 12 MHz, but its slower speed is satisfactorily offset by fewer idle cycles yielding superior throughput.

Zortech C++

The first IBM PC-based C++ compiler (not translator) aims to do for C++ what Borland has done for Pascal and Prolog: popularize a language by providing an inexpensive high-quality compiler embedded in a useful environment. The toolset includes the optimizing compiler, a linker, an editor that's integrated with the compiler, a Make utility, and a graphics library. This product will play a significant role in the imminent ascendancy of C++. ■

continued

The Hot Performers.

ME 386-20
Tower

ME 386-18

ME 386-20

20 MHz 80386-20 processor Microsoft OS/2 and DOS compatible 1 MB 32-bit RAM running at "0" wait state (upgradable to 8 MB) Socket for 80387/80287 math co-processor High performance NCL floppy/hard disk controller 1.2 MB floppy disk drive CMOS clock/calendar with battery back-up Enhanced 'keyboard'

\$2350

Upright Case
Add \$300



ME 386-18

18 MHz 80386 processor Microsoft OS/2 and DOS compatible 512K 32-bit memory on board Two 32-bit expansion slots Socket for 80387 math co-processor High-performance NCL floppy/hard disk controller 1.2 MB floppy disk drive CMOS clock/calendar Enhanced AT keyboard **\$1799**

★ SPECIAL

ME V20 64K (upgradable to 640K) 360K floppy disk drive graphics card

WHILE THEY LAST!

ME 286-12

8/12 MHz 80286 processor 512K memory (upgradable to 1 MB on board) "0" wait state option (s.i. 15.3) Microsoft OS/2 and DOS compatible 8 I/O expansion slots High-performance NCL floppy/hard disk controller 1.2 MB floppy disk drive CMOS clock/calendar Enhanced keyboard **\$899**

The Network Solution

ELS Network for two-to-four users. Increase your company's productivity without making a big increase in expenditures. Complete software... **\$499**

Call for all Novell Products

Prices and availability
subject to change
without notice.



ME Roadrunner

12 MHz 80286 processor Socket for 80287 math co-processor 640K memory (1 MB option) New Super-Twist LCD with Backlit and Reverse; 640 x 200 dots (640 x 400 option); 80 char. x 25 lines Monochrome/Color graphics card for external monitor 6 expansion slots Floppy/hard disk controller Serial/parallel/clock-calendar 1.2 MB floppy disk drive 20 MB hard disk (30, 40, or 60 MB optional) 12-function AT style keyboard 110/220V auto-switchable 20 pounds **\$1799**

HOT PORTABLES

Roadrunner Plus (386)

Intel 80387 processor 6/16 MHz clock speed 1 MB of memory Socket for math co-processor Floppy/hard disk controller 1.2 MB high capacity floppy disk drive 42 MB fast access hard disk (60 MB optional) Serial/parallel ports Color/mono display card for external monitor New Super-Twist LCD with Backlit and Reverse; 640 x 400 dots; 80 characters x 25 lines 6 expansion slots 12-function keyboard 110/220V auto-switchable 20 pounds **\$3399**

CALL TOLL-FREE

(800) MICRO-21
in Calif. (714) 662-1973

ME MICRO EXPRESS

2114 South Grand Avenue
Santa Ana, California 92705
Fax: (714) 662-1258 - Telex: 910 240 3029

First Annual BYTE Award Winners

- A/UX Development System** \$8399
HyperCard..... \$49
 (bundled with Mac SE, Plus, II)
 Apple Computer, Inc.
 20525 Mariani Avenue
 Cupertino, CA 95014
 (408) 996-1010
Inquiry 890.
- Battery Watch**..... \$39.95
 Traveling Software, Inc.
 18702 North Creek Pkwy.
 Bothell, WA 98011
 (800) 343-8080
 In Washington, (206) 483-8088
Inquiry 891.
- Bookshelf** \$295
Excel for the Macintosh \$395
Excel for the IBM..... \$495
OS/2 Standard Version \$325
OS/2 Extended Version \$795
Windows/386 \$195
 Microsoft Corp.
 16011 Northeast 36th Way
 P.O. Box 97017
 Redmond, WA 98073
 (206) 882-8080
Inquiry 892.
- Choice Words**..... \$99
 Proximity Software
 3511 Northeast 22nd Ave.
 Fort Lauderdale, FL 33308
 (305) 566-3511
Inquiry 893.
- Compaq Deskpro 386/25**
Model 60 \$8299
Model 110..... \$10,200
Model 300..... \$13,299
Compaq 386s
Model 1..... \$3799
Model 20 \$4499
Model 40 \$5199
 Compaq Computer Corp.
 20555 FM 149
 Houston, TX 77070
 (800) 231-0900
 In Texas, (713) 370-0607
Inquiry 894.
- DeskJet** \$995
 Hewlett-Packard Co.
 3000 Hanover St.
 Palo Alto, CA 94304
 (415) 857-1501
Inquiry 895.
- DESQview 2.01/2.2**..... \$129.95
 Quarterdeck Office Systems
 150 Pico Blvd.
 Santa Monica, CA 90405
 (213) 392-9851
Inquiry 896.
- Documentor** \$295
 WallSoft Systems, Inc.
 233 Broadway
 New York, NY 10279
 (800) 233-3569
 In New York, (212) 406-7026
Inquiry 897.
- Epsilon Text Editor** \$195
 Lugaru Software, Ltd.
 5843 Forbes Ave.
 Pittsburgh, PA 15217
 (412) 421-5911
Inquiry 898.
- Fastback Plus**..... \$189
 Fifth Generation Systems, Inc.
 11200 Industriplex Blvd.
 Baton Rouge, LA 70809
 (504) 291-7221
Inquiry 899.
- Fast Trax**..... \$49.95
 Bridgeway Publishing Corp.
 2165 East Francisco Blvd.
 Suite A-1
 San Rafael, CA 94912
 (415) 485-0948
Inquiry 900.
- Gateway 386** prices start at \$2795
 Gateway 2000
 P.O. Box 2414
 Sioux City, IA 51107
 (800) 233-8472
Inquiry 1100.
- GrandView**..... \$295
 Symantec
 1020 Torre Ave.
 Cupertino, CA 95014
 (415) 964-6300
 after January, (408) 253-9600
Inquiry 1101.
- Illustrator 88** \$495
 Adobe Systems
 1585 Charleston Rd.
 P.O. Box 7900
 Mountain View, CA 94039
 (415) 961-4400
Inquiry 1102.
- LANtastic** \$399
 Artisoft, Inc.
 3550 North First Ave., Suite 330
 Tucson, AZ 85179
 (602) 293-6363
Inquiry 1103.
- Lightspeed C** \$175
 Symantec Corp.
 THINK Technologies Division
 135 South Rd.
 Bedford, MA 01730
 (800) 648-4465
 In Massachusetts, (617) 275-4800
Inquiry 1104.
- MacDisk**
230-megabyte hard disk \$3295
330-megabyte hard disk \$3995
 Priam Corp.
 20 West Montague Expressway
 San Jose, CA 95134
 (408) 434-9300
Inquiry 1105.
- MacInTax**..... \$119
 SoftView
 4820 Adohr Lane
 Suite F
 Camarillo, CA 93010
 (805) 388-2626
Inquiry 1106.
- Mark/Release**..... public domain
 TurboPower Software
 3109 Scotts Valley Dr., Suite 122
 Scotts Valley, CA 95066
 (408) 438-8608
 Also available on BIX
Inquiry 1107.
- Mathematica 1.02 Enhanced**
Mac II \$795
Mac Plus/SE \$495
 Wolfram Research, Inc.
 P.O. Box 6059
 Champaign, IL 61821
 (217) 398-0700
Inquiry 1108.

- Maximum Storage WORM**
500-megabyte external unit.. \$4450
APX 4100 (internal unit)..... \$4250
Maximum Storage, Inc.
5025 Centennial Blvd.
Colorado Springs, CO 80919
(719) 531-6888
Inquiry 1109.
- NEC P5XL Serial/Parallel Printer**
for Epson..... \$1425
NEC P5XL Parallel Printer
for IBM, Epson, or Diablo..... \$1295
NEC Information Systems
1414 Massachusetts Ave.
Boxborough, MA 01719
(617) 264-8000
Inquiry 1110.
- NeXT Computer \$6500**
NeXT Inc.
3475 Deer Creek Blvd.
Palo Alto, CA 94304
(415) 424-0200
Inquiry 1111.
- Norton Commander \$89**
Norton Utilities Standard \$100
Norton Utilities Advanced \$150
Peter Norton Computing, Inc.
2210 Wilshire Blvd.
Suite 186
Santa Monica, CA 90403
(213) 453-2361
Inquiry 1112.
- PageMaker 3.0, Mac version.....\$595**
PC version\$795
Aldus
411 First Ave. S
Suite 200
Seattle, WA 98104
(206) 622-5500
Inquiry 1113.
- PC Outline..... shareware**
PC Outline Plus.....\$195
Brown Bag Software, Inc.
2155 South Bascom
Suite 114
Campbell, CA 95008
(800) 523-0764
In California, (408) 559-4545
Inquiry 1114.
- PixelPaint\$395**
PixelPaint Professional.....\$595
SuperMac Technology, Inc.
295 North Bernardo
Mountain View, CA 94043
(415) 964-8884
Inquiry 1115.
- PolyBoost..... \$79.95**
Polytron Corp.
1700 Northwest 167th Place
Beaverton, OR 97006
(800) 547-4000
In Oregon, (503) 645-1150
Inquiry 1116.
- Procomm Plus..... \$89**
Datastorm Technologies, Inc.
1621 Towne Dr.
Suite G
Columbia, MO 65202
(314) 474-8461
Inquiry 1117.
- QuickShare\$465**
Compatible Systems Corp.
P.O. Drawer 17220
Boulder, CO 80308
(303) 444-9532
Inquiry 1118.
- SideKick Plus.....\$199.95**
Sprint\$199.95
Turbo C 2.0.....\$149.95
Turbo Debugger\$149.95
Turbo Pascal 5.0\$149.95
Turbo Prolog 2.0\$149.95
Borland International, Inc.
1800 Green Hills Rd.
P.O. Box 660001
Scotts Valley, CA 95066
(408) 438-8400
Inquiry 1119.
- Soft-ICE\$386**
Nu-Mega Technologies
P.O. Box 7606
Nashua, NH 03060
(603) 888-2386
Inquiry 1120.
- SpinRite \$59**
Gibson Research Corp.
22991 La Cadena
Laguna Hills, CA 92653
(714) 830-2200
Inquiry 1121.
- Sun386i \$7990 to \$19,990**
Sun Microsystems, Inc.
2550 Garcia Ave.
Mountain View, CA 94043
(415) 960-1300
Inquiry 1122.
- Toshiba T1000 \$1249**
Toshiba T3100/20 \$4699
Toshiba America, Inc.
9740 Irvine Blvd.
Irvine, CA 92718
(714) 583-3000
Inquiry 1123.
- TrueScan \$2495**
Calera Recognition Systems, Inc.
2500 Augustine Dr.
Santa Clara, CA 95054
(408) 986-8006
Inquiry 1124.
- VEGA\$499**
Video Seven, Inc.
46335 Landing Pkwy.
Fremont, CA 94538
(415) 656-7800
Inquiry 1125.
- Zenith FTM Monitor**
ZCM 1490-SW.....\$999
TurbosPort 386 Laptop
Model 40 \$7999
Model 40M \$8499
(comes with 2400BPX AutoSync
Modem)
Zenith Data Systems
1000 Milwaukee Ave.
Glenview, IL 60025
(312) 699-4800
Inquiry 1126.
- Zortech C++\$149.95**
Zortech, Inc.
366 Massachusetts Ave.
Suite 303
Arlington, MA 02174
(800) 848-8408
In Massachusetts, (617) 646-6703
Inquiry 1127.



**Create a 3.5"
Micro Diskette
with unlimited
protection against
a hostile world.**

You're covered. BASF molds the rigid plastic jacket of its 3.5" Micro Diskette to its own specifications, providing unsurpassed protection for the flexible disk within. Call 800-343-4600 for the name of your nearest supplier.

The Spirit of Innovation.

Circle 308 on Reader Service Card



WHAT LIES AHEAD

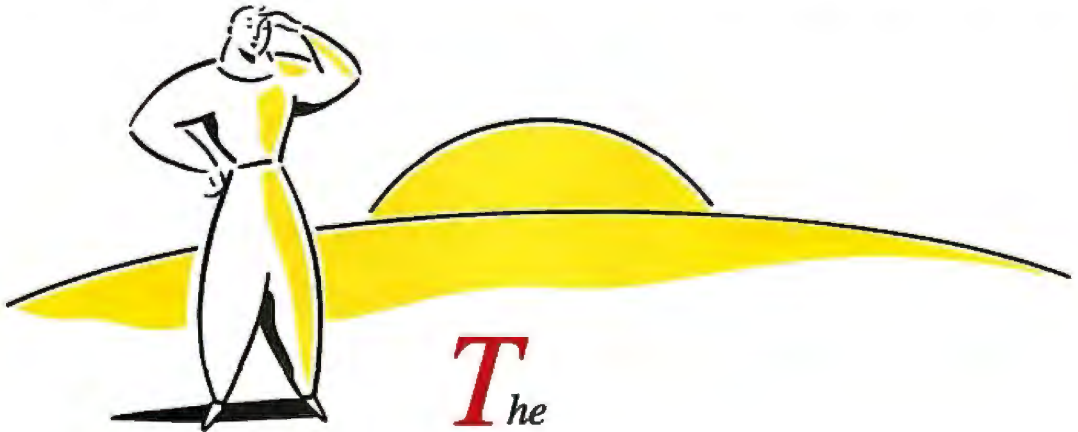

The
is the traditional time for prognosticating about the future. Rather than give you our predictions for the year ahead, we thought it would be a whole lot more interesting if we asked some of the pioneers and visionaries of computer science what they think lies ahead, in their areas of expertise, and in computer science at large. Here are their thoughts, in their own words.

Marvin Minsky

Jack Kilby

Grace M. Hopper

Dennis Ritchie

Ryoichi Mori

Ray Kurzweil

Jerome Feldman

Terry Winograd

Charles Simonyi

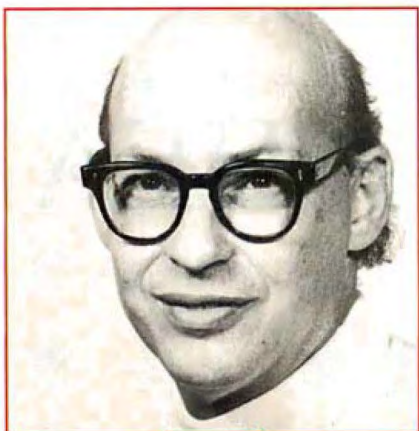

Marvin Minsky

Donner Professor of Science, founder of the Artificial Intelligence Laboratory and Media Laboratory at MIT. Professor Minsky is a pioneer in the field of artificial intelligence.

It is easier to predict what computers will do in the far future than what they'll do in the next few years. This is because we can see some trends in current research, but can't really guess how long it will take to apply the results of past research. The first computer programs did only what they were programmed to do. The programs we use today are more resourceful, because they exploit the knowledge in specialized databases.

The trouble is that present-day expert systems are devoid of what we call common sense, so each such program is like an idiot savant—proficient at some specialty but incompetent at anything else. So, for example, robots are good for commercial applications in factories, where everything is so uniform. There, the tasks are so repetitive that machines need little common sense.

But consider the problem of making a robot physician. We already have some parts for this. For example, there already exist some computer programs that can read a patient's medical history and then, in certain kinds of disease, diagnose and plan the patient's treatment—and they can do this more reliably than the average doctor can. When it comes to the real world, studies have shown that in a horrifying proportion of hospital cases, the wrong treatments and medications are given to the wrong patients.

But today's computerized robots still cannot see well enough to look out at you and see who you are. Nor do they yet have good enough eye-hand coordination to put your pillow into a clean pillowcase. Worst of all, they can't yet handle speech well enough to distinguish your words and know what they mean. Our medical robots can compete, in some particular specialty, with a doctor's decade of advanced education—but not with what a 5-year-old child can do!

What can we do to make smarter machines? First we'll have to build up huge databases of the kinds of knowledge that humans have. One such attempt is already under way, with a program called Cyc, directed by Douglas Lenat at Microelectronic and Computer Technology in Austin, Texas. The goal of the Cyc (from the word "encyclopedia") project is to give a computer enough knowledge to be able to reason about typical subjects in an encyclopedia. At present, this is being done by

programming, but eventually we'll want machines that learn from experience. Fortunately, the past few years have seen increasing attention given to research on machine learning, and this should produce many useful applications in the future.

But factual knowledge will not be enough. We'll also need systems that "manage" themselves—that can decide which knowledge to use in different circumstances, what to do about uncertainty, when not to believe what they have been told, and how to learn better ways to learn. Our machines must also know about how to pursue goals, how to resolve conflicts, and how to make sensible economic decisions about how to proceed when the resources at hand are limited, as they always are in the real world.

Although computer-based artificial intelligence already does many useful things, we still know very little about these higher-level aspects of thinking. In my research, I propose several theories about how the great computers in human brains do many commonsense sorts of things. But none of these theories is proven yet. All we can be certain of now is that there will be years of thrilling research ahead.

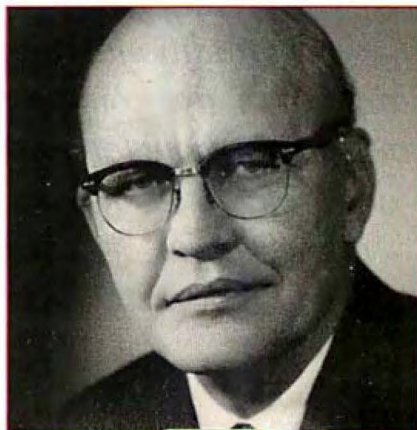

Jack Kilby

Inventor of the integrated circuit, Kilby was recently honored with the installation of a historic marker commemorating the thirtieth anniversary of the IC at Texas Instruments' headquarters in Dallas.

The development of integrated circuits has always been a horse race between the circuit designers and the process people—the people who actually make the chips. At the moment the process people are somewhat ahead, permitting much higher yields and much larger chips.

This scenario is pressuring circuit designers to develop more complex CAD systems for ever-larger digital designs. Today, the existing tools permit development of chips with 50,000 to 100,000 gates per chip. Tools now under development will permit designs of up to 1 million gates per chip, or the design of several chips with that number of gates.

In principle, this situation should permit the continued decrease in the cost per gate of logic, both in terms of nonrecurring engineering costs and production costs. There is some evidence that this decrease may be slower than the projections of

the past would suggest. As the line widths approach one micron, the processes seem to become more complex and more costly. The need for extreme cleanliness also has a price.

Integrated-circuit research and development is still very active and, in the future, will result in many new products. Gallium arsenide is becoming practical and will find significant applications—particularly in the microwave area. Superconductors will play a part, as will entirely new methods of computing, such as neural networks. Optical computing may also find significant applications.



Grace M. Hopper

A Rear Admiral retired from the U.S. Navy, Hopper is now senior consultant for Digital Equipment Corp., Washington, DC. She created the first compiler, which converted a high-level (human-readable) language into the binary code of the Univac computer.

It's difficult to predict the future in this business. When I stood in front of the Mark I, there was no way I could have guessed that there would be magnetic core storage. When I stood in front of a Univac III that had magnetic core storage, I couldn't imagine transistors—we didn't have them yet. No matter what I look at today, there's something totally unknown that isn't in our vision yet that will happen.

I can say I think that within the next 5 to 10 years we'll have photonics—light-driven computers—because Bell Labs already has one. That's probably the most exciting coming development. We're making the transition from the Model T to the Model A, but I can't guess what's coming up next. There are, however, some possibilities that look quite promising.

I wrote the first compiler back in 1952, so I suppose I can claim to have started computer-assisted software. When I look at this object-oriented programming they're talking about, all I see is bigger globs than I thought up for the subroutines of the first compiler. That direction should continue.

I think we're facing an information overload. We're putting information out of systems without looking carefully at how it's going to be used. Does it feed to another system? Or is the data going to people and are we giving them the information in the best format possible? We've been letting the programmers run riot, and we've forgotten about the systems analysts and sys-

tems designers—we're not using them. Big banks and big insurance companies have them, but a lot of people are just depending on programmers.

I recently heard of a case where two companies merged and needed to merge their data processing systems. The programmers just added things together and forgot to notice that one company started a new year on January 1, and the other one started its new year on April 1. They ended up just adding the year-to-date together.

I'm fascinated by some of the best of the expert routines, but at intervals I have to remind people that no computer will ever ask a new, reasonable question. That's what people do. I'm skeptical of neural networks because people are writing the programs and designing the networks that are designing the programs. I wish we knew more about how we think.

I think our biggest problem in the foreseeable future, and it's serious, is that we're not going to have enough trained young people. Within 5 years, we'll be acutely short of electronic and electrical engineers, technicians, professors—we're going to be short of everything. Companies are going to have to hire people and then train them. In this regard, we ought to make use of retirees. I'm trying to set up retiree clubs to encourage people—people who no longer want to work 5 days a week, 8 hours a day but might be very glad to work 3 days a week, 4 hours a day—to train these young people coming up.

Planes started flying in 1903, and by 1943, we had a DC-2. The computer first ran in 1943. We're at the DC-2 stage. We're only at the beginning. We haven't half gotten started yet.



Dennis Ritchie

An AT&T Bell Laboratories Fellow, Ritchie was codesigner of the Unix operating system and the C programming language.

This is a very interesting period in Unix standardization. We're in the middle of two important developments and it's quite exciting to guess how they will unfold.

The first concerns AT&T, Sun, and the OSF (Open Systems Foundation, a collection of major computer manufacturers formed to counter what they see as an attempt by AT&T and Sun to corner the growing Unix market). AT&T supplies Unix System V, while Sun's system, SunOS, was originally based on a version of Unix called BSD (Berkeley Software Distribution).

continued

The tension between the System V and BSD variants has been annoying to everyone. A bit more than a year ago, AT&T and Sun announced that the next versions of their operating systems would be merged. The appearance of OSF at the beginning of 1988 suggested the possibility of a new pair of partly incompatible versions of Unix. Since the summer, however, it's become apparent that AT&T, Sun, and OSF have become sensitive to this problem and seem to be trying to work out a solution.

The other set of events is equally important—or maybe more so. This is the work, parts of which are nearly complete, that the official standards bodies are carrying out. In 1989, we may expect to have an official ANSI C, and the ISO (International Standards Organization) standard should follow soon after. The ANSI X3J11 committee working on the draft for the new specification of the C language has just transmitted the draft to its parent body.

Likewise, some of the IEEE standardization work on POSIX (IEEE's name for its system) is nearing completion—especially the system services part of the operating system. The specification for the user interface to the core applications isn't far behind. It seems that most of the major suppliers of Unix and Unix-compatible systems are serious about complying with the ANSI and IEEE standards. I believe this development is very important and very promising.

I don't see significant changes in languages in the lower-level areas such as systems programming. Some newer languages such as Modula-3 are coming into prominence and finding applications over older languages such as Pascal. Presumably, Ada will be growing due to forces such as the government and others that are picking it up.

More changes will be occurring in high-level areas other than traditional languages. When I say higher-level languages, I'm talking about products that are not often thought of as languages. In some ways, the method in which you talk to spreadsheets is a language. In another way, interfaces, such as the Mac interface, are languages. They're very different than text-based languages, but they can be thought of as languages.

In the middle area are environments such as Unix shells. They are akin to fourth-generation ideas—they have very powerful underlying primitives. That sort of approach means that more people will be able to program. As Unix continues to spread, people will learn to encapsulate short series of commands, add a few tests, and soon find themselves programming.

What's happening in languages today has been influenced by the work that came out of Xerox—work such as graphics interfaces and Smalltalk. As more computer power becomes available at less cost, more people will be able to use higher-level languages.



Ryoichi Mori

Professor at the Institute of Information Sciences and Electronics, University of Tsukuba, Japan, Professor Mori has been in the forefront of the Japanese microelectronics industry and the TRON projects.

Over the past 20 years, I have seen two important innovations come along. In 1973, I predicted that the microcomputer would be the most important issue for many decades. In 1978, I came to the conclusion that the first Japanese word processing machine, the Toshiba JW-10, would change the history of Japanese documentation work. I predicted that the Japanese word processor would reach not only to the offices, but also to personal document work.

Now I believe that "superdistribution" will be the most interesting and important issue in the field of personal computing in the foreseeable future. Superdistribution is a way of distribut-

ing programs, using a tamper-resistant module to keep track of usage rights and billing charges.

Steve Weingart of the IBM Watson Research Center and I have designed these tamper-resistant modules. His module uses analog detection of attacks. An IBM system to utilize the module, ABYSS (A Basic Yorktown Security System, created by Steve White and Liam Comerford), uses a token card. My method uses digital detection and has a system architecture—thus, I named it "superdistribution."

In one way, superdistribution is analogous to superconductivity. In superconductivity, *electrons* flow without resistance; in superdistribution, *digital information* flows without resistance. The key to eliminating the resistance is to eliminate copy protection and piracy so as to safeguard the interests of users, manufacturers, and distributors, who will then promote free distribution rather than hinder it.

Superdistribution is different from conventional distribution in that it allows users to obtain and test software from anywhere in the world before paying for it, as well as to rent and purchase full usage rights anytime. At the same time, a software vendor can restrict software implementation to a set of qualified users without any need for active verification. No explicit contract is needed. With this system, running new software will be like turning on a faucet and getting water. Billing will be automatic for both user and vendor.

The information that accompanies the superdistribution software includes controls on its usage and testing. The billing information collected by the module can be retrieved by means of telecommunications, a system analogous to reading a water meter.

Although software superdistribution resembles the distribution of electricity, gas, and water, it is even more convenient. No material medium is needed for superdistribution, and the information is transmitted at the speed of light. Superdistribution can be used not just for computer programs but for compact disks and digital-audio tapes as well.

continued

Affordable Large Format Plotting Starting at \$1695.*

A-E
\$2695.
(sugg. ret. \$2995.)

A-D
\$2295.
(sugg. ret. \$2695.)

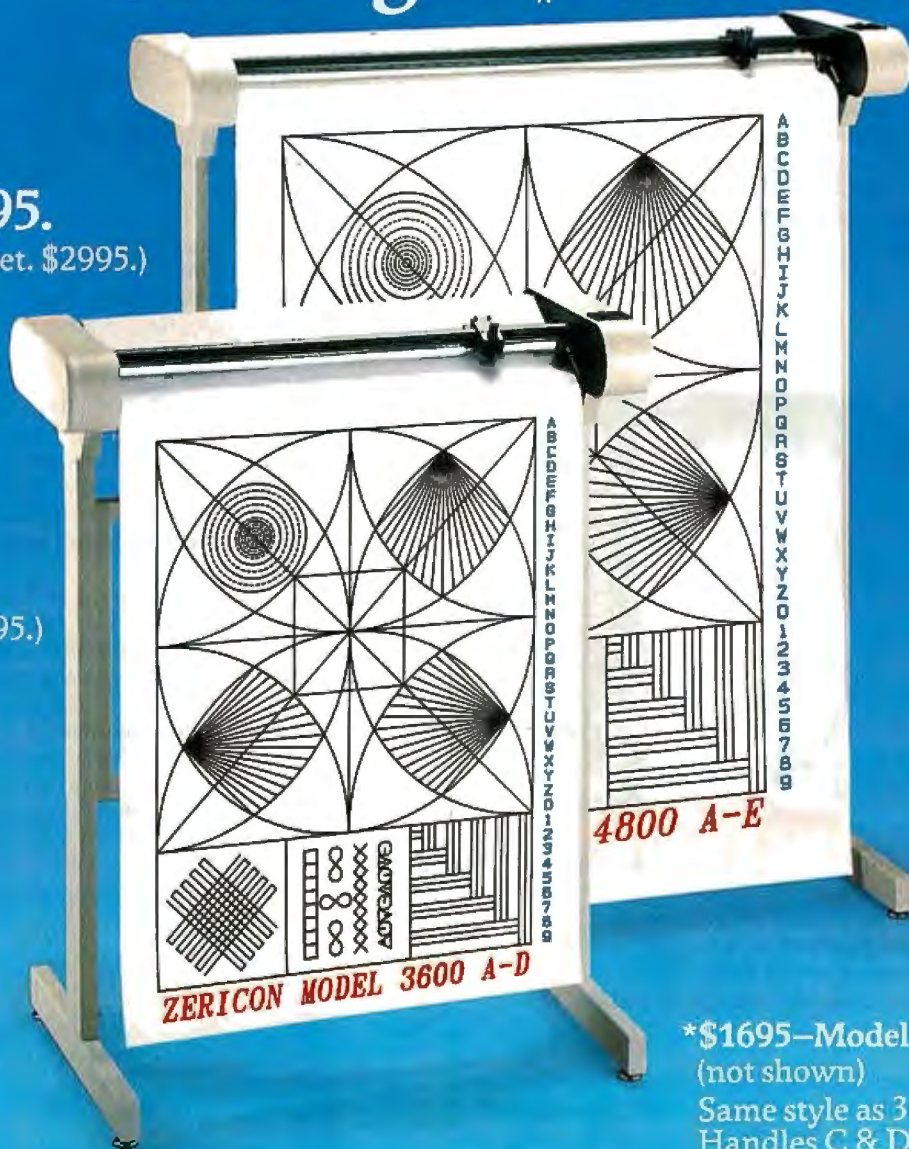

***\$1695—Model 3610 C/D**
(not shown)
Same style as 3600 A-D
Handles C & D size media

Features that say value...

Economical: \$1,000 less than other large format plotters.

Compatible: Operates with all popular CAD software supporting DM/PL.™

Multiple Media Sizes as small as 8½" x 11" or as large as 36" x 48" eliminates the need for a second plotter.

Practical speed you can really use: 10" per second assures good drawing throughput while optimizing the speed at which most plotter pens can draw without skipping.

Repeatability and Resolution: .004 assures quality suitable for the most demanding applications including PCB artwork.

Vacuum Paper Hold Down guarantees perfect registration.

Unique: X&Y rescaling allows calibration to one part in 10,000. Ideal for applications where scale is critical.

**CALL NOW AND WE'LL SEND YOU
A FREE SAMPLE PLOT.**

(415) 490-8380 Fax (415) 490-3906

Dealer inquiries invited.

ZERICON

40491 Encyclopedia Circle
Fremont, California 94538

Made in USA

DM/PL is a trademark of Houston Instrument

Over the past 5 years, the Japan Electronic Industry Development Association has intensively investigated the superdistribution concept. (Among the other projects initiated by JEIDA are VLSI technology research, the Fifth Generation Computer, and TRON.) In April of 1987, JEIDA established the Superdistribution Technology Committee, which I chair, to actively pursue this concept. The committee, which includes experts from Nippon Telegraph and Telephone and from all the major Japanese mainframe manufacturers, foresees no major obstacles to realizing superdistribution in the near future.



Ray Kurzweil

Chairman and CEO of Kurzweil Music Systems and Kurzweil AI, Kurzweil played a crucial role in the development of digital synthesis of music and sound.

Einstein said, "I never think of the future, it comes soon enough." Unfortunately, those of us who attempt to apply science have little choice but to contemplate the rapidly changing trends of technology.

I believe the coming year will see the culmination of a number of trends that have been in gestation for many years. In speech recognition, for example, progress has continued to accelerate since it first became a practical technology in the early 1980s, principally as a means of entering simple and repetitive inventory data and control commands. Now, with the advent of large-vocabulary discrete word-recognition systems, and aided by knowledge-engineering software (software that encodes the structure and context of specific domains of knowledge), printed documents in large quantities are being routinely generated solely by voice. In the next few years, we will see a rapid increase in the acceptance of such systems, particularly in fields with highly structured knowledge bases, such as medicine.

We will also see significant research gains in large-vocabulary recognizers that can simultaneously handle continuous speech and large branching factors. These systems will emerge commercially during the next several years and will begin to achieve a much-anticipated ubiquity during the 1990s.

The application of advanced digital signal processing techniques and artificial intelligence technologies to the creation of music is moving even more quickly. Now that computer-based

instruments can capture the rich time-varying tonal qualities of complex instruments such as the piano, we are beginning to see a trend away from the historical link between playing technique and the sounds generated. It is now possible, through the industry's standard communications protocol called MIDI (musical instrument digital interface), to play a guitar on a piano keyboard or vice versa.

In 1989, we will see electronic music "controllers" emulating the playing techniques of many other acoustic instruments including many wind and string instruments, drums, and others. We will also see progress toward a more ideal generation of controllers, where human factors are no longer limited by the physical requirements of creating sounds acoustically.

At the same time, we will see the emergence of a new genre of software for computer-assisted improvisation. Unlike their crude "easy-play" forebears, these intelligent accompanists will be programmed with an understanding of musical theory. Professionals will use such software to assist them with many chores of the composition process: to automatically generate a walking bass line, expand a harmonic progression, or compute a rhythmic sequence.

Beginners will use other versions of this type of software to generate musically satisfying multi-instrumental "works" in the early stages of their learning to play and to understand musical theory. By combining the new controllers with intelligent sequencing software, musicians will be able to surpass the limitations of human fine motor coordination.

In another area, the advent of low-cost "intelligent" character-recognition software will fuel continued expansion of desktop publishing and on-line database systems, as well as provide affordable sensory aids for the visually impaired. The entire imaging field will begin a major expansion in 1989, culminating in a multibillion dollar industry by the early 1990s.

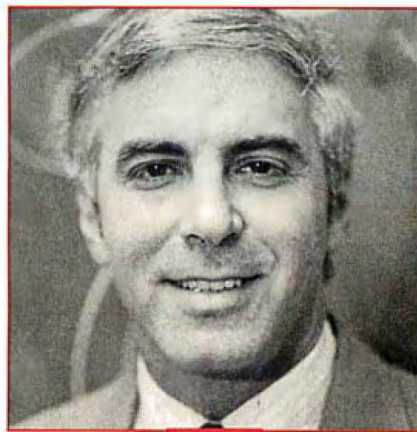

Jerome Feldman

Director of the International Computer Science Institute, Berkeley, California, Feldman has been called the "father of connectionism."

In the near future, I see a large and growing interest in massively parallel computation of a somewhat granular nature. Systems that perform this kind of processing are called neural net-

continued



GRaphic Animation System for Professionals

Convince yourself!

Send us \$2.00 for Episode I
"The Adventures of Ferguson Floppy"

"GRASP is clearly the hands-down winner in terms of sheer power, flexibility, and speed. Nothing else even comes close."

—PC Magazine

Program in the
4th Dimension...

ANIMATE!

Get unlimited action and interaction with the most powerful PC animation system available, by calling Grasp routines from your programs in C, Pascal, Basic, and other languages.

Or develop your graphics applications directly in Grasp! Take advantage of

- 74 animation & effects commands
- 25 predefined fades
- single-command animation
- all major graphics modes
- screen capture and graphics printing utilities

Includes Pictor, a full-featured paint program, completely integrated with Grasp for fast development and editing of programs and graphics.

GRASP 3.1
\$149

Paul Mace
SOFTWARE

400 Williamson Way
Ashland, OR 97520
800-523-0258

works, connectionist systems, and parallel-distributed-processing (PDP) systems.

The basic idea, and I think it's a good one, is that because of advances in the fields of computer science, electronics, biology, and psychology, we're learning enough about the way animal's brains work to judge whether some of this might apply to technology. There may be some practical uses for neural networks in the areas of vision, sound analysis, motor control, and others, if we understand how the brain makes these things happen. Animals are much better at certain kinds of tasks than any computer or software you can build.

But it would take a large investment to solve these problems. There's enormous potential, but I think a lot of the excitement in this field is based on the potential rather than technical know-how. The big question is, is this the appropriate time to try to exploit ideas from the life sciences and technology?

I've been doing research in this area for over a decade. Some people think neural networks will become practical in 5 years. I've seen a number of commercial and military ventures based on the assumption that this technology will be here soon. There's no way that's going to happen. I don't think we can put a time frame on complex systems because there are large areas that we don't understand. But with some breakthroughs, it could happen more quickly.

On the other hand, billions of dollars are spent each year on computing and software, and some small neural-network-type applications will come along. But it doesn't make sense for government or private enterprise to invest heavily in neural net-

works where the returns will be a very long time in coming.

A lot of people are doing this now, based more on hope rather than a technological foundation. This hope takes two forms. The first is the belief that if you build computers more like a brain, you should be able to solve brain-like problems more naturally on them. The other is that techniques in machine learning, which have indeed improved, are going to be good enough to be able to use any old brain-like machine; that if you train it with these techniques, it'll get smart. But both of these hopes have no technological basis.

We don't yet have the scientific understanding about what's needed for a vision or a speech machine. If we understood the problem, we could build the appropriate machine. A lot of the hype has been based on the hope that you could somehow shortcut this process—that we wouldn't have to understand speech or motor control or vision; the learning rules alone would make neural computers smart.

One thing I do know: With excellent scientists working on this, there will be good progress in the next couple of years: mathematical theories, hardware, software—all you would expect out of an active area of research. Some simple applications will become practical that won't even scratch the surface of scientific understanding. No one knows how long it will be before there will be major applications in this area.

People in this field are saying that the greatest danger to the progress of the technology is exaggerated expectations. As long as people doing the work have patience and don't claim outrageous things, I think the field has a long and productive future.



Terry Winograd

Associate Professor at Stanford University. Winograd has been a leading investigator in the field of natural language processing, and is coauthor of Understanding Computers and Cognition.

The year 1989 will see an acceleration of the progress from "connectivity" to "compatibility" to "coordination."

Connectivity, the first step toward integrated communication, is well under way, with widespread networking and universal low-level protocols rapidly gaining acceptance. Soon, the basic connectivity of computers will be taken for granted in the same way as the connectivity of roads and of telephones.

Next there is compatibility. It is useless to connect two ma-

chines if the document prepared on one cannot be printed or viewed on the other or if applications on one cannot work with the other. We are beginning to see progress through the creation of comprehensive standards for languages, databases, communication protocols, and interaction architectures. Standards based on SQL, SAA, Unix, X Window, and the like will still take a while to reach the uniform acceptance that we see at lower levels, but the process is well in motion.

The third level, coordination, is just coming to be recognized as a central issue. For users, the purpose of integration is not to share data or connect processors, but to integrate the work. Work is not about files and databases or spreadsheets and forms. It is customers, orders, products, designs, and the myriad of specialized things that appear in different lines of endeavor. The emergence of groupware reflects a growing recognition that the industry needs to move away from thinking about integration of the devices and data, and turn its attention to the integration of work activities.

This shift requires addressing the nature of work in organizations. Organizations are structures for the social coordination of action, generated in conversations based on requests and promises, and associated with times for completion. This scenario works regardless of whether the request is the placing of an order or a memo asking for a design team to be formed.

By directly addressing this universal dimension of human communication, we can design action/coordination systems that apply principles of conversation management to keep track of what is going on and what needs to be done. By doing so, we create a coherent principled structure around which the details of activities, interfaces, data files, and printouts make sense.

Over the next few years, the development of conversation/action systems will create a new level of standards and integration, making it possible to create people-centered systems that bring new clarity to the coordination of human action.



Charles Simonyi

Manager of Advanced Languages at Microsoft. As chief architect of applications, Simonyi oversaw the development of many of the firm's most popular applications.

Just as the strength of a rope is derived from intertwined fibers, each shorter than the load-carrying length, the health of the microcomputer industry is built on the myriad of developments and controversies that emerge, interact, and complete in a never-ending pattern. On the whole, I believe 1989 will be a year of delivery more than a year of new promises.

A Grand Consensus has emerged, and in 1989 the consensus is that the future belongs to the graphical user interface, to the mouse, and to networked personal computers. For example, I often see the drawing of a mouse as an illustration to set the mood for some popular article where personal computing is mentioned. Other pointing devices will be developed—especially for use with laptops.

Computer networks will continue to grow and groupware will become much more common, not only as E-mail and file or printer servers, but also as specific features in standard word processors, spreadsheets, and the like. These will be but a few of the many innovations in the already established categories of personal computer applications. New categories will be rare, and current applications such as document processing and desktop publishing may even lose their separate identities.

On the implementation side, the industry already has a remarkable consensus on using C. At the same time, the object-oriented programming paradigm is emerging as the most widely applicable software engineering advance since structured programming. It will be very exciting to see how these two trends interact and reinforce each other in C++ and in other C derivatives. Of course, the original motivation for C was a desire for simplicity and elegance, so C purists will object to the elaboration of the language. My feeling is that while the C pioneers made an incredibly valuable contribution, the trend is toward the emergence of several variations of C and the dominance of a single, very powerful, object-oriented superset of C.

In hardware, we'll see investments in RISC (reduced-instruction-set computer) architectures because of the promise of performance gains. The speed of traditional-architecture chips will also be greatly improved, despite difficulties such as the requirement for software compatibility. Many clever RISC ideas, such as reduced-cost subroutine linkage, could enhance non-RISC or even high-level-language performance. ■

BUGS

Search & Destroy

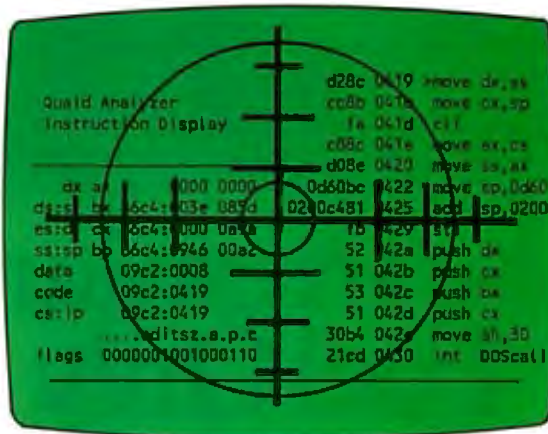

Quaid Analyzer is the ultimate diagnostic tool for the expert programmer.

With Quaid Analyzer you can trace any software without source code; monitor any interrupt; scroll through memory; debug code written in any language; easily change values in memory, registers and at i/o ports. And you never need to type a command!

Now you can have the same powerful tool used to develop CopyWrite. Quaid Analyzer. If you need to search and destroy bugs. *fast.*

To order **Quaid Analyzer**, call us with your credit card, or send us a check for \$200 US funds. We ship within a day at our expense.

QUAID Analyzer

OR YOU'LL NEVER KNOW WHAT YOU'RE MISSING.

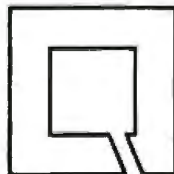

Quaid Software Limited
Third Floor, Dept. B641
45 Charles St. E.
Toronto, Ontario
Canada M4Y 1S2.
(416) 961-8243.



Use Premium Fuel Only.

Ditto.

Take ½ gallon of gasoline formulated for high-performance motor cars.

Add a clod of dirt, a quart of kerosene, a tablespoon of sugar, and a dollop of axle grease. Sprinkle with rust particles and dog hairs. Stir.

You'd be *crazy* to put *that* in your Ferrari, right?

But what we've just concocted is the petroleum equivalent of a kilowatt of ordinary electricity.

Emerson UPS's Provide Clean Fuel For Computers.

Since today's computers are no less high performance machines than the most sophisticated automobiles, they need highly-refined fuel, too.

An Emerson Uninterruptible Power Source is the *electrical* equivalent of a petroleum refinery. Raw fuel in, good fuel out.

Such a simple solution to all the harm spikes, sags, and blackouts can do.

Unrefined Electricity Does Crude Things To Computers.

Unlike bandsaws, washing machines and tv's, computer circuits are hypersensitive to the slightest power variations. Data can be scrambled or vaporized in a few milliseconds. Programs can crash unceremoniously.

Fact is, many problems blamed on hardware or software are, in reality, the fault of raw electricity. Industry statistics show that half the downtime, lost employee and machine productivity, and maintenance costs are the direct result of bad electricity.

A typical computer site experiences about 7 blackouts, over 500 sags and more than 2,000 spikes and surges per year. Plus there's almost continuous line noise at even the best locations.

Power surges alone are credited by one insurance company with \$35 million in pc losses just last year.

Any way you look at it, making sure your computer gets premium fuel is up to you. Fortunately, it's easy and affordable.

UPS Performance And Throughput.

Most people think of Emerson UPS systems as just battery backup

protection against power outages.

In reality, they're also the best power *conditioners* money can buy. They work *continuously*, uniquely providing an impenetrable barrier that isolates your computers from power problems.

The result: You get the level of performance your computer was designed to deliver. The level you paid for.

The High Performance UPS Manufacturer.

Emerson makes a full line of UPS, power conditioning and distribution systems, even simple surge protectors.

All feature quiet operation, attractive design, UL-listed safety, operation that is one-switch simple, and proven reliability backed by the best service in the business.

So, let us help you rev up your productivity. **Simply call 1-800-BACK-UPS** for our free introductory brochure and the name of your local representative. Or write: Emerson Computer Power, 3300 S. Standard St., Santa Ana, CA 92702.



EMERSON
Computer Power
Computers Won't Run Right
On The Wrong Fuel.

THE X WINDOW SYSTEM

Born as a means to network graphics workstations, MIT's X Window is gaining ground as a windowing system for Unix

Dick Pountain

Windowing user interfaces are now the accepted way of interacting with computers. People may still argue about whether they prefer icons or filenames, pull-down or pop-up menus, but no one disputes the usefulness of splitting the display screen into several areas that clearly separate different software functions.

Though purely character-based windows are quite workable (consider pop-up utilities like Borland's SideKick), the industry trend is to adopt the full overlapping-windows metaphor that treats the screen like a bit-mapped graphics image with "soft" typefaces and a mouse-driven pointer that can move around by single-pixel increments. Windows then appear to be active objects that can obscure one another, can be moved and resized, and can contain pointer-activated controls for scrolling and zooming. Special kinds of windows (e.g., menus and dialog boxes) present you with choices from which to select by pointing rather than by typing commands.

Examples of such interfaces familiar to us are the Apple Macintosh interface; Microsoft Windows for IBM PC-compatible systems; Digital Research's GEM, used on the Atari ST and some PC compatibles; and the Intuition interface of the Commodore Amiga.

Two features that are common to all these interfaces is that they are for single-user systems and they are closely tied to the hardware of the computer on which they run. This is partly because such graphical displays impose a much larger computational burden than traditional character-based systems do; thus, their implementation tends to be highly optimized for speed by using direct video memory accesses and even, in the case of the Amiga, custom hardware assistance in the shape of a blitter chip.

In the world of engineering workstations, windowing interfaces have been the norm for several years now. In that world, the almost universal adoption of the Unix operating system combined with the need to share data over networks has generated more pressure for standardization than in the personal computer world.

The goal has been a network-transparent, device-independent way for a program running on a network workstation to create windows on the screen of another workstation that might have been made by a different manufacturer.

Despite the emergence of some proprietary systems, such as Sun's NeWS, it looks as though the workstation world is settling on the X Window System that was developed at MIT.

continued

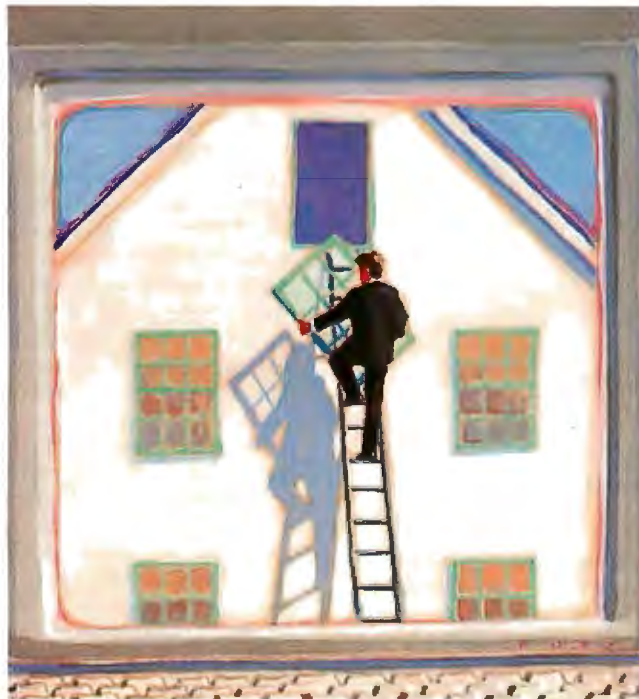

The significance for personal computer users is that the worlds of the PC and the workstation are very rapidly converging (see the article "Sun's Newest Workstation: the Sun386i" by Tom Thompson in the July 1988 BYTE). Top-end PCs already use the same processors (i.e., the 80386 or the 68020/30) as leading workstations. Networking is now widespread among larger PC users.

Meanwhile, CAD and desktop publishing applications have created a need for true high-resolution graphics. These latter

two application areas are also beginning to make people want a portable, device-independent way of exchanging graphical information. So far, that demand has been met by Adobe's PostScript Page Description Language, which has now spawned Display PostScript as a possible video graphics standard in apparent competition with X Window (but see below).

X History

The X Window System has sprung up in a mere 4 years, thanks to the enthusiasm of a group of programmers at MIT and elsewhere. It arose in 1984 out of an MIT project called Athena, which investigated the use of networked graphics workstations as a teaching aid for students in various disciplines.

The idea was that each student should have a windowing graphics workstation on which he or she could run local tools like word processors and spreadsheets while simultaneously being able to call up library pictures and documents from remote sources.

Since MIT has a mix of hardware from Digital Equipment Corp., IBM, and other manufacturers, it was clear that the students needed a hardware-independent protocol for sending graphics around the network. The development of this protocol by Bob Schiefler, along with work by Jim Gettys, Ralph Swick, and others, led to the X Window System. It has progressed in those 4 years from version 4 up to the current release, which is version 11.2.

In 1986, the Athena team decided to release version X 10.4 on tape to other interested parties for a nominal charge (reminiscent of the way Unix was spread in its early days). The positive response was overwhelming. Hewlett-Packard and DEC even designed new workstations around X Window.

Finally, in January 1988, MIT formed a consortium with most of the leading workstation manufacturers to develop X Window further and have it adopted as an ANSI standard. The members of the X Consortium included Apollo, Apple, AT&T, DEC, HP, Sun, IBM, Televideo, and Tektronix. The copyright for X Window is held by the consortium members, but permission for its use is granted to any party interested in implementing it.

What Is X Window?

The MIT team designed X Window as a distributed, network-transparent, device independent, multitasking windowing and graphics system. It permits you to display multiple applications on the same screen, and it lets one application use many windows. It supports overlapping and hidden windows, text with soft fonts, and two-dimensional graphics drawing.

X Window achieves device independence by splitting the job of drawing windows into two parts, using the increasingly familiar client/server model (see the article "A Personal Transputer" in the June 1988 BYTE). The client is an application program making requests of the server to draw windows, text, and other objects. The server program runs on each workstation, drawing the required objects on the display.

The client communicates with the server by sending packets of instructions conforming to the X Protocol, which is, in effect, a high-level graphics-description language. Each workstation has its own server, which contains the hardware-dependent drivers for that workstation. An X server controls not only the screen but also the keyboard and a pointing device with up to five buttons (see figure 1). The application programmer links the client program with X Window using Xlib, a library of graphics and windowing functions.

The client and server might be resident on the same worksta-

continued

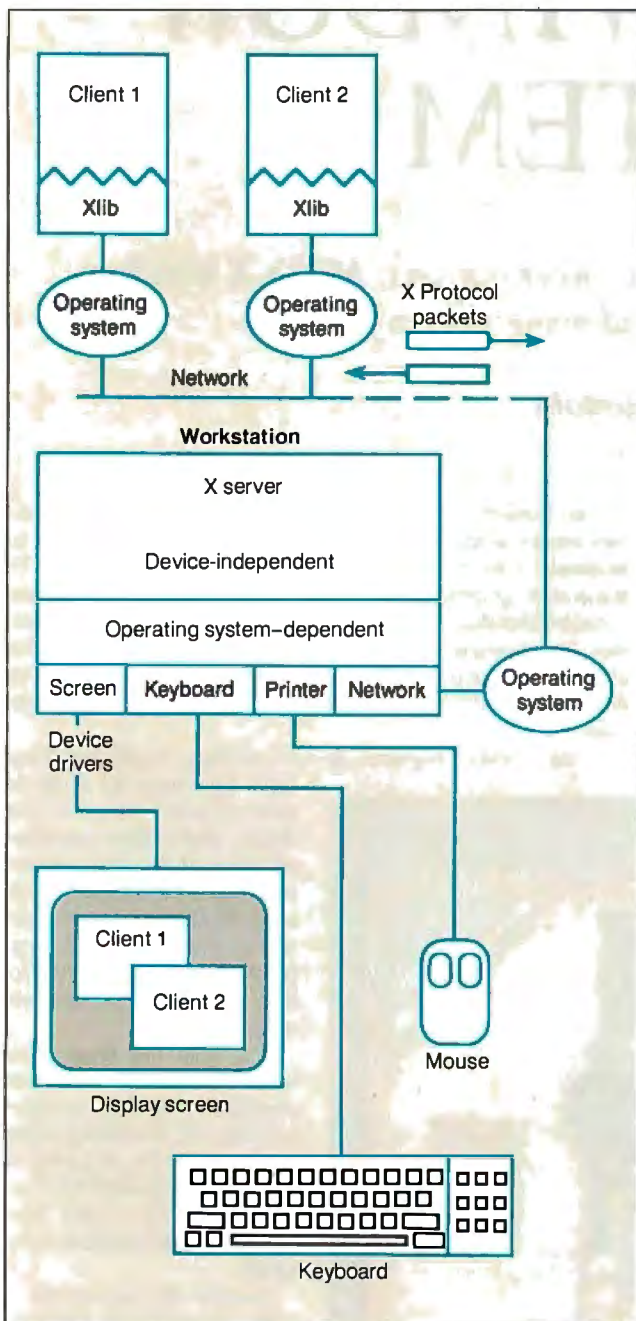

Figure 1: The client program sends packets of instructions to the server, which contains the hardware-dependent drivers for that workstation. An X server controls not only the screen but also the keyboard and a pointing device with up to five buttons.

You No Longer Have to Share the Lower 640K With Your Debugger

Periscope I's new board uses ZERO memory in the lower 640K. Yet it has plenty of room to safely store all debugging information, like symbols, as well as the powerful Version 4 software.

Periscope's hardware adds the power to solve the really tough debugging problems.

The break-out switch lets you break into the system any time. You can track down a bug instantly, or just check what's going on, without having to reboot or power down and back up. That's really useful when your system hangs! The switch is included with Periscope I, Periscope II, and Periscope III.

Periscope I has a **NEW** board with 512K of write-protected RAM, user-expandable to 1MB, for the Periscope software, symbol tables, and all related debugging information. Normal DOS memory (the lower 640K) is thus totally freed up for your application, and Periscope is protected from being overwritten by a run-away program. The new board's footprint is only 32K, so you can use it in PC, AT, and 386 systems with EGA/VGA and EMS boards installed (not possible with the previous 56K board). It can also be used with Periscope III to provide additional write-protected memory.

Periscope III has a board with 64K of write-protected RAM to store the Periscope software and as much additional information as will fit. AND...

The Periscope III board adds another powerful dimension to your debugging. Its hardware breakpoints and real-time trace buffer let you track down bugs that a software-oriented debugger would take too long to find, or can't find at all!

The Periscope III hardware-breakpoint board captures information in real-time, so you'll find bugs that can't be found with a software-based debugger.

Periscope's software is solid, comprehensive, and flexible.

It helps you debug just about any kind of program you can write... thoroughly and efficiently.

Periscope's the answer for debugging device-drivers, memory-resident, non-DOS, and interrupt-driven programs. Periscope works with any language, and provides source and/or symbol support for programs written in high-level languages and assembler.

David Nanian, President of Underware, Inc. (of BRIEF fame) says this about the new Periscope Version 4:

"Periscope has always been an unbelievable assembler-level debugger. Version 4 has turned it into a terrific source-level debugger as well. Aside from major enhancements like the source-level improvements, all the little changes make a really big difference, too. For instance, symbol lookups and disassemblies are noticeably faster, and highlighting the registers that have changed really makes life easier. Once again, Periscope has raised the industry standard for debuggers!"



The **NEW** Periscope I memory board keeps all debugging information out of the lower 640K. Can be used in PCs, ATs, and 386s with both EGA/VGA and EMS boards installed. The Periscope break-out switch enables you to recover from a hung system. Included with Models I, II, and III.



What's New in Periscope Version 4:

- View local symbols from Microsoft C (Version 5)
- Debug Microsoft windows applications
- Set breakpoints in PLINK overlays
- Improved source-level support
- Monitor variables in a Watch window
- 80386 debug register support
- Debug using a dumb terminal
- PS/2 watchdog timer support
- Use mixed-case symbols
- Set breakpoints on values of Flags
- Much more!

- **Periscope I** includes a **NEW** full-length board with 512K of write-protected RAM; (user-expandable to 1MB); break-out switch; software and manual for \$795.
- **Periscope II** includes break-out switch; software and manual for \$175.
- **Periscope II-X** includes software and manual (no hardware) for \$145.
- **Periscope III** includes a full-length board with 64K of write-protected RAM, hardware breakpoints and real-time trace buffer; break-out switch; software and manual. Periscope III for machines running up to 10 MHz with one wait-state is \$1395. Plus the new Model I board, \$1995.

Due to the volatility of RAM costs, prices on board models are subject to change without notice.

REQUIREMENTS: IBM PC, XT, AT, PS/2, 80386 or close compatible (Periscope III requires hardware as well as software compatibility; thus will not work on PS/2 or 80386 systems); DOS 2.0 or later; 64K available memory (128K at installation time); one disk drive; an 80-column monitor.

Call us with your questions. We'll be happy to send you free information or help you decide on the model that best fits your needs.

Order Your Periscope, Toll-Free, Today!
800-722-7006

MAJOR CREDIT CARDS ACCEPTED

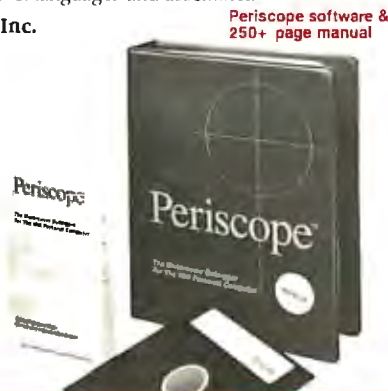

Periscope software & 250+ page manual



The
Periscope
Company, Inc.

1197 PEACHTREE ST. • PLAZA LEVEL
ATLANTA, GA 30361 • 404 / 875-8080

Ma

While the X Window System provides the mechanism for drawing windows and sending graphics around a network, it doesn't mandate the user interface that runs on top of it. The user interface specifies what windows and icons will look like, how the user will interact with them, and so on. Examples of user interfaces for other windowing systems are the Macintosh Finder and the OS/2 Presentation Manager, while Open Look (see the article "Face to Face with Open Look," by Tony Hoeber in the December 1988 BYTE) provides a user interface for Unix windowing systems like X Window and NeWS.

X.Desktop, another window manager, is a complete desktop manager for Unix systems based on X Window, written by the Cambridge, England, firm IXI Ltd. X.Desktop is a client ap-

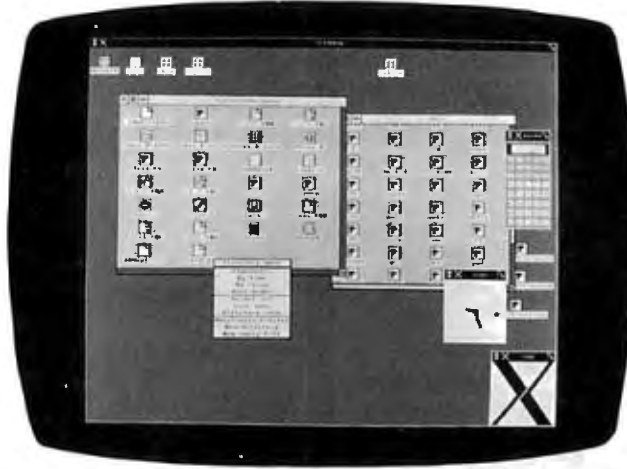

plication that runs on your workstation for the duration of a session. It completely hides the normal spartan Unix shell, though you can call up an ordinary shell in a window any time you need to.

The icon-based desktop (see photo) will be familiar to anyone who has used

a Macintosh system, or X.Desktop adds a few refinements of its own to the metaphor. For example, you can give parameters to a program by dragging the icon for the data file to the program icon and dropping it on top. To edit a file, you drag its icon on top of the icon for the required editor.

What really distinguishes X.Desktop is its configurability. You can change not only the icons that represent a file type, but also the actions performed when an icon is clicked on or dropped onto another. By modifying

and by providing alternative X Window managers, it is possible for X.Desktop to emulate the behavior of any other desktop system with great precision.

IXI is offering X.Desktop as a product, and it is currently being considered by several major Unix ve-

tion, as when a single user is executing a program locally, or they may be very widely separated. For example, a person with a graphics terminal in London, England, could execute a program on a Cray-2 in Berkeley, California, by using a satellite link in a wide-area network. The physical means of communication is immaterial to X Window since the X Protocol is the same in all cases, that is, network-transparent. Communication schemes used with X Window include shared memory, message passing, and transputer links at the local workstation level and RS-232C, Ethernet, token ring, and many others between workstations.

Though X Window has been developed mainly under Unix, it is not dependent on any particular operating system. It can be implemented on top of any operating system, as it has been for VAX/VMS. However, where possible, X Window uses operating system calls to establish the connections between the Xlib functions and the network, and between the network and the X server. This implies that some operating systems, notably multitasking ones with network support, will be far more suitable than others. It is also possible to create mixed operating system networks by implementing an X server for the "foreign" system. MS-DOS microcomputers have been added as X Window terminals to Unix-based networks by just this kind of hybridization.

The X Server

The chain of communication in opening a window under X Window has seven links, depicted in figure 1 but summarized as follows:

Application -> Xlib -> OS -> X Protocol -> OS -> X server -> Screen

An X server program controls the display screen, keyboard, and mouse on the workstation. A single workstation might have several screens driven by the same server (like those big screens for the Macintosh), or a single computer might run more than one server with different graphics terminals attached. More likely, each workstation will have its own X server.

Since a single X server can service requests from many client applications, the screen might have several windows containing the output from different programs. The client programs might be running on the server machine or on several others in the network. Equally, programs running on the local machine or workstation can open windows on other workstations. This means you can create very sophisticated electronic mail systems under X Window.

For example, the leader of a workgroup might pop up a menu window on the screen of each member of the group. They would have to click a preference from the menu, and the results of this "ballot" would be returned to the application program on the leader's workstation, where it would be displayed in a table. This is an illustration of two-way communication in which the X server returns user input from a keyboard or mouse to the client program.

The X server's primary job is to share scarce resources among the client applications that request them. The two principal resources are processor time, for drawing and text manipulation, and screen space. An intermediary program, the window manager (see below), doles out the screen space. The server is responsible for scheduling work performed on behalf of the client programs, for memory management, and for such subsidiary processes as maintaining the communications links with each client.

The server performs all these functions by using the services of the underlying operating system. X Window can be used for a truly distributed system; when it opens a window on another workstation screen, it is the remote CPU that is doing the drawing.

The current X11 version of the server can perform two-dimensional drawing of lines, rectangles, circles, arcs, text, and arbitrary bit maps on monochrome or color displays with up to 32 bits per pixel. The X server also loads new fonts from operating system files, stores them in memory, and makes them available for text writing.

From a structural point of view, an X server consists of a device-independent layer that receives and translates client request messages in the X Protocol format, an operating system-dependent layer that interfaces to a particular operating system, and a device-dependent layer that is a collection of device drivers for the specific hardware supported. To port X Window to a new system, only the latter two layers need rewriting.

Window Hierarchies, Events, and Window Managers

When you open a window under X Window, it becomes part of a hierarchy just like the DOS subdirectory structure. Each screen has its own hierarchical structure and a "root" window that fills the whole screen. The root window can have "child" windows that occupy part of the screen. These in turn can have further children. The overlap and visibility of windows is controlled by the stack order of siblings of the same level, but children always stay in front of their parents. (Figure 2 illustrates this principle.) The number of windows you can create (and destroy) is almost limitless. Each window has attributes such as foreground, background, and border color, cursor shape, and a color map.

Pop-up menus, radio buttons, and dialog boxes are implemented as trees of child windows, since windows are used for all screen interactions. The X server can only output via a window, and it can allow more than one client to output via the same window.

Input from the keyboard must also go into a window, normally the one in which the cursor currently resides. However, X Window has an "input focusing" feature that allows a client program to specify some other window as the source for input. In addition, a client can grab the mouse pointer under certain circumstances.

X Window applications, like those of Microsoft Windows or the Macintosh, are event driven. The main part of a window application program is a loop that waits for an event to happen and then jumps to the appropriate action. The X server recognizes many event types including pointer motion, key press, button press and release, window entry and exit, input focus switching, exposure of previously covered windows, color map event, and status change. Also, communications from the client programs can cause events.

The stated philosophy of the X Window System is to provide only the mechanism for drawing windows, not the policy for using them. This differentiates it from Microsoft Windows, Macintosh, GEM, and other systems that provide both. Under X Window, the policy must be provided by a separate program called a "window manager," which is just an ordinary client program.

Client programs have to negotiate with the window manager, which has the last say in all matters of screen usage. The proper protocol is for clients to offer the manager "window hints" of their wishes (something like "I want a 20-row-by-30-column window at row 10 column 10 in the foreground"). The manager can then use any available algorithms to satisfy these requests

as fairly as it can. It can, for example, resize existing windows or alter their stacking order. Windows can be restacked, moved, resized, closed, or reduced to an icon via the attentions of a window manager. A window manager can also alter the way events are delivered, grab the mouse pointer, and change the input focus.

In fact, a window manager can impose any policy its implementer can dream up. It might forbid the overlapping of windows altogether and send a rude message to any client program that asks for too much screen.

More sensibly, a window manager can emulate other windowing systems. If you have several window managers present in your system, you can switch from the Macintosh look, complete with scroll bars, to the Microsoft Windows look just by running a new manager. Several development firms are presently working on window managers that emulate the OS/2 Presentation Manager.

Xlib, X Toolkits, and X Protocol

A programmer wishing to write applications that run under X Window must perform all windowing and drawing by using

continued

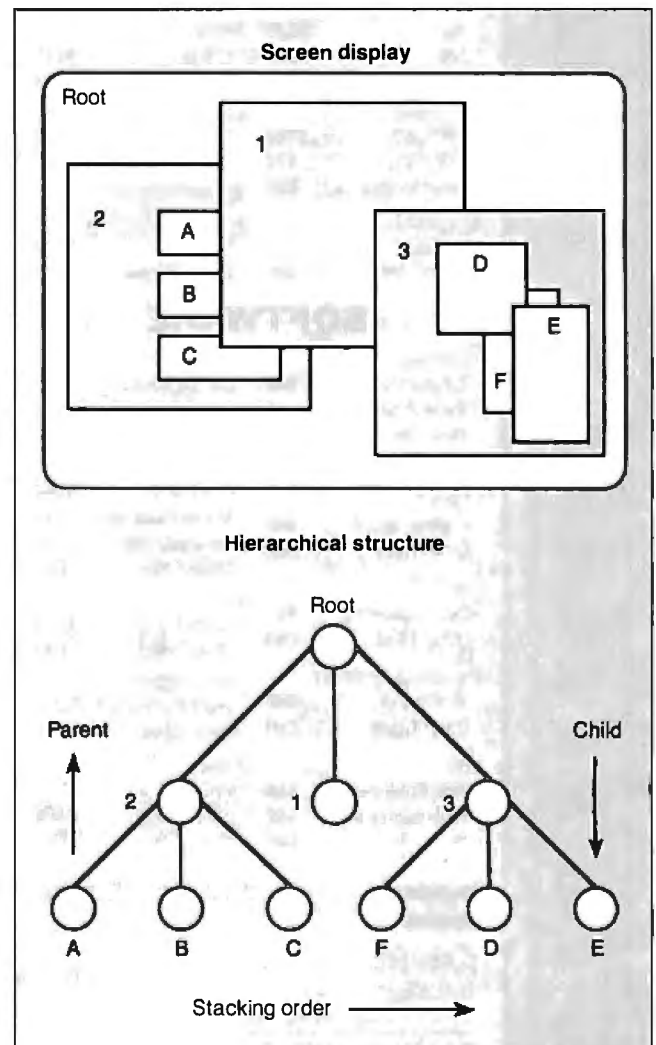

Figure 2: X Window treats overlapping windows as a hierarchy.

1-800-528-1054

ORDER LINE



Unbeatable Prices

The Acknowledged Leader in the Computer Mail Order Industry
Call About the Availability of Other Products Not Listed.

HARDWARE

PRINTERS:

Epson
LQ500 \$289
LX800 175
Other Models Call

NEC
P2200 \$349
Other Models Call

Okidata
182 + \$225
320i 330
Other Models Call

Panasonic
KXP1080i \$160
KXP1091i 179
Other Models Call

DRIVES:
Toshiba
3½ (1.4MB) \$99

CARDS:

Paradise
VGA Professional \$469
Other Models Call

Video 7
VGA Deluxe \$205
Other Models Call

MODEMS:

Hayes
1200B \$275
Other Models Call

US Robotics
All Models Call

MONITORS:

Princeton Graphics
Ultrasync \$509
Other Models Call

SOFTWARE

Boreland
Turbo Pascal \$86
Turbo Prolog 89
Other Titles Call

Central Point
Copy II
Option Board \$99
Other Titles Call

Dac
Dac Accounting ... \$53
Other Titles Call

Paperback Software
VP Planner \$47
Other Titles Call

PFS
First Publisher ... \$65
Professional Write 102
Other Titles Call

Peter Norton
Norton Advanced .. \$69
Norton Utilities ... 47
Other Titles Call

Microsoft
C Compiler \$254
Macro Assembler .. 84
Windows 286 54
Other Titles Call

Lotus
Lotus 1, 2, 3 \$285
Other Titles Call

Word Perfect
Word Perfect 5.0 \$219
Other Titles Call

Xerox
Ventura
Publishing \$465
Other Titles Call



• No Charge for VISA and MasterCard.
• We Do Not Charge Your Card Until Your Order is Shipped.
• All products including D.O.A.'s, carry only manufacturer's warranties. We do not honor guarantees, rebates, trial period privileges or promotional programs offered by manufacturers.
• You Pay The Ground Shipping 1-10# \$6.00; 11-20# \$10.00 (Except Alaska & Hawaii), We Pay The Air Difference.
• Free Air Applies ONLY to Orders Over \$100.

• No APO, FPO, or international orders please.
• Call Before Submitting R.O.'s. Ask for National Accounts.
• Personal and Company Checks Will Delay Shipping 3 Weeks.
• Prices, Terms & Availability Subject to Change Without Notice.
• Add 5% for C.O.D. Orders.
• We Do Not Guarantee Machine Compatibility.
• Mailing Address: TELEMART, 8804 N. 23rd Ave., Phoenix, AZ 85021.
• To Place an Order: 1-800-528-1054.
• To Follow Up On An Order: (602) 944-1037.
• Order Line Hours: Mon.-Fri. 7:00am-6:00pm, Saturday 9:00 am-1:00 pm.
• Order Processing: (602) 944-1037, 10:00 a.m.-3:00p.m. Mon.-Fri.

only procedures from the Xlib library, which is available in C, Pascal, FORTRAN, Modula-2, and Ada. If you write your program this way, you should be able to port it to any hardware that supports an X server by simply recompiling without altering the code.

X Window's

main competition is Display PostScript, which offers more powerful typographic functions—though the two systems are not exclusive and might even complement each other.

Xlib contains more than 200 procedures, many of which resemble those found in any graphics library. For example, the drawing primitives include XDrawPoint, XDrawRectangle, XFillRectangle, and XDrawArc.

Xlib supports clipping, stippling, and tiling operations as well as the manipulation of raw bit maps. It supplies other procedures to create and configure windows (XCreateWindow, XResizeWindow, XDestroyWindow), and still others concerned with events, queries, font manipulation, keyboard, pointer, and color control.

Opening an X Window application involves eight steps in sequence:

1. Open a connection to the server with XOpenDisplay.
2. Create a top-level window with XCreateWindow.
3. Set standard properties for the top-level window, including hints for the window manager.
4. Create window resources such as graphics contexts.
5. Create any other windows needed.
6. Select the desired events for these windows.
7. Map the windows.
8. Enter the event loop.

The "graphics context" referred to in step 4 is a data structure that contains information about a drawing: the foreground and background colors, line width, and clipping region. Mapping is an initialization process that makes a window viewable. The C source code in listing 1 shows how this initial sequence looks for a simple application that prints the traditional "first" program of any language, "Hello World."

Closing an application properly involves killing all windows, freeing all resources, and then calling XCloseWindow. Should you fail to do this and merely exit, the server will eventually notice and close the windows down itself, since it is responsible for maintaining the client connection.

If you have linked your application to the required Xlib routines, at run time X Window will generate the equivalent X Protocol requests to send to the X server. These requests corre-

continued

Doing Business Since 1980 - A Division of E.W. Marketing, Inc.



Listing 1: An X Window program for a window that displays Hello, World. If you press a mouse button, it responds Hi!.

```

/***** X include files *****/
#include <X11/Xlib.h>
#include <X11/Xutil.h>

/***** declarations *****/
char hello[] = {"Hello, World."};
char hi[] = {"Hi!"};

/***** main *****/
main(argc, argv)
int argc;
char *argv[];
{
    Display *mydisplay;
    Window mywindow;
    GC mygc;
    XEvent myevent;
    KeySym mykey;
    XSizeHints myhint;
    int i, done;
    char text[10];

    /* initialization */
    mydisplay = XOpenDisplay("");
    myhint.x = 200;
    myhint.y = 200;
    myhint.width = 350;
    myhint.height = 250;
    myhint.flags = PPosition | PSize;
    mywindow = XCreateSimpleWindow(mydisplay, DefaultRootWindow(mydisplay),
        myhint.x, myhint.y, myhint.width, myhint.height, 5, 0, 1);
    XSetStandardProperties(mydisplay, mywindow, hello, hello, None, argv,
        argc, &myhint);
    mygc = XCreateGC(mydisplay, mywindow, 0, 0);
    XSelectInput(mydisplay, mywindow, ButtonPressMask|KeyPressMask|ExposureMask);
    XMapWindow(mydisplay, mywindow);

    /* main event-reading loop */
    done = 0;
    while( done == 0)
    {
        XNextEvent(mydisplay, &myevent);
        switch(myevent.type)
        {
            case Expose: /* repaint window on expose events */
                if(myevent.xexpose.count == 0)
                    XDrawImageString( mydisplay, mywindow, mygc,
                        50, 50, hello, strlen(hello) );
                break;
            case MappingNotify: /* process keyboard mapping changes */
                XRefreshKeyboardMapping(&myevent);
                break;
            case ButtonPress:
                XDrawImageString(mydisplay, mywindow, mygc,
                    myevent.xbutton.x, myevent.xbutton.y,
                    hi, strlen(hi) );
                break;
            case KeyPress:
                i = XLookupString(&myevent, text, 10, &mykey, 0);
                if( i==1 && text[0] == 'q' )
                    done = 1;
                break;
        } /* switch (myevent.type) */
    } /* while (done == 0) */

    /* Termination */
    XUnmapWindow(mydisplay, mywindow);
    XFreeGC(mydisplay, mygc);
    XDestroyWindow(mydisplay, mywindow);
    XCloseDisplay(mydisplay);
    exit(1);
}

```

Contemporary Programming & Software Design Series

Ten modules teach you how to write your own programs or modify existing software to fit your needs:

- Getting Started in Programming & Software Design
- Attacking the Problem
- How to Design the Solution and Arrange it Logically
- Coding the Program: High Level Languages
- Coding the Program: Assembly Language
- Testing and Debugging Made Easy
- Creating Meaningful Documentation
- Modifying & Updating Existing Programs
- Tools & Tricks for Program Design
- Writing Advanced Programs



15 Day Trial Examination Order Form

YES! I would like to learn how to make any computer do exactly what I want it to do and would like to examine the first module in the Series absolutely free. If I decide to keep it, I will pay just \$24.95 plus \$2.25 shipping and handling. I will then receive future modules automatically, one every 4 to 6 weeks. Each of

the 10 modules in the Series is \$24.95 plus \$2.25 shipping and handling and comes on the same 15-day Trial Examination basis. There is no minimum number of modules that I must buy and I may cancel at any time simply by notifying you.

If I do not choose to keep the first module, I will return all materials in good condition and pay nothing. Future modules will be canceled and I will be under no further obligation.

Available for IBM PC/IBM PC Compatibles (requires BASIC) and Commodore 64/128™ microcomputers.

Check your preference: IBM Commodore 64/128

Name _____
(Please Print)

Street _____

City/State/ZIP _____

Phone Number: () _____

All orders subject to approval and payable in U.S. funds only. Available in U.S. and Canada only. Add stamp and mail today.

2500-019



Post Office
Will Not
Deliver Without
First Class
Stamp



McGraw-Hill Continuing Education Center
3939 Wisconsin Avenue
Washington, D.C. 20016-9265



Make Any Computer Do Exactly What You Want With McGraw-Hill's

Contemporary Programming & Software Design Series



From Writing Your Own Programs to Modifying Existing Software, Here's the New, Easy, and Low Cost Way to Unlock the Secrets of Your Computer

Whether you use computers for business, for personal applications, or for fun, off-the-shelf programs will never do everything you want them to do for you. That's because they were written by programmers to satisfy what they perceived as the needs of the greatest number of potential users—often missing some or many of your specific needs.

That's why McGraw-Hill's new Contemporary Programming and Software Design Series teaches you how to create your own software . . . either from scratch or by making key modifications to existing programs.

There is nothing magical about it. You learn the process of building a computer program step-by-step with McGraw-Hill *Concept Modules* sent to you one at a time, once a month. Each of the ten modules in the Series takes you through an important step in the development of the structure and detailed logic of a program, including testing, debugging, and documentation.

Unique Interactive Hands-On Instruction

Each module includes an easy-to-understand guide PLUS a 5¼" floppy disk containing typical programs and interactive instruction that you can run on IBM PCs, PC compatibles and Commodore 64 and 128 computers for hands-on experience.

In the first Module, for example, when your sample program (Declining Interest Loans) appears on your screen, you'll find errors on certain program lines. You'll also see that the program is only three-quarters completed.

Now comes the fun part. You'll discover how this program is built, and in the process you'll learn how to identify and correct errors. And by the end of Module 1, you'll actually have completed this program yourself.

But there's more. Special graphics on your screen work in conjunction with the accompanying guide to amplify, illustrate, and deepen your understanding of software design principles.



The Crucial 95%—Learn the Foundation of Computer Programming

While the Series includes interactive disks that run on specific computers, everything you learn you can apply to any language or machine. Why is this possible? Because McGraw-Hill knows programming is far more than coding a program into the computer using a specific language. In the real world of computers, 95% of the programming process is carried out using design techniques that are independent of specific language or machine. It is this crucial 95% that you thoroughly understand and master in the Series.

Make no mistake. Almost all books and courses on "programming" teach you only the final 5% of the total programming process—namely, how to code in a specific language. . . information of little value if you don't know how to reach the point in the programming process when you are ready to code.

With the Series, however, you'll learn to create your own programs from scratch, even modify off-the-shelf programs. You'll learn enough BASIC and machine language to get you started on the remaining 5% of the programming process.

Build Your Own Personal Software Library

The sample programs you work with throughout the Series are excellent learning tools. But they're more than that. By combining the sample programs onto one master disk, you'll have the start of your own personal software library. In addition to the programs you've written and modified throughout the Series, you'll also receive dozens of the most popular public domain and user-supported programs, such as data base manager, word processor, calendar generator, appointments reminder and much, much more.

15-Day No-Risk Trial

To order your first module without risk, send the postage-paid card today. Examine the first module for 15 days and see how the Series will help you make your computer do exactly what you want it to do!



If someone has beaten you to the card, write to us for ordering information about the Contemporary Programming and Software Design Series.



McGraw-Hill
Continuing Education Center
3939 Wisconsin Avenue
Washington, DC 20016

CHEAP!



ZENITH

SUPERSPORT 2 Drive \$ 1498
 SUPERSPORT 20MB HD \$ 2197
 SUPERSPORT 286 20M \$ 3034
 SUPERSPORT 286 40M \$ 3376



286 12MHz

512K 100ns RAM (Exp. 1MB)
 0 Wait States
 1.2MB Floppy Drive
 Hard/Floppy Controller
 Advanced 101 Keyboard
 1 Year Warranty
 Norton S.I. Rating 13.3

\$999

Monitor sold separately



NEC MULTISYNC II

\$559



AT&T

6300 WGS I Drive \$ 989
 6300 WGS30M \$ 1268
 6386 WGS \$ 3326

Monitor sold separately



EPSON

Equity I+ \$ 688
 Equity II+ \$1039
 Equity III+ \$1344
 LT Laptop Dual Drive \$1189
 LT Laptop 20M Harddisk \$1792

Monitor sold separately



NEC

Powermate

1 \$ 1198
 1 28M \$ 1527
 386/16 \$ 2585
 386/20 \$ 3299

Monitor sold separately

All Original NEC Components
 All Models Include Keyboard



NEC

Powermate Portable 20M \$ 2358
 Powermate Portable 40M \$ 2744
 Powermate Port. SX 42M \$ 3768
 Multiplex EL II \$ 1419
 Multiplex HD \$ 2248



TOSHIBA

T1000 \$ 777
 T1100 PLUS \$ 1388
 T1200F \$ 1579
 T1200H 20M \$ 2259
 T3100/20 \$ 2987
 T3200 \$ 3744
 T5100 \$ 4784

HARD DISK DRIVES

SEAGATE 20M w/Cont	\$ 267
30M w/Cont	\$ 276
40M w/Cont	\$ 444
40M	\$ 448
80M	\$ 659
MINISCRIBE	
40M w/Cont	\$ 334
40M #3650	\$ 298
40M 28ms	\$ 659
71M 28ms	\$ 748
MICROPOLIS	
153M 23ms w/Cont	\$ 1594
332M 18ms w/Cont	\$ 2389

DISK DRIVES

PLUS 20M Hardcard	\$ 498
40M Hardcard	\$ 629
TOSHIBA	
3.5" 720K	\$ 88
3.5" 1.44M	\$ 126
5.25" 360K	\$ 89
5.25" 1.2M	\$ 89
AMR 5.25" for PS/2	\$ 239
AMDEK Laserdrive with MS Bookshelf	\$ 799

MODEMS

HAYES 1200B Internal	\$ 229
2400B Internal	\$ 368
1200 External	\$ 268
2400 External	\$ 397
2400P PS/2	\$ 359
US ROBOTICS	
1200 Internal	\$ 88
2400 Internal	\$ 164
2400 External	\$ 99
1200 External	\$ 166
2400 External	\$ 277
Coaster 2400 PS/2	\$ 277
VENTEL	
2400B for PS/2	\$ 348

VIDEO CARDS

Boca EGA	\$ 144
Hercules Mono +	\$ 169
Hercules Color	\$ 139
Hercules INColor	\$ 266
NECGB-1	\$ 268
Nitro Monographic	\$ 49
Nitro Color Card	\$ 49
Paradise Autosw 480	\$ 172
Paradise VGA Plus	\$ 269
PGS Laserpage	\$ 532
PGS PG-1600	\$ 532
Video-7 Vega VGA	\$ 269

SAMSUNG

S-300	\$ 649
8 MHz XT Compatible	
360K Drive, 6 Exp Slots	
S-500	\$ 1098
10 MHz AT Compatible	
1.2M Drive, 8 Exp Slots	
S-800	\$ 2598
20 MHz 80386	
1.2M Drive, 8 Exp Slots	
EGA Video Adapter	

AST COMPUTER SYSTEMS

286 Model 80	\$ 1539
286 Model 90	\$ 2039
286 Model 120	\$ 2355
286 Model 140	\$ 2677
286 Model 170	\$ 3089
386 Model 300	\$ 2699
386 Model 340	\$ 3999
386 Model 390	\$ 5349
386 Model 3150	\$ 6149
386 Model 3320	\$ 6788

NEC PRINTERS

PS 10" wide	\$ 463
CP6 10" Color	\$ 549
P7 16" wide	\$ 644
CP7 16" Color	\$ 733
P2200 10" wide	\$ 359
PSXL 16" Color	\$ 877
P9XL 16" Color	\$ 1079
LC890 Silentwriter	\$ 3433
ELF-350 19 cps	\$ 417
3500 3.5 cps	\$ 896
8800 55 cps	\$ 1166

CITIZEN PRINTERS

120D	\$ 184
180D	\$ 199
MSP-10	\$ 268
MSP-18E	\$ 369
MSP-18E	\$ 337
MSP-45	\$ 488
MSP-50	\$ 422
MSP-55	\$ 551
Prismare 35	\$ 533
Tribute 124	\$ 498
Tribute 224	\$ 664

EPSON PRINTERS

LX-800	\$ 189
FX-850	\$ 339
FX-1050	\$ 488
LQ-500	\$ 328
LQ-850	\$ 519
LQ-950	\$ 597
LQ-1050	\$ 737
LQ-2550 Color	\$ 939

OKIDATA PRINTERS

182 PLUS	\$ 224
192 PLUS	\$ 318
193 PLUS	\$ 412
292 IBM Parallel	\$ 416
293 IBM Parallel	\$ 533
294 Color Parallel	\$ 754
393	\$ 944
393 Color	\$ 1045
LASERLINE 6 Par	\$ 1348

PANASONIC PRINTERS

KX-P10801	\$ 198
KX-P10911	\$ 218
KX-P10921	\$ 344
KX-P1592	\$ 436
KX-P1593	\$ 492
KX-P1524	\$ 555
KX-P3131 17 cps	\$ 327
KX-P3151 22 cps	\$ 519
Laser Partner	\$ 1738

PRINTERS

AST TurboLaser/PS	\$ 3383
DICOMX 150	\$ 332
DICOMX 300W	\$ 515
GEMICOM 4410 400 lpm	\$ 4689
4440 800 lpm	\$ 5979
OTC 850XL	\$ 1644
XEROX 4020-Color	\$ 1088

SOFTWARE

Aldus Pagemaker 3.0	\$ 488
Carbon Copy	\$ 109
Clipper	\$ 395
Crosstalk 16	\$ 98
DBXL Diamond Rel.	\$ 118
Deskview 2.0	\$ 77
Disk Optimizer	\$ 44
Eureka	\$ 98
Fastback Plus	\$ 94
Fontage Plus	\$ 196
Fontage Plus 386	\$ 288
Generic CADD	\$ 78
Kings Quest	\$ 34
Managing Money	\$ 119
Microsoft C5.1	\$ 281
MS QuickBasic	\$ 64

SOFTWARE

Microsoft EXCEL	\$ 296
Microsoft Word 4	\$ 209
Microsoft Works	\$ 114
Microsoft Write	\$ 119
MS Windows 2	\$ 68
MS Windows 386	\$ 123
MS Flight Simulator	\$ 34
MS Macro Am 5.1	\$ 98
Homestead	\$ 36
Paradox 1.1	\$ 282
Paradox 2.0	\$ 429
PF9: Pro Write	\$ 139
PF9: First Choice	\$ 88
Paik Peterbrush	\$ 148
Q & A	\$ 189
Quattro	\$ 144

SOFTWARE

Xerox Ventura 2.0	\$ 474
QuickDraw Diam Ref.	\$ 337
Reflex	\$ 87
Sideways	\$ 43
Smart Not	\$ 52
SQZ Plus	\$ 62
Supercalc 4	\$ 259
Tarbo Basic	\$ 59
Tarbo C	\$ 98
Tarbo Lightening	\$ 59
Tarbo Pascal 5.0	\$ 98
Tarbo Prolog	\$ 84
VF Planner	\$ 58
Wor Perfect 5.0	\$ 235
Wordstar Prof.	\$ 218
Yeager Adv Flight	\$ 29

SCANNERS

AST TurboScan	\$ 1233
DEST Scan Plus	\$ 1798
Panasonic OCR	\$ 1798
PGS LS300 w/fnt	\$ 698
PGS LS300 OCR	\$ 939

INTEL

8087 4.77MHz	\$ 99
8087 8 MHz	\$ 142
80287 6 MHz	\$ 179
80287 8 MHz	\$ 243
80287 10 MHz	\$ 289
80287 16 MHz	\$ 448
80387 20 MHz	\$ 689
80387 16 MHz	\$ 349
Above Bd 286 512K	\$ 249
Above Bd PS/2 OK	\$ 249
Inboard 386/PC NR	\$ 889
Inboard 386/AT NR	\$ 988

MOUSE DEVICES

MICROSOFT Mouse	\$ 97
With Windows 2.0	\$ 138
LOGITECH Mouse	\$ 74
With LogICADD	\$ 118
Publisher Mouse	\$ 113
HiRes Mouse	\$ 86

Note: Specify either Serial or Bus Version

MONITORS

Amdek 410A	\$ 138
432 VGA Mono	\$ 156
732 VGA Color	\$ 414
1280 & video card	\$ 638
AST Monochrome	\$ 129
AST EGA Color	\$ 117
Epson Mono	\$ 474
Epson Color	\$ 288
Epson EGA Color	\$ 368
Genius Dtp Sys	\$ 1288
NEC Monograph	\$ 1244
NEC Multisync XL	\$ 2075

MONITORS

NEC Multisync II	\$ 559
NEC Multisync GS	\$ 179
NEC Multisync Plus	\$ 858
PGS HX-12	\$ 436
PGS Max-15	\$ 264
PGS LM-300	\$ 538
PGS UltraSync	\$ 539
Taxan Crystal View	\$ 1434
WYSE WV-700	\$ 717
Zenith 149	\$ 109
Zenith 1390	\$ 419
Zenith 1490	\$ 584

ACCESSORIES

Printer Cable 6'	\$ 9
Printer Cable 10'	\$ 14
Parallel Adapter	\$ 29
Serial Adapter	\$ 29
Game Adapter	\$ 19
101 Keyboard	\$ 68
PS/2 Keybd Exten	\$ 16
PS/2 Monitor Exten	\$ 21
Xidex DSDD Diska	\$ 7
Xidex 1.2M Diska	\$ 13
IBM 3.5" 1 M Diska	\$ 29
IBM 3.5" 2M Diska	\$ 58

NITRO MICRO

120 West Main Street • CARMEL, IN 46032

800-382-3888

HOURS (E.S.T.)
 9-7 Monday-Friday
 12-5 Saturday

MasterCard VISA

Please add 3% for shipping & handling. NO SURCHARGE FOR CREDIT CARDS and we do not charge until we ship. All items subject to availability and price change. All standard orders are sent UPS.

THE TOKEN RING

Our newest column takes a hard look at the nuts and bolts of current technology

Editor's note: *In this issue, we inaugurate a new column by Brett Glass, a hardware designer, programmer, and author with some impressive credentials. Brett was one of the architects of Texas Instruments' TMS380 chip set (which implements the IEEE 802.5 Token Ring local-area network) and coauthored Living Videotext's ThinkTank 2.0. He founded BADGE, the Bay Area Amiga Developers' Groupe, and is an instigator of the Hackers' Conference, an annual get-together for the pioneers of the microcomputer revolution. Brett holds a BSEE from the Case Institute of Technology and an MSEE from Stanford University. In Under the Hood, Brett will present in-depth analyses of significant new technology, as well as provide technical background for understanding the material that appears elsewhere in BYTE. We feel fortunate to have a writer of Brett's caliber on-board, and we welcome your response to this new column. If you'd like to contact him personally, see the note at the end of the column.*

—KS

The IBM Token Ring has captured more than 50 percent of the microcomputer local-area-network market and more than 20 percent of all LAN applications worldwide. This specification (also known as the ANSI/IEEE 802.5 standard) got a late start relative to other LAN standards. IBM released it in late 1985, years after Ethernet and ARCnet. Why has the Token Ring become so popular so quickly? And what's really going on under the hood? In this article, I'll tell the "inside story" of the Token Ring and show why it's likely to be the dominant LAN standard by the end of this decade.

Token Ring Fundamentals

Before I go any further, it's vital to understand where the term Token Ring comes from. The nodes in a Token Ring, which can be microcomputers, minicomputers, mainframes, or other types of computer equipment, are electrically connected to one another in a "ring" configuration, as shown in figure 1.

Each node receives information from one of its neighbors (its nearest active upstream neighbor, or NAUN for short) and transmits it to the node immediately downstream. Unless a node is transmitting its own data, it passes on whatever information it receives from its NAUN verbatim. Thus, any node can transmit information to any other node by sending it through some or all of the others. The

total effect resembles an endless, circular version of the party game Telephone, in which players occasionally add their own information to the circle. This is the ring part of the Token Ring.

But what is a token, and what role does it play in making the network function? Well, as mentioned above, each node on the ring can either transmit its own data or retransmit the data it receives from its NAUN. As you might expect, however, it can't do both at the same time. Thus, if two nodes on the ring try to transmit simultaneously, it's probable that one will "swallow" the other's data and keep it from propagating to the entire ring. To avoid this, the nodes take turns transmitting, keeping track of whose turn it is to talk by passing around an electronic "baton" called a token.

A token is a short (24-bit) message that says to the node that receives it, "It's your turn to send data if you want to." When a node that wants to transmit receives a token (see figure 1a), it changes the token into a frame, appending its address, the recipient's address, and the data (see figure 1b). The transmitting node is said to be in possession of the token. No other node can talk; each must obediently retransmit the data as it sees it. When the frame reaches its destination node, it is passed on (see figure 1c), with status bits within the frame changed to indicate that it was received. The frame continues moving along the ring

until it arrives back at the sender.

Now, it isn't very useful for the frame to go around the ring more than once: On its initial circuit, it has already visited every node on the ring. Therefore, the sending node doesn't retransmit its own data. Instead, on recognizing its own frame, it "strips" the frame from the ring and passes a token to its nearest downstream neighbor (see figure 1d). The cycle repeats, with each node getting a chance to speak in turn.

This explanation is a bit simplistic (it doesn't include the notion of priority, for instance), but it covers the basics of the Token Ring architecture. The true brilliance of the Token Ring design lies in the subtleties added by IBM's scientists in Zurich and engineers from both IBM and Texas Instruments.

The Token Ring has the ability to prioritize access to the ring, "heal" after a cable breaks, disconnect malfunctioning nodes, and identify the locations of noisy connections within the network—capabilities absent from most other popular network standards. In the sections that follow, I'll explore some of these features in greater depth.

The Physical Layer: Logical Ring, Physical Star

I'll start my tour of the Token Ring with the lowest layer of the Open Systems Interconnection reference model: the phys-

continued

ical layer. The first thing you'll notice if you look at the hardware of a typical Token Ring is that it doesn't look like a ring at all; rather, it resembles a star (see figure 2). Each network node uses a single two-pair cable to connect to a device called a wiring concentrator, or, in Token Ring parlance, a medium access unit (MAU). One pair is for receiving data, the other for sending data.

The star-shaped wiring topology has two advantages. First, only one cable is needed from each station on the network to a single, centralized location. (Telephone systems are wired the same way. In fact, IBM suggests that the same conduits and wiring closets be used for both.) This design requires more cable than if you were to simply connect successive nodes, but it makes it much easier to add new nodes and remove old ones.

The second advantage is that it's easy to bypass an inactive or malfunctioning node at the MAU by connecting its upstream node directly to its downstream neighbor (see figure 3). When you turn a workstation off or when a node leaves the ring because of a malfunction, current ceases to flow in the "phantom circuit" (see figure 4) associated with that node. A relay opens in the MAU, and the ring reconfigures itself without the inactive machine.

If only one MAU is in the network, the MAU configures all the stations attached to it into a ring. If there is more than one MAU, each links its stations into a single ring that runs through all the MAUs.

Each node attaches to the MAU via a special four-conductor connector. The connector is hermaphroditic; that is, it can mate with identical connectors. When a connector is unplugged, short-

ing bars inside join the send circuit to the receive circuit, allowing the attached device to perform loopback tests on itself and the cable.

The connections between a node and the remainder of the Token Ring are transformer-coupled. This limits common-mode voltages and breaks ground loops that could cause harmful interference on the ring.

Longer Distances

In a bus-based network, like ARCnet and Ethernet, each network node must be able to be heard by all the others, thereby limiting the total size of the network to the distance that a single adapter's signal can reach. But since each node on the Token Ring needs to send a signal only as far as the next node, a Token Ring can be much larger. A Token Ring node can be

continued

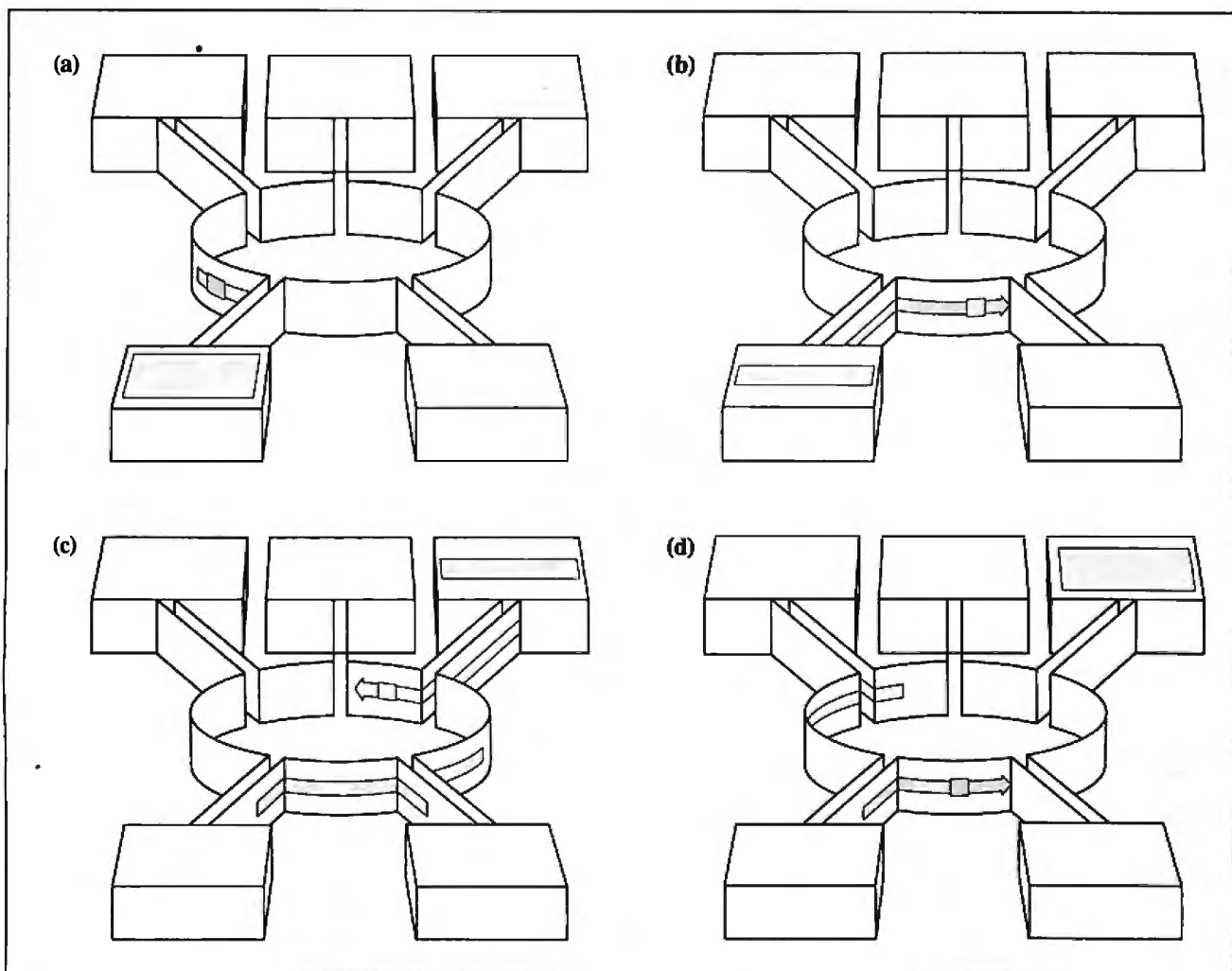

Figure 1: A functional overview of the Token Ring. (a) The sending station waits for a token; (b) the sending station makes the token a frame by adding addresses and data; (c) the receiving station copies data and sets the "copied bit"; and (d) the sending station removes the data and generates a new token. (Figure courtesy of IBM Corp.)

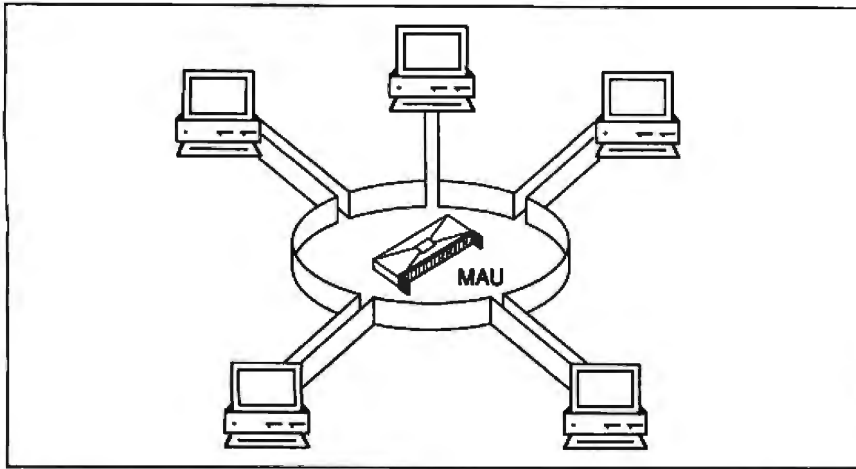

Figure 2: At the lowest level, the physical layer, a Token Ring looks like a star (hence the term "star-wired ring topology") in which each node is connected to a wiring concentrator, the medium access unit.

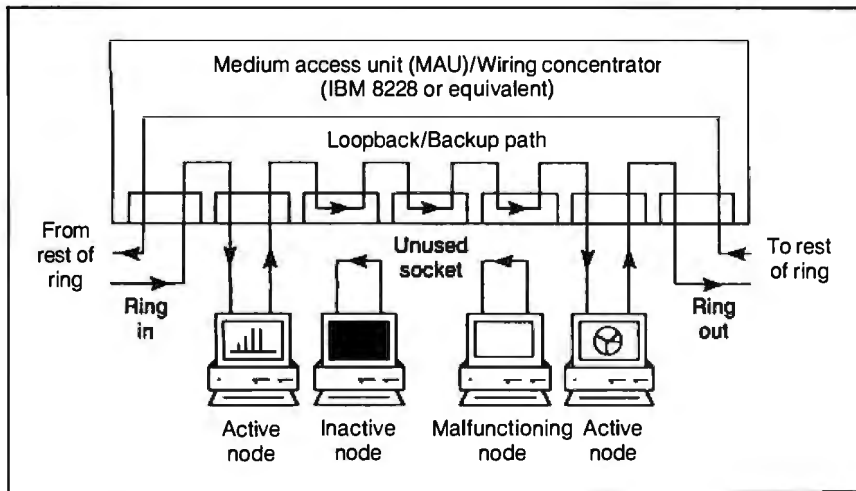

Figure 3: Signal flow in the medium access unit. Note that any or all nodes in the star-wired ring can be bypassed if necessary.

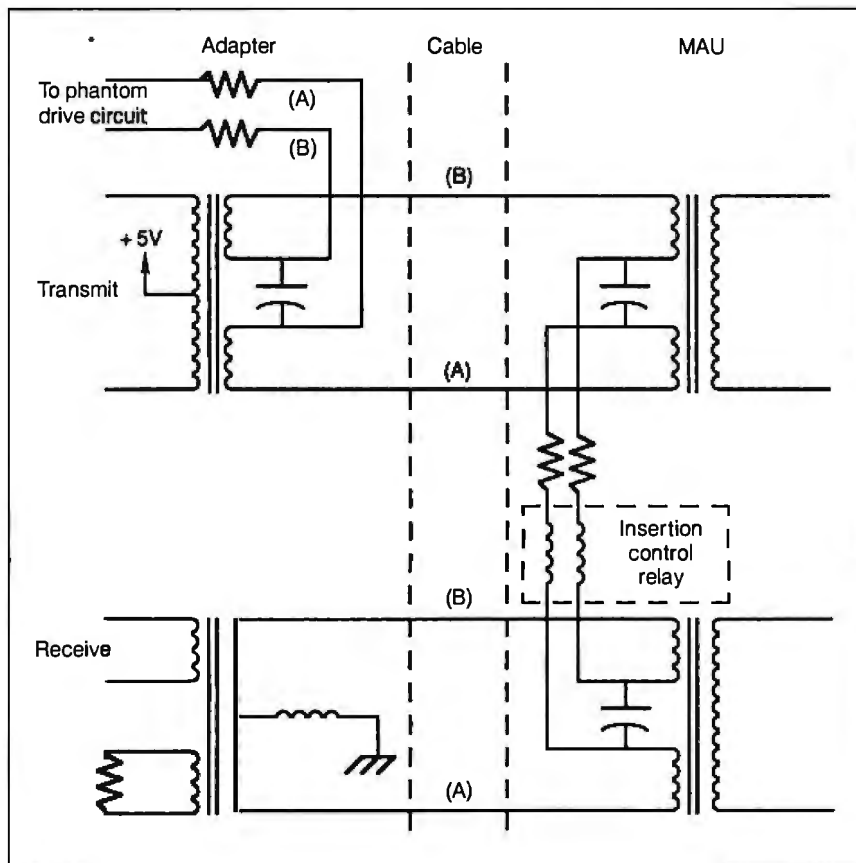

Figure 4: The "phantom circuit" is essential to ring maintenance. If a node is on a damaged section of the ring or if requested by the local-area-network management program, a node removes itself from the ring by removing its voltage from the circuit (deactivating the phantom circuit). The presence of too much or too little current in the phantom circuit indicates a wiring problem. (Figure courtesy of Texas Instruments.)

Encoding

The Token Ring uses differential Manchester encoding to transmit bits on the ring. Manchester encoding schemes are “self-clocking”—they attempt to guarantee enough up-and-down transitions in the incoming signal so that it’s easy to predict when the next transition is going to occur.

Manchester and differential Manchester encoding require that there be a transition in the middle of each bit. In Manchester encoding (see figure A), the direction of the midbit transition determines whether the bit was a 0 (high-to-low transition) or a 1 (low-to-high transition).

In differential Manchester encoding (see figure B), the bit is a 0 if a transition occurs at the beginning of the bit time and a 1 if there is no transition at the beginning. Differential Manchester encoding was chosen for the Token Ring because it is polarity-independent, making the Token Ring easier to wire. The transmit and receive pairs and the transformers that drive them can be connected without keeping track of “positive” and “negative” leads.

The Token Ring also uses Manchester code violations—occasional bits without transitions in the middle—to make delimiters completely unambiguous (see figure C). Besides 0 and 1, the Token Ring standard defines two “non-data” bits: J, a 1 bit without the middle transition, and K, a 0 bit without the middle transition.

When it’s not sending data, a node “idles”—usually by transmitting 0 bits continuously. This provides the downstream node with a large number of transitions with which it can synchronize its clocking circuits. In no case should a station ever transmit more than 5 consecutive half-bits without a transition. If a node does not see a transition on its input after 5 half-bit times, a “BURST5 Error” has taken place. The

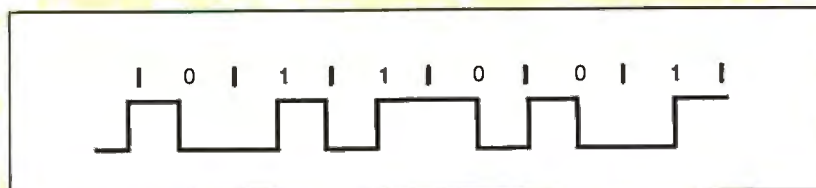

Figure A: Manchester encoding.

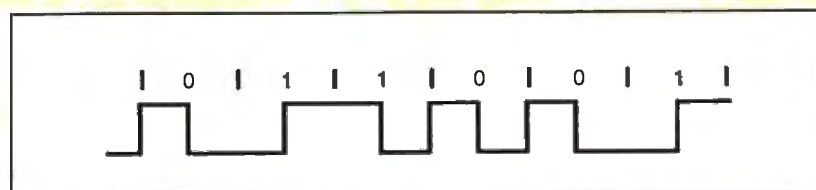

Figure B: Differential Manchester encoding.

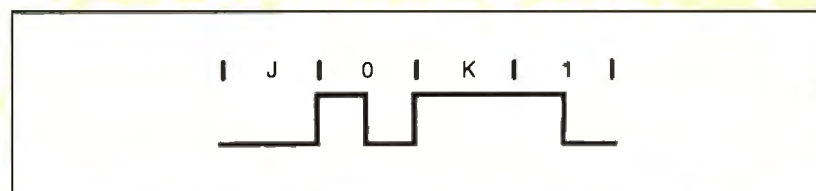

Figure C: Manchester code violations.

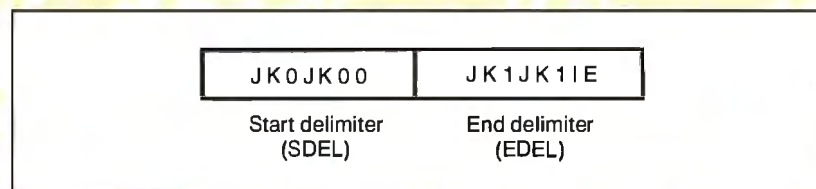

Figure D: The abort delimiter consists of a start delimiter and an end delimiter together.

node assumes that a serious ring problem has occurred and attempts to reestablish contact with its neighbors.

When the ring is idle, the stations on the ring continuously relay a token. A token consists of 3 bytes: a start delimiter, an access control field, and an end

delimiter (see figure D). The most-significant bit of each byte is transmitted first; this is the reverse of Ethernet, RS-232C, and most other serial communications standards. The start delimiter and end delimiter contain Manchester code violations (Js and Ks); this guaran-

up to 300 meters away from its MAU, while an Ethernet (without repeaters) can span 500 meters maximum.

The MAC Sublayer

Let’s examine the signals the Token Ring’s physical medium carries and the techniques used to arbitrate access to the ring: the media access (MAC) sublayer.

Data is transmitted on the ring using differential Manchester encoding (see

the text box “Encoding” above), typically at 4 megabits per second (IEEE will release a 16-Mbps Token Ring standard soon). When the ring is idle, the stations on the ring continuously relay a token (sometimes called a “free token”) to one another.

When a node that wishes to transmit receives a token, it examines the priority bits to make sure its message has a priority at least as large as that of the token. If

it does, it converts the token into a frame. Occasionally, a node will “decide” to abort a transmission in the middle. To do so, it sends an abort delimiter sequence, which consists of the start delimiter and the end delimiter together.

Addressing on the Token Ring

The IEEE 802.5 specification allows address sizes on the Token Ring. Besides a 6-byte address (the same length as in

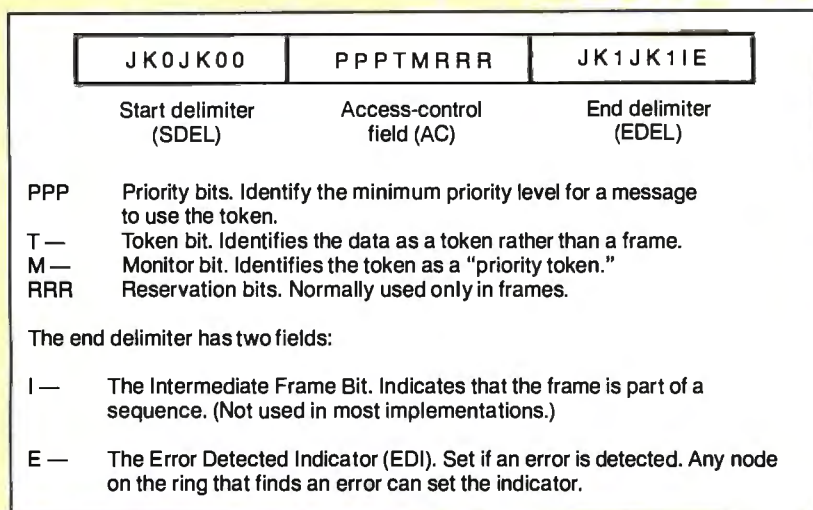

Figure E: Token format.

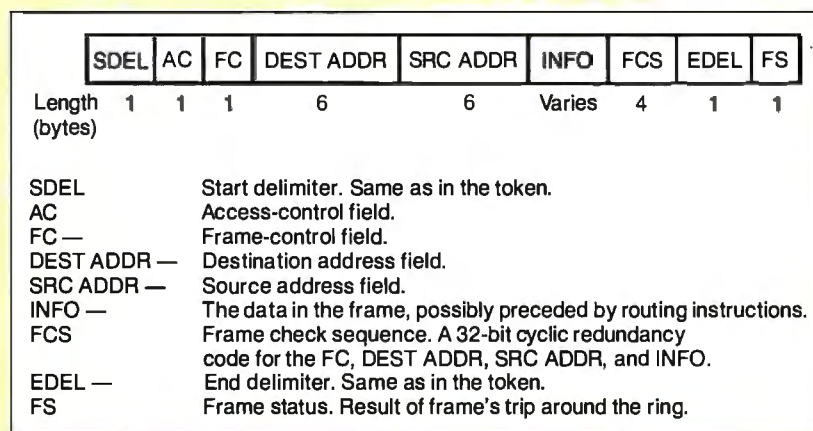

Figure F: Frame format.

tees that they will not be mistaken for ordinary data bytes.

When a node that wants to transmit receives a token, it changes the token into a frame, appending its address, the recipient's address, and the data (see figure E). The frame also contains a

frame-control field, a cyclic redundancy code, and a status byte.

In the event that a node needs to abort a transmission in the middle, it sends an abort delimiter sequence, which consists of the start delimiter and the end delimiter together (see figure F).

other IEEE standards), "short" 2-byte addresses are available for small networks.

The source address and destination address fields of a frame can do more than identify a single sender and recipient for the frame. The most significant bit of a source address is the routing information indicator, used when two or more rings are interconnected by nodes called bridges. When this bit is a 1, it indicates

that the frame will specify not only the address of the destination node, but also a route to it—possibly spanning several rings. This technique is called source routing. Because the route is already worked out, the job of a bridge is simple. All it needs to do is follow the sender's routing instructions, which are tacked onto the beginning of the INFO field.

Destination addresses also have bits and bit patterns with special signifi-

cance. It's possible to earmark frames for a server, a group of nodes, or all nodes (a broadcast address).

Functional addressing is a powerful feature built into every Token Ring adapter. By sending a frame to a functional address, a node can use network services—like a parameter server, an error monitor, or a network manager—without knowing the address of the nodes that provide those services to the ring.

The Active Monitor

So far, most of the features I've looked at assume that the ring is up and running properly. But what if something goes wrong? When you first bring the ring up, or when any malfunction requires reconfiguration, the nodes on the ring test their equipment and send signals to one another to identify their NAUNs.

The nodes select one node (normally the active node with the numerically largest address) as the active monitor. This node is designated to perform special "watchdog" functions. The process by which neighbors are identified and the active monitor is chosen is called "beaconing." Once the active monitor has been chosen, it clears the ring and issues a token to restart normal ring operation.

The most basic function of the active monitor is to provide a clocking signal for the Token Ring. All other stations on the ring "listen" to this signal and synchronize with it. (The active monitor uses its own crystal to clock the data it transmits.)

The active monitor's next responsibility is to ensure that a token is circulating on the ring. First, the active monitor has to make sure that the token "fits" on the ring by introducing a 24-bit shift register into the ring. (Each node is designed to incur a minimal delay, typically 1 to 2 bit times. The wiring of the ring may not have 24 bits of delay all by itself. If the signal travels on the ring at two-thirds the speed of light, the ring needs to be $\frac{2}{3} \times 3 \times 10^8$ meters/second \times 24 bits / $[4 \times 10^6$ bits/second] long, or at least 1200 meters long, for the wiring to delay the signal 24 bit times.)

The active monitor also watches for "lost tokens." If it does not see a frame or a token go by within any 10-millisecond period, it clears the ring and starts a new token circulating. These actions keep the token from being irretrievably lost if a station fails to retransmit it.

The active monitor checks for frames and priority tokens (tokens with a priority greater than 0) that circulate around the ring more than once. It does this by

continued

checking the setting of the monitor bit in the access control (AC) field of each token or frame it sees. If the active monitor receives a priority token or frame with the monitor bit cleared, it sets the bit as it passes on the information. If the token or frame returns when it should not, the active monitor will discover that the monitor bit is already set to 1, and it will immediately purge the ring of data and restart the token-passing process.

Finally, the active monitor must "re-

assure" the other stations on the ring that it is present and working. To do this, it broadcasts an active-monitor-present frame to the rest of the ring. If an AMP frame fails to circulate every so often, another station (the standby monitor) takes over the active monitor's job.

A Matter of Priority

On most other LANs, all nodes compete on an equal basis for use of the physical medium. For instance, there's no way

for an Ethernet station to say, "I have a very important message to send; please let me go next!" As an Ethernet gets crowded with traffic, it becomes likely that collisions, or just bad luck, will cause a delay of high-priority messages. We say that networks like the Ethernet are not "deterministic"—there's no upper bound on the amount of time it will take a node to gain access. In some situations, like sensitive control applications, the delays can be disastrous.

Some networks are deterministic but lack priority structures. ARCnet, which is a token-passing bus network, guarantees that each node can talk in turn, but the turns are always distributed evenly. There's no provision for getting an urgent message to its destination faster.

The Token Ring, however, has a unique scheme that provides for multiple priority levels and egalitarian, round-robin access on each level. The key to this scheme is the AC field present in each token or frame, which carries priority information and accepts "reservations" for the next use of the token.

After a station transmits a frame, it examines the AC field when the frame returns. If the reservation bits of the AC field contain a number greater than the priority level on which the station is currently transmitting, it means that one or more nodes wish to transmit at the higher priority as soon as possible. The sender emits a token with the higher priority. Since a station can use only a token that has a priority less than or equal to the priority of the frame that it wants to transmit, the token travels the ring until it reaches the station that urgently needs it.

Figure 5 shows an example of the Token Ring's reservation system at work. In the simple three-node ring shown, with nodes at 5, 7, and 12 o'clock, station 5 is transmitting. Station 7 would normally use the token next, followed by station 12. But since station 12 has an urgent message to transmit, it changes the reservation field at the beginning of station 5's frame. Station 5 honors the reservation, emitting a priority token that station 7 cannot use.

Once station 12 is through transmitting and the frame has completed its circle, station 12 strips its frame from the ring and passes the priority token onward. The priority token completes its loop (being used in turn by any other nodes having urgent messages) until it returns back to station 5 (which originated the priority token). Station 5 then demotes the token to a lower priority and gives station 7 its turn.

continued

KILL 8051 BUGS FAST.

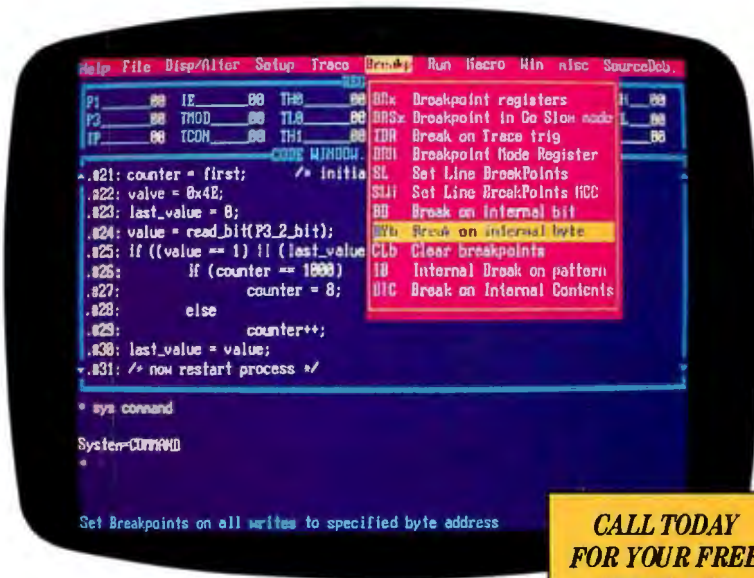

**CALL TODAY
FOR YOUR FREE
VIDEO AND
SOFTWARE DEMO.
(408) 866-1820**

Nohau's EMUL51-PC emulator and trace board make a sophisticated bug-hunting pair for your 8031/8051 projects. Plug the EMUL51-PC into your PC, XT, AT or compatible and find bugs that other emulators can't. Our powerful software makes it a snap to use.

- Source Level Debugging for PL/M-51 and C-51
- 48 bits wide 16K deep trace buffer
- 20 MHz real-time emulation
- Complete 8051 Family support including proliferation chips
- Available in either "Plug-in" or "Box" configurations

WORLDWIDE CALL:

Austria	02 22 38 76 38-0
Australia	02 654 1873
Benelux	+31-1858-16133
Denmark	02 65 81 11
France	01 69 412 801
Great Britain	01 464 2586
Israel	03 499034
Korea	04 784 7841
Portugal	01 83 56 70
Scandinavia	+46 40 922425
Spain	03 217 2340
Switzerland	01 740 41 05
West Germany	08 131 16 87



The EMUL51-PC comes with a 5-ft. cable, software and 1 year hardware warranty with free software updates. Trace board optional.

NOHAU
CORPORATION

51 E. Campbell Ave.
Campbell CA 95008
(408) 866-1820

FORMS-TYPER: THE ONE FOR PRE-PRINTED FORMS

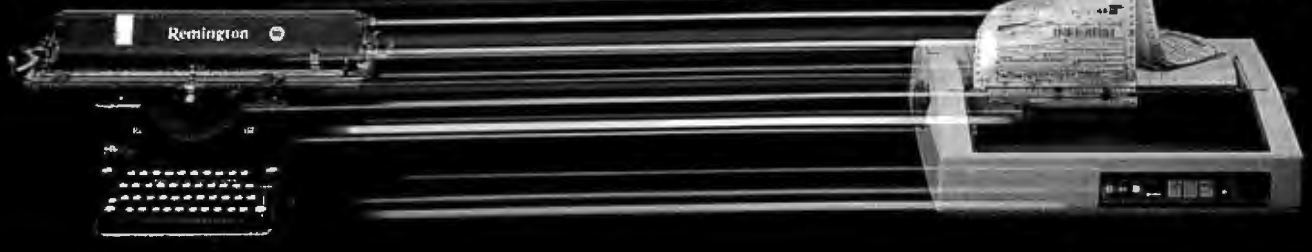

DOES FOR FORMS WHAT WORD-PROCESSING DID FOR DOCUMENTS

TYPE PRE-PRINTED FORMS WITH THE SPEED OF A WORD-PROCESSOR.

FORMS-TYPER gives you all the speed, ease, and neatness of a word-processor with pre-printed forms. If you have ever tried using a word-processing program to fill in forms you know they cannot handle the precise alignment requirements of tax forms, insurance forms, Medicare forms, etc.

FILL-IN-THE-BLANK DATA ENTRY LETS ANY TYPIST PRODUCE PERFECT PRE-PRINTED FORMS EVERY TIME.

You no longer have to tediously align your typewriter on each blank. Just enter the information field by field directly onto your PC screen. You can also include instructions describing the information to enter in each field, so even an inexperienced typist can produce accurate, neat forms the first time.

REVIEW THE INPUT AND CORRECT ANY ERRORS BEFORE YOU PRINT EXPENSIVE FORMS.

CHANGES AND REPRINTING CAN BE DONE IN SECONDS.

Never retype an entire form over again when you need one change or correction made. All your information is stored away in files that can be retrieved to make changes for reprinting (Just like word-processing).

DEFINE THE LAYOUT OF ANY FORM IN MINUTES WITHOUT USING CUMBERSOME TEMPLATES, INACCURATE GRID COORDINATES, OR MEASURING OF ANY KIND.

Defining a form is easy because FORMS-TYPER's unique Typewriter Mode allows you to control your printer just like a typewriter. Simply insert the form in the printer and align it. Move the printhead to each blank using the arrow keys and type "x's" on the form for the maximum length of each field. This "teaches" the program exactly where the field is and how large it is. In addition to the field name you can include a detailed description of the field and instructions to help inexperienced typists fill in the form. Defining the layout takes about as much time as it would to type the form one last time.

EASILY MATCH ANY NON-STANDARD SPACING WITH MICRO-ADJUST CAPABILITY.

Other forms programs and word-processors are inadequate for pre-printed forms since most forms use non-standard spacing. FORMS-TYPER adjusts the print position by as little as 1/10th of a character so each field prints exactly where you want.

SPECIAL TYPEWRITER MODE LETS YOU ADD COMMENTS ANYWHERE ON A FORM.

Turns your PC into a typewriter so that you can add information to the form as desired at any location.

PERFORM CALCULATIONS AND CONDITIONAL PRINT FUNCTIONS.

For example, if you enter an "x" in the Overnight Priority Box on a waybill you can specify that if this condition is met, a fixed or calculated amount will be printed in the "Total" field.

FORMS-TYPER CONTAINS PRE-BUILT FORM DEFINITIONS FOR WAYBILLS USED BY MAJOR CARRIERS.

These pre-built forms let you jump right into FORMS-TYPER and see just how easy it is to use. Samples provided are: Federal Express, Delta Dash, Emery, Purolator, Quickpak Worldwide, Express Mail, American Airlines, Eastern, United, US Air, Continental, Yellow Freight, Carolina, Consolidated and Greyhound.

Requirements

Printers: NEC 3500, 8800, IBM Quietwriter, Diablo/Xerox 630, C-ITOI Starwriter F10. Call for other daisy wheel printers.
Memory: 384K
DOS Level: 2.0 or higher
Note: 360K drives need 10 MB hard disk

FORMS-TYPER ORDER FORM		
Send me () FORMS-TYPER for \$99.95 • \$7.00 Shipping & Handling Texas Residents add 8% Sales Tax. Add \$15.00 for Overseas Orders.		
() 5 1/4" 360K Disks	() 5 1/4" 1.2 MB	() 3 1/2" Disks
PAYMENT: () Check or Money Order () Master Card () Visa		
Card #	Exp. Date	
Card Holder Name _____		
Ship To Name _____		
Address _____		
City, State, Zip _____		
Telephone _____		

To Order, mail coupon or call, 713/688-2894.

Universal Computer Consulting, Inc.
3724 Dacoma
Houston, Texas 77092

The Token Ring priority system has some especially nice properties. First, the priority of the token is always restored by the same node that raised it. Thus, a request for a high-priority token does not destroy the round-robin scheme on a lower level.

Second, it can recursively nest on all eight possible priority levels. Suppose, for instance, that station 5, from the previous example, had placed a reservation for priority level 6 while station 12 was transmitting (see figure 6). Station 12 would elevate the priority of the token exactly as station 5 did and allow it to circulate. Station 12 would then restore the priority to 3. Station 5, in turn, would restore the priority of the token to 0 again.

You can now see why the active monitor watches for recirculating priority tokens. Since each station that raises the priority of a token is responsible for low-

ering it again, a recirculating priority token indicates that a node has malfunctioned.

This scenario demonstrates only two levels of nested priority, not the most complicated (seven-level) case. But no matter how deeply priorities are nested, the result is the same: Round-robin order is maintained on each level, and the next node to transmit is always the one with the highest priority. These orderly and evenhanded procedures for selecting the next node to transmit pay off especially well under heavy loads. When many nodes contend for use of the network, a 4-Mbps Token Ring can perform nearly as well as a 10-Mbps Ethernet, while a 16-Mbps Token Ring can provide more than double the throughput.

I've already discussed one way in which faulty equipment can be removed from the Token Ring: the phantom cir-

cuit. Nodes that don't pass a thorough self test verifying that they can communicate properly with the rest of the ring remove themselves from the network. A more subtle feature, however, is the Token Ring's ability to localize intermittent faults and noisy links.

As you may recall, each node examines every token or frame it sees and sets the error-detected indicator if it detects any errors. The error-tracking process does not stop there. Each node maintains an internal count of how many times it set the EDI. Network management software can access this counter. If there is an intermittent or noisy path in a Token Ring network, the system can always track it down to a specific stretch of cable (a "failure domain") by determining which node is just downstream.

In certain cases, it's also possible to

continued

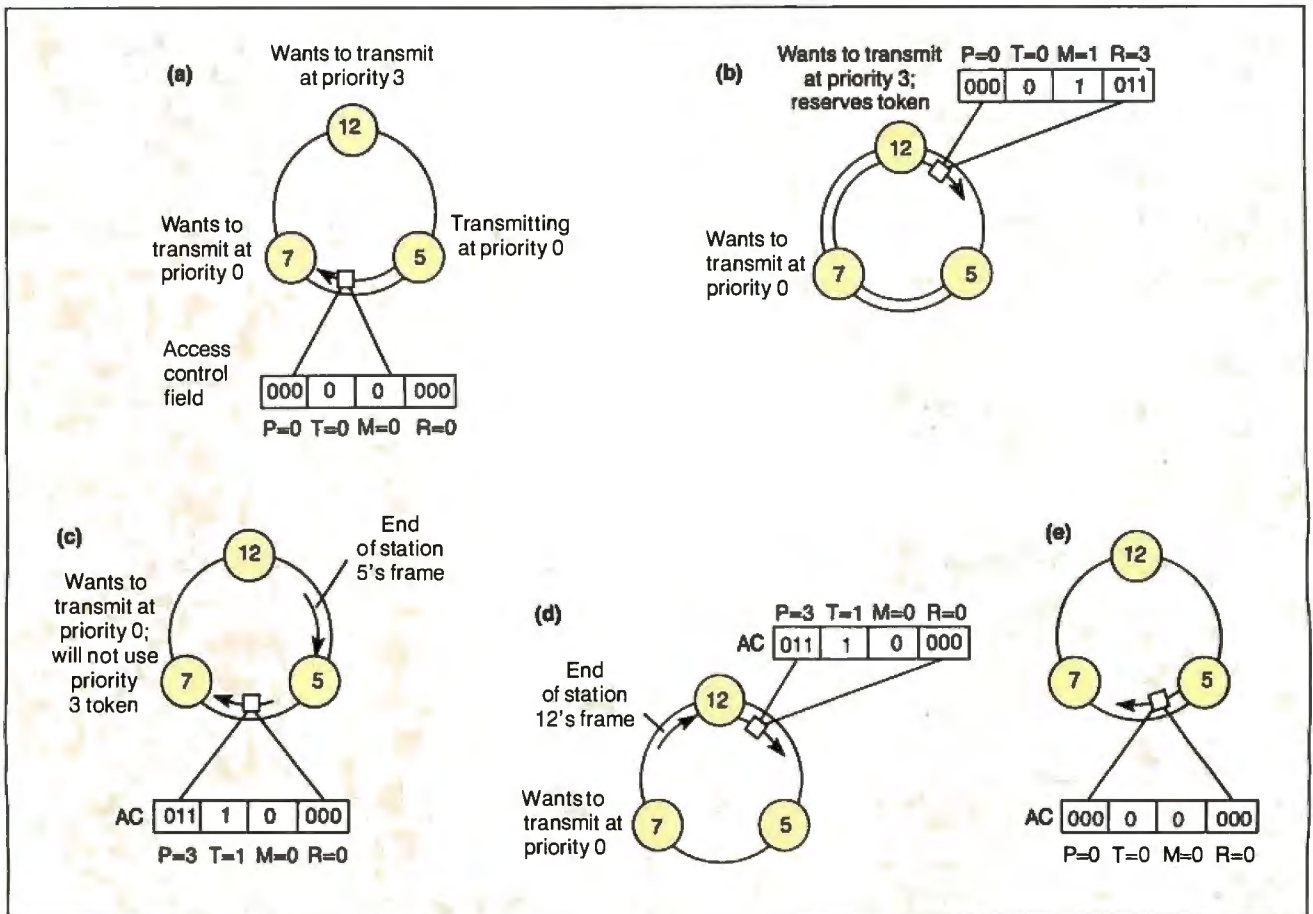

Figure 5: Placing a reservation. (a) Station 5 is transmitting a frame to station 7 on the ring. Normally, station 7 would be the next node to get the token, even though station 12 had a higher-priority frame to transmit. (b) Station 12 sees that the reservation field of the frame is less than 3 and places a 3 there. The frame continues back to station 5, which absorbs the frame and emits a token. (c) The token emitted by station 5 had priority 3, so station 7 does not use it. The token continues on to station 12, which uses the token to transmit a frame. (d) When station 12 has finished transmitting, it releases a token, still at priority level 3. (e) Station 5 receives a token at priority level 3 and "remembers" that it was the one to raise the priority of the token. It therefore restores the priority to 0 so that station 7 will have a chance to transmit.

Figure 6: If, in figure 5, station 5 had placed a reservation for priority level 6 while station 12 was transmitting, station 12 would elevate the priority of the token, allow it to circulate, then restore the priority to 3. Station 5, in turn, would restore the priority of the token to 0 again.

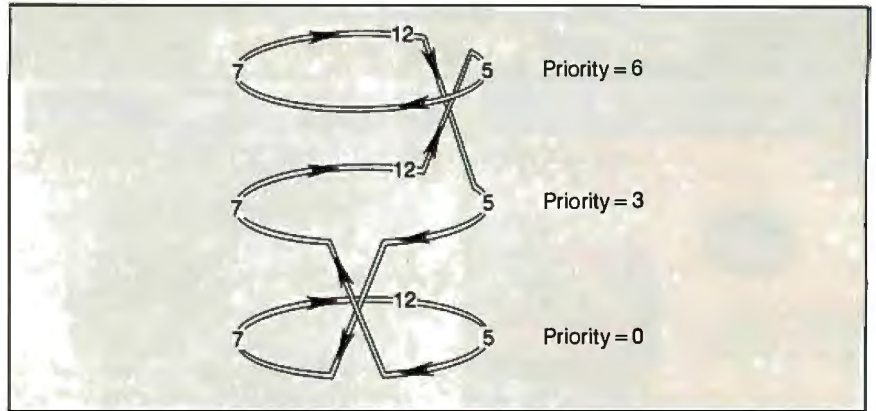

Figure 7: The Token Ring can reconfigure itself to bypass shorts or breaks in a cable. In this diagram, the ring continues to function despite a cable break between MAU 3 and MAU 4.

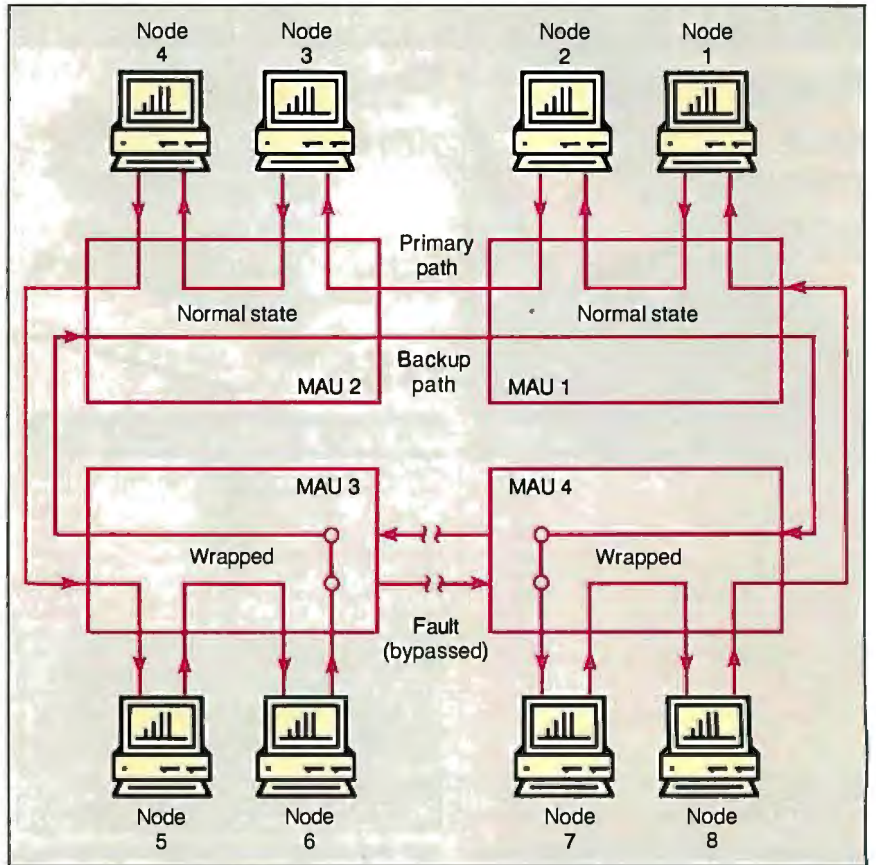
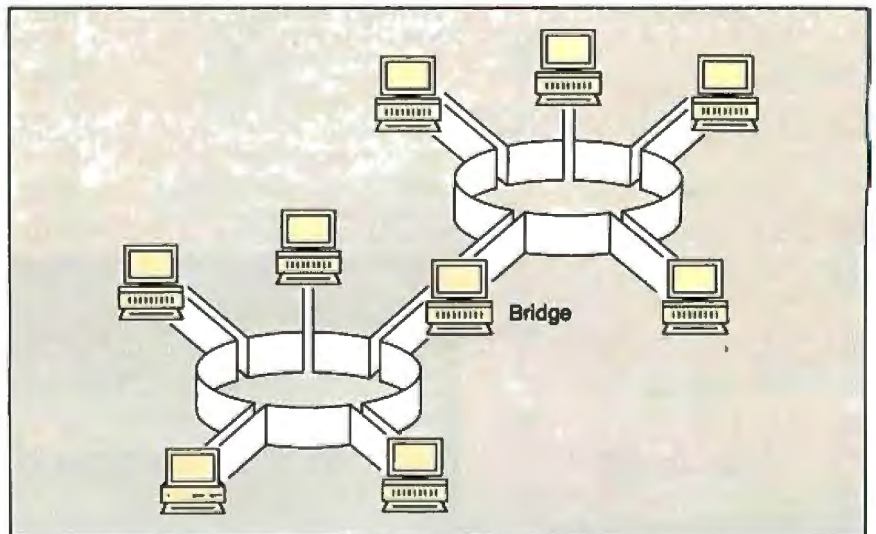

Figure 8: A Token Ring bridge, a node that is on two rings at the same time and can pass frames from one ring to the other. (Figure courtesy of IBM Corp.)



VAX Power - PC Price!

If you need or are accustomed to the throughput of a 32-bit mini, including any of DEC's VAX series, MicroWay has great news for you. The combination of our NDP compilers and our mW1167 numeric coprocessor gives VAX speed to your 386 PC! If you don't own a 386 PC, we provide a number of powerful PC and AT upgrade paths.

MicroWay offers transputer based parallel processing boards and languages for the PC, AT, or 386. Each T800 RISC processor on these boards packs the power of a 20 MHz 386/1167. A Quadputer, with four T800s, boasts 40MIPS/6 megaflops of throughput.

Many NDP Fortran-386 users are reporting turnaround times that are two to six times faster than their VAX. They are a function of the VAX processor being used, the speed of the 386, the number of users served by the VAX, and the coprocessor being used with the 386.

32-Bit Compilers and Tools

NDP Fortran-386™ and NDP C-386™ Compilers generate globally optimized, mainframe quality code. Both run in 386 protected mode under Phar Lap extended MS-DOS, UNIX, or XENIX. The memory model employed uses 2 segments, each of which can be up to 4 gigabytes. They generate code for the 80287, 80387, or mW1167. Both include high speed EGA graphics extensions written in C that perform BASIC-like screen operations.

- **NDP Fortran-386™** Full implementation of FORTRAN-77 with Berkeley 4.2, VAX/VMS and Fortran-66 extensions. \$595
- **NDP C-386™** Full implementation of AT&T's PCC with MS and ANSI extensions. . . . \$595

NDP Package Pricing:

387FastPAK: NDP Compiler, Phar Lap and 80387 Coprocessor 16 MHz: \$1299
20 MHz: \$1499

1167FastPAK: NDP Compiler, Phar Lap and mW1167 Coprocessor 16 MHz: \$1695
20 MHz: \$2295

Phar Lap Development Tools \$495
Virtual Memory Extension \$295

NDP Windows™ — NDP Windows includes 80 functions that let you create, store, and recall menus and windows. It works with NDP C-386 and drives all the popular graphics adapters: Library: \$125, C Source: \$250

NDP Plot™ — Calcomp compatible plot package that is callable from NDP Fortran. It includes drivers for the most popular plotters and printers and works with CGA, Hercules, EGA and VGA. \$325

NDP/FFT™ — Includes 40 fast running, hand coded algorithms for single and double dimensioned FFTs which take advantage of the 32-bit addressing of the 386 or your hard disk. Callable from NDP Fortran with mW1167 and 80387 support. \$250
387FFT for 16-bit compilers. \$250

HALO 88 to NDP Graphics Interface — This module enables you to call graphics routines in HALO 88 from NDP Fortran or C. \$100

Dr. Robert Atwell, leading defense scientist, calculates that NDP Fortran-386 is saving him \$12,000 per month in rentals of VAX hardware and software while doubling his productivity!

Fred Ziegler of AspenTech in Cambridge, Mass. reports, "I ported 900,000 lines of Fortran source in two weeks without a single problem!" Aspen Tech's Chemical Modeling System is in use on mainframes worldwide and is probably the largest application to ever run on an Intel processor.

Dr. Jerry Ginsberg of Georgia Tech reports, "My problems run a factor of six faster using NDP Fortran-386 on an mW1167 equipped 386/20 than they do on my MicroVAX II."

Our NDP compilers and NDP utilities are the key to taking advantage of the two to five-fold increase in speed that the mW1167 provides. The compilers generate mainframe style code, while our utilities simplify ports from either the PC or the mainframe world. A new utility enables our NDP compilers to call HALO 88.

If you are curious about the benefits of the NDP/mW1167 approach, consider the following (price estimates are for complete systems):

Coprocessor	Speed (Flops)	Price
80287-10	80,000	\$3,000
80387-20	440,000	\$5,000
mW1167-20	2,100,000	\$6,000

When driven by a 32-bit compiler, the mW1167 approaches the speed of a \$600,000 VAX 8650! In fact, many of our users have reported increases in turnaround of 2 to 4 times that of their VAX! Call us for complete details.

MicroWay® 80386 Support (508) 746-7341

Parallel Processing

Monoputer 2™

The world's most popular PC transputer development product now extends the memory available for developing transputer applications from 2 to 16 megabytes. The board now features a DMA bus interface for fast I/O. Monoputer 2, an ideal platform for porting mainframe Fortran or C code, provides the speed of a 386/20 for 20% of the cost!

Monoputer 2 with T414 (0 MB) \$995
Monoputer 2 with T800 (0 MB) \$1495

Quadputer™

This board for the XT, AT, or 386 can be purchased with 2, 3 or 4 transputers and 1, 4 or 8 megabytes of memory per transputer. Two or more Quadputers can be linked together to build networks with mainframe power which use up to 100 or more transputers. One customer's application has gone from 8 hours on a mainframe to 16 minutes on a system containing five Quadputers. from \$3495

Transputer Compilers and Applications

MicroWay offers Parallel languages for the Monoputer and Quadputer.

Logical Systems Parallel C \$595
MicroWay Occam2 \$495
3L Parallel C \$895
3L Parallel Fortran \$895
MicroWay Prolog Interpreter \$750
Microfield - Finite element analysis . . \$1600
ParaSoft: Parallel Environment \$300
Performance Monitor \$200
C Source Level Debugger \$300
T800/NAG™ (See NDP/NAG) \$2750

387BASIC™ — Our 16-bit MS compatible compiler introduces numeric register variables to produce the fastest running 80x87 code on the market. \$249

Compaq 386/20/25 Add-Ons

RAMpak™ — One megabyte 32-bit memory module fits in Compaq memory slot . . . CALL mW1167™ is built at MicroWay using Weitek components and includes an 80387 socket.
mW1167-16 \$995
mW1167-20 \$1595
mW1167 Microchannel-16 \$1295
mW1167 Microchannel-20 \$1595
Weitek 3167-25 \$2495
80387-20 \$595
80387-25 \$695

Numeric Coprocessors

8087 \$99
8087-2 \$145
80287-8 \$239
80287-10 \$279
80387-16 \$425
80387-16SX \$450
80387-20 \$595
80387-25 \$695
287Turbo-12 (for AT compatibles) . . . \$450
256K 100ns DRAM \$13
256K SIMMS \$119
1 MB SIMMS \$450
(All of our Intel coprocessors include 87Test.)

Intelligent Serial Controllers

MicroWay's AT4™, AT8™, and AT16™, the fastest intelligent serial controllers, run in AT, 80386 and PS/2 PCs. They come with drivers for UNIX, XENIX, and PC MOS.
AT4 . . . \$795 **AT8** . . . \$995 **AT16** . . . \$1295

32-Bit Applications

PSTAT-386 — Popular mainframe statistics package. The full version was ported. . . \$1495

NDP/NAG™ — Features a library of 268 engineering and scientific numerical algorithms. Callable from NDP or 3L Fortran. \$895

12 MHz PC Accelerators

FastCACHE-286 12 MHz \$299
SuperCACHE-286 12 MHz \$399
FastCACHE-286 9 MHz \$199

MicroWay

World Leader in PC Numerics

P.O. Box 79, Kingston, MA 02364 USA (508) 746-7341
32 High St., Kingston-Upon-Thames, U.K., 01-541-5466
USA FAX 617-934-2414 Australia 02-439-8400 Germany 069-75-1428

bypass a run of cable that has been completely destroyed. Look at figure 7 and notice the backup path. When two or more MAUs are connected in a ring, this path goes unused, because the ring goes in one end of each MAU and out the other.

But suppose that, for some reason, one of the cables connecting the MAUs into a ring fails. To get the ring up and running again, all you need to do is to remove the failed cable from both MAUs, allowing the backup path, which runs through all the MAUs, to complete the loop. Voilà! The ring is up and running again. If the MAU is an "intelligent wiring center" (IBM doesn't make one, but Proteon and other vendors do), you may not even need to remove the cable. The network management software is able to reroute the ring without any human intervention whatsoever.

Bridges and Backbones

A bridge is a node that is on two rings at the same time and is able to pass frames from one ring to the other. Figure 8 shows a simple bridge. Figure 9 shows multiple rings bridged to a backbone

ring. In large installations, a backbone ring connects many rings to each other. It consists of a series of bridges, each connecting a local ring to the backbone.

NetBIOS and the Token Ring

Originally, the IBM NetBIOS (see my article "Understanding NetBIOS" on page 301) had to handle many of the same functions that the Token Ring provides. The firmware present on most Token Ring adapters (the LLC sublayer) orders packets and ensures their delivery. Therefore, the NetBIOS API (Application Program Interface) is provided by a NetBIOS emulator.

Despite the extra layer of interface, the Token Ring card usually performs better than the original IBM PC Network.

Token Ring Chip Sets

As of this writing, three chip sets implement the Token Ring architecture. The two produced by IBM and Ungermann-Bass are proprietary and not available to the general public. The third, the Texas Instruments TMS380, is available to all who wish to build an interface to the Token Ring.

The TMS380 chip set consists of five parts. The two Ring Interface chips (TMS38051/52) contain the analog components to interface to the ring. The Protocol Handler (TMS38020/21) manages the bit-level ring protocols.

The Communications Processor (TMS38010) contains a 16-bit microprocessor and 2.75K bytes of RAM; it executes firmware (co-developed by Texas Instruments and IBM) from a ROM in the Protocol Handler. The System Interface (TMS38030) connects the whole package to a Motorola or an Intel microprocessor bus.

We can expect the chip set to shrink to two chips soon, and to a single chip eventually. IBM uses its proprietary chip set on the PC and PS/2 Token Ring cards, but it uses the Texas Instruments chip set on the Token Ring adapter for the RT. This is a good indication that the two implementations are compatible.

As this article went to press, the IEEE 802.5 committee was finalizing the text of the standard for the 16-Mbps Token Ring, and IBM released new dual-speed (4-/16-Mbps) Token Ring adapters. In-

continued

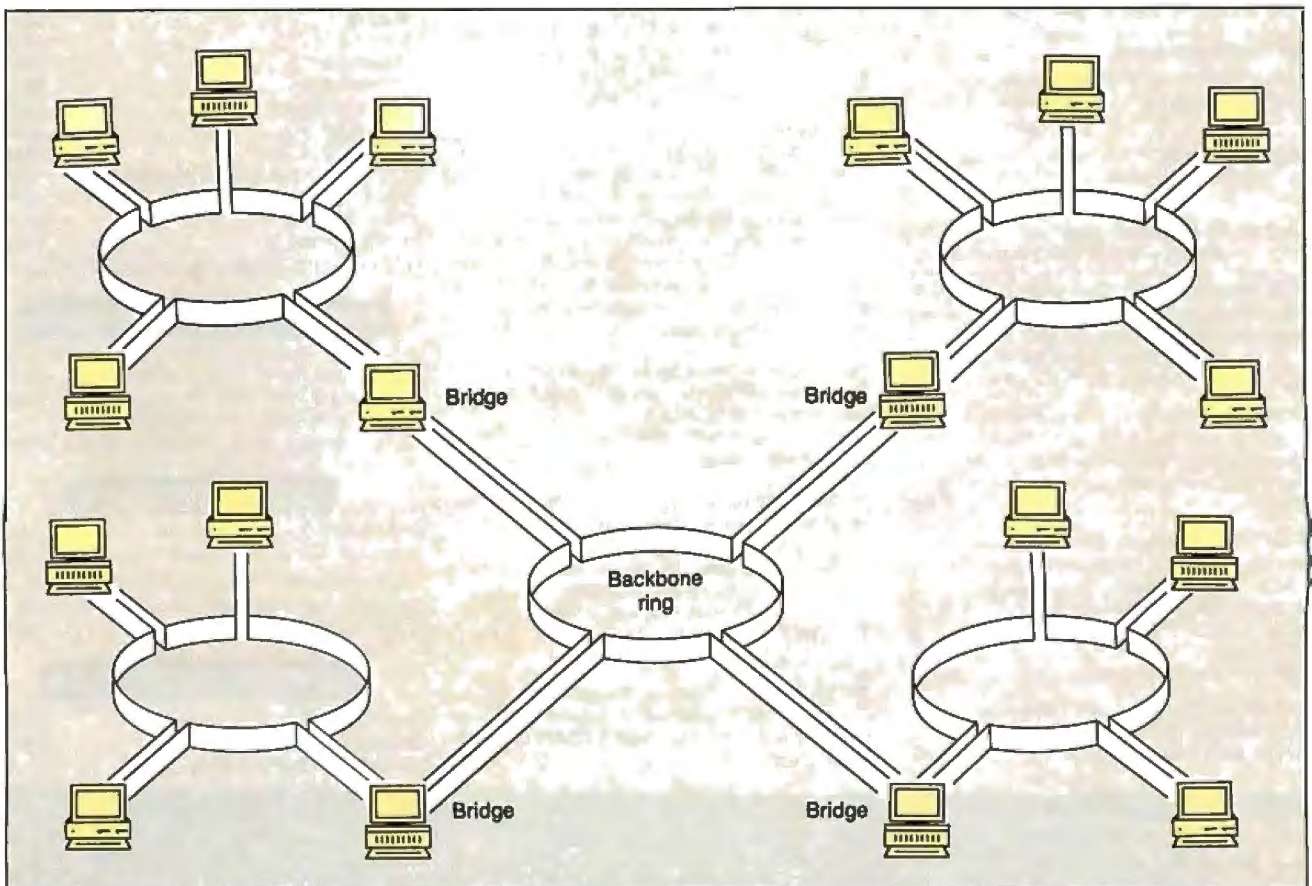

Figure 9: A backbone ring consists of a series of bridges in a ring, each connecting a peripheral ring to the backbone.

SAVE 15% ON MCGRAW-HILL COMPUTER BOOKS AND SOFTWARE

INTRODUCING PC-DOS AND MS-DOS

By T. Sheldon. 374 pp., illus., softbound Find out about the free advanced capabilities of DOS and how to use them. "Wonderfully enlightening. . . well-written. . . my pick for technical book of the year." — *Online Review* 056559-7.

Regular Price: \$24.95

Your Price: \$21.20.

EGA/VGA: A Programmer's Reference Guide

By B. Kliewer. 269 pp, softbound The first to detail technical aspects of the new IBM Enhanced Graphics Adapter and Virtual Graphics Display—how to design programs for these leading graphics standards. 035089-2

Regular Price: \$24.95

Your Price: \$21.20.

HOW TO BE A SUCCESSFUL COMPUTER CONSULTANT

By A.R. Simon. 256 pp., illus., softbound Everything you have to know to set up and run your own computer consultant (or software development) business, full- or part-time. No business experience required! 057296-8.

Regular Price: \$19.95.

Your Price: \$16.95.

A COMPREHENSIVE GUIDE TO AI AND EXPERT SYSTEMS

By R.I. Levine, D.E. Drang, & B. Edelson. 256 pp., 99 illus., softbound All about artificial intelligence and how to utilize it on your personal computer. Gives you everything from basic concepts to sophisticated programming techniques. 037470-8.

Regular Price: \$22.95

Your Price: \$19.50

Also available in a TURBO PASCAL Edition! This new edition shows you how to apply AI programming techniques to create expert systems in TURBO PASCAL for your own use. 037476-8.

Regular Price: \$19.95

Your Price: \$16.95.

INTRODUCING UNIX™ SYSTEM V

By R. Morgan & H. McGilton. 480 pp., illus., softbound Guides you step by step through the facilities, commands, utilities, and applications of System V, AT&T's new version of the UNIX operating system. 043152-3.

Regular Price: \$24.95

Your Price: \$21.20

UNIX™ UTILITIES:

A Programmer's Guide

By R.S. Tare. 640 pp., illus., softbound Save time and effort with popular UNIX utilities! Helps you write efficient, bug-free programs and significantly reduce turnaround time. 062884-X

Regular Price \$24.95

Your Price: \$21.20

DATABASE EXPERT'S GUIDE TO DATA-BASE2

By B. Larson. 442 pp. The first to provide in-depth coverage and instruction in Database2 for programmers, database administrators and others with mainframe database experience. Make sure you're ready by IBM's conversion date of 1992!

Hardcover: 036488-5 Regular Price: \$39.95 **Your Price: \$33.95**

Softcover: 023267-9 Regular Price \$24.95 **Your Price: \$21.20.**

DATABASE EXPERT'S GUIDE TO SQL

By Frank Lusardi. 224 pp. This user-friendly guide provides programmers and managers with a thorough introduction to Structured Query Language (SQL) and relational database concepts. It describes the language's constructs and guides you through complex syntactical possibilities, while emphasizing SQL's practical use in designing and implementing databases.

Hardcover 039006-1 Regular Price: \$39.95 **Your Price: \$33.95.**

Softcover 039002-9 Regular Price: \$24.95 **Your Price: \$21.20.**

MICROEXPERT SOFTWARE

By B. Thompson & W. Thompson. Your own expert system! This affordable expert system shell allows you (beginner or programmer) to see how a system works as you build it yourself.

Creation includes tutorial for design of knowledge base and creation of rules. Source code provided. "Highly recommended," *Online Today*.

IBM PC 852109-2 Regular Price: \$64.95 **Your Price: \$55.20.**

Apple II 852110-6 Regular Price: \$54.95 **Your Price: \$46.70.**

HARD DISK MANAGEMENT IN THE PC & MS DOS ENVIRONMENT

By Thomas Sheldon. 224 pp., illustrated. This guide for organizing and managing a hard disk system gives procedures needed to build a menu system and directory structure.

Softcover 056556-2 Regular Price: \$24.95 **Your Price: \$21.20.**

FOR FAST SERVICE CALL 1-800-2-MCGRAW OR MAIL THIS COUPON
Prices subject to change without notice.

McGraw-Hill Publishing Company
P.O. Box 400, Hightstown, NJ 08520

15-DAY FREE EXAMINATION

Please send me — at 15% off the regular price — the products whose code numbers (the number before the regular price in above advertisement) I have checked below. I understand I have 15 days for free examination before I send payment for those titles I want to keep (plus postage, handling, and local tax) and return any unwanted products postpaid.

- | | | |
|---|---|---|
| <input type="checkbox"/> 056559-7 \$21.20 | <input type="checkbox"/> 043152-3 \$21.20 | <input type="checkbox"/> 039002-9 \$21.20 |
| <input type="checkbox"/> 035089-2 \$21.20 | <input type="checkbox"/> 062884-x \$21.20 | <input type="checkbox"/> 852109-2 \$55.20 |
| <input type="checkbox"/> 057296-8 \$16.95 | <input type="checkbox"/> 036488-5 \$33.95 | <input type="checkbox"/> 852110-6 \$46.70 |
| <input type="checkbox"/> 037470-8 \$19.50 | <input type="checkbox"/> 023267-9 \$21.20 | <input type="checkbox"/> 056556-2 \$21.20 |
| <input type="checkbox"/> 037476-8 \$16.95 | <input type="checkbox"/> 039006-1 \$33.95 | |

Name _____

Address _____

City _____ State _____ Zip _____



23-F229-5000-1

Protects while you type!

- Remains In Place while you use your computer.
- Avoids Costly Repairs. Protects delicate electronics from dust, spills, smoke, ashes, staples.
- Soft. Flexible, retains normal keyboard feel.
- Washable, Durable High-Tech Polymer lasts years.
- Hundreds of Models. SafeSkin is available for most PCs, laptops, workstations and clone keyboards.
- Office • Home • Factory • Classroom • Laboratory

List Price \$29.95. Please call or write for free color brochure. Dealer inquiries encouraged.

SafeSkin™

Keyboard Protector

Merritt Computer Products, Inc./4561 S. Westmoreland
Dallas, Texas 75237/(214) 339-0753 • Fax (214) 339-1313

Compact Disk Products, Inc.

CD-ROM/WORM

ALL PRODUCTS, LOWEST PRICES, EXPERT ADVICE

INTRODUCTORY OFFERS

- Each \$695 or \$895 (CD-ROM Drive with your choice of:
- NEW Programmer's Reference Library (Microsoft) . . . \$995
 - McGraw Hill Science and Technical Reference Set . . . \$920
 - Grolier Electronic Encyclopedia . . . \$995
 - Microsoft Bookshelf or PCGS Library . . . \$895

CD-ROM SOFTWARE

- | | | |
|--|-----|--------|
| Oxford English Dictionary | NEW | \$945 |
| Comstock Stock Photography Cn CD | NEW | \$445 |
| Educorp Public Domain/Shareware for the Mac | NEW | \$179 |
| The New Grolier Electronic Encyclopedia | | \$359 |
| McGraw Hill or Bookshelf or PCGS (Add \$25 for McGraw) | | \$269 |
| The Bible Library | | \$495 |
| Kirk-Othmer Encyclopedia of Chemical Technology | | \$945 |
| Registry of Mass Spectral Data | | \$2655 |
| Geovision U.S. Atlas and Mapmaker | | \$795 |

TOLL FREE ORDER LINE • 800-MEGABYTE (634-2296)

CD-ROM and WORM DRIVES

- | | |
|--|--------|
| Hitachi 1503S External CD-ROM Drive with Audio | \$729 |
| 1503S with Digital Audio Output | \$1229 |
| Hitachi 3500S Internal 1/2 Height CD-ROM Drive w/Audio | \$749 |
| NEC Intersect CD-ROM Drives for the Apple/Mac | CALL |
| Mextor 800 MB WORM Drive | \$3899 |
| Dptotech Laserbank 400 MB WORM Drive | \$2799 |

CD-Play (\$69) Pop-up utility that permits user to play all audio CDs on Hitachi and compatible drives. Output to headphones or amplifier.

CD-PlaySampler (\$149) Same features as CD-Play plus the ability to name two points on an audio CD and loop between them.

CD-AudioFile (\$149) Automatically creates database records of all your audio CDs. Allows you to store a preferred play sequence for each disk. Automatic recognition of CDs. Creates DBase compatible records.

CDP
Compact Disk Products
223 E. 85th St.
New York, NY 10028
Tel 212-737-8400
Fax 212-439-9109
CompuServe 75530214

Free 3 Month
Subscription to
CD-ROM Review
with orders over
\$300

**INTERNATIONAL ORDERS
A SPECIALTY**
Australian Agent: KEWIE
145 Cosham Rd.
Kew, Victoria 3101
Tel. (03) 817-5833

corporated in the new boards is Early Token Release, which lets more than one frame (but only one free token) occupy the ring at one time. A proposal that may be adopted soon describes dual rings that rotate in opposite directions and merge to form a single ring if a cable fails. This feature is supported by Proteon but not by IBM.

An Animated Demonstration

This article has covered much of what there is to know about the Token Ring. For those readers who want to learn more or who want a graphical explanation, I've saved a fun and interesting surprise for last. The marketing folk at IBM's Research Triangle Park facility have developed a freely redistributable animated presentation on the Token Ring that will run on any IBM PC with a CGA.

First, download the file TOKN-DEMO.ARC from the BIX listings file area "FROMBYTE88." (Warning: It's almost 180K bytes long.) Use PKXARC to unpack it onto a formatted floppy disk. Make the floppy disk the logged drive and type AUTOEXEC. You'll see a wonderful interactive demonstration of tokens running around rings, changing into frames with messages, shifting priorities, and vaporizing mysteriously. (Watch out for the mischievous starship *Enterprise!* The demonstration software uses a special technique to produce up to 20 simultaneous colors on an IBM CGA and isn't guaranteed to work with all EGA or VGA implementations. However, you should still be able to follow the demonstration (perhaps sans some of the brilliant colors) on almost any compatible system. Have fun! ■

Many thanks to Leon Adams and Leslie Price of Texas Instruments for providing vital materials for this article. Thanks also to IBM for use of diagrams and the Token Ring interactive demonstration.

BIBLIOGRAPHY

LAN Primer (RTC Support Tool). Dallas: Texas Instruments, 1987.

The IBM Token-Ring Network Decision, 2nd ed. Armonk, NY: IBM, 1986.

TMS380 Adapter Chipset User's Guide. Dallas: Texas Instruments, 1986.

TMS380 Adapter Chipset User's Guide Supplement. Dallas: Texas Instruments, 1987.

We welcome your response to this column. You can contact Brett Glass c/o BYTE, One Phoenix Mill Lane, Peterborough, NH 03458. You can also contact him as "glass" on BIX.

The shortest distance between two points. Pro-C.™



System design

Finished application

The C source code applications generator.

At last, the distance between system design and final application is shorter than ever before. Pro-C maximizes your productivity by creating commercial applications in C source code.

Pro-C quickly generates well-structured, fully-commented C code the way you would write it. This allows you to concentrate on systems design instead of wasting time repeatedly rewriting code. Plus, Pro-C can also be used as a powerful prototyping tool that readily converts system design into clean, professional code.

Learning to use Pro-C is simple: Menu guide you through every step, and context-sensitive help is always available. Pro-C quickly generates source code for screen programs, reports, menus, and multi-file updates, as well as concise system documentation and context-sensitive help.

PC Tech Journal applauded the power of Pro-C in a recent review: "The generated C code is excellent, including many comments and the type of functional organization that a good programmer would choose. . . Pro-C excels at what it was designed for."

Pro-C is the only source code generator that runs under the MS-DOS™, QNX™, XENIX™ and UNIX™ operating systems. Unlike most 4GL's, Pro-C doesn't require a run time environment—increasing performance without royalty fees.

For added flexibility, a separate product, Pro-C Workbench™, provides the C source code for over 60 Pro-C library routines that can be modified to your requirements.

Pro-C code is optimized for a variety of compilers, including Microsoft™ C V5.0 and later, Quick C V1.0, Turbo C® V1.0 and later, Lattice® C V3.2, and Zortech™ V2.05.

Pro-C: Beyond programmer productivity tools Eliminate repetitive programming. Streamline application development. Achieve maximum productivity.

Order Pro-C today. Call (800) 265-2682.

For information on corporate purchases, call Chris Finnegan at (519) 745-2700.



VESTRONIX

ALLEN SQUARE 180 KING STREET SOUTH SUITE 230
WATERLOO, ONTARIO, CANADA N2J 1P8 (519) 745-2700

ADDITIONAL LOCATIONS: UNITED KINGDOM 01-790-2424
GERMANY 6155-6008-0 JAPAN 03-407-8561

MS-DOS & Microsoft are registered trademarks of Microsoft Corp. UNIX is a trademark of AT&T Bell Laboratories. Turbo C is a registered trademark of Borland International. QNX is a trademark of Quantum Software Systems Ltd. Lattice is a registered trademark of Lattice, Inc. Zortech is a trademark of Zortech, Inc.

Circle 290 on Reader Service Card

JANUARY 1989 • B Y T E 377

WANT To Know A Secret?



“My Daddy says file-Pro is the best DataBase Management System and so do over 300,000 other people. He must be right, he helped to create filePro 11 years ago.”

filePro is the software of choice in FORTUNE 1000 companies, government, thousands of businesses, and VAR's worldwide. The choice is simple when you want portability, a powerful development environment, a fast and efficient database engine and significant productivity when developing applications.

Yet, with all these customers and **file-Pro's** capabilities, we wondered why **filePro** wasn't as well known

as some other DataBase Management Systems. We found out that we had to tell more people about **filePro**, but calling all of you on the phone would take too long. So we decided to let you try **filePro** yourself.

Key Features:

- Total Portability from single-user to multi-user to networks. DOS to XENIX® to UNIX® to ULTRIX®.
- Full Screen Editor; Fast, Easy Layout for Screens & Reports.
- Development Environment, Powerful & flexible - great productivity.
- Relational Database Management System.
- Report Writer: Fast prototyping, and flexibility.
- Award Winning Manual - covers everything filePro offers - cover to cover.

...And Many More Features that will excite you.

“Small Is Better”



The Small Computer Company, Inc.
41 Saw Mill River Road, Hawthorne, NY 10532
(914) 769-3160

XENIX is a registered trademark of Microsoft. UNIX is a registered trademark of AT&T. ULTRIX is a registered trademark of Digital Equipment.

Clip coupon and send check or use your credit card. If you decide to buy **filePro** we'll reimburse the cost of the demo system.

Yes! Let me in on the secret!

Please send me a complete **filePro** demonstration system for only \$50.00.

Name _____

Phone _____

My Name: _____

Address _____

City _____ State _____ Zip _____

Credit Card: MC VISA # _____

Check Enclosed Expiration Date: ___/___/___

DOS: _____ 386 XENIX _____
(Hardware) (Hardware)

UNIX: _____ 286 XENIX _____
(Hardware) (Hardware)

Your Demonstration System will be shipped within 3 weeks upon receipt of your order.



TREES 'N KEYS, Part 1

Keyed file systems can help unlock the data you've got stored in humongous databases

We have stepped into the era of big disks; I mean *big* disks. Not 2½ years ago, a full-height 10-megabyte hard disk drive was a respectable piece of hardware. Nowadays, you'd be lucky to find one in a flea market. A 20-megabyte half-height drive is now the *minimum* mass storage device a serious purchaser of microcomputers will settle for; and even so, the 20-megabyte hard disk drives are fast fading behind hedges of 40- and 80-megabyte drives. A better-than-100-megabyte hard disk drive is no longer something you hear about, it's something you've got your eye on for when the price comes down to within arm's reach of your budget. Then there's the gluttonous promise of optical storage.

This portends not only thousands of files stored in the space that once held only 360K bytes, but also the proliferation of large files—files holding megabytes' worth of information. Of course, as wonderful as it is to have the capacity for such giant databases, the very size of the files makes retrieving information from them that much tougher (read: takes longer).

Disk drive manufacturers can help some: They can reduce seek time, provide caching on the disk, and so on. Adding more buffers to your operating-system's file management handling can help, too, but there's a limit to what all this caching and buffering can do. You can stretch that limit considerably if you work on the structure of your data, not just how you retrieve it.

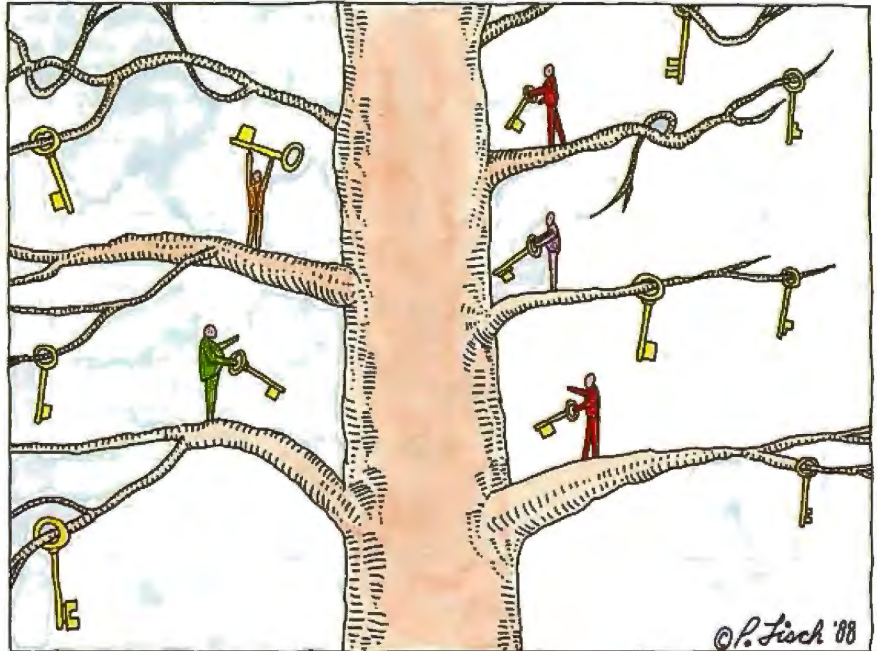

Keyed Files

I'll start the discussion of keyed file systems (KFSes) with an analogy: a drawer full of manila folders—the kinds with the raised tabs. Each folder holds several pages' worth of information on a customer. When you open the drawer, you're faced with an orderly arrangement of alphabetized customer names. So, when your boss swoops into your office unannounced for the latest lowdown on a given account, you can be in and out of the drawer with the goods in a matter of seconds.

In this analogy, the drawer is the database, consisting of two parts: The tabs represent the key file, and the papers within each folder represent the data file. The information on a given tab is referred to as a *key* (hence the term *key file*), a unique pointer to the information (the papers) associated with that key. The primary function of a KFS is similar to that of the drawer example: You give the database a key, and the program re-

turns the information associated with that key.

Figure 1 graphically represents a simple KFS. Each entry in the key file is composed of a key and a data pointer. The data pointer indicates an offset into the data file where the record attached to the given key is located. So, in this example, we can see that Henry Carls lives at 100 South Park Ave.

Applications of KFSes are often similar to the uses of a filing cabinet: A database of sales history records might be keyed by client name or salesperson; a school enrollment database might have a data file of student information keyed by social security numbers; a general-ledger database might contain transactions keyed by ledger account numbers.

Of course, a KFS has some advantages over a filing cabinet; otherwise, we'd all pick manila folders over microcomputers when it came time to build a database. The two most critical assets are speed

continued

(you want to locate a customer's data from a list of 10,000 names in seconds rather than minutes) and the ability to handle *large* databases: Hundreds of thousands of records should not strain the KFS. I'll address the issue of speed first; the issue of database size gets taken care of in the process.

Trees

Based on the premise that the most important job of a KFS is locating keys, a good bet is that the KFS will spend the lion's share of its time handling searches in the key file. I'm assuming that the data pointer associated with a key is contiguous with the key, so once the key is found, retrieving that data requires only one disk access. Drawing from the analo-

gy of a sudden request from the boss, the KFS will have no foreknowledge of which key a user might request.

This means that you have to be careful about choosing the means by which the key file is maintained. Storing keys in a hodgepodge won't work at all, since searching for a key would require, on the average, that the system examine half the keys. You might try storing the keys as a huge, sorted, one-dimensional array, but that means that every time you add a new key, the system has to shift piles of keys around to make a "hole" at the proper place in the list for the new entry (a process known as *insertion sorting*). A singly linked or doubly linked sorted list (described in next month's column) solves the insertion problem, but then

you have to come up with some mechanism to guarantee that the program won't have to perform a disk access every time a key is examined (looking for a key in a 5000-entry file would take an average of 2500 seeks).

The key files used by the system that I present here are stored using a B-tree data structure. The B-tree is often confused with the binary tree, but actually the B-tree is a step up in sophistication. All the algorithms I'll use for managing the B-trees have corresponding algorithms in binary trees. I picked the B-tree structure because of its elegance and because it provides speed when used with a large database. Many professional database packages use variants of the B-tree data structure; Btrieve (SoftCraft, Austin, Texas) and db_File (Raima Corp., Bellevue, Washington) come immediately to mind.

Examine the binary tree shown in figure 2. Notice that each entry in the file contains a key field and a data pointer, as in figure 1. Now, however, I've flanked each key and data pointer with two *key-node pointers*. Each unit—consisting of a key, data pointer, and left and right node pointers—is referred to as a *node*.

Moving from any node through its left node pointer, you go "down" the tree to nodes with keys that are lexicographically less; following the right node pointer, you move to nodes with keys greater than the current key. (Note: For the remainder of this article, I'll simply say "less" or "greater" when comparing one key to another. The system I present here stores keys based on string comparisons, but you can easily modify it to store keys based on numerical comparisons.)

Figure 3 shows a B-tree key file. Now each node holds multiple keys—four, in this example. As in the binary-tree example, the pointer to the left of a key points to nodes with lesser keys, and the pointer to the right of a key points to nodes with greater keys.

Let's say that you want to search a file of 100 entries in a binary tree for a specific key. By beginning at the root and determining whether your search item is less or greater than the key in the root node, you can eliminate half of the tree (unless you're lucky and the sought-after key is in the root). You've eliminated 50 keys from a search of 100 keys. Moving down a level and examining the next node again eliminates half: 25 keys remain for the routine to sift through. The third search reduces the number to 12, and the process continues. If your desired key lies on the bottommost level,

continued

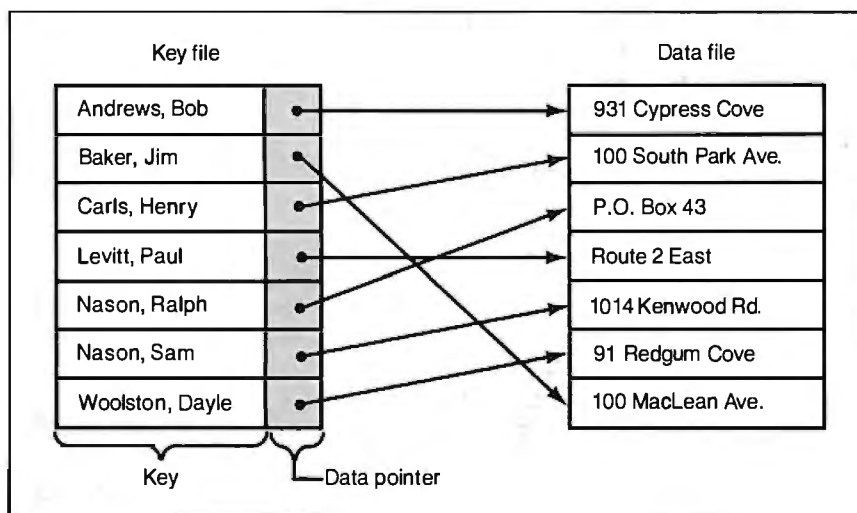

Figure 1: A super-simple KFS. The key file holds keys and attached data pointers. Each data pointer is an offset into the data file where the associated data is located.

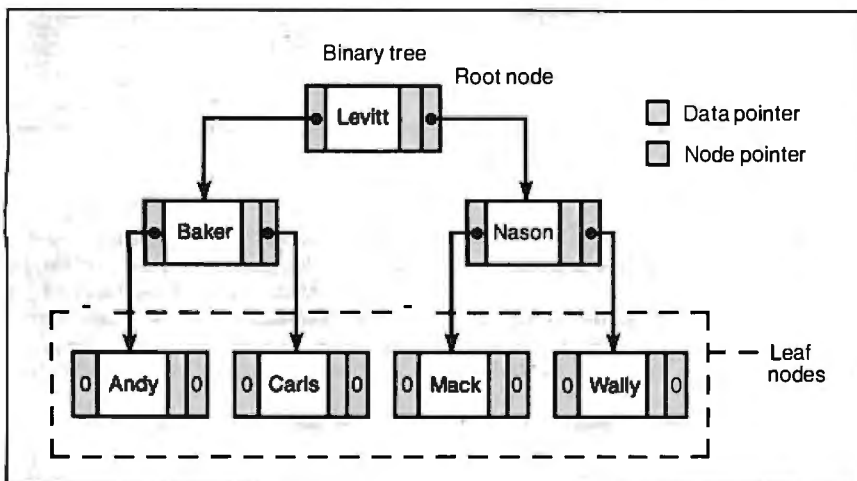
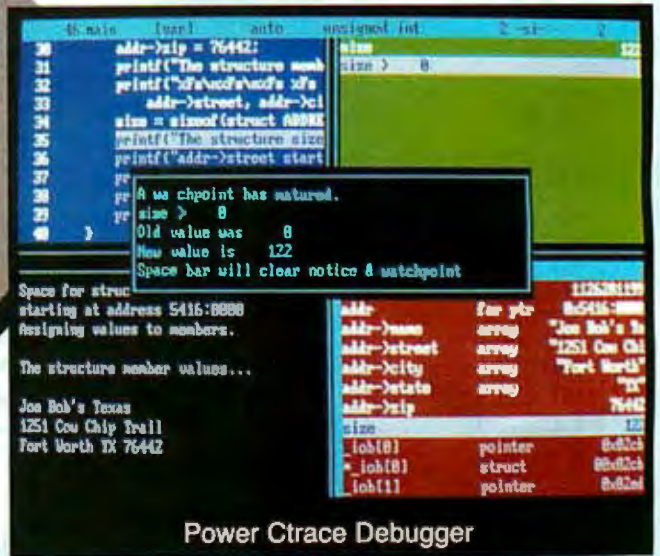

Figure 2: A binary tree. The search for a particular key begins on the root node. Key-node pointers, flanking the key and its associated data pointer, point "down" the tree to other key nodes.

Power

Incredible Value!

Don't take our word for it, take theirs...



"Do you know what the underground bargain C compiler of this year is? It's the Mix Power C compiler. For under \$25 with shipping, it is one heck of a good compiler."

Victor Schneider
Dr. Dobb's Journal, June 88 (Letter to the editor)

"Overall, Power C's performance is remarkable for the price. Quite compatible with the Microsoft C and Turbo C 'standards', Power C is a heavyweight contender in the educational, hobbyist, and perhaps even the professional market — at a bantamweight price."

Stephen Davis
PC Magazine, September 13, 88 (Review)

"Power C is an unbelievable product for \$19.95, and is very competitive with Turbo C, Microsoft C, and Microsoft's new Quick C in both features and performance. It is excellent for the beginner who wants to learn C, or for the experienced programmer who wants to develop professional applications. The manual alone is worth the price of this package, and the generous library source code and assembler offer adds to the value of it. If you have any desire to program in C, or want a more powerful C compiler, get a copy of Power C!"

Michael Cortese
Computer Shopper, August 88 (Review)

"The Ctrace debugger is where Mix really shines. It is magnificent. It's not only better than the stripped down debugger Microsoft includes with Quick C, it's better than the full debugger Microsoft provides with its high-end compiler (Codeview)."

David Weinberger
Computer Shopper, November 88 (Review)

Circle 186 on Reader Service Card



Technical Specifications

Power C includes: Power C compiler with integrated Make, Power C Linker, Power C Libraries (450 functions), the Power C book (680 pages), and support for...

- ANSI standard
- IEEE floating point
- 8087/80287 coprocessor
- auto-sensing of 8087/80287
- automatic register variables
- unlimited program size
- mixed model (near & far pointers)
- graphics on CGA, EGA, VGA, & Hercules

Optional Products:

- Power Ctrace debugger
- Library source code
- BCD business math

Order now by calling our toll free number or mail the coupon to Mix Software, 1132 Commerce Drive, Richardson, TX 75081.

1-800-333-0330

For technical support call: 1-214-783-6001
Minimum System Requirements:
DOS 2.0 or later, 320K memory, 2 floppy drives or hard drive.
Runs on IBM PC, XT, AT, PS/2 and compatibles.

60 day money back guarantee

Name _____
Street _____
City _____
State _____ Zip _____
Telephone _____

Paying by: Money Order Check
 Visa MC AX Discover

Card # _____
Card Expiration Date _____

Computer Name _____ Disk Size 5¼" 3½"

Product(s) (Not Copy Protected)

Power C compiler (\$19.95) \$ _____
 Power Ctrace debugger (\$19.95) \$ _____
 Library Source Code (\$10.00) \$ _____
(includes assembler & library manager)
 BCD Business Math (\$10.00) \$ _____

Add Shipping (\$5 USA - \$20 Foreign) \$ _____
Texas Residents add 8% Sales Tax \$ _____
Total amount of your order \$ _____

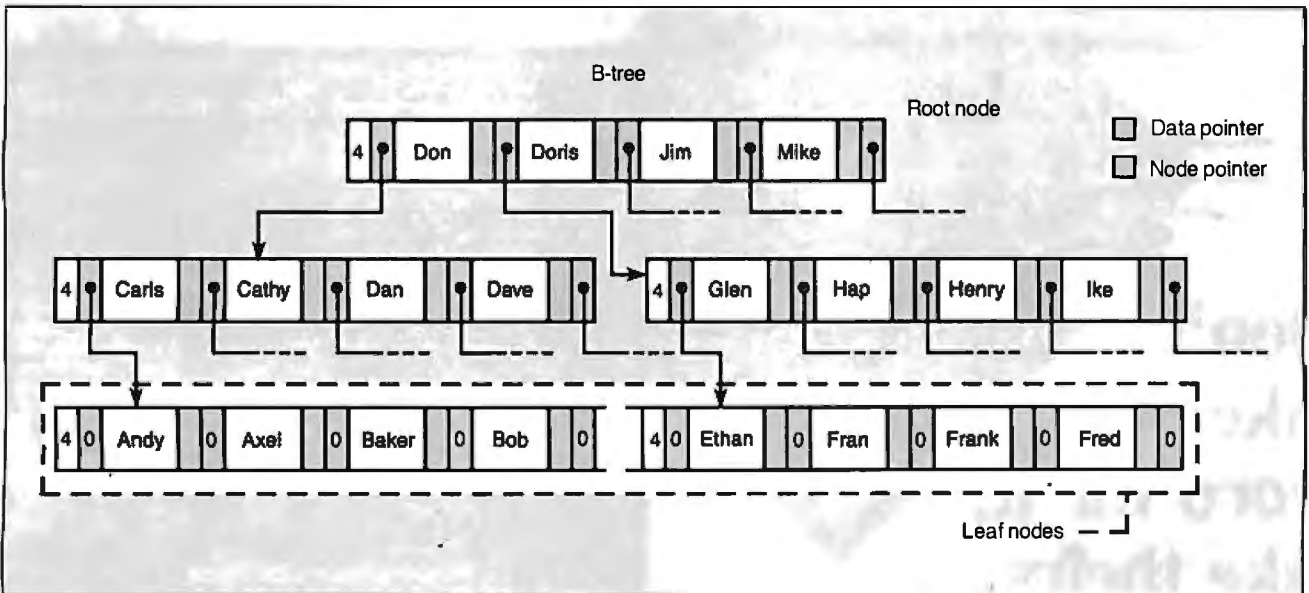

Figure 3: A B-tree of order 4. Now, each node holds multiple keys. (Note the dashed-line key pointers leading to nodes not shown.)

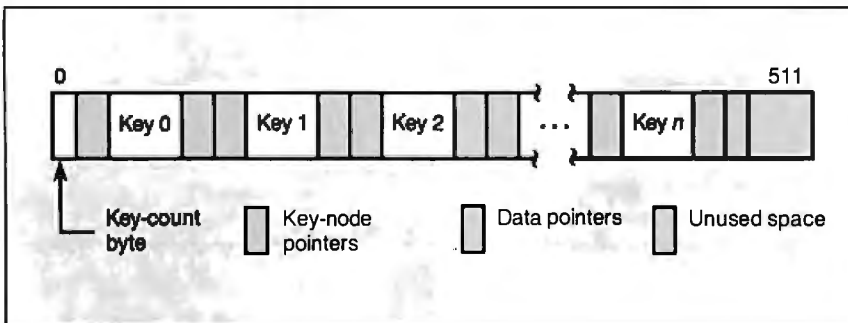

Figure 4: Format of a B-tree node. The node's length is deliberately set to 512 bytes, the usual size of a physical disk sector. The unused space at the right end of the node varies depending on key length (constant for a given key file) and the number of keys on the node.

Table 1: The first sector of the key file is reserved by the KFS software; it holds descriptive information about the file (e.g., how many keys are currently in it, and the key length). This information is held in the first 10 bytes of the sector. You might want to expand this system to hold such information as the date the file was created, when it was last updated, or the name of its associated data file (if any).

No. of bytes	Variable name	Description
1	KFTYPE	Type of key file; "K" = standard file (i.e., a data file is attached); "O" = key-only file (i.e., no data file is attached).
3	NOKEYSL/NOKEYSH	Number of keys in the file.
2	KAVSEC	First record on available list.
2	NXKYSC	Next free key sector.
1	KEYLEN	Key length.
1	MAXKS	Maximum keys per sector.

you will have examined a total of six nodes, the worst-case search of a balanced binary tree of this size.

Now store the same 100 keys in a B-tree structure with 4 keys per node (a B-tree of order 4). Again, begin the search by examining the root node; this divides the keys into five equal-size partitions. The first search reduces the number of keys you'll have to examine in the next step to 20. Dropping to the appropriate node down on the next level and searching it reduces the search by a factor of 5 a second time. Now you have narrowed the search to 4 keys. At the third level, you'll locate your target. The worst-case search examines only three nodes for a B-tree of order 4 with 100 keys stored in the tree. (Again, in this example, I've put the target key on a leaf node.)

You can see that a B-tree gains an even greater advantage when you align the nodes to disk sectors and fill the node with keys. (This is how my B-tree system works; a key node and a key sector refer to the same thing, and a single disk-read operation pulls an entire node into memory.) For a large file of 10,000 keys, a balanced binary tree requires a worst case of 14 seeks to find a key, while a B-tree of order 4 needs only 7 seeks, and a B-tree of order 10 needs only 5. (For more statistics, a 1,000,000-key file stored in binary-tree fashion requires 20 seeks maximum, a B-tree of order 4 takes 10, and a B-tree of order 10 takes only 7. I'm assuming all nodes are full in these examples.)

continued

NEW
Release

Well, almost everyone prefers MICROSTAT-II



If you like using statistics packages that require a couple of dozen disks and a manual that reads like a Ph.D. dissertation, you probably won't like Microstat-II. On the other hand, if you need an easy-to-use statistics package that lets you start solving problems five minutes after it's installed, Microstat-II is your answer.

Whether you use statistics to support your spreadsheet work and reports, pure research, or anything in between, Microstat-II Rel. 1.5 has the features and performance you demand:

Ease of Use. Microstat-II uses an *intuitive menuing system* for program selection. There is no complex command language to learn or expensive training costs to pay. You'll do more work faster with Microstat-II because it takes fewer keystrokes to accomplish a given task. Fewer keystrokes means faster results and fewer mistakes.

Speed. Microstat-II processes your data up to *eight times faster* than competing packages - even faster with a math chip.

And we gain this speed advantage without any loss of accuracy.

Coverage. Whether you use simple descriptive statistics or Stepwise multiple regression, nonparametrics or ANOVA, we have the procedures you need.

Compatibility. Creating data files is a snap and you can import ASCII, DIF, and dBase files into Microstat-II. Results can be saved as ASCII files for easy incorporation into your reports.

Microstat-II runs on an IBM PC, XT, AT or compatible with 512K of memory, two floppy disks or a hard disk. The package price is \$395.00. If you're still not convinced, try a demo disk for \$19.95 (credited towards purchase).

We are so sure that you'll like Microstat-II, we offer a 30 day money back guarantee. Contact your software dealer or give us a call. (If you already own Microstat-II Rel. 1.0, call for details on free update!)

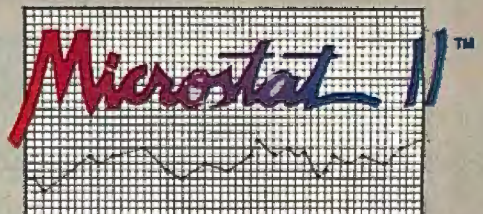

Ecosoft Inc.

6413 N. College Ave.

Indianapolis, IN 46220

1-800-952-0472 • FAX: 317-251-4604

Trademarks: Microstat-II - Ecosoft Inc. IBM PC, XT, AT - International Business Machines.
Registered Trademarks: IBM - International Business Machines.

ECOSOFT

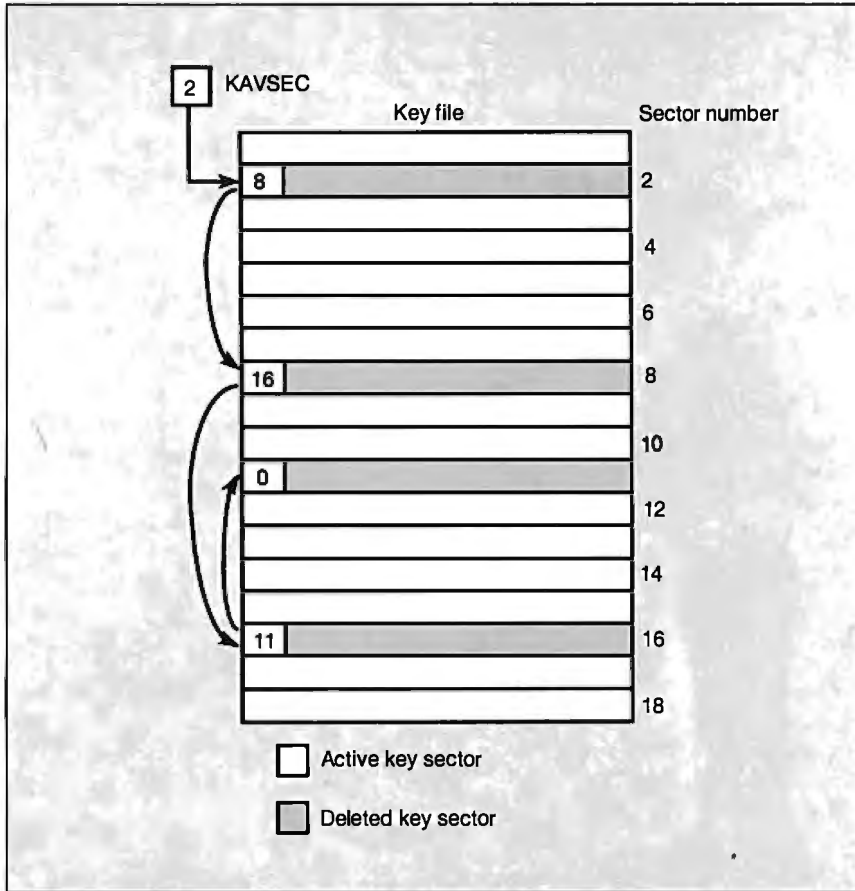

The Structure of the Structure

The structure of a key node for my B-tree system is shown in figure 4. The first byte of each node indicates the current number of keys in that node. This field is followed by the key and data-pointer substructure that is bracketed by key-node pointers. In a key file, all keys will be kept to a fixed length by either padding or truncating (alphanumeric keys are usually padded on the right with blanks or nulls). Each key-node pointer is a 16-bit quantity indicating a sector number. I'll talk later about the data-file structure; for now, all you need to know is that the data pointer is a 24-bit quantity that references a record in a data file.

As keys are added to and removed from the node, the key-count byte is incremented and decremented. The node itself has a fixed size of 512 bytes (the size of a typical MS-DOS disk sector). Since keys can be from 1 to 64 bytes, there will usually be some unused bytes near the end of the node. (I arrived at the 64-byte maximum through my own experience. This accommodates nearly every application of keyed files you can come up with. As usual, the source code is available, so if you don't like that maximum, you can change it.) The advantages of the B-tree scheme make it worthwhile to tolerate such wasted data space.

When it opens a key file, the KFS management software must know some details about the B-tree before it can perform any functions with the file. Since searches always begin at the root, it has to know which sector the root node is on. It has to know how many bytes long the keys are, and what the next available sector number is so that new nodes can be added. All this information is stored in sector 0 (see table 1).

Finally, the system has to be able to delete keys (I'll go into that algorithm next month). So it's possible that all keys could be deleted from a given sector. When this happens, that sector is placed on an *available list*—a chain of records free for use, as shown in figure 5. Use of the available list stabilizes the size of the file as keys are added and removed.

Having defined the structure of the B-tree, I'll describe how to use it, beginning with the routine for locating a key.

Finding That Key

As you've seen in the examples, the search process begins at the root. The real workhorse is SCANKEY (its pseudocode is in listing 1). SCANKEY manipulates an imaginary roving marker (composed of the pair CURRENT_KEY_SECTOR

continued

Figure 5: When all keys are deleted from a key node, that node is placed on a singly linked list of available nodes, the available list. The variable KAVSEC points to the first sector of this list. The next time a new key node is needed, the software picks the lead node off the available list—8, in this case—instead of extending the file by using sector 19.

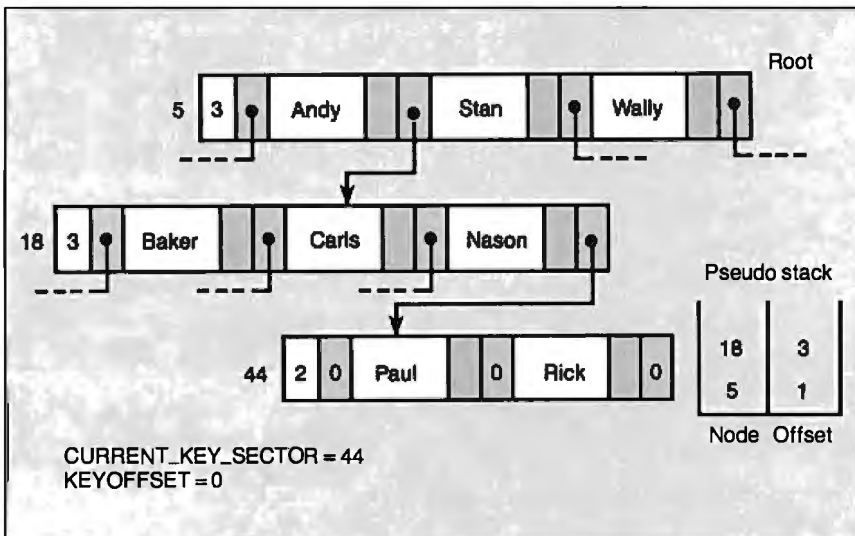

Figure 6: SEEK_KEY searches for the key PAUL in this example. As the routine moves down the tree, it records its trail on the pseudo stack. SEEK_KEY leaves CURRENT_KEY_SECTOR set to the target node and KEYOFFSET set to the key number within the node.

*COMPUSERVE ANNOUNCES HUMAN INTELLIGENCE
FOR YOUR IBM.*



Sam Taylor
marketing information manager
Joy Overstreet
computer sales & training
Nancy Keep
law office automation consultant

George Conklin
minister

Mark Murphy
computer programmer
Donald Landwirth
computer consultant

James Hawkins
physician

Thousands of people just like you have put their heads together to form one of the world's most advanced data processors — CompuServe's IBM® and IBM-compatible forums. And they'd like you to join them.

Forum members share problems and solutions on our bustling message center. They access and contribute to huge data libraries teeming with the best shareware and public domain software anywhere. And they take on the latest computing topics in live, online conferences.

Nothing can make your computer as intelligent or as friendly as CompuServe's Forum members.

To join CompuServe, see your computer dealer. To order direct or for more information, call 800 848-8199. In Ohio and Canada, call 614 457-0802. If you're already a member, type GO IBMNET at any ! prompt.

Formal B-Trees

The initial formulation of B-tree structures was made by R. Bayer and E. McCreight in 1972 (see reference 1). Well-known computer scientist Donald Knuth has a good discussion of B-trees in *The Art of Computer Programming, Volume III: Sorting and Searching* (see reference 2), where he gives a formal description and suggests some variations.

If you want to get rigorous, a B-tree of order n satisfies these properties:

- Every node in the tree has $\leq n$ sons.
- Every node, except for the root and leaf nodes, has $\geq n/2$ sons.
- The root node has at least two sons unless the root is a leaf.
- All the leaf nodes are at the same level, and they have no nonempty key-node pointers.
- A node with i sons contains $i-1$ keys.

From these properties, you can derive the formula for the retrieval performance of a B-tree. Namely, for a B-tree of order n filled with K keys, the height

h of the tree has the upper bound given by the following:

$$h \leq 1 + \log_{(n/2)+1} ((K+1)/2)$$

Some alterations to the fundamental B-tree scheme provide optimizations that could prove useful in specific applications. For example, if your database is used only for retrieval (e.g., an on-line dictionary file), a quick and easy way to create a B-treelike keyed file system is to follow these steps:

1. Create a hodgepodge key and data file (see figure 1 in the main text).
2. Sort the keys (keeping data pointers attached) and store them to disk so that there is a fixed number of key/data-pointer pairs per key file sector (except, perhaps, for the last sector). These sectors become the leaf nodes.
3. Scan through the key sectors, copying from each one the last (i.e., greatest) key (do not erase the key as you copy it). As you copy each key, attach the sector number from which it came. The new list of keys and pointers (it's already

sorted) will become your next-level keys. Append this list to the key file in the same manner as described in step 2. Repeat step 3, creating new levels on each pass. Each level will have fewer keys than the preceding level; continue until you end up with a number of keys small enough to fit on a single sector. That sector becomes the root.

You now have a keyed file structure much like a B-tree, except that each key is associated with one pointer. At every level but the leaf nodes, a key's pointer indicates the subtree holding all keys smaller than or equal to that key. At the leaves, the pointers are data pointers.

Also, notice that some keys are replicated at each level and that *all* the keys appear at the leaves. If you tack additional pointers onto leaf nodes so that each points to its left and right siblings, then accessing keys in ascending or descending order becomes a snap. The additional space consumed by nonleaf keys would certainly be tolerable in large-file applications, where sequential access is critical.

and KEYOFFSET); you give SCANKEY a key node and a target key, and it returns with the marker set to the target's location on the node (if the target key was found) or where the target key would be if it had been on the node.

It should be easy for you to follow the pseudocode for the SEEK_KEY routine in listing 2. First, of course, SEEK_KEY has to verify that there are any keys in the file. If not, the routine exits immediately with a "key not found" error. Otherwise, SEEK_KEY sets the current key node to the root node and begins the process of repeatedly calling SCANKEY until that routine either returns a "key found" condition or encounters a leaf node. If SEEK_KEY hits a leaf node, there is no more tree to search, and the routine exits with a "key not found" error.

Notice that, as SEEK_KEY moves down into the tree in search of its target, it blazes its trail on what I refer to as a *pseudo stack* (using the PUSH() function). This pseudo stack operates just like a processor push-down stack (first in, first out)—you can push and pop its entries—but an element on the pseudo stack is a key-node/key-offset pair. So, when SEEK_KEY completes, you can trace its trail through the tree by examining the

pseudo stack's contents (see figure 6). You'll see the reasons for maintaining this stack in upcoming routines. Now that you know how to find a key, you need to get something into the tree so that you can have keys to look for.

Adding Keys

The CREATE_KEY routine (see listing 3) begins by making sure there are keys in the tree. If not, CREATE_KEY calls GET_NEW_KEY_SECTOR, which returns a new, empty key node. This node will become the tree's root. If the file does have keys in it, CREATE_KEY calls SEEK_KEY to verify that the key you're trying to add to the file is not already in the B-tree. Notice that SEEK_KEY performs two functions: If it finds the key, then CREATE_KEY exits with a "key already exists" error; if it doesn't find the key, it at least has created the pseudo stack and has set the roving marker to reflect the path and position of the key if it had been in the file. In other words, SEEK_KEY returns telling CREATE_KEY either "the key is in the file right here" or "here's where the key should be."

Assuming the call to SEEK_KEY fails, CREATE_KEY gets the green light and attaches the data associated with the key to

the node. It does this by moving the target key into a holding area called the FLOATING_KEY buffer. Once CREATE_KEY has built the data record and written it to the data file, it records the pointer to that record in its proper place in the FLOATING_KEY buffer. (The routine is building a "key packet," consisting of a key, a data pointer, and left and right key-node pointers, in the FLOATING_KEY buffer, and it is preparing to tuck that packet into the appropriate position in the tree file.)

To perform the insertion, CREATE_KEY copies the contents of the CURRENT_KEY_SECTOR into another holding area called the WORKING_KEY buffer. CREATE_KEY then makes a "hole" for the new key by shoving all the keys one notch to the right, starting with the key position given by KEYOFFSET. Next, the routine copies the contents of the FLOATING_KEY buffer into the hole and increments the node's key count by 1.

Now, if life were easy, you could write the updated node back out to disk and go home. But inserting the new key may have made the node too large to fit in a single sector; CREATE_KEY checks the newly incremented key count to determine whether the node can fit. Fortu-

nately, I've defined the WORKING_KEY buffer to be larger than a standard sector—larger, in fact, by the margin of an additional key and its attendant pointers. If the node does overrun the sector size, then CREATE_KEY must split the node.

To split a node, locate the central key on the node, copy that key into the FLOATING_KEY buffer, write all the keys to the left of the central key to one node (you can use the original node), and write all the keys to the right of the central key onto another, newly created node. Next, set the left and right node pointers of the key in the FLOATING_KEY buffer to point to the left and right halves

of the split node.

And what about the key and key-node pointers that you copied into the FLOATING_KEY buffer? That key becomes the parent of the two halves of the node that you split. This is how a B-tree grows. If the node that was split in the preceding paragraph is the only node of the tree, then the contents of the FLOATING_KEY buffer become the tree's new root. Otherwise, you have to insert the contents of the FLOATING_KEY buffer into the parent of the original node.

Once again, the contents of the pseudo stack determine where you insert the

continued

Listing 1: In this pseudocode listing, SCANKEY searches the current key node for the target key (CURRENT_KEY). The routine leaves KEYOFFSET set to the key's location if it's found, or to where the key would be if it were on the node.

```
{ This routine scans the key node -- represented by the array
{ KEY_NODE[] -- for a match with the target key, CURRENT_KEY.
{ KEY_NODE[] is loaded by GET(CURRENT_KEY_SECTOR) and written
{ to disk by PUT(CURRENT_KEY_SECTOR).
{ KEYOFFSET indicates a key position (0 for leftmost, 1 for the
{ next to the right, etc...) and not a byte offset.
SCANKEY:
```

```
KEYOFFSET := 0; IFLAG := 0;
WHILE KEYOFFSET < NUMBER_KEYS
BEGIN
  IF key at KEY_NODE[KEYOFFSET] = CURRENT_KEY then RETURN;
  IF key at KEY_NODE[KEYOFFSET] > CURRENT_KEY
  BEGIN
    IFLAG := 1;
    RETURN;
  END
  KEYOFFSET := KEYOFFSET + 1;
END
IFLAG := 1;
RETURN
```

Listing 2: The pseudocode for SEEK_KEY.

```
{ This routine searches for a key. If the key is found,
{ CURRENT_KEY_SECTOR holds the key node that key is on,
{ KEYOFFSET points to the key, and IFLAG is set to 0.
{ Otherwise, IFLAG is set to 1, and
{ CURRENT_KEY_SECTOR and KEYOFFSET show where the key
{ *would* have been.
{ NOTE: GET() and PUT() read and write key sectors to
{ and from the disk file.
SEEK_KEY:
IF number of keys in file = 0 then RETURN file empty error;
Clear Pseudo stack;
CURRENT_KEY_SECTOR := Root;
REPEAT
  GET( CURRENT_KEY_SECTOR );
  CALL SCANKEY;
  IF key found RETURN;
  { If the key node pointer is empty, the search has
  { encountered a leaf.
  IF KEY_POINTER[KEYOFFSET] = 0
    RETURN key not found error;
  { Push pseudo stack.
  PUSH( CURRENT_KEY_SECTOR, KEYOFFSET );
  { Search down the subtree.
  CURRENT_KEY_SECTOR := KEY_POINTER[KEYOFFSET];
END REPEAT
```

The best Modula-2

compilers for PCs and
compatibles

Taylor Modula-2

The professional high-performance compiler for PCs: the fastest compiler in the world!

- * unrivalled speed of compilation
7,000–10,000 lines per minute (80286, 8 MHz).
- * excellent code
Mini-computer standard global optimisation. Code performs 1580 Dhystone tests per second! (80286, 8 MHz)
- * ultra-compact
high code density and a library of unrivalled compactness (23 modules in a total of 13k!)
- * completely standard implementation
Follows NASLIM standard for Modula-2. BIOS independent – uses MS-DOS exclusively.
- * easy to use
Straightforward user interface. Comprehensive documentation for system programmers.
- * Guarantee and support
One year guarantee. Maintenance contracts available. Swiss quality product.

Taylor Modula-2 Demo disk \$900
\$10

M2SDS \$99

The professional Modula-2 software development system M2SDS comprises the following features in an easy-to-use window environment.

- modern, syntax-driven editor
- fast compiler
- linker producing EXE programs
- unique library manager
- comprehensive standard library

There are a vast number of tools, toolboxes, demo disks, public domain programs and books for M2SDS – probably more than for any other development system! M2SDS was used for the writing of the Farsight integrated business software package!

Demo disks \$10

JPI-Modula-2 \$149

A reasonably-priced Modula-2 compiler with a complete development environment, integrated Make function and a powerful code generator.

Available for PC, HP9000/300, IBM PC compatible, and other systems.

Terms, conditions and the sales law information apply to all orders.

The Modula-2 people:

INTERFACE TECHNOLOGIES

3336 Richmond, Suite 323
Houston, TX 77098-9990 (713) 523 8422

Dealer inquiries welcome

International	United Kingdom: 01/6567333
Austria: 0222/4545010	Germany: 02983/8337;
Belgium: 071/366133	0731/26932;
France: 20822682	0821/85737;
Italy: 02/405174	04106/3998;
Scandinavia: +45/3/512014	0531/347121
Switzerland: 01/9455432	

A
A. + L. Meier-Vogt
Im Späßen 23
CH-8906 Bonstetten/ZH
Switzerland
Tel. (41)(1) 700 30 37

IEEE-Z

IOtech offers the widest selection of *easy-to-use* IEEE 488 (GPIB) interfaces for the Macintosh.

• NuBus IEEE board for the Macintosh II

• SCSI / IEEE controller for the Macintosh Plus, SE & II

• Serial / IEEE controller for long-distance applications

• Serial / IEEE plotter converter for HP-IB plotter interfacing

• Desk accessory software for IEEE control from any application

• Language drivers for IEEE control from Basic, C, Fortran, Pascal, Hypercard and more

• Menu-driven software for scientific analysis and graphics

• **30 day money-back guarantee**

• **2 year warranty**

• **Call or send for your FREE Technical Guide**



IOtech...the choice is easy

IOtech

(216) 439-4091 Telex 6502820864
Fax (216) 439-4093

25971 Cannon Road • Cleveland, Ohio 44146

London (0734) 86-12-87 • Paris (1) 34810178 • Zurich (01) 821 944
Milan 02-4120360 • Linköping 013 11 01 40 • Gornichem 01830-35333
Sidney (2) 452 3831 • Seoul 784-9942 • Munich and other European,
North African and Middle East countries not listed (089) 710020.

HANDS ON SOME ASSEMBLY REQUIRED

key. You can see in listing 3 that CREATE_KEY attempts to pop the pseudo stack and, if successful, returns within itself to do the insert. This process can repeat as many times as there are levels in the tree. Each time it repeats, it works its way toward the root, splitting nodes and mov-

ing the central key up a level. Always, as the tree grows, the keys' relationships are preserved. (Figure 7 shows the process of adding a key to a B-tree.)

Finally, CREATE_KEY must terminate with the pseudo stack and internal pointers set to the location of the newly created

Listing 3: The pseudocode for CREATE_KEY. This routine adds a new key to a B-tree file.

```
{ Add a new key to the key file.
CREATE_KEY:
  SFLAG = 0;
  IF number of keys in file = 0
    BEGIN
      GET_NEW_KEY_SECTOR;
      Root := new_key node;
      Load CURRENT_KEY value;
    END
  ELSE
    BEGIN
      CALL SEEK_KEY;
      IF key found
        RETURN key already exists error;
    END
  FLOATING_KEY := CURRENT_KEY;
  { ** Code to handle creating a new
  { ** data record goes here.
L1:
  Move KEY_NODE[] to WORKING_KEY buffer;
  Move all keys -- in WORKING_KEY buffer
  -- starting at KEYOFFSET 1 key position to the
  right;

  Move FLOATING_KEY into WORKING_KEY buffer at location
  given by KEYOFFSET;
  Increment WORKING_KEY buffer's keycount;
  IF WORKING_KEY buffer's keycount > maximum
  keys per key sector
    BEGIN
      { Note: keycount refers to the number of keys in
      { WORKING_KEY_BUFFER.
      FLOATING_KEY := WORKING_KEY[keycount/2];
      FLOATING_KEY's left key pointer :=
      CURRENT_KEY_SECTOR;
      Move leftmost keycount/2 keys from WORKING_KEY
      buffer to KEY_NODE[];
      PUT(CURRENT_KEY_SECTOR);
      GET a new key node;
      CURRENT_KEY_SECTOR := new key node;
      FLOATING_KEY's right key pointer :=
      CURRENT_KEY_SECTOR;

      IF keycount is ODD
        i:=keycount/2
      ELSE { keycount is EVEN }
        i:=keycount/2 - 1;
      Move rightmost i keys from WORKING_KEY buffer
      to KEY_NODE[];
      PUT(CURRENT_KEY_SECTOR);
      POP (CURRENT_KEY_SECTOR,KEYOFFSET);
      IF POP () failed
        BEGIN
          GET a new key node;
          ROOT := new key node;
        END
      GO TO L1;
    END
  ELSE
    BEGIN
      PUT (CURRENT_KEY_SECTOR);
      IF SFLAG = 1
        CALL SEEK_KEY;
      IFLAG=0;
      RETURN no error;
    END;
```

key. (This is particularly important in the routine I'll describe next, `SEEK_NEXT_KEY`, which must know the location of the current key in order to find the subsequent key.) There is no problem if the routine hasn't split any nodes in the process of inserting the new key. But if nodes have split, there is the probability that new nodes have been created. Then the list of key-node/offset pairs on the pseudo stack would no longer have legitimate directions for locating the recently inserted key in the tree.

So, `CREATE_KEY` sets the variable `SFLAG` whenever there has been a split. Before `CREATE_KEY` exits, it checks `SFLAG`. If `SFLAG` is set, `CREATE_KEY` calls `SEEK_KEY` with the original key, blazing

a new trail into the tree and leaving the pseudo stack, `CURRENT_KEY_SECTOR`, and `KEYOFFSET` set with correct values.

Who's Next?

Suppose you have created a KFS for your accounts payable system, and you want to print the transactions out in ascending-date order. You need a function that, given that you've just accessed a specific key, allows you to move to the next greater key in the tree (the *inorder successor*, in technical jargon). See listing 4.

First, keep in mind what the previous operations on the B-tree might have been. If a `SEEK_KEY` has taken place, then the pseudo stack holds the trail you've fol-

continued

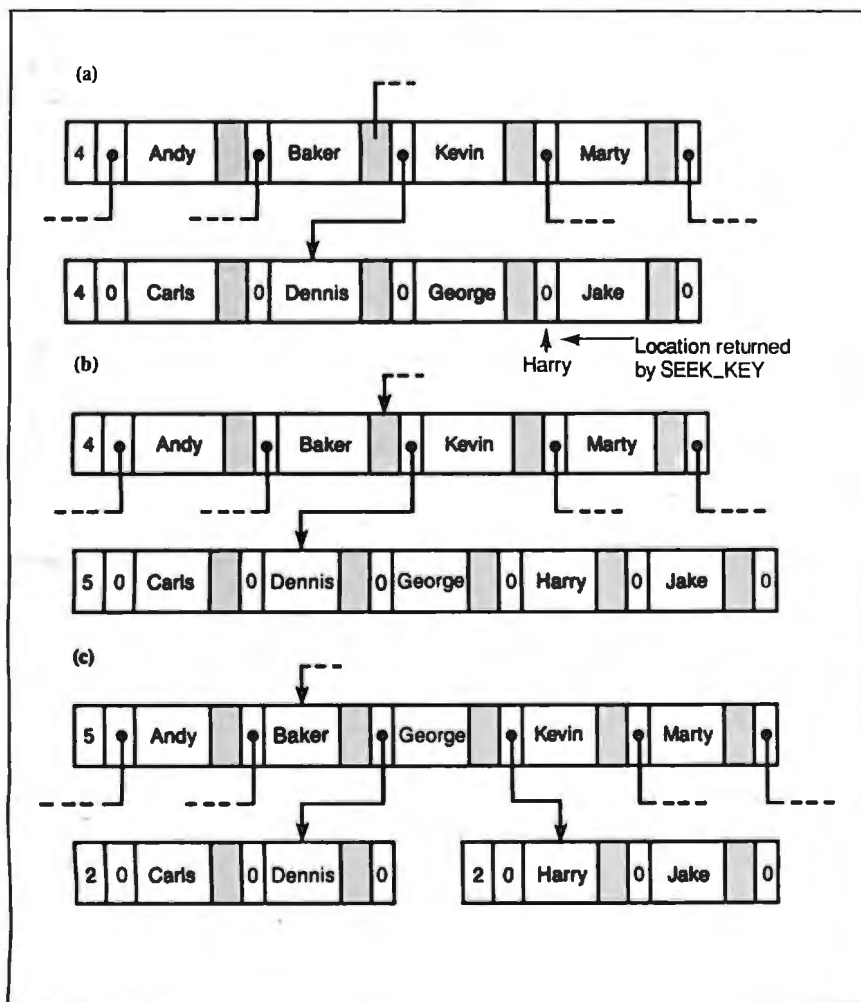

Figure 7: Inserting key HARRY into an order-4 B-tree. (a) First, `CREATE_KEY` locates where `HARRY` should go in the tree by calling `SEEK_KEY`. (b) The target key node is expanded, and `HARRY` is written in—but now the node has grown beyond the maximum number of keys allowed per node. (c) `GEORGE`, the middle key on the node, is moved up to the parent node, and the leaf node splits. Notice that now the parent node has more than the maximum number of keys allowed. It, too, will split, and `GEORGE` will move up the tree to the next parent or—if no parent exists—will become the root.

A new concept in managing Megabytes of memory

IX-BoX*

Have you ever spent hours

- searching for a letter which you know exists, but can't seem to find?
- looking for an address which you can only remember half of?
- tracking down a variable which was initialised somewhere in your programs, and which is now causing them to crash?
- rummaging through your ultra-modern database, simply because you omitted to define a simple key field when setting it up?
- searching your literature index for an urgently needed article?
- looking and looking, but without success?

Then we can help! IX-BoX will instantly find all your correspondence, addresses, programs, entries, summaries - in fact, anything and everything stored on your computer. IX-BoX delivers the document you require in seconds, and you can carry out any necessary changes to it using the built-in editor. What more could you possibly need?

IX-BoX is much more than a simple information retrieval system, yet it only costs \$ 275

Demo disk costs \$ 10

* IX-BoX is a trade mark of Snark AG, Zürich.

Farsight

Once you've used the Farsight integrated software package, you'll know the fun of working with and exploiting Megabytes of memory.

Window manager, word processor and spreadsheet together cost only \$ 99

Graphics \$ 29

Texas residents add 8% sales tax. International Orders add \$ 20 shipping.

The Modula-2 people:



INTERFACE
TECHNOLOGIES

3336 Richmond, Suite 323
Houston, TX 77098-9990 (713) 523 8422

Dealer inquiries welcome

International	
Austria: 0222/4545010	United Kingdom: 01:6567333
Belgium: 071/366133	Germany: 02983/8337;
France: 20822662	0731/26932;
Italy: 02/405174	0821/85737;
Scandinavia: +45/3/512014	04106/3998;
Switzerland: 01/9455432	0531/347121

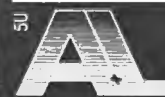

A + L Meier-Vogt
Im Späten 23
CH-8906 Bonstetten/ZH
Switzerland
Tel. (41)(1) 700 30 37

lowed into the tree, and CURRENT_KEY_SECTOR and KEYOFFSET indicate the location of the current key. In SEEK_KEY, you can see that if IFLAG is set, the last call to SEEK_KEY has failed but KEYOFFSET shows where the key would have been. The choices then become

- If IFLAG is set, clear it. KEYOFFSET is pointing to the key you want. However, if KEYOFFSET points to the right of the last key on the node, you must pop back to the parent node and repeat the process.
- If IFLAG is clear, simply move to the next key on the node if the node is a leaf

(key-node pointers on a leaf node are empty, so the node cannot be a parent). If, as in the above case, the current key is the last on the node, you must pop back to the parent, set IFLAG, and try again. (All this popping is why it's important for CREATE_KEY to keep the pseudo stack intact; otherwise, calling SEEK_NEXT_KEY immediately after CREATE_KEY would produce unpredictable results.) If the node is not a leaf, move to the next key pointer on the node. Follow that pointer to the child node, and continue following the leftmost key pointers until you encounter a leaf. The first node on that leaf is the inorder successor. Once again, as SEEK_NEXT_KEY delves into the tree on its search, it records its trail on the pseudo stack.

Listing 4: Pseudocode for SEEK_NEXT_KEY.

```
{ This routine searches for the current key's inorder
{ successor. If it hits the end of file, it rewinds
{ the key file and returns an error.
SEEK_NEXT_KEY:
IF number of keys in file = 0 then RETURN file empty error;
IF file is rewound
BEGIN
CURRENT_KEY_SECTOR := Root;
IFLAG := 1;
GOTO L1;
END
GET(CURRENT_KEY_SECTOR);
REPEAT
IF IFLAG NOT = 0
BEGIN
IF KEYOFFSET NOT = number of keys on node
BEGIN
IFLAG = 0;
RETURN;
END
IF Pseudo stack is empty
BEGIN
REWINDKEY;
RETURN end of file error;
END
POP(CURRENT_KEY_SECTOR,KEYOFFSET);
GET(CURRENT_KEY_SECTOR);
END
ELSE
{ The following code executes if this file's
{ keypointer currently points to a key.
{ This means you have to advance to that key's
{ right keypointer and search that subtree --
{ if it exists -- for the "lowest and leftmost" key.
{ KEYOFFSET is interpreted here to indicate a key
{ node pointer on KEY_NODE[]: 0 for leftmost, 1 for
{ next to the right, etc....
BEGIN
KEYOFFSET := KEYOFFSET + 1; IFLAG = 1;
WHILE key node pointer at KEYOFFSET NOT = 0
BEGIN
TEMP := key node pointer at KEYOFFSET;
PUSH(CURRENT_KEY_SECTOR,KEYOFFSET);
CURRENT_KEY_SECTOR:=TEMP;
L2: KEYOFFSET := 0;
GET(CURRENT_KEY_SECTOR);
END
END
END REPEAT
```

One special case occurs when SEEK_NEXT_KEY's attempt to pop the pseudo stack fails: The stack is empty. What's happened? Simply that the current key is the greatest (last) key in the B-tree, and the call to SEEK_NEXT_KEY has fallen off the end. The routine handles this by rewinding the file and returning an "end-of-file" error. (The term *rewinding* is handed down from the days when tape drives were the primary storage device for computers; it refers to the act of setting the pseudo stack and roving marker to the logical beginning of the file.) The very short pseudocode routine for rewinding the file appears in listing 5.

Next Month

I'll wind up my presentation of the key file handling routines with a description of the deletion algorithm and a discussion of the data-file side of things. ■

Author's note: The source code for the B-tree system will be available as of the final part of this three-part series.

REFERENCES

1. Bayer, R., and E. McCreight. *Organization and Maintenance of Large Ordered Indexes*. New York: Acta Informatica, Springer-Verlag, 1972.
2. Knuth, D. E. *The Art of Computer Programming, Volume III: Sorting and Searching*. Reading, MA: Addison-Wesley, 1973.

Rick Grehan is a BYTE senior technical editor at large. He has a BS in physics and applied mathematics and an MS in computer science/mathematics from Memphis State University. He can be reached on BIX as "rick_g."

Your questions and comments are welcome. Write to: Editor, BYTE, One Phoenix Mill Lane, Peterborough, NH 03458.

Listing 5: Pseudocode routine for rewinding the key file.

```
{ Rewind a key file.
{ This sets the roving pointer given by CURRENT_KEY_SECTOR
{ and KEYOFFSET to the file's logical start.
REWINDKEY:
CURRENT_KEY_SECTOR := 0;
KEYOFFSET := 0;
Clear Pseudo stack;
RETURN;
```

SHECOM INTRODUCING TWO NEW CONNECTIONS



286—12 MHz SHECOM VGA EGA AT—812 CGA MGA

INTEL 80286 8-12 MHz CPU
Speed Indicator on Panel
640kb RAM (1mb optional)
360kb 5.25" Floppy Drive
720kb 3.50" Floppy Drive
20mb Hard Disk Drive
2 Serial & 2 Parallel
101 Enhanced Keyboard
800 x 600 Resolution
VGA (advanced) MCGA EGA
CGA MGA MDA compatible

\$1600

12" Amber Monitor \$ 80
14" Paper White \$145
14" EGA Monitor \$410
14" Multi Scan \$560
14" VGA Monitor \$510

286—16 MHz 286—20 MHz SHECOM AT—16

INTEL 80286 16 or 20 MHz
1024kb (1mb) RAM (expandable)
1.2mb 5.25" Floppy Drive
1.4mb 3.50" Floppy Drive
40mb (28ms) Hard Drive
Parallel & Serial I/O
101 Enhanced Keyboard
14" Paper White Monitor
w/Monochrome Controller

\$2600

OPTIONAL UPGRADE
Genoa Super EGA 600x800
with 14" EGA Monitor \$490
with 14" MultiScan Monitor ... \$630
with 14" VGA Monitor \$740
with 16" VGA Monitor \$1,250

SHECOM XT—TURBO

INTEL 8088 10 MHz CPU
256k RAM * 360kb Drive
Serial/Parallel Ports
84-Keyboard * 12 Amber
Monitor * Realtime Clock

\$585

STAND ALONE
OR AS A
TERMINAL

10 FREE
SOFTWARE
286 & 386
SYSTEMS ONLY

10 software Free with every SHECOM 286 system includes
Tutorials, EZ DOS 4.0 (3.3 compatible) operating system,
GEM Desktop, DATA EDGE (a Data Base Management program)

SHECOM
TWO YEAR
WARRANTY

SPECIALIST IN 10-NET LAN & COMPUTONE DAISY CHAIN NETWORK. ASK FOR DETAILS.

COMPUTER ACCESSORY SECTION

AST SixPakPlus w/384k for XT \$365
AST 2mb Rampage/286 w/512k \$590
Logitech Serial Mouse \$ 70
PC Serial Mouse w/EasyCad \$140
SHECOM 360kb 5.25" External Drive \$310

FAX CARD (Quadram Internal) \$295
FAX Portable (Quadram External) \$270
GENOA Super-EGA 600x800 Card \$210
Video-7 VGA Deluxe 752-410 \$255
Video-7 VEGA-VGA 800x600 \$340



FLOPPIES

Toshi/Fuji/Epson. . . 360K **\$75**
Epson/NEC. 1.2 MB **\$95**
Toshi/Panasonic. . . 760K **\$110**
NEC/Toshi. 1.4 MB **\$120**

HARD DRIVES

ST-225 20MB **\$275**
ST-238 30MB **\$299**
ST-251 40MB **\$399**
ST-251-1 40MB **\$435**

ST-4051 40MB **\$ CALL**
Miniscribe 20MB **\$320**
Miniscribe 30MB **\$340**
Miniscribe 40MB **\$610**

CONTROLLER CARD

20/30 MB Cntrl Card **\$ 80**
20/30 MB WD at C/Card .. **\$150**
20/30 MB WD RII Card **\$ 95**
20/30 MB WD Adpt RII ... **\$ 99**

(Hard Drives Include Control Card, Cable, & Formatting Disk)

CHIPS

CHIPS

CHIPS

256 DRAM
120/100/80/60 NS
1 MEG
ALL SPEEDS

MATH - CO'S
8087 All Speeds
80287 All Speeds
80387 All Speeds

SIMM
& SIP
MODULES

**SAME
DAY
SHIPPING**

**Call for Individual
& Volume Pricing**

SHECOM COMPUTERS, INC.

22755-G Savi Ranch Parkway
Yorba Linda, CA 92686
FAX: (714) 637-6293

**Call before you buy and
SAVE! SAVE! SAVE!**

Most orders shipped with 48 hours or less

HOURS

M-F 8 a.m.—6 p.m. SAT 11 a.m.—3 p.m.

Ask for our Desktop Publishing
CAD/CAM/CAE System Packages

PACIFIC TIME

Prices subject to
change without notice

INQUIRIES 714-637-4800

TECH SUPPORT 714-637-5921



SALES ORDERS CALL 1-800-366-4433

THE BUYER'S MART

A Directory of Products and Services

THE BUYER'S MART is a monthly advertising section which enables readers to easily locate suppliers by product category. As a unique feature, each BUYER'S MART ad includes a Reader Service number to assist interested readers in requesting information from participating advertisers.

RATES: 1x—\$525 3x—\$500 6x—\$475 12x—\$425
Prepayment must accompany each insertion. VISA/MC Accepted.

AD FORMAT: Each ad will be designed and typeset by BYTE. Advertisers must

furnish typewritten copy. Ads can include headline (23 characters maximum), descriptive text (250 characters is recommended, but up to 350 characters can be accommodated), plus company name, address and telephone number. Do not send logos or camera-ready artwork.

DEADLINE: Ad copy is due approximately 2 months prior to issue date. For example: November issue closes on September 8. Send your copy and payment to THE BUYER'S MART, BYTE Magazine, 1 Phoenix Mill Lane, Peterborough, NH 03458. For more information call 603-924-3754.

ACCESSORIES

PRO-CLASSIC T-SHIRTS & BUTTONS

JUST SAY NO to expensive, incompatible PCs with a T-shirt or button! T-shirt is \$12.00 plus \$1.50 shipping & handling. Button is \$1.00 plus \$0.50 s&h. State size and quantity when ordering. Send check or money order to:

Advanced Systems Consultants

21115 Devonshire St. #329, Chatsworth, CA 91311

(Sorry, no VISA/MC. CA residents MUST add sales tax. We never cash your check until order is shipped!)

Inquiry 576.

ARTIFICIAL INTELLIGENCE

EXPERT SYSTEM DEVELOPMENT

Get the award winning AGNESS to develop network based expert systems using multiple inference methods, the Merit scheme for efficient data collection, and unique explanation facilities. Use the AGNESS C talk Toolkit to embed an expert system into your application under an object oriented environment. \$795.

Applied Information Systems, Inc.

2117 West Hoyt Ave., St. Paul, MN 55108

(612) 641-9947

Inquiry 581.

ATTORNEYS

FREE BROCHURE SOFTWARE COPYRIGHT PROTECTION IN FOREIGN COUNTRIES

If you sell or want to sell your software in other countries, write for information about international copyright, what it is and who it protects. Written for software developers, vendors, programmers, and company owners. KNOW YOUR RIGHTS in selling software in other countries.

DR. FREDRIC ABRAMSON, ATTORNEY AT LAW

Intellectual property and international business law
2155 Burnham Rd., Gaithersburg, MD 20878 (or)
2121 Wisconsin Ave., N.W., Suite 330, Washington D.C. 20012
Adm. in MD.; not Adm. in D.C. 301-840-9733

Inquiry 585.

FREE CATALOG

Thousands of parts and new surplus electronic parts at super low prices. FAST ORDER PROCESSING AND SHIPPING (95% of all orders shipped within 48 hours).

CALL OR WRITE FOR A FREE CATALOG. . .

ALL ELECTRONICS CORPORATION

P.O. Box 567, Van Nuys, CA 91408-0567

1-800-826-5432

Inquiry 577.

NanoLISP \$99.99

An MS-DOS Common LISP interpreter that supports most Common LISP operations and strictly adheres to the standard. Numerous advanced and extra features, excellent debugging facilities, sample AI programs, fully-indexed manual, free technical support.

Microcomputer Systems Consultants

P.O. Box 6646, Santa Barbara, CA 93160

(805) 967-2270

Inquiry 582.

BAR CODE

PRINT BAR CODES, BIG TEXT, LOGOS

On EPSON, IBM, OKI dot matrix or LaserJet. Design any format/size on ONE easy screen. 1-120 fields/label. 13 text sizes to 1" — readable at 50 ft. AIAG, MIL-STD, 2 of 5, 128, UPC/EAN, Code 39. File Input, FAST—\$279. Logos, Product Symbols. Other menu-driven bar code programs from \$49. 30 day \$ back.

Worthington Data Solutions

417-A Ingalls St., Santa Cruz, CA 95060

(800) 345-4220 In CA: (408) 458-9938

CUT RIBBON COSTS!

Re-ink your printer ribbons quickly and easily. Do all cartridge ribbons with just one inker! For crisp, black professional print since 1982. You can choose from 3 models: Manual E-Zee Inker — \$39.50

Electric E-Zee Inker — \$89.50

Ink Master (Electric) — \$159.00

1000's of satisfied users in 5 years. Money back guarantee.

BORG INDUSTRIES

525 MAIN ST., JANESVILLE, IA 50647

1-800-553-2404 In IOWA 319-987-2976

Inquiry 578.

NEW EXPERT SYSTEM

FirstExpert - A unique expert systems tool that you can master in a few hours! Generates the complete system based on your specifications! Built-in learning procedure automatically creates knowledgebase. Interactive structured induction allows you to add new knowledge at any time. Includes consultancy system. Handles up to 10,000 rules on a PC! Demos included! IBM pc's/PS-2's.

An ingenious program, buy now for only \$99.95, s/h add \$5.00

NovaCast Expert Systems

2530 Berryessa Rd. Suite 607, San Jose, CA 95132

(408) 272-4071 Fax: (408) 437-7777

Inquiry 582.

BAR CODE READERS

From the manufacturer for PC/XT/AT, & PS/2. Attaches as 2nd keyboard, reads as keyed data. External or bus install. With steel wand—\$399. Supports All Novell! Kimtron, Link, Wyse, RS-232. Supports Alloy PC-TERM. Portables, Lasers, Badge. 30 day \$ back.

Worthington Data Solutions

417-A Ingalls St., Santa Cruz, CA 95060

(800) 345-4220 In CA: (408) 458-9938

SELF-INKING PRINTER RIBBON

Awarded United States Patent #4701062

Lasts 10-15 times longer than the conventional ribbon

For printers using 1/2" width open spool ribbon:

Okidata 82A-83A-84-92-93 Dec LA 180/120

Teletype-33, 35 Dec LA 30/IBM 1443

Star Gemini 10X Teletype-Model 40

Extel TI 800/810, 820, 880

Contact us by mail, phone or telex and we will forward you a brochure.

CONTROLLED PRINTOUT DEVICES, INC.

POB 869, Baldwin Rd., Arden, NC 28704

(704) 684-9044 • TELEX: (FILMON-AREN) 577454

Inquiry 579.

Buy your own Book

Get a fully supported LISP program for the MAC without the padded price to pay for an expensive book. \$20 buys it MAC plus or equivalent runs it. Order now and save.

Ooson Software

Box 33113, Coon Rapids, MN 55433

Inquiry 583.

PRINT BAR CODES/BIG TEXT FROM YOUR PROGRAM

Add bar codes and big graphics text to your program. Print from ANY MS-DOS language. Bar codes: UPC, EAN, 2 of 5, MSI, Code 39. Epson, OkI, IBM dot matrix text up to 1/2". LaserJet up to 2". Font cartridges not required. \$159-\$239. 30 day \$\$ back.

Worthington Data Solutions

417-A Ingalls St., Santa Cruz, CA 95060

(800) 345-4220 In CA: (408) 458-9938

FREE CATALOG

A complete source for computer supplies at low prices. Fast Service: Diskettes • Latest Accessories • Books • Software • Dust Covers • Furniture • Data Cartridges • Plotter Pens • Cleaning Supplies • Tapes • Ribbons • Printers • Computer Paper • Copier Supplies • Surge Protectors • Cables • Print Wheels • MUCH MORE!!!

Call, write or circle inquiry card for a FREE CATALOG

GAAN COMPUTER SUPPLIES

186 B East Sunnyside Ave., Campbell, CA 95008

(800) 523-1238, In Calif. (408) 370-6747

Inquiry 580.

muLISP™ 87 for MS-DOS

Fast, compact, efficient LISP programming environment. muLISP programs run 2 to 3 times faster & take 1/2 to 1/3 the space of other LISP's. 450 Common LISP functions, multi-window editing & debugging, flavors, graphics primitives, lessons & help, demo programs, comprehensive manual.

Soft Warehouse, Inc.

3615 Harding Ave., Suite 505, Honolulu, HI 96816

(808) 734-5801

Inquiry 584.

COMPLETE LINE OF BAR CODE PRODUCTS

• PrintBar II • PrintBar Softprints
• PrintBar I • CodeScan 2000

FREE BROCHURES (916) 622-4640

Bear Rock Software Co.

6069 Enterprise Dr. Placerville, CA 95667

Inquiry 586.

THE BUYER'S MART

BAR CODE

BAR CODE SOLUTIONS

We make bar coding very easy with our complete line of readers. Our PC-Wand readers network, or work with your keyboard or terminal, or are carried around taking inventory, entering sales and clocking time. Our bar code label printing software packages work with MS-DOS or PC-DOS and most matrix or laser printers. We also sell pre-printed labels. Our hardware can work with nearly every computer in the world.

International Technologies & Systems Corp.
635-C North Berry St., Brea, CA 92621
(714) 990-1880 FAX: 714 990-2503 TLX 0502824734 MCI

Inquiry 587.

BAR CODE MADE EASY

PERCON® E-Z-READER™ keyboard interfaces and multiuser RS-232 models make it easy to add bar code to virtually any computer/terminal WITHOUT SOFTWARE MODIFICATION. Immediate shipping. Two year warranty. Bar code printing software available. Call for details on fast, accurate, easy software entry. Substantial reseller discounts.

PERCON®

2190 W. 11th St., Eugene, OR 97402
(503) 344-1189

Inquiry 588.

PC BAR CODE SPECIALISTS

Bar code readers designed for fast, reliable, cost effective data entry. Looks just like keyboard data. Choice from stainless steel wand or laser interface. Also, powerful Bar Code and Text printing software. Great warranty. Dealer inquiries welcome.

Seagull Scientific Systems
15127 N.E. 24th, Suite 333, Redmond, WA 98052
206-451-8966

DATA INPUT DEVICES

Bar Code & Magnetic Stripe Readers for microcomputers & terminals, including IBM PS/2 & others, DEC, Macintosh, AT&T, CT, Wyse, Wang. All readers connect on the keyboard cable & are transparent to all software. Low cost bar code print programs, magnetic encoders, & portable readers are also available. GSA contract #GSD0K87AGS5346.

TPS Electronics

4047 Transport, Palo Alto, CA 94303
415-856-6833 Telex 371-9097 TPS PLA
FAX: 415-856-3843

Inquiry 589.

BBS/PUBLIC DOMAIN

MEDCOM INFO BBS

(714) 996-6666 (213) 644-5580
32 lines, 3/12/24, 8N1

PC-Pursuitable (complete cost & signup info online), multi-user games, group chat, E-Mail & message boards, computer art, many SIGs, INFO-MAT Magazine, downloadable software (191MB), contract & perm job lists, shopping mall, Calif. foreclosure info. FREE TRIAL.

6312 E. Santa Ana Cym Rd. #361, Anaheim, CA 92807
Voice (714) 996-7982

Inquiry 590.

450+ New Titles Added Each Month

18+ Special Interest Forum message bases plus Real Time Conferencing. USA TODAY Decision-Line News Service. Quarterly Newsletter & BBS System Users Guide. PC Pursuit Accessible. 780 MB on line. Complete PC SIG library. VISA/MC

9 Incoming lines. FREE DEMO MODE
(503) 761-8100 12/2400 N,8,1
RANDOM ACCESS Information Network
P.O. Box 16675, Portland OR 97216

Inquiry 591.

CAD/CAM

PHOTO PLOTTING

from your Smartwork Edit file or any RS-274 Gerber Photo Plot file. Raster type Photoplotting supplied on .007" thick Kodak Ultraline film. Plot data accepted by modem, 5 1/4", 3 1/2" MS-DOS format disks or 9 track mag tape. Gerber plot file 8"x10" plots start from \$15.00.

Call for details.

KEPRO CIRCUIT SYSTEMS

Fenton, MO

1-800-325-3878 / 1-314-343-1630 in MO.

Inquiry 592.

P-CAD MOUSE

A quality mouse designed to run with the P-CAD software. It requires one RS232C COM Port for the connection. No external security device is needed any more. Complete hardware and documentation for \$575. Call or write for more information. Three years warranty. Checks, COD, VISA, MC accepted.

UNITEK SYSTEM

9228 Vancouver Drive, Sacramento, CA 95826
(916) 982-6075

P-CAD trademark of Personal CAD System, Inc.

Inquiry 593.

CASE

FINITE STATE PROGRAM COMPILERS

State programs develop quicker, run faster and use less memory than sequential programs. A few keystrokes can replace hundreds of instructions. The Compiler, a CASE software development tool, forms source state programs in: Ada, BASIC, C, FORTRAN and Pascal. FOR IBM DOS. Price \$200 per lang. (With Primer and Debugger) Sampler \$50.00 (With all manuals & credit)

AYECO 5025 Nassau Circle, Orlando
INCORPORATED FL 32808 (407) 295-0930

Inquiry 594.

JOINT APPLICATION DESIGN and PROTOTYPING WORKBENCH

Developers! Reduce your costs and improve user satisfaction. Give users a hands on feel for the system. Build a full working model of a system in just hours. PC-PROTO is easy to use, flexible, and writes the documentation for you. From \$149.

Kartech, Inc. (416) 656-2032
165 Pinewood Ave., Toronto, Ontario, Canada M6C 2V6

Inquiry 595.

CD-ROM

CD-ROM Drives & Titles

Largest selection for PC & Mac.
Microsoft Programmers Library & Drive \$995
Compu er Library \$695 • Public Domain S/W \$99.

Drives from \$699. Hundreds of titles from \$29.

MC/VISA/AMEX, Money-back Guarantee.

Call or write for free 100 page catalog.

Get it all from "The Bureau"

Bureau of Electronic Publishing
121 Norwood Ave., Upper Montclair, NJ 07043
(201) 746-3031

Inquiry 596.

Government Databases on CD-ROMs

Detailed US databases available on 5 CD-ROMs: Economics, Labor, Agriculture, Consumers, and Food. Soon: Health, Business, Tax, Energy and more. Includes software to make tables, DIF or ASCII. \$65 each, MS-DOS req. CD-ROM publishing services available.

Hopkins Technology

421 Hazel Lane, Hopkins, MN 55343
(612) 931-9376 CIS 74017,614

Inquiry 597.

COMMUNICATIONS

NEW! FAST! AFFORDABLE!

The LSPC SERIAL/2 is a dual channel, multi-protocol, asynchronous serial interface for the PC/AT. The max data rate is 400 kbps externally clocked. Typical applications are high speed data acquisition, SDLC/HDL C communications with mainframes, protocol conversion, and LANs. Get fast, flexible performance at a low cost of \$245. CALL OR WRITE NOW!

Computer Modules, Inc.

2348 C Walsh Avenue, Santa Clara, CA 95051
(408) 496-1881 Fax: (408) 496-1886

Inquiry 598.

Bi-Directional File X-fers

Multi-Com telecommunications program offers the following

- ★ Simultaneous Downloading/Uploading
- Send/Receive Console Messages During File Transfers
- 100% Line Utilization During Multi-File Transfers
- Uses Full Duplex AOLC Protocol
- More Efficient Than Xmodem, Kermit, etc.
- Saves Time and Cuts Connect Costs

Information & 5 1/4" Demo Disk \$5.00 + \$3 s/h

Program Pkg., 3 1/4" & 5 1/4" disks, manual \$49.95 + \$4 s/h

Multiplex Systems (412) 276-3374 24 hrs.

P.O. Box 16174, Pittsburgh, PA 15242

Inquiry 599.

FAX MACHINES \$395

MURATA FAX M11200/1600 \$695/CALL
SHARP FO300/420 \$1095/1295
SHARP FO220/550 \$CALL Low Price
RICOH 10/20 \$CALL/1595
SANYO SF100/SF200 \$995/1195
CANON 20 (100)/8 \$1075/CALL
TOSHIBA Laptop Computers \$759 & up

Prepay prices VISA/MC 2% COD 2% restock 20%

TELEPHONE PRODUCT CENTER
12603 Hoover St., Gardnerville, CA 92641
800-444-3199

Inquiry 600.

COMPUTER INSURANCE

INSURES YOUR COMPUTER

SAFEWARE provides full replacement of hardware, media and purchased software. As little as \$39 a year provides comprehensive coverage. Blanket coverage; no list of equipment needed. One call does it all. Call 8 am-10 pm ET. (Sat. 9 to 5)

TOLL FREE 1-800-848-3469

(Local 614-262-0559)

SAFEWARE, The Insurance Agency Inc.

Inquiry 601.

COMPUTER SOFTWARE

'C' DOCUMENTATION TOOLS

- C-CALL \$39 Creates graphic-tree of caller/called structures, and files-vs-procedure table-of-contents
- C-HDR \$39 Creates/inserts/updates headers for each procedure showing caller/called and identifiers
- C-LIST \$26 List, action-diagram, reformt programs
- C-REF \$29 Local/global/parameter cross reference
- SPECIAL \$99 All 4 plus integrated C-DOC version

SOFTWARE BLACKSMITHS INC.

6064 St. Ives Way, Mississauga, ONT Canada L5N-4M1
(416) 858-4466

Inquiry 602.

CROSS ASSEMBLERS

CROSS ASSEMBLERS

Universal Linker, Librarian

Targets for 36 Microprocessors
Hosts: PC/MS DOS, micro VAX, VAX 8000

Developed and supported at:

ENERTEC, INC.

BOX 1312, Lansdale, PA 19446
215-362-0966 MC/VISA

Inquiry 603.

THE BUYER'S MART

CROSS ASSEMBLERS

Professional Series

PseudoCode releases it's PseudoSam Professional Series of cross assemblers. Most popular processors. Macros, Conditional Assembly, and Include Files. Virtually unlimited size. For IBM PC's, MS-DOS 2.0 or greater. With manual for \$35.00. Each additional \$20.00. (MI res. 4% tax). Shipping \$5, Canada \$10, Foreign \$15. Visa/MC. (Dealer Inquiries Welcome).

Kore

6910 Patterson, Caledonia, MI 49316
616-791-9333

Inquiry 604.

CROSS ASSEMBLERS

Macros, PC Compatible, Relocatable, Conditionals, Fast, Reliable from \$150

also: Disassemblers

EPROM Programmer Board

MICROCOMPUTER TOOLS CO.

Phone (800) 443-0779

In CA (415) 825-4200

912 Hastings Dr., Concord, CA 94518

Inquiry 605.

680X0 Cross Assemblers

Now, inexpensive quality 680X0 Cross Assemblers that use your IBM PC or compatible. All versions include extensive listing facilities, up to 32 char labels, sorted symbol tables, INCLUDE files, PATH names, ORG, DC, DS, EQU, many other directives (except MACROS), printed manuals. Basic versions create S-records. Linking versions create either S-records or relocatable modules, and include a linker which creates S-records or binary output files. Not copy protected. Minimum requirements are 320K, DOS 2.0X, & 16V+ DSD01.

Basic 68000/68010—\$49.95 Linking 68000/68010—\$89.95

Basic 68020—\$69.95 Basic 68020/68881—\$129

Checks, VISA, MC accepted. MN residents +6% sales tax. No PO's or COD's, please.

RAVEN Computer Systems

Box 12116, St. Paul, MN 55112 (612) 636-0365

Inquiry 606.

6800-Family Development Software

Combine our software and your PC for a powerful development system for the Motorola 6800, 6801, 6809, and 68HC11. Our C Compilers feature a complete implementation (excluding bit fields) of the language as described by K&R and yield 30-70% shorter code than other compilers. Our Motorola-compatible Assemblers feature macros and conditional assembly. Linker and Terminal Emulator included.

Wintek Corporation

1801 South St., Lafayette, IN 47904

(800) 742-6809 or (317) 742-8428

Inquiry 607.

Z80/HD64180

Cross assemblers run on PC and are compatible with Microsoft M80/L80. \$195.00 for assembler and linker. We have CP/M emulator cards for PC. Up to 12.5 mhz Z80 clock speed, starting at \$249.95! Also Z80/HD64180 C compilers.

Z-World

1772 Picasso Ave., Davis, CA 95616 (916) 753-3722

Inquiry 608.

DATA CONVERSION

MEDIA CONVERSION/DATA TRANSLATION

More than just a straight dump or ASCII transfer!

Word Processing, DBMS, and Spreadsheet data on Disk or Tapes transferred directly into applications running on Mainframes, Minis, Micros, Dedicated Word Processors, Typesetters, and Electronic Publishing systems.

IBM PS/2 & Macintosh supported
#1 in the translation industry!

CompuData Translators, Inc.

3325 Wilshire Blvd., Suite 1202, Los Angeles, CA 90010

(213) 387-4477 1-800-825-8251

Inquiry 609.

DATA CONVERSION

CONVERT

W-2's AND 1099's
TO MAGNETIC MEDIA
FOR IRS

FROM 75¢ PER RECORD
APPROVED SERVICE BUREAU

DataCopy Service of Texas

3306 W. Walnut #400, Garland, Texas 75042

(214) 272-7751

Inquiry 610.

DATABASE MGMT SYSTEMS

FREE TRIAL dBASE III CLON!!

"1 on 1 is a programmable relational DBMS . . . The menu mode is a fancier and more complete version of DBases's assistant mode. . . 1 on 1 + 311 is a great deal for those who would be glad to have a dBASE III PLUS clone!"

** PC MAGAZINE 5/17/88 **

Free 30 day trial full program USA only or Buy now get free upgrade. Money back guarantee \$99 + \$5. S/H chkl/Amex. CAN +\$4. Other +\$10. Call or write:

1 on 1 Computer Solutions

26 Finchwood Dr., Trumbull, CT 06611 203-375-0914
dBASE III is a trademark of Ashton-TATE

Inquiry 611.

DATA/DISK CONVERSION

QUALITY CONVERSIONS

• Disk • Scanning • Tape

*TYPEWRITTEN \$33 per page to ASCII

*TYPESET 6-24 point Low Rates

(*WP Formats available)

IMAGES

Logos/Line Art/Glossies

1st Run Computer Services Inc.

1261 Broadway, Suite 508, New York, NY 10001

(212) 779-0800

Inquiry 612.

Get the Expertise You Need!

Disk/Disk • Tape/Disk • OCR

Over 1,000 formats! 3 1/2, 5 1/4, or 8 inch disks; 9 track mag tape; 10 MB Bernoulli cartridge. Data base and word processor translation. Specialists in Government Security Data. Call for free consultation.

Computer Conversions, Inc.

9580 Black Mt. Rd., Ste J, San Diego, CA 92126

(619) 693-1697

Inquiry 613.

DISK CONVERSIONS

Media transfer to or from: IBM, Xerox, DEC, Wang, Lanier, CPT, Micom, NBI, CT, also WP, WS, MS/NWRD, DW4, MM, Samna, DEC DX, MAS 11, Xerox-Writer, ASCII.

FREE TEST CONVERSION

CONVERSION SPECIALISTS

531 Main St., Ste. 835, El Segundo, CA 90245

(213) 545-6551 (213) 322-6319

Inquiry 614.

DISK & TAPE CONVERSIONS AUTOMATICALLY

SAVE TIME AND MONEY

Over 1000 formats from Mini, Micro Mainframe, Word Processors, & Typesetters.

TAPE Conversions as low as \$23.00 MB

DISK Conversions as low as \$15.00 per Disk

Call or write TODAY for a cost saving quotation.

CREATIVE DATA SERVICES

1210 W. Latimer Ave., Campbell, CA 95008

(408) 866-6080

Inquiry 615.

DATA/DISK CONVERSION

DISK INTERCHANGE SERVICE COMPANY

DISC specializes in transferring files between incompatible disk formats, and between disk and 9-track tape.

- Dedicated Word Processors
- Mini, Micro & Mainframe Computers
- 9-Track Tape (800, 1600 and 6250 BPI)
- MSDOS, CP/M, UNIX, DOS, PRODOS, TSX+, RT-11

2 Park Drive • Westford, MA 01886

(508) 692-0050

Inquiry 616.

MAG TAPE ↔ Disk Disk ↔ Disk

- We are PC & MAC experts
- Lowest prices guaranteed
- All PC's, MAC's, micros, minis & mainframes supported.

Integrated Data Service

5439 Seneca Place, Simi Valley, CA 93063

(805) 584-0023

Inquiry 617.

IBM PC ↔ to ↔ HP FILE COPY

IBM PC to HP File Cop allows IBM PCs, PS/2, compatibles to read, write files written by Hewlett Packard Series 70, 80, 200, 300, 1000, 9000's. We offer custom work using our file copy utilities and program translators. Call for estimate, catalog, data sheet.

Oswego Software 312/554-3567
507 North Adams St. Fax 312/554-3573
Oswego, Illinois 60543 Telex 858-757

Inquiry 618.

CONVERSION SERVICES

Convert any 9 track magnetic tape to or from over 1000 formats including 3 1/2", 5 1/4", 8" disk formats & word processors. Disk to disk conversions also available. Call for more info. Introducing OCR Scanning Services.

Pivar Computing Services, Inc.

165 Arlington Hgts. Rd., Dept. #B
Buffalo Grove, IL 60089 (312) 459-6010

Inquiry 619.

DEMOS/TUTORIALS

INSTANT REPLAY III

Build Demos, Tutorials, Prototypes, Presentations, Music, Timed Keyboard Macros, and Menu Systems. Includes Screen Maker, KeyStroke/Time Editor, Program Memorizer, and Animator. Read Great Reviews! Simply the BEST. Not copy protected. No royalties. 60 day satisfaction money back guar. IBM and Compatib. \$149.95 U.S. Chiv/Cr. Crd. Demo Diskette \$5.00

NOSTRADAMUS, INC.

3191 South Valley Street (ste 252)

Salt Lake Cit., Utah 84109 (801) 487-9662

Inquiry 620.

DISASSEMBLERS

SOFT-X-PLORE

See "BYTE's May '88 issue pg. 78". Disassemble 500 kb (*) program at 10,000/min. (*) in any file, ROM/RAM memory up to 80386 instruction set (*). SOFT-X-plore:

- * is for MS/DOS 2.0+ systems
- * uses 20 algorithms and seven passes (*)
- * only \$729.95 plus S&H w/30 day guarantee.

To order call (800) 446-4656 or info (203) 560-0236

Or write: RJSWANTEK INC.

178 Brookside Rd., Newtonington CT 06111

* best on the market MCVISA accepted

Inquiry 621.

THE BUYER'S MART

DISK COMPATIBILITY

IBM PC's USE Mac DISKS

MatchMaker lets you plug any Macintosh external floppy drive into an IBM PC. Half size card and software lets you copy to/from, view directory, initialize, or delete files on the Mac diskette. Works with PCs, XT's, AT's, and compatibles. The easy way to move information!

\$149.00 Visa/MC/COD/Chk.

Micro Solutions Computer Products
132 W. Lincoln Hwy., DeKalb, IL 60115 815/756-3411

Inquiry 622.

DISK DRIVES

PS/2 DRIVES FOR PC's AT's

CompatiKit/PC \$309
CompatiKit/AT \$250

Built-in floppy controllers—no problem.

Supports multiple drives and formats. Lets your computer use IBM PS/2 1.4M diskettes plus more! Call for further information or to place an order. VISA/MC/COD/CHECK.

Micro Solutions Computer Products
132 W. Lincoln Hwy., DeKalb, IL 60115 815/756-3411

Inquiry 623.

DISK DUPE EQUIPMENT

DO YOUR OWN DUPLICATION

Copy 10,000 or only 10 in as little as 15 seconds each with famous Mountain Duplication equipment at the very best prices!! See us for all of your duplication equipment needs from Disks to Drives to Duplicators.

SYSTEMS SUPPORT DATA

223 North Royal Avenue, Front Royal, VA 22630
1-800-231-4355

Inquiry 624.

DISK DUPLICATION

WE COPY YOUR DISKS FOR LESS

- Specializing in duplicating disks provided by the customer
- 3 1/2" or 5 1/4"
- 5 1/4" PRICES — 22 cents to 30 cents a disk!!
- 3 1/2" PRICES — 35 cents to 50 cents a disk!!
- Bad disks returned
- Fast turnaround
- You choose the quality of the disk, we'll duplicate them!!
- We can help with labels, sleeves, printing — just ask
- No hidden costs

DISK-O-DATA

366 Massachusetts Ave., Suite 303, Arlington, MA 02174
800-848-8408 617-646-6703

Inquiry 625.

SOFTWARE PRODUCTION

- Disk duplication
- All formats
- EVERLOCK copy protection
- Label/sleeve printing
- Full packaging services
- Warehousing
- Drop shipping
- Fulfillment
- 48-hour delivery
- Consultation & guidance

Star-Byte, Inc.

713 W. Main St., Lansdale, PA 19446
215-368-1200 800-243-1515

Inquiry 626.

DUPLICATION IS THE SINCEREST FORM OF FLATTERY

Let us Flatter you!!! See us for all disk duplication needs. 10 disks to 100,000 and more All formats—All systems. Best prices—Our own in-house printing of documentation—labels-sleeves.

SYSTEMS SUPPORT DATA

223 North Royal Avenue, Front Royal, VA 22630
1-800-231-4355

Inquiry 627.

DISKETTES

CHEAP DISKS!!!

Although this headline may not convey quality. . . . our 3 1/2" floppy disks do!

100% Certified

720k only 98¢

1.44 MEG only \$2.60

SYSTEMS SUPPORT DATA

223 North Royal Avenue, Front Royal, VA 22630
1-800-231-4355

Inquiry 628.

DUPLICATION SERVICES

SOFTWARE DUPLICATION

- One Stop Shopping
- Custom Packaging
- Copy Protection
- Technical Support
- Drop Shipping
- Fast Turnaround
- Competitive Pricing

SATISFACTION GUARANTEED

800-222-0490 NJ 201-462-7628

MEGASoft

P.O. Box 710, Freehold, NJ 07728 See our ads on page 411.

Inquiry 629.

SOFTWARE KIT PACKAGING

OEM supplier to one of the world's largest computer companies offers quality packaging for your computer products. Quality products reflecting your companies image is our highest priority. Ask about PREFORMATTED DISKETTES for R&D. Call or write.

UNISPEC CORPORATION

4845 Transit Road Unit K-8, Depew, NY 14043
(716) 633-2810 Fax (716) 633-2813

Inquiry 630.

ELECTRONIC PROJECTS

BUILD TALKING ROBOT!

- Build B.E.R.T.® the Basic Educational Robot Trainer
- Featured in BYTE April & May / 87
- Even a child can program this talking Robot, built from off-the-shelf components
- Minimum Kit \$50.00 U.S.
- Complete Kit \$180.00 U.S.
- +10% S/H VISA welcomed
- For further information write to:

GoCo Dist.

Suite 808, 1146 Harwood St., Vancouver, B.C. Canada V6E 3V1
VISA orders only: 604-681-0595

Inquiry 631.

ENTERTAINMENT

★ ★ ★ EGA Chess ★ ★ ★

- "Challenging". . . "Relentless". . . —PC Mag
- Fully Animated High Resolution Graphics
- Solves Mate In 7. . . On Screen Clock
- Huge Opening Book. . . Select Level
- Save/Restart/Print Your Own Games
- Requires 256K EGA/VGA 5.25" disk
- \$34.95 (\$5.00 for Demo)

CUBE Microsystems

P.O. Box 26064, Overland Park, KS 68225
(913) 649-6747 VISA/MC

Inquiry 632.

NEMESIS™ Go Master®

Go, a game of strategic elegance, has been a way of life in the Orient for over four thousand years. Many consider Go to be the secret of the Japanese businessman's success. "While chess is a game of war; Go is a game of market share" [President of Nikko Hotels].

"If you are interested in Go, buy this program."
Game of the Month J. Pournelle BYTE 7/87

Toyogo, Inc. The Leader in Computer Go.
78 Bedford St. #34-Y, Lexington, MA 02173, (617) 861-0488

Inquiry 633.

ENTERTAINMENT

BEAT THE LOTTERY

\$5 Demo Disk of Gall Howard's **Smart Luck Computer Advantage™** for your favorite Lotto game. (Please specify.)

FREE... with your Demo disk order. . . Gall Howard's 64-page **Pocket Guide to Lottery Winning Wheeling Systems.** Send check or money order for \$5 for 5 1/4" (\$6 for 3 1/2") demo disk to: **Smart Luck Computer Systems**
Dept. B-5, P.O. Box 1519, White Plains, NY 10602

Inquiry 634.

FLOW CHARTS

FLOW CHARTING II+ HELPS YOU!

Precise flowcharting is fast and simple with **Flow Charting II+**. Draw, edit and print perfect charts: bold and normal fonts, 26 shapes — 95 sizes; fast entry of arrows, bypasses & connectors; Fast Insert Line; shrink screen displays 200-column chart; 40 column edit screen for detail work, much more!

PATTON & PATTON

81 Great Oaks Blvd., San Jose, CA 95119

1-800-525-0082 (Outside CA)

408-629-5376 (CA/Int'l)

Inquiry 635.

STRUCTURED FLOW CHART

NSChart creates Nassi-Shneiderman (structured) flowcharts from a simple PDL. Keywords define structures & text strings appear in the chart. Easy to create, even easier to revise! Automatic chart sizing, text centering. Translators from many languages available. For Mac and IBM PC.

SILTRONIX, INC.

P.O. Box 82544, San Diego, CA 92138

1-800-637-4888

Inquiry 636.

HARDWARE

DIGITAL SIGNAL PROCESSOR

DSP products for the IBM PC/XT/AT based on the TI TMS32010 and TMS320C25. Designed for applications in communications, instrumentation, speech, and numeric processing. Offered with 12 bit 80 KHz A/D and D/A and continuous data acquisition & playback option. \$650 and up.

DALANCO SPRY

89 Westland Ave., Rochester, NY 14618

(716) 244-6007

Inquiry 637.

CHIP CHECKER

- 74/54 TTL + CMOS
- 14/4000 CMOS
- 14-24 Pin Chips
- 8000 Nat. + Signetics
- 9000 TTL
- 3" + .6" IC widths

Tests/Identifies over 650 digital chips with ANY type of output in seconds. Also tests popular RAM chips. IBM compatible version \$259. C128 + C64 version \$159.

DUNE SYSTEMS

2603 Willa Dr., St. Joseph, MI 49085

(616) 983-2352

Inquiry 638.

INDUSTRIAL STRENGTH SINGLE BOARD COMPUTER

Has optimum features for monitor + control applications:
16 Chan A/D • 4 RS232/422 Ports • 48 Prog I/O Lines
• 8 Opto INs • 8 HiDrive OUTs • 4 Timers • Watchdog
• 104K Memory • 5.25 x 8.0 Options: Resident FORTH OS with Target Compiler, Editor, Assembler, + Auto Load/Start; 5 MHz 8085 • 4 Chan DIA • Battery Backed Clock/RAM • Networking • PC Support.

E-PAC 1000+ \$249.00 E-PAC 2000+ \$448.00

EMAC INC.

P.O. Box 2042, Carbondale IL 62902 (618) 528-4525

Inquiry 639.

THE BUYER'S MART

HARDWARE

FREE CATALOG

Protect your computer power from black-outs, brown-outs, audio/video hash and surges! Complete line of low cost Emergency Power Supply units, Line Conditioners and Surge Suppressors prevent damage and loss of valuable data. Prevent errors, malfunctions and false printouts! Send for money saving catalog today.

INDUS-TOOL

730 W. Lake St., Chicago, IL 60606
Phone 312-648-2191

Inquiry 640.

Rack-Mounted AT 286 or 386

Industrial, Med-Tech, Laboratory and Comm. needs
Intel 80286 or 80386 CPU daughter card
Passive back plane (5-10 expansion slots)
Fits standard 19" rack
Heavy-duty dual fans
Clean air filter
High-speed, high-quality hard disk available
Slide-mounted CPU chassis for easy maintenance access
Power supply up to 360 Watts. For details and prices, Contact:

(516) 589-8666

International
Telecommunications Services

Inquiry 641.

LATEST AWARD BIOS

PC/XT * 286 * 386

Support For:

- Enhanced Keyboards
- EGA & VGA Graphics
- 3.5" Floppies & More...

Authorized AWARD Distributor

Call 1-800-423-3400

KOMPUTERWERK, INC.
851 Parkview Blvd., Pittsburgh, PA 15215

Inquiry 642.

Apple • Service Parts
• Accessories • Systems •
BUY ★ SELL ★ TRADE
PRE-OWNED Electronics, Inc.

30 Clematis Avenue, Waltham, MA 02154
800-274-5343 FAX 617-891-3556
Service Centers and Dealers welcome

Inquiry 643.

HARDWARE/COPROCESSOR

SCI/FOX™ PARALLEL COPROCESSOR

PC/XT/AT/386 plug-in board with Fort software. 10 MIPS operation, up to 50 MIPS burst. 64K to 1M byte memory. Uses Harris RTX 2000™ RISC realtime CPU with 1-cycle multiply, 1-cycle 14-priority interrupts, two 256-word stacks, three 16-bit timer/counters, 16-bit i/o bus. Ideal for real-time control, signal and image processing and multiple board operation. From \$1,995.

SILICON COMPOSERS, INC. (415) 322-8763
210 California Ave., Suite K, Palo Alto, CA 94306

Inquiry 644.

INVENTORY MANAGEMENT

STOCK-MASTER 4.0

Commercial grade inventory management software at micro prices.

- Supports all 12 transaction types
- Trend Analysis
- Quality Control
- Multiple Locations
- Purchase Order Tracking
- Open Order Reporting
- Serial/Lot # Tracking
- Stock Status Reporting
- Activity History Analysis
- Bill of Materials
- Purchase Order Writing
- Order Entry
- Material Requirements
- On Line Inquiry

Applied Micro Business Systems, Inc.
177-F Riverside Ave., Newport Beach, CA 92663 714-759-0562

Inquiry 645.

LANS

Are you about to spend thousands of dollars for

Novell or 3-COM?

The Invisible Network does the same thing, but costs only \$249 per machine. True NETBIOS-compatible Local Area Network with high-speed 1.8 Mbps interface cards, cables, and all networking software. Works great with Multi-user dBASE, Clipper, QuickSilver, FoxBASE+, and all other file-sharing and multi-user software.

Database Specialties (415) 652-3630
P.O. Box 2975, Oakland, CA 94618

LAPTOP COMPUTERS

LAPTOP SPECIALS

Toshiba • Zenith • NEC • DATAVUE • SHARP •
NEW! Hard drives available for Tandy 1400 LT &
Toshiba 1100+ • AFFORDABLE 5¼" or 3½"
DRIVE UNITS for LAPTOPS & DESKTOPS •
DICONIX PRINTERS • 768 card for T1000 • 2400
BAUD MODEMS for Laptops • Fast reliable and
friendly service. For LOW Pricing call

COMPUTER OPTIONS UNLIMITED
201-469-7678 (7 Days, 9 am-10 pm Eastern time)

Inquiry 646.

2 PC - FILE TRANSFER UTILITY

2 PC: Connects any two PC's for file transfer and communication. Features * 115,200 baud transfer rate * directory trees * chat mode * file tagging/viewing/deletion * print facility * universal cable * free cable wiring diagram (so you can "rod your own" cable) * 3¼" & 5¼" disks. Complete - \$55 (List: \$80), w/o cable - \$45. 2PC Lite: Less Expensive, Works Great! Complete - \$40 (List: \$50), w/o cable - \$30. RJ-11 cables optional. Both programs have 43-line mode.

Cables sold separately: ser/par, kbd, mon, & others

Thompson Computing, 587F N. Ventu Park Road,
Suite 306, Newbury Park, CA 91320, (805) 498-7653.
VISA/MC add 4%. \$3.50 S/H.

Inquiry 647.

LAP - LINK

The ultimate solution for linking laptop computer with any IBM compatible desktop PC. 115,200 baud transfer rate—faster than any other product available. No installation necessary, easy to use split screen design. Includes incredible "universal cable" that connects any two computers. Transfer entire disks faster than a DOS copy command! Only \$129.95 including universal cable and both 3¼" and 5¼" disks. "Bridge" owners can trade in for only \$89.95 w/o cable.

Travelling Software, Inc.

18702 North Creek Parkway, Bothell WA 98011
1-800-343-8080 (206) 483-8088

Inquiry 648.

MEMORY CHIPS

MEMORY CHIPS

41256-15-12-10	Call	51000 (1 Meg)	Call
48K-15	Call	51256 for Compaq 386	Call
4164-12	Call	8087-32	Call
41128 Piggy Back for AT	Call	80287-6-8-10	Call
41464-12 (84Kx4)	Call	80367	Call
414256 (256Kx4)	Call	NEC-A-20-B	Call
2764-27128, 27256, 27512	Call	Mouse	Call

Prices subject to change

ESSKAY 718-353-3353

Inquiry 649.

MONITOR INTERFACE

DRIVE MULTIPLE MONITORS

with one PC using our VOPEX video port expanders. Featuring no loss of resolution or color, presentations are more dramatic. We have a VOPEX for PC, PS/2, MAC II & workstations. Units are available from 2 to 10 output ports.

NETWORK TECHNOLOGIES INC.
800-RGB-TECH or 218-543-1646 MC/VISA/AMEX
19145 Elizabeth St., Aurora, OH 44202

Inquiry 650.

PC BOARDS

P-C-B ARTWORK MADE EASY!

Create and Revise Printed-Circuit-Artwork on your IBM or Compatible
* Help Screens * Dip & Sip Library
* Printer and Plotter Artwork * Supports Mice
* Auto-Router available * ICON Menus
Requirements: IBM or Compatible PC, 384K RAM, DOS 3.0 or later. PCBboards: \$99.00 DEMO: \$10.00

PCboards

2110 14th Ave. South, Birmingham, AL 35205
(205) 933-1122

Inquiry 651.

80 programs for IBM PC

Games, quizzes, trivia, utilities, antiviral, programming techniques, how to use DOS and BIOS. All in super fast assembly language. Includes source code and software license.

DISK1—360K \$5 720K \$6 Book—\$18

Zipfast electronics

Box 12238, Lexington, KY 40581-2238

Inquiry 652.

POETRY PROCESSOR

remember... **POETRY PROCESSOR** BYTE 2/85 pp 221-228?

Michael Newman's **POETRY PROCESSOR**, is now available for IBM PCs & compatibles. Includes text editor, form editor & templates, 25,000-word rhyming dictionary, automated metrical scansion, rhyme check, user "Instant Anthology" network... \$89.95
"Should delight anyone who loves words... Justifies a recommendation..." Peter H. Lewis, N.Y. Times... "downright user-sympathetic." *Washington Post*

Call 201-525-2122 for details on ordering **POETRY PACKAGE** — also incl. N.E.R.D. a slant/internal rhyme dict. \$59.95 & ORPHEUS A-B-C, a poetry tutorial \$49.95 at special XMAS discount. Or send ck or mto to:

Michael Newman

cto The Paris Review, 541 E. 72nd St., NYC, NY 10021

PROGRAM SUBCONTRACT

In a Time Jam?

Let us do your software work in TPascal or TC or M/C. Guaranteed fast turn, low price and satisfaction. To your specs or we'll design tool

Automated Software

3239 Mill Run, Raleigh, NC 27612
800-227-7681 or 919-782-9045

Inquiry 653.

PROGRAMMERS TOOLS

TURBO SCREEN MASTER

Produce data entry screens and help windows for Turbo Pascal and Turbo C. Menu-driven, context sensitive help, configurable edit commands, flexible data validity checking, colors, IBM-PC graphics characters. Generates Pascal and C source code. Only \$69.95 plus \$3.00 S&H. WA residents add 7.8%.

BLUE BRIDGE SOFTWARE

7401 W. Canal Drive, Suite 343
Kennewick, WA 99336
(509) 627-6729

Inquiry 654.

TLIB™ 4.1 Version Control

"TLIB" is a great system!" — *PC Tech Journal* 3/88. Full-featured configuration mgmt for software professionals. All versions of your code instantly available. Very compact, only changes are stored. Check-in/out looks, revision merge, branching, more. Mainframe deltas for Pansophic, ADR, IBM, Unisys, MS-DOS. \$99.95, or 5-station LAN \$299.95 + shipping

BURTON SYSTEMS SOFTWARE

P.O. Box 4156, Cary, NC 27519 (919) 856-0475

Inquiry 655.

THE BUYER'S MART

PROGRAMMERS TOOLS

FORTRAN NAMELIST EMULATOR

NAMLST™ subroutine library provides Fortran programmers with an emulation of NAMELIST and associated read and write routines. Supports Fortran 77 data types, 31 character names, control of output line length, tab stops, paging, plus features not found in compilers with NAMELIST statements. Popular Fortran 77 compilers. Literature available. Price \$150.

Data Ready

4647 T Highway 280 E— Suite 150, Birmingham, AL 35242
(205) 991-6381

Inquiry 656.

Programmer's Calculator

See "What's New" pg. 78, BYTE Nov. 1988. Memory resident & stand alone. Results in BIN, OCT, DEC & HEX simultaneously. Fully customizable! Tutorial and thorough documentation. \$29.95

Falk Data Systems

5322 Rockwood Ct., El Paso, TX 79932
(915) 584-7670

Inquiry 657.

DEVELOPMENT TOOLS

Professional Programmers Extender: Standard Mac interface, lists, printing, graphics, tiling. Extender GraphPac: Quality color graphs. Line, bar, semi-log, customizable symbols.

INVENTION Software (313) 996-8108

Inquiry 658.

TURBO PLUS \$149.95

Programming tools for Turbo Pascal 5.0 Screen Painter, Code Generator, I/O Fields, Dynamic Menus, Programming Unit Libraries, Sample Programs, 280 Page Illustrated Manual, 60 Day Satisfaction Guarantee! Brochures & Demo Diskettes avail. Highly Favorable Reviews! IBM & Compatibles.

Nostradamus Inc.

3191 South Valley St. (Suite 252) Salt Lake City, UT 84109
(801) 487-9662

Inquiry 659.

Get INSIDE!

INSIDE! is a powerful software performance analysis tool for popular PC compilers. INSIDE! measures the execution time of every function or procedure with microsecond accuracy or computes how often each source line is executed. Simply compile your application and INSIDE! does the rest. \$75. VISA/MC/COD

Paradigm Systems Inc.

P.O. Box 152, Milford, MA 01757
(800) 537-5043 In MA: (508) 478-0499

Inquiry 660.

Modula-2 DBMS: \$39

ModBase 2.0 is a B-Tree file manager that uses Ashton Tate's dBase III data file format. New version is four times faster than previous release and includes all new manual, plus advanced features such as automatic index file maintenance. For JPI, Logitech, Stony Brook, FST compilers. \$39 price includes all source code. Ask about our screen, graphics, EMS, engineering, Btrieve and Netware support libraries, too. *MC/VISA/AMEX/PC/COD.*

PMI

4536 SE 50th, Portland, OR 97206
(503) 777-8844; FAX: (503) 777-0934

Inquiry 661.

PROGRAMMERS TOOLS

FREE BUYER'S GUIDE

Programmer's Connection is an independent dealer representing more than 300 manufacturers with over 800 software products for IBM personal computers and compatibles. We have serviced the professional programmer since 1984 by offering sound advice and low prices. Call or write today to receive your FREE comprehensive Buyer's Guide.

Programmer's Connection US 800-336-1166
7249 Whipple Ave. NW Canada 800-225-1166
North Canton, OH 44720 International 216-494-3781

Inquiry 662.

DISASSEMBLERS

MPU OBJECT CODE on your PC

Relocatable, symbolic disassemblers are now available for the Motorola, Intel, RCA, TI, Rockwell, & Zilog micros! Automatic label generation, assembly capability and much more. Call and ask for what you need.

RELMS™

P.O. Box 6719, San Jose, CA 95150
(408) 356-1210

TWX 910-379-0014 (800) 448-4880

Inquiry 663.

Copyright your software with:

"Copyright-it®"

Runs on IBM PC, XT, AT,
and compatibles.

Send \$25 check to:

synthetic intelligence™
New York 286 Fifth Ave. #707, NY 10001

Inquiry 664.

PUBLIC DOMAIN

OUTSTANDING IBM SOFTWARE ONLY \$2.75/DISK OR LESS

Our collection contains the latest versions of the Best Shareware and Public Domain Programs. Most are menu driven with full documentation. 350" format is also available. Orders shipped First Class Within 24 hours and Satisfaction is guaranteed. Write for free printed catalogue or send a 25¢ stamp for a disk catalogue.

A.C.L. (916) 973-1850

1621 Fulton Ave., Suite #35-B, Sacramento, CA 95825

Inquiry 665.

\$3.00 SOFTWARE FOR IBM PC

Hundreds to choose from, wordprocessors, databases, spreadsheets, games, lotto, communications, business, music, bible, art, education, language and useful utilities for making your computer easier to learn. Most programs have documentation on the disk.

WRITE FOR YOUR FREE CATALOG TODAY!

BEST BITS & BYTES

P.O. Box 8245 Dept-B, Van Nuys, CA 91409
In CA: (818) 781-9975 800-245-BYTE

Inquiry 666.

FREE SOFTWARE BEST OF PUBLIC DOMAIN & SHAREWARE.

Carefully selected and edited programs for I.B.M.
Send S.A.S.E. for free catalog.

C.C.S., Inc. Dept. B1
P.O. Box 312, Lafayette Hill, PA 19444

Inquiry 667.

PUBLIC DOMAIN

FREE CATALOG PUBLIC DOMAIN/SHAREWARE

• 400 IBM PC & compatibles disks •
200 Amiga disks • 125 Atari ST disks
PC disks as low as \$1.25 each, Amiga & ST as low as \$1.60 each! Rent or buy. *Free shipping!* Call toll free, write or circle reader service for FREE BIG CATALOG with full descriptions. Please specify computer—48 hr. turnaround!

Computer Solutions

P.O. Box 354—Dept. B, Mason, Michigan 48854
1-800-874-9375 (M-F 10-6 EST) 1-517-628-2943

Inquiry 668.

RENT SOFTWARE \$1/DISK

Rent Public Domain and User Supported Software for \$1 per diskfull or we'll copy. IBM (3 1/2" also), Apple, C-64, Sanyo 550 and Mac. Sampler \$3. VISA/MC. 24 hr. info/order line. (619) 941-3244 or send #10 SASE (specify computer) Money Back Guarantee!

FutureSystems

Box 3040 (T), Vista, CA 92083
office: 10-6 PST Mon-Sat. (619) 941-9761

Inquiry 669.

FREE IBM SOFTWARE

FREE CATALOG also contains SHAREWARE, 5 1/4 and 3 1/2-inch. All categories. ENGINEERING, CAD, DESKTOP PUBLISHING, LANGUAGES, UTILITIES, BUSINESS, GRAPHICS, SPREADSHEETS, WORD PROCESSORS, CHURCH, MEDICAL, HEALTH, EDUCATION, HOME.

SECTOR SYSTEMS COMPANY, INC.

Dept. 81, 418 Ocean Avenue, Marblehead, MA 01945
(617) 639-2625

Inquiry 670.

INEXPENSIVE DISK SUBSCRIPTION

25 double sided disks a year packed with the ultimate games programs and utilities. Also information about everything in life business and personal, designed to get everything and anything you desire from life fast and easily. **GUARANTEED** One double sided disk every two weeks. Also along with your regular subscription we'll even send you an extra disk based catalog 4 times a year featuring over 8000 products of all kinds 40 to 80¢ below retail. Use this wholesale catalog for the savings or to make huge profits. This disk subscription will change your life financially, technically as well as humanly. So we invite you to enhance your life and broaden your horizons. Join us now and get 30 disks for this low price of only \$29.95 that's only 99 cents for each fully packed double sided disk. The greatest investment you will ever make. For IBM PC/XT/AT and compatibles. Send check or money order to:

Smart Work International
14 Carmie Dr. Lake Hopacon, NJ 07849

Inquiry 671.

FREE SOFTWARE

Buy or Rent \$1/disk

World's largest Free Software Library of IBM PC & Compatibles and Macintosh. Over 3000 programs for Religion, Utilities, Business, Com., Word Processor, Education, and Games on 5.4" and 3.5" format. Best quality, Lowest rate, and Fastest service. For fast free catalogue write to:

SOFTSHOPPE

P.O. Box 15022, Ann Arbor, MI 48106
(313) 763-8721

Inquiry 672.

FREE SOFTWARE

We send you 15-20 new IBM programs a month on 5 disks—FREE! You pay only \$5. shipping/handling. Annual membership reg. \$29.95. Join today for only \$9.95 and we'll send you over 30 programs on 10 disks as a bonus—FREE! No gimmicks—no catches!

toll free 800 669-2669 ext 348

SOFTWARE of the MONTH CLUB
we take visa/mastercard/amax

Inquiry 673.

THE BUYER'S MART

SECURITY

THE ULTIMATE COPY PROTECTION

- Completely Menu Driven
- Defeats All Hardware/Software Copiers
- No Source Code Changes
- Multiple Layering
- No Damaged Media
- Full Hard Disk Support
- Unlimited Metering
- FREE Demo Disk

Quite Simply The Best Way To Protect Your Valuable Software Investment

STOPCOPY™ \$325⁰⁰ STOPCOPY PLUS™ \$450⁰⁰

BBi COMPUTER SYSTEMS®
14105 Heritage La., Silver Spring, MD 20906 (301) 871-1094

Inquiry 674.

PRIVACY-YES/VIRUS-NO

TOBY™ is a complete and powerful software package for the protection of privacy and integrity of all data files such as spreadsheets, data bases, word processing, graphics, CAD/CAM files, etc. Special format converters for modern VBI use included. TOBY employs simple menu-driven commands featuring helpful user dialogue. A clear, concise instruction manual is included for initial orientation. For the IBM PC line and true compatible computers (8037, 80387 or 80387) required, program memory 38K. Specially 5.25" or 3.5" media. TOBY features a practical yet serious cryptographic capability based on the professionally-respected algorithm of MacClean and Marsaglia (no DES, no RSA); US sales only. Check or MO for \$125 (Mass orders add \$15).

CSI

P.O. Box 98, Newton, MA 02168

Inquiry 675.

BIT-LOCK® SECURITY

Pinacy SURVIVAL 5 YEARS proves effectiveness of powerful multilayered security. Rapid decryption algorithms. Reliable/remote port transparent security devices. PARALLEL or SERIAL port. Complemented by economical KEY-LOCK™ and multifunctioned COMPU-LOCK™ including countdown, timeout, data encryption, and multiproduct protection.

MICROCOMPUTER APPLICATIONS

3167 E. Otero Circle, Littleton, CO 80122

(303) 922-6410/770-1863

Inquiry 676.

COPY PROTECTION

The world's leading software manufacturers depend on Sofguard copy protection systems. Your FREE DISKETTE introduces you to SuperLock™—invisible copy protection for IBM-PC (and compatibles) and Macintosh.

- Hard disk support
- Customized versions
- No source code changes
- LAN support
- New upgrades available

(408) 773-9680

SOFTGUARD SYSTEMS, INC.

710 Lakeway, Suite 200, Sunnyvale, CA 94088
FAX: (408) 773-1425

Inquiry 677.

SOFTWARE/ACCOUNTING

dBASE BUSINESS TOOLS

- General Ledger
- Accounts Recvbl.
- Order Entry
- Sales Analysis
- Purch Ord/Inventory
- Accounts Payable
- Job Costing
- Job Estimating

\$99 EA. + s&h w/dBASE 2, 3 or 3+ SOURCE CODE

dATAMAR SYSTEMS™ Cr. Crd/Chk/COD

4876-B Santa Monica Ave. San Diego, CA 92107 (619) 223-3344

Inquiry 678.

SOFTWARE/BASIC

QB 4.5 LIBRARIES

Make QuickBASIC 4.5 even better with our FINALLY Family of Products. Programming tools, WINDOWING, Graphics and more! FREE CATALOG of Compiled BASIC Tools. (800) 423-3400.

KOMPUTERWERK, INC.

851 Parkview Blvd., Pittsburgh, PA 15215

Inquiry 679.

SOFTWARE/BASIC

QuickWindows

As seen in the Microsoft Value-Pack Catalog! Create windows, pop-up and pull-down menus, data-entry screens, and multiple-input dialog boxes quickly and easily. Full support of Microsoft mouse. Join the many Fortune 500 companies using QuickWindows and order your copy today. QuickWindows \$79. Advanced \$139. For Microsoft QuickBASIC or BASCOM. See pg.78, BYTE, March '88.

Software Interphase, Inc.

5 Bradley St., Suite 106 • Providence, RI 02908
(401) 274-5465 Call now for Free Demo Disk

Inquiry 680.

SOFTWARE/BUSINESS

DATA ENTRY SYSTEM

Heads-down data entry with two-pass verification for the IBM PS/2-PC/XT/AT & compatibles. Features include: Auto dupskip, verify bypass, range checks, table lookups, a complete edit language. Fully menu driven. Price \$395

Call for our free 30 day trial period.

COMPUTER KEY

21929 Makah Rd., Woodway, WA 98020
Tel: 206/776-6443 USA: 800/356-0203 Fax: 206/776-7210

SOFTWARE/BUSINESS

"HANDWRITING" BY COMPUTER

Now Trash-proof your mailings!

Unique new program "writes" letters and addresses envelopes in script. Many handwriting styles available including ordinary, calligraphy and even Thomas Jefferson! For IBM PC/XT/AT, compatibles and 24-pin dot matrix or HP laser printers.

PC SOFTWARE SERVICES, INC.

16405 Bridge End Rd., Suite 102, Miami Lakes, FL 33014
(305) 362-9277

Inquiry 685.

Simplify the Business of Business

with

SIMPLESOFT'S Business Software

- * General Ledger
- * Accts Receivable
- * Cashflow

\$49.95 each + S&H

*** Write for FREE CATALOG ***

SIMPLESOFT SOFTWARE CORPORATION

1402 E. Guadalupe Road, Suite 228, Tempe, AZ 85283
(602) 831-8105

Inquiry 686.

SOFTWARE/CHURCH

PowerChurch Plus®

Fast, friendly, reliable church administration system. Full fund accounting, mailing lists, membership, contributions, attendance, word processing, accts. payable, payroll, multi-user support, and much more - all for \$695 complete. FREE demo version.

F1 SOFTWARE

P.O. Box 3096, Beverly Hills, CA 90212
(213) 854-0865

Inquiry 687.

THE ASSESSOR SERIES

Research statistics and business planning software... GEOGRAPHIC ASSESSOR cost-of-living/salary levels for 3000+ cities... COMPETITIVE SALARY ASSESSOR rates for 2500+ commonly surveyed jobs... VALUATION ASSESSOR for gift, tax, ESOP planning™; privately held stock... MARKET PLANNING ASSESSOR simulating potential for product sales in 3000+ N. American areas

(\$92 each per quarter, \$279 annual subscription)

ECONOMIC RESEARCH INSTITUTE

801 Dove Street, Newport Beach, CA 92660
(714) 833-9801

Inquiry 682.

ROMAR CHURCH SYSTEMS™

Membership-61 fields plus alternate addresses, labels, letters, reports any field(s). Offering-256 funds; optional pledge; statements; post to 255 w/c; Finance-gen. ledger w/budget; up to 500 subtotals & 99 depts, month & YTD reports anytime for any month. Attendance-8 service times, 250 events per service; 60 consecutive weeks, 78-6555 for floppy, 3 1/2" & hard disk. Add too short! Write for free 48-page guide.

Romar Church Systems, Attn: BJB

P.O. Box 4211, Elkhart, IN 46514

(219) 262-2188

Inquiry 688.

SOFTWARE/ENGINEERING

PRACTICAL ENGINEERING TOOLS

Hobbyists—Students—Engineers

CIRCUIT DESIGN...CompDes, menu selections from basic electricity through circuit designs.
MATHEMATICS...CompMath, menu selections from general math through statistics.
ANALYSIS...CompView, Fourier Analysis of waveforms and filters. PC/MSDOS. \$49 each. VISAMC

BSOFT SOFTWARE (614) 491-0832

444 Colton Rd., Columbus, OH 43207

Inquiry 689.

LetterBase™

New E-Z way to keep track of people AND print dated and self-addressed form letters AUTOMATICALLY. Also does custom letters, labels for rotary desk files and phone directories. Extremely EASY and FAST. Supports Laser Printers. Order today for \$79.95 and receive FREE program to convert standard mail list files. IBM, 384K, HD. Mail today to:

Parkside Computer Systems (714) 638-1888
1241 Landfair, Santa Ana, CA 92705 Visa/MC

Inquiry 684.

Affordable Engineering Software

FREE APPLICATION GUIDE & CATALOG

Circuit Analysis • Root Locus • Thermal Analysis • Plotter Drivers • Engineering Graphics • Signal Processing • Active/Passive Filter Design • Transfer Function/FFT Analysis • Logic Simulation • Microstrip Design • PC/MSDOS • Macintosh • VISAMC

BV Engineering Professional Software

2023 Chicago Ave., Suite B-13, Riverside, GA 30257
(714) 781-0252

Inquiry 690.

THE BUYER'S MART

SOFTWARE/ENGINEERING

Engineer's Aide

Join the Desktop Engineering Revolution!

- Pipeline/Ductwork Sizing
- Office/Control Valve Sizing
- Pump/Fan/Compr. Sizing
- Project Financial Analysis
- Heat Exchanger Sizing
- Conversion Calculator
- Fluid Properties Library
- Specification Writer

Above programs in one stand alone integrated package for \$695. For IBM PC & Macintosh.

EPCON

1-800-367-3585 P.O. Box 270, Woodfield, OH 43793

Inquiry 691.

MATHMATE

Versatile Math software with direct connection to Lotus 1-2-3 for advanced curve fitting and automatic LOG-LOG plots. Powerhouse solutions for more day to day math problems. Includes 3 solvers, 3 calculators and math graphics. \$149. 30 day money back guarantee.

MCAE Technologies, Inc.

3474 Nova Scotia Ave., San Jose, CA 95124
(408) 371-6095

Inquiry 692.

SIMULATION WITH GPSS/PC™

GPSS/PC™ is an IBM personal computer implementation of the popular mainframe simulation language GPSS. Graphics, animation and an extremely interactive environment allow a totally new view of your simulations. Simulate complex real-world systems with the most interactive and visual yet economical simulation software.

MINUTEMAN Software

P.O. Box 171/Y. Stow, Massachusetts, U.S.A.
(508) 897-5662 ext. 540 (800) 223-1430 ext. 540

Inquiry 693.

Circuit Analysis — SPICE

- Non-linear DC & Transient; Linear AC.
- Version 3B1 with BSIM, GaAs, JFET, MOSFET, BJT, diode, etc. models, screen graphics, improved speed and convergence.
- PC Version 2G6 available at \$95.

Call, write, or check inquiry # for more info.

Northern Valley Software

26327 Rothrock Dr., Rancho Palos Verdes, CA 90274
(213) 541-3677

Inquiry 694.

FREE ENGINEERING MAGAZINE

Personal Engineering is a monthly magazine sent free of charge (USA only) to scientists/engineers who use PCs for technical applications. Topics each month include instrumentation • Data Acq/Control • Design Automation. To receive a free sample issue and qualification form either circle below or send request on letterhead to:

Personal Engineering Communications

Box 1821, Brookline, MA 02146

Inquiry 695.

EC-Ace ANALOG CIRCUIT ANALYSIS

You can afford to get started with EC-Ace, a subset of the powerful ECA-2 circuit simulator. Includes all the basics and built-in graphics.

- AC, DC, Temperature, Transient
- A full 525 pg. ECA-2 manual.
- Interactive, twice as fast as SPICE.

EC-Ace 2.31 IBM PC or Mac \$145.

Call 313-663-8610 for FREE DEMO

Tatum Labs, Inc.

1478 Mark Twain Ct., Ann Arbor, MI 48103

Inquiry 696.

SOFTWARE/ENGINEERING

TIME RESPONSE SOLUTIONS

Of control systems and dynamic differential equations, linear and nonlinear, with TUTSIM™, America's #1 choice for Simulation. Block Diagram based simulation language, and FANSIM™ for FFT and Frequency Analysis (see BYTE, Oct., 88, pg 60.). Both programs for IBM PC's.

TUTSIM Products (Formerly APPLIED II)
200 California Ave., Palo Alto, CA 94306
(415) 325-4800

Inquiry 697.

SOFTWARE/FINANCIAL

Historical Stock Market Data

MOLLY (RE: "What's New" BYTE 10/88 p. 84), with over 150,000 daily prices (4 Mbytes) on major indexes many from the 1920s. Including all 3 Dow Indexes, S&P 500, Int. Rates and more for \$199.95. ECONOMIC Database with 160 data series, most begin in the 1940s, for \$159.95. All files are in WK1 format for use with spreadsheets. IBM & Mac. Demo disk \$5.00. Guaranteed!

MarketBase Inc.

250 W 90 St., New York, NY 10024
1-800-MARKETS

Inquiry 698.

SOFTWARE/FORTRAN

FORTRAN77 PROGRAMMER'S ASSISTANTS FREE YOU FOR MORE CREATIVE WORK

ASSISTANT I—12 productivity tools (beautifier, checker, documenter, function maker, action chart, etc.) & a source library with 300 essential subroutines. (MS-DOS) \$245
ASSISTANT II—FORTRAN77-to-C translator with run-time library (source) & 4 C productivity tools. (MS-DOS) \$475 demo \$10. 30 day money back guarantee. ORDER NOW!!

MicroTools

1082 E. El Camino Real #5, Sunnyvale, CA 94067
(408) 243-7888

Inquiry 699.

SOFTWARE/GEOLOGICAL

GEOLOGICAL CATALOG

Geological software for log plotting, gridding/contouring, hydrology, digitizing, 3-D solid modelling, synthetic seismogram, fracture analysis, image processing, scout ticket manager, over 50 programs in catalog. Macintosh too! Please call, or write, for Free Catalog!

RockWare, Inc.

4251 Kipling St., Suite 555, Wheat Ridge, CO 80033 USA
(303) 423-5645

Inquiry 700.

SOFTWARE/GRAPHICS

TurboGeometry Library

Over 150 283 dimensional routines, includes Intersections, Transformations, Equations, HiddenLines, Perspective, Curves, Areas, Volumes, Clipping, Planes, Vectors, Distance, Polydecomp, IBM PC and Comp. MAC, MSDOS 2+, Turbo Pascal, Turbo C, MSC & Turbo Pascal MAC, 400 pg. manual, source code. \$149.95 + 5.00 S&H. Foreign add \$18.00. VISA, MC, Chk. P.O. 30 Day guarantee.

Disk Software, Inc.

2116 E. Arapaho Rd., #487, Richardson, TX 75081
1-800-635-7760
(214) 423-7288 FAX: 214-423-4465

Inquiry 701.

S E G S

SCIENTIFIC & ENGINEERING GRAPHICS SYSTEM

See "What's New" pg 82, BYTE June, 1988 Log, Data & Linear Axes; Curve Fitting & Smoothing 12-3 Interface; Numeric Spreadsheet. Supports all Video Standards, PC Printers & Plotters. 10 Curves w/5000 points each. Plus much more. Call Today.

Edmond Software

3617 Window Drive 1-405-842-0558
Edmond, Oklahoma 73013 1-800-992-3425

Inquiry 701.

SOFTWARE/GRAPHICS

PEN PLOTTER EMULATOR

FPLOTT turns your dot matrix or laser printer into an HP pen plotter. Fast hi-res output. No jagged lines. Vary line width, color. Works with Autocad, Drafrix, etc. Supports NEC P5/P6, IBM Proprietary, Epson LQ/FX, Toshiba, HP Laserjet. Hercules/CGA/EGA/VGA for preview. \$84 check/m.o.

FPLOTT CORPORATION

24-16 Steinway St., Suite 605, Astoria, NY 11103
212-418-8469

Inquiry 702.

GRAPHICS PRINTER SUPPORT

AT LAST! Use the *PrtSc* key to make quality scaled B&W or color reproductions of your display on any dot matrix, inkjet, or laser printer. GRAFPLUS supports all versions of PC or MS-DOS with IBM (incl. EGA, VGA), Techar, and Hercules graphics boards. \$49.95.

Jewell Technologies, Inc.

4740 44th Ave. SW, Seattle, WA 98116
800-628-2828 x 527 (206) 937-1081

Inquiry 703.

FORTRAN PROGRAMMER?

Now you can call 2-D and 3-D graphics routines within your FORTRAN program.

- GRAF/MATIC: screen routines \$135.
- PLOT/MATIC: plotter driver 135.
- PRINT/MATIC: printer driver 135.

For the IBM PC, XT, AT & compatibles. We support a variety of compilers, graphics bds., plotters and printers.

MICROCOMPATIBLES

301 Prelude Dr., Dept. B, Silver Spring, MD 20901 USA
(301) 593-0683

Inquiry 704.

SOFTWARE/INVESTMENT

Compare over 1,300 Mutual Funds with Business Week's Mutual Fund Scoreboard and your IBM PC or compatible. Use simple menu commands to search and sort on over 25 information fields. No additional software required. Data transfers easily to Lotus 1-2-3. Search, sort, a page, rank, display and print reports—at the touch of a key!

Only \$66.95 each for an Equity or Fixed Income Diskette \$199.95 per subscription for either the Equity or Fixed Income version \$319.90 for a subscription to both versions (a savings of \$80)

Order now or request more information by calling 1-800-553-3575 (In Illinois, call 1-312-250-9292)

Or write to: **Business Week Diskettes**
P.O. Box 821, Elk Grove, IL 60009

Inquiry 705.

STOCKS OPTIONS FUTURES

Turn Your PC Into A

MARKET QUOTATION MONITOR
100 page book covers satellite and radio data reception of financial news and quotes for your PC, \$19 (includes demo diskette). Free informative catalog of

- Data receivers and kits
- Quote processing and display software
- Descrambling software utilities

303-223-2120 \$5 Demo Diskette

DATARx

111 E. Drake Rd., Suite 7041, Fort Collins, CO 80525

Inquiry 706.

SOFTWARE/LANGUAGES

FORTHWITH DRUMA FORTH-83

Powerful. Well designed. User friendly. Attractively priced. Enhance productivity. Reduce development time.

- No 64K limit, 16 bit speed to 320K, 1MB+ memory.
- On-line dictionary, full DOS & file interface.
- Assembler, editor, examples, many utilities

15 day unconditional guarantee. From \$76, \$88 \$2, VISAMC. IBM PC/XT/AT & all compatibles. Other packages: Inquire

DRUMA INC.

6448 Hwy. 290 East E103, Austin, TX 78723

Orders: 512-323-0403 BBoard: 512-323-2402

Inquiry 707.

THE BUYER'S MART

SOFTWARE/LANGUAGES

FORTRAN for Macintosh

Language Systems FORTRAN is a full-featured FORTRAN 77 compiler integrated w/MPW. Full ANSI FORTRAN 77 plus VAX-type extensions. SANE numerical calculations & data types incl. COMPLEX*16, 68000, 68020 and 68881 object code. Arrays greater than 32K. Link with Pascal, C, MacApp. \$359 w/MPW via air. MC/VISA/Check. MAC+, SE, Mac II, HD req.

Language Systems Corp.
441 Carlisle Drive, Herndon, VA 22070
(703) 478-0181

Inquiry 708.

EASY TO C

The C Workshop interactive software teaches you C. Do real C program exercises with built-in editor and compiler. Feedback guides you to solution. All you need to learn C, including our 384-page book. \$69.95 + \$5 Ship. PC compatibles.

MC/VISA/AE/Check.

Wordcraft

3827 Penniman Ave., Oakland, CA 94619
(800) 888-0852 x955

Inquiry 709.

SOFTWARE/LASER FONTS

Scalable LaserJet Typefaces

We offer the largest library of high quality typefaces at the lowest price! With the FontMaker program and our scalable typefaces, you can quickly and easily make soft fonts in any size (3-720 pts). You can select the width, slant, rotation, flop, reverse of any font.

Basic Set (8 typefaces, FontMaker) \$69.95
The Typeface Library (264 typefaces) \$489.95

DIGI-FONTS, Inc.

3000 Youngfield St., Lakewood, CO 80215
(800) 242-5665 (303) 233-8113

Inquiry 710.

SOFTWARE/MATHEMATICS

MATH EDITING FOR THE PC

$$x_i^2 = \sum_{k=0}^n \left[x_k^{2n} \binom{n}{k} \right] + \left(\frac{1}{\alpha \pm \beta x} \right)$$

- MathEdit constructs math equations to be inserted into WordPerfect and TeX documents.
- User-friendly interface—no new word processor needs to be learned
- MathEdit—\$149

K-TALK
COMMUNICATIONS

50 McMillen Ave., Suite 100
Columbus, Ohio 43201
(614) 294-3535

Inquiry 711.

What? You've never seen a complex function?

Try $f(z)$ - The Complex Variables Graphing Package for PC's or Macintosh

"Let our animated screens show you what the printed page cannot."
(Ask about our 4D Hypercube)

Lascaux Graphics

(212) 654-7429

Inquiry 712.

SOFTWARE/MUSIC

IBM MUSIC FEATURE CARD!

Option card with 8 voice, multi-timbral MIDI synthesizer on board. Includes 240 pre-programmed Yamaha sounds, 96 programmable patches and a MIDI in/out thru interface. Use two cards to double capacities. An all-in-one MIDI Studio for IBM and compatibles for only \$495. Software available for recording, arranging and educational needs. Packages recommended. Dealers, catalogers, & VARS call for discount schedule.

Distributed by MIX BOOKSHELF
6400 Hollis St., #12, Emeryville, CA 94608 (415) 653-3307
1-800-233-9604

Inquiry 713.

400 B Y T E • JANUARY 1989

SOFTWARE/PACKAGING

HARD TO FIND COMPUTER SUPPLIES FOR SOFTWARE DEVELOPERS & POWER USERS

Cloth binders & slipcases like IBM's. Vinyl binders, boxes, and folders in many sizes. Disk pages, envelopes, & labels. Low quantity imprinting. Bulk disks. Everything you need to bring your software to market. Disk and binder mailers. Much more! Low Prices! Fast service. Call or write for a FREE CATALOG.

Anthropomorphic Systems, Limited
376 E. St. Charles Rd., Lombard, IL 60148

1-800-DEAL-NOW 312-629-5160

Inquiry 714.

SAVE SAVE SAVE LET'S TALK LABELS

We do disk labels (5 1/4" & 3 1/2")
• Better • Faster • Cheaper •
Because we specialize in disk labels... Let's Talk

We also have Tyvek Sleeves
Mailers • Binders • Vinyl Pages
We are a complete software packaging service.
Hice & Associates
9303 Cincinnati-Columbus Rd., Wms Chester, OH 45069
513-777-0133

Inquiry 715.

SOFTWARE/PRINTER

PRINTER GENIUS

Powerful memory resident printer management • Control printer features from menus or within documents
• Print spool to disk files or memory • Background print
• File & directory browse • Edit small text • and more...
• User friendly pop-up screens • 92 page manual •
• Preset for all printers • Completely flexible • PC MS-DOS • \$89 + \$4 S/H • VISA/MC

Nor Software Inc.

527 3rd Ave., Suite 150, New York, NY 10016
(212) 213-9118

Inquiry 716.

SOFTWARE/SCANNERS

Optical Character Recognition

Stop retyping: PC-OCR™ software will convert typed or printed pages into editable text files for your word processor. Works with HP ScanJet, Panasonic and most other scanners. Supplied with 18 popular fonts. User trainable: you can teach PC-OCR™ to read virtually any typestyle, incl. foreign fonts. Proportional text, matrix printer output, Xerox copies OK. \$385. Check/VISA/MC/AmExp/COD

Essex Publishing Co.
P.O. Box 391, Cedar Grove, NJ 07009
(201) 783-6940

Inquiry 717.

SOFTWARE/SCIENTIFIC

DATA ACQUISITION & ANALYSIS ON PC'S

- Free application assistance. Tell us about your DSP, process control A/D or DA needs. Our expert engineering staff will provide you with a system solution to fit your needs and budget.
- A/D & IEEE488 boards from MicroByte, Scientific Solutions and Analog Devices 78-6555
- Analysis software including PRIME FACTOR FFT subroutine library, FOURIER PERSPECTIVE II advanced linear systems analysis.
- Menu driven software from Linkel, Laboratory Technologies, Quinn Curtis, and Golden. Scientific Engineering 2 & 3D graphics.

See "What's New" page 80, BYTE July, 1988
LOW PRICES! Satisfaction GUARANTEED!

ALLIGATOR TECHNOLOGIES

P.O. Box 8706, Fountain Valley, CA 92708
Tel. (714) 850-9984 FAX. (714) 850-9987 MCI. ALLIGATOR

Inquiry 718.

POWERFUL EQN SOLVER

\$99 RISK FREE OFFER WITH FREE WORD PROCESSOR!
• "A real Bargain! IEEE" • "Dev. over 40 years by aerospace & vets"
• EE TIMES • Defines new function s' Engg Tools CURVE" • Graph results ACROSS SINGULARITIES • Change para. characteristics
• Fit 60th order curves (polynomial) to imported data • COMPLEX/real roots • Coupled Diff Eq • Indefinite Integrals • More
• MS-DOS, 640k, graphics card

Call Today! 800/621-0849 x 330
8:30-5:30 PTime • VISA/MC/AMEX/Check

Curve Systems International
747 Moreno Ave., LA, CA 90049

Inquiry 719.

SOFTWARE/SCIENTIFIC

ORDINARY/PARTIAL DIFFERENTIAL EQN SOLVER

FOR THE IBM PC & COMPATIBLES

MICROCOMPATIBLES INC.
301 Prelude Ct., Silver Spring, MD 20901
(301) 593-0683

Inquiry 720.

"powerful and easy to use..."

Ask for our free 16 page brochure with complete product descriptions and detailed technical application notes (and for a brief description of two of our products see "What's New", Byte, page 84, July/88).

MicroMath Scientific Software

2034 East 7000 South
Salt Lake City, Utah 84121-3144
(801) 943-0290

Inquiry 721.

Scientific/Engineering/Graphics Libraries

Turbo Pascal, Turbo C, Microsoft C

Send for FREE catalogue of software tools for Scientists and Engineers. Includes: Scientific subroutine libraries, device independent graphics libraries (including EGA, HP plotter and Laserjet support), scientific charting libraries, 3-D plotting library, data acquisition libraries, menu-driven process control software. Versions available for a variety of popular languages.

Quinn-Curtis

1191 Chestnut St., Unit 2-5, Newton, MA 02164
(617) 965-5660

Inquiry 722.

Scientific Software

Scientific CALCULATOR parallel processing & graphics, Sci.NOTEPAD free-form data management, DIALSEARCH literature searches, SCI.GRAPHPAD and SCI.STATPAD graphics-aided data analysis (log/semilog plots, errorbars, curve fit, more). From \$85- On 5 1/4" and 3 1/2" MS-DOS disks. 30 day \$ back. VISA/MC/P.O. Also see our ad under LANGUAGES.

Scientific LOGICS Inc.

21910 Alcazar Ave., Cupertino, CA 95014
(408) 446-3575 Compuserv 74017,663

Inquiry 723.

KALMAN FILTERING SOFTWARE

Dr. Bierman's FORTRAN programs and source code libraries are still in use all JPL and vastly simplify use or development of Kalman Filter applications. These highly regarded algorithms and code implementations are compiled to run on PC/MS DOS-based machines or for your own development in source code. All code is fully documented.

- Bierman Estimator Program (Executable) \$250
- Bierman Estimator Program (Source Code) \$500
- Bierman Estimation Subroutine Library (Source Code) \$1500

5 1/4" Floppies or 0 Track Tape
TAU CORPORATION 485 Alberto Way, La Brea, CA 95032
408 395-9191 • TELEX: 184302 TAU UT

Inquiry 724.

SOFTWARE/SECURITY

KEEP YOUR PC PRIVATE!

MicroLock PC Security Software protects MS-DOS files and programs from unauthorized access. MicroLock features unlimited passwords, Quick Encryption, Locks Directories, Hides files, Locks EXE and .COM files, uses one simple control menu win-screen help!

Only \$89.95! (+\$3 s/h) 30 DAY MONEY BACK GUARANTEE
Check/VISA/MC

MicroNiche, Inc.

The Summit, Suite 110, 4350 Brownsboro Rd.
Louisville, KY 40207
Orders: (502) 893-4526 FAX: (502) 893-4503

Inquiry 725.

THE BUYER'S MART

SOFTWARE/SECURITY

KEEP YOUR FILES TO YOURSELF
Protect from the competition all your PC/AT sensitive files. Use the ultimate data security program:

ENCRYPT
EASY! FAST! RELIABLE! No hard disk required. For extrasafety, do all your file transfers using coded data.
ATTENTION: Coded data is unbreakable.
\$50 30 day \$ back

R. T. RATO
Est Luz, 173-3E 1600 LISBOA PORTUGAL

Inquiry 726.

SOFTWARE/TAX PREP

1040 TAX PACKAGE — \$10
OUR 12th Year— Featured on the cover of *Personal Computing*. Includes 1040, schedules A B C D E & SE. Easy input, help screens & other forms handled via one line input. For IBM PC's & compatibles & C64's. COD's pay shipping—prepaid we pay.

JJR DATA Research
7 Wildwood Dr., Dix Hills, NY 11746
516 643-1931

Inquiry 732.

STATISTICS

STATISTICAL NAVIGATOR™

Statistical Navigator an expert system using AI strategies to help guide the researcher to the appropriate statistical analysis. Based on your answers, it suggests several analyses ranked by suitability. It explains what the analysis does and how it fits your objectives and assumptions. Special intro price \$99.95+5/h.

VISA/MC/AMEX/PO, 30 day-guarantee.
The Idea Works, Inc.
100 West Briarwood, Columbia, MO 65203
1-800-537-4866 314-445-4554

Inquiry 737.

HANDS OFF THE PROGRAM®

- Locks Hard Disk. - Restricts Floppy Use.
- Protects Subdirectories.
- Normal Use of DOS Commands and Application Software.
- IBM PC, XT, AT and True Compatibles.
- DOS V2.0 and Higher. Hard Disk System.
- Keep Other People's HANDS OFF Your System

- \$89.95 VISA/MC

SYSTEM CONSULTING, INC.
314 Canterbury Dr., Pittsburgh, PA 15238
(412) 963-1624

Inquiry 727.

1988 TAXES

FAST, EASY, ACCURATE

IBM/Compatibles, Commodore-Amiga. Prints forms, audits taxes, multiple returns, 20 forms and schedules, saves to disk, forecast 1989 taxes. ONLY \$34.95. Add \$4 S/H, MA add 5% Sales Tax, Check, M.O., Credit Cards.

Quality Business Systems
P.O. Box 805, Hudson, MA 01749
1-800-225-5800

Inquiry 733.

MINITAB's a PC of cake!

MINITAB's intuitive commands are easy to use and remember. Features descriptive statistics, regression, time series, chi-square, fit-res graphics, much more. PC version incl. LOTUS interface, 30-day trial, network pricing. Call for FREE brochure.

Minitab, Inc.
3081 Enterprise Dr., State College, PA 16801
(814) 238-3280

Inquiry 738.

SOFTWARE/SORT

OPT-TECH SORT/MERGE

Extremely fast Sort/Merge/Select utility. Run as an MS-DOS command or CALL as a subroutine. Supports most languages and filetypes including dBase and dBASE. Unlimited filesizes, multiple keys and much more! MS-DOS \$149. XENIX \$249.

(702) 588-3737

Opt-Tech Data Processing
P.O. Box 678 - Zephyr Cove, NV 89448

Inquiry 728.

SOFTWARE/TOOLS

NATURAL LANGUAGE SOFTWARE

Use JAKE to create a front end to your database, game, or graphics program! JAKE translates English queries and commands into C function calls and data structures. JAKE offers context-sensitive semantic processing; interfaces easily; <64K mem.

\$495. INTERACTIVE DEMO \$10

ENGLISH KNOWLEDGE SYSTEMS, INC.
5525 Scotts Valley Dr., #22, Scotts Valley, CA 95066
(408) 438-6922

Inquiry 734.

NCSS

Professional, easy to use, menu driven statistical system. Used by over 5,000 researchers.

- 5.0 Statistical System —\$99
- 5.1 Graphics (2D & 3D)—\$59
- 5.3 Power Pac Supplement—\$49
- 5.4 Exp. Design/QC—\$49
- 5.5 Survival Analysis—\$59

We accept checks, PO's, Visa, MC. Add \$3 s/h.

NCSS-B
865 East 400 North, Kaysville, UT 84037
801-546-0445

Inquiry 739.

SOFTWARE/STRATEGIC

WANTED: CEO, Compaq Corp. or Microsoft, or Chrysler, or Union Carbide, or Georgia Pacific, or...

Business Week's Business Advantage simulation software puts you behind the desk of some of the most powerful business leaders in America. You make the decisions, you deal with competition, you set the strategy, you face the consequences. This exciting simulation has fourteen Chief Executive positions open, and is available in both PC and Mac formats. Only \$49.95 puts you in one of their shoes. Additional cases available for only \$29.95 (plus \$5.00 shipping and handling). To order, or for more information, please call:

BUSINESS WEEK
c/o Strategic Management Group, Inc.
3624 Market Street, Philadelphia, PA 19104
1-800-445-7089

Inquiry 729.

STATISTICS

STATA

NEW RELEASE NOW AVAILABLE. Even better graphics, expanded on-line help, and much more. Still only \$590. Quantity and Academic Discounts available. \$20 Demo. Call toll-free for more information. AX/VISA/MC.

1-800-STATAPC
Computing Resource Center
10801 National Boulevard, Los Angeles, CA 90064
(213) 470-4341

Inquiry 735.

SOFTWARE/TAX PREP

W-2 & 1099 ON FLOPPY

The MAG COLLECTION of programs make an IRS/SSA FORMAT floppy from a data entry screen or imported ASCII file. Includes manual and application forms.

- Used nation wide
- Step-by-step data entry
- Free phone support
- Menus, user friendly
- Prints W-2 & 1099
- PC compatible

Illinois Business Machines Inc.
Department MAG
1403 Box 310 Troy Rd., Edwardsville, IL 62025
PH. # (618) 692-6060

Inquiry 730.

THE SURVEY SYSTEM

An easy-to-use package designed specifically for questionnaire data. Produces banner format, cross tabs & related tables, statistics (incl. regression) & bar charts. Codes and reports answers to open-end questions. All reports are camera-ready for professional presentations. CRT interviewing option.

CREATIVE RESEARCH SYSTEMS
15 Lone Oak Cir., Dept. B, Petaluma, CA 94952
707-765-1001

Inquiry 736.

A-Cross

This year's #1 Cross Tab package!

Easy to learn & easy to use. Superfast. Supereasy "Point & Pick" operation. #1 in connections, statistics and tabulation features. Output to Lotus.WKS files, ASCII, and laser printers. #1 with leading market research firms and Fortune 500 companies. Accepts dBase, ASCII & Column-binary data. CALL FOR INFO AND FREE DEMO DISK...

STRAWBERRY SOFTWARE
42 Pleasant Street, Watertown, MA 02172
(617) 923-8800 or FAX: (617) 926-0134

Inquiry 741.

APRIL 15th™

Tax preparation package based on Lotus 1-2-3, 2.0 for IBM-compatible PC w/512K. Includes 1040, 1040A, all Schedules & 12+ supporting Forms. IRS-acceptable printouts (except 1040, 1040A). Easy-to-use menu functions & Help files, 1988 Version \$49.95. Low-cost '87 demo available for '88 tax planning.

JD Enterprises
P.O. Box 658 St. Ann MO 63074
(314) 427-3353

Inquiry 731.

STATISTICS CATALOG!

If you need statistics for IBM PC or Apple II, call us and let our technical advisors help you find the statistics programs you need. Write or call now to get a FREE catalog of statistics and quality control software.

HUMAN SYSTEMS DYNAMICS
9010 Reseda Blvd., Ste. 222
Northridge, CA 91324
(800) 451-3030 (818) 993-8536 (CA)

Inquiry 736.

Spreadsheet Statistics

NEW! 23 comprehensive statistics and forecasting modules for analyzing LOTUS worksheets. Low cost \$24.95 each. Easy to use. Includes tutorial. Basic and advanced statistics with graphics and many user-definable options. Compare. Free brochure.

Walonick Associates, Inc.
6500 Nicollet Ave. S., Minneapolis, MN 55423
(612) 866-9022

Inquiry 742.

THE BUYER'S MART

UTILITIES

BASIC FORMAT UTILITY +

FORMATS SOURCE CODE WITH BOLD VARIABLES, OR KEYWORDS, UNDERLINED LOOPS, OTHER OPTIONS. CROSS REFERENCE VARIABLES, CALLS, AND REDIRECTS. FAST ON SCREEN VARIABLE TRACE. NUMBER/UN-NUMBER UTILITY AIDS PROGRAM DEVELOPMENT. FOR LATEST BASICS. \$25.00 (DOS 2+) MONEY BACK GUARANTEE

AVID COMPUTING

1012 MORSE AVE, #11, SUNNYVALE, CA 94086
(408) 747-0244

Inquiry 743.

UTILITIES

The NOVA UTILITIES

Twelve advanced DOS programs that are on every user's wish list. Disk editor, file recovery, point-and-shoot window directory manager, encrypt and compress files, DOS command line qualifiers, find, view, delete, move, copy, more! *L ss* than \$6 per program at only \$69.95 complete with 100+ page manual.

NOVA SOFTWARE, Inc.

P.O. Box 37464, Albuquerque, NM 87176 (505) 836-8400

Inquiry 747.

UTILITIES

\$79.95!!

Order the RED Utilities now! Programs include: Disk cache speeds hard and floppy disks. Printer spooler. Batch file compiler speeds batch files. Path command for data files. Wild card exceptions. Sort directories. Over 10 more programs. IBM PC. Visa/MC. Send for free catalog.

The Wenham Software Company

5 Burley St., Wenham, MA 01984 (508) 774-7036

Inquiry 750.

MATCH PRINTERS TO PC

For less than \$30 MatchFont and Match-a-Printer are great for foreign and scientific writings. Get all the characters you need from most programs and printers (Apple & Epson printers, daisywheels, etc.). Greek, French, Italian, Spanish, German, Swedish, Japanese, graphics. . . You name it! To receive a demo disk send \$5 refundable upon purchase to: Call or write 818-906-6791

MATCH SOFTWARE

6426 Coldwater Canyon, North Hollywood, CA 91606-1113

Inquiry 744.

Recover deleted files fast!

Disk Explorer now includes automatic file recovery. You type in the deleted file's name. Disk Explorer finds and restores it. Disk Explorer also shows what's really on disk; view, change or create formats, change a file's status, change data in any sector. MS-DOS \$75 U.S. Check/Credit card welcome.

QUAD SOFTWARE LIMITED

45 Charles St. E. 3rd Fl.
Toronto, Ontario, Canada M4Y 1S2
(416) 961-8243

LOGGER®

Logger, for IBM-PC and compatibles, tracks and reports: User, Time on, Time off, Directories used, Programs used, Program start/end time, and calculates totals. Tracks directories/files: Opened, Created, Renamed, Deleted. Completely transparent. Retail for \$74.95 with quantity discounts available.

System Automation Software, Inc.

8555 16th St., Silver Spring, MD 20910
1-800-321-3267 or 1-301-565-8080

Inquiry 748.

WORD PROCESSING

FARSI / GREEK / ARABIC / RUSSIAN

Hebrew, all European, Scandinavian, plus either Hindi, Punjabi, Bengali, Gujarati, Tamil, Thai, Korean, Viet, or IPA. Full-featured multi-language word processor supports on-screen foreign characters and NLQ printing with no hardware modifications. Includes Font Editor. \$355 dot matrix; \$150 add'l for laser; \$19 demo. S/H in U.S. incl'd. Req. PC, 640K, graphics. 30 day Guarantee. MC/VISA/AMEX

GAMMA PRODUCTIONS, INC.

710 Wilshire Blvd., Suite 609, Santa Monica, CA 90401
213/384-8622 Tlx: 5106008273 Gamma Pro S/M

Inquiry 751.

ATTENTION FORMAT VICTIMS!!!

REARGUARD password protects you from accidental formatting of your hard disk. Not memory resident nor modifies DOS. Completely automated in allation. Manual and diskette provided.

ONLY \$29.00 + \$4.00 S/H VISA/MC/COD UPS B/R

MICROBRIDGE COMPUTERS

655 Sky Way #125, San Carlos, CA 94070
Order toll free 1-800-523-8777
415-593-8777 (CA) 212-334-1858 (NY)
TELEX EZLINK 62873089 FAX 415-593-7675

Inquiry 745.

DuangJan

Bilingual word processor for English and: Armenian, Bengali Euro/Latin, Greek, Hindi, Khmer, Lao, Punjabi, Russian, Sinhalese, Tamil, Thai, Viet. . . \$109+\$5 s/h (foreign + \$12 s/h). Font editor included. For IBM with dot-matrix & LaserJet printer. Demo \$6 + \$1 s/h.

MegaChomp Company

3524 Cottman Ave., Philadelphia, PA 19149-1606
(215) 331-2748

Inquiry 752.

COPY AT TO PC

The 1.2mB drive has long been known to READ but NOT reliably WRITE on 360KB floppies. With "COPYAT2PC"™ 1.2mB drives CAN reliably WRITE 360KB floppies saving a slot for a second hard disk or backup tape. "COPYAT2PC" (Not Copy Protected) offers the preferable SOFTWARE SOLUTION! ONLY \$79+\$4 S/H VISA/MC/COD UPS B/R

MICROBRIDGE COMPUTERS

655 Skyway, San Carlos, CA 94070
Order toll free 1-800-523-8777
415-593-8777 (CA) 212-334-1858 (NY)
TELEX EZLINK 62873089 FAX 415-593-7675

Inquiry 746.

FastTrieve®

FastTrieve, for IBM-PC and compatibles, indexes your wordprocessing documents to instantly (< 1 sec.) retrieve text using your search expressions (boolean statements, phrases, spelling variations). Retrieved text can be edited, printed, and saved to disk. Retail for \$99. Discounts available.

System Automation Software, Inc.

8555 16th St., Silver Spring, MD 20910
1-800-321-3267 or 1-301-565-8080

Inquiry 749.

PC-Write 3.0 — Shareware

Fast, full featured word processor for IBM PC. Now edits large files & multiple columns. Also spell check, mailmerge, networking, ASCII, and macros. Easy to use, optional menus. Supports 500 printers incl. lasers. Software, guide and tutorial on disk: \$16. Registration with manual, support newsletter and 2 free updates: \$89.

90 day money back guarantee. VISA/MC.

Quicksoft 1-800-888-8088
219 First Ave. N., #224-BYTC, Seattle, WA 98109

Inquiry 753.

ADVERTISE YOUR COMPUTER PRODUCTS HERE

for as little as \$425 in

THE BUYER'S MART

For more information call
Mark Stone at BYTE
603-924-3754

Priority One

Break through the XT speed barrier. The new VTI 33-XT Turbo computer sprints along at a fast 10 MHz processing speed. That's power enough to move quickly through your most demanding jobs.

These hot new systems come with everything you could want or need — the things the other guys charge extra for. This means a full 640K RAM memory is standard. Many other systems sold today come with only 256K RAM. The extra memory you need on other systems means a \$200 upgrade — with ours, it's already installed.

Each system is thoroughly tested and backed by a full one year warranty and the assistance of our Toll-Free Technical Support Hotline.

Features

- 4.77/10MHz Turbo Processing Speed
- 640K bytes of RAM memor
- Serial and parallel ports
- 5 slots for system expansion
- CGA/MGA and Hercules video built-in
- Clock calendar w/battery backup
- IBM-XT compatible
- 135 Watt Power Supply
- MS-DOS 3.3/GW-BASIC
- One year warranty

FREE With every system purchase:
Spinnaker™ Easy Working Word Processor



Single Floppy System
with Monochrome Monitor
and Spinnaker Word Processor

\$739
BMV151

30 Mbyte System
with Monochrome Monitor
and Spinnaker Word Processor

\$1059
BMV152



Citizen MATE/12
12.5 MHz EGA Color AT System

- 1 Mbyte RAM
- HO Controller
- EGA Comp. Video
- EGA Monitor

\$1799
BMC1255

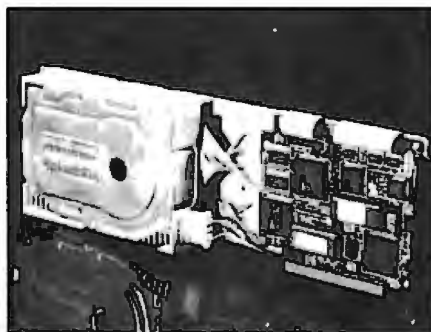

Zip Card
21 Mbyte Hard Disk on a Card

- 65 ms avg. access
- Shock mounting
- Plated media
- 1 Year Warranty

\$279
BMPRIZC21

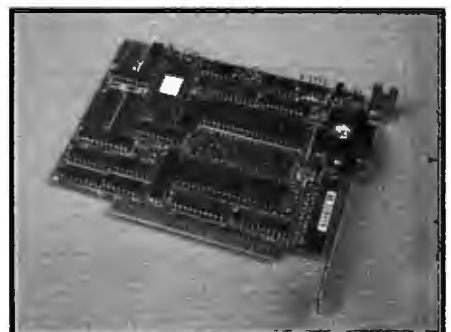

Zipper +
Hayes Compatible Modems
1200 bps internal 2400 bps internal

\$49.99
MBPRIM1

\$99.99
MBPRIM2

Maxtor Hard Drives

AT1120	120 Mbytes (MFM/28ms)	BMMXT1140	\$1,499.00
AT160	160 Mbytes (MFM/28ms)	BMMXT2190	\$1,649.00
AT320E	319 Mbytes (ESDI/17ms)	GMMXT4380E	\$2,649.00

PRODUCT AND PRICING MAY NOT BE AVAILABLE IN RETAIL STORES



Proud member of
abcd
The Microcomputer
Industry Association

MMC
MEMBER



PRIORITY 1 ELECTRONICS

21622 Plummer St., Chatsworth, CA 91311

(800) 423-5922  
FAX (818) 709-4362

- Same Day Shipping
- Money Back Guarantee (call for details)
- No credit card surcharge - limited to stock on hand

Circle 215 on Reader Service Card

NEC V20 & V30 CHIPS

Replace the 8086 or 8088 in Your IBM PC and Increase Its Speed by up to 30%! Price Part No.

UPD70108-5 (5MHz) V20 Chip	\$ 7.49
UPD70108-8 (8MHz) V20 Chip	\$10.75
UPD70108-10 (10MHz) V20 Chip	\$12.95
UPD70116-8 (8MHz) V30 Chip	\$ 9.95
UPD70116-10 (10MHz) V30 Chip	\$16.95

7400

Part No.	1-9	10+	Part No.	1-9	10+
7400	29	19	7485	49	59
7402	29	19	7486	45	35
7404	29	19	7489	195	185
7406	35	25	7490	49	39
7408	39	29	7493	45	35
7407	39	29	74121	39	29
7408	35	25	74123	49	39
7410	29	19	74125	55	45
7414	49	39	74126	55	45
7416	35	25	74143	495	485
7417	35	25	74150	135	125
7418	29	19	74154	135	125
7430	29	19	74158	149	139
7432	39	29	74173	79	69
7438	39	29	74174	59	49
7442	49	39	74175	59	49
7445	79	69	74176	79	69
7446	89	79	74181	195	185
7447	89	79	74182	195	185
7448	195	185	74193	79	69
7472	39	29	74198	185	175
7473	39	29	74221	89	79
7474	39	29	74273	195	185
7475	49	39	74365	59	49
7476	45	35	74367	59	49

74LS

74LS00	26	16	74LS165	75	65
74LS02	28	18	74LS166	89	79
74LS04	28	18	74LS173	39	29
74LS05	28	18	74LS174	39	29
74LS06	59	49	74LS175	39	29
74LS07	59	49	74LS189	395	385
74LS08	28	18	74LS191	59	49
74LS10	26	16	74LS193	89	79
74LS14	49	39	74LS211	69	59
74LS27	35	25	74LS240	59	49
74LS30	28	18	74LS243	69	59
74LS32	28	18	74LS244	69	59
74LS42	49	39	74LS245	79	69
74LS47	89	79	74LS259	89	79
74LS73	39	29	74LS273	89	79
74LS74	35	25	74LS279	49	39
74LS75	39	29	74LS322	349	339
74LS76	39	29	74LS365	49	39
74LS85	59	49	74LS366	49	39
74LS86	29	19	74LS367	49	39
74LS90	49	39	74LS368	49	39
74LS93	49	39	74LS373	79	69
74LS123	49	39	74LS393	69	59
74LS125	49	39	74LS393	69	59
74LS138	49	39	74LS590	595	585
74LS139	49	39	74LS624	195	185
74LS154	119	109	74LS629	249	239
74LS157	45	35	74LS640	109	99
74LS158	39	29	74LS645	109	99
74LS163	49	39	74LS670	99	89
74LS164	59	49	74LS686	239	229

74SIPROMS*

74S00	25	74S188*	149
74S04	25	74S189	149
74S08	29	74S196	149
74S10	25	74S240	139
74S32	29	74S244	119
74S74	29	74S253	59
74S85	89	74S287	149
74S86	29	74S294	149
74S124	149	74S373	149
74S174	49	74S374	149
74S175	49	74S472*	295

74F

74F00	25	74F139	59
74F04	25	74F157	59
74F08	25	74F193	295
74F10	25	74F240	89
74F32	29	74F253	69
74F74	29	74F253	59
74F86	39	74F373	79
74F138	59	74F374	79

CD-CMOS

CD4001	19	CD4076	59
CD4008	59	CD4081	22
CD4011	19	CD4082	22
CD4013	29	CD4093	35
CD4015	49	CD4097	69
CD4017	49	CD40103	49
CD4018	59	CD40107	49
CD4020	59	CD4510	69
CD4024	45	CD4511	69
CD4027	35	CD4520	75
CD4030	65	CD4522	75
CD4040	65	CD4538	79
CD4049	29	CD4541	89
CD4050	29	CD4543	79
CD4051	59	CD4553	395
CD4052	59	CD4555	79
CD4053	59	CD4559	795
CD4063	29	CD4566	195
CD4065	29	CD4568	59
CD4067	149	CD4584	49
CD4069	19	CD4585	69
CD4070	25	CD4588	69
CD4071	22	MC14411P	795
CD4072	22	MC14490P	449

MICROPROCESSOR COMPONENTS

MISCELLANEOUS CHIPS	Price	6500/6800/68000 Cont.	Price	8080 SERIES Cont.	Price
D765AC	3.95	6845	2.75	8228	1.95
WD9216	3.95	6850	1.95	8237-5	4.25
Z80, Z80A, Z80B SERIES		6852	75	8243	1.75
Z80	1.19	6854	1.19	8250A	4.95
Z80-CTC	1.29	MC68000L8	9.95	8250B (For IBM)	5.95
Z80-PIO	1.29	MC68000L10	11.95	8251A	1.69
Z80A	1.29	MC68010L10	49.95	8253-5	1.95
Z80A-CTC	1.65	MC68020C12B	99.95	8254	3.95
Z80A-DART	4.95	8031	3.95	8255A-5	2.95
Z80A-PIO	1.89	80C31	9.95	8259-5	2.95
Z80A-SIO/O	3.95	8035	1.49	8272	3.95
Z80B	2.75	8073A	6.95	8279-5	2.95
Z80B-CTC	3.95	8080A	2.25	8741	9.95
Z80B-PIO	3.95	8085A	2.49	8742	19.95
		8086	3.95	8748 (25V)	7.95
		8088-2	2.49	8748H (HMOS) (2IV)	6.95
		8088	3.95	8749	9.95
		8088-2	3.95	8751 (35-8MHz)	39.95
		8087 (5MHz)	99.95	8751H (35-12MHz)	44.95
		8087-2 (8MHz)	159.95	8755	13.95
		8088	4.95		
		8088-2	6.95		
		8116	4.95		
		8155-2	3.49		
		8155-2	2.95		
		8203	6.95		
		8212	2.29		
		8224	2.25		

MICROPROCESSOR SALE!

Part No.	Description	Price
8052AHBASIC	CPU w/BASIC Interpreter	\$24.95
MC68000P12	16-Bit MPU (12MHz)	\$12.95
MC68701	8-Bit EPROM Microcomputer	\$14.95
MC68705P3S	8-Bit EPROM Microcomputer	\$9.95
MC68705U3S	8-Bit EPROM Microcomputer	\$10.95
80286-10	16-Bit Hi Performance MPU	\$69.95
80287-8	Math Co-processor (8MHz)	\$244.95
80287-10	Math Co-processor (10MHz)	\$309.95
80387-16	Math Co-processor (16MHz) GRID ARRAY	\$474.95
80387-20	Math Co-processor (20MHz) GRID ARRAY	\$749.95

DYNAMIC RAMS

Part No.	Description	Price
*118-15	16384 x 1 (150ns)	1.99
*128-20	131,072 x 1 (200ns) (Populated)	3.25
*164-100	65,536 x 1 (100ns)	3.49
*164-120	65,536 x 1 (120ns)	2.95
*164-150	65,536 x 1 (150ns)	2.59
*164-200	65,536 x 1 (200ns)	2.95
*7MS4416-12	16,384 x 4 (120ns)	7.75
*1286-80	262,144 x 1 (80ns)	13.49
*128-150	262,144 x 1 (150ns)	12.49
*1286-120	262,144 x 1 (120ns)	11.95
*1286-150	262,144 x 1 (150ns)	11.49
*1464-15	65,536 x 4 (150ns) (4464)	14.75
*S11000P-10	1,048,576 x 1 (100ns) 1 Meg	39.95
*S14286P-10	262,144 x 4 (100ns) 1 Meg	59.95

STATIC RAMS

*2016-12	2048 x 8 (120ns)	4.49
*2018-45	2048 x 8 (45ns)	6.95
2102	1024 x 4 (350ns)	89
2114N	1024 x 4 (450ns)	99
2114N-ZL	1024 x 4 (350ns) Power	1.49
21C14	1024 x 4 (200ns) CMOS	49
5101	256 x 4 (450ns) CMOS	2.95
*3110P-3	2048 x 8 (150ns) CMOS	4.95
*3110LP-3	2048 x 8 (150ns) LP CMOS	5.99
*3284LP-12	8192 x 8 (120ns) LP CMOS	10.49
*3284LP-15	8192 x 8 (150ns) LP CMOS	9.95
*3284LP-15	8192 x 8 (150ns) LP CMOS	9.49
6514	1024 x 4 (350ns) CMOS	3.75
*43266-15L	32,768 x 8 (150ns) Low Power	16.49
*6225LP-12	32,768 x 8 (120ns) LP CMOS	17.95

EPROMS

TMS2610	2048 x 8 (450ns) 25V	6.95
TMS2632	4096 x 8 (450ns) 25V	5.95
TMS2632A	4096 x 8 (450ns) 21V	4.49
TMS2694	8192 x 8 (450ns) 25V	6.95
TMS32716	2048 x 8 (450ns) 3 Voltage	6.05
1702A	256 x 8 (1µs)	4.95
2708	1024 x 8 (450ns)	6.95
2716	2048 x 8 (450ns) 25V	3.75
2716-1	2048 x 8 (350ns) 25V	4.25
27C18	2048 x 8 (450ns) 25V CMOS	4.25
2725	4096 x 8 (450ns) 25V	3.95
2732A-20	2048 x 21V	3.95
2732A-25	4096 x 8 (250ns) 21V	3.95
27C32	4096 x 8 (450ns) 25V CMOS	4.95
2764-20	8192 x 8 (200ns) 21V	4.25
2784-25	8192 x 8 (250ns) 21V	3.99
2784A-25	8192 x 8 (250ns) 12.5V	3.69
2784-45	8192 x 8 (450ns) 21V	3.99
2784B-15	8192 x 8 (150ns) 12.5V CMOS	5.95
27128-20	16,384 x 8 (200ns) 21V	6.95
27128-25	16,384 x 8 (250ns) 21V	5.95
27128A-25	16,384 x 8 (250ns) 12.5V	5.95
27C128-25	16,384 x 8 (250ns) 21V CMOS	5.95
27256-20	32,768 x 8 (200ns) 12.5V	8.95
27256-25	32,768 x 8 (250ns) 12.5V	8.49
27C256-25	32,768 x 8 (250ns) 12.5V CMOS	6.25
27512-20	65,536 x 8 (200ns) 12.5V	10.95
27512-25	65,536 x 8 (250ns) 12.5V	9.95

2818A-25	2048 x 8 (250ns) 5V Read/Write	6.25
2817A	2048 x 8 (350ns) 5V Read/Write	7.95
2865A-30	8192 x 8 (300ns) 5V Read/Write	9.95
82B13 (21V)	2048 x 8 (350ns) 5V Read Only	1.19

COMMODORE CHIPS

LAQ670	8.66
WD1770	8.55
913062P	1.25
6504A	1.19
6507	2.95
6510	12.95
6522	2.95
6525	4.95
6626	14.95
6632	5.49
6645-1	3.95
6660	10.95
6667	24.95
6669	15.95
6572	10.95
6681 (12V)	12.95
6582 (9V)	14.95
8502	7.95
8554	4.95
8566	9.95
8701	9.95
8721	14.95
8722	13.95
*26104-04	12.95
31055A-05	9.95
31018-03	12.95
310018-03	12.95
31020-04	12.95
328302-01	14.95
328573-01	17.95
328100PLA	15.95
901225-01	15.95
901227-01	15.95
901229-05	15.95

74C/CMOS

74C00	29	74C174	49
-------	----	--------	----

Worldwide • Since 1974

QUALITY COMPONENTS • COMPETITIVE PRICING
• PROMPT DELIVERY



COMPUTER PRODUCTS

Jameco IBM AT Compatible 16MHz 80286 NEAT Motherboard

- Expandable to 8MB RAM (Zero-K included)
- 8/12 or 8/16MHz switchable
- Supports all NEAT functions including shadow RAM, EMS 4.0, RAM re-mapping and selectable wait states
- 80287-10 Coprocessor capability
- Norton SI rating of 15.6
- AMI BIOS ROMs included
- One-year warranty

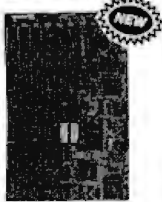

JE3010 8/12/16MHz NEAT

— Additional Motherboards —

JE1001	4.77/8MHz (PC/XT)	\$ 89.95
JE1002	4.77/10MHz (PC/XT)	\$109.95
JE3005	8/12MHz (AT)	\$329.95

Jameco IBM PC/XT/AT Compatible Computer Cases

JE1019	Standard PC/XT Flip-Top Case	\$34.95
JE1010	Standard PC/XT Slide Case	\$39.95
JE1011	Baby XT Turbo Flip-Top Case	\$69.95
JE1014	Baby AT Flip-Top Case	\$54.95
JE1017	Baby AT Slide Case	\$69.95
JE1018	Baby AT Flip-Top Case	\$69.95
JE1019	Baby AT Flip-Top Case	\$69.95

TEST EQUIPMENT

- Metex M4650:**
- Handheld, high accuracy
 - 4 1/2 Digit LCD
 - Manual ranging with Overload Protection
 - Audible continuity tester
 - Tests: AC/DC Voltage, Resistance, Continuity, Capacitance, Frequency
 - One Year Warranty
 - Size 7 1/2 x 3 5/8 x 1 5/8

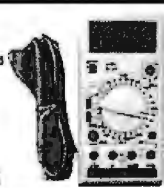

JAMECO SOLDERLESS BREADBOARD SOCKETS

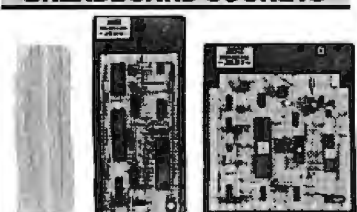

Part No.	Dim. L' x W"	Contact Points	Binding Posts	Price
JE20	6 1/2 x 3/4	200	0	\$ 2.95
JE21	3 1/4 x 2 1/8	400	0	\$ 4.95
JE22	6 1/2 x 1 3/8	630	0	\$ 5.95
JE23	6 1/2 x 2 1/8	830	0	\$ 7.95
JE24	6 1/2 x 3 1/8	1,360	2	\$14.95
JE25	6 1/2 x 4 1/8	1,660	3	\$22.95
JE26	6 1/2 x 5 1/8	2,390	4	\$27.95
JE27	7 1/4 x 7 1/8	3,220	4	\$37.95

400041	NSC Linear Data Book-Vol. I (88)	\$ 14.95
400042	NSC Linear Data Book-Vol. II (88)	\$ 9.95
400043	NSC Linear Data Book-Vol. III (88)	\$ 9.95
210830	Intel Memory Handbook (88)	\$17.95
230843	Intel Microsystem Handbook, Set (88)	\$24.95

Jameco IBM PC/XT 8MHz Turbo Compatible Kit With 256K RAM

- Free! QAPLUS Diagnostic Software Included!
- Free! PC Write Word Processing Software Included!
- 256K RAM Included, Expandable to 640K
- 4.77 or 8MHz Switchable
- AMI BIOS ROM Included
- Save \$128.06



Build Your Own And LEARN!

Part No.	Description	Price
JE1001	4.77/8MHz Turbo Motherboard (Zero-K RAM — includes AMI BIOS ROM)	!
JE1010	Flip-Top Case	34.95
JE1015	XT/AT Compatible Keyboard	59.95
JE1020	5.25" DSDD Disk Drive (Black Bezel)	89.95
JE1030	150 Watt Power Supply	59.95
JE1040	360K Floppy Controller	29.95
JE1050	Mono/Graphics Card with Printer Port	59.95
AMBER	12" Monochrome Amber Monitor	
41256-150	256K RAM (9 chips)	

Save \$128.06 Regular Lis.
JE3002 IBM Compatible PC/XT 8MHz Turbo Kit... \$

IBM COMPATIBLE DISPLAY MONITORS

AMBER	12" Amber Monochrome	\$99.95
CTX2410	14" RGB Color	\$279.95
14"	EGA Color - EGA/CGA Compatible, 720 x 350 Max. Resolution (PC/XT/AT)	
TM5154		\$399.95
14"	EGA Monitor and EGA Card - EGA compatible, 720 x 350 Max. Resolution - displays up to 16 colors (PC/XT/AT)	
JE1059	SAVE \$40.00	\$519.95

13" VGA Monitor and VGA Card - VGA compatible, 800 x 560 Max. Resolution - displays up to 256 colors (PC/XT/AT)
JEVGA... \$649.95

JAMECO IBM PC/XT/AT COMPATIBLE CARDS

Graphic Display Cards	CGA or EGA!	
JE1050	Mono Graphics Card w/Printer Port (PC/XT/AT)	\$59.95
JE1052	Color Graphics Card w/Printer Port (PC/XT/AT)	\$49.95
JE1055	EGA Card with 256K Video RAM (PC/XT/AT)	\$159.95
JE1071	Multi I/O with Drive Controller and Mono Graphics (PC/XT)	\$119.95

JE1044	360K Floppy/Hard Disk Controller Card (PC/XT)	\$129.95
JE1045	360K/720K/1.2MB/1.44MB Floppy/Hard Disk Controller Card (AT)	\$149.95

COMPUTER PERIPHERALS

AMI 80386 Motherboards



- Expandable to 2MB (Zero-K incl.) of 32-bit RAM with expansion board (included)
- Expand additional 8MB using the JE3030 (below, Zero-K incl.)
- XT footprint-AT compatible
- 80387-16/20 capability
- Built-in set-up and diagnostics
- Includes AMI BIOS ROMs
- One-year warranty

JE3020	16MHz 80386 (AT)	\$1399.95
JE3025	20MHz 80386 (AT)	\$1699.95
JE3030	8MB (Zero-K) Daughterboard	\$299.95

Seagate 20,30 40 and 60MB Half Height Hard Disk Drives



ST225	20MB Drive only (PC/XT/AT)	\$224.95
ST225XT	20MB w/Controller (PC/XT)	\$269.95
ST225AT	20MB w/Controller (AT)	\$339.95
ST238	30MB Drive only (PC/XT/AT)	\$249.95
ST238XT	30MB w/Controller (PC/XT)	\$299.95
ST238AT	30MB w/Controller (AT)	\$389.95
ST251	40MB Drive only (PC/XT/AT)	\$429.95
ST251XT	40MB w/Cont. Card (PC/XT)	\$469.95
ST251AT	40MB w/Controller Card (AT)	\$539.95
ST251-1	40MB Fast 28ms (Drive only)	\$499.95
ST277	60MB Drive only (PC/XT/AT)	\$499.95
ST277XT	60MB w/Controller (PC/XT)	\$549.95
ST277AT	60MB w/Controller Card (AT)	\$639.95

Tape Cartridge... \$24.95

Jameco 5.25" PC/XT & AT Compatible Disk Drives

JE1022	360K Black Bzl. (PC/XT/AT)	\$ 89.95
JE1021	360K Beige Bzl. (PC/XT/AT)	\$ 89.95
JE1022	1.2MB Beige Bzl. (PC/XT/AT)	\$109.95

3.5" PC/XT/AT Compatible Disk Drives

MF353B	3.5" 720KB (Mounting Frame Included) (PC/XT/AT)	\$129.95
MF355B	3.5" 1.44MB (Mounting Frame Included) (PC/XT/AT)	\$129.95

Datal 2400/1200/

NEW Pocket Version!

- Hayes command compatible
- Bell 103/212A compatible
- Auto-dial/auto-answer
- FCC approved
- 1-year warranty
- Includes MaxiMite Communication Software (except 1200P)

1200P	1200/300 Baud Pocket Modem	\$ 99.95
1200H	1200/300 Baud Internal Modem	\$ 69.95
2400S	2400/1200/300 Internal Modem	\$129.95
1200C	1200/300 Baud External Modem	\$ 99.95
2400E	2400/1200/300 External Modem	\$199.95

Data Sheets — 50¢ each
Prices Subject to Change

Send \$2.00 Postage for a FREE 1989 CATALOG
FAX Numbers: 415-592-2503 or 415-595-2664
Telex: 176043

U.S. Funds Only
Shipping: Add 5% plus \$1.50 Insurance
(May vary according to weight)

California Residents:
Add 6%, 6 1/2% or 7%
Sales Tax

©1989 Jameco Electronics 1/89



\$20 Minimum Order
IBM is a registered trademark of International Business Machines
Mail Order Electronics • Worldwide
Jameco
ELECTRONICS



1355 Shoreway Road, Belmont, California 94002

24 HOUR ORDER HOTLINE (415) 592-8097 • The Following Phone Lines Are Available From 7AM-5PM P.S.T.:

• Customer Service (415) 592-8121 • Technical Assistance (415) 592-9990 • Credit Department (415) 592-9983 • All Other Inquiries (415) 592-7108

DISCOVER US!



29¢
NO MINIMUM

- 5.25 DS/DD, Black
- In Tyvek Sleeve
- 5 Color Labels w/Tabs
- Shrink Wrapped

IN 16 COLORS 41c



59¢
NO MINIMUM

- 5.25 DS/HD, Black
- In Tyvek Sleeve
- 5 Color Labels w/Tabs
- Shrink Wrapped

IN 8 COLORS 89c



\$1.07
NO MINIMUM

- 3.5 DS/DD, Blue & Gray
- 5 Color Labels
- Shrink Wrapped

IN 6 COLORS \$1.28

\$3.55 • 3.5 DS/HD, Blue & Gray
IN BULK • 5 Color Labels
• Shrink Wrapped

Sentinel Disk Mailer with Anti-Static Liner . . . 39¢

CONTINUOUS FORM LABELS

Size	Across	Box Qty.	Price/1,000
2 3/4 x 7/16	1 across	10,000	\$1.95
2 3/4 x 7/16	4 across	20,000	\$1.95
2 1/2 x 15/16	1 across	5,000	\$2.18
2 1/2 x 15/16	3 across	15,000	\$1.98
2 3/4 x 2 3/4	1 across	2,500	\$12.00
2 3/4 x 1-7/16	1 across	5,000	\$3.00
3 x 15/16	4 across	20,000	\$2.00
3.3 x 15/16	4 across	20,000	\$2.05
3 1/2 x 15/16	1 across	5,000	\$1.90
3 1/2 x 15/16	2 across	10,000	\$1.90
3 1/2 x 15/16	3 across	15,000	\$1.90
3 1/2 x 15/16	4 across	20,000	\$1.90
4 x 15/16	1 across	5,000	\$3.21
4 x 15/16	3 across	15,000	\$3.21
4 x 1 7/16	1 across	5,000	\$3.25
4 x 1 7/16	3 across	15,000	\$3.25

Many other sizes available. Call for further information.
*Designed for the 3 1/2" disk. Prices quoted for full boxes only



"The Quality Disk & Label Specialist Since 1982"
1040 Broadway, Westville, NJ 08093

1-800-426-3303

609-456-6996 • FAX #609-456-7172
All orders F.O.B. Westville, NJ. Fresno, CA.
C.O.D. orders add \$2.20. Pre-approved purchase orders, Visa & MasterCard accepted.
All products assembled in the USA.

AVPROM™

\$295



For IBM-PC's & compatibles, menu-driven AVPROM programs EPROMs up to 8x faster than serially-connected units (20 sec. for 2764).

- Programs 2716 thru 27512A.
- 4- and 10 socket gang versions too. Call for prices.

For complete specs, free 32 pg. development tool catalog, call

800-448-8500.
or 207-236-9055

AVOCET

SYSTEMS, INC.
120 Union St., Rockport, ME 04856

Circle 31 on Reader Service Card

Cross-32 Meta Assembler

Table based macro cross-assembler using the manufacturer's assembly mnemonics.

Includes manual and MS-DOS assembler disk with tables for all of the following processors:

1802	64180	65C02	65816
6801	6805	6809	68HC11
680X0	80X86	COP400	COP800
8048	8051	8085	8096
TMS320	TMS370	Z8/Z80	...MORE

Users can create tables for other processors!

Generates listing, symbol table and binary, Intel, or Motorola hexcode.

Free worldwide airmail shipping & handling.

Check, MO, VISA or MC: US\$199 or CN\$249

Universal Cross-Assemblers
POB 384, Bedford, NS
Canada B4A 2X3
(902) 864-1873

Circle 283 on Reader Service Card

6809 Single Board Computer

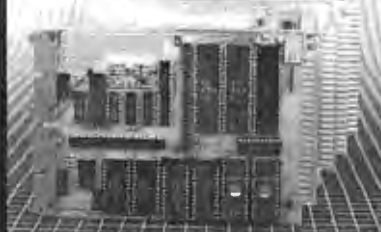

6809 MPU, 2 serial ports, 4 parallel ports, RAM, EPROM, real-time clock, watchdog timer, 44-pin 4.5" x 6.5" PCB

EXPANSION MODULES: RAM, EPROM, CMOS RAM/battery, analog I/O, serial I/O, parallel I/O, counter/timer, IEEE-488, EPROM programmer, floppy disks, cassette, breadboard, keyboard/display.

WINTEK
Wintek Corp.
1801 South Street
Lafayette, IN 47904
317-742-8428

Circle 300 on Reader Service Card

Quero 68000 Software Development Tools

Since 1983, professional quality tools for the entire 68xxx family including the 68030. Hosts: MS-DOS, UNIX and VAX.

C Compilers
C Source Level Debuggers
Macro Assembler Packages
Disassemblers
Simulators

AVOCET

Systems®, Inc

800/448-8500
FAX: 207/236-6713
Telex: 467210 AVOCET CI

Circle 227 on Reader Service Card

UNIVERSAL PROGRAMMER

ONLY \$585 COMPLETE
(Manual, Disk, S/W, PC Interface Card, Cable included)



UNIVERSAL PROGRAMMER

- programs E(EP)ROMs (upto 1 MegBit), PAL, FPL, Bipolar PROM, 8748 & 8751 series.
- tests Static and Dynamic RAMs, TTL and CMOS logic chips.
- All of above functions are performed only on single unit without any additional module.

INDIVIDUAL PROGRAMMERS are also available:
(EEPROM programmer (4, 8, 16 sockets), PAL programmer, BIPOlar programmer, 8748 series programmer, 8751 series programmer, Memory IC & TTL tester.)

XELTEK
473 SAPIEN COURT #21
SANTA CLARA, CA 95054
TEL (408) 752-6995
FAX (415) 27-6995

ORDER TOLL FREE
1-800-541-1975 (outside CA)
VISA, MASTR. & AMEX
ACCEPTED

Circle 302 on Reader Service Card

BIG MOUTH™

REAL VOICE Digital Recording
for your PC, XT, AT or Compatible

- ◆ VOICE MAIL SYSTEM
- ◆ TELEMARKETING
- Inbound & Outbound
- ◆ SMARTEST ANSWERING MACHINE
- ◆ AUTODIALER—DATABASE
- ◆ VOICEPAD™
- Voice for your Programs
- ◆ PROGRAMMER'S TOOLKIT
(optional \$79.00)

1/2 card, software, cables, and speaker

\$269.00 + 5 s/h

(415) 652-9600
Talking Technology, Inc.
4383 Piedmont Ave, Suite B
Oakland, CA 94611

Circle 262 on Reader Service Card

Special!
COMPLETE-PC
 ANSWERING MACHINE ...\$209
 FAX-PC ... \$299
 HAND SCANNER ... \$155

Logitech
 C7 Clear Mouse & Paint
 \$85

SAVE UP TO 70%

SINCE 1984



PRODUCTS NOT LISTED ... CALL!

CAD...etc.

PC & MAC

New Orders: 1-800-621-3999

AST Premium
 286/386
Call

ZENITH 1490
 FlatScreen
\$579

DRAFIX
 Ultra, 1 Plus or 3D Module
Call

MITSUBISHI
 Diamond Scan AT 40Mb Disk
\$477 \$379

VENTURA PAGE-MAKER
 PUB 2.0
\$457 Call

Summagraphics
 Mac 12x12 Tablet
\$269

DESIGN CAD
 Standard or 3D
\$145

SMART MODEM
 1200Bint. 2400Bint.
\$59 \$115

PANASONIC
 1091i-m2 1124
\$179 Call

SCANNERS
 ScanMan or Complete PC HandScanner
\$155

PRINTERS & LASERS

Alps	Call
Canon BJ-130	Call
Citizen 180-D	157
MSP-15E	295
MSP-40	269
MSP-45	389
MSP-50	345
MSP-55	440
Premiere 35	439
Tribute 124	439
Tribute 224	439
Diconix 150	295
HP LaserJet II	1690
JDL 850 Series	Call
NEC LC890	Call
Panasonic 1080i-m2	155
1091i-m2	189
1124	Call
1592/1595	382/418
1524	515
Toshiba 321-SL	455
341-SL	609
351-SX	888
Others	Call

SOFTWARE (cont.)

Excell PC	281
FastBack	69
FastBack Plus	85
FormTool	52
Freelance Plus	293
Fox Base Plus	179
GEM Draw Plus	159
Generic Cadd 3.0	48
Generic Cadd Others	Call
Harvard Graphics	255
In House Acct	107
King Quest IV	35
Laplinc Plus	74
Liesure Suit Larry II	35
Lighting Hard Disk Speedup	59
Lotus 123 2.01	Call
Lotus Agenda	Call
Managing Your Money	113
MathCad 2.0	195
MicroSoft Flight Sim	35
MicroSoft Windows 2.0	56
MS-Dos 3.3	95
Norton Util4.0	45
Novell Netware 286	Call
PageMaker 3.0	Call
Paradox 2.0	391
PC Tools Deluxe	Call
PathMinder 4.0	55
Peachtree Accounting II	145
Peachtree Quere	Call
PFS: First Choice 2.0	77
PFS: First Publisher 2.0	54
PFS: Professional File 2.0	Call
PFS: Professional Plan 1.02	51
PFS: Professional Write 2.0	102
Plan Perfect	185
Q&A	177
Q&A Write	115
Quattro	132
Rapid File	172
R:Base for DOS	415
ShipMate™ (ups Manifest)	199
SideKick Plus	Call
Smart Sysmen	418
Sprint	115
Tops	101
Turbo Basic, C, or Pascal	85
Ventura Publishing 2.0	458
VersaCad & Libraries	Call
Windows	Call
WordPerfect 5.0	Call
XTree	33
XTreePro	58
XTreeNet	Call

HITACHI Digitizer
 10 Year Warranty
 Puma Pro 12x12
 (replacing Tiger Tablet)
 4-Btn Cursor, 1-Btn Pen & Mouse Emulator.
\$349

Digitizers & Plotters (cont.)

DMP 51MP	3550
DMP 51	3200
DMP 52MP	2600
DMP 52	2300
DMP 56A	3800
DMP 61	2890
DMP 62	3990
MP Options	Call
Hitachi Puma Tab (10-Year Warranty)	Call
PumaPro 12x12,4btn,Pen,SW	349
PumaPro 12x12,12btn,SW	369
Ioline	Call
JDL 850 Series	Call
Kita IS 12x12	285
IS 12x17	485
Summagraphics 12x12 Plus	329
18x12 Pro w/4 Butt & Stylus	559
Mac Bit Pad 12x12, 4But,Sty	269

DRIVES, MODEMS & FAX

Mitsubishi AT 40/64 Mb Hard Drive	
1/2 ht., 23ms	389
Panasonic FAX Board	689
Seagate ST225 w/card	260
ST238 30Mb w/card	285
Sharp Fax UX-140 & Phone	969
Smart Modem 1200B intw/sw	58
2400B int w/sw	115
Toshiba 3.5 XT/AT 720k Drive	89
5.25 XT/AT 360k Drive	75
US Robotics	
Courier 2400	279
Courier 2400E	299
HST 9600	599

COMPUTERS

ASTPremium	
286 Model 80	1349
286 Model 140X	2098
386 Model 300	2475
Mitsubishi MP286L	Call
NEC Multispeed	1079
Multispeed EL II	1423
Multispeed HD	2209
Toshiba Laptops	Call
T1000	745
Zenith Laptops	
SuperSport-Dual	1570
SuperSport 20Mb	2357
SuperSport 286 20Mb	3298
SuperSport 286 40Mb	Call

MONITORS

Arndek 1280 & Card	639
210A	87
Hitachi	Call
Mitsubishi DiamondScan 1381	477
Monitorm Viking	Call
NEC Multisync II	565
Multisync GS	185
Others	Call
Samsung	Call
Sony Designs LaserView	Call
Sigma Multiscan 1302	650
Multiscan 1303	475
Zenith 1490 Flatscreen	579

SOFTWARE

AutoSketch®	59
BoeingGraph	195
By-Line	169
Carbon Copy Plus	103
Clipper	369
Copy II PC	18
Corefast	85
Dac Easy 3.0	58
dBaseIV	Call
DesignCad	145
Desklink	92
DesqView	69
Draflix 1 Plus	Call
Draflix Ultra	Call
Draflix 3D Mod & Options	Call
Dollars & Sense	95
EasyXtra	54

T-1000 \$745

BOARDS & NETWORKS

3-Com Etherlink	Call
Adage AD10/4	Call
AD10/8L	Call
ArcNet	Call
Artist	Call
AST	Call
ATI EGA Wonder	169
VIP VGA	249
Copy II Opt Board Dlx	95
EtherNet Plus	Call
Genoa VGA 760x1024	379
Hercules Graphics Plus	169
Intel AboveBoard 286/512k	359
AboveBoard PS 286/512k	388
Paradise EGA 480	Call
VGA Plus	Call
VGA Plus 16	Call
VGA Pro	Call
Sigma Designs VGA	209
Tops Flashcard	143
Verticom	Call
Video 7 Vega Deluxe	177
V-Ram	Call
Vega VGA	\$255
Western Digital EtherNet Plus	Call

Intel coprocessors
 Genuine & New

8087-2 (<=10MHz)	132
80287-8	205
80287-10 (>=10MHz)	239
80387-16	Call
80387-20	Call
80387-25	549
80387-SX	398
80C287A (for Laptops)	299

MOUSE

Logitech C7 Serial or Bus	64
C7 Clear Mouse & Paint	85
HiRez Bus	82
Bus & Paint	82
Serial & Publisher	104

OPTICAL

OptiDriverKit	525
40 ms equiv. for most optiDrives	

HELPERS

Logical Connection 256/512k	Call
Others	Call
ScanMan	155

It PAYS to BUY-MHI!
 Service You Expect !!

Volume Bids Welcome!
 VISA MASTERCARD PO's Just Call First.

Sharp Fax \$898

Model FO-300
 Group 3, 2, FMG1
 Auto & Manual
 Build-in Phone
 16-level Half-Tones
 Accepts 11" wide Documents
 Confidential Trans & Recv

MHI Warehouse, Inc.
 8129 N. 35th Ave. #2-306
 Phoenix, AZ 85051
 New Orders:
1-800-621-3999
 Order Info: 602-997-8877
 Fax: 602-843-3833

Pre-approved P.O.'s are welcome. Prices reflect cash discount and are subject to change without notice. Product compatibility, warranties, & claims are responsibility of manufacturer only. All returns are subject to a restocking fee. Personal/Company checks delay shipping. AZ orders only add 6.7% tax. Orders are processed same Day. International orders Call (802) 861-1090.

Order **BYTE** and **BIX** on disk Today!

Best of BIX on Disk

Receive highlights of each month's activities on BIX—BYTE's world-class on-line conferencing system. You can read and search the text with any word processor. Each disk contains the most interesting and informative recent discussions specific to the machine you own. For example, order the IBM disk, and get the highlights from IBM-specific conferences. Disks can be ordered singly or by annual subscription.

BYTE Program Listings on Disk

BYTE listings on disk are the right choice if you want to compile or read the complete source code listings of programs. BYTE listings are available from December 1985 to present at the prices stated below.

Full Text of BYTE on Disk

Now you can order disks containing the full, machine-searchable text of articles. You can read and search the text with any word processor. Excellent for reference and research! Disks can be ordered singly or by annual subscription. Full text of BYTE is available starting from September 1988.

BYTE also offers listings in print form. Order bound versions of the complete source code listings of programs excerpted from our articles. Handy for quick reference. Order singly or by annual subscription; with or without accompanying diskette version.

Call toll-free for more information: 800-258-5485.

ORDER FORM: To place your order, fill out the card and mail.

	IN USA		OUTSIDE USA	
	Single Month (1 disk)	Annual Subscription (13 disks)	Single Month (1 disk)	Annual Subscription (13 disks)
5-1/4 Inch: <input type="checkbox"/> IBM PC Other disk formats available. Call toll-free.	<input type="checkbox"/> Full Text of BYTE \$9.95 <input type="checkbox"/> BYTE Listings \$9.95 <input type="checkbox"/> Best of BIX \$9.95	<input type="checkbox"/> Full Text of BYTE \$79.95 <input type="checkbox"/> BYTE Listings \$79.95 <input type="checkbox"/> Best of BIX \$79.95	<input type="checkbox"/> Full Text of BYTE \$12.95 <input type="checkbox"/> BYTE Listings \$12.95 <input type="checkbox"/> Best of BIX \$12.95	<input type="checkbox"/> Full Text of BYTE \$99.95 <input type="checkbox"/> BYTE Listings \$99.95 <input type="checkbox"/> Best of BIX \$99.95
3-1/2 Inch: <input type="checkbox"/> Apple Macintosh <input type="checkbox"/> Atari ST <input type="checkbox"/> Amiga <input type="checkbox"/> IBM PS/2	<input type="checkbox"/> Full Text of BYTE \$10.95 <input type="checkbox"/> BYTE Listings \$10.95 <input type="checkbox"/> Best of BIX \$10.95	<input type="checkbox"/> Full Text of BYTE \$89.95 <input type="checkbox"/> BYTE Listings \$89.95 <input type="checkbox"/> Best of BIX \$89.95	<input type="checkbox"/> Full Text of BYTE \$13.95 <input type="checkbox"/> BYTE Listings \$13.95 <input type="checkbox"/> Best of BIX \$13.95	<input type="checkbox"/> Full Text of BYTE \$109.95 <input type="checkbox"/> BYTE Listings \$109.95 <input type="checkbox"/> Best of BIX \$109.95

FOR DIRECT ORDERING
CALL TOLL FREE:
800-258-5485



Call: M-F, 8:30 a.m. to 4:30 p.m. Eastern Time

(603-924-9281 for New Hampshire residents)

For credit card orders only.



PLEASE COMPLETE IN FULL

JANUARY

Name _____

Address _____

City _____ State _____ Zip _____

County or Parish _____ Country _____

Credit Card # _____ Exp. Date _____

Signature _____ Date _____

Please allow 4-8 weeks for delivery.

• Please indicate the issue date below. If you are beginning an annual subscription, note the starting issue.

Full Text of BYTE
Month _____ Year _____

BYTE Program Listings
Month _____ Year _____

Best of BIX
Month _____ Year _____

Check enclosed

MasterCard

VISA

U.S. funds enclosed
(If ordering from outside the U.S. please remit in U.S. funds drawn on U.S. bank. Thank you.)

Order **BYTE** and **BIX** on disk **Today!**

BYTE Program Listings on Disk

Best of BIX on Disk

Receive highlights of each month's activities on BIX—BYTE's world-class on-line conferencing system. You can read and search the text with any word processor. Each disk contains the most interesting and informative recent discussions specific to the machine you own. For example, order the IBM disk, and get the highlights from IBM-specific conferences. Disks can be ordered singly or by annual subscription.

BYTE also offers listings in print form. Order bound versions of the complete source code listings of programs excerpted from our articles. Handy for quick reference. Order singly or by annual subscription; with or without accompanying diskette version.

Call toll-free for more information: 800-258-5485.

ORDER FORM: To place your order, fill out the card and mail.



NO POSTAGE
NECESSARY
IF MAILED
IN THE
UNITED STATES

BUSINESS REPLY MAIL

FIRST CLASS MAIL PERMIT NO. 10 PETERBOROUGH, NH

POSTAGE WILL BE PAID BY ADDRESSEE

BYTE & BIX on Disk

One Phoenix Mill Lane
Peterborough, NH 03458-9990



FREE CATALOG

RS-232C INTERFACE & MONITORING EQUIPMENT CATALOG

WRITE or CALL for YOUR FREE COMPREHENSIVE B & B ELECTRONICS CATALOG TODAY! Pages and pages of photographs and illustrated, descriptive text for B&B's complete line of RS-232 converters, RS-422 converters, current loop converters, adapters, break-out boxes, data switches, data splitters, short haul modems, surge protectors, and much, much more. Most products meet FCC Part 15J. Your RS-232 needs for quality, service and competitive prices will be more than met by B&B ELECTRONICS. **Manufacturer to you, no middleman!** Money-back guarantee! Same-day shipment! One-year warranty on products! Technical support is available.

Write For Your FREE Catalog Today!

B & B electronics
MANUFACTURING COMPANY
4002A Baker Road, P.O. Box 1040 • Ottawa, IL 61350
Phone: 815-434-0846



Order direct from manufacturer TODAY & SAVE!

Circle 33 on Reader Service Card

NEW! INSTANT TERMINAL

"EXACT TERMINAL EMULATION AND COMMUNICATIONS SOFTWARE"

- PRECISE EMULATION OF THE DEC VT52, VT100, VT102, VT220
- EXPANSION MODULES FOR OVER 40 EXACT EMULATIONS
- 9 FILE TRANSFER PROTOCOLS.
- EASY TO USE, QUICK TO INSTALL, AND MUCH MORE
- IBM PC, XT, AT, PS/2

FOR INFORMATION 800/548-9777

ONLY
\$97.50

SOFTRONICS
303/593-9540
TELEX 450236

Circle 248 on Reader Service Card

9-Track Tape Subsystem for the IBM PC/XT/AT



Now you can exchange data files between your IBM PC and any mainframe or mini-computer using IBM compatible 1600 or 6250 BPI 9-Track tape. System can also be used for disk backup. Transfer rate is up to 4 megabytes per minute on PCs and compatibles. **Subsystems include 7" or 10 1/2" streaming tape drive, tape coupler card and DOS compatible software.** For more information, call us today!

QUALSTAR

9621 Irondale Ave., Chatsworth, CA 91311
Telephone: (818) 882-5822

Circle 225 on Reader Service Card

Can you graph, solve, find minima, maxima points of inflection, etc... of this equation in 5 minutes or less?

$$5 * \cos(x * (1/x)) + 10 * \exp(\sin(x)) - (x^3) = F(x)$$

With **THIRD** you can do this and much more!



Demo Diskette \$5.00

TRILOBYTE, INC.
596 Abolition St.
Hato Rey, P.R. 00918
(809) 767-1839

Circle 278 on Reader Service Card

PROGRAMMERS FOR IBM PC/XT/AT



- Select Device with vender name & type number directly
- Enable user to set up Program Pulse Width, Vpp, Vcc.
- Over-program Pulse Width & Iteration Counts.
- Capable of set & 8/16/32-bits wide-word programming.

XP6000A Adapter & cable installs in PC for connecting programmer externally	\$55
XP6001 1-socket 1M-bits EPROMs programmer	\$160
XP6002 8-socket 1M-bits EPROMs programmer	\$375
XP6003 1-socket MCS-48 micros programmer	\$215
XP6004 1-socket MCS-51 micros programmer	\$270
XP6014 4-sockets 1M-bits EPROM programmer	\$260
AT-1D1/A EPROM Eraser erases 30 24-pin ICs with timer	\$195

2 YEARS GUARANTEE • 30 DAYS MONEY BACK WARRANTY

Xender Corporation
2824 KENNEDY BLVD., J. J. BUSBY CITY, NJ 07030
Xender TEL: 201-659-8291 Tlx: 910 240 4144 CHAMPION Fax: 201-864-9737

Circle 363 on Reader Service Card

Industrial Control Systems Intelligent Terminals Diskless Systems

ROMDISK™

For the IBM PC, XT, AT PS/2 and PC DOS* or MS DOS*

Diskless Systems

- Emulates a diskette or hard disk, adapter and disk drive—SSDD (180K), DSDD (360K), HC (786K or 1.2MB) 720K or 1.44MB.
- Standard and Cassette models for both EPROM and SRAM technology. Interchangeable EPROM and SRAM cassettes.
- Two Autoboot, File and EPROM programming modes.
- Simply copy a Master Diskette to program the EPROMs.
- List prices with memory ICs from \$295. Models available OEM without EPROMs.

EPROM MODELS programmable and read only
SRAM MODELS read and write—battery backed
FLASH EPROM MODELS electrically erasable and reprogrammable

CURTIS, INC.

 2837 N. Fairview Av. • St. Paul, MN 55113
612/631-9512 Fax 612/631-9508



*IBM PC, XT, AT and PC DOS are trademarks of IBM. MS DOS is a trademark of Microsoft

Circle 69 on Reader Service Card

SONY

	2-4 box	5-9box	10+box
3 1/2" DS	15 ⁹⁵	15 ⁸⁰	15 ⁵⁵
2 meg HD	37 ⁹⁵	37 ⁵⁰	36 ⁹⁵

	MAC-PAC-50 (50)	(100)	"NO LABEL" (400)
3 1/2" SINGLE	1.15 ^{ea}	1.12 ^{ea}	1.09 ^{ea}
DOUBLE	1.27 ^{ea}	1.22 ^{ea}	1.19 ^{ea}

Old Health
Diskette Connection

Delaware 1-800-451-1849
P.O. BOX 10247, WILMINGTON, DE 19850
Oklahoma 1-800-654-4058
P.O. BOX 1674, BETHANY, OK 73008
Nevada 1-800-621-6221
P.O. BOX 12396, LAS VEGAS, NV 89112

TELEX #4933362 FAX #405-495-4598

BASF

5 1/4" DOUBLE SIDE HIGH DENSITY	PACKAGED 10 PER BOX		
	2 Boxes	5 Boxes	10 Boxes
	6 ⁶⁰	6 ⁴⁰	6 ²⁰

MF-1D	11 ⁶⁰	11 ³⁵	11 ²⁰
MF-2D	14 ²⁰	13 ⁹⁵	13 ⁸⁰
MF-2HD	36 ³⁵	35 ⁷⁵	35 ⁴⁵

Old Health
Diskette Connection

Delaware 1-800-451-1849
P.O. BOX 10247, WILMINGTON, DE 19850
Oklahoma 1-800-654-4058
P.O. BOX 1674, BETHANY, OK 73008
Nevada 1-800-621-6221
P.O. BOX 12396, LAS VEGAS, NV 89112

TELEX #4933362 FAX #405-495-4598

maxell

OPTICAL DISKS CALL

	Packed 10/Box	2 Box	5Box	10Box
5 1/4" *	MD-2D	6 ⁸⁵	6 ⁷⁰	6 ⁵⁵
	MD-2HD	12 ⁵⁰	12 ²⁵	11 ⁹⁵

3 1/2" *	MF 1DD	~ 12 ⁶⁵	12 ⁴⁵	12 ²⁵
	MF 2DD	~ 15 ⁶⁰	15 ⁴⁰	15 ²⁵
	MF 2HD	~ 37 ⁰⁰	36 ⁵⁰	35 ⁹⁵

8" *	FD1-1200	~ 19 ⁹⁵	19 ²⁰	18 ⁴⁵
	FD2-1200	~ 23 ⁶⁵	22 ⁷⁵	21 ⁸⁰

Old Health
Diskette Connection

Delaware 1-800-451-1849
P.O. BOX 10247, WILMINGTON, DE 19850
Oklahoma 1-800-654-4058
P.O. BOX 1674, BETHANY, OK 73008
Nevada 1-800-621-6221
P.O. BOX 12396, LAS VEGAS, NV 89112

TELEX #4933362 FAX #405-495-4598

Minimum order \$200.00. No Surcharge on Visa MasterCard. COD orders add \$3.00 Surface. Shipping UPS add \$3.00 per 100 for 3 1/2" or 5 1/4", add \$4.00 per 100 for 8". U.S. Mail delivery add 9%. *Prices subject to change without Notice.

This could be the most productive phone number you call today. Toll free.

1 (800) 531-5369

(Or, if you prefer to FAX your order—1 (512) 344-2985.)

TrippLite® Battery Back-Ups

Protect your equipment and data by providing safe shut down time for your computer systems and other sensitive equipment during black or brown-outs. Data loss from one black-out can cost you hundreds, if not thousands of dollars. These units feature AC line spike and noise suppressors, status indicator lights and heavy gel-cell batteries—a regulated battery charger automatically restores battery to full charge when AC power returns.

\$1299.00

\$799.00 **\$399.00**

\$299.00 **\$599.00**

\$239.00

BC-200 200-W BC-325 325-W BC-750 750-W SC-BC-2000 2000-W BC-1200 1200-W BC-450 450-W

This complete TrippLite® Series offers reliable battery back-up at an extremely low price.

TrippLite® Voltage Regulator - Line Conditioners

\$79.00 **\$149.00** **\$199.00**



LS-600 LC-1200 LC-1800

TrippLite® Line Stabilizer/Conditioners automatically adjust varying input voltage to provide full voltage support during a low voltage condition while suppressing spikes and line noise.

OMNI Power Director

CC16-P **\$79.95**

TrippLites' ISOBAR command console provides the highest level of surge and noise suppression of any console unit on the market today. Features include 6 outlets, 5 lighted power switches, protection indicator light, 15 amp circuit breaker and 12-foot power cord.

Eprom Programmer

EW-904 **\$179.95**

You can program your own EPROMS with this EPROM programmer—it can program up to 4, 16K thru 512K EPROMS simultaneously—easy to use software is included.

Eprom Eraser

LA-6T **\$79.95**

You can erase your EPROMS quickly and easily at home or workplace with this easy to use EPROM eraser with built-in timer. It features an adjustable exposure time with alarm and is static protected. Without timer (not shown). LA-6A **\$59.95**

Hard Drive Cases



SDH-2H **\$99.00**

This sturdy metal cabinet is capable of handling up to two 1/2 height hard disk drives—comes complete with fan, switching power supply and mounting hardware. (Drive cables not included) 14 1/2" W X 13 1/2" D X 2 1/2" H.

Cable Assemblies

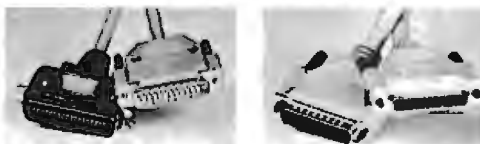

PC/AT Parallel Printer Cables DB-25 - 25 Line Cables Male-Male

Stock #	Length	Price	Stock #	Length	Price
PPC301-6	6 ft.	\$ 6.95	25MM-6	6 ft.	\$ 6.95
PPC301-10	10 ft.	7.95	25MM-10	10 ft.	7.95
PPC301-15	15 ft.	11.95	25MM-25	25 ft.	17.95
PPC301-25	25 ft.	17.95	25MM-50	50 ft.	33.95
PPC301-6RA	6 ft.	12.95	25MM-100	100 ft.	62.95

POPULAR CABLES DB-25 - 25 Line Cables Male-Female

Stock #	Description	Price	Stock #	Length	Price
MEC-6	Monitor Ext.	\$5.95	25MF-6	6 ft.	\$ 6.95
KEC-6	Keyboard Ext.	3.85	25MF-10	10 ft.	7.95
ACPC-03	Power Adapter	4.95	25MF-25	25 ft.	17.95
ATM-6	AT Modem Cable	6.95	25MF-50	50 ft.	33.95
	call Other cables available		25MF-100	100 ft.	62.95

Switchboxes



These sturdy metal switchboxes allow you to share computers, printers and other peripherals quickly and easily. They have gold-plated contacts and are EMI-RFI protected.

DB-25 25 Line Switchboxes

Stock #	Description	Price
AB25-2	Two position	\$19.95
AB25-3	Three position	25.95
AB25-4	Four position	28.95
AB25-5	Five position	38.95
AB25-6	Six position	59.95
AB25-X	Cross over	28.95

Centronics 36 Line Switchboxes

Stock #	Description	Price
AB36-2	Two position	\$23.95
AB36-3	Three position	29.95
AB36-4	Four position	34.95
AB36-5	Five position	44.95
AB36-X	Cross over	37.95

We carry a complete line of switchboxes for your different requirements. Call for more information!

Altex Electronics, Inc.

"Your Electronics Supply House"

TERMS: Minimum order \$10.00. We accept Mastercard, Visa, and American Express at no additional charge. For C.O.D. orders, add \$2.20. For orders under \$100.00, add \$3.00 handling and actual UPS shipping charges. For orders over \$100.00, we pay handling charge—you pay actual UPS shipping charges plus insurance. Purchase orders accepted from approved accounts. All returns require an RMA# and are subject to a restocking fee. Texas residents add 7.5% sales tax. Prices subject to change and we are not responsible for typographical errors.

Store Hours: 8:00-6:00 M-F, 10:00-2:00 SAT CST
10731 Gulfdale, San Antonio, Texas 78216

ON TARGET ASSOCIATES
 Products and Services
 for Design and Manufacturing Engineers.

MicroChannel Design Consulting
 Prototype Cards
 Newsletter
PS/2 ——— ASIC's
 ——— Extender Cards
 ——— Adapter Bracket Sets
 ——— Burn-in Mother Boards

We will move your PC/XT/AT products to the Micro Channel, or create your new design.

CALL: (408) 980-7118
 for our Free catalog

**ON TARGET
 TARGET
 TARGET**
 ...the PS/2 leaders.

PS/2 and Micro Channel are trademarks of IBM Corp.

Circle 198 on Reader Service Card

REAL WORLD I/O
 For PC/XT/ATs



DG24 • 24 line digital I/O; 10 MHz 8255. \$55
AD500 • 8 channel 12-bit (plus sign) integrating A/D; prog. gains of 1, 10 & 100; 7 digital I/O lines. \$239
AD100 • Single channel version of AD500; 10 digital I/O lines. Same programmable gains. 700 meg input Z. \$149
AD1000 • 8 channel 12-bit A/D; 25 us; sample & hold; 3.5 MHz timer/counters; 24 digital I/O lines. \$295
ADA300 • 8 channel 8-bit 25 us A/D; single D/A sample & hold; 24 digital I/O lines. \$239
AD200 • 4 channel 12-bit 125 us A/D; 3.5 MHz timer/counters; 24 digital I/O lines. \$239
DA600 • Fast settling dual bipolar D/A. \$179
PD200 • Prototype board w/ address decoder; manual \$99

All boards include BASIC, Pascal, C, and Forth drivers. 30 day return; 1 year warranty. Call for "Real World Interfacing" application notes.

Real Time Devices, Inc.
 P.O. Box 906 State College, PA 16804
(814) 234-8087

Circle 232 on Reader Service Card



E(E)PROM, MICRO & MEMORY CARD PROGRAMMER... \$345-\$595

- No personality modules for E(E)Proms & Intel Micros.
- All 24/28/32 pin EProms to 1 MBit (upgradeable to 32MB)
- 8741, -2, -4, -8, -8H, -9, -9H, -51, -C51, -52, -55, 9761. EEPROMS.
- Memory Cards: Seiko/Epson, GI. Flash EProms. On-board Programming capability. Easy F/W upgrades. Modular design.
- Stand-alone E(E)Prom & Memory Card Duplication / Verify.
- User friendly menu - driven driver for IBM-PC & Macintosh.
- Autobaud RS232 to any computer. Hex/Binary/Intel/Motorola.
- Built-in Eraser/Timer option (\$50). Gang-Module ready.
- Direct technical support. Full 1 year warranty.

Call today for datasheets!

B&C MICROSYSTEMS INC.
 355 West Olive Ave, Sunnyvale, CA 94086
 (408)730-5511 FAX: (408)730-2155 TLX: 984185

BUY QUALITY FOR LESS!
DYSAN

5 1/4" DS/DD 39¢
100% CERTIFIED LIFETIME WARRANTY
 Price based on quantity of 250 in bulk includes Tyvek sleeves and label kits.

800-222-0490
 In NJ 201-462-7628
 FAX 201-462-5658

• 24 HOUR SHIPMENT •
MEGA Soft
 P.O. Box 710, Freehold, NJ 07728
 Full service duplication facility

Circle 169 on Reader Service Card

BUY QUALITY FOR LESS!
MAXELL

5 1/4" DS/DD 59¢
3 1/2" DS/DD 1.15
LIFETIME WARRANTY
 Price based on quantity of 300 in bulk includes Tyvek sleeves and label kits.

800-222-0490
 In NJ 201-462-7628
 FAX 201-462-5658

• 24 Hour Shipment •
MEGA Soft
 P.O. Box 710, Freehold, NJ 07728

Circle 170 on Reader Service Card

Satellite Communication
MICROSAT II
 Expansion Board \$700



IMMEDIATE DELIVERY

- For IBM PC/XT/AT and compatible.
- Satellite data receiver - 9600 baud.
- Satellite bulletin board.
- Satellite video and audio option - Add \$200

PERSONAL SPACE COMMUNICATIONS
 707 Johnson Road, Blaine WA 98230
 (509)597-6298 TLX 04-508306 FAX (509)597-6214

Circle 208 on Reader Service Card

SABINA

MasterCard VISA

SAME DAY SHIPMENT
D - RAMS

41256 - 06	\$12.30
41256 - 10	\$11.00
41256 - 12	\$10.80
41256 - 15	\$9.80
1mg x 1 - 10	...	\$35.00
1mg x 1 - 08	...	\$40.00

MATH CO - PROCESSORS

8087	\$98.00
8087 - 02	\$140.00
80287 - 08	\$220.00
80287 - 10	\$270.00
80387 - 16	\$360.00
80387 - 20	\$510.00
80387 - 25	\$620.00

CALL FOR LOWEST PRICES
1-800-2-SABINA

SABINA INTERNATIONAL, INC.
 657 Brea Canyon Road Suite #4
 Walnut, California 91789
 (714)594-6336 • FAX (714)595-4008
 PRICES SUBJECT TO CHANGE WITHOUT NOTICE

Circle 235 on Reader Service Card

LOW COST INTERFACE CARDS FOR PC/XT/AT



PC485D \$95
[RS 485/422 INTERFACE]

- Meets the EIA RS-485 standard for multipoint bus transmission and the EIA RS-422A standard.
- Can be configured as COM1 or COM2.
- Line terminators are jumper selectable.
- High speed differential drivers allow fast data transfer over long cables (over 4,000 ft). Max. Baud rate 56KB/115KB.
- Tri-state line drivers permit implementation of LANs.
- Two wire (half duplex) operation. DB9 or phone jack.
- Sample communication software available. (\$50)

PC488A \$145
[IEEE - 488 INTERFACE]

- Includes INSTALLABLE DOS DEVICE DRIVERS and software support for BASIC.
- Optional language support for C, PASCAL, FORTRAN and ASSEMBLY \$50
- Selectable base I/O address, IRQ and DMA.
- CONTROLLER / TALKER / LISTENER capability.
- Customer support via dedicated 24 hours B&C Microsystems BULLETIN BOARD.
- Compatible with most IEEE-488 Software Packages for the IBM-PC (e.g. ASYSTANT GPIB, Lotus Measure, etc.).
- Hardware compatible with NI. GPIB - PCIIA.

PC488B \$345
[IEEE - 488 CARD WITH]
[BUILT-IN BUS ANALYZER]

- GPBASIC package complements IBM/Microsoft BASIC interpreter and compiler to create a programming environment similar to HP desktop computers.
- Additional libraries of over 20 high level 488 dedicated functions for C, Pascal or Fortran available (\$50 ea.).
- Powerful menu-driven bus analyzer, which can run in the foreground or in the background while 488 programs or commands are executed, features program stepping, break points and real time bus data capture (4k circular buffer).
- Instant toggling between foreground and Analyzer screen.
- Dipswitch selectable Base Address, IRQ, DMA.
- Talker/Listener/Controller capability. Based on TMS-991.
- NEC-7210 based version (NI PCII/IIA compatible) - \$ 445

MC/VISA/AMEX Call today for datasheets!

B&C MICROSYSTEMS INC.
 355 West Olive Ave, Sunnyvale, CA 94086
 (408)730-5511 FAX (408)730-2155 TLX: 984185

Circle 35 on Reader Service Card



REMOTE DATA ACQUISITION AND CONTROL

Despite its low cost, power and ease of use, the A-BUS I/O system until recently had a major limitation: it had to be located close to the controlling computer. Now two new serial adapters from Alpha Products have removed this restriction. Any computer with an RS232 port can control the A-BUS line of data acquisition and control cards. Using standard telephone type cable, the A-BUS system can be located up to 500 feet away from the computer. With the addition of a Modem the A-BUS cards can be controlled from anywhere. As with all A-BUS cards, the adapters are easily installed and are programmed using standard commands.

NEW SERIAL PROCESSOR HAS BRAIN

The low cost SP-127 Serial Processor fills a great need in remote data acquisition. It includes a complete BASIC interpreter and can run programs independently of the host computer. This distributed processing relieves the host computer of housekeeping chores and low level decision making. The SP-127 can read and record data at set intervals for later reviewing or recalling at the host's convenience. The Serial Processor communicates with any computer through an RS232 port and includes a complete BASIC interpreter with 32K of memory. Adding a Modem turns the SP-127 into a automated remote data and control station.

THE A-BUS ON NETWORK

The usefulness of the A-BUS has been expanded with the addition of "Serial Nodes". These inexpensive (\$49) devices provides the ability to connect up to 16 complete A-BUS systems to a single serial port on any computer. The node also functions as a repeater to increase the reach of the adapter beyond the 500 foot limit. Nodes work in conjunction with the company's SA-129 Serial A-BUS Adapter. Plant-wide data collection and control should become widespread thanks to the system's low cost, outstanding capabilities, and easy of use.

ADVANCE IN MOTION CONTROL

Breaking new ground in motion control and robotics, Alpha's Smart Quad Stepper Controller outperforms systems costing 5-10 times more. This \$299 board includes a multitasking microprocessor capable of controlling 4 stepper motors simultaneously at speeds up to 1000 steps per second. Four Axis positioning is perfect for robot arms, positioners, pick and place, etc. Commands are intuitive; plain English words and a forgiving syntax make it easy to write (and edit) command sequences. Scaling factors allow for meaningful units of your choice, and 32 bit floating point arithmetic ensures accurate calculations. The "learn" feature involves storing a series of movements so that even a complex sequence can be repeated easily. Alpha's engineers thoughtfully included direct drivers for small motors, and a variety of inputs (limit switches, remote keypad, panic button, etc.). An SC-149 can be set up quickly and easily, minimizing development time or allowing more effort to be devoted to the rest of the robotic project.

A-BUS™ MAGIC

Classroom to advanced industrial applications.

Be a Wizard in your Lab, Factory, College, Home...

It used to be difficult and costly to do process control, robotics, data acquisition, monitoring and sensing with your computer. Now the low-cost A-BUS system makes it easy to do almost any project you can imagine.

Versatility. A-BUS cards handle most interfacing, from flipping switches, to reading temperature to moving robot arms, to lighting lamps, to counting events, to sensing switches...

Adaptability. The A-BUS is modular, allowing expansion well beyond your needs. It works with almost any computer, or even as a remote data station with the new serial adapters.

Simplicity. You can start using the A-BUS in minutes. It's easy to connect, and software is a breeze to write in any language.

Reliability. Careful design and rugged construction make the A-BUS the first choice in specialized I/O.

An A-BUS system consists of: = An A-BUS adapter plugged into your computer = A cable to connect the adapter to 1 or 2 A-BUS function cards. = The same cable will also fit an A-BUS Motherboard for expansion to up to 25 cards in any combination.

Call our application engineers to discuss your project.

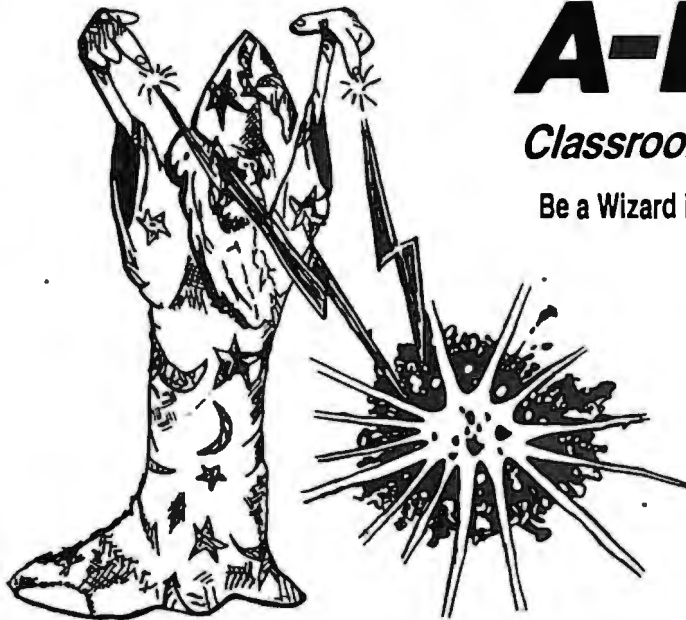

NEW: REMOTE A-BUS! Use the new Serial (RS-232) Adapter or Processor to control any A-BUS system. Cards can be up to 500 ft away using phone type cable, or off premises using a modem. Call or send for the A-BUS Catalog covering all the new products.

Important

All A-BUS Systems: ♦ Come assembled and tested ♦ include detailed manuals with schematics and programming examples ♦ Can be used with almost any language (BASIC, Pascal, C, assembler, etc.) using simple "IN" and "OUT" commands (PEEK and POKE on some computers) ♦ Can grow up to 25 cards (in any combination) per adapter ♦ Provides jumper selectable addressing on each card ♦ Require a single low cost unregulated 12V power supply ♦ Are usually shipped from stock. (Overnight service is available.)

About Alpha Products

Founded in 1976 for the purpose of developing low cost I/O devices for personal computers. Alpha has grown to serve over 70000 customers in over 60 countries. Our customers include many of the Fortune 500 (IBM, Hewlett-Packard, Tandy, Bell Labs, GM...) as well as most major universities. We design, manufacture, sell and service the A-BUS products in the USA.
Overseas distributors: England: Cady Science Assoc. Ltd. 051 342 7033.
Australia: Brumby Technologies Pty. Ltd. 759 1638. France: Coserm 46 86 64 75

Inputs, Outputs, etc.

Digital Input: 8 optically isolated inputs. Input can be 5 to 100V voltage levels or switch closures. IN-141: \$65

D/A converter: 4 Channel 8 Bit D/A converter with output amplifiers and separate adjustable references. DA-147: \$149

24 line TTL I/O: Connect 24 input or output signals (TTL 0/5V levels or switches). Variety of modes. (Use 8255A) DG-148: \$72

Digital Output Driver: 8 outputs: 250mA at 12V. Drive relays, solenoids, stepper motors, lamps, etc. ST-143: \$78

Clock with Alarm: Powerful clock/calendar. Battery backup. Timing to 1/100 sec. Alarm relay, LED and buzzer. CL-144: \$98

Touch Tone Decoder: Each tone is converted into a number which is stored on the board. PH-145: \$87

A-BUS Prototyping card: 4x4.5" card. Will accept up to 10 I.C.s. With power & ground bus. PR-152: \$16

Counter Timer: Three 16 bit counters/timers. CT-150: \$132

Relay Card: 8 individually controlled industrial relays each with status LED's (3A at 120VAC contacts. SPST). RE-140: \$142

Reed Relay Card: 8 reed relays (20ma at 50VDC. SPST). Individually controlled and latched, with status LEDs. RE-156: \$109

Analog Input: 8 analog inputs. 0-5.1V in 20mV steps (8 bits). 0-100V range possible. 7500 conversions/second. AD-142: \$142

12 Bit A to D: Analog to digital converter. Input range -4V to +4V, expandable to 100V. On-board amplifier. Resolution 1mV. Conversion time 130ms. 1 channel. (Expand to 8 channels with the RE-156 card) AN-146: \$153

Digital Input: 8 optically isolated inputs. Input can be 5 to 100V voltage levels or switch closures. IN-141: \$65

Motion Control

Smart Quad Stepper Controller: The world's finest.

On board microprocessor controls four motors simultaneously. Uses simple English commands like "MOVE ARM 10.2 INCHES LEFT". For each axis, you control coordinates (absolute or relative), ramping, speed, units, scale factors, etc. Many inputs for limit switches etc. On the fly reporting of speed, position, etc. Built in drivers for small motors (such as MO-103 or 105). SC-149: \$299
Options: ▶ 5 amp/phase power booster for 1 motor: PD-123: \$49
▶ Remote "teach" keypad for direct motor control: RC-121: \$54
▶ Stepper motors and cables: send for catalog

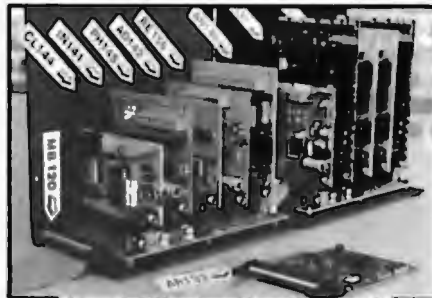

A large A-BUS system with two Motherboards

Stepper Driver Kit: For experimenting with stepper motors. Includes 2 MO-103 motors and a ST-143 dual driver PA-181: \$99

Stepper Motors:

MO-103: 2 1/4" dia. 1/4" shaft. 7.5"/step. 12V. 5 oz-in torque. \$15

MO-104: 2" dia. 1/4" shaft. 1.8"/step. 5V. 60 oz-in torque. \$45

MO-105: 1.7" square. 2" shaft. 3.75"/step. 12V. 6 oz-in. \$15

A-BUS Adapters

- ▶ Can address 64 ports and control up to 25 A-BUS cards.
- ▶ Require one cable. Motherboard required if more than 2 cards.

A-BUS Parallel Adapters for:

IBM PC/XT/AT & compatibles. Use one short or long slot.	AR-133: \$69
Apple II, II+, IIe Plug into any slot.	AR-134: \$52
Commodore 64, 128 Plug into Expansion Port.	AR-139: \$48
TRS-80 Model 102, 200 Use 40 pin "System bus".	AR-136: \$76
Model 100 (Tandy portable) Plug into socket on bottom.	AR-135: \$75
TRS-80 Model 3, 4, 4D Y-Cable available if 50 pin bus is used.	AR-132: \$54
TRS-80 Model I Plug into 40 pin expansion bus.	AR-131: \$39
Tandy Color Computers File ROM slot. Multiplex or Y-Cable	AR-138: \$49

A-BUS Cable: Necessary to connect any parallel adapter to one A-BUS card or to first motherboard. 50 pin, 3 ft. CA-165: \$24
Special Cable for two A-BUS cards CA-162: \$34

Serial Adapter: Connect A-BUS systems to any RS-232 port. Allows up to 500 ft from computer to A-BUS. SA-129: \$149

Serial Processor: same as above plus built in BASIC for off-line monitoring, logging, decision making, etc. SP-127: \$189
Use SA-129 or SP-127 with modems for remote data acquisition.

Motherboard: Holds up to 5 A-BUS cards in sturdy aluminum frame with card guides. A sixth connector allows (using cables CA-161: \$12) additional Motherboards to be added. MB-120: \$108

Power Supply: Power pack for up to 5 cards. PS-128: \$12

Complete Catalog Available

For Orders and Info call (203) 656-1806
Weekdays from 9 to 5 EST or FAX 203 656-0756

Ordering Information: We accept Visa, Mastercard, Checks, and M.O. Purchase orders are subject to credit approval. C.O.D. is \$4 extra. CT residents add 7.5% sales tax. Shipping: \$4 per order (usually UPS ground), UPS 2nd Day Air: \$4 extra. Next Day service available. Canada: \$6 per order (Airmail). Outside US and Canada: Add 10% of order total.



Alpha Products
A Sigma Industries Company

ALPHA Products

242-B West Avenue, Darien, CT 06820

DiskMASTER[®]
The Ultimate
Diskette Value ...

3 1/2" - 135TPI DS-DD COLOR		3 1/2" - 2MB DS-HD BLACK
1.15	BULK COLOR	3.10
1.25	PLASTIC STORAGE BOX	3.25
5-1/4" - 48 TPI DS-DD		DS-HD 96 TPI IBM-AT Compatible
.49	BULK COLOR OR GRAY	.90
.59	BOXED COLOR	.99

TECENTECH

DiskCourier
Travel Pouch and Color Disks

.84	PLASTIC STORAGE BOX COLOR	1.39
.63	BULK COLOR	1.15
3-1/2" - 135 TPI DS-DD COLOR		3-1/2" - 135 TPI BLACK DS-HD
1.75	PLASTIC STORAGE BOX	4.50

.64	DS-HD 96 TPI IBM-AT Compatible	.94
3-1/2" DS-HD		3-1/2" DS-DD
4.50		1.34

3M & Pelikan

5-1/4" - 48 TPI DS-DD		DS-HD 96 TPI IBM-AT Compatible
.72		1.48

Nashua

5-1/4" - 48 TPI DS-DD		DS-HD 96 TPI IBM-AT Compatible
.47	BOXED	.80

BULK

32¢ 5-1/4" DS/DD 48 TPI
Exceeds ANSI specifications
+ 6¢ FOR TYVEK

ORDERING INFORMATION

TERMS: P.O. orders accepted, government and schools on net 30. SHIPPING: U.S. orders add \$3.00 per 100 diskettes or fraction thereof, add \$3.00 for COD orders.
PRICE PROMISE: We will better any lower delivered price on the same products and quantities advertised nationally.

Toll Free Order Line:
1-800-233-2477

DISC INTERNATIONAL

NEW

**CURRENT LOOP
ADAPTER FOR
IBM PS/2**



- Configurable as Serial RS-232
- Built-in Null Modem Eliminator
- Supports 20, 30, and 60 mA values
- Supports Com1 through Com8

1-800-553-1170

QUA TECH
INCORPORATED

478 E. Exchange St., Akron, OH 44304
TEL: (216) 434-3154 FAX: (216) 434-1409
TLX: 5101012726

NEW

**PARALLEL PORT
FOR PS/2**



MODELS 50, 60, 80

- LPT1, LPT2, LPT3
- Optional Serial Port
- OEM Pricing Available

1-800-553-1170

QUA TECH
INCORPORATED

478 E. Exchange St., Akron, OH 44304
TEL: (216) 434-3154 FAX: (216) 434-1405
TLX: 5101012726

NEW

MU



COMMUNICATION BOARD

- Four Independent RS-232 Ports
- Flexible Interrupt/Address Options
- Discounts Available
- For Models 50, 60, 80

1-800-553-1170

QUA TECH
INCORPORATED

478 E. Exchange St., Akron, OH 44304
TEL: (216) 434-3154 FAX: (216) 434-1409
TLX: 5101012726

RS-422
Communications Board



- For IBM PC/XT/AT/PS/2
- Dual channel RS-422/RS-485
- Selectable/shareable interrupts
- Differential drivers to 4000 ft.
- Immediate delivery

1-800-553-1170

QUA TECH
INCORPORATED

Leaders in Communication technology
478 E. Exchange St., Akron, OH 44304
(216) 434-3154 TLX: 5101012726

PALMERASE[™]
World's Smallest UV Eraser

\$4995



PALMERASE[™] can erase 20, 24, 28, and 40pin EPROMs in less than 3 minutes! Also, larger erasers are available to handle EPLDs, MICROs and other UV erasable devices. Please call today for more information on an eraser that's right for you.

LOGICAL
DEVICES, INC.

1201 N.W. 65th Place, Ft. Lauderdale, FL 33309
1-800-331-7766 in Florida: (305) 974-0967

the **HUSKY**[™]

EPROM
PLD
MICRO
GANG
SET



PC based PROGRAMMER
\$599.00*

*modules not included.

What's New at AMERICAN DESIGN COMPONENTS?

"The Source" of the electro-mechanical components for the hobbyist.

We warehouse 60,000 items at American Design Components—expensive, often hard-to-find components for sale at a fraction of their original cost!

You'll find every part you need—either brand new or removed from equipment (RFE) in excellent condition. But quantities are limited. Order from this ad, or visit our retail showroom and find exactly what you need from the thousands of items on display.

OPEN MON.-SAT., 9-5

THERE'S NO RISK!

With our 90-day warranty, any purchase can be returned for any reason for full credit or refund.

12" EGA COLOR MONITORS 25 KHz — High Res...

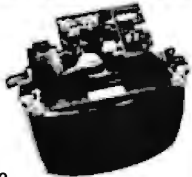

Perfect for text, CAD, & other graphics. 8-color display. Scanning freq. to 25KHz. Res.: 752 x 410. Input: 110/220V, 50/60Hz., 75W. Mtd. in metal chassis. Works ideally w/the EGA "Wonder Card." Diagram incl. Hitachi #CD1215-DTL.

Item #18059 \$129.00

COMMODORE PLUS 4 COMPUTER...



Built-in software includes a word processor, spread sheet, graphics, & filing system. Comes complete with power supply and instruction manual.

(Customer Returns — Tested Good!)

Item #19202 \$49.95

9" OPEN FRAME MONITORS...



TTL—Green Phosphor Input: 12VDC. Audiotronics #900964-04 Item #17198 New — \$19.95

Composite—Black & White Input: 12VDC. (Mtd. in metal chassis.) Motorola #XM226-21 Item #19694 New — \$22.95

THERMAL PRINTER Dot Matrix—120 CPS

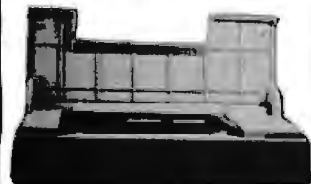

Print speed: 120 CPS. Paper width: 8 1/2"; 80/132 columns/line. With RS-232 IBM serial interface. Operates on 115/230V, 50/60Hz. Hewlett Packard #HP2671A Item #19705 \$79.00 (Removed from working systems!)

5 1/4" FULL-HEIGHT HARD DISK DRIVES



40Mb (AT/XT Compat.) Hi speed, 40 ms. access time. Quantum #Q540 Item #17765 New — \$379.00
10Mb (ST412 Compat.) Major manufacturers — Get them while they last! Item #17199 \$99.00 ea.

5 1/4" HALF-HEIGHT HARD DISK DRIVES



10Mb (IBM® Compatible) Mfr— NEC #D5124 Item #19704 New — \$99.00
20Mb (ST225 Compatible) Mfr— Olivetti #EM5520/2 Tested-Like New! Item #20060 \$159.00

5 1/4" FULL-HEIGHT FLOPPY DISK DRIVE (IBM® Compat.)



48 TPI, 40 Track, Double Side/Double Density Tandon #TM100-2 or equiv. Item #7928 \$79.00 New 2 for \$150.00 New

3 1/2" MICROFLOPPY DISK DRIVE



1 Mb (unformatted), 135 TPI, 3 ms. access time. Power requirements: +12, +5 volts. Removed from operational computers—TESTED — LIKE NEW! Mfr— NEC, model FD1035 Item #17171 \$79.00 ea. 2 for \$150.00

EXTERNAL DISK DRIVE CHASSIS



With 60W power supply (fan cooled). Can accommodate any of the following: 2 full-ht. drives.....ADCItem#7928 2 floppy drives.....#10005/17171 1 hard drive.....#19704 & 1 floppy.....#10005 Input: 115/230V, 50/60 Hz. Orig. for Burroughs computer. Dim: 11" W x 8"H x 12"D Item #14541 \$59.50

115 CFM MUFFIN® TYPE FANS



115VAC; 60Hz.; 21W; 28A.; 3100RPM; 5-blade model; aluminum housing. Can be mtd for blowing or exhaust. Dimen.: 4 1/16" sq. x 1 1/2" deep Mfr: Howard Industries or equiv. Item #1864 New — \$9.95 W/Adjustable Speed Control Item #20611 \$12.95

ELECTRONIC CASH REGISTER DRAWER (Computer Operated)



Fits right underneath your PC. Comes with metal cash drawer and cover, which are removable. Security switch w/key allows you to open or lock drawer manually. Brown cabinet; mtd on rubberft. OAdim.: 18 3/4" W x 4" H x 15" D. Item #12265 New — \$49.95

PC/XT/AT Compatible ENHANCED LAYOUT 101-KEY KEYBOARD



★ Membrane
★ 12 Function Keys
★ Separate Numerical Cursor
★ LED indicators for Scroll, Caps & Number lock
★ 1" inclination Foot Stand Mfr. #29079 Item #19680 New — \$49.95

COMMODORE C-64 POWER SUPPLY



DC Output: 5VDC @ 7.5W and 9VAC @ 6.7VA Input: 117VAC, 50/60Hz. Commodore #310157-02 (black) Item #19315 New — \$24.95

STEPPING MOTORS for ROBOTICS...

Precision steppers with increments from 1 to 7.5°. Speeds up to 5,000 steps.



Fig. 1 2" L x 2 1/4" dia. x 2 1/4" H

Item No.	Step Angle	DC Volt.	DC Torque oz./in.	Type	Mfr. & Part No.	Fig.	Price
5275	1.8°	1.8	72	PM 2Ø	Superior MO61-FF-6201B	1	\$19.95 ea. 2 for \$37.50
7630	1.8°	3.0	200	PM	Superior MO92-FT-402	1	\$34.50 ea. 2 for \$59.50
16410	1.8°	12.0	700*	PM	Applied Motion 4017-839	2	\$9.95 ea. 2 for \$14.95

*Grams per Cm.

HIGH POWER SWITCHING POWER SUPPLY



DC Output: +5V @ 18A -5V @ 2.5A +12V @ 2.5A Input: 115/230VAC, 50/60Hz. Dim: 13" L x 4 1/2" W x 1 1/2" H Mfr— Sola #39-139 Item #17210 New — \$29.95

We carry a complete line of Computer & Game Accessories and Equipment! ...Please call or write with your requirements...

ANTI-GLARE SCREENS...

Glare & reflection filters that improve speed, accuracy & operator comfort...



IBM PC MonochromeItem #19215 IBM PC ColorItem #19216 AT&T MonochromeItem #19223 Apple MacintoshItem #19225 Compaq PortableItem #19226 New — \$8.95 ea.; 2/ \$15.00

MAGNIFYING LAMP



Multi-position, 30", completely adjust. swing arm, w/3-way metal C-clamp. Has 4" diopter magnifying lens, w/ruler. Porcelain lamp socket & on/off switch; uses up to a 60V bulb. Color: beige. UL listed. Item #13136 New — \$29.95

PROTOTYPING DEVICE w/EPROM INTERFACE — (Z8603) Complete microcomputer



2KbROM; 128 bytes RAM; 32I/O lines; up to 62Kb addressable extern. space ea.; 144 byte reg. file. 124 G.R. reg.; 4 I/C port reg.; 16 status & contr. reg.; Full duplex UART; 2 program. 8-bit counter/timers On-chip oscill. accepts crystal or external clock drive; 1.5V power supply. TTL compat. Item #18515 \$24.95

DYNAMIC MEMORY BOARD



★ Software incl.
★ 0-256Kb memory in 64Kb increments
★ Fully socketed for easy upgrade (IBM parity checking)
★ Memdisk: simulates high-speed disk in RAM memory
★ Allows you to print while still using the computer
Techmar #MUJ203010 (w/o RAM) Item #19977 New — \$29.95
★ Set of 9 — 64Kb RAM Chips Item #19983 9 chips for \$17.50

AMERICAN DESIGN COMPONENTS, 815 FAIRVIEW AVE., P.O. BOX 220, FAIRVIEW, N.J. 07022

YES! Please send me the following items—

Item No.	How Many?	Description	Price	Total

Shipping & handling: we ship UPS unless otherwise specified. Add \$3 plus 10% of total. Canadian: \$3 plus P.C. cost. Charge only. Sales Tax (N.J. residents only, please add 6% of total)

ORDER TOTAL

Printed on Recycled Paper

FREE! Fall '88 Catalog with every order!

For all phone orders, call TOLL FREE 800-524-0809. In New Jersey call (201) 941-5000.

MINIMUM ORDER \$15. Byte-189

My check or money order is enclosed.
 Charge my credit card.
 Visa Master Card Amex

Card No. _____
Exp. Date _____
Signature _____
Telephone: Area Code _____ Number _____
Name _____
Address _____
City _____
State _____ Zip _____

All inquiries and free catalog requests—call (201) 941-5000.

Don't compare Our Price Only. . . But Also Quality *

PCI-286-12

- 80286-12
- 1.2 MB Floppy Drive
- 640K RAM
- Serial / Parallel / Game
- 101-Key Enhanced Key Board
- SI = 13.3 (1 Wait)
- SI = 15.2 (0 Wait \$100 Option)
- 6/12 MHz Key Board Switchable
- WA2 HD & FD Controller
- 80287 SOCKET
- 200W POWER SUPPLY

MONO SYSTEM
 • W/Mono Monitor
 • 20 MB Hard Disk

\$1255

VGA COLOR SYSTEM
 • W/VGA Card & Monitor
 • 20 MB Hard Disk

\$1855

EGA COLOR SYSTEM
 • W/EGA Card + Monitor
 • 20 MB Hard Disk

\$1640



PCI-386-16

- W/40 MB HD

\$2395

PCI-386-20

\$2695

GAS PLASMA 286-1

- 80286-12 CPU
- SI = 13.3
- 3 1/2" FD 1.44 MB
- 20 MB HD ST-138
- LCD Screen (640 X 400)
- I/O Card Parallel/Serial/Game
- 640K RAM



GAS PLASMA 286-16 ___ \$2495

- CPU 80286-16
- SI = 18

LCD-286-10 PORTABLE ___ \$1655.00

- 10 MHZ 80286 SI=10.3
- 12 MHZ SI = 13.3 (Option \$50.00)
- 16 MHZ SI = 18 (Option \$250.00)
- 640K RAM
- LCD Screen 640 X 200 (Option 640 X 400 \$180.00)
- Super Twist & Back Lighting
- 86 Key Board
- External / Parallel / Game
- 1.2 MB Floppy drive
- 20 MB Hard Disk
- 80287 Socket
- 200 W Power Supply
- Side 15 3/4" X 9 1/2" X 8"
- 23 LBS

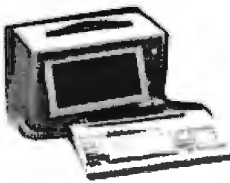

LCD-386-16 ___ \$2795.00

- 80386-16 MHZ
- 40 MB Hard Disk
- 80387 Socket

LCD-386-20 ___ \$3095.00

- 80386-20 MHZ
- 40 MB Hard Disk
- 80387 Socket

CRT-PORTABLE-286 ___ \$1449

- Compaq Type
- 80286 (10 MHz or 12 MHz)
- 12 MHz SI = 13.3 (Option \$50.)
- 16 MHz SI = 18 (Option \$250)
- One 1.2 MB Floppy Drive
- 200 W Power Supply
- TTL Display 9" Amber
- AT Key Board
- Serial / Parallel / Game
- WA2 HD & FD Controller
- 20 MB Hard Disk



CRT-386-16 \$2595 CRT-386-20 \$2895

- 80386-16

PCI PACIFIC COMPUTER

702 S. Del Mar Ave., #B,
 San Gabriel, California 91776
 (FAX) 818-286-8662

(818) 571-5548 (Technical support)

(800) 421-1102 (IN CA) ORDER ONLY

(800) 346-7207 (OUT CA)

Mon - Sat
 9:00 AM - 6:00 PM



*ALL SYSTEMS COME WITH ONE YEAR PARTS & LABOR WARRANTY

Computers For The Blind

Talking computers give blind and visually impaired people access to electronic information. The question is how and how much?

The answers can be found in "The Second Beginner's Guide to Personal Computers for the Blind and Visually Impaired" published by the National Braille Press. This comprehensive book contains a Buyer's Guide to talking microcomputers and large print display processors. More importantly it includes reviews, written by blind users, of software that works with speech.

This invaluable resource book offers details on training programs in computer applications for the blind, and other useful information on how to buy and use special equipment.

Send orders to:

National Braille Press Inc.
 88 St. Stephen Street
 Boston, MA 02115
 (617) 266-6160

\$12.95 for braille or cassette, \$14.95 for print. (\$3 extra for UPS shipping)

NBP is a nonprofit braille printing and publishing house.

IBM COMPATIBLES REDUCED BY 20% to 40%

CAT™ 8MHZ BASE SYSTEM

- 256K (Opt. 640K) • 150 Watt Power Supply • AT Style Keyboard & Case
- 4.77 or 8 MHz Keyboard Selectable
 - FDC
- 8087 Socket • 360K Floppy Drive • 1 Year Warranty

\$39900



10MHz ADD \$2500

CAT 386 SYSTEM

- 12" Amber Monitor
- 1.2 Meg Floppy Drive
- 1 Meg of Memory
- Parallel, Serial & Clock
- 70 Meg Hard Drive

16MHz **\$279900**
20MHz **\$299900**

CAT™ 286-10 BASE SYSTEM

- 512K Exp. to 1 MEG • 200 Watt Power Supply • AT Style Keyboard
- Western Digital Controller • 1.2 Meg Floppy • Legal Bios w/manuals • Systems Documentation • 1 yr war. • Clock/Calc
- 10MHz DTK Motherboard

\$79900

12MHz ADD \$1000

11.3 NORTONS SL



OPTION A
12" Mono Amber Monitor
Graphics Card w/par port

\$51900

OPTION B
640 x 200 Color Monitor
Graphics Card w/par port

\$69600

OPTION C
12" Mono Amber Monitor
Graphics Card w/par port
20 Meg Hard Drive

\$78800

OPTION A AT
12" Mono Amber Monitor
Graphics Card w/par port

\$94900

OPTION B AT
640 x 200 Color Monitor
Graphics Card w/par port

\$109600

OPTION C AT
12" Mono Amber Monitor
Graphics Card w/par port
40 Meg Hard Drive

\$139900

(800) 654-7762 ★ FOR LOW PRICES & FAST DELIVERY ★ (800) 654-7762

int'l COPROCESSORS

If Your PC Uses the Intel	Running at..	Then You Need Intel	MEADS Price
8088	5MHz or less	8087	9750
8088 or 8086	8MHz or less	8087-2	14350
8086	10MHz or less	8087-1	20900
80286	6-8MHz	80287	15900
80286	8-12MHz	80287-8	22900
80286	10MHz or more	80287-10	25900
80386	16MHz	80387-16	38750
80386	20MHz	80387-20	54900
80386	25MHz	80387-25	68900
386SX	16MHz	80387-SX	42900

VIDEO CARDS

Vega VIDEO SEVEN	17900
Everex EGA 640 x 350 w/par. port	16900
Everex VGA 640 x 400, 17 VGA Modes	24900
Everex PGA 640 x 480, 256/4096 Colors	62900
MEAD Monographics w/par port Hercules comp.	5800
MEAD Color graphics w/par port Hercules comp.	5800

ACCESSORIES OF ALL KINDS

150 Watt Power Supply Direct PC Replacement	5400
200 Watt Power Supply Direct AT Replacement	7900
Dos 3.2 w/GW Basic	6900
Everex Ram Expansion for AT or XT starting at	5900
No Slot Clock	3900

Seagate HARD DRIVES

COMPLETE KITS	1 YEAR WARRANTY
ST125 20Meg 40 Mil 1/2 Ht	29900
ST225 20Meg w/cont. & Cables	26900
ST238 30Meg w/cont. & Cables	29900
ST251 40Meg 1/2 HT 40 Mil w/software	37900
ST251-1 40Meg, 28 Mil Sec	46900
ST277R 60MB 40 Mil 1/2 Ht	48900
ST4026 20Meg Full Ht 40 Mil	27900
ST4038 30Meg 40 Mil Full Ht	30900
ST4053 40MB 28 Mil Full Ht	51900
ST4096 80Meg Full Ht w/software	64900
Fastrax Software	4900

MODEMS BY EVEREX™

EV-923 EverCom 12 300/1200 bps Bitcom Software	7400
EV-941 EverCom 24 2400 Baud Int. Bitcom Software	13900
EV-945 External 2400 Baud	19900
For error correcting add \$10.00	
Hayes Compatible Major Manufacturers	
1200 Baud Internal w/Software	5900
1200 Baud External fully Hayes Compatible	9900
2400 Baud Internal 1/2 card w/software	10900
2400 Baud External Fully Hayes Compatible	12900

TAPE BACKUPS BY EVEREX™

40MB Mini Cartridge, 1.8MB/min, XT	35900
40MB Mini Cartridge, 3.6MB/min, AT	35900
40MB Streaming Cassette, 5MB/min w/cont.	58900
60MB Streaming Cassette, 5MB/min w/cont.	64900
60MB Streaming 600A, 5MB/min w/Full cont.	84900
125MB Streaming Cartridge, 5MB/min w/Full cont.	111900
Excell 60 Model 60/80	99900
Excell 125 Model 60/80	126900
External Add 19500	

CONTROLLERS BY WESTERN DIGITAL

WX-1 8 Bit 1/2 Sized for XT	6900
WA-2 16 Bit Full Sized Hard/Floppy	11900
WD-27X 8 Bit RLL 1/2 Size	7900
WAH 16 Bit Hard Drive Controller	12900
RA2 16 Bit RLL Hard/Floppy for AT	15900
MEAD Floppy Disk Controller for XT	2900
MEAD 1.2 Meg & 360K Controller for XT	5900
Cable Set for Hard Drive Only	500

MONITORS BY SAMSUNG

1252 12" Amber w/Tilt & Swivel Base	7900
1257 12" Amber Flat Screen 720 x 350	9900
1464 14" Color 640 x 200, 16 colors	23900
1453 14" EGA 640 x 350, 64 colors/31	36900
CN4551 Multisync EGA 720x480	43900
IBM CGA/VGA/PGA/EGA Compatible	

FLOPPY DRIVES FROM YOUR LOW PRICE LEADER

360K 1/2 Ht. PC Compatible — Mitsumi	6900
1.2 Meg Mitsubishi Black Face	7900
720K 3/2" Drive w/5/4" mounting	8900
1.44 Meg 3/2" Drive w/5/4" mounting	11900
360K Tandon TM100-2 Full Ht.	8900
160K Tandon TM100-1 Full Ht.	3900

PRINTERS BY

Panasonic		CITIZEN	
KXP10801 144CPS	199	180D 180CPS 9 Pin 10"	179
KXP10911 192CPS	229	MSP40	379
KXP10921 240CPS	379	MSP45	479
1592 214CPS 15"	499		
1595 288CPS 15"	549	Parallel 6 ft. Cable	\$1400
1524 240CPS 24 pin	649		

Liquidation ★ Closeouts ★ Discontinued Items ★ Overstocked

SAVE UP TO 90% OFF RETAIL — All New 90 Day Warranty*

LETTER QUALITY PRINTER

DAISYWHEEL PRINTER MANUFACTURED BY C.ITOH

Why pay \$1149 for a C.Itoh
STARWRITER™ F-10
When our 40 cps letter quality daisywheel printer from the same manufacturer is only

\$29900
ea.

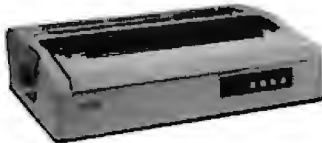

OPTIONS

- 6 ft. Serial Cable \$ 1900
- Bidirectional Tractor 14900
- Cut Sheet Feeder 19900
- Serial to Parallel Converter 9900

STANDARD FEATURES

- 40 CPS • Accepts Paper to 15 inches • Form Length and Pitch Set from Control Panel
- Industry compatible ribbon, printwheels and control commands • RS232 Serial Interface

RAM UPGRADES

WE BUY EXCESS RAMS PLEASE CALL OR FAX LIST

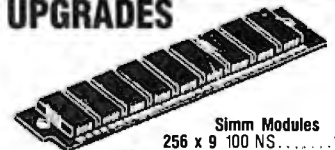

4164 150 NS	295	41256 100 NS	1215	256 x 9 100 NS	12900
4164 120 NS	325	41256 80 NS	1315	256 x 9 120 NS	11900
4164 100 NS	345	4464 150 NS	1545	1Meg x 9 120 NS	39900
41256 150 NS	1145	1Meg x 1 120 NS	3790	1Meg x 9 100NS	42900
41256 120 NS	1175	1Meg x 1 100 NS	3990	1Meg x 9 80NS	54900
				1Meg x 8 120NS	39900

STATIC BUSTER

Attached to the CRT face and keyboard, Static Buster works just like a sponge, dissipating static at a rated 20,000 volts in less than two seconds.

List 7900

Mead 1900

MEAD CLOSEOUTS

Intel 2764 New Eproms	300
Original Compaq 360K Drives	4900
Demo Mono Monitors 30 Day Warranty	4900
5 Meg Hard Drive	6900
Solder Sucker	900

10 MEG HARD DISK KIT

Includes Controller & Cables
• 1/2 Height • 80 Msec
New/Major Manufacturer
Mead 17900

EXTENSION CABLES

- 6 Foot
- Specify Monitor or Keyboard

List 2900

Mead 1400

AT CASE OR BABY AT CASE

- 2 Bay Standard AT Style Case
- Keylock Power and Hard Drive LED's

List 149

Mead 3400

List 9900

Mead 2900

1200 BAUD MODEM

- Hayes Compatible w/software
- Auto Answer / Auto Dial
- 1/2 Card Internal

List 9900

Mead 5400

800-654-7762

SALES: 7 a.m.-6 p.m. PST

702-294-0204

CUSTOMER SERVICE / ORDER STATUS:
9 a.m.-4 p.m. PST

FAX 702-294-1168

Trademarks are Registered with their respective Co.'s. Prices Subject to Change

*RAM not include. All are new. 90 Day warranties.

All RAM items subject to price change.

All Products 90 Day Warranty unless stated otherwise.



1000 Nevada Hwy. • Unit 101 • Boulder City, NV 89005

WE ALSO PURCHASE EXCESS INVENTORY

NO SURCHARGE FOR MC/VISA

TERMS:

MC • VISA • CDD • CASH

Purchase Orders from Qualified firms

Personal Checks • AE add 4%

20% Restocking Fee on Non-Defective Returns



SHIPPING: (min. 65) UPS

SPEECH PRODUCTS

For PCs and compatibles

SYNTHESIZER—only \$79.95



The next versatile and best sounding speech product available for under \$4000! The amazing **Speech Thing** provides text-to-speech as well as PCM and ADPCM speech and music reproduction. Comes with "Thing" D/A converter that attaches to the parallel printer port **outside** the computer—ideal for laptops. Will not interfere with normal printer operation. Also comes with audio amplifier/speaker and power adapter. Software includes two advanced text-to-speech programs, digitized speech and music files, full screen waveform editor, sampling music keyboard, special effects mixing board, and drivers so you can add speech and sound effects to programs written in BASIC, C, PASCAL, and others. Includes 54 page manual. **SPEECH THING—\$79.95.**

DIGITIZER—only \$89.95



The **Voice Master PC Digitizer** is a full 8-bit PCM sampler board. Fits in any available slot. Up to 15,000 samples per second. Input pre-amp has automatic gain control and 4.5 KHz low pass filter. Includes a quality headset microphone. Software included for recording and editing sound files for playback through **Speech Thing**. Also includes a real-time spectrum display and oscilloscope display as well as assembly language source listings for writing your own drivers. **BONUS:** Voice recognition program included which is callable via an interrupt vector. Demonstration program written in GWBASIC. **VOICE MASTER PC DIGITIZER—\$89.95.**

VOICE RECOGNITION—only \$49.95



A price/performance breakthrough! Equal in performance to other systems costing hundreds more \$\$\$! The amazing **Voice Master Key** program adds voice recognition to just about any program or application. You can voice command up to 256 keyboard macros. Fully TSR and occupies less than 64K. Instant response time and high recognition accuracy. Easy and fun to use—no compilers or editors required. Works with CAD, desktop publishing, word processor, spread sheet, even other TSR programs. A **genuine productivity enhancer**. **Voice Master Key** can also be called from within a program for adding voice recognition to custom applications. **Voice Master Key** requires the **Voice Master PC Digitizer** for operation. (Please note: **Voice Master Key** will not replace the keyboard or mouse except under certain circumstances. Not to be confused with the still unavailable "voice typewriter.") **VOICE MASTER KEY—\$49.95.**

BONUS OFFER! Buy **Voice Master Key** with **PC Digitizer** for only \$129.95—you save \$10!
BETTER BONUS OFFER! Buy all three: **Speech Thing**, **PC Digitizer**, and **Voice Master Key** for only \$189.95—you save \$20!
 ALL OF THESE PRODUCTS ARE OF PROFESSIONAL QUALITY.
ORDER HOTLINE: (503) 342-1271

Monday-Friday, 8 AM to 5 PM Pacific Time
 Add \$5 for shipping and handling on all orders. Add an additional \$3 for 2nd day delivery. All goods shipped UPS. Master Card and VISA, money order, cashiers check or personal checks accepted (allow a 3 week shipping delay when paying by personal check). Foreign inquiries contact Covox for C&F price quotes. Specify computer type when ordering. **30 DAY MONEY BACK GUARANTEE** IF NOT COMPLETELY SATISFIED. **ONE YEAR WARRANTY ON HARDWARE.** Call or write for **FREE** product catalog.



COVOX INC. 875-D COMBER ST
 EUGENE, OREGON 97402 U.S.A.
 TEL: 503-342-1271 FAX: 503-342-1283

9-Track Tape Drives: Yes!
 for IBM PC/XT/AT/386
 and PS/2



Interchange tapes from mainframes.

Important features:

- 800, 1600, 3200, 6250 BPI
- EBCDIC/ASCII conversion
- IBM & ANSI labeled tapes
- Network backup
- DOS, XENIX, Microport
- Highest quality customer service

For quick delivery we stock all major manufacturers' tape drives, including Cipher, Kennedy, M4 Data, Qualstar.

Prices start at \$3,755. Call Today!

Overland Data, Inc.

5620 Kearny Mesa Rd. • San Diego, CA 92111
 Tel: (619) 571-5555 • FAX: (619) 571-0982



not only a
 printer buffer!

THIS IS THE MOST SOPHISTICATED
PRINTER BUFFER - MULTIPLEXOR - SWITCH

WITH TWO SEPARATE INPUTS (SERIAL AND PARALLEL) AND TWO SEPARATE OUTPUTS (SERIAL AND PARALLEL) CAN BE USED LIKE STANDARD BUFFER WITH ANY INPUT TO ANY OUTPUT BUT ALSO YOU CAN CONNECT 2 COMPUTERS TO 1 PRINTER OR 1 COMPUTER TO 2 PRINTERS OR 2 COMPUTERS AND 2 PRINTERS... AND MORE... 1 COMPUTER TO 3 PRINTERS OR 3 COMPUTERS TO 1 PRINTER
 HIGH CAPACITY - 64 KB TO 256 KB AND - 256 KB TO 1 MB MODELS A AND B | PAUSE, COPY AND RESET FUNCTIONS
 SERIAL PORTS WITH 7 OR 8 BITS WORD LENGTH, 1 OR 2 STOP BIT, PARITY, XON/XOFF, DTR, RTS

DOB-A-04K \$ 195 DOB-B-256K \$ 255 (**)

(**) Power supply and parallel cables are included

ALSO, WE HAVE THE MOST COMPLETE DATA CONVERTER UNIT CONVERTS RS232 SERIAL TO CENTRONICS PARALLEL OR VICE VERSA, JUST BY MOVING JUMPERS BAUD RATES AND PROTOCOL FULLY PROGRAMMABLE FROM 150 TO 10200 BAUDS INCLUDES: DTR, RTS, XON/XOFF, PARITY, etc

DCU \$ 80 (**)

(**) Power supply and cables NOT included



serial \leftrightarrow parallel
 bi-directional converter



INTECTRA Inc.—Dept.232

2629 TERMINAL BLVD

MOUNTAIN VIEW-CA-94043

(415) 967-8818 TX 345545

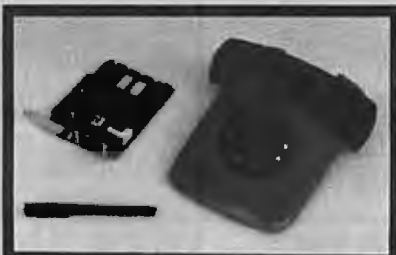

30 DAY FREE TRIAL

SUPERIOR PERFORMANCE... NOT ERRORS AND NOISE. WE CAN PROVE IT. NO COMPROMISE 2400, 1200, 300 BAUD MODEM. FULL FEATURED, HAYES COMPATIBLE IBM INTERNAL • SOFTWARE INCLUDED • DEALERS INQUIRE • 30 DAY MONEY BACK TRIAL. CALL FOR DETAILS

CompuCom Corporation
 (800) ACT ON IT (408) 732-4500

**16-BIT RESOLUTION
 ANALOG-TO-DIGITAL
 CONVERTER**

**12,000 SAMPLES/SEC
 for IBM PC, XT & AT
 SINGLE PIECE PRICE**

\$475

We manufacture a broad line of data acquisition and control hardware and software for Apple and IBM computers.

Call for quotes on custom hardware or complete systems.

LAWSON LABS, INC.

5700 RAIBE ROAD
 COLUMBIA FALLS, MT 59912
 800.321.6355 or 406.387.6355



DEVICE PROGRAMMER

\$550 \$750



1 Megabit of DRAM. User upgradable to 32 Megabit 4x20 LCD Display, 3.6 Zif socket, RS232, PARALLEL in and out 20 Key tactile keypad (not membrane). 32K internal EEPROM (easy firmware upgrades) **QUICK PULSE ALGORITHM** (27256 in 5 sec. 1 Megabit in 17 sec.) Completely stand alone, 10 day money back guarantee 2 year warranty, made in U.S.A. Technical support by phone, Complete manual and schematic.

NEEDHAM'S ELECTRONICS

4535 Orange Grove Ave., Sacramento, CA 95841

Call for more information

Phone (916) 924-8037 FAX (916) 972-9960
 VISA/MC

You don't need to be an expert to diagnose and correct problems involving PC setup. All you need is **HELPME™** software! More than 300 tests. On-screen help for understanding and correcting identified problems. Quick identification of system configuration and compatibility. \$99 plus shipping and handling. MC and VISA accepted. California Software Products, Inc., 525 N. Cabrillo Park Drive, Santa Ana, CA 92701 (714) 973-0440.

PC Software for \$3.49

Thousands of IBM/Compatible Public Domain and Shareware Programs Are Available from the Micro Star Library, and All Priced at Only \$3.49/Disk

We feature the best and most up-to-date shareware available.

Our software is guaranteed against bugs, defects, etc.

And We Offer FREE Technical Support For Our Customers

ORDER TODAY on our TOLL FREE PHONE LINES • ORDERS SHIPPED OUT SAME OR NEXT DAY



WINTER SPECIAL!

Buy 12 Disks —
GET 4 MORE

FREE

A Savings of \$13.96!
Offer expires February 28, 1989

DOS

DOS TUTORIAL (1301) Teaches you to use DOS.
STILL RIVER SHELL (1304) Run DOS commands from a menu. Makes DOS easy.
BATCH FILE TUTORIAL (1305) Utilize batch file processing.
MORE DOS TIPS (1318, 1323) (2 disks) More about DOS.
HELP DOS (1326) On line DOS help with menus. Includes DOS dictionary of terms and a hints menu.

TELECOMMUNICATIONS

Q-MODEM 3.1 (1101, 1102, 1144) (3 disks) Powerful but easy to use. Fast.
RBBS V16.1A (1107-1109, 1150) (4 disks) Multi-user BBS.
PROCOM 2.42 (1112-1113) (2 disks) Hacker's delight. Real capability. Latest version.

SECURITY/HACKING

UNPROTECT PROTECTED PROGRAMS (1202) Make backups of protected software.
UNPROTECT II (1203-1204) (2 disks) Ways to backup commercial software.
UNPROTECT III (1205) Unprotect Softguard protection.
UNPROTECT IV (1206) More programs you can unprotect.

ADULTS ONLY (2901)

Animated Req. CGA.
MAXINE (2902) Incredible ble. (CGA)
POKER (2903)



Arccade

game (CGA)
X-RATED COLOR SHOW (2915) Beautiful girls. (CGA)
X-RATED PRINTSHOP (2909) Graphics for Printshop.

PC-FILE + 2.0 (801, 805, 837) (3 disks) Rated better than dBase III+ by Consumer Rpts.
PC-GRAPH (802) Create graphics from PC FILE.
FILE EXPRESS 4.0 (803-804) Powerful system. Allows 32,000 records. Sorts up to 10 key fields.
DBASE III+ ROUTINES (851-852) (2 disks) Latest utilities to help you utilize dBase III+

EDUCATION

FUNNELS AND BUCKETS (204) A fun way to learn math.
MATHPAK (202) Tutorial with lessons in higher math.
PC-TOUCH (204) Learn typing.
BASIC TUTORIAL (208) Learn programming with BASIC.
BEGINNING SPANISH (211) Tutorial.
SPANISH II (232) Sequel.
BIBLEQ (214) Learn the Bible with this Q-A tutorial.
FACTS 50 (239) Geography lessons for U.S. Nice graphics.

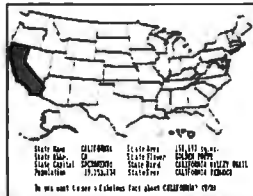

APPLICATIONS

FORM LETTERS (1907) Commonly used form letters and business applications.
EZ-FORMS (1908) Make forms to meet different needs.
MANAGER'S PLANNER (1920) Daily planner. Prints out.
HOME INVENTORY (1966) Track all your possessions.
BIORHYTHM (1990) Display the 3 biological cycles: physical, emotional, intellectual.
FAMILY HISTORY (2203-2204) (2 disks) Create files and genealogical reports.
DR DATA LABEL (2327) Powerful mailing list program. Customize labels to size.
LOTTO PROPHECY (2364) Best Lotto program we've seen.
CITY DESK (2513) Simple desktop publisher.

LOTUS MACROS (601) Save hours of work. (Req. Lotus)
LOTUS SPREADSHEET TEMPLATES (602) Ready-made. (Requires Lotus 1-2-3)
GOAL-SEEKER V3.5 (624) Achieve objectives by changing spreadsheet variables and seeing result. (Requires Lotus.)
LOTUS TUTORIAL (630) Learn Lotus (requires Lotus).

MICRO STAR

1105 SECOND ST. • ENCINITAS, CA 92024

HOURS: Monday - Saturday 7 AM - 5:00 PM, Pacific Time

TERMS: We accept MasterCard, VISA, Checks (allow 10 days to clear), Money Orders, and COD (add \$4.00).
MINIMUM ORDER: 5 Disks, \$3.49 per disk. 3 1/2" format add \$1/disk.
SHIPPING & HANDLING: \$3.50 (Total per order).
MAIL-IN ORDERS: Circle disk numbers. Include name & address.

GAMES

ARCADE GAMES (106) Has Kong, 3-D Pacman, Bricks, Pango. (Requires color.)
BASIC GAMES (107) Pacman, Lunar Lander, Startrek, Meteor, Breakout, and others.
CARD GAMES (109) Canasta, hearts, draw poker & bridge.
STRIKER (110) Defender-like game. "Top Gun" in space.
FLIGHTMARE (112) Futuristic fighter pilot game. (Requires color graphics adapter.)
SLEUTH (117) Who done it?
DND (119) Like Dungeon and Dragons.
ROUND 42 (120) Better than Space Invaders. 42 levels.
GAMES IN BASIC (124) Lander, biorhythms, desert, Phoenix, Star Wars, others.
QUEST (152) Role playing adventure fantasy game. (Requires CGA)
SPACE WAR (158) Dogfight in outer space, using phasers, photon torpedoes, etc.
BRIDGE PAL (174) Complete game of contract bridge, with tutorial.
FENIX (193) Just like the famous arcade game.
PINBALL GAMES (197) Pinball, Rain, Twilight Zone, Wizard, etc.
KID-GAMES (GAM8) Animals math, clock game, alphabet, etc.
CHESS (GAM9) Incredible. 2D and 3D. Many levels. Play back moves, store games.



EGA RISK (GAM11) World domination in great color. Includes EGA Asteroids.
PC PRO-GOLF (GAM27-28) Great graphics. Complete 18 hole, 72 par course. (CGA)
PEARL HARBOR (GAM32) Shoot down Jap Zeros before they destroy U.S. Fleet. (CGA)
ULTIMA 21 DELUXE (GAM34) Best Blackjack game around. Includes Video Poker.
FORD SIMULATOR (GAM37) Great driving simulation. (CGA)



MUSIC

PIANOMAN 3.2 (304) Turn your keyboard into a piano.
PC-MUSICIAN (302) Compose, save, and play music.

CHRISTMAS SONGS (311) Play your favorites on a PC.

WORD PROCESSING

PC-WRITE 2.71 (401-402) (2 disks) Latest version of this popular program w/spelling checker.
PC-TYPE+ (421-423) (3 disks) Excellent. Includes mail merge, 100,000 word spelling checker. Interfaces with PC-File+, PC-Style.
MAXI-MAX (432) 59 macros to use with Word Perfect 4.2 or later. 11 templates for forms, border designs, etc.

GRAPHICS

KEYDRAW CAD SYSTEM (1001, 1002, 1065) (3 disks) Popular. Also uses mouse. (Requires color graphics - CGA.)
DANCAD 3-D (1051, 1052) (2 disks) Create 3-D graphics. Rotate, magnify, etc. Runs on CGA, EGA, or Hercules.

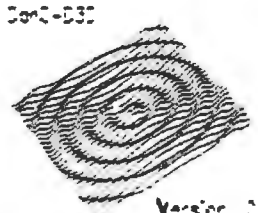

SIDEWAYS (1007) Prints text sideways. Useful for spreadsheets.

SIMCGA/HGCIBM (1027, 1062) (2 disks) Use with Hercules graphics card/compatibles to run programs requiring CGA on your monochrome PC.

IMAGE 3-D (1048) Create and edit 3-D objects. Move, scale, rotate and tip image.
FINGERPAINT (1050) Use keyboard or mouse to draw. Like MacPaint. (Requires CGA or EGA.)

FANTASY (1057) Create flowing graphic images with mouse or keyboard. (CGA).
FLOWCHARTING (1078-1079) Complete system for flowcharts, organizational, electrical, etc., with symbols.

RELIGION

THE BIBLE (3301-3306) (6 disks) Old Testament, King James version.
THE BIBLE (3307-3308) (2 disks) New Testament, King James version.
WORD WORKER (3309-3310) (2 disks) Bible search program. New Testament, King James version.
BIBLEMEN (3330) Excellent Bible quiz program.

PC-PROFESSOR (1401) BASIC tutorial. Good.
BASIC PROGRAM GENERATOR (1402) The menu driven way to write programs.

B-WINDOW (1407) Give windowing capabilities to your Basic program.

UTILITIES

HOMEBASE (2608, 2612, 2613) Complete desktop organizer. Great!
LIGHTNING PRESS (2718) Printshop clone. Includes graphics for many uses.

1. CREATING CARD
2. POSTER
3. LETTERHEAD
4. BUSINESS CARD
5. PRINTED SCRIPT
6. EXIT TO DOS



PROFESSIONAL MASTERKEY (2805) Like Norton's. Retrieve deleted files. A lifesaver.
BAKER'S DOZEN (2821) 13 utilities from Buttonware.
AUTOMENU (3003) Make PC menu driven. Incl. passwords.
SCREEN (3006) Save your monitor from screen burn-in.
DOT MATRIX FONTS (3064-3062) (2 disks) Print your text in different fonts. Works with most printers.

MARKET CGA (BUS17) Performs sophisticated analysis on stocks, funds, etc. (EGA version is BUS 16).

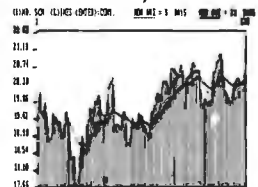

MARKET CGA (BUS17) Bill clients for time and materials, advances, retainers, etc. Computes taxes, past due interest, etc. Has full G/L.

BILLPOWER+ (BUS40) Bill clients for time and materials, advances, retainers, etc. Computes taxes, past due interest, etc. Has full G/L.
CPA LEDGER (706-708) (3 disks) Complete general ledger for corporations, partnerships or sole proprietors.
PERSONAL FINANCE MANAGER (745) Household budget manager. Keep track of checking, savings, investments.

PAYROLL USA (725-726) Up to 2,000 employees in any state. dBaseIII and Lotus compatible. Complete P/R system.
EXPRESS CHECK (786) Check account with running balance, monthly reports, etc. Prints checks.
FINANCE MANAGER II (774-775) (2 disks) For personal or small business financial management.

AS-EASY-AS (505) Great. Includes screen help menus. Utilizes function keys. A Lotus clone that reads Lotus files.
PC-CALC+ (512-514) (3 disks) Jim Button's famous Lotus clone.

3M *FREE! DataSaver...
a \$13.95 diskette filer!!

DS-DD	Quantity Discounts Available min. 5 boxes	DS-HD
.69	5.25" 3M Diskettes	*1.29
1.54	3.50" 3M Diskettes	3.92
1.89	8.00" 3M Diskettes	2.15
.85*	3M Mark Q PC "Formatted" Disks	
3.99	3M Highland Box Diskettes (min 10 bx)	
.52	3M No Logo w/Tyvek, labels, & w/p	
DC-1000	12.60	DC-300XLP 19.40
DC-2000	17.05	DC-600A 21.45
3M Mag. Tapes 2400' WTS (min 10 reels)	12.50	
3M Mag. Tapes 1200' WTS (min 10 reels)	9.25	

BASF *FREE Plastic Library Box

SS-DD	Quantity Discounts Available	DS-HD
.53*	5.25" BASF Diskettes	.89
1.59	8.00" BASF Diskettes	1.79
DS-DD	3.50" BASF Diskettes in FREE	DS-HD
1.34	Color-Coder a \$14 ⁹⁵ Value	3.79
.62	5.25" DS/DD BASF Diskettes with FREE BASF VCR Tape or Plastic Box	
.38	5.25" DS/DD BASF NoLogo Diskettes with Tyvek sleeves, labels & w/p.	

maxell	MD-20MP WHILE	MD-20MP SUPPLIES	MF-2HD LAST!
.69*	1.35*	3.75	
Verbatim DataLife	5.25" DSDD	3.25" DSHD	3.50" DSDD
.69	1.30	1.49	
Dysan	5.25" DSDD	3.25" DSHD	3.50" DSDD
.76	1.29*	1.52	

COLOR DISKS	5.25" DSDD	3.50" DSDD	3.50" DSHD
KAO	.69*	1.59*	3.25
	COLOR	COLOR	2MB
SONY	MD-20 002000	MF-20B 00300XLP	MF-2HD 00600A
.65*	1.65*	3.65	
Data Cartridges	16.95	18.95	20.95

Verbatim	MD-20	RAINBOW FUJI COLOR	COLOR FILM DISK
.75			
Nashua	MD-20	MF-2	
.46	.79	1.26	
PRECISION	5.25" DSDD	3.25" DSHD	3.50" DSDD
.39	.79	1.24	

COLOR DISK	5.25" DSDD	3.25" DSHD	3.50" DSDD
.39	.84	1.14	
WITH TYVEK SLEEVES	W/P	TABS	
BULK DISK	5.25" DSDD	3.25" DSHD	3.50" DSDD
.29	.59	1.07	
WITH TYVEK SLEEVES	W/P	TABS	

RIBBONS STORAGE

— Please call for information 78-6555

TERMS: No surcharge on VISA, Mastercard or AMEX. COD only add \$3.00. Prepaid orders deduct 2% cash discount. PO's accepted from recognized institutions and corporations on Net 30. Bank draft, T/T or L/C acceptable. Shipping: \$4/100 or fewer disks. Reduced shipping charges on larger quantities. Price quoted for case (100 disks) quantities less than a case add 5%. (Min. order \$25.00)

WE BEAT ANY PRICE!

Toll Free Order Line: 1-800-523-9681
Information Line: 1-801-255-0080
TLX-9102404712 FAX-801-572-3327

DISKOTECH
DISKCO TECHNOLOGIES, INC.
213 Cottage Avenue
P.O. Box 1339 Sandy, Utah 84091

PAL/EPROM PROGRAMMER for PC

VERSION 2 of Software and Hardware \$475

- Programs 20 and 24 pin MMI, NS, TI, Altera, Cypress, Ricoh/ Panatice PALs. EPLD (UV erasable), polarity, and RA types.
- Functions include: read, write, verify, protect, edit, print, and file load and save of program. JEDEC files supported.
- 2716-27512 EPROMs.
- Functions include: read, write, verify, blank check, HI/LO split, edit in ASCII, HEX, or Decimal. INTEL Hex and Motorola 'S' Record file support.



200/100 MHz LOGIC ANALYZER for PC

LA27100	\$1299
LA27200	\$1899

• 24 Channel mode with 4K/Channel • 6 Channel mode with 16K/Channel
Internal Rates from 250MHz (LA27200) or 100MHz (LA27100) to 250 Hz
External Clock from DC to 50 MHz • 16 Level Triggering Sequence
Threshold Voltage Level at TTL, ECL, or 8V to +14V variable • Data Display as Timing Diagram or State List • Save/Load Data and Setup Info

(201) 994-6669
Link Computer Graphics, Inc.
4 Sparrow Dr., Livingston, NJ 07039

Circle 152 on Reader Service Card

Dynamic Electronics

SIMMS

CALL FOR PRICES

INTEL	DRAMS	SIMMS
8087	64K	256 X 8
80287	256K	X9
80387	4464	1 Meg X 8
80387SX	1 Meg	1 Meg X 9
80C287A		

Phone 714-855-0411
Fax: 714-855-8504
23222 COMMERCE CENTER DR. #L
LAGUNA HILLS, CA 92653, USA

Circle 93 on Reader Service Card

EMU-TEK

Presto!
A Link to Mainframe Graphics

Find out how our whole family of EMU-TEK graphics terminal emulation software makes good sense for the work you do. Call today for more information.

FTG DATA SYSTEMS

(714) 995-3900
(800) 962-3900 (800) 972-3900 (Calif.)
10801 Dale St., Suite M-2
Stanton, CA 90680

Circle 110 on Reader Service Card

HARD DRIVE SALE

SEAGATE

ST- 225	\$ 255.00
with controller and cable	
ST- 238	\$ 265.00
with controller and cable	
ST- 251	\$ 325.00
ST- 251-1	\$ 420.00
ST- 125	\$ 289.00
with controller and cable	
ST- 138	\$ 359.00
with controller and cable	

A.N. Wholesale & Retail, Inc.
1320 South Dixie Hwy, Suite 256
Miami, Fla 33146

Phone: (305) 284-0827
Fax: (305) 284-0831

Circle 32 on Reader Service Card

Get the whole story on graphics terminal emulation.

EMULATOR



To find out more about software that lets your PC emulate TEKTRONIX™ 4105/6/7/9 and DEC VT100™ terminals, call or write:

GRAFFPOINT
4340 Stevens Creeks Blvd., Suite 280,
San Jose, CA 95129 (408) 249-7951

Circle 119 on Reader Service Card

Why waste time?

ACCELERATE with VCACHE™

HARD DISK ACCELERATOR

- Caching eliminates repetitive disk accesses
- Use up to 15 Mb of extended/expanded or 500 Kb of standard memory

DISKETTE ACCELERATOR
SCREEN ACCELERATOR

FAST — FRIENDLY — SAFE

VCACHE

GOLDEN BOW SYSTEMS

\$59.95

Add \$3 for shipping/handling. California residents add 7% sales tax

2870 Fifth Avenue Suite 201
San Diego, CA 92103
800/284-3269



Circle 118 on Reader Service Card

TIMELINE INC.

ORDER DESK ONLY

Continental U.S.A.
(800) 872-8878

Inside California
(800) 223-9977

L.A. & Technical Info
(213) 217-8912

OEM INQUIRIES
WELCOME

SUPER SELL-A-THON

PERSYST™ MONOCHROME DISPLAY AND MULTIFUNCTION CARD FOR IBM PC/AT

This card has 1 serial port and 1 parallel port. It can be expanded to 1.5MB memory. This card has extended memory only. (This is not EMS or EEMS.)

You can attach a monochrome monitor to the card as well as hook up a lightpen.

Also includes utility software: drive emulator, printer spooler, utility to control calendar/clock.

Uses 64K or 265 K chips.
0-K memory on board.

\$59.00

HIGH POWERED 3-D GRAPHICS FOR YOUR IBM PC VECTRIX™ COLOR CARD

Includes: Board, manual and driver software.

Features:

- 9 color planes, 672x480 pixels.
- 20 & 30 operation modes, 4096 colors.
- Also emulates IBM CGA card.
- On-board processors—Intel 80188 and NEC 7220.
- 75 high-level graphics commands in firmware.
- Character-like commands generated by I/O statements in high level language used to control graphics operation.
- Compatible with Auto-CAD.

(Note: Card uses 2-B bit slots.)

\$350.00

HITACHI DOT MATRIX

LIQUID CRYSTAL DISPLAY

- 16 characters x 1 line • 5v power required • C-MOS/TTL compatible signal level
- Built-in RAM for display data storage • Multiple instruction set (based on 13 commands)
- Built-in C-MOS LCD driver & controller • Easy "Microprocessor" interface • Low power consumption • 5x10 dot matrix formation with cursor, alphanumerics & special symbols • 98 ASCII character generator (plus 64 katakana) • 8 programmable characters • ribbon cable connector already prewired.

Physical size 3-1/8" L x 1-3/8" W x 1/4" D

5 for \$25

NEC FLOPPY DRIVES

1/2 Ht. 360K 5 1/4"

1/2 Ht. 720K 3 1/2"

DS/DD **\$65.00**

DS/DD **\$79.00**

LCD DISPLAY

480 dot x 128 dot graphic and alphanumeric display.

Easy "Microprocessor" interface. Documentation included.

Approx. size: 10"Wx4"Hx.05"D

\$99.00

ROBOTIC LENS with infrared sensors (auto focus)

Great source of optical and electro-mechanical parts and systems including the basis for an infrared communications system.

Contains f1.4 - 12 to 72 mm (6x) zoom lens with auto focusing capability. DC motor driven or manual zoom and focus systems with precision gear reduction units, mechanical clutches, and high quality DC motors. DC rotary actuator controlled iris diaphragm unit.

Option Available: Infrared distance measuring system (focusing unit) with control electronics \$10.00.

\$19.00

TAPE BACKUP CARTRIDGES—DC300 XIDEX \$10.00

(2 pc. minimum)

DC1000 No label \$5.00

(4 pc. minimum)

FULCRUM TRACK BALL

• Stationary 76-6555

• PC Magazine Editors

• First Choice for CAD Use

New Menu Key

• Do Lotus 123

Wordperfect or your own menus

\$89

EPSON QX-10 MOTHERBOARD

w/your choice: ASCII Keyboard (Enclosed) or HASCII (para)

\$89.95

We work with any IBM compatible disk drive & CPU

• 201504C-1 1200k compatible • 4096K Memory • RAM 256K on board

• C-MOS RAM 2K EPROM 2748K 80486 CPU Clock • C-MOS real-time clock interface • Serial and Parallel DMA 7 channels

Interrupt levels: 15. Counter/timer & channels. Card slots 5. Compatible with any TTL monitor (except 10 bit with enclosed keyboard) & fits with bare keyboard

ADAPTEC 4000A SCSI Controller \$60.00

I/O for the ST412-506 Interface using MFM encoding

ZENITH 7" MONITOR

- Flat faceplate
- 900 lines at center
- 650 lines at corners
- Operates from 12VDC at 1.4 amp
- Vertical input is 47 to 63 Hz
- Horizontal frequency: 15 KHz (adjustable)
- For split video (TTL inputs) operation. Not composite video.



22 MHz TYPICAL BANDWIDTH
\$29.95
4 For \$99

POWER SUPPLY YOUR CHOICE! BLOWOUT! \$12.00

Minimum 2 per Order

Please check dimensions. These are open frame supplies.

188 Watt Switching Power Supply.

On/off switch in the front. Built in filter for easy power cord plug-in. Open frame, L-bracket type. Two 4-pin power plugs for floppy and/or hard disk drives.

Output: +5.05V @ 22A, +12.02V @ 4A, -12V @ .5A, +12.59 Reg. @ 1.5A D.C.

Dimensions: 13 1/2" L X 5 1/2" W X 2 3/4" H

Compower 130 Watt supply. Unit is open framed.

Output: +5V @ 5A, +12V @ 5A, -12V @ 5A
Dimensions: 8 1/4" L x 4 3/4" W x 2 1/2" H

Power Systems — 180 Watt supply. Unit is open framed with 2 four pin power connectors built onto the unit.

Output: +5V @ 20A, +12V @ 4A, -12V @ 5A
Dimensions: 9 1/4" L x 4 3/4" W x 2 1/2" H

THE RETURN OF THE SPY IN THE SKY

NEC UPD791D — (CHARGE COUPLED DEVICE) 4096 ELEMENT — LINEAR IMAGE SENSOR



The charge coupled device is soldered to a pre-amplifier board. (We sold out of the A/D board that accompanied the unit... They went fast!) Since this is an analog device, the circuitry to provide timing signals and convert analog outputs to digital MUST BE SUPPLIED BY THE PURCHASER to interface to a microprocessor based system.

Timing requirements could be determined from a NEC manual on the 791D or from the schematic on the A/D board. PLEASE NOTE: We have the A/D board schematic, but unfortunately, we do NOT have the NEC manual. Designed for page scanning applications including facsimile. (Optical character recognition and other imaging applications which require high resolution and high sensitivity)

\$39.95

10 Milliwatt-Hellum Neon LASER TUBE \$99.00

NEC 5261 (Same as 5260)

10 Milliwatt (Max Output)—5 Mw (minimum)

Tube is in cylindrical housing 15" long. Emits Red beam. -Class IIIb Laser-Random Polarization-Non-polarized Laser-Mode: TEM₀₀-Beam diam. at 1/e²: .83mm-Beam divergence: .96mrad-Operating Voltage: 2350V±.100-Starting Voltage: <10KV-Operating Current: 6.5 mA

VGA Color Graphics Package

Possible Display Modes VGA Graphics:

- 800x560x16 colors
- 320x200x256 colors
- 640 x 480 x 16 colors
- 640 x 350 x 16 colors
- 640 x 200 x 16 colors
- 640 x 200 black and white
- 320 x 200 x 4 colors
- 40 and 80 column character mode

The manufacturer of this monitor SET THE STANDARD FOR COLOR GRAPHICS. The card is an ATI improved VIP CARD. The package comes with user friendly manual and step-by-step instructions. One year warranty on the monitor. Two year warranty on the card

Hercules™ Graphics Compatible

- Max resolution (800x560)
- Bandwidth: 17 Mhz
- Software selectable to VGA, EGA, CGA, MDA, HGA
- Anti-reflective, coated non-interface flicker free screen • .31 dot pitch

\$649.00

UPDATE YOUR XT/ ATTO VGAGRAPHS

Call for Qty. Discounts



1490 W. ARTESIA BLVD, GARDENA, CA 90247

Order Desk Only OEM Inquiries Welcome

Inside California Continental U.S.A. L.A. Area & Technical Info.

(800) 223-9977 (800) 872-8878 (213) 217-8912

15% Restocking fee for returned orders.



Minimum Order: \$20.00. Shipping & handling charges via UPS Ground: \$.50/lb. UPS Air: \$1.00/lb. Minimum Charge: \$4.00. We accept cashiers checks, MC or VISA. No personal check COD's. California residents add 6 1/2% sales tax. We are not responsible for typographical errors. All merchandise subject to prior sale. Phone orders welcome. Foreign Orders require special handling. Prices subject to change without notice.

BULK DISKS

**All Items In Stock
100% Guaranteed
MC, VISA, COD Accepted
24 Hour Shipment
Call For Our Monthly Specials**

3.5" DS/DD

- SONY 1.29
- DATASAFE 1.09
- TDK DS/HD 3.85

5.25" DS/HD

- TDK 1.29
- DATASAFE .89

5.25" DS/DD

- MAXELL .64
- VERBATIM .59
- 3M .57
- DATASAFE .35

Prices based on 200 Disks
Includes Labels, Sleeves & Tape
Smaller Quantities Available

In NJ **800-426-0247** FAX
201-892-5655 201-892-6186

PRINCETON DISKETTE

432 Macarthur Dr. ■ Brick, NJ 08724

SIBEC II



The ideal solution for embedded control applications and stand alone development.

- 8052 Basic CPU
- PROM Programmer
- ISBX* Expansion Bus
- Highest Quality
- 1 Year Warranty

\$228.00 QTY 1
Call Now! (603) 469-3232

Inquire about our 8051 product development kit for the IBM PC/XT/AT.

 **Binary Technology, Inc.**
Main St., P.O. Box 67 Meriden, NH 03770
*ISBX is a trademark of Intel Corporation.

FRAME GRABBERS

MODEL	RESOLUTION	PRICE with frame grab	PRICE without frame grab
HRT 256-4	256 x 256 x 4	495	NA
HRT 256-8	256 x 256 x 8	795	NA
HRT 512-8	512 x 512 x 8	995	NA
HRT 512-24	512 x 512 x 24	1995	1495

- CALL FOR DIFFERENT MODELS
- IBM PC/XT/AT COMPATIBLE
- DIGITALIZE IN REAL TIME
- COMPOSITE VIDEO IN
- 24 BIT RGB OUT except model HRT 256-4
 - 16 level gray scale out
- SOFTWARE LIBRARY OF IMAGE ANALYSIS ROUTINES
- FREE SOFTWARE UPGRADES TO REGISTERED OWNERS
- FULL CREDIT ON UPGRADE PURCHASE IN FIRST YEAR
- RETURN OLD BOARD AND JUST PAY DIFFERENCE

INPUT DEVICES (optional)

Microsoft Mouse (bus or serial) \$99
Bit Pad Plus by Summagraphics \$359

 **HRT** HIGH RES TECHNOLOGIES
P.O. BOX 76
LEWISTON, N.Y. 14092
PHONE 416-497-6493 FAX 416-497-1988

Circle 213 on Reader Service Card

Circle 129 on Reader Service Card

EPROM PROGRAMMER CROSS ASSEMBLERS



MODEL SX151

RS232C OR STAND ALONE (all models). Communication protocol: XMODEM, HEX, and BIN. Programs: EEPROMS, 2716 - 27512 and CMOS. Programs (w/adaptor): 25XX, 27101 (and above), 68701, 68705, 68764/6, 8741/2, 8744, 8748/9, 8751/2, 8755, 87252, and CMOS. More available soon. Model SX151 \$214 (assembled with case). Other models are available from \$49 (kit).

Cross assemblers by PseudoCode for IBM-PCs \$35, 280, 4802, 6502, 68001/2/3/5/8/9/11, 68000/8/10 8048/9, 8051/2, 8080/5, 8096, and more soon.

 **KORE, Inc.**
6910 Patterson S.E.
Caledonia, MI 49316
(616) 791-9333



\$5 for shipping (USA), plus \$3.00 COD.



Sure it's insured?

SAFEWARE® Insurance provides full replacement of hardware, media and purchased software. As little as \$39/yr. covers:

- Fire • Theft • Power Surges
- Earthquake • Water Damage • Auto Accident

For information or immediate coverage call:
1-800-848-3469
In Ohio call 1-614-262-0559



SAFEWARE, The Insurance Agency, Inc.

DATA ACQUISITION TO GO INTERFACE FOR ANY COMPUTER FREE IBM SOFTWARE



Connects via RS-232. Fully IBM compatible. Built-in BASIC. Stand alone capability. Expandable. Battery Option. Basic system: 16 ch. 12 bit A/D, 2 ch. D/A, 32 bit Digital I/O. Expansion boards available. Direct Bus units for many computers.

(201) 299-1615
P.O. Box 246, Morris Plains, NJ 07950

ELEXOR

Circle 147 on Reader Service Card

Circle 236 on Reader Service Card

Circle 97 on Reader Service Card

HARD DISK CONTROLLERS

ADAPTEC

PC/XT Controller ST506/412	\$45
2070 PC/XT to 506/412 RLL	\$69
2071 PC/XT to ST506 RLL (1 drive)	\$59
2072 PC/XT RLL	\$79
2370 PC/XT to ST506 RLL	\$99
3530 SCSI to Tape CMC 36	\$78
4000 SCSI to ST506/412	\$89
4000A SCSI to ST506/412	\$129
4070 SCSI to ST506/412 RLL	\$98
4520 SCSI to ESDI	\$98
5500 SCSI to ST506/412	\$125
5590 SCSI to SMD	\$175

XEBEC

S1410 SASI Controller	\$89
S1420 SASI to 5 1/4" Floppy & Hard Disk Controller	\$29
Apple II, II+, IIE Host Adapter	\$29

OTHERS

DTC 510A SASI controller	\$98
DTC 5187 AT to ST506/412, No Floppy	\$98
Konan DJ-210 3 1/2" SASI to ST506/412 (Xebec 1410 clone)	\$89
WD 1002-SHD Xebec Compatible SASI Controller	\$109
Western Digital 1003WAH	\$119
Manuals	\$.88 each
Cables Available	Ask for Pricing
Hard Drives 20-380 MB	Call

Computer Surplus Store
715 Sycamore Dr. ■ Milpitas, CA 95035
Phone: 408-434-1060
Fax: 408-434-0931
Twx: 1561447
"We Buy and Sell!"

SAVE ON

9 TRACK TAPE SYSTEM

FOR IBM PC/XT/AT



- Mainframe to PC Data Transfer
- High Speed Backup
- All Software, Complete System
- Service and Support, easy installation

call (818) 343-6505 or write to:
CONTECH Computer Corp.
P.O. Box 153 Tarzana, Calif. 91356

CONTECH

TurboFlow \$69

Flowchart drawing for IBM PC/XT/AT/PS2

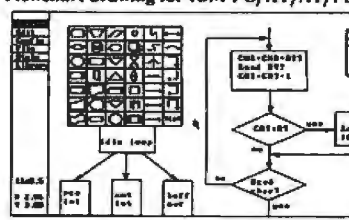

\$89 with Logitech mouse!

- Pop-up icon menus
- Variable size symbols
- Paper size to 34" x 44"
- Hercules mono, CGA, EGA
- HP-GL, DM/PL, SweepP Plotters
- Automatic PANNing to scan drawing quickly
- IBM/EPSON, NEC, OKIDATA, HP LaserJet

Daytron Electronics Inc.
610 S. Sherman #104, Richardson, Tx 75081
Add s&h (\$4 USA, \$15 foreign), Texas residents add 8% sales tax
For technical information call 214-669-2137

Order Today! 1-800-882-5822
Money-back guarantee

Circle 64 on Reader Service Card

Circle 66 on Reader Service Card

ACP's HOT SHEET

LATEST PRICES AND PRODUCTS!

MEMBER
MMC FAX...
 MICROCOMPUTER MARKETING COUNCIL
 of the Direct Marketing Association, Inc.

499.
CFAX/CFAX 9600 PC FAX Card
 CFAX/CFAX 9600 with a 9,600bps facsimile modem and an optional 2,400bps Hayes-compatible modem. Fax to any Group III. Card + software included.

DFI 400dpi Hand Scanner 229.
 Works w/popular OTP software, includes Halo DPE, a full-featured OTP program, also available OCR SOFTWARE (optional)...99.

Toshiba Floppy Drives
ACP Super Sale Priced!
99.95
 3.5" 720K Floppy Drive
 Gray or black, 5.25" mount kit, P/N FDD4403

ACP Super Sale Priced!
110.
 1.2Mb AT Floppy Drive
 Gray bezel, P/N ND-08DE-G

Super Special! 512K Upgrade with Purchase... 99.

799.
AMAX/Advanced 286/10 MHz BareBones
 Includes 101-key keyboard, 1.2Mb floppy, floppy/HD controller card, OK expands to 1 Meg.
Call for Custom Configurations...

• LOW COST COMPATIBLE CARDS •

ACP Advanced CGA/IBM Monographics/EGA w/print port	55.	XT floppy controller, 1.44Mb	89.
Colorgraphics w/print port	55.	AT 3.0Mb w/Multi I/O, OK	199.
SuperEGA, Genoa compatible	149.	AT Super Multi I/O/floppy	119.
SuperVGA, 1024x768	269.	PS/2 Multi I/O	99.
Diamond Multi I/O, 2s.p. c/c/XT	139.	PS/2 Floppy controller, 1.44Mb	89.
XT Six-Pak compatible/OK	89.	HP Laserjet 1Mb Ram card	399.
XT 286 Accelerator card	269.	MOTHERBOARDS	
XT Multi I/O w/floppy controller	69.	XT Turbo w/BIOS, 8MHz	89.
XT dual floppy controller	29.	XT Turbo w/BIOS, 10MHz	279.
XT Serial I/O card	29.	AT Baby w/BIOS, 12MHz	289.
XT/AT Parallel I/O card	29.	AT 386 w/BIOS, 16MHz	1499.
AT Serial I/O card	39.	COMPLETE PC	
XT/AT Game adapter port	29.	CFAX 4800 PC fax board	349.
XT/AT EPROM programmer	149.	CHS 200DP Hand Scanner	179.

• FLOPPY DISC DRIVES •

SONY 31/2" Micro Floppy 144Mb	139.	ND04D 360K Floppy black bezel	84.
TEAC 558V 360K Floppy/PC/XT/AT	89.	ND04E-G 360K Floppy AT gray	84.
TOSHIBA AMERICA FDD4403 31/2" Micro 720K	99.	ND08E-G 1.2Mb AT gray	110.
31/2" Micro 1.44Mb w/kit	139.	ADVANCED	
		360K Floppy-black bezel	69.
		1.2Mb Floppy-black bezel	89.
		3.5" 1.44Mb Floppy w/kit	99.
		3.5" 720K Floppy/wkit	79.

• PRINTERS •

DIGONICS/KODAK 1301 Portable printer (parallel)	339.	P2200, 24pin(360x360dpi)	399.
300P w/write carriage(parallel)	539.	LC890 Silentwriter Laser printer	3395.
EPSON LX800 Bicolor, 180cps	209.	OKIDATA	
EX800 FX288e, FX88e, LB850, LQ1050L, LQ500, etc.	call.	M-233, 180cps/NC, D	995.
ACP is your full line Epson dealer		KX-P109H, 192cps draft, par	198.
HEWLETT PACKARD Laserjet Series II	call.	KX-P109Z, 240cps draft, 132	339.
Deskjet w/laser quality	895.	KX-P1524, 24pin, 80cps/NLQ	549.
Scanjet flatbed scanner	call.	STAR	
IBM PRINTERS		NK 1000, 80 col, 9 pin	199.
Printer II, 240cps	435.	NK 1000, Rainbow, 80 col, 9 pin	269.
Printer II X24, 240cps/24pin	635.	NK 1040, 80 col, 24 pin	299.
Printer II X24, 240cps/24pin	895.	TOSHIBA	
NEC		P321SL, 24pin, 216cps	499.
		P341SL, 24pin, 216cps	699.
		P315X, (coloradd 5179)	1099.
		Pageless 12, High volume laser	call.

AST RESEARCH INC.
Your Choice... Advantage AT or Rampage AT 99.
QUADRAM Silver Quad 89.
 (Sispak compat)
 • Liberty XT, EMS... 89.
 • Quadprint Accelerator... 89.

SPECIAL PURCHASE!!
85Mb Hard Drive
 Includes EDSI AT Controller...
749.
 ACP's Special Year-End Sale!

20 Mb Hard Drive Kit 249.
20 Mb Hard Card 288.
 At this low low price, you can't afford not to buy one.

• IO MEMORY/GRAPHICS CARDS •

AST Research		AboveBoard PS/286 512K, 10MHz	30 475.
Xlrammer/286, 512K, 10MHz	call.	80287 102, 80287-8	255.
Adv Prom AT/286 512K, 10MHz	399.	80287-1, PS-2 205, 80287-10	309.
Rampage AT/286 512K, EMS, PS/2	699.	80287-2, 188, 80287-16	549.
Rampage AT 512K, LIMA, 0.102Mb	489.	80287-4, 185, 80287-20	799.
RampagePlus/286, OK, mode/50	399.	ORCHID Technology	
RampagePlus/286, OK, up to 80Mb	399.	Tiny Turbo 286 REDUCED	299.
ATI Sixpakplus, OK	call.	Designer 8008-Bit, EGA Card	269.
ATI Technologies		ProDesigner Plus 16-bit VGA 512K	329.
EGA Wonder 800	289.	RAMOUSTE 50/PS/2, 2Mb	699.
VGA VIP	299.	PARADISE	
VGA Wonder (1024x768)	call.	VGA Plus 16	289.
2400crt int. Modem w/WMP-5	199.	VGA Professional	369.
GENOA		Autowitch 480 EGA card	199.
Super EGA/Hi-Res Plus	229.	QUADRAM	
Super VGA/Hi-Res	339.	Microazul buffer w/54K	269.
Super VGA	299.	Quadprint XT accelerator	89.
Superspectrum mono CGA/EGA	149.	Liberty EMS XT card, OK	89.
INTEL		Silver Quadboard, Sispak comp.	69.
Inboard 386PC to 386/16MHz	895.	VIDEO 7	
Inboard 386/AT to 386/16MHz	1095.	Vega VGA, Deluxe, EGA Card	219.
Inboard 386/AT install kits ea.	185.	Vega VGA, 8-bit VGA card	329.
Inboard 386/AT 1Mb piggyback bd.	505.	Fastwrite VGA, 16-bit VGA card	419.
Aboveboard 2 Plus, OK, mode/50	329.	VramVGA, CAD VGA card	649.
Aboveboard 286 512K, DS/PS/2	399.		

• HARD DISK DRIVES •

MICROPOLIS 1333A 512Mb Full Int. 30ms	649.	65Mb ST277R, AT, (40ms)HH	549.
1335 85Mb Full Int. 30ms	699.	38Mb ST403E, AT, (40ms)FH	499.
MAKTOR		42Mb ST405A, AT, (40ms)FH	649.
XT 1005 85Mb MFM	849.	40Mb ST405A, AT, (28ms)FH	699.
XT 1140 743Mb MFM	1495.	21Mb ST125, 3.5" (28ms)HH	329.
XT 4380 380Mb, ESDI	2995.	30Mb ST138, 3.5" (28ms)HH	429.
PLUS Development		WESTERN DIGITAL	
Plus20 Hardcard, 20Mb, 49ms	549.	Fixed/330 PS/2 mode 30	389.
Plus40 Hardcard, 40Mb, 39ms	699.	Fixed/30	399.
SEAGATE		1008RAH Controller 1, interleave	199.
21Mb ST225, AT, (65ms)HH	289.	1003RAH Controller FULL AT	187.
30Mb ST238R, 165ms, 11.1L, AT/H	299.	1003W42 Floppy/Hard/AT	149.
42Mb ST275, AT, (40ms)HH	399.	1002-27X Controller FULL AT	98.
42Mb ST275, AT, (28ms)HH	459.	1002-WX1 Controller XT	89.

...includes FREE CABLE with Purchase!
TOSHIBA 321SL 499.
 ACP's Special Sale!
 • 120d... 149. Sale!
 • 180d... 189. CITIZEN

• MODEMS •

Advanced MODEMS		Connection Coprocessor 2400 baud	249.
1200baud w/software(internal)	69.	2400B Modem 2/50; 50, 70, 80	319.
1200baud External w/software	89.	2400B Classic Modem 2, XT/AT	269.
2400baud w/software(internal)	99.	MIGENT	
2400baud External w/software	139.	Pocket MODEM 1200	safe 95.
HAYES		PROMETHEUS	
Smartmodem 2400B w/sw(int)	447.	2400G External	188.
Smartmodem 2400 External	447.	2400B/2 w/software(internal)	149.
INTEL		1200B/2 w/software(internal) safe	89.
Connection Coprocessor w/sw(int)	799.		

• MONITORS •

AMDEK		NEC	
310A 12" amber TTL	REDUCED-88!	Multisync II 13" TTL analog	595.
410A 12" amber/green or white	153.	Multisync Plus 15" VGA/EGA	945.
1280 13" graphics (1280x800)	799.	Multisync XL 20" (1024x768)	2275.
LaserDrive CDROM w/Microsoft	899.	Monog eyes (1024x1024)	1555.
IBM MONITORS		SAMSUNG-MTEC	
8503 12" Mono(E40X480)	199.	12" amber TTL monochrome	88.
851214" Color analog	499.	14" amber flat screen TTL mono	198.
8513 12" CGA(640x480)	549.	14" white flat screen TTL mono	129.
8514 15" Hi-res(1024x768)	1255.	14" CGA/RGB Color	288.
MAGNAVOX		14" EGA Color	388.
RGB Color display 80/CGA	288.	14" VGA Color	388.
EGA Color display	399.	WYSE	
VGA Color display	499.	WY30 14" terminal	349.
		WY50 14" terminal	419.
		WY60 14" terminal ASCII	519.

NUMONICS CORPORATION SPECIAL PURCHASE!!
Cordless Mouse 99.95
 Includes drivers, charger, receiver, T-mouse & PC Port. Reg. 199.95
Manager Mouse 59.95
 Includes drivers, charger, receiver, T-mouse & PC Port. Reg. 149.95

New!
Tallgrass Technologies
NEW! 40MB TAPE BACKUP!!
 Backup your data with removable cassette tapes. your choice Model 1040i XT/AT, 1040 PS/2.
338.
 Call for other models and external systems...

• TAPE BACKUP/VIDEO •

ALPHAMICRO		IRWIN	
VCR Videotape tape backup card	349.	1100 XT/AT 10Mb backup(int)	198.
IONEGA		120D AT 20Mb backup(int)	398.
Bernoulli 20Mb 51/4" internal	945.	145CAT 40Mb backup(int)	498.
Bernoulli 20Mb 51/4" external	1188.	TALLGRASS Technologies	
Tri-pak 20Mb cartridge, 51/4"	189.	1020XT 20Mb backup(int)	318.
Tri-pak 20Mb cartridge, 8"	255.	1040 AT 40Mb backup(int) (see box)	
PC3B Adapter card PC/XT/AT	189.	1040 XT 40Mb backup(int) (see box)	
PS4 Adapter PS/2mod. 50,60,80	299.		

Toshiba Laptops
 The Complete Toshiba family of Laptops from ACP - L.A.'s #1 Source!
Toshiba T-1000 Laptop... 779.
 T-1200F.....reg. \$2099.....ACP 1395.
 T-1200FB..... Special Price!.....call ACP!
 T-1200H.....reg. \$3499.....ACP 2395.
 T-1200HB..... Special Price!.....call ACP!
 T-3100/20.....reg. \$4699.....ACP 2995.
 T-3200.....reg. \$5799.....ACP 3995.
 T-5100.....reg. \$7499.....ACP 4995.

New! from RAY-O-VAC 995
 ACP's Special Introductory Price.....
AT Replacement Battery
 Direct replacement for AT/286/386 real-time clocks

SOFTWARE SPECIALS!!

Lotus 1-2-3 325.
 Ventura 499.
 PageMaker 499.
 Word Perfect 239.
 Excel 299.

Rated No. 1
 Box of 10... **699**
 Quantity of 1104, only 7.50 each.

Polaroid DataRescue™
IBM DS/DD Gray Disks
 Backed by DATA RESCUE... Polaroid will retrieve your data FREE if you lose it!

more to choose...
 -3.5" DS/DD 1Mb 16.50
 -3.5" HD 2Mb... 39.95
 -3.5" HD 1.61Mb 14.99

419. ACP's Sale Price
MULTISYNCH MONITOR (Multisynch Compatible)

Advanced Computer Products, Inc.
 Authorized Dealers for: Hyundai • AST • Epson • Citizen • NEC • Okidata • Sony • Masell • Seagate • Toshiba • Sharp • Magnavox

800-FONE ACP
 800-366-3227 • 714-558-8813
 Customer Service 714-558-1356

for Fast Service Order by Phone!

• \$25.00 Minimum MAIL ORDER
 • No Surcharge for VISA or Mastercard
 • Volume purchasing agreements available
 • Orders subject to availability
 • Pricing subject to change without notice
 • Supply limited on certain items
 • ACP Retail store pricing may vary. Not responsible for typos
 • Limited warranties and other conditions may apply

Call for Corporate VPA's...

THROW AWAY YOUR COMPUTER MANUALS!

Learn Popular Software Programs With . . .

VIDEO INSTRUCTION TOOLS

Lotus 1-2-3 (4 hours)	\$ 99.95
WordPerfect 5.0 (4 1/2 hours)	129.95
WordPerfect 4.2 (3 hours)	99.95
DOS 3.3 (3 1/2 hours)	129.95
Intro To IBM-PC (1 1/2 hours)	79.95
PageMaker 3.0 - PC (2 hours)	179.95
PageMaker 3.0 - MAC (2 hours)	179.95
Ventura Publisher (2 hours)	179.95
Ventura - techniques (2 hours)	179.95
Q & A (1 1/2 hours)	79.95
MicroSoft Word - MAC 4.0 (2 1/2 hours)	129.95
MicroSoft Works (1 1/2 hours)	79.95
HyperCard - MAC (2 hours)	79.95

These video tapes are self-contained training guides, which demonstrate every command in a given software package, while showing the computer screen and keyboard **SIMULTANEOUSLY**. Save money . . . call today!

MICHAEL HALVERSON & ASSOCIATES
1313 Newburgh, Westland, MI 48185
(313) 729-0325 / FAX: (313) 729-0238

FOR PRODUCT INFORMATION

1-800-537-1641

MAJOR CREDIT CARDS ACCEPTED

Circle 96 on Reader Service Card



Tango. Now More than Ever, The Best Value in PCB Design.

Take a look at the all new Tango Series II. Our pop-up menu interface sets a new standard for ease-of-use and productivity. Lay out simple prototypes or complex, multi-layer, SMT designs with over 100 new features including user-definable tracks, pads, and grids.

For IBM-PCs and compatibles, Tango-PCB Series II, just \$595. Tango-Route Series II autorouter, just \$495. Both include one year's updates, free tech support, 30-day money-back guarantee.

Call today: **FREE EVALUATION PACKAGE**
800-433-7801 619-695-2000

ACCEL Technologies, 7358 Trade Street, San Diego, CA 92121

Circle 14 on Reader Service Card

NEW EPROM PROGRAMMER

- Programs 2764 in 8 sec.
- Reads programs, copies over-475 devices from 35 mfg: s: 2716-2751, 27011, 68764, 68766, 2804-28256, etc.
- Optional microcontroller heads support 874x and 87C51 series
- Improved design now programs over twice as fast
- Automatically uses the fastest algorithm recommended by the manufacturer to ensure reliable data storage
- Connects via RS-232 to any computer: PC, XT, AT, 15/2, Mac, etc
- Supports XMODEM/XMODEM CRC protocols & ASCII file xfers
- Supports Intel, Motorola, hex-space, straight hex and binary files
- Checksums supported • 8 baud rates to 38,400
- 30-day money-back guarantee • Collates 16 & 32-bit data
- Engr support team for fast updates • Gold Textul ZIP IC socket
- One-year warranty (parts and labor) • Same day shipment
- Toll-free technical support • UV erasers from \$34.95
- Thousands of satisfied customers attest to the EP-1's great value
- Low price of \$349 includes IBM compatible communications program, user's manual and two free firmware update coupons.

CALL TODAY FOR MORE INFO 1-800-225-2102

BP MICROSYSTEMS

10681 Haddington #190, Houston, TX 77043
(713) 461-9430 FAX (713) 461-7413

Circle 362 on Reader Service Card

Diablo Super D2 Ribbons
150% higher yield than HyType II.
Provides the highest quality print.
Order No. 9R2986 **\$4.65**

Super Sale Price on 3M 3.5" Micro Diskettes
2.0 MB Diskette (DSHD)
Supplies Limited. Order Now.
\$3.40 ea.

Toll Free: 800-258-0028
Michigan: 800-632-2468

FREE CATALOG
Complete Line of Quality Supplies For Your Com puter.
FOREIGN INQUIRIES INVITED
Minimum Order \$25.00. S&H: \$2.00/Dozen.
Prices Subject to Change.

Precision Data Products™
P.O. Box 8367, Grand Rapids, MI 49518
616-452-3457 • FAX: 616-452-4814

Circle 212 on Reader Service Card

ICs PROMPT DELIVERY!!!

SAME DAY SHIPPING (USUALLY)
QUANTITY ONE PRICES SHOWN for NOV 14, 1988

OUTSIDE OKLAHOMA: NO SALES TAX

DYNAMIC RAM		
SIMM	1Mx9 80 ns	\$475.00
SIMM	1Mx9 85 ns	390.00
SIMM	256Kx9 60 ns	160.00
1Mbit	1Mx1 100 ns	33.50
41256	256Kx1 100 ns	12.95
51258	* 256Kx1 100 ns	13.50
41256	256Kx1 120 ns	12.25
41256	256Kx1 150 ns	10.75
41264	+ 64Kx4 120 ns	17.95
EPROM		
27C1000	128Kx8 200 ns	\$29.50
27C512	64Kx8 200 ns	13.95
27256	32Kx8 150 ns	8.25
27128	16Kx8 250 ns	5.75
STATIC RAM		
62256P-10	32Kx8 100 ns	\$22.95
6264P-12	8Kx8 120 ns	10.80

640K MOTHERBD UPGRADE: Zenith 150, IBM PC/XT, Compaq Portable & Plus, Top Vectra

80087-2 80287-8 80337-16 80387-20
\$160.00 \$245.00

OPEN 6 1/2 DAYS, 7:30 AM-10 PM SHIP VIA FED-EX ON SAT
WE EXPORT ONLY TO CANADA, GUAM, PUERTO RICO & VIRGIN ISLANDS

SAT DELIVERY INCLUDED ON FAST DELIVERY PORTABLE & PLUS VECTRA
FAX ORDERS RECEIVED BY: TEL: 800-433-7801 619-695-2000
FAX: 619-695-1184

MAINTAINS VISA or UPS CASH CDD
Factory New, Prime Parts on PC
MICROPROCESSORS UNLIMITED, INC.
24 000 S. Peoria Ave. (918) 267-4961
BEGGS OK 74421

No minimum order. Please note that prices are subject to change. Shipping & insurance extra. \$ up to \$1 for passing materials. Orders received by 4 PM CST can usually be delivered the next morning, via Federal Express Standard Air or EMS, or guaranteed next day priority One or EMS.

Circle 177 on Reader Service Card

Z80 or HD64180

iC-80 In-Circuit Emulator

- Can be configured for Z80 or HD64180.
- C source code level debugging with our C compiler.
- Works with IBM-style PC.
- 64K overlay memory.
- Base price \$995.00. \$1340.00 including one probe and symbolic debug software.

Z-World, 1772 Picasso Ave, Davis, CA 95616
(916) 753-3722
Fax: (916) 753-5141.
In Germany: iSystem 08131/1687

Circle 306 on Reader Service Card

SKI & LEARN FRENCH!

Full-time & Part-time work all over Europe from a Swiss Alps base while you fine-tune hardware installations and train operators!
Join a young, dynamic team with one foot in the UK and the other in Switzerland this season. Train, learn and progress in many business skills, sports and cultural areas.

- PC Hardware Application & Support Engineers
- FW II & III, Dbase IIIplus & IV, Ventura &/or Pagemaker - Software support specialists
- Desk Top Publishing, Graphic Designer/Artists

Applications are requested for exceptional and ambitious people, flexible about working hours and the balance between compensation and the quality of life.
For more information, first Fax (021 26 1042) or mail your brief typed CV with full phone contact details, passport style photo if possible, and handwritten cover letter to:
THORBURN & ASSOCIATES
POB 1225, 1001 LAUSANNE, SWITZERLAND

Circle 271 on Reader Service Card

IMAGING CARD

DV-01 GRAY SCALE FRAME GRABBER

Composite video in/out
256 x 240 resolution
Digitize/display at frame speed
256 gray levels in
16 Meg. color palette out
PC/XT/AT compatible

\$849.00 Complete with software
VISA/MC Demo Disk available

Control Vision

P.O. Box 596, Pittsburg, KS 66762
(316) 231-6647

Circle 67 on Reader Service Card

FREE!

Turn-key PC Systems Handbook

NEW 1988 3rd Edition

Save Time and Money Over 1000 Hard-to-Find Hardware and Software Items of Special Interest to Technical PC Users:

- RS 232/IEEE 488 Networks
- Stepping & Servo Motor Controls
- Ruggedized PC's
- RackMig, 80286 & 80386
- Laboratory Automation
- 1 MHz A/D
- Digital Scopes to 200 MHz
- High Speed Bus Adapters
- Waveform Synthesizers
- Data Loggers
- PC Bus Expansion Chassis
- And Much More

A How-to-Handbook that enables you to configure the BEST products from the world's leading PC hardware and software vendors into risk free turn-key system solutions that meet your needs.
Toll Free Hotline for application assistance and convenient one stop shopping at competitive prices. 100% Satisfaction Guaranteed.

Call or write for a FREE Handbook today!
203-786-5151
(9:00 AM to 5:00 PM E S T)

CyberResearch, Inc.
P.O. Box 9565, New Haven, CT 06536
Fax: 203-786-5023 Telex: 9102501037

Circle 70 on Reader Service Card

California Digital

17700 Figueroa Street • Carson, California 90248



Color Monitor
Better Than **EGA**
\$1095 **\$289**

Ideal for CAD/CAM and Desk Top publishing applications. The Roland CD/240 color monitor has a resolution of 720 pixels by 400 lines on a .31mm dot pitch 12" non-glare screen. VGA specifications in text mode EGA in graphic mode.
Comparable monitor and card packages retail at over \$1095. California Digital has made a special purchase and is able to offer the CD/240 and 132 column VGA/EGA graphic card for only \$389.

20" Analog Color
\$1895 **\$659**



Ever try gathering a classroom of students around a 12 inch monitor? This 20 inch analog RGB monitor is the ideal solution. High screen resolution of 1200 pixels by 950 lines allow extra fine detail without the dots looking like golf balls. 256 colors and VGA compatible. Super value originally sold for over \$2000. Only 350 available.



NEC/890 Laser Printer
\$3295

PC Magazine has chosen the NEC-890 best laser printer of the year. (Jan. 12, 1988). And its obvious why... the printer is Postscript, Hewlett Packard, and Apple compatible, and comes standard with three megabytes of memory. The 890 accepts data from parallel, serial and Apple-Talk devices.
NEC has also incorporated 40 built-in fonts along with two paper trays into this industrial quality laser printer.

Hewlett Packard Laser II, 8 pages per minute..... \$1659
QMS PS/810 2 Meg., 35 fonts, Postscript 8 pgs..... 3879
Apple Laser Writer II..... 1899
Texas Instruments 2115 Postscript 15 pgs..... 5426
Quadram Quadlaser with 5 megabytes..... 2995

Hitachi CD-ROM
\$495

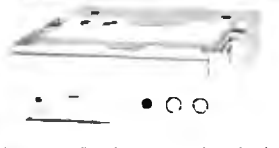

Compact disk is a relatively new medium for storage of read-only digital data. One removable disk is capable of storing over 500 megabyte of data on a disk the same size as an audio CD. The CDR-3500 will install in a PC in the space of one 5 1/4" drive. Other CD-ROM Products Available: Sony 510 internal \$539; Amtek Laserdrive/1 system \$679; Hitachi 4D-1503SUY external with IBM host adapter and MS ext. DOS \$699; Panasonic **WORM** drive \$1095.

Murata 1200 FAX
\$759

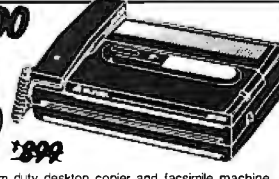

The Murata 1200 is a medium duty desktop copier and facsimile machine. Automatic record keeping of transmit and receive reports. CCITT group II and group III compatible. Capable of scanning 10" documents. LCD display. Other FAX Equipment available: Canon Faxphone 20... \$1259; Panasonic 1200... \$1159; Sharp 80 (flat copier)... \$895. Also: Ricoh; Toshiba; Brother; Cobra; NEC; Xerox; PacTel.

PRINTRONIX 4160 CAD Printer
\$1495 ~~\$5995~~



The 4160 is a bond paper printer that emulates the Versatec model V/80, 1200A and 3200A plotters. This is the ideal heavy duty printer for CAD/CAM applications. The perfect printer for high speed CAD proofs, bar codes, schematics or anywhere that fast graphic output is required.
Other Printronix available: P300...\$3795; P600...\$5795.

Texas Instruments ProCalc 95
\$200 \$85



The ProCalc 95 Scientific features a full alphanumeric keyboard along with a two line dot matrix LCD display. Complete with hard carrying case.
Texas Instruments original price \$200. Now available from California Digital for only \$85. Printers & software cartridges available.



FaxCard
Turn your PC into a FAX Machine!
The FaxCard 200 gives you the capability of sending and receiving World wide FAX transmissions. Preprogram your computer to send FAX messages to all your branch offices at a specific time.
Foreground and background reception Manual auto dial and redial • Communication log look-up • Software compatible with PC pan/brush, Worstar, Dr. Halo and any AS-CII text editor.

\$119 2400 Baud Modem
2400 baud with forward error correcting make the Maxon MAX/2400 an unbeatable value at only \$119.
Fully compatible with the Hayes command set and CCITT V.22 standards. Error correcting, auto bauding and "adaptive equalization" allow the MAX/2400 to maintain reliable data transmission over marginal phone lines.
Manufactured by Maxon Systems, one of the World's largest producers of consumer electronics. Originally priced at \$295. While supplies last California Digital is offering the MAX/2400 at only \$119.

40 Meg. Tape Back-up
\$239 ~~\$559~~

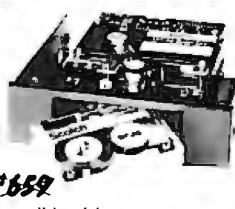

Head Crash, Power Spikes or just poor disk maintenance... Don't loose data because you didn't back up. The ALL/40 is an inexpensive way to save and restore files in the event that your data has been destroyed.
This 40 megabyte half height tape back is manufactured by North Americas largest producer of data retrieval equipment. No need to purchase a separate tape controller... the ALL/40 attaches directly to your existing floppy disk controller. Supplied software allows your computer to back up any time Day or Night. Come back in the morning and 40 megabytes of irreplaceable data has been stored on one Scotch DC/2000 data cassette. Back up entire hard disk, modified files only, or by file name. Loss of data is inevitable but when you are backed up on an ALL/40 its not a catastrophe.

Hitachi 11 by 17 Plotter
\$895 \$695



The Hitachi 672/XD is a four color 11 by 17 (B size) plotter with superior accuracy and repeatability (.3mm). The 672 accepts HPGL 7475 commands and is both Centronics parallel and RS232C compatible.
The 672 plots at a fast eight inches per second in axial direction and eleven inches at an angle of 45 degrees. The plotter also features a self contained digitizing function that allows data to be entered into your computer from printed graphs and blue prints. Four different color pens are supplied with the plotter but a wide variety of technical pens are available.

40 Megabyte Hard Disk Kit
\$397
Forty megabyte internal hard disk drive, controller and cables all for only \$397.
The kit includes the a 40 milisecond Miniscribe 3650 drive and a half slot Western Digital controller.



Five Inch Winchester Disk Drives

SEAGATE 225 20 Meg. 1/2 Ht.	239	229
SEAGATE 238 30 Meg. RLL	259	249
SEAGATE 251/151 M. 28ms.	459	449
SEAGATE 4096 96 M. 35ms.	659	639
MINISCRIBE 8425 25 M. 65ms.	239	227
MINISCRIBE 3650 50M 61 ms.	419	399
MINISCRIBE 6085 90 meg.	795	779
MINISCRIBE 3053 25 ms. 1/2 ht.	459	439
FUJITSU 2242 55 M. 35ms.	1299	1229
FUJITSU 2243 86 M. 35ms.	1695	1619
RODIME RD-204E 53 Meg.	895	859
MAXTOR XT1140 140 Meg.	1595	1550
MAXTOR XT2190 192 Meg.	1919	1875
TOSHIBA MK56 70 M. 30ms.	1289	1229
CONTROL DATA WREN "V"	call	

Price does not include controller. each two+

Winchester Controllers for IBM/PC

XEBEC 1220 with floppy controller	159
DTG 5150XC	119
OMTI 5527 RLL controller	99
ADAPTEC 2070 RLL controller	99
ADAPTEC 2372A 1/1 interleaf	159
WESTERN DIGITAL WD/1002WX2	89
WESTERN DIGITAL 1003WAH or WA2 139	
WESTERN DIGITAL 1007/WA2 ESDI	239
SCSI/SASI Winchester Controllers	
XEBEC 1410A 5 1/4" foot print	239
WESTERN DIGITAL 1002-05E5 1/4"	229
DMTI 20L	89
Winchester Accessories	
Dual floppy enc. and powersupply	59
Winchester enclosure and supply	139
Switching power supply	49



One Two Ten

TEC501 1/2 height sgl.side	49	39	35
TANDON 10 1/4 full ht. 96 TPI.	99	89	79
FUJITSU 5 1/4" half height	65	63	57
MITSUBISHI new 501 half ht.	119	109	105
MITSUBISHI 504A AT comp.	149	139	135
TEAC FD55BV half height	89	85	79
TEAC FD55FV 96 TPI, half ht.	119	109	105
TEAC FD55GF for IBM AT	109	105	99
PANASONIC 455 Half Height	109	99	89
PANASONIC 475 1.2 Meg./96	119	115	109
Switching power supply			49
Dual enclosure for 5 1/4" drives			59

3 1/2" DISK DRIVES

SONY MP-53W 720K/Byte	129	125	119
SONY MP-73W, 2 Meg.	159	149	call
TEAC 35FN 720 K/Byte	129	119	115
TEAC 35HN/30, 2 Meg.	159	149	145
5 1/4" form factor kit			20

8" DISK DRIVES

QUME 842 double sided	189	179	175
QUME 841 single sided	119	109	99
SHUGART 851 R dbl. sided	319	309	299
REMEX RFD4000 dbl. sided	189	179	165
OLIVETTI 851	189	179	165

Heath H/89 Computer
\$179



Hard to believe... but we found a stash of brand new Zenith/Heath Model H/89 computers. These computers feature the Zilog Z-80 CPU and operate under CP/M. The unit incorporates a 12 inch green screen, three serial ports and one 5 1/4" disk drive. Zenith's original price was \$1895. We have 350 units available for sale, while supplies last we are offering the H/89 at only \$179. Word processing and communication software included.

Every year since 1973, customers from virtually every nation in the free World have chosen California Digital for their data processing requirements. If its computer, California Digital has it... complete minisystem or just one microchip. California Digital offers over 10,000 unique computer products. Regardless of how specialized your data processing requirements... California Digital is your one stop shopping solution.

TECHNICAL & CALIFORNIA
(213) 217-0500
TOLL FREE ORDER LINE
(800) 421-5041

Telefax • (213) 217-1951

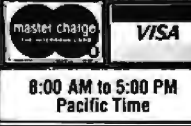

TRANSLATE BASIC TO PASCAL

P-TRAL, Woodchuck Industries' program for IBM PC and MS-DOS compatibles translates

Microsoft BASIC source code to Turbo Pascal source. Comes with full documentation and tutorial. \$179.00

P-Tral is also available for the Apple II series. Write or call for more details.

WOODCHUCK INDUSTRIES, INC.
340 WEST 17 STREET Ste 2B NY, NY 10011
(212) 206-6490 / 924 0576



9-TRACK MAG. TAPE SUBSYSTEM* FOR THE IBM PC/XT/AT AND...



For information interchange, backup and archival storage, AK Systems offers a 9-track, IBM format-compatible 1/2" magnetic tape subsystem for the IBM PC, featuring:

- IBM format 1600/3200 and 800 cpi.
- Software for PC-DOS, MS-DOS, XENIX.
- Also for AT&T, DEC, VAX, VME, S-100, RS-232, IEEE488.

* formerly IBEX Mainstreamer

Write, phone or TWX for information.

AKSystems

20741 Mainita St
Chatsworth, CA 91311
(818) 709-8100
TWX: 910-483-2071

DYNAMIC RAMS

SIMM	80/100	\$CALL
1MBIT	100ns	\$36.00
514256	100ns	\$39.00
41464	150ns	\$14.75
41256	120ns	\$12.25
✓ 41256	150ns	◀ \$10.15 ▶
✓ 51258	100ns	\$12.25
✓ 4164	150ns	◀ \$ 2.85 ▶

* For high-speed Zip. Pcc. Smm. Please Call!

PROCESSORS		E.PROMS		
80387-20	20MHz	27C101	250ns	\$ 24.00
80387-18	18MHz	27C512	200ns	\$ 15.00
80287-10	10MHz	27512	250ns	\$ 8.50
80287-8	8MHz	27C256	250ns	\$ 8.50
80287-1	1MHz	27256	250ns	\$ 4.50
8087	5MHz	27128A	250ns	\$ 6.25
8087	5MHz	27C08A	200ns	\$ 4.85
Y-30	8MHz	2784	250ns	\$ 3.00
Y-20	10MHz	42256	120ns	\$ 19.00
Y-20	8MHz	4364	150ns	\$ 13.50

I.C. EXPRESS

15358 Valley Blvd. City of Industry, CA 91746 Tel: 818-369-2688
ORDER TOLL FREE (800) 892-8889 (Mon-Fri 8-5 PST)
(800) 892-8889 • (800) 882-8181
Please Call!
CALL FOR CURRENT PRICES & VOLUME DISCOUNTS
Price shown for cash. Minimum Order \$100. Prices are subject to change. Minimum order \$10.00. Shipping & handling. UPS Ground \$3.00. Air \$7.00 (1 lb.)
ALL MERCHANDISE IS 100% GUARANTEED WITH PROMPT DELIVERY

Circle 301 on Reader Service Card

Circle 17 on Reader Service Card

Circle 134 on Reader Service Card

DIGITAL VOICE CARD (DVC) for IBM PC, XT, AT and compatibles

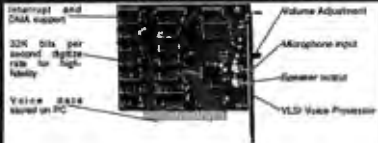

GET A VOICE CARD TODAY AND LET YOUR PC DO THE TALKING.

The DVC comes complete with driver software and demonstration programs in C, BASIC, PASCAL and DBASE. It is simple to program and ready for use. A built-in VLSI voice processor handles the chore of digitizing and modulation. It digitizes voice input at 8K samples per second, 10 bits A/D, D/A. Voice data are transferred between processor and memory through selectable DMA channels. The recording and playback are done concurrently with user program and with minimal CPU overhead. It does not tie up CPU time while processing the voice data. The DVC can continuously record and playback voice for up to 170 minutes on a 20M harddisk.

- APPLICATIONS**
- Stales, exhibit presentation
 - Voice message management in a store, factory, office, and hospital
 - Computerized security and monitoring system
 - Voice alarm and reminder for busy executives
 - Speech analysis and voice synthesis
 - Voice mail on a floppy or through a modem
 - Voice question and answer
 - Sound-effect in games and simulation
 - Voice output for industrial control/automation

DVC (Digital Voice Card for PC/XT/AT)	\$85.00
MIC (Microphone for DVC)	\$12.00
SPK (Speaker for DVC)	\$8.00
VPB (Voice in a Box, up to 32 seconds)	\$60.00
VPB-II (up to 64 seconds)	\$85.00

We accept VISA, Mastercard or cash in U.S. please call
1-800-263-7487
Computer Age Ltd.
Tel: (416) 859-4178
Fax: (416) 859-0772

Release 2.0 Available Now

Circle 59 on Reader Service Card

IEEE-Z

Easiest IEEE 488 (GPIB/HPiB) Interfaces for your PC, PS/2, Macintosh, HP and more!

- Controllers
- Converters
- Extenders
- Buffers
- Boards



Please see our ad on page 388.

Call or send for your FREE Technical Guide

Otech (216) 439-4091

25971 Cannon Road • Cleveland, Ohio 44148
Telax 6502820864 • Fax (216) 439-4093

Circle 140 on Reader Service Card

6805/6305 SINGLE CHIP MICROCOMPUTER DEVELOPMENT SYSTEMS

Each of three products allows the IBM PS2/PC/XT/AT to be used as a complete development system for the Motorola 6805 series single chip microcomputers. MCPM-1 supports the MC68705 family, MCPM-2 supports the MC1468705 family and MCPM-3 supports the MC68HC05 family. Each system is \$495 and includes a programming circuit board with driver, cross assembler and Simulator/Debugger software. A system is also available for the HITACHI 63705 ZTAT micro.

THE ENGINEERS COLLABORATIVE
Route 3, Box 8C, Barton, VT 05822
(802) 525-3458 FAX (802) 525-3451

Circle 101 on Reader Service Card

DIGITAL OSCILLOSCOPE SYSTEM \$99

- A08-B1 card & DIG-OSC-8 Software
- Analog input
 - 8 bit resolution
 - use as a storage scope
 - saves waveform to disk
 - 110us conversion
 - High input impedance
 - 0-3V range
 - 7 TTL inputs
 - for IBM PC and compatibles.

\$299

DAS 12

- 12 bit Data Acquisition System
- 8 Bi-Z, S.E. input channels
- Full Scale: +/- 10V, 5V, 500mV, 50mV
- 25us conversion
- Sample/hold for precision readings
- software to simulate 8 channel DVM, data logger, plot data
- TTL I/O, trigger sampling or control external devices
- option available: 12 bit analog output, add \$100

DASIF \$199

- high speed (1.1us conversion) 8-bit data acquisition system
- 8 Bi-Z, S.E. input channels, GAIN of 1, 10, 100, 0-3V Full Scale

FG-CTR \$199

- software controlled function generator variable frequency oscillator
- 8mV, 20mV, Square Wave
- software controlled: freq, amp, offset, signal selection
- use as sweep generator, clock source

All boards have a user manual, demo software with source code in Pascal, BASIC, C and a one year warranty.

JB COMPU-TRONIX
3816 N. Wadsworth Blvd.
Wheat Ridge, CO 80033
(303) 425-9586

Call for FREE CATALOG, accept MC/VISA orders

Circle 143 on Reader Service Card

System 1800 Basic System \$899
(MADE IN U.S.A. WITH QUALITY)

- Intel 80286 CPU
- Fully compatible with IBM AT
- 60 MHz selectable, 8 slots
- 5.12K on 1M mother board
- 18.5 watt power supply 100/220
- Clock/Calendar, Error, Hard/Soft
- FCG class "B" approved
- 46 Hour factory/high temp dynamic burn-in
- 12 MEG Trac Dr. AT Keyboard
- Mouse/Joystick, Laser/Joystick, Novel, all prop Software
- 200 pages of documentation (manual and S.A.)
- 80287 CPU Processor socket
- 80,000 units installed with customer report on file
- Made in U.S.A. with 1 year warranty

Special \$999

VGA Sys. (Basic Sys. + Everex VGA card + HP Easypc Plus Mon.) \$1494
Super VGA Sys. (Basic Sys. + Everex VGA card + NEC Monitor 8058 [33cm] Mon.) \$1500
Custom 1800 10MHz/286 0 w/ 512K, 3.5 P. KB, Base system \$1099
System 1800 10MHz/286 0 w/ 1 meg RAM, 40.0 base system \$1355
System 3000 19MHz/386 0 w/ 1 meg RAM, Base system \$895
System 3000 33MHz/386 0 w/ 1 meg RAM, Base system \$2300

Full Line of Everex Products Available

PEC 286 180210	\$ 825	System 1600XT 10MHz/286K	\$533
Model PEC 286/10MHz/512K	\$ 895	System 1600XT 12MHz/256K	\$630
Model PEC 286/12MHz/512K	\$1095	New Paradise VGA Plus 15 bit VGA Monitor (Special)	\$441
Model PEC 286/16 MHz/512K			

Schwab Computer Center
"The Everex Store" - Authorized Everex Corp. VAR
2492 El Camino Real, San Diego, CA 92105
Daily UPS M-F 10-7; SAT 11-4
Price change without notice VISA/MC/AE

Circle 241 on Reader Service Card

LOW-LOW-LOW

hp Laserjet Printer Series II \$1650

hp Scanjet Scanner + interface kit \$1285

IBM COMPAG Apple ACER
EVEREX AST & other

XT/AT Compatibles & 386 Computers
CALL for LOW PRICES

Gov't, Corporate, Schools, Dealers, & Export INQUIRIES WELCOME.

SURAK inc.

44862 Osgood Road, FREMONT, CA 94539
PH: (415) 651-5101 FAX: (415) 651-5241
1-800-543-1001
VISA, Master Card accepted. w/sc

Circle 257 on Reader Service Card

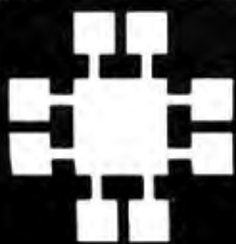

JDR Microdevices

10 years of commitment to you!

As we celebrate our 10th year in business, we'd like to give a **special thanks to all our loyal customers!** Our business is built upon your trust and confidence in us, things we take very seriously.

To those of you who have never ordered from us, here are 10 reasons to give us a try:



1. **30 day money back guarantee on every item***

You can buy with confidence from JDR because you can return any purchase within 30 days for a complete refund.

2. **One year limited warranty on every item***

We warranty all our products to be free of defects in materials or workmanship for one year from date of purchase.

3. **Toll-free ordering: call 800-538-5000**

Monday-Friday 7 AM-5 PM, Saturday 10 AM-3 PM (PST).

4. **Toll-free customer service**

We're here to help--just give us a call.

5. **Toll-free, top-notch technical support**

Our 24-person support staff provides technical help before or after you make your purchase!

6. **Extensive product testing**

Every new product is put through extensive testing in our own labs before we add it to our selection.

7. **Wholesale prices on volume orders**

Just ask for our Wholesale Department.

8. **Fast shipping**

Most orders are processed and shipped within 48 hours. Need it tomorrow? Ask about our Overnight rates.

9. **Shareware by Buttonware**

Complimentary software with every purchase over \$100.

10. **Electronic BBS: (408) 374-2171**

For 24-hr. ordering, technical support, tips and more!

*A full copy of our terms is available upon receipt.

"We wish to thank you and your staff for the great service you extended to our department with our orders. We really appreciate it when a company expedites our order in such a timely manner, with quality merchandise and competitive prices."

—Sally A. Callaway, Kalispell, MT

"We really appreciate JDR Microdevices, a vendor which provides products and service that can be relied upon for excellence"

--Diane M. DuBois, San Jose CA

"I have your MCT-XTMB and MCT-FDC and was very pleased to find the instructions were the best by far for any circuit board I have seen. A compliment should be in order."

—C.C., Marstons Mills, MA

"THANKS! The response to my letter about the problem I was having was GREAT! Robert called me and assured me that he was going to find a solution. HE DID! Please give him my thanks for his help."

—Clyde Hussey, Sylva, NC

"I found JDR's tech support to be responsive, helpful and honest—appreciably more so than other companies I have dealt with. I would certainly use JDR for other purchases and will recommend the company to associates with confidence."

—N.G., Melville, NY



JDR Microdevices

MMG
MICROCOMPUTER
MARKETING COUNCIL
of the Direct Marketing Association, Inc.

• 30 DAY MONEY BACK GUARANTEE • 1 YEAR WARRANTY ON ALL PRODUCTS • TOLL-FREE TECHNICAL SUPPORT
• COMPLETE CUSTOMER SATISFACTION • SUPERIOR SERVICE • FRIENDLY, KNOWLEDGEABLE SALES STAFF

STATIC RAMS

PART	SIZE	SPEED	PRICE
2112	256x4	450ns	2.99
2114	1024x4	450ns	.99
2114L-2	1024x4	200ns	1.49
TC5516	2048x8	250ns	3.95
TMM2016-200	2048x8	200ns	3.25
TMM2016-150	2048x8	150ns	3.29
TMM2016-100	2048x8	100ns	4.29
HM5116-4	2048x8	200ns	4.95
HM5116-3	2048x8	150ns	5.95
HM5116-2	2048x8	120ns	6.45
HM5116LP-4	2048x8	200ns	5.95
HM5116LP-3	2048x8	150ns	6.45
HM5116LP-2	2048x8	120ns	6.95
HM6264LP-15	8192x8	150ns	9.95
HM6264LP-12	8192x8	120ns	10.95
HM43256LP-15	32768x8	150ns	12.95
HM43256LP-12	32768x8	120ns	14.95
HM43256LP-10	32768x8	100ns	19.95

CALL TO CONFIRM CURRENT PRICES

DYNAMIC RAMS

PART	SIZE	SPEED	PRICE
4116-200	16384x1	200ns	.89
4116-150	16384x1	150ns	.99
MK4332	32768x1	200ns	6.95
4164-150	65536x1	150ns	2.89
4164-120	65536x1	120ns	3.19
4164-100	65536x1	100ns	3.99
TMS4164	65536x1	150ns	2.89
TMS4416	15384x4	150ns	8.95
41128-150	131072x1	150ns	5.95
TMS4464-15	65536x4	150ns	10.95
TMS4464-12	65536x4	120ns	11.95
41256-150	262144x1	150ns	12.45
41256-120	262144x1	120ns	12.95
41256-100	262144x1	100ns	13.45
41256-80	262144x1	80ns	13.95
41256-60	262144x1	60ns	13.95
HMS1258-100	262144x1	100ns	13.95
1 MB-120	1048576x1	120ns	34.95
1 MB-100	1048576x1	100ns	37.95

CALL TO CONFIRM CURRENT PRICES

EPROMS

PART	SIZE	SPEED	Vpp	PRICE
2708	1024x8	450ms	25V	4.95
2716	2048x8	450ms	25V	3.49
2716-1	2048x8	350ms	25V	3.95
2732	4096x8	450ms	25V	3.95
2732A	4096x8	250ms	21V	3.95
27C64	8192x8	250ms	12.5V	4.95
2764	8192x8	450ms	12.5V	3.49
2764-250	8192x8	250ms	12.5V	3.69
2764-200	8192x8	200ms	12.5V	4.25
NCM68766	8192x8	350ms	21V	15.95
27128	16384x8	250ms	12.5V	4.95
27128A-200	16384x8	200ms	12.5V	5.95
27C256	32768x8	250ms	12.5V	7.95
27256	32768x8	250ms	12.5V	5.95
27256-200	32768x8	200ms	12.5V	7.95
27512	65536x8	250ms	12.5V	11.95
27C512	65536x8	250ms	12.5V	12.95
27C101-20	131072x8	200ms	12.5V	34.95

CALL TO CONFIRM CURRENT PRICES

CO-PROCESSORS

8087	5 MHz	99.95
8087-2	8 MHz	159.95
8087-1	10 MHz	229.95
80287	5 MHz	178.95
80287-B	8 MHz	249.95
80287-10	10 MHz	309.95
80387-16	16 MHz	499.95
80387-20	20 MHz	799.95
80387-25	25 MHz	999.95



INCLUDES MANUAL & SOFTWARE GUIDE

CALL OUR WHOLESALE DEPT. FOR VOLUME QUOTES

HIGH-TECH SPOTLIGHT

30 DAY MONEY-BACK GUARANTEE TOLL-FREE TECHNICAL SUPPORT

MICROPROCESSORS

6500	8000	8200			
6502	2.25	8031	3.95	8253-5	1.95
6502A	2.69	8035	1.49	8254	2.79
6502B	4.25	8039	1.95	8255	1.49
65C02*	7.95	8052AH		8255-5	1.59
6520	1.65	BASIC	34.95	8256	15.95
6522	2.95	8080	2.49	8259	1.95
6522A	5.95	8085	1.95	8259-5	2.29
6526	3.95	8085A-2	3.75	8272	4.39
6532	5.95	8086	6.49	8274	4.95
6545A	3.95	8088	5.99	8275	16.95
6551	2.95	8088-1	12.95	8279	2.49
6551A	6.95	8088-2	7.95	8279-5	2.95
* CMOS		8155	2.49	8282	3.95
		8156	2.95	8283	3.95
		8155-2	3.95	8284	2.25
		8741	9.95	8286	3.95
		8742	29.95	8287	3.95
		8748	7.95	8288	4.95
		8749	9.95		
		8755	14.95		
		80286	79.95		
		80286-8	249.95		

6800

6800	1.95
6802	2.95
6803	3.95
6809	2.95
68B09	5.99
6809E	2.95
6810	1.95
6820	2.95
6821	1.25
68B21	1.85
6840	3.95
6845	2.75
68B45	4.95
6847	4.75
6850	1.95
68B50	1.75
6883	22.95
68000	9.95

8200

8205	3.29
8212	1.49
8216	1.49
8224	2.25
8228	2.25
8237	3.95
8237-5	4.75
8238	4.49
8243	1.95
8250	6.95
8251	1.29
8251A	1.69
8253	1.59

Z-80

Z80-CPU	1.25
Z80A-CPU	1.29
Z80B-CPU	2.75
Z80A-CTC	1.69
Z80B-CTC	4.25
Z80A-DART	4.95
Z80B-DART	6.95
Z80A-DMA	5.95
Z80A-PIO	1.89
Z80B-PIO	4.25
Z80A-SIO/0	5.95
Z80B-SIO/0	12.95
Z80A-SIO/1	5.95
Z80B-SIO/1	5.95
Z80B-SIO/2	12.95
Z8671BASIC	9.95

SIMMS SINGLE IN-LINE MEMORY MODULES

PART NO.	ORGANIZATION	SPEED	PRICE
41256A8B-15	256K X 8-BIT	150NS	89.00
41256A8B-12	256K X 8-BIT	120NS	99.00
41256A8B-10	256K X 8-BIT	100NS	129.00
42100A8B-10	1MB X 8-BIT	100NS	429.00
42100A9B-10	1MB X 9-BIT	100NS	529.00
42100A9B-80	1MB X 9-BIT	80NS	599.00

V-20 SERIES

SPEED UP YOUR PC BY 10 TO 40%!

- HIGH SPEED ADDRESS CALCULATION IN HARDWARE
- PIN COMPATIBLE WITH 8088
- SUPERSET OF 8088 INSTRUCTION SET
- LOW POWER CMOS

V20*	5 MHz	8.95	V20*	8 MHz	10.95
V20*	10 MHz	12.95	V30	8 MHz	13.95

VOLTAGE REGULATORS

7805T	.49	7812K	1.39
7808T	.49	7905K	1.69
7812T	.49	7912K	1.49
7815T	.49	78L05	.49
7905T	.59	78L12	.49
7908T	.59	79L05	.69
7912T	.59	79L12	1.49
7915T	.59	LM323K	3.49
7805K	1.59	LM338K	4.49

PALS

16L8	2.95
16R8	2.95
16R6	2.95
16R4	2.95

UARTS

AY5-1013	3.95
AY3-1015	4.95
TR1602	3.95
2651	4.95
IM5402	3.95
IM5403	9.95
MS8250	6.95
MS16450	10.95

MISCELLANEOUS

ADC0804	2.99	9334	1.75
ADC0809	3.85	9369	2.85
DAC0800	3.29	9560	2.85
DAC0809	1.95	ULN2003	.79
DAC1022	5.95	MAX232	7.95
MC1408L8	1.95	MC3470	1.95
82T8	1.29	MC3487	2.95
8T97	.59	AY5-3600	
DP8304	2.29	PRO	11.95

INTERSIL

ICL7107	10.95
ICL7660	1.89
ICL8038	3.85
ICM7207A	9.95
ICM7208	15.95

LINEAR COMPONENTS

TL071	.69	LM380	.89	XR2206	3.95
TL072	1.09	LM383	1.89	XR2211	2.85
TL074	1.95	LM386	.85	LM9217	7.99
TL081	.59	LM393	.45	CA3046	.89
TL082	.99	LM394H	5.95	CA3146	1.29
TL084	1.49	LM399H	5.95	MC3373	1.29
LM301	.34	TL494	4.20	MC3470	1.95
LM309K	1.25	TL497	3.25	MC3480	8.95
LM310	1.75	NE555	.29	MC3487	2.95
LM311	.59	NE556	.49	LM3900	4.99
LM311H	.89	NE558	.79	LM3909	.98
LM311K	3.49	NE564	1.95	LM3911	2.25
LM312H	1.75	LM565	.95	LM3914	1.89
LM317T	.69	LM566	1.49	LM3915	1.89
LM318	1.49	LM567	.75	MC4024	3.49
LM319	1.25	NE570	2.95	MC4044	1.69
LM323K	3.49	NE590	2.50	RC4136	1.25
LM324	.34	NE592	.89	RC4558	.69
LM331	3.95	LM723	.49	LM1360	1.49
LM334	1.19	LM733	.98	75107	1.49
LM335	1.79	LM741	.29	75108	1.49
LM336	1.75	LM747	.69	75110	1.95
LM338K	4.49	MC1330	1.69	75150	1.95
LM339	.59	MC1350	1.19	75154	1.95
LF347	2.19	LM1458	.35	75188	1.25
LF353	.59	LM1488	.49	75189	1.25
LF356	.99	LM1489	.49	75451	.39
LF357	.99	LM1496	.85	75452	.39
LM358	.59	ULN2003	.79	75477	1.29

HIGH SPEED CMOS LOGIC

74HC00	.21	74HC244	.85	74HCT139	.35
74HC04	.25	74HC245	.85	74HCT139	.55
74HC08	.25	74HC263	.69	74HCT157	.59
74HC14	.35	74HC377	.69	74HCT161	.79
74HC32	.35	74HC373	.69	74HCT240	.89
74HC74	.35	74HC390	.79	74HCT244	.89
74HC138	.45	74HC374	.69	74HCT245	.99
74HC139	.45	74HC400	.89	74HCT273	.99
74HC154	1.09	74HCT00	.25	74HCT373	.99
74HC157	.55	74HCT04	.27	74HCT374	.99
74HC161	.65	74HCT08	.25	74HCT393	.99
74HC164	.65	74HCT32	.27	74HCT4040	.99
74HC175	.59	74HCT74	.45	74HCT4060	1.49

STANDARD CMOS LOGIC

4001	.19	4028	.65	4069	.19
4011	.19	4040	.69	4070	.29
4013	.35	4042	.59	4081	.22
4015	.29	4044	.69	4093	.49
4016	.29	4046	.69	14411	9.95
4017	.49	4047	.69	14433	14.95
4018	.69	4049	.29	14497	6.95
4020	.59	4050	.29		

CRYSTALS

32,768 KHz	.95
1.0 MHz	2.95
1.8432	2.95
2.0	1.95
2.4576	1.95
3.579545	1.95
4.0	1.95
5.0	1.95
5.0688	1.95
6.0	1.95
6.144	1.95
8.0	1.95
10.0	1.95
10.738635	1.95
12.0	1.95
14.31818	1.95
16.0	1.95
18.0	1.95
18.432	1.95
20.0	1.95
22.1184	1.95

OSCILLATORS

1.0MHz	5.95
1.8432	5.95
2.0	5.95
2.4576	5.95
2.5	5.95
4.0	4.95
5.0	4.95
5.0688	4.95
6.0	4.95
6.144	4.95
8.0	4.95
10.0	4.95
12.0	4.95
14.31818	1.95
15.0	1.95
16.0	4.95
18.432	4.95
20.0	4.95
24.0	4.95

BIT RATE GENERATORS

MC14411	9.95
BR1941	4.95
4702	9.95
COM5016	6.95
COM8116	8.95
MM5307	4.95

DISCRETE

1N751	.49	2N4403	.25
IN5402	.25	2N6045	1.75
IN4004	10/1.00	MPS-A13	.40
IN4148	25/1.00	TIP31	.49
KBP02	.55	4N26	.69
PN2222	.10	4N27	.69
2N2222	.10	4N28	.69
2N2907	.25	4N33	.89
2N3055	.79	4N37	1.19
2N3904	.10	MCT-2	.59
2N3906	.10	MCT-6	1.29
2N4401	.25	TIL-111	.99

CAPACITORS

TANTALUM		ELECTROLYTIC	
1.0µf	15V .12	RADIAL	
6.8	15V .42	1µf	50V .34
10	15V .45	4.7	50V .11
22	15V .99	10	50V .11
1.0µf	35V .45	47	35V .13
2.2	35V .19	100	16V .18
4.7	35V .39	100	50V .23
10	35V .69	220	35V .20
		470	25V .30
		2200	16V .70
		4700	25V 1.45
DISC		AXIAL	
10pf	50V .05	1µf	50V .14
22	50V .05	10	16V .14
33	50V .05	10	50V .16
47	50V .05	22	16V .14
100	50V .05	47	50V .19
220	50V .05	100	35V .19
.001µf	50V .05	470	50V .29
.005	50V .05	1000	16V .29
.01	50V .07	470	50V .29
.05	50V .07	1000	16V .29
.1	12V .10	2200	16V .70
.1	50V .12	4700	16V 1.25

BYPASS CAPACITORS

.01xx	CERAMIC DISC	100/5.00	
.01xx	MONOLITHIC	100/10.00	
.1xx	CERAMIC DISC	100/6.50	
.1xx	MONOLITHIC	100/12.50	
CLOCK CIRCUITS			
MC146818	5.95	MM58174	9.95
MM58167	9.95	MSM5832	2.95

SOLDER STATION

UL APPROVED
 ■ ADJUSTABLE HEAT SETTING
 ■ TIP TEMPERATURE READOUT
 ■ REPLACEMENT TIPS AVAILABLE \$2.95
 168-2C

\$49.95

FULL 1 YEAR WARRANTY ON EVERY PRODUCT!

POWER SUPPLIES

APPLE TYPE SUPPLY
 ■ APPLE CONNECTOR
 ■ +5V @ 6A, +12V @ 3A, -5V @ 1A, -12V @ 1A
 PS-A \$49.95

FLOPPY DRIVE SUPPLY
 ■ +5V @ 2.5A, +12V @ 2A, -12V @ .1A
 ■ +5V @ 5A, IF +12 NOT USED
 PS-ASTEC \$24.95

36 WATT SUPPLY
 ■ +5V @ 2.5A, +12V @ 1.5A
 ■ 3 PIN INPUT, 6 PIN OUTPUT
 ■ SELECTABLE 110V-220V 5 X 3 X 1.6"
 PS-3045 \$12.95

MICRO SUPPLY
 ■ UL APPROVED, 144 WATTS
 ■ +5V @ 18A, +12V @ 4A, -12V @ 500MA
 PS-1554 \$29.95

WIREWAP PROTOTYPE CARDS

FR-4 EPOXY GLASS LAMINATE WITH GOLD PLATED EDGE-CARD FINGERS AND SILK SCREENED LEGENDS.

FOR PS/2

JDR-PR32	32 BIT PROTOTYPE CARD	69.95
JDR-PR16	16 BIT WITH I/O DECODING LAYOUT	49.95
JDR-PR16PK	PARTS KIT FOR JDR-PR16 ABOVE	15.95
JDR-PR16V	16 BIT FOR VIDEO APPLICATIONS	39.95

FOR AT

JDR-PR10	16BIT WITH I/O DECODING LAYOUT	34.95
JDR-PR10PK	PARTS KIT FOR JDR-PR10 ABOVE	12.95

FOR XT

JDR-PR1	WITH +5V AND GROUND PLANE	27.95
JDR-PR2	AS ABOVE WITH I/O DECODING LAYOUT	29.95

EXTENDER CARDS

FOR PROTOTYPE DEBUGGING, TESTING AND TROUBLESHOOTING.

EXT-8088	XT COMPATIBLE	29.95
EXT-80286	AT COMPATIBLE	39.95
EXT-16	MICROCHANNEL 16 BIT	69.95
EXT-32	MICROCHANNEL 32-BIT	99.95

NEW LOW PRICES! SOLDERLESS BREADBOARDS

WBU-204-3	1360 TIE PTS	12.95
WBU-204	1660 TIE PTS	19.95
WBU-206	2390 TIE PTS	24.95
WBU-208	3220 TIE PTS	34.95

"SNAPABLE" HEADERS

CAN BE SNAPPED APART TO MAKE ANY SIZE HEADER. ALL WITH .1" CENTERS

1x40	STRAIGHT LEAD	.99
1x40	RIGHT ANGLE LEAD	.49
2x40	2 STRAIGHT LEADS	2.49
2x40	2 RIGHT ANGLE LEADS	2.99

GENDER CHANGERS

GENDER-FF	FEMALE-FEMALE	7.95
GENDER-MM	MALE-MALE	7.95
GENDER-MF	MALE-FEMALE	7.95
GENDER-NM	NULL MODEM	6.95
GENDER-JB	JUMPER BOX	6.95
GENDER-MT	MINISTER	14.95

EPROM ERASERS

SPECTRONICS CORPORATION

Model	Timer	# of Chips	Intensity (uW/Cm ²)	Unit Cost
PE-140	NO	9	8,000	\$ 89
PE-140T	YES	9	8,000	\$136
PE-240T	YES	12	9,600	\$188

DATASE II \$39.95

■ SHORT POCKET SIZE! ■ ERASES MOST EPROMS/EPLD'S IN 3 MINUTES
 ■ ALL SIZES UP TO 4 AT A TIME

DATASE II

RS-232 BREAKOUT BOX

FOR TROUBLESHOOTING SERIAL COMMUNICATIONS

- OPEN/CLOSE INDIVIDUAL CIRCUITS
- 20 JUMPERS CROSS-CONNECT ANY TWO CIRCUITS
- 10 LEDS SHOW CIRCUIT ACTIVITY

GENDER-BO 34.95

I/O CONNECTORS/RIBBON CABLE

DESCRIPTION	ORDER BY	CONTACTS					
		10	20	26	34	40	50
SOLDER HEADER	IDHxxS	.82	1.29	1.68	2.20	2.58	3.24
RIGHT ANGLE SOLDER HEADER	IDHxxSR	.85	1.35	1.76	2.31	2.72	3.39
WIREWAP HEADER	IDHxxW	1.86	2.98	3.84	4.50	5.28	6.63
RIGHT ANGLE WIREWAP HEADER	IDHxxWR	2.05	3.28	4.22	4.45	4.80	7.30
RIBBON HEADER SOCKET	IDSxx	.63	.89	.95	1.29	1.49	1.69
RIBBON HEADER	IDMxx	--	5.50	6.25	7.00	7.50	8.50
RIBBON EDGE CARD	IDExx	.85	1.25	1.35	1.75	2.05	2.45
10' PLASTIC RIBBON CABLE	RCxx	1.60	3.20	4.10	5.40	6.40	7.50

FOR ORDERING INSTRUCTIONS, SEE D-SUBMINIATURE CONNECTORS BELOW

D-SUBMINIATURE CONNECTORS

DESCRIPTION	ORDER BY	CONTACTS						
		9	15	19	25	37	50	
SOLDER CUP	MALE	DBxxP	.45	.59	.69	.69	1.35	1.85
	FEMALE	DBxxS	.49	.69	.75	.75	1.39	2.29
RIGHT ANGLE PC SOLDER	MALE	DBxxPR	.49	.69	--	.79	2.27	--
	FEMALE	DBxxSR	.55	.75	--	.85	2.49	--
WIREWAP	MALE	DBxxPW	1.69	2.56	--	3.89	5.69	--
	FEMALE	DBxxSW	2.76	4.27	--	6.84	9.95	--
I/O RIBBON CABLE	MALE	IDBxxP	1.39	1.99	--	2.25	4.25	--
	FEMALE	IDBxxS	1.45	2.05	--	2.35	4.49	--
HOODS	METAL	MHOODxx	1.05	1.15	1.25	1.25	--	--
	PLASTIC	HOODxx	.39	.39	--	.39	.69	.75

ORDERING INSTRUCTIONS: INSERT THE NUMBER OF CONTACTS IN THE POSITION MARKED "x" OF THE "ORDER BY" PART NUMBER LISTED. EXAMPLE: A 15 PIN RIGHT ANGLE MALE PC SOLDER WOULD BE DB15PR

MOUNTING HARDWARE 59¢

I/O SOCKETS/DIP CONNECTORS

DESCRIPTION	ORDER BY	CONTACTS								
		8	14	16	18	20	22	24	28	40
SOLDERTAIL SOCKETS	xxST	.11	.11	.12	.15	.18	.15	.20	.22	.30
WIREWAP SOCKETS	xxVW	.59	.69	.69	.99	1.09	1.39	1.49	1.69	1.99
ZIF SOCKETS	ZIFxx	--	4.95	4.95	--	5.95	--	5.95	6.95	9.95
TOOLED SOCKETS	AUGATxxST	.62	.79	.89	1.09	1.29	1.39	1.49	1.69	2.49
TOOLED WW SOCKETS	AUGATxxVW	1.30	1.80	2.10	2.40	2.50	2.90	3.15	3.70	5.40
COMPONENT CARRIERS	ICCxx	.49	.59	.69	.99	.99	.99	.99	1.09	1.49
DIP PLUGS (IDC)	IDPxx	.95	.49	.59	1.29	1.49	--	.85	1.49	1.59

FOR ORDERING INSTRUCTIONS SEE D-SUBMINIATURE CONNECTORS ABOVE

SHORTING BLOCKS \$101.00

LITHIUM BATTERIES

- 6.8V FOR 286/386 COMPUTERS
- MOTHERBOARD CONNECTOR
- ADHESIVE VELCRO STRIP FOR EASY MOUNTING

LITHIUM 6.8V \$11.95

LITHIUM-3V 3V COIN TYPE LITHIUM BATTERY \$1.95
 3V-MHW BATTERY HOLDER \$1.49



JDR MICRODEVICES, 110 KNOWLES DRIVE, LOS GATOS, CA 95030
 LOCAL (408) 866-6200 FAX (408) 378-8927 TELEX 171-110

RETAIL STORE: 1256 SOUTH BASCOM AVE., SAN JOSE, CA
 HOURS: MON.-FRI. 9-7, SAT. 9-5, SUN. 12-4 (408) 947-8881

ORDER TOLL FREE 800-538-5000

COPYRIGHT 1989 JDR MICRODEVICES

CONTINENTAL U.S.

TERMS: MINIMUM ORDER \$10.00 FOR SHIPPING AND HANDLING INCLUDE \$2.50 FOR UPS GROUND AND \$3.50 UPS AIR. ORDERS OVER 1 LB. AND FOREIGN ORDERS MAY REQUIRE ADDITIONAL SHIPPING CHARGES—PLEASE CONTACT THE SALES DEPARTMENT FOR THE AMOUNT. CA RESIDENTS MUST INCLUDE APPLICABLE SALES TAX. PRICES ARE SUBJECT TO CHANGE WITHOUT NOTICE. WE ARE NOT RESPONSIBLE FOR TYPOGRAPHICAL ERRORS. WE RESERVE THE RIGHT TO LIMIT QUANTITIES AND TO SUBSTITUTE MANUFACTURER. ALL MERCHANDISE SUBJECT TO PRIOR SALE. A FULL COPY OF OUR TERMS IS AVAILABLE UPON REQUEST. ITEMS PICTURED MAY ONLY BE REPRESENTATIVE.

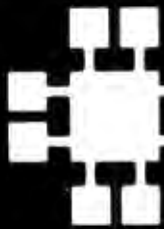

JDR Microdevices®

30 DAY MONEY BACK GUARANTEE • 1 YEAR WARRANTY ON ALL PRODUCTS • TOLL-FREE TECHNICAL SUPPORT
COMPLETE CUSTOMER SATISFACTION • SUPERIOR SERVICE • FRIENDLY, KNOWLEDGEABLE SALES STAFF

MMC
MICROCOMPUTER
MARKETING COUNCIL
of the Direct Marketing Association, Inc.

PROMETHEUS 2400 BAUD MODEM

\$129.95

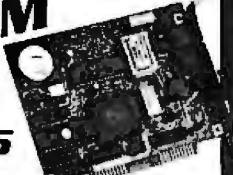

INTERNAL 2400 BAUD

- AUTO DIAL ANSWER
 - SELF TEST ON POWER-UP
 - FULL OR HALF DUPLEX
 - TOUCHTONE OR PULSE DIALING
 - HAYES & BELL SYSTEMS COMPATIBLE
 - MIRROR II COMMUNICATIONS SOFTWARE INCLUDED
- PRO-24I 1200 BAUD 1/2 CARD **\$129.95**
PRO-12I 1200 BAUD 1/2 CARD **\$69.95**
PRO-24M 2400 BAUD FOR PS/2 **\$249.95**

EXTERNAL 2400 BAUD

- 2400/1200/300 HAYES COMPATIBLE
 - 8 EASY-TO-READ STATUS LED'S
 - CALL PROGRESS MONITORING & ADJUSTABLE VOLUME
 - 2ND PHONE JACK FOR VOICE COMMUNICATIONS
 - REQUIRES SERIAL PORT & CABLE (OPTIONAL)
- PRO-24E **\$169.95**
PRO-12E 1200 BAUD EXTERNAL **\$99.95**

APPLE/MACINTOSH MODEMS

- MACINTOSH 2400 BAUD EXTERNAL AS ABOVE WITH C.BLE AND PROCOM-M SOFTWARE.
- PRO-24EM **\$199.95**
PRO-24A APPLE II 2400 BAUD MODEM **\$179.95**
PRO-12A APPLE II 1200 BAUD MODEM **\$139.95**

POCKET MODEM

\$99.95



- YOU'LL NEVER BE FAR FROM YOUR DATA WITH THIS 6 OUNCE HAND-HELD POCKET MODEM
- 1200/300 BAUD ■ BATTERY & AC POWER
 - SERIAL INTERFACE (DB25) ■ 4 STATUS INDICATORS
- GVC-12P **\$69.95**
GVC-24P 2400 BAUD VERSION **\$249.95**



KEYBOARDS

- WITH TACTILE FEEDBACK
- MAX-5339 ENHANCED STYLE LAYOUT **\$84.95**
MAX-5060 84 KEY LAYOUT **\$64.95**
- BTC ENHANCED STYLE LAYOUT**
- AUTOSENSE FOR XT OR AT COMPATIBLES
 - LED INDICATORS ■ AUTO REPEAT FEATURE
 - SEPARATE CURSOR PAD
- BTC-5339 **\$79.95**
- BTC B4 KEY LAYOUT**
- SOFTWARE AUTOSENSE FOR XT OR AT COMPATIBLES
 - LED INDICATORS ■ AUTO REPEAT
- BTC-5060 **\$59.95**
- BTC AUDIBLE "CLICK" KEYBOARD**
- ENHANCED STYLE, 101 KEY KEYBOARD
 - LED INDICATORS ■ AUTO REPEAT
- K-103-A **\$84.95**

OFI HANDY SCANNER 400 DPI

\$249.95

NOT ALL HANDY SCANNERS ARE THE SAME!

- INSTANTLY SCANS UP TO 4" WIDE IMAGES
- 100, 200, 300, 400 DPI BOTH DIRECTIONS
- B&W AND 3 HALF TONE MODES
- 32 LEVELS OF GRAY SCALE
- HERCULES CGA AND EGA COMPATIBLE
- INCLUDES HALO DPE AND IMAGE EDITOR SOFTWARE HS-3000



LOGITECH HIREZ MOUSE

\$99.95



HIGH RESOLUTION BUS MOUSE FOR BETTER RESPONSE AND LESS HAND MOVEMENT. IDEAL FOR CAD WORK

- 320 DPI ■ INCLUDES DRIVER, TEXT EDITOR & POP UP MENUS ■ NO PAD, POWER SUPPLY OR PORT REQUIRED

LOGITECH 3-BUTTON MOUSE

- PC MAGAZINE EDITORS CHOICE! ALL MODELS HAVE SERIAL SUPPORT (COM1/COM2), 200 D.P.I. RESOLUTION, LOTUS 1-2-3 SHELL, SELF-INSTALLING SOFTWARE AND "POINT EDITOR"
- LMOUSE **\$79.95**
LMOUSE-P SERIAL MOUSE W/LOGIPAIN **\$99.95**
LMOUSE-BP BUS MOUSE W/LOGIPAIN **\$99.95**
LMOUSE-BPBL BUS MOUSE W/PUBLISHER PKG **139.95**
LMOUSE-BPC BUS MOUSE W/LOGIPAIN/CAD **149.95**

24-HR. ON-LINE ORDERING! (408) 374-2171

JDR'S ELECTRONIC BULLETIN BOARD OFFERS TECHNICAL SUPPORT, CONFERENCING AND MORE

DATA SWITCH BOXES

TYPE	# OF POS.	PARALLEL	SERIAL	PRICE
PUSHBUTTON	2-WAY	AB-P	AB-S	39.95
ROTARY	2-WAY	RSP-2P	RSS-2S	24.95
ROTARY	3-WAY	RSP-3P	RSS-3S	27.95
ROTARY	4-WAY	RSP-4P	RSS-4S	29.95



MOLDED COMPUTER CABLES

- HIGH QUALITY GOLD-PLATED CONTACTS; CABLE AND CONNECTORS ARE 100% SHIELDED. MOLDED ASSEMBLY.
- CBL-PRINTER PC PRINTER CABLE **\$9.95**
CBL-PRINTER-25 AS ABOVE - 25 FOOT **\$15.95**
CBL-PRINTER-RA RIGHT ANGLE PRINTER **\$15.95**
CBL-DB25-MM DB25 MALE TO DB25 MALE **\$9.95**
CBL-DB25-MF DB25 MALE TO DB25 FEMALE **\$9.95**
CBL-9-SERIAL 9 PIN TO 25 PIN SERIAL **\$6.95**
CBL-KBD-EXT KEYBOARD EXTENSION **\$7.95**
CBL-GNT-MM 36 PIN CENTRONICS-M/M **\$14.95**
CBL-HD-20 20 PIN HARD DISK CABLE **\$3.95**
CBL-HD-34 34 PIN HARD DISK CABLE **\$4.95**
CBL-HD-34D 34 PIN DUAL HARD DISK **\$6.95**
CBL-FDC-EXT 37 PIN EXTERNAL FLOPPY **\$9.95**
CBL-MNT-9 9 PIN MONITOR EXTENSION **\$6.95**
CBL-MODEM DB25 TO DB25 FEMALE **\$7.95**

VGA COMPATIBLE PACKAGE

\$649.00

- 800 X 560 MAXIMUM RESOLUTION
 - 640 X 480 IN 16 COLORS
 - 320 X 200 IN 256 COLORS
 - IBM STYLE ANALOG MONITOR
 - FULLY VGA, EGA, CGA, HERCULES & MONOCHROME COMPATIBLE
- VGA-PKG

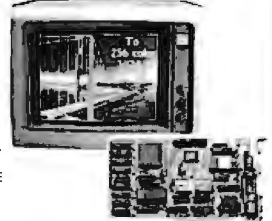

NEC MULTISYNC II

\$599.95

- AUTO FREQ ADJUSTMENT ■ RESOLUTION AS HIGH AS 800 X 560 ■ TEXT MODE & TEXT COLOR ■ INCL. ADAPTOR
- NEC-MULTI

JDR MULTI

\$499.95

- FULL FEATURED MULTISCAN MONITOR WITH UNLIMITED COLORS ■ HIGH RESOLUTION, 14" NON-GLARE DISPLAY
 - AUTO SWITCHING ■ TTL/ANALOG VIDEO INPUT
- JDR-MULTI

RELISYS EGA

\$399.95

- 800X560 MAXIMUM RESOLUTION ■ 31 MM DOT PITCH
 - 14" BLACK MATRIX SCREEN ■ 16 COLORS SWIVEL BASE
- EGA-MONITOR

EGA SPECIAL - SAVE \$60!

BUY THE RELISYS EGA AND THE MCT EGA CARD TOGETHER AND SAVE \$60.00 JUST \$489.00

RGB MONITOR

\$279.95

- COLOR/GREEN/AMBER SWITCH ■ 41MM DOT PITCH
 - 640 X 240 RESOLUTION ■ 14" NON-GLARE SCREEN
 - TILT AND SWIVEL BASE
- RGB-MONITOR

FLAT SCREEN

\$139.95

- LOW DISTORTION 14" GLARE-RESISTANT AMBER SCREEN
- 720 X 350 MAXIMUM RESOLUTION ■ IBM COMPATIBLE
- TTL INPUT ■ SWIVEL BASE

GM-1488

MONO-SAMSUNG WITH 12" SCREEN

\$129.95

TILT & SWIVEL MONITOR STANDS

- MS-100 **\$12.95**
MS-200 5 OUTLETS AND SURGE SUPPRESSOR **\$39.95**

UPRIGHT CASE

\$299.95

SLEEK UPRIGHT DESIGN SAVES SPACE, ADDS STYLE!

- ACCOMMODATES ALL SIZES OF MOTHERBOARDS
- 250 W POWER SUPPLY INCLUDED
- MOUNTS FOR 3 FLOPPY & 4 HARD DRIVES
- TURBO & RESET SWITCH
- SPEED DISPLAY, POWER & DISK LED'S
- INCL. MOUNTING HARDWARE, FACEPLATES & SPEAKER

CASE-100

- CASE-FLIP FOR 8088 MOTHERBOARDS **\$34.95**
CASE-SLIDE FOR 8088 MOTHERBOARDS **\$39.95**
CASE-70 FOR 286 MOTHERBOARDS **\$89.95**
CASE-JR MINI-286 W/POWER SUPPLY **\$149.95**

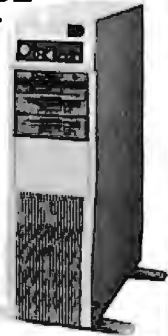

POWER SUPPLIES

- ALL OUR POWER SUPPLIES ARE UL APPROVED, 110/220V.
- PS-135 IBM XT COMPATIBLE, 135 WATTS **\$59.95**
PS-150 IBM XT COMPATIBLE, 150 WATTS **\$69.95**
PS-200 IBM AT COMPATIBLE, 200 WATTS **\$89.95**
PS-250 IBM AT COMPATIBLE, 250 WATTS **\$129.95**

1.44 MB 3 1/2" DRIVE

\$99.95



- ULTRA HIGH DENSITY
- ALSO WORKS WITH 720K DISKS
- FDD-1.44X BLACK FACEPLATE
- FDD-1.44A BEIGE FACEPLATE
- FDD-SOFT SOFTWARE DRIVER \$19.95

1/2 HEIGHT FLOPPY DISK DRIVES

- FD-55B 5-1/4" TEAC DS/DD 360K \$99.95
- FD-55G 5-1/4" TEAC DS/HD 1.2M \$129.95
- M2551A 5-1/4" FUJITSU DS/DD 360K \$89.95
- M2553K 5-1/4" FUJITSU DS/HD 1.2M \$119.95
- FDD-360 5-1/4" DS/DD 360K \$69.95
- FDD-1.2 5-1/4" DS/HD 1.2M \$109.95
- MF355X 3-1/2" MITSUBISHI 1.44MB (BLACK) \$129.95
- MF355A 3-1/2" MITSUBISHI 1.44MB (BEIGE) \$129.95
- FDD-3.5X 3-1/2" DS/DD 720K (BLACK) \$97.95
- FDD-3.5A 3-1/2" DS/DD 720K (BEIGE) \$97.95

TAPE BACK-UP DRIVES

- AR5240X ARCHIVE TAPE DRIVE -XT'S & AT'S \$369.95
- AR5540A FASTER TAPE DRIVE -AT'S ONLY \$369.95
- AR340 40 MB TAPE CARTRIDGES \$24.95

DISKETTES

- N-MD2D BOX OF 10 5-1/4" 360K DS/DD \$6.95
- N-MD2H BOX OF 10 5-1/4" 1.2 MB DS/HD \$13.95
- N-3.5DS BOX OF 10 3-1/2" 720K DS/DD \$16.95
- N-3.5HD BOX OF 10 3-1/2" 1.44 MB DS/HD \$49.95
- N-MD2D BULK 360K DS/DD (MIN. 50 DISKS) EA. 49c

DRIVE ACCESSORIES

- FD-ARAIL MTG. RAILS FOR AT COMPATIBLE \$2.95
- FD-55MHV HALF-HEIGHT MOUNTING HARDWARE \$2.95
- FD-5Y Y-POWER ADAPTOR FOR DRIVES \$2.95
- FD55P BEIGE FACEPLATE FOR TEAC DRIVES \$2.95



Kits include a Seagate hard disk drive, drive controller, cables and instructions.
HDKIT20 20 Mb System Kit
HDKIT30 30 Mb System Kit

20 Mb kit \$269
30 Mb kit \$299



SIZE	MODEL	AVG. SPEED	HT.	DRIVE ALONE	WITH MCT CONTROLLER			
					HDC	RLI	AFH	AFH-RLI
20MB	ST-225	65 ms	Half	\$225	\$269	-	\$339	-
30MB RLL	ST-238	65 ms	Half	\$249	-	\$299	-	\$389
40MB	ST-251	40 ms	Half	\$379	\$419	-	\$489	-
40MB	ST-251-1	28 ms	Half	\$469	\$449	-	\$519	-
60MB RLL	ST-277	40 ms	Half	\$449	-	\$499	-	\$589
30MB	ST-4038	40 ms	Full	\$559	\$603	-	\$659	-
80MB	ST-4096	28 ms	Full	\$629	-	-	\$729	-

INBOARD 386/PC

***\$895.00**



UPGRADE YOUR XT TO A 386 FOR LESS THAN \$900

- 16 MHZ PROCESSOR REPLACES 8088
- 1 MB MEMORY INSTALLED
- EXPAND TO 3 MB WITH PIGGYBACK CARD
- 5 YEAR WARRANTY

PCIB 1200

- PIGGYBACK MEMORY BOARDS
- PCIB1210 1 MB INSTALLED \$649.00
- PCIB1220 2 MB INSTALLED \$1195.00



"Your products and prices have kept us coming back now for two years...keep up the good work."
 --P.S., Sterling Heights, MI

"We'll continue to do business with you whenever we can."
 --James Hillegass, Minneapolis, MN

"...I will not hesitate to order anything from JDR ---because I know your policy is to stand behind your products 100%."
 --Robert Rindy, Grand Forks, NB

"A note thanking your technical support staff in helping me with my computer problem...(They are) very thorough and knowledgeable. Thanks!
 --J.F., Troy, MI

INTERFACE CARDS

BY MODULAR CIRCUIT TECHNOLOGY

DRIVE CONTROLLERS

FLOPPY DISK CONTROLLER \$29.95

SINGLE SLOT CONTROL OF 4 FLOPPIES
 ■ INTERFACES UP TO 4 FDD'S TO AN IBM PC OR COMPATIBLE ■ SUPPORTS DS/DD AND DS/OD W/ DOS 3.2
 MCT-FDC

1.2 MB FLOPPY CONTROLLER \$69.95

ADD VERSATILITY AND CAPACITY TO YOUR XT
 ■ SUPPORTS 2 DRIVES, CAN MIX 360K AND 1.2 MB
 ■ ALLOWS DATA TO FLOW FREELY FROM XT'S TO AT'S
 MCT-FDC-1.2

FLOPPY/HARD CONTROLLER \$139.95

XT SYSTEM SHORT OF SLOTS? THIS CARD FREES ONE UP!
 ■ INTERFACES UP TO 2 FDD'S & 2 HDD'S. CABLING FOR 2 FDD/HDD ■ SUPPORTS BOTH DS/DD & DS/OD W/ DOS 3.2
 MCT-FH

286/386 FLOPPY/HARD \$149.95

FLOPPY/HARD DISK CONTROL IN A TRUE AT DESIGN
 ■ SUPPORTS UP TO 2 360K/720K/1.2 MB FDD'S
 ■ SUPPORTS 2 HDD'S USING STANDARD TABLES
 MCT-AFH

HARD DISK CONTROLLER \$79.95

HARD DISK CONTROL AT AN ECONOMICAL PRICE
 ■ SUPPORTS 16 DRIVE SIZES INCLUDING 10,20,30 & 40 MB
 ■ DIVIDE 1 LARGE DRIVE INTO 2 LOGICAL DRIVES
 MCT-HDC

RLI CONTROLLER \$119.95

TRANSFER DATA 50% FASTER
 ■ SUPPORTS UP TO 2 RLL HARD DRIVES
 ■ DESIGNED FOR XT COMPATIBLES
 MCT-RLI

286/386 FLOPPY/HARD RLL \$199.95

IMPROVE SPEED AND STORAGE OF YOUR AT COMPATIBLE
 ■ SUPPORTS UP TO 2 RLL HARD DISCS AND 2 FLOPPIES
 ■ SUPPORTS 360/720/1.2 MB FLOPPIES IN 5.25" & 3.5"
 MCT-AFH-RLL

MULTIFUNCTION CARDS

MULTI I/O FLOPPY CONTROLLER \$79.95

A PERFECT COMPANION FOR OUR MOTHERBOARDS
 ■ SUPPORTS UP TO TWO 360K FLOPPIES, 720K W/ DOS 3.2
 ■ SERIAL, PARALLEL, GAME PORT, CLOCK/CALENDAR
 MCT-MIO
 MIO-SERIAL—2ND SERIAL PORT \$15.95

MULTI I/O CARD \$59.95

USE WITH MCT-FH FOR MINIMUM OF SLOTS USED
 ■ SERIAL PORT, CLOCK/CALENDAR WITH BATTERY
 ■ PARALLEL PORT ADDRESSABLE AS LPT1 OR LPT2
 MCT-IO

286/386 MULTIFUNCTION \$139.95

ADDS UP TO 3 MB OF RAM TO YOUR AT
 ■ USER EXPANDABLE TO 1.5 MB OR 3 MB WITH OPTIONAL PIGGYBACK BOARD (OK INSTALLED) ■ INCLUDES SERIAL AND PARALLEL PORT
 MCT-AMF
 MCT-AMF-MC PIGGYBACK BOARD \$29.95
 AIO -SERIAL 2ND SERIAL PORT \$24.95

286/386 MULTI I/O CARD \$59.95

USE WITH MCT-AFH MINIMUM OF SLOTS USED
 ■ SERIAL, PARALLEL AND GAME PORTS ■ USES 16450 SERIAL SUPPORT CHIPS FOR HIGH SPEED OPS
 MCT-AIO
 AIO-SERIAL 2ND SERIAL PORT \$24.95

MEMORY CARDS

576K RAM CARD \$59.95

A CONTIGUOUS MEMORY SOLUTION IN A SHORT SLOT
 ■ USER SELECTABLE CONFIGURATION UP TO 576K
 ■ USES 64K & 256K RAM CHIPS (OK INSTALLED)
 MCT-RAM

EXPANDED MEMORY CARD \$129.95

2MB OF LOTUS INTEL MICROSOFT MEMORY FOR AN XT
 ■ CONFORMS TO LOTUS INTEL EMS ■ USER EXPAND-ABLE TO 2 MB ■ CAN BE USED AS EXPANDED OR CONVENTIONAL MEMORY, RAMDISK AND SPOOLER
 MCT-EMS
 MCT-AEMS 286/386 VERSION \$139.95

DISPLAY ADAPTORS

MONOCHROME GRAPHICS \$59.95

TRUE HERCULES COMPATIBILITY SUPPORTS LOTUS 1-2-3
 ■ PARALLEL PRINTER PORT CONFIGURES AS LPT1 OR LPT2 ■ USES VLSI CHIPS TO ENSURE RELIABILITY
 MCT-MGP

E6A ADAPTOR \$149.95

100% IBM COMPATIBLE PASSES IBM EGA DIAGNOSTICS
 ■ 256K OF VIDEO RAM ALLOWS 640 X 350 IN 16 OF 64 COLORS ■ COMPATIBLE WITH COLOR AND MONOCHROME ADAPTORS ■ HERCULES COMPATIBLE
 MCT-EGA

COLOR GRAPHICS ADAPTOR \$49.95

COMPATIBLE WITH IBM GRAPHICS STANDARDS
 ■ SUPPORTS RGB, COLOR, & COMPOSITE MONOCHROME
 ■ 640/320 X 200 RESOLUTION, LIGHT PEN INTERFACE
 MCT-CG

MONOGRAPHICS MULTI I/O \$119.95

TOTAL SYSTEM CONTROL FROM A SINGLE SLOT!
 ■ CTRL 2 FLOPPIES, SERIAL, PARALLEL, GAME PORT, CLOCK CAL ■ RUN COLOR GRAPHICS SOFTWARE ON A MONOCHROME MONITOR
 MCT-MGMI0

286/386 MONOGRAPHICS I/O \$99.95

USE THIS "DO EVERYTHING" CARD TO HOOK UP YOUR MONOCHROME MONITOR, PARALLEL PRINTER, MODEM AND JOYSTICK AT THE SAME TIME. THE ONLY OTHER CARD YOUR SYSTEM NEEDS IS A FLOPPY/HARD CONTROLLER.
 ■ AT COMPATIBLE
 ■ 720 X 348 RESOLUTION, 80 & 132 COLUMN TEXT
 ■ PARALLEL, SERIAL & GAME PORTS
 ■ HERCULES COMPATIBLE MONOGRAPHICS
 ■ INCLUDES SOFTWARE FOR RUNNING COLOR GRAPHICS PROGRAMS ON A MONOCHROME MONITOR.
 MCT-MGAIO



JDR MICRODEVICES, 110 KNOWLES DRIVE, LOS GATOS, CA 95030
 LOCAL (408) 866-6200 FAX (408) 378-8927 TELEX 171-110

RETAIL STORE: 1256 SOUTH BASCOM AVE., SAN JOSE, CA
 HOURS: MON.-FRI. 9-7, SAT. 9-5, SUN. 12-4 (408) 947-8881

ORDER TOLL FREE 800-538-5000

COPYRIGHT 1988 JDR MICRODEVICES

CONTINENTAL U.S.

TERMS: MINIMUM ORDER \$10.00 FOR SHIPPING AND HANDLING INCLUDE \$2.50 FOR UPS GROUND AND \$3.50 UPS AIR. ORDERS OVER 1 LB. AND FOREIGN ORDERS MAY REQUIRE ADDITIONAL SHIPPING CHARGES—PLEASE CONTACT THE SALES DEPARTMENT FOR THE AMOUNT. CA RESIDENTS MUST INCLUDE APPLICABLE SALES TAX. PRICES ARE SUBJECT TO CHANGE WITHOUT NOTICE. WE ARE NOT RESPONSIBLE FOR TYPOGRAPHICAL ERRORS. WE RESERVE THE RIGHT TO LIMIT QUANTITIES AND TO SUBSTITUTE MANUFACTURER. ALL MERCHANDISE SUBJECT TO PRIOR SALE. A FULL COPY OF OUR TERMS IS AVAILABLE UPON REQUEST. ITEMS PICTURED MAY ONLY BE REPRESENTATIVE.

BUILD YOUR OWN SYSTEM



OVER 20,000 JDR SYSTEMS HAVE ALREADY BEEN BUILT. EASY TO ASSEMBLE IN JUST 2 HOURS WITH A SCREWDRIVER.

12 MHz MINI-286 \$1232.75

- 12 MHz MINI-286 MOTHERBOARD ■ 512K RAM MEMORY
- MINI-AT CASE WITH POWER SUPPLY
- 84 KEY KEYBOARD ■ MONOCHROME MONITOR
- 1.2 MB FLOPPY DRIVE ■ FLOPPY / HARD CONTROL
- GRAPHICS ADAPTOR

10 MHz TURBO 8088 \$661.00

- INCLUDES SERIAL PORT, 2 PARALLEL PORTS, CLOCK/CALENDAR AND GAME ADAPTOR ■ RUNS COLOR GRAPHICS ON A MONOCHROME MONITOR
- MOTHERBOARD ■ 256K RAM MEMORY ■ 135 WATT POWER SUPPLY ■ FLIP-TOP CASE ■ 84 KEY KEYBOARD
- 360K FLOPPY DRIVE ■ MONOGRAPHICS I/O CARD ■ MONOCHROME MONITOR

MOTHERBOARDS

TURBO 4.77/8 MHz \$99.95

- XT COMPATIBLE ■ NORTON SI 1.7 ■ 4.77 OR 8 MHz OPERATION WITH 8088-2 AND OPTION-AL 8087-2 CO-PROCESSOR ■ FRONT PANEL LED SPEED INDICATOR AND RESET SWITCH SET SUPPORTED ■ CHOOSE NORMAL/TURBO MODE OR SOFTWARE SELECT PROCESSOR SPEED

MCT-TURBO

MCT-XMB STANDARD MOTHERBOARD \$87.95

10 MHz SINGLE CHIP \$129.95

- XT COMPATIBLE ■ NORTON SI 2.1 ■ USES LESS POWER, IMPROVES RELIABILITY ■ KEY SELECTABLE SPEED, 4.77 MHz OR 10 MHz ■ 2.3 TIMES FASTER THAN A STANDARD ■ RESET SWITCH, KEYLOCK, & SPEED / POWER INDICATORS SUPPORTED

MCT-TURBO-10

80286 6/10 MHz \$379.95

- AT COMPATIBLE ■ LANDMARK AT SPEED 10 MHz
- NORTON SI 10.3 ■ 8 SLOTS (TWO 8-BIT, SIX 16-BIT) ■ HARDWARE SELECTION OF 6 OR 10 MHz
- FRONT PANEL LED INDICATOR ■ SOCKETS FOR 1MB OF RAM AND 80287 ■ ONE WAIT STATE
- BATTERY BACKED CLOCK ■ KEYLOCK SUPPORTED ■ RESET SWITCH

MCT-286

12 MHz MINI-286 \$399.95

- AT COMPATIBLE ■ LANDMARK AT SPEED 13.2 MHz
- NORTON SI 11.6 ■ 6 MHz, 10 MHz (0/1 WAIT STATE), 12 MHz (1 WAIT STATE) ■ ZYMO ASICS FOR FEWER CHIPS, GREATER RELIABILITY ■ SUPPORTS 512K-1024K MEMORY ■ RECHARGEABLE HIGH CAPACITY NI-CAD BATTERY ■ SIX 16-BIT SLOTS, TWO 8-BIT SLOTS
- MOUNTS IN STANDARD XT CASE

MCT-M286-12

MCT-M286 6/10 MHz MINI 80286 BOARD \$389.95

NEW! MODULAR PROGRAMMING SYSTEM

MODULAR CIRCUIT TECHNOLOGY

THE IDEAL SYSTEM FOR DEVELOPERS; AN INTEGRATED MODULAR SYSTEM THAT EXPANDS AS YOUR NEEDS GROW. ALL THE MODULES USE A COMMON HOST ADAPTOR CARD SO YOU NEED JUST ONE SLOT TO PROGRAM EPROMS, PROMS, PALS AND MORE.

HOST ADAPTOR CARD \$29.95

- A UNIVERSAL INTERFACE FOR ALL THE PROGRAMMING MODULES
- USER SELECTABLE PROGRAMMABLE ADDRESSES PREVENT ADDRESSING CONFLICTS
- INCLUDES MENU-DRIVEN SOFTWARE PACKAGE
- INCLUDES MOLDED CABLE

MCT-MAC

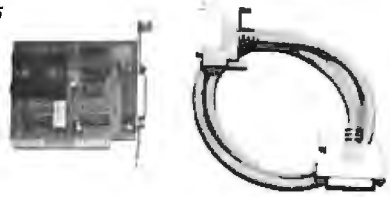

UNIVERSAL MODULE \$499.99

- PROGRAMS EPROMS, EEPROMS, PALS, BI-POLAR PROMS, 8748 & 8751 SERIES DEVICES
- PROGRAMS 16V8 & 20V8 GALs (GALLIUM ARSENIDE) FROM LATTICE, NS, SGS
- TESTS TTL, CMOS, DYNAMIC & STATIC RAMS
- LOAD DISK, SAVE DISK, EDIT, BLANK CHECK, PROGRAM, AUTO, READ MASTER, VERIFY & COMPARE
- TEXT TOOL SOCKET ACCEPTS .3 TO .6" WIDE IC'S FROM 8-40 PINS

MCT-MUP

EPROM MODULE \$119.95

- PROGRAMS 24-32 PIN EPROMS, CMOS EPROMS AND EEPROMS FROM 16K TO 1024K
- HEX TO OBJ CONVERTER
- AUTO, BLANK CHECK/PROGRAM/VERIFY
- VPP 5, 12.5, 12.75, 13, 21 & 25 VOLTS
- NORMAL, INTELLIGENT, INTERACTIVE, & QUICK PULSE PROGRAMMING ALGORITHMS

MCT-MEP

MCT-MEP-4 FOUR-EPROM PROGRAMMER \$169.95

MCT-MEP-8 EIGHT-EPROM PROGRAMMER \$259.95

MCT-MEP-16 SIXTEEN-EPROM PROGRAMMER \$499.95



DIGITAL IC MODULE \$129.95

- TESTS TTL, CMOS, DYNAMIC & STATIC RAM
- AUTO SEARCH FOR UNKNOWN PART NUMBERS
- USER-PROGRAMMABLE TEST PROCEDURES

MCT-MIC

PAL MODULE \$249.95

- PROGRAMS MMI, NS, TI 20 & TI 24 PIN DEVICES
- BLANK CHECK, PROGRAM, AUTO, READ MASTER, VERIFY & SECURITY FUSE BLOW

MCT-MPL

PAL PROGRAMMING DEVELOPMENT SOFTWARE

MCT-MPL-SOFT \$99.95

8748 MODULE \$179.95

- PROG, 8741, 8742, 8748, 8749 & 8750 EPROMS & PROMS
- LOAD DISK, SAVE DISK, EDIT, BLANK CHECK, PROGRAM, AUTO, READ MASTER, VERIFY & COMPARE
- NORMAL & INTELLIGENT PROGRAMMING ALGORITHMS

MCT-MMP

BI-POLAR MODULE \$259.95

- PROG. AMD, MMI, NS, TI & SIGNETICS BI-POLAR PROMS
- LOAD DISK, SAVE DISK, EDIT, BLANK CHECK, PROGRAM, AUTO, READ MASTER, VERIFY

MCT-MBP

EPROM PROGRAMMER

\$129.95

- PROGRAMS 27XX AND 27XXX EPROMS UP TO 27512
- SUPPORTS VARIOUS PROGRAMMING FORMATS & VOLTAGES
- SPLIT OR COMBINE CONTENTS OF SEVERAL EPROMS OF DIFFERENT SIZES
- READ, WRITE, COPY, ERASE CHECK & VERIFY
- SOFTWARE FOR HEX AND INTEL HEX FORMATS

MCT-EPROM



BARGAIN HUNTER'S CORNER

CITIZEN PRINTER \$169.95



- 9 PIN DOT MATRIX PRINT HEAD
- 180 CPS DRAFT MODE, 29 CPS NLO MODE
- CENTRONICS PARALLEL INTERFACE, SERIAL OPTIONAL
- DUAL PITCH, DOUBLESTRIKE, ITALICS & SUPERSCRIP
- DOT ADDRESSABLE GRAPHICS IN SIX DENSITIES
- COMPRESSED, EXPANDED AND EMPHASIZES PRINT RC-180D

SPECIAL ENDS 3/31/89



JDR MICRODEVICES, 110 KNOWLES DRIVE, LOS GATOS, CA 95030
LOCAL (408) 866-6200 FAX (408) 378-8927 TELEX 171-110

RETAIL STORE: 1256 SOUTH BASCOM AVE., SAN JOSE, CA
HOURS: MON.-FRI. 9-7, SAT. 9-5, SUN. 12-4 (408) 947-8881

ORDER TOLL FREE 800-538-5000

COPYRIGHT 1989 JDR MICRODEVICES

CONTINENTAL U.S.

TERMS: MINIMUM ORDER \$10.00 FOR SHIPPING AND HANDLING INCLUDE \$2.50 FOR UPS GROUND AND \$3.50 UPS AIR. ORDERS OVER 1 LB. AND FOREIGN ORDERS MAY REQUIRE ADDITIONAL SHIPPING CHARGES—PLEASE CONTACT THE SALES DEPARTMENT FOR THE AMOUNT. CA RESIDENTS MUST INCLUDE APPLICABLE SALES TAX. PRICES ARE SUBJECT TO CHANGE WITHOUT NOTICE. WE ARE NOT RESPONSIBLE FOR TYPOGRAPHICAL ERRORS. WE RESERVE THE RIGHT TO LIMIT QUANTITIES AND TO SUBSTITUTE MANUFACTURER. ALL MERCHANDISE SUBJECT TO PRIOR SALE. A FULL COPY OF OUR TERMS IS AVAILABLE UPON REQUEST. ITEMS PICTURED MAY ONLY BE REPRESENTATIVE

Buy with

Confidence

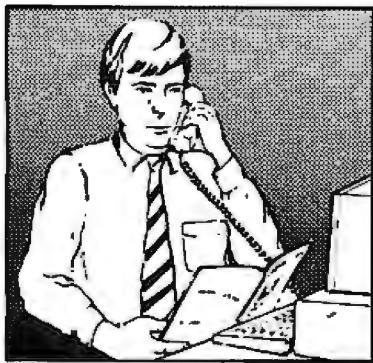

In an effort to make your telephone purchasing a more successful and pleasurable activity, The Microcomputer Marketing Council of the Direct Marketing Association, Inc. offers this advice, "A knowledgeable buyer will be a successful buyer." These are specific facts you should know about the prospective seller before placing an order:

Ask These Important Questions

- How long has the company been in business?
- Does the company offer technical assistance?
- Is there a service facility?
- Are manufacturer's warranties handled through the company?
- Does the seller have formal return and refund policies?
- Is there an additional charge for use of credit cards?
- Are credit card charges held until time of shipment?
- What are shipping costs for items ordered?

Reputable computer dealers will answer all these questions to your satisfaction. Don't settle for less when buying your computer hardware, software, peripherals and supplies.

Purchasing Guidelines

- State as completely and accurately as you can what merchandise you want including brand name, model number, catalog number.
- Establish that the item is in stock and confirm shipping date.
- Confirm that the price is as advertised.
- Obtain an order number and identification of the sales representative.
- Make a record of your order, noting exact price including shipping, date of order, promised shipping date and order number.

If you ever have a problem, remember to deal first with the seller. If you cannot resolve the problem, write to MAIL ORDER ACTION LINE, c/o DMA, 6 E. 43rd St., New York, NY 10017.

This message is brought to you by:

the MICROCOMPUTER
MARKETING COUNCIL
of the Direct Marketing
Association, Inc.
6 E. 43rd St.,
New York, NY 10017

MMCG
MICROCOMPUTER
MARKETING COUNCIL
of the Direct Marketing Association, Inc.

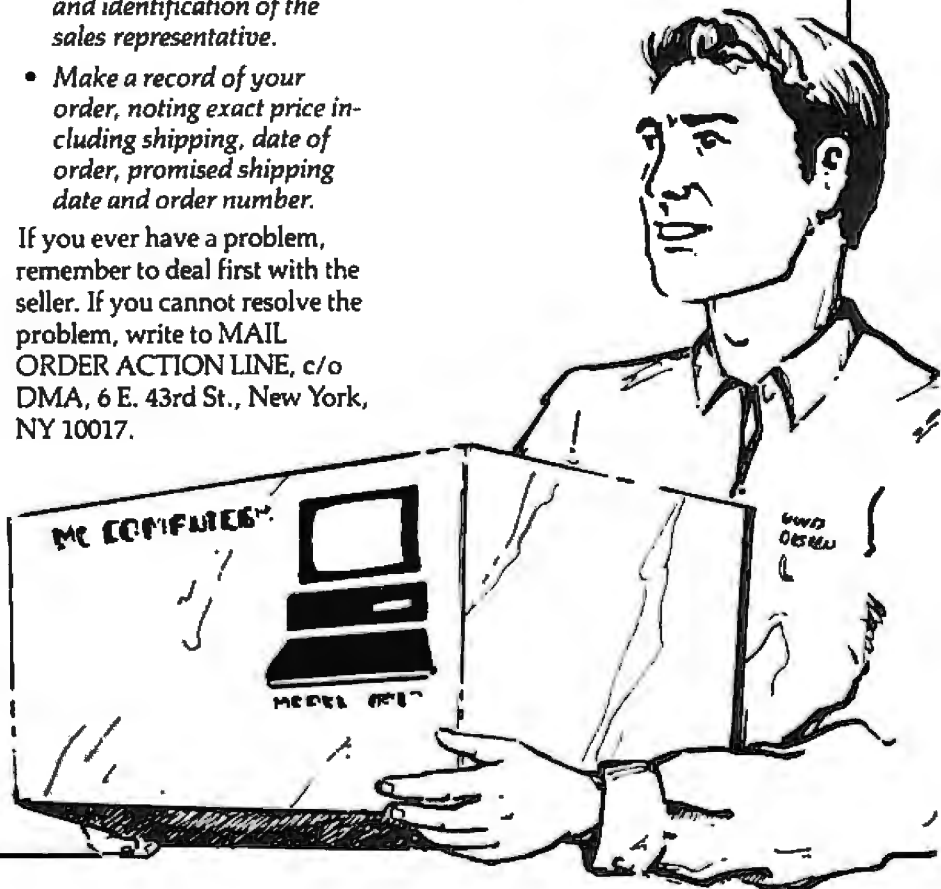

EDITORIAL INDEX BY COMPANY

Index of companies covered in articles, columns, or news stories in this issue
Each reference is to the first page of the article or section in which the company name appears

INQUIRY #	COMPANY	PAGE	INQUIRY #	COMPANY	PAGE	INQUIRY #	COMPANY	PAGE
	ACADEMIC PRESS	51		EASTGATE SYSTEMS.....	11		MARQ TECHNOLOGIES	11
1149	ACCOUNTING BY DESIGN.....	67	865	EASTMAN KODAK	67		MATSUSHITA ELECTRIC INDUSTRIAL.....	11
	ADDISON-WESLEY	51	1138	EDWARD K. REAM	67	1109	MAXIMUM STORAGE	327
1102	ADOBE SYSTEMS	327	875	ECCO.....	67	964	MAXON SYSTEMS	273
1133	AEGIS DEVELOPMENT.....	67		ELECTRONIC ARTS.....	151		MCGRAW-HILL.....	51
1164	AETECH	213	1171	EMPRESS SOFTWARE	317	866	MEGA DRIVE SYSTEMS.....	67
1131	AJIDA TECHNOLOGIES	67	882	EON SYSTEMS.....	67	1145	MENTAL AUTOMATION.....	67
1113	ALDUS.....	327	861	EVEREX	67	880	MERIDIAN DATA	67
1165	ALISA SYSTEMS	317	978	EXCELAN	259, 317	956	MERIDIAN TECHNOLOGY.....	273
	AMERICAN VOICE INPUT/OUTPUT SOCIETY	11	1172			889	METAPHOR	11
959	ANTIC SOFTWARE	273	1147	EXPERIENCE IN SOFTWARE	67		MEXTEL	67
890	APPLE COMPUTER	317, 327		FIFTH GENERATION SYSTEMS.....	67, 327		MICROELECTRONIC AND COMPUTER TECHNOLOGY	343
1166			998	FRESOFT	273	1001	MICROPRO INTERNATIONAL	127
1167	APPLIX.....	317	970	FTP SOFTWARE	259	892	MICROSOFT	109, 151, 223, 273, 285, 317, 327
1150	APT SOFTWARE.....	67	977	FUTURE DOMAIN	67	952		
1103	ARTISOFT	327	871			975		
1018	ASHTON-TATE	11, 97	1100	GATEWAY 2000.....	327	1008		
	AT&T BELL LABORATORIES	11, 343	876	GEMINI TECHNOLOGY	67	1176		
1168	BANYAN SYSTEMS	285, 317	1121	GIBSON RESEARCH	327	1200		
872	BBS ELECTRONICS	67	1021	GTCO	162	1129	MICROTEK	67
980	BICC DATA NETWORK.....	259	1142	GW INSTRUMENTS	67		MIT SOFTWARE DISTRIBUTION CENTER	353
990	BIT SOFTWARE	67		HALSTED PRESS	51		MITSUBISHI ELECTRONICS AMERICA	11
1013	BORLAND INTERNATIONAL.....	109, 327	885	HARCOM SECURITY SYSTEMS... 67		1177	NATIONAL CENTER FOR COMPUTING APPLICATIONS... 317	
900	BRIDGEWAY PUBLISHING.....	327	973	HAYES MICROCOMPUTER PRODUCTS.....	273	1141	NATIONAL INSTRUMENTS	67
1114	BROWN BAG SOFTWARE.....	67, 327	895	HEWLETT-PACKARD	259, 327	860	NEC HOME ELECTRONICS (U.S.A.).....	67
1148			981			1110	NEC INFORMATION SYSTEMS... 327	
1020	CALCOMP	162	961	HILGRAEVE.....	273	982	NETWORK GENERAL.....	259
1124	CALERA RECOGNITION SYSTEMS.....	327	1022	HITACHI AMERICA	162	1111	NEXT	327
1144	CALIFORNIA SCIENTIFIC SOFTWARE.....	67	984	HOECHST-CELANESE	253		NIPPON TELEPHONE AND TELEGRAPH	343
1000	CANON U.S.A.	127	1023	HOPKINS TECHNOLOGY	67	1019	NOLO PRESS.....	97
869	CAPITAL EQUIPMENT.....	67		HOUGHTON-MIFFLIN	51		NORTHBANK.....	11
993	CENTRAL POINT SOFTWARE.....	67	851	HOUSTON INSTRUMENT.....	162	1007	NORTHGATE COMPUTER SYSTEMS.....	109
1146	CHECKFREE TECHNOLOGIES.... 67		852	HOWARD W. SAMS	51	1178	NOVELL.....	285, 309, 317
	CLARIS.....	11	853			1120	NU-MEGA TECHNOLOGIES.....	327
	CODENOLL	253	857	IBM	11, 179, 201, 285, 309, 367	1025	NUMONICS	162
1169	COEFFICIENT SYSTEMS	317		IBM JAPAN	11	1014	OASIS PRESS	109
1017	COLORADO MEMORY SYSTEMS.....	97		IBM WATSON RESEARCH CENTER	343	1179	ODESTA	317
955	COMMUNICATIONS RESEARCH GROUP	273	1015	IMAGINE THAT!	97		ON TECHNOLOGY	11
894	COMPAQ COMPUTER	327	1173	INFORMIX SOFTWARE.....	317	864	ONLINE COMPUTER SYSTEMS... 67	
969	COMPATIBLE SYSTEMS	273, 327	856	INTEL.....	11, 155, 195		OPEN SYSTEMS FOUNDATION... 343	
1118				INTERGRAPH	11	1180	ORACLE.....	309, 317
991	CONNECT COMPUTER	67	879	INTERLAN	67, 259			
858	CONTROL SYSTEMS.....	201	979			1181	PACER SOFTWARE	317
867	CUMULUS	67	886	INTERLOCK	67	999	PARCPLACE SYSTEMS	143
1006	D ² SOFTWARE.....	109	1004	INTERSTEL	109	1026	PENCEPT	162
881	DATAMEDIA	67	1016	IRWIN MAGNETIC SYSTEMS	97,	887	PENTAX TEKNOLOGIES	67
968	DATASTORM TECHNOLOGIES	273, 327		IXI	353	1112	PETER NORTON COMPUTING... 327	
1170	DAYNA COMMUNICATIONS	317	1174	KEA SYSTEMS	317	1134	PHAR LAP SOFTWARE	67
868	DAYSTAR DIGITAL	67	1175	KINETICS, A DIVISION OF EXCELAN.....	317	1003	PHOTOGRAPHIC SCIENCES.....	109
888	DESKTOP TECHNOLOGY	67	960	KORTEK.....	273	983	PINPOINT PUBLISHING	67
957	DIGITAL COMMUNICATIONS ASSOCIATES.....	155, 273	1024	KURTA.....	162	1136	POCKET SOFT.....	67
	DIGITAL EQUIPMENT	11, 253	972	LATTICE	273	1116	POLYTRON	327
854	DOLCH COMPUTER SYSTEMS... 189		1130	LAZERUS	67		PRENTICE-HALL.....	51
958	DOW JONES SOFTWARE	273		LOGISTIQUE LMM.....	151	1105	PRIAM.....	327
997	DPEX.....	67	963	LOTUS DEVELOPMENT	67, 273	954	PRIMARY DATA.....	273
	DREXLER TECHNOLOGY	11	1128			994	PRODUCTIVITY SOFTWARE.....	67
			898	LUGARU SOFTWARE.....	327	893	PROXIMITY SOFTWARE	327
			974	MAINSTAY	273			

INQUIRY #	COMPANY	PAGE	INQUIRY #	COMPANY	PAGE	INQUIRY #	COMPANY	PAGE
863	QIC RESEARCH	67	953	UNITED SOFTWARE INDUSTRIES	273	855	WOLFRAM RESEARCH.....	239, 327
	QUARK	11				1108		
896	QUARTERDECK OFFICE SYSTEMS.....	327	1137	VESTRONIX.....	67	988	XYQUEST.....	67
	RAIMA	383	1125	VIDEO SEVEN.....	327	996	YOLLES DEVELOPMENT	67
1182	RELATIONAL TECHNOLOGY	317	1143	VISIONICS	67	951	ZENITH DATA SYSTEMS ...	109, 135,
971	RELAY COMMUNICATIONS.....	273	1190	WALKER RICHER & QUINN	317	1011	327	
	RICHARDBRONSON	11	897	WALLSOFT SYSTEMS.....	327	1126		
1132	RIX SOFTWARE.....	67	874	WESTERN DIGITAL IMAGING.....	67	1127	ZORTECH.....	327
1199	ROYKORE SOFTWARE.....	233	1191	WHITE PINE SOFTWARE	317			
1183	SANTA CRUZ OPERATION	317						
883	SCENARIO.....	67						
884	SCITECH	67						
1027	SEIKO INSTRUMENTS U.S.A.	162						
862	SHARP ELECTRONICS.....	67						
878	SIMPLE NET SYSTEMS	67						
	SOFTCRAFT	383						
966	SOFTKLONE DISTRIBUTING	273						
962	SOFTRONICS	273						
1106	SOFTVIEW	327						
967	SOFTWARE PUBLISHERS	273						
965	SOFTWARE VENTURES	273						
995	SOFTWAY	67						
986	SOLUTIONS INTERNATIONAL	67						
	SONY	11						
1140	SPECTRA BLUE	67						
	STANFORD RESEARCH INSTITUTE	11						
1010	STRATEGIC SIMULATIONS.....	109						
1009	STRATEGIC STUDIES GROUP.....	109						
1028	SUMMAGRAPHICS	162						
1122	SUN MICROSYSTEMS	11, 327, 343						
1184	SUN MICROSYSTEMS, TOPS DIVISION.....	317						
873	SUNRIVER	67						
1115	SUPERMAC TECHNOLOGY	327						
1185	SYBASE	317						
1101	SYMANTEC.....	109, 327						
1104								
1005	SYNOPTICS COMMUNICATIONS	253						
1186	SYNTAX.....	317						
	TANDY	11						
1187	TECHNOLOGY CONCEPTS	317						
877	10NET COMMUNICATIONS ..	67, 135						
950								
	TEXAS INSTRUMENTS	367						
870	THE PERISCOPE COMPANY.....	67						
	THE SOCIETY OF NEWSPAPER DESIGN	11						
1139	THE WHITEWATER GROUP	67						
987	THOMPSON COMPUTING	67						
976	3COM	67, 253, 259, 285, 317						
985								
1188								
1002	TMA.....	109						
1135	TML SYSTEMS	67						
1012	TOSHIBA AMERICA	11, 109, 327						
1123								
891	TRAVELING SOFTWARE	317, 327						
1189								
992	TRITON TECHNOLOGIES	67						
1107	TURBOPOWER SOFTWARE	327						

COMING UP IN BYTE

PRODUCTS IN PERSPECTIVE:

In the front of the book will be Microbytes, What's New, and Short Takes. Next month's Short Takes will include products for computer security, programmer's tools, a writer's utility package, the Apple IIC+, and more.

Our **First Impression** will take a look at the most recent incarnation of Borland's Paradox database for the IBM PC.

February's **Product Focus** will deal with six of the latest generation of C compilers, which represent the most recent advances by software houses to address the needs of serious programmers.

System reviews will consider the newest Zenith and Ogivar 80386 portable computers, as well as Tandy's Model 5000 80386.

Hardware reviews will start out with a look at five new floppy disk drives and controllers for both the IBM PC and the Macintosh.

Another review looks at four midsize SCSI hard disk drives for the Mac.

In **software reviews**, we have a group review of three assemblers: MASM, Turbo Assembler, and OPTASM. We'll also review a new C programming toolkit for both the Mac and the Microsoft Windows environment on the PC, called XVT. **Application reviews** will include consideration of two of Ashton-Tate's latest, the long-awaited dBASE IV and Full Impact.

IN DEPTH:

Personal workstations is the subject of our February In-Depth section. It will begin with Nick Baran providing a working definition of just what a personal workstation is. Speaking directly to that point, Stan Diehl and Steve Apiki have performed a bit of garage-shop magic in a piece about the ultimate upgrade. Other articles will feature the ins and outs of performance measurement, a comparison of RISC chips, the state of the art in workstation graphics, how well the Mac II and 80386 machines function as workstations, a survey of the current crop, and more.

FEATURES:

We'll look at how microcomputers are being used in **sequencing DNA**. Dick Pountain explores a new storage medium, **digital paper**. Roy Kimbrell has contributed a series of **C programs**. Charles Hart has also contributed a series of programs to accompany his interesting piece on **Turbo windowing**. In our Hands On section of the Features department, Brett Glass focuses his hardware lens on **disk drive interfaces**, while Rick Grehan continues the January theme by presenting part 2 of his **B-tree project**.

READER SERVICE

Advertising Supplement included with this issue:
Jade Computer (U.S. and Canada Subscribers)

BYTEWEEK trial offer for West Coast and Northeast subscribers.

* Correspond directly with company.

Inquiry No.	Page No.	Inquiry No.	Page No.	Inquiry No.	Page No.	Inquiry No.	Page No.
314 S-100	307	414 INK INTERNATIONAL	96IS-22	497 COMTEK DATA	MW-1	Pacific Coast 96 PC 1-12	
330 SHECOM	391	415 INTERQUADRAM	96IS-5	498 OS ASSOCIATES	MW-2	519 3-F ASSOCIATES	PC-5
331 SHECOM	391	416 INTERQUADRAM	96IS-7	499 OS ASSOCIATES	MW-2	520 ALTEC TECHNOLOGY	PC-4
332 SIMPLENET	292	417 INTERQUADRAM	96IS-9	500 Y.E.S. MULTINATIONAL	MW-7	* BYTE TIPS	PC-6
333 SIMPLENET	292	418 INTERQUADRAM	96IS-11			521 CAMBRIDGE DIRECT	PC-16
334 SOFTKLONE DISTRIBUTING	248B	422 JB DESIGNS & TECH LTD.	96IS-16	Mid-Atlantic 96 M/AT 1-8			
335 SPIDER SYSTEMS	275	434 KADOR	96IS-18	* BYTE TIPS	M/AT-4	522 COPY TECHNOLOGIES	PC-3
336 TATUNG	284	419 MAYFAIR MICROS	96IS-37	486 COMPARE COMPUTERS	M/AT-3	523 COPY TECHNOLOGIES	PC-3
337 TELCOR	269	* MICROCOMP.MKTG.COUNCL IS-42		467 COMPARE COMPUTERS	M/AT-3	* CORTEX COMPUTING	PC-6
338 UNIVERSAL COMPUTER SYS.	369	421 MICRO TECHNOLOGY	96IS-35	* EXPOCONSUL INT'L	M/AT-6,7	528 INTEC	PC-15
339 XECOM INC.	257	423 MUREX IND. SYS.	96IS-20	489 NET LOGIC	M/AT-2	528 LEINBACH, INC.	PC-15
INTERNATIONAL SECTION 96 IS 1-48		424 MUTEK	96IS-36	490 NET LOGIC	M/AT-2	529 MATRIX	PC-1
<i>No North American Inquiries please.</i>		425 NOVELL DEVELOPMENT	96IS-27	491 OWL COMPUTER	M/AT-1	535 NU-MEGA	PC-14
401 ACER	96IS-30,31	426 PHILIPS CONSUMER ELECT	96IS-2	Northeast 96 NE 1-16			
402 ALADDIN KNOWLEDGE SYS.	96IS-24	* ROBT.TINNEY GRAPHICS	96IS-40,41	503 APPLIED PROG. ELEC.	NE-6	531 SEVERE DISCOUNT COMP.	PC-2
403 APRICOT COMPUTERS	96IS-14,15	433 SBT	96IS-33	* BYTE TIPS	NE-4	532 SF MICRO	PC-7
* BIX	96IS-38	427 SEMITECH MICRO	96IS-25	504 COMPARE COMPUTERS	NE-5	533 TODAY COMPUTER	PC-11
404 BLUE CHIP TECHNOLOGY	96IS-34	* SOFTLINE CORPORATION	96IS-17	505 COMPARE COMPUTERS	NE-5	534 TODAY COMPUTER	PC-11
435 BYTEBITS	96IS-34	426 SOFTWARE APS	96IS-18	506 COMPUTER RESOURCE CTR.	NE-15	527 UNDER-WARE ELECT.	PC-9
* BYTE CIRCULATION	96IS-32	436 STONE COMPUTECH CO.	96IS-36	* COMPUTERS FOR THE BLIND	NE-2	South 96 SE 1-8	
405 CALEND	96IS-29	437 STONE COMPUTECH CO.	96IS-36	507 COMTEK DATA	NE-11	* BYTE TIPS	SO-4
406 CONTROL TELEMETRY	96IS-20	429 TECHPOWER CO	96IS-28	508 ELECTRIFIED DISCOUNTERS	NE-1	476 COMP. MASTERS OF AUGUSTA	SO-1
407 CUBIX	96IS-21	430 TRIANGLE DIGITAL	96IS-34	509 EXECUTIVE PHOTO & SPLY.	NE-13	477 DRS POWER PRODUCTS	SO-2
408 DATEX	96IS-39	431 U.S.A. SOFTWARE	96IS-13	* EXPOCONSUL INT'L	NE-8,9	478 DRS POWER PRODUCTS	SO-2
409 EXCELAN	96IS-43	REGIONAL SECTIONS		510 JASMINE COMP. SYS.	NE-7	479 GENERAL BUSI. MACHINES	SO-6
432 ELONEX	96IS-19	Midwest 96 MW 1-8		511 JASMINE COMP. SYS.	NE-7	480 GREAT LAKES COMPUTERS	SO-5
410 GAMMA PRODS.	96IS-26	* BYTETIPS	MW-4	513 PC LINK	NE-3	481 GREAT LAKES COMPUTERS	SO-5
411 GREY MATTER	96IS-44	495 COMPARE COMPUTERS	MW-3	514 PRECISION RECHARGE	NE-12	483 KNAPCO	SO-3
412 GTCO	96IS-23	496 COMPARE COMPUTERS	MW-3	512 UNDER-WARE ELECT.	NE-16	482 UNDER-WARE ELECT.	SO-8
413 INES	96IS-18						

MIDWEST

Computing
for

Oppner
McGraw-Hill Publishing

Continued
01302

READER SERVICE

To get further information on the products advertised in BYTE, fill out the reader service card by circling the numbers on the card that correspond to the inquiry number listed with the advertiser. This index is provided as an additional service by the publisher, who assumes no liability for errors or omissions.

* Correspond directly with company.

Index to Advertisers by Product Category

Inquiry No.	Page No.	Inquiry No.	Page No.	Inquiry No.	Page No.	Inquiry No.	Page No.
HARDWARE		194 NEEDHAM'S ELECTRONICS . . . 418		373	MONITORS	106 FLAGSTAFF ENGINEERING . . . 108	
366	ADD INS	302 XELTEK 406		9 3 LYNX TECHNOLOGIES 203		129 HIGH RES TECHNOLOGIES . . . 422	
18 ALPHA PRODUCTS CO. 412,413		363 XENDER 409		417 INTEROUADRAM 96IS-9		159 LOGITECH 95	
34 B&C MICRO 411		369	INSTRUMENTATION	184 MITSUBISHI 114,115		160 LOGITECH 95	
35 B&C MICRO 411		92 DSP DEVELOPMENT CORP. 184		191 NANA O 232		279 TRUE DATA 174	
404 BLUE CHIP TECHNOLOGY 96IS-34		97 ELEXOR 422		185 MITSUBISHI 114,115		292 VIDEX 139	
48 CAPITAL EQUIPMENT 204		328 OUA TECH 291		190 NANA O 232			
59 COMPUTER AGE LTD. 426		370	KEYBOARDS/MICE	191 NANA O 232		379	SOFTWARE SECURITY
67 CONTROL VISION 424		131 HOOLEON COMPANY 106		336 TATUNG 284		402 ALADDINKNOWLEDGE SYS. 96IS-24	
407 CUBIX 96IS-21		132 HOOLEON COMPANY 106		265 TAXAN, CORP. 147		406 CONTROL TELEMETRY 96IS-20	
71 DATA TRAM 45		133 HOUSTON INSTRUMENTS 89				230 RAINBOW TECH. 154	
76 DEFINICON 159		141 ITAC SYSTEMS, INC. 80		374	NETWORK HARDWARE	231 RAINBOW TECH. 154	
77 DEFINICON 159		157 LOGITECH 21		18 ALPHA PRODUCTS CO. 412,413			
82 DIGIBOARD 206		158 LOGITECH 81		36 BAY TECHNICAL ASSOC. 150		380	SYSTEMS
83 DIGIBOARD 207		197 NUMONICS 50		310 BUFFALO PRODUCTS 279		401 ACER 96IS-30,31	
95 EDCGMBH 102		242 SCI. ACCES 219		311 CARRIER CURRENTTECH., INC. 255		520 ALTEC TECHNOLOGY 96PC-4	
412 GTCO 96IS-23		244 SEIKO 175		312 CARRIER CURRENTTECH., INC. 255		* AMPRO 119	
413 INES 96IS-18		358 SUMMAGRAPHICS 55		407 CUBIX 96IS-21		403 APRICOT COMPUTERS 96IS-14,15	
319 INTEL CORP. 250,251		371	MASS STORAGE	408 DATEX 96IS-39		25 AST RESEARCH 101	
415 INTEROUADRAM 96IS-5		17 AK SYSTEMS 426		320 ITRON 321		26 AST RESEARCH 101	
416 INTEROUADRAM 96IS-7		308 BASF 342		323 MICROTEST, INC. 319		37 BEST COMPUTER 178	
418 INTEROUADRAM 96IS-11		* MAXELL DATA PRODUCTS 7		424 MUTEK 96IS-36		38 BEST COMPUTER 178	
139 IO TECH 388		361 OVERLAND DATA 418		489 NET LOGI 6M/AT-2		* BINARY TECH, INC. 422	
140 IO TECH 426		225 QUALSTAR CORP. 409		490 NET LOGI 96M/AT-2		521 CAMBRIDGE DIRECT 96PC-16	
143 JB COMPL 426		259 SYSGEN, INC. 19		325 NETLINE 263		49 CLUB AMERICAN TECH. 132,133	
422 JB DESIGNS & TECH LTD. 96IS-16		288 VERBATIM CORPORATION 31		208 PERSONAL SPACE COMM 411		* COMPAQ COMP. CORP. 32A-F	
151 LAWSON LABS, INC. 418				329 ROSE ELECTRONICS 272		507 COMTEK DATA 96NE-11	
423 MUREX IND. SYS. 96IS-20				298 WIESEMANN & THEIS' 315		72 DATAWORLD 194	
196 NOHAU CORP. 368				375	POWER SUPPLIES	73 DATAWORLD 194	
208 PERSONALSPACE COMM 411				477 DRS POWER PRODUCTS 96SO-2		76 DEFINICON 159	
426 PHILIPS CONSUMER ELECT. 96IS-2				478 DRS POWER PRODUCTS 96SO-2		77 DEFINICON 159	
220 OUA TECH 414				99 EMERSON COMP. POWER 352		79 DELL COMPUTER CORP. CII,1	
221 OUA TECH 414				100 EMERSON COMP. POWER 352		432 ELONEX 96IS-19	
222 OUA TECH 414				201 PARA SYSTEMS 103		102 EVEREX(COMPUTER DIV.) 28,29	
223 OUA TECH 414				207 PERMA POWER 208		103 EVEREX (COMPUTER DIV.) 28,29	
232 REAL TIME DEVICES 411				243 SCOPE ELECTRONICS 208		104 FIVESTAR COMPUTER 230,231	
262 TALKING TECHNOLOGIES 406				376	PRINTERS/PLOTTERS	113 GATEWAY 2000 185	
429 TECHPOWER CO. 96IS-28				36 BAY TECHNICAL ASSOC. 150		480 GREAT LAKES COMPS. 96SO-5	
266 TELEBIT 156,157				310 BUFFALO PRODUCTS 279		481 GREAT LAKES COMPS. 96SO-5	
268 TELEBYTE TECHNOLOGY 145				111 FUJITSU AMERICA 90,91		* IBM CORP. 73	
430 TRIANGLE DIGITAL 96IS-34				112 FUJITSU AMERICA 90,91		135 IEEE 117	
280 TRUEVISION 337				127 HEWLETT-PACKARD 221		510 JASMINE COMP. SYS. 96NE-7	
306 Z-WORLD 424				128 HEWLETT-PACKARD 222		511 JASMINE COMP. SYS. 96NE-7	
367	DRIVES			161 MANNESMANN TALLY 187		171 MEGATEL 106	
32 A.N. WHOLESALE & RETAIL 420				162 MANNESMANN TALLY 187		173 MICRO EXPRESS 339	
* SEAGATE 107				* NEC INFORMATION SYS. CIII		174 MICRO EXPRESS 339	
272 TIGERTRONICS 100				214 PRINCETON GRAPHIC SYS. 173		183 MICROWAY 153	
296 WELTEK DIGITAL 112				234 ROLAND 126		* NEC HOME ELECT. DIV. 210,211	
297 WELTEK DIGITAL 112				282 UNITED INNOVATIONS 44		491 OWL COMPUTER 96M/AT-1	
368	HARDWARE PROGRAMMERS			304 ZERICON 347		218 PROTEUS TECHNOLOGY 27	
31 AVOCET SYSTEMS, INC. 406				377	PRINTER RIBBONS	229 RADIO SHACK CIV	
34 B&C MICRO 411				21 AMERICAN RIBBON 54		233 RENEGADE TECHNOLOGY 8,9	
35 B&C MICRO 411				61 COMPUTER FRIENDS 48		427 SEMITECH MICRO 96IS-25	
362 BP MICROSYSTEMS 424				514 PRECISION RECHARGE 96NE-12		532 SF MICRO 96PC-7	
120 GTEK, INC. 79				378	SCANNERS/DIGITIZERS	255 SUNTRONICS 118	
121 GTEK, INC. 79				71 DATA TRANSLATION 45		533 TODAY COMPUTER 96PC-11	
147 KORE INC. 422				105 FLAGSTAFF ENGINEERING 108		534 TODAY COMPUTER 96PC-11	
152 LINKCOMPUTERGRAPHICS 420						274 TOSHIBA COMPUTERS 36,37	
						275 TOSHIBA COMPUTERS 36,37	
						293 VNS AMERICA 56,57	
						295 WELLS AMERICAN 39	
						300 WINTEK CORP. 406	

READER SERVICE

Advertising Supplement included with this issue:
Jade Computer (U.S. and Canada Subscribers)

BYTEWEEK trial offer for West Coast and Northeast subscribers.

* Correspond directly with company.

Inquiry No.	Page No.	Inquiry No.	Page No.	Inquiry No.	Page No.	Inquiry No.	Page No.	
303	ZEOS INTERNATIONAL . . . 140,141	386	IBM/MS-DOS APPLICATIONS Word Processing	46	CALIFORNIA SOFTWARE . . . 418	53	COMPACT DISK PRODUCTS . . . 376	
SOFTWARE		253	STATSOFT 113	47	CALIFORNIA SOFTWARE . . . 418	486	COMPARE COMPUTERS 96M/AT-3	
381	APPLE2/MAC APPLICATIONS Scientific/Technical	387	IBM/MS-DOS — CAD	522	COPY TECHNOLOGIES . . . 96PC-3	487	COMPARE COMPUTERS 96M/AT-3	
252	SPSS, INC. 229	22	AMER. SMALL BUS. COMP. 144	523	COPY TECHNOLOGIES . . . 96PC-3	495	COMPARE COMPUTERS . . . 96MW-3	
382	APPLE2/MAC LANGUAGES	29	AUTODESK, INC. 64	524	CORTEX COMPUTING . . . 96PC-6	496	COMPARE COMPUTERS . . . 96MW-3	
227	OUELO 406	63	COMPUTER RESOURCE TECH167	69	CURTIS INC. 409	504	COMPARE COMPUTERS . . . 96NE-5	
383	IBM/MS-DOS APPLICATIONS Business/Office	107	FORESIGHT RESOURCES . . . 280	* DAYTRON ELECTRONICS, INC. 422	80	DEPARTMENTAL TECH., INC. 137	505	COMPARE COMPUTERS . . . 96NE-5
* APPLIED COMP. SERVICES . . . 146		108	FORESIGHT RESOURCES . . . 280	117	GOLDEN BOW 248	54	COMPUCLASSICS 197	
23 ASHTON-TATE 148,149		115	GENERIC SOFTWARE 215	118	GOLDEN BOW 420	57	COMPUSAVE 53	
24 ASHTON-TATE 148,149		116	GENERIC SOFTWARE 215	122	HAMMERLY COMP. SERVICES 227	62	COMPUTER MAIL ORDER . . . 22,23	
109 FOX SOFTWARE 25		299	WINTEK CORP. 5	146	KNOWLEDGE GARDEN 299	476	COMP. MASTERS OF AUGUSTA 96SO-1	
110 FTG DATA SYSTEMS 420		388	IBM/MS-DOS — LAN	529	MATRIX 96PC-1	64	COMPUTER SURPLUS STORE 422	
410 GAMMA PRODS. 96IS-26		409	EXCELAN 96IS-43	* MICROSOFT 13-15	65	COMPUTERLANE, UNLTD. . . . 193		
414 INK INTERNATIONAL . . . 96IS-22		489	NET LOGIC 6M/AT-2	499	OS ASSOCIATES 96MW-2	66	CONTECH 422	
178 MICRORIM 82,83		490	NET LOGIC 16M/AT-2	498	OS ASSOCIATES 96MW-2	88	DISC INTERNATIONAL 414	
179 MICRORIM 82,83		332	SIMPLENET 292	499	OS ASSOCIATES 96MW-2	89	DISK COTECH 420	
192 NANTUCKET 333		333	SIMPLENET 292	204	PAUL MACE SOFTWARE 128	90	DISKETTE CONNECTION 409	
425 NOVELL DEVELOPMENT . . 96IS-27		353	SOFTWARE LINK, THE 161	206	PERISCOPE COMPANY 355	91	DISKS TO GO 406	
* ORACLE 77		354	SOFTWARE LINK, THE 161	359	PETER NORTON 134	93	DYNAMIC ELECTRONICS 420	
22 OUIQUE 32		355	SPIDER SYSTEMS 275	360	PETER NORTON 134	508	ELECTRIFIED DISCOUNTERS . . 96NE-1	
* RAIMA 35		389	IBM/MS-DOS — GRAPHICS	326	PRO-MARK 291	509	EXEC. PHOTO & SUPPLY 96NE-13	
43 SBT 96IS-33		* DAYTRON ELECTRONICS, INC. 422		327	PRO-MARK 291	479	GEN. BUS. MACHINES . . . 96SO-6	
* SCITOR CORP 235		114	GENERAL PARAMETRICS 121	224	QUAID SOFTWARE 351	411	GREY MATTER 96IS-44	
246 SMALL COMPUTING CO. . . . 378		203	PAUL MACE SOFTWARE 349	530	SAK TECHNOLOGIE . . . 96PC-13	123	HARD DRIVES INT'L 200	
258 SYMANTEC 47		278	TRILOBYTE INC. 409	240	SAX SOFTWARE 198	124	HARD DRIVES INT'L 200	
338 UNIVERSAL COMPUTER SYS. 369		390	IBM/MS-DOS — LANGUAGES	256	SUPERSOFT 58	134	I.C. EXPRESS 426	
289 VERSASOFT 104		11	A + L MEIER VOGT 387	281	TURBO POWER 116	142	JAMECO 404,405	
384	IBM/MS-DOS APPLICATIONS Scientific/Technical	42	BORLAND 71	* VERMONT CREATIVE S/W . . . 10	301	WOODCHUCK IND. 426	364	J.D.R. MICRODEVICES 427
14 ACCEL TECH 424		43	BORLAND 71	501	IBM/MS-DOS COMMUNICATIONS	6	J.D.R. MICRODEVICES . . . 428,429	
27 ASYST SOFTWARE 209		50	CNS, INC. 30	51	COEFFICIENT SYSTEMS 204	7	J.D.R. MICRODEVICES . . . 430-432	
39 BINARY ENGINEER 258		74	DAYSTAR COMPUTING 60	52	COEFFICIENT SYSTEMS 205	483	KNAPCO 96SO-3	
94 ECOSOFT 383		75	DAYSTAR COMPUTING 60	315	DIVERSIFIED COMP 319	148	LA COMPUTER 408	
356 HORSTMANN 40		98	ELLIS COMPUTING, INC. 44	316	FTP SOFTWARE 270	419	MAYFAIR MICROS 96IS-37	
164 MATHSOFT 69		144	JENSEN & PARTNERS, INT'L. 111	119	GRAFFPOINT 420	166	MEAD COMPUTER 417	
351 NATIONAL INSTRUMENTS . . 142		149	LAHEY COMPUTER SYSTEMS 205	167	MEDIA CYBERNETICS 217	169	MEGASOFT 411	
352 NATIONAL INSTRUMENTS . . 142		163	MANX SOFTWARE SYSTEMS . 105	168	MEDIA CYBERNETICS 217	170	MEGASOFT 411	
202 PATTON & PATTON 124		186	MIX SOFTWARE 381	334	SOFTKLONE DISTRIBUTING 248B	96	MICHAEL HALVERSON & ASSOC. 424	
237 SAIC 54		211	POLYTRON, CORP. 49	248	SOFTRONICS 409	421	MICRO TECHNOLOGY . . . 96IS-35	
251 SPECTRUM 93		227	OUELO 406	277	TRAVELING SOFTWARE 245	175	MICROCOM SYSTEMS 24	
260 SYSTAT 212		239	SANTA CI 87	503	APPLIED PROG. ELEC. . . . 96NE-6	* MICROCOMP. MKTG. COUNCIL 96IS-42		
261 SYSTAT 212		* S/W DEV 99		33	B&B ELECTRONICS 409	177	MICROPROCESSORS UNLTD. 424	
385	IBM/MS-DOS APPLICATIONS Spreadsheet	254	STSC 243	41	BOFFIN LTD. 131	182	MICROSTAR 419	
117	GOLDEN BOW 248	284	USERSOI 125	* BUYER'S MART 392-402	183	MICROWAY 373		
526	INTEC 96PC-15	290	VESTRO 377	* CALIFORNIA DIGITAL 425	187	MONTGOMERY GRANT 266		
527	INTEC 96PC-15	305	ZORTECH 61	283	UNIV. CROSS-ASSEMBLERS . 406	188	MR. BOOKS, INC. 52	
		391	IBM/MS-DOS — UTILITIES			189	M.H.I. 407	
		12	A + L MEIER VOGT 389			195	NITRO MICRO 362	
		28	ATRON 66			340	ON-LINE STORE 331	
		30	AVOCET SYSTEMS, INC. 326			199	PACIFIC COMPUTER 416	
		40	BLAISE COMPUTING INC. 33			200	PACIFIC COMPUTER 416	
		42	BORLAND 71			513	PC LINK 96NE-3	
		43	BORLAND 71			205	PC NETWORK 371	
		44	BUMBLEBEE SOFTWARE INC. 102			212	PRECISION DATA PRODUCTS 424	
		405	CALEND 96IS-29			213	PRINCETON DISKETTE 422	

FREE INFORMATION

Want More Information About the Products and Advertisers Featured in this Issue?

1

Circle numbers on reply card which correspond to numbers assigned to items of interest to you.

2

Check all the appropriate answers to questions "A" through "C".

3

Print your name and address and mail.

Fill out this coupon carefully. PLEASE PRINT.

Name _____

Title _____ (_____) _____
Phone

Company _____

Address _____

City _____ State _____ Zip _____

A. What is your level of management responsibility?

- 1 Senior-level Management
- 2 Other Management
- 3 Non-Management

B. What is your primary job function/principal area of responsibility? (Check one.)

- 1 Administration
- 2 Accounting/Finance
- 3 MIS/DP/Information Center
- 4 Product Design and Development
- 5 Research and Development
- 6 Manufacturing
- 7 Sales/Marketing
- 8 Purchasing
- 9 Personnel
- 10 Education/Training
- 11 Other: _____

C. Please indicate your organization's primary business activity: (Check one.)

- 1 Computer-Related Businesses: Manufacturer (Hardware, Software)

- 2 Computer Retail Stores
- 3 Consultants
- 4 Service Bureau/Planning
- 5 Distributor/Wholesaler
- 6 Systems House/Integrator/VAR
- 7 Other: _____

Non-Computer-Related Businesses:

- 8 Manufacturing
- 9 Finance, Insurance, Real Estate
- 10 Retail/Wholesale
- 11 Education
- 12 Government
- 13 Military
- 14 Professions (Law, Medicine, Engineering, Architecture)
- 15 Consulting
- 16 Other Business Services
- 17 Transportation, Communications, Utilities
- 18 Other: _____

JANUARY
491RSU

1	2	3	4	5	6	7	8	9	10	11	12	13	14	15	16	17	18	19	20	21	22	23	24	25	26	27	28	29	30
31	32	33	34	35	36	37	38	39	40	41	42	43	44	45	46	47	48	49	50	51	52	53	54	55	56	57	58	59	60
61	62	63	64	65	66	67	68	69	70	71	72	73	74	75	76	77	78	79	80	81	82	83	84	85	86	87	88	89	90
91	92	93	94	95	96	97	98	99	100	101	102	103	104	105	106	107	108	109	110	111	112	113	114	115	116	117	118	119	120
121	122	123	124	125	126	127	128	129	130	131	132	133	134	135	136	137	138	139	140	141	142	143	144	145	146	147	148	149	150
151	152	153	154	155	156	157	158	159	160	161	162	163	164	165	166	167	168	169	170	171	172	173	174	175	176	177	178	179	180
181	182	183	184	185	186	187	188	189	190	191	192	193	194	195	196	197	198	199	200	201	202	203	204	205	206	207	208	209	210
211	212	213	214	215	216	217	218	219	220	221	222	223	224	225	226	227	228	229	230	231	232	233	234	235	236	237	238	239	240
241	242	243	244	245	246	247	248	249	250	251	252	253	254	255	256	257	258	259	260	261	262	263	264	265	266	267	268	269	270
271	272	273	274	275	276	277	278	279	280	281	282	283	284	285	286	287	288	289	290	291	292	293	294	295	296	297	298	299	300
301	302	303	304	305	306	307	308	309	310	311	312	313	314	315	316	317	318	319	320	321	322	323	324	325	326	327	328	329	330
331	332	333	334	335	336	337	338	339	340	341	342	343	344	345	346	347	348	349	350	351	352	353	354	355	356	357	358	359	360
361	362	363	364	365	366	367	368	369	370	371	372	373	374	375	376	377	378	379	380	381	382	383	384	385	386	387	388	389	390
391	392	393	394	395	396	397	398	399	400	401	402	403	404	405	406	407	408	409	410	411	412	413	414	415	416	417	418	419	420
421	422	423	424	425	426	427	428	429	430	431	432	433	434	435	436	437	438	439	440	441	442	443	444	445	446	447	448	449	450
451	452	453	454	455	456	457	458	459	460	461	462	463	464	465	466	467	468	469	470	471	472	473	474	475	476	477	478	479	480
481	482	483	484	485	486	487	488	489	490	491	492	493	494	495	496	497	498	499	500	501	502	503	504	505	506	507	508	509	510
511	512	513	514	515	516	517	518	519	520	521	522	523	524	525	526	527	528	529	530	531	532	533	534	535	536	537	538	539	540
541	542	543	544	545	546	547	548	549	550	551	552	553	554	555	556	557	558	559	560	561	562	563	564	565	566	567	568	569	570
571	572	573	574	575	576	577	578	579	580	581	582	583	584	585	586	587	588	589	590	591	592	593	594	595	596	597	598	599	600
601	602	603	604	605	606	607	608	609	610	611	612	613	614	615	616	617	618	619	620	621	622	623	624	625	626	627	628	629	630
631	632	633	634	635	636	637	638	639	640	641	642	643	644	645	646	647	648	649	650	651	652	653	654	655	656	657	658	659	660
661	662	663	664	665	666	667	668	669	670	671	672	673	674	675	676	677	678	679	680	681	682	683	684	685	686	687	688	689	690
691	692	693	694	695	696	697	698	699	700	701	702	703	704	705	706	707	708	709	710	711	712	713	714	715	716	717	718	719	720
721	722	723	724	725	726	727	728	729	730	731	732	733	734	735	736	737	738	739	740	741	742	743	744	745	746	747	748	749	750
751	752	753	754	755	756	757	758	759	760	761	762	763	764	765	766	767	768	769	770	771	772	773	774	775	776	777	778	779	780
781	782	783	784	785	786	787	788	789	790	791	792	793	794	795	796	797	798	799	800	801	802	803	804	805	806	807	808	809	810
811	812	813	814	815	816	817	818	819	820	821	822	823	824	825	826	827	828	829	830	831	832	833	834	835	836	837	838	839	840
841	842	843	844	845	846	847	848	849	850	851	852	853	854	855	856	857	858	859	860	861	862	863	864	865	866	867	868	869	870
871	872	873	874	875	876	877	878	879	880	881	882	883	884	885	886	887	888	889	890	891	892	893	894	895	896	897	898	899	900
901	902	903	904	905	906	907	908	909	910	911	912	913	914	915	916	917	918	919	920	921	922	923	924	925	926	927	928	929	930
931	932	933	934	935	936	937	938	939	940	941	942	943	944	945	946	947	948	949	950	951	952	953	954	955	956	957	958	959	960
961	962	963	964	965	966	967	968	969	970	971	972	973	974	975	976	977	978	979	980	981	982	983	984	985	986	987	988	989	990
991	992	993	994	995	996	997	998	999	1000	1001	1002	1003	1004	1005	1006	1007	1008	1009	1010	1011	1012	1013	1014	1015	1016	1017	1018	1019	1020
1021	1022	1023	1024	1025	1026	1027	1028	1029	1030	1031	1032	1033	1034	1035	1036	1037	1038	1039	1040	1041	1042	1043	1044	1045	1046	1047	1048	1049	1050
1051	1052	1053	1054	1055	1056	1057	1058	1059	1060	1061	1062	1063	1064	1065	1066	1067	1068	1069	1070	1071	1072	1073	1074	1075	1076	1077	1078	1079	1080
1081	1082	1083	1084	1085	1086	1087	1088	1089	1090	1091	1092	1093	1094	1095	1096	1097	1098	1099	1100	1101	1102	1103	1104	1105	1106	1107	1108	1109	1110
1111	1112	1113	1114	1115	1116	1117	1118	1119	1120	1121	1122	1123	1124	1125	1126	1127	1128	1129	1130	1131	1132	1133	1134	1135	1136	1137	1138	1139	1140
1141	1142	1143	1144	1145	1146	1147	1148	1149	1150	1151	1152	1153	1154	1155	1156	1157	1158	1159	1160	1161	1162	1163	1164	1165	1166	1167	1168	1169	1170
1171	1172	1173	1174	1175	1176	1177	1178	1179	1180	1181	1182	1183	1184	1185	1186	1187	1188	1189	1190	1191	1192	1193	1194	1195	1196	1197	1198	1199	1200

Please send me one year of BYTE Magazine for \$24.95 and bill me. Offer valid in U.S. and possessions only.



NO POSTAGE
NECESSARY
IF MAILED
IN THE
UNITED STATES

BUSINESS REPLY MAIL

FIRST CLASS MAIL PERMIT NO. 176 PITTSFIELD, MA

POSTAGE WILL BE PAID BY ADDRESSEE

BYTE

READER SERVICE
PO Box 5110
Pittsfield, MA 01203-9926
USA



FREE INFORMATION

Want More Information About the Products and Advertisers Featured in this Issue?

1 Circle numbers on reply card which correspond to numbers assigned to items of interest to you.

2 Check all the appropriate answers to questions "A" through "C".

3 Print your name and address and mail.



NO POSTAGE
NECESSARY
IF MAILED
IN THE
UNITED STATES

BUSINESS REPLY MAIL
FIRST CLASS MAIL PERMIT NO. 176 PITTSFIELD, MA

POSTAGE WILL BE PAID BY ADDRESSEE



READER SERVICE
PO Box 5110
Pittsfield, MA 01203-9926
USA



Fill out this coupon carefully. PLEASE PRINT.

Name _____
 Title _____ (_____) _____
 Phone _____
 Company _____
 Address _____
 City _____ State _____ Zip _____

- A. What is your level of management responsibility?**
- 1 Senior-level Management
 - 2 Other Management
 - 3 Non-Management
- B. What is your primary job function/principal area of responsibility? (Check one.)**
- 1 Administration
 - 2 Accounting/Finance
 - 3 MIS/DP/Information Center
 - 4 Product Design and Development
 - 5 Research and Development
 - 6 Manufacturing
 - 7 Sales/Marketing
 - 8 Purchasing
 - 9 Personnel
 - 10 Education/Training
 - 11 Other: _____
- C. Please indicate your organization's primary business activity: (Check one.)**
- 1 Computer-Related Businesses:
 - 2 Computer Retail Stores
 - 3 Consultants
 - 4 Service Bureau/Planning
 - 5 Distributor/Wholesaler
 - 6 Systems House/Integrator/VAR
 - 7 Other: _____
 - 8 Non-Computer-Related Businesses:
 - 9 Manufacturing
 - 10 Finance, Insurance, Real Estate
 - 11 Retail/Wholesale
 - 12 Education
 - 13 Government
 - 14 Military
 - 15 Professions (Law, Medicine, Engineering, Architecture)
 - 16 Consulting
 - 17 Other Business Services
 - 18 Transportation, Communications, Utilities
 - 19 Other: _____

1	2	3	4	5	6	7	8	9	10	11	12	13	14	15	16	17	18	19	20	21	22	23	24	25	26	27	28	29	30
31	32	33	34	35	36	37	38	39	40	41	42	43	44	45	46	47	48	49	50	51	52	53	54	55	56	57	58	59	60
61	62	63	64	65	66	67	68	69	70	71	72	73	74	75	76	77	78	79	80	81	82	83	84	85	86	87	88	89	90
91	92	93	94	95	96	97	98	99	100	101	102	103	104	105	106	107	108	109	110	111	112	113	114	115	116	117	118	119	120
121	122	123	124	125	126	127	128	129	130	131	132	133	134	135	136	137	138	139	140	141	142	143	144	145	146	147	148	149	150
151	152	153	154	155	156	157	158	159	160	161	162	163	164	165	166	167	168	169	170	171	172	173	174	175	176	177	178	179	180
181	182	183	184	185	186	187	188	189	190	191	192	193	194	195	196	197	198	199	200	201	202	203	204	205	206	207	208	209	210
211	212	213	214	215	216	217	218	219	220	221	222	223	224	225	226	227	228	229	230	231	232	233	234	235	236	237	238	239	240
241	242	243	244	245	246	247	248	249	250	251	252	253	254	255	256	257	258	259	260	261	262	263	264	265	266	267	268	269	270
271	272	273	274	275	276	277	278	279	280	281	282	283	284	285	286	287	288	289	290	291	292	293	294	295	296	297	298	299	300
301	302	303	304	305	306	307	308	309	310	311	312	313	314	315	316	317	318	319	320	321	322	323	324	325	326	327	328	329	330
331	332	333	334	335	336	337	338	339	340	341	342	343	344	345	346	347	348	349	350	351	352	353	354	355	356	357	358	359	360
361	362	363	364	365	366	367	368	369	370	371	372	373	374	375	376	377	378	379	380	381	382	383	384	385	386	387	388	389	390
391	392	393	394	395	396	397	398	399	400	401	402	403	404	405	406	407	408	409	410	411	412	413	414	415	416	417	418	419	420
421	422	423	424	425	426	427	428	429	430	431	432	433	434	435	436	437	438	439	440	441	442	443	444	445	446	447	448	449	450
451	452	453	454	455	456	457	458	459	460	461	462	463	464	465	466	467	468	469	470	471	472	473	474	475	476	477	478	479	480
481	482	483	484	485	486	487	488	489	490	491	492	493	494	495	496	497	498	499	500	501	502	503	504	505	506	507	508	509	510
511	512	513	514	515	516	517	518	519	520	521	522	523	524	525	526	527	528	529	530	531	532	533	534	535	536	537	538	539	540
541	542	543	544	545	546	547	548	549	550	551	552	553	554	555	556	557	558	559	560	561	562	563	564	565	566	567	568	569	570
571	572	573	574	575	576	577	578	579	580	581	582	583	584	585	586	587	588	589	590	591	592	593	594	595	596	597	598	599	600
601	602	603	604	605	606	607	608	609	610	611	612	613	614	615	616	617	618	619	620	621	622	623	624	625	626	627	628	629	630
631	632	633	634	635	636	637	638	639	640	641	642	643	644	645	646	647	648	649	650	651	652	653	654	655	656	657	658	659	660
661	662	663	664	665	666	667	668	669	670	671	672	673	674	675	676	677	678	679	680	681	682	683	684	685	686	687	688	689	690
691	692	693	694	695	696	697	698	699	700	701	702	703	704	705	706	707	708	709	710	711	712	713	714	715	716	717	718	719	720
721	722	723	724	725	726	727	728	729	730	731	732	733	734	735	736	737	738	739	740	741	742	743	744	745	746	747	748	749	750
751	752	753	754	755	756	757	758	759	760	761	762	763	764	765	766	767	768	769	770	771	772	773	774	775	776	777	778	779	780
781	782	783	784	785	786	787	788	789	790	791	792	793	794	795	796	797	798	799	800	801	802	803	804	805	806	807	808	809	810
811	812	813	814	815	816	817	818	819	820	821	822	823	824	825	826	827	828	829	830	831	832	833	834	835	836	837	838	839	840
841	842	843	844	845	846	847	848	849	850	851	852	853	854	855	856	857	858	859	860	861	862	863	864	865	866	867	868	869	870
871	872	873	874	875	876	877	878	879	880	881	882	883	884	885	886	887	888	889	890	891	892	893	894	895	896	897	898	899	900
901	902	903	904	905	906	907	908	909	910	911	912	913	914	915	916	917	918	919	920	921	922	923	924	925	926	927	928	929	930
931	932	933	934	935	936	937	938	939	940	941	942	943	944	945	946	947	948	949	950	951	952	953	954	955	956	957	958	959	960
961	962	963	964	965	966	967	968	969	970	971	972	973	974	975	976	977	978	979	980	981	982	983	984	985	986	987	988	989	990
991	992	993	994	995	996	997	998	999	1000	1001	1002	1003	1004	1005	1006	1007	1008	1009	1010	1011	1012	1013	1014	1015	1016	1017	1018	1019	1020
1021	1022	1023	1024	1025	1026	1027	1028	1029	1030	1031	1032	1033	1034	1035	1036	1037	1038	1039	1040	1041	1042	1043	1044	1045	1046	1047	1048	1049	1050
1051	1052	1053	1054	1055	1056	1057	1058	1059	1060	1061	1062	1063	1064	1065	1066	1067	1068	1069	1070	1071	1072	1073	1074	1075	1076	1077	1078	1079	1080
1081	1082	1083	1084	1085	1086	1087	1088	1089	1090	1091	1092	1093	1094	1095	1096	1097	1098	1099	1100	1101	1102	1103	1104	1105	1106	1107	1108	1109	1110
1111	1112	1113	1114	1115	1116	1117	1118	1119	1120	1121	1122	1123	1124	1125	1126	1127	1128	1129	1130	1131	1132	1133	1134	1135	1136	1137	1138	1139	1140
1141	1142	1143	1144	1145	1146	1147	1148	1149	1150	1151	1152	1153	1154	1155	1156	1157	1158	1159	1160	1161	1162	1163	1164	1165	1166	1167	1168	1169	1170
1171	1172	1173	1174	1175	1176	1177	1178	1179	1180	1181	1182	1183	1184	1185	1186	1187	1188	1189	1190	1191	1192	1193	1194	1195	1196	1197	1198	1199	1200

JANUARY
491RSU

Please send me one year of BYTE Magazine for \$24.95 and bill me. Offer valid in U.S. and possessions only.

TO MAKE YOUR WRITING MORE RIVETING, STOP USING DULL CHARACTERS.

24-wire print quality. 9-wire price.

Ho. Hum.
Yawn. That's
how people

react when your writing fails to keep them glued to the page. But you'll get readers' attention and keep it, when you write with appealing, fully-developed characters. Like the ones created by our Pinwriter® P2200 printer.

The P2200's 24-wire print head produces crisp, fully-formed characters for a 9-wire price. Which means you get print quality that people will stop and read. At a price that won't stop you.

Of course, stand-out print quality is just one reason the P2200 is so outstanding.

It sprints through 55 letter quality CPS

or 170 in draft mode. Dresses up memos, let-

ters, etc., with up to 128 type variations. And, like all our Pinwriters, it works with more software packages than any other 24-wire printer.

For more information about the entire Pinwriter Family, call 1-800-343-4418. And discover what a little character development can do for your writing.

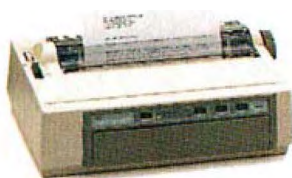

**NEC PRINTERS. THEY ONLY STOP
WHEN YOU WANT THEM TO.**

NEC

Tandy Computers: The broadest line of PCs in America.



The Tandy® 4000 LX

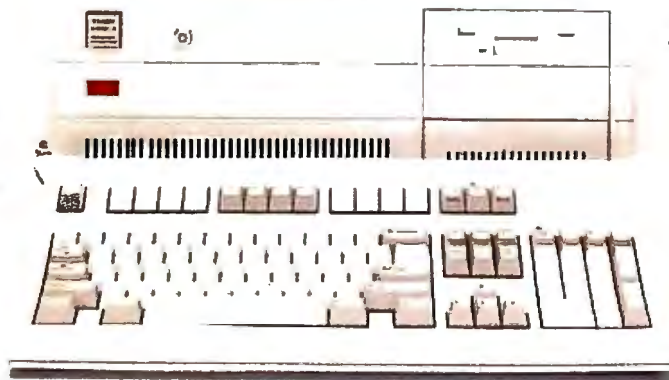

Get the power
and performance
of Intel's 80386
...at 20 MHz.

To streamline your heavy business tasks, turn to the Tandy 4000 LX. With its 32-bit Intel® 80386 microprocessor operating at 20 MHz, the 4000 LX delivers a new level of performance to sophisticated database management and spreadsheet analysis applications.

Two megabytes of zero wait-state memory make the 4000 LX ready to use with MS® OS/2, as well as MS-DOS® software. With this much memory standard, the Tandy 4000 LX is also ready to use as the

hub of a powerful multiuser office system running SCO™ XENIX® software. And as a network file server in a 3Com® workgroup, the 4000 LX provides 20 MHz performance for exceptionally high-speed data transfer.

The Tandy 4000 LX is highly expandable. Three front-panel device slots and eight expansion slots give power users the flexibility needed in configuring the optimum system. VGA graphics for desktop publishing, an Intel 80387 math

coprocessor for math-intensive applications and SCSI technology for high-performance disk storage are but a few of the many expansion options available.

And for entry-level 386™ power, we offer the original Tandy 4000. Using an 80386 processor that operates at 16 MHz, the 1MB Tandy 4000 is the perfect low-cost choice for the heavy power user.

The new generation Tandy 4000 LX. From the best-selling family of PC compatibles made in America.

Tandy Computers: Because there is no better value™

Intel/Reg. TM and 386/TM Intel Corp. MS, MS-DOS and XENIX/Reg. TM Microsoft Corp. SCO/TM The Santa Cruz Operation. 3Com/Reg. TM 3Com Corp.

Radio Shack®
COMPUTER CENTERS
A DIVISION OF TANDY CORPORATION