

# COMMERCIAL VEHICLES 2021

CHEVROLET 





# STRONG TRUCKS BUILD STRONG BUSINESSES.

You're only as good as your team. Your people. And your trucks. Chevy has a team of commercial vehicles you can count on to get the job done. The strong lineup starts with the reliable Silverado 1500 and continues

with the hardworking Silverado HD, plus the capable Silverado 3500 HD Chassis Cab. Add this to the medium-duty Silverado 4500 HD/5500 HD/6500 HD Chassis Cabs, the maneuverable

Low Cab Forward series and Express Vans, now with a more powerful available 6.6L V8 gas engine. The sum is a strong and formidable lineup capable of addressing your business needs.

## COMMERCIAL PROGRAMS

### ONSTAR BUSINESS SOLUTIONS

OnStar Business Solutions is a family of products that offers insight to find efficiencies, the opportunity to make better decisions, and the confidence in knowing your people and your assets are protected and connected. Learn more at [OnStar.com/BusinessSolutions](https://OnStar.com/BusinessSolutions).

Manage the way your business moves with OnStar Vehicle Insights™<sup>1</sup> by OnStar Business Solutions. You can see your fleet in real time and receive actionable information to make more informed decisions. Learn more at [OnStarVehicleInsights.com](https://OnStarVehicleInsights.com).

### BUSINESS CHOICE

This program<sup>2</sup> can give you a great value on the vehicles you count on. Business Choice includes a cash allowance on either GM Accessories or Upfits<sup>3</sup>; and you can even add most current retail offers to your deal. Learn more at [chevrolet.com/business-choice-offers](https://chevrolet.com/business-choice-offers).

### BUSINESS ELITE DEALERS

These specialized dealers provide the know-how to help you select the right vehicles for the job. Plus, every Business Elite service department has the facilities, tools and technicians for your needs. Learn more at [chevrolet.com/commercial/business-elite](https://chevrolet.com/commercial/business-elite).



<sup>1</sup> Terms apply. Available on select properly equipped 2015 model year and newer GM vehicles (excludes Volt, Low Cab Forward Trucks and GM vehicles built without OnStar Hardware, which includes but is not limited to select base Chevrolet and GMC trucks). Requires an active connected vehicle services plan. Fees, services, and availability subject to change without notice. Applicable taxes not included. Does not include emergency or security services. Diagnostics capabilities vary by vehicle model. Not all issues will deliver alerts. See [OnStarVehicleInsights.com](https://OnStarVehicleInsights.com) for details and limitations. <sup>2</sup> 2021 GM BUSINESS CHOICE REQUIREMENTS: The 2021 GM Business Choice Program is valid from January 5, 2021, to January 2, 2023. Customer must purchase or lease a vehicle during the program period and be able to provide proof of business ownership. Vehicle must be used in the day-to-day operations of the business and not solely for transportation purposes. This program may not be compatible with other offers or incentive programs. Consult your Chevrolet dealer for program compatibility and other restrictions. For complete program requirements, including information regarding offers, vehicles, equipment, options, warranties and ordering, consult your Chevrolet dealer. <sup>3</sup> Equipment from independent suppliers is not covered by the GM New Vehicle Limited Warranty. GM is not responsible for the safety or quality of independent supplier alterations.



SILVERADO 1500

## THE VERY DEFINITION OF WORK ETHIC.

There's over a century of science and sweat ingrained into Chevy Silverado. We've been doing this a long time, so we know what it takes. There are eight trims and a number of engine choices, including a powerful 2.7L Turbo available on WT. There's also an available 6.2L V8 that delivers best-in-class V8 towing<sup>1</sup> and an available Duramax<sup>®</sup> 3.0L Turbo-Diesel that offers 23 MPG city and an unsurpassed 33 highway<sup>2</sup>. And you won't find a pickup that works harder for you, thanks to best-in-class standard cargo bed volume and features like the new Multi-Flex Tailgate, available on all eight trim levels and providing six different functions to help improve loading, unloading and accessing the cargo bed.

<sup>1</sup> Class is Half-Ton Full-Size Pickup segment. Requires Silverado 1500 Double Cab Standard Bed RST 4x4 with available Max Trailering Package and 20" wheels.  
<sup>2</sup> EPA estimated 2WD.

Silverado 1500 Regular Cab Long Bed  
WT 2WD in Summit White.

## SILVERADO 1500

For more info, go to [Silverado 1500 Specifications and Dimensions](#).



New Multi-Flex Tailgate offers multiple ways to access the truck bed.

Available bed-mounted 120-volt power outlet.

With 8 available cameras, you have up to 15 camera views<sup>5</sup>

### SILVERADO 1500 HIGHLIGHTS

- Numerous engine choices, all designed specifically for trucks, including gas and diesel options
- 13,300 lbs. maximum available towing capability<sup>1</sup>
- 2,280 lbs. maximum available payload capacity<sup>2</sup>
- Durabed is designed with a roll-formed high-strength steel floor that's stronger, lighter and more durable than a traditional stamped steel floor
- The cargo area includes 12 standard tie-downs, with nine more available removable tie-downs from Chevrolet Accessories
- Durabed offers 89.1 cu. ft.<sup>3</sup> of cargo volume on Long Bed, 71.7 cu. ft.<sup>3</sup> on Standard Bed and 62.9 cu. ft.<sup>3</sup> on Short Bed
- The new Multi-Flex Tailgate is available and can be ordered on all eight trim levels and offers six different functions that are designed to help improve loading, unloading and accessing the cargo bed
- Available Work Truck Package that includes skid plates and a heavy-duty air filter with air filter monitor
- Safety Confidence Package, available on WT, Custom and Custom Trail Boss, includes Forward Collision Alert<sup>4</sup>; Automatic Emergency Braking<sup>4</sup>; Front Pedestrian Braking<sup>4</sup>; steering wheel-mounted controls and Driver Information Center with 4.2-inch diagonal color display



<sup>1</sup> Requires Silverado 1500 Double Cab Standard Bed RST 4x4 with available 6.2L V8 engine, Max Trailering Package and 20" wheels. Before you buy a vehicle or use it for trailering, carefully review the Trailering section of the Owner's Manual. The weight of passengers, cargo and options or accessories may reduce the amount you can tow. <sup>2</sup> Requires Silverado 1500 Regular Cab Long Bed 2WD with 2.7L Turbo engine. For comparison purposes only. See the Owner's Manual and the label on the vehicle door jamb for the carrying capacity of a specific vehicle. <sup>3</sup> Cargo and load capacity limited by weight and distribution. <sup>4</sup> Read the vehicle Owner's Manual for important feature limitations and information. <sup>5</sup> Read the vehicle Owner's Manual for more important feature limitations and information. Some camera views require available accessory camera and installation. Not compatible with all trailers. See your dealer for details.

## SILVERADO 1500 TOWING



# CONFIDENCE IS KEY.

Silverado offers integrated towing technology that delivers confidence and makes hauling big loads easy. It starts with the available Advanced Trailering Package that includes Hitch Guidance with Hitch View<sup>1</sup>, hitch area lighting, electric parking brake hookup assist, an integrated trailer brake controller, trailer theft alert, an in-vehicle Advanced Trailering System with myChevrolet Mobile App<sup>2</sup> and more. The available Advanced Trailering System has an In-Vehicle App<sup>3</sup> that offers customized trailer profiles. Other available features include predeparture checklists, trailer lighting diagnostics and trailer tire pressure/temperature monitoring.<sup>4</sup> New features include available Jack-Knife Alert,<sup>5</sup> Trailer Length Indicator,<sup>5</sup> Trailer Angle Indicator with Guidelines<sup>5</sup> and Bed View with Zoom and Bed Hitch Guidance<sup>1</sup>.

<sup>1</sup> Read the vehicle Owner's Manual for important feature limitations and information. <sup>2</sup> Available on select Apple and Android devices. Service availability, features and functionality vary by vehicle, vehicle equipment, trim level, device and the plan you are enrolled in. Some features may require a working electrical system. User terms apply. Device data connection required. Visit [onstar.com](http://onstar.com) for details and limitations. <sup>3</sup> App functionality and features vary with vehicle equipment and trim level. Data connection may be required. Some features require active service plan and working electrical system. User terms and limitations apply. <sup>4</sup> Requires available Trailer Tire Pressure Monitor Sensors. <sup>5</sup> Works with conventional box-type and camper trailers only. Some camera views require available accessory camera and installation. Not compatible with all trailers. Customers can see their dealer for full details. Read the vehicle Owner's Manual for important feature limitations and information.

**Silverado 1500 Crew Cab Short Bed  
High Country 4x4 in Oxford Brown  
Metallic with available features.**

## SILVERADO 1500 TOWING

Jack-Knife Alert warning (requires a compatible trailer) is included with the available Technology Package.

myChevrolet Mobile App with Trailing<sup>1</sup> syncs with the available Advanced Trailing System.

An integrated trailer brake controller is available.

Available Trailer Tire Pressure Monitoring System also checks tire temperature<sup>2</sup>

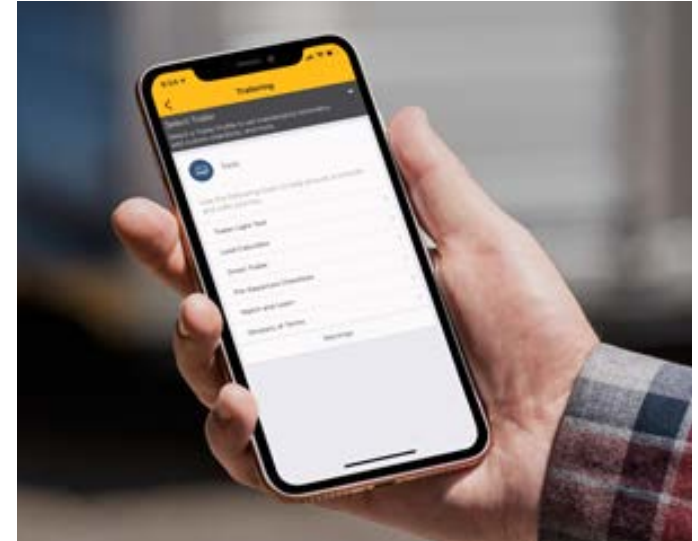

<sup>1</sup> Available on select Apple and Android devices. Service availability, features and functionality vary by vehicle, vehicle equipment, trim level, device and the plan you are enrolled in. Some features may require a working electrical system. User terms apply. Device data connection required. Visit [onstar.com](https://onstar.com) for details and limitations. <sup>2</sup> Requires available Trailer Tire Pressure Monitor Sensors.

# IT STARTS WITH A STRONG BACKBONE.

Silverado uses the right material in the right place to do the right job. That means high-strength steel in the frame, bed and safety cage and strong, lightweight aluminum in the doors, hood and tailgate, with everything optimized for durability, safety, mass and function.

The **frame is light**, but has great torsional rigidity. As much as 80% of the frame is made of high-strength steel.

Even with a long wheelbase, a wide, tall stance, and loads of cargo volume, Silverado is impressively aerodynamic. That's because Chevrolet engineers spent over 500 hours in the wind tunnel, testing airflow around the vehicle. All this testing paid off: Silverado is the most aerodynamic full-size pickup in Chevrolet history.



The **independent short/long arm front suspension** provides excellent wheel alignment, ride comfort and tunability with reduced weight. The live axle rear suspension includes 2-stage, semi-elliptic multileaf springs to strike a balance between payload management and ride quality.

Silverado 4x4 models offer **two Autotrac® transfer cases**. The 2-speed transfer case (standard on Trail Boss

models and High Country; included with the Z71 Off-Road Package on other models) features Auto, 2 High, 4 High and 4 Low settings. The single-speed transfer case (standard on WT, Custom, LT, RST and LTZ) offers Auto, 2 High and 4 High. It also includes a Driver Mode Selector with Terrain mode, designed to optimize low-speed off-road driving.

The available **Driver Mode Selector** allows you to choose different drive

modes (based on the vehicle's equipment) that alter the throttle and traction systems to better handle varying road conditions.

Normal is for everyday driving; Sport is useful during quick driving maneuvers; Tow/Haul aids in trailering; Snow is helpful in slippery conditions; Terrain optimizes low-speed driving over rough terrain; and Off-Road helps on grass, gravel, dirt and snow-covered roads.

An **electro-hydraulic boost** or "e-boost" system produces on-demand power for smooth, reliable, consistent braking whether the truck is loaded, unloaded or hauling a heavy trailer. And the Duralife coating helps increase rotor life.



## SILVERADO 1500 TECHNOLOGY

Available features include up to six USB ports<sup>1</sup> and a 120-volt power outlet.

Available wireless Apple CarPlay<sup>®2</sup> (shown) and wireless Android Auto<sup>™3</sup> compatibility.

Available Rear Camera Mirror<sup>4</sup>

Available Chevrolet Infotainment 3 Premium system<sup>5</sup> with Navigation<sup>6</sup>



<sup>1</sup> Not compatible with all devices. <sup>2</sup> Vehicle user interface is a product of Apple and its terms and privacy statements apply. Requires compatible iPhone and data plan rates apply. <sup>3</sup> Vehicle user interface is a product of Google and its terms and privacy statements apply. Requires the Android Auto app on Google Play and a compatible Android smartphone. Data plan rates apply. You can check which smartphones are compatible at [g.co/androidauto/requirements](http://g.co/androidauto/requirements). <sup>4</sup> Read the vehicle Owner's Manual for important feature limitations and information. <sup>5</sup> Chevrolet Infotainment System functionality varies by model. Full functionality requires compatible Bluetooth and smartphone, and USB connectivity for some devices. <sup>6</sup> Map coverage available in the United States, Puerto Rico and Canada.

Apple CarPlay, iPhone, Siri and Apple Music are trademarks of Apple Inc., registered in the U.S. and other countries. Android and Android Auto are trademarks of Google LLC.

SILVERADO HD



## THE STRONGEST, MOST CAPABLE SILVERADO HD EVER.

That headline isn't just words on a page. It's something the 2021 Chevrolet Silverado HD has earned. Purpose-built to handle your biggest jobs, with strength and bold style to spare. Powertrain options that finish every workday, then ask for overtime. The ability to pull up to 36,000 lbs<sup>1</sup> (18,050 lbs. as shown) or carry up to 7,442 lbs<sup>2</sup> of payload is available, with advanced trailering technologies designed to make a long day of towing easy. Not to mention the hardworking, highly functional Durabed. The bottom line: Silverado HD is an MVP for any business need.

<sup>1</sup> Requires Silverado 3500 HD Regular Cab Long Bed WT 2WD DRW with available Duramax 6.6L Turbo-Diesel V8 engine, Max Trailering Package and gooseneck hitch. Before you buy a vehicle or use it for trailering, carefully review the Trailering section of the Owner's Manual. The weight of passengers, cargo and options or accessories may reduce the amount you can tow. <sup>2</sup> Requires Silverado 3500 HD Regular Cab Long Bed 2WD DRW. For comparison purposes only. See the Owner's Manual and the label on the vehicle door jamb for the carrying capacity of a specific vehicle.

**Silverado 2500 HD Crew Cab Standard Bed WT in Silver Ice Metallic with available Duramax 6.6L Turbo-Diesel V8 engine and additional available features.**

## SILVERADO HD

For more info, go to [Silverado HD Specifications and Dimensions](#).



### SILVERADO HD HIGHLIGHTS

- 6.6L V8 gas engine with Direct Injection and Variable Valve Timing, 401 horsepower and 464 lb.-ft. of torque and 6-speed transmission
- Available Duramax 6.6L Turbo-Diesel V8 engine with 445 horsepower and 910 lb.-ft. of torque and Allison® 10-speed automatic transmission
- 36,000 lbs. of maximum towing capability<sup>1,2</sup> with available Duramax 6.6L Turbo-Diesel V8
- 17,370 lbs. of maximum towing capability<sup>2,3</sup> with 6.6L V8 gas engine
- Maximum payload of 7,442 lbs.<sup>4,5</sup>
- Standard Durabed with a roll-formed high-strength steel floor that's stronger, lighter and more durable than a traditional stamped steel floor
- 12 standard tie-downs all rated to 500 lbs.<sup>5</sup> per corner in any direction
- Safety Confidence Package, available on 2500 HD WT and Custom and 3500 HD WT, includes Forward Collision Alert,<sup>6</sup> Automatic Emergency Braking,<sup>6</sup> cruise control, steering wheel-mounted controls and Driver Information Center with 4.2-inch diagonal color display



The available Gooseneck/5th Wheel Package includes just about everything you need to start pulling big trailers.

Available on 4x4 models, the Snow Plow Prep/Camper Package makes snow plow installation easier than ever. Shown below with upfit from an independent supplier.<sup>7</sup>

Silverado HD interior features abundant storage areas.

<sup>1</sup> Requires Silverado 3500 HD Regular Cab Long Bed 2WD DRW with available Duramax 6.6L Turbo-Diesel V8, Max Trailering Package and gooseneck hitch. <sup>2</sup> Before you buy a vehicle or use it for trailering, carefully review the Trailering section of the Owner's Manual. The weight of passengers, cargo and options or accessories may reduce the amount you can tow. <sup>3</sup> Requires Silverado 2500 HD Regular Cab Long Bed with 17" wheels and available gooseneck/fifth-wheel hitch. <sup>4</sup> Requires Silverado 3500 HD Regular Cab Long Bed 2WD DRW. <sup>5</sup> These maximum payload ratings are intended for comparison purposes only. Before you buy a vehicle or use it to haul people or cargo, carefully review the Vehicle Loading section of the Owner's Manual and check the carrying capacity of your specific vehicle on the label on the inside of the driver door jamb. <sup>6</sup> Read the vehicle Owner's Manual for important feature limitations and information. <sup>7</sup> Shown with upfit from an independent supplier. Equipment from independent suppliers is not covered by the GM New Vehicle Limited Warranty. GM is not responsible for the safety or quality of independent supplier alterations.

## SILVERADO HD TOWING



# CONFIDENT AND IN CONTROL.

Silverado 3500 HD Crew Cab Long Bed  
LT 2WD DRW in Black with available  
Duramax 6.6L Turbo-Diesel V8 engine  
and additional available features.

Looking for big numbers? Silverado HD with the available Duramax 6.6L Turbo-Diesel V8 engine tows up to 36,000 lbs.<sup>1,2</sup> Here's something else.

Every Silverado HD Dually pickup with the available Duramax 6.6L V8 can pull over 30,000 lbs.<sup>2</sup> There's also tons of advanced towing tech to give you peace

of mind when you're towing a heavy load. Because Silverado HD doesn't just provide capability – it delivers confidence every time you hitch up.

<sup>1</sup> Requires Silverado 3500 HD Regular Cab Long Bed WT 2WD DRW with available Duramax 6.6L Turbo-Diesel V8 engine, Max Trailering Package and gooseneck hitch.  
<sup>2</sup> Before you buy a vehicle or use it for trailering, carefully review the Trailering section of the Owner's Manual. The weight of passengers, cargo and options or accessories may reduce the amount you can tow.

## SILVERADO HD TOWING

Jack-Knife Alert warning (requires a compatible trailer), standard on High Country and available on LTZ!

myChevrolet Mobile App with Trailing<sup>2</sup> syncs with the available Advanced Trailing System.

Trailing mirrors are standard on every Silverado HD.

Bed View<sup>3</sup> allows you to see the cargo bed to help with fifth-wheel or gooseneck hitching or to briefly check on cargo. Cargo Bed Zoom and Bed Hitch Guidance are new additions for the 2021 model year.

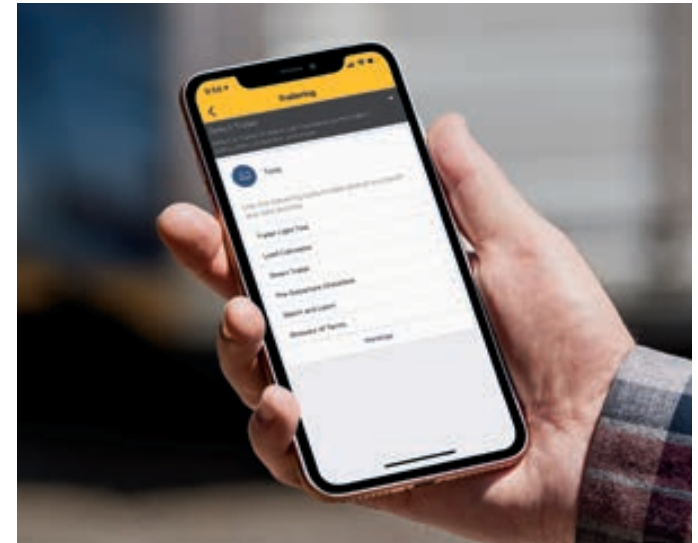

<sup>1</sup> Requires available LTZ Convenience Package II. <sup>2</sup> Available on select Apple and Android devices. Service availability, features and functionality vary by vehicle, vehicle equipment, trim level, device and the plan you are enrolled in. Some features may require a working electrical system. User terms apply. Device data connection required. Visit [onstar.com](https://onstar.com) for details and limitations. <sup>3</sup> Safety or driver assistance features are no substitute for the driver's responsibility to operate the vehicle in a safe manner. The driver should remain attentive to traffic, surroundings and road conditions at all times. Visibility, weather and road conditions may affect feature performance. Read the vehicle Owner's Manual for more important feature limitations and information.

# CORE STRENGTH.

Under the sheet metal is where Silverado HD truly excels.

Every element was designed to deliver our best heavy-duty truck ever. To make that happen, we used seven different types of steel, with each gauge chosen to maximize capability. That means we used the right material in the right place to help do the right job.

Everything about this truck has been optimized for durability and dependability to help ensure you're driving the strongest, most capable Silverado HD ever.



To create a solid structure that stands up to heavy-duty usage, we used a combination of **high-strength and ultra-high-strength steel** throughout the cab and frame.

Silverado HD features a **fully boxed ladder-type frame** with nine high-strength steel cross members, making it strong and stiff to deliver a more confident towing experience and maximize load-hauling capability.

Heavy-duty capability requires enhanced cooling. On models with the available Duramax 6.6L Turbo-Diesel V8 engine, you'll find a massive **28-inch cooling fan** to meet the high cooling demands that come with pulling big loads.

The **integral front-end structure** provides notable advantages by reducing mass and improving ride and handling. It also helps manage noise and vibration and crash impact forces.

Every Silverado HD features **robust axles** to handle heavy loads. In fact, the ring gear in the rear axle on 3500 HD models with the available Duramax 6.6L Turbo-Diesel V8 engine measures a full 12 inches to help deliver all 910 lb.-ft. of torque in first gear.

**Large-diameter front and rear prop shafts** and strong U-joints have been optimized to handle high torque output and improve durability.

The **electric parking brake** introduces two major benefits: Steep Grade Apply, which engages on grades greater than 15% when the driver shifts into Park for additional brake support, and Park Grade Hold Assist, which enhances Hill Hold to help keep your truck firmly in place on inclines or declines of 8% or more. Both features keep the transmission linkage from binding so you can more easily shift into gear after being parked on a steep grade.

## SILVERADO HD TECHNOLOGY

Available Head-Up Display.

Available power-up/-down tailgate lets you easily raise or lower the tailgate using the key fob.

With a compatible trailer attached and a turn signal activated, the available Rear Side View Camera display will show a full screen down the side of the truck along with a Trailer Length Indicator<sup>1</sup> to aid in lane-change maneuvers by visually showing obstructions with the trailer in adjacent lanes.

Available 120-volt bed outlet.



<sup>1</sup> Safety or driver assistance features are no substitute for the driver's responsibility to operate the vehicle in a safe manner. The driver should remain attentive to traffic, surroundings and road conditions at all times. Visibility, weather and road conditions may affect feature performance. Read the vehicle Owner's Manual for more important feature limitations and information. Not compatible with all trailers. Customers can see their dealer for full details.

## SILVERADO 3500 HD CHASSIS CAB



# BORN TO HAUL.

Silverado 3500 HD Chassis Cab remains strong and capable for any job you throw its way. Both Chassis Cab and Box Delete models provide a solid platform for the upfits<sup>1</sup> you need to run your business. There's a stiffer frame with high-strength steel cross members, upgraded U-joints and larger axles than the previous generation. You'll also find an abundance of power and payload capacity with a choice of a 6.6L V8 gas engine or a Duramax 6.6L Turbo-Diesel V8 engine, the latter paired with an Allison<sup>®</sup> 10-speed automatic transmission.

<sup>1</sup> Shown with upfit from an independent supplier. Equipment from independent suppliers is not covered by the GM New Vehicle Limited Warranty. GM is not responsible for the safety or quality of independent supplier alterations.

Silverado 3500 HD Regular Cab  
Chassis Cab Work Truck 4x4 in  
Silver Ice Metallic, shown with an  
upfit from an independent supplier!



## SILVERADO 3500 HD CHASSIS CAB

For more info, go to [Silverado 3500 HD Chassis Cab Specifications and Dimensions.](#)



### 3500 HD CHASSIS CAB HIGHLIGHTS

- 6.6L V8 gas engine with 401 horsepower and 464 lb.-ft. of torque and 6-speed automatic transmission
- Available Duramax 6.6L Turbo-Diesel V8 with 910 lb.-ft. of torque with standard exhaust brake and Allison® 10-speed automatic transmission
- Integrated PTO capability available with the Duramax 6.6L Turbo-Diesel V8 and Allison 10-speed transmission
- Available in Regular Cab or Crew Cab models, with a choice of two wheelbases for Regular Cab models
- Robust frame with high-strength steel cross members
- Larger axles with a 12" ring gear on Turbo-Diesel models
- Automatic locking rear differential
- GVWR of 14,000 lbs<sup>1</sup>
- Three fuel tank options – front, rear or combined – for an available total fuel capacity of 63.5 gallons



Silverado 3500 HD Crew Cab Chassis Cab LT with a service body upfit from an independent supplier<sup>2</sup>

Silverado 3500 HD Regular Cab Chassis Cab LT with a stake body upfit from an independent supplier<sup>2</sup>

Silverado interior provides plenty of storage compartments and comfort amenities.



<sup>1</sup> Maximum Gross Vehicle Weight Rating (GVWR). When properly equipped; includes weight of vehicle, passengers, cargo and equipment. <sup>2</sup> Shown with upfit from an independent supplier. Equipment from independent suppliers is not covered by the GM New Vehicle Limited Warranty. GM is not responsible for the safety or quality of independent supplier alterations.

SILVERADO 4500 HD/5500 HD/6500 HD



# ANYTHING LESS JUST ISN'T ENOUGH.

The Silverado 4500 HD, 5500 HD and 6500 HD Chassis Cabs can shoulder the heavy loads with a wide variety of chassis options to provide plenty of upfit<sup>1</sup> flexibility for your business needs. Excellent maneuverability and forward visibility, along with multiple cab-to-axle options and GVWRs, help make the toughest work easier to tackle. Because when it comes to the job, the only word that matters is: done.

<sup>1</sup> Shown with upfit from an independent supplier. Equipment from independent suppliers is not covered by the GM New Vehicle Limited Warranty. GM is not responsible for the safety or quality of independent supplier alterations.

Silverado 5500 HD Regular Cab LT  
4x4 in Summit White with available  
features, shown with an upfit  
from an independent supplier!

## SILVERADO 4500 HD/5500 HD/6500 HD

For more info, go to [Silverado 4500 HD/5500 HD/6500 HD Specifications and Dimensions.](#)



Silverado 5500 HD Crew Cab with a utility upfit from an independent supplier<sup>2</sup>

Silverado 6500 HD Regular Cab with a dump truck upfit from an independent supplier<sup>2</sup>

### 4500 HD, 5500 HD AND 6500 HD CHASSIS CAB HIGHLIGHTS

- Duramax 6.6L Turbo-Diesel V8 engine optimized for medium-duty applications with 350 horsepower and 700 lb.-ft. of torque
- Allison® 6-speed close-ratio transmission with double overdrive designed for medium-duty applications
- Standard exhaust brake
- GVWRs up to 23,500 lbs!<sup>1</sup>
- Single-piece straight frame rails with no welds or brackets and a clean top-of-rail design to make upfitting simple and efficient
- Eight cab-to-axle options, 10 wheelbase options and five axle-to-end-of-frame options
- Three levels of available fuel capacity – a standard 40-gallon rear tank, an available 25-gallon front tank or both – provide a combined total capacity of 65 gallons
- Up to 50-degree wheel cut for impressive maneuverability
- Available heavy-duty locking rear differential
- Available rear air suspension for better ride and easier loading/unloading



<sup>1</sup> Silverado 6500 HD. Maximum Gross Vehicle Weight Rating (GVWR). When properly equipped; includes weight of vehicle, passengers, cargo and equipment. <sup>2</sup> Shown with upfit from an independent supplier. Equipment from independent suppliers is not covered by the GM New Vehicle Limited Warranty. GM is not responsible for the safety or quality of independent supplier alterations.

**SILVERADO 4500 HD/5500 HD/6500 HD**

Silverado 6500 HD Regular Cab LT with box truck upfit from an independent supplier!

Silverado 5500 HD Regular Cab LT with snow plow and salt spreader upfits from an independent supplier!

Silverado 6500 HD Regular Cab LT and Silverado 5500 HD Crew Cab LT, both with available features and upfits from independent suppliers!



<sup>1</sup> Shown with upfit from an independent supplier. Equipment from independent suppliers is not covered by the GM New Vehicle Limited Warranty. GM is not responsible for the safety or quality of independent supplier alterations.

**SILVERADO 4500 HD/5500 HD/6500 HD**

Clamshell engine cover provides easy walk-up engine access.

There are seven different cab-to-axle options ranging from 60 to 162 inches.

The battery box is conveniently located underneath the driver door.



COLORADO



## ALL-STAR UTILITY PLAYER.

Colorado offers on-the-job capability in a smaller, more maneuverable size. It's built with hardworking truck attributes like a fully boxed high-strength steel frame with seven cross members and powerful engines that include an available 308-horsepower 3.6L V6 or an available Duramax 2.8L Turbo-Diesel with 369 lb.-ft. of torque. Colorado also offers truck-proven technologies like Electric Power Steering, StabiliTrak® Electronic Stability Control System and Auto Grade Braking.

<sup>1</sup> Chevrolet Accessories are dealer-installed and covered by the GM 3-year/36,000-mile (whichever comes first) New Vehicle Limited Warranty when ordered with your new Colorado. See your dealer for details.

Colorado Crew Cab Long Box WT  
in Summit White with available  
features and dealer-installed  
Chevrolet Accessories!

## COLORADO

For more info, go to [Colorado Specifications and Dimensions.](#)



### COLORADO HIGHLIGHTS

- Three engines to choose from:
  - 2.5L direct injected 4-cylinder engine with 200 horsepower and 6-speed automatic transmission
  - Available 3.6L direct injected DOHC V6 engine with 308 horsepower and 275 lb.-ft. of torque and 8-speed automatic transmission
  - Available Duramax 2.8L Turbo-Diesel I-4 engine with 181 horsepower and 30 MPG highway<sup>1</sup> and 6-speed automatic transmission
- Standard CornerStep rear bumper
- Maximum payload of 1,550 lbs<sup>2</sup> with available 3.6L engine
- Available Z82 Trailing Package and integrated trailer brake controller
- Available automatic locking rear differential
- 4-wheel antilock disc brakes with Duralife rotors
- Four standard fixed lower tie-downs with an additional 13 available
- Available factory-installed spray-on bedliner
- Fleet Safety Package<sup>3</sup> available on LT, includes Forward Collision Alert<sup>4</sup>, Lane Departure Warning<sup>4</sup> and Automatic Emergency Braking<sup>4</sup>



With the available Duramax 2.8L Turbo-Diesel engine, Colorado can tow up to 7,700 lbs<sup>5</sup>

Standard rear underseat storage on Extended Cab models.

Rear seatbacks on Crew Cab models fold down for extra storage space.



<sup>1</sup> EPA-estimated MPG city/highway: Colorado 2WD with available Duramax 2.8L Turbo-Diesel engine 20/30. <sup>2</sup> Requires Colorado Crew Cab Short Box WT 4x4 with available 3.6L V6 engine. These maximum payload ratings are intended for comparison purposes only. Before you buy a vehicle or use it to haul people or cargo, carefully review the Vehicle Loading section of the Owner's Manual and check the carrying capacity of your specific vehicle on the label on the inside of the driver door jamb.

<sup>3</sup> Restrictions apply. See your dealer for details. <sup>4</sup> Read the vehicle Owner's Manual for important feature limitations and information. <sup>5</sup> Requires Colorado Crew Cab Short Box LT 2WD with available Trailing Package, LT Convenience Package and Safety Package. Before you buy a vehicle or use it for trailering, carefully review the Trailering section of the Owner's Manual. The weight of passengers, cargo and options or accessories may reduce the amount you can tow.

## EXPRESS CARGO VAN



# PROVEN DESIGN. DEPENDABLE PARTNER.

For many businesses, there's no substitute for a hardworking full-size van. Express 2500 and 3500 vans give you what matters most – a choice of strong powertrains, an easily configurable cargo bay, over 280 cubic feet of cargo space<sup>1</sup> and a standard-height roof that provides easy access to parking garages and takes the worry out of backing up in unfamiliar low-clearance areas. New for 2021 is an available 6.6L V8 gas engine with 401 horsepower and 464 lb.-ft. of torque.

<sup>1</sup> Express Cargo Van with Extended Wheelbase. Cargo and load capacity limited by weight and distribution.

Express 3500 Extended Wheelbase  
Cargo Van in Summit White with  
available features.



## EXPRESS CARGO VAN

For more info, go to [Express Cargo Van Specifications and Dimensions](#).



Standard wide-opening rear doors provide easy access to a massive amount of cargo space<sup>5</sup>

### EXPRESS CARGO VAN HIGHLIGHTS

- Standard 4.3L V6 engine with 276 horsepower and 298 lb.-ft. of torque, includes oil life monitor
- Newly available 6.6L V8 gas engine with 401 horsepower and 464 lb.-ft. of torque and 6-speed transmission
- Available Duramax 2.8L Turbo-Diesel engine with 181 horsepower and 369 lb.-ft. of torque with standard exhaust brake
- Full-frame design for strength and durability
- Up to 10,000 lbs<sup>1</sup> of towing capability
- Maximum payload capacity of 4,280 lbs<sup>2</sup>
- Standard StabiliTrak Electronic Stability Control System
- Available heavy-duty automatic locking rear differential
- Up to 283.6 cu. ft. of cargo space<sup>3</sup>
- Six standard D-ring cargo tie-downs
- Available safety features include Forward Collision Alert<sup>4</sup>, Lane Departure Warning<sup>4</sup>, Side Blind Zone Alert<sup>4</sup> and Rear Park Assist<sup>4</sup>



<sup>1</sup> With available 6.6L V8 gas engine. Before you buy a vehicle or use it for trailering, carefully review the Trailering section of the Owner's Manual. The weight of passengers, cargo and options or accessories may reduce the amount you can tow. <sup>2</sup> Express 3500 Cargo Van with 4.3L V6 engine and 135" wheelbase. These maximum payload ratings are intended for comparison purposes only. Before you buy a vehicle or use it to haul people or cargo, carefully review the Vehicle Loading section of the Owner's Manual and check the carrying capacity of your specific vehicle on the label on the inside of the driver door jamb. <sup>3</sup> Express Cargo Van with Extended Wheelbase. Cargo and load capacity limited by weight and distribution. <sup>4</sup> Read the vehicle Owner's Manual for important feature limitations and information. <sup>5</sup> Cargo and load capacity limited by weight and distribution.

## EXPRESS PASSENGER VAN



# A LARGE VAN THAT MOVES SMALL CROWDS.

Express Passenger Van is built to haul people, with a choice of 12- or 15-passenger seating, depending on model. Standard features like a StabiliTrak Electronic Stability Control System, a Tire Pressure Monitoring System<sup>1</sup> and antilock brakes let you travel with confidence. Express Passenger Van's proven design means you can count on dependable service. Technology features like a 120-volt power outlet, available 4G LTE Wi-Fi<sup>®</sup> Hotspot<sup>2</sup> and an available USB port<sup>3</sup> can help keep passengers entertained during trips.

<sup>1</sup> Does not monitor spare tire. <sup>2</sup> Service varies with conditions and location. Requires active service plan and paid AT&T data plan. Visit [onstar.com](http://onstar.com) for details and limitations. Availability subject to change. <sup>3</sup> Not compatible with all devices.

**Express 3500 Extended Wheelbase Passenger Van in Silver Ice Metallic with available features.**

## EXPRESS PASSENGER VAN

For more info, go to [Express Passenger Van Specifications and Dimensions](#).



Express Passenger Van is a practical choice for mobility and paratransit conversions?

Standard seating for 12 passengers and available seating for 15 with Extended Wheelbase.

### EXPRESS PASSENGER VAN HIGHLIGHTS

- Standard seating for 12 passengers
- Available seating for 15 with Extended Wheelbase
- Standard rear passenger air conditioning
- Standard 4.3L V6 engine with 276 horsepower and 298 lb.-ft. of torque, includes oil life monitor
- Newly available 6.6L V8 gas engine with 401 horsepower and 464 lb.-ft. of torque and 6-speed transmission
- Available Duramax 2.8L Turbo-Diesel engine with 181 horsepower and 369 lb.-ft. of torque with standard exhaust brake
- Available heavy-duty automatic locking rear differential
- Standard StabiliTrak Electronic Stability Control System
- Standard 4-wheel antilock disc brakes
- Standard Rear Vision Camera<sup>1</sup>
- Available safety features include Forward Collision Alert<sup>1</sup>; Lane Departure Warning<sup>1</sup>; Side Blind Zone Alert<sup>1</sup> and Rear Park Assist<sup>1</sup>



<sup>1</sup> Read the vehicle Owner's Manual for important feature limitations and information. <sup>2</sup> Equipment from independent suppliers is not covered by the GM New Vehicle Limited Warranty. GM is not responsible for the safety or quality of independent supplier alterations.

**EXPRESS CUTAWAY**



## **CUT OUT FOR ANY SIZE DELIVERY.**

If you need additional volume and capacity over a traditional van and still want ease and convenience for the operator, check out Express Cutaway. The full-frame design of Express Cutaway can handle a wide variety of upfits<sup>1</sup>, including service/utility, cube body or shuttle bus. Its robust construction is strong, versatile and proven. The perimeter frame provides a stable platform for a confident driving experience and many years of durability. Express Cutaway is cut out to be the right choice for whatever you have in mind.

<sup>1</sup> Shown with upfit from an independent supplier. Equipment from independent suppliers is not covered by the GM New Vehicle Limited Warranty. GM is not responsible for the safety or quality of independent supplier alterations.

**Express 4500 Cutaway in Summit  
White, shown with an upfit from  
an independent supplier!**

## EXPRESS CUTAWAY

For more info, go to [Express Cutaway Specifications and Dimensions](#).



Express 4500 models feature dual rear wheels for heavier applications.

Utility truck upfits are available in multiple configurations from independent upfitters<sup>2</sup>

### EXPRESS 3500 AND 4500 CUTAWAY HIGHLIGHTS

- Standard 4.3L V6 engine with 276 horsepower and 298 lb.-ft. of torque
- Newly available 6.6L V8 gas engine with 401 horsepower and 464 lb.-ft. of torque and heavy-duty 6-speed transmission
- Available GVWR up to 14,200 lbs<sup>1</sup>
- Full ladder-type frame design for strength and durability
- Up to three different available wheelbase lengths – 139", 159" and 177"
- Available automatic locking rear differential
- StabiliTrak Electronic Stability Control System
- Hill Start Assist
- 4-wheel antilock disc brakes



<sup>1</sup> Express 4500 Cutaway. Maximum Gross Vehicle Weight Rating (GVWR). When properly equipped; includes weight of vehicle, passengers, cargo and equipment. <sup>2</sup> Shown with upfit from an independent supplier. Equipment from independent suppliers is not covered by the GM New Vehicle Limited Warranty. GM is not responsible for the safety or quality of independent supplier alterations.

## LOW CAB FORWARD



# FOR BIG LOADS IN TIGHT SPACES.

From construction to landscaping to wholesale delivery, Low Cab Forward trucks offer a smarter way to work, with a high level of maneuverability, low cost of ownership and remarkable reliability. The agile cab-over design makes them perfect in congested urban areas or tight jobsites where visibility is key. From the powerful 6500 XD to the city-friendly 3500, Chevy Low Cab Forward offers an efficient and dependable lineup featuring Regular Cab and Crew Cab configurations with a choice of gas or diesel engine and a wide range of wheelbases and upfits!

<sup>1</sup> Shown with upfit from an independent supplier. Equipment from independent suppliers is not covered by the GM New Vehicle Limited Warranty. GM is not responsible for the safety or quality of independent supplier alterations.

**Low Cab Forward 4500 Regular Cab  
in Arc White, shown with an upfit  
from an independent supplier!**

## LOW CAB FORWARD

For more info, go to [Low Cab Forward Specifications and Dimensions](#).



Low Cab Forward 6500 XD Regular Cab with an upfit from an independent supplier!

Low Cab Forward trucks come in a choice of wheelbases for your professional needs.

### LOW CAB FORWARD HIGHLIGHTS

- 3500 and 4500:
  - 6.6L V8 gasoline engine
  - 6-speed automatic transmission with double overdrive
  - 350 horsepower and 425 lb.-ft. of torque
  - Available in Regular Cab and Crew Cab configurations
- 4500 HD, 4500 XD, 5500 HD and 5500 XD:
  - 5.2L I-4 Turbo-Diesel engine
  - 6-speed automatic transmission with double overdrive
  - 215 horsepower and 452 lb.-ft. of torque
  - Available in Regular Cab and Crew Cab configurations
- 6500 XD:
  - 5.2L I-4 Turbo-Diesel engine
  - Allison® 2550 Rugged Duty Series (RDS) 6-speed automatic transmission with double overdrive
  - 215 horsepower and 520 lb.-ft. of torque
  - Available in Regular Cab
- Ladder-type frame with single-piece straight frame rails for strength and durability features standardized modular hole spacing and a clean, flat top for easier body mounting/upfit<sup>1</sup>
- GVWRs up to 25,950 lbs<sup>2</sup>
- Available in a range of wheelbases for body applications ranging from 10 ft. to 30 ft.
- Standard cornering lamps



<sup>1</sup> Shown with upfit from an independent supplier. Equipment from independent suppliers is not covered by the GM New Vehicle Limited Warranty. GM is not responsible for the safety or quality of independent supplier alterations. <sup>2</sup> Low Cab Forward 6500 XD. Maximum Gross Vehicle Weight Rating (GVWR). When properly equipped; includes weight of vehicle, passengers, cargo and equipment.

# PUBLIC SERVICE VERSATILITY.

All vehicles shown with  
aftermarket equipment.

Chevrolet commands authority with its formidable lineup of diverse, reliable Police Pursuit Vehicles (PPV) and Special Service Vehicles (SSV). Designed to help protect those who protect us, each vehicle offers cutting-edge safety features and impressive cargo capacity.

**Tahoe.** Tahoe PPV is the full-size, no-compromise officers' patrol vehicle and the only pursuit-rated, police-rated body-on-frame SUV. The available Rear Camera Mirror<sup>1</sup> provides a wide view that would normally be obstructed by partitions or K-9 inserts.

**Silverado.** Silverado SSV offers unique specialty equipment options such as spot lamps, a standard surveillance mode circuit, a high-output alternator and a 110-volt power supply in the cargo bed.

**Express Passenger Van.** Chevrolet Express is ideal for prisoner transport with its traditional roof height,

equipment transfers and ease of access to sally ports or garages.

**Malibu and Traverse.** Malibu and Traverse Fleet Packages offer a comprehensive list of available safety and driver assistance features to help your plainclothes officers stay alert while detecting potential hazards.

<sup>1</sup> Safety or driver assistance features are no substitute for the driver's responsibility to operate the vehicle in a safe manner. The driver should remain attentive to traffic, surroundings and road conditions at all times. Visibility, weather and road conditions may affect feature performance. Read the vehicle Owner's Manual for important feature limitations and information.



## ELECTRIC

Bolt EV combines electric efficiency with ample interior space.

### ELECTRIC FUTURE

Tremendous changes are occurring at Chevrolet as we shift to an all-electric future. This spells good news for commercial vehicle operators who are considering electric vehicles for their fleets. Right now, depending on which state you live in, your business could also qualify for additional state tax incentives. EV incentives vary by state and are subject to change. Check your state's website for details. Also, talk with your electricity provider about additional savings and rebates in your area.



### BOLT EV

Running an efficient business for some may come down to an ultra-efficient car for deliveries around the city. The 2021 Bolt EV offers an EPA-estimated 259 miles of range<sup>1</sup> on a full charge as well as less maintenance than a gas vehicle, since you don't need to worry about oil changes, transmission fluid flushes or spark plug replacement. That means you'll have all the range you need for your daily routes and you won't be spending any time – or money – at the pump.



<sup>1</sup> EPA-estimated 259-mile EV range. Your actual range may vary based on several factors, including temperature, terrain, battery age, and how you use and maintain your vehicle.

## SPARK

Spark is a small car that's perfect for urban deliveries or just getting around the city. It's not only fun to drive, it also fits almost anywhere you need to go with space for associates and smaller cargo. Available smart technology helps keep you connected along the way. And with an EPA-estimated 38 MPG highway,<sup>1</sup> the 2021 Spark keeps your business running.

## MALIBU

With a sophisticated appearance and remarkable driving dynamics, the 2021 Malibu could be an excellent tool for your sales force. Malibu is ready to take you wherever the road leads. The turbocharged RS makes an emphatic statement, and Premier surrounds you with all-encompassing luxuries. Prepare to be impressed, because everything about Malibu reflects your good taste.

Top: Spark offers great value and versatility.

Bottom: Malibu seats five in comfort and style.



<sup>1</sup> Spark has an EPA-estimated 29 MPG city/38 highway with 5-speed manual transmission and 30 MPG city/38 highway with available Continuously Variable Transmission (CVT). Spark ACTIV has an EPA-estimated 29 MPG city/37 highway with 5-speed manual transmission and 30 MPG city/37 highway with available CVT.

## TAHOE

The most versatile and advanced Tahoe ever includes 122.9 cu. ft. of maximum cargo volume<sup>1</sup> and a third row that offers up to 10 inches more leg room. Tahoe also features an available Four-Corner Air Ride Adaptive Suspension. Add in powerful engines, including the available Duramax 3.0L Turbo-Diesel, a host of standard advanced safety features and numerous driver assistance technologies, and it's evident that Tahoe will be a valuable asset to your business.



Top: Tahoe offers abundant cargo space plus room for up to nine passengers<sup>2</sup>

Bottom: Suburban offers nine-passenger seating<sup>2</sup> with as much as 144 cu. ft. of cargo space<sup>1</sup>

## SUBURBAN

The longest-selling full-size SUV is more spacious, with increased second- and third-row leg room and up to 144.7 cu. ft. of maximum cargo volume! It's forward-thinking, with available features like a best-in-class Rear-Seat Media System and first-in-class Power Sliding Center Console. And it's more versatile, with available features that include a Four-Corner Air Ride Adaptive Suspension and powerful engines – including the Duramax 3.0L Turbo-Diesel.



<sup>1</sup> With second- and third-row seats folded flat. Cargo and load capacity limited by weight and distribution. <sup>2</sup> Nine-passenger seating available on LS with front 40/20/40 split-bench seat.

## SUVS

**Top:** Every Chevrolet Blazer, Equinox and Trax offers five-passenger seating and the convenience of split-folding rear seats.

**Bottom:** Trailblazer offers surprising storage flexibility, while Traverse can tow up to 5,000 lbs<sup>5</sup>, when properly equipped.



## SUVS

**Blazer.** Seats up to five. With the rear seats folded flat, offers up to 64.2 cu. ft. of maximum cargo space!<sup>1</sup>

**Equinox.** Seats up to five. With the rear seats folded flat, offers up to 63.9 cu. ft. of maximum cargo space!<sup>1</sup>

**Trax.** Seats up to five. With the rear seats folded flat, offers up to 48.4 cu. ft. of maximum cargo space<sup>1</sup> and can carry items up to 8 ft. long with the fold-flat front passenger seat.

**Trailblazer.** Seats up to five. With the rear seats folded flat, offers up to 54.4 cu. ft. of maximum cargo space<sup>1</sup> and can carry items up to 8.5 ft. long with the fold-flat front passenger seat.<sup>2</sup>

**Traverse.** Seats up to eight.<sup>3</sup> With the rear seats folded flat, offers up to a best-in-class<sup>4</sup> 98.2 cu. ft. of maximum cargo space!



<sup>1</sup> Cargo and load capacity limited by weight and distribution. <sup>2</sup> Fold-flat front-passenger seat not available on Trailblazer L. <sup>3</sup> Seating for eight is standard on L and LS; available on LT with second-row 60/40 split-bench seat. RS, Premier and High Country seat seven. <sup>4</sup> Class is Mid SUV segment. <sup>5</sup> With available trailering equipment. Before you buy a vehicle or use it for trailering, carefully review the Trailering section of the Owner's Manual. The weight of passengers, cargo and options or accessories may reduce the amount you can tow.

## SILVERADO 1500 MODEL AVAILABILITY

● AVAILABLE – NOT AVAILABLE

### REGULAR CAB – LONG BED



TRIM	STANDARD ENGINE	AVAILABLE ENGINES	2WD	4x4
WT	4.3L EcoTec3 V6 (LV3)	2.7L Turbo (L3B), 5.3L EcoTec3 V8 (L82), 5.3L EcoTec3 V8 (L82/YK9) <sup>1</sup>	●	●

### CREW CAB – SHORT BED



TRIM	STANDARD ENGINE	AVAILABLE ENGINES	2WD	4x4
WT	4.3L EcoTec3 V6 (LV3)	2.7L Turbo (L3B), 5.3L EcoTec3 V8 (L82), 5.3L EcoTec3 V8 (L82/YK9) <sup>1</sup>	●	●
Custom	4.3L EcoTec3 V6 (LV3) <sup>2</sup>	2.7L Turbo (L3B), 5.3L EcoTec3 V8 (L82) <sup>2</sup> , 5.3L EcoTec3 V8 (L82/YK9) <sup>1</sup>	●	●
Custom Trail Boss	4.3L EcoTec3 V6 (LV3)	5.3L EcoTec3 V8 (L82), 5.3L EcoTec3 V8 (L82/YK9) <sup>1</sup> , 6.2L EcoTec3 V8 (L87)	–	●
LT	2.7L Turbo (L3B)	5.3L EcoTec3 V8 (L84), 5.3L EcoTec3 V8 (L84/YK9) <sup>3</sup> , Duramax 3.0L I-6 (LM2)	●	●
RST	2.7L Turbo (L3B)	5.3L EcoTec3 V8 (L84), 5.3L EcoTec3 V8 (L84/YK9) <sup>3</sup> , 6.2L EcoTec3 V8 (L87) <sup>5</sup> , 6.2L EcoTec3 V8 (L87/NSS <sup>4</sup> ), Duramax 3.0L I-6 (LM2)	●	●
LT Trail Boss	5.3L EcoTec3 V8 (L84), 5.3L EcoTec3 V8 (L84/NSS <sup>4</sup> )	6.2L EcoTec3 V8 (L87), 6.2L EcoTec3 V8 (L87/NSS <sup>4</sup> )	–	●
LTZ	5.3L EcoTec3 V8 (L84), 5.3L EcoTec3 V8 (L84/YK9) <sup>3</sup>	6.2L EcoTec3 V8 (L87) <sup>5</sup> , 6.2L EcoTec3 V8 (L87/NSS <sup>4</sup> ), Duramax 3.0L I-6 (LM2)	●	●
High Country	5.3L EcoTec3 V8 (L84), 5.3L EcoTec3 V8 (L84/YK9) <sup>3</sup> , 5.3L EcoTec3 V8 (L84/NSS <sup>4</sup> ) <sup>7</sup>	6.2L EcoTec3 V8 (L87) <sup>5</sup> , 6.2L EcoTec3 V8 (L87/NSS <sup>4</sup> ), Duramax 3.0L I-6 (LM2)	●	●

Go to Silverado 1500 model overview.



### DOUBLE CAB – STANDARD BED



TRIM	STANDARD ENGINE	AVAILABLE ENGINES	2WD	4x4
WT	4.3L EcoTec3 V6 (LV3)	2.7L Turbo (L3B), 5.3L EcoTec3 V8 (L82), 5.3L EcoTec3 V8 (L82/YK9) <sup>1</sup>	●	●
Custom	4.3L EcoTec3 V6 (LV3) <sup>2</sup>	2.7L Turbo (L3B), 5.3L EcoTec3 V8 (L82) <sup>2</sup> , 5.3L EcoTec3 V8 (L82/YK9) <sup>1</sup>	●	●
LT	2.7L Turbo (L3B)	5.3L EcoTec3 V8 (L84), 5.3L EcoTec3 V8 (L84/YK9) <sup>3</sup> , Duramax 3.0L I-6 (LM2)	●	●
RST	2.7L Turbo (L3B)	5.3L EcoTec3 V8 (L84), 5.3L EcoTec3 V8 (L84/YK9) <sup>3</sup> , 6.2L EcoTec3 V8 (L87), 6.2L EcoTec3 V8 (L87/NSS <sup>4</sup> ), Duramax 3.0L I-6 (LM2)	–	●

### CREW CAB – STANDARD BED



TRIM	STANDARD ENGINE	AVAILABLE ENGINES	2WD	4x4
WT	4.3L EcoTec3 V6 (LV3)	2.7L Turbo (L3B), 5.3L EcoTec3 V8 (L82), 5.3L EcoTec3 V8 (L82/YK9) <sup>1</sup>	●	●
Custom	4.3L EcoTec3 V6 (LV3) <sup>2</sup>	2.7L Turbo (L3B), 5.3L EcoTec3 V8 (L82) <sup>2</sup> , 5.3L EcoTec3 V8 (L82/YK9) <sup>1</sup>	–	●
Custom Trail Boss	4.3L EcoTec3 V6 (LV3)	5.3L EcoTec3 V8 (L82), 5.3L EcoTec3 V8 (L82/YK9) <sup>1</sup> , 6.2L EcoTec3 V8 (L87)	–	●
LT	2.7L Turbo (L3B)	5.3L EcoTec3 V8 (L84), 5.3L EcoTec3 V8 (L84/YK9) <sup>3</sup> , Duramax 3.0L I-6 (LM2) <sup>5</sup>	●	●
RST	2.7L Turbo (L3B)	5.3L EcoTec3 V8 (L84), 5.3L EcoTec3 V8 (L84/YK9) <sup>3</sup> , 6.2L EcoTec3 V8 (L87) <sup>5</sup> , 6.2L EcoTec3 V8 (L87/NSS <sup>4</sup> ), Duramax 3.0L I-6 (LM2)	–	●
LT Trail Boss	5.3L EcoTec3 V8 (L84), 5.3L EcoTec3 V8 (L84/NSS <sup>4</sup> )	6.2L EcoTec3 V8 (L87), 6.2L EcoTec3 V8 (L87/NSS <sup>4</sup> )	–	●
LTZ	5.3L EcoTec3 V8 (L84), 5.3L EcoTec3 V8 (L84/YK9) <sup>3</sup>	6.2L EcoTec3 V8 (L87), 6.2L EcoTec3 V8 (L87/NSS <sup>4</sup> ), Duramax 3.0L I-6 (LM2)	–	●
High Country	5.3L EcoTec3 V8 (L84), 5.3L EcoTec3 V8 (L84/NSS <sup>4</sup> ) <sup>7</sup>	6.2L EcoTec3 V8 (L87), 6.2L EcoTec3 V8 (L87/NSS <sup>4</sup> ), Duramax 3.0L I-6 (LM2)	–	●

<sup>1</sup> Effective March 2021, the 5.3L EcoTec3 V8 (L82) engine with YK9 is not equipped with Active Fuel Management, resulting in reduced efficiency. Please see page 39 for details. <sup>2</sup> Limited availability. <sup>3</sup> On certain 2021 model year vehicles, the 5.3L EcoTec3 V8 (L84) engine with YK9 is not equipped with Dynamic Fuel Management, resulting in reduced efficiency. Please see page 39 for details. <sup>4</sup> Most vehicles built on or after 6/7/21 equipped with a V8 engine and 10-speed automatic transmission are not equipped with Automatic Stop/Start and its content. Contact a dealer for details on a specific vehicle. Vehicles not equipped with Automatic Stop/Start will be less fuel efficient. Please see page 39 for details. <sup>5</sup> Requires available 4x4. <sup>6</sup> Standard on 2WD. <sup>7</sup> Standard on 4x4.

## SILVERADO 1500

### STANDARD EQUIPMENT FOR ALL SILVERADO 1500 TRIMS

#### MECHANICAL

**Brakes** – 4-wheel antilock disc with Duralife brake rotors and brake lining wear indicator

**Frame** – fully boxed frame with hydroformed front section

**StabiliTrak** – Electronic Stability Control System and Traction Control; includes Electronic Trailer Sway Control and Hill Start Assist

**Steering** – rack-and-pinion with Electric Power Steering (EPS) assist

#### EXTERIOR

**Bumper** – rear CornerSteps

**Cargo area lighting** – integrated with center high-mounted stop lamp

**Fuel filler** – capless fueling

**Lamps** – daytime running lamps, automatic on/off with automatic delay

**Pickup bed** – Durabed

**Tailgate and bed rail** – protection cap

**Tie-downs** – 12 fixed cargo tie-downs, rated at 500 lbs! per corner

**Tire** – carrier lock

**Tire** – full-size spare

Go to Silverado 1500  
model overview.



#### INTERIOR

**Airbags**<sup>2</sup> – dual-stage frontal airbags for driver and front outboard passenger; seat-mounted side-impact airbags for driver and front outboard passenger; head-curtain airbags for front and rear outboard seating positions; includes front outboard Passenger Sensing System for frontal outboard passenger airbag

**Air conditioning** – includes rear-seat air vents on Double Cab and Crew Cab

**Air filter monitor**

**Assist handles** – driver and front passenger, A-pillar; rear passenger, B-pillar

**Connectivity** – Bluetooth® phone connectivity and wireless audio streaming<sup>3</sup> and Apple CarPlay®<sup>4</sup> and Android Auto™<sup>5</sup> compatibility

**Display** – outside temperature

**Door locks** – manual (Regular Cab); power programmable with lockout protection and manual rear door child security (Double Cab and Crew Cab)

**Instrument cluster** – 6-gauge with speedometer, fuel level, engine temperature, tachometer, voltage and oil pressure

**Media** – USB port<sup>6</sup>

**Power outlet** – 12-volt auxiliary, front

**Rear Seat Reminder**<sup>7</sup> (Double Cab and Crew Cab)

**Rear Vision Camera**<sup>8</sup>

**Teen Driver technology**

**Tire Pressure Monitoring System** – with Tire Fill Alert (does not apply to spare tire)

**Windows** – manual (Regular Cab); power with driver express-up/-down, all others express-down (Double Cab and Crew Cab)

<sup>1</sup> These maximum payload ratings are intended for comparison purposes only. Before you buy a vehicle or use it to haul people or cargo, carefully review the Vehicle Loading section of the Owner's Manual and check the carrying capacity of your specific vehicle on the label on the inside of the driver door jamb. <sup>2</sup> A NOTE ON CHILD SAFETY: Always use seat belts and the correct child restraint for your child's age and size, even with airbags. Even in vehicles equipped with the Passenger Sensing System, children are safer when properly secured in a rear seat in the appropriate infant, child or booster seat. Never place a rear-facing infant restraint in the front seat of any vehicle equipped with an active frontal airbag. See your vehicle Owner's Manual and the child safety seat instructions for more safety information. <sup>3</sup> Go to [my.chevrolet.com/learnAbout/bluetooth](http://my.chevrolet.com/learnAbout/bluetooth) to find out which phones are compatible with the vehicle. Full Bluetooth feature functionality varies by device, model and software version. <sup>4</sup> Vehicle user interface is a product of Apple and its terms and privacy statements apply. Requires compatible iPhone and data plan rates apply. <sup>5</sup> Vehicle user interface is a product of Google and its terms and privacy statements apply. Requires the Android Auto app on Google Play and an Android compatible smartphone running Android 5.0 or higher. Data plan rates apply. <sup>6</sup> Not compatible with all devices. <sup>7</sup> Does not detect people or items. Always check rear seat before exiting. <sup>8</sup> Read the vehicle Owner's Manual for important feature limitations and information.

## SILVERADO 1500 (CONTINUED)

Go to Silverado 1500  
model overview.



### ENGINE SPECIFICATIONS

ENGINE	ADVANCED TECHNOLOGY	HORSEPOWER/ TORQUE	MAX TOWING	EPA-ESTIMATED FUEL ECONOMY – 2WD	EPA-ESTIMATED FUEL ECONOMY – 4X4	EPA-ESTIMATED FUEL ECONOMY – TRAIL BOSS 4X4
2.7L Turbo (L3B)	Equipped with Active Fuel Management and Automatic Stop/Start	310 hp @ 5600 rpm/ 348 lb.-ft. Torque @ 1500 rpm	9,600 lbs. Max Towing Capability <sup>1,2</sup>	20 MPG City/23 Highway (2WD)	19 MPG City/22 Highway (4x4)	–
3.0L Turbo-Diesel I-6 (LM2)	Equipped with Diesel Exhaust Brake System and Automatic Stop/Start	277 hp @ 3750 rpm/ 460 lb.-ft. Torque @ 1500 rpm	9,500 lbs. Max Towing Capability <sup>1,3</sup>	23 MPG City/33 Highway (2WD)	22 MPG City/26 Highway (4x4)	–
4.3L EcoTec3 V6 (LV3)	Equipped with Active Fuel Management	285 hp @ 5300 rpm/ 305 lb.-ft. Torque @ 3900 rpm	7,900 lbs. Max Towing Capability <sup>1,2</sup>	16 MPG City/21 Highway (2WD)	15 MPG City/20 Highway (4x4)	14 MPG City/18 Highway (Trail Boss 4x4)
5.3L EcoTec3 V8 (L82)	Equipped with Active Fuel Management	355 hp @ 5600 rpm/ 383 lb.-ft. Torque @ 4100 rpm	10,900 lbs. Max Towing Capability <sup>1,4</sup>	15 MPG City/21 Highway (2WD)	15 MPG City/20 Highway (4x4)	14 MPG City/18 Highway (Trail Boss 4x4)
5.3L EcoTec3 V8 (L82/YK9 <sup>5</sup> )	Not Equipped with Active Fuel Management	355 hp @ 5600 rpm/ 383 lb.-ft. Torque @ 4100 rpm	10,900 lbs. Max Towing Capability <sup>1,4</sup>	14 MPG City/21 Highway (2WD)	14 MPG City/20 Highway (4x4)	13 MPG City/18 Highway (Trail Boss 4x4)
5.3L EcoTec3 V8 (L84)	Equipped with Dynamic Fuel Management and Automatic Stop/Start	355 hp @ 5600 rpm/ 383 lb.-ft. Torque @ 4100 rpm	11,500 lbs. Max Towing Capability <sup>1,6</sup>	17 MPG City/23 Highway (2WD)	16 MPG City/22 Highway (4x4)	16 MPG City/21 Highway (Trail Boss 4x4)
5.3L EcoTec3 V8 (L84/YK9 <sup>7</sup> )	Equipped with Automatic Stop/Start; Not Equipped with Dynamic Fuel Management	355 hp @ 5600 rpm/ 383 lb.-ft. Torque @ 4100 rpm	11,500 lbs. Max Towing Capability <sup>1,6</sup>	15 MPG City/22 Highway (2WD)	14 MPG City/21 Highway (4x4)	–
5.3L EcoTec3 V8 (L84/NSS <sup>8</sup> )	Equipped with Dynamic Fuel Management; Not Equipped with Automatic Stop/Start	355 hp @ 5600 rpm/ 383 lb.-ft. Torque @ 4100 rpm	9,300 lbs. Max Towing Capability <sup>1,9</sup>	–	15 MPG City/21 Highway (4x4)	15 MPG City/21 Highway (Trail Boss 4x4)
6.2L EcoTec3 V8 (L87)	Equipped with Dynamic Fuel Management and Automatic Stop/Start	420 hp @ 5600 rpm/ 460 lb.-ft. Torque @ 4100 rpm	13,300 lbs. Max Towing Capability <sup>1,10</sup>	–	16 MPG City/21 Highway (4x4)	15 MPG City/19 Highway (Trail Boss 4x4)
6.2L EcoTec3 V8 (L87/NSS <sup>8</sup> )	Equipped with Dynamic Fuel Management; Not Equipped with Automatic Stop/Start	420 hp @ 5600 rpm/ 460 lb.-ft. Torque @ 4100 rpm	13,300 lbs. Max Towing Capability <sup>1,10</sup>	–	15 MPG City/20 Highway (4x4)	14 MPG City/19 Highway (Trail Boss 4x4)

<sup>1</sup> Before you buy a vehicle or use it for trailering, carefully review the Trailering section of the Owner's Manual. The weight of passengers, cargo and options or accessories may reduce the amount you can tow. <sup>2</sup> Requires Silverado 1500 Regular Cab Long Bed 2WD. <sup>3</sup> Requires Silverado 1500 Double Cab Standard Bed 2WD or Crew Cab Short Bed 2WD. <sup>4</sup> Requires Silverado 1500 Crew Cab Short Bed Custom 4x4 with available Custom Max Trailering Package. <sup>5</sup> Effective March 2021, the 5.3L EcoTec3 V8 (L82) engine with YK9 is not equipped with Active Fuel Management, resulting in reduced efficiency. <sup>6</sup> Requires available Max Trailering Package and Silverado 1500 Double Cab Standard Bed 2WD or Crew Cab Short Bed 2WD. <sup>7</sup> On certain 2021 model year vehicles, the 5.3L EcoTec3 V8 (L84) engine with YK9 is not equipped with Dynamic Fuel Management, resulting in reduced efficiency. <sup>8</sup> Most vehicles built on or after 6/7/21 equipped with a V8 engine and 10-speed automatic transmission are not equipped with Automatic Stop/Start and its content. Contact a dealer for details on a specific vehicle. Vehicles not equipped with Automatic Stop/Start will be less fuel efficient. <sup>9</sup> Requires Silverado 1500 Crew Cab Short Bed Trail Boss 4x4 or Crew Cab Standard Bed Trail Boss 4x4. <sup>10</sup> Requires Silverado 1500 Double Cab Standard Bed RST 4x4 with available Max Trailering Package and 20-inch wheels.

## SILVERADO 1500 (CONTINUED)

Go to Silverado 1500  
model overview.



### DIMENSIONS

	REGULAR CAB	DOUBLE CAB	CREW CAB
Length	229.5"	231.7"	231.7"-241.2"
Wheelbase	139.6"	147.5"	147.4"-157.1"
Height	75.6"	75.6"-78.5"	75.4"-78.3"
Width	81.1"	81.2"	81.2"

	REGULAR CAB	DOUBLE CAB	CREW CAB
Head Room (front/rear)	43.1"/-	43.0"/39.9"	43.0"/40.1"
Leg Room (front/rear)	44.5"/-	44.5"/35.2"	44.5"/43.4"
Shoulder Room (front/rear)	66.1"/-	66.0"/64.9"	66.0"/65.2"
Hip Room (front/rear)	60.9"/-	61.2"/60.2"	61.2"/60.2"

### MAXIMUM CAPACITIES

	REGULAR CAB	DOUBLE CAB	CREW CAB
Fuel tank (approximate)	28 gallons -	24 gallons 22 gallons (2WD Diesel)	24 gallons 22 gallons (2WD Diesel)

Cargo volume <sup>1</sup>	89.1 cubic feet (Long Bed) 71.7 cubic feet (Standard Bed) 62.9 cubic feet (Short Bed)
---------------------------	---------------------------------------------------------------------------------------------

<sup>1</sup> Cargo and load capacity limited by weight and distribution.



## SILVERADO 1500 (CONTINUED)

Go to Silverado 1500  
model overview.



### PAYLOAD AND TRAILER WEIGHT RATINGS

MODEL	ENGINE	MAX PAYLOAD (LBS.) <sup>1</sup>	MAX CONVENTIONAL TRAILER WEIGHT (LBS.) <sup>2</sup>
<b>REGULAR CAB</b>			
Long Bed 2WD	2.7L Turbo	2,280	9,600
	4.3L V6	2,250	7,900
	5.3L V8 (L82) with 6-speed	2,180	10,000
	5.3L V8 (L82/YK9 <sup>3</sup> ) with 6-speed	2,180	10,000
Long Bed 4x4	2.7L Turbo	2,160	9,400
	4.3L V6	2,130	7,600
	5.3L V8 (L82) with 6-speed	2,070	9,700
	5.3L V8 (L82/YK9 <sup>3</sup> ) with 6-speed	2,070	9,700
<b>DOUBLE CAB</b>			
Standard Bed 2WD	2.7L Turbo	2,060	9,300
	4.3L V6	2,040	7,600
	5.3L V8 (L82) with 6-speed	1,970	9,700
	5.3L V8 (L82/YK9 <sup>3</sup> ) with 6-speed	1,970	9,700
	5.3L V8 (L84) with 8-speed	1,970	9,800
	5.3L V8 (L84/YK9 <sup>4</sup> ) with 8-speed	1,970	9,800
	Duramax 3.0L I-6	1,780	9,500
Standard Bed 2WD with Max Trailering Package	5.3L V8 (L84) with 8-speed	2,190	11,500
	5.3L V8 (L84/YK9 <sup>4</sup> ) with 8-speed	2,190	11,500

MODEL	ENGINE	MAX PAYLOAD (LBS.) <sup>1</sup>	MAX CONVENTIONAL TRAILER WEIGHT (LBS.) <sup>2</sup>
<b>DOUBLE CAB (CONTINUED)</b>			
Standard Bed 4x4	2.7L Turbo	2,050	9,100
	4.3L V6	2,020	7,400
	5.3L V8 (L82) with 6-speed	1,950	9,500
	5.3L V8 (L82/YK9 <sup>3</sup> ) with 6-speed	1,950	9,500
	5.3L V8 (L84) with 8-speed	1,960	9,500
	5.3L V8 (L84/YK9 <sup>4</sup> ) with 8-speed	1,960	9,500
	6.2L V8 (L87)	1,690	9,300
	6.2L V8 (L87/NSS <sup>5</sup> )	1,690	9,300
	Duramax 3.0L I-6	1,770	9,100
	5.3L V8 (L84) with 8-speed	2,180	11,100
Standard Bed 4x4 with Max Trailering Package	5.3L V8 (L84/YK9 <sup>4</sup> ) with 8-speed	2,180	11,100
	6.2L V8 (L87)	2,090	12,100
	6.2L V8 (L87/NSS <sup>5</sup> )	2,090	12,100
Standard Bed RST 4x4 with Max Trailering Package and 20" Wheels	6.2L V8 (L87)	1,990	13,300
	6.2L V8 (L87/NSS <sup>5</sup> )	1,990	13,300
Standard Bed Trail Boss 4x4	4.3L V6	1,770	7,300
	5.3L V8 (L82) with 6-speed	1,670	9,400
	5.3L V8 (L82/YK9 <sup>3</sup> ) with 6-speed	1,670	9,400
	6.2L V8 (L87)	1,780	9,300
	6.2L V8 (L87/NSS <sup>5</sup> )	1,780	9,300

<sup>1</sup> These maximum payload ratings are intended for comparison purposes only. Before you buy a vehicle or use it to haul people or cargo, carefully review the Vehicle Loading section of the Owner's Manual and check the carrying capacity of your specific vehicle on the label on the inside of the driver door jamb. <sup>2</sup> Before you buy a vehicle or use it for trailering, carefully review the Trailering section of the Owner's Manual. The weight of passengers, cargo and options or accessories may reduce the amount you can tow. <sup>3</sup> Effective March 2021, the 5.3L EcoTec3 V8 (L82) engine with YK9 is not equipped with Active Fuel Management, resulting in reduced efficiency. Please see page 39 for details. <sup>4</sup> On certain 2021 model year vehicles, the 5.3L EcoTec3 V8 (L84) engine with YK9 is not equipped with Dynamic Fuel Management, resulting in reduced efficiency. Please see page 39 for details. <sup>5</sup> Most vehicles built on or after 6/7/21 equipped with a V8 engine and 10-speed automatic transmission are not equipped with Automatic Stop/Start and its content. Contact a dealer for details on a specific vehicle. Vehicles not equipped with Automatic Stop/Start will be less fuel efficient. Please see page 39 for details.

## SILVERADO 1500 (CONTINUED)

Go to Silverado 1500  
model overview.



### PAYLOAD AND TRAILER WEIGHT RATINGS

MODEL	ENGINE	MAX PAYLOAD (LBS.) <sup>1</sup>	MAX CONVENTIONAL TRAILER WEIGHT (LBS.) <sup>2</sup>
<b>CREW CAB</b>			
Short Bed 2WD	2.7L Turbo	2,060	9,300
	4.3L V6	2,040	7,600
	5.3L V8 (L82) with 6-speed	2,060	9,700
	5.3L V8 (L82/YK9 <sup>3</sup> ) with 6-speed	2,060	9,700
	5.3L V8 (L84) with 8-speed	2,060	9,700
	5.3L V8 (L84/YK9 <sup>4</sup> ) with 8-speed	2,060	9,700
	Duramax 3.0L I-6	1,870	9,500
Short Bed 2WD with Max Trailering Package	5.3L V8 (L84) with 8-speed	2,180	11,500
	5.3L V8 (L84/YK9 <sup>4</sup> ) with 8-speed	2,180	11,500
Standard Bed 2WD	2.7L Turbo	1,990	9,200
	4.3L V6	1,960	7,600
	5.3L V8 (L82) with 6-speed	1,990	9,600
	5.3L V8 (L82/YK9 <sup>3</sup> ) with 6-speed	1,990	9,600
	5.3L V8 (L84) with 8-speed	1,990	9,700
Standard Bed 2WD with Max Trailering Package	5.3L V8 (L84) with 8-speed	2,110	11,400
	5.3L V8 (L84/YK9 <sup>4</sup> ) with 8-speed	2,110	11,400
Short Bed 4x4	2.7L Turbo	2,050	9,100
	4.3L V6	2,020	7,400
	5.3L V8 (L82) with 6-speed	2,050	9,500
	5.3L V8 (L82/YK9 <sup>3</sup> ) with 6-speed	2,050	9,500
	5.3L V8 (L84) with 8-speed	2,060	9,400
	5.3L V8 (L84/YK9 <sup>4</sup> ) with 8-speed	2,060	9,400
	5.3L V8 (L84) with 10-speed	2,060	9,200
	5.3L V8 (L84/NSS <sup>5</sup> ) with 10-speed	2,060	9,200
	6.2L V8 (L87)	1,670	9,200
	6.2L V8 (L87/NSS <sup>5</sup> )	1,670	9,200
Short Bed Custom 4x4 with Custom Max Trailering Package	Duramax 3.0L I-6	1,870	9,000
	5.3L V8 (L82) with 6-speed	2,050	10,900
	5.3L V8 (L82/YK9 <sup>3</sup> ) with 6-speed	2,050	10,900

MODEL	ENGINE	MAX PAYLOAD (LBS.) <sup>1</sup>	MAX CONVENTIONAL TRAILER WEIGHT (LBS.) <sup>2</sup>
<b>CREW CAB (CONTINUED)</b>			
Short Bed 4x4 with Max Trailering Package	5.3L V8 (L84) with 8-speed	2,170	11,100
	5.3L V8 (L84/YK9 <sup>4</sup> ) with 8-speed	2,170	11,100
	6.2L V8 (L87)	2,060	11,900
	6.2L V8 (L87/NSS <sup>5</sup> )	2,060	11,900
Short Bed Trail Boss 4x4	4.3L V6	1,770	7,300
	5.3L V8 (L82) with 6-speed	1,990	9,400
	5.3L V8 (L82/YK9 <sup>3</sup> ) with 6-speed	1,990	9,400
	5.3L V8 (L84) with 10-speed	1,770	9,300
	5.3L V8 (L84/NSS <sup>5</sup> ) with 10-speed	1,770	9,300
	6.2L V8 (L87)	1,870	9,300
Standard Bed 4x4	6.2L V8 (L87/NSS <sup>5</sup> )	1,870	9,300
	2.7L Turbo	2,000	9,000
	4.3L V6	1,970	7,400
	5.3L V8 (L82) with 6-speed	2,000	9,400
	5.3L V8 (L82/YK9 <sup>3</sup> ) with 6-speed	2,000	9,400
	5.3L V8 (L84) with 8-speed	2,010	9,300
	5.3L V8 (L84/YK9 <sup>4</sup> ) with 8-speed	2,010	9,300
	5.3L V8 (L84) with 10-speed	2,010	9,100
	5.3L V8 (L84/NSS <sup>5</sup> ) with 10-speed	2,010	9,100
	6.2L V8 (L87)	1,590	9,100
Standard Bed 4x4 with Max Trailering Package	6.2L V8 (L87/NSS <sup>5</sup> )	1,590	9,100
	Duramax 3.0L I-6	1,820	9,000
	5.3L V8 (L84) with 8-speed	2,120	11,100
	5.3L V8 (L84/YK9 <sup>4</sup> ) with 8-speed	2,120	11,100
Standard Bed Trail Boss 4x4	6.2L V8 (L87)	2,010	11,900
	6.2L V8 (L87/NSS <sup>5</sup> )	2,010	11,900
	4.3L V6	1,710	7,200
	5.3L V8 (L82) with 6-speed	1,710	9,300
	5.3L V8 (L82/YK9 <sup>3</sup> ) with 6-speed	1,710	9,300
	5.3L V8 (L84) with 10-speed	1,720	9,300
	5.3L V8 (L84/NSS <sup>5</sup> ) with 10-speed	1,720	9,300
	6.2L V8 (L87)	1,820	9,200
	6.2L V8 (L87/NSS <sup>5</sup> )	1,820	9,200

<sup>1</sup> These maximum payload ratings are intended for comparison purposes only. Before you buy a vehicle or use it to haul people or cargo, carefully review the Vehicle Loading section of the Owner's Manual and check the carrying capacity of your specific vehicle on the label on the inside of the driver door jamb. <sup>2</sup> Before you buy a vehicle or use it for trailering, carefully review the Trailering section of the Owner's Manual. The weight of passengers, cargo and options or accessories may reduce the amount you can tow. <sup>3</sup> Effective March 2021, the 5.3L EcoTec3 V8 (L82) engine with YK9 is not equipped with Active Fuel Management, resulting in reduced efficiency. Please see page 39 for details. <sup>4</sup> On certain 2021 model year vehicles, the 5.3L EcoTec3 V8 (L84) engine with YK9 is not equipped with Dynamic Fuel Management, resulting in reduced efficiency. Please see page 39 for details. <sup>5</sup> Most vehicles built on or after 6/7/21 equipped with a V8 engine and 10-speed automatic transmission are not equipped with Automatic Stop/Start and its content. Contact a dealer for details on a specific vehicle. Vehicles not equipped with Automatic Stop/Start will be less fuel efficient. Please see page 39 for details.

## SILVERADO HD MODEL AVAILABILITY

● AVAILABLE – NOT AVAILABLE

Go to Silverado HD model overview.



### REGULAR CAB – LONG BED



TRIM	2500 HD	3500 HD SRW	3500 HD DRW	STANDARD ENGINE	AVAILABLE ENGINE	2WD	4x4
WT	●	●	●	6.6L V8 gas	Duramax 6.6L V8	●	●
LT	●	●	●	6.6L V8 gas	Duramax 6.6L V8	●	●

### DOUBLE CAB – STANDARD BED



TRIM	2500 HD	3500 HD SRW	3500 HD DRW	STANDARD ENGINE	AVAILABLE ENGINE	2WD	4x4
WT	●	–	–	6.6L V8 gas	Duramax 6.6L V8	●	●
Custom	●	–	–	6.6L V8 gas	Duramax 6.6L V8	●	●
LT	●	–	–	6.6L V8 gas	Duramax 6.6L V8	●	●

### DOUBLE CAB – LONG BED



TRIM	2500 HD	3500 HD SRW	3500 HD DRW	STANDARD ENGINE	AVAILABLE ENGINE	2WD	4x4
WT	●	●	●	6.6L V8 gas	Duramax 6.6L V8	●	●
Custom	●	–	–	6.6L V8 gas	Duramax 6.6L V8	●	●
LT	●	●	●	6.6L V8 gas	Duramax 6.6L V8	●	●

### CREW CAB – STANDARD BED



TRIM	2500 HD	3500 HD SRW	3500 HD DRW	STANDARD ENGINE	AVAILABLE ENGINE	2WD	4x4
WT	●	●	–	6.6L V8 gas	Duramax 6.6L V8	●	●
Custom	●	–	–	6.6L V8 gas	Duramax 6.6L V8	●	●
LT	●	●	–	6.6L V8 gas	Duramax 6.6L V8	●	●
LTZ	●	●	–	6.6L V8 gas	Duramax 6.6L V8	●	●
High Country	●	●	–	6.6L V8 gas	Duramax 6.6L V8	–	●

### CREW CAB – LONG BED



TRIM	2500 HD	3500 HD SRW	3500 HD DRW	STANDARD ENGINE	AVAILABLE ENGINE	2WD	4x4
WT	●	●	●	6.6L V8 gas	Duramax 6.6L V8	●	●
Custom	●	–	–	6.6L V8 gas	Duramax 6.6L V8	●	●
LT	●	●	●	6.6L V8 gas	Duramax 6.6L V8	●	●
LTZ	●	●	●	6.6L V8 gas	Duramax 6.6L V8	●	●
High Country	●	●	●	6.6L V8 gas	Duramax 6.6L V8	–	●

## SILVERADO HD

### STANDARD EQUIPMENT FOR ALL SILVERADO HD TRIMS

MECHANICAL
Air filter – high-capacity with air filtration monitoring
Brakes – 4-wheel antilock disc with Duralife brake rotors and brake lining wear indicator
Cooling – external engine and transmission oil coolers
Differential – automatic locking rear
Engine – 6.6L V8 gas with Variable Valve Timing (VVT) and Direct Injection
Frame – fully boxed frame with hydroformed front section
StabiliTrak – Electronic Stability Control System and Traction Control; includes Electronic Trailer Sway Control and Hill Start Assist
Trailer Package – trailer hitch with 2.5-inch receiver and 2-inch insert, 7-pin wiring connector and Hitch Guidance <sup>1</sup>
Transmission – 6-speed automatic
EXTERIOR
BedSteps – integrated on forward portion of bed on driver and passenger side
Bumper – rear CornerSteps
Cargo area lighting – integrated with center high-mounted stop lamp
Fuel filler – capless fueling (gas engine only)
Lamps – daytime running lamps, automatic on/off with automatic delay
Pickup bed – Durabed
Tailgate and bed rail – protection cap
Tie-downs – 12 fixed cargo tie-downs, rated at 500 lbs: per corner

Go to Silverado HD model overview.



EXTERIOR (CONTINUED)
Tire – carrier lock
Tire – full-size spare
INTERIOR
Airbags <sup>3</sup> – dual-stage frontal airbags for driver and front outboard passenger; seat-mounted side-impact airbags for driver and front outboard passenger; head-curtain airbags for front and rear outboard seating positions; includes front outboard Passenger Sensing System for frontal outboard passenger airbag
Air conditioning
Air vents – rear, heating/cooling (Double Cab and Crew Cab)
Assist handles – driver and front passenger, A-pillar; rear passenger, B-pillar
Connectivity – Bluetooth® phone connectivity and wireless audio streaming <sup>4</sup>
Display – outside temperature
Door locks – manual (Regular Cab); power programmable with lockout protection and manual rear door child security (Double Cab and Crew Cab)
Instrument cluster – 6-gauge with speedometer, fuel level, engine temperature, tachometer, voltage and oil pressure
Power outlet – 12-volt auxiliary, front
Rear Seat Reminder <sup>5</sup> (Double Cab and Crew Cab)
Rear Vision Camera <sup>1</sup>
Teen Driver technology
Tire Pressure Monitoring System – with Tire Fill Alert (does not apply to spare tire)
Windows – manual (Regular Cab); power with driver express-up/-down, all others express-down (Double Cab and Crew Cab)

<sup>1</sup> Read the vehicle Owner's Manual for important feature limitations and information. <sup>2</sup> These maximum payload ratings are intended for comparison purposes only. Before you buy a vehicle or use it to haul people or cargo, carefully review the Vehicle Loading section of the Owner's Manual and check the carrying capacity of your specific vehicle on the label on the inside of the driver door jamb. <sup>3</sup> A NOTE ON CHILD SAFETY: Always use seat belts and the correct child restraint for your child's age and size, even with airbags. Even in vehicles equipped with the Passenger Sensing System, children are safer when properly secured in a rear seat in the appropriate infant, child or booster seat. Never place a rear-facing infant restraint in the front seat of any vehicle equipped with an active frontal airbag. See your vehicle Owner's Manual and the child safety seat instructions for more safety information. <sup>4</sup> Go to [my.chevrolet.com/learnAbout/bluetooth](http://my.chevrolet.com/learnAbout/bluetooth) to find out which phones are compatible with the vehicle. Full Bluetooth feature functionality varies by device, model and software version. <sup>5</sup> Does not detect people or items. Always check rear seat before exiting.

## SILVERADO HD (CONTINUED)

Go to Silverado HD  
model overview.



### ENGINES

**6.6L V8 GAS** Standard on all 2500 HD and 3500 HD models.

Variable Valve Timing (VVT) and Direct Injection

6-speed automatic transmission

401 hp @ 5200 rpm

464 lb.-ft. of torque @ 4000 rpm

Displacement: 6564 cc (400 cu. in.)

Bore and stroke: 103.25 mm x 98 mm

Compression ratio: 10.75:1

Alternator: 170 amps

**DURAMAX 6.6L TURBO-DIESEL V8** Available on 2500 HD and 3500 HD models.

Direct Injection with high-pressure common rail

Allison® 10-speed automatic transmission

445 hp @ 2800 rpm

910 lb.-ft. of torque @ 1600 rpm

Displacement: 6619 cc (403 cu. in.)

Bore and stroke: 103 mm x 99 mm

Compression ratio: 16.0:1

Alternator: 220 amps

### DIMENSIONS

	REGULAR CAB	DOUBLE CAB	CREW CAB
Length	235.5"	240.4"-256.5"	250.0"-266.0"
Wheelbase	141.5"	149.4"-162.5"	158.9"-172.0"
Height	79.9"-80.9"	79.8"-80.9"	79.7"-80.9"
Width	81.8"-96.8"	81.9"-96.8"	81.9"-96.8"

	REGULAR CAB	DOUBLE CAB	CREW CAB
Head Room (front/rear)	43.1"/-	43.0"/39.9"	43.0"/40.1"
Leg Room (front/rear)	44.5"/-	44.5"/35.2"	44.5"/43.4"
Shoulder Room (front/rear)	66.1"/-	66.0"/64.9"	66.0"/65.3"
Hip Room (front/rear)	60.9"/-	61.2"/60.2"	61.2"/60.2"

### MAXIMUM CAPACITIES

	REGULAR CAB	DOUBLE CAB	CREW CAB
Fuel tank (approximate)	36 gallons 28 gallons (Diesel)	36 gallons 29 gallons (Standard Bed Diesel)	36 gallons

Cargo volume <sup>1</sup>	69.6 cubic feet (Standard Bed) 83.5 cubic feet (Long Bed)
---------------------------	--------------------------------------------------------------

<sup>1</sup> Cargo and load capacity limited by weight and distribution.

# SILVERADO HD (CONTINUED)

Go to Silverado HD model overview.



## PAYLOAD AND TRAILER WEIGHT RATINGS

MODEL	ENGINE	WHEEL SIZE	GVWR (LBS.) <sup>1</sup>	MAX PAYLOAD (LBS.) <sup>2</sup>	MAX CONVENTIONAL TOWING (LBS.) <sup>3</sup>	MAX GOOSENECK/5TH-WHEEL TOWING (LBS.) <sup>3</sup>
<b>2500 HD REGULAR CAB</b>						
Long Bed 2WD	6.6L V8 gas	17"/18"	9,900	3,757	14,500	17,370
	6.6L V8 gas	17"	10,000	3,857	14,500	17,370
	6.6L V8 gas	18"/20"	10,150	3,979	14,500	17,340
	Duramax 6.6L V8	17"	10,550	3,544	14,500	18,510
	Duramax 6.6L V8	18"/20"	10,750	3,715	14,500	18,480
Long Bed 4x4	6.6L V8 gas	17"/18"	10,000	3,544	14,500	17,060
	6.6L V8 gas	17"	10,250	3,794	14,500	17,060
	6.6L V8 gas	18"/20"	10,450	3,965	14,500 <sup>4</sup>	17,030
	Duramax 6.6L V8	17"	10,900	3,581	14,500	18,190
	Duramax 6.6L V8	18"/20"	11,025	3,715	14,500 <sup>4</sup>	18,160
<b>2500 HD DOUBLE CAB</b>						
Standard Bed 2WD	6.6L V8 gas	17"/18"	10,000	3,541	14,500	17,050
	6.6L V8 gas	17"	10,050	3,591	14,500	17,050
	6.6L V8 gas	18"/20"	10,250	3,762	14,500	17,000
	Duramax 6.6L V8	17"	10,700	3,390	14,500	18,200
	Duramax 6.6L V8	18"/20"	10,900	3,561	14,500	18,170
Standard Bed 4x4	6.6L V8 gas	17"/18"	10,000	3,226	14,500	16,740
	6.6L V8 gas	17"	10,350	3,576	14,500	16,740
	6.6L V8 gas	18"/20"	10,550	3,747	14,500 <sup>4</sup>	16,710
	Duramax 6.6L V8	17"/18"	10,000	2,375	14,500	12,610
	Duramax 6.6L V8	17"	11,000	3,375	14,500	17,890
Long Bed 2WD	Duramax 6.6L V8	18"/20"	11,200	3,546	14,500 <sup>4</sup>	17,860
	6.6L V8 gas	17"/18"	10,000	3,420	14,500	16,930
	6.6L V8 gas	17"	10,200	3,620	14,500	16,930
	6.6L V8 gas	18"/20"	10,400	3,792	14,500	16,900
	Duramax 6.6L V8	17"	10,900	3,424	14,500	18,040
Long Bed 4x4	Duramax 6.6L V8	18"/20"	11,100	3,595	14,500	18,010
	6.6L V8 gas	17"/18"	10,000	3,133	14,500	16,650
	6.6L V8 gas	17"	10,500	3,633	14,500	16,650
	6.6L V8 gas	18"/20"	10,750	3,854	14,500 <sup>4</sup>	16,620
	Duramax 6.6L V8	17"/18"	10,000	2,236	14,500	11,690
Long Bed 4x4	Duramax 6.6L V8	17"	11,200	3,436	14,500	17,750
	Duramax 6.6L V8	18"/20"	11,450	3,657	14,500 <sup>4</sup>	17,720

MODEL	ENGINE	WHEEL SIZE	GVWR (LBS.) <sup>1</sup>	MAX PAYLOAD (LBS.) <sup>2</sup>	MAX CONVENTIONAL TOWING (LBS.) <sup>3</sup>	MAX GOOSENECK/5TH-WHEEL TOWING (LBS.) <sup>3</sup>
<b>2500 HD CREW CAB</b>						
Standard Bed 2WD	6.6L V8 gas	17"/18"	10,000	3,429	14,500	16,940
	6.6L V8 gas	17"	10,150	3,579	14,500	16,940
	6.6L V8 gas	18"/20"	10,350	3,751	14,500	16,900
	Duramax 6.6L V8	17"	10,000	2,532	14,500	13,660
	Duramax 6.6L V8	18"/20"	10,000	2,561	18,140	13,470
	Duramax 6.6L V8	17"	10,800	3,332	14,500	18,050
	Duramax 6.6L V8	18"/20"	11,050	3,553	18,500	18,500
	6.6L V8 gas	17"/18"	10,000	3,139	14,500	16,650
	6.6L V8 gas	17"	10,450	3,589	14,500	16,650
	6.6L V8 gas	18"/20"	10,650	3,760	14,500 <sup>4</sup>	16,620
Standard Bed 4x4	Duramax 6.6L V8	17"	10,000	2,241	14,500	11,720
	Duramax 6.6L V8	18"/20"	10,000	2,213	17,850	11,530
	Duramax 6.6L V8	17"	11,150	3,391	14,500	17,750
	Duramax 6.6L V8	18"/20"	11,350	3,563	18,500 <sup>4</sup>	18,500
Standard Bed High Country 4x4	6.6L V8 gas	20"	10,650	3,413	14,500	16,280
	Duramax 6.6L V8	20"	11,350	3,229	18,500	18,310
Long Bed 2WD	6.6L V8 gas	17"/18"	10,000	3,329	14,500	16,840
	6.6L V8 gas	17"	10,300	3,629	14,500	16,840
	6.6L V8 gas	18"/20"	10,500	3,800	14,500	16,810
	Duramax 6.6L V8	17"	10,000	2,365	14,500	12,550
	Duramax 6.6L V8	18"/20"	10,000	2,336	17,970	12,350
	Duramax 6.6L V8	17"	11,000	3,365	14,500	17,880
	Duramax 6.6L V8	18"/20"	11,200	3,536	18,500	18,500
	6.6L V8 gas	17"/18"	10,000	3,040	14,500	16,550
	6.6L V8 gas	17"	10,650	3,690	14,500	16,550
	6.6L V8 gas	18"/20"	10,850	3,862	14,500 <sup>4</sup>	16,520
Long Bed 4x4	Duramax 6.6L V8	17"	10,000	2,076	14,500	10,620
	Duramax 6.6L V8	18"/20"	10,000	2,047	16,560	10,240
	Duramax 6.6L V8	17"	11,350	3,426	14,500	17,590
	Duramax 6.6L V8	18"/20"	11,550	3,597	18,500 <sup>4</sup>	18,500
Long Bed High Country 4x4	6.6L V8 gas	20"	10,850	3,506	14,500	16,170
	Duramax 6.6L V8	20"	11,550	3,337	18,500	18,500

<sup>1</sup> Maximum Gross Vehicle Weight Rating (GVWR). When properly equipped; includes weight of vehicle, passengers, cargo and equipment. <sup>2</sup> These maximum payload ratings are intended for comparison purposes only. Before you buy a vehicle or use it to haul people or cargo, carefully review the Vehicle Loading section of the Owner's Manual and check the carrying capacity of your specific vehicle on the label on the inside of the driver door jamb. <sup>3</sup> Before you buy a vehicle or use it for trailering, carefully review the Trailering section of the Owner's Manual. The weight of passengers, cargo and options or accessories may reduce the amount you can tow. <sup>4</sup> With available 18" mud-terrain tires (QG3), maximum conventional towing is 12,000 lbs.

## SILVERADO HD (CONTINUED)

Go to Silverado HD model overview.



### PAYLOAD AND TRAILER WEIGHT RATINGS

MODEL	ENGINE	WHEEL SIZE	GVWR (LBS.) <sup>1</sup>	MAX PAYLOAD (LBS.) <sup>2</sup>	MAX CONVENTIONAL TOWING (LBS.) <sup>3</sup>	MAX GOOSENECK/5TH-WHEEL TOWING (LBS.) <sup>3</sup>
<b>3500 HD REGULAR CAB</b>						
Long Bed 2WD SRW	6.6L V8 gas	18"/20"	10,750	4,481	14,500	17,200
	Duramax 6.6L V8	18"/20"	11,500	4,215	14,500	21,500
Long Bed 4x4 SRW	6.6L V8 gas	18"/20"	11,100	4,534	14,500	16,950
	Duramax 6.6L V8	18"/20"	11,800	4,217	14,500	21,500
Long Bed 2WD DRW	6.6L V8 gas	17"	14,000	7,442	16,800	16,800
	Duramax 6.6L V8	17" (5th-Wheel)	14,000	6,523	20,000	32,000
	Duramax 6.6L V8	17" (Gooseneck)	14,000	6,465	20,000	36,000 <sup>4</sup>
Long Bed 4x4 DRW	6.6L V8 gas	17"	14,000	7,145	16,800	16,710
	Duramax 6.6L V8	17"	14,000	6,196	20,000	31,760
<b>3500 HD DOUBLE CAB</b>						
Long Bed 2WD SRW	6.6L V8 gas	18"/20"	11,100	4,373	14,500	16,700
	Duramax 6.6L V8	18"/20"	11,850	4,130	14,500	21,490
Long Bed 4x4 SRW	6.6L V8 gas	18"/20"	11,400	4,391	14,500	16,500
	Duramax 6.6L V8	18"/20"	12,150	4,148	14,500	21,210
Long Bed 2WD DRW	6.6L V8 gas	17"	14,000	6,985	16,400	16,400
	Duramax 6.6L V8	17"	14,000	6,059	20,000	31,500
Long Bed 4x4 DRW	6.6L V8 gas	17"	14,000	6,703	16,390	16,270
	Duramax 6.6L V8	17"	14,000	5,777	20,000	31,340

MODEL	ENGINE	WHEEL SIZE	GVWR (LBS.) <sup>1</sup>	MAX PAYLOAD (LBS.) <sup>2</sup>	MAX CONVENTIONAL TOWING (LBS.) <sup>3</sup>	MAX GOOSENECK/5TH-WHEEL TOWING (LBS.) <sup>3</sup>
<b>3500 HD CREW CAB</b>						
Standard Bed 2WD SRW	6.6L V8 gas	18"/20"	11,000	4,316	14,500	16,700
	Duramax 6.6L V8	18"/20"	11,750	4,135	20,000	21,500
Standard Bed 4x4 SRW	6.6L V8 gas	18"/20"	11,350	4,365	14,500	16,530
	Duramax 6.6L V8	18"/20"	12,100	4,185	20,000	21,300
Standard Bed High Country 4x4 SRW	6.6L V8 gas	20"	11,350	4,068	14,500	16,230
	Duramax 6.6L V8	20"	12,100	3,915	20,000	21,030
Long Bed 2WD SRW	6.6L V8 gas	18"/20"	11,150	4,333	14,500	16,700
	Duramax 6.6L V8	18"/20"	11,900	4,013	20,000	21,330
Long Bed 4x4 SRW	6.6L V8 gas	18"/20"	11,500	4,398	14,500	16,410
	Duramax 6.6L V8	18"/20"	12,250	4,078	20,000	21,040
Long Bed High Country 4x4 SRW	6.6L V8 gas	20"	11,500	4,093	14,500	16,110
	Duramax 6.6L V8	20"	12,250	3,947	20,000	20,910
Long Bed 2WD DRW	6.6L V8 gas	17"	14,000	6,894	16,300	16,200
	Duramax 6.6L V8	17"	14,000	5,892	20,000	31,400
Long Bed 4x4 DRW	6.6L V8 gas	17"	14,000	6,610	16,240	16,120
	Duramax 6.6L V8	17"	14,000	5,662	20,000	31,180
Long Bed High Country 4x4 DRW	6.6L V8 gas	17"	14,000	6,390	16,020	15,900
	Duramax 6.6L V8	17"	14,000	5,488	20,000	31,000

<sup>1</sup> Maximum Gross Vehicle Weight Rating (GVWR). When properly equipped; includes weight of vehicle, passengers, cargo and equipment. <sup>2</sup> These maximum payload ratings are intended for comparison purposes only. Before you buy a vehicle or use it to haul people or cargo, carefully review the Vehicle Loading section of the Owner's Manual and check the carrying capacity of your specific vehicle on the label on the inside of the driver door jamb. <sup>3</sup> Before you buy a vehicle or use it for trailering, carefully review the Trailering section of the Owner's Manual. The weight of passengers, cargo and options or accessories may reduce the amount you can tow. <sup>4</sup> Requires WT with available Max Trailering Package.

## SILVERADO 3500 HD CHASSIS CAB

Go to Silverado 3500 HD Chassis Cab model overview.



### MODEL AVAILABILITY ● AVAILABLE

MODEL	REGULAR CAB	CREW CAB	2WD	4x4	STANDARD ENGINE	STANDARD HP @ RPM/LB.-FT. TORQUE @ RPM	AVAILABLE ENGINE	AVAILABLE HP @ RPM/LB.-FT. TORQUE @ RPM	STANDARD SEATING (REGULAR CAB/ CREW CAB)
Silverado 3500 HD	●	●	●	●	6.6L V8 gas	401 @ 5200/464 @ 4000	Duramax 6.6L V8	445 @ 2800/910 @ 1600	3/6

## STANDARD EQUIPMENT

### MECHANICAL

Air filter – high-capacity with air filtration monitoring

Alternator – 170 amps

Axle – dual rear wheel

Battery – heavy-duty, 720 cold-cranking amps

Brakes – 4-wheel antilock, 4-wheel disc with Duralife rotors and brake lining wear indicator

Cooling – external engine oil and auxiliary external transmission oil coolers

Differential – automatic locking rear

Fuel tank – front and rear, 63.5-gallon

StabiliTrak – Electronic Stability Control System and Traction Control; includes Electronic Trailer Sway Control and Hill Start Assist

Steering – recirculating ball with smart flow power steering system

Transfer case – 2-speed electronic shift with push-button controls (4x4 models)

### EXTERIOR

Bumpers – front, Black

Daytime running lamps – with automatic exterior lamp control

Door handles – Black

Headlamps – halogen reflector with halogen daytime running lamps

Lamps – Smoked Amber roof marker (LED)

Mirrors – vertical trailering, manual-folding and manual-extending with lower convex mirrors

Recovery hooks<sup>1</sup> – front, frame-mounted, Black

### INTERIOR

Airbags<sup>2</sup> – dual-stage frontal airbags for driver and front outboard passenger; seat-mounted side-impact airbags for driver and front outboard passenger; head-curtain airbags for front and rear outboard seating positions; includes front outboard Passenger Sensing System for frontal outboard passenger airbag

Air conditioning – single-zone

Assist handles – driver and front passenger, A-pillar; rear passenger, B-pillar

Connectivity – Bluetooth<sup>®</sup> phone connectivity and wireless audio streaming<sup>3</sup>

Compass – located in instrument cluster

Display – outside temperature

Driver Information Center – 3.5-inch diagonal monochromatic display

Entertainment – Chevrolet Infotainment 3 system<sup>4</sup> with 7-inch diagonal color touch-screen

Floor covering – rubberized-vinyl

Instrument cluster – 6-gauge cluster with speedometer, fuel level, engine temperature, tachometer, voltage and oil pressure

Media – USB port<sup>5</sup>; on instrument panel

Seat – rear 60/40 folding bench (folds up), 3-passenger (includes child seat top tether anchor) (Crew Cab)

Seats – front 40/20/40 split-bench

Tire Pressure Monitoring System – with Tire Fill Alert (does not apply to spare tire)

<sup>1</sup> To avoid the risk of injury, never use recovery hooks to tow a vehicle. See the Owner's Manual for more information. <sup>2</sup> A NOTE ON CHILD SAFETY: Always use seat belts and the correct child restraint for your child's age and size, even with airbags. Even in vehicles equipped with the Passenger Sensing System, children are safer when properly secured in a rear seat in the appropriate infant, child or booster seat. Never place a rear-facing infant restraint in the front seat of any vehicle equipped with an active frontal airbag. See your vehicle Owner's Manual and the child safety seat instructions for more safety information. <sup>3</sup> Go to [my.chevrolet.com/learnAbout/bluetooth](http://my.chevrolet.com/learnAbout/bluetooth) to find out which phones are compatible with the vehicle. Full Bluetooth feature functionality varies by device, model and software version. <sup>4</sup> Chevrolet Infotainment System functionality varies by model. Full functionality requires compatible Bluetooth and smartphone, and USB connectivity for some devices. <sup>5</sup> Not compatible with all devices.



## SILVERADO 3500 HD CHASSIS CAB (CONTINUED)

Go to Silverado 3500 HD Chassis Cab model overview.



### PAYLOAD AND VEHICLE WEIGHT RATINGS

MODEL	ENGINE	AXLE RATIO	GCWR (LBS.) <sup>1</sup>	MAX PAYLOAD (LBS.) <sup>2</sup>	GVWR (LBS.) <sup>3</sup>
Silverado 3500 HD Regular Cab Chassis Cab 2WD (146" Wheelbase)	6.6L V8 gas	3.73	24,000	7,571	14,000
	Duramax 6.6L V8	3.42	40,000	6,638	14,000
Silverado 3500 HD Regular Cab Chassis Cab 2WD (171" Wheelbase)	6.6L V8 gas	3.73	24,000	7,454	14,000
	Duramax 6.6L V8	3.42	40,000	6,516	14,000
Silverado 3500 HD Crew Cab Chassis Cab 2WD (177" Wheelbase)	6.6L V8 gas	3.73	24,000	7,040	14,000
	Duramax 6.6L V8	3.42	40,000	6,078	14,000
Silverado 3500 HD Regular Cab Chassis Cab 4x4 (146" Wheelbase)	6.6L V8 gas	3.73	24,000	7,204	14,000
	Duramax 6.6L V8	3.42	40,000	6,271	14,000
Silverado 3500 HD Regular Cab Chassis Cab 4x4 (171" Wheelbase)	6.6L V8 gas	3.73	24,000	7,159	14,000
	Duramax 6.6L V8	3.42	40,000	6,221	14,000
Silverado 3500 HD Crew Cab Chassis Cab 4x4 (177" Wheelbase)	6.6L V8 gas	3.73	24,000	6,713	14,000
	Duramax 6.6L V8	3.42	40,000	5,751	14,000

<sup>1</sup> Gross Combination Weight Rating. <sup>2</sup> These maximum payload ratings are intended for comparison purposes only. Before you buy a vehicle or use it to haul people or cargo, carefully review the Vehicle Loading section of the Owner's Manual and check the carrying capacity of your specific vehicle on the label on the inside of the driver door jamb. <sup>3</sup> Maximum Gross Vehicle Weight Rating (GVWR). When properly equipped; includes weight of vehicle, passengers, cargo and equipment.

## SILVERADO 4500 HD/5500 HD/6500 HD

Go to Silverado 4500 HD/  
5500 HD/6500 HD  
model overview.



### MODEL AVAILABILITY ● AVAILABLE

MODEL	REGULAR CAB	CREW CAB	2WD	4x4	STANDARD ENGINE	STANDARD HP @ RPM/ LB.-FT. TORQUE @ RPM	STANDARD SEATING (REGULAR CAB/CREW CAB)
Silverado 4500 HD	●	●	●	●	Duramax 6.6L V8	350 @ 2700/700 @ 1600	3/6
Silverado 5500 HD	●	●	●	●	Duramax 6.6L V8	350 @ 2700/700 @ 1600	3/6
Silverado 6500 HD	●	●	●	●	Duramax 6.6L V8	350 @ 2700/700 @ 1600	3/6

## STANDARD EQUIPMENT

### MECHANICAL

Batteries – heavy-duty dual, 1,100 cold-cranking amps, includes battery box mounted to left side under cab

Brakes – hydraulic, heavy-duty system with 4-channel ABS

Brake – driveline parking brake system

Emissions – 50-state certified

Engine – Duramax 6.6L Turbo-Diesel V8

Exhaust brake

Fuel tank – rear, 40-gallon, mounted between frame side rails and behind rear axle

StabiliTrak – Electronic Stability Control System and Traction Control; includes Electronic Trailer Sway Control and Hill Start Assist

Transmission – Neutral-at-Stop; automatic transmission shifts to Neutral when the service brake is depressed while the vehicle is at a complete stop, and remains in Neutral until the service brake is released

### EXTERIOR

Assist steps

Bumper – front, Black

Daytime running lamps – with automatic exterior lamp control

Door handles – Black

Fuel filler – capped

Glass – solar absorbing, tinted

Grille guard screen – insect protection

Headlamps – halogen projector-beam

Lamps – cargo area, cab-mounted with switch on center switch bank, Smoked Amber roof marker

Wheels – 19.5" Black-painted steel

### INTERIOR

Airbags<sup>1</sup> – single-stage frontal airbags for driver and front outboard passenger; seat-mounted side-impact airbags for driver and front outboard passenger; head-curtain airbags for front and rear outboard seating positions (Crew Cab); single-stage frontal airbags for driver and front outboard passenger; seat-mounted side-impact airbags for driver and front outboard passenger; head-curtain airbags for front outboard seating positions; includes airbag deactivation switch for front outboard passenger airbag (Regular Cab)

Assist handles – driver and front passenger, A-pillar

Cruise control – steering wheel-mounted

Door locks – power

Seats – front 40/20/40 split-bench, 3-passenger, driver and front passenger recline with outboard head restraints and center fold-down armrest with storage

Steering column – manual tilt-wheel

Upfitter switch kit – provides up to four 30-amp circuits to facilitate installation of aftermarket electrical accessories<sup>2</sup>; located on the instrument panel

<sup>1</sup> A NOTE ON CHILD SAFETY: Always use seat belts and the correct child restraint for your child's age and size, even with airbags. Even in vehicles equipped with the Passenger Sensing System, children are safer when properly secured in a rear seat in the appropriate infant, child or booster seat. Never place a rear-facing infant restraint in the front seat of any vehicle equipped with an active frontal airbag. See your vehicle Owner's Manual and the child safety seat instructions for more safety information.

<sup>2</sup> Equipment from independent suppliers is not covered by the GM New Vehicle Limited Warranty. GM is not responsible for the safety or quality of independent supplier alterations.

## SILVERADO 4500 HD/5500 HD/6500 HD (CONTINUED)

Go to Silverado 4500 HD/  
5500 HD/6500 HD  
model overview.



### PAYLOAD AND VEHICLE WEIGHT RATINGS

MODEL	SERIES	AXLE RATIO	MAX GCWR (LBS.) <sup>1</sup>	MAX PAYLOAD (LBS.) <sup>2</sup> (REGULAR CAB/CREW CAB)	GVWR (LBS.) <sup>3</sup>
Silverado Chassis Cab 2WD	4500 HD	4.10	30,000	6,494/5,750	14,001
	4500 HD	4.10	30,000	7,493/6,749	15,000
	4500 HD	4.10	30,000	8,493/7,749	16,000
	4500 HD	4.10	30,000	8,993/8,249	16,500
	5500 HD	4.10	30,000	9,993/9,249	17,500
	5500 HD	4.10	30,000	10,493/9,749	18,000
	5500 HD	4.10	30,000	11,933/11,196	19,500
	6500 HD	4.10	30,000	13,940/13,196	21,500
	6500 HD	4.10	30,000	15,380/14,636	22,940
Silverado Chassis Cab 4x4	6500 HD	4.10	30,000	15,940/15,196	23,500
	4500 HD	4.30	34,000	5,830/5,186	14,001
	4500 HD	4.30	34,000	6,829/6,186	15,000
	4500 HD	4.30	34,000	7,829/7,186	16,000
	4500 HD	4.30	34,000	8,329/7,686	16,500
	5500 HD	4.30	34,000	9,329/8,686	17,500
	5500 HD	4.30	34,000	9,829/9,186	18,000
	5500 HD	4.30	34,000	11,269/10,693	19,500
	6500 HD	4.30	34,000	12,686/12,193	21,000
	6500 HD	4.30	34,000	14,276/13,693	22,500
	6500 HD	4.30	34,000	14,776/14,193	23,000

<sup>1</sup> Gross Combination Weight Rating. <sup>2</sup> These maximum payload ratings are intended for comparison purposes only. Before you buy a vehicle or use it to haul people or cargo, carefully review the Vehicle Loading section of the Owner's Manual and check the carrying capacity of your specific vehicle on the label on the inside of the driver door jamb. <sup>3</sup> Maximum Gross Vehicle Weight Rating (GVWR). When properly equipped; includes weight of vehicle, passengers, cargo and equipment.

## SILVERADO 4500 HD/5500 HD/6500 HD (CONTINUED)

Go to Silverado 4500 HD/  
5500 HD/6500 HD  
model overview.



### PAYLOAD AND VEHICLE WEIGHT RATINGS

MODEL	SERIES	AXLE RATIO	MAX GCWR (LBS.) <sup>1</sup>	MAX PAYLOAD (LBS.) <sup>2</sup> (REGULAR CAB/CREW CAB)	GVWR (LBS.) <sup>3</sup>
Silverado Chassis Cab 2WD	4500 HD	4.56	35,000	6,494/5,750	14,001
	4500 HD	4.56	35,000	7,493/6,749	15,000
	4500 HD	4.56	35,000	8,493/7,749	16,000
	4500 HD	4.56	35,000	8,993/8,249	16,500
	5500 HD	4.56	35,000	9,993/9,249	17,500
	5500 HD	4.56	35,000	10,493/9,749	18,000
	5500 HD	4.56	35,000	11,933/11,196	19,500
	6500 HD	4.56	35,000	13,940/13,196	21,500
	6500 HD	4.56	35,000	15,380/14,636	22,940
Silverado Chassis Cab 2WD	6500 HD	4.56	35,000	15,940/15,196	23,500
	4500 HD	4.88	37,000	6,494/5,750	14,001
	4500 HD	4.88	37,000	7,493/6,749	15,000
	4500 HD	4.88	37,000	8,493/7,749	16,000
	4500 HD	4.88	37,000	8,993/8,249	16,500
	5500 HD	4.88	37,000	9,993/9,249	17,500
	5500 HD	4.88	37,000	10,493/9,749	18,000
	5500 HD	4.88	37,000	11,933/11,196	19,500
	6500 HD	4.88	37,000	13,940/13,196	21,500
Silverado Chassis Cab 2WD	6500 HD	4.88	37,000	15,380/14,636	22,940
	6500 HD	4.88	37,000	15,940/15,196	23,500

<sup>1</sup> Gross Combination Weight Rating. <sup>2</sup> These maximum payload ratings are intended for comparison purposes only. Before you buy a vehicle or use it to haul people or cargo, carefully review the Vehicle Loading section of the Owner's Manual and check the carrying capacity of your specific vehicle on the label on the inside of the driver door jamb. <sup>3</sup> Maximum Gross Vehicle Weight Rating (GVWR). When properly equipped; includes weight of vehicle, passengers, cargo and equipment.

# COLORADO

Go to Colorado model overview.



## MODEL AVAILABILITY ● AVAILABLE – NOT AVAILABLE

TRIM LEVEL	STANDARD ENGINE	AVAILABLE ENGINES	2WD	4x4	EXTENDED CAB LONG BOX	CREW CAB SHORT BOX	CREW CAB LONG BOX
WT	2.5L DOHC 4-cylinder	3.6L DOHC V6, Duramax 2.8L Turbo-Diesel <sup>1</sup>	●	●	●	●	●
LT	2.5L DOHC 4-cylinder	3.6L DOHC V6, Duramax 2.8L Turbo-Diesel <sup>2</sup>	●	●	●	●	●
Z71	3.6L DOHC V6	Duramax 2.8L Turbo-Diesel <sup>3</sup>	●	●	●	●	●
ZR2	3.6L DOHC V6	Duramax 2.8L Turbo-Diesel	–	●	●	●	–

## STANDARD EQUIPMENT

### MECHANICAL

Brakes – 4-wheel antilock, 4-wheel disc with Duralife rotors

Frame – fully boxed

StabiliTrak – Electronic Stability Control System and Traction Control

Steering – Electric Power Steering assist

### EXTERIOR

Cargo box lamp – back of cab

Daytime running lamps

Fuel filler – capless fueling

Glass – windshield shade band

Tailgate handle – Black

Tire – compact spare or full-size spare

### INTERIOR

Airbags<sup>4</sup> – dual-stage frontal airbags for driver and front passenger; seat-mounted side-impact airbags for driver and front outboard passenger; head-curtain airbags for front and rear outboard seating positions; includes front outboard Passenger Sensing System for frontal passenger airbag

Door locks – power programmable with lockout protection and rear door child security

Media – two USB ports<sup>5</sup> and auxiliary input jack in front center console

Rear Vision Camera<sup>6</sup>

Seat – driver power adjuster

Steering column – manual tilt

Teen Driver technology

Theft-deterrent system – engine immobilizer

Tire Pressure Monitoring System – with Tire Fill Alert (does not monitor spare tire, if equipped)

Visors – driver and front passenger, vanity mirrors

Windows – power driver express-up/-down, all others express-down

## PAYLOAD AND TRAILER WEIGHT RATINGS

ENGINE	AXLE RATIO	MAX GCWR (LBS.) <sup>8</sup>	MAX TRAILER WEIGHT (LBS.) <sup>7</sup>			
			EXTENDED CAB 2WD	EXTENDED CAB 4x4	CREW CAB 2WD	CREW CAB 4x4
2.5L DOHC 4-cylinder	4.10	8,500	3,500	3,500	3,500	–
3.6L DOHC V6	3.42	12,000	3,500	3,500	3,500	3,500
3.6L DOHC V6 with Trailering Package	3.42	12,000	7,000	7,000	7,000	7,000
Duramax 2.8L Turbo-Diesel 4-cylinder	3.42	12,700	–	7,700 <sup>1</sup>	7,700	7,600

<sup>1</sup> Available on Fleet and Government orders only. <sup>2</sup> Not available on Extended Cab or Crew Cab Long Box 2WD models. <sup>3</sup> Crew Cab 4x4 only. <sup>4</sup> A NOTE ON CHILD SAFETY: Always use seat belts and the correct child restraint for your child's age and size, even with airbags. Even in vehicles equipped with the Passenger Sensing System, children are safer when properly secured in a rear seat in the appropriate infant, child or booster seat. Never place a rear-facing infant restraint in the front seat of any vehicle equipped with an active frontal airbag. See your vehicle Owner's Manual and the child safety seat instructions for more safety information. <sup>5</sup> Not compatible with all devices. <sup>6</sup> Read the vehicle Owner's Manual for important feature limitations and information. <sup>7</sup> Before you buy a vehicle or use it for trailering, carefully review the Trailering section of the Owner's Manual. The weight of passengers, cargo and options or accessories may reduce the amount you can tow. <sup>8</sup> Gross Combination Weight Rating.

## EXPRESS CARGO VAN

Go to Express Cargo  
Van model overview.



### MODEL AVAILABILITY

TRIM/SERIES	DRIVE	WHEELBASE	STANDARD ENGINE	STANDARD HP @ RPM/ LB.-FT. TORQUE @ RPM	AVAILABLE ENGINES	MAX PAYLOAD (LBS.) <sup>1</sup>	STANDARD SEATING
2500 Regular Wheelbase	RWD	135"	4.3L V6	276 @ 5200/298 @ 3900	6.6L V8, Duramax 2.8L	3,280	2
2500 Extended Wheelbase	RWD	155"	4.3L V6	276 @ 5200/298 @ 3900	6.6L V8, Duramax 2.8L	3,060	2
3500 Regular Wheelbase	RWD	135"	4.3L V6	276 @ 5200/298 @ 3900	6.6L V8, Duramax 2.8L	4,280	2
3500 Extended Wheelbase	RWD	155"	4.3L V6	276 @ 5200/298 @ 3900	6.6L V8, Duramax 2.8L	4,060	2

### STANDARD EQUIPMENT

#### MECHANICAL

Brakes – 4-wheel antilock, 4-wheel disc

Engine – 4.3L V6 with Direct Injection and Variable Valve Timing

Exhaust – aluminized stainless steel muffler and tailpipe

StabiliTrak – Electronic Stability Control System with traction assistance; includes Electronic Trailer Sway Control and Hill Start Assist

Suspension – front independent with coil springs and stabilizer bar; rear drive axle with multi-leaf springs

Transmission – 8-speed automatic, electronically controlled with overdrive and Tow/Haul mode

#### EXTERIOR

Bumpers – front and rear, Black-painted with step pad

Daytime running lamps

Door – swing-out passenger-side, 60/40 split

Headlamps – dual halogen

Mirrors – manual, Black

#### EXTERIOR (CONTINUED)

Wheels – 16" painted-steel with gray center caps and steel spare

Wipers – front intermittent wet-arm with pulse washers

#### INTERIOR

Airbags<sup>2</sup> – frontal for driver and right-front passenger; seat-mounted side-impact for driver and right-front passenger; roof-rail mounted head-curtain provides coverage for outboard seating positions

Air conditioning – single-zone manual

Audio system – AM/FM stereo with MP3 player, seek-scan, digital clock, TheftLock, random select, auxiliary jack and two front door speakers

Console – engine cover with open storage bin and three cup holders

Defogger – side windows

Power Convenience Package – power windows and power door locks

Power outlet – 120-volt

Seats – front bucket with outboard head restraints and inboard armrests, vinyl trim

<sup>1</sup> These maximum payload ratings are intended for comparison purposes only. Before you buy a vehicle or use it to haul people or cargo, carefully review the Vehicle Loading section of the Owner's Manual and check the carrying capacity of your specific vehicle on the label on the inside of the driver door jamb. <sup>2</sup> A NOTE ON CHILD SAFETY: Always use seat belts and the correct child restraint for your child's age and size, even with airbags. Even in vehicles equipped with the Passenger Sensing System, children are safer when properly secured in a rear seat in the appropriate infant, child or booster seat. Never place a rear-facing infant restraint in the front seat of any vehicle equipped with an active frontal airbag. See your vehicle Owner's Manual and the child safety seat instructions for more safety information.

## EXPRESS CARGO VAN (CONTINUED)

Go to Express Cargo  
Van model overview.



### PAYLOAD AND VEHICLE WEIGHT RATINGS

MODEL	ENGINE	PAYLOAD (LBS.) <sup>1</sup>	GVWR (LBS.) <sup>2</sup>	MAX TRAILER WEIGHT (LBS.) <sup>3</sup>
2500 Regular Wheelbase	4.3L V6	3,280	8,600	7,400
	6.6L V8	3,060	8,600	10,000
	Duramax 2.8L	2,870	8,600	7,000
2500 Extended Wheelbase	4.3L V6	3,060	8,600	7,100
	6.6L V8	2,790	8,600	10,000
	Duramax 2.8L	2,660	8,600	6,100
3500 Regular Wheelbase	4.3L V6	4,280	9,600	7,400
	6.6L V8	4,010	9,600	10,000
	Duramax 2.8L	3,870	9,600	6,200
3500 Extended Wheelbase	4.3L V6	4,060	9,600	7,200
	6.6L V8	4,090	9,900	10,000
	Duramax 2.8L	3,960	9,900	6,000

<sup>1</sup> These maximum payload ratings are intended for comparison purposes only. Before you buy a vehicle or use it to haul people or cargo, carefully review the Vehicle Loading section of the Owner's Manual and check the carrying capacity of your specific vehicle on the label on the inside of the driver door jamb. <sup>2</sup> Maximum Gross Vehicle Weight Rating (GVWR). When properly equipped; includes weight of vehicle, passengers, cargo and equipment. <sup>3</sup> Before you buy a vehicle or use it for trailering, carefully review the Trailering section of the Owner's Manual. The weight of passengers, cargo and options or accessories may reduce the amount you can tow.

## EXPRESS PASSENGER VAN

Go to Express Passenger Van model overview.



### MODEL AVAILABILITY

TRIM/SERIES	DRIVE	WHEELBASE	STANDARD ENGINE	STANDARD HP @ RPM/ LB.-FT. TORQUE @ RPM	AVAILABLE ENGINES	MAX PAYLOAD (LBS.) <sup>1</sup>	STANDARD SEATING
2500	RWD	135"	4.3L V6	276 @ 5200/298 @ 3900	6.6L V8, Duramax 2.8L	2,550	12
3500 Regular Wheelbase	RWD	135"	4.3L V6	276 @ 5200/298 @ 3900	6.6L V8, Duramax 2.8L	3,320	12
3500 Extended Wheelbase	RWD	155"	4.3L V6	276 @ 5200/298 @ 3900	6.6L V8, Duramax 2.8L	3,210	12

### STANDARD EQUIPMENT

#### MECHANICAL

Brakes – 4-wheel antilock, 4-wheel disc

Engine – 4.3L V6 with Direct Injection and Variable Valve Timing

Exhaust – aluminized stainless steel muffler and tailpipe

StabiliTrak – Electronic Stability Control System with traction assistance; includes Electronic Trailer Sway Control and Hill Start Assist

Suspension – front independent with coil springs and stabilizer bar; rear drive axle with multi-leaf springs

Transmission – 8-speed automatic, electronically controlled with overdrive and Tow/Haul mode

#### EXTERIOR

Bumpers – front and rear, Black-painted with step pad

Daytime running lamps

Door – swing-out passenger-side, 60/40 split

Glass – full-body window package

Headlamps – dual halogen

Mirrors – manual, Black

#### EXTERIOR (CONTINUED)

Wheels – 16" painted-steel with gray center caps and steel spare

Wipers – front intermittent wet-arm with pulse washers

#### INTERIOR

Airbags<sup>2</sup> – frontal for driver and right-front passenger; seat-mounted side-impact for driver and right-front passenger; roof-rail mounted head-curtain provides coverage for outboard seating positions for first three rows only

Air conditioning – front and rear

Audio system – AM/FM stereo with MP3 player, seek-scan, digital clock, TheftLock, random select, auxiliary jack and two front door speakers

Console – engine cover with open storage bin and three cup holders

Defogger – front and side windows

Heater – rear auxiliary

Mirror – rearview, with Rear Vision Camera<sup>3</sup> display

Power Convenience Package – power windows and power door locks

Power outlet – 120-volt

Seats – 12-passenger (2-3-3-4 seating configuration; 4-passenger seat is a 50/50 split, 2-piece configuration)

### PAYLOAD AND VEHICLE WEIGHT RATINGS

MODEL	ENGINE	PAYLOAD (LBS.) <sup>1</sup>	GVWR (LBS.) <sup>4</sup>	MAX TRAILER WEIGHT (LBS.) <sup>5</sup>
2500 Regular Wheelbase	4.3L V6	2,550	8,600	6,700
	6.6L V8	2,360	8,600	9,600
	Duramax 2.8L	2,200	8,600	6,300
3500 Regular Wheelbase	4.3L V6	3,540	9,600	6,700
	6.6L V8	3,350	9,600	9,600
	Duramax 2.8L	3,210	9,600	5,700
3500 Extended Wheelbase	4.3L V6	3,210	9,600	6,300
	6.6L V8	3,320	9,900	9,200
	Duramax 2.8L	3,190	9,900	5,300

<sup>1</sup> These maximum payload ratings are intended for comparison purposes only. Before you buy a vehicle or use it to haul people or cargo, carefully review the Vehicle Loading section of the Owner's Manual and check the carrying capacity of your specific vehicle on the label on the inside of the driver door jamb. <sup>2</sup> A NOTE ON CHILD SAFETY: Always use seat belts and the correct child restraint for your child's age and size, even with airbags. Even in vehicles equipped with the Passenger Sensing System, children are safer when properly secured in a rear seat in the appropriate infant, child or booster seat. Never place a rear-facing infant restraint in the front seat of any vehicle equipped with an active frontal airbag. See your vehicle Owner's Manual and the child safety seat instructions for more safety information. <sup>3</sup> Read the vehicle Owner's Manual for important feature limitations and information. <sup>4</sup> Maximum Gross Vehicle Weight Rating (GVWR). When properly equipped; includes weight of vehicle, passengers, cargo and equipment. <sup>5</sup> Before you buy a vehicle or use it for trailering, carefully review the Trailering section of the Owner's Manual. The weight of passengers, cargo and options or accessories may reduce the amount you can tow.



## EXPRESS CUTAWAY

Go to Express Cutaway  
model overview.



### MODEL AVAILABILITY

TRIM/SERIES	DRIVE	WHEELBASE	CAB-TO-AXLE LENGTH	STANDARD ENGINE	STANDARD HP @ RPM/ LB.-FT. TORQUE @ RPM	STANDARD TRANSMISSION	AVAILABLE ENGINE	MAX PAYLOAD (LBS.) <sup>1</sup>	STANDARD SEATING
Express 3500 Cutaway	RWD	139"	80"	4.3L V6	276 @ 5200/298 @ 3900	8-speed automatic	6.6L V8	7,150	2
Express 3500 Cutaway	RWD	159"	100"	6.6L V8	401 @ 5200/464 @ 4000	6-speed automatic, heavy-duty		7,120	2
Express 3500 Cutaway	RWD (DRW)	177"	118"	6.6L V8	401 @ 5200/464 @ 4000	6-speed automatic, heavy-duty		7,080	2
Express 4500 Cutaway	RWD (DRW)	159"	100"	6.6L V8	401 @ 5200/464 @ 4000	6-speed automatic, heavy-duty		8,920	2
Express 4500 Cutaway	RWD (DRW)	177"	118"	6.6L V8	401 @ 5200/464 @ 4000	6-speed automatic, heavy-duty		8,870	2

### STANDARD EQUIPMENT

MECHANICAL
Alternator – 150 amps
Battery – 600 cold-cranking amps, maintenance-free with rundown protection and retained accessory power
Brakes – 4-wheel antilock, 4-wheel disc
Engine – 4.3L V6 with Direct Injection and Variable Valve Timing (3500)
Exhaust – aluminized stainless steel muffler and tailpipe
StabiliTrak – Electronic Stability Control System with traction assistance; includes Electronic Trailer Sway Control and Hill Start Assist
Steering – power
Suspension – front independent with coil springs and stabilizer bar; rear drive axle with multi-leaf springs
Transmission – 6- or 8-speed automatic, electronically controlled with overdrive and Tow/Haul mode; includes cruise grade braking and powertrain grade braking
EXTERIOR
Bumpers – Black-painted with step pad
Daytime running lamps
Grille – Black

EXTERIOR (CONTINUED)
Headlamps – dual halogen
Mirrors – manual, Black
Tires – LT245/75R16E all-season, blackwall (3500)
Wheels – 16" 8-lug painted-steel, heavy-duty
Wipers – front intermittent wet-arm with pulse washers
INTERIOR
Airbags <sup>2</sup> – frontal for driver and right-front passenger
Air conditioning – single-zone manual
Audio system – AM/FM stereo with MP3 player, seek-scan, digital clock, TheftLock, random select, auxiliary jack and two front door speakers
Console – engine cover with open storage bin and three cup holders
Defogger – side windows
Power outlet – 120-volt
Seats – front bucket with outboard head restraints and inboard armrests, vinyl trim

### PAYLOAD AND VEHICLE WEIGHT RATINGS

MODEL	ENGINE	PAYLOAD (LBS.) <sup>1</sup>	GVWR (LBS.) <sup>3</sup>
Express 3500 Cutaway 139" Wheelbase	4.3L V6	5,360	9,900
	6.6L V8	7,150	12,300
Express 3500 Cutaway 159" Wheelbase	6.6L V8	7,120	12,300
Express 3500 Cutaway 177" Wheelbase	6.6L V8	7,080	12,300
Express 4500 Cutaway 159" Wheelbase	6.6L V8	8,920	14,200
Express 4500 Cutaway 177" Wheelbase	6.6L V8	8,870	14,200

<sup>1</sup> These maximum payload ratings are intended for comparison purposes only. Before you buy a vehicle or use it to haul people or cargo, carefully review the Vehicle Loading section of the Owner's Manual and check the carrying capacity of your specific vehicle on the label on the inside of the driver door jamb. <sup>2</sup> A NOTE ON CHILD SAFETY: Always use seat belts and the correct child restraint for your child's age and size, even with airbags. Even in vehicles equipped with the Passenger Sensing System, children are safer when properly secured in a rear seat in the appropriate infant, child or booster seat. Never place a rear-facing infant restraint in the front seat of any vehicle equipped with an active frontal airbag. See your vehicle Owner's Manual and the child safety seat instructions for more safety information. <sup>3</sup> Maximum Gross Vehicle Weight Rating (GVWR). When properly equipped; includes weight of vehicle, passengers, cargo and equipment.

## LOW CAB FORWARD

Go to Low Cab Forward  
model overview.



### MODEL AVAILABILITY ● AVAILABLE – NOT AVAILABLE

MODEL	REGULAR CAB	CREW CAB	WHEELBASE (IN.)	STANDARD ENGINE	STANDARD HP @ RPM/ LB.-FT. TORQUE @ RPM	GVWR (LBS.) <sup>1</sup>	PAYLOAD RANGE (LBS.) <sup>2</sup>	OVERALL LENGTH (IN.)
3500	●	●	109-176	6.6L V8	350 @ 4500/425 @ 3800	12,000	6,033-6,796	200.5-267.5
4500	●	●	109-176	6.6L V8	350 @ 4500/425 @ 3800	14,500	8,229-8,941	200.5-267.5
4500 HD	●	●	109-176	5.2L I-4 Diesel	215 @ 2500/452 @ 1850	14,500	7,686-8,456	200.5-267.5
4500 XD	●	●	109-176	5.2L I-4 Diesel	215 @ 2500/452 @ 1850	16,000	8,760-9,526	200.5-267.5
5500 HD	●	●	109-200	5.2L I-4 Diesel	215 @ 2500/452 @ 1850	17,950	10,600-11,381	200.5-291.5
5500 XD	●	●	109-212	5.2L I-4 Diesel	215 @ 2500/452 @ 1850	19,500	12,101-12,794	200.5-303.5
6500 XD	●	–	152-248	5.2L I-4 Diesel	215 @ 2500/520 @ 1650	25,950	15,046-16,444	274.4-418.5

## DIMENSIONS

### REGULAR CAB

MODEL	OVERALL WIDTH (IN.)	OVERALL HEIGHT (IN.)	AXLE WIDTH (IN.)	CAB TO AXLE (IN.)	CAB TO END OF FRAME (IN.)	WHEELBASE (IN.)	OVERALL LENGTH (IN.)
3500	81.3	90.0	65.6	86.5-153.5	129.6-196.6	109-176	200.5-267.5
4500	81.3	90.9	65.6	86.5-153.5	129.6-196.6	109-176	200.5-267.5
4500 HD	81.3	90.8	65.6	86.5-153.5	129.6-196.6	109-176	200.5-267.5
4500 XD	81.3	92.4	65.6	86.5-153.5	129.6-196.6	109-176	200.5-267.5
5500 HD	81.3	92.4	65.6	86.5-177.5	129.6-220.6	109-200	200.5-291.5
5500 XD	81.3	92.4	65.6	86.5-189.5	129.6-232.6	109-212	200.5-303.5
6500 XD	93.5	107.0-112.0	81.1	127.0-223.0	192.9-337.0	152-248	274.4-418.5

### CREW CAB

MODEL	OVERALL WIDTH (IN.)	OVERALL HEIGHT (IN.)	AXLE WIDTH (IN.)	CAB TO AXLE (IN.)	CAB TO END OF FRAME (IN.)	WHEELBASE (IN.)	OVERALL LENGTH (IN.)
3500	81.3	90.0	65.6	88.5-114.5	131.6-157.6	150-176	241.5-267.5
4500	81.3	91.1	65.6	88.5-114.5	131.6-157.6	150-176	241.5-267.5
4500 HD	81.3	90.8	65.6	88.5-114.5	131.6-157.6	150-176	241.5-267.5
4500 XD	81.3	92.4	65.6	88.5-114.5	131.6-157.6	150-176	241.5-267.5
5500 HD	81.3	92.4	65.6	88.5-114.5	131.6-157.6	150-176	241.5-267.5
5500 XD	81.3	92.4	65.6	88.5-114.5	131.6-157.6	150-176	241.5-267.5

<sup>1</sup> Maximum Gross Vehicle Weight Rating (GVWR). When properly equipped; includes weight of vehicle, passengers, cargo and equipment. <sup>2</sup> These maximum payload ratings are intended for comparison purposes only. Before you buy a vehicle or use it to haul people or cargo, carefully review the Vehicle Loading section of the Owner's Manual and check the carrying capacity of your specific vehicle on the label on the inside of the driver door jamb.

# DIMENSIONS – SILVERADO 1500 & SILVERADO 2500 HD

## SILVERADO 1500 REGULAR CAB LONG BED

Go to [Silverado 1500 overview](#) →

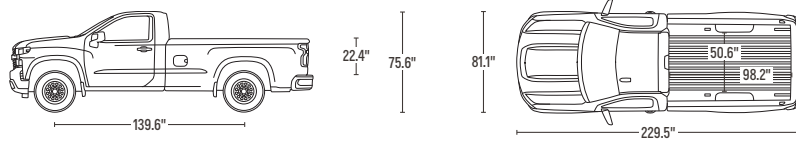

## SILVERADO 2500 HD REGULAR CAB LONG BED

Go to [Silverado HD overview](#) →

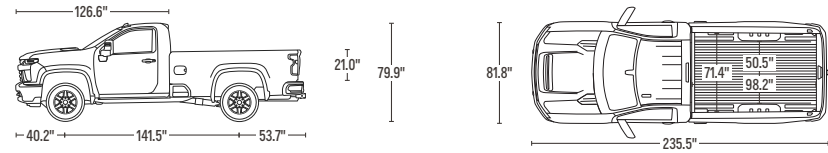

## SILVERADO 1500 DOUBLE CAB STANDARD BED

Go to [Silverado 1500 overview](#) →

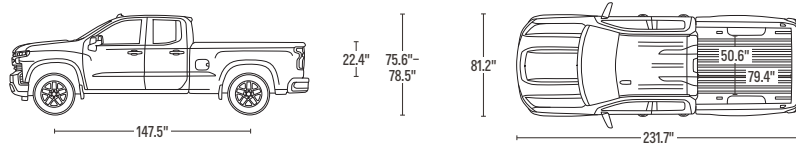

## SILVERADO 2500 HD DOUBLE CAB STANDARD BED

Go to [Silverado HD overview](#) →

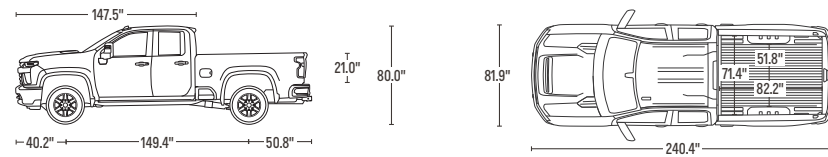

## SILVERADO 1500 CREW CAB SHORT BED

Go to [Silverado 1500 overview](#) →

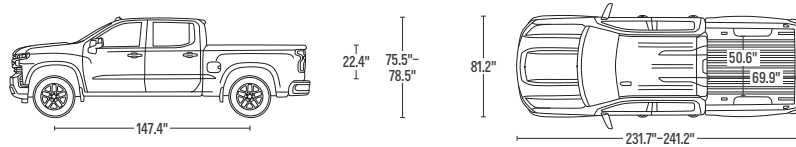

## SILVERADO 2500 HD DOUBLE CAB LONG BED

Go to [Silverado HD overview](#) →

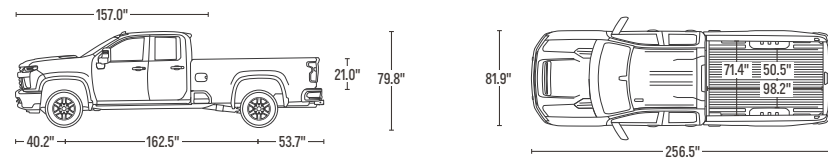

## SILVERADO 1500 CREW CAB STANDARD BED

Go to [Silverado 1500 overview](#) →

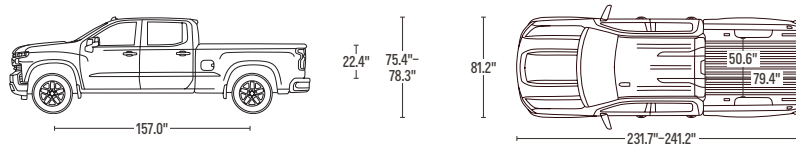

## SILVERADO 2500 HD CREW CAB STANDARD BED

Go to [Silverado HD overview](#) →

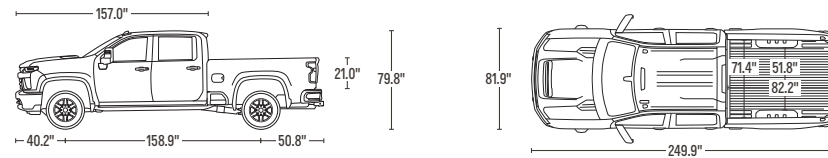

## SILVERADO 2500 HD CREW CAB LONG BED

Go to [Silverado HD overview](#) →

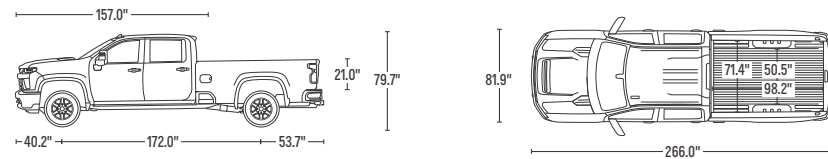

NOTE: For a complete list of all Commercial Vehicle dimensions and specifications, go to [chevrolet.com](http://chevrolet.com).

## DIMENSIONS – SILVERADO 3500 HD & 4500 HD/5500 HD/6500 HD

### SILVERADO 3500 HD REGULAR CAB LONG BED SRW

Go to [Silverado HD overview](#) →

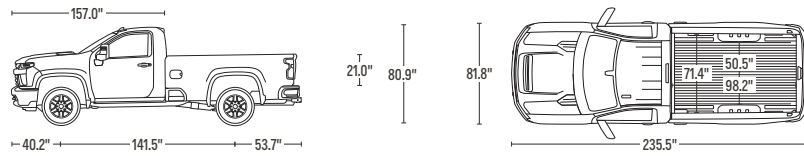

### SILVERADO 3500 HD CREW CAB LONG BED DRW

Go to [Silverado HD overview](#) →

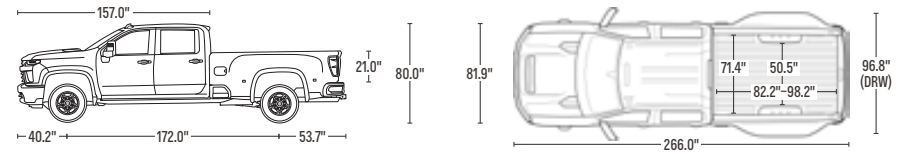

### SILVERADO 3500 HD REGULAR CAB LONG BED DRW

Go to [Silverado HD overview](#) →

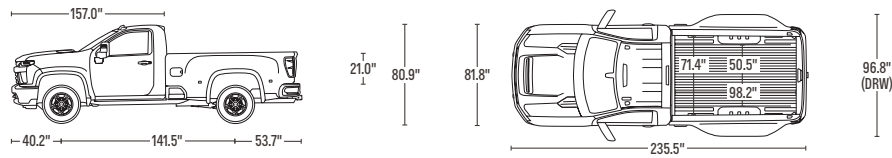

### SILVERADO 3500 HD REGULAR CAB CHASSIS CAB

Go to [Silverado 3500 HD Chassis Cab overview](#) →

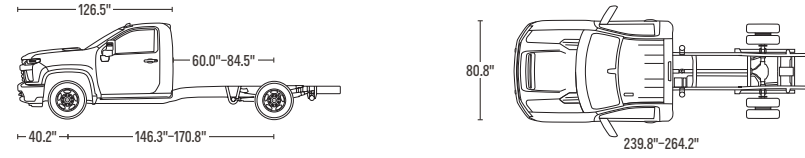

### SILVERADO 3500 HD DOUBLE CAB LONG BED SRW

Go to [Silverado HD overview](#) →

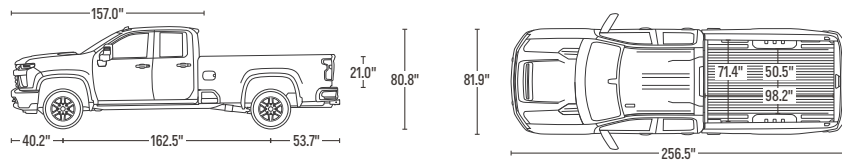

### SILVERADO 3500 HD CREW CAB CHASSIS CAB

Go to [Silverado 3500 HD Chassis Cab overview](#) →

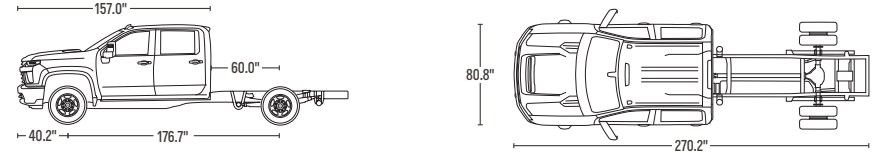

### SILVERADO 3500 HD DOUBLE CAB LONG BED DRW

Go to [Silverado HD overview](#) →

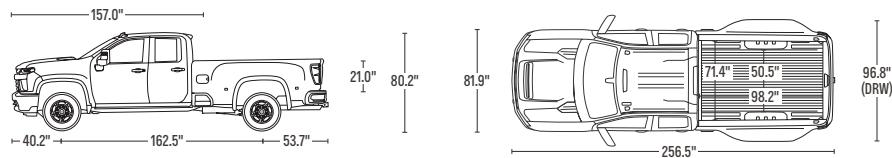

### SILVERADO 4500 HD/5500 HD/6500 HD REGULAR CAB

Go to [Silverado 4500 HD/5500 HD/6500 HD overview](#) →

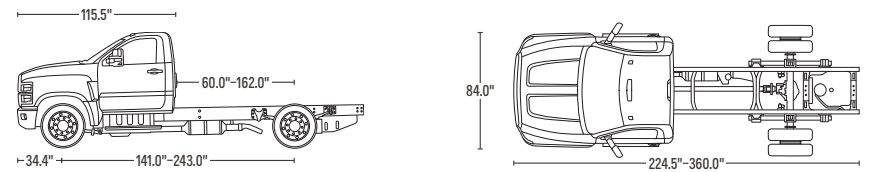

### SILVERADO 3500 HD CREW CAB STANDARD BED SRW

Go to [Silverado HD overview](#) →

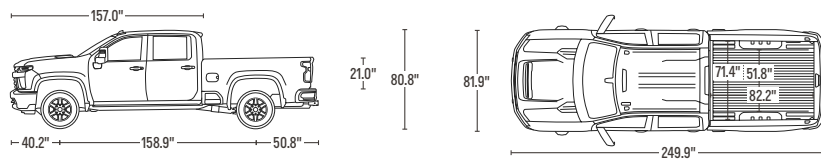

### SILVERADO 4500 HD/5500 HD/6500 HD CREW CAB

Go to [Silverado 4500 HD/5500 HD/6500 HD overview](#) →

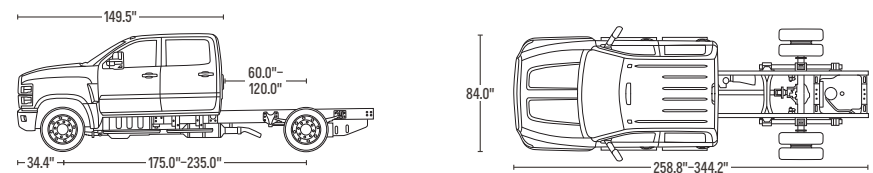

### SILVERADO 3500 HD CREW CAB LONG BED SRW

Go to [Silverado HD overview](#) →

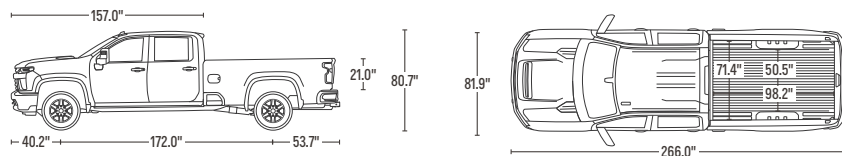

NOTE: For a complete list of all Commercial Vehicle dimensions and specifications, go to [chevrolet.com](#).

## DIMENSIONS – COLORADO, EXPRESS & LOW CAB FORWARD

### COLORADO EXTENDED CAB

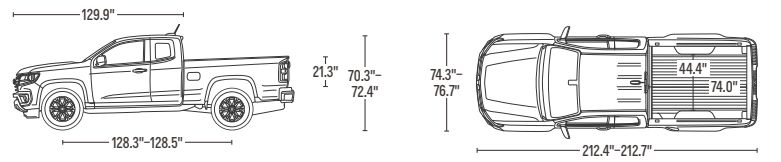

### COLORADO CREW CAB SHORT BOX

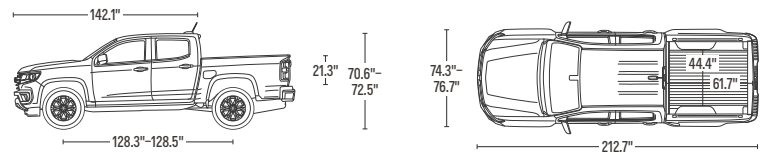

### COLORADO CREW CAB LONG BOX

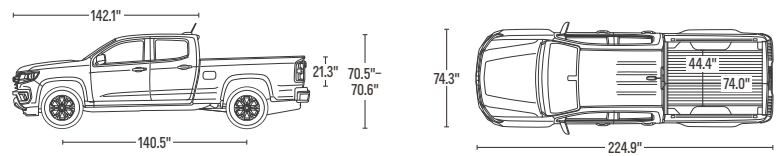

### EXPRESS CARGO VAN 135" Wheelbase/155" Wheelbase

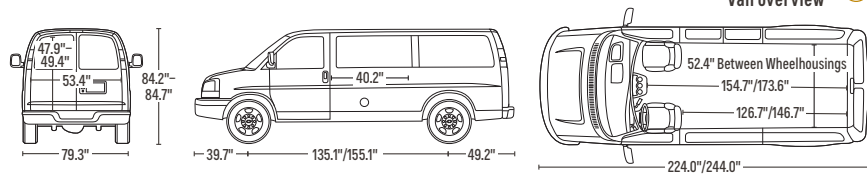

### EXPRESS PASSENGER VAN 135" Wheelbase/155" Wheelbase

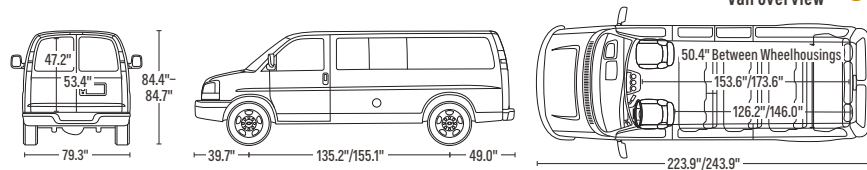

### EXPRESS CUTAWAY 139" Wheelbase/159" Wheelbase/177" Wheelbase

Go to Express Cutaway overview →

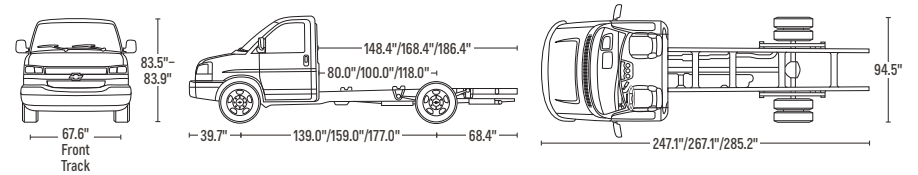

### LOW CAB FORWARD (LCF) REGULAR CAB/CREW CAB 109" Wheelbase-212" Wheelbase

Go to Low Cab Forward overview →

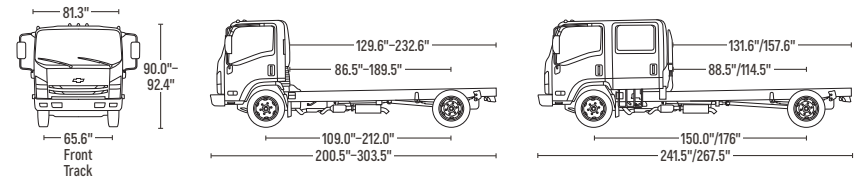

### LOW CAB FORWARD (LCF) 6500 XD 152" Wheelbase-248" Wheelbase

Go to Low Cab Forward overview →

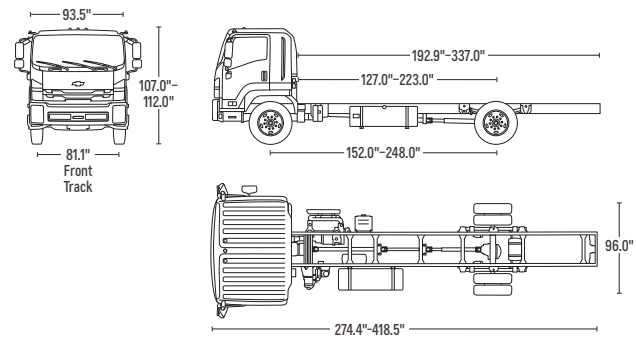

NOTE: For a complete list of all Commercial Vehicle dimensions and specifications, go to [chevrolet.com](http://chevrolet.com).

## WARRANTY

**5-year/60,000-mile transferable Powertrain Limited Warranty.** Qualifying 2021 Chevrolet Commercial vehicles come with a 5-year/60,000-mile<sup>1</sup> transferable Powertrain Limited Warranty. Low Cab Forward with gas engine comes with a 5-year/75,000-mile<sup>1</sup> Powertrain Limited Warranty. Plus, you get 5 years/60,000 miles<sup>1</sup> of the 24/7 Roadside Assistance Program, the Courtesy Transportation Program<sup>2</sup>; and much more. Qualifying fleet purchases of either Low Cab Forward with gas engine or Silverado models with available Duramax 6.6L Turbo-Diesel V8 engine come with a 5-year/100,000-mile<sup>1</sup> Powertrain Limited Warranty. Low Cab Forward with diesel engine comes with a 3-year/unlimited-mile Powertrain Limited Warranty and 24/7 Roadside Assistance Program. Bolt EV comes with an

8-year/100,000-mile<sup>1</sup> Electric and Hybrid Vehicle Warranty Coverage and Courtesy Transportation Program. See dealer for details.

**New Vehicle Limited Warranty.** GM vehicles registered in the USA are covered for 3 years/36,000 miles<sup>1</sup>. The complete vehicle is covered, including towing to your nearest Chevrolet dealership and cosmetic corrosion resulting from defects. Repairs will be made to correct any vehicle defect, and most warranty repairs will be made at no charge. In addition, rust-through corrosion will be covered for 6 years/100,000 miles<sup>1</sup>. Low Cab Forward rust-through corrosion will be covered for 4 years/unlimited miles. See dealer for details.

## IMPORTANT INFORMATION

**Chevrolet Owner Center (my.chevrolet.com).** Everything you need to know. Anything you need to do. Your Chevrolet Owner Center makes it easy. Create your account today to get the most out of your new vehicle. Get special alerts and offers, schedule service, review your maintenance schedule, and view how-to videos specifically for your vehicle. All online, anytime. Visit the Owner Center today to register or take a tour.

**Powertrain.** Chevrolet products are equipped with engines and/or propulsion systems produced by GM Global Propulsion Systems or other suppliers to GM worldwide. The powertrain components in Chevrolet products may also be used in other GM makes and models.

**Assembly.** Chevrolet vehicles and their components are assembled or produced by different operating units of General Motors, its subsidiaries or suppliers to GM worldwide. We sometimes find it necessary to produce Chevrolet vehicles with different or differently sourced components than originally scheduled. Since some options may be unavailable when your vehicle is assembled, we suggest you verify that your vehicle includes the equipment you ordered and that, if there were changes, they are acceptable to you.

**Chevrolet Connected Services and OnStar.** Connected vehicle services vary by vehicle model and require an active service plan, working vehicle electrical system, cell reception and GPS signal. Visit onstar.com for details and limitations.

**A note on child safety.** Always use seat belts and the correct child restraint for your child's age and size, even with airbags. Even in vehicles equipped with the Passenger Sensing System, children are safer when properly secured in a rear seat in the appropriate infant, child or booster seat. Never place a rear-facing infant restraint in the front seat of any vehicle equipped with an active frontal airbag. See your vehicle Owner's Manual and the child safety seat instructions for more safety information.



**BUSINESS ELITE**

**BUSINESS CHOICE OFFERS**  
FLEXIBLE SOLUTIONS FOR YOUR BUSINESS

**Business Choice/Business Elite.** You can get the commercial vehicles you depend on every day, equipped with the features you need to get the job done. If you are a qualified commercial customer<sup>3</sup> and purchase or lease an eligible Chevrolet van or truck, Business Choice offers incentive towards upfit

equipment or accessories to meet your business needs. Visit gmbusinesschoice.com for details. Visit chevrolet.com for special offers and to find a Chevrolet dealer.

**Important words about this catalog.** We have tried to make this catalog comprehensive and factual. We reserve the right, however, to make changes at any time, without notice, in prices, colors, materials, equipment, specifications, models and availability. Specifications, dimensions, measurements, ratings and other numbers in this catalog and other printed materials provided at the dealership or affixed to vehicles are approximations based on design and engineering drawings, prototypes and laboratory tests. Your vehicle may differ due to variations in manufacture and equipment. Since some information may have been updated since the time of printing, please check with your Chevrolet dealer for complete details. Chevrolet reserves the right to lengthen or shorten the model year for any product for any reason or to start and end model years at different times. Certain vehicle features may lose their usefulness over time due to obsolescence from technological changes. Unless otherwise noted, all claims based on GM segmentation and latest available competitive information. Excludes other GM vehicles.

**Spare tire information.** There is no standard jack or spare tire in Express Cutaway models. Your vehicle has a tire sealant and compressor kit that uses a liquid tire sealant to temporarily seal up to a one-quarter-inch puncture in the tread area of the tire. After using the tire inflator kit, it is recommended that you take the tire to an authorized retailer for inspection and repair as soon as possible, but at least within 100 miles of driving. The tire sealant cannot seal and inflate sidewall damage, punctures larger than one-quarter inch, or a tire that has unseated from the wheel. The sealant can only be used on one tire and for one time before its expiration date.

**Gmmobility.com (1-800-323-9935).** GM Mobility™ offers financial assistance for eligible adaptive equipment to make automotive travel easier for persons with disabilities or special transportation needs. To learn more about special GM Mobility offers, visit gmmobility.com.

**Trailer and off-road driving information.** Please go to chevrolet.com and carefully review an Owner's Manual for important safety information about trailering or off-road driving in your vehicle.

## WE'VE GOT YOUR BACK

At Chevrolet, giving you a completely satisfying ownership experience is our top priority. That's why if you ever need assistance, feel free to contact us at these websites or phone numbers.

**GMupfitter.com.** Offering nearly everything you need to begin upfitting<sup>4</sup> your Chevy Commercial vehicle, including handling 2-D and 3-D math data; taking hotline questions; and supplying Body Builders Manuals (from 1999 to present), Technical Bulletins and Best Practices Guidelines.

**24-Hour Roadside Assistance Program (1-800-CHEV-USA).** The Chevrolet Roadside Assistance Program provides you with the following services for 5 years or 60,000 miles:<sup>1</sup> Emergency Towing (to closest Chevrolet dealer from a legal roadway), Lockout Service (keys locked inside vehicle), Flat Tire Changes (spare installed), Fuel Delivery (\$5 worth of fuel delivered on the road) and Jump Starts (at home or on the road). For specific terms and conditions, please contact your Chevrolet Roadside Assistance advisor at 1-800-243-8872. Some services may incur costs.

**Courtesy Transportation Program.** Ask your Chevrolet dealer for Courtesy Transportation if you leave your vehicle for extended repairs under the New Vehicle Limited Warranty or Powertrain Limited Warranty. Ask if you qualify for expense reimbursement and/or vehicle rental. Services vary by dealer. Does not apply to Express Cutaway or Low Cab Forward models.

**Chevrolet Customer Assistance Center (1-800-222-1020).** Talk directly to customer relationship managers who can handle any inquiries related to vehicle operation, warranty coverages, or product or service concerns you may have. Please refer to your Owner's Manual for Customer Assistance information.

**Chevrolet.com/safety.** Chevrolet is committed to keeping you and your family safe – from the start of your journey to your destination. That's why Chevrolet vehicles offer standard and available safety and security features to help give you peace of mind.

**Marketing and incentives.** Visit chevrolet.com/current-deals or call 1-800-950-CHEV (1-800-950-2438) for new product, current incentive and marketing program information.

**The BuyPower Card.** The Chevrolet BuyPower Card – Every purchase you make with the BuyPower Card from Capital One\* helps you earn toward an eligible new Chevrolet, Buick, GMC or Cadillac vehicle. There's no limit on the amount you can earn or redeem, and your Earnings don't expire. Visit chevroletbuypowercard.com/catalogs.

\* Capital One, N.A. is the issuer of the BuyPower Card. General Motors ("GM") is responsible for the operation and administration of the Earnings program.

GM, the GM logo, Chevrolet, the Chevrolet logo and the slogans, emblems, vehicle model names, vehicle body designs and other marks appearing in this catalog are the trademarks and/or service marks of General Motors, its subsidiaries, affiliates or licensors. Allison is a registered trademark of Allison Transmission, Inc. ©2021 OnStar. All rights reserved. ©2021 General Motors. All rights reserved. June 2021.

## FIND NEW ROADS™

<sup>1</sup> Whichever comes first. <sup>2</sup> Courtesy Transportation Program does not apply to Express Cutaway and Low Cab Forward models. <sup>3</sup> To qualify for the GM Business Choice Program, your vehicle must be used in the day-to-day operations of your business and not solely for transportation purposes, and you must provide proof of your business. See your dealer for complete program details. <sup>4</sup> Equipment from independent suppliers is not covered by the GM New Vehicle Limited Warranty. GM is not responsible for the safety or quality of independent supplier alterations.