

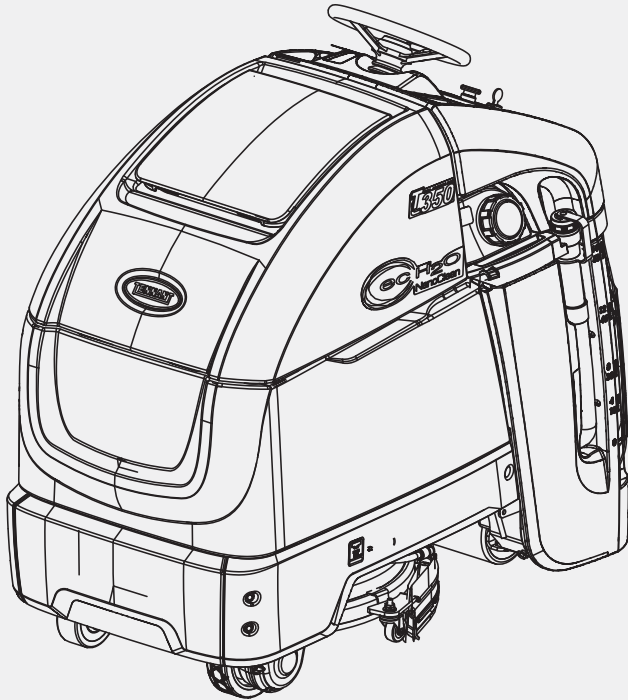

T350

Stand-On Rider Scrubber English **EN** Operator Manual



Hygenic[®] Fully Cleanable Recovery Tank
Tennant True[®] Parts
IRIS[®] a Tennant Technology
Pro-Panel[®] Controls
Smart-Fill[™] Automatic Battery Watering
Insta-Click[™] Magnetic Disk



North America / International



For the latest Parts Manuals and other
language Operator Manuals, visit:

www.tennantco.com/manuals

9016417
Rev. 01 (02-2021)



INTRODUCTION

This manual is available for each new model. It provides necessary operation and maintenance instructions.



Read this manual completely and understand the machine before operating or servicing it.

This machine will provide excellent service. However, the best results will be obtained at minimum costs if:

- The machine is operated with reasonable care.
- The machine is maintained regularly - per the maintenance instructions provided.
- The machine is maintained with manufacturer supplied or equivalent parts.

To view, print or download manuals online visit www.tennantco.com/manuals

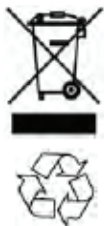

PROTECT THE ENVIRONMENT

Please dispose of packaging materials and used machine components such as batteries in an environmentally safe way according to your local waste disposal regulations.

Always remember to recycle.

Tennant Company
10400 Clean Street
Eden Prairie, MN 55344-2650
Phone: (800) 553-8033

www.tennantco.com

1-STEP, Pro-Membrane, Severe Environment, Zone Settings, and Quiet-Mode are trademarks of Tennant Company.

Trojan® and HydroLINIK® are registered trademark of Trojan Battery Company.

Windows 7® is a registered trademark of the Microsoft Corporation.

This product may contain portions of software that have various 3rd party licenses. More information can be found at:
www.tennantco.com/opensource

Specifications and parts are subject to change without notice.

Original Instructions, copyright 2017, 2021 TENNANT Company.

INTENDED USE

The T350 stand-on rider floor scrubber is intended for commercial use, for example in hotels, schools, hospitals, factories, shops, offices and rental businesses. It is designed to scrub hard floor surfaces (concrete, tile, stone, synthetic, etc.) in an indoor environment. This machine is not intended for cleaning carpets. Use only recommended pads/brushes and commercially available floor cleaning detergents. Do not use this machine other than described in the Operator Manual.

MACHINE DATA

Please fill out at time of installation for future reference.

Model No. - _____

Serial No. - _____

Installation Date - _____

MACHINE SERIAL NUMBER LOCATION

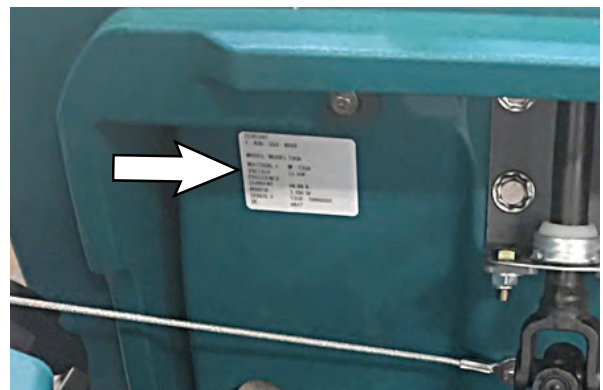

UNCRATING MACHINE

Carefully check machine for signs of damage. Report damages at once to carrier. Contact distributor or Tennant for missing items.

To uncrate the machine, remove straps, wheel blocks and shipping brackets. Using the supplied ramp carefully back the machine off the pallet. Make sure scrub head is in the raised position.

ATTENTION: Do not remove machine from pallet without using ramp, machine damage may occur.

ATTENTION: Due to the center of gravity being higher (making it easier to tip machine) for machines without batteries installed, use care when uncrating the machine if it does not have batteries installed. Install batteries before moving machine from pallet.

CONTENTS

Introduction	2	Operation Of Controls -	
Intended Use.....	2	Pro-Panel Controls	28
Machine Data	2	Home Screen	28
Machine Serial Number Location	2	Help Button	28
Uncrating Machine	2	Login Screen.....	28
Contents	3	Ec-H2o Indicator (Option)	29
Important Safety Instructions - Save These		1-Step Button	29
Instructions	6	Vacuum Fan Button	29
Operation.....	10	Brush Pressure Button.....	29
Machine Components	11	Solution Flow Button.....	30
Scrub Head Types.....	11	Brush Change Button.....	30
Control Panel Components.....	12	Severe Environment Button	
Pro-Membrane Control Panel Model	12	(Ec-H2o Model Option)	30
Pro-Panel Control Model.....	13	Quiet-Mode Button (Option).....	31
Machine Symbols.....	14	Battery Discharge Indicator.....	31
Pro-Panel Symbols	15	Video Tutorial Button	
Installing Batteries.....	16	(Operator Mode Home Screen)	31
Battery Specifications	16	Preset Zone Control Buttons.....	31
How The Machine Works	17	Service Indicator Button.....	32
Brush And Pad Information	17	Fault Screens.....	32
Machine Setup	18	Machine Operation.....	34
Attaching Squeegee Assembly	18	Pre-Operation Checklist	34
Installing Brushes / Pads.....	19	Operating Machine	34
Filling Solution Tank	20	Double Scrubbing.....	36
Filling Severe Environment Detergent		Emergency Shut-Off Button	37
Tank (Ec-H2o Model Option)	21	While Operating Machine.....	37
Ec-H2o Water Conditioning Cartridge		Circuit Breaker Panel	38
(Ec-H2o Model)	22	Hour Meter	38
Filling Automatic Battery Watering Tank		Draining Tanks	39
(Option)	23	Draining Recovery Tank	39
Control Panel Operation	24	Draining Solution Tank	40
Operation Of Controls -		Service Indicator Codes	41
Pro-Membrane Controls	24	On-Board Battery Charger Service	
1-Step Button	24	Indicator Codes	42
Brush Pressure Button.....	24	Ec-H2o System Service Indicator Codes	
Solution Flow Button.....	24	(Option)	43
Quiet-Mode Button (Option).....	24	Maintenance	44
Severe Environment Button		Maintenance Chart.....	44
(Ec-H2o Model Option)	25	Machine Maintenance	46
Preset Zone Control Buttons.....	25	Yellow Touch Points	46
Ec-H2o Button / Indicator (Option).....	26	After Daily Use	46
Service Indicator	26	After Weekly Use	48
Battery Discharge Indicator.....	26	After Every 50 Hours Of Use.....	49
Automatic Battery Watering Indicator		After Every 100 Hours Of Use.....	49
(Option)	26	After Every 200 Hours Of Use.....	49
Brush Change Button.....	27	Electric Motors	49
Vacuum Fan Button	27		

CONTENTS

Batteries.....	50	Changing Preset Zone Control	
Maintenance-Free Batteries.....	50	Buttons.....	85
Flooded (Wet) Lead-Acid Batteries.....	50	Changing The On-Board Battery	
Checking Connections / Cleaning.....	50	Charger Settings	
Charging Batteries.....	51	(Pro-Panel Model).....	86
Battery Charger Settings.....	52	Calibrating The Touch.....	86
Changing On-Board Battery Charger			
Settings (Pro-Membrane Model).....	52		
Hydrolink® Battery Watering System			
(Trojan® Battery Option).....	54		
Manual Battery Watering System			
(Trojan® Battery Option).....	55		
Smart-Fill Automatic Battery Watering			
(Option).....	57		
Battery Compartment Drain Valve.....	58		
Brush And Pad Replacement.....	59		
Replacing Brush(Es) Or Pad(S) On			
Pro-Panel Machines.....	59		
Replacing Brush(Es) Or Pad(S) On			
Pro-Membrane Panel Machines.....	61		
Squeegee Blade Replacement.....	62		
Replacing Squeegees On Machines With			
20 In. (500 Mm) Scrub Heads.....	62		
Replacing Squeegees On Machines With			
24 In. (600 Mm) Scrub Heads.....	64		
Ec-H2o Water Conditioning Cartridge			
Replacement.....	66		
Machine Jacking.....	67		
Jacking Up The Front Of The Machine....	68		
Jacking Up The Rear Of The Machine....	68		
Pushing, Towing, And Transporting The			
Machine.....	69		
Pushing And Towing The Machine.....	69		
Transporting The Machine.....	69		
Storing Machine.....	70		
Freeze Protection.....	70		
Machine Troubleshooting.....	72		
General Machine Dimensions/Capacities/ Performance.....	74		
Supervisor Controls.....	77		
Pro-Membrane Control Panel Model.....	77		
Entering The Supervisor Control			
Modes.....	77		
Pro-Panel Controls Model.....	79		
Entering The Supervisor Mode.....	79		
To Add / Edit Profiles.....	80		
Enabling The Login Screen.....	82		
Disabling The Login Screen.....	83		
Changing The Factory-Assigned			
Supervisor Login Code.....	84		
Changing The Scrub Speed.....	85		

IMPORTANT SAFETY INSTRUCTIONS - SAVE THESE INSTRUCTIONS

The following precautions are used throughout this manual as indicated in their descriptions:



WARNING: To warn of hazards or unsafe practices that could result in severe personal injury or death.

FOR SAFETY: To identify actions that must be followed for safe operation of equipment.

The following information signals potentially dangerous conditions to the operator. Know when these conditions can exist. Locate all safety devices on the machine. Report machine damage or faulty operation immediately.



WARNING: To Reduce the Risk of Fire, Explosion, Electric Shock or Injury:

- Read manual before operating machine.
- Do not use or pick up flammable materials or reactive metals.
- Do not use near flammable liquids, vapors or combustible dusts.

This machine is not equipped with an explosion proof motor. The electric motor will spark upon start up and during operation which could cause a flash fire or explosion if machine is used in an area where flammable vapors/liquids or combustible dusts are present.

- Batteries emit hydrogen gas. Explosion or fire can result. Keep sparks and open flame away when charging.
- Disconnect battery cables and charger cord before cleaning and servicing machine.
- Do not charge batteries with damaged cord. Do not modify plug.

If the charger supply cord is damaged or broken, it must be replaced by the manufacturer or its service agent or a similarly qualified person in order to avoid a hazard.

- Do not use outdoors. Store indoors.

IRIS Telemetry - This machine may be equipped with technology that automatically communicates over the cellular network. If the machine will be operated where cell phone use is restricted because of concerns related to equipment interference, please contact a Tennant representative for information on how to disable the cellular communication functionality.

FOR SAFETY:

1. Do not operate machine:
 - Unless trained and authorized.
 - Unless operator manual is read and understood.
 - Unless mentally and physically capable of following machine instructions.
 - Under the influence of alcohol or drugs.
 - While using a cell phone or other types of electronic devices.
 - With brake disabled.
 - If not in proper operating condition.
 - With pads or accessories not supplied or approved by Tennant. The use of other pads may impair safety.
 - In outdoor areas. This machine is for indoor use only.
 - In areas where flammable vapors/liquids or combustible dusts are present.
 - In areas that are too dark to safely see the controls or operate the machine.
 - In areas with possible falling objects.
 - Do not place weights or heavy objects on the operator presence pedal and/or green go pedal.
2. Before Starting Machine:
 - Check machine for fluid leaks.
 - Make sure all safety devices are in place and operate properly.
 - Check steering for proper operation.
3. When using machine:
 - Use only as described in this manual.
 - Do not pick up burning or smoking debris, such as cigarettes, matches or hot ashes.
 - Go slowly on inclines and slippery surfaces.
 - Follow site safety guidelines concerning wet floors.
 - Do not scrub on inclines that exceed 9% grade or transport on inclines that exceed 9% grade.
 - Do not turn on inclines or ramps
 - Reduce speed when turning.
 - Keep all parts of body inside operator station while machine is moving.

- Always be aware of surroundings while operating machine.
 - Always allow head clearance when going through doorways, low ceilings, and overhangs.
 - Drive slowly through doorways and narrow openings, especially with the dual disk model as squeegee extends beyond width of machine.
 - Do not access the video / help screens while the machine is moving. (Pro-Panel)
 - Use care when reversing machine.
 - Keep children and unauthorized persons away from machine.
 - Do not allow machine to be used as a toy.
 - Do not carry passengers on any part of the machine.
 - Report machine damage or faulty operation immediately.
 - Follow mixing, handling and disposal instructions on chemical containers.
 - Follow site safety guidelines concerning wet floors.
4. Before leaving or servicing machine:
- Stop on level surface.
 - Turn off machine and remove key.
5. When servicing machine:
- All work must be done with sufficient lighting and visibility.
 - Keep work area well ventilated.
 - Avoid moving parts. Do not wear loose clothing, jewelry and secure long hair.
 - Block machine tires before jacking machine up.
 - Jack machine up at designated locations only. Support machine with jack stands.
 - Use hoist or jack that will support the weight of the machine.
 - Do not push or tow the machine without an operator controlling the machine.
 - Do not push or tow the machine on inclines with the brake disabled.
 - Do not power spray or hose off machine near electrical components.
 - Disconnect battery connections and charger cord before working on machine.
 - Do not use incompatible battery chargers as this may damage battery packs and potentially cause a fire.
 - Inspect charger cord regularly for damage.
 - Do not plug in charger if prongs are wet.
 - Open recovery tank to vent batteries if temperature is above 80°F/27°C when charging batteries.
- Do not disconnect the off-board charger's DC cord from the machine receptacle when the charger is operating. Arcing may result. If the charger must be interrupted during charging, disconnect the AC power supply cord first.
 - Avoid contact with battery acid.
 - Always follow site safety rules when disposing battery compartment liquid.
 - Keep all metal objects off batteries.
 - Use a non-conductive battery removal device.
 - Use a hoist and adequate assistance when lifting batteries.
 - Battery installation must be done by trained personnel.
 - Follow site safety guidelines concerning battery removal.
 - All repairs must be performed by trained personnel.
 - Do not modify the machine from its original design.
 - Use Tennant supplied or approved replacement parts.
 - Wear personal protective equipment as needed and where recommended in this manual.



For Safety: wear protective gloves.



For Safety: wear eye protection.

6. When loading/unloading machine onto/off truck or trailer:
- Drain tanks before loading machine.
 - Use a ramp that can support the machine weight and operator.
 - Do not drive on a slippery ramp.
 - Do not operate the machine on a ramp incline that exceeds an 18% grade level.
 - Use a winch if ramp incline exceeds an 18% grade level.
 - Lower scrub head and remove squeegee before tying down machine.
 - Block machine tires.
 - Tie machine down to truck or trailer.

SAFETY

The following safety labels are mounted on the machine in the locations indicated. Replace damaged / missing labels.

WARNING LABEL - Located on access panel.

⚠ WARNING	⚠ AVERTISSEMENT	⚠ ADVERTENCIA
	<p>TO REDUCE THE RISK OF FIRE, EXPLOSION, ELECTRICAL SHOCK, OR INJURY:</p> <ul style="list-style-type: none"> • Read manual before operating machine. • Do not use or pick up flammable materials. • Do not use near flammable liquids, vapors or combustible dusts. • Batteries emit hydrogen gas. Explosion or fire can result. Keep sparks and open flame away when charging. • Disconnect battery cables and charger plug before servicing machine. • Do not charge batteries with damaged cord. • Do not use outdoors. Store indoors. 	<p>POUR RÉDUIRE LES RISQUES D'INCENDIE, L'EXPLOSION, DE CHOC ELECTRIQUE OU DE LESSURE:</p> <ul style="list-style-type: none"> • Lisez le manuel avant d'utiliser la machine. • N'utilisez pas ou ne ramassez pas de matériaux inflammables. • N'utilisez pas près de liquides, vapeurs ou poussières inflammables. • Les batteries émettent de l'hydrogène gazeux. Risque d'incendie et d'explosion. Évitez toute étincelle et toute flamme nue lors de la charge des batteries. • Débranchez les câbles des batteries et le cordon du chargeur avant l'entretien de la machine. • Ne chargez pas les batteries avec un cordon endommagé. • N'utilisez pas à l'extérieur. Entrez-les à l'intérieur.
		<p>PARA REDUCIR EL RIESGO DE INCENDIO, EXPLOSION, CHOQUE ELECTRICO, O LESIONS:</p> <ul style="list-style-type: none"> • Lea el manual antes de utilizar la máquina. • No utilice ni recoja materiales inflamables. • No utilice la máquina cerca de líquidos, polvos o vapores inflamables. • Las baterías emiten hidrógeno. Peligro de incendio o explosión. Mantenga la máquina alejada de chispas y llamas cuando se esté cargando. • Desconecte los cables de la batería antes de realizar el servicio a la máquina. • No cargue las baterías si el cable está dañado. • No utilice la máquina al aire libre. Guárdela en un lugar cerrado. <p style="text-align: right; font-size: small;">1215281</p>

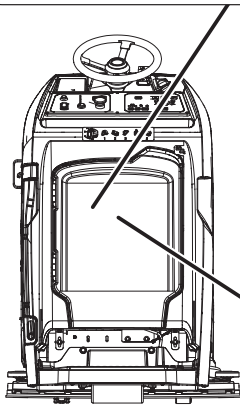

WARNING LABEL - Electrical hazard. Disconnect battery cables before servicing machine.

Located on on-board battery charger mounting plate.

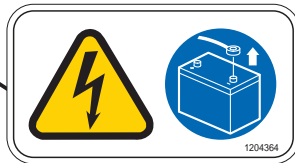

WARNING LABEL - Batteries emit hydrogen gas. Explosion or fire can result. Keep sparks and open flame away when charging.

Located on bottom of recovery tank.

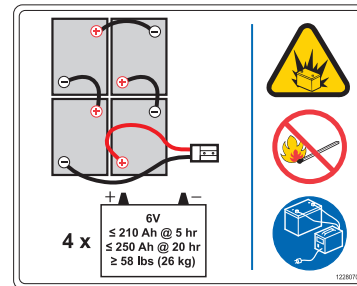

WARNING LABEL - Spinning brush. Keep hands away.

Located on top of scrub head.

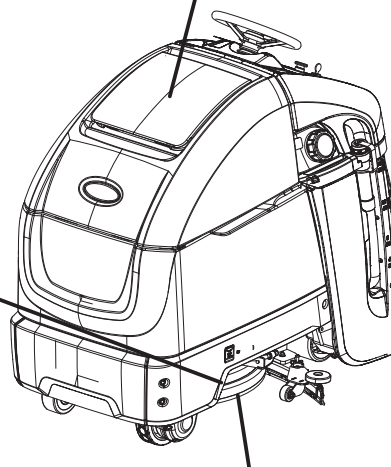

WARNING LABEL - Magnetic Field Hazard. Magnetic pad driver/brush can be harmful to those with pacemakers or medical implants.

Located on Insta-Click magnetic pad driver/brush.



MACHINE COMPONENTS

1. Steering Wheel
2. Key switch
3. Forward / Reverse switch
4. Emergency shut-off button
5. Hour meter
6. Horn button
7. Control panel
8. Speed knob
9. Operator presence pedal
10. Green go pedal
11. Solution tank
12. Solution tank fill port
13. Solution tank level / drain hose
14. Recovery tank
15. Recovery tank cover
16. Recovery tank drain hose
17. Battery compartment
18. Automatic battery watering tank (option)
19. Severe Environment detergent tank (option - with ec-H2O option only)
20. Detergent mixing ratio knob (option - with ec-H2O option only)
21. ec-H2O module (option)
22. ec-H2O water conditioning cartridge (option)
23. On-board battery charger (option)
24. Circuit breaker panel
25. Squeegee assembly
26. Scrub head
27. Scrub head skirt
28. On-board battery charger power cable
29. Access panel
30. Double scrub caster knob

SCRUB HEAD TYPES

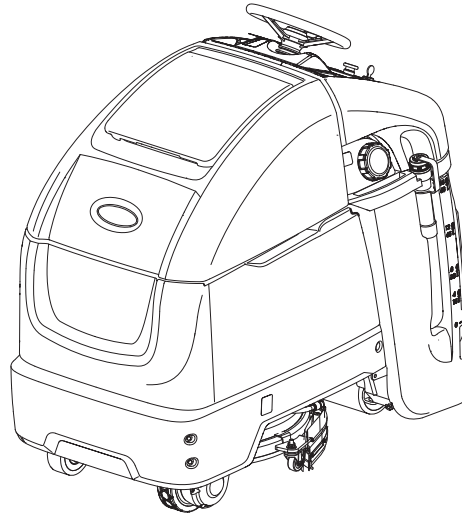

20 in. 500 mm Single Disk

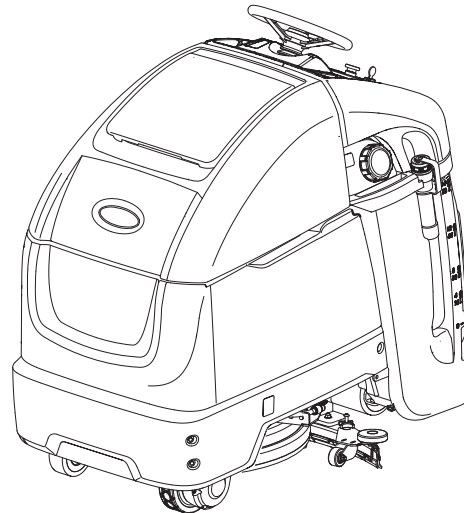

24 in. / 600 mm Dual Disk

CONTROL PANEL COMPONENTS

PRO-MEMBRANE CONTROL PANEL MODEL

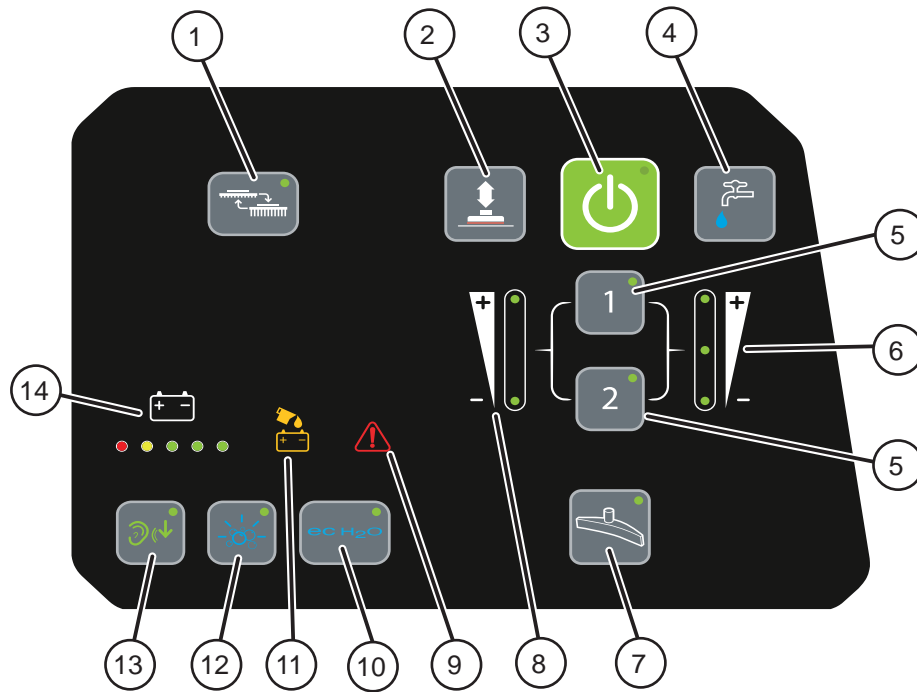

1. Brush change button
2. Brush pressure button
3. 1-Step button
4. Solution flow button
5. Preset zone control buttons
6. Solution flow indicator
7. Vacuum fan button
8. Brush pressure indicator
9. Service indicator
10. ec-H₂O Button (option)
11. Automatic battery watering indicator (option)
12. Severe Environment button (option)
13. Quiet-mode button (option)
14. Battery discharge / fault code indicator

PRO-PANEL CONTROL MODEL

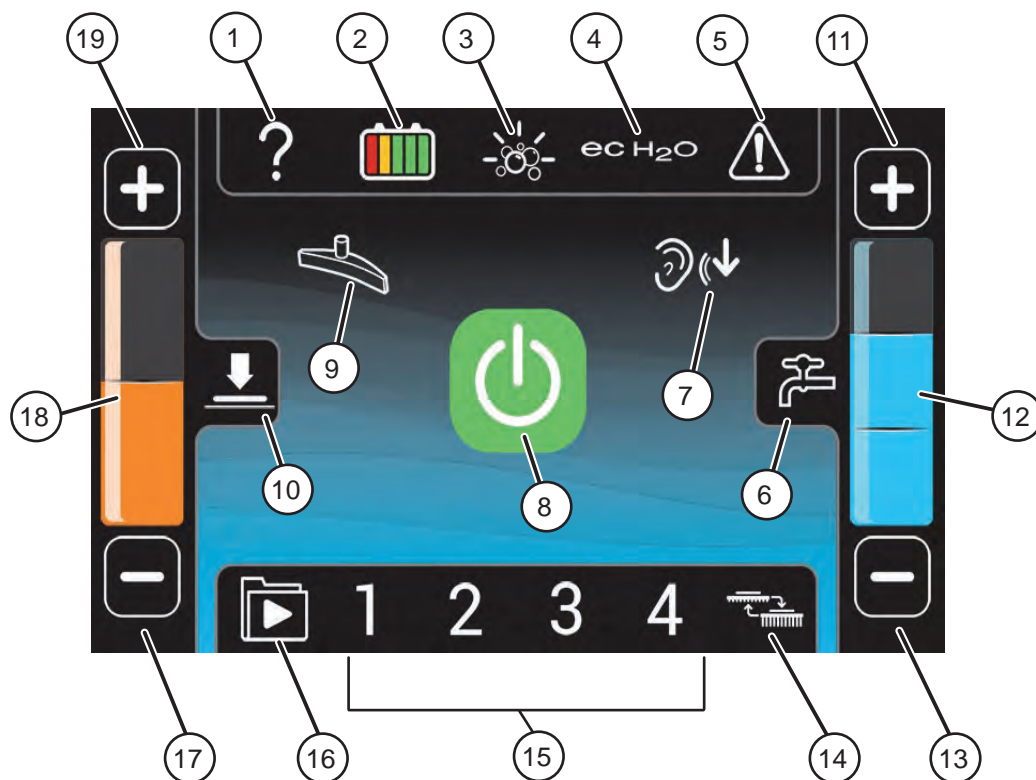

1. Help button
2. Battery discharge indicator (BDI)
3. Severe Environment button (option)
4. ec-H₂O button / indicator (option)
5. Service indicator / button
6. Solution flow button
7. Quiet mode button (option)
8. 1-Step button
9. Vacuum fan button
10. Brush pressure button
11. Solution flow increase button
12. Solution flow indicator
13. Solution flow decrease button
14. Brush change button
15. Preset zone control buttons
16. Video tutorial button
17. Brush pressure decrease button
18. Brush pressure indicator
19. Brush increase button

OPERATION

MACHINE SYMBOLS.

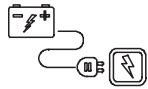

Battery charger

ec H₂O

ec-H₂O scrubbing (option)



Fast scrub speed



Horn



Slow scrub speed



Solution flow



Direction (forward / reverse)



Automatic battery watering (option)



Key Off



Circuit breaker



Key On



Brush pressure

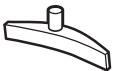

Vacuum fan



Battery charge

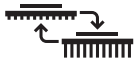

Change brush



Severe Environment (option)



Quiet mode (option)



1-Step



Service indicator





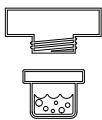

























Jack point



Filter location

PRO-PANEL SYMBOLS

	Home screen		Machine Settings		Factory reset
	Back arrow		Operator videos		Operator
	Login		Supervisor menu		Supervisor
	Control help		Video help		Add profile
	Start-up video		Add / Edit profiles		Edit profile
	About		Battery selection		Copy profile
	Video list button		Enable login		Delete profile
	Video button		Disable login		User login
	Video rotate view		Calibrate touch		Enter
					Backspace

OPERATION

INSTALLING BATTERIES



WARNING: Batteries emit hydrogen gas. Explosion or fire can result. Keep sparks and open flame away when charging.

FOR SAFETY: When servicing machine, wear appropriate personal protection equipment as needed. Avoid contact with battery acid.

BATTERY SPECIFICATIONS

Requires four 6 volt deep-cycle batteries, ≤ 240 Ah @ 20 hr.

Contact distributor or Tennant for battery recommendations.

FOR SAFETY: Before leaving or servicing machine, stop on level surface, turn off machine, and remove key.

1. Lift the recovery tank to access the battery compartment.

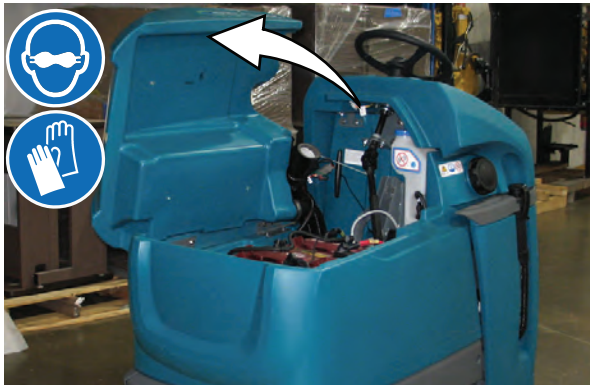

2. Carefully install the batteries into the battery compartment tray and arrange the battery posts as shown.

FOR SAFETY: When servicing machine, use a hoist or adequate assistance when lifting batteries.



3. Using the supplied battery post boots, connect the cables to battery posts, RED TO POSITIVE (+) & BLACK TO NEGATIVE (-). Tighten cable connections to batteries per battery manufacturer specifications.

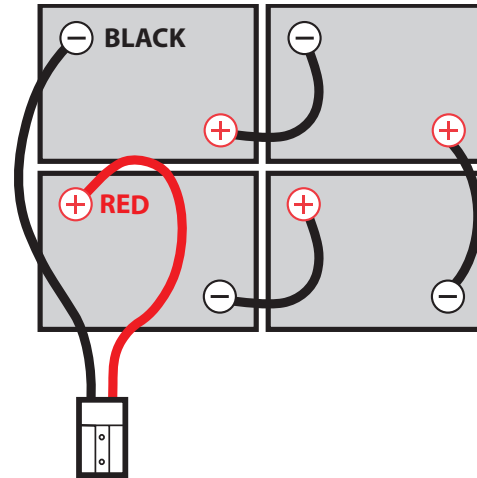

IMPORTANT: Before charging batteries, make sure the battery charger and the machine's battery discharge indicator are properly set for battery type. Failure to properly set will result in battery damage. See BATTERY CHARGER SETTINGS.

ATTENTION: Do not disconnect battery cables while charger is plugged in, circuit board damage may result.

ATTENTION: Batteries serve as a counterweight. Always maintain the minimum counterweight to ensure machine stability and traction.

IRIS Battery Charging Metrics Notification: Machines equipped with capability to report battery charging data via IRIS are supplied with a charger and set of batteries from the factory. When a battery reaches its end of life and must be replaced, Tennant highly recommends that the same battery type be used to continue to maximize the machines performance. In the event a battery with a different amp hour (AH), type (Flooded, AGM, Gel), or manufacturer is selected for replacement please contact Tennant technical service department for assistance in determining the feasibility of the replacement batteries and if so, selecting the correct charging profile. Availability of IRIS battery metric reporting is not guaranteed with third party supplied batteries.

NOTE: If there is liquid in battery compartment, drain battery compartment before installing batteries. See BATTERY COMPARTMENT DRAIN VALVE.

HOW THE MACHINE WORKS

Conventional scrubbing:

When using the conventional scrubbing mode, water and detergent mixture from the solution tank flows to the floor and the rotating brush(es)/pad(s) scrub the floor clean. As the machine moves forward, the squeegee with vacuum suction picks up the dirty solution from the floor into the recovery tank.

ec-H₂O NanoClean Technology (option):

When using the ec-H₂O NanoClean technology, normal water passes through a module where it is electrically converted into a cleaning solution. The electrically converted water attacks the dirt, allowing the machine to easily scrub away the suspended soil. The converted water then returns to normal water in the recovery tank.

BRUSH AND PAD INFORMATION

For best results, use the appropriate brush or pad for the cleaning application. Listed below are brushes and pads and the applications for which each is best suited.

NOTE: The amount and type of soilage play an important role in determining the type of brush or pad to use. Contact a Tennant representative for specific recommendations.

Soft nylon bristle scrub brush (White) -

Recommended for cleaning coated floors without removing finish. Cleans without scuffing.

Polypropylene bristle scrub brush (Black) - This general purpose polypropylene bristle scrub brush is used for scrubbing lightly compacted soilage. This brush works well for maintaining concrete, wood and grouted tile floors.

Super abrasive bristle scrub brush (Gray) -

Nylon fiber impregnated with abrasive grit to remove stains and soilage. Strong action on any surface. Performs well on buildup, grease, or tire marks.

Polishing pad (White) - For maintaining highly polished or burnished floors.

Buffing pad (Red) - For light duty scrubbing without removing floor finish.

Scrubbing pad (Blue) - For medium to heavy duty scrubbing. Removes dirt, spills, and scuffs.

Stripping pad (Brown) - For stripping of floor finish to prepare the floor for recoating.

Polypropylene Side Brush - For general sweeping of light to medium debris.

Heavy duty stripping pad (Black) - Used for aggressive stripping of heavy finishes/sealers, or very heavy duty scrubbing.

Surface preparation pad (Maroon) - Used for very aggressive chemical free removal of floor finish to prepare the floor for re-coating.

Tufted pad driver - Standard pad driver has short bristles, or "tufts," on the back to hold the pad in place. This driver works with all Tennant pads except the black high productivity pad.

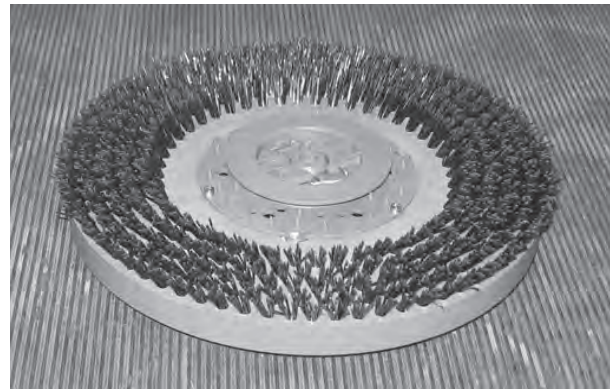

OPERATION

MACHINE SETUP

ATTACHING SQUEEGEE ASSEMBLY

1. Lower the scrub head.

FOR SAFETY: Before leaving or servicing machine, stop on level surface, turn off machine, and remove key.

2. Rotate the squeegee carriage assembly to the right side of the machine to access the squeegee carriage.

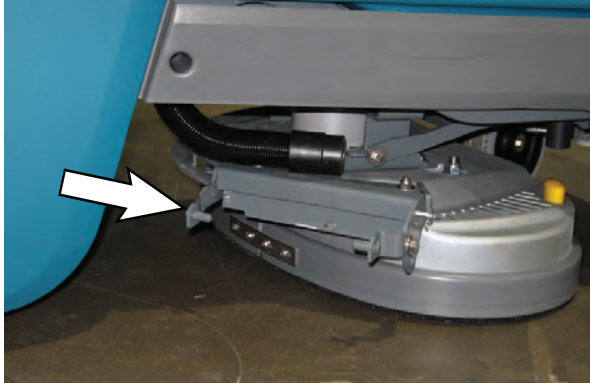

3. Align the squeegee carriage pins into the squeegee assembly bracket.

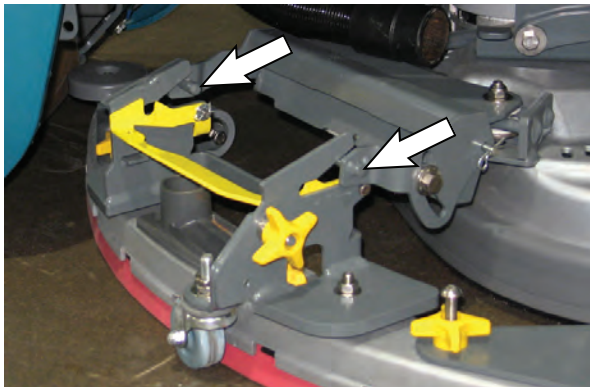

4. Slide the squeegee assembly onto the squeegee carriage until both squeegee carriage pins are secured in the bracket.

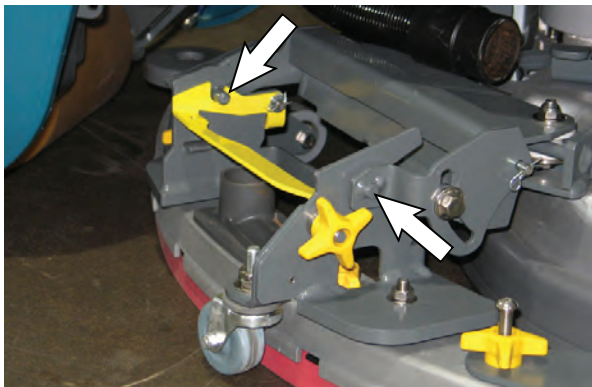

5. **Machines with 20 in. (500 mm) scrub heads only:** Be sure both squeegee tabs are positioned above the scrub head skirt.

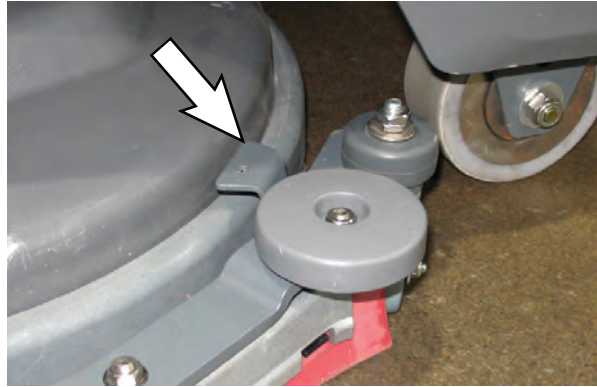

6. Connect the vacuum hose to the squeegee assembly.



7. Rotate and center the squeegee assembly underneath the machine.



INSTALLING BRUSHES / PADS

1. Stand with both feet on the operator platform (do not press the green go pedal), turn the key to the ON position, and press the brush change button to raise the scrub head to the correct level for installing the pad(s).

Machines with Pro-Membrane controls: Wait for the green LED light to stop flashing and remain illuminated. See REPLACING BRUSH(ES) PAD(S) ON PRO-MEMBRANE MACHINES.

Machines with Pro-Panel controls: Follow prompts on screen and wait for green check mark to appear in the display. See REPLACING BRUSH(ES) PAD(S) ON PRO-PANEL MACHINES.

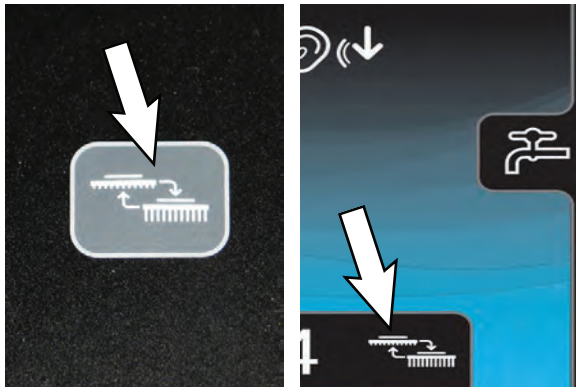

FOR SAFETY: Before leaving or servicing machine, stop on level surface, turn off machine, and remove key.

2. Attach the pad to the pad driver before installing the driver. Secure pad with center-lock.

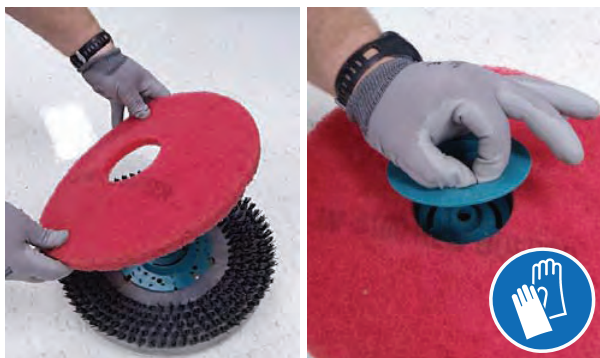

3. **Machines with magnetic brushes or pad drivers:** Position the brush under the scrub head and lift the brush up onto the scrub head until the magnet in the scrub head secures the brush.



WARNING: Magnetic Field Hazard. Magnetic pad driver/brush can be harmful to those with pacemakers or medical implants.



Machines with 3-lug brush hubs: Position the three lugs into the motor hub slots and give the pad driver / brush a quick counter-clockwise turn to engage hub.



Replace pads or brushes when they no longer clean effectively.

4. To remove the pad driver(s) / brush(es), repeat Step 1, and then remove the brushes from under the scrub head.

OPERATION

FILLING SOLUTION TANK

FOR SAFETY: Before leaving or servicing machine, stop on level surface, turn off machine, and remove key.

1. Remove the cap from the solution tank.



2. Insert the fill hose into the yellow strainer and ensure the hose is held securely into place in the strainer.



3. Fill the solution tank with water until level reaches the 53 L (14 G) mark on the solution tank indicator.

ec-H2O Scrubbing (Option)- Fill solution tank with only cool clean water (less than 70°F/21°C). Do not add conventional floor cleaning detergents. An ec-H2O system fault will occur if cleaning detergents are added.

Conventional Scrubbing - Fill solution tank with water (not to exceed 60°C/140°F). Pour a recommended cleaning detergent into the solution tank according to mixing instructions on the container.

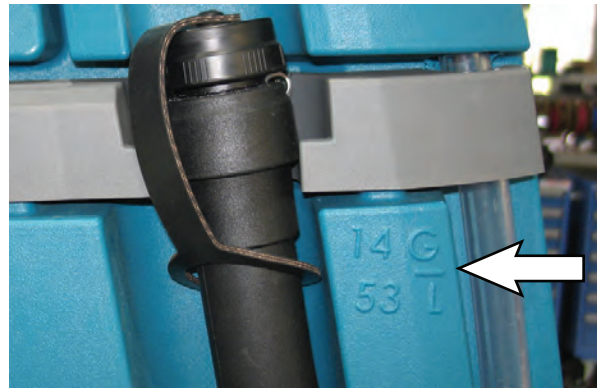

ATTENTION: For Conventional Scrubbing, only use commercially approved cleaning detergents. Machine damage due to improper detergent usage will void the manufacturer's warranty.



WARNING: Flammable materials can cause an explosion or fire. Do not use flammable materials in tank(s).

NOTE: Do not use the ec-H2O system when there are conventional cleaning detergents in the solution tank. Drain, rinse, and refill the solution tank with clean cool water before operating the ec-H2O system. Conventional cleaning detergents will cause an ec-H2O system fault.

4. Turn off the water supply and remove the fill hose from the yellow strainer.
5. Replace the cap on the solution tank.

FILLING SEVERE ENVIRONMENT DETERGENT TANK (ec-H2O MODEL OPTION)

FOR SAFETY: Before leaving or servicing machine, stop on level surface, turn off machine, and remove key.

1. Pull the access panel open to access the Severe Environment tank.

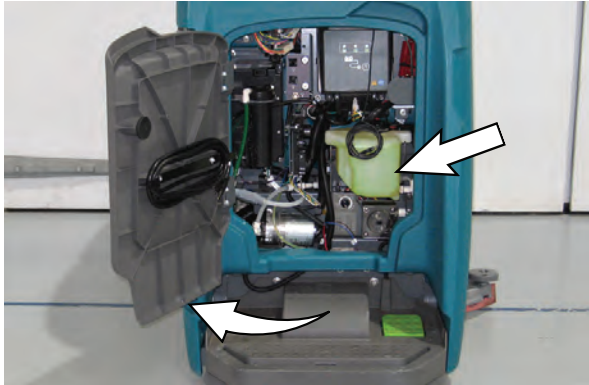

2. Remove the Severe Environment tank from the machine and set it on the floor.



NOTE: Remove the Severe Environment tank from the machine before filling the tank with detergent to prevent damaging electronic components.

3. Remove black cap from Severe Environment tank and add a recommended cleaning detergent at full concentration. Do not add water.



WARNING: Flammable materials can cause an explosion or fire. Do not use flammable materials in tank(s).

ATTENTION: Only use commercially approved cleaning detergents in the Severe Environment tank. Do not use cleaners based with d-limonene. Machine damage due to improper detergent usage will void the manufacturer's warranty.

NOTE: To prevent from running out of detergent while operating, it is recommended to refill the Severe Environment tank when refilling the solution tank.

4. Replace cap on the Severe Environment tank.
5. Adjust the detergent mixing ratio knob according to the cleaning detergent's mixing instructions.

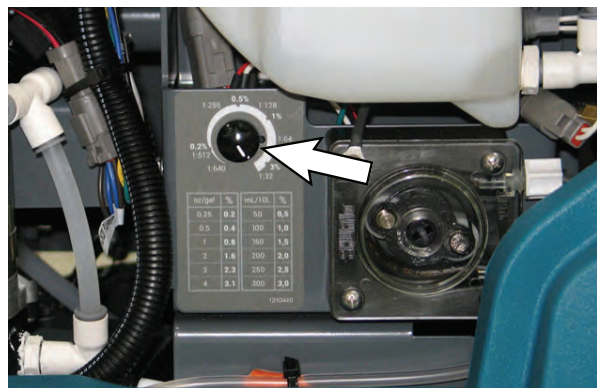

OPERATION

ec-H2O WATER CONDITIONING CARTRIDGE (ec-H2O MODEL)

FOR SAFETY: Before leaving or servicing machine, stop on level surface, turn off machine, and remove key.

The ec-H2O system is equipped with a water conditioning cartridge. The cartridge is designed to protect the machine's plumbing system from potential scaling.

The cartridge is required to be replaced when it reaches its maximum water usage or expiration time on when the cartridge was activated, which ever comes first.

Depending on machine usage a new cartridge can last anywhere from 12 to 24 months.

All cartridges are labeled with a manufacture date. The shelf-life of an un-installed cartridge is one year from manufacture date. For new cartridge replacement, the ec-H2O module timer must be reset. See ec-H2O WATER CONDITIONING CARTRIDGE REPLACEMENT.

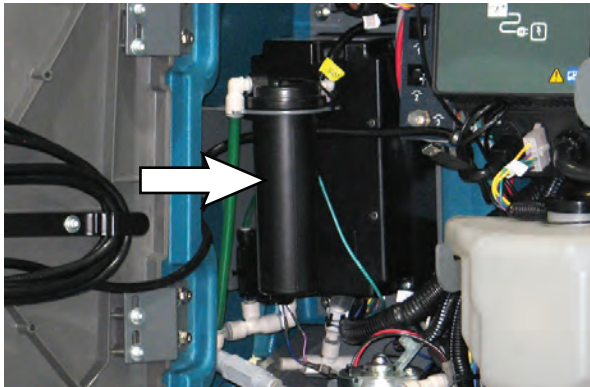

The control panel will signal the following code when it's time to replace the cartridge. The ec-H2O icon will begin to blink blue and red. See SERVICE INDICATOR CODES for further details.

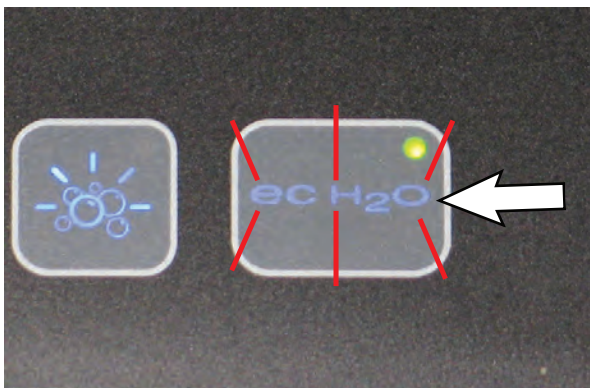

Pro-Membrane Models



Pro-Panel Models

ATTENTION: During first time use and after replacing the water conditioning cartridge, the ec-H2O system will automatically override the selected solution flow rate for up to 75 minutes.

FILLING AUTOMATIC BATTERY WATERING TANK (OPTION)

FOR SAFETY: Before leaving or servicing machine, stop on level surface, turn off machine, and remove key.

1. Lift the recovery tank to access the automatic battery watering tank. Drain recovery tank before lifting tank.

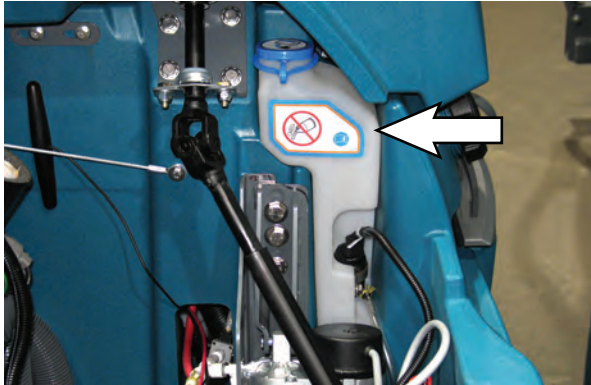

2. Reposition the automatic battery watering tank so that it can be easily filled.



3. Remove the blue cap from the automatic battery watering tank.

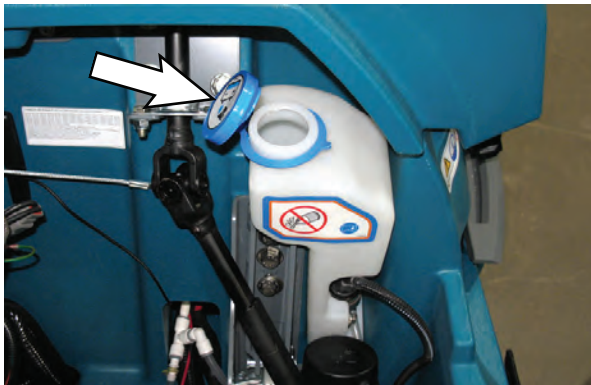

4. Pour distilled water into tank. To avoid getting water on sensitive components, use a funnel to fill automatic battery watering tank.

FOR SAFETY: When using machine, only use distilled water when filling the automatic battery watering tank.

5. When the tank needs refilling, the automatic battery watering indicator will alert user to add distilled water. See CONTROL PANEL OPERATION for further details.

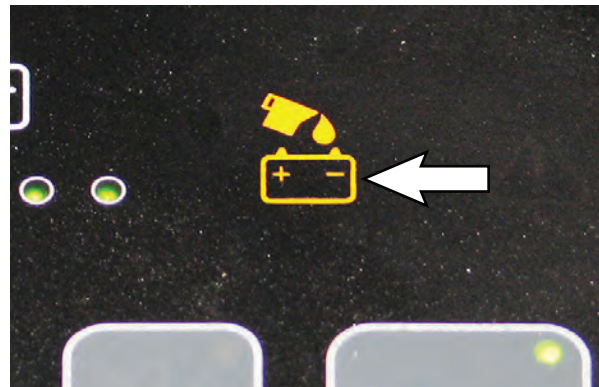

Pro-Membrane Model



Pro-Panel Model

6. Replace blue cap on automatic battery watering tank and return the automatic battery watering tank to the upright stowed position.

OPERATION

CONTROL PANEL OPERATION

The control panel operation can be set up with lockout functionality by using the Supervisor Controls feature. This will prevent the operator from changing or saving the settings. See SUPERVISOR CONTROLS instructions at the back of the manual.

The supervisor controls feature will lower machine variability for consistent, repeatable cleaning results, provide machine quality assurance regardless of user experience, and reduce user training requirements.

OPERATION OF CONTROLS - PRO-MEMBRANE CONTROLS

1-STEP BUTTON

With key turned on, press the 1-Step button to activate the scrub function. The scrub head and squeegee will lower to floor. Press button again to stop the scrub function and to raise scrub head and squeegee.

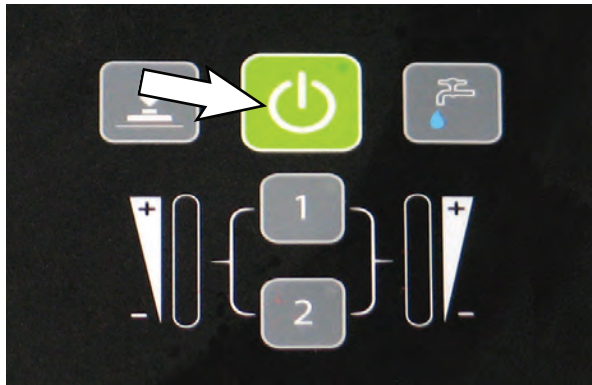

BRUSH PRESSURE BUTTON

Press the brush pressure button to increase or decrease the brush pressure. The brush pressure indicator will display the pressure setting. One LED = Low pressure and two LED's = High pressure.

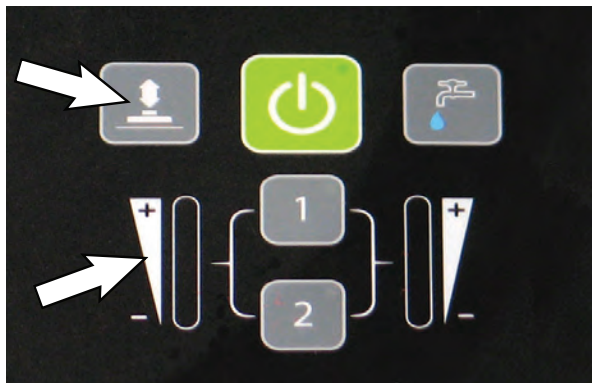

SOLUTION FLOW BUTTON

Press the solution flow button to increase or decrease the solution flow rate. The solution flow indicator will display flow setting. No LED = No flow, One LED = Low flow, two LED's = Medium flow, three LED's = High flow.

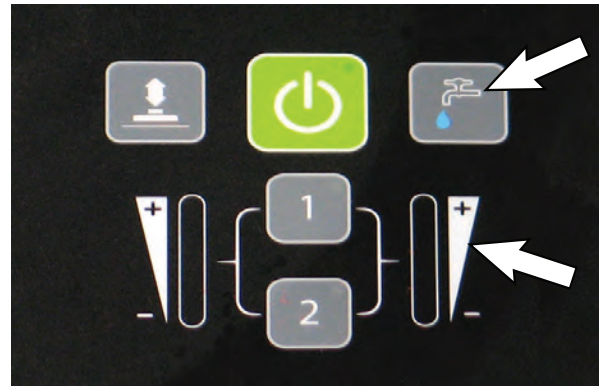

QUIET-MODE BUTTON (OPTION)

Press the Quiet-Mode button to reduce the vacuum motor sound. The LED will illuminate when activated. Press button again to turn off.

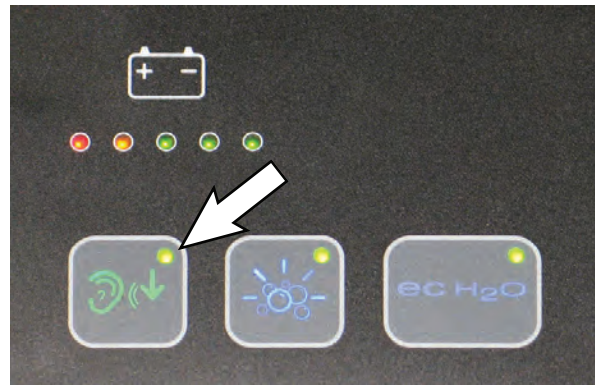

**SEVERE ENVIRONMENT BUTTON
(ec-H2O MODEL OPTION)**

NOTE: When the Severe Environment mode is turned on, the ec-H2O system will automatically turn off and the brush pressure and solution flow settings will increase to the high settings. When turned off, the settings will revert back to the original settings. When operating the Severe Environment mode for extended periods, if desired, the solution flow rate and the down pressure can be decreased to a lower setting to conserve solution and detergent usage and optimize battery run time.

Press the Severe Environment button to deliver a boost of cleaning detergent for areas with excessive soil buildup.

Press button one time for a 30 second boost. A green LED in the corner will blink slowly when dispensing. During the last 5 seconds, the LED will blink rapidly as an alert that the dispensing is about to stop.

To deliver a continuous detergent boost, press and hold button for 3 seconds until green LED turns solid green. Press button at anytime to turn off.

To alert user when Severe Environment tank is empty, the bubbles icon will blink for 15 seconds. If button is pressed when tank is empty, the bubbles icon will continue to blink for 15 seconds until tank is refilled.

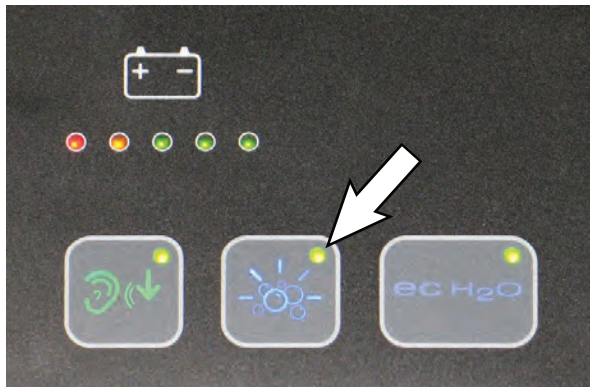

PRESET ZONE CONTROL BUTTONS

Note: Zone 3 is only available on machines built before serial number 11003113.

Use the zone control buttons to preset up to three zones with different solution flow rates, brush pressures, scrub speeds and scrub modes.

- Zone 1 = Preset Zone Control Button 1
- Zone 2 = Preset Zone Control Button 2
- Zone 3 = Preset Zone Control Buttons 1 & 2

The zone control buttons are factory preset for different scrubbing applications. To use Zone 3, press zone buttons 1 & 2 at the same time. A green LED in the corner will turn on when activated.

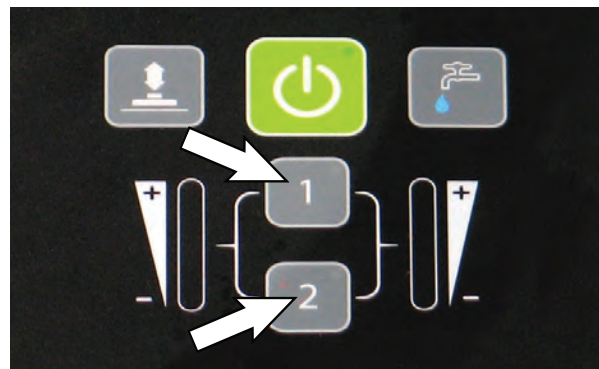

To preset the zone control buttons for different scrubbing applications, select the desired settings from list below, then press and hold the zone button until the green LED blinks three times to save preset. To preset zone 3, press and hold zone buttons 1 & 2 at the same time.

- Brush pressure setting
- Solution flow rate
- Quiet-Mode on or off
- ec-H2O system on or off (option)
- Severe Environment mode on or off (option)
- Maximum scrub speed (see Supervisor Controls)

NOTE: The Severe Environment mode and ec-H2O system cannot be preset together.

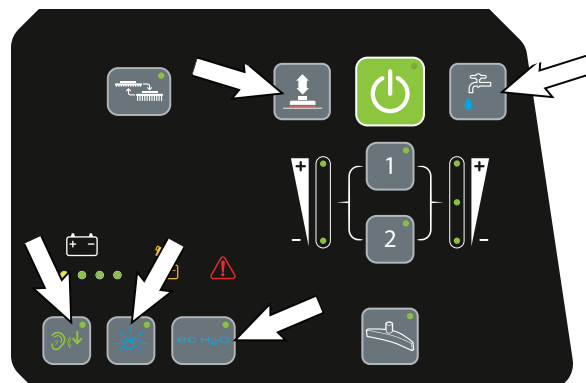

OPERATION

ec-H2O BUTTON / INDICATOR (OPTION)

The ec-H2O system automatically turns on at each key start. A blue ec-H2O indicator appears when machine is equipped with the ec-H2O option. The green LED illuminates when ec-H2O is activated. To turn off the ec-H2O system, press the ec-H2O button. The green LED indicator will disappear.

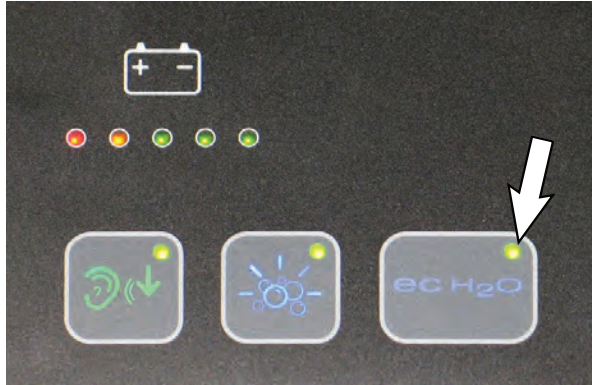

ec-H2O INDICATOR	CONDITION
Solid green	Normal operation
Blinking blue/red	Water conditioning cartridge expired. Replace cartridge.
Solid or blinking red	A system fault has occurred. See Service Indicator Codes.

NOTE: If a fault occurs to the ec-H2O system, the machine may automatically turn off the ec-H2O system and convert over to conventional scrubbing. The service indicator icon will remain solid red or continue to blink red until the ec-H2O fault is serviced.

SERVICE INDICATOR

When the machine or on-board battery charger detects a fault, the service indicator will light up and begin flashing. The battery discharge indicator lights will also flash a fault code. See SERVICE INDICATOR CODES to diagnose machine fault.



BATTERY DISCHARGE INDICATOR

The battery discharge indicator (BDI) displays the charge level of the batteries while the machine is operating. When the batteries are fully charged, all five indicators are lit. When the discharge level reaches the red light, stop scrubbing and recharge the batteries. When the red light begins to flash, the scrub function will be disabled to protect the batteries from total discharge. The machine will still propel when the red light is flashing. This will allow user to transport the machine to the charging station.

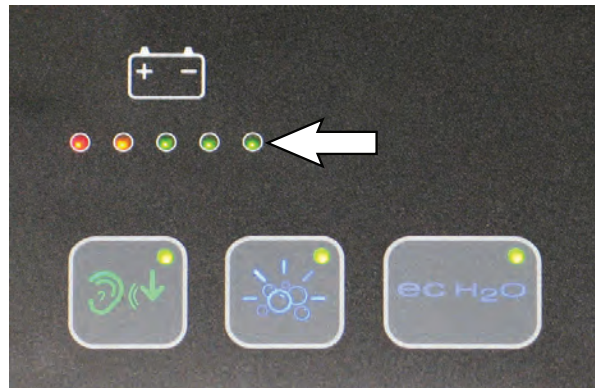

AUTOMATIC BATTERY WATERING INDICATOR (OPTION)

The automatic battery watering indicator will flash when the battery watering tank is empty and needs refilling. To protect the batteries from damage, the machine's scrub function will be disabled after 10 hours of additional use if tank is not refilled. When the indicator flashes rapidly, the scrub function will be disabled. Add distilled water and restart key to clear the flashing indicator. See FILLING AUTOMATIC BATTERY WATERING TANK.

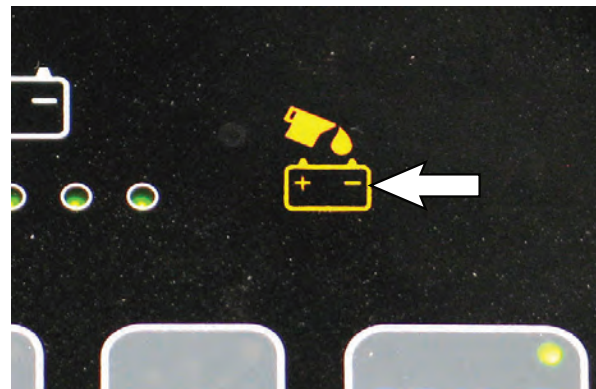

BRUSH CHANGE BUTTON

Machines with 3-lug brushes: Press the brush change button. The scrub head will completely raise to allow the scrub brush(es) to be removed from under the scrub head, and then reinstalled.

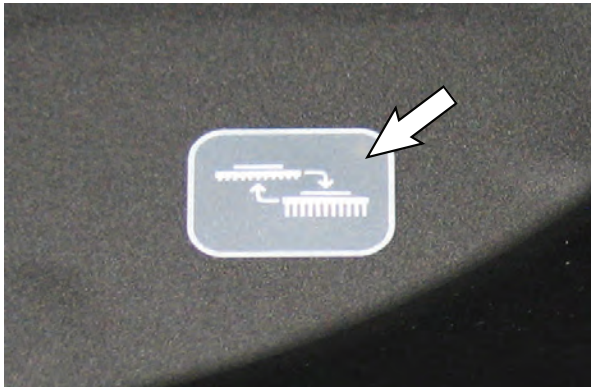

Machines with magnetic brushes: Press the brush change button to release the brush(es) from the scrub head. The scrub head will completely raise to disengage the brush(es) from the scrub head, and then partially lower to allow the brush(es) to be removed from under the scrub head. Reinstall brush(es) with scrub head in partially lowered position.

VACUUM FAN BUTTON

Press the vacuum fan button to turn on the vacuum fan. Press button again to turn off the vacuum fan. The vacuum fan automatically turns on when the 1-Step button is pressed.

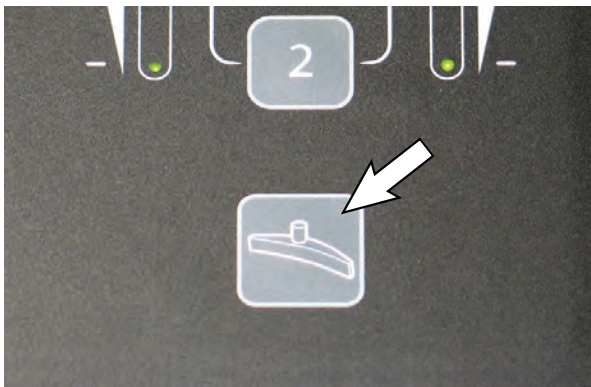

OPERATION

OPERATION OF CONTROLS - PRO-PANEL CONTROLS

HOME SCREEN

There are two types of user modes that will interface with the home screen.

Supervisor Mode - Capable of machine operation with full use of all controls, along with configuring permissions and restrictions for the operator mode and login capability.

Operator Mode - Capable of machine operation with permissions and restrictions controlled by the supervisor.

At key start up, a new machine from the factory will automatically start up in the supervisor mode.

To configure the home screen with permissions and restrictions and login capability for Operator Mode, see SUPERVISOR CONTROLS instructions at the back of the manual.

Supervisor Mode home screen provides access to the machine settings button and to the maximum scrub speed button.



Operator Mode home screen restricts access to the machine settings button and maximum scrub speed button.



HELP BUTTON

For first time users, press the help button (?) to access the help screen. The help screen will allow you to select a different screen language, enable login settings, help identify control panel icons, view machine start-up video and access machine system information.

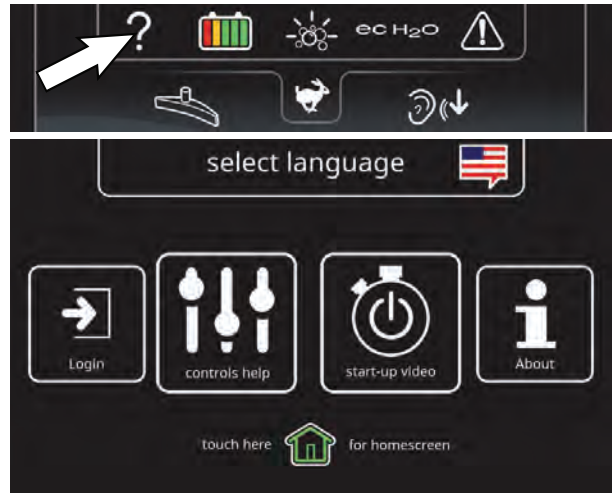

LOGIN SCREEN

When login is enabled in the supervisor mode, a login screen will appear at key start up. Enter your assigned login code and press the green arrow to access the home screen. See SUPERVISOR CONTROLS instructions at the back of the manual to enable login at start up.

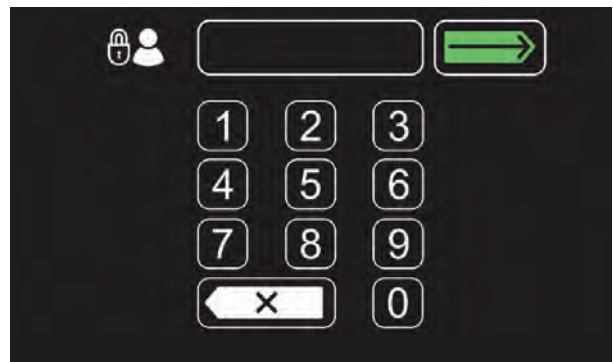

ec-H₂O INDICATOR (OPTION)

The ec-H₂O system automatically turns on at each key start. The ec-H₂O icon will appear on the home screen indicating that the system is activated. Press the ec-H₂O button to turn off the ec-H₂O system. A slash mark over the icon will indicate that the ec-H₂O system is turned off.

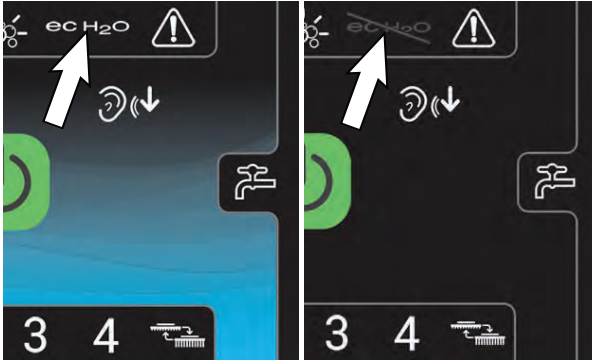
**1-STEP BUTTON**

Press the 1-Step button to activate the scrub function. The scrub head and squeegee will lower to floor. Press button again to stop the scrub function and to raise scrub head and squeegee.

**VACUUM FAN BUTTON**

Press the vacuum fan button to turn on the vacuum fan. Press button again to turn off the vacuum fan. The vacuum fan automatically turns on when the 1-Step button is pressed.

**BRUSH PRESSURE BUTTON**

Press the brush pressure button to display the brush pressure indicator. Press the (+) button to increase brush pressure. Press the (-) button to decrease the brush pressure.

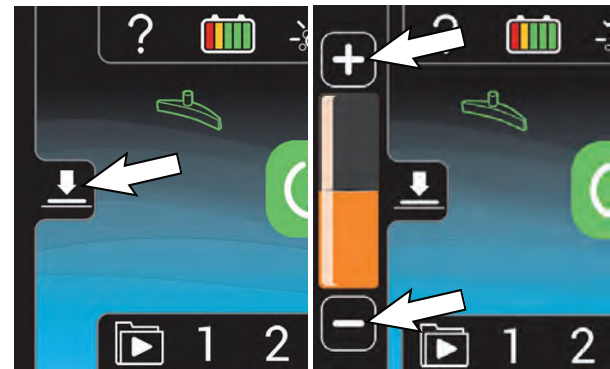

NOTE: If brush pressure is set too high for scrubbing conditions, the brush pressure setting will automatically reduce to a lower setting and begin flashing. When flashing, reduce brush pressure to prevent brush motor overload.

OPERATION

SOLUTION FLOW BUTTON

Press the solution flow button to display the solution flow indicator. Press the (+) button to increase solution flow. Press the (-) button to decrease the flow solution or to turn it off.

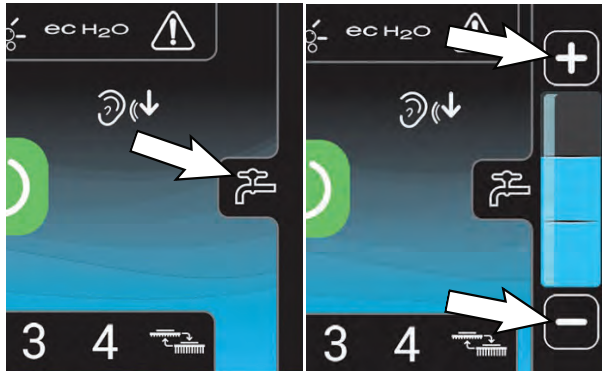

BRUSH CHANGE BUTTON

Machines with standard brushes: Press the brush change button. The scrub head will completely raise to allow the scrub brush(es) to be removed from under the scrub head, and then reinstalled.

Machines with magnetic brushes: Press the brush change button to release the brush(es) from the scrub head. The scrub will completely raise to disengage the brush(es) from the scrub head, and then partially lower to allow the brush(es) to be removed from under the scrub head. Reinstall brush(es) with scrub head in partially lowered position.

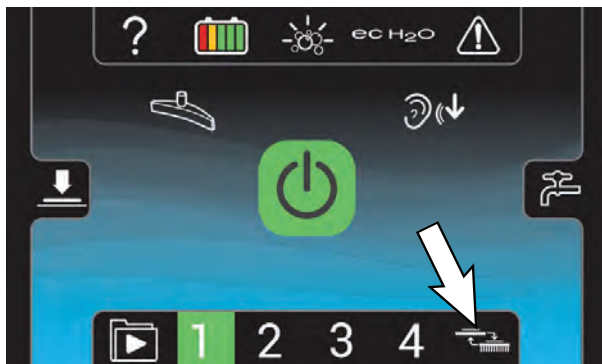

SEVERE ENVIRONMENT BUTTON (ec-H2O MODEL OPTION)

Press the Severe Environment button to deliver a boost of cleaning detergent for areas with excessive soil buildup.

Press button one time for a 30 second detergent boost. The button will turn green and a 30 second count down timer will start. Press button at anytime to turn off.

To deliver a continuous detergent boost, press and hold button for 3 seconds until a continuous timer is displayed. Press button at anytime to turn off.

To alert user when the Severe Environment detergent tank is empty, the button will blink yellow.

NOTE: When the Severe Environment mode is turned on, the ec-H2O system will automatically turn off and the brush pressure and solution flow settings will increase to the high settings. When turned off, the settings will revert back to the original settings. When operating the Severe Environment mode for extended periods, if desired, the solution flow rate and the down pressure can be decreased to a lower setting to conserve solution and detergent usage and optimize battery run time.

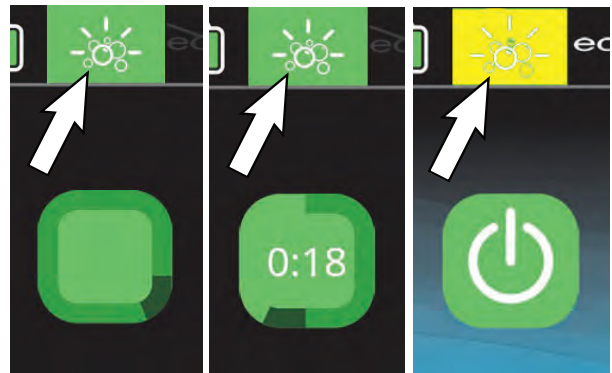

QUIET-MODE BUTTON (OPTION)

Press the Quiet-Mode button to reduce the vacuum motor sound for noise restricted areas. The button will turn green when activated. Press button again to turn off.

NOTE: When the Quiet-Mode is activated the water pickup will slightly be reduced.



BATTERY DISCHARGE INDICATOR

The battery discharge indicator (BDI) displays the charge level of the batteries while the machine is operating. When the batteries are fully charged, all five indicators are lit. When the discharge level reaches the red light, stop scrubbing and recharge the batteries. When the red light begins to flash, the scrub function will be disabled to protect the batteries from total discharge. The machine will still propel when the red light is flashing. This will allow user to transport the machine to the charging station.



VIDEO TUTORIAL BUTTON (Operator Mode Home Screen)

Press the video tutorial button to access the video tutorial screen. It includes videos on how to perform specific operation and maintenance procedures. Press the video buttons to start video. Press the rotate button for additional videos. The lower right video button provides a list of additional tutorial videos.

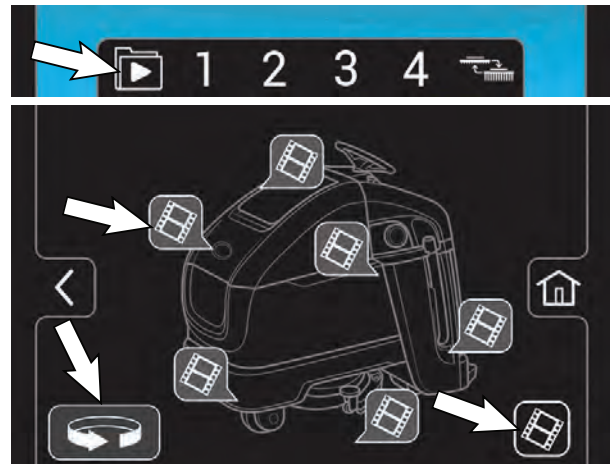

PRESET ZONE CONTROL BUTTONS

Use the zone control buttons to preset up to four zones with different solution flow rates, brush pressure, scrub speeds, and scrub modes.

The four zone control buttons are factory preset for different scrubbing applications. The zone control button will turn green when zone is activated.

NOTE: Only the supervisor mode has the capability to change the factory zone settings. See SUPERVISOR CONTROLS instructions at back of manual.



OPERATION

SERVICE INDICATOR BUTTON

The service indicator button will flash yellow or red when a machine fault is detected. Press the service indicator button to view fault screen.

Flashing yellow indicates a warning that requires service, but machine is still operable. Flashing red indicates a fault which will shut down the machine and require service. See FAULT SCREENS.



FAULT SCREENS

When a fault is initially detected, the following fault screens will automatically pop up to indicate the fault.

Press the left and right arrow button at top of screen to scroll through the fault screens.

Yellow machine fault screen - Machine fault has been detected. A fault code will appear below the fault icon. See SERVICE INDICATOR CODES.



Flashing Blue and Red ec-H2O Screen - The water conditioning cartridge has expired. See ec-H2O WATER CONDITIONING CARTRIDGE REPLACEMENT.



Yellow ec-H2O Fault Screen - Machine detected an ec-H2O system water or plumbing fault.

Red ec-H2O Fault Screen - Machine detected an ec-H2O system electrical fault.

A fault code will appear below the ec-H2O icon. See SERVICE INDICATOR CODES.



NOTE: If a fault occurs to the ec-H2O system, the machine may automatically turn off the ec-H2O system and convert over to conventional scrubbing. The service indicator button will continue to flash until the ec-H2O fault is serviced.

Yellow Automatic Battery Watering Fault

Screen - The automatic battery watering tank is empty and needs refilling. To protect the batteries from damage, the machine's scrub function will be disabled after 10 hours of additional use if tank is not refilled. Add distilled water to the battery watering tank and restart key to clear fault. See FILLING AUTOMATIC BATTERY WATERING TANK.

Red Automatic Battery Watering Fault

Screen - The automatic battery watering tank is empty and needs refilling. The scrub function is disabled until tank is refilled. Add distilled water to battery watering tank and restart key to clear fault. See FILLING AUTOMATIC BATTERY WATERING TANK.



OPERATION

MACHINE OPERATION

FOR SAFETY: Do not operate machine, unless operator manual is read and understood.

PRE-OPERATION CHECKLIST

- Check the battery fluid. Fill as necessary.
- Machines with Smart-Fill Automatic Battery Watering option: Check the automatic battery watering tank. Fill with distilled water as necessary.
- Check the battery charge level. Charge as necessary.
- Check brushes for wear and damage. Remove wire, string, or twine wrapped around the main scrub brushes.
- Check scrub head skirt for damage and ensure skirt is properly positioned on scrub head.
- Clean the squeegee water trap.
- Check the squeegee vacuum hose for debris or blockage.
- Check the squeegees for damage and wear.
- Confirm the recovery tank is drained and cleaned.
- Check the recovery tank cover seal for wear and damage.
- Clean the recovery tank debris tray.
- Clean the float shut off screen.
- ec-H2O* Scrubbing: Confirm all conventional cleaning agents/restorers are drained and rinsed from the solution tank.
- ec-H2O* Scrubbing: Confirm the solution tank is filled with clear cool water only.
- Machines with SE (Severe Environment) option: Check detergent tank level. Fill detergent tank as necessary.
- Check steering for proper operation.
- Check the horn.
- Check maintenance records to determine maintenance requirements.

OPERATING MACHINE

For control panel operating instructions, see CONTROL PANEL OPERATION.

1. Turn the key switch to the ON position.

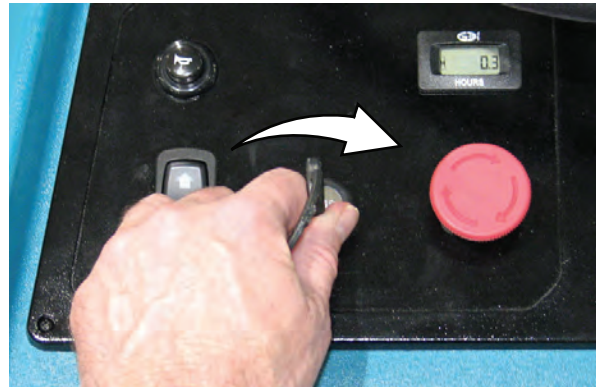

2. Position both feet on the operator platform so the heels are pressing the operator presence pedal. The right foot is OFF the green go pedal.



3. *ec-H2O* models - The *ec-H2O* system will automatically turn on at key start up. The *ec-H2O* indicator will appear on the control panel indicating that the system is activated.

ATTENTION: When conventional scrubbing with cleaning detergents in solution tank, make sure to turnoff the ec-H₂O system by pressing the ec-H₂O switch. If cleaning detergent is accidentally cycled through ec-H₂O system, a system fault will occur. To clear fault, drain solution tank, add clear water and operate the ec-H₂O system to clear fault. If fault repeats, continue to recycle key until fault clears. See SERVICE INDICATOR CODES for further detail.

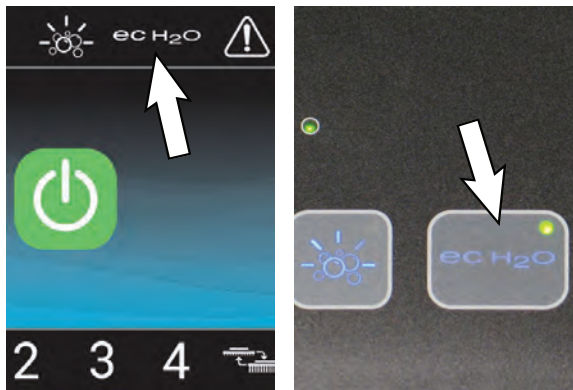

Pro-Panel

Pro-Membrane

- Place the forward / reverse switch into the direction needed to travel.



NOTE: If forward / reverse switch lights are flashing rapidly, be sure right foot is not pressing the green go pedal. The machine will not accept input from the forward / reverse switch if the lights are rapidly flashing.

NOTE: The forward / reverse switch must be pressed to reset direction whenever the operator presence pedal is released.

- Press the 1-Step button to activate the scrub function. The scrub head and squeegee will lower to the floor.

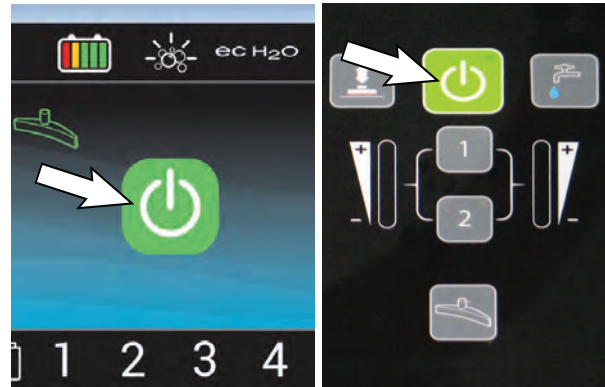

Pro-Panel

Pro-Membrane

- With the heels of both feet still on the operator presence pedal, place right foot onto the green go pedal to begin scrubbing.

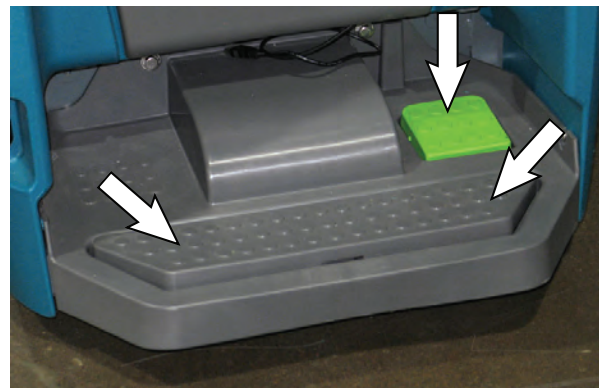

- Adjust the scrubbing speed by turning the speed dial to the desired speed.



- To stop scrubbing, while the machine is still in motion press the 1-Step button to stop scrubbing. The squeegee will briefly remain lowered to the floor to pick up remaining water, and then raise.
- Remove foot from the green go pedal to stop machine and turn the key off.

OPERATION

DOUBLE SCRUBBING

Double scrubbing is the process of making two or more passes over a heavily soiled area. The first pass is made with the squeegees raised to allow the solution to soak into the floor. Use the double scrubbing method to clean heavily soiled areas.

Double scrubbing can be performed using the ec-H₂O SCRUBBING SYSTEM (option) or CONVENTIONAL SCRUBBING methods.

Loosen the double scrub caster knob, lower the double scrub caster, and tighten the knob to secure the squeegee into the raised position.

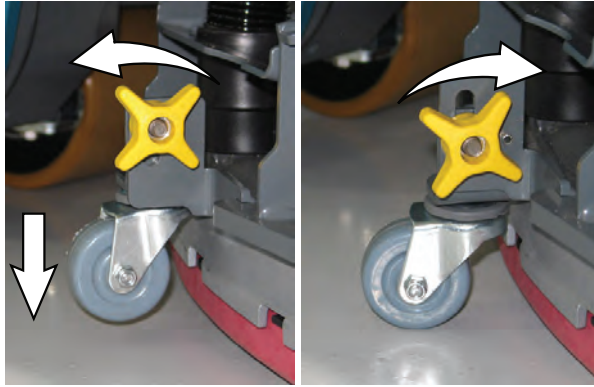

Machines equipped with Pro-Membrane Control Panel: Press the 1-Step button and then the vacuum fan button. The light in the vacuum fan will turn off and the vacuum fan will stop operating a few seconds later.

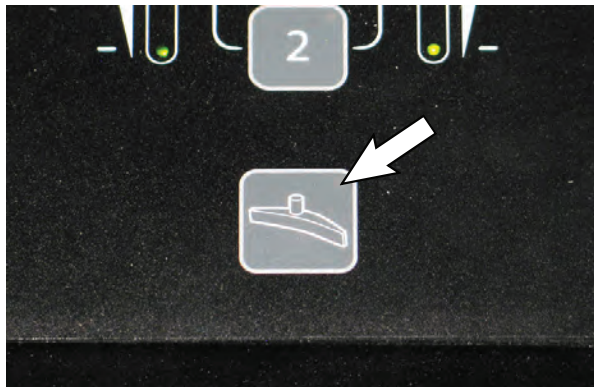

Machines equipped with Pro-Panel: Press the 1-Step button and then the vacuum fan button. The vacuum fan button will no longer be illuminated and the vacuum fan will stop operating.



Scrub the heavily soiled area. Let the cleaning solution soak on the floor for 3-5 minutes.

FOR SAFETY: When using machine, go slowly on inclines and slippery surfaces.

Before scrubbing the floor a second time, loosen the double scrub caster knob, raise the double scrub caster, and tighten the caster knob to secure the double scrub caster in the raised position. Press the vacuum fan button to turn on the vacuum fan. The light in the button will come on. Scrub the floor a second time to pick up the cleaning solution.



WARNING: Flammable materials or reactive metals can cause an explosion or fire. Do not pick up.

NOTE: If needed, reduce solution flow when scrubbing the floor for a second time.

NOTE: Double scrubbing is not recommended in areas where the cleaning solution will run under racks or damage products.

EMERGENCY SHUT-OFF BUTTON

Push the emergency shut-off button in the event of an emergency. This red button shuts off all power to machine. To regain power, turn the button clockwise and restart the key.

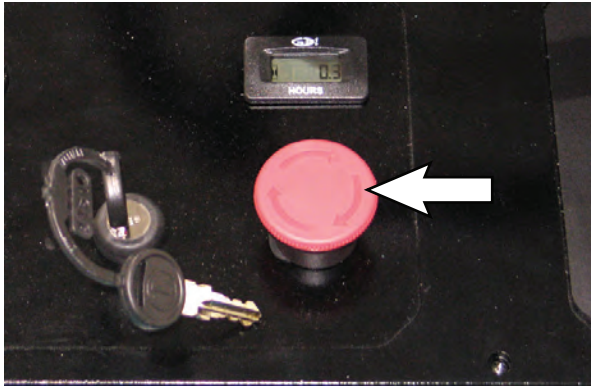

WHILE OPERATING MACHINE



WARNING: Flammable materials or reactive metals can cause an explosion or fire. Do not pick up

1. Overlap each scrub path by 2 inches/5 cm.
2. Keep machine moving to prevent damage to floor finish.
3. Wipe squeegee blades with a cloth if blades leave streaks.
4. Avoid bumping the machine into posts and walls.
5. To avoid damaging the squeegee, be sure squeegee remains centered under the machine when driving between work sites.

FOR SAFETY: When using machine, always allow head clearance when going through doorways, low ceilings, and overhangs. Drive slowly through doorways and narrow openings, especially with the dual disk model as squeegee extends behind width of machine.

6. Avoid turning machine on inclines and ramps.
7. When draining and refilling machine, always top off the optional Severe Environment tank with detergent.

FOR SAFETY: When using machine, Do not scrub on inclines that exceed 9% grade or transport on inclines that exceed 9% grade.

8. Pour a recommended foam control solution into the recovery tank if excessive foam appears.

ATTENTION: Foam buildup will not activate the float shut-off screen, vacuum motor damage will result.

9. Use the double scrubbing method for heavily soiled areas. First scrub the area with the squeegee up, let solution set for 3-5 minutes, then scrub the area a second time with squeegee down.
10. When leaving the machine unattended, park on level surface, turn machine off, and remove key.
11. Do not operate machine in areas where the ambient temperature is above 110°F/43°C or below freezing 36°F/2°C.

OPERATION

CIRCUIT BREAKER PANEL

FOR SAFETY: Before leaving or servicing machine, stop on level surface, turn off machine, and remove key.

The machine is equipped with resettable circuit breakers to protect the machine from a current overload. If a circuit breaker trips, disconnect the battery cable connection and reset the breaker by pressing the reset button after the breaker has cooled down. Reconnect the battery cable connection. If the circuit breaker does not reset or continues to trip contact service personnel.

Open the access door to access the circuit breaker panel.

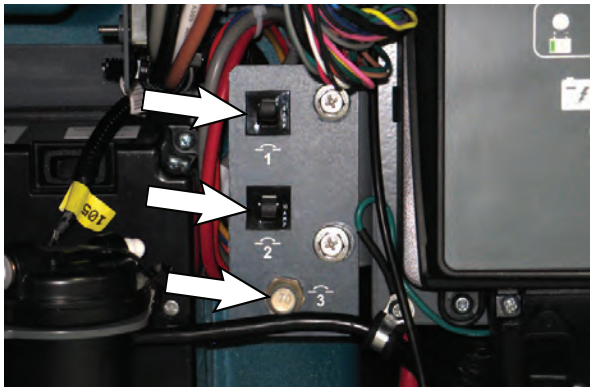

Circuit Breaker	Rating	Circuit Protected
CB1	4 A	Key switch
CB2	10 A	ec-H2O, automatic battery watering
CB3	70 A	Propel controller

FOR SAFETY: When servicing machine, all repairs must be performed by trained personnel.

HOUR METER

The hour meter records the number of hours the machine has been operated. Use the hour meter to perform specific maintenance procedures and to record service history.

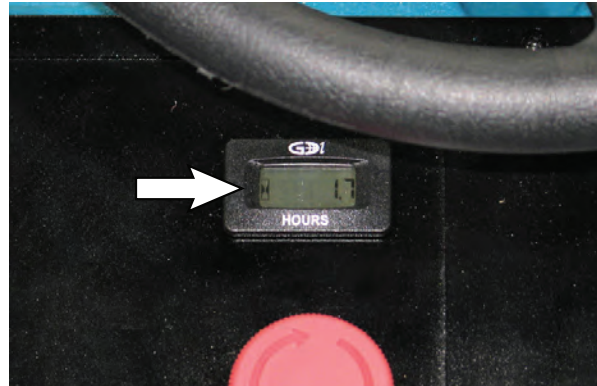

DRAINING TANKS

DRAINING RECOVERY TANK

Drain and clean the recovery tank after each use.

1. Transport the machine to drain area.

FOR SAFETY: Before leaving or servicing machine, stop on level surface, turn off machine, and remove key.

2. Remove the recovery tank drain hose from the hook, hold the hose nozzle near the drain, remove the cap from the hose, and drain the recovery tank.



NOTE: When using a bucket to drain the machine, do not use the same bucket to fill the solution tank.

3. Remove and clean the float shut-off screen.



4. Remove the debris tray and empty.



Rinse out the recovery tank with clean water and wipe clean of any soil residue.



FOR SAFETY: When servicing machine, do not power spray or hose off machine. Electrical malfunction may occur. Use damp cloth.

OPERATION

DRAINING SOLUTION TANK

Drain the solution tank daily.

1. Transport the machine to drain area.

FOR SAFETY: Before leaving or servicing machine, stop on level surface, turn off machine, and remove key.

2. To drain remaining water from solution tank, pull the solution tank level hose from the solution tank.



3. Rinse solution tank with clean water. Firmly reconnect the hose to the solution tank after rinsing / draining tank.
4. Remove the solution tank filter and clean screen after every 50 hours of use. Drain solution tank before removing filter.



SERVICE INDICATOR CODES

When the machine or battery charger detects a fault, the service indicator will flash. A fault code will be provided to determine problem as described below.

Pro-Membrane Control Panel (LED)

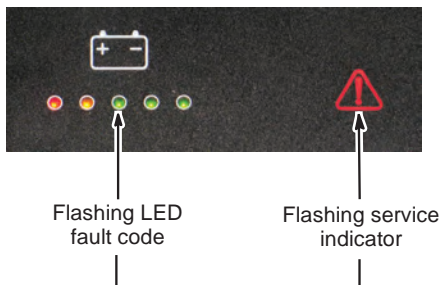

Pro-Panel Controls (LCD)

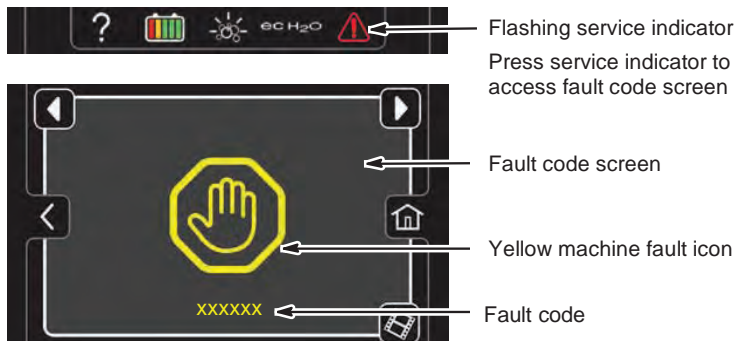

LED Fault Code ☀ = Flashing	LCD Fault Code	Cause	Solution
☀☀☀☀☀	0xFFFF0	Emergency shut-off button activated	Release emergency shut-off button and restart machine. If fault persists, contact service.
●●●☀●	0x0201	Actuator Open Warning	Contact service.
●●●☀☀	0x0101	Scrub Motor Open Warning	Contact service.
●●☀●●	0x0501	Vacuum Motor Open Warning	Contact service.
●●☀●☀	0x0601	Detergent Pump Open Warning	Contact service.
●●☀☀●	0x0910	Propel Breaker Tripped Fault	Disconnect battery and reset circuit breaker. If issue persists, contact service.
●●☀☀☀	0x0901	Propel Motor Open Fault	Contact service.
●☀●●☀	0x0301	Solution Valve Open Warning	Contact service.
●☀●●☀☀	0x0303	Solution Valve Over Current	Contact service.
●☀☀☀●	0xFF20	Scrub Controller CAN Communication Fault	Power cycle machine. If fault persists, contact service.
	0x0B04	Battery Watering CAN Fault	
☀●●●☀	0x0900	Propel I-Drive Generic Fault	Power cycle machine. If fault persists, contact service.
	0x0903	Propel Communication Lost	
	0x0904	Propel Power Cycle Needed	
	0x0905	Propel Current Limit Fault	
	0x0920 - 0x0943	Propel Faults	
☀●●☀●	0x0906	Propel Motor Short Low Fault	Contact service.
	0x0907	Propel Motor Short High Fault	

OPERATION

LED Fault Code ☼ = Flashing	LCD Fault Code	Cause	Solution
☼ ● ● ☼ ☼	0x0103	Scrub Motor Over Current	Contact service.
	0x0104	Scrub Motor Over Current 1	
	0x0105	Scrub Motor Over Current 2	
☼ ● ☼ ● ☼	0x0902	High Throttle Fault	Release green go pedal or remove green go pedal obstruction. Power cycle machine. If fault persists, contact service.
☼ ● ☼ ☼ ●	0x0107	Scrub Motor FET Fault	Contact service.
	0x0207	Actuator Motor FET Fault	
	0x0307	Valve FET Fault	
	0x0507	Vacuum Motor FET Fault	
	0x0607	Detergent Pump FET Fault	
☼ ● ☼ ☼ ☼	0x0503	Vacuum Over Current Fault	Contact service.
	0x0504	Vacuum Over Current 1 Fault	
	0x0505	Vacuum Over Current 2 Fault	
☼ ☼ ● ● ●	0x0506	Vacuum Shorted Load Fault	Contact service.
☼ ☼ ● ● ☼	0x0603	Detergent Pump Over Current Fault	Contact service.
	0x0604	Detergent Pump Over Current 2 Fault	
	0x0605	Detergent Pump Over Current 1 Fault	
☼ ☼ ● ☼ ●	0x0606	Detergent Pump Shorted Load Fault	Contact service.
☼ ☼ ● ☼ ☼	0x0926	Propel Over Temperature Warning	Allow propel motor to cool. Power cycle machine. If fault persists, contact service.
☼ ☼ ☼ ● ☼	0x0106	Scrub Motor Short Fault	Contact service.
☼ ☼ ☼ ☼ ●	0x0102	Voltage / Power Loss	Contact service.

NOTE: Contact a Tennant Service representative for all other fault codes.

ON-BOARD BATTERY CHARGER SERVICE INDICATOR CODES

LED Fault Code ☼ = Flashing	LCD Fault Code	Cause	Solution
☼ ☼ ☼ ● ●	0xF100	Charger error condition.	Contact service.
	0xF104	Batteries unable to charge correctly	Contact service.
● ☼ ☼ ● ●	0xF101	Charger is not connected to battery pack.	Check cable connections. If fault code persists, contact service.
● ☼ ● ● ●	0xF102	Charger overheated.	Let charger cool. Move to well ventilated area. If fault persists, contact service.
● ☼ ☼ ☼ ●	0xF103	Charger communication fault.	Power cycle machine. If fault code persists, contact service.

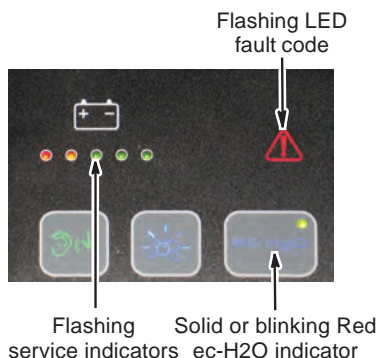

ec-H2O SYSTEM SERVICE INDICATOR CODES (OPTION)

Pro-Membrane Control Panel (LED)

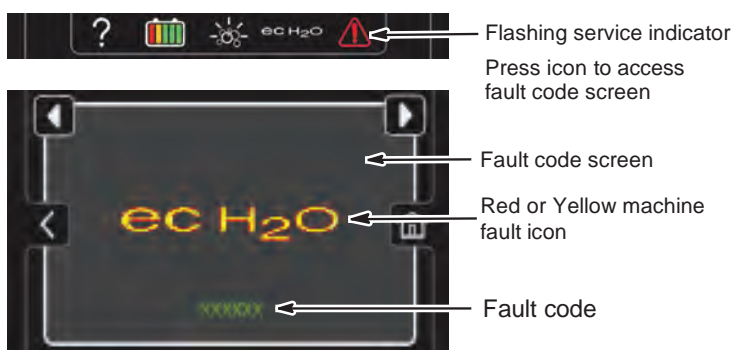

Pro-Panel Controls (LCD)



LED Fault Code ☼ = Flashing	LCD Fault Code	Cause	Solution
● ☼ ☼ ☼ ●	0x0704	ec-H2O CAN Fault	Power cycle machine. If fault persists, contact service.
● ☼ ● ☼ ●	0x0711	ec-H2O Pump Open Warning	Power cycle machine. If fault persists, contact service.
● ☼ ☼ ☼ ☼	0x0713	ec-H2O Pump Over Current	Contact service.
☼ ● ● ● ●	0x0717	ec-H2O Pump FET Fault	Contact service.
☼ ● ☼ ● ●	0x0703	ec-H2O Circuit Breaker Tripped	Reset circuit breaker. If trips again, contact service.
	0x0700	ec-H2O Electrical Faults	Contact service.
	0x0712		
	0x0716		
	0x0720		
	0x0727		
	0x072A		
	0x0741		
	0x0746		
0x0747			
	0x0702	ec-H2O Water and Plumbing Faults	Contact service.
	0x0708		
	0x0721		
	0x0723		
	0x0726		
	0x0728		
	0x0781	Detergent Tank Empty	Refill detergent tank.
ec-H2O indicator blinking blue/red	0x0707	Water conditioning cartridge expired	Replace water conditioning cartridge.

*Verify if cleaning detergent was added to solution tank. If ec-H2O system was operated with cleaning detergent, drain solution tank, add clear water and operate the ec-H2O system until the fault code clears.

MAINTENANCE

MAINTENANCE

MAINTENANCE CHART

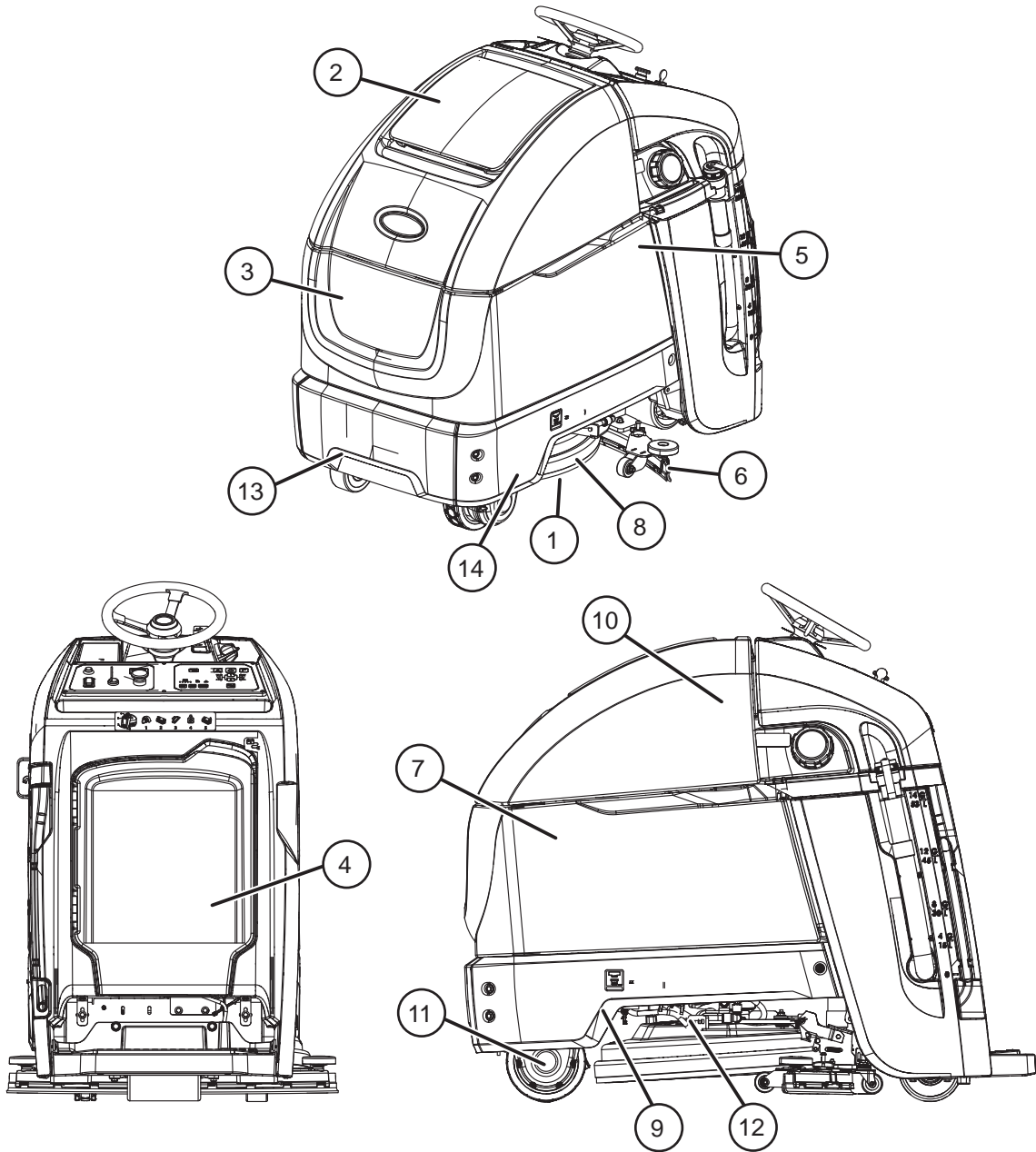

The table below indicates the Person Responsible for each procedure.

O = Operator.

T = Trained Personnel.

Interval	Person Resp.	Key	Description	Procedure	Lubricant/ Fluid
Daily	O	1	Pad(s)	Check, flip or replace	
	O	1	Brush(es)	Check, clean	
	O	6	Squeegee	Clean, check for damage and wear	
	O	8	Scrub head skirt	Check for damage and wear	
	O	2	Recovery tank	Drain, rinse, clean float shut-off screen and debris tray	
	O	3	Solution tank	Drain, rinse	
	O	4	Severe Environment tank (option)	Check, refill	CAD
	O	5	Automatic battery watering tank (option)	Check, refill	DW
	O	7	Batteries	Charge if necessary	
Weekly	O	7	Battery cells	Check electrolyte level	DW
	O	7	Battery compartment	Check for liquid	
	O	6	Squeegee assembly drip trap reservoir (dual disk model)	Check. Clean	
50 Hours	O	2	Recovery tank lid seal	Check for wear	
	O	9	Solution tank filter	Remove and clean	
100 Hours	O	7	Battery watering system (option)	Check hoses for damage and wear	
200 Hours	O	7	Batteries, terminals and cables	Check and clean	
	T	13	Steering chain	Lubricate, check tension, and check for damage and wear	GL
	T	14	Steering cable	Check tension. Check for damage and wear	
750 Hours	T	10	Vacuum motor	Replace carbon brushes	
1250 Hours	T	11	Propel motor	Replace carbon brushes	
	T	12	Brush motor(s)	Replace carbon brushes	

LUBRICANT/FLUID

DW Distilled water

CAD Commercial approved detergent

GL SAE 90 weight gear lubricant

MAINTENANCE

MACHINE MAINTENANCE

To keep the machine in good working condition, simply perform the following maintenance procedures.

FOR SAFETY: Before leaving or servicing machine, stop on level surface, turn off machine, and remove key.

FOR SAFETY: When servicing machine wear personal protection equipment as needed. All repairs must be performed by trained personnel.

YELLOW TOUCH POINTS

This machine features easy to find yellow touch points for simple service items. No tools are required to perform these maintenance operations.

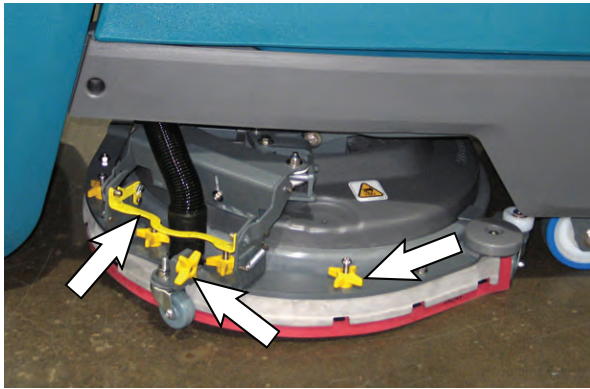

AFTER DAILY USE

1. Turn pad over or replace when worn. See BRUSH AND PAD REPLACEMENT.

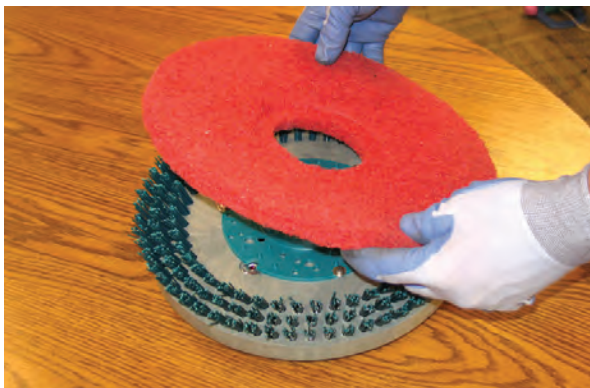

2. Replace brushes when they no longer clean effectively. See BRUSH AND PAD REPLACEMENT.

3. Wipe the squeegee blades clean. Inspect blades for wear and damage. Rotate blades if worn. See SQUEEGEE BLADE REPLACEMENT.



4. Clean scrub head skirt. Check for wear and damage. Replace if worn or damaged.



5. Drain, rinse out, and clean the recovery tank. See DRAINING TANKS





FOR SAFETY: When servicing machine, do not power spray or hose off machine. Electrical malfunction may occur. Use damp cloth.

6. Remove the debris tray and empty.



7. Remove and clean the float shut-off screen.



8. Drain and rinse out the solution tank.



9. Severe Environment option - Refill the Severe Environment tank with a recommended cleaning detergent at full concentration. Replace cap.



10. Automatic battery watering option - Refill tank with distilled water. Replace cap.

NOTE: Check for liquid in the battery compartment whenever replenishing the automatic battery watering tank. Drain all liquid from the battery compartment. See BATTERY COMPARTMENT DRAIN VALVE.



MAINTENANCE

11. Charge batteries. See BATTERIES.

ATTENTION: Do not disconnect battery cables while charger is plugged in, circuit board damage may result.

12. Clean the outside surface of the machine with an all purpose cleaner and damp cloth.



AFTER WEEKLY USE

1. Check the electrolyte level in all batteries. See BATTERIES.

NOTE: If machine is equipped with the automatic or manual battery watering system, See BATTERIES.

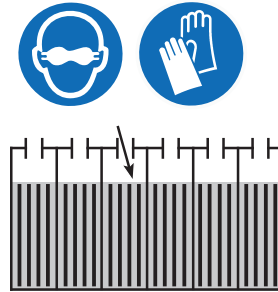

2. Check for liquid in the battery compartment. See *BATTERY COMPARTMENT DRAIN VALVE*.



3. **Machines with 24 in. (600 mm) scrub heads only:** Remove the drip trap cover from the squeegee assembly and clean reservoir.

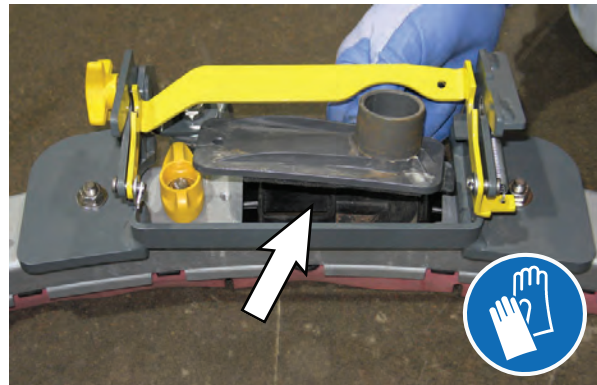

AFTER EVERY 50 HOURS OF USE

1. Inspect and clean the seal on the recovery tank lid. Replace seal if damaged.



2. Drain solution tank. Remove the solution tank filter and clean screen. Turn the filter bowl counter-clockwise to remove.



AFTER EVERY 100 HOURS OF USE

If machine is equipped with the optional battery watering system, check hoses for leaks, loose hose connections and for damage or wear. Replace system if damaged.

FOR SAFETY: When servicing batteries, wear personal protection equipment as needed. Avoid contact with battery acid.

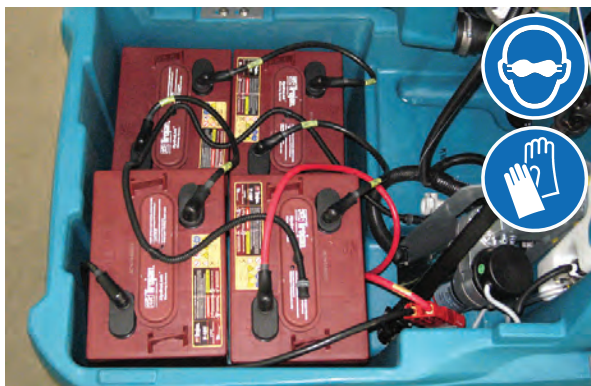

AFTER EVERY 200 HOURS OF USE

1. Check batteries for loose battery and clean the surface of the batteries, including terminals and cable clamps to prevent corrosion. See BATTERIES.
2. Check for damage or wear and lubricate the steering chain.

FOR SAFETY: When servicing machine, all repairs must be performed by trained personnel.

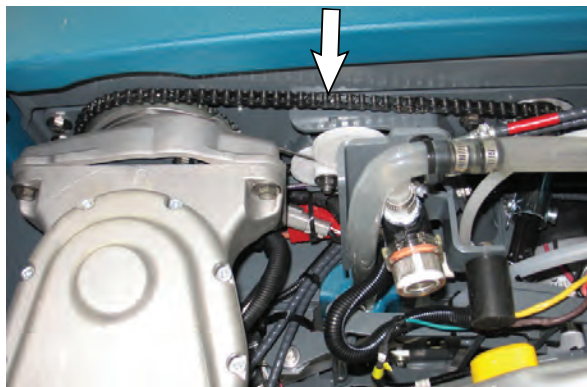

3. Check the steering cable for damage or wear. Use tension gauge to check steering cable tension.

FOR SAFETY: When servicing machine, all repairs must be performed by trained personnel.

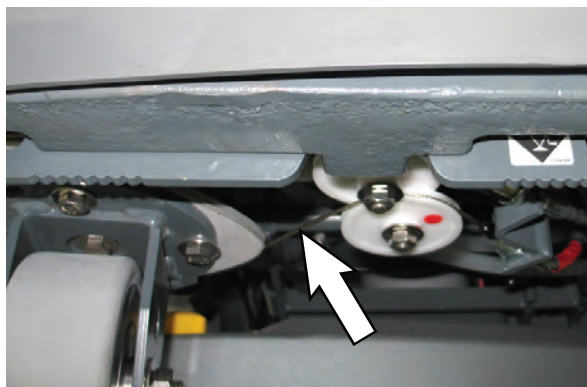

ELECTRIC MOTORS

Replace motor carbon brushes as indicated. Contact trained personnel for carbon brush replacement.

Carbon Brush Replacement	Hours
Vacuum motor	750
Propel motor	1250
Brush motor(s)	1250

MAINTENANCE

BATTERIES

FOR SAFETY: Before leaving or servicing machine, stop on level surface, turn off machine, and remove key.

The lifetime of the batteries depends on proper maintenance. To get the most life from the batteries:

- Do not charge the batteries more than once a day and only after running the machine for a minimum of 15 minutes.
- Do not leave the batteries partially discharged for long period of time.
- Only charge the batteries in a well-ventilated area to prevent gas build up.
- Allow the charger to complete charging the batteries before re-using the machine.
- Maintain the proper electrolyte levels of flooded (wet) batteries by checking levels weekly.

Your machine is equipped with either flooded (wet) lead-acid or maintenance-free (Sealed AGM) batteries supplied by Tennant.

FOR SAFETY: When servicing machine, keep all metal objects off batteries. Avoid contact with battery acid.

MAINTENANCE-FREE BATTERIES

Maintenance-free (Sealed AGM) batteries do not require watering. Cleaning and other routine maintenance is still required.

FLOODED (WET) LEAD-ACID BATTERIES

The flooded (wet) lead-acid batteries require routine watering as described below. Check the battery electrolyte level weekly.

NOTE: If machine is equipped with the automatic or manual battery watering system, proceed to the BATTERY WATERING SYSTEM instructions.

The electrolyte level should be slightly above the battery plates as shown before charging. Add distilled water if low. **DO NOT OVERFILL.** The electrolyte will expand and may overflow when charging. After charging, distilled water can be added up to about 3 mm (0.12 in) below the sight tubes.

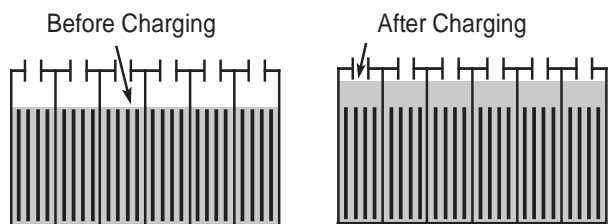

CHECKING CONNECTIONS / CLEANING

After every 200 hours of use, check for loose battery connections and clean the surface of the batteries, including terminals and cable clamps to prevent battery corrosion. Use a scrub brush with a strong mixture of baking soda and water. Do not remove battery caps when cleaning batteries.



CHARGING BATTERIES

The charging instructions in this manual are intended for the battery charger supplied with your machine. The use of other battery chargers that are not supplied and approved by Tennant are prohibited.

If your machine is equipped with an off-board battery charger refer to the charger's owners manual for operating instructions. Contact distributor or Tennant for battery charger recommendations if machine is not equipped with charger.

FOR SAFETY: Do not use incompatible battery chargers as this may damage battery packs and potentially cause a fire.

IMPORTANT NOTICE: The battery charger is set to charge the battery type supplied with your machine. If you choose to change to a different battery type or capacity (i.e. flooded (wet) lead-acid, maintenance-free, sealed, AGM batteries, etc.), the charger's charging profile must be changed to prevent battery damage. See BATTERY CHARGER SETTINGS.

1. Transport the machine to a well-ventilated area.



WARNING: Batteries emit hydrogen gas. Explosion or fire can result. Keep sparks and open flame away when charging.

2. Park the machine on a flat, dry surface, turn off machine and remove key.

FOR SAFETY: When servicing batteries, stop on level surface, turn off machine, and remove key.

3. If the machine is equipped with flooded (wet) lead acid batteries check the battery electrolyte level weekly before charging. For models equipped with the automatic battery watering system, check if the automatic battery water tank needs refilling. Add distilled water if low.
4. For models equipped with an on-board charger, remove the charger's power cord from the storage hooks and plug power cord into a properly grounded wall outlet.

FOR SAFETY: Open recovery tank if temperature is above 80°F/27°C when charging batteries.

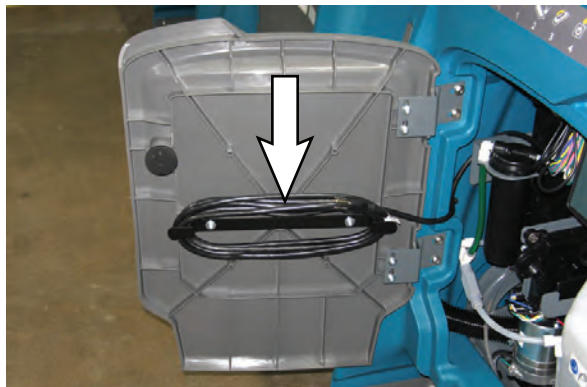

For models equipped with off-board chargers, first connect the charger's DC cord into the machine's battery charge receptacle then plug the AC power supply cord into a properly grounded wall outlet. Refer to the off-board battery charger's owner manual for operating instructions. Do not close the recovery tank on the charger cables when charging with an off-board charger.

FOR SAFETY: Do not disconnect the off-board charger's DC cord from the machine's receptacle when the charger is operating. Arcing may result. If the charger must be interrupted during charging, disconnect the AC power supply cord first.

5. The charger will automatically begin charging and shut off when fully charged. The maximum charging cycle may take up to 6-12 hours depending on battery type.

On-board battery charger: The battery discharge indicator lights will ripple back and forth during the charging cycle. When all five lights repeatedly flash two times, the charging cycle is complete.

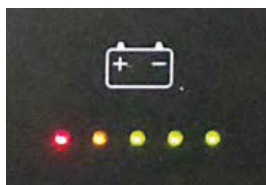

Pro-membrane



Pro-panel

ATTENTION: Do not disconnect battery cables while charger is plugged in, circuit board damage may result.

MAINTENANCE

6. After charging batteries unplug the power supply cord and wrap cord around the cord hooks.

For models equipped with an off-board charger, always disconnect the AC power supply cord first before disconnecting charger from machine.

BATTERY CHARGER SETTINGS

The battery charger is set to charge the battery type supplied with your machine. If you choose to change to a different battery type or capacity, the charger's charging profile must be changed to prevent battery damage.

The machine's battery discharge indicator (BDI) must also be reprogrammed to match battery type to prevent battery damage and/or short run-time.

NOTE: For machines shipped without batteries, the battery discharge indicator and the on-board battery charger are set for GEL batteries as the default. If you choose to use a different battery type, the settings must be changed as described as below.

NOTE: For machines shipped without batteries and supplied with an Off-Board Charger, the off-board battery charger is set for wet lead-acid batteries from the factory. The machine's battery discharge indicator is set for GEL batteries as the default. The battery discharge indicator must be reprogrammed to match charger settings (See OFF-BOARD BATTERY CHARGER below).

IRIS MODELS: For models equipped with capability to report battery charging data via IRIS, Tennant recommends using the same battery type. If a different amp hour or battery type is desired, contact Tennant Service Department.

OFF-BOARD BATTERY CHARGER:

1. To change the off-board battery charger settings, refer to the off-board charger's owner manual.
2. To reprogram the machine's battery discharge indicator (BDI):

Pro-Membrane Model - Service application software required, contact service.

Pro-Panel Model - See CHANGING THE ON-BOARD BATTERY CHARGER SETTINGS in the SUPERVISOR section for Pro-Panel models.

ON-BOARD BATTERY CHARGER:

Pro-Membrane Model - To change the on-board battery charger settings, service application software required, contact service. As an alternative, the charger profile may be manually changed. See CHANGING ON-BOARD BATTERY CHARGER SETTINGS for Pro-Membrane model. The battery discharge indicator will automatically reprogram to match battery type when the battery charger profile is changed.

Pro-Panel Model - To change the on-board battery charger settings, see CHANGING THE ON-BOARD BATTERY CHARGER SETTINGS in the SUPERVISOR section for Pro-Panel models. The battery discharge indicator will automatically reprogram to match battery selection.

CHANGING ON-BOARD BATTERY CHARGER SETTINGS (Pro-Membrane model)

To manually change the on-board battery charger settings for a different battery type, carefully follow instructions as described below:

NOTE: The manual method is only an alternative if unable to change setting by use of the Service Application Software performed by Service.

1. Disconnect the battery cable connection at machine.

FOR SAFETY: When servicing machine, stop on level surface, turn off machine, and remove key.

2. Open the access panel to access the on-board battery charger.
3. Carefully peel back the charger display label to access the dial settings.

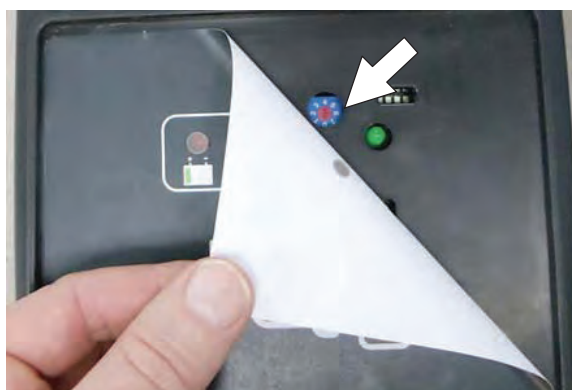

4. Using a small standard screwdriver, turn the dial to the appropriate battery type according to the following chart.

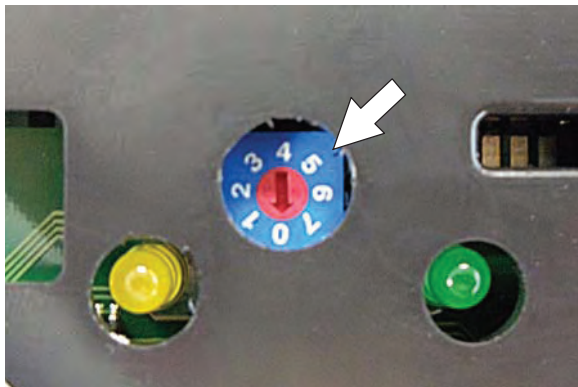

Dial Position	Battery Description Settings with AH Ranges
0	CAN-BUS setting*
1	Wet, Trojan 180-260 AH
2	Wet, Trojan 270-360 AH
3	Wet, Enersys/Tab 200-350 AH
4	AGM, Tianneng 180-260 AH
5	AGM, Discover 200-350 AH
6	Gel, Sonnenschein 80-150 AH

** The CAN-BUS setting, dial position "0", is the software setting that is programmed to match battery type supplied with machine. When the dial is manually changed to a different setting, it should not be reset back to "0" otherwise battery damage may result. Service Application Software is required to reset dial back to "0". Contact Service.*

5. Re-apply the display label.
6. To set the BDI for the new battery type, plug the on-board battery charger cord into an electrical outlet. The machine's software will automatically reprogram the BDI to the new battery type.

MAINTENANCE

HYDROLINK® BATTERY WATERING SYSTEM (Trojan® Battery OPTION)

The following instructions are for models equipped with the HydroLink battery watering system option.

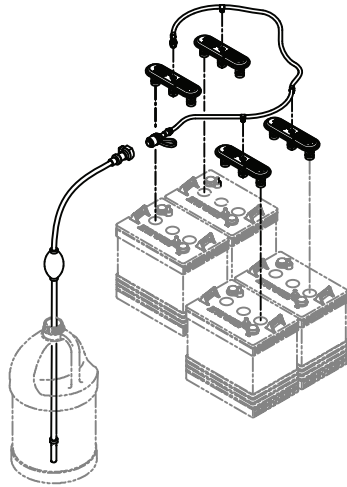

The optional HydroLink battery watering system provides a safe and easy way to maintain the proper electrolyte levels in your batteries. It is designed exclusively for Trojan flooded (wet) lead-acid batteries.

FOR SAFETY: When servicing machine, wear personal protection equipment as needed. Avoid contact with battery acid.

Before using the battery watering system check hoses and connections for damage or wear.

1. Fully charge batteries prior to using the battery watering system. Do not add water to batteries before charging, the electrolyte level will expand and may overflow when charging.
2. After charging batteries, check the battery electrolyte level indicators located on the battery covers. If the level indicator is white add water as described in the following instructions. If the level indicators are black the electrolyte is at the correct level, no water is required.



3. Locate the battery fill hose coupler inside the battery compartment. Remove the dust cap and connect the hand pump hose.

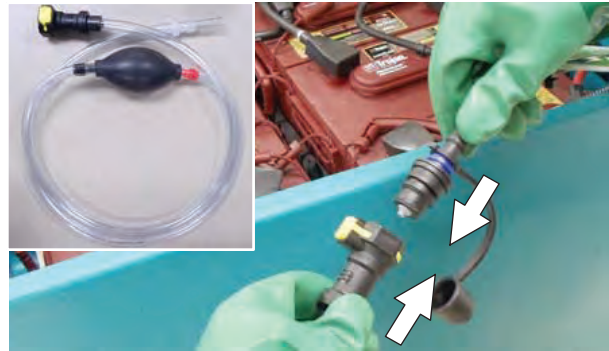

4. Submerge the other end of the hand pump hose into a bottle of distilled water



5. Squeeze the bulb on the hand pump hose until firm. The level indicators will turn black when full.

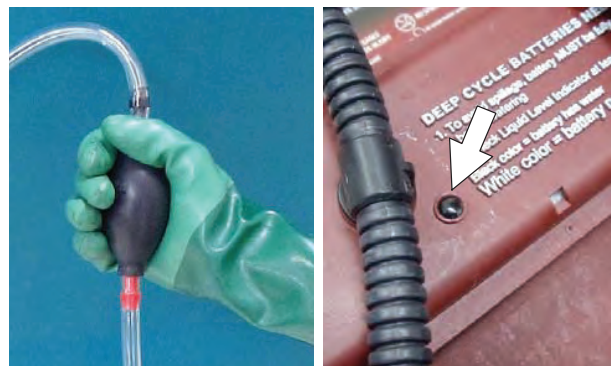

6. After adding water, replace the dust cap on the battery fill hose and store the hand pump hose inside the machine's battery compartment for future use.

**MANUAL BATTERY WATERING SYSTEM
(Trojan® Battery OPTION)**

The following instructions are for models equipped with the manual battery watering system option.

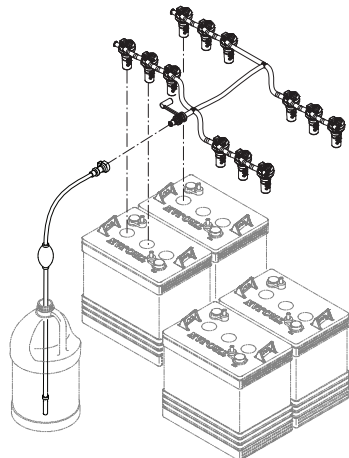

The optional manual battery watering system provides a safe and easy way to maintain the proper electrolyte levels in your batteries. It is designed exclusively for Trojan flooded (wet) lead-acid batteries.

FOR SAFETY: When servicing machine, wear personal protection equipment as needed. Avoid contact with battery acid.

Before using the battery watering system check hoses and connections for damage or wear.

1. Fully charge batteries prior to using the battery watering system. Do not add water to batteries before charging, the electrolyte level will expand and may overflow when charging.
2. After charging batteries, check the battery electrolyte level indicators located on the battery covers.



3. If the level indicator has a low white float add water as described in the following instructions.

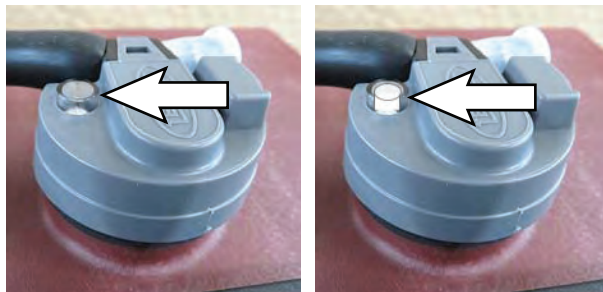

Low Float = Add Water High Float = Full

4. Locate the battery fill hose coupler inside the battery compartment. Remove the dust cap and connect the hand pump hose.

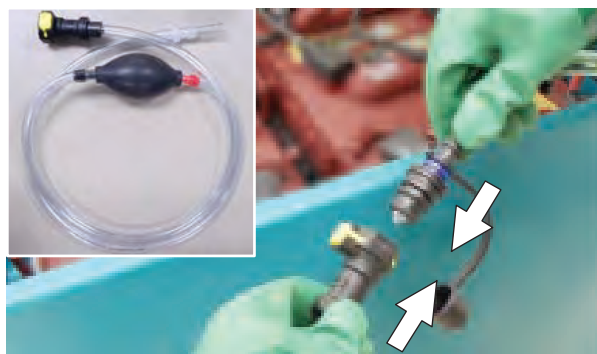

5. Submerge the other end of the hand pump hose into a bottle of distilled water



MAINTENANCE

6. Squeeze the bulb on the hand pump hose until firm. The white float will rise when full.

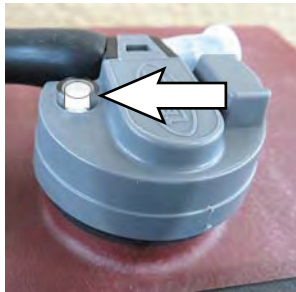

High Float = Full

7. After adding water, replace the dust cap on the battery fill hose and store the hand pump hose inside the machine's battery compartment for future use.

SMART-FILL AUTOMATIC BATTERY WATERING (OPTION)

FOR SAFETY: When servicing machine, wear personal protection equipment as needed. Avoid contact with battery acid.

The automatic battery watering system is designed to automatically refill the batteries after the machine reaches a limited number of charge cycles. Do not remove battery caps and manually add water to the batteries.

Check the automatic battery watering system for leaks, loose hose connections and for damage or wear. Replace if damaged.



Check the water level in the automatic watering tank periodically. Add distilled water when low.

FOR SAFETY: When servicing machine, only use distilled water when filling the automatic battery watering tank.



For machines equipped with the battery electrolyte indicators, the white float will rise and become visible when they are full. They will lower when water is needed.

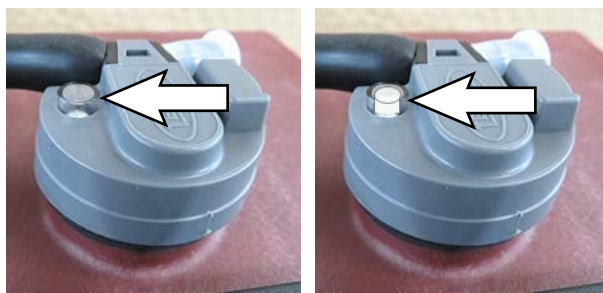

Low Float = Add Water

High Float = Full

The automatic battery watering indicator will also alert user to add distilled water when tank is empty. See CONTROL PANEL OPERATION for further details.

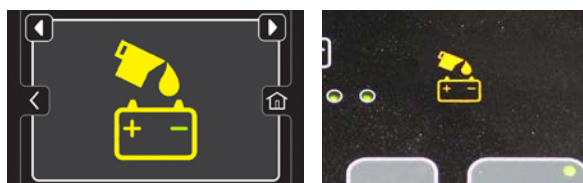

MAINTENANCE

BATTERY COMPARTMENT DRAIN VALVE

If the battery compartment tray has liquid in it, use the drain valve to drain it. Neutralize the compartment using a scrub brush with a strong mixture of baking soda and water.

FOR SAFETY: When servicing machine, always follow site safety rules when disposing battery compartment liquid.

1. Position front end of machine over area where battery compartment can be safely drained, turn off the machine, and remove the key.

FOR SAFETY: Before leaving or servicing machine, stop on level surface, turn off machine, and remove key.

2. Open the battery compartment drain valve and allow the liquid to drain from the battery compartment:

FOR SAFETY: When servicing machine, wear personal protection equipment as needed. Avoid contact with battery acid.

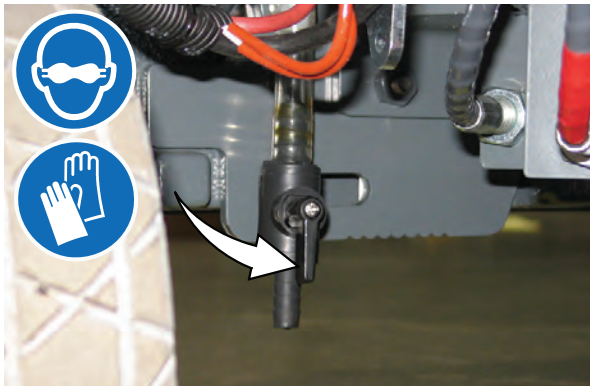

3. Close the battery compartment drain valve after all liquid has drained from the battery compartment.

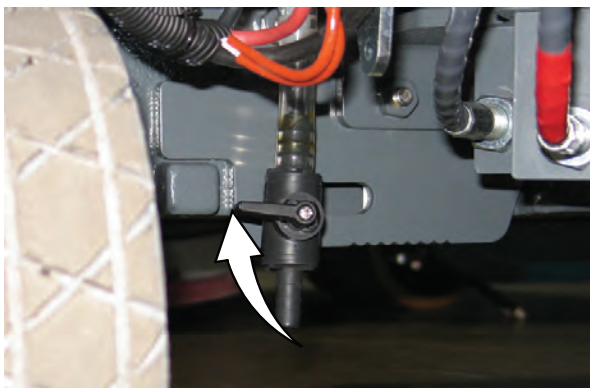

BRUSH AND PAD REPLACEMENT

Replace the pads when they no longer clean effectively. Replace the brushes when they no longer clean effectively.

Cleaning pads must be placed on pad drivers before they are ready to use. The cleaning pad is held in place with a center disk. Both sides of the pad can be used for scrubbing. Turn the pad over to use the other side.

Cleaning pads need to be cleaned immediately after use with soap and water. Do not wash the pads with a pressure washer. Hang pads, or lay pads flat to dry.

NOTE: Always replace brushes and pads in sets. Otherwise one brush or pad will be more aggressive than the other.

REPLACING BRUSH(ES) OR PAD(S) ON PRO-PANEL MACHINES

1. Stand with both feet on the operator presence pedal (do not press the go pedal), turn the key to the ON position, and press the brush change button to raise the scrub head to the correct level for changing the brush(es) or pad(s).



NOTE: Remain standing on the operator presence pedal until the scrub head has moved through the entire range of motion and has stopped moving. Process will be paused if the operator presence pedal is released. Step back onto the operator presence pedal and press brush change button again to continue the process. Turn key switch to OFF position to abort process.

2. Press the brush change button to disengage the brush.

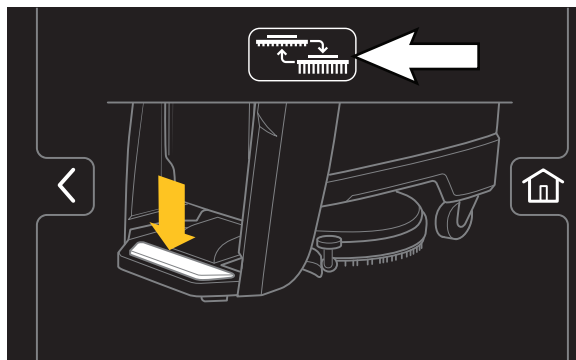

The brush change button will turn green while the scrub head repositions to allow the brush or pad driver to be changed.

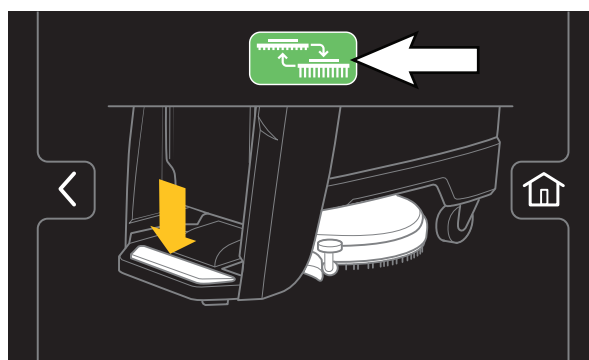

3. Wait for the green check mark to appear on the Pro-Panel display.

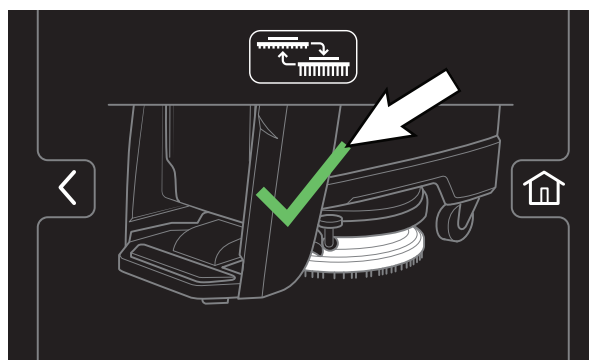

4. Release the operator presence pedal.

MAINTENANCE

5. **Machines equipped with magnetic brush hubs:** Remove the brush or pad driver from under the scrub head.



WARNING: Magnetic Field Hazard. Magnetic pad driver/brush can be harmful to those with pacemakers or medical implants.



Machines equipped with 3-lug brush hubs:
To remove the brush or pad driver, grip the disk and give it a quick turn.



6. **Machines equipped with magnetic brush hubs:** Push the new brush or pad driver under the scrub head and lift the brush or pad driver until the magnet secures the brush or pad to the drive hub.

Machines equipped with 3-lug brush hubs:
Position the three lugs into the motor hub slots and give the pad driver / brush a quick counter-clockwise turn to engage hub.

7. Ensure the brush or pad driver is securely mounted on the brush drive hub.

8. Ensure the scrub head skirt is properly positioned on the scrub head.

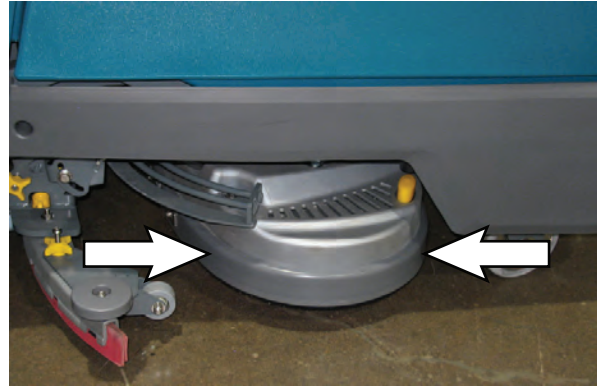

9. Repeat procedure for the other brush or pad driver, if machine is equipped with dual brush scrub head.

REPLACING BRUSH(ES) OR PAD(S) ON PRO-MEMBRANE PANEL MACHINES

1. Stand with both feet on the operator presence pedal (do not press the go pedal), turn the key to the ON position, and press the brush change button to raise the scrub head to the correct level for changing the brush(es) or pad(s).

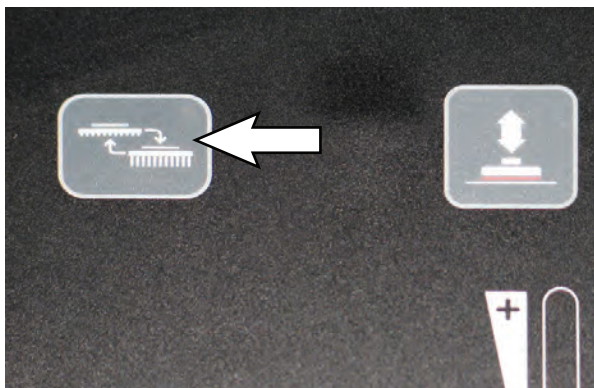

NOTE: Remain standing on the operator presence pedal until the scrub head has moved through the entire range of motion. Process will be paused if the operating presence pedal is released. Step back onto the operator presence pedal and press the brush change button again to continue the process. Turn key switch to OFF position to abort process.

2. Release the operator pedal when the green LED stops flashing and remains illuminated solid green.
3. **Machines equipped with magnetic brush hubs:** Remove the brush or pad driver from under the scrub head.



WARNING: Magnetic Field Hazard. Magnetic pad driver/brush can be harmful to pacemaker wearers or medical implants.



Machines equipped with 3-lug brush hubs:

To remove the brush or pad driver, grip the disk and give it a quick turn.



4. **Machines equipped with magnetic brush hubs:** Push the new brush or pad driver under the scrub head and lift the brush or pad driver until the magnet secures the brush or pad to the drive hub.

Machines equipped with 3-lug brush hubs:

Position the three lugs into the motor hub slots and give the pad driver / brush a quick counter-clockwise turn to engage hub.

5. Ensure the brush or pad driver is securely mounted on the brush drive hub.
6. Ensure the scrub head skirt is properly positioned on the scrub head.

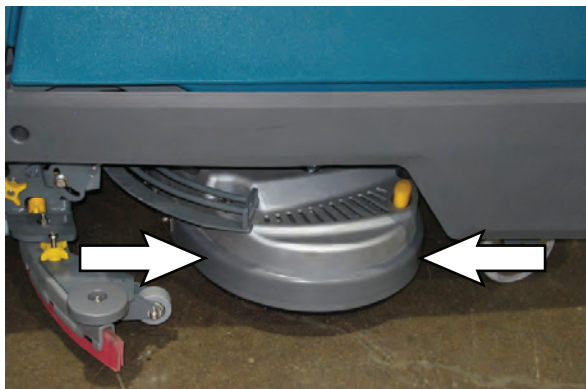

7. Repeat procedure for the other brush or pad driver, if machine is equipped with dual brush scrub head.
8. Step back onto the operator presence pedal to allow the machine to complete the brush change cycle.

MAINTENANCE

SQUEEGEE BLADE REPLACEMENT

Each squeegee blade has four wiping edges. When the blades become worn, simply rotate the blades end-for-end or top-to-bottom for a new wiping edge. Replace blade if all four edges are worn.

REPLACING SQUEEGEES ON MACHINES WITH 20 IN. (500 MM) SCRUB HEADS

1. Stop the machine and lower the scrub head.

FOR SAFETY: Before leaving or servicing machine, stop on level surface, turn off machine, and remove key.

2. Rotate the squeegee assembly to the right side of the machine.

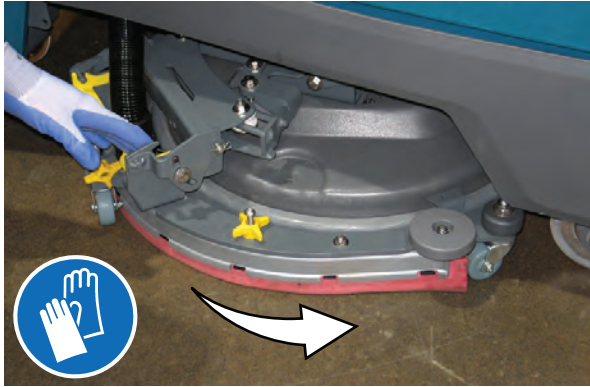

3. Disconnect the vacuum hose from the squeegee assembly.



4. Squeeze the squeegee retainer lever and remove the squeegee assembly from the machine.



5. Fully loosen the four knobs on squeegee assembly. This will separate the spring loaded blade retainer from squeegee frame.

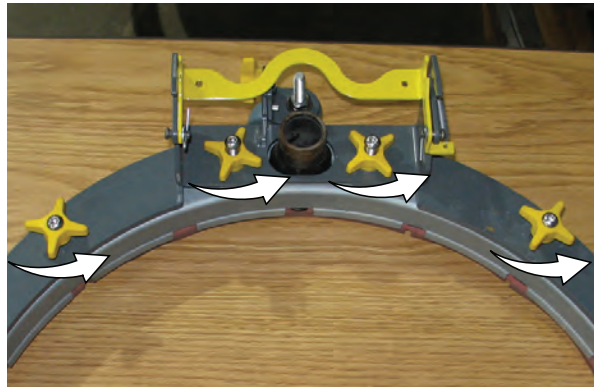

6. Remove worn blade(s) from the blade retainer.



7. Rotate the rear blade(s) to a new wiping edge and reinstall blade(s). Make sure to align the slots in the blade(s) with retainer tabs.

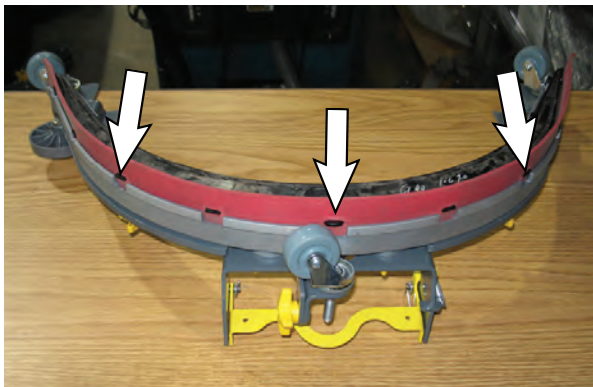

10. Slide the squeegee assembly onto the squeegee carriage until both squeegee carriage pins are secured in the bracket.

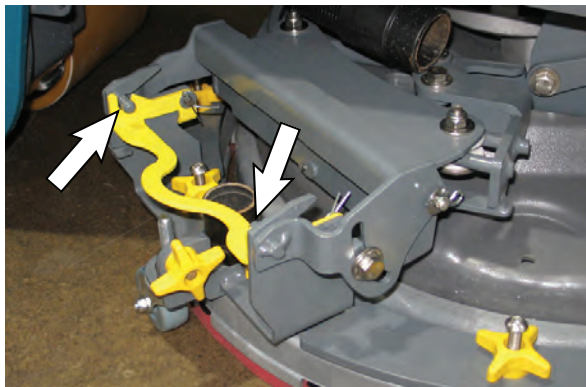

8. Squeeze the squeegee frame and blade retainer together and re-tighten the four knobs.



11. Be sure both squeegee tabs are positioned above the scrub head skirt.



9. Position the squeegee assembly bracket near the squeegee carriage and align the squeegee carriage pins into the squeegee assembly bracket.

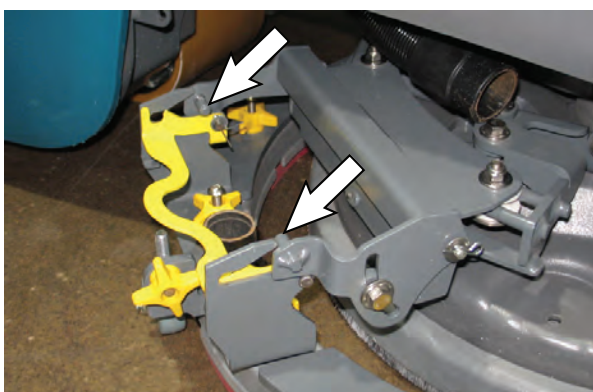

12. Connect the vacuum hose to the squeegee assembly.

13. Rotate and center the squeegee assembly underneath the machine.

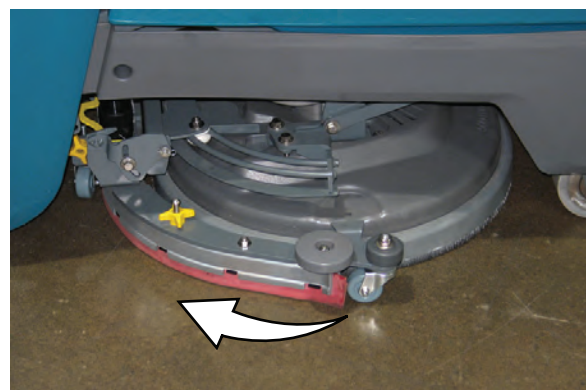

MAINTENANCE

REPLACING SQUEEGEES ON MACHINES WITH 24 IN. (600 MM) SCRUB HEADS

1. Stop the machine and lower the scrub head.

FOR SAFETY: Before leaving or servicing machine, stop on level surface, turn off machine, and remove key.

2. Rotate the squeegee assembly to the right side of the machine.

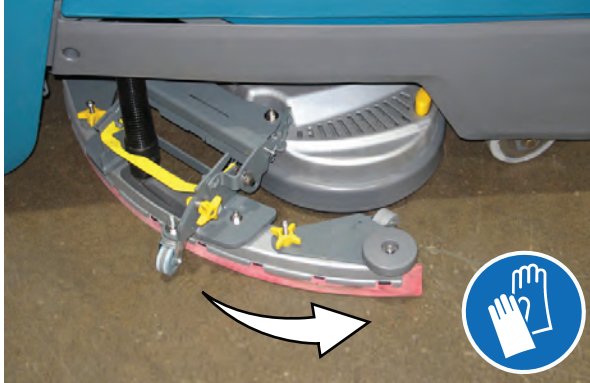

3. Disconnect the vacuum hose from the squeegee assembly.



4. Squeeze the squeegee retainer lever and remove the squeegee assembly from the machine.



5. Fully loosen the two outside knobs on squeegee assembly. This will separate the spring loaded blade retainer from squeegee frame.

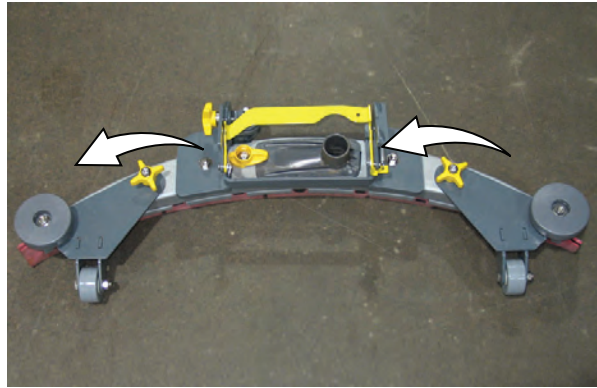

6. Remove worn blade(s) from the blade retainer.



7. Rotate the rear blades to a new wiping edge and reinstall blades. Make sure to align the slots in the blades with retainer tabs.

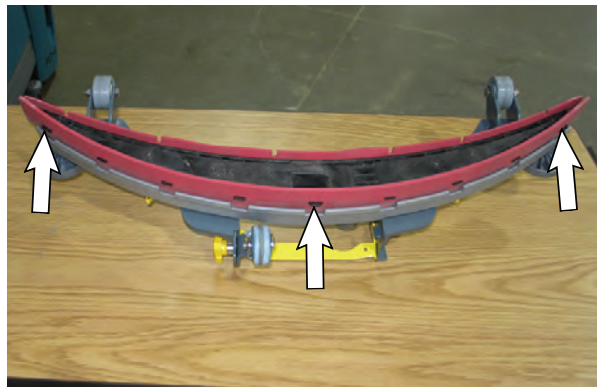

8. Squeeze the squeegee frame and blade retainer together and re-tighten the two outside knobs.

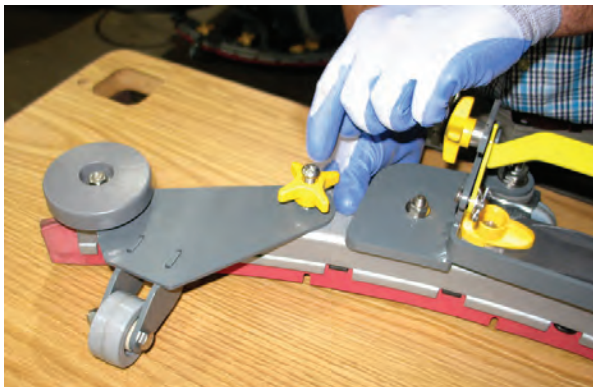

9. Position the squeegee assembly bracket near the squeegee carriage and align the squeegee carriage pins into the squeegee assembly bracket.

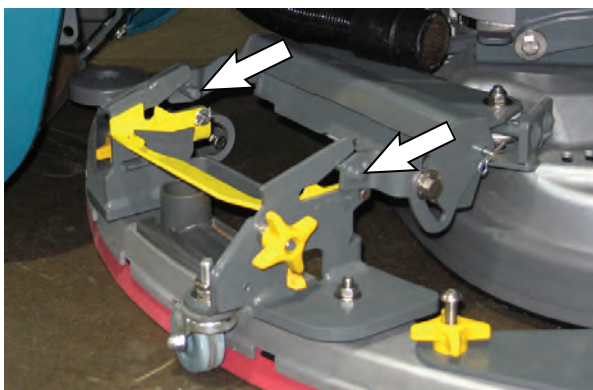

10. Slide the squeegee assembly onto the squeegee carriage until both squeegee carriage pins are secured in the bracket.

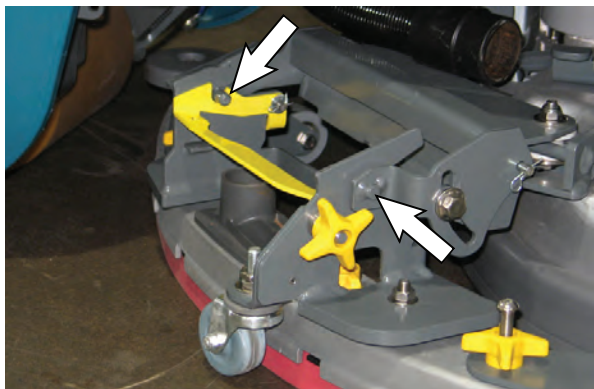

11. Connect the vacuum hose to the squeegee assembly.

12. Rotate and center the squeegee assembly underneath the machine.

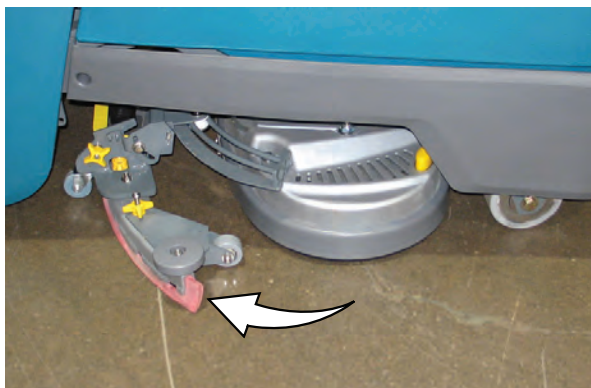

MAINTENANCE

ec-H2O WATER CONDITIONING CARTRIDGE REPLACEMENT

FOR SAFETY: Before leaving or servicing machine, stop on level surface, turn off machine, and remove key.

The water conditioning cartridge is required to be replaced when it reaches its maximum water usage or expiration time of when the cartridge was activated, whichever comes first. The control panel will signal a code when it's time to replace cartridge. See CONTROL PANEL OPERATION for further details.

Depending on machine usage, on average, a new cartridge can last anywhere from 12 months for heavy machine usage to 24 months for light machine usage.

ATTENTION: During first time use and after replacing the water conditioning cartridge, the ec-H2O system will automatically override the selected solution flow rate for up to 75 minutes.

1. Park the machine on a level surface and remove the key.
2. Open the access door to access the ec-H2O water conditioning cartridge.



3. Disconnect the two hose connectors from the top of the cartridge by pressing the gray collars inward and pulling the connectors outward. Lift cartridge to remove.

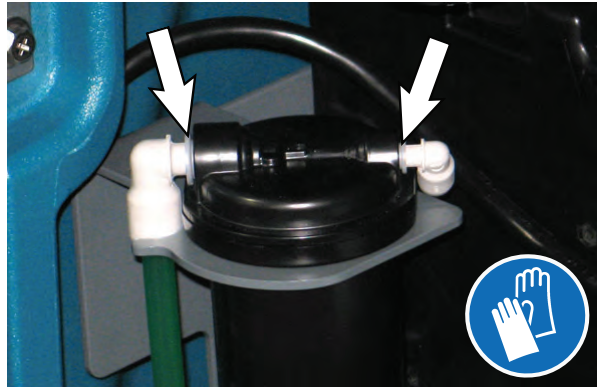

4. Fill in the installation date on the new cartridge label.

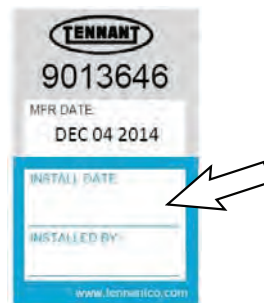

5. Install the new cartridge and reconnect the two hoses. Make sure the hose connectors are fully inserted into the cartridge.

Carefully read and understand all steps first before performing the following procedure.

- a. Turn key on.
- b. Press and hold the service switch, located on the ec-H2O module, for 10 seconds. After releasing service switch, the three solution flow indicator lights will begin to (ripple) move back and forth.
- c. Within 5 seconds after releasing the service switch, while the three indicator lights are moving back and forth, quickly press and release the solution flow button located on ec-H2O module. The three indicator lights will then blink three times to indicate timer has been reset. Repeat process if the three indicator lights do not blink three times.

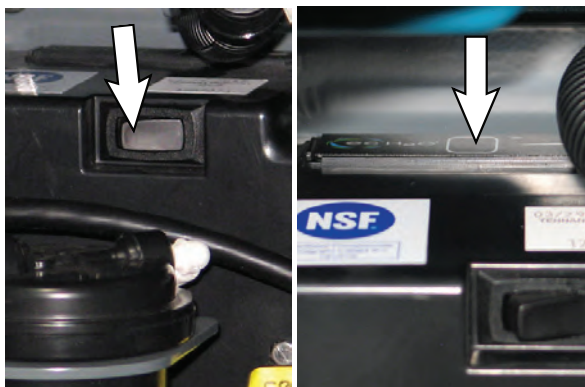

MACHINE JACKING

FOR SAFETY: Before leaving or servicing machine, stop on level surface, turn off machine, and remove key.

Use the designated locations to jack up the machine for service. Empty the recovery and solution tanks and position the machine on a level surface before jacking.

FOR SAFETY: When servicing machine, jack machine up at designated locations only. Support machine with jack stands. Use jack or hoist that will support the weight of the machine.

Rear jack point.

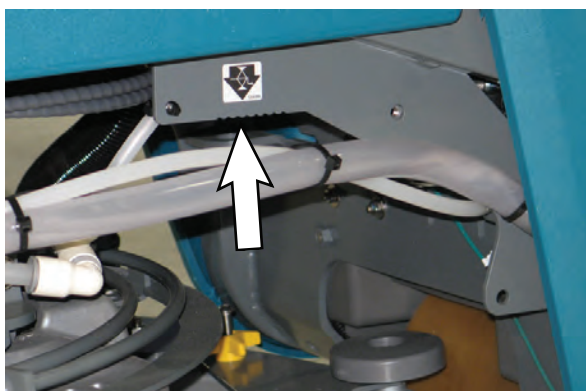

Front jack points.

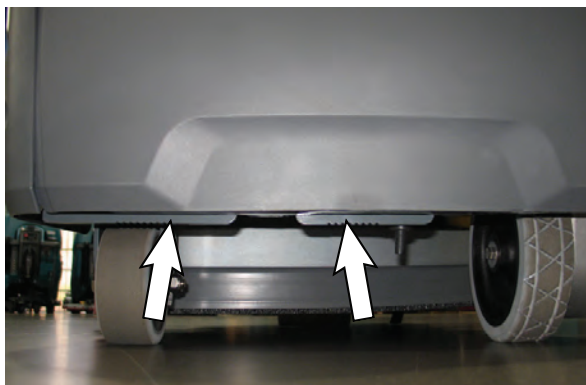

MAINTENANCE

JACKING UP THE FRONT OF THE MACHINE

FOR SAFETY: Before leaving or servicing machine, stop on level surface, turn off machine, and remove key.

1. Position the steering wheel so the front steering wheel is oriented straight out to the front of the machine.
2. Block the rear wheel.
3. Position a floor jack under the center jack point located at the front of the machine.
4. Use floor jack to raise machine from the floor.



5. Place a jack stand underneath the other jack point and lower the machine onto the jack stand so both the jack stand and floor jack are supporting the weight of the machine.

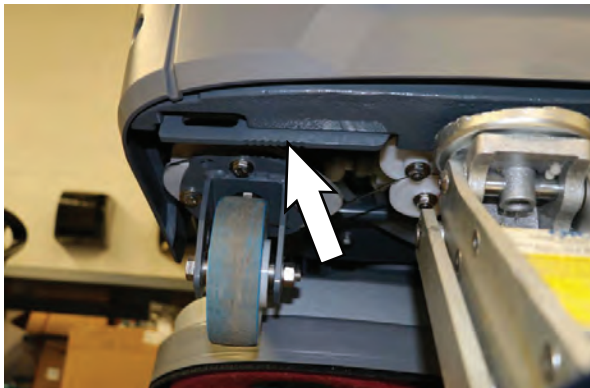

6. When finished with maintenance, use floor jack to raise machine from jack stand, remove the jack stand from under the machine, and lower the machine to the floor.

JACKING UP THE REAR OF THE MACHINE

FOR SAFETY: Before leaving or servicing machine, stop on level surface, turn off machine, and remove key.

1. Block both front drive wheels.
2. Rotate the squeegee assembly to the right side of the machine.
3. Remove the lower shroud from the machine.

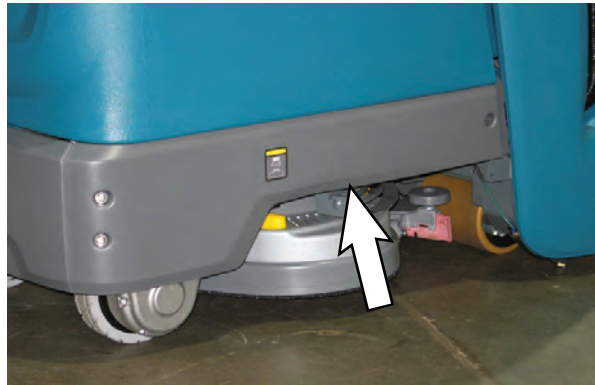

4. Position a floor jack under the tie down / jack point and arrange all hoses / cables so they are not crushed when the machine is jacked up off the floor.



5. Use a floor jack to raise machine from the floor.

- Place a block of wood underneath the rear of the machine to provide additional support.

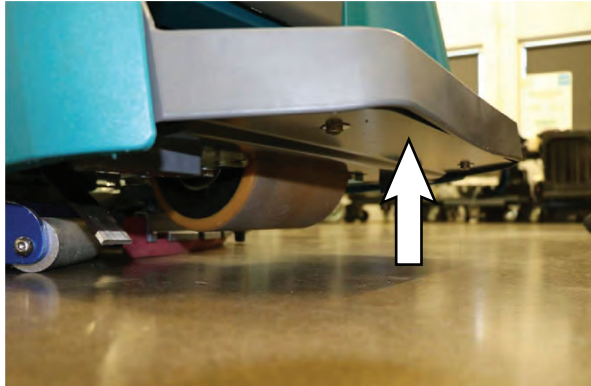

- When finished with maintenance, use floor jack to raise machine from jack stand, remove the block of wood from under the machine, and lower the machine to the floor.
- Reinstall the lower shroud onto the machine.

PUSHING, TOWING, AND TRANSPORTING THE MACHINE

PUSHING AND TOWING THE MACHINE

FOR SAFETY: When servicing the machine, do not push or tow the machine without an operator controlling the machine.

If the machine becomes disabled, it can be pushed from the front or rear, but it can only be towed from the front.

The brake must be disabled before towing or pushing the machine. To disable the brake, insert the tip of a small screw driver between the electronic brake lever and the hub. The machine can move freely when the brake is disabled.

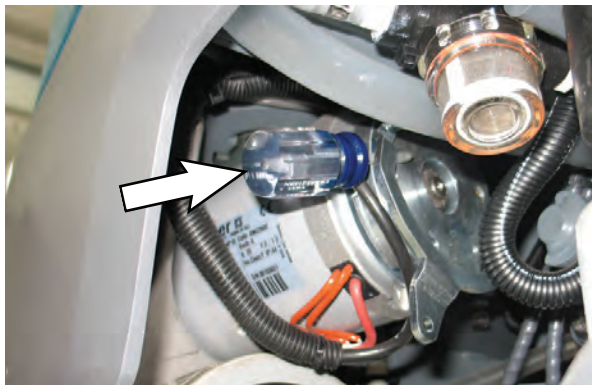

Only push or tow the machine for a very short distance and do not exceed 3.2 kp/h (2 mph). It is NOT intended to be pushed or towed for a long distance or at a high speed.

ATTENTION! Do not push or tow machine for a long distance or damage may occur to the propelling system.

Immediately after pushing the machine, remove the screw driver from between the electronic brake lever and the hub. NEVER operate the machine with the brake disabled.

FOR SAFETY: Do not operate machine with brake disabled.

TRANSPORTING THE MACHINE

When transporting the machine by use of trailer or truck, carefully follow loading and tie-down procedure:

- Drain tanks, raise the scrub head and remove the squeegee assembly.
- Carefully load machine in trailer or on truck.

FOR SAFETY: When loading/unloading, use a ramp that can support the machine weight and operator. Do not turn on inclines or ramps. Do not drive on a slippery ramp.

FOR SAFETY: When loading/unloading, Do not operate the machine on a ramp incline that exceeds an 18% grade level. Use a winch if ramp incline exceeds an 18% grade level

- Once loaded, position the front of the machine up against the front of the trailer or truck. Lower the scrub head and turn key off.
- Place a block behind each wheel.
- Using tie-down straps, secure the machine using the four tie-down brackets located on the machine frame. It may be necessary to install tie-down brackets to the floor of your trailer or truck.

NOTE: When transporting machine in an open truck or trailer, secure recovery tank lid.

ATTENTION: Do not use control console area or accessory storage rails for tie-down locations, damage may occur.

MAINTENANCE

STORING MACHINE

The following steps should be taken when storing the machine for extended periods of time.

1. Charge the batteries before storing machine to prolong the life of the batteries. Recharge batteries once a month.
2. Disconnect batteries before storing.
3. Drain and rinse recovery tank and solution tank.
4. Store the machine in a dry area with squeegee and scrub head in the up position.

ATTENTION: Do not expose machine to rain, store indoors.

5. Open the recovery tank lid to promote air circulation.
6. If storing machine in freezing temperatures, proceed to FREEZE PROTECTION.

NOTE: To prevent potential machine damage store machine in a rodent and insect free environment.

FREEZE PROTECTION

Storing machine in freezing temperatures.

1. Completely drain solution tank and recovery tank.
2. Empty the water from the solution tank filter located under machine. Replace filter.



3. Pour 1 gallon / 4 liters of propylene glycol based recreational vehicle (RV) antifreeze into the solution tank.

Models equipped with optional Severe Environment detergent tank - Lift tank from machine and empty the detergent from tank. Return tank. Pour a 1/4 gallon / 1 liter of propylene glycol based recreational vehicle (RV) antifreeze into the detergent tank.



4. Models not equipped with ec-H₂O system
- Turn machine on and operate the solution flow system. Turn the machine off when the antifreeze is visible on the floor.

Models equipped with ec-H₂O system and Severe Environment mode - Set the detergent ratio dial to the highest concentration. Turn machine on and set solution flow rate to high. Operate ec-H₂O scrubbing and press the Severe Environment button to cycle the antifreeze through both systems. Turn machine off when antifreeze is visible on the floor. This may take up to two minutes.

Models equipped with ec-H₂O system - Turn machine on and set the solution flow rate to high and operate ec-H₂O scrubbing to cycle antifreeze through system. Turn machine off when antifreeze is visible on the floor. This may take up to two minutes.

5. Models equipped with optional automatic battery watering tank - Lift tank from machine and empty the water from tank.

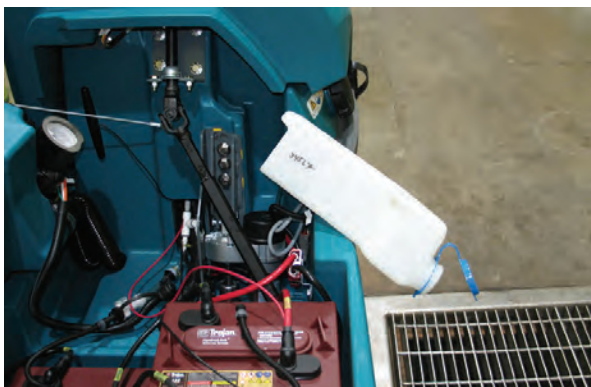

IMPORTANT: DO NOT add antifreeze to the automatic battery watering tank.

6. After storing machine in freezing temperatures, drain any remaining antifreeze from the solution tank and from the optional Severe Environment detergent tank. Add clean water to solution tank and to optional detergent tank and operate the machine to flush system.
7. Refill the automatic battery watering tank with distilled water, if equipped.

MAINTENANCE

MACHINE TROUBLESHOOTING

Problem	Cause	Solution
Service indicator icon is flashing	Machine or on-board battery charger fault has been detected	See SERVICE INDICATOR CODES
ec-H2O icon is red or flashing red	ec-H2O system fault has been detected	See SERVICE INDICATOR CODES
ec-H2O icon is flashing red and blue	ec-H2O cartridge has reached maximum water usage or expiration	Change ec-H2O cartridge
Machine will not operate	Emergency shut-off button activated	Turn button to reset
	Machine fault detected	See SERVICE INDICATOR CODES
	Batteries discharged	Recharge batteries
	Loose battery cable(s)	Tighten loose cables
	Faulty battery(s)	Replace battery(s)
	Faulty key switch	Contact service
	Faulty green go pedal	Contact service
	Circuit breaker tripped	Reset circuit breaker
	Faulty control board	Contact service
On-board battery charger will not operate	Plug not connected to power supply	Check plug connection
	Batteries over discharged	Replace batteries
	Battery charger fault detected	See SERVICE INDICATOR CODES
	Faulty charger	Replace charger
	Faulty power supply cord	Replace power supply cord
Machine will not propel	Forward / reverse light flashing rapidly	Remove right foot from green go pedal
	Propel fault has been detected	See SERVICE INDICATOR CODES
	Circuit breaker tripped	Reset circuit breaker
	Faulty propel motor or wiring	Contact service
	Worn carbon brushes in motor	Contact service
Brush motor will not operate	Brush motor fault has been detected	See SERVICE INDICATOR CODES
	Faulty pad motor or wiring	Contact service
	Worn carbon brushes in motor	Contact service
	Broken or loose belt	Contact service
Vacuum motor will not operate	Squeegee assembly is raised off floor	Lower squeegee assembly to floor
	Vacuum motor fault has been detected	See SERVICE INDICATOR CODES
	Faulty vacuum motor or wiring	Contact service
Poor scrubbing performance	Debris caught in brush/pad	Remove debris
	Worn brush/pad	Replace brush/pad
	Incorrect brush pressure	Adjust brush pressure
	Wrong brush/pad type	Use correct brush/pad for application
	Low battery charge	Recharge batteries
	Uneven brush pressure	Scrub head/brushes not level. Contact service

Problem	Cause	Solution
Trailing water - poor or no water pickup	Full recovery tank or excessive foam buildup	Drain recovery tank
	Loose drain hose cap	Replace cap
	Worn squeegee blades	Rotate or replace squeegee blades
	Clogged drip trap (Squeegee assembly)	Remove cover and clean
	Clogged squeegee assembly	Clean squeegee assembly
	Loose vacuum hose connection	Secure vacuum hose connection
	Clogged vacuum hose	Flush vacuum hose
	Damaged vacuum hose	Replace vacuum hose
	Clogged float shut-off screen in recovery tank	Clean screen
	Recovery tank lid not completely closed	Check lid for obstructions
	Defective seals on recovery tank lid	Replaced seal
Little or no solution flow	Empty solution tank	Refill solution tank
	Low solution flow rate set	Increase solution flow rate
	Clogged solution tank filter	Clean filter
	Plugged solution supply line	Flush solution supply line
	ec-H2O pump does not prime	Restart machine and set flow rate to high
Severe Environment tank does not dispense detergent	No detergent	Refill tank
	Faulty float switch	Contact service
	Defective pump	Contact service
	Defective pump potentiometer	Contact service
	Faulty control panel	Contact service
Automatic battery watering tank does not dispense water	Tank is empty	Refill tank
	Defective pump	Contact service
	Pump not priming	Contact service
	Faulty control board	Contact service
Short run time	Low battery charge	Charge batteries
	Batteries need maintenance	See BATTERIES
	Defective battery or end of battery life	Replace batteries
	Battery discharge indicator (BDI) programmed incorrectly	See CHARGING BATTERIES
	Faulty charger	Replace battery charger
	Brush pressure set too high	Lower brush pressure

SPECIFICATIONS

GENERAL MACHINE DIMENSIONS/CAPACITIES/PERFORMANCE

MODEL	20 in. / 500 mm Single Disk	24 in. / 600 mm Dual Disk
Length	55 in / 1397 mm	55 in / 1397 mm
Width (Body)	26.5 in / 673 mm	26.5 in / 673 mm
Height	49 in / 1245 mm	49 in / 1245 mm
Weight	490 lb / 222 kg	495 lb / 225 kg
Weight (with batteries)	725 lb / 329 kg	730 lb / 331 kg
GVW	1100 lb / 500 kg	
Squeegee width	28.6 in / 727 mm	30.7 in / 780 mm
Solution tank capacity	14.1 gal / 53 L	
Recovery tank capacity	18.4 gal / 70 L	
Severe Environment tank capacity	0.66 gal / 2.5 L	
Automatic battery watering tank capacity	0.48 gal / 1.8 L	
Scrubbing path width	20 in / 508 mm	24 in / 610 mm
Down pressure	62 lb / 28 kg 90 lb / 41 kg	64 lb / 29 kg 91 lb / 41 kg
Scrubbing speed	0.2 - 3.6 mph / 0.32 - 5.8 km/h	
Transport speed	0.2 - 3.6 mph / 0.32 - 5.8 km/h	
Reverse speed	0 - 1.1 mph / 0 - 1.8 km/h	
Productivity rate - estimated actual	24,588 ft ² /hr / 2,287 m ² /hr	30,052 ft ² /hr / 2,795 m ² /hr
ec-H ₂ O productivity rate - est. actual	25,284 ft ² /hr / 2,351 m ² /hr	30,903 ft ² /hr / 2,874 m ² /hr
Aisle turnaround width	60 in / 1524 mm	
Ramp incline for scrubbing	9%	
Ramp incline for transporting (GVWR)	9%	
Ramp incline for loading - empty tanks	18%	
Solution flow rate	Low: 0.15 gpm / 0.57 L/min, Med: 0.35 gpm / 1.32 L/min, High: 0.50 gpm / 1.89 L/min	
ec-H ₂ O solution flow rate	Low: 0.12 gpm / 0.45 L/min, Med: 0.25 gpm / 0.95 L/min, High: 0.35 gpm / 1.32 L/min	
Brush motor(s)	24VDC, 0.87 Hp / 0.65 kW	
Propel motor	24 VDC, 0.64 Hp / 0.48 kW, 20A	
Vacuum motor	24 VDC, 0.62 Hp / 0.46 kW, 19.1A	
Water lift	42 in H ₂ O / 1067 mm	
Water lift Quiet-mode	30 in H ₂ O / 762 mm	
ec-H ₂ O solution pump	24 VDC, 2 A, 1.0 gpm / 3.8 L/min, min open flow	
Severe Environment solution pump	24 VDC, 1.7 A, 2.0 oz/min / 59 ml/min, min open flow	
Automatic battery watering pump	13.5 VDC, 4 A, 0.9 gpm / 3.5 L/min, min open flow	
Machine voltage	24 VDC	
Battery capacity	4-6V 210AH C/20 Wet, 4-6V 240AH C/20 Wet, 4-6V 220AH C/20 AGM	
Total power consumption	1.1 kW	
Battery Charger - on-board	115 - 240VAC, 50/60Hz, 24VDC, 25A	
Battery Charger - smart off-board	85 - 270VAC, 50/60Hz, 24VDC, 650W (27.1A)	
Protection grade	IPX3	
Sound pressure level L _{PA} *	63.7 dBA	64.5 dBA
Sound pressure level L _{PA} * - Quiet mode	59.7 dBA	61.3 dBA
Sound uncertainty K _{PA} *	3.0 dBA	3.0 dBA
Sound power level uncertainty L _{PA} - uncertainty K _{PA} *	82.5 dBA	84.0 dBA
Machine vibration at hand-arm*	<2.5 m/s ²	
Ambient operating temperature	Min: 36° F / 2° C Max: 110° F / 43° C	

MACHINE DIMENSIONS

500 mm / 20 in. Single Disk Model:

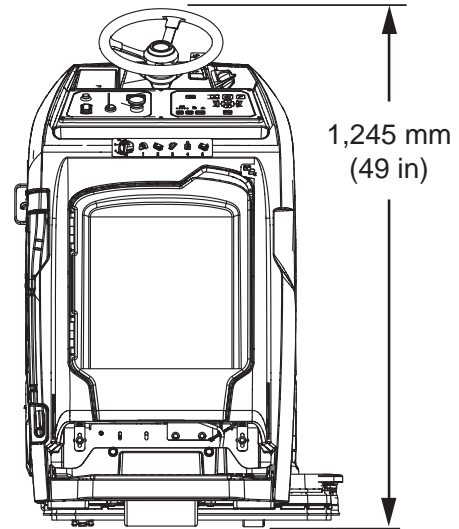
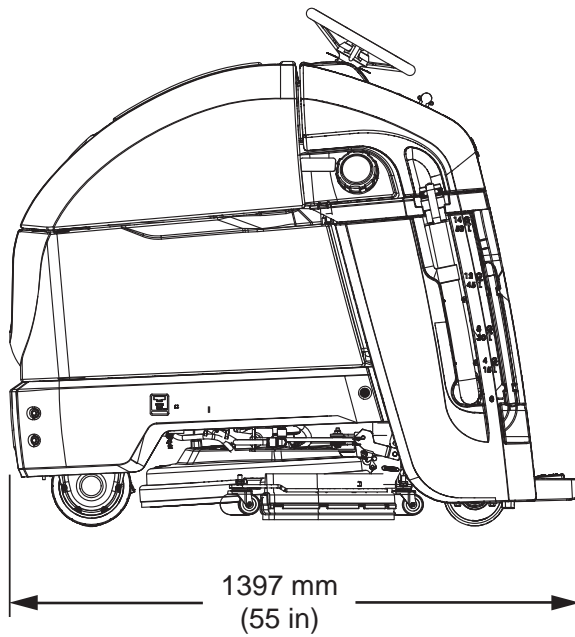
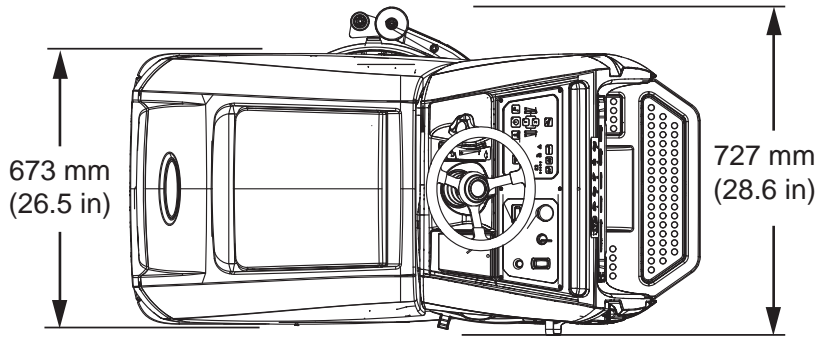

SPECIFICATIONS

600 mm / 24 in. Dual Disk Model:

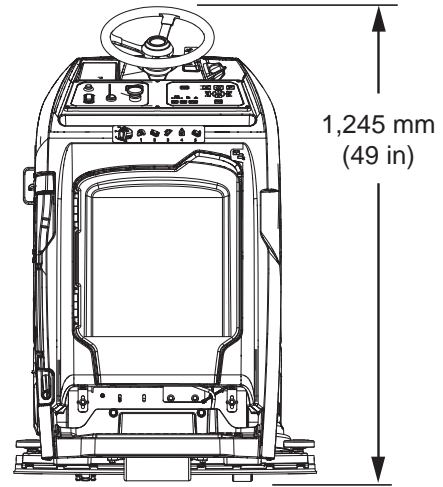
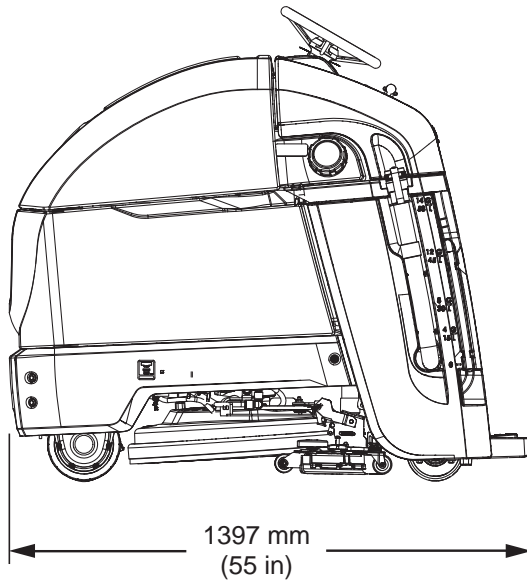
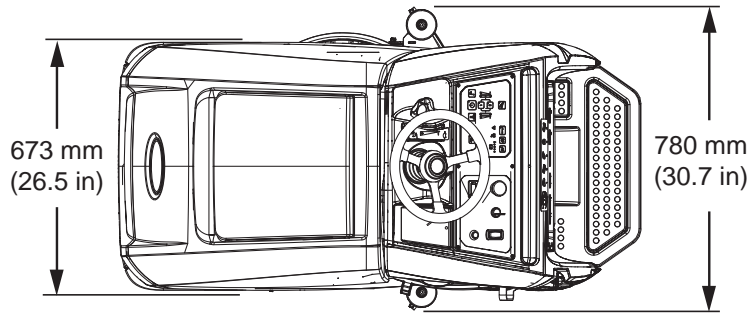

SUPERVISOR CONTROLS

ATTENTION: These instructions are intended for supervisor use only. Remove pages from manual if necessary.

The supervisor controls feature allows a supervisor to program the machine's scrubbing settings for operator use. The lockout functionality will prevent the operator from changing or saving the Zone Settings.

The supervisor controls feature will lower machine variability for consistent, repeatable cleaning results, provide machine quality assurance regardless of user experience, and reduce user training requirements.

PRO-MEMBRANE CONTROL PANEL MODEL

NOTE: Zone 3 is only available on machines built before serial number 11003113.

The machine has three supervisor control modes of operation to choose from:

Unlocked Mode 1: Operator has full control of all scrubbing parameters with the ability to reconfigure the preset zone control buttons. The Unlocked Mode 1 is the factory default setting.

Lockout Mode 2: Zone control buttons are preset and locked by supervisor. Operator has the ability to reconfigure the preset zone control buttons, but are not able to save them.

Lockout Mode 3: Zone control buttons are preset and locked by supervisor. Operator is restricted to only use the zone control buttons preset by supervisor.

ENTERING THE SUPERVISOR CONTROL MODES

1. Park the machine on a level surface and turn the key to off (O) position.
2. Press and hold the brush pressure button while turning the key on. Release button when the far right battery discharge indicator LED turns on. After releasing button, the active supervisor control mode will display as described in step 3.

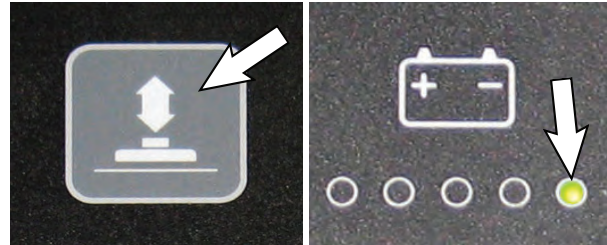

3. To select or change a supervisor control mode, press and hold the specific zone control button until the LED blinks three times. For lockout mode 3, press and hold zone control buttons 1 and 2 at same time. After selection is made, the LED will turn solid to indicate new mode.

- Unlocked mode 1 = Zone control button 1
- Lockout mode 2 = Zone control button 2
- Lockout mode 3 = Zone control buttons 1 & 2

NOTE: Zone 3 is only available on machines built before serial number 11003113.

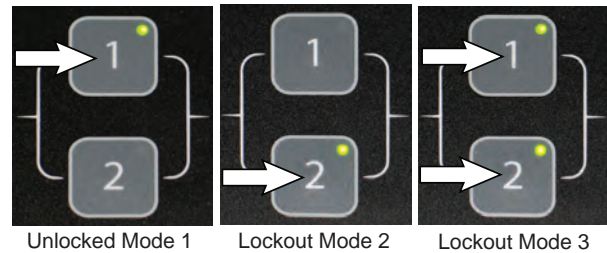

4. Press the solution flow button to configure the zone control button presets for lockout modes 2 or 3.



SUPERVISOR CONTROLS

5. Configure the zone control button presets from list below, then press and hold zone control button until it blinks three times to save preset. Repeat process for other two zones. To preset zone control 3, press zone control buttons 1 and 2 at the same time.

Zone control presets:

- Brush pressure rate
- Solution flow rate
- Quiet-Mode button on or off
- ec-H₂O mode switch on or off
- Severe Environment button on or off
(Hold button for 3 seconds until LED turns on)
- Maximum scrubbing speed setting

To adjust the maximum scrub speed setting, press the Severe Environment button to cycle through the five speed selections as described below. For models without the Severe Environment button, press area on panel as shown. The button is hidden.

The speed selection is displayed by the battery discharge indicator LED's. The red LED represents the lowest speed. The far right green LED represents the highest speed.

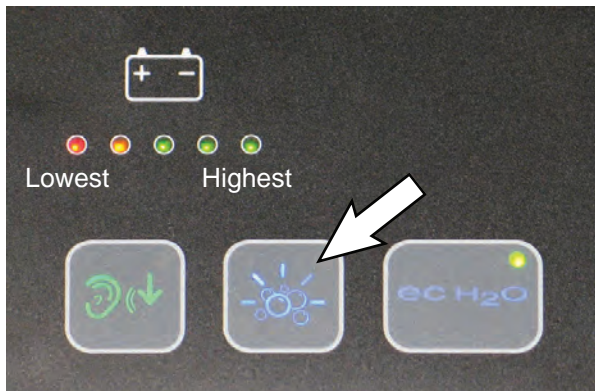

NOTE: The maximum scrub speed setting can only be adjusted in supervisor control lockout modes 2 and 3.

6. To exit the supervisor control mode, turn key off.

PRO-PANEL CONTROLS MODEL

There are two types of user modes that will interface with the home screen.

Operator Mode - Capable of machine operation with permissions and restrictions controlled by the supervisor. The operator mode home screen restricts access to the machine settings button and maximum scrub speed button. There are two types of user modes that will interface with the operator home screen:



Supervisor Mode - Capable of machine operation with full use of all controls, along with configuring permissions and restrictions for the operator mode and login capability. The supervisor mode home screen provides access to the machine settings button and to the maximum scrub speed button.



A new machine from the factory will automatically start up in the supervisor mode with a preassigned default supervisor profile. The machine's factory-assigned supervisor login code is "1234". This login code is not required until it is enabled. The default supervisor profile name and login code can be changed as described in this section. If the new assigned supervisor mode login code is forgotten, use the recovery login code 836626826.

ENTERING THE SUPERVISOR MODE

1. Turn on the machine. The home screen will display at start up. Press the help button.



2. Press the login button.



3. First time use - Enter the factory-assigned supervisor mode login code "1234" then press the green enter button.

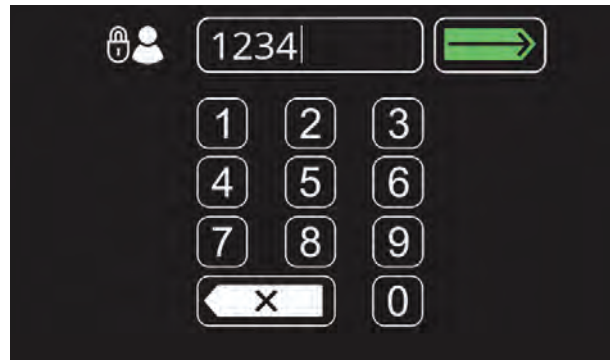

SUPERVISOR CONTROLS

- The supervisor mode home screen will appear. Press the machine settings button.



- The machine's setting screen provides access to the following menu.

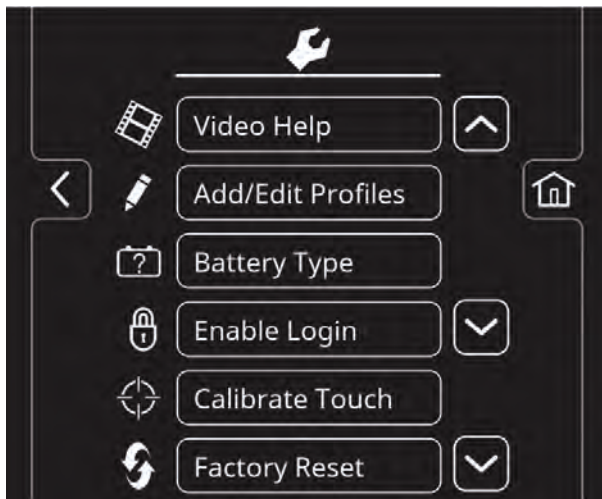

Video Help - Use to view specific operation and maintenance procedures.



Add/Edit Profiles - Use to add/edit user profiles for machine use.



Battery Type - Use to configure the machine for different battery types. See BATTERIES.



Enable Login - Use to activate a required login code at machine start up to operate machine.



Calibrate Touch - Use this to recalibrate the touch screen if the touch points become misaligned.



Factory Reset - Resets the supervisor login code back to the factory default code "1234", removes user profiles and resets any custom preset zone control buttons back to the factory preset zones.

TO ADD / EDIT PROFILES

- Press the Add/Edit Profiles button to enter a new user profile.

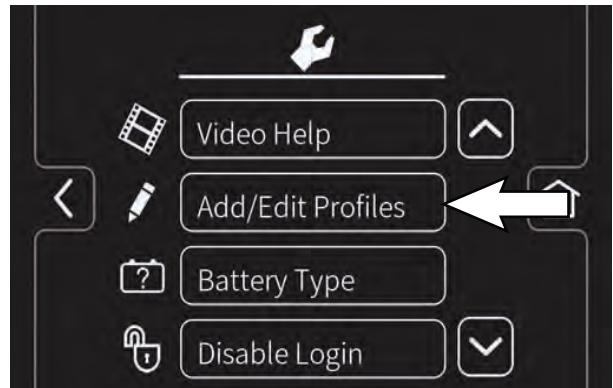

- Press the Add Profile button to add a new user profile.

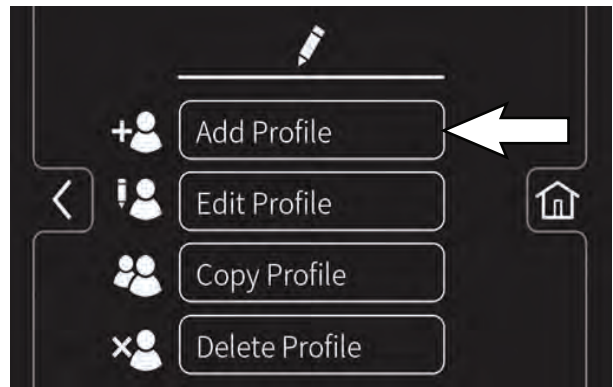

Press the Edit Profile button to edit an existing profile.



Press the Copy Profile button to copy an existing profile.



Press the Delete Profile button to delete an existing profile.

3. Press the Operator button to add an Operator mode profile or press the Supervisor button to add an additional supervisor mode profile.

Note: The machine's default supervisor profile can not be deleted from profile list.

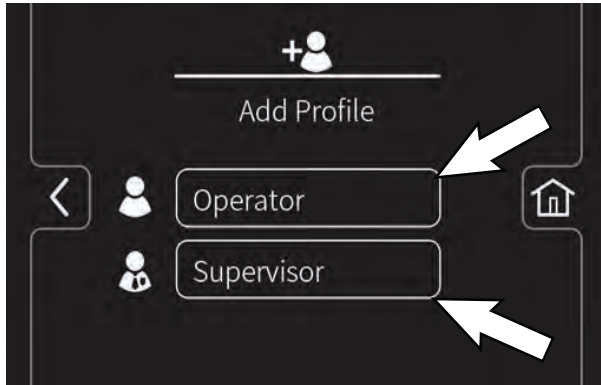

Press the Operator button to add / edit / copy / delete an operator profile .



Press the Supervisor button to add / edit / copy / delete a supervisor profile.

4. Enter the name of the new user profile then press the green enter button.



5. Assign a login code for the new user profile then press the green enter button. The new login code can be any combination of numbers ranging from 3 to 8 digits in length.



6. Select the controls the new user should only have access to use. Green represents unlocked controls and gray represents locked controls. Press the flashing save button to save new profile.

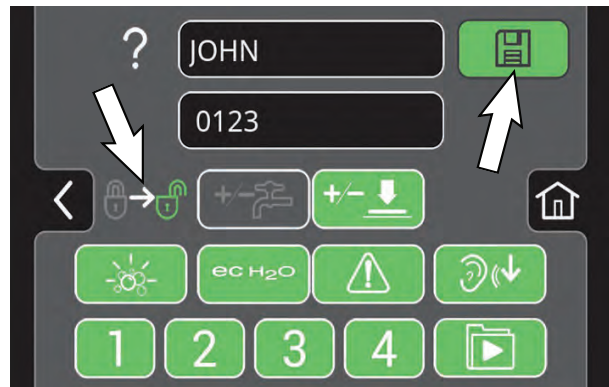

7. The new user profile is now saved to the operator profile list as shown. Multiple Operator and Supervisor user profiles can be added. Press the back arrow to return to the previous screen to add more user profiles.

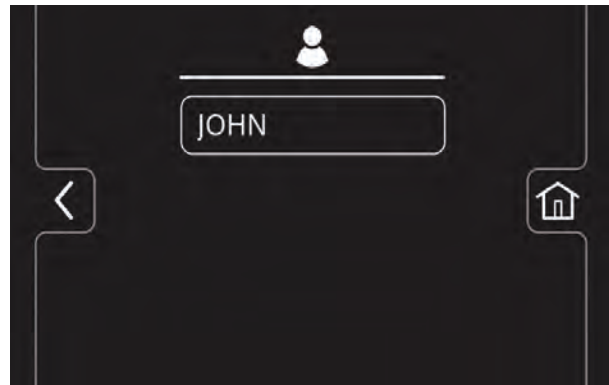

SUPERVISOR CONTROLS

8. To enable the login screen at start up, see Enabling the Login.

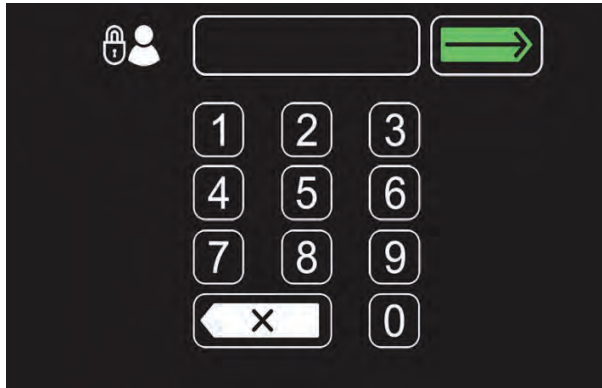

ENABLING THE LOGIN SCREEN

1. Turn on the machine.
2. Press the help button and log into the machine as supervisor mode. See Entering the Supervisor Mode.
3. Press the machine setting button.



4. Press the Enable Login button. The Enable button will change from Enable Login to Disable Login.

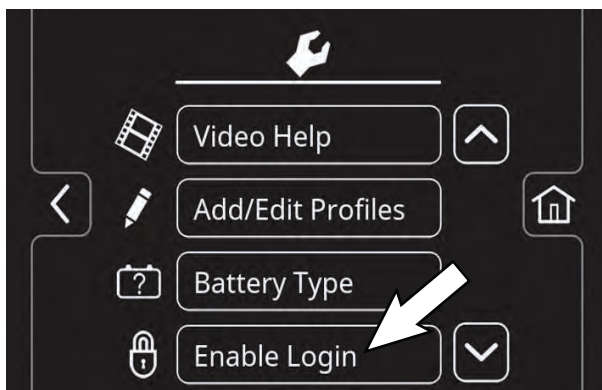

5. Press the yes button to enable login.

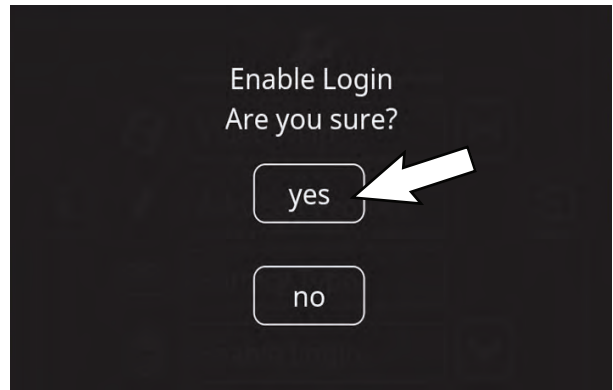

6. Now at machine start up, the login screen will display. The user will need to enter their assigned login code to operator machine.

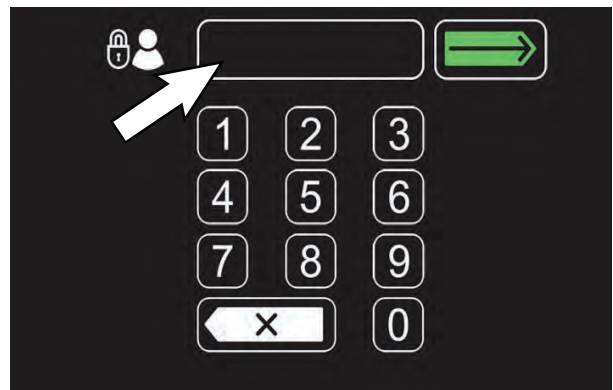

7. When the user is done operating the machine, it is recommended the user log out by pressing the help button, and then pressing the logout button. Turning the key to the off position is another way to also logout.

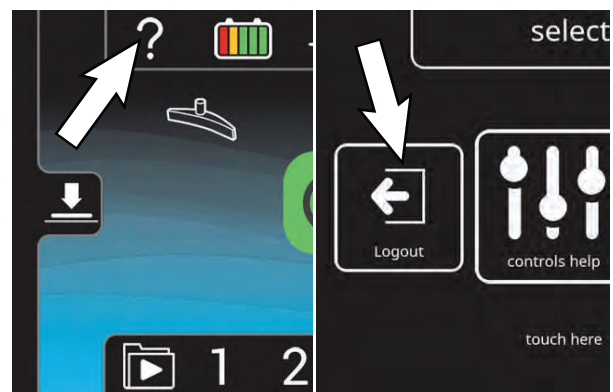

DISABLING THE LOGIN SCREEN

1. Turn on the machine.
2. Press the help button and log into the machine as supervisor mode. See ENTERING THE SUPERVISOR MODE.
3. Press the machine settings button.



4. Press the Disable Login button.

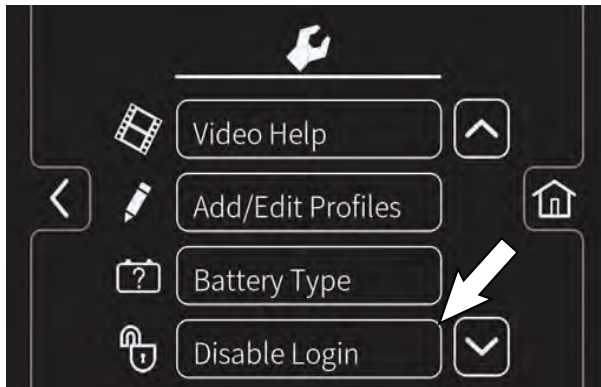

5. Press the yes button to disable the login at machine start up.

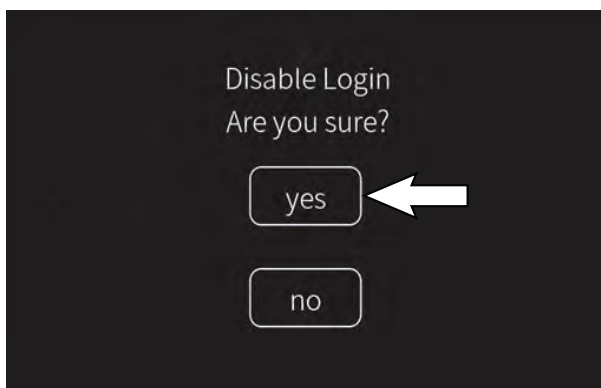

6. Press either the Operator button or Supervisor button to select desired user profile as your home screen default without login.

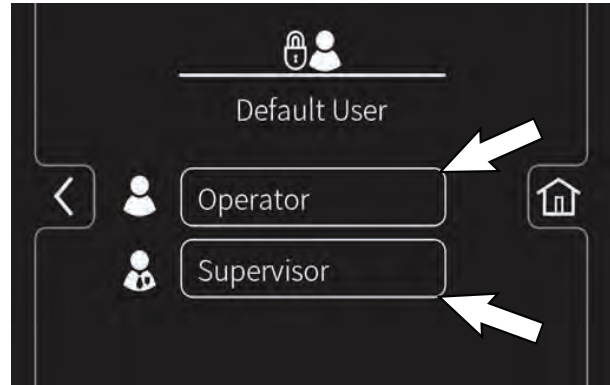

7. Select a pre-assigned user profile. In this example, operator profile "JOHN" is selected. Turn the key off to apply the setting.

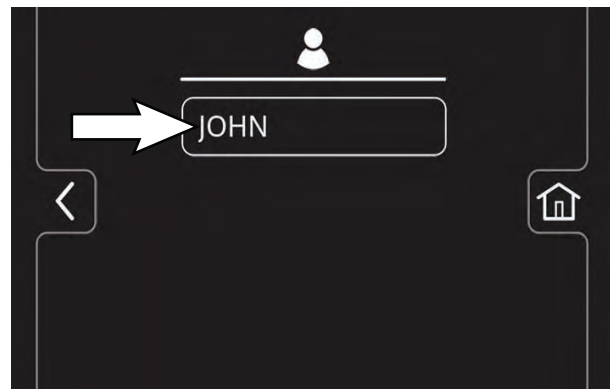

8. At start up, the home screen is now set for the desired user profile as the default without login.

NOTE: To change to a different user profile as the default home screen without login, you must re-enable login and repeat the disabling login instructions.

SUPERVISOR CONTROLS

CHANGING THE FACTORY-ASSIGNED SUPERVISOR LOGIN CODE

1. Press the machine's setting button.



2. Press the Add/Edit Profiles button.

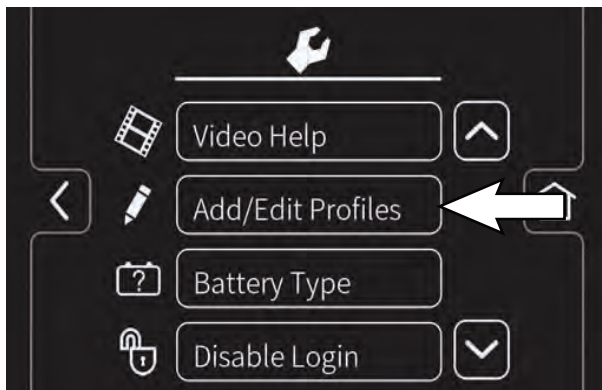

3. Press the Edit Profile button.



4. Press the Supervisor button then press the DEFAULT SUPER button.

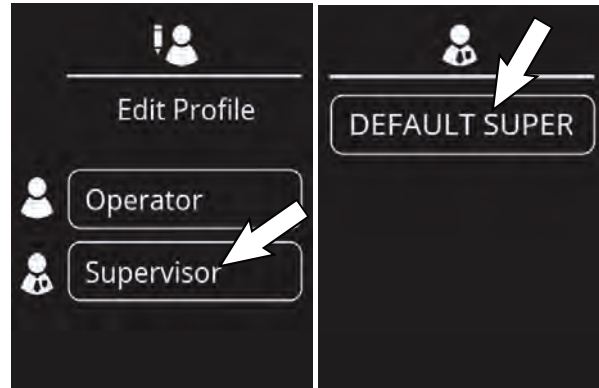

5. Press the factory-assigned login code and enter a new login code. Press the flashing save button to save the new login code.

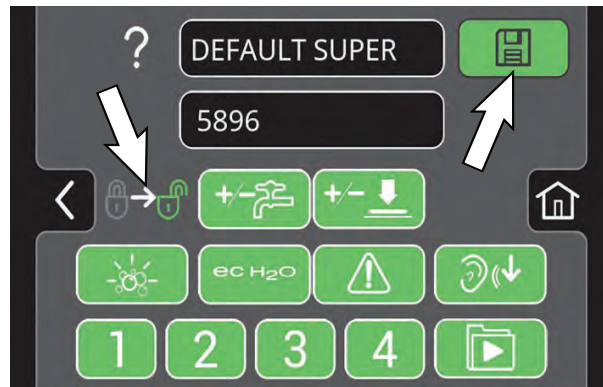

CHANGING THE SCRUB SPEED

1. Turn on the machine.
2. Press the help button and log into the machine as supervisor mode. See ENTERING THE SUPERVISOR MODE.
3. Press the Maximum scrub speed button to access the scrub speed adjustment bar.

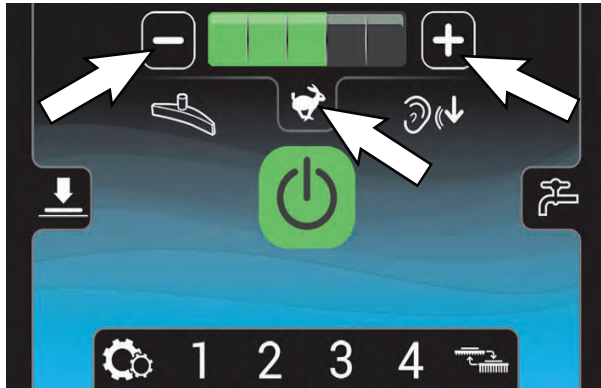

4. Press the (+) button to increase the maximum scrub speed. Press the (-) button to decrease the maximum scrub speed.

CHANGING PRESET ZONE CONTROL BUTTONS

1. Select the desired settings from list below.
 - Brush pressure rate
 - Solution flow rate
 - Quiet-Mode on or off
 - ec-H₂O system on or off (option)
 - Severe Environment mode on or off (option)
 - Maximum scrub speed
2. Turn on the machine.
3. Press the help button and log into the machine as supervisor mode. See Entering the Supervisor Mode.

4. Then press and hold a zone button until a screen prompts you to name the new preset zone. Select “yes” to name the preset zone.

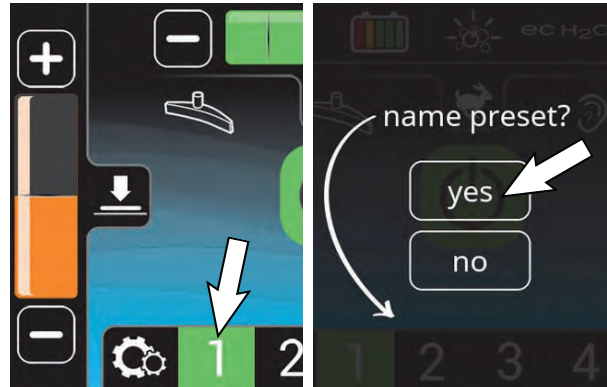

5. If the zone settings are configured to scrub a lobby for example, name the zone “LOBBY”. Press the green arrow to save the new zone preset.



6. The name will appear above the zone setting number when the zone button is pressed. Repeat process for other zone presets.

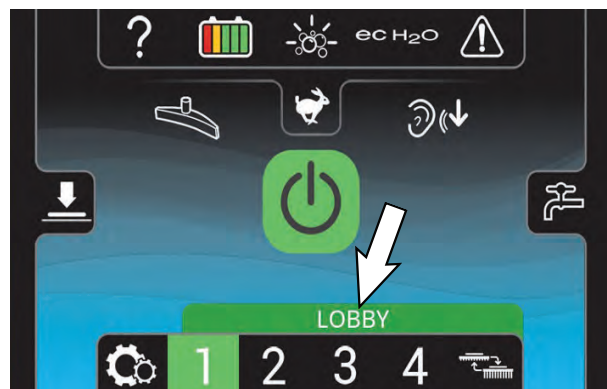

SUPERVISOR CONTROLS

CHANGING THE ON-BOARD BATTERY CHARGER SETTINGS (Pro-Panel model)

1. Turn the key to the on position.
2. Press the settings button located on the home screen.



3. Press the Battery Type button.

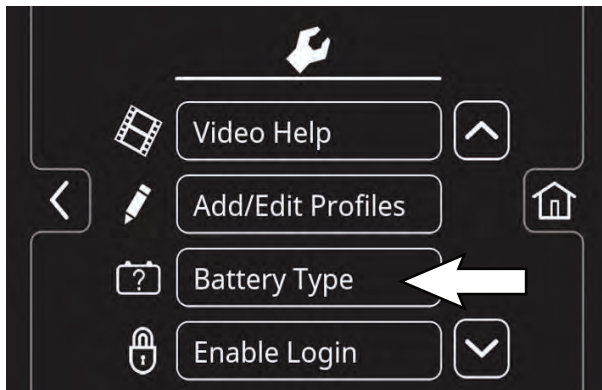

4. Select battery type and brand installed in machine. See battery label to determine type and brand. Press the up and down arrows to scroll through battery selection.

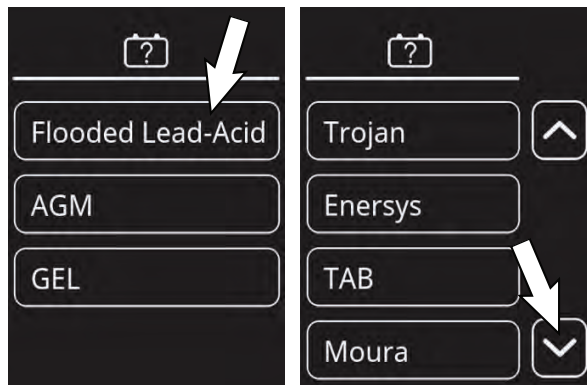

NOTE: The battery charger profile and battery discharge indicator will automatically reprogram when battery type is selected.

CALIBRATING THE TOUCH

1. Turn on the machine, login to the main operation screen, and press the setting button to access the supervisor settings screen. See *ENTERING THE SUPERVISOR MODE*.
2. Press the Calibrate Touch button to recalibrate touch. If the touch points become misaligned.

Located on side of machine.

To change the on-board battery charger settings, service application software required, contact service. As an alternative, the charger profile may be manually changed. See **CHANGING ON-BOARD BATTERY CHARGER SETTINGS**. The battery discharge indicator will automatically reprogram to match battery type when the battery charger profile is changed.