



ProFit WH Series

Horizontal Water-Source Heat Pump Units



Installation, Operation & Maintenance



! WARNING

If the information in this manual is not followed exactly, a fire may result causing property damage, personal injury, or loss of life.

! WARNING

QUALIFIED INSTALLER

Improper installation, adjustment, alteration, service, or maintenance can cause property damage, personal injury or loss of life. Startup and service must be performed by a Factory Trained Service Technician. Keep a copy of this IOM with the unit.

Table of Contents

AAON ProFit Features and Options Introduction	5
Safety	6
WSHP Series Feature String Nomenclature	10
General Information.....	12
Codes and Ordinances	12
Receiving Unit	13
Storage	13
Direct Expansion (DX) Systems.....	13
Wiring Diagrams.....	14
Installation.....	15
Locating the Unit	15
Condensate Drain Piping	16
Lifting and Handling the Unit.....	19
Blower Motor and Fan Access.....	19
Refrigerant-to-Water Heat Exchanger Water Piping.....	19
Electrical	24
Duct Connection	27
Startup.....	29
Supply Fans.....	29
Fan Air Flow Adjustment	29
Adjusting Refrigerant Charge.....	30
Operation.....	33
AAON WSHP Pioneer Silver Controller.....	33
Maintenance.....	39
DX Cooling.....	39
Condensate Drain Pans	39
Supply Fans.....	39
Filter Replacement.....	39
Replacement Parts.....	40
Warranty, Service, and Parts Department.....	40
Filter Information.....	40
Appendix A - Heat Exchanger Corrosion Resistance.....	43

V01030 · Rev. B · 230131

Index of Tables and Figures

Tables:

Table 1 - Clearances.....	17
Table 2 - Glycol Concentration.....	21
Table 3 - Water Connections	22
Table 4 - Nameplate Voltage Markings & Tolerances	24
Table 5 - Control Wiring.....	26
Table 6 - Acceptable Refrigeration Circuit Values at AHRI ISO 13256 WLHP Conditions.....	31
Table 7 - R-410A Refrigerant Temperature-Pressure Chart.....	32
Table 8 - LED Diagnostic Codes.....	37
Table 9 - Glycol Percentage Setpoints.....	38
Table 10 - 006-012 WH Unit Series Filters (A Cabinet).....	40
Table 11 - 015 & 018 WH Series Unit Filters (B Cabinet)	41
Table 12 - 024 & 030 WH Series Unit Filters (C Cabinet)	41
Table 13 - 036 & 042 WH Series Unit Filters (D Cabinet)	42
Table 14 - 048 & 060 WH Series Unit Filters (E Cabinet).....	42

Figures:

Figure 1 - Access Panels.....	13
Figure 2 - Foam Shipping Block.....	15
Figure 3 - Mounting Horizontal Units	15
Figure 4 - Vibration Grommet Installation	15
Figure 5 - Condensate Drain Piping.....	16
Figure 6 - Drain Trap	17
Figure 7 – Horizontal Configuration Orientations.....	17
Figure 8 - Filter Rack Closed with Clip.....	27
Figure 9 – Filter Rack Open with Clip.....	27
Figure 10 - Using the Filter Pull	27
Figure 11 - WSHP Series Supply Fan	29
Figure 12 - Pioneer Silver Controller Layout.....	35

AAON ProFit Features and Options Introduction

Energy Efficiency

- Direct Drive Supply Fan
- Scroll or Rotary Compressor
- High Efficiency Electronically Commutated (EC) Motor
- Copper Coaxial Refrigerant-to-Water-Heat Exchanger
- AHRI Certified Performance

Indoor Air Quality

- Stainless Steel Drain Pan

Controls

- 5 Wire Thermostat Control

Installation and Maintenance

- Color-Coded Wiring and Wiring Diagram

Environmentally Friendly

- R-410A Refrigerant

Extended Life

- Sturdy Galvanized Steel Construction
- Induction Brazing
- Stainless Steel Drain Pan
- 5 Year Parts Warranty

Reduced Sound

- Compressors Mounted with Rubber-in-Shear Isolators on an Isolation Plate with Rubber-in-Shear Isolation to the Cabinet
- Sound Absorbing Fiberglass Cabinet Insulation
- Floating Water Connections

Safety

Attention must be paid to the following statements:

NOTE - Notes are intended to clarify the unit installation, operation and maintenance.

⚠ CAUTION - Caution statements are given to prevent actions that may result in equipment damage, property damage, or personal injury.

⚠ WARNING - Warning statements are given to prevent actions that could result in equipment damage, property damage, personal injury or death.

⚠ CAUTION

Rotation must be checked on all **COMPRESSORS AND MOTORS** of 3 phase units at startup by a qualified service technician.

Scroll compressors are directional and can be damaged if rotated in the wrong direction. Compressor rotation must be checked for proper operation, without using external refrigerant pressure gauges. Often, a compressor running in reverse rotation will be much louder than a normal compressor, and will not develop much of a temperature differential between the suction and discharge lines.

Fan motor rotation must also be checked for proper operation. Alterations must only be made at the unit power connection.

⚠ CAUTION

To prevent damage to the unit, do not use acidic chemical coil cleaners. Do not use alkaline chemical coil cleaners with a pH value greater than 8.5, after mixing, without first using an aluminum corrosion inhibitor in the cleaning solution.

⚠ CAUTION

Cleaning the cooling tower or the water loop with harsh chemicals, such as hydrochloric acid (muriatic acid) or chlorine, can damage the refrigerant-to-water heat exchanger. Care must be taken to avoid allowing chemicals to enter the refrigerant-to-water heat exchanger. See Appendix A - Heat Exchanger Corrosion Resistance for more information.

! CAUTION

PVC (Polyvinyl Chloride) and CPVC (Chlorinated Polyvinyl Chloride) are vulnerable to attack by certain chemicals. Polyolester (POE) oils used with R-410A and other refrigerants, even in trace amounts, in a PVC or CPVC piping system will result in stress cracking of the piping and fittings and complete piping system failure.

! WARNING

OPEN LOOP APPLICATIONS

Failure of the refrigerant-to-water heat exchanger as a result of chemical corrosion is excluded from coverage under AAON Inc. warranties and the heat exchanger manufacturer's warranties.

! WARNING

Some chemical coil cleaning compounds are caustic or toxic. Use these substances only in accordance with the manufacturer's usage instructions. Failure to follow instructions may result in equipment damage, injury or death.

! WARNING

Do not work in a closed area where refrigerant or nitrogen gases may be leaking. A sufficient quantity of vapors may be present and cause injury or death.

! WARNING

UNIT HANDLING

To prevent injury or death lifting equipment capacity must exceed unit weight by an adequate safety factor. Always test-lift unit not more than 24 inches high to verify proper center of gravity lift point to avoid unit damage, injury or death.

! WARNING

ELECTRIC SHOCK AND FIRE HAZARD

Failure to follow safety warnings exactly could result in dangerous operation, serious injury, death or property damage.

Improper servicing could result in dangerous operation, serious injury, death, or property damage.

- Before servicing, disconnect all electrical power to the unit to avoid shock hazard or injury from rotating parts. Follow proper Lockout-Tagout procedures.
- When servicing controls, label all wires prior to disconnecting. Reconnect wires correctly.
- Verify proper operation after servicing. Secure all service panels.

 **WARNING**

GROUNDING REQUIRED

All field installed wiring must be completed by qualified personnel. Field installed wiring must comply with NEC/CEC, local and state electrical code requirements. Failure to follow code requirements could result in serious injury or death. Provide proper unit ground in accordance with these code requirements.

 **WARNING**

During installation, testing, servicing and troubleshooting of the equipment it may be necessary to work with live electrical components. Only a qualified licensed electrician or individual properly trained in handling live electrical components must perform these tasks.

Standard NFPA-70E, an OSHA regulation requiring an Arc Flash Boundary to be field established and marked for identification of where appropriate Personal Protective Equipment (PPE) be worn, must be followed.

 **WARNING**

ROTATING COMPONENTS

Unit contains fans with moving parts that can cause serious injury. Do not remove panel containing fans until the power to the unit has been disconnected and fan has stopped rotating.

 **WARNING**

WATER FREEZING

Failure of the refrigerant-to-water heat exchanger due to freezing will allow water to enter the refrigerant circuit and will cause extensive damage to the refrigerant circuit components. Any damage to the equipment as a result of water freezing is excluded from coverage under AAON warranties and the heat exchanger manufacturer warranties.

 **WARNING**

WATER PRESSURE

Prior to connection of condensing water supply, verify water pressure is less than maximum pressure shown on unit nameplate. To prevent injury or death due to instantaneous release of high pressure water, relief valves must be field supplied on system water piping.

1. READ THE ENTIRE INSTALLATION, OPERATION AND MAINTENANCE MANUAL. OTHER IMPORTANT SAFETY PRECAUTIONS ARE PROVIDED THROUGHOUT THIS MANUAL.
2. Startup and service must be performed by a Factory Trained Service Technician.
3. The unit is for indoor use only. See General Information section for more unit information.
4. Every unit has a unique equipment nameplate with electrical, operational, and unit clearance specifications. Always refer to the unit nameplate for specific ratings unique to the model you have purchased.

WSHP Series Feature String Nomenclature

Gen	Unit Configuration										:	Accessory Options																													
Major Rev	Size	Series	Minor Rev	Voltage	Eff. Level	Comp Style	Loop Type	Coil Type	Heat Type	Heat Staging	1	2	3A	3B	4	5	6A	6B	7	8	9	10	11	12	13	14	15	16													
WHB	-	024	-	C	-	0	-	3	-	1	-	0	0	0	-	0	0	:	0	0	-	0	E	-	0	0	-	0	0	-	0	0	0	0	0	-	0	A	0	0	0

MODEL OPTIONS

Generation and Orientation

WH = Horizontal Water-Source Heat Pump

Major Revision

B = ProFit

Unit Size

006 = 6,000 Btu/hr = ½ ton
 009 = 9,000 Btu/hr = ¾ ton
 012 = 12,000 Btu/hr = 1 ton
 015 = 15,000 Btu/hr = 1 ¼ ton
 018 = 18,000 Btu/hr = 1 ½ ton
 024 = 24,000 Btu/hr = 2 ton
 030 = 30,000 Btu/hr = 2 ½ ton
 036 = 36,000 Btu/hr = 3 ton
 042 = 42,000 Btu/hr = 3 ½ ton
 048 = 48,000 Btu/hr = 4 ton
 060 = 60,000 Btu/hr = 5 ton

Series

A = A Cabinet (006, 009 & 012)
 B = B Cabinet (015 & 018)
 C = C Cabinet (024 & 030)
 D = D Cabinet (036 & 042)
 E = E Cabinet (048 & 060)

Minor Revision

0 = Minor Revision 0

Voltage

3 = 460V/3Φ/60Hz
 4 = 575V/3Φ/60Hz
 A = 265V/1Φ/60Hz
 B = 115V/1Φ/60Hz
 C = 208-230V/1Φ/60Hz
 D = 208-230V/3Φ/60Hz

Efficiency Level

0 = Std Efficiency Compact Box

Compressor Style

0 = R-410A On/Off Compressor - Heat Pump

Loop Type

0 = Water Loop (Cooling Tower Only, EWT ≥ 60°F)
 A = Ground Loop Application
 B = Ground Water Application

Coil Type

0 = Copper Coaxial Refrigerant-to-Water Heat Exchanger + Fin & Tube Condenser Coil

Heat Type

0 = No Heating

Heating Staging

0 = No Heating

1: Unit Orientation

0 = Right Hand Return + Left Hand Supply
 A = Right Hand Return + End Supply
 B = Left Hand Return + Right Hand Supply
 C = Left Hand Return + End Supply

2: Supply Fan

B = Standard Fan + ECM Motor

3A: Filter Rack

0 = Open Return - Slide-Out Filter Rack

3B: Filters

A = 2" MERV 8 Pleated Filter
 E = 1" MERV 8 Pleated Filter
 F = 1" MERV 11 Pleated Filter
 G = 1" MERV 13 Pleated Filter
 I = 1" Fiberglass Filter
 J = 2" Fiberglass Filter
 K = 2" MERV 11 Pleated Filter
 L = 2" MERV 13 Pleated Filter

4: Refrigeration and Dehumidification Options

0 = Standard

WSHP Series Feature String Nomenclature

Gen	Unit Configuration										:	Accessory Options																															
Major Rev	Size	Series	Minor Rev	Voltage	Eff. Level	Comp Style	Loop Type	Coil Type	Heat Type	Heat Staging	1	2	3A	3B	4	5	6A	6B	7	8	9	10	11	12	13	14	15	16															
WHB	-	024	-	C	-	0	-	3	-	1	-	0	0	0	0	0	-	0	0	:	0	0	-	0	E	-	0	0	-	0	0	-	G	0	0	0	0	-	0	A	0	0	0

5: Service Disconnect

0 = Standard - 5 kAIC

D = 5 kAIC Standard / 100 kAIC w/ Field Installed Fusing

F = 100 kAIC Fusing w/ Fused Disconnect - 30 Amp

G = 100 kAIC Fusing w/ Fused Disconnect - 60 Amp

6A: Control Sequence

0 = Terminal Block for Thermostat + Pioneer Silver Controller

A = Terminal Block for Thermostat + Pioneer Silver Controller + Expansion Board

6B: Control Options

0 = Standard - No Communication

7: Cabinet Options

G = 1/2" Fiberglass Cabinet Insulation + Stainless Steel Drain Pan

H = 1/2" Fiberglass Cabinet Insulation + Stainless Steel Drain Pan + Low Sound Package + MLV

8: WSE

0 = Standard - None

9 & 10: Blank

00 = Standard - None

11: Code Options

0 = Standard - ETL USA Listing

B = ETL USA + Canada Listing

12: Shipping Options

0 = Standard

13: Cabinet Access

A = Standard

14 & 15: Blank

00 = Standard - None

16: Cabinet

0 = Galvanized Steel Cabinet Construction

General Information

AAON ProFit Water-Source Heat Pump units (WSHP) are designed for indoor installation only. Units are assembled, wired, charged and run-tested at the factory.

WARNING

Improper installation, adjustment, alteration, service or maintenance can cause property damage, personal injury or loss of life. Startup and service must be performed by a Factory Trained Service Technician. A copy of this IOM must be kept with the unit.

CAUTION

These units must not be used as a "construction heater" at anytime during any phase of construction. Very low return air temperatures, harmful vapors, and misplacement of the filters can damage the unit and its efficiency.

Certification of Cooling Models

- a. Certified as a commercial central air conditioner with electrically operated compressors.
- b. Certified for indoor installation only.
- c. Certified with refrigerant R-410A coils.

Codes and Ordinances

Units have been tested and certified, by ETL, in accordance with UL Safety Standard 1995/CSA C22.2 No. 236.

System must be sized in accordance with the American Society of Heating, Refrigeration and Air Conditioning Engineers Handbook.

Installation of units must conform to the ICC standards of the International Mechanical Code, the International Building Code, Installation of Air Conditioning and Ventilating Systems Standard, NFPA 90A, and local building, plumbing and waste water codes. All appliances must be electrically grounded in accordance with local codes, or in the absence of local codes, the current National Electric Code, ANSI/NFPA 70 or the current Canadian Electrical Code CSA C22.1.

CAUTION

The Clean Air Act of 1990 bans the intentional venting of refrigerant as of July 1, 1992. Approved methods of recovery, recycling, or reclaiming must be followed.

WARNING

Coils and sheet metal surfaces present sharp edges and care must be taken when working with equipment.

WARNING

Failure to observe the following instructions will result in premature failure of your system and possible voiding of the warranty.

Receiving Unit

When received, check the unit for damage that might have occurred in transit. If damage is found, it must be noted on the carrier's freight bill. A request for inspection by carrier's agent must be made in writing at once. Check nameplate to ensure the correct model sizes and voltages have been received to match the job requirements.

All units are shrink-wrapped in blue wrap. If a unit shows up with any other color wrap, the unit has been opened. Check unit thoroughly for damage that necessitated re-wrapping.

If repairs must be made to damaged goods, notify the factory before any repair action is taken in order to protect the warranty. Certain equipment alteration, repair, and manipulation of equipment without the manufacturer's consent may void the product warranty. Contact the AAON Warranty Department for assistance with handling damaged goods, repairs, and freight claims: 918-382-6450.

Note: Upon receipt check shipment for items that ship loose. Consult order and shipment documentation to identify potential loose-shipped items.

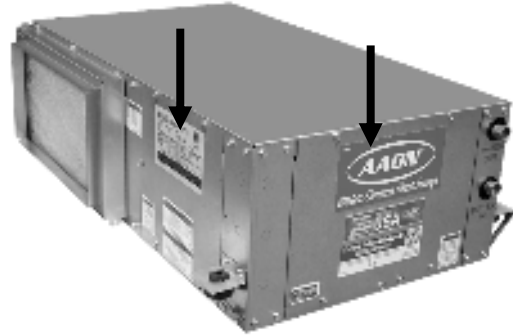

Figure 1 - Access Panels

Storage

If installation will not occur immediately following delivery, store equipment in a dry protected area away from construction traffic and in the proper orientation as marked on the packaging with all internal packaging in place. Secure all loose-shipped items.

Direct Expansion (DX) Systems

All systems are factory assembled, leak tested, charged with R-410A refrigerant, and run tested.

All systems include air coil, reversing valve, liquid line filter dryer, thermal expansion valve (TXV), and compressor.

Always control the unit from the thermostat, or control panel, never at the main power supply, except for emergency or complete shutdown of the unit.

During the cooling season, if the airflow is reduced due to dirty air filters or any other reason, the cooling coils can get too cold which can cause excessive liquid to return to the compressor. As the liquid concentration builds up, oil is washed out of the compressor, leaving it starved for lubrication.

The compressor life will be seriously shortened by reduced lubrication and the pumping of excessive amounts of liquid oil and refrigerant.

Wiring Diagrams

Unit specific wiring diagrams are affixed inside the control compartment panel.

Installation

AAON equipment has been designed for quick and easy installation.

Before startup of the unit, check the supply blower and remove the foam shipping block that may be included to support the blower assembly before installation, or damage may occur.

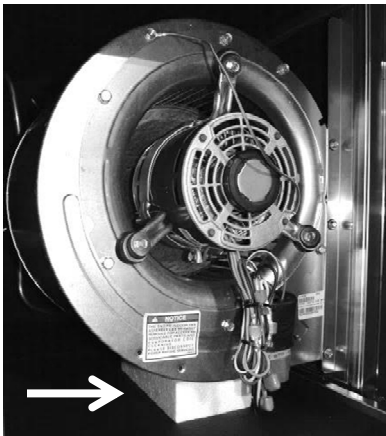

Figure 2 - Foam Shipping Block

Locating the Unit

Placement of the unit relative to ductwork, electrical and plumbing must be carefully considered. Supply and return air plenum or duct can be mounted directly to the duct connection flanges. Use a properly sized duct transition to connect supply duct to unit supply air opening. Return duct flanges are only included on units with the optional 4-sided filter rack. Use flexible gasket material to seal the duct to the unit.

Verify ceiling, floor, or foundation can support the total unit weight, including accessory weights.

To properly support the horizontal WSHP unit and reduce sound and vibration, it must be mounted level in both horizontal directions. These units are designed to be suspended via threaded rod (field provided) through all four hanger brackets using the

four (4) vibration grommets (factory provided) and 3/8" washers (field provided) and as shown in Figure 3.

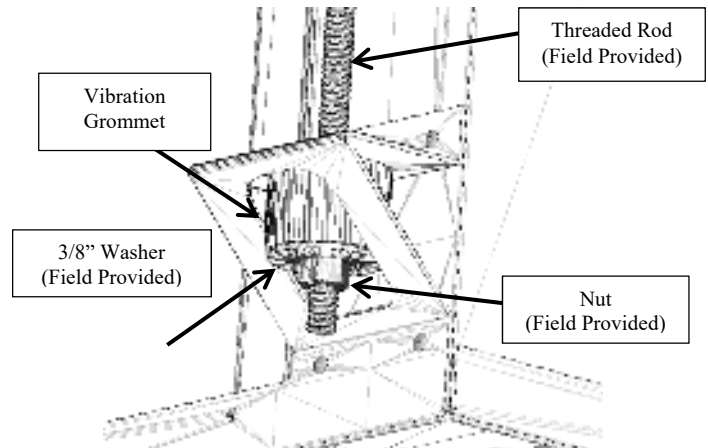

Figure 3 - Mounting Horizontal Units

Verify the top of the vibration grommet is inserted into (or through) the hole provided in the hanger bracket, as pointed out in Figure 4.

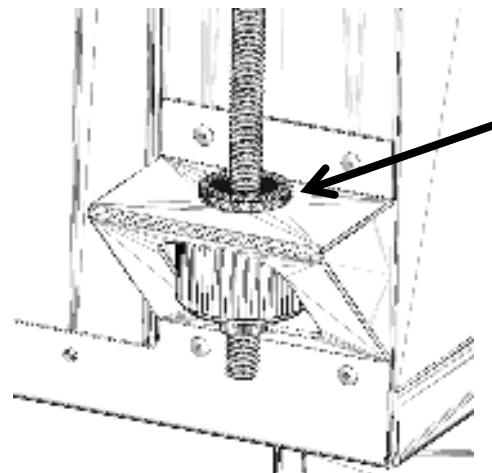

Figure 4 - Vibration Grommet Installation

The threaded rod and nut must be adequately sized to support the total unit weight. Avoid installing units directly above or adjacent to sound-sensitive areas.

Note: Ductwork must be supported independently from the unit. The unit must not support supply and/or return ductwork.

Allow adequate service clearances as shown on the unit nameplate and unit drawing. Consult your local building codes for additional service clearance requirements.

Allow adequate space for piping access and panel removal. Water piping is on the compressor end and condensate drain connections are located on the opposite end.

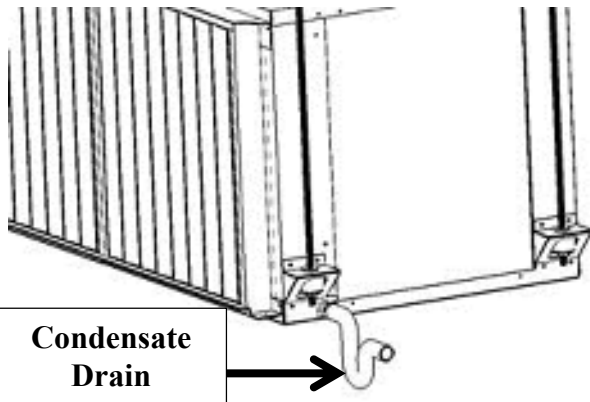

Figure 5 - Condensate Drain Piping

! CAUTION
Emergency drain pan is recommended for all applications where a risk of water damage to surrounding structure or furnishings. Refer to local codes.

Floor Mounted Units

Make sure the unit is level and mounted on a field supplied platform with a minimum height to allow for proper depth of the

condensate line p-trap. Other installation provisions may be necessary according to job specifications.

It is recommended that a vibration isolation pad be used when floor mounting a unit

Condensate Drain Piping

A p-trap and drain line must be installed on horizontal units, with the p-trap not to exceed 6" from the drain connection. Use the same pipe size or larger as/than the drain connection and pitch downward toward drain. Use an air break in long runs of condensate lines. *Note: All horizontal units require a field installed p-trap.*

! CAUTION
Unit must not be operated without p-traps. Failure to install a p-trap may result in overflow of condensate water.

Draw-through cooling coils will have a negative static pressure in the drain pan area. This will cause an un-trapped drain to back up due to air being pulled up through the condensate drain piping.

Condensate drain trapping and piping must conform to all applicable governing codes.

Note: Drain connection is a 3/4" MTP.

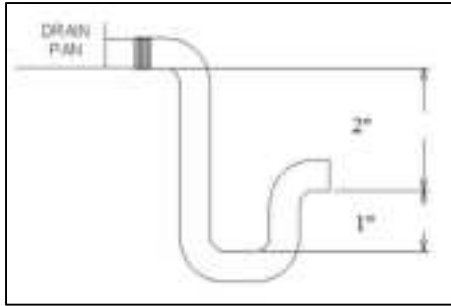

Figure 6 - Drain Trap

The total height from the trap inlet to the top of the bottom bend of the trap must be 2” minimum.

The height from top of the bottom bend of the trap to the bottom of the leaving pipe must be at least equal to 1”. This ensures that enough water is stored in the trap to prevent losing the drain seal during unit startup.

Table 1 - Clearances

Minimum Clearances Required			
Capacity	Front/Control Panel	Back	Air Intake
006, 009, 012	20	24	6
015, 018	20	20	6
024, 030	20	20	6
036, 042	20	20	6
048, 060	20	20	6

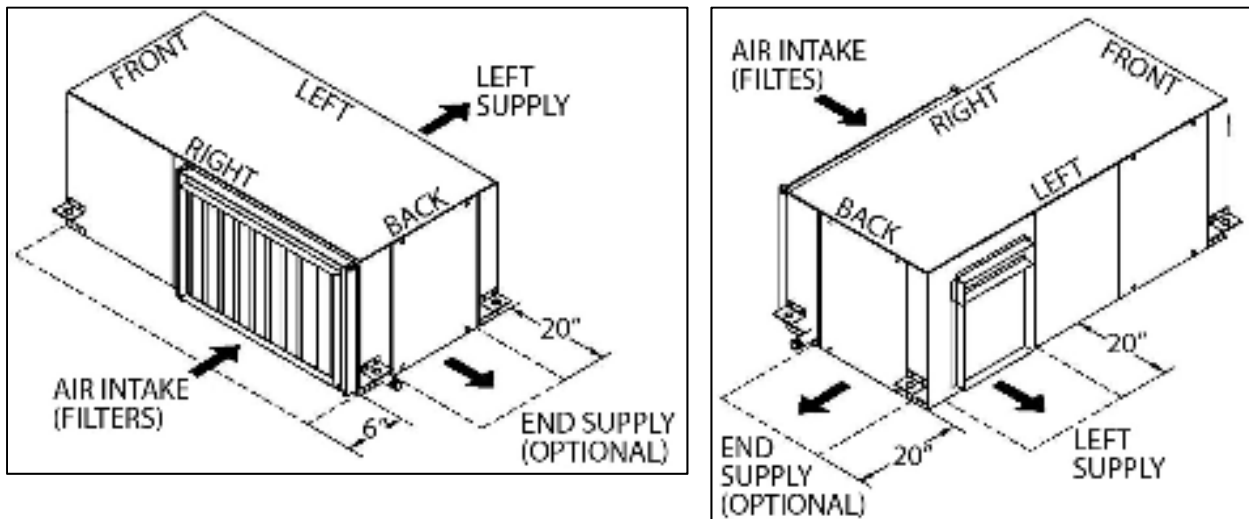

Figure 7 – Horizontal Configuration Orientations

Blower Assembly Removal and Discharge Modification

The AAON WSHP discharge direction can be selected in ECat and is also designed so that the discharge direction can be field modified if needed.

Note: DO NOT perform this action while unit is hanging. It MUST be done on a solid working surface. Otherwise, serious unit damage may occur.

- 1) Using a $\frac{5}{16}$ " socket, remove the shipping screw on the outside of the right or discharge side of the unit.



- 2) Remove the four (4) self-tapping sheet metal screws holding the access panel in place.

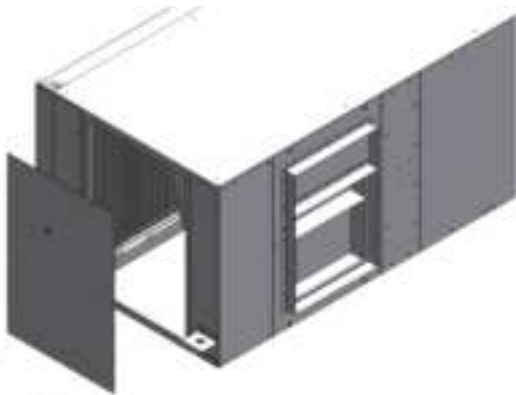

- 3) Remove the side blower access panel and disconnect the blower wiring.
- 4) Remove the four (4) self-tapping sheet metal screws holding the blower assembly in place.

- 5) Pull the blower assembly out of the unit for service.

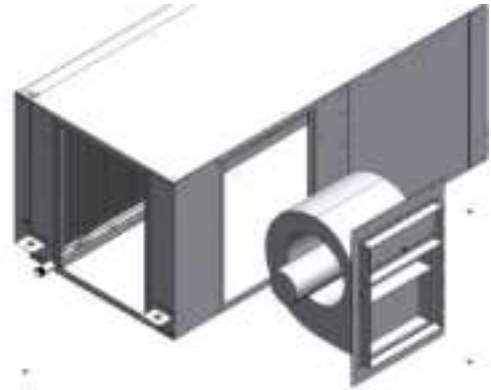

- 6) Invert blower assembly 180 degrees so that the blower can be rewired using the opposite access.

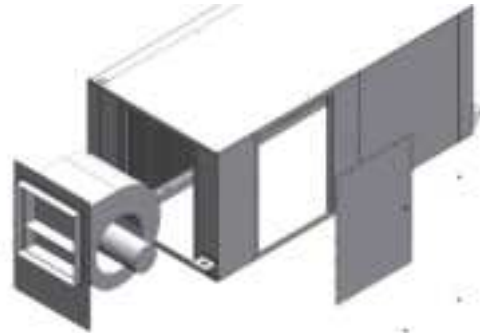

- 7) Fasten blower using the existing holes and self-tapping screws.
- 8) Rewire the blower and fasten the access panels using self-tapping screws.

Lifting and Handling the Unit

Before lifting unit, be sure that all shipping material has been removed from unit.

Unit may be lifted with a pallet jack.

WARNING

UNIT HANDLING

Incorrect lifting can cause damage to the unit, injury or death. Lifting equipment capacity must exceed unit weight by an adequate safety factor. Always test lift unit not more than 24 inches high to verify proper center of gravity lift point.

Blower Motor and Fan Access

To access the blower motor and fan, first remove the blower assembly as outlined in the appropriate “Blower Assembly Removal” for your unit.

Once the blower assembly is on a working surface:

- 1) Remove the five (5) screws that secure the blower motor to the blower assembly.



- 2) Pull the motor and blower up and out of the blower assembly.



- 3) Separate the motor from the blower sub assembly, place the sub assembly (motor side down) and remove the set screw as shown below.



- 4) The blower can now be separated from the motor.

Refrigerant-to-Water Heat Exchanger Water Piping

Open Loop Applications

This product contains refrigerant-to-water heat exchanger made of cupronickel or copper and is subject to severe corrosion and failure when exposed to chlorides.



WARNING

OPEN LOOP APPLICATIONS

Failure of the refrigerant-to-water heat exchanger as a result of chemical corrosion is excluded from coverage under AAON Inc. warranties and the heat exchanger manufacturer's warranties.

Do not allow water containing any form of chlorides to enter this heat exchanger.

Common forms of chlorides include:

1. Seawater mist entering an open cooling tower system.
2. Contaminated make-up water containing salt water.
3. Water loop systems that have been disinfected.

Chlorides will result in a premature failure of the refrigerant-to-water heat exchanger.

Failure of the refrigerant-to-water heat exchanger as a result of chemical corrosion is excluded from coverage under AAON warranties and the heat exchanger manufacturer warranties.

Failure of the refrigerant-to-water heat exchanger may allow water to enter the refrigerant circuit and may cause extensive damage to the refrigerant circuit components. Any damage to the equipment as a result of refrigerant-to-water heat exchanger failure from chemical corrosion due to the fluid in the refrigerant-to-water heat exchanger is excluded from coverage under AAON warranties and the heat exchanger manufacturer warranties.



WARNING

OPEN LOOP APPLICATIONS

Cupronickel refrigerant-to-water heat exchangers must be used with all open loop applications. Failure to use a Cupronickel heat exchanger may result in premature failure of your system and possible voiding of the warranty.



CAUTION

Cleaning the cooling tower or water loop with harsh chemicals such as hydrochloric acid (muriatic acid), chlorine or other chlorides, can damage the refrigerant-to-water heat exchanger. Care must be taken to avoid allowing chemicals to enter the refrigerant-to-water heat exchanger. See Appendix A - Heat Exchanger Corrosion Resistance for more information.

Freezing Water in the Heat Exchanger

This product contains one refrigerant-to-water heat exchanger. A refrigerant-to-water heat exchanger contains refrigerant in one passage and water in another passage. Water is subject to freezing at 32°F. When water freezes in a heat exchanger significant forces are exerted on the components of the heat exchanger where the water is confined.

Failure of the refrigerant-to-water heat exchanger due to freezing will allow water to enter the refrigerant circuit and will cause extensive damage to the refrigerant circuit components. Any damage to the equipment as a result of water freezing in the refrigerant-to-water heat exchanger is excluded from

coverage under AAON warranties and the heat exchanger manufacturer warranties.

Unit is capable of operating with Entering Water Temperatures (EWT) as low as 57°F during cooling mode without the need for an automatic flow regulating water valve. If the EWT is expected to be lower than 57°F or more stable operation is desired, an automatic flow regulating water valve must be installed.

 WARNING
WATER FREEZING
Failure of the refrigerant-to-water heat exchanger due to freezing will allow water to enter the refrigerant circuit and will cause extensive damage to the refrigerant circuit components. Any damage to the equipment as a result of water freezing is excluded from coverage under AAON warranties and the heat exchanger manufacturer warranties.

Glycol solutions are required if ambient temperatures are expected to fall below freezing or if the loop water temperature is below 50°F while operating in the heating mode with the design minimum flow rate. Adding glycol causes an increase in pressure drop resulting in a decrease in unit performance. A minimum concentration of 20% glycol solution is required. The unit controller contains dip switches to set the loop glycol percentage. Set the glycol percentage to the closest option available, rounding down if needed.

The option selected will reset the Leaving Water Temperature safety for the unit. AAON will not be responsible for frozen coaxial coils due to improper selection of glycol percentage. See Leaving Water Temperature Alarm section for more details.

Table 2 - Glycol Concentration Freezing Points

% Glycol	Ethylene Glycol	Propylene Glycol
0	32°F	32°F
20	18°F	19°F
30	7°F	9°F

Water loop piping runs through unheated areas or outside the building must be insulated.

Never operate the unit in heat pump mode with a saturated suction temperature below 35°F for pure water systems or below the freezing point +3°F of the aqueous solution of water and glycol.

Water Piping

 WARNING
WATER PRESSURE
Prior to connection of the water supply, verify water pressure is less than maximum pressure shown on unit nameplate. To prevent injury or death due to instantaneous release of high pressure water, drain valves must be field supplied on water piping. Supply water connection may require a backflow preventer to prevent supply makeup water from backing up into the public water system.

! CAUTION

PVC (Polyvinyl Chloride) and CPVC (Chlorinated Polyvinyl Chloride) are vulnerable to attack by certain chemicals. Polyolester (POE) oils used with R-410A and other refrigerants, even in trace amounts, in a PVC or CPVC piping system will result in stress cracking of the piping and fittings and complete piping system failure.

Only use approved water pipe material. Do not use galvanized material for water lines/fittings.

Table 3 - Water Connections

Horizontal WSHP	Supply and Return Connection Size (in. FPT)
006, 009, 012, 015, 018	1/2"
024, 030, 036, 042	3/4"
048, 060	1"

Water pump must be field sized and installed between the cooling tower or geothermal wellfield and self-contained unit. System must be sized in accordance with the ASHRAE Handbook. Use engineering guidelines to maintain equal distances for supply and return piping and limit bend radii to maintain balance in the system. Balancing valves, permanent thermometers and gauges may be required.

! CAUTION

Installing contractor is responsible for properly sizing and installing water system components. Improper fluid flow due to valves, piping, or improper pump operation may result in unacceptable unit operation and void warranty.

! CAUTION

WATER PIPING

Follow national and local codes when installing water piping. Incorporate vibration eliminators on connections to the unit to reduce noise and vibration and shutoff valves to facilitate servicing. Supply and return water piping must be at least as large as the unit connections and larger depending on length of runs, rise and bends.

Before connection to the unit, the water system must be flushed to remove foreign material that could cause fouling. Install a screen strainer with a minimum of 20 Mesh ahead of the inlet to prevent fouling and internal tube damage. Mineral content of the water must be controlled. All make-up water has minerals in it and as the water is evaporated in the cooling tower, these minerals remain. As the mineral content of the water increases, the conductivity of the water increases. A bleed-off (drain valve) must be provided for the water loop. Field provided and installed water treatment program must be compatible with stainless steel, copper, aluminum, ABS plastic, and PVC. Batch feed processes must never be used as concentrated chemicals can cause

corrosion. Never use hydrochloric acid (muriatic acid) or chlorine as it will corrode stainless steel.

Water loop piping runs through unheated areas or outside the building must be insulated.

NOTE: Ball valves must be installed in the water supply and return lines for unit isolation and water flow balancing. All manual flow valves must be of the ball valve design. Globe or gate valves must not be used due to high pressure drops and poor throttling characteristics.

Pressure and temperature ports are recommended in water supply and return lines for system balancing. These openings must be 5 to 10 pipe diameters from the unit water connections. To allow for mixing and temperature stabilization, wells in the water piping must extend at least $\frac{1}{2}$ pipe diameter into the pipe.

Piping systems must not exceed 10 ft/sec fluid velocity to ensure tube wall integrity and reduce noise.

Electrical

Verify the unit nameplate agrees with power supply. WSHP Series units are provided with single point power wiring connections. A complete set of unit specific wiring diagrams, showing factory and field wiring are located inside the controls compartment panel.

Table 4 - Nameplate Voltage Markings & Tolerances

Hz	Nameplate Voltage	Nominal System Voltage	Operating Voltage Range ¹		Acceptable Performance Range ²	
			Min	Max	Min	Max
60	115	120	104	127	108	126
	208/230	208/240	187	254	187	252
	208	208	187	228	187	228
	230	240	208	254	216	252
	265	277	240	293	249	291
	460	480	416	508	432	504
	575	600	520	635	540	630

Notes:

1. Operating voltage is the min and max voltage for which the unit can function. Never operate outside of this min and max voltage.
2. The Acceptable Performance Range is the min and max voltage for which the unit performance is designed and rated to give acceptable performance
3. **Note:** All units are factory wired for either 115V, 208V/230V, 265V, 460V, or 575V.

The transformer configuration must be checked by a qualified technician prior to service, especially if unit is to be connected to a 208V or 230V supply. Note: All our units are default wired to 208V for the 208V/230V option. To utilize 230V service, interchange the yellow and red wire terminals from the transformer.

Red-Black for 208V

Yellow-Black for 230V

WARNING

Disconnect all electrical power sources before servicing the unit. More than one power source may be provided. Failure to do so may result in injury or death from electrical shock or entanglement in moving parts.

All units require field supplied electrical overcurrent and short circuit protection. Device must not be sized larger than the Maximum Overcurrent Protection (MOP) shown on the unit nameplate.

Codes may require a disconnect switch be within sight of the unit.

A unit-mounted disconnect switch is available as an option. It is important to note that this is a method for convenient maintenance of the unit, but does not provide unit protection or isolation.

Electrical supply can enter through the side of the controls compartment where knockouts and/or capped pre-cut holes have been provided. Horizontal units have been provided with both high and low voltage holes at the top and bottom of the unit. Entry must be made into one each of these locations.

A single point connection to a definite purpose contactor is provided on the control panel, or to the unit-mounted disconnect switch (if installed) on the corner panel. High voltage conductors must enter the control panel in a separate opening and separate conduit than 24V low voltage conductors. High voltage and low voltage openings are nominally sized at 1-1/8" and 7/8" respectively.

Note: Alternate locations for field cut electrical entries must be approved by AAON factory.

 CAUTION
Installing Contractor is responsible for proper sealing of the electrical entries into the unit. Failure to seal the entries may result in damage to the unit and property.

Size supply conductors based on the unit Minimum Current Ampacity (MCA) rating. Supply conductors must be rated a minimum of 75°C.

Protect the branch circuit in accordance with code requirements. The unit must be electrically grounded in accordance with

local codes, or in the absence of local codes, the current National Electric Code, ANSI/NFPA 70 or the current Canadian Electrical Code CSA C22.1.

Wire power leads to the unit's contactor or main disconnect. All wiring beyond this point has been completed by AAON and cannot be modified without effecting the unit's agency/safety certification.

Supply voltage must be within the min/max range shown on the unit nameplate. Available short circuit current must not exceed the short circuit current rating (SCCR) shown on the unit nameplate.

 CAUTION
Three phase voltage imbalance will cause motor overheating and premature failure.

Voltage imbalance is defined as 100 times the maximum deviation from the average voltage divided by the average voltage. The maximum allowable imbalance is 2%.

Example:
 $(221V+230V+227V)/3 = 226V$, then
 $100*(226V-221V)/226V = 2.2\%$, which exceeds the allowable imbalance.

Check voltage imbalance at the unit disconnect switch and at the compressor terminal. Contact your local power company for line voltage corrections.

Installing contractor must check for proper motor rotation and check blower motor amperage listed on the motor nameplate is not exceeded.

! CAUTION

Rotation must be checked on all MOTORS AND COMPRESSORS of three phase units. Supply fan motors must all be checked by a qualified service technician at startup and any wiring alteration must only be made at the unit power connection.

Wire control signals to the unit’s low voltage thermostat connections on the control board, located in the controls compartment. Consult unit wiring diagram for more detailed instructions on control signal wiring connections. If any factory installed wiring must be replaced, use a minimum 105°C type AWM insulated conductors.

! CAUTION

Scroll compressors are directional and can be damaged if rotated in the wrong direction. Compressor rotation must be checked for proper operation, without using external refrigerant pressure gauges. Often, a compressor running in reverse rotation will be much louder than a normal compressor, and will not develop much of a temperature differential between the suction and discharge lines.

! WARNING

Disconnect all electrical power sources before servicing the unit. More than one power source may be provided. Failure to do so may result in injury or death from electrical shock or entanglement in moving parts/

Thermostat Control Wiring

If a thermostat is used for unit control, locate thermostat on an inside wall 4-5 feet above the floor where it will not be subjected to drafts, sun exposure, or heat from electrical fixtures or appliances. Control wiring must deliver adequate voltage to components to assure proper operation. Control voltage returning from controller circuit must be a minimum of 21 VAC. To assure proper wiring use the following chart to determine the allowable wiring distances.

Table 5 - Control Wiring

Wire Size (Stranded) - Copper Conductors Only	Total Wire Distance Allowable
20 AWG	200 ft
18 AWG	350 ft
16 AWG	500 ft
14 AWG	750 ft
12 AWG	1250 ft

$$\text{Total Wire Distance Allowable} = \frac{\text{(Quantity of Control Wires)} \times \text{(Control Wire Distance)}}{\text{Total Wire Distance Allowable}}$$

Take the total wire distance allowable and divide by the number of wires to be connected. This indicates the distance allowable for that size wire. The wiring to the unit must not exceed the total wire distance allowable. If the voltage at the connectors is less than 21 VAC, isolation relays must be installed. If under external control 21 VAC must be field verified. All external devices must be powered via a separate external power supply.

Example:

A total of 5 wires must be pulled 75ft to a control the unit. What size wire must be used?

According to Table 5, 18 AWG allows for 70ft (350 ft. /5 wires) and 16 AWG allows for 100ft (500 ft. /5 wires). Thus, 16 AWG must be used.

Filter Pull Setup

Do not operate the unit without filters in place. Each unit has a filter pull located in the filter section of the unit. The filter pull must be setup prior to installing or changing the filters.

If side access to the filters is desired, then no further action is required. If bottom access to the filters is desired, then the filter pull must be removed.

If unit includes 4-sided filter rack, clips must be opened to remove filters and filter pull.



Figure 8 - Filter Rack Closed with Clip



Figure 9 - Filter Rack Open with Clip

1. The filter pull is located in the filter area as shown in **Error! Reference source not found.**. If necessary, from the SIDE filter access open the filter access door.



Figure 10 - Using the Filter Pull

2. The filter pull is now accessible. Grasp the filter pull and lift it approximately ¼” and with moderate force, pull it out and away from the unit.
Note: Use caution that filters are clear of access holes so that filter damage does not occur. See Figure 10.
3. Because the filter pull may be longer than available room, it may be necessary to roll, bend or cut the slide to be completely removed.
4. Reinstall the filters, taking note of correct orientation with regard to airflow.
5. If necessary, close the filter access door and press the fastener clip firmly until locked into position.

Duct Connection

Attach duct to flanges provided on the unit. Use a properly sized duct transition to connect supply duct to unit supply air opening. The installer is responsible for sealing ducts to the flanges to prevent air leaks.

Intake air enters the side of the units, where the air filters are located. The left or right hand return depends on feature selected when ordering the units. Ductwork must be sized in accordance with the ASHRAE Handbook. Ductwork must be installed in accordance with NFPA Standard 90A.

When attaching duct to the unit, use a flexible/compressible material rated for duct connections. A three inch flexible connector for both return and supply duct connections is recommended.

Startup

(See back of the manual for startup form)

Operation Limits

	Cooling	Heating
Min. Entering Air	60°F	45°F
Max Entering Air	100°F	80°F
Min. Entering Water	30°F	20°F
Max Entering Water	110°F	90°F
Min. GPM/Ton	1.5	
Max GPM/Ton	4	
Min. CFM/Ton	300	

WARNING

Improper installation, adjustment, alteration, service or maintenance can cause property damage, personal injury or loss of life. Startup and service must be performed by a Factory Trained Service Technician. Keep a copy of this IOM with the unit.

WARNING

Electric shock hazard. Shut off all electrical power to the unit to avoid shock hazard or injury from rotating parts.

During startup, it is necessary to perform routine checks on the performance of the unit. This includes checking of the air flow, the air filters, and water flow. Due to the charge-critical nature of these units, refrigerant pressure gauges must only be hooked up to the unit if there is suspicion of an issue within the circuit.

Supply Fans

Units are equipped with direct drive forward curved or backward curved plenum supply fan assemblies that deliver the air volume specified according to unit size and job requirements.

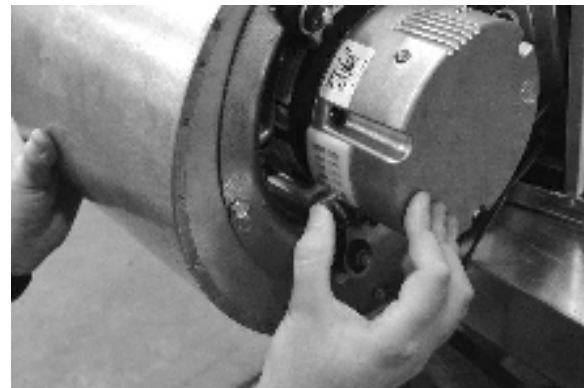

Figure 11 - WSHP Series Supply Fan

Fan Air Flow Adjustment

A specific air volume is delivered by the PSC fans. Field airflow adjustment may be required at startup.

Standard PSC motors have limited RPM Adjustment to adjust airflow. Each motor type has three speed taps to select from: High, Medium, and Low. Adjustment for the PSC speed must be made by altering the motor power connected to the motor. (WH015 - 060).



Adjustment for the A cabinet units (WH006-012) is made by adjusting the DC voltage signal to the motor from the Pioneer Expansion board or the Pioneer Gold board. Low fan speed is achieved by connecting the compressor Y call from the thermostat to Y1

on the control board. The higher fan speed is achieved by connecting Y from the thermostat to Y2 on the control board.

Motor Tap RPMs

Fan Speed	RPM	PSC Tap
High	1200	Black
Med	950	Blue
Low	800	Red

Note: RPMs are approximate, and will vary slightly depending on TSP across the blower assembly

For unit operation at ISO 13256-1 rating conditions, PSC blower motors must use “High” Speed and 8. B through E cabinet unit (WH015-060). WH ½ - 1 ton units may also require specific dip-switch settings. Please consult factory for details.

Filters

Do not operate the unit without filters in place. Unit must be checked for correct filter placement during startup. Operation of the equipment without filters will result in a clogged air coil.

CAUTION

Before completing startup and leaving the unit a complete operating cycle must be observed to verify that all components are functioning properly.

Adjusting Refrigerant Charge

Unit must be operating in the cooling mode to adjust the refrigerant charge.

CAUTION

Due to the charge-critical nature of these units, charge must only be adjusted if absolutely necessary.

Adjusting the charge of a system in the field must be based on determination of liquid sub-cooling and evaporator superheat. On a system with a TXV liquid sub-cooling is more representative of the charge than evaporator superheat but both measurements must be taken.

Before Charging

Unit being charged must be at or near full load conditions before adjusting the charge.

Units equipped with hot gas reheat must be charged with the hot gas reheat valves closed while the unit is in cooling mode to get the proper charge. After charging, operate the unit in reheat (dehumidification) mode to check for correct operation.

After adding or removing charge the system must be allowed to stabilize, typically 10-15 minutes, before making any other adjustments.

The type of unit and options determine the ranges for liquid sub-cooling and evaporator superheat. Refer to the tables below when determining the proper sub-cooling.

Checking Liquid Sub-Cooling

Measure the temperature of the liquid line as it leaves the refrigerant-to-water heat exchanger.

Read the gauge pressure at the liquid line close to the point where the temperature was taken.

Convert the pressure obtained to a saturated temperature using the appropriate refrigerant temperature-pressure chart.

Subtract the measured liquid line temperature from the saturated temperature to determine the liquid sub-cooling.

Compare calculated sub-cooling to the table below for the appropriate unit type and options.

Checking Evaporator Superheat

Measure the temperature of the suction line close to the compressor.

Read gauge pressure at the suction line close to the compressor.

Convert the pressure obtained to a saturated temperature using the appropriate refrigerant temperature-pressure chart.

Subtract the saturated temperature from the measured suction line temperature to determine the evaporator superheat.

Compare calculated superheat to the following table for the appropriate unit type and options.

 CAUTION
<p>DO NOT OVERCHARGE! Refrigerant overcharging leads to excess refrigerant in the refrigerant-to-water heat exchanger coils resulting in elevated compressor discharge pressure.</p>

Table 6 - Acceptable Refrigeration Circuit Values at AHRI ISO 13256 WLHP Conditions

Water-Source Heat Pump	
Sub-Cooling	4-8°F
Superheat	8-15°F

 CAUTION
<p>Thermal expansion valve must be adjusted to approximately 8-15°F of suction superheat. Failure to have sufficient superheat will damage the compressor and void the warranty.</p>

Adjusting Sub-Cooling and Superheat Temperatures

The system is overcharged if the sub-cooling temperature is too high and the evaporator is fully loaded (low loads on the evaporator result in increased sub-cooling) and the evaporator superheat is within the temperature range as shown in the table above (high superheat results in increased sub-cooling).

Correct an overcharged system by reducing the amount of refrigerant in the system to lower the sub-cooling.

The system is undercharged if the superheat is too high and the sub-cooling is too low

Correct an undercharged system by adding refrigerant to the system to reduce superheat and raise sub-cooling.

If the sub-cooling is correct and the superheat is too high, the TXV may need adjustment to correct the superheat.

Table 7 - R-410A Refrigerant Temperature-Pressure Chart

°F	PSIG	°F	PSIG	°F	PSIG	°F	PSIG	°F	PSIG
20	78.3	47	134.7	74	213.7	101	321.0	128	463.2
21	80.0	48	137.2	75	217.1	102	325.6	129	469.3
22	81.8	49	139.7	76	220.6	103	330.2	130	475.4
23	83.6	50	142.2	77	224.1	104	334.9	131	481.6
24	85.4	51	144.8	78	227.7	105	339.6	132	487.8
25	87.2	52	147.4	79	231.3	106	344.4	133	494.1
26	89.1	53	150.1	80	234.9	107	349.3	134	500.5
27	91.0	54	152.8	81	238.6	108	354.2	135	506.9
28	92.9	55	155.5	82	242.3	109	359.1	136	513.4
29	94.9	56	158.2	83	246.0	110	364.1	137	520.0
30	96.8	57	161.0	84	249.8	111	369.1	138	526.6
31	98.8	58	163.8	85	253.7	112	374.2	139	533.3
32	100.9	59	166.7	86	257.5	113	379.4	140	540.1
33	102.9	60	169.6	87	261.4	114	384.6	141	547.0
34	105.0	61	172.5	88	265.4	115	389.9	142	553.9
35	107.1	62	175.4	89	269.4	116	395.2	143	560.9
36	109.2	63	178.4	90	273.5	117	400.5	144	567.9
37	111.4	64	181.5	91	277.6	118	405.9	145	575.1
38	113.6	65	184.5	92	281.7	119	411.4	146	582.3
39	115.8	66	187.6	93	285.9	120	416.9	147	589.6
40	118.1	67	190.7	94	290.1	121	422.5	148	596.9
41	120.3	68	193.9	95	294.4	122	428.2	149	604.4
42	122.7	69	197.1	96	298.7	123	433.9	150	611.9
43	125.0	70	200.4	97	303.0	124	439.6		
44	127.4	71	203.6	98	307.5	125	445.4		
45	129.8	72	207.0	99	311.9	126	451.3		
46	132.2	73	210.3	100	316.4	127	457.3		

Operation

Unit operations must be controlled with thermostat and unit controller, never at the main power supply, except for emergency or complete shutdown of the unit.

AAON WSHP Pioneer Silver Controller

Part Number: V67470

Description

The WSHP Pioneer Silver Controller contains all the functionality required to operate the basic configuration of the units. The controller requires commands from a standard heat pump room thermostat and has outputs to control a supply fan, compressor, and reversing valve. The control also contains a port for communication to the Pioneer Silver Expansion Board for additional functionality.

NOTE: If the application currently uses an obsolete mercury bulb type thermostat, it must be upgraded to an electronic thermostat. The unit will not function properly when controlled via a mercury bulb thermostat.

General Specifications

Electrical

Supply Voltage

24VAC (+25%/-15%), Class 2

Supply Power

15VA

Outputs

Relay Outputs: 1A maximum per output.

Input Requirements

Resistive Inputs: require 10K Type 3 Thermistor

24VAC Inputs: Inputs provide 4.7kΩ Load

Environmental

Operating Temperature

32 to 158°F (0 to 70°C)

Storage Temperature

-4 to 158°F (-20 to 70°C)

Humidity (Storage and Operating)

0 to 95% RH non-condensing

Mounting & Dimensions

Mounting

Board is mounted via four shoulder eyelets located on the corners of the circuit board.

Dimensions

5.5" x 4.0"

Inputs and Outputs

Pluggable Screw Terminal Block H2

AL1 = Dry, normally open contact with terminal AL2. Contact closes when controller is in alarm.

AL2 = Dry, normally open contact with terminal AL1. Contact closes when controller is in alarm.

COM = 24VAC Common.

ESD = Emergency shutdown Input. 24VAC or common must be used as input for unit operation. Jumper to COM is factory installed.

NS = Night setback mode enable. 24VAC or common may be used as inputs.

NO = Dry, normally open contact with terminal IN. Contact closes when compressor is active.

IN = Common input for terminals NO and NC.

NC = Dry, normally closed contact with terminal IN. Contact opens when compressor is active.

Pluggable Screw Terminal Block H5

24V = 24VAC power output for thermostat.

NS_OV = Night setback override input.

Input requires 24VAC to activate.

O = Thermostat input for reversing valve operation. Input requires 24VAC to activate.

COM = 24VAC common for thermostat power.

G = Thermostat input for fan operation.

Input requires 24VAC to activate.

NS_TH = Night setback compressor enable.

Input requires 24VAC to activate.

Y = Thermostat input for compressor operation. Input requires 24VAC to activate.

AL = 24VAC wet alarm output.

Pluggable Screw Terminal Block H1

+ = Network terminal used for communication with the expansion board.

- = Network terminal used for communication with the expansion board.

S = Shield

Quick Disconnect Terminals

P1 - AUX = Auxiliary alarm terminal. Dry contact with AUX IN enables alarm.

P2 - AUX IN = Auxiliary alarm terminal.

Dry contact with AUX enables alarm.

P3 - TEST = Delay override terminal. Dry contact with TEST IN enables the delay override function.

P4 - TEST IN = Delay override terminal.

Dry contact with TEST enables the delay override function.

Alarm Status LED D5

See Table 8 for flash codes.

Relay Status LEDs

COMP = Compressor Relay

ALARM = Alarm Relay

FAN = Fan Relay

RV = Reversing Valve Relay

Dip Switch SW1

See Table 9 - Glycol Percentage Setpoints

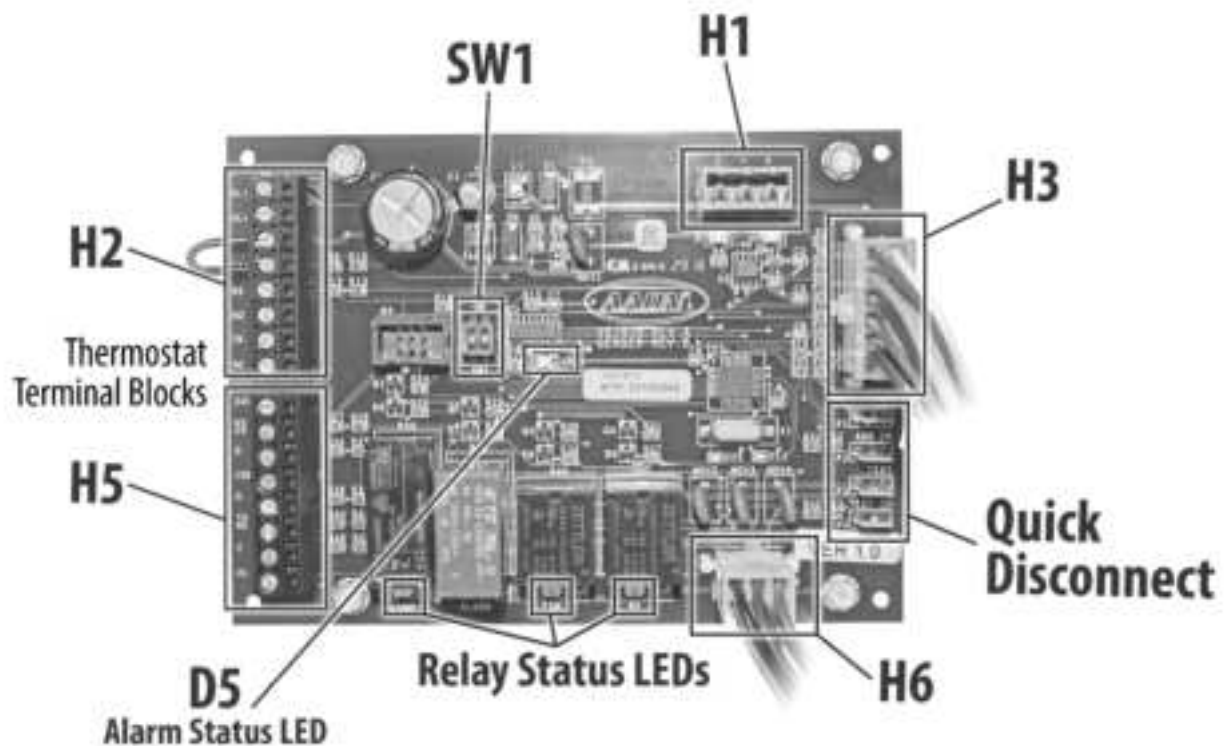

Figure 12 - Pioneer Silver Controller Layout

Sequences of Operation

Supply Fan Operation

Supply fan will enable upon receiving a 24VAC input on the “G” terminal or a call for compressor operation unless an alarm prevents the fan from operating. There is a 30 second minimum off timer for the fan. The supply fan is enabled for 15 seconds after the last stage of cooling, heating, or dehumidification stages off. Not all alarms will prevent supply fan operation.

The alarms that disable the fan are:

- 1) Emergency Shutdown
- 2) Condensate Overflow
- 3) Low Voltage
- 4) High Voltage

Compressor Operation

The compressor will enable upon receiving a 24VAC input on the “Y” terminal or a 24VAC input on the “TH_NS” terminal if in night setback mode unless an alarm is active. If the supply fan was not enabled prior to the compressor call, then the supply fan will enable for 5 seconds before the compressor is started.

The compressor has a minimum on time of 3 minutes and a minimum off time of 2 minutes to prevent short cycling. These delays can be shortened to 5 seconds if the controller is in test mode. If the unit goes into an alarm then the minimum on time will be ignored and the compressor will disable. All alarms will disable the compressor.

Reversing Valve Operation

The reversing valve will enable if the compressor has been operational for a minimum of 5 seconds.

The default reversing valve position is for heating operation. Therefore, in compressor cooling operation 24VAC must be applied to the “O” terminal.

Random Start Delay

The controller will enter a random start delay in these situations:

- 1) The unit powers up
- 2) Recovery from emergency shutdown alarm
- 3) Recovery from high voltage alarm
- 4) Recovery from low voltage alarm
- 5) Night setback mode is disabled

The random start delay will be between 3 and 60 seconds. The fan and compressor will not be operational during this time. The random start delay will be ignored if the unit is in test mode.

Building Occupancy Status

Occupied Mode

The controller will operate according to the thermostat inputs.

Night Setback Mode

Night setback mode is enabled upon receiving a 24VAC or a 24VAC common input on the “NS” terminal. While in night setback mode the controller will ignore the normal thermostat signals. Instead the controller will use the “NS_TH” input as the fan and compressor enable signal operating at full compressor capacity. When the unit is taken out of night setback mode the controller will execute a random start delay.

The night setback mode can be overridden with a 24VAC input to the night setback override terminal “NS_OV”. Once the override signal is received, night setback will

be overridden for 2 hours even if the signal is removed. While night setback is overridden the controller will respond to the normal thermostat signals.

Test Mode

Test mode is enabled by connecting the two quick disconnect terminals “TEST” and “TEST IN” together. The controller will remain in “Test Mode” as long as the terminals are connected to each other. The controller will exit “Test Mode” immediately upon removal of the jumper. While in “Test Mode” there will be no random start delay, and the compressor minimum on and minimum off times are reduced to 5 seconds each. The 5 second delay between compressor and reversing valve operation is still present as well as the 5 second delay between the supply fan and compressor.

Alarms

LED Fault Codes

The controller provides a status LED (D5) in the center of the board to indicate the unit status. A green status light indicates that the unit is powered up and that the controller is not detecting any fault conditions. A flashing red status light indicates that the controller has detected a fault condition and is now in alarm mode. The number of flashes indicates what alarm is present. Table 8 describes the meaning of the flash codes.

Table 8 - LED Diagnostic Codes

Number of LED Flashes	Fault
1	High Discharge Pressure
2	Emergency Shutdown
3	Auxiliary Alarm
4	High Condensate Level Alarm
5	Low Control Voltage Alarm
6	High Control Voltage Alarm
7	Low Suction Pressure
8	Leaving Water Temperature Alarm
9	Air Coil Low Temperature Alarm
10	Entering Water Temperature Alarm

Automatic Reset Alarms

The following alarms will automatically reset themselves once the fault condition clears.

Low Control Voltage Alarm

The low voltage alarm will activate when the 24VAC control voltage drops to 20VAC +/-5%. Below this voltage the onboard normally open relays are not guaranteed to close. The low voltage alarm will release when the voltage rises above 22VAC +/-5%. Once the fault is cleared the controller will activate a random start delay. This alarm will disable the compressor, the supply fan, and the reversing valve.

High Control Voltage Alarm

The high voltage alarm will activate when the 24VAC control voltage increases to 32VAC +/-5%. Any voltage higher than this risks damaging components on the control board. The alarm will release when the control

voltage decreases to 30VAC +/-5%. Once the fault is cleared the controller will activate a random start delay. This alarm will disable the compressor, the supply fan, and the reversing valve.

Leaving Water Temperature Alarm

To prevent freezing of the liquid heat exchanger, the leaving water temperature alarm will activate and turn the compressor off if the refrigerant saturated suction temperature during heating drops below the freeze protection temperature setpoints in Table 9 - Glycol Percentage Setpoints, based on the glycol percentage that is input into the controller. The alarm will deactivate (allowing the compressor to run again) after ten minutes have expired and the refrigerant saturated suction temperature rises 5°F above the freeze protection temperature. If the alarm is activated again within two hours, the refrigerant saturated suction temperature must rise 5°F above the freeze protection temperature and the unit power must be cycled off and on or the compressor activation call from the thermostat must be removed and then restarted.

The glycol percentage DIP switch “SW1” is used to set the glycol percentage that is used in the system for freeze protection. This switch is located in the center of the control board. The freeze protection setpoints change based on the glycol percentage that is input to the controller. It is critical that this setting matches the actual glycol percentage used in the system to prevent damage caused from freezing. Inputting a glycol percentage that is higher than actually used in the system can cause extensive damage from freezing.

Table 9 - Glycol Percentage Setpoints

Switch 1 Position	Switch 2 Position	Glycol Percentage	Leaving Water Temperature Alarm Activation	Leaving Water Temperature Alarm Deactivation
Off	Off	0%	35°F	40°F
Off	On	10%*	30°F	35°F
On	Off	20%	23°F	28°F
On	On	30%	15°F	20°F

*Setting not recommended. 20% or more glycol solution is required if ambient temperatures are expected to fall below freezing or if the loop water temperature is below 50°F while operating in the heating mode.

Air Coil Temperature Alarm

The air coil low temperature alarm will trigger if the air coil temperature drops below 30°F. The alarm will release when the coil temperature increases to 35°F. This alarm will disable the compressor but allow operation of the supply fan.

Entering Water Temperature Alarm

The entering water temperature alarm is used to prevent freezing in the waterside economizer coil. Entering water temperature is only monitored if a unit is ordered with a waterside economizer coil. This temperature sensor is wired to the Pioneer Silver Expansion Board. If the entering water temperature falls to 35°F, the waterside economizer coil will be deactivated until the entering water temperature rises above 40°F. The supply fan and the compressor are allowed to operate when this alarm is activated.

Emergency Shutdown Alarm

The emergency shutdown input requires a constant connection to either 24VAC or 24VAC common for normal operation. If the 24VAC or 24VAC common signal is removed, then the controller will enter emergency shutdown mode. This alarm will disable the compressor and the supply fan. This alarm will release when the 24 VAC input is restored.

Lock Out Alarms

The following alarms will not automatically reset themselves on the fault condition clears.

For these alarms to clear one of the following two conditions must be met:

- 1) Controller is power cycled
- 2) Fault condition is corrected and the compressor call is removed

Auxiliary Input Alarm

The auxiliary alarm will enable if the compressor has been operational for at least 2 minutes and a dry contact has been made between the “AUX” and “AUX IN” quick disconnect terminals for 10 seconds. This alarm will disable the compressor but allow the supply fan to operate. If a secondary drain pan is to be used, the secondary drain pan overflow switch must be wired into the Auxiliary Input Alarm.

High Condensate Level Alarm

The high condensate level alarm will enable if the resistance between the condensate level sensor and 24VAC common is less than 100kΩ for more than 30 seconds. This alarm will disable both the compressor and the supply fan.

High Discharge Pressure Alarm

The high discharge pressure alarm will enable if the high pressure switch opens. This alarm will disable the compressor but allow the supply fan to operate.

Low Suction Pressure Alarm

The low suction pressure alarm will activate and turn the compressor off if the low suction pressure switch is open for 10 seconds. The alarm will deactivate if 15 minutes has expired and the low pressure switch has closed. If the alarm is activated again within two hours, the unit power must be cycled off and on.

Maintenance

See back of the manual for maintenance log.

At least once each year, a qualified service technician must check out the unit. Supply fans, evaporator coils and air filters must be inspected monthly.

WARNING

Improper installation, adjustment, alteration, service or maintenance can cause property damage, personal injury or loss of life. Installation and service must be performed by a qualified installer. Keep a copy of this IOM with the unit.

See Startup section for information on air flow adjustment.

DX Cooling

Set unit controls to cooling mode of operation with supply fans on. Check the fans for correct operating direction, amperage and voltage. Check compressor operation, rotation, amperage and voltage to the unit nameplate (check the amperage on the load side of the compressor contactor). Check for

24V signal across the reversing valve terminals.

Condensate Drain Pans

Drain pans will have moisture present and require periodic cleaning to prevent microbial growth. Cleaning of the drain pans will also prevent any possible plugging of the drain lines and overflow of the pan itself. Cleaning of the drain pans and inside of the unit must be done only by qualified personnel.

Supply Fans

CAUTION

Blower wheels must be inspected for excessive dust build up periodically and cleaned if required. Excessive dust build up on blower wheels may cause an unbalanced state; leading to vibration and/or component failure. Damages due to excessive dust build up will not be covered under factory warranty.

WARNING

Electric shock hazard. Shut off all electrical power to the unit to avoid shock hazard or injury from rotating parts.

Supply Fan Lubrication

Supply fan motors are permanently lubricated and require no oiling.

Filter Replacement

Monthly filter inspection is required to maintain optimum unit efficiency. It is strongly recommended that filter media be replaced monthly.

⚠ WARNING

Electric shock hazard. Shut off all electrical power to the unit to avoid shock hazard or injury from rotating parts.

See *Filter Information* section for reference to the correct size and quantity of filters.

Replacement Parts

Parts for AAON equipment may be obtained by contacting your local AAON representative. When ordering parts, reference the unit serial number and part

number located on the external or internal nameplate of the unit.

Note: Warranty end date can be found on the unit nameplate.

AAON

Warranty, Service, and Parts Department
 2425 S. Yukon Ave.
 Tulsa, OK 74107
 Ph: 918-382-6450
techsupport@aaon.com
www.AAON.com

Note: Before calling, have the model and serial number of the unit available to help answer questions regarding the unit.

Filter Information

Table 10 - 006-012 WH Unit Series Filters (A Cabinet)

Feature 3B	Quantity/Size (W x H x D)	Type
A	(1) 18" x 10" x 2"	Pleated, MERV 8
K		Pleated, MERV 11
L		Pleated, MERV 13
E	(1) 18" x 10" x 1"	Pleated, MERV 8
F		Pleated, MERV 11
G		Pleated, MERV 13
I	(1) 18" x 10" x 1"	Fiberglass
J	(1) 18" x 10" x 2"	

Table 11 - 015 & 018 WH Series Unit Filters (B Cabinet)

Feature 3B	Quantity/Size (W x H x D)	Type
A	(1) 25" x 16" x 2"	Pleated, MERV 8
K		Pleated, MERV 11
L		Pleated, MERV 13
E	(1) 25" x 16" x 1"	Pleated, MERV 8
F		Pleated, MERV 11
G		Pleated, MERV 13
I	(1) 25" x 16" x 1"	Fiberglass
J	(1) 25" x 16" x 2"	

Table 12 - 024 & 030 WH Series Unit Filters (C Cabinet)

Feature 3B	Quantity/Size (W x H x D)	Type
A	(1) 25" x 18" x 2"	Pleated, MERV 8
K		Pleated, MERV 11
L		Pleated, MERV 13
E	(1) 25" x 18" x 1"	Pleated, MERV 8
F		Pleated, MERV 11
G		Pleated, MERV 13
I	(1) 25" x 18" x 1"	Fiberglass
J	(1) 25" x 18" x 2"	

Table 13 - 036 & 042 WH Series Unit Filters (D Cabinet)

Feature 3B	Quantity/Size (W x H x D)	Type
A	(2) 14" x 20" x 2"	Pleated, MERV 8
K		Pleated, MERV 11
L		Pleated, MERV 13
E	(2) 14" x 20" x 1"	Pleated, MERV 8
F		Pleated, MERV 11
G		Pleated, MERV 13
I	(2) 14" x 20" x 1"	Fiberglass
J	(2) 14" x 20" x 2"	

Table 14 - 048 & 060 WH Series Unit Filters (E Cabinet)

Feature 3B	Quantity/Size (W x H x D)	Type
A	(1) 24" x 20" x 2" (1) 14" x 20" x 2"	Pleated, MERV 8
K		Pleated, MERV 11
L		Pleated, MERV 13
E	(1) 24" x 20" x 1" (1) 14" x 20" x 1"	Pleated, MERV 8
F		Pleated, MERV 11
G		Pleated, MERV 13
I	(1) 24" x 20" x 1" (1) 14" x 20" x 1"	Fiberglass
J	(1) 24" x 20" x 2" (1) 14" x 20" x 2"	

Appendix A - Heat Exchanger Corrosion Resistance

Potential Problem	Chemical(s) or Condition	Range for Copper Heat Exchangers	Range for Cupro-Nickel Heat Exchangers
Scaling	Calcium & Magnesium Carbonate	Less than 350 ppm	Less than 350 ppm
Corrosion	pH Range	7-9	5-9
	Total Dissolved Solids	Less than 1000 ppm	Less than 1500 ppm
	Ammonia, Ammonium Hydroxide	Less than 0.5 ppm	Less than 0.5 ppm
	Ammonium Chloride, Ammonium Nitrate	Less than 0.5 ppm	Less than 0.5 ppm
	Calcium Chloride/ Sodium Chloride	Less than 125 ppm	Less than 125 ppm – Note 4
	Chlorine	Less than 0.5 ppm	Less than 0.5 ppm
	Hydrogen Sulfide	None Allowed	None Allowed
Biological Growth	Iron Bacteria	None Allowed	None Allowed
	Iron Oxide	Less than 1 ppm	Less than 1 ppm
Erosion	Suspended Solids	Less than 10 ppm	Less than 10 ppm
	Water Velocity	Less than 8ft/s	Less than 12 ft/s

Notes:

1. Harness in ppm is equivalent to harness in mg/l
2. Grains/gallon = ppm divided by 17.1
3. Copper and cupronickel heat exchangers are not recommended for pool applications for water outside the range of the table.
4. Saltwater applications (approx. 25,000 ppm) require secondary heat exchangers due to copper piping between the heat exchanger and the unit fittings.

WH Series Startup Form

Job Name: _____	Date: _____
Address: _____	
Model Number: _____	
Serial Number: _____	Tag: _____
Startup Contractor: _____	
Address: _____	
Phone: _____	

Pre Startup Checklist

Installing contractor must verify the following items.	
1. Is there any visible shipping damage?	<input type="checkbox"/> Yes <input type="checkbox"/> No
2. Is the unit level?	<input type="checkbox"/> Yes <input type="checkbox"/> No
3. Are the unit clearances adequate for service and operation?	<input type="checkbox"/> Yes <input type="checkbox"/> No
4. Have all electrical connections been tested for tightness?	<input type="checkbox"/> Yes <input type="checkbox"/> No
5. Does the electrical service correspond to the unit nameplate?	<input type="checkbox"/> Yes <input type="checkbox"/> No
6. On 208/230V units, has transformer tap been checked?	<input type="checkbox"/> Yes <input type="checkbox"/> No
7. Has overcurrent protection been installed to match the unit nameplate requirement?	<input type="checkbox"/> Yes <input type="checkbox"/> No
8. Have all set screws on the fans been tightened?	<input type="checkbox"/> Yes <input type="checkbox"/> No
9. Does the fan rotate freely?	<input type="checkbox"/> Yes <input type="checkbox"/> No
10. Does the field water piping to the unit appear to be correct per design parameters?	<input type="checkbox"/> Yes <input type="checkbox"/> No
11. Is all copper tubing isolated so that it does not rub?	<input type="checkbox"/> Yes <input type="checkbox"/> No
12. Are air filters installed with proper orientation?	<input type="checkbox"/> Yes <input type="checkbox"/> No
13. Have condensate drain and p-trap been connected?	<input type="checkbox"/> Yes <input type="checkbox"/> No

Ambient Temperature

Ambient Dry Bulb Temperature _____ °F	Ambient Wet Bulb Temperature _____ °F
---------------------------------------	---------------------------------------

Supply Fan Assembly

Alignment <input type="checkbox"/>		Check Rotation <input type="checkbox"/>		Nameplate Amps _____	
Number	hp	L1	L2	L3	
1					

Compressors/DX Cooling

Only connect gauges for troubleshooting

Check Rotation <input type="checkbox"/>					
Number	L1	L2	L3	Head Pressure PSIG	Suction Pressure PSIG
1					

Refrigeration System 1 - Cooling Mode

Due to the charge-critical nature of these units, charge must only be adjusted if absolutely necessary

	Pressure	Saturated Temperature	Line Temperature	Sub-cooling	Superheat
Discharge				N/A	N/A
Suction				N/A	
Liquid					N/A

Refrigeration System 1 - Heating Mode (Heat Pump Only)

	Pressure	Saturated Temperature	Line Temperature	Sub-cooling	Superheat
Discharge				N/A	N/A
Suction				N/A	
Liquid					N/A

Unit Configuration Cooling Mode

No Water Leaks <input type="checkbox"/>	
Water Flow _____ gpm	
Water Inlet Temperature _____ °F	Water Outlet Temperature _____ °F

Unit Configuration Heating Mode (Heat Pump Only)

No Water Leaks <input type="checkbox"/>	
Water Flow _____ gpm	
Water Inlet Temperature _____ °F	Water Outlet Temperature _____ °F

Water/Glycol System

1. Has the entire system been flushed and pressure checked?	<input type="checkbox"/> Yes <input type="checkbox"/> No
2. Has the entire system been filled with fluid?	<input type="checkbox"/> Yes <input type="checkbox"/> No
3. Has air been bled from the heat exchangers and piping?	<input type="checkbox"/> Yes <input type="checkbox"/> No
4. Is the glycol the proper type and concentration (N/A if water)?	<input type="checkbox"/> Yes <input type="checkbox"/> No
5. Is there a minimum load of 50% of the design load?	<input type="checkbox"/> Yes <input type="checkbox"/> No
6. If geothermal, does water piping include insulation?	<input type="checkbox"/> Yes <input type="checkbox"/> No
7. What is the freeze point of the glycol (N/A if water)? _____	

Maintenance Log

This log must be kept with the unit. It is the responsibility of the owner and/or maintenance/service contractor to document any service, repair or adjustments. AAON Service and Warranty Departments are available to advise and provide phone help for proper operation and replacement parts. The responsibility for proper startup, maintenance, and servicing of the equipment falls to the owner and qualified licensed technician.

Entry Date	Action Taken	Name/Tel.

Literature Change History

July 2022

First Version

January 2023

Second Version



AAON
2425 South Yukon Ave.
Tulsa, OK 74107-2728
www.AAON.com

WH Series ProFit
Installation, Operation &
Maintenance
V01030 · Rev. B · 230101

Factory Technical Support: 918-382-6450

Note: Before calling Technical Support, please have the model and serial number of the unit available.

Parts: For replacement parts please contact your local AAON Representative.

It is the intent of AAON to provide accurate and current product information. However, in the interest of product improvement, AAON reserves the right to change pricing, specifications, and/or design of its product without notice, obligation, or liability.