

GE STEAM POWER

**The Power of Yes.**



[ge.com/power](http://ge.com/power)



GE provides a full range of service solutions to help achieve optimum performance from your existing steam turbine portfolio. Drawing on GE's advanced service solutions and technology options and worldwide resources, our Steam Turbine application engineers have the required expertise to re-evaluate and reconfigure your unit to meet your current or future operating needs.

- More than 5000 GE OEM Steam Turbines installed globally
- Service Solutions for oOEM Steam Turbines
- Global Field Service organization with Steam Turbine specialists
- Solutions for a large number of Steam Turbines and Generators
- Workshop repairs and on-site repairs

### **Our offerings:**

Upgrade and Retrofit Solutions for improved output and efficiency • Turbine capacity adjustments • Life extension programs • Spare parts packages • Reverse engineered • oOEM spare parts • Customizes repair solutions • Minor and Major Overhauls • Availability and reliability improvements

## Table of Contents

### Introduction

**This is Steam Power**

**Total Plant Solutions**

Steam Power Plant Solutions

**Outage Services**

**Upgrades**

**Digital Solutions**

### Product Offerings

**Other Original Equipment Manufacturing (oOEM)**

**Digital Solutions**

**Steam Turbines**

**Industrial Steam Turbines**

**Multi-Year Agreements**

**Field Services**

**Customer Training**

**RePower and Relocation Services**

**Outcomes**

**Generators**

**Boilers**

**Air Quality Control Systems (AQCS)**

**Controls**

© November 2019, General Electric Company. GE Proprietary Information - This document contains General Electric Company (GE) proprietary information. It is the property of GE and shall not be used, disclosed to others or reproduced without the express written consent of GE, including, but without limitation, in the creation, manufacture, development, or derivation of any repairs, modifications, spare parts, or configuration changes or to obtain government or regulatory approval to do so, if consent is given for reproduction in whole or in part, this notice and the notice set forth on each page of this document shall appear in any such reproduction in whole or in part. The information contained in this document may also be controlled by the US export control laws. Unauthorized export or re-export is prohibited. This presentation and the information herein are provided for information purposes only and are subject to change without notice. NO REPRESENTATION OR WARRANTY IS MADE OR IMPLIED AS TO ITS COMPLETENESS, ACCURACY, OR FITNESS FOR ANY PARTICULAR PURPOSE. All relative statements are with respect to GE technology unless otherwise noted.





**Michael Keroulle**  
President & CEO - Steam Power

The steam power industry has never been more demanding. Operating budgets are tighter and the need for flexibility never more critical. When it comes to our customers' most pressing challenges, GE Steam Power is here to support them. When they come to us for help, our answer is "Yes."

Whether you're building a new power plant or maintaining one that's been running for decades, GE can provide hardware, software and manpower to help keep your plant running optimally, meeting all regulations and delivering power with the right returns. For the past 100 years, we've been a leader in cleaner coal technology and a trusted partner to deliver more value to our customers over the lifecycle of their plants. We are dedicated to technologies that are improving economics, are cleaner, and more sustainable.

Today the newest coal plants being built are using GE's ultra-super critical technology that can deliver 47.5% net plant efficiency rates — significantly higher than the global average of 34%. When you add GE's digital offerings, the results are even more impressive. And as the world's environmental regulations become even stricter, GE's broad portfolio of air quality control systems can help you meet the world's strictest regulations and provide cleaner air for local communities.

With a third of the global installed base each year, we perform more than a thousand outages and partner with our operators around the globe through more than 200 multi-year agreements. We have a hundred years of coal-fired power service expertise across 90+ OEM brands, and 24/7 on-call product support to help keep your power plant up and running. Every day, more than 6,000 field service engineers are on the ground, delivering solutions that ensure a productive future for power plants all over the world.

Can you count on GE to be your full lifecycle partner for coal and nuclear power plants? With local teams and service centers in more than 70 countries around the world, GE brings our global reach and local expertise to help our customers deliver affordable power, local jobs, and better infrastructure to help growing economies. Our employees use a century of steam power expertise to help customers overcome their toughest challenges. It's all about delivering higher efficiency, lower emissions and better economics for our customers around the world.

**This is our commitment to you. This is the Power of Yes.**

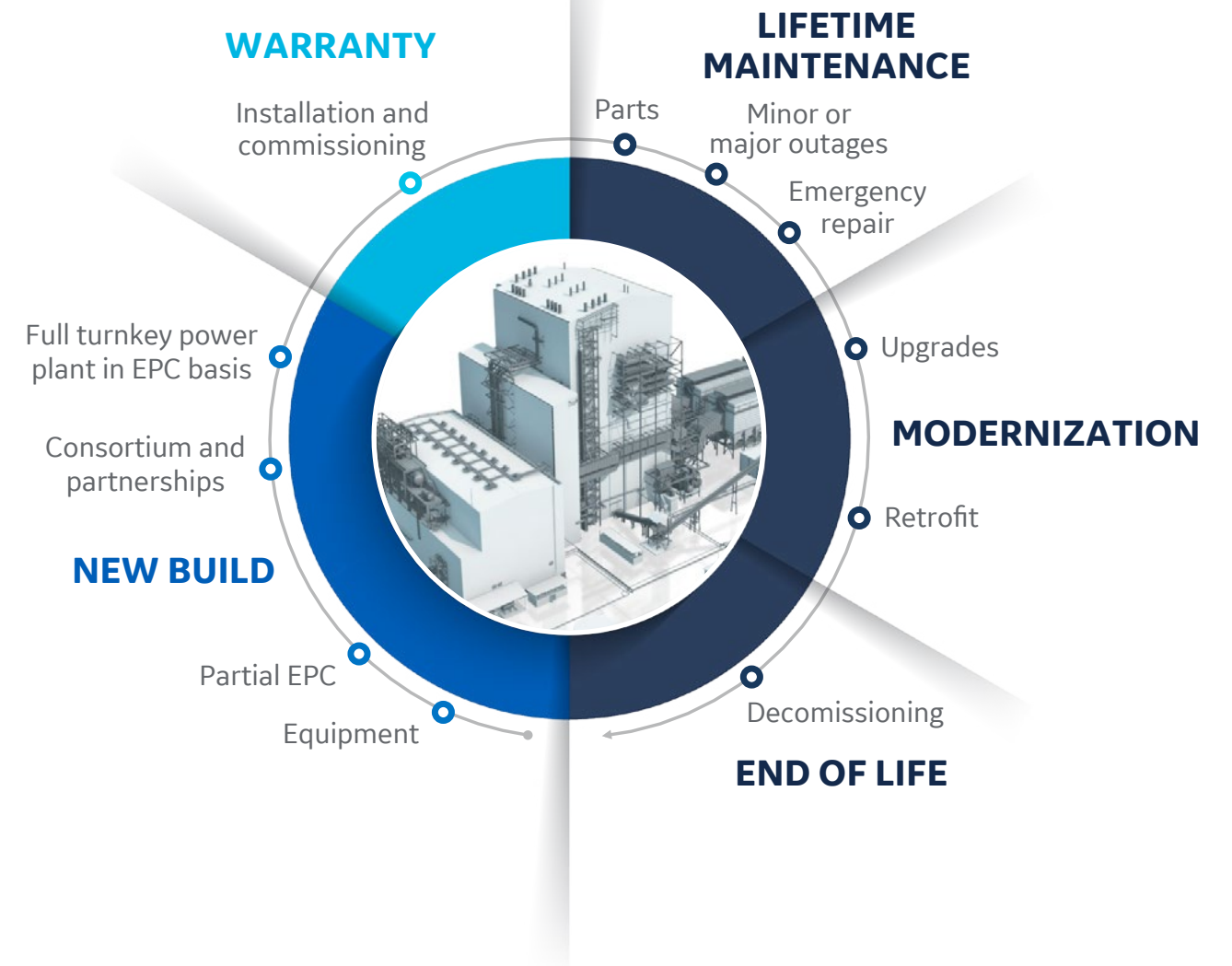



# This is Steam Power

## Your Steam Life Cycle Partner

Worldwide network of steam experts delivering services locally



### The World's Largest Installed Base

- ✓ 5000+ Steam Turbines
- ✓ 2500+ Generators
- ✓ 1000+ Boilers
- ✓ 4000+ AQCS



### Enabling Us to Deliver Each Year to Our Customers

- ✓ 1000+ outages
- ✓ 200+ long-term service agreements\*
- ✓ 100+ steam turbine upgrades
- ✓ 300+ inspections
- ✓ 60+ generator rewinds
- ✓ 50+ boiler upgrades
- ✓ 30+ AQCS upgrades



### Our Dedicated Community of Experts

- ✓ 24/7 product support
- ✓ 10,500 field service representatives
- ✓ Complete **OEM services partner**
- ✓ Services for **90+ other OEM brands**

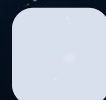

TOTAL PLANT  
SOLUTIONS



TABLE OF  
CONTENTS

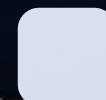

\* Including Managed Maintenance Programs (MMPs)



# Total Plant Solutions

Power producers around the world face growing pressure to drive their plants' performance to new levels—enhancing reliability, efficiency, output and flexibility while lowering life-cycle costs. In this increasingly competitive marketplace, you deserve a trusted partner with the expertise, technology and resources to help you achieve your desired outcomes. Through GE's portfolio, we can deliver solutions for total power plant assets across 90+ OEM brands, including:

## Solutions & Service

- Outage Services
- Upgrades
- Digital Solutions
- Multi-Year Service Agreements
- Field Services
- Customer Training
- Repower and Relocation Services

## Outcomes



Output



Efficiency



Reliability & Availability



Flexibility



Emissions

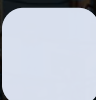



# Steam Power Plant Solutions

- **120+** years of “plant-as-a-system” expertise
- **90+** OEM brands serviced
- **120+** million hours of operating data analyzed
- **1** partner to deliver all of your plant solutions

Whether you’re operating a large fossil steam plant, nuclear plant or industrial plant, you need flexible and creative solutions. Steam Power can work with you to develop a strategy that enhances your current performance, while protecting you against future uncertainty.

- Large fossil steam plant ... operating cost reduction
- Industrial ... reliability and operating flexibility

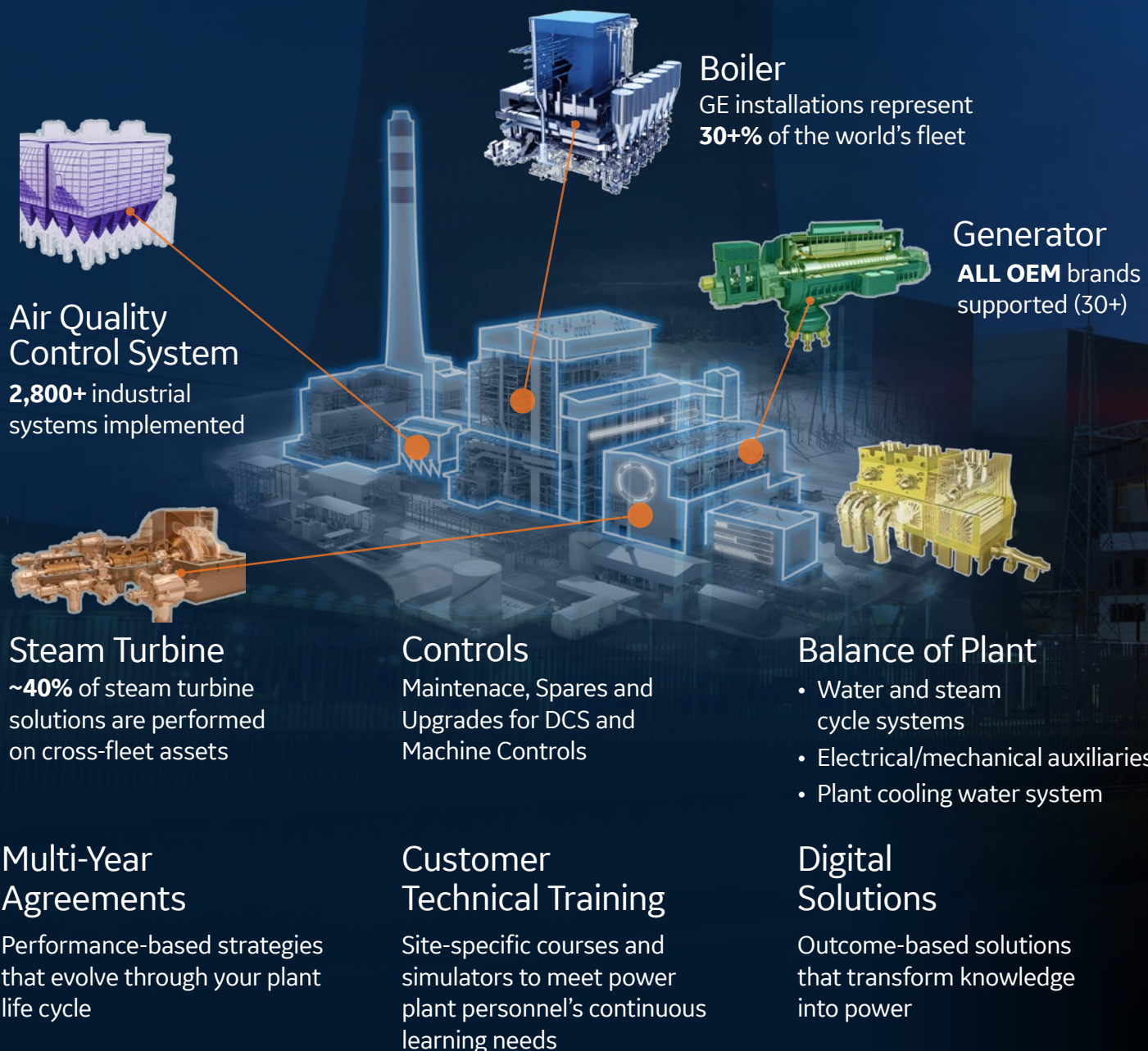

## OUTCOMES

- Output**  
South Africa’s Eskom Arnot steam plant partnered with GE to develop a plant solution including upgrades to turbine modules, boiler components and pumps that increased its output by **300 MW**.
- Efficiency**  
System-level upgrades from GE can reduce steam plant fuel costs up to **10%**.
- Reliability & Availability**  
PGE **Extended the life** of its Belchatow 6 plant in Poland 15 years by implementing a boiler, steam turbine and generator package solution.
- Flexibility**  
With OpFlex\* digital solutions, GE steam plant customers can turndown to as low as **10%** load.
- Emissions**  
GE plant solutions can be customized to help customers comply with country/region specific emissions requirements including technology to reduce SO<sub>x</sub> emissions up to 99%.



## Solutions Developed To Meet Your Needs

 [Click the links below for more information](#)





## **Output:** Is your plant ready to increase return on current capacity

Rapid changes in the power industry are making capacity management an increasingly critical operational challenge for power producers in today's volatile conditions, particularly plants providing reserve capacity during periods of high demand. GE can deliver an integrated view at the plant level and across all of your assets.

- Advance Steam Path Upgrades for small and large turbines
- Advance Steam Path Upgrades for oOEM
- Retrofits for Industrial OEM and oOEM

- Replacement Generator

- Boiler Upgrades and Tuning
- PV-PRO\* System for mills
- Pressure Part modifications

- AQCS mechanical and electrical upgrades
- SulfiTrac\* for reduced WFGD parasitic load
- EPOQ and OpOpt for reduced ESP parasitic load

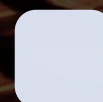
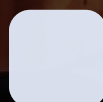





## Efficiency: Is your plant delivering on your desired business outcomes through enhanced efficiency?

The growing mix of renewables, volatile fuel prices and emergence of competitive applications globally requires today's power generation fleet to run more efficiently than ever before. Plants facing variable fuel prices, fuel quality and load levels are adopting new approaches to improve efficiency and reduce operating costs. GE's Steam Plant solutions can help your plant achieve better efficiency results with more frequent dispatch, more attractive margins and lower fuel costs.

- Plant Efficiency Advisor
- BoilerOpt
- Digital Boiler +
- Fuel Management Advisor
- Mill Optimization

### Advance Steam Path Upgrades covering:

- HP/IP/LP cylinders
- Coal Nuclear and Industrial fleet
- OEM and other OEM Steam Turbines

- Boiler Upgrades and Tuning
- PV-PRO\* System for Mills
- Pressure Part modifications

- SIR high-voltage power supply for ESP
- Upgraded Controllers for ESP-EPIC & ERIC; and for FF- EFFIC
- Optimization algorithms for ESP and FF operation
- SulfiTrac\* Sulfite Analyzer for wet FGD power reduction and mercury control
- Optipow valve for FF bag pulsing
- Isoswirl for SCR flow mixing optimization

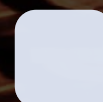
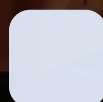





## **Flexibility:** Is your plant configured and controlled for enhanced cyclic operation?

Improved plant and fleet flexibility is essential when responding to the challenges of increased renewables, grid fluctuations and fuel price volatility. Plants are increasingly focused on increasing revenue during high demand while decreasing costs when demand is low. With cutting-edge tools and data-driven insights, GE can unlock new opportunities to increase your plant's flexibility.

- Digital Boiler +
- Rotor Stress Controller
- Turbine Startup Optimization
- Turbine Lifetime Advisor
- Mill Optimization

- OpFlex\* package
- Shell Warming System
- Low Load District Heating
- Steam Turbines Subject to Flexible Operation

- FlexSuite for Boiler including Low Load and Ramp Rate packages
- Fuel Conversions and Co-Firing
- Hot Gas Temperature Control Solutions
- Plasma Ignition System

- WFGD SulfiTrac\* for greater range of coal quality flexibility
- ESP EPOQ and OpOpt for greater range of coal quality flexibility

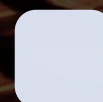
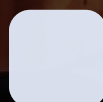





## Reliability & Availability: Is your plant providing the information and insights you need to proactively manage key performance metrics?

As the power industry faces a complex set of new dynamics and emerging disruptive forces to the operating environment, the expectation to maintain high reliability and availability benchmarks remains. Incentive and penalty levels associated with achieving these benchmarks are increasing in many regions. GE's proven technologies can help your plant meet rising performance expectations.

GE offers a broad portfolio of technical trainings to develop and retain high level of expertise of your personnel, supporting the efficient operation of your plant.

- Asset Performance Management
- Generator Health Monitoring
- Valves & Actuator Monitoring System
- Turbine Torsional Vibration Advisor
- Boiler Health Monitor
- Fuel Management Advisor

- Valve upgrades & retrofits
- Control System Upgrade
- Steam Path upgrades for large and Industrial OEM & oOEM
- Retrofits for large & Industrial OEM & oOEM
- Lifetime Assessment & Life extension

- AmStar\* Thermal Spray coatings
- Component Rebuilds
- T-PRO\* Fuel Firing System
- PV-PRO System for Mills

- Monitoring
- Robotic Inspections
- Rewinds
- Replacement Generator
- Auxiliary Systems Upgrades

- Preventive maintenance via Predix / ProMo for ESP and dry FGD

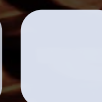
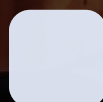





## **Emissions:** Is your plant prepared to increase returns within emissions regulations?

Power plants that rely on fossil fuels to generate electricity will play a significant role in producing the world's electricity long into the future. For example, coal-based power is expected to contribute 30% of the world's electricity through 2025. Changing regulations and developing emissions standards have created the need for active management of emissions levels. GE understands how to navigate evolving conditions and deliver tailored solutions to help your plant comply with stringent emissions regulations.

- BoilerOpt
- Digital Boiler +
- Mill Optimization
- Fuel Management Advisor
- Emission Scorecard

- Ultra Low NOx Burners
- Umbrella SNCR (U-SNCR)
- Fuel Conversions and Co-Firing
- Bottom Ash and Fly Ash Systems

- Mer-Cure for advanced Mercury reduction technology
- ESP and FF upgrades for particulate control
- Wet and Dry FGD upgrades for SOx control
- SCR Upgrades for NO<sub>x</sub> control



Can GE increase  
my plant  
lifetime and  
availability?

# YES.

In just **six months** GE designed, manufactured and replaced the stations 40-year-old Stator Core for Kriel power plant, South Africa. This was a first of its kind complex modification project in the region and an important project for the station in bringing back Unit 2 into full service. With a total capacity of 3000 MW, the stations six generators were originally built in 1971 by Brown by Boveri Company and are one of many legacy brands that we support in our services business.

**This is the Power of Yes.**

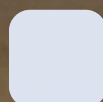

TOTAL PLANT  
SOLUTIONS



TABLE OF  
CONTENTS

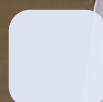



## PARTS

GE uses advanced engineering techniques and high-quality materials to manufacture spare parts that help you get more out of your assets. Every part is thoroughly tested and backed by our OEM warranty, leading to improved output, increased efficiency and extended maintenance intervals.

## REPAIRS

Our advanced repair solutions are cost-effective, properly scoped to your operational needs and enhanced to reduce your downtime. Our vision is to support one of the world's best-running fleets, and we do this by delivering new capabilities and programs, all of which are driven by a culture of accountability and a commitment to your organization's desired outcomes.

## MAINTENANCE

Make the right decisions about repairs, replacement and appropriate upgrades for performance improvements with help from GE's outage services team. Proper planning and expert support are essential to minimizing the length of your outages and decreasing downtime.

 [Click the tabs below for more information](#)

[Steam](#)

[Generator](#)

[Boiler](#)

[AQCS](#)



Can GE help to retrofit my existing plant?

# YES.

GE helped modernize India's 1,350 MW Ukai power station by upgrading the high-pressure and intermediate-pressure full modules and a low-pressure inner block. The retrofit extended the life of the plant by **25 years**, and restored its output to its original 200 MW capacity. The project also helped the plant **reduce its coal consumption** by more than **140,000 tons per year** and its CO<sub>2</sub> emissions by **180,000 tons per year**.

**This is the Power of Yes.**

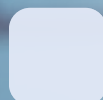

TOTAL PLANT SOLUTIONS



TABLE OF CONTENTS

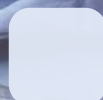



# Adapting to a Changing Industry

The global power industry is changing rapidly. Today's power plants are required to operate in new ways that differ from their original concept. GE's comprehensive suite of plant upgrades provides the capability and flexibility to position your plant for a successful future.

Whether you need more output, improved emissions, extended asset life or enhanced operational flexibility to run at lower loads or on a non-traditional fuel, we can customize a solution to meet your commitments.

## Steam Power's solutions portfolio can:

- Improve plant heat rate as much as 15%
- Increase output by up to 10%
- Reduce emissions to as low as 5 ppm NO<sub>x</sub>
- Help achieve part-load operation as low as 10% load with emissions compliance
- Extend asset life up to 20 Years
- Harness digital insights to drive plant improvement and scenario evaluation

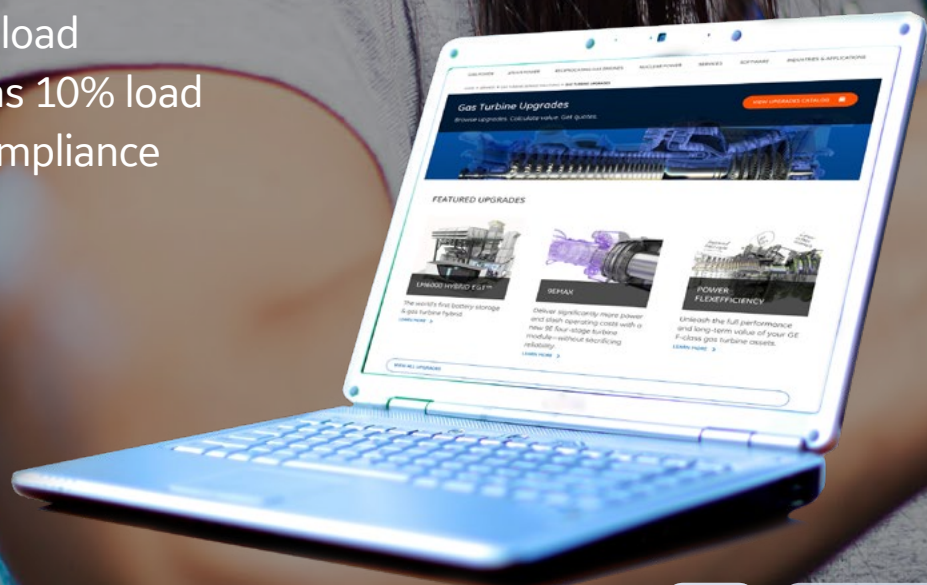

[i Click the tabs below for more information](#)

Steam

Generator

Boiler

AQCS





# Industry in Transition

The convergence of industrial with digital is transforming the way we power our lives. Decarbonization, decentralization, digitization, democratization — these trends are creating an environment of disruption and driving the need for digital industrial software and services. In response, energy needs to become more efficient, reliable, secure, and sustainable.

The energy landscape will change more over the next 10 years than it did in the previous 100. In addition to the expansion of digital power solutions, power generation will grow more complex and encompass a diverse range of sources. Renewable energy will expand exponentially, and with more people installing solar and scrutinizing the sources of their electricity, a new type of customer — the prosumer — is emerging.

Challenges? Yes, but also unprecedented opportunity — at least for forward-thinking organizations. Success in this new digital power era will require adaptation, innovation, and leadership. Energy companies of the future will be predictive, prescriptive, and fully autonomous. And we stand ready to help reach these goals with energy software that harnesses the potential of an entire connected system. By creating a common data fabric, making applications modular, layering in machine learning, and taking a distributed approach with architecture and execution, we can help you achieve Network-Level Optimization.



# Multi-Year Service Agreements

In today's dynamic industry, power producers are challenged to deliver more flexibility and improve profitability. Through our multi-year service agreements, we continue to demonstrate our commitment to adding value to your operations as a long-term partner. To meet these demands, GE is transforming its approach to service agreements by integrating digital technologies and the actual hands-on maintenance work, with a lifetime view.

GE's digitally enabled MYA's provide a unique framework to integrate GE's digital applications with highly skilled and specialized experts to streamline the maintenance process for your core equipment. There is no single model to a MYA, we leverage our expertise and technology tools to develop a customized program that protects both your equipment and your business objectives.

MYA's provide predictable cash flows, a streamlined procurement process, improved outage planning, risk management, maintenance cost reduction and guaranteed outcomes to secure your business results in today's challenging environment. Through GE's portfolio of Steam Plant solutions, our MYAs look beyond the power island to increase value and enable your plant to be more competitive and attractive in the industry.

## Delivering Productive Outcomes



Plant Profitability



Plant Competitiveness



Plant Attractiveness

## How We Help Enable Them



Customer Technical Training



Asset Management Planning



Maintenance, Repairs and Field Services

Advanced Technology Upgrades



Software and Data Analytics Solutions



Total Plant Capabilities



Flexible Commercial Models



# Field Services

## A Global Field Services Powerhouse

GE's expert team of field services personnel has deep technical knowledge and cutting-edge tools to deliver the outcomes you need. Our technical field advisors, craft personnel and on-site services teams are highly regarded across the industry for their ability to create customized solutions to virtually any power generation challenge, when and where you need it.

### Field Services will deliver:

- More productive, reliable, outcomes
- Greater communication and collaboration with you and within our team
- One team of technical field advisors, craft personnel and other field services experts
- Standardized processes and consistency in field service methods and practices
- Operational excellence in all we do
- A structure offering you the right mix of GE's total plant capabilities



**SOLUTIONS POWERED BY GE'S TOTAL PLANT CAPABILITIES**



**SHARED VALUES OF SAFETY, QUALITY AND INTEGRITY**



**EXPERT PROBLEM SOLVERS WITH ADVANCED TOOLS & TECH**

**150 MILLION HOURS**  
OF OPERATING DATA

**125+ YEARS**  
COMBINED FIELD SERVICES EXPERIENCE

**90+ OEM BRANDS SERVED**

**EXTENSIVE EXPERTISE**



**ENHANCED COLLABORATION**



**BETTER COMMUNICATION**



**FLAWLESS EXECUTION**

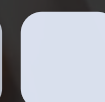
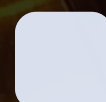

<sup>1</sup>A proposal to transfer Power Services field services fulfillment activities and related support functions in Europe to field services and the proposed organization design is being discussed with employee representatives across Europe as appropriate and where required by law before any final decisions are taken. This process is likely to take some months and the proposed transfer to field services to be implemented on a phased country by country basis.



# Customer Training

## Meeting your continuous learning needs

A continuous path of learning helps plant personnel gain the knowledge and skills needed to run an efficient, successful plant. GE Power Services Customer Training can suggest the right mix of training options to align with your plant configuration, equipment technology, employee audience, and time constraints.

- **Site-Specific Courses.** Our high value training service offers a variety of 200 courses that are tailored to your specific site by your assigned GE instructor and dedicated training project manager. Courses are delivered either at your site or at one of our global learning centers in the language of your choice, and on a schedule that works for you. Courses may contain a mix of classroom learning, site walkdowns, and hands-on training.
- **Open Enrollment Courses.** With technology-specific content, our Open Enrollment training offers a comprehensive selection of more than 75 English-language courses for small staff or new team member training, or to expand the skills of select employees. Your employees train at one of our learning centers with students from around the world. Courses offer a mix of classroom learning techniques, and may contain walkdowns and/or hands-on training.
- **Online Courses.** A cost-effective solution for a broad range of employees, our 25-plus Online English-language courses let you train your personnel anytime, anywhere, and at their own pace. Each course ranges in duration from one to four consecutive hours, and can be started and stopped at the student's discretion.
- **Multi-Year Training Agreements.** Simplify your training, budgeting, and planning efforts with our long-term flexible training offering. This agreement entitles you to a fixed number of annual training days for GE's Site-Specific and/or Open Enrollment courses, unlimited use of all our available Online courses, plus exclusive access to our Remote Turbine Operations Simulator. We partner with you throughout your plant's lifecycle to help you select the training solutions that best meet your evolving needs.

## GE Power Services Customer Training

### Comprehensive Flexible Training Solutions to Meet your Total Plant Needs

Digital Solutions | Steam Turbines | Generators | Boilers | HSRG



Plan & Install



Operate & Maintain



Upgrade



Improve



Leadership



Supervisors



Operators



Mechanical  
Maintenance  
Engineers



Electrical  
Maintenance  
Engineers



Instrumentation  
& Controls  
Specialists

[www.geenergytechnicaltraining.com](http://www.geenergytechnicaltraining.com)

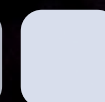



Can GE help  
increase  
production at  
my steel plant?

# YES.

Working with one of the world's leading steel producers, POSCO, our team is retrofitting 50-year-old steam turbines. Nearly **doubling its ability to generate steam** for steel production, the solution will enable POSCO to meet its production goals and stay competitive globally.

**This is the Power of Yes.**





# RePower and Relocation Services

## RePower

Achieve significant performance improvements in output and fuel efficiency to restart the clock on your plant's life with GE's RePower service. This complete shaftline upgrade can improve your existing turbine's performance and add years of profitability and life to your power plant. With more than 100 successfully completed flange-to-flange replacement projects across all frame sizes and on five continents, GE has the proven capability and experience to craft the right solution to keep your plant running at its peak potential. GE can RePower existing GE assets or non-GE assets to gain significant performance improvements for your plant. With GE's RePower and relocation services, you can:

- Address multiple asset improvements in one simple upgrade
- Reduce emissions to comply with new regulations
- Increase profitability by improving your steam turbine, plant efficiency, reliability, availability and output
- Lower lifecycle maintenance costs

## Plant Rehabilitation and Relocation

Plant rehabilitation and relocation provides operators with a fast track to reliable power supply, combining our plant integration expertise with the proven performance of GE equipment.

Rehabilitating plants that are currently in standstill mode, partially dismantled or damaged offers operators a quick path to power recovery and an opportunity to inject technology for more competitive operation.

Plant relocation is an option to not only revitalize an underutilized asset, but also move it to a more advantageous location. Through this program, we help you return standstill units to operation.

For Industrial Steam Turbines, our competitive engineering studies and inspections are supporting you evaluating an equipment to be reapplied or resold for another application

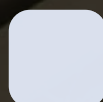
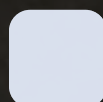



# Product Offerings

 Click the tabs below for more information

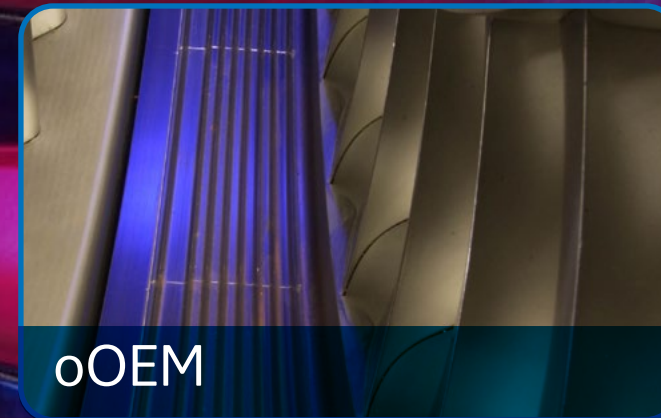



# Steam Turbines



**5,000+** installed units



Up to **1,755 MW** configurations



More than **110 years** of steam turbine experience  
 – 1,000+ utility steam turbine upgrades from all major OEM fleets



**Strategic outage planning** for **rapid response** to emergent needs

- Experienced steam turbine specialists in every region
- Fulfillment process aligned to support long-lead critical parts
- Commercial process to support your inquiries



Wide **variety** of offerings to **meet your key needs**

## Key Programs:

- ASP upgrades for large fossil LP
- SEC/DEC 600MW ASP solutions
- ASP upgrades for Industrial ST OEM

- Shell Warming System
- Low Load District Heating
- Steam Turbines Subject to Flexible Operation

- Dense Pack Advanced Steam Path upgrade
- Full Shaft line package for Chinese OEM
- Fossil Plant Solution for Regulatory Compliance
- Hitachi™/Toshiba™ Steam Turbine ASP

- Valve Upgrades for extended maintenance interval
- Control System Upgrades
- ASP Upgrades for AEG KANIS and Wesel
- Lifetime Assessment and life extension





# Global Repair Service Centers

STEAM TURBINE REPAIR NETWORK

Through our continual investment in local resource development, GE is well-positioned to deliver repair services where and when you need them. Critical to managing our global presence, GE has mastered the logistics necessary to maintain reliable supply chains, coordinate resources, and comply with regional regulations.



# Electro-Mechanical Testing

SPECIALIZED TESTS FOR IMPROVED PERFORMANCE

Our specialized tests help you detect unusual condition before they become serious problems. The following tests and activities are typically recommended by GE's Product Services team to improve unit performance:

- **Torsional testing** Determines resonant frequencies for torsional vibration. This test supports engineering to help ensure adequate separation between the rotor train and grid frequency.
- **Acoustic testing** Measures sound pressure levels and analyzes spectral content to identify root causes of excessive machinery noise.

- **Operational deflection shape (ODS) modeling** Deduces the cause of excessive vibration and develops recommendations for resolution. A vibration survey is conducted to build a three-dimensional "forced running shape" model of the unit.
- **Improved tenon stress relief** Greatly reduces environmental health and safety (EHS) and quality concerns with the salt bath process for relieving welded tenons through this self-contained induction stress relief system.





# Onsite Services

## REPAIR OFFERINGS

Transporting turbine components off site for repair can increase your outage time by days or weeks, while the additional handling requirements can expose the equipment to risk of further damage.

GE's On-site Services (OSS) offers highly technical onsite inspections and premium repairs for global power generation customers through our EHS, quality, technical, and operational excellence. We work hard to meet and exceed your expectations, on budget, every time. We bring the inspection and repairs directly to your location to help you reduce outage time and achieve substantial cost savings. Our On-site Inspection and Repair teams offer:

- **Comprehensive services:** We provide a full range of services—from typical inspections, repair and machining to highly specialized services offered by GE Power.
- **Extensive tooling:** GE's OSS is one of the largest onsite service organizations, with more than 500 pieces of portable equipment and an extensive tooling inventory.
- **Experience:** Our team of qualified GE specialists includes machining supervisors, engineers and technicians with an average experience level of more than 20 years.
- **Global responsiveness:** All equipment is completely mobile and can be transported to any required destination around the world within hours of notification.

### Steam Turbine Inspections

GE's inspection services help prevent catastrophic high-speed rotor issues. Each configuration requires the following rotor-specific tests and analysis:

- Boresonic inspection of older bored rotors looks for indications of deterioration from the inside to the outside.
- Periphery ultrasonic testing for solid rotors examines the outside of the rotor for indications of potential issues.

- Phased array wheel dovetail testing looks for indications of stress corrosion cracking (SCC) in time to repair the wheel and prevent bucket liberation.
- Wheelsonic inspections employ a series of tests to evaluate the integrity of wheels on a built-up, low-pressure rotor.
- Finger bucket dovetail inspections provide a comprehensive look that includes:
  - **Non-destructive Testing (NDT)**
    - Boresonic inspection system
    - UT bucket attachments (STG wheel dovetails)
    - MT bucket attachments (STG wheel dovetails)
    - Wheelbore
    - Solid rotor volumetric
  - **Electromagnetic Testing (EMT)**
    - Rotor/bucket instrumentation
  - **Borescope**
    - Hot borescope

### Steam Turbine Repairs

- **Machining**
  - Collector ring grinding
  - Stud drilling and tapping
  - Bore plug removal/installation
  - Valve bore and chest repair

- **Welding**
  - Diaphragm repairs
  - Faro arm inspections
  - Shell and joint repairs
  - Valve seat replacements
- **Bucket Repair**
  - Bucket replacement/repair
  - Cover installation and machining
  - Finger-dovetail pin replacements
  - Tie wire brazing and repair
  - Tenon welding and cover foxholing

- **On-site Machining**
  - Diaphragm fit machining
  - Computer numerical control (CNC) dovetail/longshank machining
  - Dense pack upgrades
  - Coupling line and mirror boring
  - Horizontal joint machining
  - Large rotor machining
  - Journal machining
  - Low-speed balance

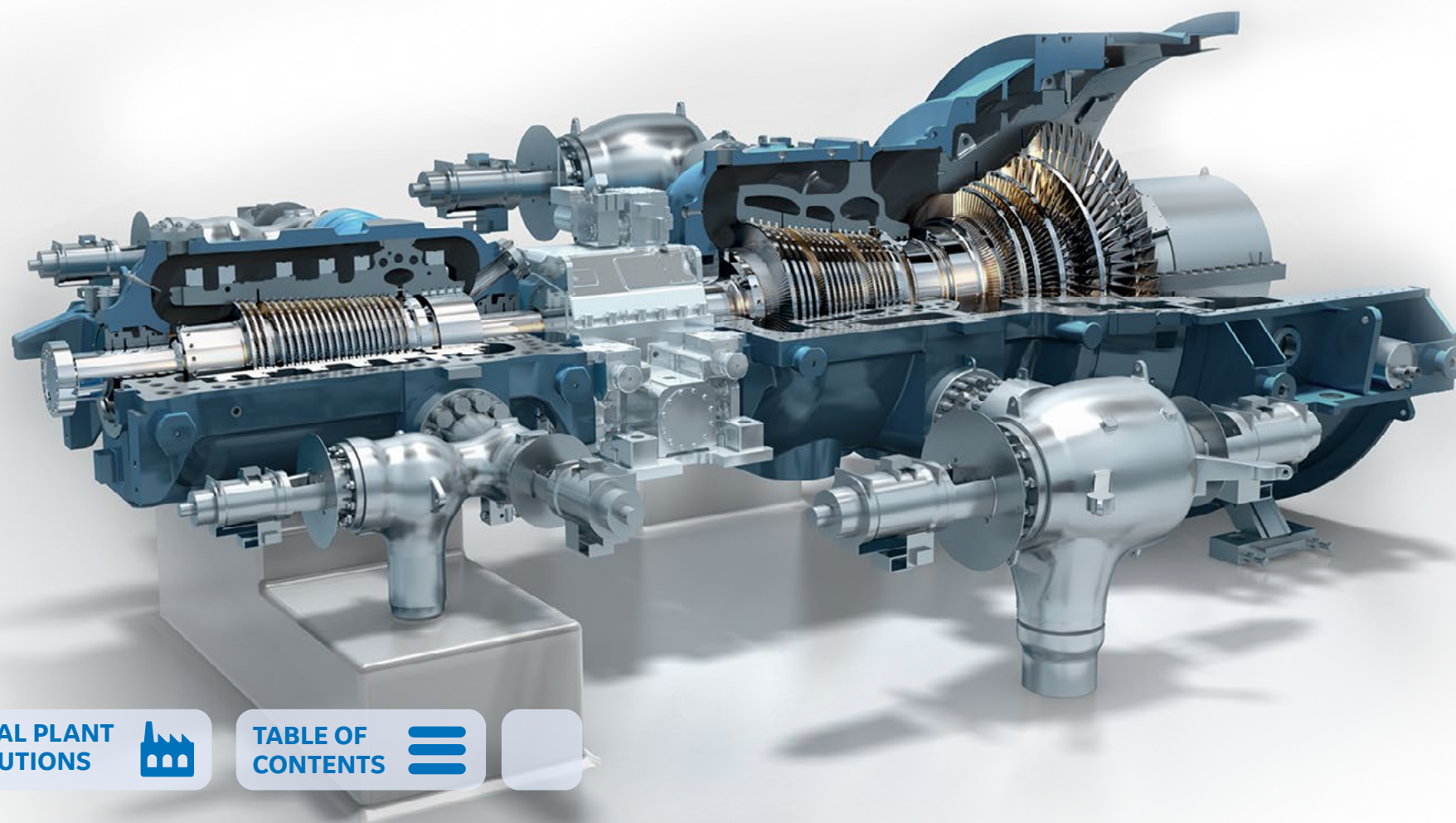



# Steam Turbine Maintenance

EFFICIENCY IN PLANNING AND EXECUTION

GE performs a comprehensive range of overhaul and field services, and has a wealth of experience covering all GE and non-GE machine types, including impulse and reaction. These machines include 3,000 rpm and 3,600 rpm fossil units, nuclear units (including half-speed, wet machines) and high-speed industrial turbines.

With a global network and mobile workshops in a variety of strategic areas, GE is able to provide quick and effective engineering services at any location. These services include manufacturing and specialist repair of any part, from individual buckets to a new rotor.

We also provide a full range of outage planning, management and execution activities. Unplanned work is significantly reduced, thanks to our extensive fleet management experience. We achieve this by working with you to ensure that maintenance is properly targeted and spare parts are always ready in the best lead time.



### Outage Applicability

Major	Minor
✓	✓

# Steam Turbine Repairs

A RANGE OF SPECIALIST TECHNIQUES

To save the cost and lead times associated with replacement parts, GE offers a range of complex repair techniques. Many of these relate to weld repairs, as follows:

- **Rotor repairs:** With more than 80 years of welded rotor technology experience, GE provides joining of new forged sections, shaft buttering, disc repair, and disc head buildup with new material. We also offer a number of techniques for straightening rotors.
- **Blading repairs:** With experience across the range of impulse and reaction blading, GE provides dressing and weld repairs for all types of fixed and moving buckets, including linking and attachment features. For last stage buckets (LSBs), we also offer leading edge hardening and shielding options.
- **Casing repair:** GE can correct minor cracking and change the geometry of highly stressed areas. We can also re-round distorted casings and add new weld material.



### Outage Applicability

Major	Minor
✓	✓





# Blade Stocking Program

QUICK RESPONSE TO YOUR DEMANDS

To meet the needs of a challenging generation industry, GE is focused on quickly responding to your demands. Our blade stocking program is one example. It employs a cross-departmental process to support emergent blade requests for the following blade types:

- Fossil last-stage and L-1 blades of a broad range of sizes
- Industrial rear stage blades
- Blades for several Steam Turbines from the GE family designs

## Outage Applicability

Major	Minor
✓	✓

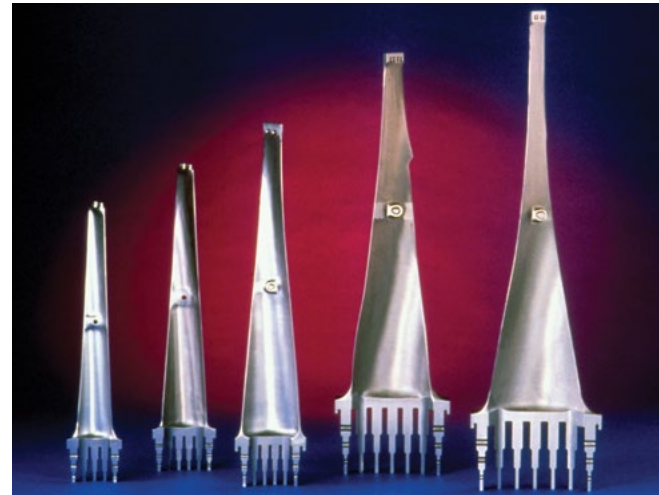

# Parts for Non-GE Turbines

QUALITY REPLACEMENTS FOR ALMOST ANY TURBINE

With a broad technology legacy and extensive experience with other manufacturers' machines, GE can provide replacements for almost any turbine. When drawings and data are not available, we use our established laser scanning and re-engineering process. In addition to providing manufacturing data, the CAD model provides the basis for an engineering analysis. This allows us to offer technology improvements, including advanced materials and standard part replacements.

## Outage Applicability

Major	Minor
✓	✓

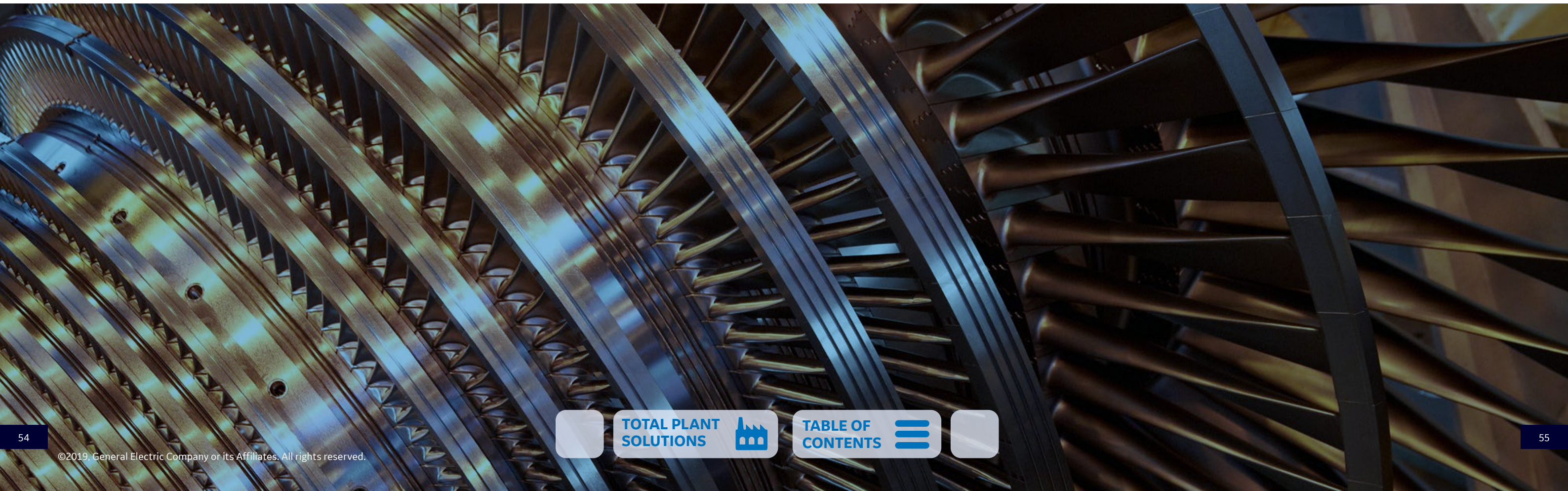



# Advanced Steam Path (ASP) Upgrade

IMPROVE EVERY ASPECT OF YOUR OPERATION

Steam turbines generally have a working life of 30 years or more. During this time, improvements in technology enable designs of greater efficiency, reliability and flexibility. However, because large generation assets are difficult to replace, operation often is extended, and additional reliability issues arise.

Many of the advantages of new technology can be applied by replacing major components on an existing machine. This alleviates plant changes, as well as related civil engineering work. Upgrades involving a new rotor, known as retrofits, can be applied to individual cylinders, or the entire turbine. The digital solutions, such as, Asset Performance Management (APM), Rotor Stress Controller, etc. can also be implemented to address reliability and flexibility. The following projects can be executed within a typical major outage period:

- Efficiency improvement
- Output improvement
- Life extension
- Reliability and availability improvement
- Reduced maintenance
- Digital enhancement

We also provide a full range of outage planning, management and execution activities. We can implement the above improvements on steam turbines from GE or from other OEMs.

## Outage Applicability

Major	Minor
✓	

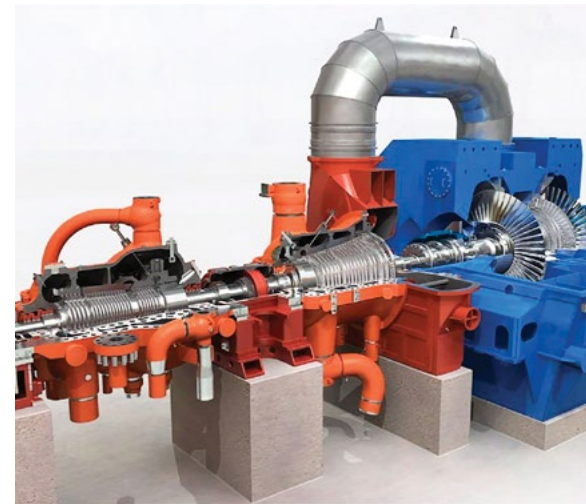

## Technical Data

Efficiency improvement	Output improvement
Up to 10% (depending on cylinder)	Up to 10% (depending on cylinder)

# Steam Turbine Services

GREATER OUTPUT, EFFICIENCY AND OPERATING LIFE

Expand the output and efficiency capabilities of your GE steam turbine equipment without sacrificing reliability or asset life.

In addition to improving reliability and extending asset life, we provide a complete range of cost-effective steam turbine solutions spanning inspections to complete flange-to-flange upgrades for industrial, fossil, and nuclear steam turbines from 5 MW to 1,700 MW. With more than 110 years of experience in the manufacturing, installation and maintenance of steam turbines, GE has a global installed base of more than 5,000 steam turbines. Our team has performed more than 1,000 conversions, modifications, and uprates while responding to thousands of planned and emergent outages.

Regardless of your needs, GE has the capability to

support planned and unplanned outages. Understanding the criticality of reducing downtime, our team can help you extend equipment running time between planned maintenance outages; eliminate unplanned outages with our digital solutions for monitoring and diagnostics; and reduce the duration of necessary outages. Our steam turbine services offer the following benefits:

- Short cycle (less than 10 days)
- Advanced thermal balance capability
- Execution of services onsite or at a regional certified GE repair shop





# Dense Pack\* Advanced Steam Path (ASP) Upgrade

IMPROVE EFFICIENCY ON MATURE ASSETS



## Outage Applicability

Major	Minor
✓	

Improve the efficiency of your mature steam turbines, enhance plant profitability and competitiveness, and extend the life of your assets with Dense Pack steam path re-configuration technology. This upgrade solution can help decrease aerodynamic losses and leakages within the steam path to help drive better efficiency across your entire power plant cycle. These upgrades are available for high-pressure (HP) or high-pressure/intermediate-pressure (HP/IP) sections of fossil units—typically 300 MW or larger—that are scheduled for an outage within the next three or more years, or that have extensive maintenance needs. Our upgrades provide:

- Advanced aerodynamic buckets and nozzles
- Various coatings that help your steam turbine last longer between outages, with less damage caused by solid particle erosion (SPE)
- Advanced sealing technologies (such as brush seals, elliptical packing, and improved clearances)
- Modern mechanical technology (such as rugged control stage buckets and Gen2 integral covered buckets)





# ASP Upgrades for Fossil LP Rotors & Back End Optimization

IMPROVE TURBINE OUTPUT, PARTS RELIABILITY, AND OPERATION LIMITS



Extend your parts and component reliability, even as your steam turbine experiences different load levels, with GE's fossil LP rotor replacement and upgrade. Delivering up to a 2.5% improvement in turbine output—due to increased annulus area and better steam path flow—this upgrade can reduce outage duration by 21 days, compared to rotor Fineline\* weld repairs during unplanned outages.

A well-integrated system control approach provides automation to reach optimal conditions and reduce operator involvement and variability.

The new alarm and trip limits expand the safe operating space, particularly for sites that have experienced operating limitations on hot summer days due to limitations of air-cooled condensers.

The LP rotor replacement is applicable to all units that are experiencing reliability issues due to SCC or other similar phenomena.

The fossil LP rotor upgrade:

- Offers advanced steam path technology providing improved performance
- Provides more efficient, cost-effective, and reliable last stage blades
- Increases annulus area
- Provides increased cycling capabilities
- Allows extended rotor inspection interval of 10 years
- Increases operating space regarding backpressure alarm/trip

## Outage Applicability

Major	Minor
✓	✓

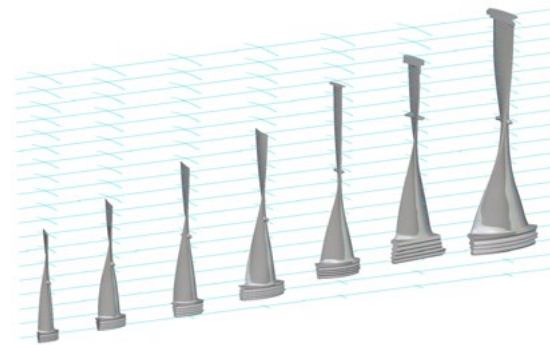

50Hz UST LSB portfolio





# ASP Upgrade for Small Steam Turbines

IMPROVE EFFICIENCY AND OUTPUT

Improve the efficiency and output of your boiler and reactor feed pump turbines with advanced steam path technology. Our small steam turbine upgrade:

- Addresses pump degradation or replacement
- Sustains performance
- Increases reliability and availability by addressing TIL 1206

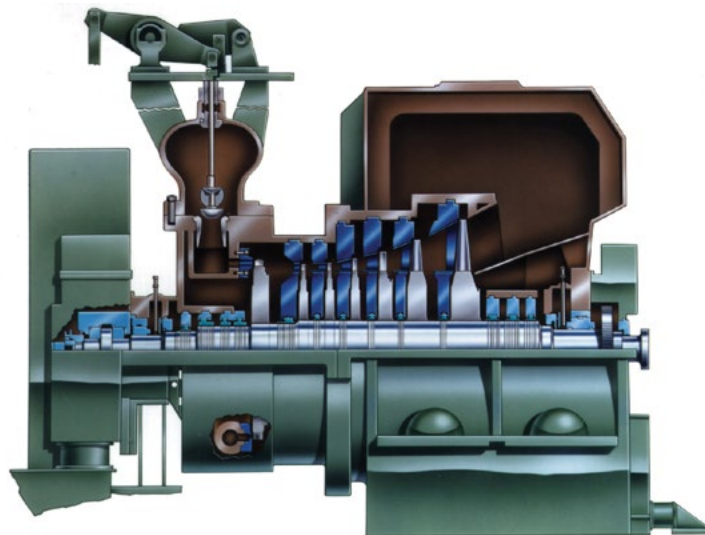

Improve the efficiency and output of your mechanical drive and small generator drives for industrial applications with unit-specific steam path upgrades, using advanced steam path technology. Our upgrade:

- Accommodates change of use, such as process flows and new steam conditions
- Sustains performance
- Increases reliability and availability

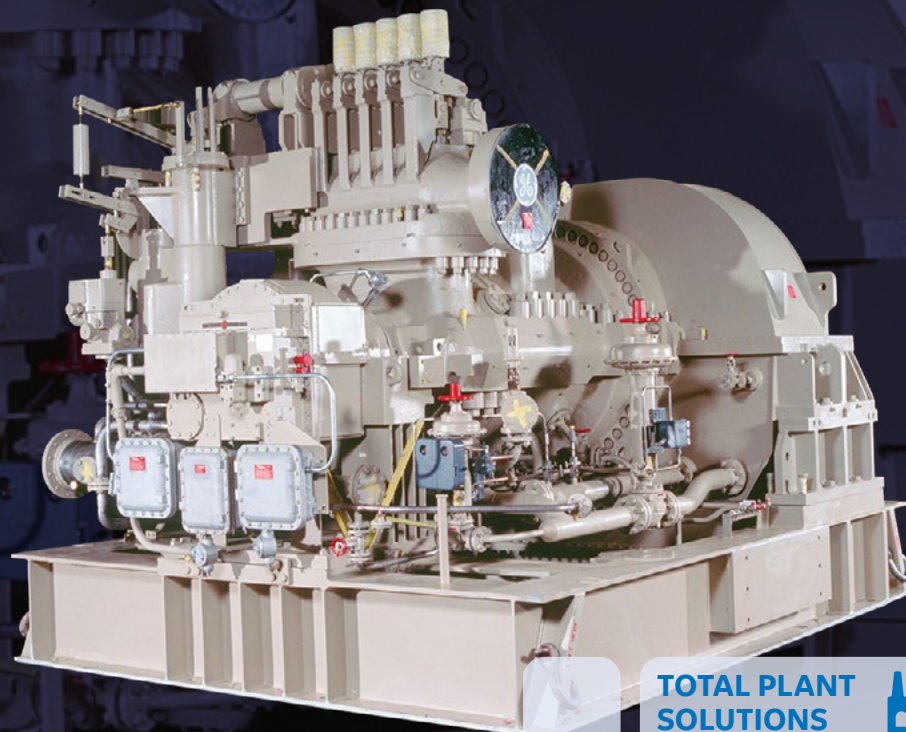

# ASP Upgrade for Nuclear Steam Turbine

ENHANCE EFFICIENCY AND RELIABILITY

A number of “built-up” rotors have experienced SCC in key ways in nuclear and supercritical steam environments. To address these SCC issues, GE offers LP monoblock rotors and LP section upgrades. Both of these solutions increase reliability by eliminating shaft and wheel bore crevices where harmful SCC contaminants can concentrate, and by reducing wheel stresses. The LP section upgrade offers incremental performance benefits by applying high-efficiency buckets and diaphragms, an advanced steam guide, enhanced sealing, low-stress dovetails, integral covered buckets, and a modern 43-inch last stage bucket.

**The LP Monoblock Rotor offers the following benefits:**

- Significantly reduces SCC susceptibility in the wheel dovetails
- Reduces rotor in-service inspection scope due to boreless rotor
- Improves output and heat rate for units with the 43-inch L-0, resulting in up to 1% improvement in output

**The LP section upgrade offers the following benefits:**

- Significantly reduces SCC issues through new low-stress dovetail configuration
- Improves turbine output and heat rate:
  - 38- to 43-inch L-0 stage bucket delivers up to 4.5% in output improvement
  - L-0 stage bucket delivers up to 3.5% in output improvement
- Delivers reduced inspection requirements and an extended rotor inspection interval of 10 years

**Outage Applicability**

Major	Minor
✓	

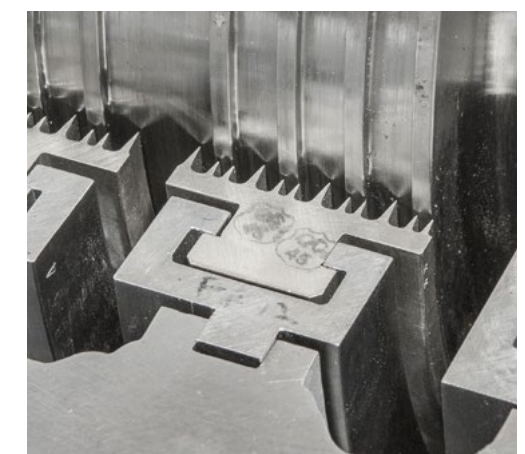



# Shell Warming System

IMPROVE START TIME AND LOADING



Unit availability and component reliability of the steam turbine fleet are key focus areas for owners. Reducing top-to-bottom shell temperature differentials greatly lessens the likelihood of rub-induced vibration events. GE has developed a robust system that delivers startup flexibility by ensuring temperature uniformity across shells. This upgrade is intended for the HP/IP shell (single-shell configuration), and enables the unit to maintain a set temperature for the turbine shell while reducing transient shell deflections. These deflections target reduced seal wear, which corresponds to longer sustained HP/IP section efficiencies. When combined with GE's Agility\* offering, start times (cold, warm, and hot) are reduced. Our shell warming system:

- Provides faster steam turbine start times; helps eliminate cold starts
- Delivers improved cyclic life expenditure improvements. Cold starts have the potential to incur largest cyclic life debits
- Provides better sustained performance. There are fewer vibrations/rubs, and less seal wear during starts and stops
- Further improves start time when combined with Agility software

## Outage Applicability

Major	Minor
✓	✓

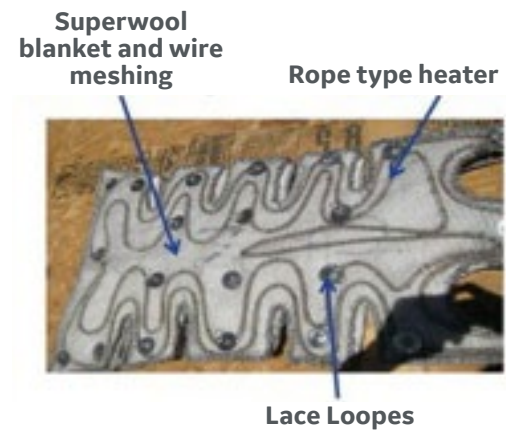

Electric heating blankets installed on upper half in between HP and IP exhaust bowl to drive shell upward during startup, reducing shell sag.

Add top and bottom inner and outer thermocouples.

Electric heating blankets are installed on lower half in between HP and IP to minimize upper to lower shell delta T's during shutdown cooldown.

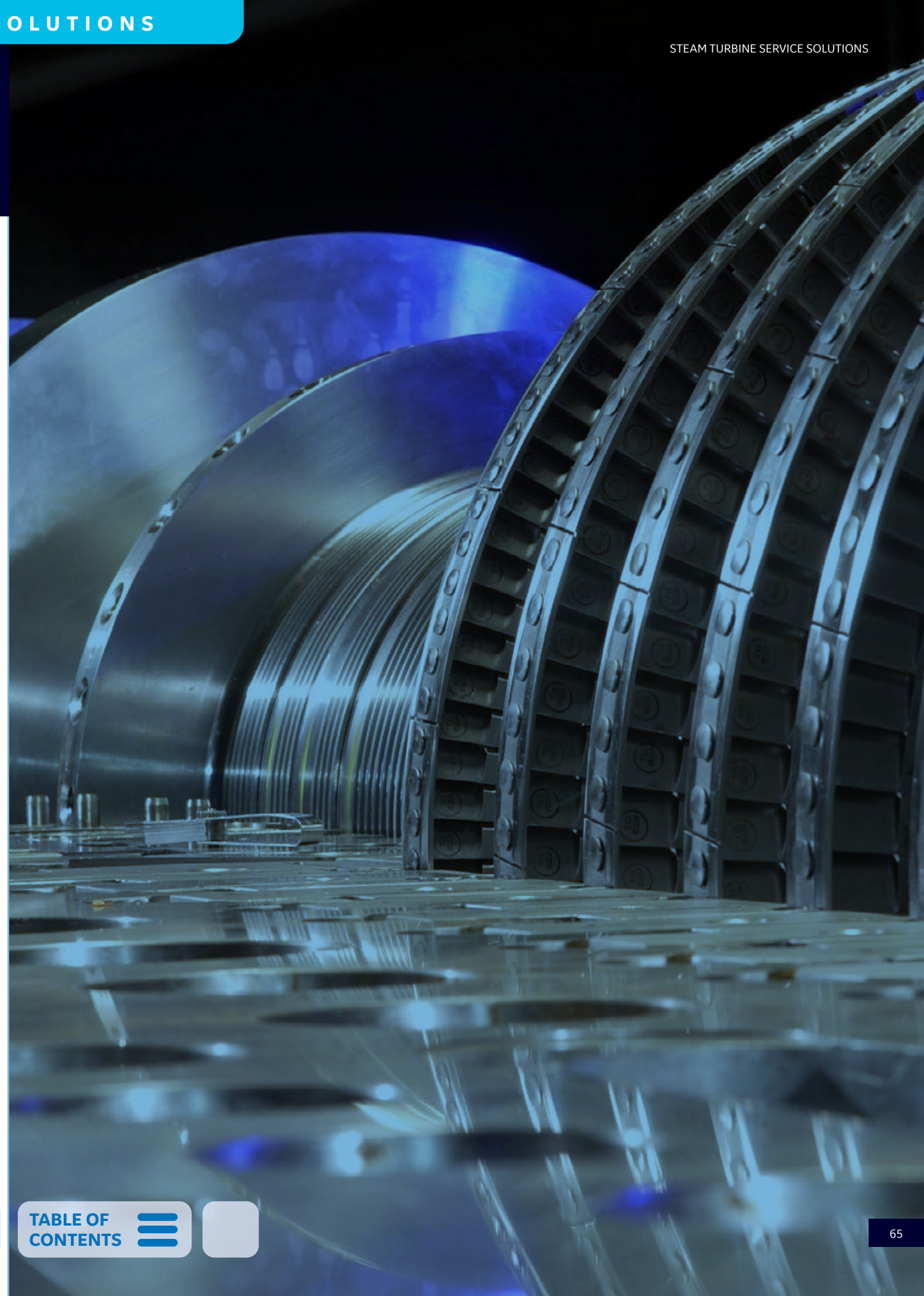
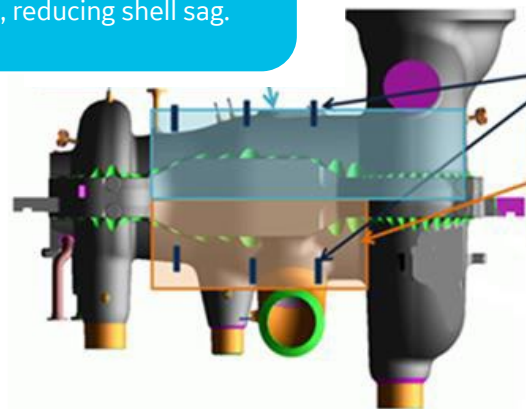



# Valve Upgrades

IMPROVE LIFE, EFFICIENCY AND CONTROL FLEXIBILITY

After many years of operation, steam chests and valves begin to suffer from end-of-life issues such as thermal cycling damage and the interaction of creep and fatigue. These problems may be compounded by demands for more flexible operation. Older valve technologies may also feature less than optimum flow paths and poor control precision.

GE has a wealth of experience in upgrading valves on many fleets and machine types. The most common way to achieve significant benefits is to upgrade the parts to improved, modern technologies. These can be adapted to the geometry, layout and interfacing systems of the unit under consideration.

GE has also developed a digital package with additional sensors to provide assessment functions for valve monitoring and diagnostics, including solid particle erosion, clearance life, casing life and actuator performance, etc. Our valve upgrades offer the following benefits:

- Lifetime extension
- Efficiency improvement
- Control improvement
- Digital enhancement



## Outage Applicability

Major	Minor
✓	



TOTAL PLANT SOLUTIONS

# Control System Upgrades

RELIABILITY AND PRECISION TO MEET MODERN EXPECTATIONS



## Outage Applicability

Major	Minor
✓	

Steam turbines depend on the reliability, accuracy and flexibility of their control systems. Modern electricity grids demand ever more stringent levels of control that cannot be met by older systems, particularly those that preceded modern digital electronics.

Based on many years of experience in turbine manufacturing and servicing, GE has developed a range of control upgrade solutions, both for our own machines and those of other manufacturers. These solutions are tailored to meet your specific requirements and may incorporate other plant areas or improvements to valve actuators. Our control system upgrades offer:

- Operational flexibility
- Lifetime extension
- Improved reliability and availability
- Reduced O&M costs

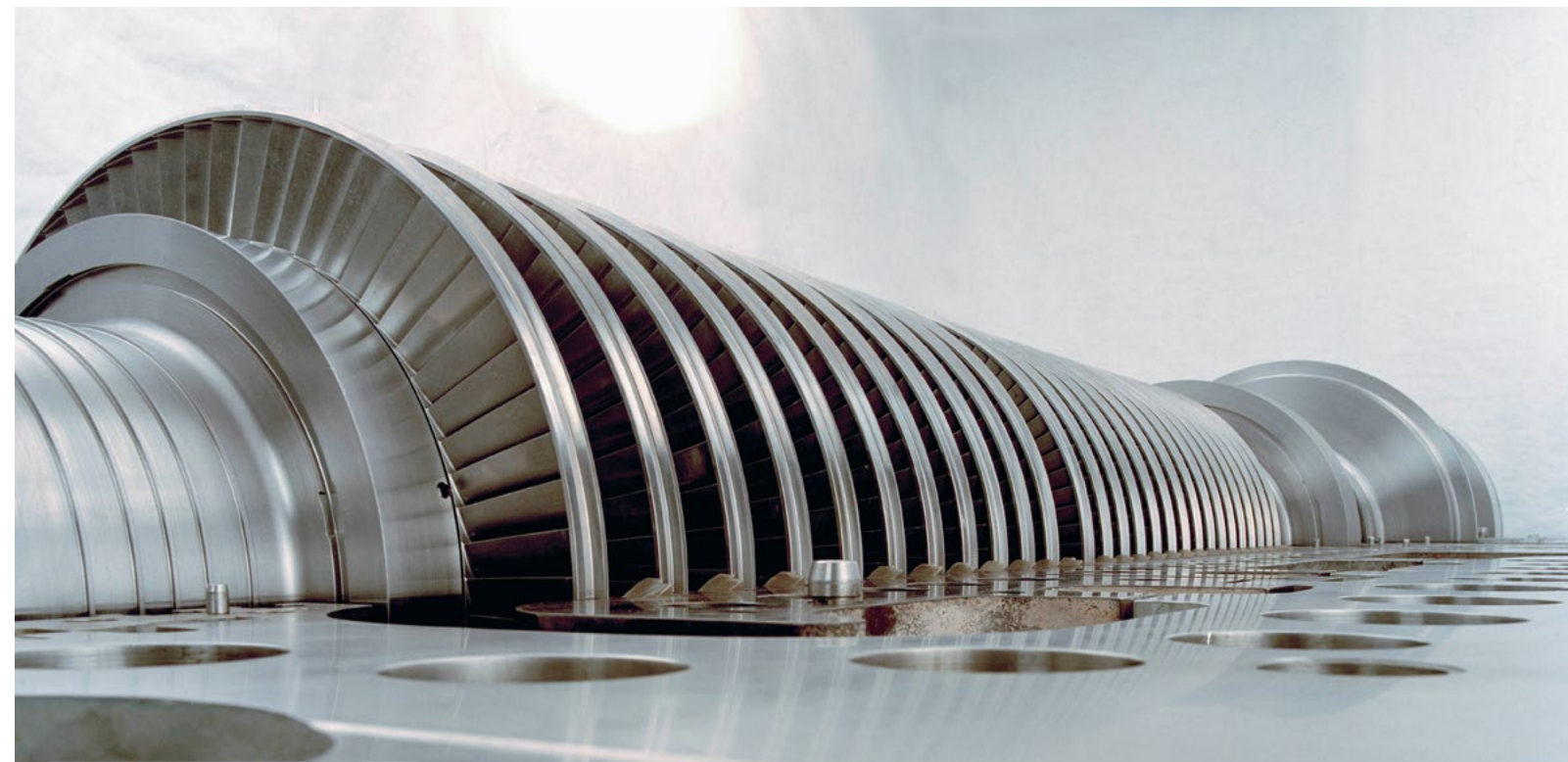

TABLE OF CONTENTS



# Industrial Steam Turbines

GE provides a full range of service solutions to help achieve optimum performance from your existing steam turbine portfolio. Drawing on GE's advanced service solutions and technology options and worldwide resources, our industrial steam turbine application engineers have the required expertise to re-evaluate and reconfigure your unit to meet your current or future operating needs.

- More than 4,500 installed globally
- Service solutions for more than 20,000 oOEM
- Global field service organization with industrial steam turbine specialists
- Solutions for a large number of industrial steam turbines and generators
- Workshop repairs and on-site repairs

## Offerings

- Upgrade and retrofit solutions for improved output and efficiency
- Turbine capacity adjustments
- Life extension programs
- Spare parts packages
- Reverse engineered oOEM spare parts
- Customized repair solutions
- Minor and major overhauls
- Availability and reliability improvements





# Service Solutions for Industrial Steam Turbines

## Field Service

With best practices and advanced tools for disassembly and assembly, GE plans carefully to reduce downtime and ensure on-time completion with the highest quality results.

### Our offering:

- Maintenance services, e.g. minor and major overhauls
- Erection and commissioning
- Removal and installation
- Condition assessment and non-destructive testing
- Site repairs

## Reconditioning and Repair

GE has developed an array of proven repair techniques for all parts of the industrial steam turbine.

### Our offering:

- Rotor repairs, straightening, balancing, weld repairs, disc head repairs, disassembly, and rebuild
- Casing repairs and re-rounding
- Guide blade carrier and diaphragm repair
- Control stage and blading repairs
- Sealing realignment and replacement
- Bearing rebabbiting

The repairs are usually executed in our specialized repair workshops or even on-site with our mobile repair equipment.

## Mobile Workshops

- Full shaft-line machining of rotors
- Balancing of rotors
- On-site machining for turbine and generator components, including casings, shafts, and valves
- Specialized mechanical and electrical testing for generators

## Parts Offerings

GE provides spare parts for its legacy machines and for a large number of non-GE industrial steam turbines. GE's extensive expertise in reverse engineering enables us to support our customers with standard and complex industrial steam turbine parts during ongoing overhauls.

### Our offering:

- Steam turbine blading
- Blades or unbladed rotors
- Guide blade carriers
- Diaphragms
- Gland segments
- Bearings
- Valve internals and actuators
- Fasteners, gaskets, and seals
- Filters, consumables

## Improvements

Our improvements offering is designed to boost the turbine's reliability and efficiency and can even reduce CO<sub>2</sub> emissions by replacing individual parts with improved components.

### An improvement upgrade can be the answer to a large number of issues that our customers are facing:

- Generic technical issues
- Parts lifetime
- Performance and efficiency degradation
- Parts obsolescence

GE offers a large upgrade portfolio, ranging from improved sealings, bearings, valve components, and steam path blading to improvements for control systems, hydraulic systems, and generator parts.

## Performance Improvement

Performance upgrades and retrofits can give a steam turbine a new lease on life, boost reliability and efficiency, and can help to reduce CO<sub>2</sub> emissions.

This can be achieved by partial or full steam path components replacement, which is designed and manufactured with latest engineering tools and methods

### The upgrade and retrofit replacement scope can include:

- Individual steam path modifications of individual blading stages
- Complete exchange of inner module, including new rotor
- Flange-to-flange turbine replacement

GE's retrofit and upgrade solutions can be installed during a standard or slightly extended turbine outage.

## Plant/Process Changes

Changes in the customer's production process may require turbine modifications

- Capacity changes
- Extractions mass flow change
- Controlled extractions
- Admission and/or exhaust modifications

Based on customer's needs, GE evaluates the new requirements to determine modifications required for optimal operation at the new conditions.

### This could include:

- Uprate: Modifying to increased power or flow needs
- Derate: Optimizing performance for reduced power or flow needs
- Process steam adjustments: Changed or even controlled steam extraction

### Our offering:

- Steam path re-calculation and optimization
- Parts replacement scope determination
- Design and component supply
- Installation, commissioning, performance measurement





Can GE help  
me stay  
competitive as  
an industrial  
power facility?



# YES.

We have a **century of experience** in the industry sector. Recently, our team delivered a steam turbine upgrade for one of the world's largest ammonia producers, as well as supplied spare turbine parts for compressor trains. The results? The facility reduced its operational costs by **doubling the length of time** between maintenance intervals.

**This is the Power of Yes.**



TOTAL PLANT  
SOLUTIONS



TABLE OF  
CONTENTS

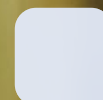



# Other Original Equipment Manufacturing (oOEM) Solutions



115 years of **power generation and Industrial** services experience



Plant solutions for **90+ oOEM brands**



**4,000+** engineers globally



**50+** repair shops in **25 countries**



**3,200+** monitored plant assets across numerous **oOEMs**



**24/7** monitoring and diagnostics

With the largest services portfolio in the industry, Steam Power can support more than **90 oOEM** brands across all major plant assets.



**80+ steam** turbine oOEM brands, including: Siemens, KWU, Westinghouse, Toshiba, MHI, and LMZ

**~40%** of steam turbine upgrade solutions are performed on cross-fleet brand equipment



**Maintenance and repair solutions** for steam turbine brands, including: Siemens, LMZ, SEC, Ansaldo, and Electrosila



Capabilities to service **oOEM brands**, including: Siemens, Ansaldo, BHEL, BRUSH, generators manufactured by Chinese OEMs, Electrosila, Electrotyazhmash, MHI, Hitachi, and Toshiba

Additionally, our robust portfolio of digital solutions features breakthrough power generation capabilities that bridge assets across your plant and fleet infrastructures, delivering OEM—agnostic turnkey solution regardless of the configuration.



# Other Original Equipment Manufacturers

GE SOLUTIONS FOR STEAM TURBINES

Within our holistic service offering, ranging from engineering consultancies up to modernizations and APS, we cover 20-plus oOEM brands.

## Technical Support

- Root cause analysis
- Life time assessments
- Multi-year agreements

## Field Services

- Annual/Minor/Medium/Major inspections
- Experienced personnel
- Local support

## Spare Parts

- Wide range of spare parts
- Fast reverse engineering
- High quality and improved design—all parts meeting GE design standards

## Repairs

- Simple and complex (e.g. rotor strengthening)
- Mobile machining
- Service workshops

## Upgrades/System Improvements

- Steam path upgrades
- Valve upgrades
- ST auxiliary system upgrades

## ASPs

- Cylinder retrofits—inner blocks and full modules
- Shaft-line retrofits, including auxiliary systems



**+20 oOEM** brands covered by our services



**+30 inspections** executed globally on oOEM STs



**+420 oOEM** cylinders retrofitted by GE, on all continents, all major brands

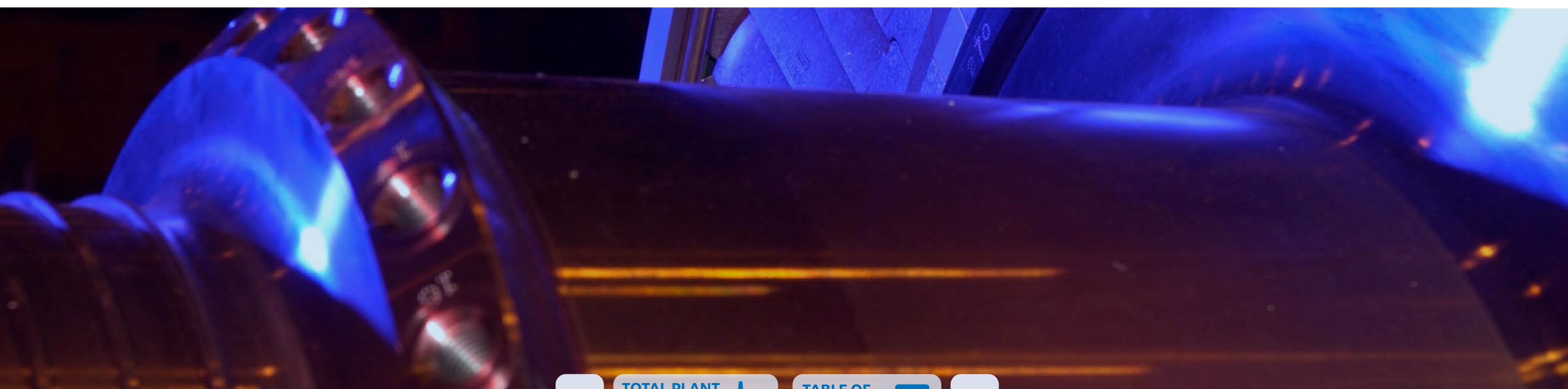



# Other Original Equipment Manufacturers

FOR GENERATORS, BOILERS AND AQCS

Our oOEM portfolio spans supply, repairs, multi-year agreements (MYAs), inspections, upgrades and digital solutions, while applying patented technologies to help extend maintenance intervals and improve asset performance for over 90 oOEM brands across major plant assets.

## Air Quality Controls System (AQCS) Solutions

**Our portfolio includes:**

- Comprehensive parts replacement, including reverse engineering, design improvement and supply
- Advanced technology upgrades to digital solutions
- Field Service for minor and major overhauls
- Life extension

## Generator Solutions

**Our portfolio includes:**

- Sensor monitoring of equipment operation to support condition-based maintenance
- Robotic inspections not requiring field removal to reduce outage time and lower maintenance costs
- Rewinds for all conventionally cooled turbine generators within a C-inspection
- Large stator upgrades for steam nuclear and coal plants to extend output and operating life

## Boiler Solutions

**Our portfolio includes:**

- Comprehensive parts replacement, including reverse engineering, design improvement and supply
- Advanced technology upgrades to digital solutions
- Field Service for minor and major overhauls
- Fuel conversions and emissions solutions
- Life extension

By harnessing GE's MYAs, you not only have access to our numerous commercial and operational offerings, but also benefit from outcome-based solutions warranted by our unprecedented digital capabilities.



**1000+ oOEM assets** now being monitored



**MYA contracts** on steam plants with oOEM equipment that **guarantee improvements** in asset performance and customer service over the life of the contract

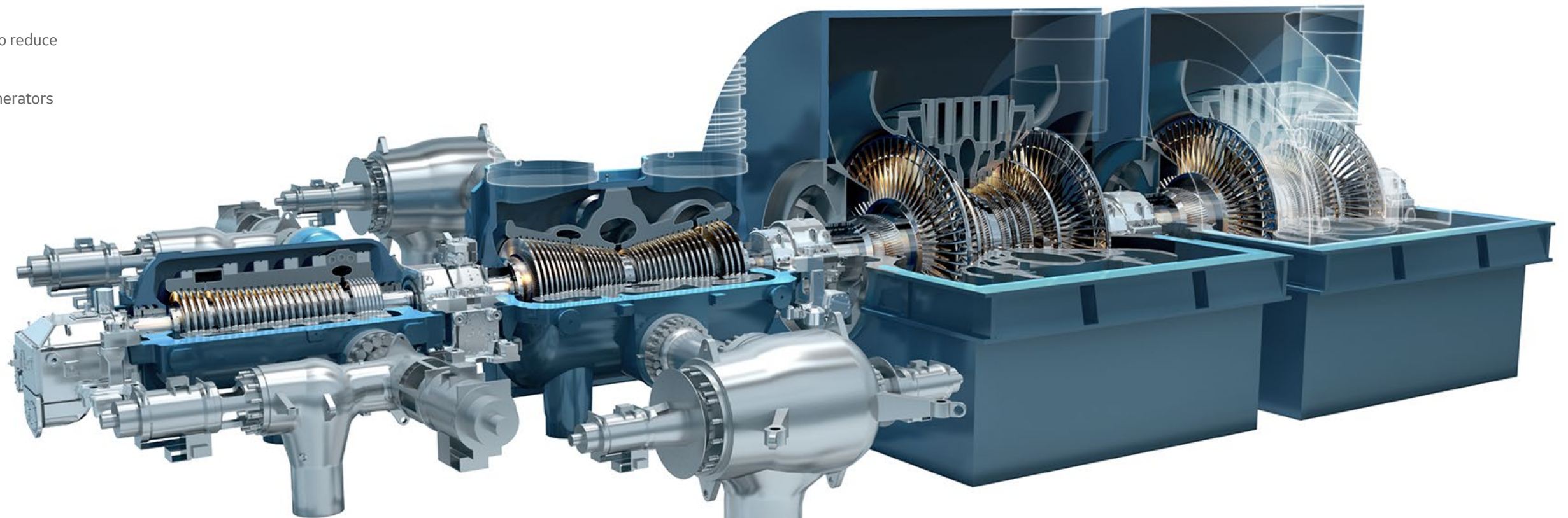

TOTAL PLANT SOLUTIONS



TABLE OF CONTENTS





Can GE fully  
refurbish my  
coal plant  
running  
on oOEM  
equipment?

# YES.

Our teams can work on more than **90 oOEM brands**, and we are currently doing just that for two coal power plants in Turkey – Yeniköy and Kemerköy. With the steam turbine, generator and boiler coming from different competitors, we will modernize and refurbish the plants to boost the **efficiency level by 6%** and significantly decrease local pollution.

**This is the Power of Yes.**

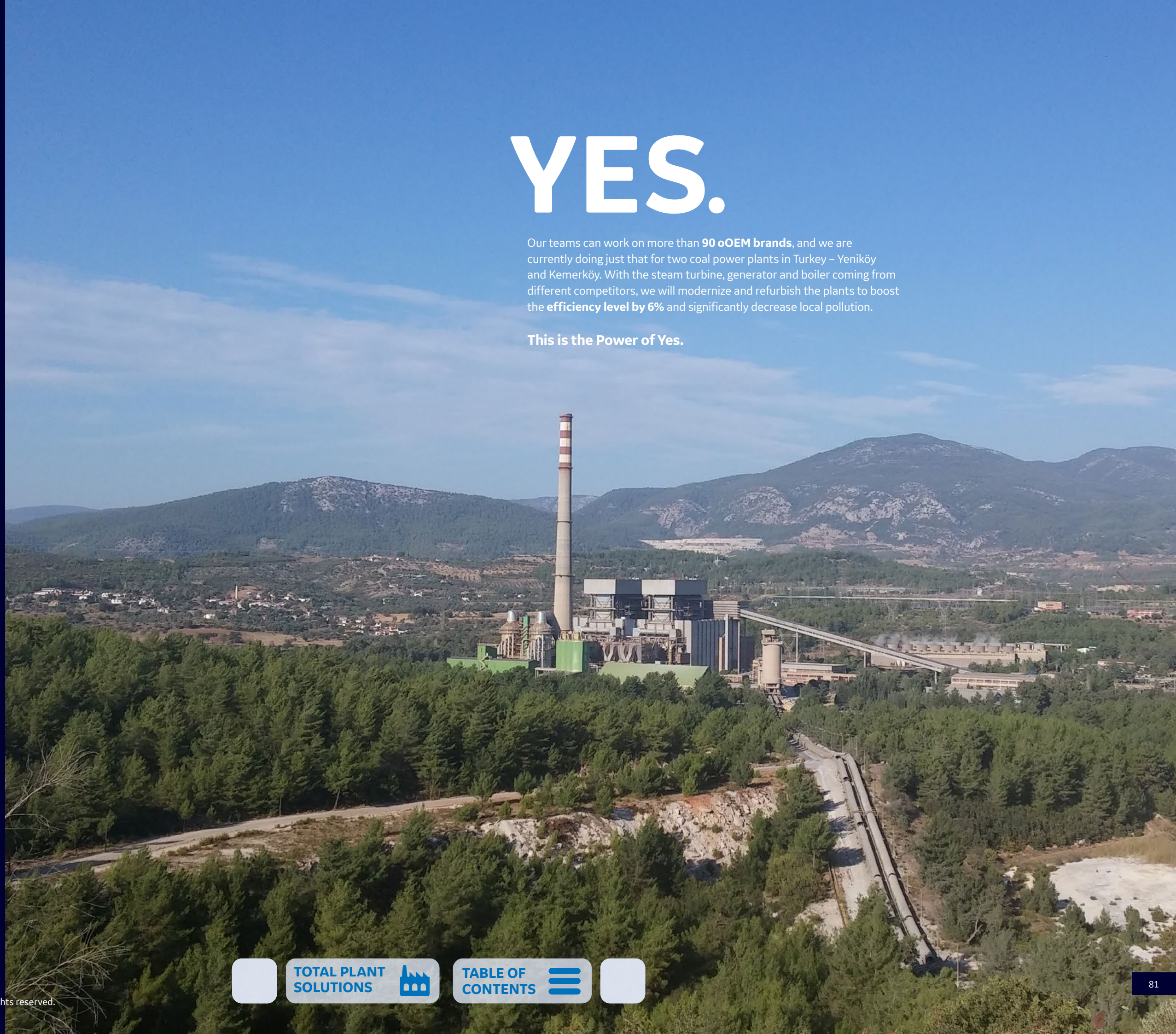



# Generators



**100+** years of experience

- 700+ rewinds over the last decade
- **1000+** outage inspections each year, including **160 robotic** inspections



World-class **response time** for emergent needs

- Strategically placed facilities for any kind of repairs
- Large pool of highly trained, safe, and experienced generator specialists and winders



**Continuous investment** in upgrade and repair technology



**Comprehensive portfolio** of solutions built around critical needs of any type or make of generator



**Leading online monitoring solutions** to support condition-based maintenance

## Key Programs:

- Monitoring
- Robotic Inspection
- Stator Rewind
- Rotor Rewind
- Replacement Generator
- Auxiliary Systems Upgrades



# Generator Health Monitoring

HIGHEST LEVEL OF ASSURANCE

GE's remote Generator Health Monitoring provides a comprehensive service to any operator to assess the health of the generator by supplying key information for condition-based maintenance and to help prevent unplanned downtime and losses.

For the highest level of assurance, opt for remote continuous online monitoring and benefit from weekly checks and in-depth reports from our experts.

GE's Generator Health Monitoring provides the following benefits:

- Early fault identification
- Extended outage intervals
- Fewer unplanned outages
- More accurate planning and execution of outage work



### Outage Applicability

Generator Closed - Visual	Generator Open Rotor In - Minor	Generator Open Rotor Out - Major
✓	✓	✓



### Suite of Modules

#### Available Modules

Partial Discharge

Rotor Flux

Rotor Shaft Voltage

End Winding Vibration

#### Stand-alone Boxes

Collector Health Monitor

Stator Leakage Monitoring System

# GOLD\* Service

ECONOMIC CONDITION MONITORING FOR YOUR GENERATOR



### Outage Applicability

Generator Closed - Visual	Generator Open Rotor In - Minor	Generator Open Rotor Out - Major
✓	✓	✓

Our periodic online monitoring service allows you to cost-effectively assess the condition of your generator, for any original equipment manufacturer (OEM). It involves the installation of permanent sensors, followed by twice-yearly measurements and an expert report, allowing you to make informed decisions about your planned maintenance.

GOLD Service benefits include:

- Extended outage intervals
- Fewer unplanned outages
- More accurate planning and execution of outage work

### Technical Data

#### Available Modules

Partial Discharge

Rotor Flux

Rotor Shaft Voltage





# Generator Offline Inspection, Rotor In-Situ (Air-Gap)

GREATER OPERATIONAL CONFIDENCE BETWEEN MAJOR OUTAGES



GE's offline inspection solutions include the latest robotic tool technology that can perform a complete air gap inspection program with the rotor installed.

Combining GE's robotic inspection technology and field service expertise, we can help provide an increased level of operational confidence between major outages. In-situ offline inspections are fully embedded in GE's modular condition assessment portfolio, and can enhance outage duration and reduce risks related to rotor removal. Combine the air gap inspection with an in-situ retaining ring inspection to get even more from your outage time.

**Benefit from:**

- Reduced downtime
- Reduced risk—rotor stays in place
- Lower workforce costs due to reduced dismantling requirements

### Outage Applicability

Generator Closed - Visual	Generator Open Rotor In - Minor	Generator Open Rotor Out - Major
	✓	

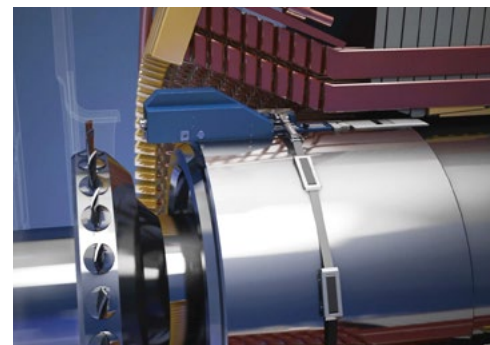

### Technical Data

Base Scope	Extended Scope
Visual Inspection	DC High Voltage Test
Robotic Slot Wedge Assessment	Leakage Current Measurement
Robotic Low Flux	Up to 60% Time Savings with In-Situ Inspections
Insulation Resistance Measurement	
Up to 40% Time Savings with In-Situ Inspections	

# Generator Offline Inspection, Retaining Ring

DELIVERING GENERATOR RELIABILITY



GE's retaining ring scanner is a robotic inspection tool made for detecting stress corrosion cracks without the need to remove the retaining rings. The dismantling requirements are reduced and the inspection can be carried out with the rotor in-situ or removed.

Enhance your outage time and increase the level of assurance between major outages by carrying out an air gap inspection in parallel with your retaining ring offline inspection.

**Benefit from:**

- Reduced downtime
- Lower workforce costs due to reduced dismantling requirements
- Enhanced accuracy related to characterization and location of defects

### Outage Applicability

Generator Closed - Visual	Generator Open Rotor In - Minor	Generator Open Rotor Out - Major
	✓	✓

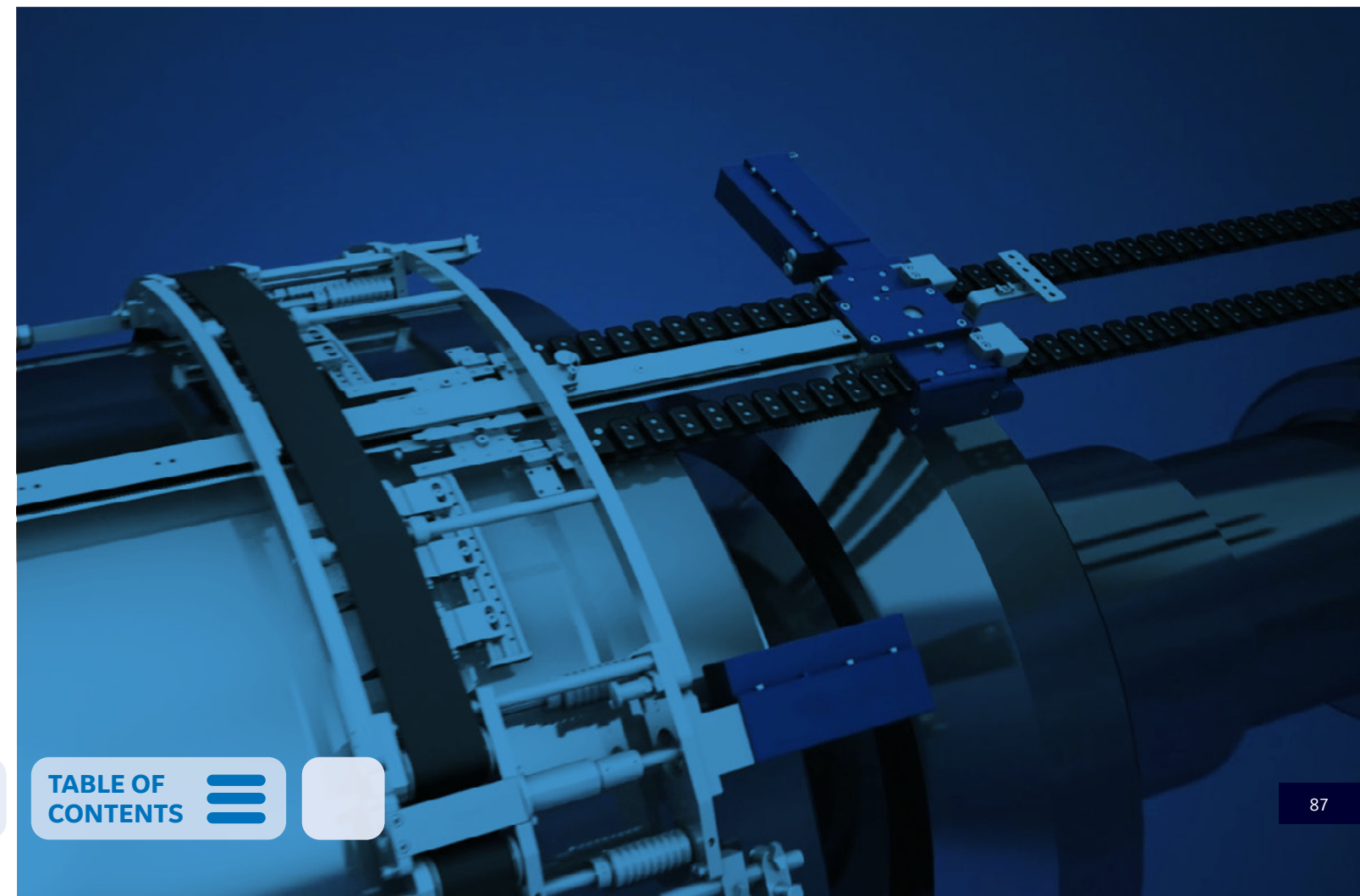



# Generator Offline Inspection - Rotor Ex-Situ

DELIVERING GENERATOR AVAILABILITY



GE's Test and Inspection Program is a set of modular solutions to thoroughly assess the condition of your generator during a major outage. Based on decades of experience across one of the largest installed fleets, our diagnostic experts will provide you with a detailed analysis and recommendations for reliable operation.

Example tests include:

- Generator endwinding vibration testing (Bump Test): Determines if additional support is required for the endwindings.
- Generator stator cooling water flow test (UT Flow): Pinpoints individual bars with rates that are lower than average low flow that can lead to higher stator bar temperature and accelerated ground wall insulation aging and an eventual forced outage. This test is performed during a major outage.

### Outage Applicability

Generator Closed - Visual	Generator Open Rotor In - Minor	Generator Open Rotor Out - Major
		✓

# CUPROPLEX\*

REMOVES COPPER OXIDES FROM GENERATOR STATOR BARS



CUPROPLEX is a proven service to remove copper oxide build-up from stator bars and the cooling water system to restore cooling efficiency and avoid overheating damage.

It is the only process that can be applied while the generator is online and in normal operation.

For heavily flow restricted bars we have developed CUPROPLEX-S.

Benefits of this service include:

- No disassembly requirements
- Controlled process
- Reduced environmental impact—no hazardous liquid waste
- Return to full output in as little as two days

### Outage Applicability

Generator Closed - Visual	Generator Open Rotor In - Minor	Generator Open Rotor Out - Major
✓	✓	✓

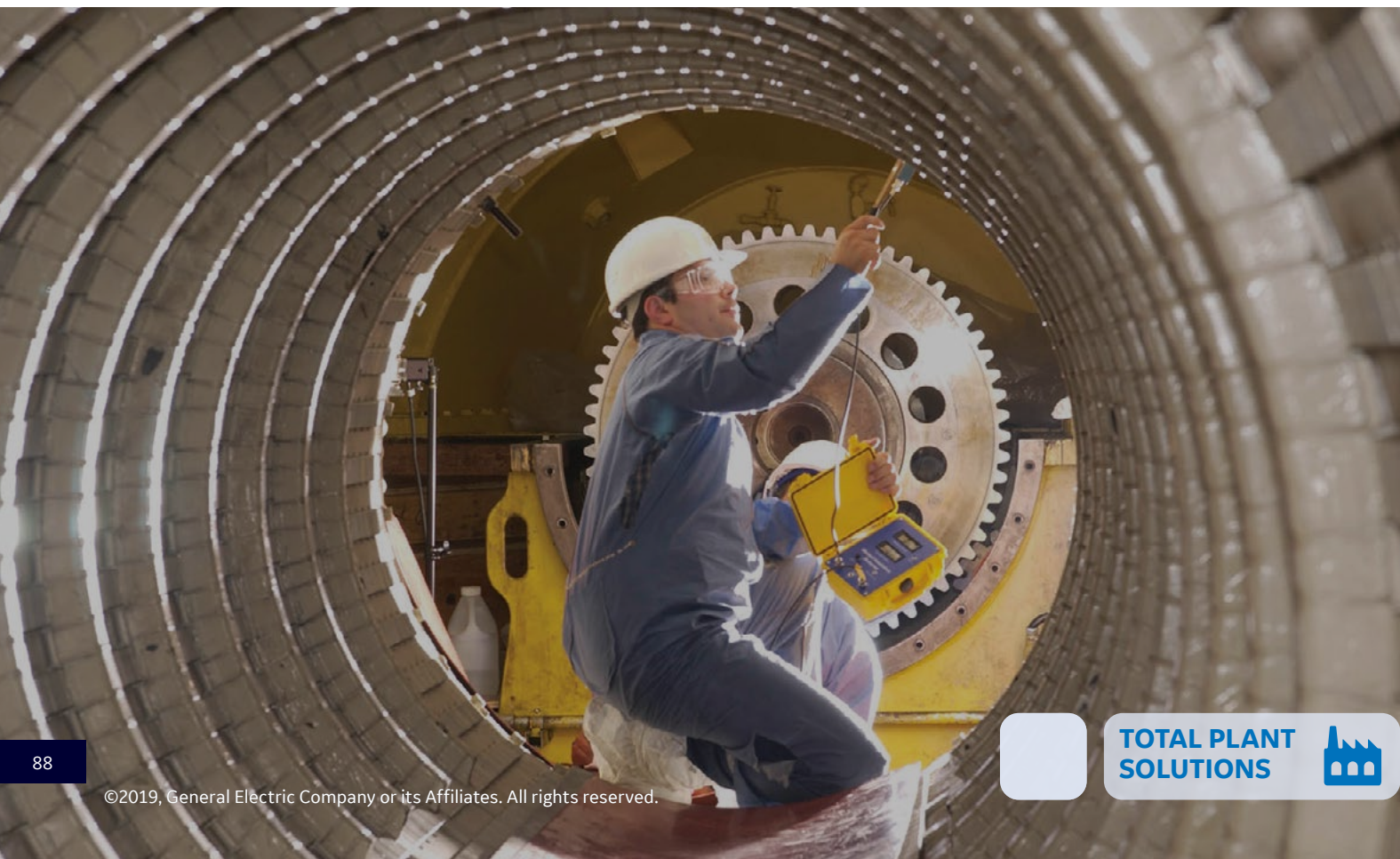
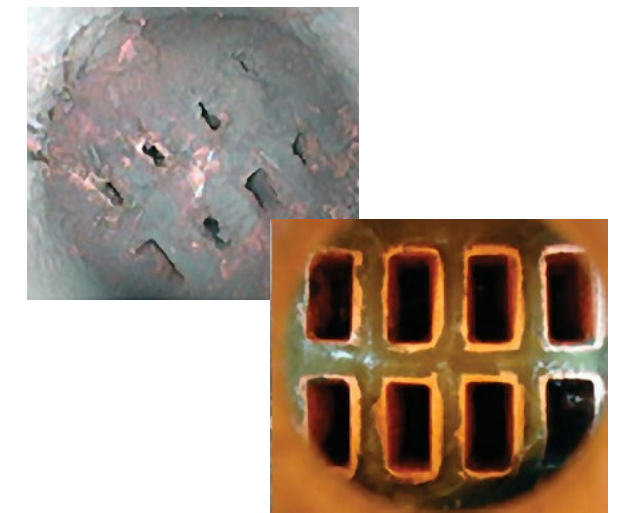



# Onsite Repairs

A REPAIR PORTFOLIO BUILT AROUND YOUR CRITICAL NEEDS



By drawing on decades of design and repair experience, we developed a wide range of onsite repair solutions to increase the reliability of your generator asset.

GE's onsite repair solutions include:

- **APLETEC\* - Stator water box leakage repair**  
Seal leaking water boxes by exposed coating, with only disconnecting the hydraulic hoses (no bar removal)
- **Metal spraying - Onsite rotor repair**  
Rotor seal oil journals repair - Low coefficient of friction of the sprayed metal, reducing rubbing effects between rotor shaft and oil seal rings
- **On-site stator core repair**  
Prosthesis - Alternative technology to partial core ends restacking
- **On-site stator winding bar re-insulation or replacement**  
Alternative repairs to support fast returns to service



### Outage Applicability

Generator Closed - Visual	Generator Open Rotor In - Minor	Generator Open Rotor Out - Major
	✓	✓





# Generator Workshop Repairs

A GLOBAL NETWORK OF FACILITIES FOR ANY KIND OF REPAIR

# Global Repair Service Centers

GENERATOR REPAIR NETWORK

GE is at the forefront of continuous improvements. Our leading workshop facilities are equipped with the latest tools and equipment technology to repair any type and make of generator to restore full operational confidence.

GE is well positioned to deliver repair services where and when you need us by continually investing to develop local resources. Critical to managing this global presence, we've mastered the logistics to maintain reliable supply chains, coordinate resources, and comply with regional regulations.



Outage Applicability		
Generator Closed - Visual	Generator Open Rotor In - Minor	Generator Open Rotor Out - Major
	✓	✓



## Repair capabilities by region:

Americas (4 Service Centers)		
Capability	Repair	New Parts
Stator Bar Manufacturing		✓
Stator Winding	✓	
Rotor Winding	✓	
Motor/Hydro Repair	✓	
Generator Inspections	✓	
Rotor High Speed Balancing	✓	

Middle East/Africa (1 Service Centers)	
Capability	Repair
Stator Winding	✓
Rotor Winding	✓
Motor/Hydro Repair	✓
Generator Inspections	✓
Exciter Inspection & Rewind	✓
Rotor High Speed Balancing	✓

Europe (12 Service Centers)		
Capability	Repair	New Parts
Stator Bar Manufacturing		✓
Stator Winding	✓	
Rotor Winding	✓	
Motor/Hydro Repair	✓	
Generator Inspections	✓	
Exciter Inspection & Rewind	✓	
Rotor Manufacturing		✓
Coil Manufacturing		✓
Stator Stacking		✓
Rotor High Speed Balancing	✓	

Asia (3 Service Centers)	
Capability	Repair
Rotor Winding	✓
Motor/Hydro Repair	✓
Generator Inspections	✓
Stator Winding	✓

■ Americas
 ■ Middle East/Africa
 ■ Europe
 ■ Asia



# Generator Upgrades

FLEXIBLE SOLUTIONS TO MEET YOUR NEEDS

# Stator Upgrades

EXTEND LIFE AND INCREASE OUTPUT



Select the best solution for you with help from GE's generator experts. Our investment into developing upgrade solutions—including electrical power systems, full train rotor dynamics, controls and heat exchangers—can have a big impact on your aging systems. GE's generator upgrade solutions include:

- Capacity Upgrades: Choose from options to uprate your generator up to 20% of current capacity.
- Generator Replacements: High-power density replacement generators can be tailored to meet your needs, with reduced plant impact. These solutions use the latest technologies to provide higher efficiency and reliability.
- Generator to Condenser Conversion: GE now offers engineered solutions that convert existing synchronous generators, powered by gas or steam turbines, into synchronous condensers.



No matter the type of generator you own, GE provides a comprehensive portfolio of stator upgrades including rewinds, midsections, and core restacks and replacements for any make of generator to improve reliability and availability. Our stator upgrades deliver the following key advantages:

- Increased output is achieved through the implementation of the latest technology insulation material and improved end-winding support systems.
- Reduced downtime results from the use of high-tech manufacturing processes, advanced tools, and standardized methods.

### Outage Applicability

Generator Closed - Visual	Generator Open Rotor In - Minor	Generator Open Rotor Out - Major
		✓

### Technical Data

Advantages
Up to 20% Output Increase <sup>†</sup>
18-day Stator Rewind <sup>†</sup>

<sup>†</sup> Depending on generator type

<sup>†</sup> Depending on generator type





# Field Upgrades

EXTEND LIFE AND INCREASE OUTPUT

GE provides a comprehensive portfolio of field upgrades for any make of generator to provide the fastest return to service. Depending on your preference, we will rewind your field at site or in a workshop. For selected types we can provide you with an exchange field to reduce downtime.



### Outage Applicability

Generator Closed - Visual	Generator Open Rotor In - Minor	Generator Open Rotor Out - Major
		✓

### Technical Data

#### Advantages

18-day Rotor Rewind†

Up to 42 Days Time Saving†

† Depending on generator and upgrade type

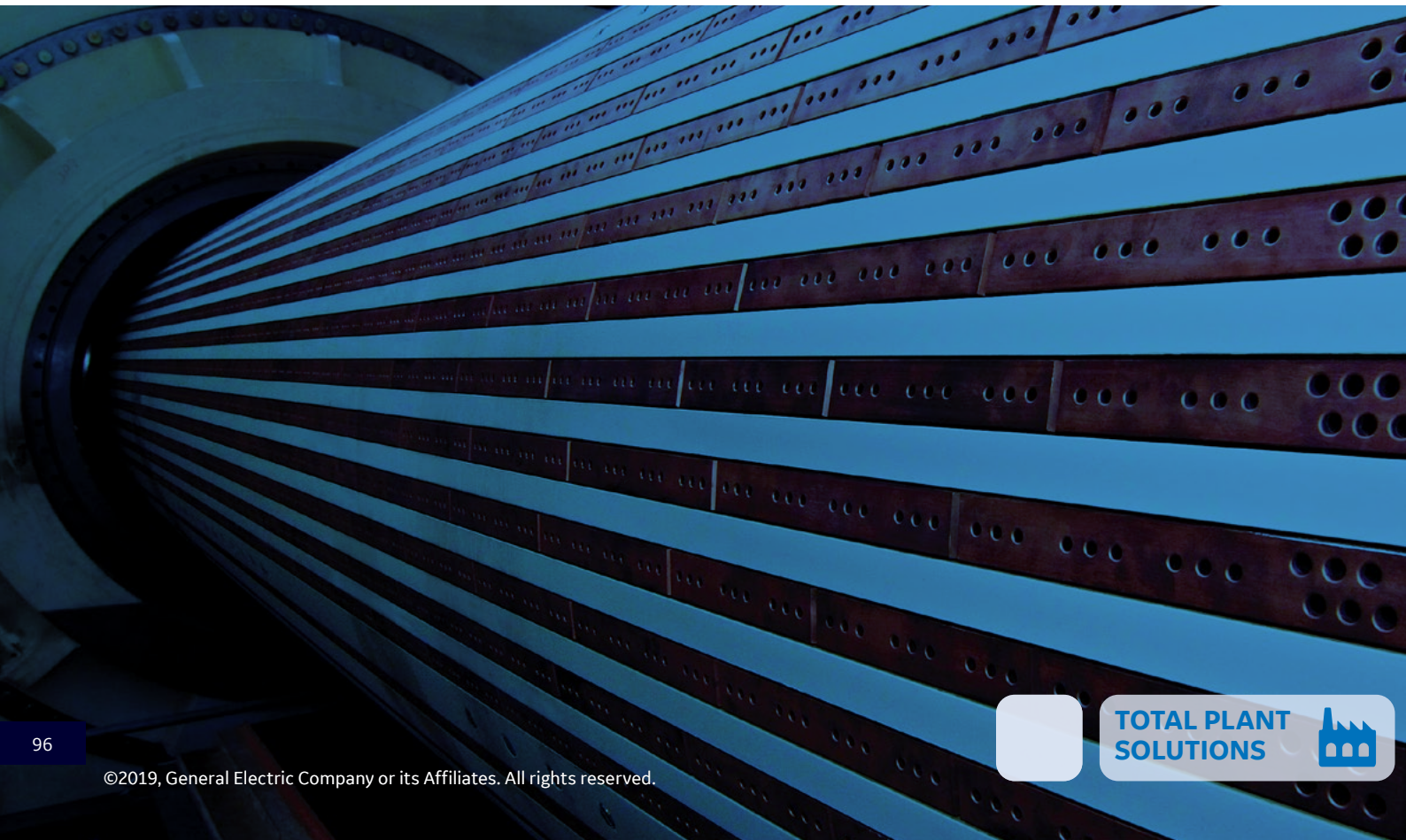

# Auxiliary Systems Upgrades

COMPLIANCE WITH TODAY'S SAFETY REGULATIONS



### Outage Applicability

Generator Closed - Visual	Generator Open Rotor In - Minor	Generator Open Rotor Out - Major
	✓	✓

GE offers upgrades for generator auxiliary systems, including electrical systems from static excitation to brushless exciters.

From assessments to identify upgrade potentials, through partial modernizations, to replacements of complete systems, we address parts obsolescence, safety regulations, and redundancy or reliability requirements with our technology-driven solutions.





# Excitation Systems

RELIABLE GENERATOR CONTROL

## A FLEXIBLE AND CONFIGURABLE PORTFOLIO ACROSS A RANGE OF POWER GENERATION APPLICATIONS

GE has developed a broad portfolio of excitation solutions to respond to your specific requirements. These range from standardized configurations offering added value and short lead times, to flexible and customizable solutions for more demanding applications.

Depending on your needs, your excitation solution can be delivered with the following redundancy configurations:

- Simplex configuration (no redundancy)
- Control redundancy
- Power bridge redundancy: dual, N-1, N-2
- Cooling systems redundancy
- Power supplies redundancy

GE's complete portfolio offers excitation solutions for both brushless and static applications across two product lines, EX2100e and ControGen<sup>®</sup>. The ControGen platform extends the excitation portfolio to high current applications.

EX2100e and ControGen SX regulators are designed for brushless applications.

EX2100e regulators are available in two versions, 35A and 120A (excitation currents up to 35A and 120A, respectively). These regulators offer a standardized solution based on the Mark<sup>®</sup> VIe control platform, which can provide seamless integration for customers already using the Mark VIe distributed control systems (DCS) and turbine controls in order to maintain a consistent hardware platform. It also helps to streamline plant operation and maintenance, since both the plant control system and excitation solution share the same development, diagnostic, and troubleshooting tools. This greatly simplifies training of operation personnel.

EX2100e regulators are designed with the latest Insulated Gate Bipolar Transistor (IGBT) technologies, using an H-bridge configuration and IGBT-controlled active discharge design for better excitation current control.

ControGen SX, a second regulator solution for brushless applications, features two versions, 50A, and 200A. The compact design of the 50A regulator provides a low-footprint solution for demanding brushless applications. It is designed for both new projects and retrofit projects requiring a high degree of customization, specific packaging, and complex mechanical integration. The 50A ControGen SX regulator provides additional flexibility regarding the power technology. Customers can opt for either IGBT chopper-based configuration or Silicon Controlled Rectifier (SCR) configuration.

The 200A ControGen SX regulator, based on an "all-in-one-box" concept for the control and communication modules and separated SCR power bridge, is designed for higher excitation currents up to 200A with full flexibility for integration, satisfying the most demanding retrofit projects.

The EX2100e static exciter solution is based on GE's Mark VIe control platform with two options:

- A standardized option with predefined configurations, offering better value and shorter lead time
- A more open and flexible option, for more demanding applications, providing a range of customization possibilities.

The embedded Mark VIe hardware platform enables EX2100e static exciters to interface easily with other Mark VIe products (DCS and turbine control). This reduces the complexity of plant operation and maintenance thanks to the common development, diagnostic, and troubleshooting tools.

More complex and demanding static excitation applications require the ControGen HX solution, with increased customization options available for the control, communication, and power technology. ControGen HX can deliver excitation currents as high as 10000A with its control designed to drive up to six SCR bridges and with active current sharing capability ensuring optimal distribution of current among parallelized power bridges.

The entire excitation product line is available in several configurations:

- Can be supplied as a complete excitation system in a single cabinet
- Can be installed (delivered as a kit or as pre-assembled frames) in an existing cubicle

GE offers a complete dismantling, installation, commissioning, and training services.

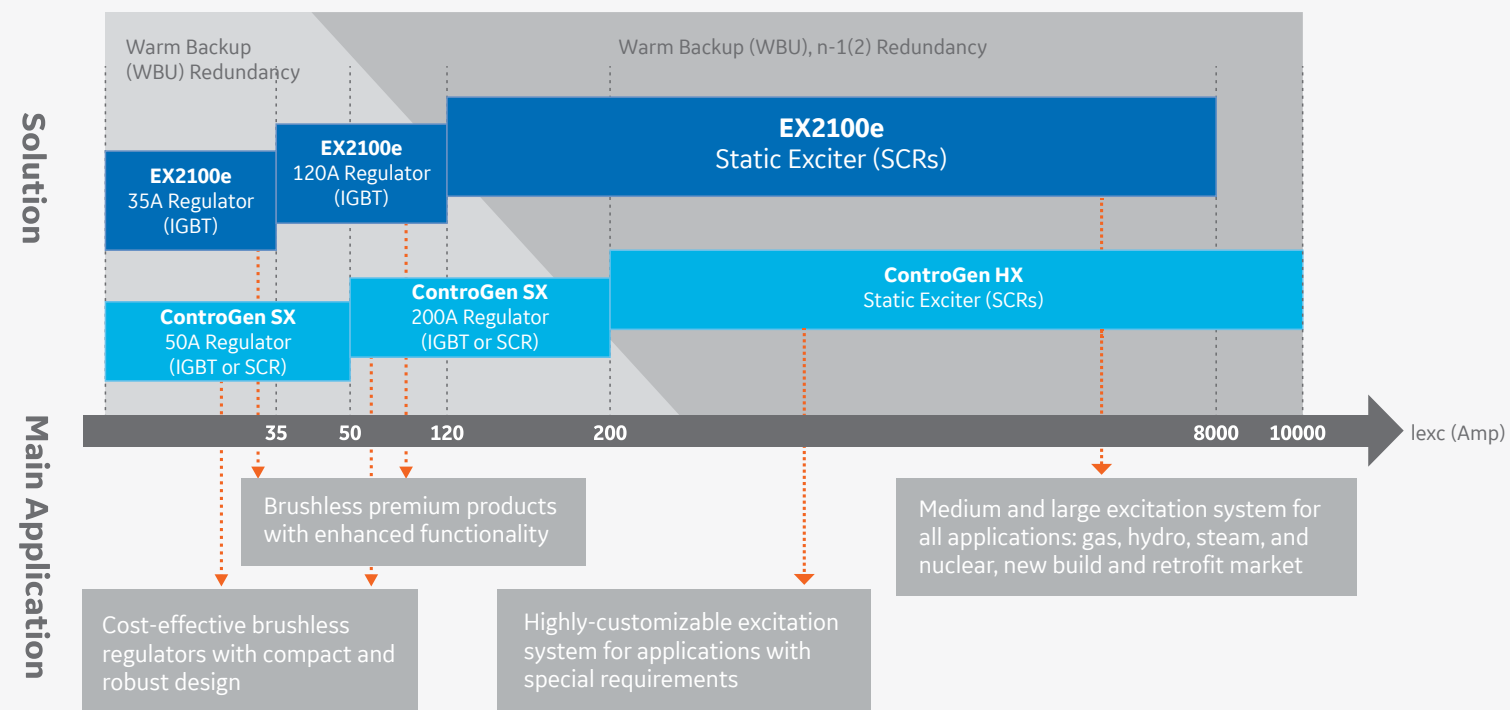

TOTAL PLANT SOLUTIONS



TABLE OF CONTENTS





# Excitation Systems

PRODUCTS DETAILS

## LIFECYCLE MANAGEMENT AND SERVICES

GE understands that extending equipment lifecycles and maximizing equipment reliability are critical to the productivity and profitability of your operations. Through established domain expertise and a global team, GE can help you get the most of your assets throughout their lifecycle. GE offers professional lifecycle support and a range of cost-effective services across the lifecycle of the excitation solutions.

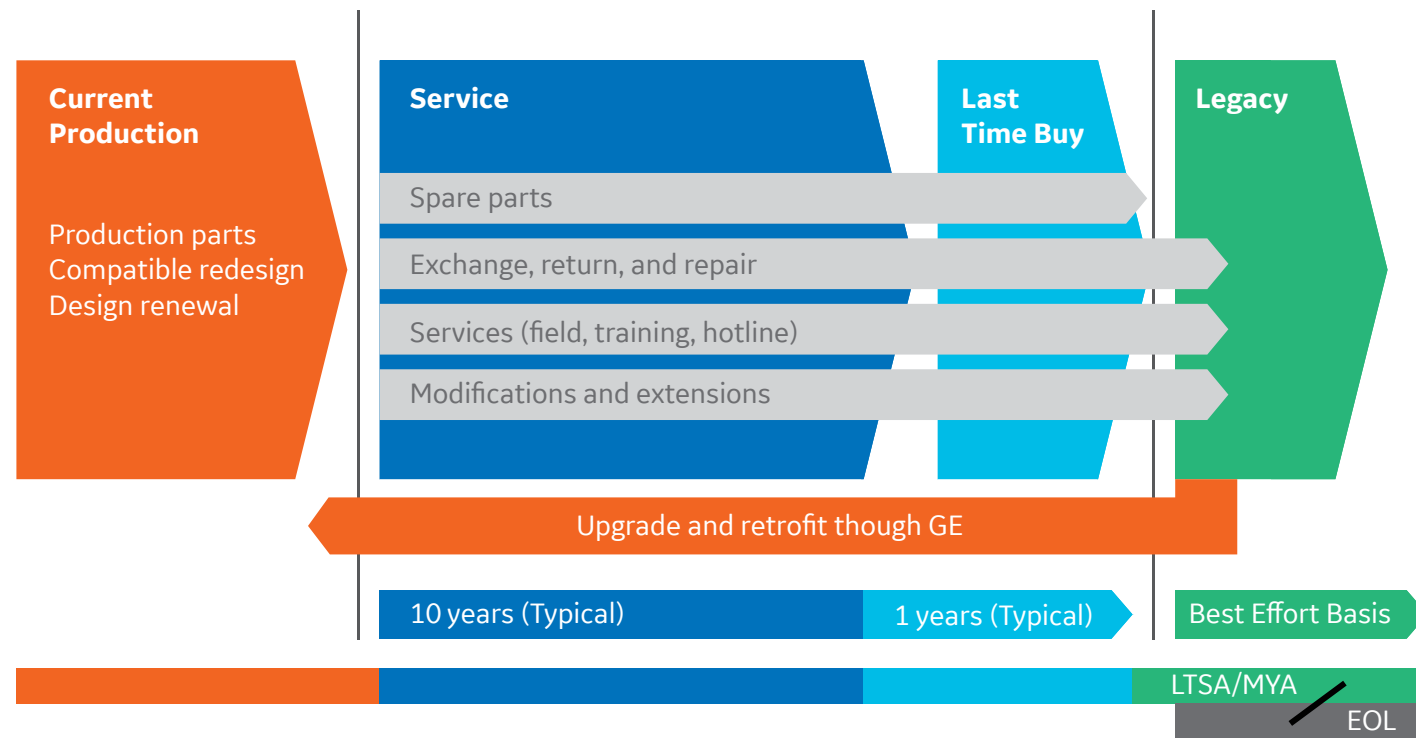

# Excitation Systems

AVR MIGRATION PACK, GENERATOR CONTROL PANE

### Service and Support Agreements

Long-term service agreements provide high-quality parts and services and extended service contracts to extend equipment lifecycles.

### Support for Operation and Maintenance

- Preventative maintenance: Reduce unplanned downtime.
- Corrective maintenance: Lessen downtime after a failure through rapid response.
- Hands-on training: GE offers standard or customized training for your engineering, operators, and maintenance staff.
- Spare parts and repair: Help reduce capital investment, while increasing system utilization and performance.

### Performance Optimization

Control tuning available to enhance the performance of your assets

### Software Services

Assessment audits identify vulnerabilities, while security services help protect hardware and data from internal and external threats.

### Monitoring and Diagnostics

Reliable and cost-effective trending data of key assets can improve the efficiency of your operations.

### Migration Services

Easily retrofit outdated control systems with tools designed for rapid transition to the latest technology. This can help to extend the lifecycle of your assets and eliminates reliance on obsolete systems and parts.

### Emergency Services

Quick support and fast mobilization of experts



### WE SUPPORT OUR EXCITATION PORTFOLIO WITH

- Power system stabilizer (PSS) implementation/PSS tuning
- Integrating volatile energy sources (solar, wind) with power networks is a growing challenge for grid operators and impacts the operation of existing producing generators. Active power oscillations created on transmission lines can limit the amount of power that may be transferred. To address this, PSS needs to be tuned on a regular basis.
- Power bridge health check with thermography
- Infrared cameras can detect objects through thermal radiation and assist with temperature monitoring, early fire detection, and prevention of temperature-related incidents.
- Generator protection tuning and synchronizer tuning
- Testing and tuning your generator protection relay can help increase the availability and reliability of your generator and provide information that can be used to improve performance.

TOTAL PLANT SOLUTIONS

TABLE OF CONTENTS





# Generator Conversion to Synchronous Condenser

NEW LIFE FOR PHASED-OUT STEAM PLANT SYNCHRONOUS GENERATORS

Tens of steam turbine generators operating in the thermal power plants have found a re-purpose of use by converting to Synchronous Condensers.

Synchronous Condensers are the most effective technology to support grids impacted by substantial renewable penetration, HVDC lines and existing power plant retirements, by increasing reactive power, short-circuit power, higher inertia and overload capabilities.

GE offers engineered solutions to bring these generators to a new life, including electrical motor and static starting methods, excitation & control systems and shaft line modifications, including High Inertia configuration.

## KEY BENEFITS

- Flexible conversion solutions to adapt existing generator configuration to grid requirements.
- Life cycle generator knowledge helps optimise the work needed for life extension and future operation & maintenance.
- Keep your existing plant operational.
- Low Capital Expenditure versus new solutions.
- Fast engineered solutions to implement.

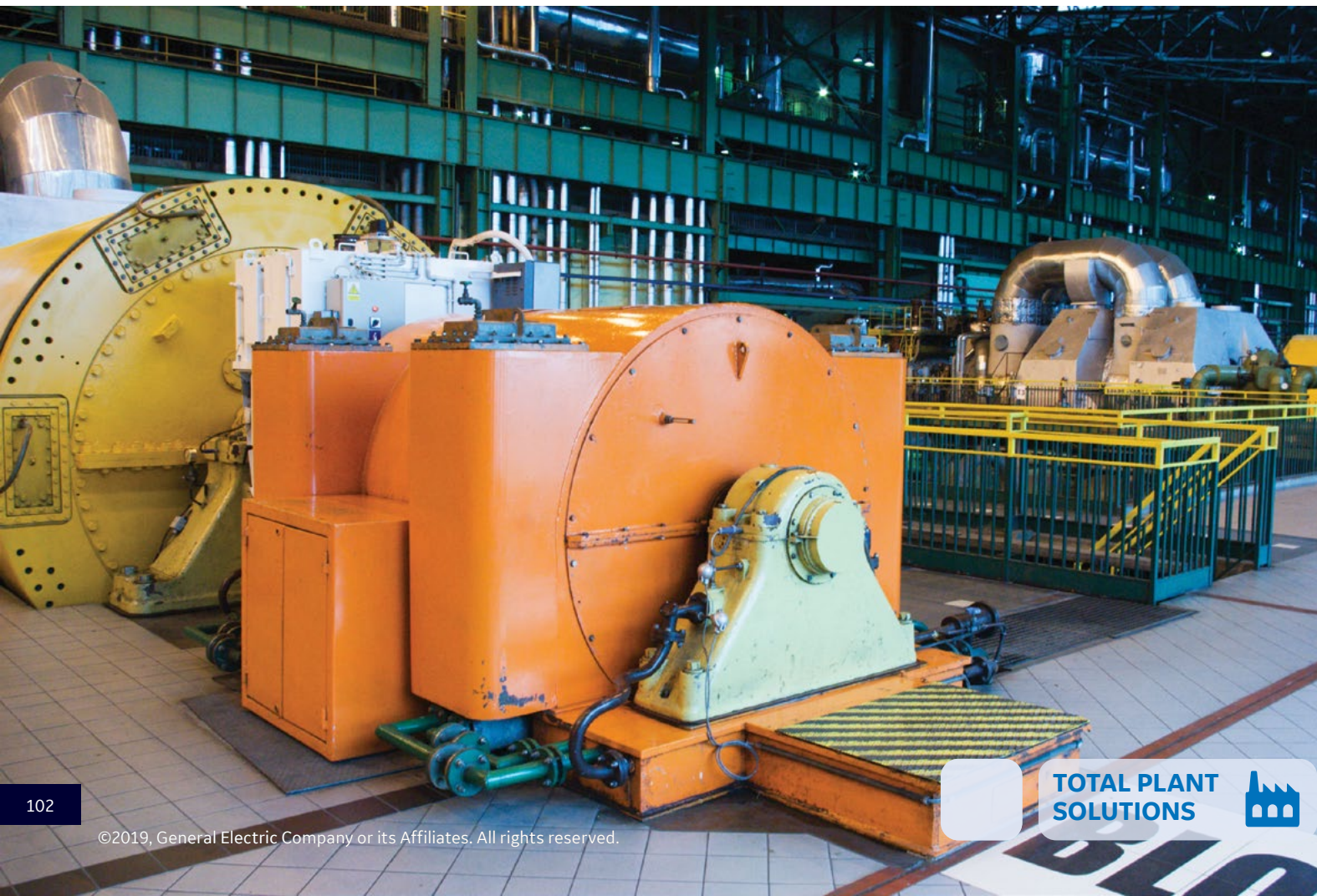



# Boilers



A coal-fired tower boiler can be **550 ft. (167 m)** tall



GE has installed more than **1,000** fossil-fired utility boilers globally, not including HRSGs



The boiler team executes more than **40,000** replacement part line items each year



A 600 MW unit's boiler contains about **130 miles** of boiler tubing



Some boilers weigh **40,000 tons**, equal to the weight of about **20,000 cars**



Depending on the unit, water and steam saturate at **680°F (360°C)** and then are superheated to **1,000°F (588°C)** before they enter the steam turbine

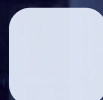

TOTAL PLANT  
SOLUTIONS



TABLE OF  
CONTENTS

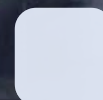



# Replacement Parts

GE offers a one-stop solution for all your boiler service needs. For GE, every part replacement is an opportunity to help keep your plant competitive and extend the service life of your equipment.

We serve the full spectrum of customer needs. Our in-kind replacements or upgraded parts include the latest technologies and materials for improved performance and extended time between outages. Or, should your operating strategy require end-of-life planning, we offer a range of economical solutions to cater to unit retirement needs.

To improve equipment reliability and reduce outage duration and frequency, we offer the following parts-related services for all major boiler manufacturers:

- Inventory management
- Equipment rebuild programs
- Technical support
- Outage kits
- 24/7 emergency support and expedited components

## PULVERIZERS

Replacement parts for all mill types - OEM and other OEM • advanced static and dynamic classifiers • grinding elements • vane wheels

## PULVERIZER AUXILIARY EQUIPMENT

Gearboxes • feeders • stokers

## PRESSURE PARTS

All boiler makes and models for small & large scale projects • boiler tubing – straight or fabricated • superheater • reheater • economizers • headers • panels • desuperheaters • drum internals • sootblowers • attachments

## FUEL DELIVERY SYSTEMS

Oil guns • coal piping and elbows • riffle distributors • tips • nozzles • low NO<sub>x</sub> burner upgrades • windboxes • dampers • tangential- and wall-fired burners

## ELECTRONICS AND CONTROLS

LIMELIGHT\* boiler electronic products • ignitors • flame spectrometers and scanners • control cabinets • process instruments • burner management systems

## BOTTOM ASH AND FLY ASH SYSTEMS

Products and services for UCC, A-S-H and GE's bottom ash and fly ash systems • clinker grinder rebuilds • hoppers • seal skirts • waterboxes with weir piping • front enclosures • ash gates • E valves • airlocks • dry drag conveyors • pugmills • submerged scraper conveyors

# Boiler Field Services

COMBINING CAPABILITIES AND EXPERIENCE TO ENHANCE PERFORMANCE



We enhance the performance of your boilers, pulverizers, air pollution control systems, ash handling systems, and auxiliary equipment.

Our expertise has been built over many years, with many customers, at many plant sites. We have solved common problems, and we have solved unique ones. Our experience has been gained across a variety of equipment types and brands, including service in utility, waste-to-energy, petrochemical, pulp and paper, and industrial sectors, and with all fuel types.

- Outage planning and inspections
- Commissioning
- Instruction/training/E-learning
- Reliability troubleshooting
- Root cause determination
- Equipment/systems testing
- Systems evaluations
- Operational reviews
- Condition assessment
- Performance improvement
- Dedicated engineer program
- Thermal spray claddings





# AmStar Thermal Spray Cladding

DEPENDABLE AND PREDICTABLE WATERWALL PROTECTION



AmStar 888\* thermal spray cladding provides dependable and predictable waterwall protection in boilers where high temperature gaseous corrosion and/or erosion may occur. Our proprietary metallurgy, surface preparation and high velocity continuous combustion (HVCC) application process resists cracking, spalling, and stress.

**Benefits include:**

- Cost effective method of extending life of tubes
- Significantly reduced equivalent forced outage rate (EFOR)
- Dependable and predictable tube protection
- Measurable and scalable
- Heat absorption of the tube not affected
- Reduced generation cost
- Corrosion prevented
- Repairable
- Applicable for any fuel type



# Repair Services

BOILER EQUIPMENT REPAIR NETWORK



As a leading supplier of quality power plant equipment and replacement parts, GE offers one complete and cost-effective solution for maintaining and repairing boiler equipment. Our Global Repair Centers (GRC) combine our extensive experience and proven processes.

**Benefits include:**

- All work done in a controlled environment using the latest technology
- All work done to engineering specifications
- Shorter lead times
- All work backed by GE's engineering experience and quality
- Certified rebuild technicians
- Documented procedures
- Inspection reports
- Warranty included



## Repair capabilities by region:

Americas		
Capability	Repair	New Parts
Boiler Component Rebuild & Overhaul	✓	✓
Pulverizer Roll Hard Facing	✓	✓
Pressure Part Fabrication & Welding	✓	✓

Europe	
Capability	
Boiler repair solutions	

■ Americas
 ■ Middle East/Africa
 ■ Europe
 ■ Asia





# Natural Gas Conversions and Co-Firing

UPGRADE MODIFICATIONS FOR STEAM BOILERS

Our installed base is one of the industry's largest, and we have more than 60 years of proven experience firing natural gas in utility and industrial fossil steam units. This experience includes firing natural gas as the main fuel, co-firing natural gas with multiple fuels, and adding gas firing to existing units. We have extensive experience converting both tangential-fired units as well as wall-fired units, for both GE and non-GE technologies.

**Benefits include:**

- Lower SOx, mercury, particulate, NOx, and ash. In the case of 100% conversion, no SOx, particulate or ash
- Higher turndown ratio (up to 10:1), depending on gas supply pressure at the burner front and equipment configuration
- Ability to balance fuel usage and leverage fuel suppliers



**Outage Applicability**

Major	Minor
✓	



# NOx Solutions

PRIMARY AND SECONDARY NOx REDUCTION TECHNOLOGIES

When a conventional SCR NOx reduction system is not practical due to space requirements, installation logistics or cost efficiencies, we offer a unique combination of technologies and engineering for cost-effective in-boiler NOx compliance.

Primary low NOx measures include our portfolio of cutting-edge low NOx burners and software solutions. On the one hand, the low NOx concentric firing system (LNCFS\*) for our OEM boilers and RSFC\* and RoBTAS\* burners for other manufacturers' boilers are commercially proven and cost-effective solutions for achieving significant NOx reductions, especially when combined with our overfire air systems. On the other hand, our software solutions such as BoilerOpt, Digital Boiler + (Autotune) and Mill Optimizer use different enabling technologies such as adaptive neural networks, Model Predictive Controls (MPC), first principal models, artificial intelligence expert systems and machine learning to improve combustion and reduce primary NOx emissions.

A secondary reduction of up to 30 percent of NOx can be achieved with a selective non-catalytic converter (SNCR) system. This works by injecting urea or ammonia in the upper part of the furnace. At temperatures of 1500° to 2010°F, the NOx is reduced without the need for a catalyst. GE's Umbrella-SNCR (U-SNCR) is unique because the urea is sprayed within the furnace with a nozzle that is adjustable in height. The process uses cooled lances to carry flexible hoses arranged in the furnace. There are no boiler size constraints, and the technology is easy to control.



**Outage Applicability**

Major	Minor
✓	

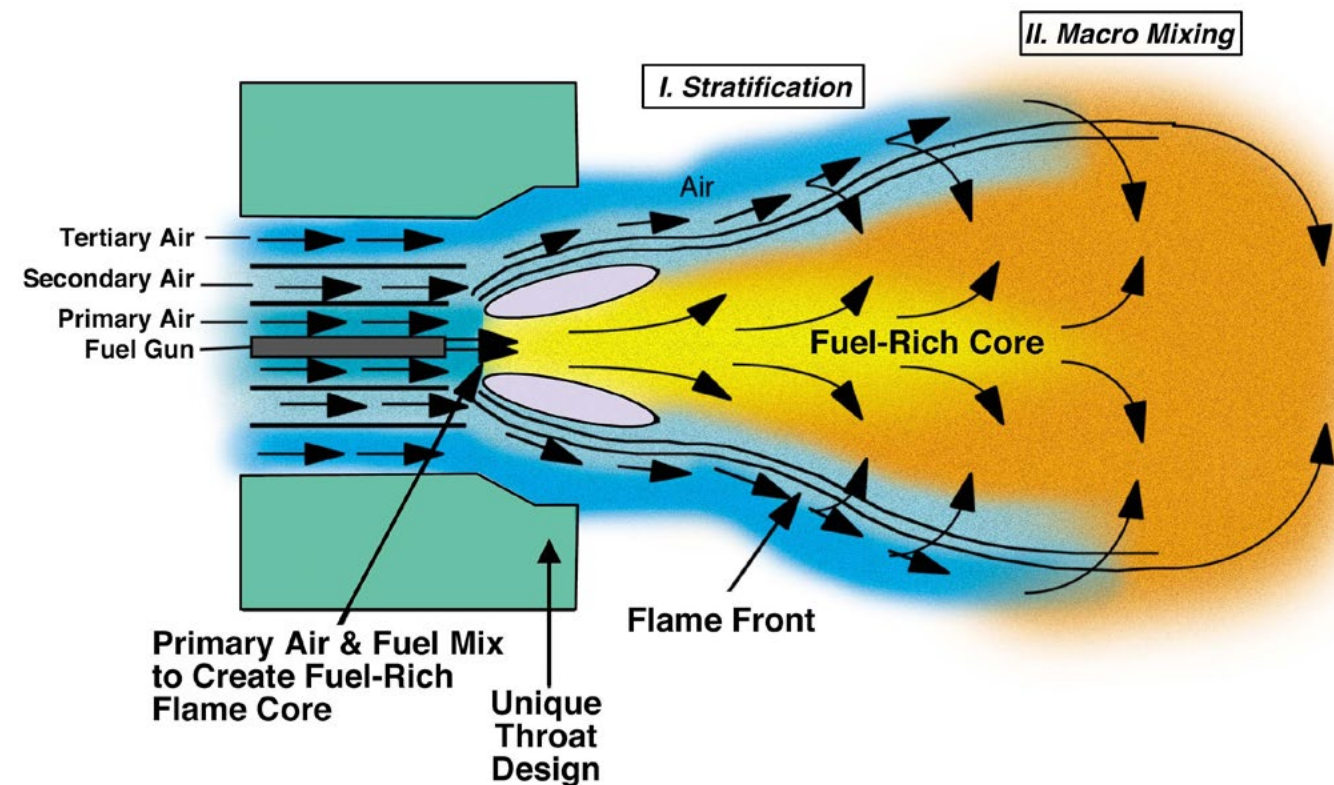



# T-PRO\* Fuel Firing System

REDUCE EROSION AND EXTEND COMPONENT LIFE

# OpFlex\* for Boiler

LOW LOAD AND RAMP RATE PACKAGES

The T-PRO Fuel Firing System reduces erosion and thermal stresses on units firing abrasive coal that can cause coal compartment components to fail. The T-PRO Fuel Firing System's innovative configuration and material selection ensures equipment reliability, longer operation between outages, and shorter outage durations.

- Increases coal nozzle and nozzle tip wear life
- Improves reliability and availability
- Increases operation time between outages and reduces outage duration
- Reduces maintenance and repair labor costs



Outage Applicability	
Major	Minor
✓	

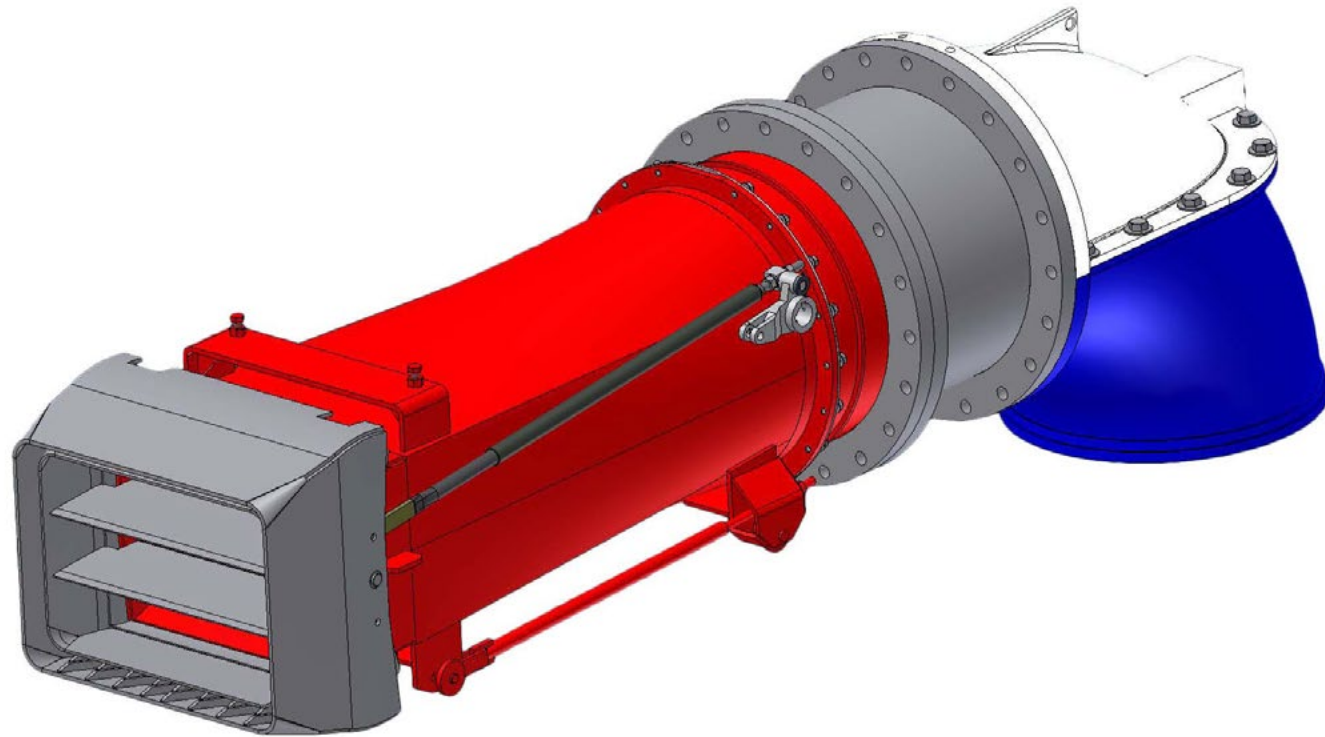

Today's steam plants must operate differently than in the past, and differently than they were designed for. As a total plant service provider and boiler original equipment manufacturer (OEM), GE offers packages that can improve the flexible operation of your boiler. The first step is to systematically assess the design and identify areas that would hinder operating the unit per your new operating parameters.

For improved ramp rate, areas that are prone to accelerated damage as a result of more frequent startups and shutdowns are identified and addressed. For low load, solutions allowing stable operations customized to your system design are identified and addressed. These solutions are applicable to all boilers, whether made by GE or other manufacturers.

Typical packages that GE offers to enhance performance and lifetime profitability while making safety, reliability and environmental compatibility top priorities include a combination of the following solutions:

- Flame scanners
- Plasma burner
- Burner upgrade
- Mill Optimizer
- Digital Boiler + (Autotune)
- Stability monitor
- Low load boiler package
- Auto tune

**Benefits include:**

- Increased flexibility
- Greater availability



Outage Applicability	
Major	Minor
✓	✓





# Plasma Ignition System\*

FOR FLAME STABILIZATION AND COLD START

GE's Plasma Ignition System reduces overall operating costs by improving low load operation and eliminating dependence on expensive oil or gas support fuels.

The Plasma Ignition System is also designed to operate continuously, supporting low load operation.

The system produces a high energy plasma, which supports volatile release and subsequent coal ignition. The released volatiles ignite and produce further heat for increased fuel devolatilization and full flame formation at the burner mouth.



**Benefits include:**

- Eliminate the use of oil/gas support fuels for flame stabilization when operating at low loads.
- Reduce coal consumption. The unit can maintain stable operation at lower loads without support fuel.
- Eliminate the need for a demineralized cooling water system.
- Greater system efficiency compared to Direct Current (DC) powered systems
- Longer electrode life compared to DC systems, reducing material cost and labor required to replace electrodes
- Eliminate oil/gas start-up system and O&M support

**Outage Applicability**

Major	Minor
✓	



# Boiler Feed Pumps

CONTROL SYSTEMS

The turbine driven Boiler Feed Pumps have a critical impact on the overall availability of the unit, but also on the performance of the unit. GE's solution for Boiler Feed Pumps provides functions such as automatic speed control, water pressure control, SIL 3 protection, and monitoring of both the turbine and the pump.

The Boiler Feed Pumps Control System can act as standalone equipment with its own single or redundant controller and a user friendly graphic interface to ease the operation and the maintenance, or it can be integrated into the main steam turbine control system to provide a performant integrated system for a reduced investment.

**Benefits include**

- Long term protection of your investment with a wide range of services and the use of a platform controlled over the full production chain that offers an extended lifecycle thanks to incremental evolutions
- Reliable and safe
- Helps reduce unplanned outages and scheduled outage duration

- User-friendly human machine interface for operation and maintenance
- Mimic designed as a Decision Support Instrument with priorities ranking
- Optimize unit responsiveness and thermal efficiency
- Operational flexibility improvement
- Unit performance improvement with fuel consumption reduction
- Helps monitor and reduce the component stress and lifetime impact caused by flexible generation
- Provides access to secured remote data analysis and improvement applications powered by GE's Predix platform
- Specific regulation and grid codes compliance





# Economizer Outlet Gas Temperature (EOGT) Control

UNIT FLEXIBILITY WITH EFFECTIVE SCR OPERATION



GE offers advanced boiler modifications and systems to control the gas temperature to the SCR so your plant can operate at low load and still comply with environmental restrictions. These systems are fully integrated with your boiler's control system (DCS) and are tailored to meet your plant's demands.

Based on your unit, we can customize the right solution to meet your operating requirements. Two examples for controlling gas temperatures are:

- **Subcritical boiler:** Our patented hot water recirculation system (HWRS) controls the EOGT by extracting a portion of the hot water from the boiler downcomers and mixing it with feedwater upstream of the economizer inlet.
- **Supercritical boiler:** Our patented economizer recirculation system (ERS) recirculates waterwall outlet fluid.

**Benefits include:**

- Easy to control gas temperatures to SCR at low loads
- Operation only during required loads; no parasitic power used at high loads
- Increased boiler flexibility
- Reduced wear and tear on boiler, since operating SCR at low loads avoids increased startup/shutdown cycles

**Technical Data**

Avoids increased startup/shutdown cycles by operating SCR at low loads
Depending on unit, turndown to as low as 35% per load

**Outage Applicability**

Major	Minor
✓	



# PV-PRO\* System

FINENESS, CAPACITY, AND OPERATIONAL FLEXIBILITY FOR COAL PULVERIZERS



**Outage Applicability**

Major	Minor
✓	

We are the milling system experts, with a deep understanding of the industry and a full range of offerings across many mill types, including those from our legacy companies (including CE, EVT, Stein, and Alstom), B&W, BPI, Riley, Hitachi, and Foster Wheeler.

The PV-PRO\* system is an integrated performance, recovery and optimization (PRO) system. Depending on your mill type, it includes an improved throat/air port, upgraded grinding zone, and an adjustable static or dynamic classifier.

**Benefits include:**

- Less pressure drop
- Improved efficiency and coal transport
- Reduced pulverizer wear for extended operations
- Better control of coal fineness

**Technical Data**

Down to 18% lower mill motor power consumption with PV-PRO system installation (at a U.S. power plant)
Down to 39% lower mill differential pressure due to PV-PRO system installation

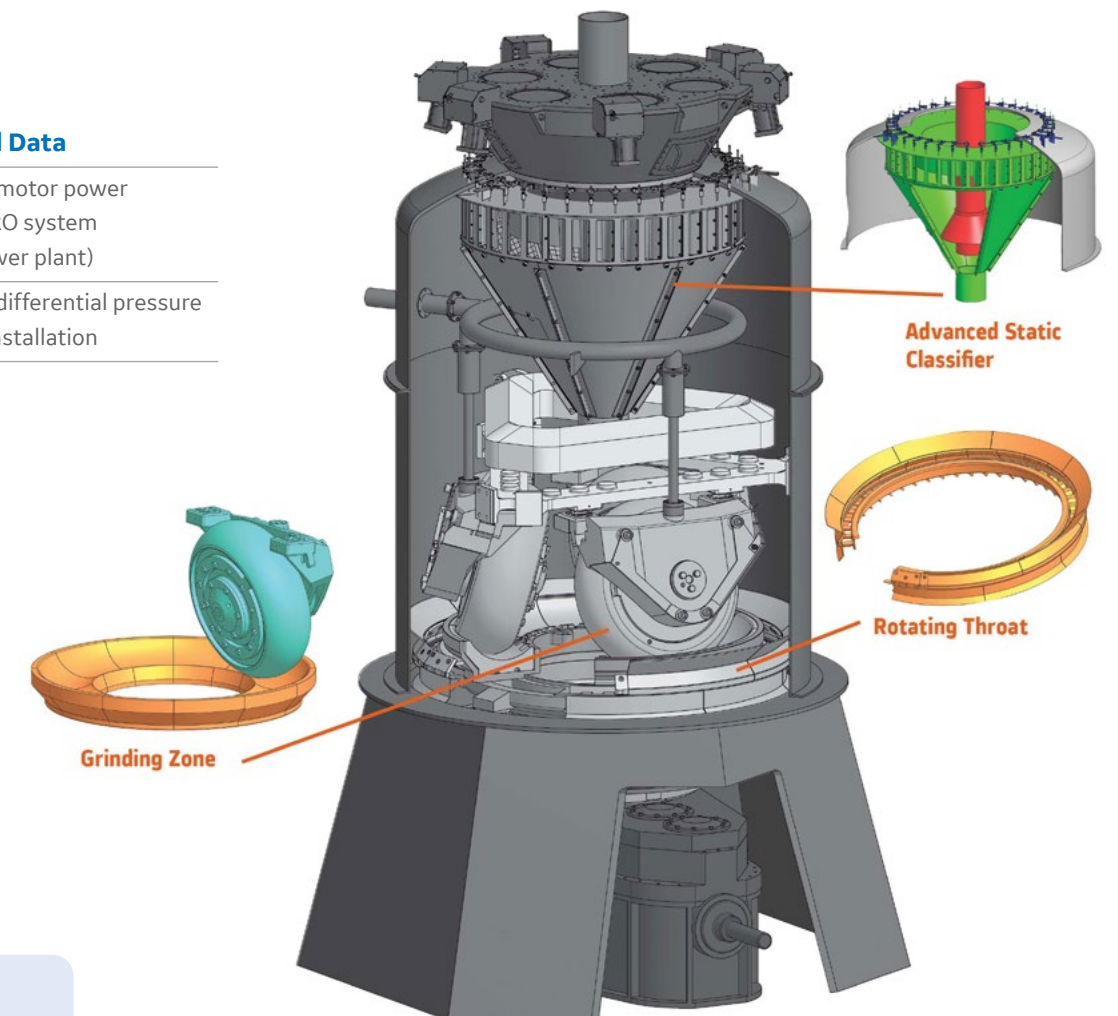



# Boiler Tuning

ACHIEVE ADVANCED BOILER PERFORMANCE



### Outage Applicability

Major	Minor
	✓

GE is one of the world's largest power service providers, and our boiler specialists travel from plant to plant, troubleshooting issues and improving performance. Let us document and report the critical operating data necessary to help your plant go beyond tune-up compliance (NOx, CO) to achieve advanced boiler performance. Beyond tuning, services can include inspections and maintenance, performance testing, engineering, parts supply, and document storage.

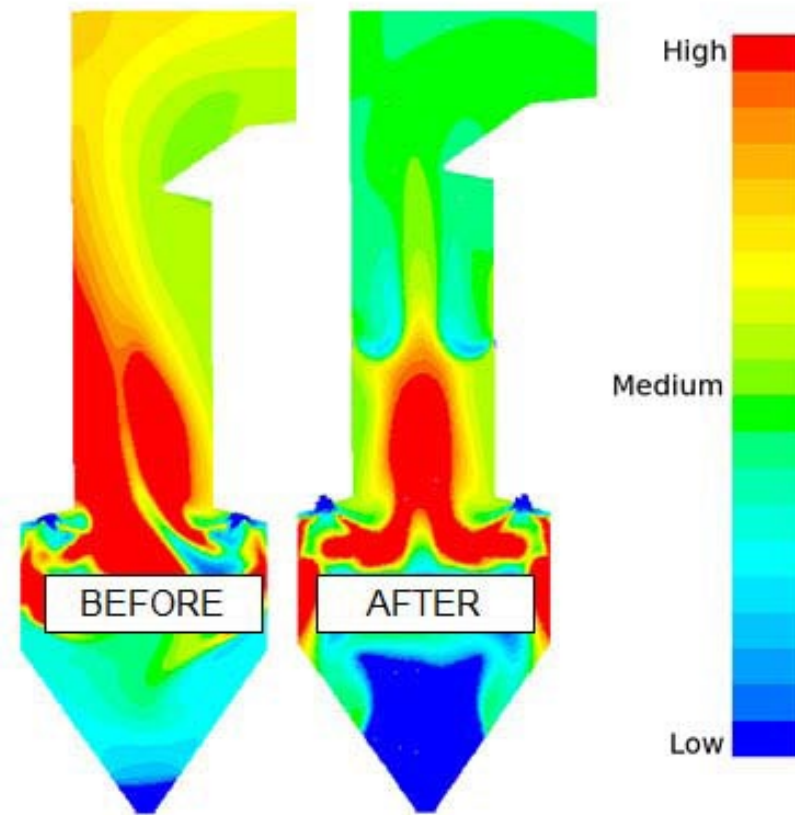



# Air Quality Control Systems (AQCS)



Over **100 years** of Environmental Equipment experience



Comprehensive product portfolio of **AQCS technologies**



Abating **> 155,000 tons** of particulates and **52 tons** of SO<sub>2</sub> through GE technologies. Particulate emission reduction of 99.97% and SO<sub>2</sub> emission reduction of 99%.



The world's largest **Electrostatic Precipitator** was built by GE and it is located at a plant in India



**Widest offering** for Mercury control-dependent upon the type of coal used and the level of Hg emissions required



**1st** to introduce the **Sulphite Analyzer** product to optimize power consumption of wet Flue Gas Desulfurization

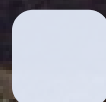

TOTAL PLANT SOLUTIONS



TABLE OF CONTENTS

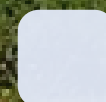



# Replacement Parts

# Inspections and Maintenance

ADVANCED TECHNOLOGY WITH LOCAL SERVICES



For original and custom-designed components such as electrostatic precipitators (ESP), fabric filters (FF) and dry and wet flue gas desulfurization (FGD), GE supplies a wide range of replacement parts and control systems. Our extensive original equipment manufacturer (OEM) knowledge and experience enables us to deliver high-quality and innovative components across the entire AQCS system. Our portfolio of parts offerings extends to cross fleet equipment. We offer an extensive range of upgraded parts for Lurgi, Rothemule, Joy and Buell ESPs and MHPS Wet FGDs

With our responsive and competitive spare parts management, you can benefit from our quick distribution, spare parts pooling and inventory programs. Based on more than 100 years of experience, GE's global supply chain responds to stringent quality requirements.

**The benefits of using GE's spare parts include:**

- Many years of operational experience with life cycle cost models and enhanced parts (ESP, FF, and wet and dry FGD)
- Dedicated research and development that delivers new technologies with increased performance
- Ability to build an appropriate and reactive supply chain for speed and cost savings
- Global sourcing with stringent quality requirements

**Field Services**

GE's global field service network has a strong local presence that supports you with the latest tools, technology, and engineering capabilities. We provide inspection services, maintenance management, field repairs, commissioning, construction, and supervision. Our vast technical and outage management experience allows us to service, retrofit, and upgrade your plant to improve the performance of both our equipment and other manufacturers' systems. With an absolute commitment to quality and EHS, GE's operational processes cover both planning and execution for on-time delivery.

**Advice and Operational Support**

GE's dedicated and experienced technical service and process engineers can provide excellent technical assistance and support to any equipment design. We help you choose the right solution to maximize your AQCS performance, availability, and reliability. Our large range of innovative services includes inspections, condition and lifetime assessments, outage management, ERP, monitoring and diagnostics, remote control and optimization (via proprietary systems ProMo and Predix\*), and training.

**Servicing other manufacturers' equipment**

Following a series of acquisitions and mergers over the last century, GE provides expertise to a broad technical product portfolio, and we can service, upgrade, or retrofit a wide range of AQCS systems.

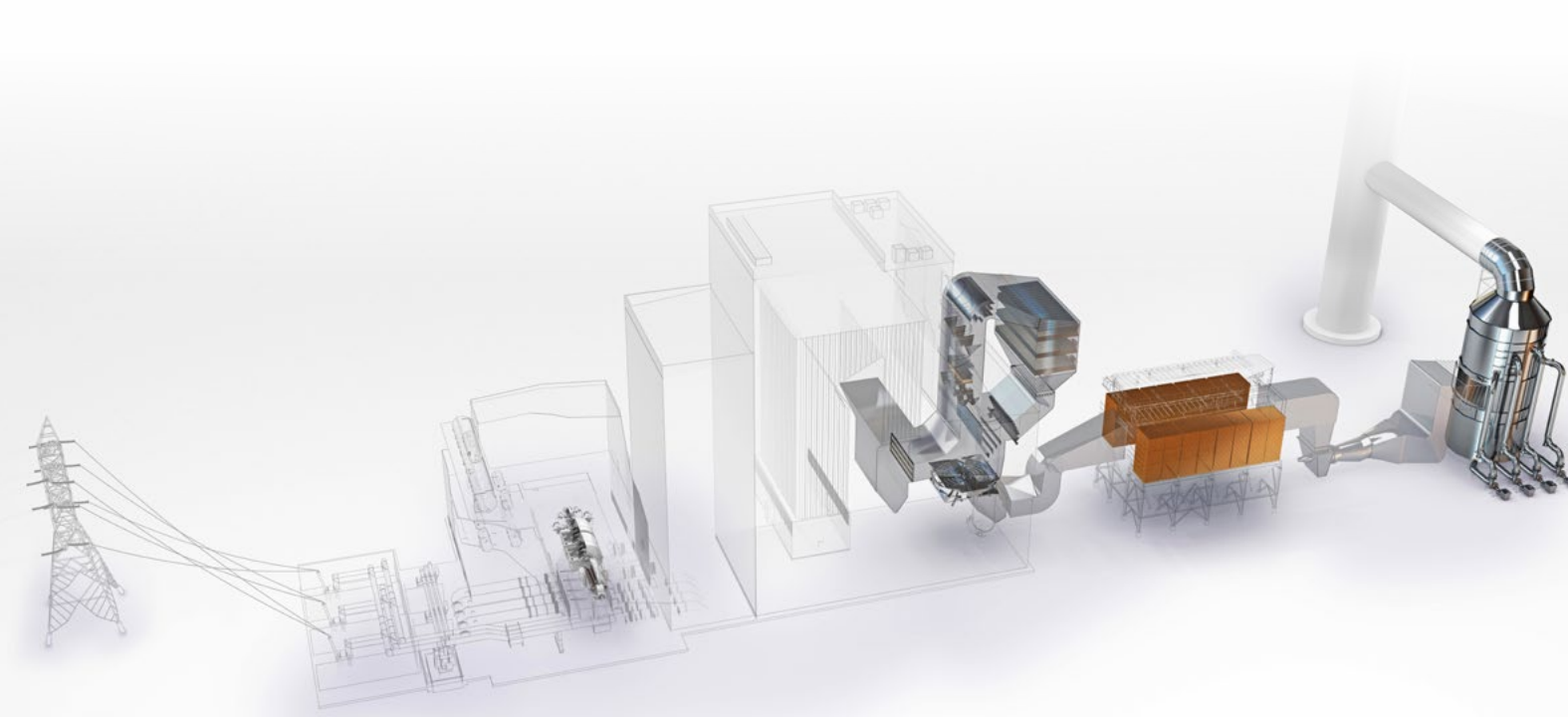





# Electrostatic Precipitator (ESP)

# Switched Integrated Rectifier (SIR)

HIGH FREQUENCY POWER SUPPLIES FOR ESPs

ESP operators can benefit from upgrade solutions to extend lifetime and lower particulate matter (PM) emissions, parasitic losses, and maintenance costs. This enables you to increase the output of your plant while maintaining your AQCS equipment. As a one-stop shop, we work with you to conduct a thorough evaluation of your plant's technical and economic conditions and then help you select the right renovation and upgrade solutions. Upgrades can be of either Mechanical or Electrical scope or a combination of both.





**Outage Applicability**

Major	Minor
✓	✓

O&M Cost Reduction





Our patented SIR technology reduces the particulate emission level and improves overall ESP performance without the need for costly extensions. With more than 4,500 SIR units in operation around the world, we offer a wide range of advanced high voltage power supplies for ESPs to meet your plant's requirements.



**Benefits include:**

- Reduces up to 70% particulate emissions compared to conventional technology, and reduces emissions levels down to below 10mg/Nm3 particulate emissions, when required
- Installs on new or existing ESPs from GE and other manufacturers
- Applies to ESPs in power and industrial applications, such as cement and pulp and paper
- Offers more than 95% electrical efficiency
- Avoids cost-intensive retrofit and longer outages

**Outage Applicability**

Major	Minor
✓	✓





# Electrostatic Precipitator Integrated Controller (EPIC)

ADVANCED ESP INTEGRATED CONTROLLER

GE's electrostatic precipitator integrated controller (EPIC) is an ESP bus-section controller for transformer rectifier sets (T/Rs), which includes basic functionalities, energy savings, current control, spark detection, and rapping efficiency. It uses software algorithms like electrostatic precipitator optimizing of charge (EPOQ) and opacity optimization (OpOpt) to obtain optimum performance from the ESP.

With EPIC well below 20mg/Nm<sup>3</sup> particulate emissions can be achieved.



### Outage Applicability

Major	Minor
✓	✓

O&M Cost Reduction ↓



# Optimization Algorithms - EPOQ & OpOpt

ESP OPTIMIZATION SOFTWARE FOR HIGHLY RESISTIVE FLY ASHES

Building on proven process experience in particulate matter control, GE's electrostatic precipitator optimizing of charge (EPOQ) software is an intelligent solution for improved ESP performance. Thanks to self-adjusting algorithms and individual bus-control, emissions can be decreased and power consumption improved when handling highly resistive fly ashes.

### Outage Applicability

Major	Minor
✓	✓





# Fabric Filter (FF)

# Electronic Fabric Filter Integrated Control (EFFIC)

ADVANCED FF INTEGRATED CONTROLLER



FF upgrades, with higher removal efficiencies, are required to allow for further reductions in particulate matter (PM) emissions as well as to maintain the performance and availability of the entire plant throughout its life cycle. Operational costs also are optimized for a quick return of investment for the FF upgrade.

### Outage Applicability

Major	Minor
✓	✓



A powerful controller, the electronic fabric filter integrated controller (EFFIC) can modernize control systems on new or existing units. This intelligent controller drives the pulse jet FF by using actual process conditions instead of traditional pressure drop methods.

Traditionally, the pulse control system must be programmed into the distributed control system (DCS). If an EFFIC is used as an interlink between the FF and DCS, the DCS programming is simplified, requiring the addition of only the most commonly used functions. The DCS will send a signal to the EFFIC, and the EFFIC automatically will control the entire array of FF functions and alarms.

### The Benefits Include:

- Longer bag life
- Less emissions
- Controlled absorbent consumption

### Outage Applicability

Major	Minor
✓	✓

O&M Cost Reduction ↓

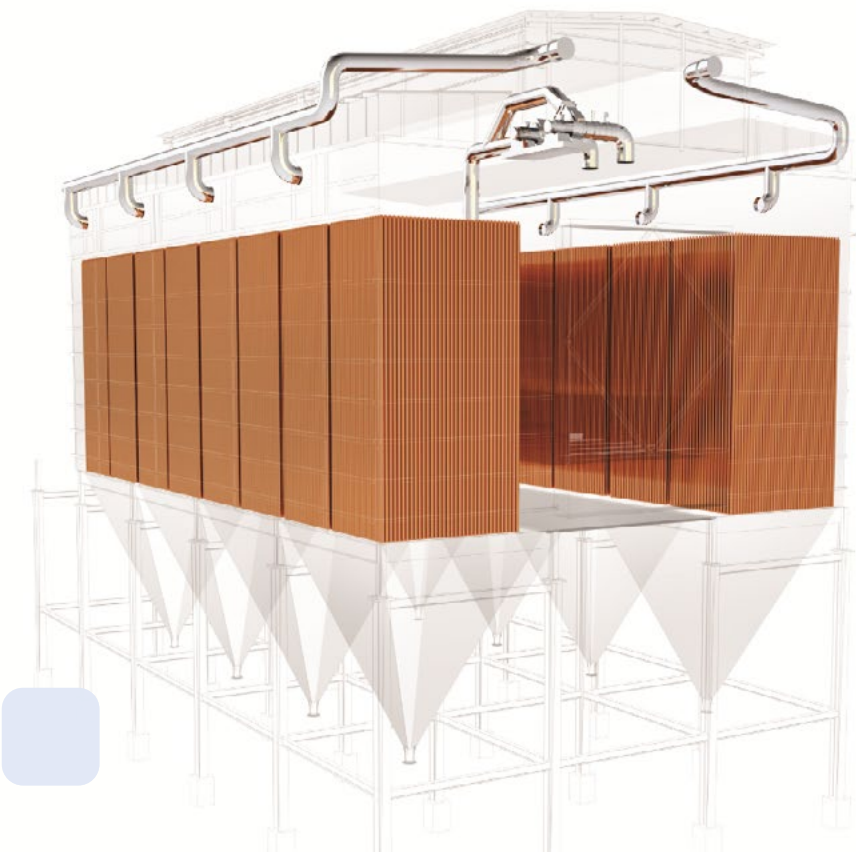

TOTAL PLANT SOLUTIONS



TABLE OF CONTENTS





# Flue Gas Desulfurization (FGD)

UPGRADES

More stringent environmental regulations require improved solutions for flue gases. GE offers a full set of wet or dry FGD service solutions to upgrade your equipment to a high-tech configuration for high performance, low energy consumption and reduced operating costs.

GE is committed to finding innovative solutions to existing FGD systems with upgrades for increased performance and energy savings. As every FGD system is unique, GE takes a tailored approach to determining the solution you need.

### FGD upgrade options include:

- Spray headers for improved design for uniform flue gas coverage
- Nozzle types for optimal droplet diameter and dispersion
- Mist eliminators to prevent droplets carryover at reduced pressure loss
- Performance enhancing plates to increase gas-to-liquid contact
- Tray upgrades for optimal velocity with additional perforated tray
- Slurry preparation equipment of ball mills, mixers and pumps

#### Outage Applicability

Major	Minor	O&M Cost Reduction
✓	✓	↓

# SulfiTrac\* Sulfite Analyzer

REDUCE POWER CONSUMPTION AND MERCURY RE-EMISSION OF WET FLUE GAS DESULFURIZATION IN REAL TIME

Our patented new SulfiTrac sulfite analyzer is the first online solution for continuous improvement of energy consumption while reducing mercury emissions. This is accomplished by measuring and controlling the sulfite ion concentrations within the wet flue gas desulfurization (WFGD) slurry.

With GE's sulfite analyzer hardware and software, you can reduce the power consumption of the oxidation air blowers by injecting only as much air as needed while maintaining gypsum purity.

Configured to cope with harsh environments in heavy industrial applications, the sulfite analyzer is suitable for most power plants or industrial processes with a WFGD.

### Benefits include:

- Reduce power consumption and costs
- Improves air input rate according to boiler load and coal sulfur conditions
- Reduces mercury re-emissions and dissolved mercury in WFGD purge stream
- Eliminates the need for chemical additives for mercury re-emissions control
- Prevents sulfite blinding and maintains high gypsum quality
- Improves manganese solubility to reduce corrosion potential
- Maintains proper speciation of selenium in WFGD purge stream.
- Installs easily with low maintenance

#### Outage Applicability

Major	Minor	O&M Cost Reduction
✓	✓	↓



TOTAL PLANT SOLUTIONS

TABLE OF CONTENTS



# Selective Catalytic Reduction System (SCR)



GE has developed an advanced, patented mercury control technology capable of high removal efficiencies. Mer-Cure\* is an enhanced activated carbon injection system with unique attributes that improve mercury oxidation and subsequent mercury capture. The sorbent is injected into the duct upstream of the air heater, allowing enhanced use of the effective temperature range for oxidation and providing longer residence time for optimal mercury capture.

For additional mercury capture and reduced sorbent consumption, our patented activated carbon milling technology can add even greater mercury capture and reduced sorbent consumption.

**Benefits include:**

- Enhanced mercury (Hg) capture by up to 90%
- Reduced sorbent consumption by up to 50%
- Lowered OPEX
- Wider range of potential sorbent suppliers

Outage Applicability	
Major	Minor
✓	

More stringent environmental regulations also require improved solutions for the nitrogen oxides (NO<sub>x</sub>) formed by the combustion process. With more than 30 years of experience with selective catalytic reduction (SCR) control technology for power generation and industry applications, GE has a wide portfolio of solutions to help customers reach their required performance levels.

Our proprietary IsoSwirl\* mixing technology and specific ammonia injection grid design is an upgrade addressing the improved performance needed for today's high performance SCRs. The IsoSwirl\* mixer technology ensures thorough and even mixing of injected ammonia with flue gas. The shape, quantity and in-duct location of the static mixing blades are tailored to customer's process conditions, ductwork arrangement and emissions requirement. This upgrade requires less tuning and is more flexible than conventional designs.

**Benefits Include:**

- Removal of up to 95% of NO<sub>x</sub> from flue gas
- The quality of the mixing enables the system to meet applications with challenging NO<sub>x</sub> emission requirements or varying operating environments.
- Lower ammonia to NO<sub>x</sub> coefficient of variation than in equivalent conventional system
- Simpler design configuration which is easier to access, maintain, operate and control.

Outage Applicability	
Major	Minor
✓	✓

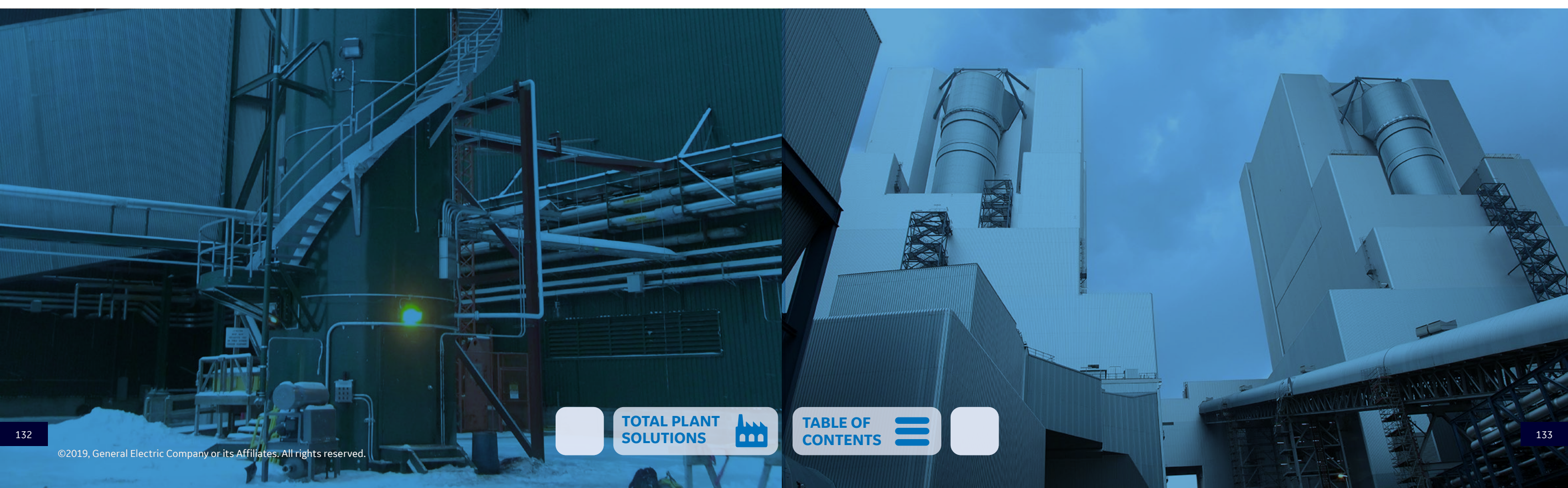



# Digital Solutions

Built on Predix\* to Empower the Electricity Value Network (EVN)

 **More than \$1 billion** annual investment by GE

 **10%** of world power generation capacity connected to Predix

 **30,000+** developers using GE's Predix solution

 **5,000+** electricity sector patents

## Benefits:

### Operations Performance Management

- Up to \$1,500,000 in fuel savings; 0.5-2% heat rate improvement

*note: For a 600MW net, 70% capacity factor, 10,000 kJ/kWh net, coal: 4,200 kcal/kg @ 40\$/t*

### Operations Performance Management

- Up to 20% reduction in NOx and 4% reduction in other greenhouse gas (GHG) emissions

### Asset Performance Management

- Up to 5% reduction in unplanned downtime and as much as \$2,000/MW annual reduction
- Up to 2% improvement in total plant readiness

### Operations Performance Management

- Faster start times, better ramp rate, better turndown

### PROFITABILITY

**Operation Performance Management:** Improve profitability and manage risk through capacity forecasting and decision support with production planning

### SECURITY

**Cyber:** From avoidance of \$1 million per NERC infraction to reduction of lost production due to a catastrophic cyber event

### FIELD SERVICE MANAGEMENT

**Digital Worker:** Up to 8% reduction in service costs



# Digital Capabilities

ENHANCING THE OPERATING PERFORMANCE OF POWER PLANTS TO INCREASE EFFICIENCY, LOWER EMISSIONS AND REDUCE COST.

By monitoring, analyzing and organizing data from more than 10,000 sensor inputs across the plant, GE's Digital Power Plant for Steam helps plant operators make smarter decisions about how to optimally run their power plants; achieving better performance, greater efficiency and improved reliability while lowering environmental impact.

**Digital Transformation consists of the following practices:**

- Connect: Creating the foundation to leverage analytics
- Monitor: Understanding the performance/health of assets
- Analyze: Determining the root causes for effective problem resolution
- Predict: Providing foresight to avoid issues before they occur
- Optimize: Maximizing the performance and profitability



up to **2%**  
Operational efficiency increase and CO<sub>2</sub> reduction



up to **70,000**  
Ton/Year fuel reduction for a 1000MW Plant



up to **2%** points  
Availability increase



down to **25%**  
Low load



up to **7%**  
Maintenance cost reduction

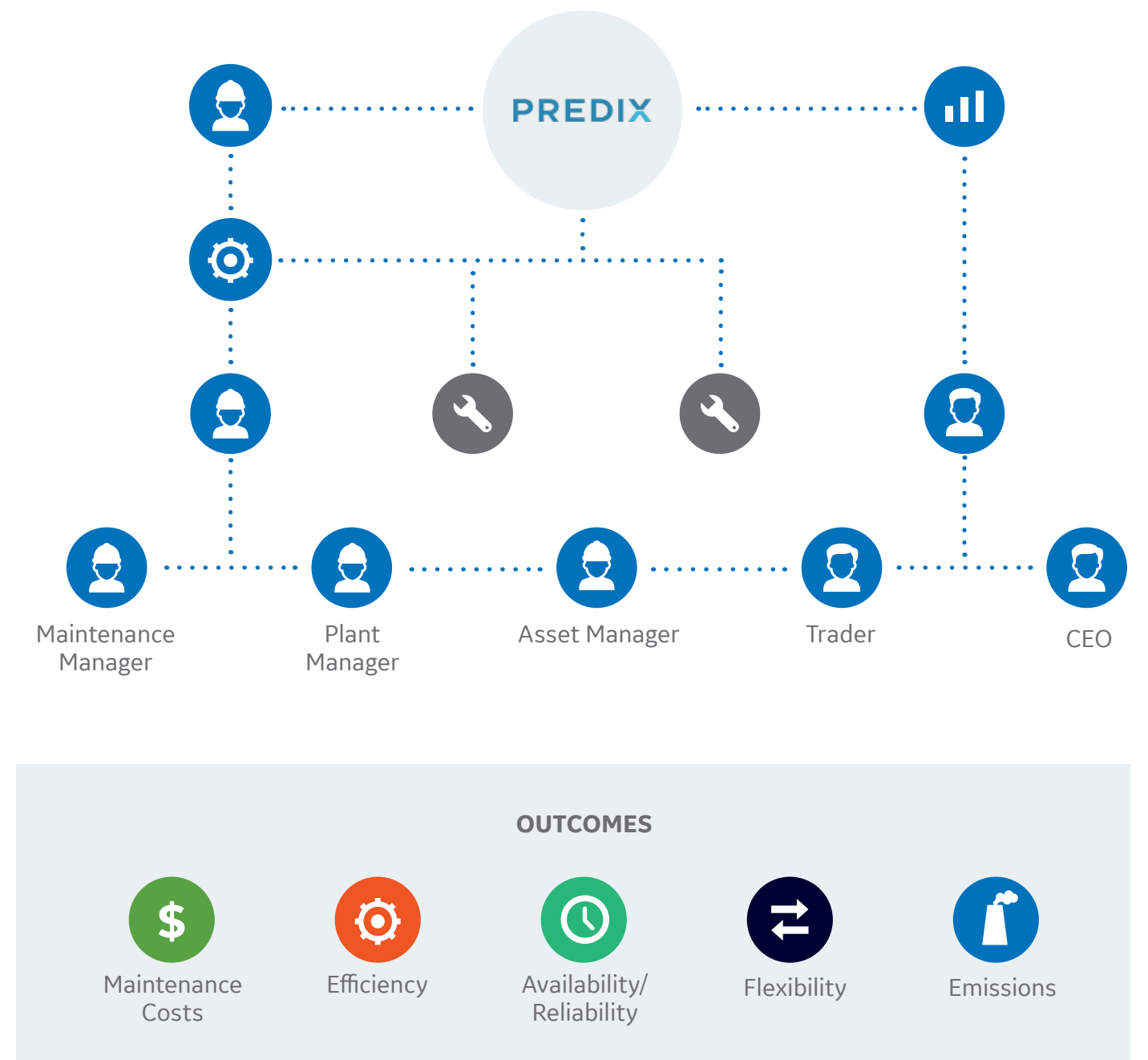
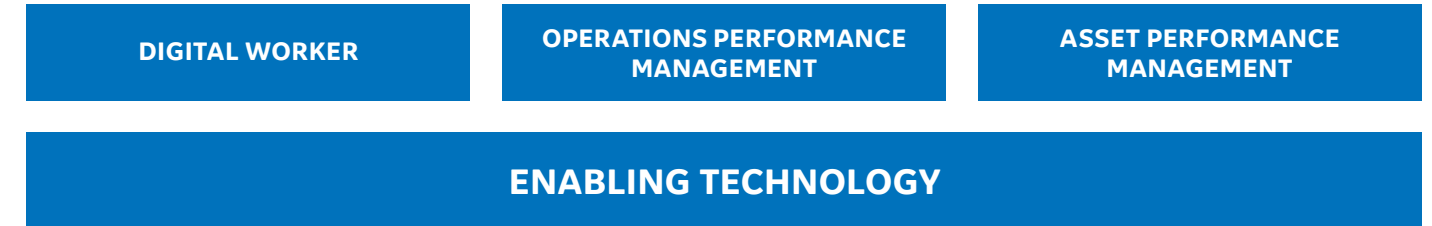



# Digital Solutions

INDUSTRY IN TRANSITION

The electricity industry is undergoing a transformation. Old approaches and techniques are no longer viable—triggering the need for widespread change in the power industry: from grid supply to consumption. By embracing digitalization, companies can apply unprecedented insights, new capabilities and innovative business models to capture enormous opportunities across the entire Electricity Value Network.

## Digital Solutions

With the growing renewables generation, new regulatory requirements, and numerous other fluctuating conditions, operational needs and business models are continually evolving. Much like operational flexibility, digital is a crucial consideration that affects power plant design and component selection. The convergence of hardware, digital software, and advanced analytics is disrupting the status quo and ushering in a new era where reactive becomes predictive, and limits get pushed to new heights.

GE's Industrial Internet capabilities are positioning plant and fleet operators to harness and monetize in ways like never before. One example is the Digital Power Plant, a suite of hardware and software solutions that enable our customers to optimize all the critical components to adapt to changing market conditions. Our platform of apps and analytics adds the power you need to break through new barriers in performance, predictability, and profitability.

## GE Power Digital Solution Map

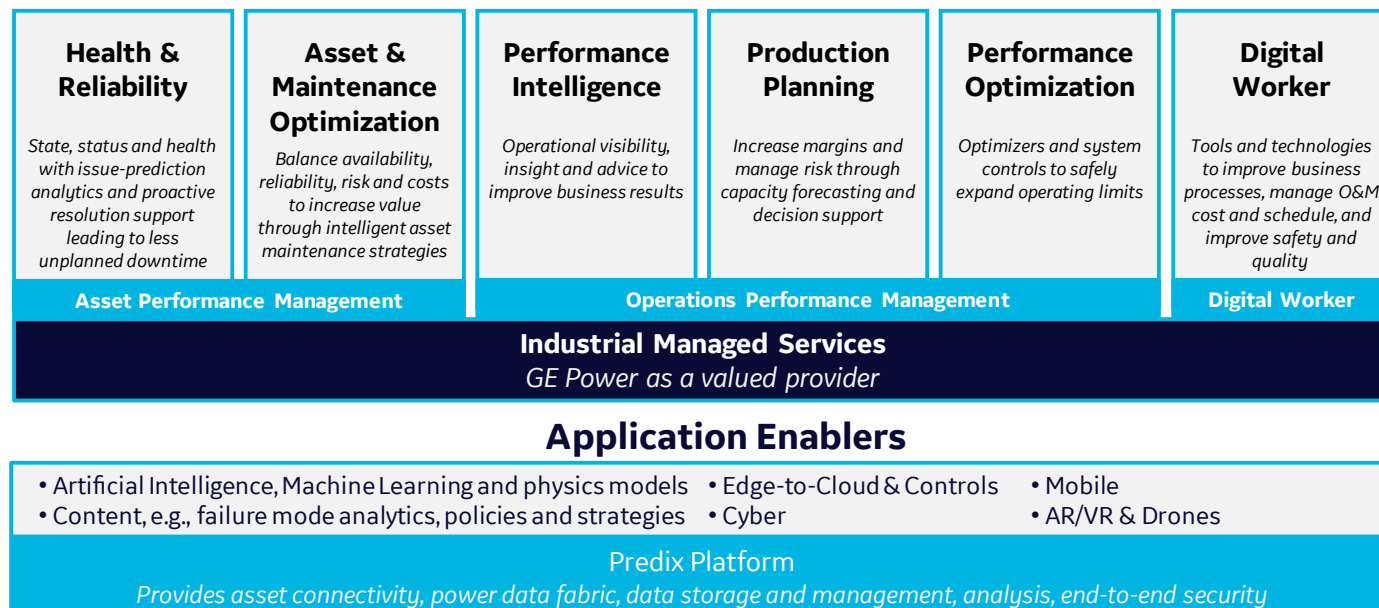

## Our solutions include:

**ASSET PERFORMANCE MANAGEMENT**

Enables the improvement of asset reliability and availability while reducing risk and maintenance costs. It connects historical data, real-time machine data, and other disparate data sources and applies advanced analytics, including physics-guided machine and deep learning, to deliver actionable insights. By predicting potential equipment failures and quickly diagnosing related issues, APM reduces unplanned downtime and improves availability. Additionally, the software helps develop customized maintenance strategies that enhance plant reliability while reducing overall maintenance needs

**OPERATIONS PERFORMANCE MANAGEMENT**

Provides critical decision support and improves productivity by pushing the operating envelope to capitalize on more economic operations for every plant in the fleet. Enabled by edge-to-cloud technology, the solution analyzes historical, plant, and other data sources to deliver executable advice or close the loop and drive desired outcomes for better efficiency, flexibility, and reliability.

**DIGITAL WORKER**

Augment the abilities of workers of every skill level. Mobile service delivery solutions, paired with predictive analytics, give workers the information they need, when they need it, whether remotely or on-site, and enable greater collaboration with other workers to accelerate knowledge sharing.

**CYBER SECURITY**

GE's expertise in operational technology cyber security can help power companies and utilities plan, design and build operational resilience into people, processes and technology. GE uses a cohesive risk management approach to address cyber security challenges throughout the evolution of a company's security maturity.



# Digital for Steam Power Plant

OUR DIGITAL PRODUCTS FOR STEAM

## Plant Efficiency Advisor

The Plant Efficiency Advisor supports plant operation, through additional information for decision support like Key Performance Indicators and Scorecards. Moreover, it continuously calculates the overall plant level and at the individual equipment component level thermodynamic performance. Finally, it facilitates the evaluation of performance deviations and their subsequent correction/ mitigation via direct tool recommendations.

This capability leverages GE's internal plant thermal performance tool, which is used during initial design of the plant and its components. Once the overall actual plant heat balance is calculated ("as-is") through data reconciliation of the imported operational data, the plant "as-should" performances are calculated using the design heat balance tool. Based on the comparison of the two, the capability monitors and identifies the performance gaps of the components in the plant. The performance tool calculates "what-if" scenarios to act as a simulator, validating assumptions and testing scenarios with different operational input parameters and component configurations.

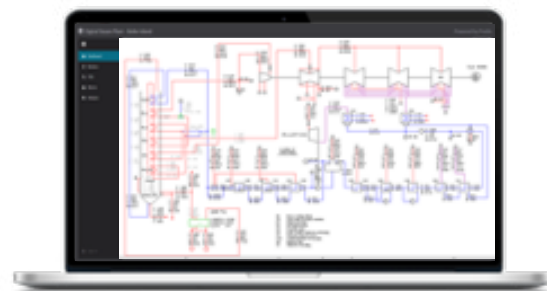

## Fuel Management Advisor

The Fuel Management Advisor provides recommendations to the operator based on advanced analytics that combine inputs from the DCS, operations of the plant, and additional feedback from an added online measurement of the coal ultimate, proximate and ash analysis before it enters the mill. This capability processes the results in real-time, providing early warning to relevant features in the case of:

- Coal quality change
- Continuous boiler control parameters adjustment
- Efficiency enhancement by optimizing auxiliary power operation
- Adapting exhaust temperatures to actual sulphur concentration
- Predicting primary NOx emissions

More generally the fuel management advisor helps decrease fuel consumption with increase of efficiency, decreased emissions, and increased availability and reliability of the boiler.



## Mill Optimization

The Mill Optimization is a digital application for coal mills that consists of a combination of mill process calculations, algorithms, inputs from the DCS system, and signals from new installed sensors (i.e. moisture sensor, vibration sensor), and coal properties sensor (i.e. fuel analyzer from the Fuel Management Advisor). This capability adjusts mill and firing system operations dynamically to best process parameters for gas flow, pulverized fuel fineness, primary NOx, etc. and adapts operational setpoints for variable loads and coal quality. This solution leverages all inputs and engineering first principles-based algorithms to optimize air flow, air temperature, grinding pressure and classifier adjustment.



## BoilerOpt: Combustion Optimization

The Combustion Optimization leverages advanced optimization technologies, such as neural networks and Model Predictive Control (MPC), to learn complex process relationships, dynamically determine the optimal fuel and air set points for the unit's goals and constraints, and direct the control system to make the necessary adjustments in real-time. This solution runs in closed-loop mode on a 24/7 basis and continuously adjusts the bias and trim settings that affect combustion performance. This results in increased boiler efficiency, reduced NOx emissions, and better control over steam temperatures, CO, LOI (Loss of Ignition), and opacity.

## BoilerOpt: Soot Cleaning Optimization

The Soot Cleaning Optimization is a soot blowing optimization software solution that determines the effect of soot blowing activity on heat transfer throughout the furnace and back pass and circumvents the negative availability and efficiency impacts of boiler over- and under-cleaning. Using expert rules and neural networks, the Soot Cleaning Optimization balances boiler cleaning actions to reduce boiler tube erosion and excessive thermal shocking, while improving steam temperatures and sprays and minimizing fouling, plugging and slagging events. It works in conjunction with existing soot blowing controls to drive closed-loop optimization.





# Digital for Steam Power Plant

OUR DIGITAL PRODUCTS FOR STEAM

## Digital Boiler+

Digital Boiler + introduces a suite of sensors, boiler hardware upgrades, advanced controls strategy, and analytics to provide two plant operating modes: Low Excess Air mode for heat rate improvement and Low Load Stability mode.

The Low Excess Air mode uses improved digital sensors located at each coal burner to provide finer control on where air is injected. With improved air distribution in the Main Burner Zone, overall excess air can be minimized while maintaining NO<sub>x</sub> and CO emissions under control. Lower excess air improves boiler efficiency, reduces auxiliary power consumption, and decreases overall emissions.

In Low Load Stability mode, Digital Boiler + eliminates combustion imbalances to ensure the stability of the flame during low load operation.

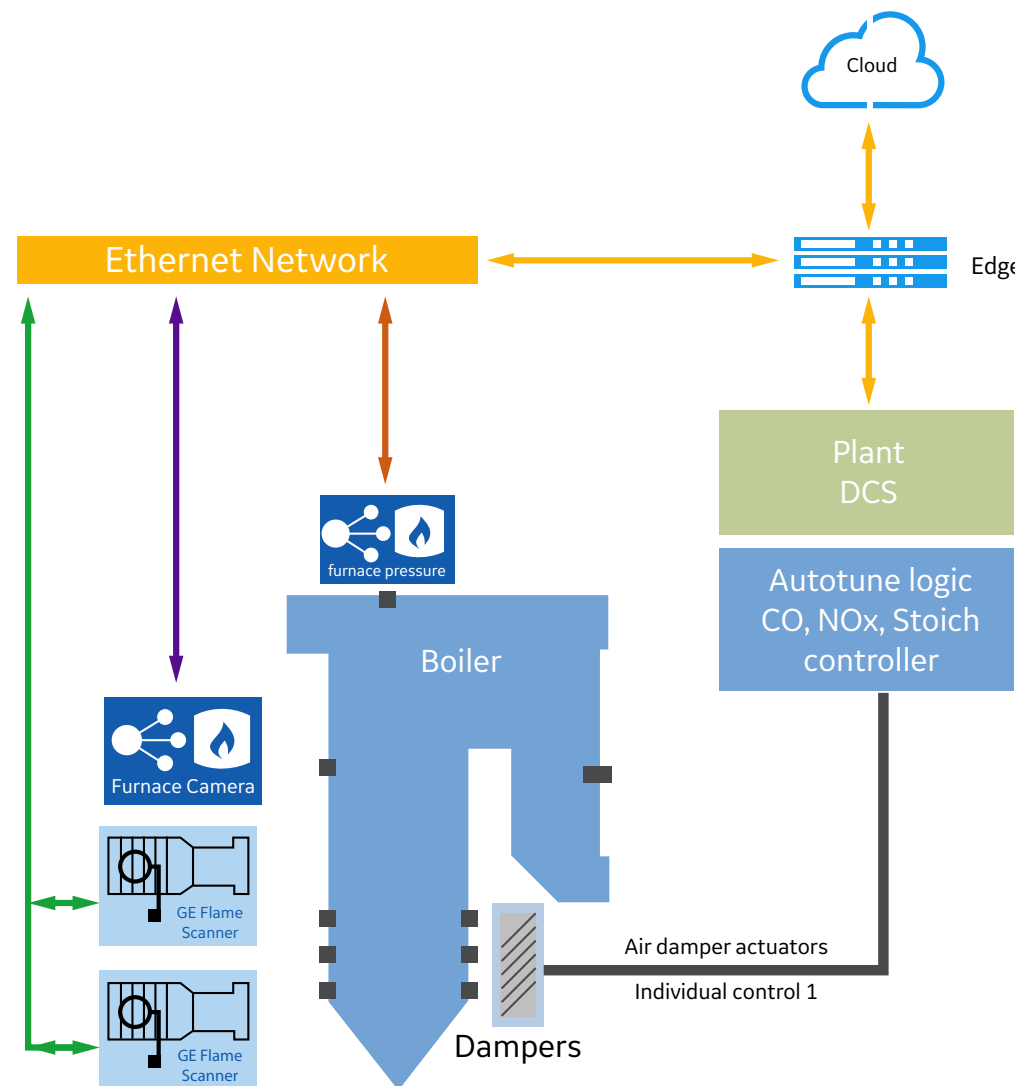

## Boiler Health Monitor For Thick-Wall Components

Boiler Health Monitor for thick-wall components is a solution that provides the true health and lifetime of thick wall components such as headers, drums, circulating pumps, etc.). This solution can be leveraged for evaluating effects of normal operation, rapid startups, load changes and cyclic operations and the impact on the lifetime of the pressure parts and creep stressed piping systems. The lifetime monitor system for thick walled components consists of:

- Thermocouples placed in critical locations on pressure parts to support creep and fatigue calculations, and alert on localized high-fatigue conditions due to flooding or overspray
- Key DCS operating data (i.e. pressures, temperatures, and steam flows) supports creep and fatigue calculations
- Analytics based on industry standards: EN 12952-4 for Creep, fatigue, and lifetime assessment calculations with enhancements based on GE boiler OEM knowledge and experience

## ESP Advisor

The ESP Advisor is a set of advanced analytics that provide further enhancement to the ESP (Electrostatic Precipitator) System and existing controls, through the continual monitoring of operations and the overall health of the major mechanical and electrical components of the ESP: (Rapping System, Gas Flow Distribution, High Voltage switchgear). These analytics will deliver improvements in availability. Following the actions of the ESP advisor can help in delaying the maintenance cycle (so that necessary spares can be procured in advance) and generate alarm conditions by identifying potential issues.

The main equipment issues tracked consist of the Rapping System (CE & DE), collecting plates, discharge electrode misalignment or breakage, contaminated insulators or baffle plate failure that cause clogging in the gas path. The carrying out of such health checks contribute to the avoidance of sparking/arcing, high opacity and particulate excursions and ESP unavailability.

## NID Advisor for Dry Flue Gas Desulfurization (DFGD)

The NID Advisor takes measurements and performs analytics to identify whether the NID (Novel Integrated Desulfurization) process is operating in an abnormal condition and provides advice on the identification of potential issues and their mitigation. Therefore, the NID advisor ensures that the process is meeting regulations while optimizing lime consumption. This algorithm monitors the overall health of the NID and suggests actions towards delaying the maintenance cycle (so that necessary spares can be procured in advance) or generate an alarm to avoid any major component failures inside the NID.

The principle is to propose potential failures that may cause abnormal response in data from the equipment. For each of these potential failures, a set of actions are then proposed as a corrective/mitigative measure.





# Digital for Steam Power Plant

OUR DIGITAL PRODUCTS FOR STEAM

## ↔ ⌚ Rotor Stress Controller

This capability monitors and controls the thermal stress within the steam turbine rotor to ensure safe and flexible operation. It leverages process measurements to calculate in real-time the present stress levels and takes necessary actions to operate the turbine as close as possible to the permissible stress limits. The key customer benefits are accelerated turbine start-ups and more robust transient operation due to improved controls, leading to better flexibility and reliability. The Rotor Stress Controller includes also a life time assessment indicator module, enabling the customer to make better trade-offs between turbine rotor life time and turbine operational flexibility, which makes it possible for the customer to make better trade-offs between life time and flexibility operation.

## ↔ ⌚ Turbine Lifetime Advisor

This capability is an advisory device that provides the customer with turbine lifetime related information for better asset performance management and more flexible operation. It records operation data such as startup time, lifetime consumption, process variables and control system parameters. It supports customer's decision-making process to optimize plant operation based on business needs and future maintenance planning. The Turbine Lifetime Advisor requires a turbine rotor stress controller, which is part of the steam turbine closed loop control function. The operation data will be stored on premise or in the cloud for further analysis.

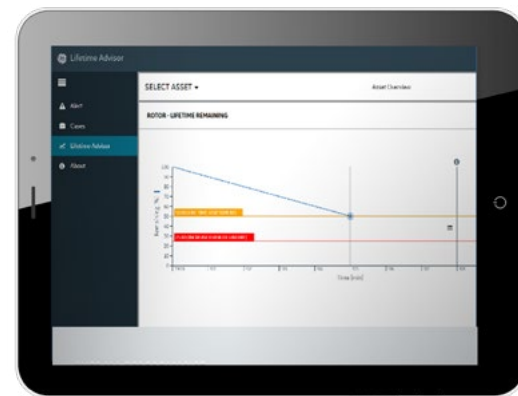

## ↔ ⌚ Turbine Startup Optimization

This capability acts as a superordinate control for turbine start-up and operation optimization including improved disturbance handling. It increases steam turbine availability, improves operational flexibility and reduces fuel consumption. The Turbine Startup Optimization is based on a model predictive control concept and combines a feedback control with an online optimization consisting of a transient digital twin with a detailed rotor stress model to predict future evolution based on past and current measurements. The key customer values include flexible and faster start-up strategies, reduced start-up time without compromising turbine lifetime, robust transient operations, and adaptable optimization based on customer specific objectives, constraints and limitations of the plant.

## ⌚ Turbine Torsional Vibration Advisor

The growing share of renewable and distributed power generation increases the risk of electrical network instabilities. Disturbances of the grid can cause fluctuations in the generator rotor torque of large power generation units, resulting in vibration of the shaft line and causing possible damage to the shaft line components.

The Turbine Torsional Vibration Advisor is a GE digital solution for model-based torsional vibration monitoring and diagnostics. The system offers the health monitoring of the power shaft line for better outage planning. The advisor enables real-time insight into stresses and vibration amplitudes at all critical locations along the rotor, for example, couplings, blades, and retaining rings of turbo-generators. It combines a state-of-the-art signal processing technology with a rotor dynamic digital twin to improve prediction accuracy.

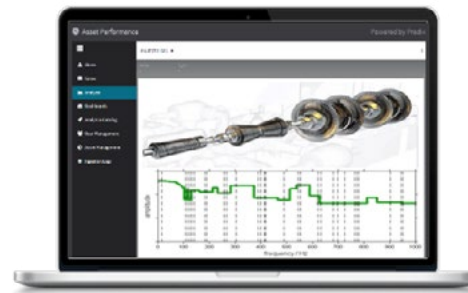

## ⌚ Valve and Actuator Monitoring System

The increasing availability of renewable energy sources has caused changes in power plant operation regimes. The steam turbines valves are now continuously controlled, whereas formerly they used to be either fully open or closed.

This capability includes required hardware and software to monitor the behavior of steam turbine valves. It provides assessment functionalities to determine valve performance and health. It improves the valve reliability and availability by visualization and advices. It helps the customer to minimize valve failures, improve maintenance planning, extend maintenance intervals, and reduce valve testing requirements



## ⌚ Generator Health Monitoring (GHM)

The Generator Health Monitor is a modular online monitoring suite available for any type of Generator that allows continuous monitoring and assessment to identify evolving issues related to:

- Stator bar insulation
- Rotor interturn insulation
- Bearing insulation and electro-erosion
- Stator end winding support tightness
- Water-cooled stator bar cooling efficiency
- Rush gear sparking and Hydrogen into water leakages for water-cooled stator bars.

This facilitates improved outage planning, increasing availability and reliability while reducing maintenance costs.

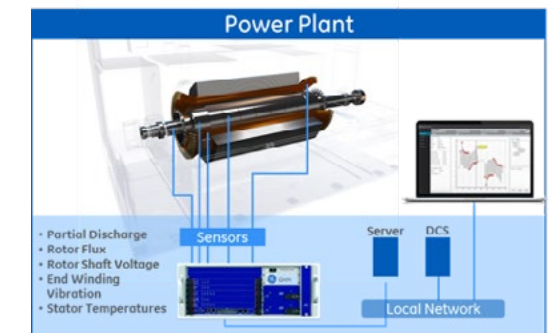



# Cyber Services

**Cyberattack and security breaches can quickly cascade into serious financial damage or impact on human safety.**

GE Power Automation & Control Cyber Services help keep installations up-to-date, recover from unplanned events faster, evaluate system security, and provide updates to prevent against external and internal threats.

These services ensure that your hardware is protected, that your system's firewall, antivirus, and patches are up-to-date, and that through a highly-secured remote access connection our trained professionals are able to access and maintain your control and intrusion detection systems.

Each of these services is performed in a secure environment, protecting your critical installations and systems, by our dedicated team specially trained and sensitized on cybersecurity regulations and standards.

## Cyber Services

CYBERSECURITY SERVICES

**GE's expertise in operational technology cyber security can help power companies and utilities plan, design, and build operational resilience into people, processes, and technology.**

**GE cybersecurity strategy is adapted to customer needs, divided into three stages:**

### STAGE 1 – ASSESS

Identify immediate security issues that can impact operations, even if the environment is thought to be air-gapped.

#### Cybersecurity Health Check

A first-level risk assessment aimed at identifying the most relevant area of improvement. Thanks to this assessment, it is possible to prioritize a smaller number of actions with high pay-off results.

#### Cybersecurity Site Assessment

In-depth, comprehensive evaluation of an operational site facility, based on industry standards and best practices, resulting in an individualized report with prioritized mitigation recommendations and strategies.

#### Regulations compliance

- NERC CIP Cyber Vulnerability Assessment
- IEC Security Practices Certification
- IEC 62443 GAP Assessment

### STAGE 2 – PROTECT

Implement security monitoring and defensive layers to comply with standards and strengthen the security posture of a company.

#### Basic Cyber Package

This offering provides a first line of protection for existing equipment/technologies to reduce attack surface and deploy the best solution with minimal system impact.

#### Key benefits:

Improve security with cost-effective solution and little or no system downtime; fast deployment of cyber defense solutions and compliance to regulations for critical infrastructure.

#### Advance Cyber Package

This package provides an in-depth knowledge of existing cyber security environment and detailed risk assessment of the plant to prevent intrusions and failures.

#### Key benefits:

Gain awareness of plant status concerning cyber security and strengthen plant security and responsiveness against threats

### STAGE 3 – PREVENT

For the industrial layers of an organization, pursue proactive and predictive security measures such as having a response plan and trained personnel to execute it during or after cyber events.

### CONSULTING CYBER SERVICES & CYBERSECURITY TRAINING

To help to coordinate cross-functional relations (including OT & IT) and to develop cybersecurity awareness, we provide a comprehensive portfolio of security training courses on integration of cyber security and compliance to National/International regulations. Training content is developed and delivered by GE's security experts to increase staff knowledge and awareness of the cyber world.

TOTAL PLANT  
SOLUTIONS



TABLE OF  
CONTENTS





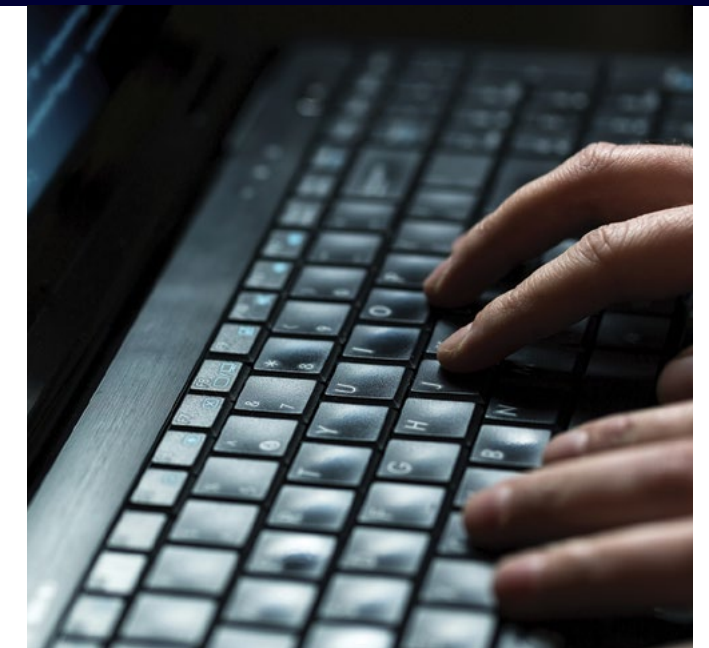
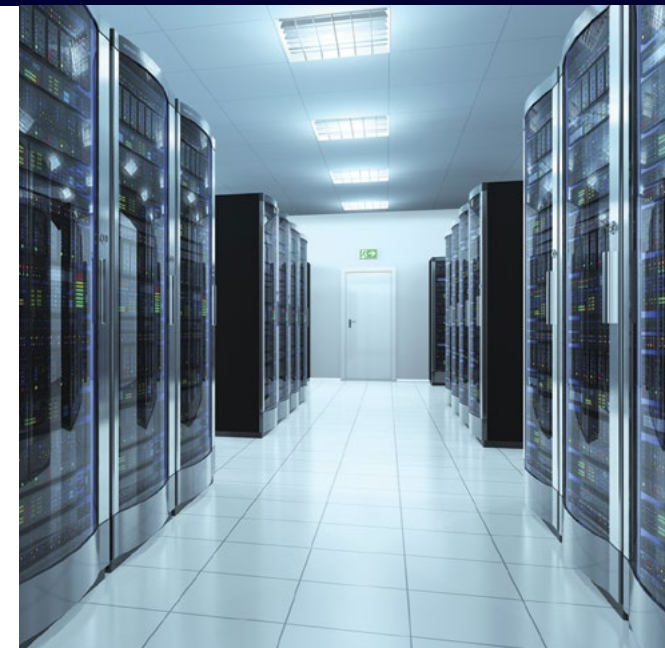

### Basic Cyber Package

- Health Check
- ALSPA Patch Management
- Port Disabling & Station Hardening
- Network Hardening
- Security Logs Collector
- Asset Content Monitoring
- Secure Remote Access

### Advanced Cyber Package

- Site Assessment
- Security Server
- Back up & Restore
- HMI Upgrade
- Intrusion Detection System
- Secured Overall External Connection

### Cyber Consulting Services

- Audits
- Cybersecurity Training/Awareness
- Support on National/International Regulations (ANSI in EU, NERC in USA)
- Incident Response (Disaster Recovery Plan)

### Back-up & Restore

Available on every Windows technology-based system, the Back-up & Restore service provides secure maintenance and operation, reducing the time needed to restart equipment or the system after a crash or other unplanned event.

#### KEY BENEFITS

- Stock Historian archives or other configurations
- First point for a fast disaster recovery plant
- Securely back-up data to an external data center
- Both full or partial back-up functions available
- Back-up periodically and when requested by the customer
- Restore from NAS or data center to DCS
- Easy retrieval from host servers for fast disaster recovery
- Easy to return to previous release of the DCS or Controcad database

### Patch Management

The Patch Management service improves your system's life cycle and increases plant availability while complying with cybersecurity regulations. We provide periodic software updates to our customers via secure remote access or by mailing a CD/DVD. This service includes operating system, antivirus, and ALSPA software updates.

#### AVAILABLE PACKAGES:

- Security patches for Windows 7 or Windows 10
- Signature and engine of antivirus
- Antivirus update
- ALSPA patches: HMI, CCAD, MFC3000/CE3000

#### KEY BENEFITS

- Performed in a secure environment
- Access to current software upgrade programs
- Easier maintainability
- Ability to bundle System Update with Remote Access for installation improvement





# Controls Services



**4,300** installed systems in operation worldwide

**3,000** Excitation

**800** Turbine controls

**500** DCS



Services, scalable and oriented to maximized value **within and beyond the technology life cycle**



**Upgrades to boost your controls:**  
Improved reliability and availability  
**-40% Maintenance cost reduction<sup>1</sup>**

## Key Solutions:

Future-proof your system with greater flexibility using our **Migration Services**

- HMI Upgrade
- Migration Pack for DCS, Turbine Controls and Excitation

Maximize the asset lifecycle while minimizing downtime and increases performance with our Lifecycle Services:

- Services agreement
- On-site services
- Spare part and repair
- Alarm rationalization
- Remote operation services
- Control loop tuning
- Simulation as a service

**Optimize performance, advance operability, and improve availability with our Plant Solutions:**

- Single integrated solution for safety and control
- Virtual plant solution for operations maintenance and EPCs
- Emergency shutdown system
- Integrated plant controls
- Outcome optimizing control
- Control, monitoring, and protection software suite



TOTAL PLANT SOLUTIONS



TABLE OF CONTENTS

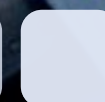



# Plant Solutions

## Control Technology for the Total Plant

### Optimized performance, advanced operability, high availability

Power Automation & Control is a global leader in power generation with a portfolio of products covering all fuel types.

Whether in design, manufacture, procurement, or servicing, GE is setting the benchmark for innovative technologies that provide clean and efficient power solutions. GE can supply anything from single components to complete turnkey power plants. Our optimization of all elements to derive the maximum lifetime value from all our customer's investments.

GE has more than 100 years of experience in the engineering, procurement, and construction (EPC) of new power plants. Our engineers are also experts in retrofitting, modernizing, and servicing existing plants. With operations in 70 countries, GE is close to customers all over the world, ensuring rapid responses and service excellence at all times.

Our solutions are adapted to each plant and ensure the safe operation of the power generating unit. Our extensive know-how ensures high electrical quality and improves the efficiency of operation. Thanks to GE's plant process and design knowledge, operators can reap the maximum benefits from their power plants.

We can provide the following hardware and software solutions for your project:

- Distributed control systems
- Turbine controllers
- Excitation systems

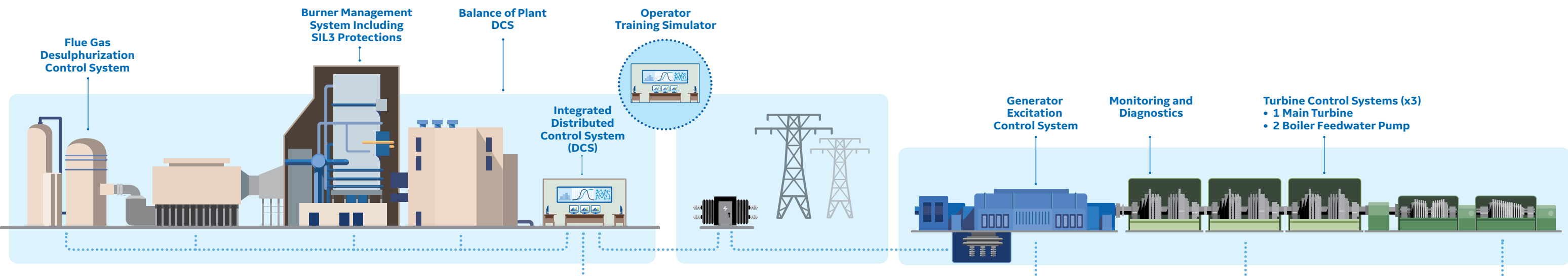

TOTAL PLANT SOLUTIONS



TABLE OF CONTENTS





# Turbine Control System

SINGLE INTEGRATED SOLUTION FOR SAFETY & CONTROL

## STEAM TURBINE CONTROL SYSTEM

GE's Steam Turbine Control Systems portfolio covers a wide range of steam turbines, from the industrial units to the nuclear units, including turbo-compressors and turbo-pumps. Thanks to our controllers and IOs portfolio, Power Automation & Control has developed a range of solutions adapted to each set of unique requirements.

## INDUSTRIAL STEAM TURBINE

Power Automation & Control provides all the functions for the industry that include automatic speed control, load control, and limitation, with a user friendly graphic interface to ease the operation and the maintenance of the unit. Based on a standard hardware and software configuration, additional features such as an electronic SIL3 overspeed protection may be provided with integrated test.

## MEDIUM & LARGE STEAM TURBINE

Based on a standard redundant configuration, this scalable solution provides speed and load control with various limitations and includes all the steam turbine protection.

For maximum availability, the controller is also available in a full Triplicated Modular Redundancy, including a full TMR SIL 3 protection system with a normal overspeed protection and a backup overspeed protection.

The PC based graphic interface can be provided for local control or remote installation in a centralized control room. Some additional features such as Historian, and communication with third party equipment are also available.

## NUCLEAR STEAM TURBINE

GE's control systems are used in dozens of nuclear power plants around the world. Thanks to this experience as the largest nuclear steam turbine manufacturer, GE has developed a strong expertise in qualifying control systems with respect to local regulations. Over the years, nuclear safety requirements have been reinforced and certain units' functions may need to be qualified according to the IEC 61513. GE's solutions for nuclear steam turbines are regularly improved to provide a high level of reliability and enable customers to meet the IEC61513 qualification.

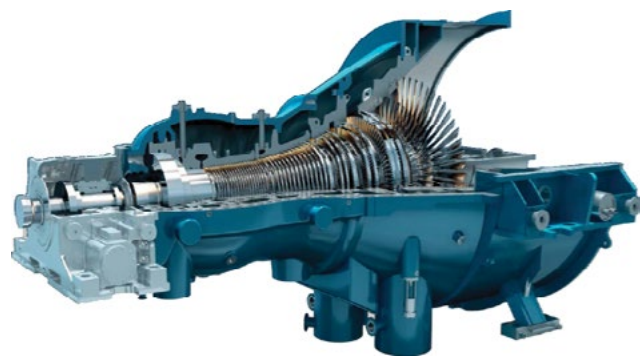

For more than sixty years GE has provided control and safety solutions for turbines of all sizes and applications. Today GE's Power Automation & Control is an industry leader for every aspect of the power generation process, providing innovating features to maximize the turbine life and improve the reliability and the safety of customers' assets.

## EXPERTISE

GE's solutions for turbine control are generated from a unique association of the turbine manufacturer's expertise and the control systems manufacturer's expertise that are enhanced within a community of GE's Experts (and ex-Alstom Power).

Our solutions are continuously improved to increase reliability and flexibility, and minimize unplanned outages while providing equipment designed for long term operation enabled by GE's product lifecycle policy and wide range of services.

## AVAILABILITY

Avoiding unplanned outages is key. In addition to the highest availability features of Triple Modular Redundancy (TMR) architecture capability for asset control and protection, GE's Turbine Control Systems provide features for prevention and troubleshooting. Fast data recording with 1 ms time stamping and an advanced monitoring solution for real time analysis of data greatly simplify root cause analysis.

## SAFETY

Without safety and security there is no sustainability. Safe operation is reinforced through IEC 61508 SIL3 Exida certified modules, fail-safe designs and TMR protection systems. GE's Turbine Control System with SIL-capable protection is designed for peace of mind, meeting the functional safety requirements of IEC 61508 and 61511. The Mark VIeS safety system is proven technology that has received the 2014 Exida safety award.

## INTEGRATED SOLUTION

GE's Turbine Control System uses a common hardware and software platform with the GE DCS and Generator Control System and common configuration for both safety and control. This fully integrated solution provides single plant control for your most valuable asset, enabling comprehensive and connected plant automation powered by GE's Predix platform.

In addition, maintenance, diagnostics, spare parts, logistics, alarms, databases, and training are required for just one system— simplifying operations.

## OPERATOR INTERFACE

Power Automation & Control understands the importance of the operator interface. Turbine Control System mimics are designed and optimized to provide quick access to essential information, and easy to use controls to allow faster operator action for all operating situations, especially during crisis management.

## CYBER-SECURITY

Cyber security is a major concern with modern Turbine Control Systems that offer a wide range of open communication with third parties. GE's control systems are hardened. Several cyber-security options are available depending on the configuration. Furthermore, most of our controllers are Achilles certified.





# High Fidelity Plant Simulation

VIRTUAL PLANT SOLUTION FOR OPERATIONS MAINTENANCE AND EPCS

Power plant builders must hand over the plant faster while reducing commissioning costs. Operators must run the power plant as efficiently as possible and maintenance personnel must be able recognize and diagnose issues as efficiently as possible without taking assets off line or impacting performance.

GE's Plant Simulator solutions provide high-performance replication of power plant process and real-time controls. High-fidelity virtualization enables Simulation Assisted Commissioning (SAC) as well as Simulation Assisted Operations (SAO) for the full plant.

## BENEFITS DURING COMMISSIONING

- Reduced lead time
- Reduced lifetime consumption and commissioning budget
- Reduced Risks

## BENEFITS IN COMMERCIAL OPERATION

- Reduced risk of operator errors
- Improved operator readiness during abnormal plant behavior
- Faster reaction to production demand
- Reduced off-spec electricity production
- Faster diagnosis by maintenance personnel
- Reduced lifetime consumption
- Reduced maintenance costs

## OPERATOR TRAINING SIMULATION

The Operator Training Simulator (OTS) is a high-performance solution that replicates the Power Plant Process and Real Time Controls. It trains operators to run the Power Plant in an optimum manner, and maintenance personnel to diagnose issues as efficiently as possible.

### The solution is based on:

- A full plant process model complying with ANSI/ISA-77.20.01-2012 Standard
- Real-time, virtualized plant controller
- Engineering and operator stations
- Instructor station with a set of training scenarios and tools

### It is offered with the following Services:

- Instructor Training Services: Normal , Degraded, Abnormal Operation Conditions
- Case Studies Workout Session, to support best practice acquisition based on real operating conditions
- Hot Line and Remote coaching

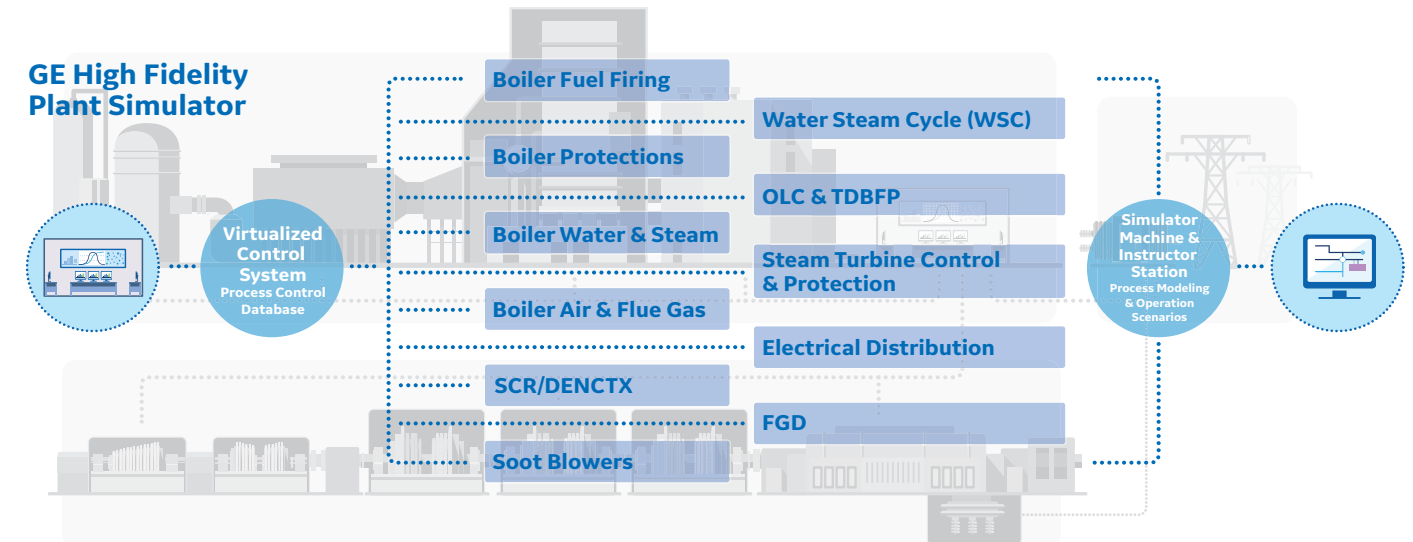

## HIGH-FIDELITY SIMULATOR SOLUTIONS FOR EPCS

The High-Fidelity Plant Simulator enables Simulated Assisted Engineering (SAE) of the plant controls and the Simulated Assisted Commissioning (SAC) for the full plant. The SAE and SAC Services are delivered to the Plant EPC.

### The solution is based on:

- A full plant process model complying with ANSI/ISA-77.20.01-2012 Standard
- Real time, virtualized plant controller
- Engineering and operator stations

### It is offered with the following services:

- Engineering Phase: Process controls verification and validation with the process owners, and when possible, some commissioning resources
- Commissioning Phase: Virtual commissioning, operating modes validation / improvement, alarms rationalization

## KEY BENEFITS

- Reduced power plant delivery time by reducing the duration of commissioning phase
  - Reduced overall commissioning cost
  - Reduced lifetime consumption during commissioning
- Additionally, such simulators can be accessed in an as-built version to support the design of subsequent plants.





# Integrated Plant Controls

MARK VIe DISTRIBUTED CONTROL SYSTEM (DCS)



GE's Distributed Control System (DCS) solutions are easily adapted to the constantly evolving requirements of industries such as power generation, and chemical processing.

They control the entire plant, including balance of plant equipment and machine controllers. Additionally, GE provides added services to operate and maintain the plant. Comprehensive solutions integrate dedicated controllers for critical components. While flexible architecture enables optimal solutions. GE's DCS solutions extend this flexibility from the traditional unit controls to complete plant solutions delivering advanced performance, operability, and availability.

For businesses that are dependent on decades of uninterrupted machine service, a redundant control system that allows for online maintenance is critical. GE's Distributed Power Automation & Control are designed to provide the high level of availability and the flexibility necessary for today's most demanding applications.

Downtime is one of the greatest detriments to productivity and profitability. It is imperative to have a system in place that provides the highest levels of system reliability and availability at all times. To meet the demands of today's connected industries, GE has combined its leadership of the Industrial Internet with its rich history of process control to deliver the Mark VIe Distributed Control System (DCS).

GE's DCS solutions feature high-speed, networked I/O for simplex, dual, and triple redundant systems. Industry-standard Ethernet communications are used for I/O, controllers, and supervisory interface to operator and maintenance stations and third-party systems.

## CONNECTIVITY

Ethernet-based I/O can easily be distributed plant wide across all balance of plant applications. Industry-standard Ethernet communications are used for I/O, controllers, and supervisory interface to operator and maintenance stations, as well as third-party systems.

## ENGINEERING & MAINTENANCE

The integrated software suite allows efficient programming and configuration of your power plant DCS. It also embeds tools for trending, analyzing, and plant diagnostics—simplifying plant maintenance activities.

## INTEGRATED APPLICATIONS

A common software suite is utilized system-wide for programming, configuration, trending, and analyzing diagnostics. It provides a single source of quality, time-coherent data at the controller and plant level to understand and adjust how a plant is operating in real time.

## SAFETY

The controller comes with integrated SIL certified IEC®-61508 Safety Management modules: the Mark VIeS, dedicated to safety-critical parts of your power plant.

## A COMPREHENSIVE APPROACH FOR CONTINUOUS OPERATIONS

GE's tightly integrated DCS solutions deliver robust process control with seamless connectivity and automated real-time information management to help you maximize uptime and productivity.

GE's DCS enables users to improve operational efficiency, optimize production, and unlock new revenue opportunities by leveraging advanced data analytics. The IICS System consists of intelligent controllers, I/O modules, secure cloud connectivity solutions, advanced analytics software, and apps to provide real time process optimization and control with minimal disruption to deployed applications. Deployed with secure embedded and/or standalone connectivity to the Industrial Internet, IICS provides flexible options for each unique customer application.

## PREDIX TECHNOLOGY FOR DISTRIBUTED CONTROL SYSTEMS

Take advantage of outcome optimizing apps by leveraging centrally managed industrial infrastructure. PREDIX software platform supports the growing Industrial Internet of things with cloud servers and Optimization Apps. Predix is a platform as a service cloud-based platform that enables industrial-scale analytics for Asset Performance Management (APM), Operations Performance Management (OPM), and Business Optimization (BO) by providing a standard way to connect machines, data, and people. Predix software can do for factories and plants what Apple's iOS did for cell phones.

High-end, yet flexible, control system provides a single hardware platform, common configuration and maintenance tools, a common operator interface, and a single Ethernet network for turbine, generator, LCI, exciter, HRSG and BOP controls.

Deep domain expertise of the main assets around the power plant allows for operations optimization and minimizes instabilities during system transients. IICS ensures a future-proof plant controls environment and allows for seamless software upgrades over its life through the GE App Store.

Cyber security is a major concern with modern Turbine Control Systems that offer a wide range of open communication with third parties. GE's control systems are hardened. Several cyber-security options are available depending on the configuration. Furthermore, most of our controllers are Achilles certified.

## KEY BENEFITS:

- Single operator interface for all equipment reduces training costs and improves operator productivity
- Integrated system, single control platform, utilizes common configuration and diagnostic apps to reduce programming, system checkout, and start-up hours
- Improve operator awareness of the plant with better root cause analysis, diagnostics and overall operational analytics that improve decision making
- Reduced project risks and integration cost via single experienced OEM
- Accurate diagnostics for shorter maintenance outages; reduce productivity losses
- Optimized component start GT fast start, optimized drum level controls, via advanced control algorithms etc.
- Reach operation excellence and reduce operation risk via High Fidelity simulator
- Reduce training costs and improved operator productivity: Consolidated operator interface allows full control from one central location
- Faster commissioning through dedicated Power Automation & Control Predix apps

TOTAL PLANT SOLUTIONS



TABLE OF CONTENTS





# Outcome Optimizing Control

# Traditional Controls Portfolio

GE'S LEGACY OF HIGH PERFORMANCE INDUSTRIAL COMPUTING PLATFORMS

## Mark VIe

GE's Mark VIe control system is an integrated control system that can deliver the high performance and flexibility needed to reliably run application specific control.

The Mark VIe UCSC runs on a real time operating system for high-speed, reliable, industrial applications. It can be configured for simplex, dual, or triple redundant operation, at incremental frame rates as fast as 10ms in any configuration. Since synchronization is important for high performance turbine control applications, the UCSC synchronizes the local processor clocks on the I/O modules.

Outcome Optimizing Controls offer advanced capabilities that simplify system architecture and dramatically reduce applied engineering costs. Mark VIe UCSC's flexible design allows for use in turbine and generator control applications, and also for DCS applications, especially in steam and gas power plants. The native PROFINET capability on the UCSC provides productivity and performance advantages necessary for DCS and BoP control applications for power generation.

### MAJOR SOLUTION BENEFITS

- Single user interface and tools across system for reduced training costs and improved operator productivity.
- Improved root cause analysis, diagnostics and overall operational decisions
- Reduced project risks and integration cost

**Small Footprint** •••••  
Maximize limited cabinet space. DIN-rail mounting for ease of installation

**Mix and Match I/O** •••••  
Use integrated PROFINET with MRP for high speed connections to our RSTI-EP, RX3i, or VersaMax I/O

**Ethernet Everywhere** •••••  
Gigabit connections with integrated switches provide connections for controlling I/O, direct messaging, or handling of data. Use TSN technology to allow multiple protocols over 1 wire without impacting performance

**Rugged by Design** •••••  
Built for harsh environments using COM Express technology. Extended temperature range for your most demanding applications



**Advanced Security** •••••

- Achilles certified for robustness against service attacks
- Secure boot to prevent malicious applications and "unauthorized" operating systems
- Trusted Platform Module (TPM) on board

**Real Time Virtualization (Predix Enabled)** •••••  
Quad core processor with embedded hypervisor and PREDIX embedded provides ability to safely add apps running in parallel with the main control. Load PREDIX CLOUD services apps for analysis and action

### OPTIMIZED PERFORMANCE, ADVANCED OPERABILITY, AND SAFETY FOR POWER GENERATION APPLICATIONS

GE's Mark VIe solution provides advanced operational capabilities to the entire fleet, including balance of plant equipment, machine controllers, and dedicated control for critical components. Flexible architecture enables optimal solutions from the traditional unit controls to complete plant solutions for optimized performance, advanced operability, and high availability. These diverse applications require a compact controller that can deliver the high performance and flexibility needed to reliably run application specific control.



TOTAL PLANT SOLUTIONS



TABLE OF CONTENTS





# ControlST Software

CONTROL, MONITORING, AND PROTECTION SOFTWARE SUITE

# Emergency Shutdown System (ESD or BMS)

AWARD-WINNING INTEGRATED SAFETY SOLUTION

GE's advanced ControlST software suite provides the foundation for the Mark\* Vle Control System in a wide range of applications. These diverse applications include the control, monitoring, and protection of everything from turbine-generators to entire plants.

Combining the best attributes of rotating machinery control with balance-of-plant control, the ControlST software suite offers flexible tools with a common time-coherent dataset to simplify operation and reduce lifecycle cost. In addition, it supports the latest model-based control technology derived from GE's thermodynamic design models to deliver the performance, operability, and reliability needed in today's connected world.

ControlST integrates vital data throughout the plant, including data from external systems that would otherwise be unavailable, and presents it in a meaningful context, reducing system costs. Armed with the right information at the right time, engineers can more effectively analyze process trends and adjust control software, operators can more quickly respond to alarms and operational disruptions, and maintenance teams can pinpoint problem areas, react proactively, and keep processes online.

### THE CONTROLST SOFTWARE SUITE INCLUDES SEVERAL HIGH-PERFORMANCE TOOLS:

- WorkstationST\* HMI and Historian management software
- ToolboxST\* configuration and diagnostic software
- CIMPLICITY\* graphics tools
- other packages for efficient plant-wide communications, monitoring, and asset management

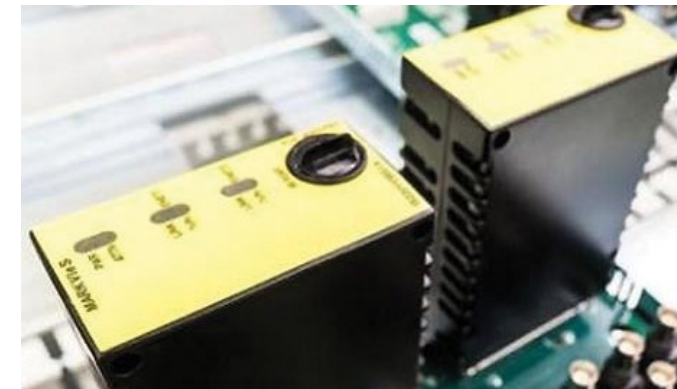
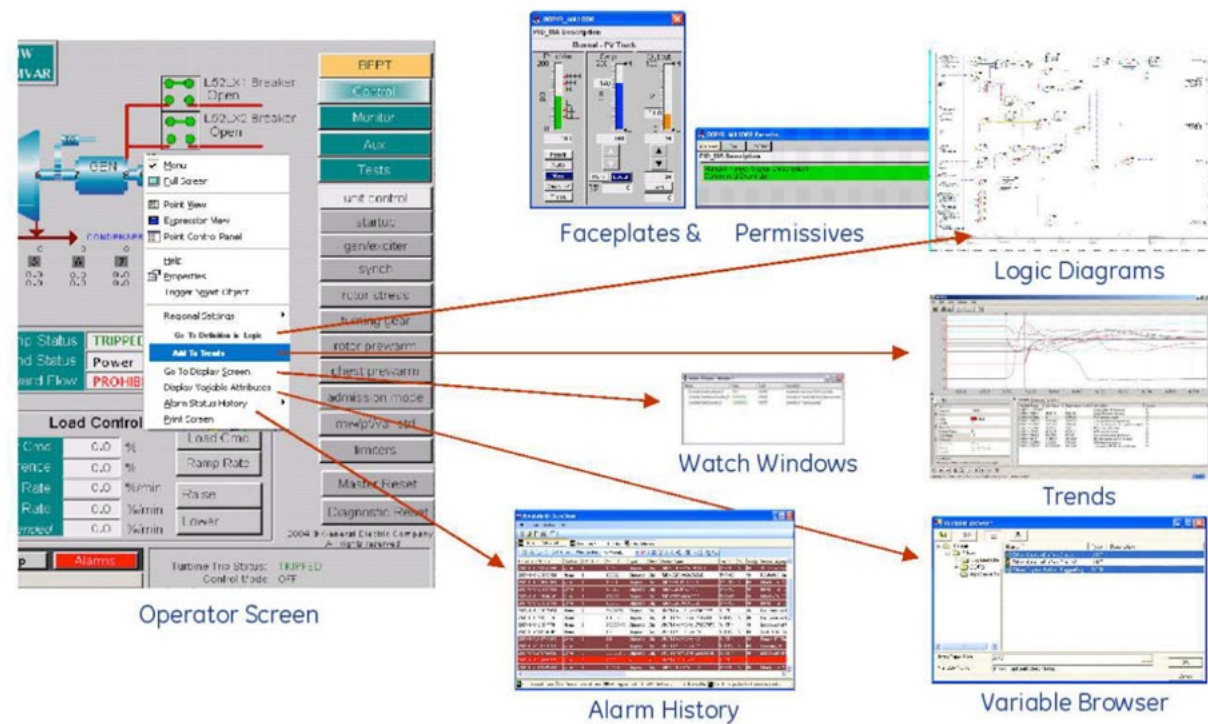

Consisting of a controller, I/O and switches, programming software, project analysis, implementation and operation services, the Mark VleS is a high-availability, Triple Modular Redundant (TMR) solution with end-to-end architecture that optimizes assets and operations and reduces costs.

The Mark VleS Safety Management System delivers a seamless, integrated, engineered solution designed to perform in the extreme conditions found in industries such as:

- Oil & Gas
- Power Generation
- Chemical and Process
- Pulp and Paper
- Mining and Minerals Engineering

### KEY BENEFITS

- Proven to protect operations and assets
- Flexibility reduces costs and improves lifecycle management
- Rugged and reliable for increased uptime
- Integrate with BPCS for better, faster decisions
- Ethernet communications enhances connectivity and performance

The Mark VleS Safety Management System reflects GE's experience of three-plus decades, four generations, and over 10,000 installed Triple Modular Redundant (TMR) systems. These proven and reliable systems perform mission critical applications worldwide, utilizing flexible Safety Integrity Level (SIL) configuration and qualified manufacturing and solution delivery processes.

The award-winning Mark VleS Safety Management System is a complete, flexible, and reliable engineered process safety system with enhanced cyber security for critical processes such as plant emergency shutdown, burner management, critical process control, fire and gas detection, and turbomachinery safety.

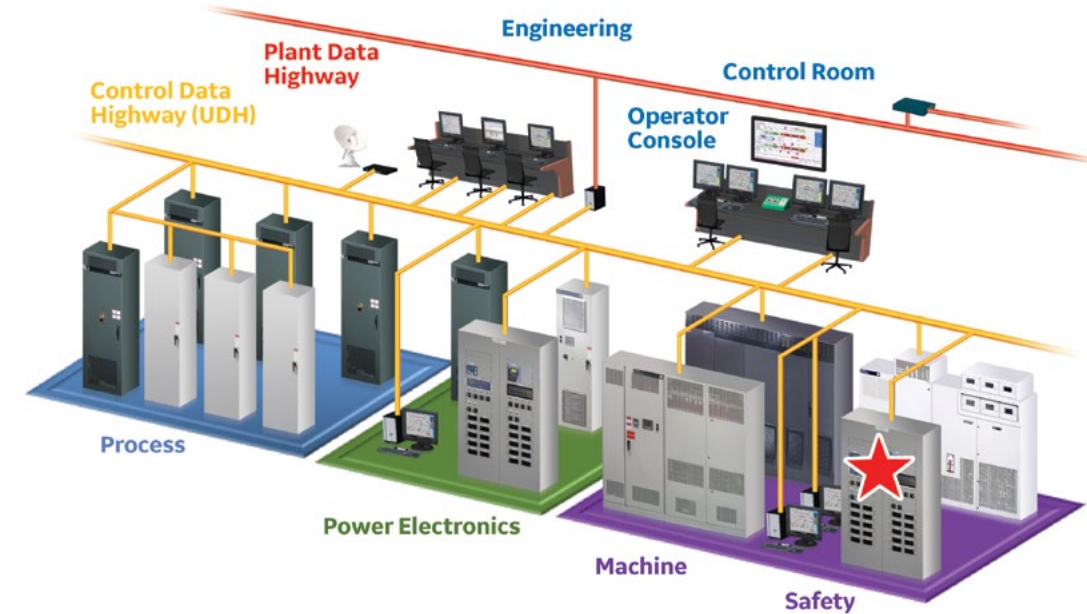

Safety Controller  
Achilles Level 1 Certified

TOTAL PLANT SOLUTIONS

TABLE OF CONTENTS



# Migration Services

DCS, TURBINE CONTROLS AND EXCITATION

## A Foundation for Success

Connecting machine-level data with networked sensors and software is critical to keeping pace with rapid growth and maintaining your competitive edge. Leverage the power of an Industrial Internet foundation and benefit from higher speed, higher performance and much greater efficiency in managing distributed assets.

Our services team can help you gain the deep operational and process visibility needed for game-changing results.

Most process automation systems have been running for more than 20 years. Decades-old components don't last forever. That's why GE has created a comprehensive migration plan that is fast and efficient.

The GE services team can provide a complete, customized migration recommendation for your operation. We act as part of your team, to plan, initiate, and implement installation with as little disruption as possible. An automation system migration usually takes as little as three hours, often while keeping your operations up and running.

As one of the biggest equipment manufacturers in the world, GE has addressed the challenges of an aging infrastructure and an aging workforce head-on, with revolutionary control systems that are easier to operate, understand and configure.

If you're looking to overcome obstacles created by your obsolete control system, such as limited parts availability, increased downtime, and increased regulation, look no further than solutions from GE's Power Automation & Control business.

## The Right Tools For the Job

### AUTOMATED CONVERSION

GE has created migration tools, like application code translator, that provide a rapid, granular overview of system architecture and allow for a rapid transition to new technology.

### PREDEFINED MIGRATION STRATEGIES

There is no better team to help you upgrade your GE components than the GE services team. We have proven migration paths that help you move forward quickly and efficiently.

### MINIMAL WIRING CHANGES

Moving legacy wiring is an intuitive process when you choose a GE solution.

### PRE-ENGINEERED GATEWAYS

Migrate at your own pace. GE has created gateways that allow for phased migrations.

### CYBER SECURE

GE's next-generation control systems are Achilles certified, and provide greater peace of mind in today's cybercentric industrial environments.

### EXPERIENCE

If you're migrating from legacy control and I/O, the GE migration services team can provide expert guidance as you step into today's technology.





# HMI Upgrade

# Alarm Rationalization

## HMI Upgrade

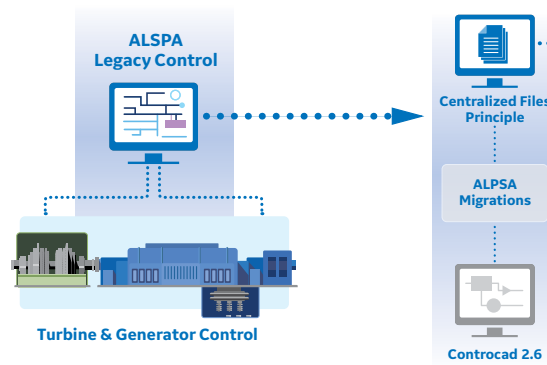

## HMI Upgrade

The performance of any asset or system is related to the performance of its interfaces. Upgrading your HMI improves uptime and allows you to take the first step to connecting to the Industrial Internet, using data and analytics to optimize your operation.

Our HMI Upgrade service is available on all ALSPA Installed Base systems including DCS, TGC, and AVR for Power Generation or Industry. Specific migration tools have been developed to reduce engineering outage time and provide for a more reliable upgrade process.

## Migration Pack

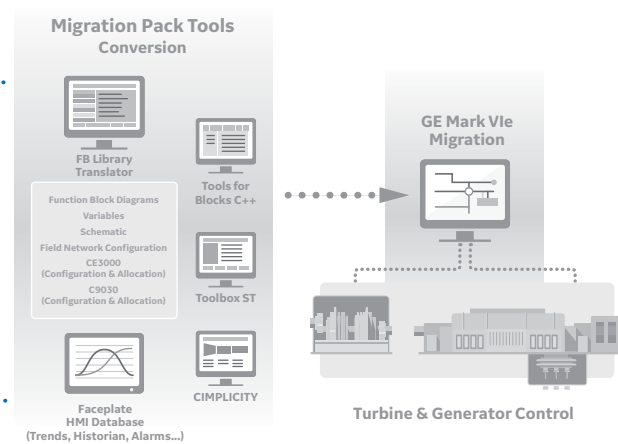

## KEY BENEFITS

- Obsolescence management is facilitated with modern equipment
- Ergonomic improvements enable operators to analyze alarms and faults faster
- Alarm management and rationalization improve availability and performance
- Easy access to remote support to accelerate troubleshooting
- New cyber security services protect the installation from external and internal risk with patch management, back-up & restore, and cyber security risk assessment solutions
- New ALSPA version has greater reliability and is compatible with Windows 10
- New ALSPA HMI is fully compatible to connect to Predix via Field Agent

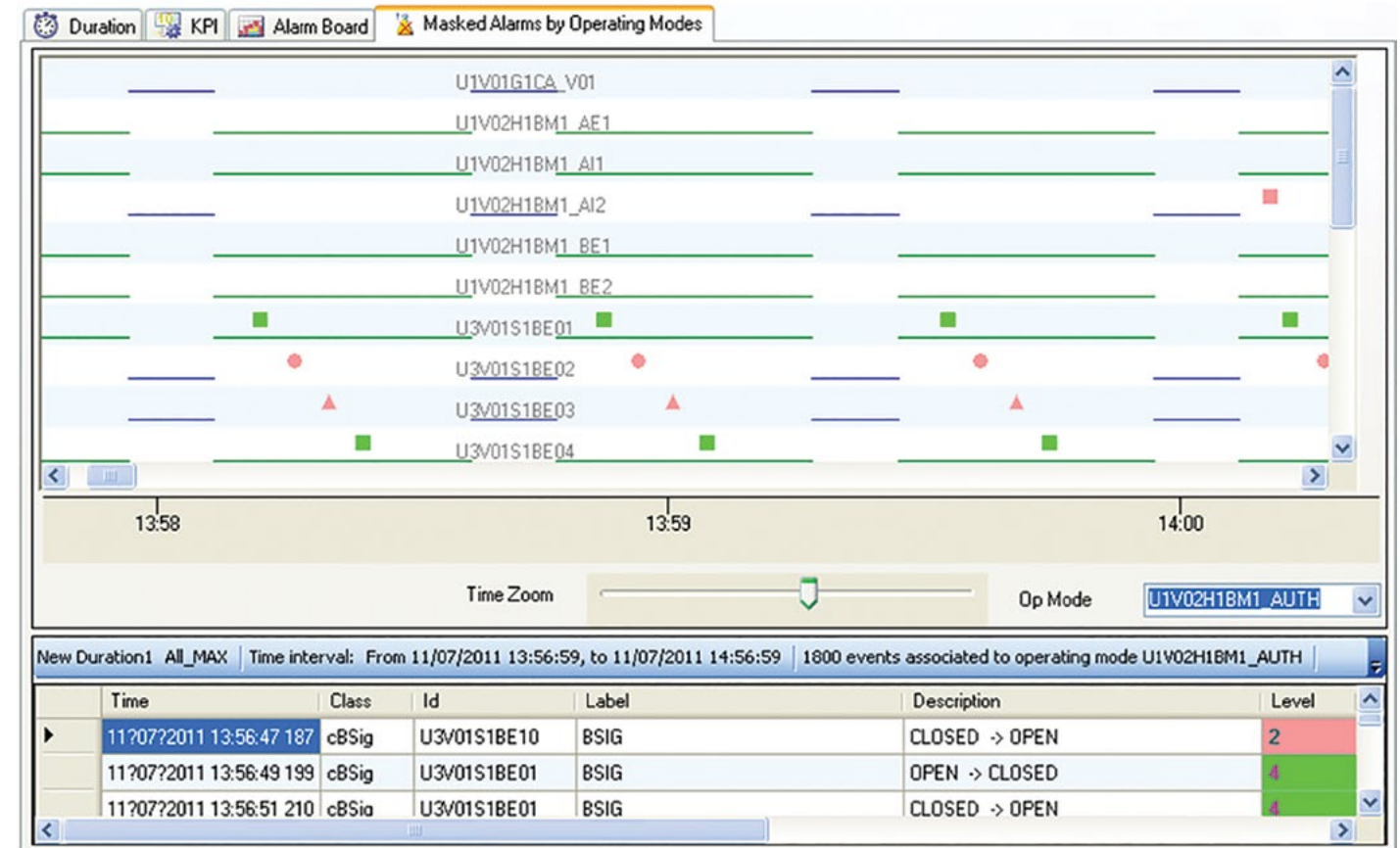

## Alarm Rationalization

Most power plant operators are overloaded with alarms during abnormal plant situations. GE has developed a unique function to present the operators with only the most critical alarms during these situations. This function is based on the following features:

- Alarm shelving
- Alarm eclipsing: only most recent, highest priority alarm in a group is shown to the operators
- Alarm grouping (synthesized alarms)
- Alarm rationalization tool
- Alarm reporting / KPI

## KEY BENEFITS

- Improved operator efficiency through elimination of non-productive tasks related to alarm acknowledgment
- Better management of plant critical situations, by allowing the operator to focus on the key problems
- Improved plant availability
- User-friendly tool allows for a step-by-step approach to improve the alarm
- Rationalization implementation can be performed online and does not involve control schemes modification
- Function compliant with EEMUA 191 Guideline (2nd edition 2007)





# Migration Services

MIGRATION PACK FOR DCS, TURBINE CONTROLS AND EXCITATION

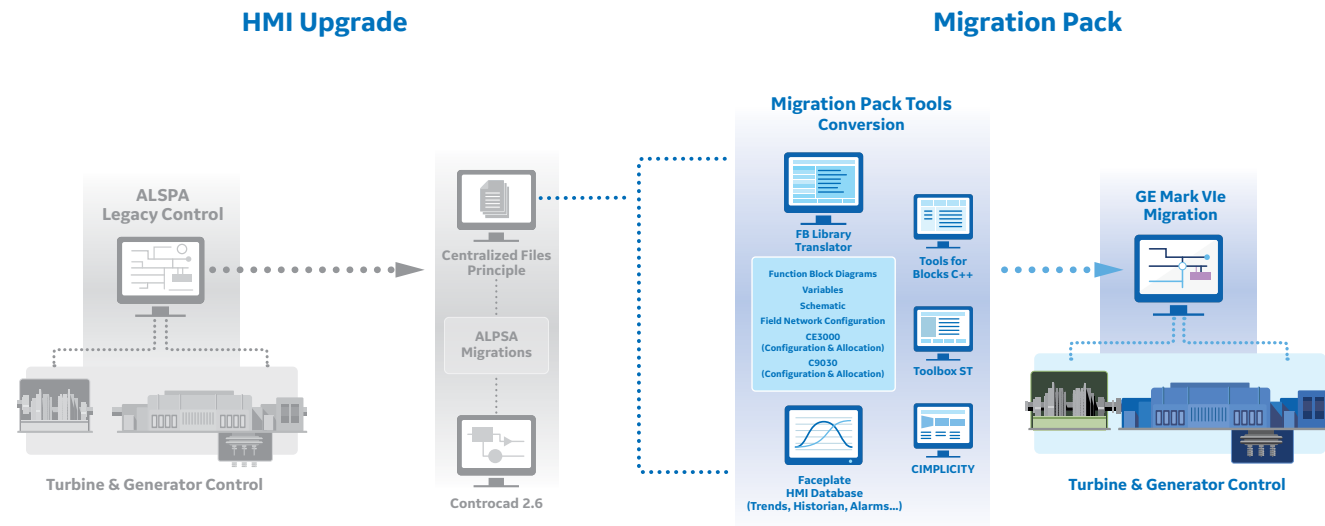

## Migration Pack

### FUTURE-PROOF YOUR SYSTEM FOR GREATER FLEXIBILITY

Extending the lifecycle of assets is a great challenge for our customers. Upgrading parts of your system can increase the life of your installation. Power Automation & Control eases the migration process of ALSPA installed base to the latest GE controls technology. No modifications to I/O modules are necessary and electronic cabinets are reused, avoiding rip and replace.

### KEY BENEFITS

- Full scalability: Entry-level to high-performance solutions
- OEM customization and configuration
- Modular design with options for pre-installed applications
- High performance for uninterrupted data transmission
- Lower total cost of ownership, fewer components to install / maintain
- Ready to run SCADA and Historian
- Achilles tested
- Higher performance in harsh conditions
- Modular design for an unchanging footprint





# Service Agreements

MULTI-YEAR AGREEMENT



## LTSA Contracting

### LONG-TERM SERVICE AGREEMENTS (TGC, AVR, DCS)

A LTSA (Long-Term Service Agreement) provides a framework contract that defines prices and conditions for service work in advance. In addition to offering preferential conditions for high quality parts and services, a LTSA reduces administrative overhead and simplifies planning.

Example of LTSA scope of activities:

- Preventive Maintenance
- Help Desk
- Spare Parts
- Field Services

### KEY BENEFITS

- Quick access to an automation expert, optimizing availability
- Preventive maintenance
- Preferred prices and conditions
- Preferred access to spare parts
- Preferred access to field services activities
- Secured operation
- Fast and secure remote access to automation experts for troubleshooting
- Access to detailed engineering documentation of the solution

# Service Agreements

EXTENDED LIFE SERVICE AGREEMENT

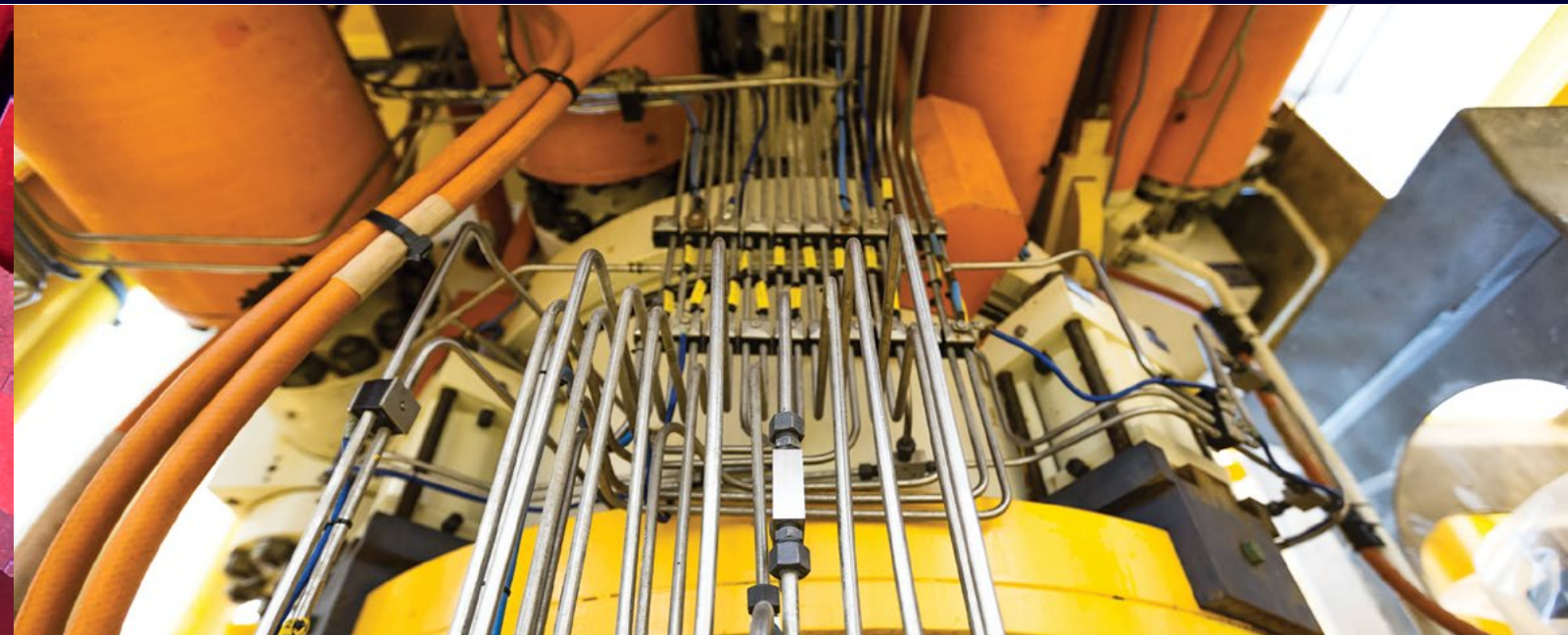

## Extended Life Service Agreement

Extended Life Service Agreements maintain the operating conditions of your control system and are dedicated to our legacy range of products. This Service Contract offers maintenance of equipment beyond the service phase of its life cycle.

- Example Extended Life Service Agreement activities:
- Maintaining technical competencies
- Manage design, programming, manufacturing, and testing capacity logistics
- Product and project documentation management
- Software configuration management
- Creation and management of the main critical and strategic parts
- Technology survey (obsolescence survey)

### KEY BENEFITS

- Preventive maintenance
- Long-Term Service Agreement benefits
- Extended equipment life, leading to optimized asset management
- Obsolescence management





# On-Site Services

ON-DEMAND

# On-Site Services

PREVENTATIVE SITE MAINTENANCE



## On-Demand Services

GE provides a wide range of professional services to improve the operation and maintenance of control systems. Our on-demand services can be performed as needed. We provide:

- Corrective Maintenance
- Control Scheme Modifications
- Control Loop Tuning
- System Extension and Interface Upgrades
- System Health Check
- Safety Analysis

## KEY BENEFITS

- Flexibility - our site services are offered through service agreements or on-demand as a standalone offer
- Access to a worldwide team of control system and process expertise
- Turnkey approach

## Preventative Site Maintenance

Preventive maintenance reduces the probability of an unplanned outage or degradation of the regulation system's operating conditions.

### Periodic maintenance is recommended to:

- Maintain the system in optimal operating condition
- Replace components that are reaching life operating limits
- Readjust the parameters of the regulation systems that allow the equipment to operate safely and at their optimal performances (control loops, limiters, PSS)

## KEY BENEFITS

- Equipment downtime is decreased and the number of major repairs are reduced
- Increased global plant availability
- Better conservation of assets and increased life expectancy, eliminating premature replacement
- Maintenance teams have less unplanned maintenance and can respond faster to new problems
- Better overall system performance

## Generator Excitation Thermography

Generator excitation thermography is one example of our preventative site maintenance offerings. Infrared cameras detect and analyze objects.

## HOT POINTS DETECTION

- Early fire detection
- Temperature monitoring
- Prevent hazardous situations based on critical temperature developments

## KEY BENEFITS

- Control of equipment in use by infrared camera
- Hot points detected, avoiding dysfunctions in the future
- Prevent risk of breaker deterioration
- Detection, identification, and correction of defects





# On-Site Services

CORRECTIVE SITE MAINTENANCE

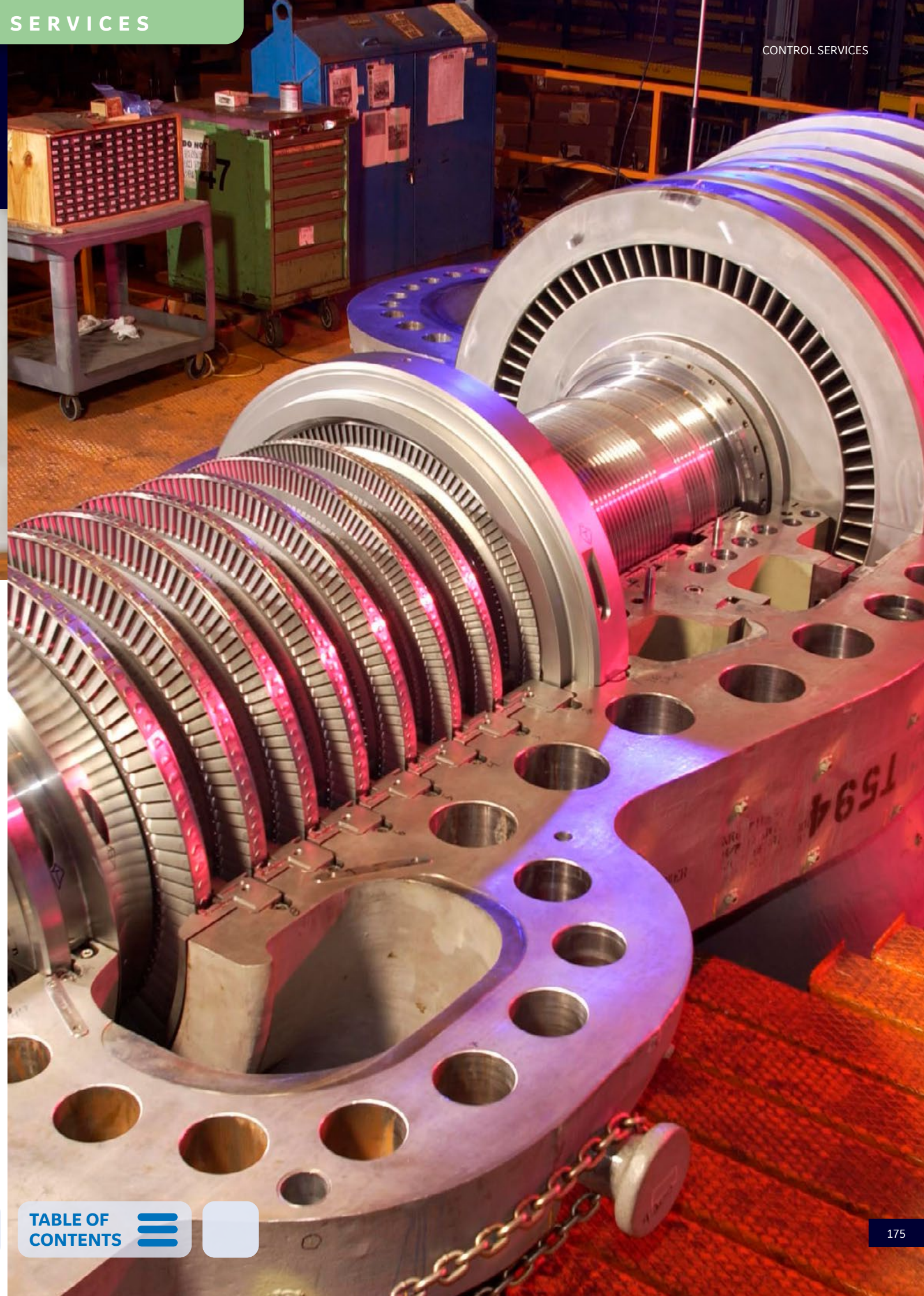

## Corrective Site Maintenance

After a fault occurs on an asset or system, corrective maintenance may be needed so it can perform its required function. There are two types of corrective maintenance:

**Temporary Solution:** Corrective maintenance carried out in order to provide a provisional solution due to inability to implement a definitive solution in a short term

**Permanent Solution:** Corrective maintenance to provide a definitive solution

When necessary, GE is able to mobilize field engineers, experts from our engineering department, or our research and development teams to minimize plant downtime. Our GE Learning program provides our field engineers with training, certifying them to provide high-quality expertise for each product in our portfolio. After our experts analyze the system and any defective components, we provide a complete report and detailed recommendations to optimize repairs.

## KEY BENEFITS

- Minimize downtime after a failure with quick responsiveness
- World wide service organization with a laser focus on fast mobilization
- Access to GE automation and process expertise





# Spare Parts & Repair

# Hands-on Training



## Spare Parts & Repair

As an Original Equipment Manufacturer, Power Automation & Control is well-qualified to service, upgrade, and repair its products while providing full support for the replacement and maintenance of equipment from third parties.

- **Testing:** GE conducts various tests to help ensure your components are defect-free and qualified for immediate service according to your specifications.
- **Customization:** GE customizes your parts so they are plug-and-play once in your facility.
- **Stock management:** GE's trained experts conduct comprehensive inspections of your components and provide detailed parts recommendations.
- **Technical investigation report:** GE analyzes your components, providing a complete report and detailed recommendations to optimize repairs and advise you on potential upgrades.
- **Quality:** Stringent quality assurance standards including the latest technical and material upgrades or improvements from GE are applied.

## KEY BENEFITS

- Minimize capital investment, maximize system utilization and performance
- Custom-made solutions
- Extend the lifecycle of your products
- Fully tested modules, ensuring improved system availability

## O&M Staff Training

Training your staff not only enables them to perform their job with confidence, but reduces operational risk, increases productivity, and maximizes the availability and reliability of your system. We offer maintenance and operation training on our solutions and products which we can customize if needed. We're flexible with location, either sending our expert engineers to your site or hosting training in one of our centers in France or the USA.

### LANGUAGES

English, French, Spanish, or other on request

### PRODUCTS

DCS, Turbine Control, AVR and Excitation, Safety Systems

### FACILITY

Training Center equipped with dedicated equipment, engineering tools, training simulators, e-learning modules  
Training facilities available in Belfort (France), Massy (France) and Charlottesville (USA, VA).

## KEY BENEFITS

- **Reduced operational risk:** Well-trained employees are vital for successful companies. By sharpening your skills with GE, you will maintain products and systems at a high-level of availability, thus reducing operational risk.
- **Increased productivity and performance:** A well-defined training program with continuous skills development and clear learning targets helps improve performance from your personnel. Well-trained operators feel more secure, can cope better in stressful situations and operate the power plant using the most efficient operating regimes.
- **Maximized availability and reliability:** Highly-skilled and trained staff make the right decisions faster during operational events. This results in optimization of costs and improves plant availability.
- **Predictive maintenance:** With GE training programs, your staff receive the skills required to detect any malfunctions as early as possible. They can therefore identify defective components by implementing an effective predictive maintenance strategy.





# Remote Operation Services

HELP DESK, REMOTE MAINTENANCE SUPPORT



## Help Desk

Our 24/7 on-call service help desk provides quick access to a GE system expert for assistance on GE DCS, Machine Control, or Excitation equipment. We have a dedicated team of system support experts and access to the original project to help us manage your case smoothly and efficiently track your requests. We take our on-demand services one step further with our Remote Maintenance Support, a secure connection to our customer to provide support and diagnostics.

### KEY BENEFITS

- Improved plant availability
- Reduced maintenance costs
- Reduced plant insurance costs

## Remote Maintenance Support

Remote maintenance support uses a secure connection to the customer's installation to audit the system, provide support and diagnostics, and deploy application updates. A complex problem, specific technologies, or process issue can easily be accessed by maintenance professionals to provide quick support and diagnostics. To identify maintenance requirements, a check-up of the system through an audit can be performed. Also, remote maintenance acts as a vehicle to allow for a corrective patch, firewall configuration assistance, and diagnostic support.

### KEY BENEFITS

- Increased system responsiveness, system availability, and easier access to experts
- Reduced costs due to decreased unplanned outages
- Preventative measures decrease the amount of failures
- First step to connecting plant to the Industrial Internet Control System





# Performance Optimization

## TUNING



### Plant Integration & Control Loop Tuning

Our experience shows that analog devices require as much regular maintenance as digital controllers. Component aging is a key factor in decreased efficiency. When an incident occurs, a failed controller can cause significant damage to other important and expensive devices and machines.

Regular and conscientious maintenance is the best precaution against faults and unforeseen outages. GE field engineers have the knowledge and experience to test and tune your controller.

#### DCS

- Performance improvement
- Energy savings
- CO<sup>2</sup> reduction
- Heat rate optimization
- Optimization PID parameters for process loops
- Faster plant start
- Automatic/manual operation
- Review of Historian database
- Eliminate potential process fault situation

#### TURBINE CONTROL

- Position Loops
- Stress Calculator

#### GENERATOR CONTROL

- Protection and Synchronizer Tuning
- PSS (Power System Stabilizer) Tuning

#### KEY BENEFITS

- Optimal asset performances
- Combined process and control knowledge
- Asset lifetime increased
- Better availability and reliability

#### SHAFT LINE INTERFACE

The upgrade and tuning of hydraulics and instrumentation parts is a key factor for optimized combined operation of the turbine and its control system. Servicing this area increases security and availability, while optimizing the valve control. This includes the implementation of the best solutions for vibration, expansion or temperature instrumentation, speed sensor, and for the control valve electrohydraulic interface.

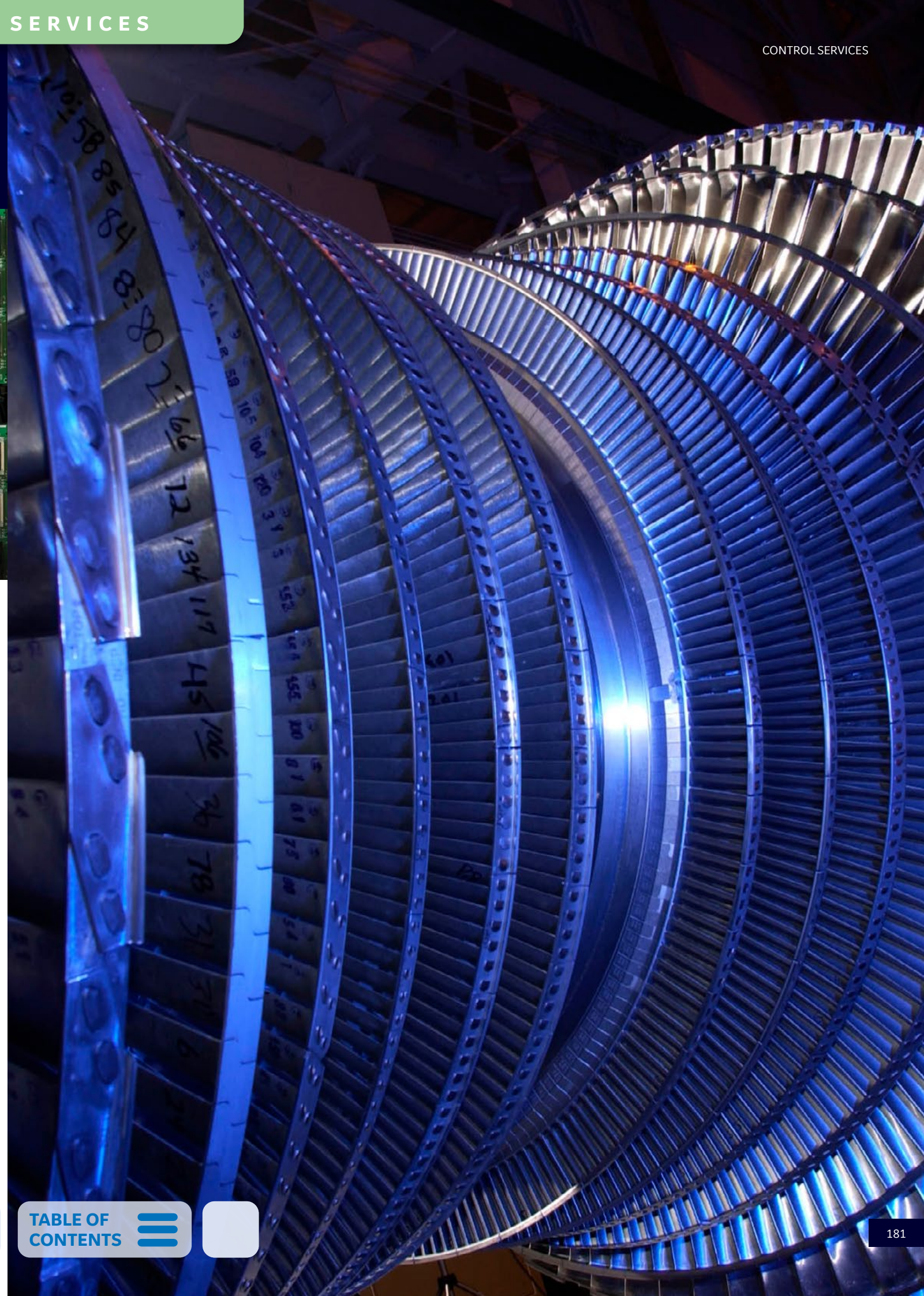

TOTAL PLANT  
SOLUTIONS



TABLE OF  
CONTENTS





# Performance Optimization

SIMULATION AS A SERVICE

## Turbine Simulator Assisted Engineering (ControlSIL/ControlHIL)

The CONTROLHIL Simulator is a high-performance solution that models the Steam Turbine Process and Real Time Controls in MIL-SIL-HIL configurations. Its primary objectives are to:

- Validate the performances of the Plant Unit Controller in closed loop with the hardware simulator before each restart (HIL)
- Train maintenance operators for a planned operation on a Controller identical to the one in the Plant
- Develop/Adjust the Regulators/Models (MIL-SIL)
- Test the modifications/parameter sets before update on real equipment (MIL-SIL)

## HYDRAULIC SIMULATION

Simulation for the retrofit of the hydraulic command proportional loop and security loop of Steam Turbine Stop Valves and Control Valves:

- Pumps
- Pipes
- Sub-actuators
- Actuators

### The solution is based on:

- A plant process modeling under MATLAB-SIMULINK: Steam Turbine, Generator, Excitation System, AVR (HIL) and/or TGC (MIL-SIL)
- Turbine Unit real time Controller
- Instructor Station with a set of simulation scenarios and tools, under LabVIEW – Test In View

### It is offered with the following services:

- Non regression tests regarding the client specifications in automatic and/or manual mode
- Validation of modifications without hardware systems
- Training

## Generator Simulator Assisted Engineering (SIMUGEN)

SimuGen is a Hardware in the Loop (HIL) simulation solution providing highly efficient and accurate testing of the generator Automatic Voltage Regulator (AVR). It embeds a real-time virtualization of the generator connected to the electrical grid and is driven by a turbine, itself controlled by the Unit Controller.

### KEY BENEFITS

- Loop design and equipment sizing optimization
- Prototype validation for custom-made solutions
- Mitigation of risks linked to design modifications
- Readiness of operators during the plant lifecycle
- Faster reaction to production demand, without risk for the real plant in design phase
- High confidence and motivation of plant operators
- Faster diagnosis by maintenance staff

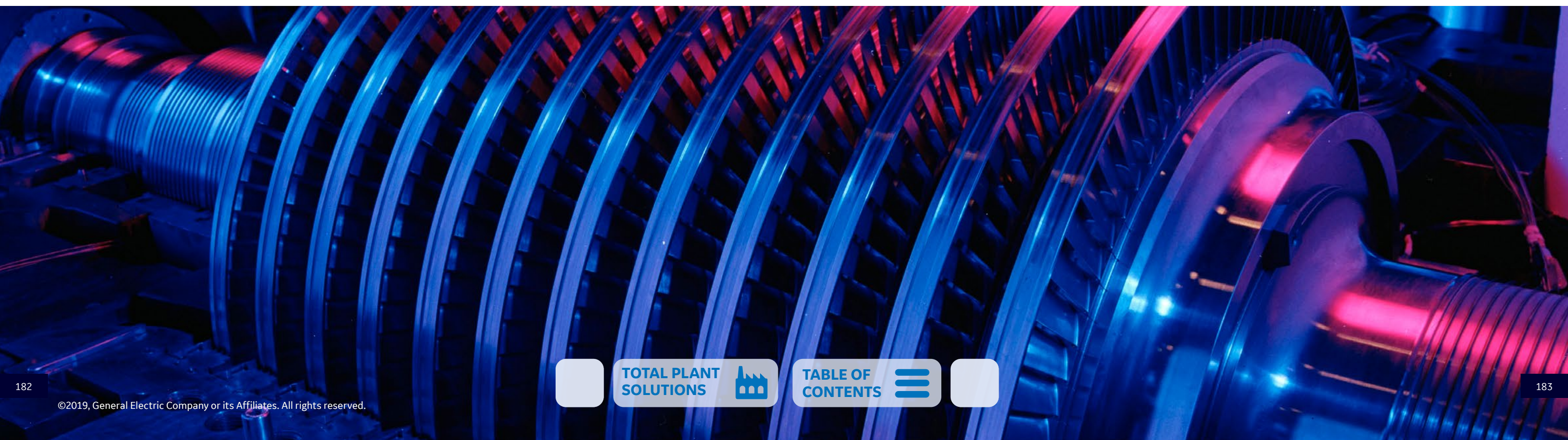



When it comes to our customers' most pressing questions, our answer is YES. It's a small but meaningful word that ensures the power is on for everyone, everywhere. At GE, we are transforming the future of steam power, creating extraordinary outcomes for tomorrow and beyond.

**This is the Power of Yes.**

Visit us to learn more  
[gepower.com/powerofyes](http://gepower.com/powerofyes)





