



LeapStory™



Parent's Guide

This guide contains important information. Please keep it for future reference.

91-003677-000 (US)

CAUTION-ELECTRIC TOY: Not recommended for children under 3 years of age. As with all electric products, precautions should be observed during handling and use to prevent electric shock.

MISE EN GARDE : JOUET ÉLECTRIQUE
Déconseillé aux enfants de moins de 3 ans. Comme avec tous les produits électriques, des précautions doivent être observées lors de la manipulation et de l'utilisation pour éviter les chocs électriques.

INTRODUCTION

Thank you for purchasing the **LeapStory™** device! Get ready to enter a magical world of storytelling, music and learning!

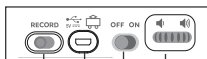

Record Button
USB Port
On/Off Switch
Volume Control

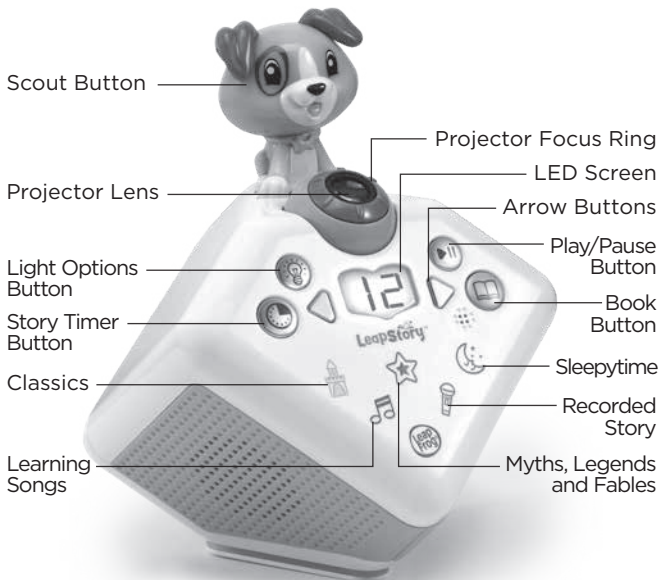

INCLUDED IN THIS PACKAGE

- One **LeapStory™** device
- One AC adapter
- One USB cord
- One parent's guide

WARNING:

All packing materials such as tape, plastic sheets, packaging locks, removable tags, cable ties and packaging screws are not part of this toy, and should be discarded for your child's safety.

NOTE:

Please keep this parent's guide as it contains important information.

ATTENTION :

Pour la sécurité de votre enfant, débarrassez-vous de tous les produits d'emballage tels que rubans adhésifs, feuilles de plastique, attaches, étiquettes et vis d'emballage. Ils ne font pas partie du jouet.

NOTE :

Il est conseillé de conserver ce guide des parents car il comporte des informations importantes.

ACTIVATE NORMAL PLAY MODE

This product is in Try-Me mode in the packaging. To activate normal play mode, please complete the following steps:

1. Slide the **On/Off Switch** to the **Off** position.
2. Slide the **On/Off Switch** to the **On** position to activate normal play mode.

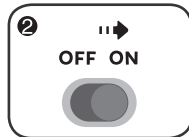
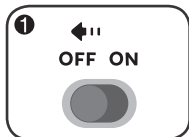

Unlock the packaging locks:

- ① Rotate the packaging locks 90 degrees counterclockwise.
- ② Pull out the packaging locks and discard.

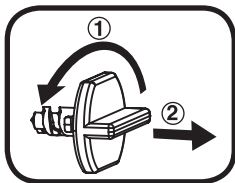

GETTING STARTED

BATTERY INSTALLATION

1. Make sure the unit is turned **OFF**.
2. Locate the battery cover on the bottom of the unit.
3. Use a screwdriver to loosen the screw and open the battery cover.
4. Install 4 new AA (AM-3/LR6) batteries into the battery box as illustrated. (The use of new alkaline batteries is recommended for maximum performance.)
5. Replace the battery cover and tighten the screw to secure.

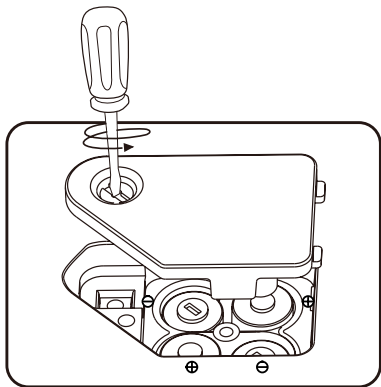

BATTERY NOTICE

- Use new alkaline batteries for maximum performance.
- Use only batteries of the same or equivalent type as recommended.
- Do not mix different types of batteries: alkaline, standard (carbon-zinc) or rechargeable, or new and used batteries.
- Do not use damaged batteries.
- Insert batteries with the correct polarity.
- Do not short-circuit the battery terminals.
- Remove exhausted batteries from the toy.
- Remove batteries during long periods of non-use.
- Do not dispose of batteries in fire.
- Do not charge non-rechargeable batteries.
- Remove rechargeable batteries from the toy before charging (if removable).
- Rechargeable batteries are only to be charged under adult supervision.

MISE EN GARDE

- Utiliser des piles alcalines neuves pour des performances maximales.
- Seules des piles du type recommandé doivent être utilisées.
- Ne pas mélanger différents types de piles ou d'accumulateurs, ne pas mélanger des piles ou des accumulateurs neufs avec des usagés.
- Ne pas utiliser des piles ou des accumulateurs endommagés.
- Mettre en place les piles ou les accumulateurs en respectant les polarités + et -.
- Ne pas mettre les bornes d'une pile ou d'un accumulateur en court-circuit (en reliant directement le + et le -).
- Enlever les piles ou les accumulateurs usagés du jouet.
- Retirer les piles ou les accumulateurs en cas de non-utilisation prolongée.
- Ne les jeter ni au feu ni dans la nature.
- Ne pas tenter de recharger des piles non rechargeables.
- Enlever les accumulateurs du jouet pour les recharger.
- Les accumulateurs ne doivent être chargés que sous la surveillance d'un adulte.

AC Adapter Safety

⚠ CAUTION: Use only the AC adapter provided with the product.

⚠ WARNING: Not suitable for children under 3 years. Misuse of AC adapter can cause electric shock.

- Connection of the AC adapter to the wall outlet should be performed only by an adult or child 8+ years of age.
- The AC adapter is not intended to be used as a toy, and the use of the AC adapter shall be under the full supervision of parents.
- As with all electrical products, precautions should be observed during handling and use to prevent electrical shock.
- The AC adapter may become warm during normal use. Always allow adequate ventilation and use care when handling the AC adapter.
- Do not connect or disconnect with wet hands.
- The AC adapter should be periodically examined for conditions that may result in the risk of fire, electrical shock or injury to persons, such as damage to the cord, plug, blades, housing or other parts, and in the event of such conditions, the cord must not be used until the damage is repaired.

The AC adapter cannot be replaced; if the cord is damaged, dispose of the AC adapter in accordance with your local electrical product recycling regulations.

Unplug the AC Adapter if any of the following conditions exist:

- The AC adapter, plug or USB cord has become frayed or damaged.
- The AC adapter is exposed to rain, liquid or excessive moisture.
- The AC adapter enclosure has become damaged.
- You suspect the AC adapter needs service or repair.

To Clean AC Adapter

Disconnect it from the wall and clean with a slightly damp cloth. Do not immerse in water or use soap or other chemicals.

Allow to dry before reusing. Do not connect to the AC outlet if wet or damaged.

AC Adapter Electrical Ratings: Input: 120V-60Hz, 150mA, AC; Output: 5V --- 1000mA, DC.

Accessories

Please read all safety instructions for any accessories or other products before using with the **LeapStory™** device. LeapFrog is not responsible for the operation of third-party accessories or their compliance with safety and regulatory standards.

 **CAUTION:** Routinely check this toy for proper and safe condition. If there is any damage or broken parts, remove toy from use.

 **WARNING:** The AC adapter or USB cord could be a strangulation hazard. Not for children under 3 years.

PRODUCT FEATURES

1. On/Off Switch

Slide the **On/Off Switch** to turn the toy **On** and **Off**.

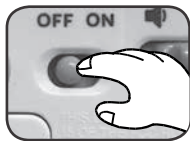

2. Volume Control

Turn the dial left or right to adjust the volume level.



3. USB Port

If desired, insert the supplied AC adapter to power the device using a wall outlet. To download free stories, follow the instructions in the “Downloadable Content” section later in this guide.

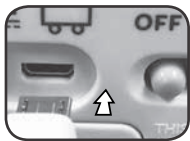

4. Record Button

Slide the button to record your own story. When instructed, press the **Scout Button** to start recording. You will have 10 minutes of recording time. The newly recorded story will overwrite the previous one.

To hear your recorded story, press the **Book Button** to navigate to the **Recorded Story** category.



5. Projector

When the **LeapStory™** device is turned on, the projector will be automatically activated. The projector will show images on the ceiling in a darkened room.

To focus these images, turn the **Projector Focus Ring**. If desired, tilt the projector forwards or backwards to adjust the position of the images on the ceiling.

To turn the projector off, press the **Light Options Button**.

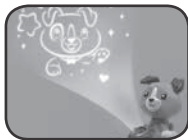

6. Projector Focus Ring

Twist clockwise and counterclockwise to adjust the focus of the projector images.



7. Book Button

Press to choose a category. Categories include: Classics; Myths, Legends and Fables; Sleepytime; Learning Songs and Recorded Story.

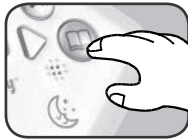

8. Play/Pause Button

Press to hear a selected story, poem or song. Press again to pause.



9. Light Options Button

Press to choose a light option. Options include:

1. Night-Light On
2. Projector and Night-Light On
3. All Off
4. Projector On



10. Story Timer Button

Press to listen to a set amount of stories or songs before the device goes to sleep. It is best to use the AC adapter when listening for long durations.



11. Automatic Shut Off

To save power, the device will be turned off automatically after about 40 seconds if a story or song is not playing.

It's recommended to plug the **LeapStory™** device into a wall outlet using the supplied AC adapter.

ACTIVITIES

Listen to a Story, Poem or Song

Press the **Book Button** to choose a category. After selecting a category, press the **Arrow Buttons** to toggle through the story options. Stories will play automatically after their titles are announced.

Included Stories, Poems and Songs

Classic Stories and Poems

1. The Tale of Peter Rabbit
2. The World of Dinosaurs
3. Briar Rose
4. The Frog Prince
5. The Three Little Pigs
6. Little Red Riding Hood
7. The Little Engine That Could
8. Rumpelstiltskin
9. Cinderella
10. The Little Mermaid
11. Goldilocks and the Three Bears
12. The Rocking Horse
13. Hansel and Gretel
14. The Three Billy Goats Gruff
15. Beauty and the Beast
16. The Gingerbread Man
17. The Little Red Hen
18. The Golden Windows
19. The Fairy
20. A Wise Old Owl
21. Baa, Baa, Black Sheep
22. Casey at the Bat
23. Hey Diddle, Diddle
24. I'm a Little Teapot
25. Itsy Bitsy Spider
26. Jack and Jill
27. Jack Be Nimble
28. Little Bo Peep

29. Pat-a-Cake, Baker's Man
30. Rock-a-Bye Baby
31. Round and Round the Garden
32. Star Light, Star Bright
33. The Noble Duke of York
34. The Owl and the Pussy Cat
35. This Little Piggy
36. Pease Porridge Hot

Myths, Legends and Fables

1. The Tortoise and the Hare
2. The Elves and the Shoe Maker
3. The Midas Touch
4. Theseus and the Minotaur
5. The Fox and the Crow
6. The Emperor's New Clothes
7. The Wind and the Sun
8. The Legend of John Henry
9. Paul Bunyan and Babe the Big, Blue Ox
10. Robin Hood and the Golden Arrow
11. Anansi and the Turtle
12. The Lucky Drum
13. Clumsy Kaito
14. The Boy Who Cried Wolf

Sleepytime Lullabies and Stories

1. Hush Little Baby (Lullaby)
2. Frère Jacques (Lullaby)
3. Brahm's Lullaby (Lullaby)
4. Peaceful Waves - Music of the Sea
5. Rainfall in the Forest
6. Animals 'Round the World Go to Sleep at Night (Relaxing story)
7. It's Bedtime Solar System (Relaxing story)
8. Owl Helps Bunny Go to Sleep (Relaxing story)
9. Ocean Dreams (Relaxing story)
10. Moonlight Music Meditation (Relaxing story)

Learning Songs

1. Counting 1 to 10
2. All The Colors Of The Rainbow
3. Five Little Birdies
4. The Days of the Week
5. Every Letter Makes a Sound
6. 10 Grapes
7. Hello Around The World
8. Knick Knack Doggie Snack Give a Dog a Bone
9. London Bridge is Falling Down
10. My First Counting Song
11. Old MacDonald Had a Farm
12. On the Farm We Can Play
13. Pat-a-Cake, Baker's Man
14. Playground Rhymes
15. Pretend With Me
16. Safety Song

17. The Shapes Song
18. We're On Our Way
19. Being a Puppy
20. The Muffin Man
21. Nap Time is Here
22. Good Night, My Sleepy Friend
23. Twinkle, Twinkle Little Star

Downloadable Content

Download free stories, songs and poems using your computer and add them to your **LeapStory™** device.

1. Power Up and Connect

Locate the **On/Off Switch** at the back of your **LeapStory™** device and slide it to the **On** position. Then, connect the device to your computer via the included USB cord.

2. Set Up

Install the LeapFrog® Connect **LeapStory™** application on your PC or Mac at leapfrog.com/connect.

3. Download

Follow the on-screen instructions to download and install a download pack.

4. Play and Learn!

Eject the **LeapStory™** device and your child is ready to play!

Warning: Do not power off the device or disconnect the USB cord while the device is being updated.

System Requirements for Computer Connection

High-speed Internet connection; monitor resolution of 1024 x 768; available USB port; 1 GB of RAM; 500 MB free disk space.

PC Requirements: Pentium® 4 or equivalent (2 GHz processor or faster recommended); Windows® 7, Windows® 8, or Windows® 10 operating system with latest service pack.

Mac Computer Requirements: Intel®-based Apple computer (1 GHz processor or faster recommended); Mac OS X 10.11+ operating system software.

Microsoft® and Windows logos are trademarks of Microsoft Corporation in the United States and other countries. MAC, APPLE, and MAC OS are trademarks of Apple Inc., registered in the U.S. and other countries.

CARE & MAINTENANCE

1. Keep the unit clean by wiping it with a slightly damp cloth.
2. Keep the unit out of direct sunlight and away from any direct heat sources.
3. Remove the batteries when the unit is not in use for an extended period of time.
4. Do not drop the unit on a hard surface and do not expose the unit to excess moisture.
5. Do not disassemble the device. If a problem occurs, remove and replace the batteries to reset the device, or try new batteries.
6. Do not drop the unit on a hard surface and do not expose the unit to or immerse it in water.

TROUBLESHOOTING

Check this section if you experience difficulty with operating the **LeapStory™** device.

Problem	Possible Cause	Correction
Your LeapStory™ device has stopped working or does not turn on	Incorrect battery polarities.	Ensure that the batteries are installed correctly.
	Weak batteries.	Replace with new batteries.
	AC adapter connection problem.	Ensure that the AC adapter connection is good.
Cannot download additional stories	The LeapFrog® Connect LeapStory™ application is not installed.	Install LeapFrog® Connect LeapStory™ application on your PC or Mac at leapfrog.com/connect .
	The LeapFrog® Connect LeapStory™ application is not working.	Disconnect the LeapStory™ device and restart the LeapFrog® Connect LeapStory™ application. Then, reconnect the LeapStory™ device to your computer again using the USB cord.
Cannot find any story in the device	The data in the LeapStory™ device has crashed.	Connect the LeapStory™ device to your computer, run the LeapFrog® Connect LeapStory™ application, select “Reset” under Settings and your LeapStory™ device will be restored. Your recorded story will be erased.
Projector not clear	Projector is out of focus.	Rotate the Projector Focus Ring clockwise or counterclockwise to adjust the focus of projection display.
	Projector lens is dirty.	Wipe the lens with a clean, dry cloth.
Projected images not visible	Room is not dark enough.	Turn off lights to darken room.

IMPORTANT NOTE:

If the problem persists, please call our Consumer Services Department at **1-800-701-5327** in the U.S. or email support@leapfrog.com. Creating and developing LeapFrog® products is accompanied by a responsibility that we take very seriously. We make every effort to ensure the accuracy of the information, which forms the value of our products. However, errors sometimes can occur. It is important for you to know that we stand behind our products and encourage you to contact us with any problems and/or suggestions you might have. A service representative will be happy to help you.

Environmental Phenomena

The unit may malfunction if subjected to radio-frequency interference. It should revert to normal operation when the interference stops. If not, it may become necessary to turn the power **OFF** and back **ON**, or remove and reinstall the batteries. In the unlikely event of an electrostatic discharge, the unit may malfunction and lose memory, requiring the user to reset the device by removing and reinstalling the batteries.

Impact de l'environnement

Une défaillance de fonctionnement de l'appareil peut survenir s'il est sujet à des interférences avec les fréquences radioélectriques. Le fonctionnement normal de l'appareil devrait reprendre avec l'arrêt des interférences. Si ce n'est pas le cas, il peut s'avérer nécessaire d'éteindre et rallumer l'appareil ou de retirer et réinstaller les piles. Dans l'éventualité peu probable d'une décharge électrostatique, un mauvais fonctionnement et une perte de mémoire de l'appareil peuvent se produire. L'utilisateur doit alors retirer et réinstaller les piles pour réinitialiser l'appareil.

DISCLAIMER AND LIMITATION OF LIABILITY

LeapFrog Enterprises, Inc. and its suppliers assume no responsibility for any damage or loss resulting from the use of this guide. **LeapFrog** Enterprises, Inc. and its suppliers assume no responsibility for any loss or claims by third parties that may arise through the use of this product. **LeapFrog** Enterprises, Inc. and its suppliers assume no responsibility for any damage or loss caused by deletion of data as a result of malfunction, dead battery, or repairs.

NOTE:

This equipment has been tested and found to comply with the limits for a Class B digital device, pursuant to Part 15 of the FCC Rules. These limits are designed to provide reasonable protection against harmful interference in a residential installation. This equipment generates, uses and can radiate radio frequency energy and, if not installed and used in accordance with the instructions, may cause harmful interference to radio communications. However, there is no guarantee that interference will not occur in a particular installation. If this equipment does cause harmful interference to radio or television reception, which can be determined by turning the equipment off and on, the user is encouraged to try to correct the interference by one or more of the following measures:

- Reorient or relocate the receiving antenna.
- Increase the separation between the equipment and receiver.
- Connect the equipment into an outlet on a circuit different from that to which the receiver is connected.
- Consult the dealer or an experienced radio/TV technician for help.

Supplier's Declaration of Conformity

Trade Name: LeapFrog®
Model: 6080
Product Name: LeapStory™
Responsible Party: LeapFrog Enterprises, Inc.
Address: 6401 Hollis Street, Suite 100,
Emeryville, CA 94608
Website: leapfrog.com

THIS DEVICE COMPLIES WITH PART 15 OF THE FCC RULES. OPERATION IS SUBJECT TO THE FOLLOWING TWO CONDITIONS: (1) THIS DEVICE MAY NOT CAUSE HARMFUL INTERFERENCE, AND (2) THIS DEVICE MUST ACCEPT ANY INTERFERENCE RECEIVED, INCLUDING INTERFERENCE THAT MAY CAUSE UNDESIRED OPERATION.

CAN ICES-3 (B)/NMB-3(B)

Caution: Changes or modifications not expressly approved by the party responsible for compliance could void the user's authority to operate the equipment.

**CLASS 1
LED PRODUCT**



***Visit our website for more
information about our products,
downloads, resources and more.***

leapfrog.com

***Read our complete warranty policy online
at leapfrog.com/warranty***

LeapFrog Enterprises, Inc.,
A subsidiary of VTech Holdings Limited.
TM & © 2019 LeapFrog Enterprises, Inc.
All rights reserved.
91-003677-000 