

# Owner's Manual



PRODIGY  
**Pocket**<sup>™</sup>  
Blood Glucose Monitoring System



Diagnostic Devices, Inc.

## Prodigy Pocket™ Meter

Dear Prodigy® Owner:

Thank you for choosing the Prodigy Pocket™ blood glucose monitoring system. Please read this manual carefully as it contains important information about your Prodigy® system. A warranty registration card is included with your system. Please return the completed card to us.

Prodigy® meters are designed to help you and your healthcare professionals monitor your blood glucose levels. This owner's manual will help you learn how to use the Prodigy Pocket™ Meter effectively. Technical support is available 24 hours/7 days a week by calling 1-800-243-2636. All questions about interpreting the results should be directed to your healthcare professionals.

The Prodigy Pocket™ is the latest technology for blood glucose monitoring, easy to use and will give you fast and accurate results with a minimal sample of blood. It has a large screen display for easy reading and is small and lightweight for portable convenience (fits in your pocket!).

The Prodigy Pocket™ Meter:

- Requires no coding; allowing you to save time and avoid human error due to coding.
- Allows you to perform Alternative Site Testing (AST).
- Has memory and data management capabilities. Prodigy®'s free software, available at [www.prodigymeter.com](http://www.prodigymeter.com), gives you and your healthcare professionals powerful graphic tools to manage your diabetes.

**Important Safety Instructions**

Read this before using your Prodigy Pocket™ Meter.

The following basic safety precautions should always be taken.

- Close supervision is necessary when the device is used by, on, or near children, handicapped persons or invalids.
- Use the device only for the intended use described in this manual.
- Do not use test strips and control solutions that are not supplied by the manufacturer.
- Do not use the device if it is not working properly, or if it has suffered any damage.
- Before using any product to test your blood glucose, read all instructions thoroughly and practice the test. Do all quality control checks as directed and consult with a diabetes healthcare professional.

**Warning:** Keep the test strip vial away from children; the vial cap and the test strips can be a potential choking hazard. Never chew or swallow a test strip. If this occurs, please seek medical assistance immediately.

**Table of Contents**

<b>Important Safety Instructions</b> .....	2
<b>Important Health-Related Information</b> .....	4
<b>About Alternative Site Testing (AST)</b> .....	5
<b>Introduction to the Prodigy Pocket™ Meter</b> .....	7
Intended Use .....	7
Test Principle .....	7
<b>Contents of the Prodigy Pocket™ Meter</b> .....	8
<b>Setting up the Prodigy Pocket™ Meter</b> .....	9
Key Functions of the Meter .....	9
Meter Display .....	10
Key Functions of the Test Strip .....	11
Important Test Strip Information .....	12
Set-Up Steps .....	13
<b>Control Solution Testing</b> .....	16
About Prodigy® Control Solution .....	16
Important Control Solution Test Information .....	17
Performing a Control Solution Test .....	18
<b>Blood Glucose Testing</b> .....	21
Preparing the Lancing Device .....	21
Getting a Blood Sample .....	22
Performing a Blood Glucose Test .....	24
<b>Using the Meter Memory</b> .....	26
<b>Viewing Results on a Personal Computer</b> .....	29
<b>Caring for your Prodigy Pocket™ Meter</b> .....	30
Maintenance .....	30
Battery .....	30
Battery Replacement .....	31
<b>System Troubleshooting</b> .....	32
Special Messages .....	32
Error Messages .....	33
Troubleshooting Guide .....	34
<b>Information about your Prodigy Pocket™ Meter</b> .....	36
Comparing Meter and Laboratory Results .....	36
<b>Specifications</b> .....	38
Performance Characteristics .....	39
Expected Test Results .....	40

**Important Health-Related Information**

Severe dehydration and excessive water loss may cause false low results. If you believe you are suffering from severe dehydration; consult a healthcare professional immediately.

Elevated blood triglycerides, reducing substances such as uric acid and ascorbic acid at normal blood concentration, or acetaminophen, dopa, methyldopa, L-dopa, and tolbutamide at normal blood concentrations should not significantly affect the results.

If you are experiencing symptoms that are not consistent with your blood glucose test results and you have followed all instructions described in the owner's manual, call your healthcare professional.

Test results below 60 mg/dL (3.3 mmol/L) indicate low blood glucose (hypoglycemia). Test results greater than 240 mg/dL (13.3 mmol/L) indicates high blood glucose (hyperglycemia). If your results are below 60 mg/dL or above 240 mg/dL, repeat the test, and if the results are still below 60 mg/dL (3.3 mmol/L) or above 240 mg/dL (13.3 mmol/L), consult your healthcare professional immediately.

Inaccurate results may occur in severely hypotensive individuals or patients in shock. Inaccurate low results may occur for individuals experiencing a hyperglycemic-hyperosmolar state. Please refer to your test strip package insert for additional important information.

## About Alternative Site Testing (AST)

There are important limitations to AST. Please consult your healthcare professional before you perform AST.

### What is AST?

Alternative Site Testing (AST) means you can use parts of the body other than your fingertips to check your blood glucose levels. The Prodigy® Pocket Meter allows you to test your palm, forearm, upper arm, calf or thigh. *See Figure 1.*

### What is the advantage?

Fingertips feel pain more readily because they are full of nerve endings (receptors). At other body sites, nerve endings are not so numerous and you will not feel as much pain as you will experience at the fingertip.

### When to use AST?

Food, medication, illness, stress, and exercise can affect blood glucose levels. Capillary blood at the fingertip reflects these changes faster than capillary blood at other sites. Therefore, if you are testing your blood glucose level during or immediately after a meal, physical exercise or stressful event, take the blood sample from your fingertip only.

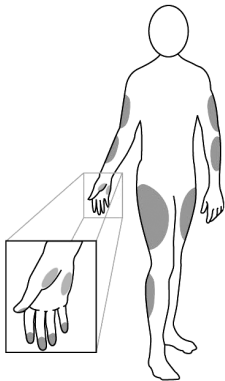

Figure 1

*Use AST only:*

- ❖ Two hours or more after your last meal.
- ❖ Two hours or more after taking insulin.
- ❖ Two hours or more after exercise.
- ❖ During steady state blood glucose conditions.

*Do not use AST if:*

- ❖ You have reason to believe you have hypoglycemia or hyperglycemia.
- ❖ Your routine glucose results are often fluctuating.
- ❖ You are pregnant.

*\*To increase the accuracy when using AST, rub the puncture site before extracting blood.*

## Introduction to the Prodigy Pocket™ Meter

### Intended Use

The system is intended for use outside the body (in vitro diagnostic use only). It should be used only for testing blood glucose (blood sugar) and only with fresh capillary whole blood samples. The system is intended for use in the home and in clinical settings. It should not be used for the diagnosis of diabetes or for the testing of newborns.

### Test Principle

Blood glucose is measured by an electric current that is produced when a blood sample mixes with the reagent (special chemicals) of the test strip. The electrical current changes with the amount of glucose in the blood sample. The Prodigy Pocket™ Meter measures the strength of the electrical current, calculates your blood glucose level and then displays your result in either mg/dL or mmol/L.

The Prodigy Pocket™ Meter, Test Strips and Control Solutions have been designed, tested and proven to work together as a system to produce accurate blood glucose test results.

**Important:** Use only Prodigy® control solutions and Test Strips with your Prodigy Pocket™ Meter. Using other test strips and control solutions with this meter can produce inaccurate results.



**Contents of the Prodigy Pocket™ Meter**

The Prodigy Pocket™ Meter is available as a meter only or as a meter kit. Please check the “REF” number marked on the outside of the box to see if you have purchased a “Meter” or a “Meter Kit”. Please review the contents of your purchase to confirm that all the components are included as listed below:

**REF 50300 Series****Your “Meter” includes:**

- Prodigy Pocket™ Meter
- One (1) 3 Volt CR 2032 Battery
- Carrying Case
- Complete Instructions:
  - Manual
  - Log Book
  - Quick Reference
  - Warranty Card

*\*You can purchase additional supplies from your provider*

**REF 50360 or 70800 Series****Your “Meter Kit” includes:**

- Prodigy Pocket™ Meter
- One (1) 3 Volt CR 2032 Battery
- Prodigy® Control Solution (4ml)
- Prodigy® Test Strips (10ct)
- Sterile Lancets (10ct)
- Lancing Device (with clear cap)
- Complete Instructions:
  - Carrying Case
  - Manual
  - Log Book
  - Quick Reference
  - Warranty Card

*\*Available in five colors. See page 41 .*

**Important:** Please review the contents of your purchase. If any items are missing, please return your meter to the place of purchase.

## Setting Up the Prodigy Pocket™ Meter

### Key Functions of the Meter

#### Test Slot

Insert the test strip here.  
The meter will turn on automatically.

#### LCD Display

Guides you through the test using symbols and simple messages.

#### Main Button

Turns the meter on or performs other functions described in this manual.

Figure 2  
Front



#### Set Button

Located in the battery compartment; used to set up the meter.

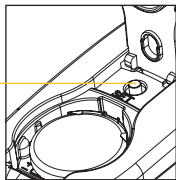

Figure 3 - Back

#### Data Port

USB Port for USB Cable connection to your computer.

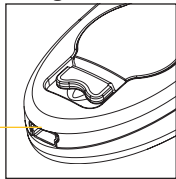

Figure 4 - Back

**Meter Display**

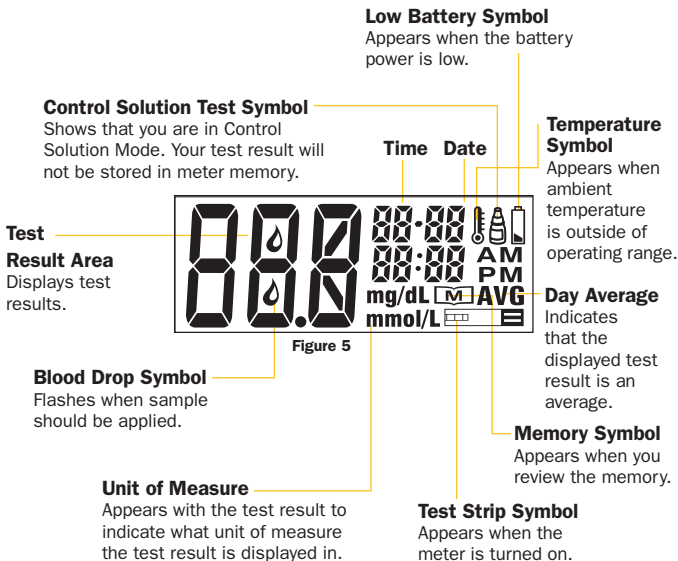

Figure 5

## Key Functions of the Test Strip

The Prodigy Pocket™ Meter measures the amount of blood glucose (blood sugar) in whole blood. Blood is applied to the opening of the absorbent channel of the test strip and is automatically drawn into the test strip.

The test strip consists of the following parts:

### **Absorbent Channel**

Apply a drop of blood and it will be drawn in automatically.

### **Confirmation Window**

Shows whether enough blood has been drawn into the test strip's absorbent channel.

### **Test Strip Handle**

Hold this part to insert the test strip into the test strip port on the meter.

### **Contact Bars**

Insert this end of the test strip into the meter. Push it in firmly until it will not go any further.



Figure 6

Please refer to the “*Performing a Blood Glucose Test*” Section for complete instructions.

**Important Test Strip Information**

- Store test strip packages in a cool, dry place between 39.2°F ~ 104°F (4°C ~ 40°C). Keep away from direct sunlight and heat. Do not refrigerate.
- Store your test strips in their original vial only. Do not transfer them to a new vial or any other container.
- With clean, dry hands, you may touch the test strip anywhere on its surface when removing it from the vial or inserting it into the meter.
- Immediately use a test strip after removing it from the vial, replace the vial cap and close it tightly.
- Only apply a blood sample or a control solution sample to the test strip's absorbent channel. Applying other substances to the test strip's absorbent channel will cause inaccurate results.
- Record the discard date on the vial label when you first open it. Discard remaining test strips 90 days after the first opening date.
- Do not use test strips beyond the expiration date printed on the package.

**Warning:** Keep the test strip vial away from children; the vial cap and the test strips can be a potential choking hazard. Never chew or swallow a test strip. If this occurs, please seek medical assistance immediately.

## Set-Up Steps

The Prodigy Pocket™ Meter has the date, time and unit of measurement presets. However, if you change the time or replace the battery, you should check and update the time and date.

### STEP 1: Insert the Battery

Open the battery cover located on the backside of the meter. Insert one (1) 3 Volt CR 2032 lithium battery. The meter should beep and turn on.

### STEP 2: Enter Set-Up Mode

Start with the meter off. Then press the **“SET”** button located in the battery compartment. The meter is now in the set-up mode.

### STEP 3: Set the Year

The year appears with the number flashing. Press and release the **“M”** button to advance the year. With the correct year on the display, press the **“SET”** button and the date will appear on the display with the month segment flashing. See *Figure 7*.

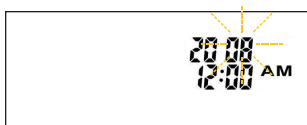

Figure 7

### STEP 4: Set the Month

Press and release the **“M”** button to advance the month. With the correct month on the display, press the **“SET”** button and the date segment will start flashing. See *Figure 8*.



Figure 8

**STEP 5: Set the Date**

Press and release the “M” button to advance the date. With the correct date on the display, press the “SET” button and the time will appear on the display with the hour segment flashing.

See Figure 9.

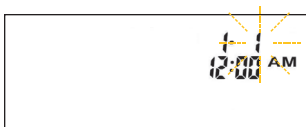

Figure 9

**STEP 6: Set the Hour**

Press and release the “M” button to advance the hour. With the correct hour on the display, press the “SET” button and the minutes segment will start flashing.

See Figure 10.



Figure 10

**STEP 7: Set the Minutes**

Press and release the “M” button to advance the minutes. With the correct minute on the display, press the “SET” button and the current unit of measurement will start flashing.

See Figure 11.



Figure 11

**Important:** Day averages are calculated from results obtained during the 7, 14 and 28 days preceding the current date and time settings. When the date and time are changed, the 7, 14 and 28-day averages may change.

**STEP 8: Unit of Measurement**

Press and release the “**M**” button until the unit of measurement you are choosing appears on the display. Press the “**SET**” button and “**dEL**” will appear with the flashing “**M**” symbol. See *Figures 12 and 13*.

Your meter can display test results in milligrams per deciliter (mg/dL) or millimoles per liter (mmol/L).

- The mg/dL unit is standard in the United States.
- The mmol/L unit is standard in Canada.

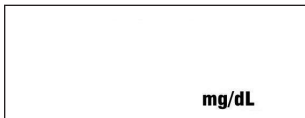

Figure 12



Figure 13

**STEP 9: Delete Memory**

When the “**dEL**” symbol and the flashing “**M**” symbol appear on the display, you can choose to clear the memory. If you do not want to clear the memory, press the “**SET**” button again to skip this step. If you want to clear ALL memory, press and hold the “**M**” button for four (4) seconds. The “- - -” image will appear on the LCD screen to indicate that all memory has been deleted.

Set-up is now completed. Press the “**SET**” button to turn off the meter. “**OFF**” is displayed before shut down. See *Figures 14 and 15*.

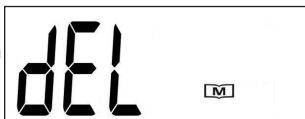

Figure 14

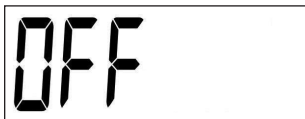

Figure 15



## Control Solution Testing

### About Prodigy® control solution

Prodigy® control solution is a red liquid that contains glucose that will react with test strips and produce a test result.

Prodigy® systems use a high or low control solution.

- ❖ First, check your contents to see if you have a high or low control solution kit.
- ❖ Then, after completing a control solution test, compare test results with the correct range (high or low) located on the back of the test strip vial.

### Why Perform A Control Solution Test?

- To ensure that your meter and test strips are working properly together.
- To allow you to practice testing without using your own blood.

### It is recommended to do a control solution test:

- Once a week (to make sure that you continue to get accurate results).
- When you begin using a new vial of test strips.
- When test strips are exposed to extreme environmental conditions.
- If you drop the meter.
- If you change the battery.

### Important Control Solution Test Information

- Use only Prodigy® control solutions.
- Check the expiration date on the control solution bottle. Do not use if expired.
- Control Solution, meter, and test strips should come to room temperature (68 - 77°F/20 - 25°C) before testing.
- Use within a period of 90 days from the date that you first open it. Record the discard date on the control solution bottle and discard after 90 days.
- Store the control solution tightly closed at temperatures below 86°F (30°C). Do not refrigerate.

**Important:** Prodigy®'s control solution ranges are located on the back of the test strip vial. They are not recommended target ranges for your blood glucose level.

## Performing a Control Solution Test

Start with the meter off.

### STEP 1: Insert Test Strip

Insert a test strip with the contact bar end entering into the test slot first. Push the test strip as far as it will go without bending it. The meter turns on automatically.

See *Figure 16*.

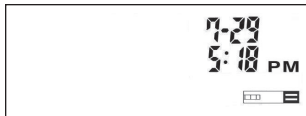





Figure 16

### STEP 2: Mark as a Control Solution Test

After the “” symbol appears on display, press the “**M**” button and a “” symbol appears on the display. With the “” symbol on the display, the meter will not store your test result in the memory.

If you decide not to perform a control solution test, press the “**M**” button again and the “” symbol will disappear. See *Figure 17*.

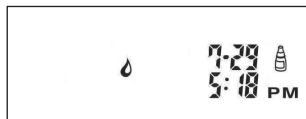

Figure 17

**Important:** Be sure that you are in Control Solution Mode so that the test result will not be stored in the meter memory.

**STEP 3: Apply Control Solution**

Shake the control solution bottle well. Remove cap. Squeeze the bottle, discard the first drop, and wipe off the dispenser tip with a clean tissue paper or cotton. Squeeze the bottle again to get a second drop onto a clean non-absorbent surface or on your fingertip first. Then apply the drop to the opening of the absorbent channel of the test strip (where it meets the narrow channel) until the confirmation window is filled. The meter begins to count down. See Figures 18, 19 and 20.

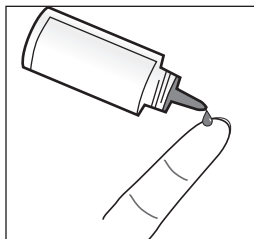

Figure 18

**Caution:** To avoid contaminating the control solution with the content of the test strip, **DO NOT DIRECTLY APPLY CONTROL SOLUTION ONTO THE TEST STRIP.**

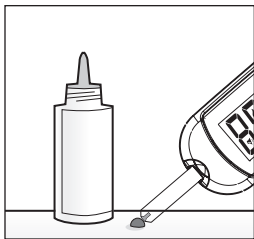

Figure 19

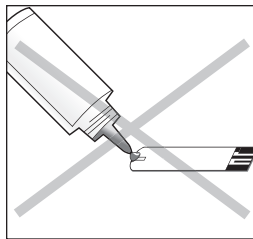

Figure 20

**STEP 4 : Check if the Test Result is in Range.**

After seven (7) seconds, the control solution test result appears on the display. Compare the test result with the range printed on the test strip vial. The result should fall within the printed range. See Figure 21.

**Out of Range Results**

If test results fall outside the range printed on the test strip vial, check “*Trouble-Shooting Guide*” located in the “*System Troubleshooting*” Section and repeat the test.

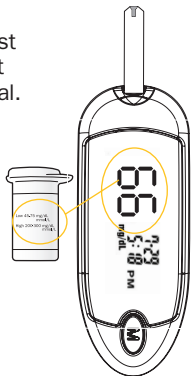
**Figure 21**

If you continue to get out-of-range results, it means that the system or the control solution may not be working properly. **DO NOT** use the system to test your blood glucose level. If you are unable to resolve the problem, contact Technical Support at **1-800-243-2636**.

**Blood Glucose Testing****Preparing the Lancing Device**

**STEP 1:** Remove the cap by twisting it off.

**STEP 2:** Insert a Sterile Lancet into the Lancing Device. Insert the lancet into the lancet holder and push down firmly until it is fully seated. Do not twist the lancet. See Figure 22.

**STEP 3:** Remove the protective cap from the lancet by twisting it and then save it for later use. See Figure 23.

**STEP 4:** Replace the cap onto the Lancing Device. Screw the cap until it is snug but not too tight.

**STEP 5:** Set the Lancing Level. The adjustable tip offers five (5) levels of skin penetration. To select the desired depth, twist the adjustable tip in either direction until the number lines up with the arrow. To select the best depth: 1-2 for soft or thin skin, 3 for average skin, 4-5 for thick or callused skin. See Figure 24.

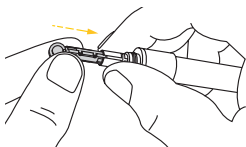

Figure 22

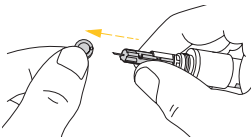

Figure 23

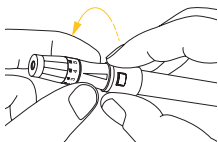

Figure 24

**Warning:** To reduce the chance of infection:

- Never share a lancet or the lancing device.
- Always use a new, sterile lancet.
- Lancets are for single use only.
- Avoid getting hand lotion, oils, dirt, or debris in or on the lancets and the Lancing Device.

**Alternative Site Testing (AST)**

When you want to obtain blood from sites other than the fingertip, use the clear cap. Screw the clear cap onto the Lancing Device until it is snug but not too tight, and then go to Step 6.

**STEP 6:** Cock the Lancing Device. Slide the ejection/cocking control back until it clicks. If it does not click, the Lancing Device may have been cocked when the lancet was inserted. See Figure 25.

*\*The Lancing Device is prepared and ready to lance your finger for a blood sample.*

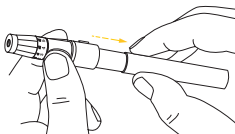

Figure 25

**Getting a Blood Sample****STEP 1: Wash Your Hands and the Puncture Site**

Use warm, soapy water. Rinse and dry your hands thoroughly.

**STEP 2: Select and Lance a Puncture Site****• Fingertip**

Hold the Lancing Device firmly against the side of your finger. Press the release button. You will hear a click, indicating that the puncture is complete. See Figure 26.

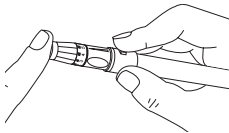

Figure 26

- **Sites other Than Your Fingertip**

Please refer to the “About Alternative Site Testing (AST)” Section. Please consult your healthcare professional before obtaining blood from sites other than your fingertip.

**Caution:** The Prodigy Pocket™ only requires a tiny sample of blood to perform a test. Choose a different spot each time you test. Repeated punctures in the same spot may cause soreness and calluses.

**STEP 3: Obtain a Blood Sample**

Do not smear the blood sample. To obtain the most accurate results, wipe off the first drop of blood and gently squeeze another drop of blood. See Figures 27 and 28.

**STEP 4: Remove the Lancet**

Take the lancet out carefully. Place the protective cap back on the exposed tip of the lancet.

*\*Always use caution when removing the lancet. Discard the lancet according to your local regulations.*

**Warning:** The first drop of blood usually contains tissue fluid and serum, which may affect the test result. It should be discarded.

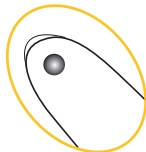

Figure 27



Figure 28



## Performing a Blood Glucose Test

### STEP 1: Insert the Test Strip

Insert a test strip with the contact bar end entering into the test slot first. Push the test strip as far as it will go without bending it. The meter turns on automatically. See Figure 29.

### STEP 2: Apply Blood Sample

When the meter shows the “”, apply blood to the opening of the absorbent channel of the test strip where it meets the narrow channel. Blood will be drawn into the test strip. See Figure 30.

The test strip confirmation window should be completely filled before the meter begins to count down. The meter will beep when the confirmation window of the test strip is full. See Figure 31.

If not, do not try to add more blood to the test strip. Discard the test strip and retest with a new one. If you have trouble filling the test strip, please contact Technical Support for assistance 1-800-243-2636.



Figure 29

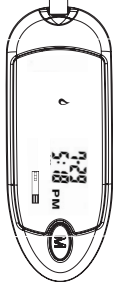
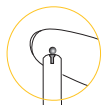

Figure 30

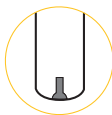

Figure 31

**Caution:****DO NOT:**

- Smear or scrape the blood onto the test strip.
- Apply blood to the test strip when the test strip is out of the meter.
- Put blood or foreign objects into the test strip port.

**STEP 3: Read Your Result**

After the meter counts down from 6 to 1, your blood glucose test result appears along with the unit of measure, date and time. This blood glucose result is automatically stored in the meter memory. Turn the meter off by removing the test strip. Discard the used test strip carefully to avoid contamination. See *Figure 32*.

**Figure 32**

**Important:** If you do not apply a blood sample within five (5) minutes, the meter will automatically turn off. You must remove the test strip and re-insert it again to turn on the meter and restart the test procedure.

## Using the Meter Memory

The Prodigy Pocket™ stores the 120 most recent blood glucose test results with date and time in its memory. It also provides you with 7, 14 and 28-day averages of your blood glucose test results. You can review the individual or average test results by entering the memory mode.

### STEP 1: Enter the Memory Mode

While the meter is turned off, press the “M” button twice. The 7-day average will appear, indicating that you are in the memory mode. If you continue to press the “M” button, the 14 and 28-day averages will appear in order. You can then review the last 120 individual test results in memory. When using the meter for the first time, “- - -” appears, showing that there are no test results in the memory. See *Figure 33*.

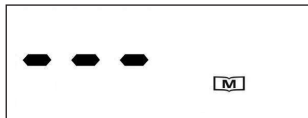

Figure 33

**STEP 2: Recalling Average Test Results**

The 7-day average is calculated from the blood glucose results obtained during the last 7 days. It also indicates how many blood glucose tests have been performed within this period, e.g., 21 (21 tests in the last 7 days). See *Figure 34*.



Figure 34

The 14-day average is calculated from the blood glucose results obtained during the last 14 days. See *Figure 35*.



Figure 35

It, too, indicates how many blood glucose tests have been performed, e.g., 41 (41 tests in the last 14 days). The 28-day average shows the same information.

**STEP 3: Recalling Individual Test Results**

After the 28-day average, the most recent test result with date and time will be shown. Press the “**M**” button once and the next most recent test result will appear. Each time you press and release the “**M**” button, the meter will recall up to your last 120 test results in order. When the memory is full, the oldest result is dropped as the newest is added. After reaching the last set of results, the meter will display the 7-day average again. See *Figure 36*.

**Figure 36****STEP 4: Exit the Memory Mode**

Press and hold the “**M**” button for three (3) seconds to turn off the meter.

**Important:** If you do not press any button for one (1) minute, the meter will show “**OFF**” and turn off automatically.

**Viewing Results on a Personal Computer**

Test Results in memory can be transmitted to your personal computer. Prodigy® Diabetes Management System Software and an USB cable are needed before installation. The free software can be downloaded from [www.prodigymeter.com](http://www.prodigymeter.com).

**STEP 1: Install Software**

Install Prodigy® Diabetes Management System Software on your computer by following the instructions provided on our website: Go to [www.prodigymeter.com](http://www.prodigymeter.com) and click on “Software Downloads.”



Figure 37

**STEP 2: Connect to a Personal Computer**

Connect the USB Cable to your computer. Connect the USB Cable to the Data Port of the meter. “Lnk” will appear if the USB cable is connected to the meter and PC. “USB” will appear on the display, indicating that the meter is successfully communicating to your computer. You can begin to download the data from the meter. See Figures 37 and 38.

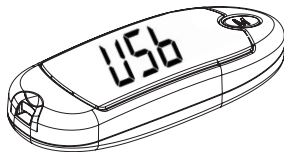

Figure 38

**STEP 3: Transmit Data**

Follow the instructions provided in the software to transmit data. Results transmitted will include date and time. Remove the USB Cable and the meter will automatically turn off.

**Important:** While the meter is connected to the PC, it is unable to perform a blood glucose test.

**Caring for Your Prodigy Pocket™ Meter****Maintenance**

The Prodigy Pocket™ does not require special maintenance.



- Avoid getting dirt, dust, blood, control solution or water inside the meter through the test port or data port.
- Store the meter, test strips and control solution in the carrying case after each use in a cool, dry place.
- Do not refrigerate.
- Use a cloth dampened with water and mild detergent to wipe the outside of the meter.

*\*Your meter is a precision instrument. Please handle it with care.*

**Battery**

Your meter comes with one (1) 3 Volt CR 2032 lithium battery.

The meter will alert you when the power is getting low by displaying two (2) different messages:

1. When the “” symbol appears alone on the display, the meter is functional and the result remains accurate, but you should change the battery as soon as possible. *See Figure 39.*
2. When the “” symbol appears together with the “E-b” symbol on the display, the battery does not have enough power for a test. You must change the battery before using the meter. *See Figure 40.*

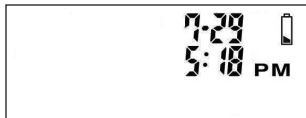

Figure 39

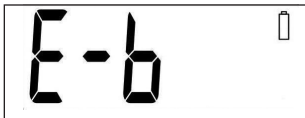

Figure 40

## Battery Replacement

To replace the battery, make sure the meter is turned off.

See Figures 41, 42 and 43.

**STEP 1:** With the meter off, press the buckle on the battery cover and lift up to open the cover.

**STEP 2:** With the “+” side facing up toward you, place the battery in the compartment and slide it upwards until it is locked into place. You should hear a beep.

**STEP 3:** If the meter does not power on after you have replaced the battery, check that the battery is correctly installed with the “+” side up.

**STEP 4:** Check the time and date. Replacing the battery does not affect the meter's memory (previous test results stored in memory). However, the date, time and units settings may need to be updated.

**Caution:** As with all small objects, the battery should be kept away from small children. If the battery is swallowed, seek medical assistance immediately.

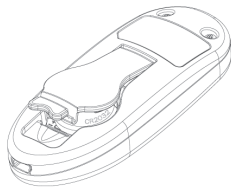

Figure 41

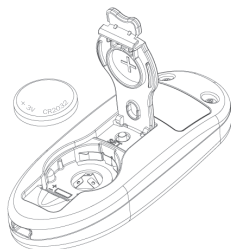

Figure 42

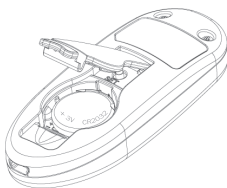



Figure 43





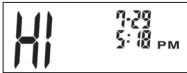

**System Troubleshooting**

Special messages and Error messages help to identify certain problems but do not appear in all cases when a problem has occurred. Improper use may cause an inaccurate result without producing an error message. In the event of a problem, refer to the information under “Action” in the “Error Messages” Section. If you have a problem, please refer to the “Troubleshooting Guide” Section. If you follow the actions recommended but the problem is not resolved, please contact Technical Support at **1-800-243-2636** for assistance.

**Special Messages**

Message	What it says	What it means
	Blood Glucose level Low	“Lo” appears when your result is below the measurement limit, which is less than 20 mg/dL (1.1 mmol/L). “Lo” indicates hypoglycemia (low blood glucose). You should immediately consult your healthcare professional.
	Blood Glucose level High	“Hi” appears when your result is above the measurement limit, which is higher than 600 mg/dL (33.3 mmol/L). You should immediately consult your healthcare professional.

**Error Messages**

Message	What it means	Action
	Appears when the battery cannot provide enough power for a test.	Replace the battery immediately.
	Appears when inserting a used test strip.	Test with a new test strip. If the problem persists, please contact Technical Support at <b>1.800.243.2636</b> .
	Appears when the environmental temperature is below the system operation range. (50°F ~ 104° or 10°C ~ 4 0°C).	Repeat the test after the meter and test strip are within the operation temperature range.
	System Error	Contact Technical Support at <b>1.800.243.2636</b>

## Troubleshooting Guide

---

### ❖ The meter does not display a message after inserting a test strip.

---

#### Probable Cause

#### What to Do

---

Battery exhausted.

Replace the battery.

---

Battery incorrectly installed or absent.

Check that the battery is correctly installed.

---

Test strip inserted upside down or incompletely.

Insert the test strip correctly with the bar end entering into the test strip first.

---

Defective meter.

Please contact Technical Support at **1-800-243-2636** for assistance.

---

### ❖ The test does not start after applying the sample.

---

#### Probable Cause

#### What to Do

---

Insufficient blood sample.

Repeat the test using a new test strip with a larger blood sample.

---

Defective test strip.

Repeat the test with a new test strip.

---

Sample applied after automatic shut-off.  
(Two (2) minutes after last user action).

Repeat the test with a new test strip. Apply sample only when the “” symbol appears on the display.

---

Defective meter.

Please contact Technical Support at **1-800-243-2636** for assistance.

---

**❖ The test does not start after applying the sample.****Probable Cause****What to Do**

Error in performing the test

Read the instructions thoroughly and repeat the test again.

Control Solution bottle not shaken well.

Shake the Control Solution bottle vigorously and repeat the test again.

Expired or contaminated Control Solution.

Check the expiration date or the discard date of the Control Solution.

Control Solution that is too warm or too cold.

Control Solution, meter, and test strips should come to room temperature (68 - 77°F/20 - 25°C) before testing.

Test strip deterioration.

Please repeat the test with a new test strip.

Meter malfunction.

Please contact Technical Support at **1-800-243-2636** for assistance.

**Information about Your Prodigy Pocket™ Meter****Comparing Meter and Laboratory Results**

The test result you obtain from your meter may differ somewhat from your laboratory results due to normal variation. Meter results can be affected by factors and conditions that do not affect laboratory results in the same way. *(See test strip package insert for typical accuracy and precision data and for important information on limitations.)* To make an accurate comparison between meter and laboratory results, follow the guidelines below.

**Before you go to the laboratory:**

- Perform a control solution test to make sure that the meter is working properly.
- It is strongly recommended to fast for at least eight (8) hours before doing comparison tests.
- Take your meter with you to the lab.

**While at the laboratory:**

- Make sure that the samples for both tests (the meter test and the laboratory test) are taken and tested within 15 minutes of each other.
- Wash your hands before obtaining a blood sample.
- Never use your meter with blood that has been collected in a gray top test tube.
- Use fresh capillary blood only.

You may still have a variation from the result because blood glucose levels can change significantly over short periods, especially if you have recently eaten, exercised, taken medication, or experienced stress.<sup>1</sup> In addition, if you have eaten recently, the blood glucose level from a finger stick can be up to 70 mg/dL (3.9 mmol/L) higher than blood drawn from a vein (venous sample) used for a lab test.<sup>2</sup>

Therefore, it is best to fast for eight (8) hours before doing comparison tests. Factors such as the amount of red blood cells in the blood (a high or low hematocrit) or the loss of body fluid (severe dehydration) may also cause a meter result to be different from a laboratory result.

*References:1) Surwit, R.S., and Feinglos, M.N.: Diabetes Forecast (1988), April, 49-51. 2) Sacks, D.B.: "Carbohydrates. "Burtis, C.A., and Ashwood, E.R. (ed.), Tietz Textbook of Clinical Chemistry. Philadelphia: W.B. Saunders Company (1994), 959.*

**Specifications**

**Dimensions:** 3.54 in. (L) x 1.38 in. (W) x .83 in. (H)  
90 mm (L) x 35 mm (W) x 21 mm (H)

**Weight:** 1.2 oz with battery  
36g

**Power source:** One (1) 3 Volt CR 2032 Battery

**Battery life:** Over 1,000 tests

**Display:** LCD

**Memory:** 120 measurement results with date and time

External output: USB Data Port

Auto electrode inserting detection

Auto sample loading detection

Auto reaction time count-down

Auto turn-off after two (2) minutes without action

Temperature warning

**Operating condition:** 50°F ~ 104°F (10°C ~ 40°C), below 85% R.H. (noncondensing)

**Storage/Transportation condition:** 39.2°F ~ 104°F (4°C ~ 30°C), below 85% R.H.

**Measurement Units:** mg/dL or mmol/L

**Measurement Range:** 20 ~ 600 mg/dL (1.1 ~ 33.3 mmol/L)

*\*The specifications may be changed without prior notice.*

### **Performance Characteristics**

---

- **Accuracy:**  $\pm 15$ mg/dL when glucose  $< 75$ mg/dL  
 $\pm 20\%$  when glucose  $> 75$ mg/dL
  - **Precision:** This study shows the CV (correlation variation) is less than 5%.
  - **The device has certified to meet the following standards:**  
98/79/EC, IEC 60601-1, IEC 61010-1, IEC 60601-1-2,  
IEC61326, and ISO 15197
-



**Expected Test Results**

<b>Time of day</b>	<b>Plasma glucose range for people without diabetes (mg/dL)/(mmol/L)</b>	<b>Your target range (mg/dL)/(mmol/L)</b>
Fasting and before meal	Less than 110 / 6.1	_____(mg/dL)/(mmol/L)
2 hours after meals	Less than 140 / 7.8	_____(mg/dL)/(mmol/L)
Bedtime	Not specified	_____(mg/dL)/(mmol/L)
Between 2 AM and 4 AM	Not specified	_____(mg/dL)/(mmol/L)

Source: ADA Clinical Practice Recommendations 2008

Please work with your doctor to determine a target range that works best for you.

The Prodigy Pocket™ is designed to help you and your healthcare professionals manage your diabetes. You must always rely on your healthcare professionals to interpret your test results and to decide how to treat your diabetes.

**Prodigy Pocket™** Meters are available in five (5) colors:

**Meter**

**REF 50300** - K (Black)

**REF 50301** - P (Pink)

**REF 50302** - B (Blue)

**REF 50303** - G (Green)

**REF 50304** - C (Camouflage)

**Meter Kit**

**REF 50360** - K (Black)

**REF 50361** - P (Pink)

**REF 50362** - B (Blue)

**REF 50363** - G (Green)

**REF 50364** - C (Camouflage)

**Meter Kit**

**REF 70800** - B (Black)

**REF 70801** - P (Pink)

**REF 70802** - B (Blue)

**REF 70803** - G (Green)

**REF 70804** - C (Camouflage)

