

electro-harmonix

OCEANS 12

Multifunction Dual Stereo Reverb

Congratulations on your purchase of the Oceans 12, our dual stereo reverb tour-de-force. Dive into uncharted sonic depths with its myriad features: two simultaneous, independent, stereo reverb engines, series and parallel control for the dual reverbs, 24 presets, external expression and footswitch input, and more. Plus, with an array of new controls like Tide for stereo image alteration, Lo-fi for diffusion reduction, infinite attenuation, send level for FX LOOPS, and split reverbs, your customization options are nearly limitless. The Oceans 12 is the reverb pedal to end all reverbs!

WARNING: Your Oceans 12 comes equipped with an Electro-Harmonix 9.6DC-200BI power supply. The Oceans 12 requires **150mA** at 9VDC with a center negative plug. Use of the wrong adapter or a plug with the wrong polarity may damage your Oceans 12 and void the warranty. Do not exceed 10.5VDC on the power plug. Power supplies rated for less than 150mA will cause the Oceans 12 to act unreliably.

- FEATURES -

- Two simultaneous, independent, stereo reverb engines
- Series or parallel dual reverb configurations
- 12 Reverb Types per engine yield a multitude of reverb effects
- Multiple modes available for each Reverb Type, including new modes exclusive to the Oceans 12
- Easy pushbutton access to extra features like reverb tails, momentary effect mode, and alternate knob functions
- 24 presets may be saved and recalled: one preset for each Reverb Type of each reverb engine
- Two-in-one expression/external-footswitch jack: control any combination of the Oceans 12's knobs with an external expression pedal, or connect an external 1-, 2- or 3-button footswitch for augmented pedal control
- Infinite hold, 1-second global pre-delay, tap tempo for Echo reverb
- Additional send/return signal routing option for mono setups
- High quality buffered analog bypass and soft switching

TABLE OF CONTENTS

- Notes and Specifications** 3
- Reverb Types and Descriptions** 3
- Quick Start Guide** 4
- Summary Chart**..... 10
- Controls and LEDs** 7
 - Dual Reverb Select Button and LEDs** 7
 - Control Knobs** 8
 - Reverb Type Knob, Preset LED, and Mini Knobs** 12
 - Illuminated Buttons** 13
 - Send/Return FX Loop**..... 15
 - Mode Button and LEDs** 17
 - Footswitches and LEDs** 18
- Connections** 20
- Reverb Type and Mini Knob Details** 22
- Dual Reverb** 28
- External Footswitch Functionality** 30
- Expression Pedal Use and Setup** 31
- Tap Tempo on the Oceans 12** 34
- Preset Use and Setup** 36
- Restoring Factory Settings** 38
- Warranty Information and Compliance**..... 39

NOTES AND SPECIFICATIONS

- Audio input impedance for mono left input: $1M\Omega$
- Audio input impedance for stereo left input: $2M\Omega$
- Audio input impedance for right input: $2M\Omega$
- Audio output impedance for each output: 550Ω
- Current draw: 150mA
- Maximum input signal level: +11 dBu
- Bypass: high quality analog buffered bypass when TAILS mode is disabled. DSP bypass when TAILS is enabled.

REVERB TYPES AND DESCRIPTIONS

REVERB TYPE	DESCRIPTION
ROOM	Warm and versatile reverb algorithms modeled after a lively room and a spacious performance hall.
SPRING	Vintage 1962 Fender® 6G15 reverb unit emulation and the classic spring algorithm from the EHX Holy Grail.
PLATE	Two emulations of a smooth, bright metal plate reverb commonly found in high-end recording studios during the 1960's and 70's.
REVERSE	A rendition of the reverse reverb trick commonly performed in studios, as well as true reversed echoes.
ECHO	Simple digital delay which feeds into a plate reverb.
TREM	A classic, periodic volume envelope applied to both the dry and wet mix of a hall reverb.
MOD	A lush combination of various modulations for creamy rich reverb tails.
DYNA	A dynamic trio of experimental reverb algorithms: swell, gate, and duck.
AUTO-INF	Auto infinite reverb, with optional chorus or flange, that listens to your playing and crossfades to a new reverb wash upon detection of newly-struck notes and chords.
SHIMMER	Two configurations of a rich octave-shifted wash of harmony in a reverberant cloud.
POLY	Two configurable bidirectional pitch-shifts that add startling dimensionality to the reverb tail.
RESONANT	Reverb excited by tunable resonators, and configurable self-oscillating filters on the reverb tail.

QUICK START GUIDE

PLUGGING IN THE OCEANS 12

1. Connect the supplied EHX9.6DC AC Adapter into the 9V jack at the top of the Oceans 12. Plug the AC Adapter into an AC outlet.
2. Connect your guitar or other instrument into the L/MONO IN jack using a standard 1/4" instrument cable. Connect the L/MONO OUT jack to your amp with another standard 1/4" instrument cable.
3. For stereo operation, connect R/SEND OUT to another amp.

DIALING IN A STANDARD REVERB EFFECT

1. Ensure none of the buttons at the top left of the Oceans 12, like TAILS, are lit. If any of the buttons are lit or blinking, press the button once to disable it.
2. Ensure that REVERB A is selected by confirming that its SELECT LED is lit. This LED is located in the center of the unit, in the section labeled SELECT. If the SELECT LED of REVERB B is lit, press the small white SELECT button to toggle reverb selection back to REVERB A.
3. Turn on REVERB A by pressing its footswitch located on the bottom left of the Oceans 12. The white bypass LED should turn on.
4. Rotate the REVERB TYPE knob clockwise to the ROOM setting for a standard reverb, if not already selected.
5. Set the two smaller knobs to the right of the REVERB TYPE knob to their middle positions.
6. Set the decay time with the TIME knob, the tone with the TONE knob, the predelay time with the PREDELAY knob, and the reverb volume with the FX LVL knob.

CHOOSING A REVERB TYPE

1. Rotate the REVERB TYPE knob in either direction until the desired REVERB TYPE LED is lit.
2. Check the table on the Oceans 12 below the mini knobs to see the corresponding parameters that can be adjusted for the chosen Reverb Type. Turn the mini knobs to experiment with different reverb effects.

USING DUAL REVERB

1. At any given time on the Oceans 12, only one of the reverb engines is selected for editing. The SELECT LED indicates which reverb engine this is. In general, reverb-editing controls affect only the selected reverb engine.
2. The default selected reverb engine should be Reverb A, and accordingly you should see the green LED labeled "A" lit.
3. If Reverb A isn't already on, turn it on by pressing the left footswitch. Once it's on, the white LED in the center moon graphic will be lit.
4. Next, tap the right footswitch corresponding to Reverb Engine B. This turns on Reverb B, and its blue SELECT LED as well as its corresponding white Reverb Type LED will light. Because Reverb B is now the most recently engaged reverb engine, the Oceans 12 makes Reverb B the currently-selected engine and blinks its blue LED to indicate this.
5. Now the reverb effects of both Reverb A and Reverb B are applied, in parallel by default, to your playing. Edits to the knobs and buttons will affect Reverb B.
6. To change your selection back to Reverb A, you can press the MODE button. Doing so will switch the selection back to Reverb A, and its green LED will blink to indicate this.
7. To bypass/engage either of the reverb engines, simply tap their respective footswitches.
8. See page 28 for detail on dual reverb operation and control.

DUAL REVERB CONFIGURATIONS

1. When dual reverbs are engaged, you can choose which configuration – parallel or series – in which to arrange them.
2. To edit this, press the button labeled FUNCTION towards the top of the Oceans 12. It should blink, along with both of the SELECT LEDs, to indicate that the controls of the Oceans 12 are now performing their alternate functions, whose graphic labels are colored teal.
3. The alternate functions of the two mini knobs in the REVERB TYPE table are labeled at the bottom of the table: SRS/PRL and A \leftrightarrow B. Briefly, the left mini knob controls series v. parallel configuration, while the right mini knob controls series order and parallel mix of the two reverbs.
4. See page 28 for more details on dual configurations.

USING AN EXPRESSION PEDAL

1. Connect your expression pedal to the EXP/FSW jack.
2. While the EXP MODE button is off, the expression pedal acts like a volume control for your dry signal before it enters the Oceans 12.
3. While the EXP MODE button is enabled, the expression pedal sweeps all parameters that are assigned to it for the current Reverb Type of the selected dual reverb.
4. You may assign any knobs you like to be swept by the expression pedal. Additionally, each knob may have a custom range and direction. See page 31 of the manual to learn how to create an Expression Setting for each Reverb Type of both dual reverb selections.

SAVING A PRESET

1. Once you have created a sound that you would like to save, press and hold the REVERB TYPE knob.
2. After half a second, the PRESET LED will begin blinking rapidly. Continue holding down the REVERB TYPE knob.
3. After two seconds of holding down the REVERB TYPE knob, the PRESET LED will stop blinking and light up solid. You can now release the REVERB TYPE knob.
4. Your preset is saved in the currently selected Reverb Type. You may save one preset for each of the 12 Reverb Types of Reverb A, and one preset for each of the 12 Reverb Types of Reverb B.

RECALLING A PRESET

1. Turn the REVERB TYPE knob to the Reverb Type you want to recall.
2. Press and release the REVERB TYPE knob. The preset sound loads and the PRESET LED lights solid.
3. If you turn a knob or change a button setting, the PRESET LED will blink rapidly to indicate a preset is loaded but the setting has been altered.

CONTROLS AND LEDS

- DUAL REVERB SELECT BUTTON AND LEDS -

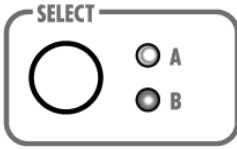

On the Oceans 12, one of the reverb engines is always currently selected, regardless of whether single or dual reverbs are engaged. All of the LEDs on the Oceans 12 – the Reverb Type LED, the mode button LEDs, the preset LED, the illuminated buttons, and the bypass LED -- always reflect the status of the currently selected reverb engine. The SELECT button allows you to toggle this selection between Reverb A and Reverb B. When you do, you'll see that the LEDs update to the status of the newly-selected reverb engine. You can also use an external footswitch to toggle between selected reverbs; see page 30 for more details on external footswitches.

If dual reverbs are engaged, the Oceans 12 will slowly blink one of the SELECT LEDs to indicate which of the reverb engines is the current selection. The Reverb Type LED of the corresponding reverb engine will also blink synchronously. The SELECT button still toggles the reverb engine selection; pressing it will blink the SELECT LED of the other reverb engine to indicate that it, now, is currently selected.

Additionally, for convenience, the selection of the current engine will always default to the last-engaged one. In other words, whenever you turn on a reverb engine with its footswitch, it immediately becomes the current selection.

See page 28 for more details and instructions on Dual Reverb operation.

- CONTROL KNOBS -

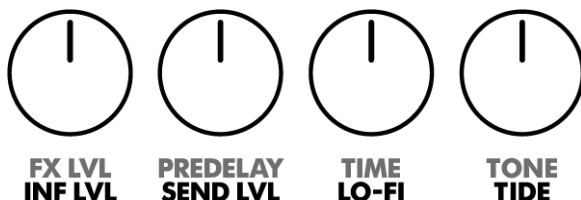

The four knobs on the left side of the Oceans 12 control the main parameters of the reverb effects. These knobs have different functions depending on the status of the illuminated FUNCTION button (see the section about Illuminated Buttons on page 13 for details on FUNCTION). The top row of white labels specifies the reverb-specific functions of the knobs, which are active when the FUNCTION button is off. The bottom row of teal labels specifies the alternate functions of the knobs, which are active when the FUNCTION button is blinking.

Reverb parameters

FX LVL – Wet/dry control that sets the balance between your dry signal and the reverb effects produced by the Oceans 12. When this knob is at the minimum position, the output is only your dry signal. As the knob is turned up, the reverb output increases in volume. As the knob is turned past 2 o'clock, the dry signal decreases in volume. When the knob is at the maximum position, the output is reverb only.

PREDELAY – For all Reverb Types except ECHO, SHIMMER, and RESONANT, the PREDELAY knob sets the pre-delay time for the reverb block. Pre-delay allows the musician to put a time delay between playing a note and hearing the onset of reverb for that note. The total range of pre-delay is from 0 to 1 seconds. As you turn the knob clockwise, the pre-delay time will increase. See the Summary Chart on page 10 to see what Reverb Types have different settings for this knob.

TIME – In all Reverb Types except REVERSE and DYNA, the TIME knob controls the decay time of the Oceans 12 reverb. As this knob is turned clockwise, the reverb time gets longer and longer, reaching infinite in all modes except SPRING, ECHO, and DYNA when the knob is as far as it will go. See the Summary Chart on page 10 to see what Reverb Types have different settings for this knob.

TONE – In all Reverb Types, TONE controls the tone or EQ of the reverb signal, so it's omitted from the columns of the Summary Chart on the

following page. As this knob is turned clockwise, the sound of the reverb gets brighter. As you turn TONE counter-clockwise, the sound of the reverb gets darker.

Alternate FUNCTION parameters

INF LVL – Works as an attenuation control for the infinite/sustain reverb sound. The default setting is fully clockwise, which corresponds to no attenuation, or full infinite/sustain volume. The infinitely sustained reverb volume decreases as the knob is turned counter-clockwise, reaching zero at fully counter-clockwise.

SEND LVL – Controls the signal level of the FX SEND when the Oceans 12 is in SEND/RETURN FX LOOP mode with a mono setup. See page 15 for details on operating the SEND/RETURN FX LOOP. This is a global parameter whose value is independent of reverb engine.

LO-FI – Controls the degree of reduction of diffusion and echo density in the reverb tails. As the diffusion and echo density decrease, certain qualities of the reverb tail, such as fullness and smoothness, start to diminish, allowing for creative low-fidelity manipulation of your favorite reverbs. When the knob is turned fully counter-clockwise, LO-FI turns off. As the knob is turned clockwise, LO-FI turns on, and the corresponding LED labeled LF next to the MODE button lights up. The degree of the LO-FI effect is increased as the knob is turned clockwise.

TIDE – Controls the amount of TIDE effect applied to the reverb output. When stereo outputs are used on the Oceans 12, TIDE subtly modulates the pan of the stereo output to gradually evolve the sound stage. When the knob is turned fully counter-clockwise, TIDE turns off. As the knob is turned clockwise, TIDE turns on, and the corresponding blue LED labeled TIDE next to the MODE button lights up. The frequency of the modulated pan is slowly increased as the knob is turned clockwise.

Reverb Type	MODE Descriptions	MODE Effect	PREDELAY	TIME
ROOM	Space type	1. Room 2. Hall	---	---
SPRING	Algorithm select	1. 6G15 2. Holy Grail	---	---
PLATE	Plate type	1. Original 2. Dark Plate	---	---
REVERSE	Algorithm select	1. Swoosh 2. Rev. echo	---	Swoosh time Reverse time
ECHO	Echo rhythm	1. 1/4 2. Dotted 1/8 3. 1/8	N/A	Reverb blend
TREM	LFO shape	1. Triangle 2. Square 3. Sine	---	---
MOD	Modulation type	1. Chorus 2. Flerb 3. Chorus + Flerb	---	---
DYNA	Algorithm select	1. Swell 2. Gate 3. Duck	---	--- Hold time ---
AUTO-INF	Reverb base	1. Hall 2. Chorus 3. Flerb	---	---
SHIM	Algorithm select	1. Original 2. Delay	--- Shimmer delays	---
POLY	Parameter control	1. Interval edit 2. Mix edit	---	---
RESONANT	Algorithm select	1. Chimes 2. Filtered	Chime delays ---	

Mini Knob 1	Mini Knob 2	Infinite Sustain?	Tap tempo?
Predel. feedback	Mod. depth	Yes	No
Spring length	Preamp drive	No Yes	No
Predel. feedback	Plate size	Yes	No
Predel. feedback	Mod. depth	Yes	No
Echo feedback	Echo delay	Yes	Yes
LFO rate	LFO depth	Yes	No
Mod rate	Depth		
Rate	Feedback	Yes	No
Blend	---		
Swell time	---		No
Release time	Threshold	Yes	No
Release time	Threshold		No
Crossfade time between washes	Trigger sensitivity	No	No
Mod rate	Mod depth	Yes	No
Shift interval #1	Shift interval #2	Yes	No
Dry/shifted mix	Shift #1/#2 mix		
Gain	Tuning	Yes	No
Q factor	Center frequency		

- REVERB TYPE KNOB, PRESET LED, AND MINI KNOBS -

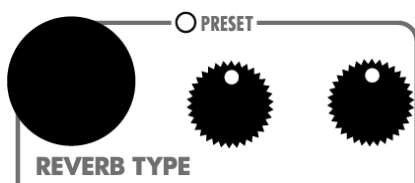

REVERB TYPE Knob

This knob is a rotary encoder that selects which of the Oceans 12's Reverb Types is active. The list ranges from ROOM at the top to RESONANT at the bottom. You can choose which Reverb Type is selected for each reverb engine.

One preset can be saved for each Reverb Type using the REVERB TYPE knob. For details on preset operation, see page 36. The PRESET LED provides a visual indication for the current preset state:

PRESET LED Off: You are in What You See Is What You Get (WYSIWYG). All current knob positions represent the effect being generated.

PRESET LED On: The preset is loaded for the currently selected Reverb Type.

PRESET LED Blinking: There are two situations where the PRESET LED blinks: 1) while saving a preset or 2) changing a knob or button setting after loading a preset. If you load a preset and then move a knob, the new knob position takes over for only that particular parameter and the PRESET LED blinks. If you return the recently moved knob to the position that is saved in the preset, the PRESET LED lights solid again.

Miniature Parameter Knobs

To the right of the REVERB TYPE knob are two mini knobs whose functions change depending on the selected Reverb Type, mode, and status of the illuminated FUNCTION button. On the face of the Oceans 12, below the mini knobs, there is a table listing the available mini knob functions for each Reverb Type. Detailed descriptions of mini knob functions start on page 22 of this manual. When the FUNCTION button is blinking, the mini knobs control the teal-highlighted parameters at the bottom of the Reverb Type table.

- ILLUMINATED BUTTONS -



EXP MODE Button – When this button is lit, EXP MODE is enabled. When an external expression pedal or control voltage is connected to the EXP/FSW jack on the rear of the Oceans 12, you can control any combination of knob parameters with your foot. When the EXP MODE button is disabled (button is not lit), the external expression pedal acts as a volume pedal for the dry signal and the signal into the reverb effect. This button is also used to set up Expression Settings (see page 31 for this procedure).

MOMENT Button – Enabling MOMENT changes the functions of the REVERB A and REVERB B footswitches to only allow the reverb effects while the footswitch is pressed down. The reverb effects are bypassed when the footswitch is released. When MOMENT is disabled, the REVERB A and REVERB B footswitches work like normal latching footswitches, toggling between bypass and effect modes with each press and release. *TIP: Use the MOMENT button in conjunction with tails to pinpoint exactly which notes or segments of a phrase receive reverb effects. However, be aware that, by default, holding down the REVERB A or REVERB footswitches while their engines' respective TAILS are on triggers infinite sustain. To toggle infinite capability and save it for an external footswitch, see the Footswitches and LEDs subsection on page 18.*

TAILS Button – When TAILS is enabled, the reverb continues to play after its engine switches to bypass, with the decay time set by the TIME knob. Switching the reverb engine to bypass occurs by either disengaging it with the footswitch, or switching the currently selected reverb engine with the SELECT button. Anything you play after entering bypass will not go through the reverb effect. If the pedal is set for infinite decay (i.e. the TIME knob is set to maximum), the reverb continues until you turn down the TIME knob or switch to a different Reverb Type. When TAILS is disabled, all reverbs stop as soon as their engines are bypassed.

FUNCTION Button – This button selects which set of parameters – primary or alternate -- is controlled by the main knobs and the mini knobs. When FUNCTION is pressed, the button and the two SELECT LEDs will blink concurrently, and all other LEDs and controls on the Oceans 12 will be disabled, to indicate that you are now editing alternate parameters.

For the main knobs, the alternate functions are INF LVL, SEND LVL, LO-FI, and TIDE, respectively. For the mini parameter knobs, these functions are SRS/PRL and A \leftrightarrow B. More details about these alternate knob parameters can be found in the Dual Reverb section on page 28.

The FUNCTION button can also toggle signal splitting, where Reverb A is sent to L/MONO OUT and Reverb B is sent to R/SEND OUT, as illustrated in the diagram below.

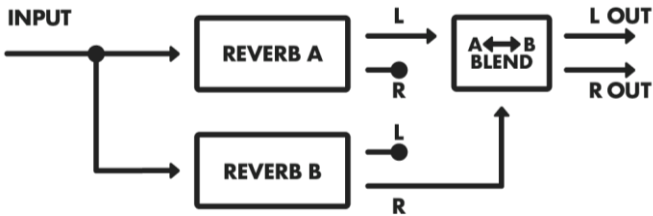

If the FUNCTION button is held down for 2 seconds while the FUNCTION mode is not already on, all of the Oceans 12's blue and green LEDs will start to blink rapidly, indicating that the two signals of the two reverb engines are now being split into L and R outputs. To disable signal-splitting and bring the Oceans 12 back to regular stereo operation, hold down the FUNCTION button when FUNCTION isn't already on. The blue and green LEDs will again start blinking rapidly to indicate that the turn-off procedure has begun. After 2 seconds, signal splitting will be disabled. The on/off status of this routing scheme is remembered even after power-cycling.

Signal splitting is disabled if the SEND/RETURN FX LOOP is on.

- SEND/RETURN FX LOOP -

The Oceans 12 has the ability to create a special, wet, mono FX LOOP either before or after the reverb block. See the following diagram:

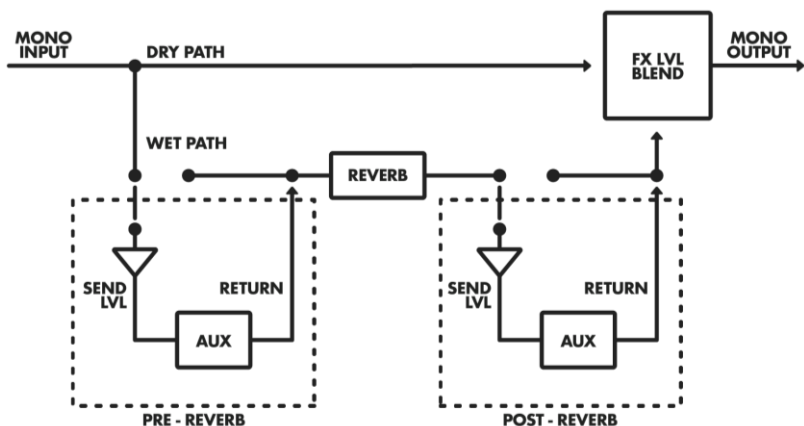

The SEND is output through the R/SEND OUT jack. The return is connected to the R/RETURN IN jack. *Tip: useful for when you'd like an effect in your chain, for example a fuzz or filter, to affect only the reverb tails, i.e. without affecting your dry signal.*

The amount of signal routed to the SEND path is controlled by the SEND LVL, the alternate parameter of the PREDELAY knob. This knob controls the SEND LVL whenever FUNCTION is on. (See page 13 for details on the FUNCTION button). When the knob is turned fully counter-clockwise, the SEND LVL is zero. The SEND LVL increases as the knob is turned clockwise, reaching unity when fully clockwise. *Note: the default value of the SEND LVL is zero. When a SEND/RETURN configuration is active, be sure to adjust the SEND LVL to your desired amount.*

The status of the Send/Return FX loop is always either *pre-reverb*, *post-reverb*, or *OFF* (i.e., regular stereo operation). If the status is either *pre-reverb* or *post-reverb*, the green S/R LED on the bottom-left of the unit (pictured below) will be lit after the pedal is powered up. The Oceans 12 will remember the FX loop status, even after removing power.



To toggle *pre-reverb* SEND/RETURN, power-cycle the Oceans 12 while holding down the FUNCTION button. If the SEND/RETURN status was previously *post-reverb* or *OFF*, it will now be *pre-reverb*. Similarly, if the SEND/RETURN status was previously *pre-reverb*, it will now be turned *OFF*.

To toggle *post-reverb* SEND/RETURN, power-cycle the Oceans 12 while holding down the TAILS button. If the SEND/RETURN status was previously *pre-reverb* or *OFF*, it will now be *post-reverb*. Similarly, if the SEND/RETURN status was previously *post-reverb*, it will now be turned *OFF*.

The SEND LVL is a global parameter that will not be tracked by presets. The configuration (pre vs. post) of the Send/Return as well as its SEND LVL, however, are remembered across power cycles.

Turning on the Send/Return FX Loop also disables the signal-splitting stereo control of the FUNCTION button.

If the configuration of the Send/Return FX Loop is *pre-reverb*, but nothing is inserted into the R/RETURN jack, the FX Loop connection is shorted and the send channel connects directly to the return for regular mono operation.

- MODE BUTTON AND LEDS -

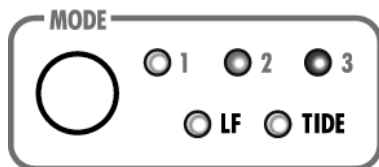

Each Reverb Type on the Oceans 12 has either two or three unique modes of operation. Pressing the MODE button cycles through these available modes. The LED labels 1, 2, or 3 show the current mode. When you switch Reverb Types, the Oceans 12 will recall the last mode you were using in that Reverb Type.

Below the three numbered LEDs are two LEDs labeled LF and TIDE. These two LEDs indicate whether LO-FI and/or TIDE, respectively, are currently on. LO-FI and TIDE are activated and controlled by turning on the FUNCTION button and adjusting the main knobs whose alternate labels are LO-FI and TIDE.

- FOOTSWITCHES AND LEDS -

The Oceans 12 has two footswitches which perform the same functions for their respective reverb engines. The left footswitch controls Reverb A, and the right footswitch controls Reverb B. Each footswitch has the functionalities described below.

Footswitch Functions

BYPASS – The BYPASS functionality of the footswitch works like that of a standard latching footswitch when the MOMENT button is not lit: press and release to toggle between bypass and effect modes. When the center white LED in the Oceans 12 graphic is lit, at least one of the reverb engines is engaged and the unit is in effect mode.

If the MOMENT button is lit, then the selected reverb engine is normally in bypass mode unless you press and hold the footswitch, at which point it goes into effect mode. Release the footswitch and it returns to bypass mode.

TAP – In ECHO reverb, press and release the footswitch two or more times to set the delay time with your foot. The tap time and the current MODE setting determine the actual delay time. After tapping in a delay time, you may cycle through the MODE settings to find the desired delay timing. The blue TAP LED at the bottom left of the Oceans 12 (pictured below) will blink at the selected echo rhythm of your tapped tempo.



INFINITE – If TAILS is on, then press and hold one of the footswitches to ramp up the reverb decay time of the associated reverb engine to infinitely sustain. The white INF LED at the bottom left of the Oceans 12 (pictured above) will blink rapidly to indicate that infinite sustain is engaged. Release the footswitch to ramp back down to the current reverb time. You may continue playing your instrument while the infinite reverb decay is sustaining; the Oceans 12 will apply fresh reverb from the second reverb engine to your new playing, indicated by the rapid blinking of its SELECT and Reverb Type LEDs. While INFINITE is sustaining, you may edit any of the knobs – these control changes will

be applied to the fresh reverb of the second reverb engine, and will be remembered when you switch back to that reverb engine.

You may also use an external footswitch to trigger INFINITE sustain. See page 30 for details on external footswitch functionality.

You can also disable the local footswitches' control of TAP and INFINITE functions. (The functions will still be enabled via external footswitch).

Tip: This is useful if you don't use an external footswitch and you'd like to prevent accidental tempo taps from occurring, or if you'd like to use the footswitches in a held-down capacity (e.g., with MOMENT and TAILS) without triggering the INFINITE sustain.

To disable/enable local footswitch control of TAP and INFINITE:

1. Unplug the Oceans 12 from power.
2. Press and hold the REVERB B footswitch while plugging power back in to the Oceans 12.
3. The BYPASS LED will flash 10 times if tap tempo and infinite are disabled. The LED will flash 2 times if tap tempo and infinite are enabled.
4. If the Oceans 12 is reset to factory defaults (see page 38), the footswitch's tap tempo and infinite functionality will be enabled.

KICKING THE SPRING TANK – In SPRING reverb, if "TAILS" is on (see "Illuminated Buttons" on page 13) in Mode 1 (Fender® 6G15) in either reverb engine, quickly double tap the footswitch to "kick" the emulated spring tank. If an external footswitch is connected to the EXP/FSW jack, then you must use that one instead of the internal one (TAILS must still be on). This will send a loud bouncy jolt through the OCEANS 12, as it would a real spring reverb unit. This action can be performed when using dual reverbs in any configuration (i.e., both series and parallel).

CONNECTIONS

L/MONO INPUT Jack – This ¼" jack is either the mono audio input or the left stereo input to the Oceans 12. In mono, the input impedance is 1MΩ. In stereo, the input impedance is 2MΩ.

R/RETURN INPUT Jack – This is the right input jack in a stereo setup. This input can also be the RETURN signal if using SEND/RETURN mode (see page 15). The input impedance is 2MΩ.

L/MONO OUT Jack – Use this output for a mono setup. In a stereo setup this is your left output. The output impedance is 550Ω.

R/SEND OUT Jack – This is the right output jack in a stereo setup. This output can also be the SEND signal if using SEND/RETURN mode (see page 15). The output impedance is 550Ω.

Combo EXP/FSW Jack – This input jack accepts either an expression pedal or an external footswitch. The Oceans 12 can automatically differentiate which of the two is connected.

EXP – Connect an expression pedal with a TRS plug to this jack to allow external control over any of the Oceans 12's knobs, or use it like a volume pedal on the dry signal before it hits the reverb effects. See page 31 for a description on how to set up and control the Oceans 12 with an external expression pedal.

The polarity of the expression pedal's plug must have the sleeve connected to the heel position (usually GND), Ring connected to the toe position and the Tip connected to the wiper. The nominal expression pedal impedance is 10kΩ though most other values will work fine. Please do not go below 6kΩ on your expression pedal's potentiometer impedance. Some suggested Expression Pedals: EHX Expression Pedal, M-Audio® EX-P, Moog® EP-2 and EP-3, Roland® EV-5 or Boss® FV-500L. Additionally, the EXP IN jack can be connected to a CV source using a TS plug; the acceptable control voltage range is 0V to 5V.

FSW - Connect an external momentary footswitch to this ¼" jack. The external footswitch may be either a single footswitch (TS plug), a dual footswitch (TRS plug), or a triple footswitch (TRS plug) such as the [EHX Triple Foot Controller](#). The external footswitches must be momentary and normally open so that when the switch is pressed down a connection is made between the sleeve and either the tip, ring or both. See page 30 for a description of all functions available on the external footswitches.

9V Power Jack – Plug the output of the Oceans 12's supplied EHX9.6DC 200mA AC adapter to the 9V power jack located at the top of the pedal. The Oceans 12 requires 150mA at 9VDC with a center-negative plug. Do not exceed 10.5VDC on the power jack. *Note: Expect unreliable behavior if the power supply rating is less than 150mA.*

REVERB TYPE AND MINI KNOB DETAILS

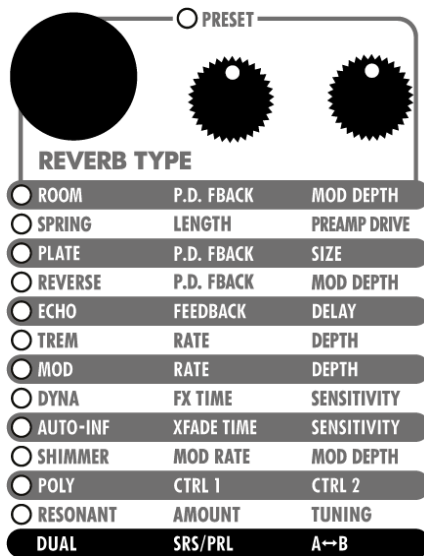

Note: for every Reverb Type, the values of the mini knobs are "sticky": they're remembered for each mode when switching between them. For example, for the ROOM Reverb Type, you can dial in distinct Predelay Feedback and Mod Depth settings for Mode 1 and Mode 2.

ROOM –

MODE: Selects between a lively room reverb from the EHX Cathedral (Mode 1) and the beloved hall reverb algorithm from the EHX Holy Grail (Mode 2).

P.D. FBACK: This knob controls the pre-delay feedback: the amount of signal that is sent from the output of the pre-delay block back to the input of the pre-delay block. With a pre-delay time long enough to hear discrete echoes, turning the P.D. FBACK knob clockwise will cause the pre-delay block to produce multiple echoes from one note. Each echo then goes into the reverb block producing multiple reverb washes from one note.

MOD DEPTH: Use this knob to add modulation to the room or hall reverb. As you turn clockwise, the modulation gets wider. Set to fully counterclockwise for no modulation.

SPRING –

MODE: Selects between our new renowned Fender® 6G15 emulation (Mode 1) and the classic spring reverb algorithm from the Holy Grail (Mode 2).

LENGTH: This knob selects spring length. The knob travel is divided into thirds, with each third selecting successively longer springs as the knob is turned clockwise. The middle third is standard length for both the Fender® 6G15 length and the original Holy Grail emulation.

PREAMP DRIVE: This knob controls a subtle amount of preamp drive before the reverb circuit. More drive is applied as you turn clockwise. Fully counterclockwise is no drive.

PLATE –

MODE: Plate type. Mode 1 is EHX's original plate from the Holy Grail. Mode 2 is a "dark plate", a tonally warmer version of the original plate.

P.D. FBACK: This knob controls the Pre-delay Feedback: the amount of signal that is sent from the output of the pre-delay block back to the input of the pre-delay block. With a pre-delay time long enough to hear discrete echoes, turning the P.D. FBACK knob clockwise will cause the pre-delay block to produce multiple echoes from one note. Each echo then goes into the reverb block producing multiple reverb washes from one note.

SIZE: Scale the size of the emulated metal plate with this knob to color the diffusion of the reverb tail. As you turn clockwise, the plate size gets larger. (The original Holy Grail plate size is located at noon.)

REVERSE –

MODE: Mode 1 is the reverse-simulating effect found on the EHX Oceans 11 and Cathedral, while Mode 2 is a reverse echo inspired by the Reverse delay mode of the EHX Grand Canyon.

P.D. FBACK: This knob controls the Pre-delay Feedback: the amount of signal that is sent from the output of the pre-delay block back to the input of the pre-delay block. With a pre-delay time long enough to hear discrete echoes, turning the P.D. FBACK knob clockwise will cause the pre-delay block to produce multiple echoes from one note. Each echo then goes into the reverb block producing multiple reverb washes from one note.

MOD DEPTH: Use this knob to add modulation to the output. As you turn clockwise, the modulation gets wider. Turn fully counterclockwise for no modulation.

ECHO –

MODE: Cycles through the tempo subdivisions of the current echo time: quarter-note (Mode 1), dotted-eighth-note (Mode 2), and eighth-note (Mode 3).

FEEDBACK: Controls the number of repeats of the delayed signal. As this knob is turned clockwise, the number of repeats increases.

DELAY: Controls the delay time of the echoes. Turn this knob clockwise to increase the delay time. Delay time ranges from 5 milliseconds to 1 second.

TREM –

MODE: Cycles through three LFO wave shapes: triangle (Mode 1), square (Mode 2), and sine (Mode 3).

RATE: Sets the rate of the amplitude LFO, from 1Hz at fully counter-clockwise to 256Hz at fully clockwise.

DEPTH: Sets the depth of the amplitude LFO. Turn this knob clockwise to increase the depth, and counter-clockwise to decrease it.

MOD –

MODE: Cycles through three different modulations. In Mode 1, a chorus is applied to the reverb. In Mode 2, flanging is applied to achieve a classic EHX flerb. In Mode 3, the chorus and flerb from your settings in Mode 1 and Mode 2, respectively, are mixed together and applied to the reverb.

RATE: Sets the rate of the modulation. In Mode 3, RATE sets the blend amount between chorus (fully counter-clockwise) and flerb (fully clockwise).

DEPTH: Sets the depth or intensity of the modulation. In Mode 3, DEPTH doesn't control anything.

DYNA –

MODE: The mode button cycles through three dynamic algorithms with non-linear outputs.

- In Mode 1, a swell algorithm is selected that suppresses note attacks and fades-in their reverb tails. TIME behaves normally and controls the reverb decay.
- In Mode 2, a noise gate is selected that opens the reverb sound for only louder notes. TIME controls the length of time the gate stays open once it's been triggered.

- In Mode 3, a ducking algorithm is applied which reduces the volume of the reverb while notes are being played. TIME behaves normally and controls the reverb decay.

FX TIME: Sets the main time-based parameter of the effect.

- For Swell (Mode 1), this is the swell time. As FX TIME turns clockwise, the length of the swell will increase.
- For Noise Gate (Mode 2), this is the release time. As FX TIME turns clockwise, the gate takes a longer time to close, making the transition more smoothly. *Note: The hold time of the Gate is controlled by the TIME knob (see Summary Chart on page 10).*
- For Ducking (Mode 3), FX TIME controls the release time of the volume suppression. As it is turned clockwise, the release time increases, which more smoothly ramps the volume of the suppressed signal back to its regular level.

SENSITIVITY: For Swell mode (Mode 1), this mini knob is not applicable. For Noise Gate (Mode 2) and Ducking (Mode 3), this controls the sensitivity of the volume-detection algorithms; as SENSITIVITY is turned clockwise, the noise gate and ducking effects are more easily triggered.

AUTO-INF –

MODE: Mode 1 is the original Auto-Inf from the Oceans 11. Mode 2 applies chorus to the reverbs, and Mode 3 applies flange to the reverbs (flerb). In Modes 1 and 2, the rate and depth of the chorus and flerb are fixed to light, tasteful values, i.e. they cannot be edited.

XFADE TIME: Controls the time it takes to crossfade between subsequent reverb washes. Longer crossfade times are achieved by turning this knob clockwise.

SENSITIVITY: Controls the sensitivity of the detection trigger. Turning this knob clockwise makes AUTO-INF more sensitive and more likely to trigger a new reverb wash with quieter notes.

SHIMMER –

MODE: Mode 1 is classic shimmer from the Oceans 11. Mode 2 is a variation on Mode 1 in which the position of the pitch-shifting block in the signal chain is altered, producing a slightly different style of shimmer.

MOD RATE: Controls the modulation rate, from 0 Hz to 8 Hz.

MOD DEPTH: Controls the modulation depth.

POLY –

MODE: The mode button cycles through two sets of controls for the mini knobs CTRL 1 and CTRL 2. In mode 1, POLY reverb is in Interval Edit mode. In mode 2, POLY Reverb is in Mix Edit mode. See the mini knob details below for descriptions of their functions.

CTRL 1: In Interval Edit mode (Mode 1), this knob controls the semitone shift interval of the first pitch shifter. At noon, there's no shift. As you turn counter-clockwise, the shift decreases to -1 octave at its minimum. As you turn clockwise, the shift increases to +1 octave at its maximum.

In Mix Edit mode (Mode 2), this knob controls the volume balance of the unshifted and shifted signals before they enter the reverb. A fully counter-clockwise knob corresponds to a fully unshifted mix, while a fully clockwise knob corresponds to a mix of only the shifted signals.

CTRL 2: In Interval Edit mode (Mode 1), this knob controls the semitone shift interval of the second pitch shifter, over the same range.

In Mix Edit mode (Mode 2), this knob controls the volume balance of the two shifted signals. At noon, there's an equal-power mix of the two pitch shifters. The counter-clockwise extreme of the knob mixes 100% of the first pitch shifter and 0% of the second pitch shifter output, while the clockwise extreme mixes the opposite: 0% of the first pitch shifter and 100% of the second pitch shifter.

RESONANT –

MODE: Selects between two new resonant algorithms. Mode 1 inserts pentatonically-tuned resonators in the reverb signal chain, allowing notes to ring when their fundamentals and harmonics excite the pitches of the resonators. Mode 2 applies resonant filtering with configurable gain and center-frequency to the reverb algorithm, gradually collapsing the reverb tail into a focused, narrow frequency band.

AMOUNT: Controls the degree of the effect. In Mode 1, this knob sets the volume of the tuned resonators. As AMOUNT is turned clockwise, the ringing pitches get louder. In Mode 2, the AMOUNT knob sets the feedback of the resonant filter. As AMOUNT is turned clockwise, the filtered reverb tail builds more quickly, eventually achieving unstable self-oscillation.

TUNING: Controls the tuning of the resonance effects. In Mode 1, this knob selects the key of the resonators. When fully counter-clockwise, the TUNING knob selects an A5 (880Hz) minor pentatonic scale. Turning the knob clockwise increases the key in increments of

semitones until reaching G#6 (1661Hz) minor pentatonic at fully clockwise. In Mode 2, this knob selects the center frequency of the resonant filter. As TUNING is turned clockwise, the center frequency gets higher.

DUAL REVERB

When the illuminated FUNCTION button is blinking, the two mini knobs change their function to provide alternate controls over the dual reverb configuration. See the Dual Reverb section on page 28 for more details.

SRS/PRL: Series or parallel – selects whether the dual reverbs are arranged in a series or parallel configuration. In series, the output of the first reverb engine feeds into the input of the second reverb engine. In parallel, the outputs of both reverb engines are summed.

To arrange the dual reverbs in SERIES, turn this knob fully counter-clockwise. To arrange them in PARALLEL, turn this knob fully clockwise.

A←→B: Selects the order (for SERIES) or the mix balance (for PARALLEL) of the two reverb engines.

In SERIES, if this knob is turned to the counter-clockwise half, it arranges the reverb engines as A first, B second (A→B). If this knob is turned to the clockwise half, the reverb engines are arranged as B first then A second (B→A).

In PARALLEL, this knob mixes the outputs of the two reverb engines. At noon or halfway, the mix is 100% reverb A added with 100% reverb B. As the knob is turned counter-clockwise, the volume of reverb B decreases, until when fully-clockwise the mix is 100% reverb A and 0% reverb B. Vice versa as the knob is turned clockwise past noon.

DUAL REVERB

The Oceans 12 is a dual stereo reverb, meaning it offers two, simultaneous, independent stereo reverbs: **Reverb A** and **Reverb B**. Engaging both of them unleashes the dual reverb functionality of the Oceans 12.

Turning on the dual reverbs is simply a matter of turning on each reverb engine with its respective footswitch. When both are on, both of the SELECT LEDs (pictured below) will be lit, with one of them slowly blinking to indicate which one is currently selected for editing.

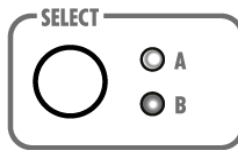

DUAL CONFIGURATIONS

When both of the reverb engines are engaged, their configuration is always either SERIES or PARALLEL. These configurations are illustrated in the diagrams below.

In SERIES, the two reverb engines are cascaded such that one processes your instrument first before sending it to the other. The wet mix of the first reverb engine is sent to the input of the second reverb engine. The output of the second one then becomes the output of the Oceans 12:

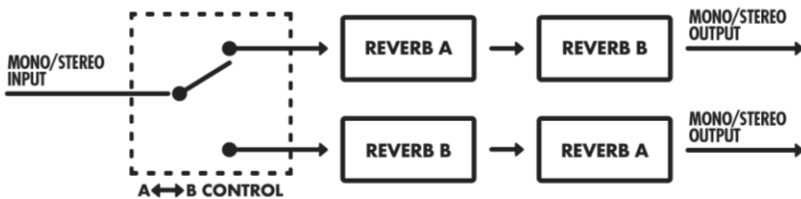

In PARALLEL, the two reverb engines individually process your instrument audio, then their outputs are mixed:

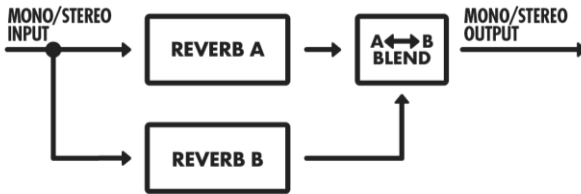

The factory default configuration is PARALLEL. You can select which configuration is active with the mini knobs after turning on the illuminated FUNCTION button. On the Oceans 12, the teal-highlighted bottom row of the Reverb Type table is labeled DUAL. When the FUNCTION button is lit, the two mini knobs change their function to these teal-highlighted alternate parameters, labeled SRS/PRL and A↔B.

SRS/PRL: To arrange the dual reverbs in SERIES, turn this knob fully counter-clockwise. To arrange them in PARALLEL, turn this knob fully clockwise. The order of the reverbs in SERIES, and their mix balance in PARALLEL, is determined by the other Mini Knob, explained below.

A↔B: In SERIES, this knob selects the order of the two reverb engines. If the knob is turned to the counter-clockwise half, then Reverb A is first and its output goes to the input of Reverb B. If the knob is turned to the clockwise half, then Reverb B is first and its output goes to the input of Reverb A.

If the dual configuration is PARALLEL, this knob controls the mix balance of the outputs of the two reverb engines. At noon, the mix is 100% Reverb A and 100% Reverb B. When this knob turns counter-clockwise past noon, the Reverb B mix decreases towards 0% at minimum. Likewise, turning clockwise past noon reduces the Reverb A mix towards 0% at maximum.

EXTERNAL FOOTSWITCH FUNCTIONALITY

The Oceans 12 accepts a single momentary footswitch (with TS plug) or a double or triple footswitch (with TRS plug) at its EXP/FSW jack. After inserting a footswitch, the Oceans 12 should rapidly blink the A/B SELECT, INF, and TAP LEDs for one second. If, instead, the EXP MODE button is blinking, the Oceans 12 mistakenly thinks an expression pedal is inserted, so re-insert the footswitch until you observe the correct confirmation. The following chart describes the functions for each footswitch depending on the current engine selection of the Oceans 12. When using a single momentary footswitch, the "TIP SWITCH" functions are available.

CURRENTLY-SELECTED REVERB ENGINE	TIP SWITCH / SINGLE FSW	RING SWITCH	TIP+RING SWITCH
A	SELECT change to Reverb B	TAP and INF for Reverb A	TAP and INF for Reverb B
B	SELECT change to Reverb A	TAP and INF for Reverb A	TAP and INF for Reverb B

When an external footswitch is connected, it overrides the TAP and INFINITE ability on the local footswitches. External triple footswitches can trigger infinite sustain regardless of TAILS status.

EXPRESSION PEDAL USE AND SETUP

The Oceans 12 accepts an expression pedal with TRS plug or control voltage (CV) on a TS plug at its EXP/FSW jack. After inserting an expression pedal, the Oceans 12 should rapidly blink the illuminated EXP MODE button for one second. If, instead, other LEDs are rapidly blinking, the Oceans 12 mistakenly thinks a footswitch is inserted, so re-insert the expression pedal until you observe the correct confirmation. Please see page 20 for specifications on acceptable expression pedals and voltage range for the Oceans 12. An expression pedal has one function when the EXP MODE Button is off, and a different one when the button is on.

EXP MODE Button Off – When the EXP MODE button is not lit, the expression pedal works like a volume pedal placed before the Oceans 12. The expression pedal controls the level of both the signal going into the reverb effects block and the level of the dry signal, generating expressive, swelling reverb effects. When the EXP MODE button is not lit, any Expression Settings (see next page) are disabled.

EXP MODE Button On – When the EXP MODE button is lit, the Oceans 12's Expression Settings are enabled. You can create an expression setting for each Reverb Type where you assign the knobs you want to sweep and customize each knob's range and direction. Any parameters that are assigned to the expression pedal will be taken over and the current knob positions will be ignored. After you create an expression setting for a particular Reverb Type it remains in memory until you change it again, even if you remove power. In addition, when you save a preset, the current Expression Setting for that Reverb Type is also saved.

Note: if the EXP MODE button is turned on while no expression pedal is connected, any parameters controlled by the expression pedal will be set to the saved toe position of the Expression Setting.

EXP for Complex Reverb Types – Take care when using an Expression pedal in some Reverb Types, like DYNA and POLY, which have different algorithms and controls for each mode. The expression pedal controls *knob* movement, not *parameter* movement, so its affected parameters may change depending on the current mode. For example, in mode 1 of POLY reverb, the parameters of the mini knobs CTRL 1 and CTRL 2 are the two pitch shifts. Let's say you assign an expression setting to CTRL 1, allowing you to sweep through the shift of Pitch 1. If you then switch to mode 2, the expression pedal will sweep through the Dry/Shifted mix, because this is what CTRL 1 affects in mode 2.

Factory Default Expression Settings (for both Reverb A and B)

Reverb Type	Default Expression Pedal Control (EXP MODE = On)
Room	Wet FX Level
Spring	Reverb time
Plate	Wet FX level
Reverse	Modulation depth
Echo	Feedback
Trem	Rate
Mod	Wet FX level
Dyna	Wet FX level
Auto-Inf	Reverb time
Shimmer	Wet FX level
Poly	Control 1
Resonant	Amount

CREATING CUSTOM EXPRESSION SETTINGS

Your Oceans 12 comes set up from the factory with some useful Expression Settings for each Reverb Type, but you might want to create your own. Here's how to create custom Expression Settings:

1. Turn the REVERB TYPE knob to select the Reverb Type for which you want to create a custom Expression Setting.
2. Press and hold the EXP MODE button. After one second, the other illuminated buttons (such as TAILS) will blink. *Note: The FUNCTION button will be made unavailable while creating custom Expression Settings*
3. Once the other buttons stop blinking, release the EXP MODE button. EXP MODE will now be blinking.
4. Set any of the Oceans 12's six knobs to the position you want them to have at the expression pedal's heel position. If you do not want a knob to be swept by the expression pedal, do not move it at this point. *Note: the only knobs that cannot be controlled by an expression pedal are REVERB TYPE, and the alternate FUNCTION parameters (INF LVL, SEND LVL, LO-FI, TIDE, SRS/PRL, and A ← → B).*
5. Press and release the EXP MODE button to save the heel settings. EXP MODE blinks rapidly now.
6. Set the six knobs to the positions you want them to have at the expression pedal's toe down setting. Again, if you do not want a knob to be swept by the expression pedal, do not turn it.
7. While setting the knobs for toe-down position, you can move the expression pedal to hear how the Expression Setting will sound.
8. You can go backwards to set the heel-down position again by pressing & holding EXP MODE for 2 seconds.

9. Once you have set the knobs for the toe-down position, press and release the EXP MODE button to save the toe settings.
10. The EXP MODE button will light solid and your custom Expression Setting for the currently selected Reverb Type is now saved and ready to use. It will remain saved even after powering down the pedal.
11. Repeat these steps if you want to update the Expression Setting.
12. Press and release the REVERB TYPE knob at any time to cancel out of Expression Setting setup without saving.

ERASING CUSTOM EXPRESSION SETTINGS

1. Turn the REVERB TYPE knob to select the Reverb Type for which you want to restore the factory default Expression Setting.
2. Press and hold the EXP MODE button. After one second, the other illuminated buttons (such as TAILS) will blink.
3. While the other buttons are still blinking, tap the footswitch of the reverb engine on which the custom expression setting is saved.
4. The other illuminated buttons will stop blinking. The Expression Setting is now restored to the factory default. You can now release the EXP MODE button.

TAP TEMPO ON THE OCEANS 12

For ECHO reverb, the Oceans 12's echo time can be set with tap tempo using either of the built-in footswitches or by using an external momentary switch. With either method, you can achieve three different echo times all in sync with your tap tempo using the MODE button. Pressing MODE while in ECHO reverb cycles through the three subdivision options, each indicated by the numbered LEDs in the MODE section. When a tapped tempo is in use, the TAP LED (pictured below), located above the Reverb A footswitch, blinks at a rate equal to the current echo time.



USING THE INTERNAL FOOTSWITCHES

1. The Oceans 12 must be set to ECHO reverb for its bypass footswitches to act as a tap tempo.
2. Press and release the footswitch which belongs to the currently-selected reverb engine at least two times at a steady tempo.
3. The delay time will be set to your tapping speed, divided by the current tap divide setting.
4. The MODE setting can be changed after tapping in the delay time to access different delay times.
5. The TAP LED above the Reverb A footswitch blinks at the rate of the current delay time.

USING AN EXTERNAL FOOTSWITCH FOR TAP TEMPO

An external momentary footswitch may be used to set tap tempo for ECHO reverb. The external switch must be a double or triple button unit with TRS plug. The external switch needs to be normally open. Upon engaging the switch, it should create a short circuit between the Tip and Sleeve of the plug to be used for tap tempo. Follow these instructions to tap in the delay time with an external footswitch:

1. Connect an external momentary footswitch to the Oceans 12's EXP/FSW jack.
2. The Oceans 12 should rapidly blink the SELECT, INF, and TAP LEDs for 1 second to indicate it has determined that an external footswitch was connected. If, instead, the EXP MODE button blinks, the Oceans

12 is mistaking your footswitch for an expression pedal. Re-insert the external footswitch jack until you get the correct LED confirmation.

3. Select ECHO reverb on the desired reverb engine. Tap the corresponding connection (RING for Reverb A, TIP+RING for Reverb B) of the external footswitch at least two times at a steady tempo. The delay time will be set to your tapping speed, divided by the Tap Divide setting selected the MODE button.
4. The TAP LED blinks at the rate of the current echo time on the current reverb engine.

PRESET USE AND SETUP

The Oceans 12 can save and recall one preset per Reverb Type for both Reverb A and Reverb B. Each preset saves all current knob settings (including all alternate FUNCTION knobs, except DUAL and FX LOOP parameters), the current expression settings, tap tempo if in Echo reverb, the mode button status, and all illuminated button settings (except FUNCTION).

SAVING PRESETS TO A REVERB TYPE

1. Use the SELECT button to select the reverb engine for which you'd like to save a preset.
2. Turn the REVERB TYPE knob to the specific Reverb Type that you want to save to.
3. Set up the sound you want to save.
4. Press and hold the REVERB TYPE knob for two seconds.
5. You will soon see the PRESET LED blink rapidly. Continue to hold down REVERB TYPE until the PRESET LED stops blinking.
6. The preset is now saved. You can release the REVERB TYPE knob.

RECALLING PRESETS USING THE REVERB TYPE KNOB

1. Use the SELECT button to select the desired reverb engine.
2. Turn the REVERB TYPE knob to the Reverb Type that you want to recall.
3. Press and release the REVERB TYPE knob. The PRESET LED lights indicating the preset has been loaded.
4. Once a preset is loaded and the PRESET LED is lit, changing to other Reverb Types automatically recalls their presets. To disable presets, see the section on the following page entitled UNLOADING PRESETS.

CHANGING PARAMETERS AFTER RECALLING PRESETS

Normally the PRESET LED lights solid after loading a preset. If you turn a knob or press a non-FUNCTION button in the top row the PRESET LED blinks to indicate that a preset is loaded but has been altered. *Note: SEND LVL and L/R SPLIT are global parameters and are NOT saved/recalled with presets.*

RELOADING ALTERED PRESETS

In the situation where a preset has been altered and therefore the PRESET LED is blinking, press and release the REVERB TYPE knob to recall the preset for the current Reverb Type.

SAVING ALTERED PRESETS

If you would like to save an altered preset to the current Reverb Type, press and hold the REVERB TYPE knob for about 2.5 seconds. Release once the PRESET LED stops blinking and is lit solid. *Note: altered Expression Settings are automatically saved to presets. See below.*

UNLOADING PRESETS

To unload a preset and return to What You See Is What You Get mode (WYSIWYG):

1. Ensure the PRESET LED is lit solid
2. Press and release the REVERB TYPE knob.
3. The PRESET LED shuts off and you are in WYSIWYG mode.

SAVING EXPRESSION PEDAL SETTINGS TO PRESETS

If the EXP MODE button is on when a preset is saved, the current Expression Setting will be saved to that Reverb Type's preset. The EXP MODE button will be saved in the on state.

If a new custom Expression Setting is created while a preset has been loaded (the PRESET LED is lit), the new setting will be automatically saved to the preset. The PRESET LED will blink at the end of the Expression Setting creation procedure to indicate that the new setting has been saved to the preset. *Note: if an expression pedal setting is created and saved while the preset is loaded, any other unsaved control alterations will be lost. Make sure to save any desired knob alterations to the preset before updating the preset's Expression Setting.*

RESTORING FACTORY SETTINGS

To restore the Oceans 12 to factory default settings, press and hold the REVERB TYPE knob while plugging power into the Oceans 12.

1. Unplug the power supply from the Oceans 12.
2. Press and hold the REVERB TYPE knob while plugging power back in to the Oceans 12.
3. The PRESET LED will flash 10 times. You can release the REVERB TYPE knob once you see this LED flashing.
4. When the knob is released, the following factory default settings will be restored:
 - All presets will be erased and restored to their factory default settings.
 - All custom Expression Mode settings will be erased and restored to the factory default Expression Mode settings.
 - The tap tempo functionality for ECHO reverb and the hold-for-infinite-sustain functionality of both footswitches will be enabled
 - Normal stereo operation will be restored by disabling SEND/RETURN and disabling signal splitting.
 - The alternate knob parameter INF LVL will be set to unity volume, while the alternate knob parameters LO-FI and TIDE will be turned off.
 - The Oceans 12 will start up in Reverb Engine A, with ROOM Reverb Type selected in Mode 1. Reverb Engine B will be set to REVERSE Reverb Type in Mode 1.

COMPLIANCE

Note: *This equipment has been tested and found to comply with the limits for a Class B digital device, pursuant to part 15 of the FCC Rules. These limits are designed to provide reasonable protection against harmful interference in a residential installation. This equipment generates, uses and can radiate radio frequency energy and, if not installed and used in accordance with the instructions, may cause harmful interference to radio communications. However, there is no guarantee that interference will not occur in a particular installation. If this equipment does cause harmful interference to radio or television reception, which can be determined by turning the equipment off and on, the user is encouraged to try to correct the interference by one or more of the following measures:*

- *Reorient or relocate the receiving antenna.*
- *Increase the separation between the equipment and receiver.*
- *Connect the equipment into an outlet on a circuit different from that to which the receiver is connected.*
- *Consult the dealer or an experienced radio/TV technician for help.*

Modifications not expressly approved by the manufacturer could void the user's authority to operate the equipment under FCC rules.



The CE logo indicates that this product has been tested and shown to conform with all applicable European Conformity directives.

WARRANTY INFORMATION

Please register online at <http://www.ehx.com/product-registration> or complete and return the enclosed warranty card within 10 days of purchase. Electro-Harmonix will repair or replace, at its discretion, a product that fails to operate due to defects in materials or workmanship for a period of one year from date of purchase. This applies only to original purchasers who have bought their product from an authorized Electro-Harmonix retailer. Repaired or replaced units will then be warranted for the unexpired portion of the original warranty term.

If you should need to return your unit for service within the warranty period, please contact the appropriate office listed below. Customers outside the regions listed below, please contact EHX Customer Service for information on warranty repairs at info@ehx.com or +1-718-937-8300. USA and Canadian customers: please obtain a **Return Authorization Number (RA#)** from EHX Customer Service before returning your product. Include—with your returned unit—a written description of the problem as well as your name, address, telephone number, e-mail address, RA# and a copy of your receipt clearly showing the purchase date.

United States and Canada

EHX CUSTOMER SERVICE
ELECTRO-HARMONIX
c/o NEW SENSOR CORP.
55-01 2ND STREET
LONG ISLAND CITY, NY 11101

Tel: 718-937-8300
Email: info@ehx.com

Europe

JOHN WILLIAMS
ELECTRO-HARMONIX UK
13 CWMDONKIN TERRACE
SWANSEA SA2 0RQ
UNITED KINGDOM

Tel: +44 179 247 3258
Email: electroharmonixuk@virginmedia.com

To hear demos on all EHX pedals visit us on the web at **www.ehx.com**
Email us at **info@ehx.com**