

EasyStand[®] Bantam medium



Owner's Manual

Please ensure the Owner's Manual stays with the unit at all times.

SYMBOL LEGEND



CAUTION/ATTENTION



**ENVIRONMENTAL
CONDITIONS**



TYPE BF APPLIED PART



DATE OF MANUFACTURE



PINCHPOINT



SEE INSTRUCTIONS FOR USE

SN

SERIAL NUMBER

R_xonly



Please be environmentally responsible and recycle this product through your recycling facility at its end of life.

Afin de préserver l'environnement, veuillez confier ce produit à votre centre de recyclage à la fin de sa durée de vie.

Nachdem dieses Produkt ausgedient hat, entsorgen Sie es bitte auf umweltfreundliche Weise, indem Sie es zu der entsprechenden Recyclingstelle bringen.

Wees a.u.b. milieubewust en recycleer dit product via uw recycleerder na het verstrijken van de levensduur.

Sea responsable con respecto al medio ambiente y recicle este producto al finalizar su vida útil en el lugar de reciclaje correspondiente.

Siate responsabili verso l'ambiente e riciclate questo prodotto, al termine della sua vita d'uso, presso la vostra sede di riciclaggio.

Kierrätä tämä tuote sen käyttöiän lopussa ympäristövastuullisella tavalla paikallisella kierrätyslaitoksella.

Var miljömedveten och återvinn denna produkt efter dess användning.

Vi ber deg ta hensyn til miljøet og resyklere dette produktet ved hjelp av de rette resyklingsfasilitetene når produktet ikke lenger kan brukes.

Vis venligst hensyn til miljøet ved at levere produktet til det nærmeste genbrugsanlæg, når det ikke længere fungerer.

Por favor, assumo responsabilidade ambiental, reciclando este produto em suas instalações de reciclagem no final de sua vida útil.

Table of Contents

Introduction	1
Safety Precautions	2
Assembly	3
Adjustments & Usage	18
Pow'r Up Lift Option Usage	25
Options & Parts Detail	30
Maintenance	31
Limited Warranty	32

Date Purchased _____ Serial # _____

Introduction

Congratulations on your purchase of the EasyStand Bantam Medium standing frame! We at Altimate Medical have designed the EasyStand Bantam Medium with your comfort and happiness in mind.

EasyStand Description

The EasyStand line of products is intended for individuals who are able to transfer independently or with assistance from a caregiver and/or lifting device. It is a useful tool for rehabilitation, home, school, and work use. EasyStand standing frames support the user from sitting to the standing position. Various options such as support, choice of manual or Pow'r Up Lift may be added to facilitate individual needs.

Indications for Use

The EasyStand Bantam Medium is intended to assist individuals who have difficulty rising from a seating position to a standing position and is indicated for individuals weighing up to 200lbs.

This manual is an integral part of your standing system and should be read completely and thoroughly by anyone that will be operating the unit. This will ensure the EasyStand Bantam Medium is assembled properly and used in the most beneficial manner.

The EasyStand Bantam Medium should always be used with a qualified adult attendant present. Should any problem arise that you cannot solve by reading this manual, please contact your local supplier or call Altimate Medical, Inc., at 800-342-8968 or 507-697-6393.

It is necessary to inspect your EasyStand Bantam Medium at least weekly to ensure it is in safe operating condition. EasyStand adjustments that are listed in the product owner's manual can be made by the operator by following the instructions for use. After an adjustment is made, inspect the EasyStand to ensure all hardware and adjustable components are properly secured per the instructions for use. Replacement of worn parts, major adjustments, or any other important corrections should be handled by an authorized supplier or service center. Only Altimate Medical, Inc., approved replacement parts should be used to ensure safety and performance.

Do not use the EasyStand Bantam Medium without consulting your physician. Failure to consult a qualified physician prior to using the EasyStand Bantam Medium could lead to severe medical problems. We recommend a good standing program be established and supervised by a qualified physician or physical therapist. R_x only

Join the Standing Community!

Our goal is simple - to empower people with disabilities to stand up for their health. Connect, share, and learn from other people with disabilities, special needs parents, clinical professionals, and the experts in standing on one of our social networking communities.

Read, share, and comment on the EasyStand Blog at blog.easystand.com

Find EasyStand on these social networking sites:



Safety Precautions

- Please read and understand all safety precautions and user instructions prior to use. Call Altimate Medical at 800-342-8968 or 507-697-6393 with any questions or for additional information.
- If a user does not meet the specifications below and has not been properly fitted by a qualified therapist or physician, Altimate Medical, Inc., does not recommend using the EasyStand Bantam Medium.

Bantam Medium- is designed to accommodate most individuals from 48" - 66" (122-168 cm) and up to 200 lbs. (91 kg).

For more detailed specifications visit our website www.easystand.com

- The EasyStand Bantam Medium should not be used without first consulting a qualified physician. Failure to consult a qualified physician prior to using the EasyStand Bantam Medium could lead to severe medical problems. We recommend a good standing program be established and supervised by a qualified, registered physical therapist.
- The EasyStand Bantam Medium should always be used with a qualified adult attendant present. Never leave a child unattended in the Bantam Medium.
- Do not make adjustments to the Bantam Medium while a child is standing. **Exception: If you ordered the supine option refer to pages 17-18. Changes in position must be performed or supervised by a qualified caregiver or medical professional.**
- It is necessary to inspect your EasyStand Bantam Medium at least weekly to ensure it is in safe operating condition. Pay particular attention for loose hardware. If your EasyStand is equipped with the optional Pow'r Up lift please inspect the electrical cables for any wear and ensure they are attached properly. Replacement of worn parts, major adjustments, or any other important corrections should be handled by an authorized dealer or service center. Only Altimate Medical, Inc. approved replacement parts should be used to ensure safety and performance.
- If your EasyStand is being used in the home environment, please inspect your unit prior to each use to ensure there is no damage or unexpected wear to the EasyStand that may have been caused unintentionally by pets, pests or children.
- Never reposition the footplates while you are in the standing position. Consult with your therapist or physician for proper foot placement and angle.
- Never elevate the legs or adjust the backrest to anterior tilt using the following arm adjustment. Only the supine option may be used to elevate the legrest with simultaneous recline of the backrest.
- Ensure the necessary support and alignment options are in position prior to placing the user into the standing position.
- If the unit was exposed to temperatures of less than 50°F (23.5°C), the unit must warm to room temperature before use.
- **Operating Conditions:** Temperature: 41°F -104°F (5°C-40°C), Relative humidity: 20% - 90% at 86°F (30°C), Atmospheric Pressure: 700 to 1060hPa.
- **Storage/Transport Conditions:** Temperature: 14°F -122°F (-10°C - 50°C), Relative humidity: 20% - 90% at 86°F (30°C), Atmospheric Pressure: 700 to 1060hPa.
- The EasyStand can be used at a maximum altitude of 3,050 meters (10,000 feet).
- The expected service life of an EasyStand is considered 5 years under normal use conditions. Note: This may vary based on frequency of use.
- Standing equipment is designed for indoor use on level surfaces only. Keep casters locked while in use.
- It is not recommended to transport the unit with a user in the standing position.
- Extreme movements laterally or front to back may cause the unit to tip.
- It is recommended the equipment be stored at normal room temperature and humidity levels.
- Altimate Medical products are specifically designed to be used with Altimate Medical accessories and options. Unless otherwise noted, accessories and options from other manufacturers have not been tested by Altimate Medical and are not recommended for use with Altimate Medical products.
- Product Modifications made without express written consent (including, but not limited to, modification through the use of unauthorized parts or attachments) are not recommended and will void the product warranty.
- The EasyStand Bantam Medium Electric Lift meets the requirements of IEC 60601-1 and 60601-2. *

 **Caution:** This equipment is designed to accommodate a range of users; therefore the unit has various adjustment slots and holes. Avoid placing fingers or other body parts in any of these areas.

 **Caution:** While in use this equipment has various moving parts, familiarize yourself with the unit and avoid placing hands or fingers near any of these areas.

 **Caution:** Advise bystanders to keep clear of the unit while in use.

* *Bantam Medium Pow'r Up Lift Option Only*

Assembly

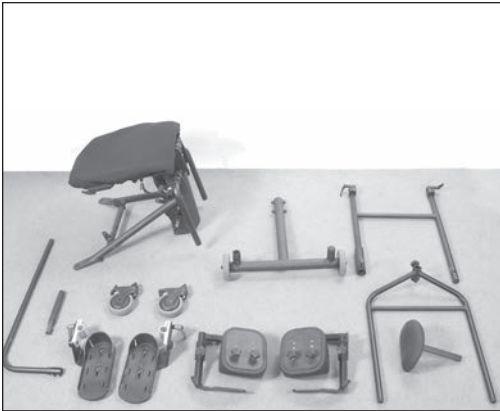

1. The base model consists of the front frame, no-tray assembly, pump handle, seat assembly, knee pads and foot plates.

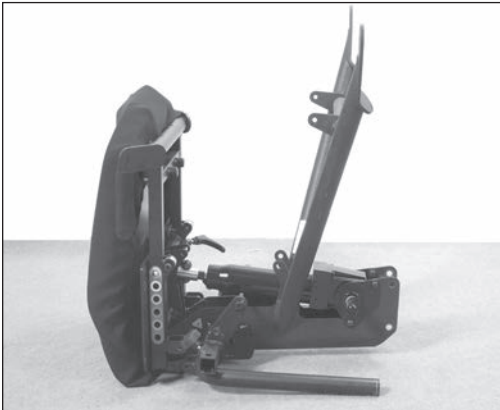

2. Position the unit as shown to install the casters.

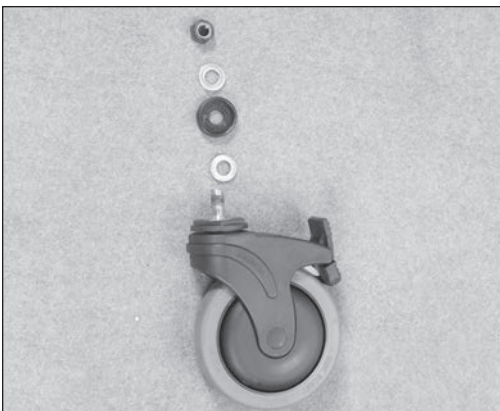

3. Remove the hardware on both casters and set out as shown. This is how the hardware will be assembled. The casters are supplied with a locking compound pre-applied to the threaded stem. Do not remove this material, it is important to prevent the casters from loosening over time.

4. Place metal washer onto the stud of the caster.



5A. Place the caster onto the unit as shown.

5B. Place the black cupped washer onto the caster stud.

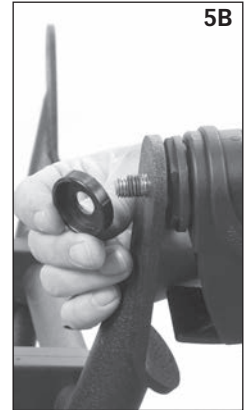

6. Place the second metal washer into the black washer on the caster stud.

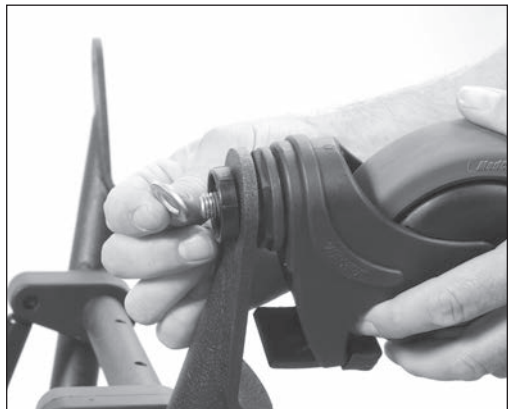



7A. Place the lock nut onto the caster stud and tighten securely using provided wrench.

7B. Place black cap onto the unit to cover hardware.

Repeat these steps for installation of the other rear caster.



8. Place the unit as shown, if the Back option was **NOT** ordered, skip to step #23.

Place the back as shown and place the following arms as shown.



9. Remove the screw from both of the following arms and set the screws aside. You will need these later.

10. Turn the knobs all the way loose, flip the grey tab of the knobs to the open position on both following arms.

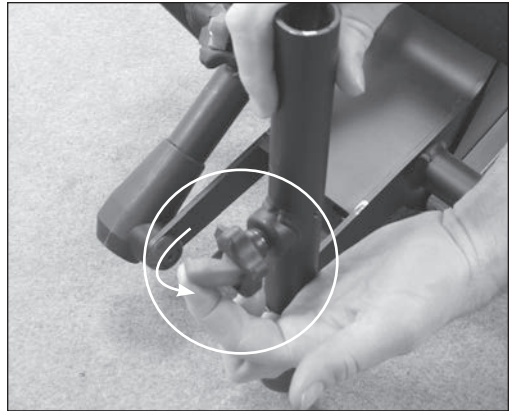

11. Insert both following arms onto the unit until the yellow color setting is reached on both following arms.



12. Place the screws back onto each following arm making sure the following arms remains in the yellow setting and both tubes are lined up. Tighten securely. Flip the grey tabs closed and tighten knobs securely.





13. Remove the two covers on the hip pivot of the back. There are three small bolts to remove on each cover. Set covers and bolts aside, these will be needed later.

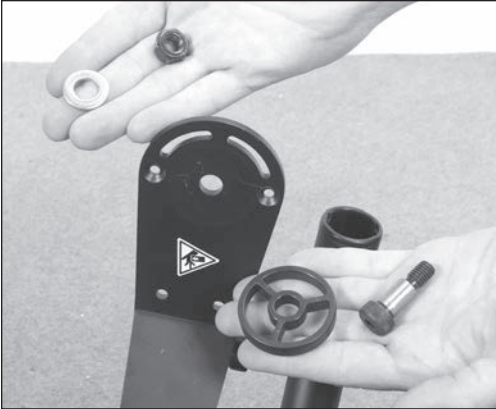

14. Remove the bolt, plastic washer, metal washer, and nut from each side of the unit.

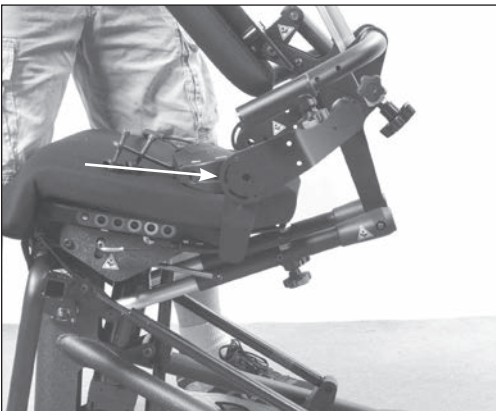

15. Position the back in the slot on the seat as shown.

16. Line up the holes and place the plastic washer between the back and the slot on the seat, insert bolt from the inside of the unit. Do the same on the other side.



17. Place the metal washer and lock nut onto the bolt.



18. Using an allen wrench and the wrench from the toolkit, tighten the bolt and lock nut **snug**. **Do not overtighten.**

Repeat steps for the other side of the unit.



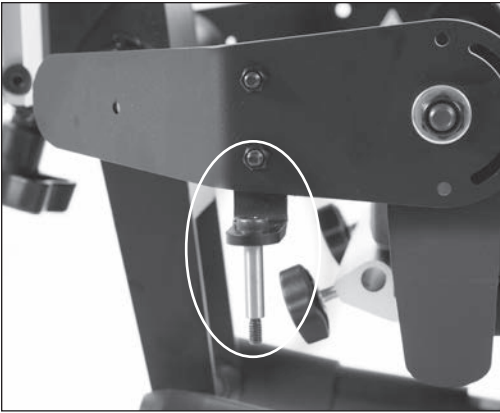

19. If the Pow'r Up Lift option was ordered, insert bolt onto the bracket on the side of the unit.

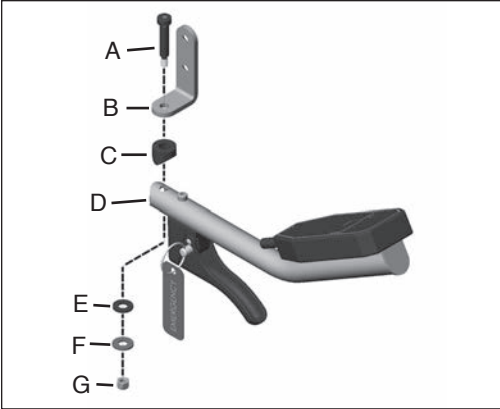

20. Install the controller by assembling as shown.

- A-Bolt
- B-Bracket
- C-Coved Washer
- D-Controller
- E-Plastic Washer
- F-Metal Washer
- G-Nut



21. Place the cover back onto the unit making sure the EasyStand label is not upside down.

22. Replace the top bolt and the bolt on the backside and tighten securely, the third bolt will be installed later.



23. Lock casters, with assistance, position unit as shown.



24. Remove all 4 bolts from the front wheel assembly. With the openings on the bottom of the frame facing down, place the wheel assembly into the seat assembly.



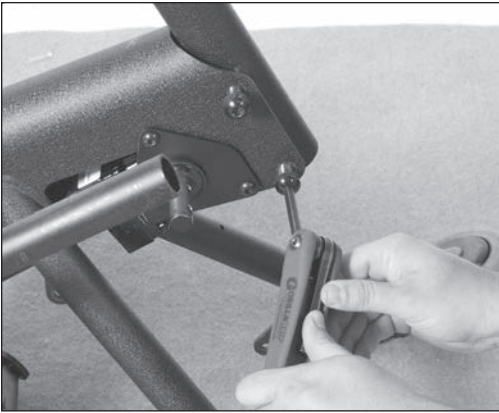

25. Insert all 4 bolts into the base and wheel assembly, make sure to start all 4 bolts, then tighten securely.



26. Place both foot plates on the unit, with the red handle to the outside of the unit.



27. If the Front Swivel Casters were ordered, place the caster assembly onto the wheel assembly facing up as shown. Insert the bolt into the assembly, place nut onto bolt and tighten securely. Do the same for the other side.

28. Place the unit back on to its wheels, remove the nuts from the Supine controller bracket.



29. Place the controller and hardware onto the unit. **Do not twist cables when installing controller.**



30. Place nuts onto the bolts and tighten securely. For controller usage see pg. 19.

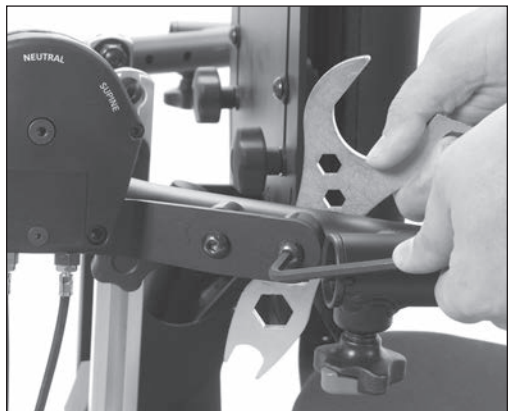



31. If the optional Shadow Tray was ordered, loosen the ratchet handles on the side of the tray, flip the arms up and tighten the ratchet handles. Lock the casters, then insert the two tray arms into the tray bracket on the bottom of the tray as shown. (for information on Shadow Tray adjustments see pg. 22).

⚠ Caution: After placing the tray into position, ensure the ratchet handles on the side of the tray are tightened securely.



32. If a Shadow Tray was ordered, skip to step #40.

If the Swing-Away front was ordered, make sure the tube insert is in place as shown.

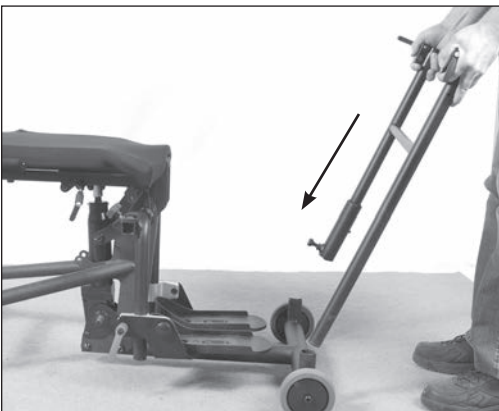

33. Place the H-frame into the slots as shown, with the ratchet handles facing away.

34. Make sure the swivel collar is placed onto the tube insert. Place the collar onto the frame until the plunger locks into place. The plunger handle needs to be pulled out to lock into place.



35. If no tray was ordered, skip to step #37. Place the tray upside down, remove the knob and nut from both tray slides and set aside. Place the tray bracket onto the bolts with the shorter ends of the bracket facing the chest pad.



36. Place the knobs onto each bolt on the longer end of the bracket and tighten snug. Place the nut onto each bolt and tighten until the thread is exposed.



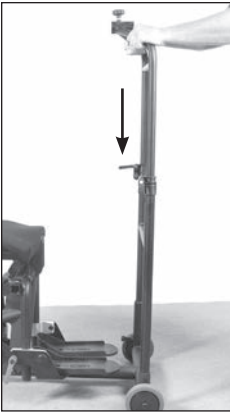

37. Place the no tray/tray assembly bracket into the H-Frame.



38. Depress the spring button to allow the bracket to slide into the H-frame (A). Once the clamp is cleared, the spring button needs to be depressed again and allow the tray to slide into position (B).

Note: There is only one spring button. The spring button will stop in the max. height position. Tighten knobs securely once the tray height is in the desired position.



39. For the No-Tray Option, insert chest pad bracket and tighten securely.

40. If a Head Support was ordered, loosen the knob and insert Head Support, tighten securely.



41. Insert each knee pad assembly into the tube along the seat post. Depress the spring button to allow the bracket to slide into place, advance until the spring button locks into place. Tighten knobs securely. For Swing-Away knees, place into the tube, and tighten knob securely.



42. Remove knobs (bolts on standard knees) from the knee pads, place the knee pads on the bracket with the larger end of the pad to the outside and the seam side down. Place into desired position and tighten securely.



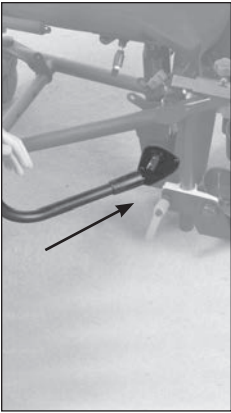

43. Attach the pump handle to the pump on the seat assembly with bolts and nuts. Remove the nuts and bolts from the pump handle. Insert the handle onto the pump. Line up holes and insert bolts, place nuts onto bolts. Tighten securely.

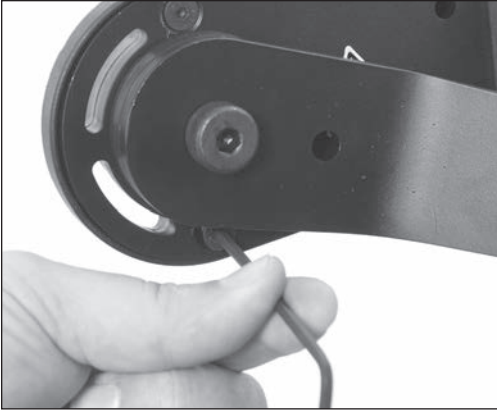

41. Pump the unit up until you have access to the third bolt on the hip pivot cover, insert bolt and tighten securely.

Adjustments & Usage

Read *all instructions* thoroughly before beginning any adjustments.

Seat Depth Adjustment

1. Prior to adjusting seat depth, make sure the Controller is in the "Sit-to-Stand" position. The seat should be lowered to a seated position for easiest adjustment.

2. Loosen the clamp lever on the outer right side of the seat tube frame underneath the seat. One full turn should be sufficient.

3. With one hand supporting the back (if equipped) depress the spring button on the outer left side of the seat tube underneath the seat. Using the back as a lever, move the seat depth to the desired setting, noting the color. If the seat depth does not move freely, check the seat upholstery at the front of the seat to ensure it can slide freely with the telescoping seat surface, you may need to release it from the velcro. Velcro is used to attach it to the front on the unit.

Re-tighten the clamp lever at this time. If the unit is not equipped with a back, the adjustment is complete. Otherwise continue.

4A & B. To adjust the following arms, loosen each knob all the way. With one hand supporting the back assembly flip the grey plunger lever in the center of each knob fully open and "clicks". Then continue to loosen the knob until resistance is felt. DO NOT continue to turn the knob counterclockwise. Forcing the knob past its stop will damage the mechanism.

⚠ Caution: Make sure to have one hand supporting the back assembly, flipping the grey plunger lever will cause the back assembly to fall back.

Using the back as a lever, adjust the following arms so that the color of the seat depth decal are matched in the indicator window on the following arms (indicator window as shown).

Release the grey plunger levers to re-engage the locking plungers in the clamp knobs. You may need to partially tighten the knobs and slightly move the back assembly to allow the locking pins to engage their "home" positions. Fully close the grey plunger levers and tighten the knobs securely.

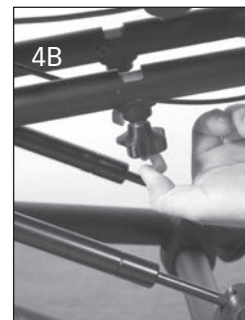

Controller Usage

Designed with ease of use and the safety and comfort of the user in mind, the Controller as shown is the single point of operation for the supine option.

5. The Controller has 3 positions, Sit-to-Stand, Neutral, and Supine.

6. There is a spring loaded safety collar (red colored) which prevents inadvertent switching between modes. It must be lifted upward into the shift knob before the mode can be changed.

Sit-to-Stand Mode

7. With the Controller in Sit-to-Stand mode, the stander functions conventionally, with the footrest carrier remaining stationary, always perpendicular to the floor. The seat raises and lowers, hinged at the knee and at the hip, with the backrest remaining approximately perpendicular to the floor, keeping the patients' torso in an upright posture throughout the range of movement.

Important: All seat depth and following arm adjustments should be made with the Controller in the Sit-to-Stand mode.



Controller Usage

Neutral Mode

8. By lifting the safety collar and rotating the shift knob into Neutral position, the footrest carrier and backrest (which are linked through the following arms) now enjoy freedom of movement. Rapid or unexpected movement is prevented by means of 2 hydraulic dampers for the safety of the user and the attendant. These dampers require no maintenance or adjustment.

9. The footrest, for the safety of the user, cannot exceed parallel with the seat, nor can knee flexion exceed the lower leg being perpendicular to the floor. With the seat parallel to the floor, the stander may be adjusted into a fully supine position. If the stander is already in the fully standing position, switching to neutral will have no functional effect until the seat begins to lower.

⚠ Caution: If the back angle adjustment has been reclined prior to switching into Neutral mode, the amount of recline will remain relative to its previous adjustment. For example, if the back is adjusted to 10 degrees reclined while the patient is seated, the backrest will be 10 degrees BELOW parallel with the seat if the unit is placed in full supine. For the comfort and safety of the patient, the operator or attendant must be fully aware of back angle adjustment and should confirm "same color" settings on the seat depth and following arm BEFORE switching to Neutral or Supine modes.



Controller Usage

Supine Mode

⚠ Caution: A properly fitted and adjusted headrest **MUST** be used with the supine option.

The Bantam Medium with Supine Option functions both as a sit-to-stand stander and a supine stander. It may be safely switched between modes at will, without removing the user from the stander.

⚠ Caution: Do not make back angle adjustments while in supine mode.

The swing-away front will need to be swung out of the way to reach a full supine position.

10. Rotating the shift knob to Supine position locks the footrest carrier, seat, and backrest to each other, and will maintain that relationship throughout the possible range of elevation. The now-locked platform may be raised and lowered as necessary by means of the hydraulic pump or Pow'r Up option, however equipped.

11. While accommodating the patient in the Supine mode in less than a fully extended position, it must be noted that the overall range of elevation will be decreased by the inverse amount. That is to say, the footrest carrier will never be allowed to move rearward PAST perpendicular to the floor. For Example - If the Supine mode is locked at a position in which the tibia is flexed 20 degrees to the femur, the locked supine platform may not be elevated past a point in which the seat is 20 degrees less than vertical and the footrest carrier perpendicular to the floor. Damage to the unit may result if you attempt to exceed these mechanical limits.

⚠ Caution: The locking mechanisms used in the supine option have very high holding power. By familiarity of the feel of the hydraulic pump or the sound of the electric actuator under load in the Pow'r Up option, depending on how the unit is equipped, the operator may be easily aware of the mechanical limits being reached with the supine option. If too great a load is placed on these mechanical locks, damage may result in either the locks or in the frame of the stander. Your warranty does not cover damage from misuse of the product.



Shadow Tray Adjustment

12. To adjust tray depth, loosen each knob as shown all the way loose. Then flip the grey plunger lever in the center of each knob fully open until it “clicks”. Continue to loosen the knob until resistance is felt. DO NOT continue to turn the knob counterclockwise. Forcing the knob past its stop will damage the mechanism.

The tray may now be removed completely, or adjusted to the desired position using the click detent positions as a guide.

13. Release the grey plunger levers to re-engage the locking plungers in the clamp knobs. You may need to partially tighten the knobs and slightly move the tray back and forth to allow the locking pins to engage their “home” positions. Fully close the grey plunger levers and tighten the knobs to secure the tray.

14. To adjust tray angle, loosen one lever clamp approximately 2 turns at either side of the tray where the extension tubes are attached, as shown. Support the tray with one hand before fully loosening the second lever clamp.

15. Move the tray surface to the desired angle and re-tighten both lever clamps securely.

⚠ Caution: Extra care should be exercised if the tray is adjusted with a patient seated in the unit to ensure they are being supported by a chest vest, chest strap or similar supportive device. Lateral guides by themselves, even models with an anterior inward curve, should not be relied upon for frontal support.

⚠ Caution: Never adjust or remove the tray while the patient is standing or in a partially standing position.



Shadow Tray Adjustment

16. To adjust the tray height, loosen both knobs on the back of the unit and set to desired position. Tighten knobs securely.



Back Option Adjustment

17. To adjust the back angle, adjust the knob to the desired position.



Lateral Support Adjustment

18. The lateral supports are optional and can be removed for transferring. The lateral support width can be adjusted by loosening the knobs on the back of the unit. Always tighten securely.

The lateral supports have a number of attachment holes on the back of the pad which will allow for additional positions vertically and horizontally. The pads may also be bolted on at a straight, 90°, 180°, or 270° position.



Please check for fit and interference by bringing the unit to the full standing position and back to sitting again without a user seated in the unit. Due to the variety of adjustments that can be made the pads may not work properly in all settings or configurations.

Hip Support Adjustment

19. The hip supports are optional and can be removed for transferring. The hip support width can be adjusted by loosening the knobs underneath the seat. Loosen the knob on the side of the unit to adjust the hip support width. Always tighten securely.



The hip supports have a number of attachment holes on the back of the pad which will allow for additional positions vertically and horizontally. The pads may also be bolted on at a straight, 90°, 180°, or 270° position.

Please check for fit and interference by bringing the unit to the full standing position and back to sitting again without a user seated in the unit. Due to the variety of adjustments that can be made the pads may not work properly in all settings or configurations.

Head Support Adjustment

20. To adjust the head support height, loosen the knob on the back of the back option, move to desired position and tighten securely.

21A. To adjust the head support depth, loosen the knob on the back of the headrest and slide into desired position, tighten securely.

21B. To adjust the head support angle, loosen the ratchet handle and place into desired position. Tighten securely.

Foot plate Adjustment

22. Adjust the foot plate by loosening the red ratchet handle on the foot plate, up or down and to the desired angle, tighten securely. Foot plates maybe be inverted for increased range.

Knee pad Adjustment

23. To adjust the knee pads, loosen the knobs and move into position. Tighten securely once desired position is complete. The standard knee pads have depth and pad rotation adjustments only. The Swing Away Knee pads swing out of the way by depressing the red button, they also have width and height adjustments.

⚠ Caution: Make knee pad adjustments while the user is in the seated position only.

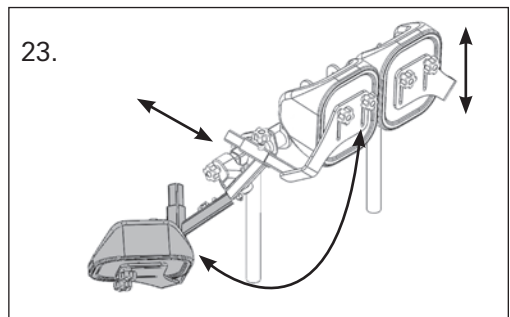
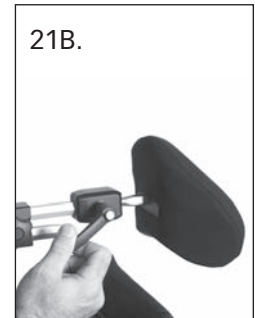

Pow'r Up Lift Option Usage

Charging the Battery

The EasyStand Bantam Medium Pow'r Up Lift uses two 12-volt sealed lead batteries rated at 2.9 amps each. An EasyStand Bantam Medium can be lifted approximately 100 times on one full battery charge. An audible alarm will sound when the battery is low. Please charge the battery after the alarm sounds. A battery needing to be fully recharged will take approximately 8 hours. The EasyStand Bantam Medium can be raised to the standing position while being charged. The function of the charger is to detect a full battery and then provide a constant potential power supply to hold the battery at a full condition without overcharging. When the battery EMF rises to a factory preset point, the charger circuit will not allow the peak output voltage to exceed that value. This factory setting protects a battery from excessive depletion of electrolyte, which can occur from overcharging. The charger can be found in the tool pouch on the back of the unit.

CAUTION: Use only the Linak charger, model numbers 00CH01-XX OR 10CH01S-00, provided by Altimate Medical with the Pow'r Up option.

1. Plug the receptacle into a wall outlet. The light on the charger will be green indicating an open circuit.
2. **FIG. A-** Plug the charger cord into the side of the hand control. The light on the charger will turn yellow indicating the batteries are being charged.
3. **FIG. B-** The unit will arrive unplugged from the battery, plug in the white cord that supplies power to the actuator and the black cord that supplies power to the remote. The black cord has a notch on it to orient the connector properly. Fully charge battery before use.
Note: The white cord has a rubber washer on it, which makes it very sticky and sometimes will not get pushed in completely, make sure to push the cord all the way into the battery.
4. When the batteries are charged, the light on the charger will turn green.
5. Fully charge the batteries every three months or less during periods of intermittent or non-use.

CAUTION: The Bantam Medium Pow'r Up Option is not designed for continuous use. Duty Cycle 5% Max, 1 min. / 19 min.

Raising the Lift - Press the UP (arrow up) button on the hand control to lift the seat.

Lowering the Lift - Press the DOWN (arrow down) button on the hand control to lower the seat.

CAUTION: Ensure the cables are attached properly per the instructions for use. Do not allow the cables to drag on the floor or to catch on objects.

FIG. A

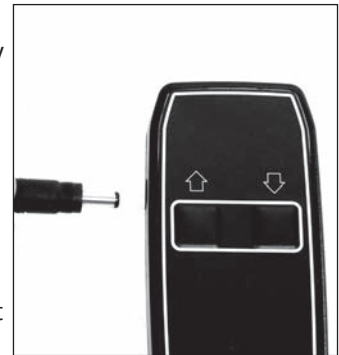

The hand pendant is a Type BF applied part.

FIG. B

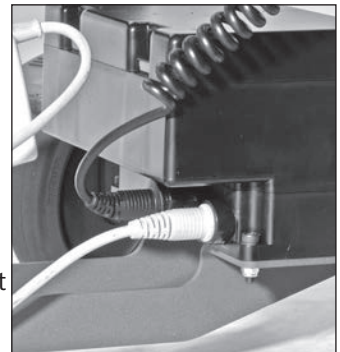

Activating the Mechanical Emergency Release

CAUTION: Using the emergency mechanical release as the primary means of returning to the seated position can cause damage to the unit. Only use the mechanical release in emergency situations.

All Altimate Medical electric lift products are equipped with a mechanical release to be used in emergency situations.

FIG. C-The release allows the user to be lowered to a seated position in the unlikely occurrence of the battery losing charge while the user is in a standing position. The actuator only retracts if the release is pulled and there is weight on the seat. The release is located on the left side of the seat and is signified by a red tag with the word "EMERGENCY."

1. To activate the emergency mechanical release pull out the quick release pin located underneath the seat.
2. Squeeze the handle and if necessary, push down on the handle.



FIG. C

Battery Replacement

The batteries are enclosed in the control box of the Pow'r Up Lift (the black box where the cords are plugged in). Once the batteries have reached their end of life and need to be replaced, do not open the control box; please contact Altimate Medical Customer Service or your medical equipment dealer for information about purchasing a replacement control box. It is recommended that the batteries be replaced every four years.

Please contact a local recycling authority for information about disposing of the old batteries.

IP Rating

The IP rating is a classification system indicating the protection degree from dust, water and impact for electrical equipment and enclosures. Pow'r Up Lift components are rated at IP21. The definition for IP21 is as follows:

First character definition: 2 - Protected against solid foreign objects of 12.5mm diameter and greater.

Second character definition: 1 - Protected against vertically falling water drops.

Electromagnetic compatibility

Pow'r Up Option components have been designed and tested to meet the applicable EMC requirements. It is unlikely that you will encounter problems with your EasyStand due to inadequate electromagnetic compatibility. However, if you notice any unusual (such as intermittent) behavior of your Pow'r Up option and the EasyStand is being used next to possible interfering equipment such as mobile phones, microwaves, or radio broadcast masts, this could be an indication of electromagnetic interference. If such behavior occurs, use the mechanical release to lower the unit to the seated position and move the EasyStand away from the interfering equipment. Please report any instance of possible electromagnetic interference to AMI's Customer Service Department.

Guidance and Manufacturer's Declaration - Electromagnetic Emissions

The EasyStand Bantam Medium is intended for use in the electromagnetic environment specified below. The customer or the user of the EasyStand Bantam Medium should assure that it is used in such an environment.

Emissions Test	Compliance	Electromagnetic Environment - Guidance
RF emissions CISPR 11	Group 1	The EasyStand Bantam Medium uses RF energy only for its internal function. Therefore, its RF emissions are very low and are not likely to cause any interference in nearby electronic equipment. The EasyStand Bantam Medium is suitable for use in all establishments, including domestic establishments and those directly connected to the public low-voltage power supply network that supplies buildings used for domestic purposes.
RF emissions CISPR 11	Class B	
Harmonic emissions IEC 61000-3-2	Class A	
Voltage fluctuations/ Flicker emissions IEC 61000-3-3	Complies	

Guidance and Manufacturer's Declaration - Electromagnetic Immunity

The EasyStand Bantam Medium is intended for use in the electromagnetic environment specified below. The customer or the user of the EasyStand Bantam Medium should assure that it is used in such an environment.

Immunity Test	IEC 60601 Test Level	Compliance Level	Electromagnetic Environment - Guidance
Electrostatic Discharge (ESD) IEC 61000-4-2	± 6 kV contact ± 8 kV air	± 6 kV contact ± 8 kV air	Floors should be wood, concrete, or ceramic tile. If floors are covered with synthetic material, the relative humidity should be at least 30 %.
Electrical Fast Transient/Burst IEC 61000-4-4	± 2 kV for power supply lines ± 1 kV for input/output lines	± 2 kV for power supply lines ± 1 kV for input/output lines	Mains power quality should be that of a typical commercial or hospital environment.
Surge IEC 61000-4-5	± 1 kV line(s) to line(s) ± 2 kV line(s) to earth	± 1 kV line(s) to line(s) ± 2 kV line(s) to earth	Mains power quality should be that of a typical commercial or hospital environment.
Voltage dips, short interruptions and voltage variations on power supply input lines IEC 61000-4-11	<5 % U_T (>95 % dip in U_T) for 0,5 cycle 40 % U_T (60 % dip in U_T) for 5 cycles 70 % U_T (30 % dip in U_T) for 25 cycles <5 % U_T (>95 % dip in U_T) for 5 s	<5 % U_T (>95 % dip in U_T) for 0,5 cycle 40 % U_T (60 % dip in U_T) for 5 cycles 70 % U_T (30 % dip in U_T) for 25 cycles <5 % U_T (>95 % dip in U_T) for 5 s	Mains power quality should be that of a typical commercial or hospital environment. If the user of the EasyStand Bantam Medium requires continued operation during power mains interruptions, it is recommended that the EasyStand Bantam Medium be powered from an uninterruptible power supply or a battery.
Power frequency (50/60 Hz) magnetic field IEC 61000-4-8	3 A/m	3 A/m	Power frequency magnetic fields should be at levels characteristic of a typical location in a typical commercial or hospital environment.

NOTE: U_T is the a.c. mains voltage prior to application of the test level.

Guidance and Manufacturer's Declaration - Electromagnetic Immunity

The EasyStand Bantam Medium is intended for use in the electromagnetic environment specified below. The customer or the user of the EasyStand Bantam Medium should assure that it is used in such an environment.

Immunity Test	IEC 60601 Test Level	Compliance Level	Electromagnetic Environment - Guidance
<p>Conducted RF IEC 61000-4-6</p> <p>Radiated RF IEC 61000-4-3</p>	<p>3 Vrms 150 kHz to 80 MHz</p> <p>3 V/m 80 MHz to 2.5 GHz</p>	<p>3 Vrms</p> <p>3 V/m</p>	<p>Portable and mobile RF communications equipment should be used no closer to any part of the EasyStand Bantam Medium, including cables, than the recommended separation distance calculated from the equation applicable to the frequency of the transmitter.</p> <p>Recommended separation distance</p> $d = 1.2 \sqrt{P}$ $d = 1.2 \sqrt{P} \text{ 80 MHz to 800 MHz}$ $d = 2.3 \sqrt{P} \text{ 800 MHz to 2.5 GHz}$ <p>Where P is the maximum output power rating of the transmitter in watts (W) according to the transmitter manufacturer and d is the recommended separation distance in meters (m).</p> <p>Field strengths from fixed RF transmitters, as determined by an electromagnetic site survey^a, should be less than the compliance level in each frequency range.^b</p> <p>Interference may occur in the vicinity of equipment marked with the following symbol:</p> <div style="text-align: center;">  </div>

NOTE 1: At 80 MHz and 800 MHz, the higher frequency range applies.

NOTE 2: These guidelines may not apply in all situations. Electromagnetic propagation is affected by absorption and reflection from structures, objects, and people.

^a Field strengths from fixed transmitters, such as base stations for radio (cellular/cordless) telephones and land mobile radios, amateur radio, AM and FM radio broadcast and TV broadcast cannot be predicted theoretically with accuracy. To assess the electromagnetic environment due to fixed RF transmitters, an electromagnetic site survey should be considered. If the measured field strength in the location in which the EasyStand Bantam Medium is used exceeds the applicable RF compliance level above, the EasyStand Bantam Medium should be observed to verify normal operation. If abnormal performance is observed, additional measures may be necessary, such as re-orienting or relocating the EasyStand Bantam Medium.

^b Over the frequency range 150 kHz to 80 MHz, field strengths should be less than 3 V/m.

Recommended separation distances between portable and mobile RF communications equipment and the EasyStand Bantam Medium

The EasyStand Bantam Medium is intended for use in an electromagnetic environment in which radiated RF disturbances are controlled. The customer or the user of the EasyStand Bantam Medium can help prevent electromagnetic interference by maintaining a minimum distance between portable and mobile RF communications equipment (transmitters) and the EasyStand Bantam Medium as recommended below, according to the maximum output power of the communications equipment.

Rated maximum output power of transmitter W	Separation distance according to frequency of transmitter m		
	150 kHz to 80 MHz $d = 1.2 \sqrt{P}$	80 MHz to 800 MHz $d = 1.2 \sqrt{P}$	800 MHz to 2.5 GHz $d = 2.3 \sqrt{P}$
0.01	.12	.12	.23
0.1	.38	.38	.73
1	1.2	1.2	2.3
10	3.8	3.8	7.3
100	12	12	23

For transmitters rated at a maximum output power not listed above, the recommended separation distance d in meters (m) can be estimated using the equation applicable to the frequency of the transmitter, where P is the maximum output power rating of the transmitter in watts (W) according to the transmitter manufacturer.

NOTE 1: At 80 MHz and 800 MHz, the higher frequency range applies.

NOTE 2: These guidelines may not apply in all situations. Electromagnetic propagation is affected by absorption and reflection from structures, objects, and people.

Options & Parts Detail

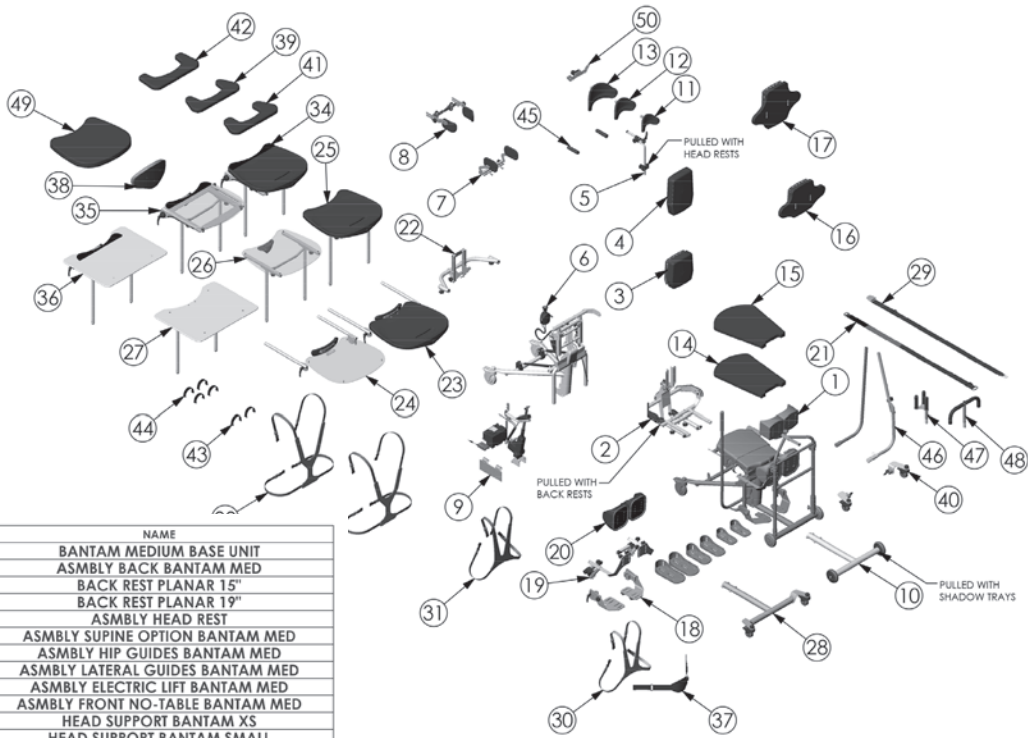

ITEM NO.	PART NO.	QTY.	NAME
1	Y5500	1	BANTAM MEDIUM BASE UNIT
2	Y5528	1	ASMBLY BACK BANTAM MED
3	Y5530	1	BACK REST PLANAR 15"
4	Y5532	1	BACK REST PLANAR 19"
5	Y5548	1	ASMBLY HEAD REST
6	Y5554	1	ASMBLY SUPINE OPTION BANTAM MED
7	Y5560	1	ASMBLY HIP GUIDES BANTAM MED
8	Y5562	1	ASMBLY LATERAL GUIDES BANTAM MED
9	Y5564	1	ASMBLY ELECTRIC LIFT BANTAM MED
10	Y5566	1	ASMBLY FRONT NO-TABLE BANTAM MED
11	T30062	1	HEAD SUPPORT BANTAM XS
12	T30065	1	HEAD SUPPORT BANTAM SMALL
13	NG30299	1	HEAD SUPPORT EVOLV LARGE
14	Y5570	1	ASMBLY SEAT CONTOUR NARROW
15	Y5572	1	ASMBLY SEAT CONTOUR WIDE
16	Y5574	1	ASMBLY BACK CONTOURED 15"
17	Y5576	1	ASMBLY BACK CONTOURED 19"
18	Y5586	1	ASMBLY FOOT MULTI-ADJ LARGE
19	Y5596	1	ASSEMBLY KNEES SWING AWAY
20	Y5600	1	ASSEMBLY KNEE PADS ROHO
21	Y3008	1	STRAP CHEST/ LAP BANTAM MEDIUM
22	Y5602	1	ASMBLY TABLE MULTI-ADJUSTABLE
23	Y5604	1	ASSEMBLY TRAY STANDARD
24	Y5606	1	ASSEMBLY TRAY CLEAR
25	Y5608	1	ASMBLY TRAY H-FRAME STANDARD
26	Y5610	1	ASMBLY TRAY H-FRAME CLEAR
27	Y5612	1	ASMBLY TRAY H-FRAME OVERSIZED
28	Y5568	1	SWIVEL FRONT BANTAM MED
29	Y3014	1	POSITIONING BELT W/BUCKLE MED
30	NG30170	1	X-STYLE CHEST VEST MEDIUM
31	NG30056	1	LARGE CHEST VEST EVOLV
32	NG30171	1	Y-STYLE CHEST VEST MEDIUM
33	NG30021	1	VEST CHEST Y SHAPE ASSEMBLY LARGE
34	Y5614	1	ASMBLY TRAY H-FRAME TILT STANDARD
35	Y5616	1	ASMBLY TRAY H-FRAME TILT CLEAR
36	Y5618	1	ASMBLY TRAY H-FRAME TILT OVERSIZED
37	Y5620	1	ASMBLY CHEST STRAP WITH PAD
38	NG30000	1	PAD FRONT EXTRA SUPPORT
39	T50160	1	ASSEMBLY ELBOW PAD SM
40	T50170	1	H-FRAME BANTAM SWIVEL WHEEL
41	T50156	1	ASSEMBLY ELBOW PAD XS
42	Y5582	1	ASSEMBLY ELBOW PAD 13"
43	Y5636	1	ASMBLY FOOT STRAP MED BANTAM
44	Y5638	1	ASMBLY FOOT STRAP SECURE MED BANTAM
45	NG50040	1	HANDLE PUSH ASSEMBLY
46	Y5632	1	HANDLE PUMP REMOVEABLE/ADJ MED
47	NG50044	1	QUAD GRIP OPTION
48	NG50070	1	ACTUATOR HANDLE EXTENSION EVOLV LG
49	NG30295	1	PADDED TRAY COVER
50	Y5634	1	ASMBLY CHEST VEST BRKT HIGH MOUNT

Maintenance

Cleaning/Disinfecting

- Clean the EasyStand with a mild, non-abrasive disinfectant or soap and water.
- Check the EasyStand at least weekly to ensure all nuts, bolts and adjustable parts are tightened securely, failure to do so may result in parts falling off which may cause a choking hazard for children.
- Do not use bleach or any other bleach-based cleaners on the EasyStand.
- Disinfecting wipes are safe to use on metal and non-porous surfaces.
- Use a damp sponge with mild soap or a mild, non-abrasive disinfectant.
- Spot clean Neoprene with mild soap and water.
- Neoprene covers may be removed and hand washed with water. Air dry the covers. Always use care when removing and replacing the covers.
- Do not dry clean any upholstery items.
- If the EasyStand is being used with one user, clean the EasyStand on a monthly basis or as needed.
- If the EasyStand is being used in a multiple-user environment, the EasyStand should be cleaned after each use.

Urethane Coated Fabrics (Dartex or generic equivalent)

- The recommended cleaning and disinfection instructions should be followed whenever possible to avoid damage to the PU membrane which could lead to premature failure of the cover.
- For superficial dirt, use a disposable wipe and a warm solution of neutral detergent. Do not use abrasive cleaners.
- Disinfect using a 0.1% sodium hypochlorite solution (1000ppmm chlorine), stronger bleach solutions not recommended.
- Thoroughly rinse any remaining cleaning solution with water and dry fabric before re-use or storage.
- Do not iron.

Hydraulic Actuator Maintenance

- An initial break-in period of approximately 50-100 full cycles is normal for the hydraulic unit. The very close fit of its mating parts gives each pump its own break-in "feel" and signature sound, signaled by a squeaking or a less-than-smooth stroke.
- If the pump is leaking oil or not holding properly contact your local EasyStand Supplier for a replacement.
- Do not exert excessive force on the pump handle or use the pump handle to move an EasyStand. This may cause damage to the pump handle and/or the pump mechanism and will void any warranty.
- User maintenance is not required or recommended on the hydraulic pump. Never apply lubricant, household oil, grease, or a similar product to any part of the unit. Some compounds may react with the seals used in the manufacture of this product. This may damage the unit and will void any warranty.
- Do not exceed the rated weight limit.
- If the EasyStand was shipped and exposed to a temperature of less than 50 degrees Fahrenheit, the hydraulic unit must warm to room temperature before use. Failure to follow this step could damage the unit and render it inoperable.
- Once the standing position is reached, the pump may settle back one stroke, this is normal.
- It is not always necessary to push the pump handle all the way back to lower the seat. Try pushing the handle back in different positions if it is difficult to lower the seat.
- If the unit is in the standing position and unoccupied, it is necessary to apply pressure to the seat of the unit while pushing the pump handle back.

Purging The Hydraulic Actuator

The hydraulic pump on the EasyStand has a high probability of getting air trapped in the internal workings of the unit. This is usually caused by in-transit handling and is quite normal. Please follow the simple steps below, as manual hydraulic systems may never operate properly unless the entrapped air is correctly purged. The unit must be at room temperature for this procedure.

1. Pump the handle until the full extension is reached.
2. Now continue pumping the handle slowly for an additional 10 strokes. This will properly purge the system.