

# **Dionex Easion Ion Chromatography System Operator's Manual**

Document No. 155028  
Revision 01  
August 2020

© 2020 by Thermo Fisher Scientific Inc. All rights reserved.

Chromeleon and OnGuard are registered trademarks of Thermo Fisher Scientific Inc. in the United States.

Adobe, Acrobat, and Adobe Reader are registered trademarks of Adobe Systems, Incorporated in the United States and other countries. Microsoft and Windows are registered trademarks of Microsoft Corporation in the United States and other countries.

PEEK is a trademark of Victrex PLC.

All other trademarks are the property of Thermo Fisher Scientific Inc. and its subsidiaries.

Thermo Fisher Scientific Inc. provides this document to its customers with a product purchase to use in the product operation. This document is copyright protected and any reproduction of the whole or any part of this document is strictly prohibited, except with the written authorization of Thermo Fisher Scientific Inc.

The contents of this document are subject to change without notice. All technical information in this document is for reference purposes only. System configurations and specifications in this document supersede all previous information received by the purchaser.

**Thermo Fisher Scientific Inc. makes no representations that this document is complete, accurate or error-free and assumes no responsibility and will not be liable for any errors, omissions, damage or loss that might result from any use of this document, even if the information in the document is followed properly.**

This document is not part of any sales contract between Thermo Fisher Scientific Inc. and a purchaser. This document shall in no way govern or modify any Terms and Conditions of Sale, which Terms and Conditions of Sale shall govern all conflicting information between the two documents.

Revision history: Revision 01 released August 2020; new product support

Software version: Chromeleon 7.2.10 MUa and later

**For Research Use Only. Not for use in diagnostic procedures.**

<b>1 • Introduction</b> .....	1
1.1 Overview of the Dionex Easion .....	1
1.2 User Documentation .....	2
1.2.1 About This Manual .....	2
1.2.2 Related Documentation .....	3
1.3 Safety Information .....	4
1.3.1 Safety Messages and Notes .....	4
1.3.2 Safety Symbols .....	6
1.4 Regulatory Compliance .....	6
1.4.1 Notice on Lifting and Handling of Thermo Scientific Instruments .....	7
1.4.2 Notice on the Proper Use of Thermo Scientific Instruments ...	7
1.4.3 Notice on the Susceptibility to Electromagnetic Transmission .	7
1.4.4 WEEE Compliance .....	7
<b>2 • Description</b> .....	9
2.1 Operating Features .....	9
2.1.1 Front Door and Top Cover .....	9
2.1.2 Component Mounting Panel .....	11
2.1.3 Rear Panel .....	13
2.2 Fluid Schematic .....	16

2.3	System Component Details	17
2.3.1	Pump	17
2.3.2	Pressure Transducer	18
2.3.3	Injection Valve with Sample Loop	19
2.3.4	Dionex CRS 500 Suppressor	20
2.3.5	Displacement Chemical Regeneration (DCR)	20
2.3.6	Conductivity Cell and Dionex DS5 Detection Stabilizer	22
2.4	Chromeleon Software	23
2.4.1	The Chromeleon ePanel Set	23
2.4.2	Software Control Modes	24
2.4.3	System Wellness	25

### **3 • Operation and Maintenance** . . . . .27

3.1	Operation Overview	27
3.2	Turning On the Dionex Easion Power	28
3.3	Connecting to Chromeleon	28
3.4	Preparing the Eluent	28
3.5	Preparing the Regenerant	29
3.6	Priming the Pump	31
3.7	Equilibrating the System	34
3.8	Verifying Operational Status	35
3.9	Configuring Standby Mode	35
3.10	Preparing Samples	35
3.10.1	Collecting and Storing	35

3.10.2 Pretreating ..... 36

3.10.3 Diluting ..... 36

3.11 Processing Samples ..... 38

    3.11.1 Overview ..... 38

    3.11.2 Manual Sample Processing ..... 39

    3.11.3 Automated (Batch) Sample Processing ..... 40

    3.11.4 Loading and Injecting Samples with an Autosampler ..... 41

    3.11.5 Loading and Injecting Samples with a Syringe ..... 42

    3.11.6 Example Chromeleon Commands for Loading and  
        Injecting Samples ..... 44

3.12 Maintenance ..... 45

**4 • Troubleshooting** ..... 47

4.1 Alarms and Error Conditions ..... 47

4.2 Liquid Leaks ..... 52

4.3 Pump Difficult to Prime or Loses Prime ..... 53

4.4 Pump Does Not Start ..... 53

4.5 No Flow ..... 54

4.6 Erratic Flow/Pressure Reading ..... 54

4.7 Excessive System Backpressure ..... 54

4.8 Peak “Ghosting” ..... 55

4.9 Nonreproducible Peak Height or Retention Time ..... 56

4.10 Abnormal Retention Time or Selectivity ..... 56

4.11 No Detector Response ..... 56

4.12 High Detector Output .....57  
4.13 Baseline Noise or Drift .....57

**5 • Service .....61**

5.1 Diagnostics and Calibrations .....61  
    5.1.1 Wellness Panel Features .....62  
    5.1.2 Calibrating the Pressure Transducer .....63  
    5.1.3 Calibrating the Flow Rate .....65  
5.2 Replacing Tubing and Fittings .....66  
5.3 Isolating a Restriction in the Liquid Plumbing .....67  
5.4 Cleaning Eluent Bottles .....69  
5.5 Changing the Sample Loop .....69  
5.6 Replacing Pump Check Valves .....70  
5.7 Cleaning Pump Check Valves .....72  
5.8 Replacing a Pump Piston Seal and Backup Seal .....73  
5.9 Replacing a Pump Piston .....79  
5.10 Replacing the Waste Valve Seal .....80  
5.11 Rebuilding the Injection Valve .....81  
5.12 Replacing the Conductivity Cell .....81  
5.13 Replacing the Suppressor .....83  
5.14 Changing the Main Power Fuses .....83

**A • Specifications .....85**

A.1 Electrical .....85

A.2	Physical	85
A.3	Environmental	85
A.4	Front and Rear Panel LEDs	86
A.5	Pump	86
A.6	Injection Valve	87
A.7	Suppressors	87
A.8	Conductivity Detector and Flow Cell	88
A.9	Autosampler	89
A.10	System Software	89
<b>B • Reordering Information</b>		<b>91</b>
<b>C • TTL and Relay Control</b>		<b>93</b>
C.1	Connecting a TTL or Relay	94
C.2	Selecting TTL Input Control Modes and Functions	95
C.3	Configuring Relay Output 1 or 2 to Respond to the Pump Flow	97
C.4	Controlling TTL and Relay Outputs	97
<b>D • FAQ</b>		<b>99</b>
D.1	How do I connect to the Dionex AS-DV?	99
D.2	Why are the retention times moving?	99
D.3	How do I adjust retention times?	99
D.4	When should I remake standards?	100
D.5	When should I remake eluents?	100

D.6 How do I shut off the system? .....100

D.7 How do I store columns? .....100

D.8 How do I know when a column is dirty? .....100

D.9 How do I clean a column? .....101

D.10 Why is the conductivity high? .....101

**E • Introduction to Ion Chromatography (IC) .....103**

**F • Glossary.....105**



## 1.1 Overview of the Dionex Easion

The Thermo Scientific™ Dionex™ Easion™ Ion Chromatography System (Dionex Easion) performs isocratic ion analyses using suppressed conductivity detection. The Dionex Easion is an integrated ion chromatography system consisting of a pump, an injection valve, and a conductivity cell. Other system components (guard column, separator column, and suppressor) are ordered separately.

The Dionex Easion is controlled with a PC (personal computer) running Windows® 10 or Windows® 8.1 operating system and the Thermo Scientific™ Dionex™ Chromeleon™ 7 Chromatography Data System (version 7.2.10 MUa and later). Chromeleon provides complete instrument control, data acquisition, and data management.

For communication between the Dionex Easion and the PC on which Chromeleon is installed, the Dionex Easion must be connected to a USB (Universal Serial Bus) port on either the PC or an external USB hub. For more information, refer to *Thermo Scientific Dionex Easion Ion Chromatography System Installation Instructions* (Document No. 155032).

**NOTE** For an introduction to basic ion chromatography concepts, see [Appendix E](#).

## 1.2 User Documentation

### 1.2.1 About This Manual

The electronic version (the PDF file) of the Dionex Easion operator's manual contains numerous hypertext links that can take you to other locations within the file. These links include:

- Table of contents entries
- Index entries
- Cross-references (underlined in blue) to sections, figures, and tables

If you are not familiar with how to navigate PDF files, refer to the Adobe<sup>®</sup> Acrobat<sup>®</sup> or Adobe Reader<sup>®</sup> Help for assistance.

<b>Chapter 1 Introduction</b>	Introduces the Dionex Easion; explains the conventions used in this manual, including safety-related information.
<b>Chapter 2 Description</b>	Describes Dionex Easion operating features, the chromatographic flow path, and the software required for Dionex Easion control.
<b>Chapter 3 Operation and Maintenance</b>	Provides operating instructions for the Dionex Easion and describes routine preventive maintenance procedures.
<b>Chapter 4 Troubleshooting</b>	Lists problems and presents step-by-step procedures for how to isolate and eliminate the cause of each problem.
<b>Chapter 5 Service</b>	Provides step-by-step instructions for routine service and parts replacement procedures that the user can perform.
<b>Appendix A Specifications</b>	Provides specifications and installation site requirements for the Dionex Easion.
<b>Appendix B Reordering Information</b>	Lists spare parts for the Dionex Easion.

<b>Appendix C TTL and Relay Control</b>	Describes the Dionex Easion TTL and relay control features.
<b>Appendix D FAQ</b>	Provides answers to frequently asked questions about Dionex Easion operation.
<b>Appendix E Introduction to Ion Chromatography</b>	Describes basic ion chromatography concepts.
<b>Appendix F Glossary</b>	Provides definitions of terms commonly used in ion chromatography.

## 1.2.2 Related Documentation

The following documents are available for download from the Thermo Fisher Scientific website or by contacting your local office.

- *Thermo Scientific Dionex Easion Ion Chromatography System Installation Instructions* (Document No. 155032)
- *Thermo Scientific Dionex AS-DV Autosampler Operator's Manual* (Document No. 065259)
- Manuals for columns and other consumable products, including:
  - *Thermo Scientific Dionex CRS 500 Product Manual* (Document No. 031727)
  - *Thermo Scientific Dionex OnGuard II Cartridges Product Manual* (Document No. 031688)
  - *Thermo Scientific Dionex Guardcap Product Manual* (Document No. 065705)
- *Chromeleon 7 Installation Guide* (Document No. 7229.0003)

## 1.3 Safety Information

The Dionex Easion is manufactured by Thermo Fisher Scientific (Shanghai) Instruments Company, Ltd. at the following location:

Jinqiao Export Processing Zone, Pu Dong  
T71-6 No. 211, Qin Qiao Road  
201206 Shanghai  
People's Republic of China

The Dionex Easion is designed for IC (ion chromatography) applications and should not be used for any other purpose. Operation of a Dionex Easion in a manner not specified by Thermo Fisher Scientific may result in personal injury.

If there is a question regarding appropriate usage, contact Technical Support for Dionex products before proceeding:

- In the U.S. and Canada, call 1-800-532-4752 and select **option 2**.
- Outside the U.S. and Canada, call the nearest Thermo Fisher Scientific office.

### 1.3.1 Safety Messages and Notes

This manual contains warnings and precautionary statements that can prevent personal injury and/or damage to the Dionex Easion when properly followed. Safety messages appear in bold type and are accompanied by icons, as shown below.



**Indicates an imminently hazardous situation which, if not avoided, will result in death or serious injury.**



**Indicates a potentially hazardous situation which, if not avoided, could result in death or serious injury.**



**Indicates a potentially hazardous situation which, if not avoided, may result in minor or moderate injury. Also used to identify a situation or practice that may seriously damage the instrument, but will not cause injury.**



**Indicates that the function or process of the instrument may be impaired. Operation does not constitute a hazard.**

### Messages d'avertissement en français



Signale une situation de danger immédiat qui, si elle n'est pas évitée, entraînera des blessures graves à mortelles.



Signale une situation de danger potentiel qui, si elle n'est pas évitée, pourrait entraîner des blessures graves à mortelles.



Signale une situation de danger potentiel qui, si elle n'est pas évitée, pourrait entraîner des blessures mineures à modérées. Également utilisé pour signaler une situation ou une pratique qui pourrait gravement endommager l'instrument mais qui n'entraînera pas de blessures.

### Warnhinweise in Deutsch



Bedeutet unmittelbare Gefahr. Mißachtung kann zum Tod oder schwerwiegenden Verletzungen führen.



Bedeutet eine mögliche Gefährdung. Mißachtung kann zum Tod oder schwerwiegenden Verletzungen führen.



Bedeutet eine mögliche Gefährdung. Mißachtung kann zu kleineren oder mittelschweren Verletzungen führen. Wird auch verwendet, wenn eine Situation zu schweren Schäden am Gerät führen kann, jedoch keine Verletzungsgefahr besteht.

### Notes

Informational messages also appear throughout this manual. These are labeled NOTE and are in bold type:

**NOTE** NOTES call attention to certain information. They alert you to an unexpected result of an action, suggest how to optimize instrument performance, and so on.

### 1.3.2 Safety Symbols

These symbols appear on the Dionex Easion or on Dionex Easion labels:



Alternating current



Primary protective conductor terminal



Secondary protective conductor terminal



Power supply is on



Power supply is off



Indicates a potential hazard. Refer to this manual for an explanation of the hazard and how to proceed.

## 1.4 Regulatory Compliance

Thermo Fisher Scientific performs complete testing and evaluation of its products to ensure full compliance with applicable domestic and international regulations. When the Dionex Easion is delivered to you, it meets all pertinent international electromagnetic compatibility (EMC), safety, and material compliance requirements and directives.

Changes that you make to your system may void compliance with one or more of these requirements and directives. Changes to your system include replacing a part or adding components, options, or peripherals not specifically authorized and qualified by Thermo Fisher Scientific. To ensure continued compliance with these requirements and directives, replacement parts and additional components, options, and peripherals must be ordered from Thermo Fisher Scientific or one of its authorized representatives.

For additional details, please refer to the CE Declaration of Conformity available on the Thermo Fisher Scientific website.

#### 1.4.1 Notice on Lifting and Handling of Thermo Scientific Instruments

For your safety, and in compliance with international regulations, the physical handling of this Thermo Fisher Scientific instrument requires a team effort to lift and/or move the instrument. This instrument is too heavy and/or bulky for one person alone to handle safely.

#### 1.4.2 Notice on the Proper Use of Thermo Scientific Instruments

In compliance with international regulations: This instrument must be used in the manner specified by Thermo Fisher Scientific to ensure protections provided by the instrument are not impaired. Deviations from specified instructions on the proper use of the instrument include changes to the system and parts replacement. Accordingly, order replacement parts from Thermo Fisher Scientific or one of its authorized representatives.

#### 1.4.3 Notice on the Susceptibility to Electromagnetic Transmission

Your instrument is designed to work in a controlled electromagnetic environment. Do not use radio frequency transmitters, such as mobile phones, in close proximity to the instrument.

For manufacturing location, see the label on the instrument.

#### 1.4.4 WEEE Compliance

This product is required to comply with the European Union's Waste Electrical & Electronic Equipment (WEEE) Directive 2012/19/EU. It is marked with the following symbol:



This symbol indicates that the equipment must not be thrown into general waste and should be collected separately and processed in accordance with local and state requirements.

**Conformité DEEE**

Ce produit est conforme avec la directive européenne (2012/19/EU) des Déchets d'Equipements Electriques et Electroniques (DEEE). Il est marqué par le symbole suivant:



Ce symbole indique que l'équipement ne doit pas être jeté avec les déchets ordinaires, mais doit être collecté séparément et traité conformément aux réglementations locales et nationales.

**WEEE Konformität**

Dieses Produkt entspricht der EU Waste Electrical & Electronic Equipment (WEEE) Richtlinie 2012/19/EU. Es ist mit dem folgenden Symbol gekennzeichnet:



Instrumente mit diesem Zeichen sind nicht für den normalen Abfall bestimmt; Entsorgung soll den lokalen Vorschriften entsprechend ausgeführt werden.



### 2.1 Operating Features

#### 2.1.1 Front Door and Top Cover

[Figure 2-1](#) illustrates the front door and top cover of the Dionex Easion.



Figure 2-1. Dionex Easion

## LEDs

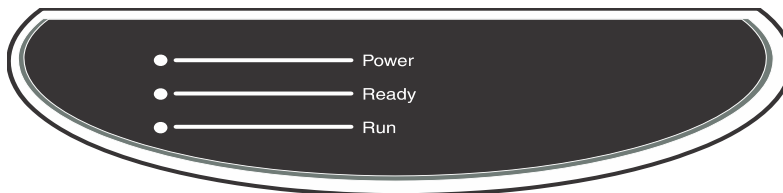

Three status LEDs (described below) are on the Dionex Easion front door.

LED Label	If On (Green)	If Flashing
<b>Power</b>	Dionex Easion power is on	Does not flash
<b>Ready</b>	System check passed, but sequence not yet started (LED remains on until run starts or sequence is aborted)	System check failed (occurs if system check executes for 10 minutes without success)
<b>Run</b>	Running/acquiring data	Error/alarm/fault (including injection valve position)

Other status information and alarm messages are displayed in the audit trail in Chromeleon. For more information about audit trail messages, see [Section 4.1](#).

## Injection Port

When the injection port is connected to the injection valve inside the Dionex Easion, the sample to be analyzed is injected into the injection port using a syringe. For automated sample injections, the Dionex Easion injection valve can be connected to a Thermo Scientific™ Dionex™ AS-DV Autosampler instead of the injection port. For more information about sample injection, see [Section 3.11.5](#).

## Eluent and Regenerant Bottles

The Dionex Easion top cover is molded to hold one eluent bottle assembly (P/N 062510) and one regenerant bottle assembly (for anion analyses: P/N 068222; for cation analyses: P/N 057713).

- Eluent carries the sample through the Dionex Easion and facilitates the ion separation process. The type of eluent used depends on the analyses performed. For example, a Dionex Easion configured for

anion analyses uses carbonate eluent, while a Dionex Easion configured for cation analyses uses methanesulfonic acid (MSA) eluent.

- Regenerant renews the ability of the suppressor to suppress eluent conductivity. A Dionex Easion configured for anion analyses uses dilute sulfuric acid regenerant. A Dionex Easion configured for cation analyses uses tetrabutylammonium hydroxide (TBAOH) regenerant. For more information about suppressor regeneration, see [Section 2.3.5](#).

### 2.1.2 Component Mounting Panel

[Figure 2-2](#) shows the components installed on the component panel behind the Dionex Easion front door.

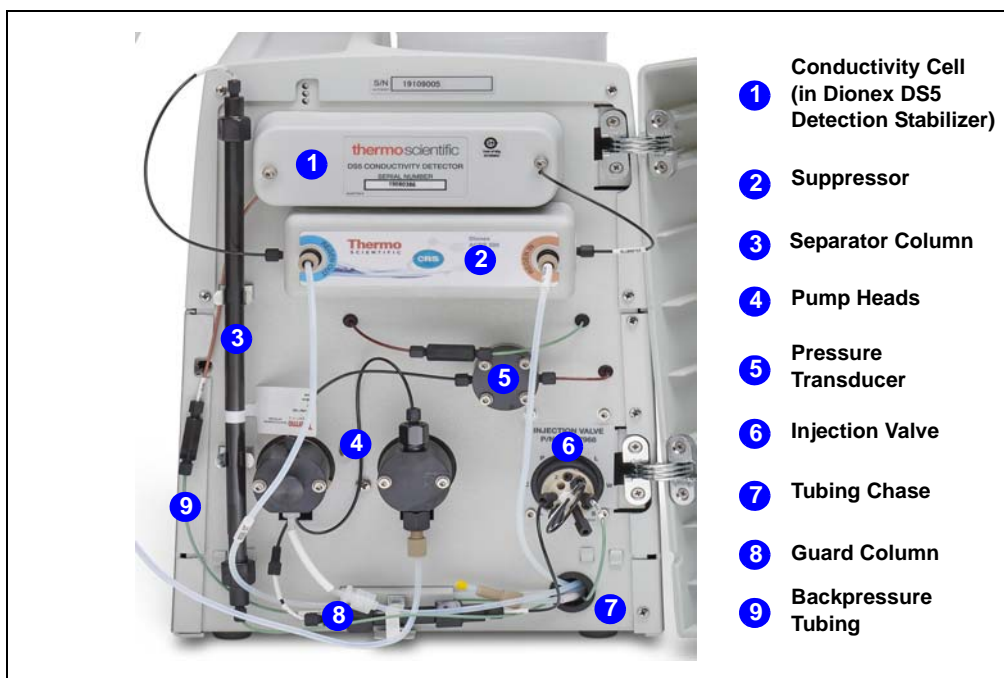

Figure 2-2. Dionex Easion Component Mounting Panel

### **Conductivity Cell**

The flow-through heated conductivity cell measures the electrical conductance of analyte ions as they pass through the cell. A heat exchanger inside the cell regulates the temperature to 40 °C (104 °F). The cell is housed inside a Thermo Scientific™ Dionex™ DS5 Detection Stabilizer (P/N 067761). For more information about the conductivity cell and Dionex DS5 Detection Stabilizer, see [Section 2.3.1](#).

### **Suppressor**

The suppressor reduces the eluent conductivity and enhances the conductivity of the sample ions, thereby increasing detection sensitivity.

The Thermo Scientific™ Dionex™ Chemically Regenerated Suppressor (Dionex CRS™ 500) is recommended for use with the Dionex Easion. For more information about suppressors, see [Section 2.3.4](#).

### **Separator and Guard Columns**

Both the separator and guard columns are packed with resin and perform the separation of the sample ions. The main function of the guard column is to trap contaminants and particulates that might damage the separator column.

### **Pressure Transducer**

The pressure transducer measures the system backpressure. For more information about the pressure transducer, see [Section 2.3.2](#).

### **Pump Heads**

The Dionex Easion includes a dual-piston serial pump. The flow rate can be set from 0.01 mL/min to 5.00 mL/min. However, for optimum performance, set the flow rate to between 0.20 and 3.00 mL/min. Setting the flow rate to 0.00 mL/min turns off the pump. For more information about the pump, see [Section 2.3.1](#).

### **Injection Valve**

The injection valve is a six-port, electrically-activated valve. For more information about the injection valve, see [Section 2.3.3](#).

## Tubing Chase

The tubing chase routes tubing from the component panel, through the Dionex Easion interior, to the rear panel.

### 2.1.3 Rear Panel

[Figure 2-3](#) illustrates the Dionex Easion rear panel.

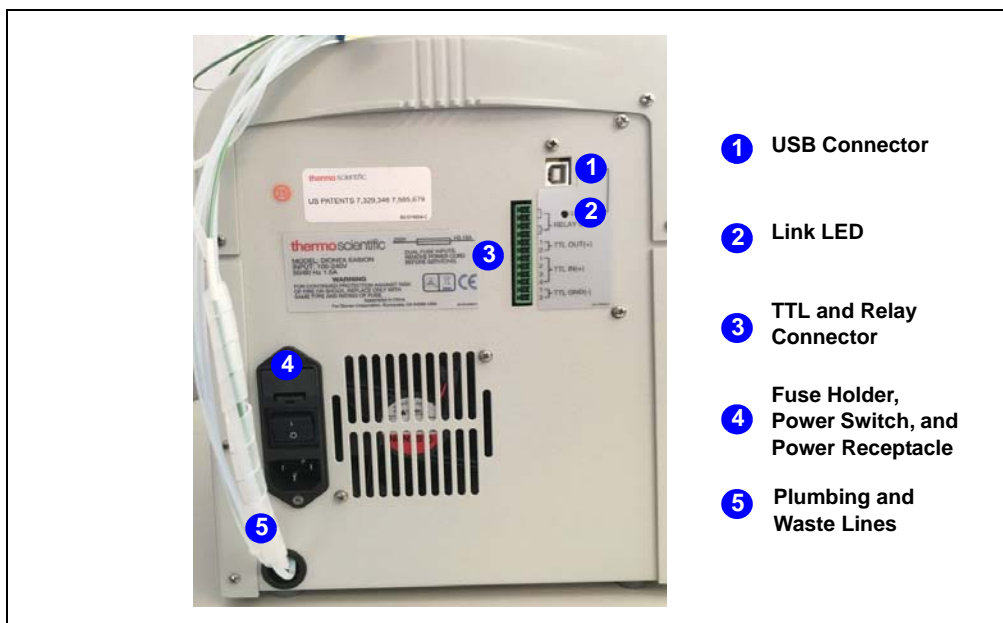

Figure 2-3. Dionex Easion Rear Panel

#### USB Connector

The USB connector connects the Dionex Easion to the PC on which Chromeleon software is installed. For the standard system configuration of one Dionex Easion connected to the PC, connect a USB cable between the USB connector and a USB port on the PC. For more information, refer to the Dionex Easion installation instructions.

## Link LED

The **Link** LED indicates the communication status between the Dionex Easion and the PC on which Chromeleon is installed.



LED Status	Description
On	Although the Dionex Easion and the PC are linked, no data is currently being transmitted or received.
Flashing	The Dionex Easion and the PC are linked and data is being transmitted.
Off	The Dionex Easion and the PC are not currently linked.

## TTL and Relay Connector

The TTL and Relay connector strip provides two TTL outputs, two relay outputs, and four TTL inputs. The outputs can be used to control functions in other TTL- or relay-controllable devices. The inputs can be used to actuate the injection valve, turn the pump on and off, and perform an autozero command. For connection instructions, see [Appendix C](#).

## Fuse Holder, Power Switch, and Power Receptacle

- The fuse holder contains two fast-blow IEC 127 fuses rated 3.15 A (P/N 954745). For instructions on how to change the fuses, see [Section 5.14](#).
- The power switch provides on/off control of power to the Dionex Easion.
- The power cord plugs into the IEC 320 three-prong receptacle.



The power supply cord is used as the main disconnect device. Make sure the socket-outlet is located near the Dionex Easion and is easily accessible.



Le cordon d'alimentation principal est utilisé comme dispositif principal de débranchement. Veillez à ce que la prise de base soit située/installée près du module et facilement accessible.



Das Netzkabel ist das wichtigste Mittel zur Stromunterbrechung. Stellen Sie sicher, daß sich die Steckdose nahe am Gerät befindet und leicht zugänglich ist.

### **Plumbing and Waste Lines**

The following lines exit the Dionex Easion through the tubing chase in the lower-left corner of the rear panel:

- Eluent
- Regenerant
- Cell outlet
- Waste (sample, regenerant, and pump priming)

## 2.2 Fluid Schematic

Figure 2-4 shows the flow path through the Dionex Easion.

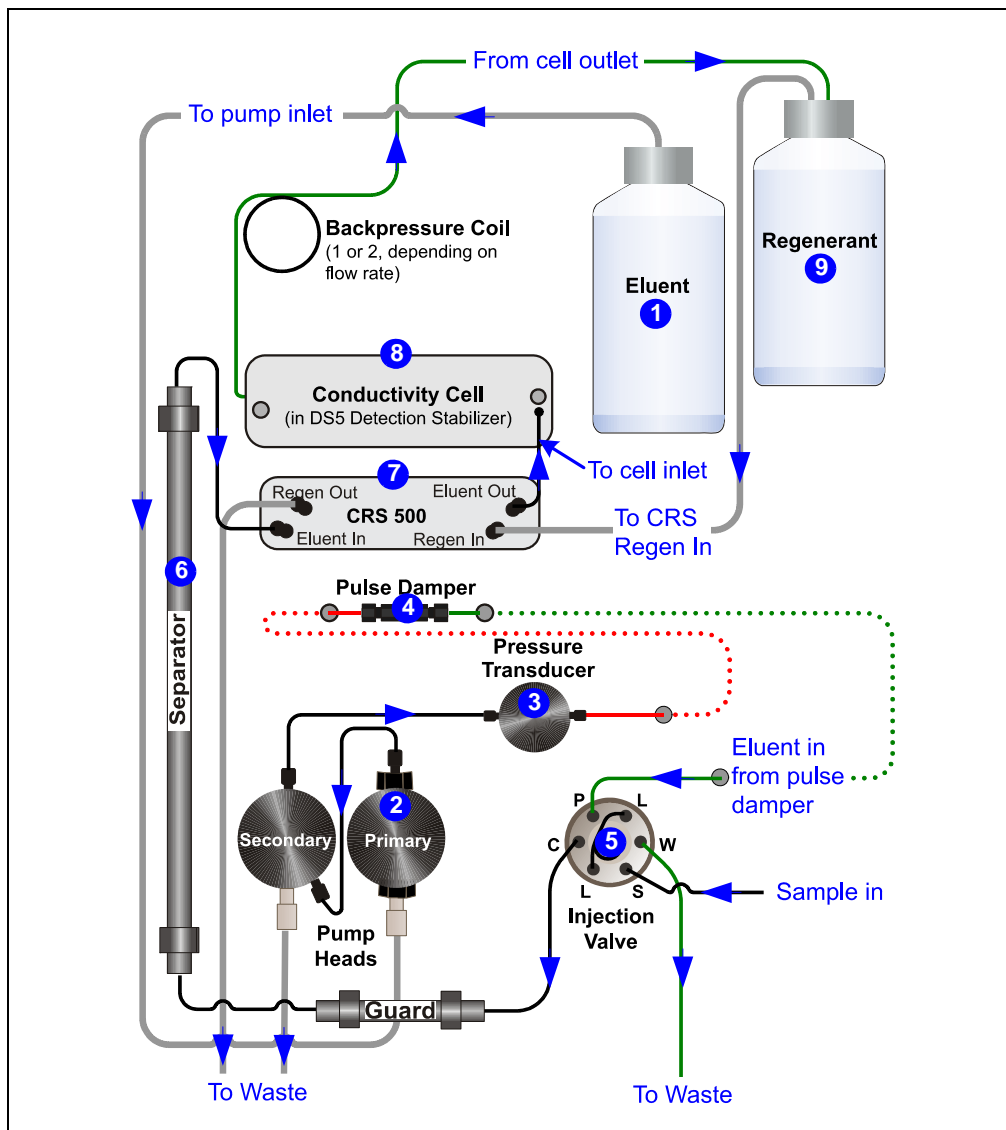

Figure 2-4. Dionex Easion Flow Schematic



- Eluent from the eluent bottle<sup>1</sup> is drawn into the pump<sup>2</sup>. The pump pushes the eluent through the pressure transducer<sup>3</sup>, which measures the system pressure, and through a pulse damper<sup>4</sup>, which smooths minor pressure variations from the pump to minimize baseline noise.
- The eluent then flows into the injection valve<sup>5</sup>. After sample is loaded into the sample loop and the injection valve is toggled to the Inject position, eluent passes through the sample loop, pushing the sample into the eluent stream.
- The eluent/sample mixture is pumped through the guard and separator columns<sup>6</sup>, where the ions are separated by the ion exchange process.
- The eluent/sample mixture then flows through the suppressor<sup>7</sup>, which suppresses the conductivity of the eluent and enhances the conductivity of the analytes. Regenerant flows continuously through the suppressor, restoring the ion exchange sites to their original state.
- The eluent/sample mixture then flows through the conductivity cell<sup>8</sup>, where the analytes are detected. A signal is produced and sent to Chromeleon software.
- Finally, the eluent flows out of the cell and into the regenerant bottle<sup>9</sup>, where it pressurizes the regenerant and forces it into the suppressor.

## 2.3 System Component Details

### 2.3.1 Pump

The Dionex Easion pump is a microprocessor-based isocratic eluent delivery system. Its variable speed, dual-piston series design ensures pulse-free pumping for the most demanding applications.

#### Primary Pump Head

The primary pump head pumps eluent into the secondary pump head (see [Figure 2-5](#)). The check valves, which prevent reverse flow through the pump, are located on the bottom (inlet) and top (outlet) of the primary pump head.

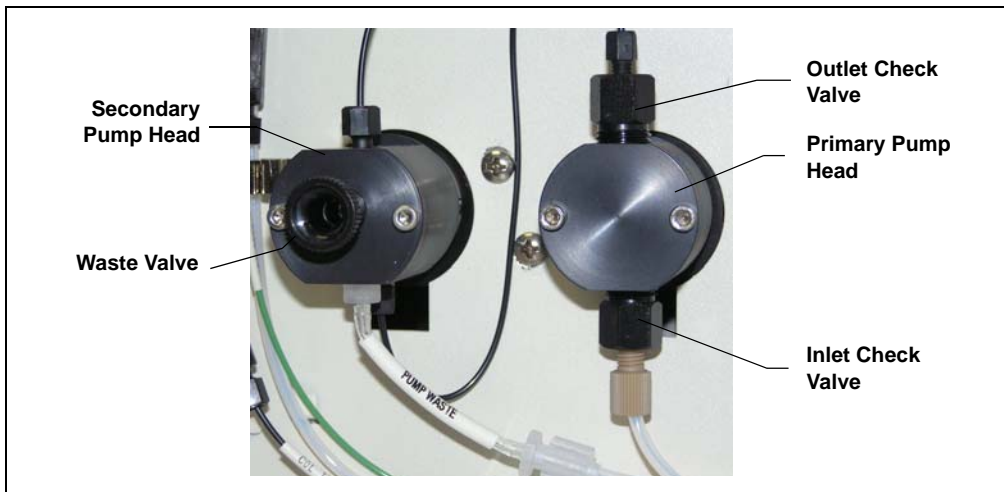

*Figure 2-5. Dionex Easion Pump Components*

### **Secondary Pump Head**

The secondary pump head delivers eluent to the pressure transducer. The waste valve is located on the front of the secondary pump head (see [Figure 2-5](#)).

To open the waste valve, turn the knob one-half turn counterclockwise. When the waste valve is in the open position, all output is directed to waste.

### **2.3.2 Pressure Transducer**

The pressure transducer measures the system pressure at the point at which the eluent flows from the pump head outlet check valve. Pressure readings indicate whether the pumping system is delivering smooth, accurate flow. You can monitor pressure readings from Chromeleon.

The system pressure should remain consistent (no more than a 3% difference from one pressure reading to the next). High and low pressure limits can be used to stop the pump flow if a limit is exceeded. Pressure limits are selected in the Chromeleon Instrument Configuration Manager (in the Dionex Easion Properties dialog box). For troubleshooting guidance if a pressure limit is exceeded, see [Section 4.7](#).

### Pulse Damper

Flow output from the pressure transducer continues to the pulse damper, which smooths minor pressure variations. From there, flow is directed to the injection valve and then to the remainder of the chromatography system.

### 2.3.3 Injection Valve with Sample Loop

The injection valve is a six-port, electrically-activated Rheodyne valve. The valve has two operating positions: Load and Inject. Eluent flows through either the Load or Inject path, depending on the valve position. A 10  $\mu\text{L}$  sample loop (P/N 042949) is installed on the valve at the factory.

[Figure 2-6](#) shows flow schematics for the valve.

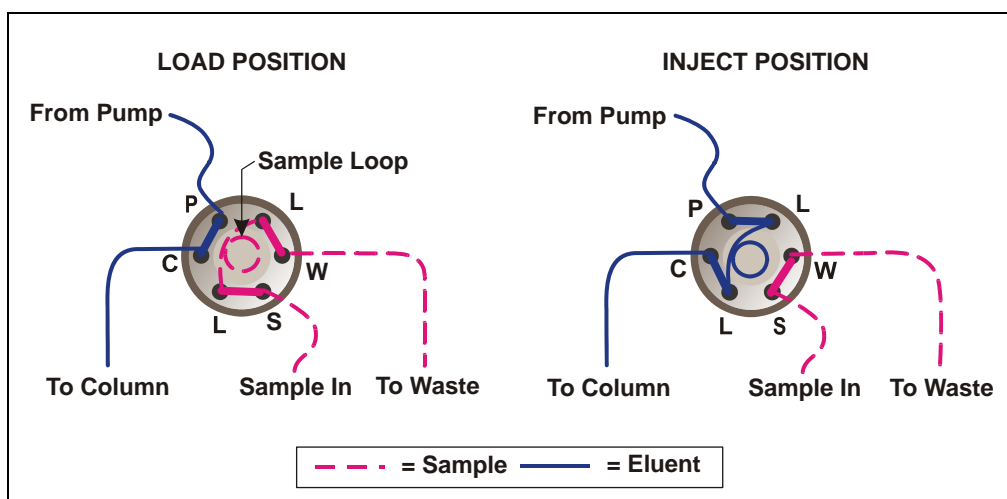

Figure 2-6. Injection Valve Flow Schematics

- In the Load position, sample is loaded into the sample loop, where it is held until injection. Eluent flows from the pump, through the valve, and to the column, bypassing the sample loop. Sample flows from the syringe (or the Dionex AS-DV sample out line, if installed), through the valve, and into the sample loop. Excess sample flows out to waste.
- In the Inject position, sample is swept to the column for analysis. Eluent flows from the pump, through the sample loop, and on to the

column, carrying the contents of the sample loop with it. For a description of how to inject samples manually, see [Section 3.11.2](#). For a description of how to inject samples with an autosampler, see [Section 3.11.4](#).

### **2.3.4 Dionex CRS 500 Suppressor**

The Dionex CRS 500 suppressor reduces the conductivity of the eluent and enhances the conductivity of the sample ions, thereby increasing detection sensitivity.

A process called Displacement Chemical Regeneration (DCR) (see [Section 2.3.5](#)) pushes regenerant from the regenerant bottle and through the suppressor. The constant flow of regenerant over the suppressor membrane continually restores the suppression ability of the suppressor.

For more information about the suppressors, refer to the Dionex CRS 500 manual.

### **2.3.5 Displacement Chemical Regeneration (DCR)**

Displacement Chemical Regeneration (DCR) is the process that restores the ability of the Dionex CRS 500 suppressor to suppress eluent conductivity. In DCR, the eluent that exits the cell is pumped into the regenerant bottle. The eluent pressurizes the bottle and pushes the regenerant into the suppressor. However, because the eluent is a different density than the regenerant, it remains separate.

- In the anion DCR process (see [Figure 2-7](#)), the eluent is less dense than the regenerant and it remains on the top of the bottle, forcing the regenerant into the regenerant line at the bottom of the bottle and out into the suppressor.
- In the cation DCR process (see [Figure 2-8](#)), the eluent is denser than the regenerant and it flows to the bottom of the bottle. This displaces the regenerant, pushing regenerant out of the regenerant line at the top of the bottle and out into the suppressor.

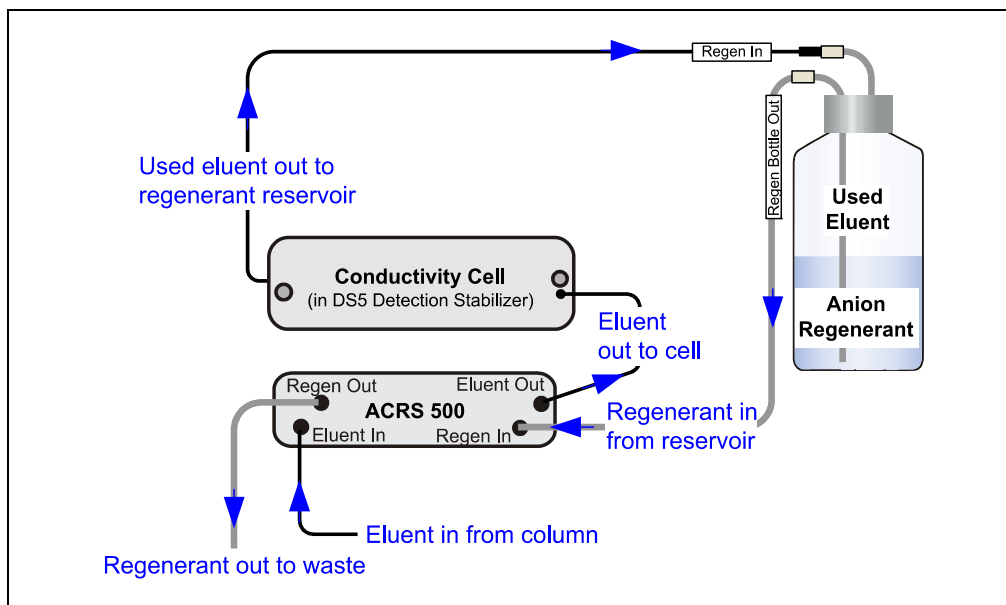

Figure 2-7. Anion Displacement Chemical Regeneration (DCR)

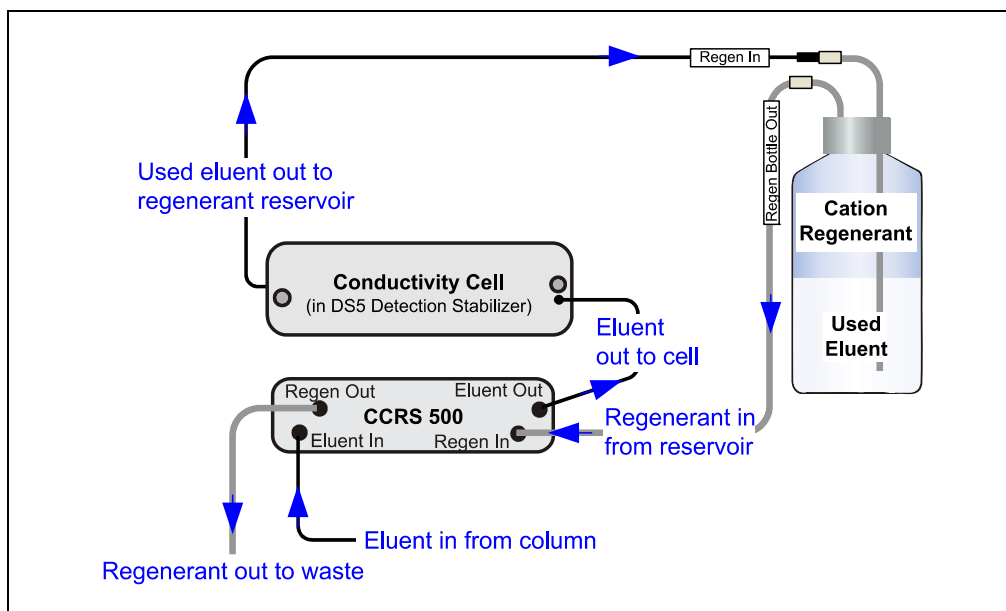

Figure 2-8. Cation Displacement Chemical Regeneration (DCR)

The following regenerant bottle assemblies are available for use with the Dionex Easion:

- The anion regenerant bottle assembly (P/N 068222) has a cap that is labeled **ANION**. The **REGEN BOTTLE OUT** line extends to the bottom of the bottle.
- The cation regenerant bottle assembly (P/N 057713) has a cap that is labeled **CATION**. The **REGEN BOTTLE OUT** line extends only about 1 cm (0.4 in) into the bottle.

For more information, refer to the installation instructions for the Displacement Chemical Regeneration (DCR) 2-Liter Kit (P/N 056882).

### 2.3.6 Conductivity Cell and Dionex DS5 Detection Stabilizer

The flow-through heated conductivity cell contains two 316 stainless steel electrodes that are permanently sealed into the PEEK™ cell body. The cell measures the electrical conductance of analyte ions as they pass through the cell.

Temperature directly affects the conductivity of a solution. For example, laboratory heating and air conditioning systems can cause a regular slow cycling in the baseline. This, in turn, can affect the reproducibility of an analysis. The higher the conductivity, the more pronounced the effect.

In ion analysis, the effect of temperature variation is minimized by suppressing eluent conductivity. Built-in preset temperature compensation also ensures that there is no major change in the baseline or in peak heights. Temperature compensation further improves baseline stability.

Direct conductive heating is used in the Dionex Easion conductivity cell to provide temperature control and compensation. A heat exchanger inside the cell regulates the temperature. All data is collected at 40 °C (104 °F).

The cell is housed inside a Dionex DS5 Detection Stabilizer (P/N 067761) (see [Figure 2-9](#)), which helps to insulate the cell from fluctuations in ambient temperature.

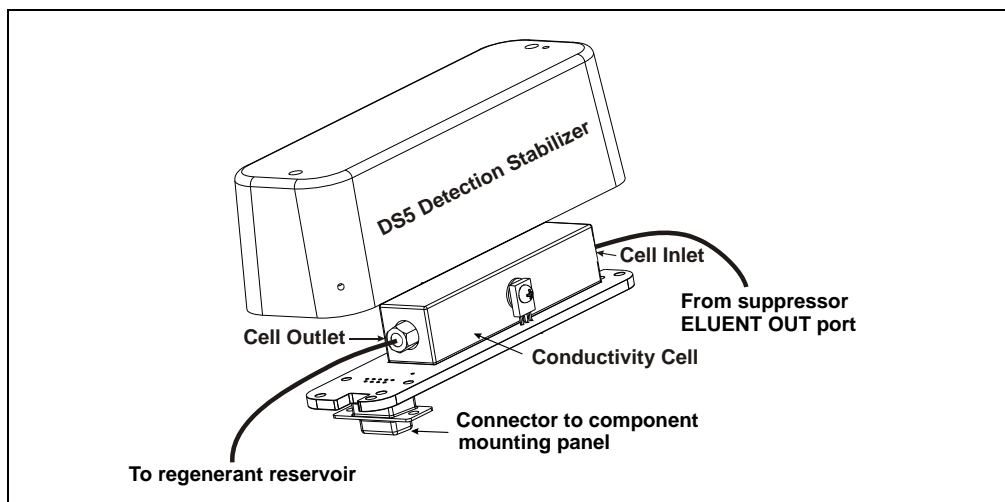

Figure 2-9. Conductivity Cell and Dionex DS5 Detection Stabilizer

The conductivity cell has two detection limit ranges: 0 to 500  $\mu\text{S}$  (the default range) and 0 to 10,000  $\mu\text{S}$ . The range to select depends on the expected detector readings for the application. The default range is appropriate for most applications.

Select the detection limit range in the Chromeleon Instrument Configuration Manager (in the Dionex Easion Properties dialog box). For more information, refer to the Chromeleon Help.

## 2.4 Chromeleon Software

The Chromeleon 7 Chromatography Data System (version 7.2.10 MUa and later) is used to control the Dionex Easion. Chromeleon provides complete instrument control, data acquisition, and data management.

### 2.4.1 The Chromeleon ePanel Set

The Chromeleon ePanel Set provides access to detailed status and control functions for each system component (pump, detector, and so on). The Home tab of the ePanel Set includes system status information, a signal plot, and controls for the most commonly used system functions. For instructions on how to connect to the ePanel Set, see [Section 3.3](#).

If the function to be performed is not available on the ePanel Set, click the **Command** icon on the Instrument toolbar above the ePanel Set or press the **F8** key to open the Chromeleon Command window. From there, you can access all commands available for the function.

[Figure 2-10](#) shows ePanel features related to the Dionex Easion.



Figure 2-10. Dionex Easion: Chromeleon ePanel Status and Control Functions

## 2.4.2 Software Control Modes

Two modes of software control are available: direct control and programmed control.

- With *direct* control, you select operating parameters and commands from the Chromeleon ePanel Set. Direct control commands are executed as soon as they are entered. For more information, see [Section 3.11.2](#).
- With *programmed* control, you create a list of control commands (known as an instrument method) to be executed in chronological order. Instrument methods can be created automatically (with the help of a software wizard). For more information, see [Section 3.11.3](#).



### **2.4.3 System Wellness**

System Wellness monitors the overall “health” of a chromatographic system. It provides built-in diagnostic and calibration features that help prevent unscheduled system shutdowns and assure reliable operation of system devices. For more information, see [Section 5.1](#).



## 3 • Operation and Maintenance

---

This chapter describes routine operating and maintenance procedures for the Dionex Easion.

### 3.1 Operation Overview

[Figure 3-1](#) illustrates the basic steps for routine operation of the Dionex Easion.

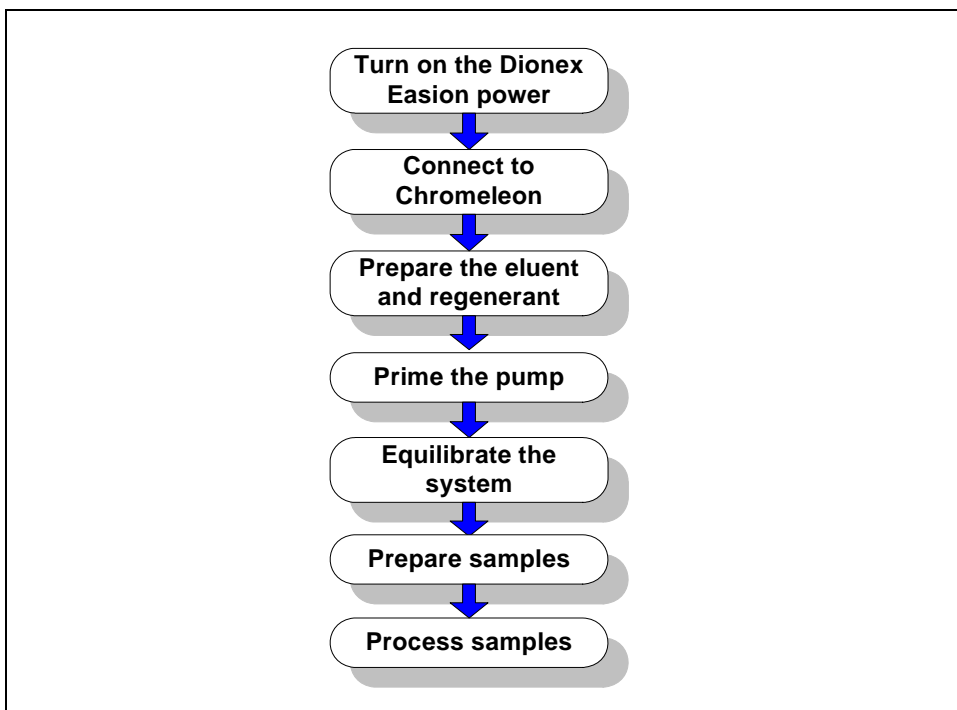

*Figure 3-1. Dionex Easion Operation Flow Chart*

### 3.2 Turning On the Dionex Easion Power

Press the power switch on the Dionex Easion rear panel (see [Figure 2-3](#)) to turn on the system power. These are the conditions at power-up:

- The pump is off.
- The injection valve is in the Load position.
- The conductivity detector begins reading the current conductivity.

### 3.3 Connecting to Chromeleon

If you are beginning operation of a Dionex Easion that has not been configured in a Chromeleon instrument, refer to the Chromeleon Help for setup instructions before proceeding.

**To start the Chromeleon client:**

1. Click **Start > All Programs > Thermo Chromeleon 7 > Chromeleon 7**.
2. In the Console, click the Instruments Category Bar.
3. Select the name of the instrument in which the Dionex Easion is configured. Chromeleon will connect to the instrument and display the ePanel Set (see [Figure 2-10](#)).

### 3.4 Preparing the Eluent

1. Prepare the eluent. For instructions, refer to the column manual.
2. Fill the eluent bottle with the prepared eluent.
3. Insert the stopper assembly tubing into the bottle and hand-tighten the cap.
4. Use the **Eluent Fill Volume** slider on the Chromeleon ePanel to reset the volume of liquid in the eluent bottle.

Chromeleon determines eluent usage by monitoring the flow rate and the length of time the pump is on. As the eluent is depleted, Chromeleon updates the **Eluent Fill Volume** display.

**IMPORTANT**

To ensure the accuracy of the Eluent Fill Volume display, reset the volume each time the eluent bottle is filled.

## 3.5 Preparing the Regenerant

The type of regenerant used with the Dionex Easion depends on the analysis. A dilute sulfuric acid regenerant is used for anion analyses; a tetrabutylammonium hydroxide (TBAOH) regenerant is used for cation analyses. Follow the instructions below to prepare either regenerant.

**NOTE** Use ASTM Type I (18.2 megohm-cm) filtered and deionized water to prepare the regenerant.

1. Verify that you have the correct regenerant bottle assembly (for anion analyses: P/N 068222; for cation analyses: P/N 057713).
  - For anions, the cap is labeled **ANION** and the **REGEN BOTTLE OUT** line extends to the bottom of the bottle.
  - For cations, the cap is labeled **CATION** and the **REGEN BOTTLE OUT** line extends only about 1 cm (0.4 in) into the bottle.
2. Rinse the regenerant bottle with deionized water.
3. Fill the bottle about halfway with deionized water.
4. Determine the regenerant concentration required for the application. To estimate the regenerant concentration required for an eluent strength, use the appropriate formula:

$$\text{Anion Regenerant Concentration} = (\text{mM eluent}) \times 2$$

$$\text{Cation Regenerant Concentration} = (\text{mM eluent}) \times 5$$

**Example:** If you are using 20 mM methanesulfonic acid (MSA) as the eluent for a cation analysis, use a regenerant concentration of 100 mM tetrabutylammonium hydroxide (TBAOH).

For more information, refer to the suppressor manual and the installation instructions for the Displacement Chemical Regeneration (DCR) 2-Liter Kit (P/N 056882).

5. Empty the required amount of concentrate (sulfuric acid for anions; TBAOH for cations) into the bottle.



**For acid concentrates (such as the anion regenerant), always pour the concentrate into deionized water, not into the empty bottle.**



Pour les concentrés acides (comme le régénérant anionique), versez toujours le concentré dans de l'eau désionisée et non dans le réservoir vide.



Gießen Sie säurehaltige Konzentrate (beispielsweise den Anionregenerenten) das Konzentrat immer in entionisiertes Wasser und nicht in den leeren Behälter.

6. Fill the bottle almost to the top with deionized water, and then place the bottle in the tray on the top of the Dionex Easion.

**NOTE** To avoid staining the Dionex Easion, be careful not to spill TBAOH on the system.

7. Using the concentrate bottle, pour additional deionized water into the bottle until it is completely filled to the top. If a few drops spill over, then it is full enough.

**IMPORTANT**

The regenerant bottle must remain filled all the way to the top at all times.

8. Insert the stopper assembly tubing into the bottle and hand-tighten the cap.
9. Invert the bottle three or four times to disperse the concentrate.

**IMPORTANT**

After the analysis begins, do not mix the contents of the regenerant bottle.

10. Verify that the liquid lines from the **ELUENT** and **REGEN** bottles are connected to the corresponding lines from the Dionex Easion (see [Figure 3-2](#)).

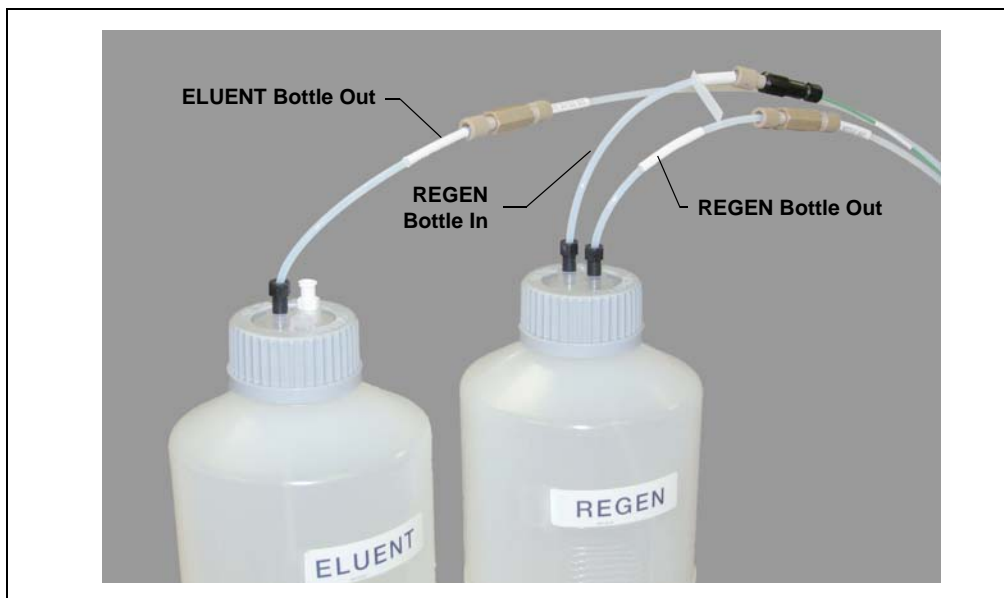

Figure 3-2. Eluent and Regenerant Bottle Liquid Line Connections

### 3.6 Priming the Pump

Prime the pump if the eluent has been changed, the eluent line contains air, or the pump heads are dry (for example, after servicing).

**NOTE** If the eluent line is empty or if pump heads are completely dry, you can use a 10 cc syringe (P/N 079803) to prime the pump (see [page 33](#)).

1. Verify that the **ELUENT** and **REGEN** bottles are filled, the bottle caps are installed and hand-tightened, and the liquid lines are connected to the bottles.
2. Verify that the waste lines are directed to a waste container.
3. Open the waste valve on the secondary (left) pump head by turning the knob one-half turn counterclockwise (see [Figure 3-3](#)). (Opening the valve directs the eluent flow path to waste and eliminates backpressure.)

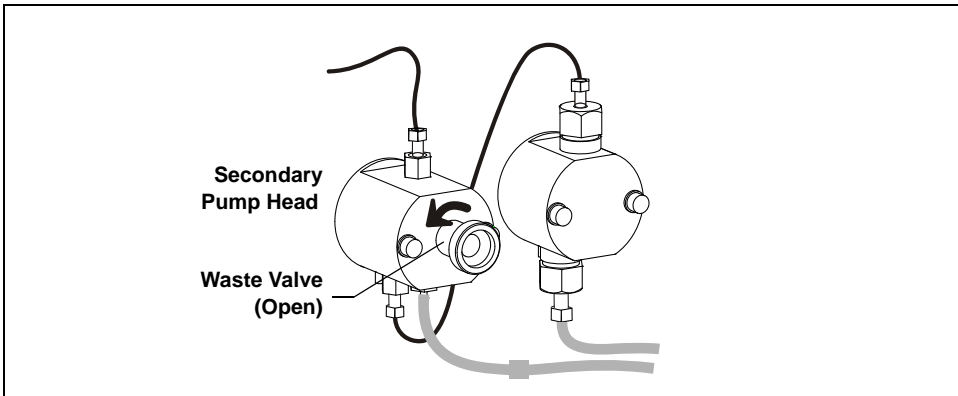

*Figure 3-3. Priming the Pump*

4. Click **Prime** on the Chromeleon ePanel (see [Figure 2-10](#)).  
–or–  
Open the Command window (by pressing the **F8** key), select the **Pump** command, and select the **Prime** option.
5. The pump will begin pumping at about 3 mL/min. Continue priming the Dionex Easion until no air bubbles are exiting the pump waste line.
6. Click the pump **Off** button on the Chromeleon ePanel.
7. Close the waste valve. **Do not overtighten.** The pump is now ready for operation.

**NOTE** A convenient way to verify that the waste valve is closed is to select the pump flow rate required for your application, turn on the pump, and then close the valve. The pressure should rise to the value expected for the application and quickly stabilize.



#### Priming the Eluent Line with a Syringe (Optional)

A syringe can be used to facilitate priming when the eluent line is empty or the pump heads are completely dry.

1. Verify that the pump is turned off.
2. Disconnect the waste line from the luer fitting on the secondary (left) pump head.
3. Connect a 10 cc syringe (P/N 079803) to the luer fitting (see [Figure 3-4](#)).

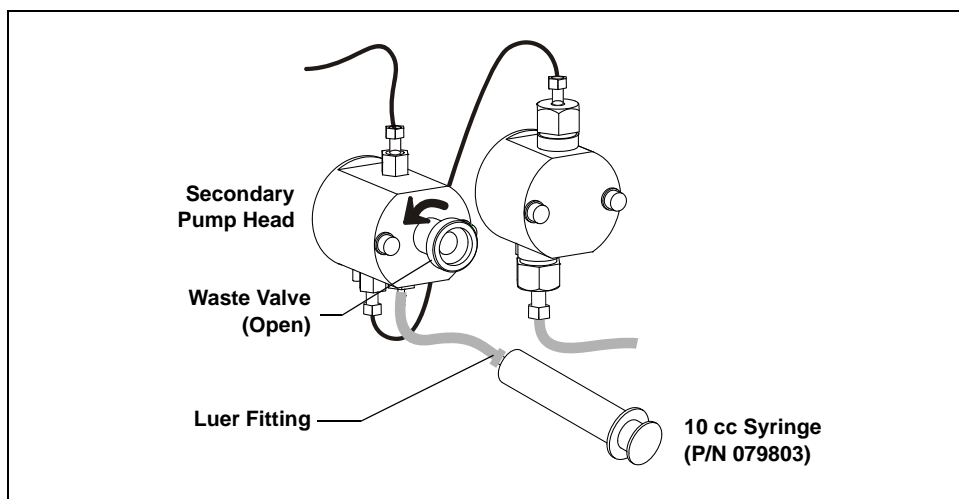

Figure 3-4. Priming the Eluent Lines

4. Open the waste valve by turning it one-half turn counterclockwise.
5. Draw the syringe back to begin removing air from the flow path.

**NOTE** When the line already contains liquid, the syringe is difficult to draw back. In this case, prime with the Prime command only (see [Section 3.6](#)).

6. When a small amount of liquid enters the syringe, remove the syringe from the luer fitting and reconnect the waste line to the luer fitting.
7. Follow the instructions in [Section 3.6](#) to finish priming.

## **3.7 Equilibrating the System**

1. Click the pump **On** button on the Chromeleon ePanel.
2. Select the flow rate recommended for the column and allow the system to equilibrate. The Chromeleon ePanel displays the background conductivity (the conductivity of the eluent without the offset performed by the autozero command).
3. Click **Autozero** on the Chromeleon ePanel to offset the background and zero the conductivity reading.
4. Monitor the system pressure to make sure it is at the expected pressure for the installed column (refer to the column manual for details) and is stable.

Note that column manuals typically provide pressure specifications for systems that *do not* include a guard column. If a guard column is installed in the Dionex Easion, the system pressure will be 15% to 20% higher than the specification in the column manual.

- If the pressure is less than expected, air may be trapped in the system. To release the air, temporarily remove the pump fitting (**P**) on the injection valve. After allowing the air to escape, reconnect the fitting.
  - If the pressure is too high, there may be a restriction in the system plumbing. For troubleshooting guidance, see [Section 4.7](#).
5. Check for leaks in the regenerant bottle.
  6. Check that liquid is flowing out of the suppressor **REGEN OUT** waste line.
  7. Monitor the baseline conductivity. In general, this should be <30  $\mu\text{S}/\text{cm}$  for a system set up for anion analyses or <2  $\mu\text{S}/\text{cm}$  for a system set up for cation analyses. Equilibration time varies, and it can take some time to reach the expected value.
    - If the conductivity is too high, see [Section 4.12](#) for troubleshooting guidance.
    - If the baseline is drifting or there is excessive “noise” (large fluctuations in readings), see [Section 4.13](#).

## 3.8 Verifying Operational Status

After the system has equilibrated, verify the actual pump pressure and stability by monitoring the pump pressure.

Record the short-term pressure fluctuations; they should be less than 0.13 MPa (20 psi). If the pressure fluctuates by more than this amount, prime the pump (see [Section 3.6](#)).

## 3.9 Configuring Standby Mode

The Dionex Easion can be configured to enter standby mode after a period of inactivity (defined as a period of time in which no data collection and no input from Chromeleon has occurred). In standby mode, the pump flow rate is reduced.

- Configure the standby mode in the Chromeleon Instrument Configuration Manager (in the Dionex Easion Properties dialog box).
- To cancel standby mode and return the pump to the normal flow rate, either turn on the pump from the Chromeleon ePanel or start a new sequence.

## 3.10 Preparing Samples

**NOTE** Sample preparation can be performed while the system is equilibrating.

### 3.10.1 Collecting and Storing

- Collect samples in high density polyethylene containers that have been thoroughly cleaned with ASTM Type I (18.2 megohm-cm) filtered and deionized water. Do not clean containers with strong acids or detergents. These will leave traces of ions on the container walls, and the ions may interfere with the analysis.
- If samples will not be analyzed on the day they are collected, filter them through clean 0.45  $\mu\text{m}$  filters immediately after collection; otherwise, bacteria in the samples may cause the ionic concentrations to change over time. Refrigerating the samples at 4 °C (39 °F) will reduce, but not eliminate, bacterial growth.

- Analyze samples containing nitrite or sulfite as soon as possible. Nitrite oxidizes to nitrate, and sulfite to sulfate, thus increasing the measured concentrations of these ions in the sample. In general, samples that do not contain nitrite or sulfite can be refrigerated for at least one week with no significant changes in anion concentrations.

### 3.10.2 Pretreating

- Analyze rainwater, drinking water, and air particulate leach solutions directly with no sample preparation (other than filtering and possibly diluting).
- Filter groundwater and wastewater samples through 0.45  $\mu\text{m}$  filters before injection, unless samples were filtered after collection.
- A Thermo Scientific™ Dionex™ High-Pressure Inline Filter (P/N 044105) is available for removing particulates down to 0.45 micron from samples. Connect the inline filter between the Dionex AS-DV outlet and the sample inlet port on the injection valve. For more information, refer to *High-Pressure Inline Filter Installation Instructions* (Document No. 032319).
- Before injection, pretreat samples that may contain high concentrations of interfering substances by putting them through Thermo Scientific™ Dionex™ OnGuard™ II cartridges. For more information, refer to the cartridge manual.
- If a Dionex AS-DV is installed, you may want to use Thermo Scientific™ Dionex™ Guardcap™ vial caps, which contain Dionex OnGuard resin and allow for automated sample preparation. For more information, refer to the vial cap manual.

### 3.10.3 Diluting

- Because the concentrations of ionic species in different samples can vary widely from sample to sample, no single dilution factor can be recommended for all samples of one type. In some cases (for example, many water samples), concentrations are so low that dilution is not necessary.
- Use eluent or ASTM Type I (18.2 megohm-cm) filtered and deionized water to dilute the sample. When using carbonate eluents,

diluting with eluent minimizes the effect of the water dip at the beginning of the chromatogram. If you dilute the sample with eluent, use eluent from the same lot to prepare the calibration standards, also. This is most important for fluoride and chloride, which elute near the water dip.

- To improve the accuracy of early eluting peak determinations (such as fluoride) at concentrations below 50 ppb, dilute standards in eluent or spike the samples with concentrated eluent to minimize the water dip. For example, spike a 100 mL sample with 1.0 mL of a 100X eluent concentrate.

## 3.11 Processing Samples

### 3.11.1 Overview

Samples can be run manually (one at a time) or grouped and run automatically (in batches). [Figure 3-5](#) shows the typical steps for each type of sample processing.

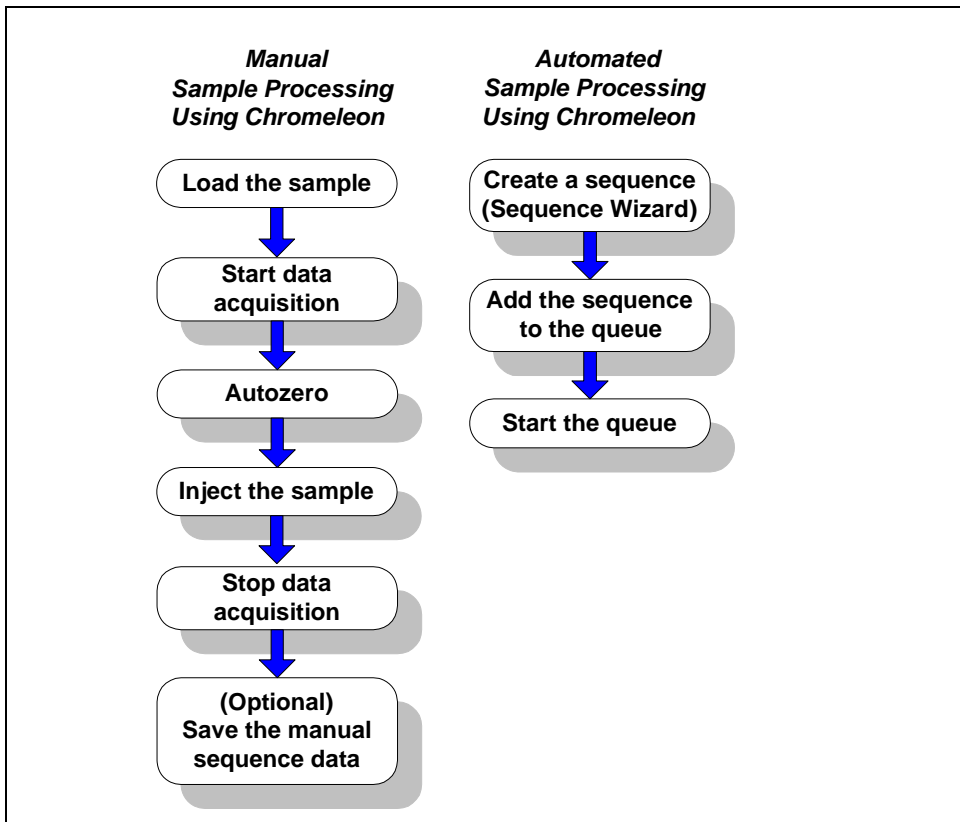

*Figure 3-5. Sample Processing Overview*

### 3.11.2 Manual Sample Processing

To manually process a sample, select operating parameters and commands from the Chromeleon ePanel. Commands are executed as soon as they are entered.

#### Summary of Manual Sample Processing

1. Complete the instructions in [Section 3.2](#) through [Section 3.10](#) to prepare the Dionex Easion for operation and to prepare the sample for processing.
2. Load the sample into the injection valve sample loop with either the Dionex AS-DV (see [Section 3.11.4](#)) or a syringe (see [Section 3.11.5](#)).
3. Click **Autozero** on the Chromeleon ePanel.
4. Switch the injection valve to the Inject position with either the Dionex AS-DV (see [Section 3.11.4](#)) or a syringe (see [Section 3.11.5](#)).

The signal plot is displayed on the Chromeleon ePanel.

5. Monitor the chromatogram. When sample data has been collected, click **Monitor Baseline** on the Instrument toolbar above the Chromeleon ePanel Set.

#### Saving Manual Data

Data from manual processing is saved in the **manual** sequence under the instrument folder in the local data vault.

#### To save the data from a manual run:

1. Select the **manual** folder and select **File > Save As**.
2. Enter a new name for the sequence.
3. Select the **Save raw data** check box.
4. Click **Save**.

### 3.11.3 Automated (Batch) Sample Processing

**NOTE** This section provides a brief overview of the steps required to perform sample analyses using Chromeleon. For detailed instructions, refer to the Chromeleon Help.

To process samples automatically, first add sample injections to a Chromeleon sequence. (A sequence determines how a group of injections will be analyzed and the order in which they will be run.) For each injection, a sequence typically includes these elements:

- An instrument method—A predefined list of commands and parameters for controlling the system and acquiring sample data.
- The chromatographic data acquired.
- A processing method—A predefined set of instructions for evaluating the data acquired.
- Templates for displaying chromatographic data on the screen and for printing reports.

There are two ways to create a sequence in Chromeleon:

- eWorkflows provide predefined templates and rules for creating new sequences. If they have been defined for your laboratory, eWorkflows are the recommended method for creating a sequence.
- The Sequence Wizard provides a series of dialog boxes that guide you through the process of creating a sequence.

After creating the sequence, you are ready to start automated sample processing.

#### Summary of Automated Sample Processing

1. Complete the instructions in [Section 3.2](#) through [Section 3.10](#) to prepare the Dionex Easion for operation and to prepare the samples for processing.
2. If a Dionex AS-DV is installed: Prepare and fill sample vials and place them in the autosampler tray. Refer to the autosampler manual for detailed instructions.



If a Dionex AS-DV is *not* installed: Load the sample into the injection valve sample loop through the sample loading port on the Dionex Easion front door (see [Section 3.11.5](#)).

3. Load the sequence into a queue and start the run. Chromeleon will perform a Ready Check to verify that the instrument is ready for operation and that the instrument methods specified in the sequence are error-free. If the Ready Check passes (and if another sequence is not currently running), the sequence is started.

### 3.11.4 Loading and Injecting Samples with an Autosampler

1. Verify that the Dionex AS-DV sample out line is connected to port **S (5)** on the injection valve. Direct the injection valve waste line as required. For more information, refer to the Dionex Easion installation instructions and the autosampler manual.
2. Prepare and fill sample vials, and place them in the Dionex AS-DV tray. For more information, refer to the autosampler manual.
3. Use one of the following methods to load sample into the injection valve sample loop and inject it onto the column:
  - Automatically: Include the Load and Inject commands in a Chromeleon instrument method (see the example method in [Section 3.11.6](#)). For more information about automated sample processing, see [Section 3.11.3](#).
  - Manually (with a Dionex AS-DV): Click **Inject** on the Chromeleon ePanel.

#### Autosampler Setup Notes

Follow these steps to verify that the Dionex Easion injection valve is controlled by the correct device.

1. Open the Chromeleon Instrument Configuration Manager.
2. In the Dionex Easion Properties dialog box, click the **Inject Valve** tab.
3. For **Pump\_InjectValve**, verify that the **Controlled By** setting is **AS**.

4. If the setting is wrong, change the device name.
  - a. Select the **Pump\_InjectValve** name and press the **F2** key. The Device Configuration dialog box appears.
  - b. Select **AS** from the **Controlled By** list.
  - c. Click **OK**.

### 3.11.5 Loading and Injecting Samples with a Syringe

This section describes two methods for loading sample into the injection valve sample loop with a syringe:

- Loading sample with a syringe through the sample loading port on the front of the Dionex Easion (*push* method)
- Loading sample with a vacuum syringe through the sample loading port on the front of the Dionex Easion (*pull* method)

**NOTE** For instructions on how to load and inject samples with an autosampler, see [Section 3.11.4](#).

#### Loading Samples with a Syringe (Push Method)

1. Verify that the sample loading port on the front of the Dionex Easion is connected to sample port **S (5)** on the injection valve (see [Figure 3-6](#)).
2. Fill a syringe with a calibration standard or sample.
3. Insert the syringe into the sample loading port on the front of the Dionex Easion.
4. Verify that the injection valve is in the Load position. If it is not, click **Load** on the Chromeleon ePanel.
5. Overfill the sample loop with five sample loop volumes. Excess sample will exit through the injection valve waste line.

**NOTE** Remember that the line from the syringe to the valve must be filled before the sample loop can be filled.

6. Leave the syringe in the port (this prevents the sample from siphoning out of the loop before injection).
7. Use one of the following methods to inject the sample onto the column.
  - Manually: Click **Inject** on the Chromeleon ePanel. For more information about manual sample processing, see [Section 3.11.2](#).
  - Automatically: Include the Inject command in a Chromeleon instrument method (see [Section 3.11.6](#)). For more information about automatic sample processing, see [Section 3.11.3](#).

### Loading Samples with a Vacuum Syringe (Pull Method)

1. Verify that the sample loading port on the front of the Dionex Easion is connected to sample port **S (5)** on the injection valve (see [Figure 3-6](#)).
2. Disconnect the waste line from port **W (6)** on the injection valve and attach a shorter line: 25 to 30 cm (10 to 12 in) of PEEK or PTFE (polytetrafluoroethylene) tubing (see [Figure 3-6](#)).

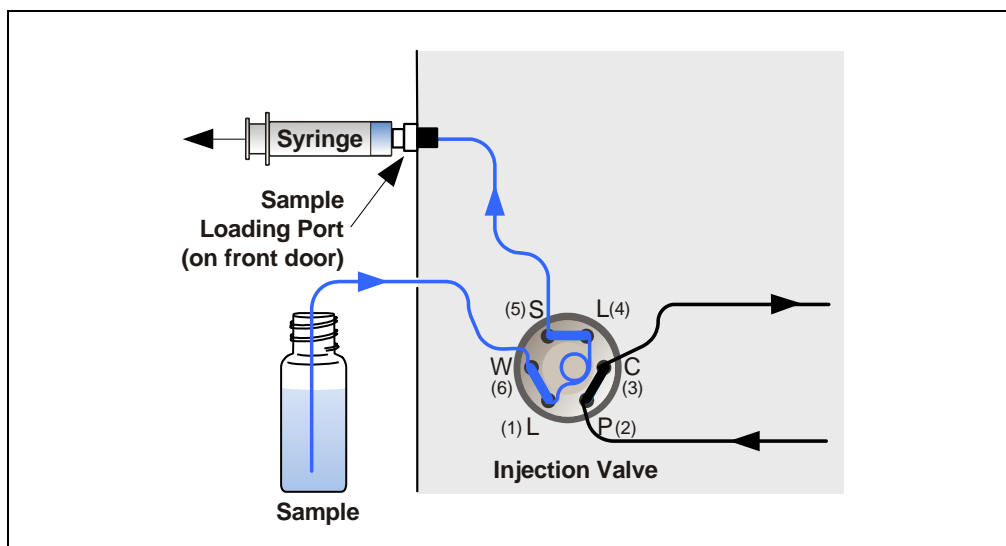

Figure 3-6. Loading Sample with a Vacuum Syringe (Pull Method)

3. Place the free end of the line into the sample.

4. Verify that the injection valve is in the Load position. If it is not, click **Load** on the Chromeleon ePanel (see [Figure 2-10](#)).
5. Insert a syringe into the sample loading port on the Dionex Easion front door and pull out the plunger to draw the sample into the injection valve. Draw at least five times the sample loop volume.

**NOTE** The line from the sample to port W (6) on the injection valve must be filled before the sample loop can be filled.

6. Use one of the following methods to inject the sample onto the column.
  - Manually: Click **Inject** on the Chromeleon ePanel. For more information about manual sample processing, see [Section 3.11.2](#).
  - Automatically: Include the Inject command in a Chromeleon instrument method (see [Section 3.11.6](#)). For more information about automatic sample processing, see [Section 3.11.3](#).

### 3.11.6 Example Chromeleon Commands for Loading and Injecting Samples

The following example shows commands for loading and injecting samples using a Dionex AS-DV.

#### Example Dionex AS-DV Instrument Method Commands

	Sampler.LoadPosition		;Switch the valve to Load.
	DeliverSample		;Deliver sample to the valve.
0.000	Autozero		;Zero the baseline.
	Wait	CycleTimeState	;Wait for cycle time (if any).
	Inject		;Switch the valve to Inject.
	ECD_1.AcqOn		;Start data acquisition.
14.000	ECD_1.AcqOff		;Stop data acquisition.

## 3.12 Maintenance

This section describes routine maintenance procedures for the Dionex Easion that users can perform. All other maintenance procedures must be performed by Thermo Fisher Scientific personnel.

### As Needed

- Make fresh eluent.
- Regularly check the eluent level and refill the eluent bottle. After refilling the bottle, use the **Eluent Fill Volume** slider on the Chromeleon ePanel to reset the volume of liquid in the bottle.

**IMPORTANT**

To ensure the accuracy of the Eluent Fill Volume display, reset the volume each time the eluent bottle is filled.

- Every time you refill the eluent bottle, also empty the regenerant bottle, rinse it, and refill it with fresh regenerant.

**IMPORTANT**

The regenerant bottle must remain filled all the way to the top at all times.

### Daily

- Check the Dionex Easion component mounting panel (see [Figure 2-2](#)) for leaks or spills. Wipe up spills. Isolate and repair leaks (see [Section 4.2](#)). Rinse off any dried eluent or regenerant with deionized water.
- Check the waste container and empty when needed.

### Weekly

- Check fluid lines for crimping or discoloration. Relocate any pinched lines. Replace damaged lines.
- Check the back of the pump head, as well as underneath the head, for evidence of liquid leaks. Normal friction and wear may gradually result in small liquid leaks around the piston seal. If unchecked, these leaks can gradually contaminate the piston housing, causing the pump to operate poorly. If leaks occur, replace the piston seals (see [Section 5.8](#)).

### Annually

- Thermo Fisher Scientific recommends performing preventive maintenance annually, as well as before scheduled Performance Qualification tests. A

Dionex Easion Preventive Maintenance Kit (P/N 088138) is available for this purpose. The kit provides parts and instructions for performing the procedure.

- If a Dionex AS-DV is installed, perform the recommended annual preventive maintenance procedure. A Dionex AS-DV Preventive Maintenance Kit (P/N 072678) is available for this purpose.

## 4 • Troubleshooting

This chapter is a guide to troubleshooting problems that may occur while operating the Dionex Easion.



- For descriptions of error messages that may be displayed in the Chromeleon audit trail and suggestions for how to troubleshoot them, see [Section 4.1](#).
- For descriptions of other operating problems and suggestions for how to resolve them, see [Section 4.2](#) through [Section 4.13](#).

If you are unable to eliminate a problem by following the instructions here, contact Technical Support for Dionex products:

- In the U.S. and Canada, call 1-800-532-4752 and select **option 2**.
- Outside the U.S. and Canada, call the nearest Thermo Fisher Scientific office.

### 4.1 Alarms and Error Conditions

If any of the following alarm conditions occurs, an error message is displayed in the Chromeleon audit trail. Each error message is preceded by an icon that identifies the seriousness of the underlying problem.

Icon	Severity Level	Description
	Warning	A message is displayed in the audit trail. If a run is in progress, it is not interrupted. Although the instrument can continue running (or can be started), Thermo Fisher Scientific recommends that you take appropriate action to remedy the situation.
	Error	A message is displayed in the audit trail or in the Ready Check results. The system attempts to correct the problem (sometimes by using an alternative parameter). If a run is in progress, it is not interrupted. If the error occurs during the Ready Check, the queue will not be started until the error is resolved.
	Abort	A message is displayed in the audit trail and the running queue is aborted.

The table below lists the Dionex Easion-related error messages, as well as their default severity levels. For troubleshooting assistance, go to the page indicated in the table.

Audit Trail Error Message	Default Severity Level	See
Conductivity exceeds limit.	Warning	<a href="#">page 48</a>
Flow rate calibration error.	Warning	<a href="#">page 48</a>
Load/inject valve error.	Error	<a href="#">page 49</a>
Module data buffer overflow. Data may have been lost.	Warning	<a href="#">page 49</a>
Pump motor lost control.	Warning	<a href="#">page 49</a>
Pump pressure hardware error.	Warning	<a href="#">page 49</a>
Pump pressure slope calibration error.	Warning	<a href="#">page 50</a>
Remaining eluent below 100 mL.	Error	<a href="#">page 50</a>
Remaining eluent below 200 mL.	Error	<a href="#">page 50</a>
The system pressure has exceeded the high pressure limit.	Abort	<a href="#">page 51</a>
The system pressure is below the low pressure limit.	Abort	<a href="#">page 51</a>

### **Conductivity exceeds limit.**

If this error occurs when you turn on the Dionex Easion power, you can disregard it. If the error occurs at other times, it should be resolved.

#### **To troubleshoot:**

Refer to the suppressor manual for troubleshooting procedures.

### **Flow rate calibration error.**

This error occurs if you try to calibrate the flow rate while the pump is off, or while the pump is on but the flow rate is not 1 mL/min.

#### **To troubleshoot:**

Be sure to click **Start Calibration** on the Wellness panel with the flow rate calibration instructions. This automatically starts the pump and sets the flow rate to 1 mL/min. For flow rate calibration instructions, see [Section 5.1.3](#).





### **Load/inject valve error.**

This error occurs if the injection valve fails to actuate within 1 second of being toggled.

#### **To troubleshoot:**

1. If a sequence is being executed, click **Stop** on the Chromeleon ePanel to cancel the current injection and stop the sequence.
2. Turn off the Dionex Easion power briefly and then restart.
3. Try to toggle the valve from Load to Inject by clicking **Inject** on the Chromeleon ePanel.
4. If the problem persists, contact Technical Support for Dionex products for assistance.



### **Module data buffer overflow. Data may have been lost.**

This error can be caused by various electronics-related problems.

#### **To troubleshoot:**

Contact Technical Support for Dionex products for assistance. The Dionex Easion electronics components cannot be serviced by the user.



### **Pump motor lost control.**

This error indicates a problem in the pump controller electronics.

#### **To troubleshoot:**

Contact Technical Support for Dionex products for assistance. The Dionex Easion electronics components cannot be serviced by the user.



### **Pump pressure hardware error.**

This error indicates a problem in the pump controller electronics.

#### **To troubleshoot:**

Contact Technical Support for Dionex products for assistance. The Dionex Easion electronics components cannot be serviced by the user.



### **Pump pressure slope calibration error.**

This error occurs if you try to calibrate the pressure slope when the pressure is less than 3 MPa (500 psi).

#### **To troubleshoot:**

1. Verify that the pump is on and that the flow rate is at the rate required for the application.
2. Verify that the pressure gauge is working correctly.
3. Verify that the number and type of installed backpressure coils is correct (see [“Insufficient conductivity cell backpressure” on page 58](#)).
4. Check for liquid leaks (see [Section 4.2](#)).



### **Remaining eluent below 100 mL.**

-or-

### **Remaining eluent below 200 mL.**

These errors occur when the eluent bottle contains less than the volume specified in the error message.

#### **To troubleshoot:**

Chromleon determines the eluent usage by monitoring the flow rate and the length of time the pump is on. After filling the eluent bottle, be sure to use the **Eluent Fill Volume** slider on the Chromleon ePanel to reset the volume of liquid in the bottle. As the eluent is depleted, the volume displayed on the ePanel is updated.

#### **IMPORTANT**

**For the Eluent Fill Volume to be accurate, you must enter the level each time the bottle is filled. The Dionex Easion does not automatically detect when the bottle is filled, nor when it is emptied.**



### **The system pressure is below the low pressure limit.**

If the system pressure falls below the minimum pressure limit for 0.5 second, Chromeleon stops the pump and this error message is displayed. The minimum pressure limit can be set to between 0 and 33.7 MPa (0 and 4900 psi) in the Chromeleon Instrument Configuration Manager.

#### **To troubleshoot:**

1. Make sure the eluent bottle is full.
2. Check for liquid leaks (see [Section 4.2](#)).
3. Prime the pump (see [Section 3.6](#)).
4. Click the pump **On** button on the Chromeleon ePanel.

For additional troubleshooting information related to pump priming, see [Section 4.3](#).



### **The system pressure has exceeded the high pressure limit.**

If the system pressure exceeds the maximum pressure limit for 0.5 second, Chromeleon stops the pump and this error message is displayed. The maximum pressure limit can be set to between 0.7 and 34.4 MPa (100 and 5000 psi) in the Chromeleon Instrument Configuration Manager.

#### **To troubleshoot:**

1. Check for blockages in the liquid lines by working your way backward from the cell to the pump (see [Figure 2-4](#)).
2. Click the pump **On** button on the Chromeleon ePanel.

For additional troubleshooting information related to system pressure, see [Section 4.7](#).

## 4.2 Liquid Leaks

- **Leaking fitting**

Locate the source of the leak. Tighten or, if necessary, replace the liquid line connection (see [Section 5.2](#)). For tightening requirements, refer to *Installation of Dionex Liquid Line Fittings* (Document No. 031432).

- **Broken liquid line**

Replace the line and fittings (see [Section 5.2](#)).

- **Blocked or improperly installed line**

Check that the lines are not crimped or otherwise blocked. Also, if the blocked line is a waste line, make sure it is not elevated at any point after it exits the Dionex Easion. If a line is blocked, replace it (see [Section 5.2](#)).

- **Loose pump check valve housing**

Make sure the check valves are firmly seated in the pump head. If they are not, tighten them carefully with an open-end wrench just until the leak stops.

- **Damaged pump piston seal**

1. Replace the piston seal (see [Section 5.8](#)).
2. If the problem persists, replace the piston (see [Section 5.9](#)).

- **Pump head not tight**

Carefully tighten the pump head mounting screws just until the leak stops.  
**DO NOT OVERTIGHTEN!**

- **Leaking pressure transducer**

Check that the liquid line connections into the pressure transducer are tight. Refer to *Installation of Dionex Liquid Line Fittings* (Document No. 031432) for tightening requirements. Replace any damaged fittings.

- **Leaking pump head waste valve**

1. Make sure the waste valve is closed. To close the valve, turn the knob clockwise, just until tight. **DO NOT OVERTIGHTEN! Overtightening may damage the valve and the pump head.**
2. Inspect the pump head. If the waste valve is the source of the leak, replace the waste valve seal (see [Section 5.10](#)).

- **Leaking Dionex CRS 500**

Refer to the suppressor manual for troubleshooting procedures.

- **Leaking injection valve**

1. Make sure the liquid line connections to the valve are tight. Replace any damaged fittings. Refer to *Installation of Dionex Liquid Line Fittings* (Document No. 031432) for tightening requirements.
2. Liquid leaks from behind the valve stator may indicate a scratched rotor seal. Rebuild the injection valve (see [Section 5.11](#)).

- **Leaking conductivity cell**

1. Check the waste lines for blockage; trapped particles can plug the lines and cause a restriction and/or leak. If necessary, clear the waste lines by reversing the direction of flow.
2. Make sure the plumbing downstream from the cell is clear; a blockage may overpressurize the cell, causing it to leak. If the problem continues, contact Technical Support for Dionex products for assistance.

### 4.3 Pump Difficult to Prime or Loses Prime

- **Empty eluent bottle and/or no eluent connected**

1. Fill the eluent bottle, and then use the **Eluent Fill Volume** slider on the Chromeleon ePanel to reset the volume of liquid in the bottle.
2. Make sure all connections are secure.

- **Dirty pump check valve**

Replace (see [Section 5.6](#)) or clean (see [Section 5.7](#)) the check valves.

- **Liquid leaks at junction between pump head and pump housing**

Replace the piston seal (see [Section 5.8](#)).

### 4.4 Pump Does Not Start

- **No power (front door Power LED indicator fails to light)**

1. Check that the power cord is plugged in.
2. Check the main power fuses and replace, if needed (see [Section 5.14](#)).

- **No communication between Dionex Easion and Chromeleon (Link LED on rear panel fails to light)**

The USB cable is not connected correctly. For connection instructions, refer to the Dionex Easion installation instructions.

### 4.5 No Flow

- **Pump not primed**

Prime the pump (see [Section 3.6](#)).

- **Broken pump piston**

Replace the piston (see [Section 5.9](#)).

### 4.6 Erratic Flow/Pressure Reading

- **Pump needs priming**

Prime the pump (see [Section 3.6](#)).

- **Damaged piston seal**

Replace the piston seal (see [Section 5.8](#)).

- **Dirty pump check valve**

Replace (see [Section 5.6](#)) or clean (see [Section 5.7](#)) the check valves.

### 4.7 Excessive System Backpressure

- **Restriction in system plumbing**

Check all liquid lines for crimping or blockage. Make sure the ferrule fittings are not overtightened onto tubing. For more information, refer to *Installation of Dionex Liquid Line Fittings* (Document No. 031432).

- **Plugged or damaged fitting**

Isolate the faulty fitting by loosening fittings, one by one, until the pressure returns to normal. Repair or replace the fitting (see [Section 5.2](#)).

- **Flow rate through columns too high**  
Check the pump flow rate.
- **Clogged column bed supports**  
Refer to the column manual for troubleshooting procedures.
- **Contaminated columns**  
Clean the columns as instructed in the column manual.
- **Plugged Injection valve passages**  
Rebuild the injection valve (see [Section 5.11](#)).

### 4.8 Peak “Ghosting”

Ghosting is the appearance of extraneous peaks in a chromatogram. These may be late-eluting peaks from a previous injection, or they may result from a contaminated, malfunctioning, or incorrectly installed injection valve. If these peaks co-elute with peaks of interest, they will cause nonreproducible peak heights and/or areas.

- **Insufficient time between sample injections**  
Wait until the previous sample has been completely eluted before making another injection.
- **Insufficient flush between samples**  
Flush the sample loop with at least 10 loop volumes of deionized water or sample between sample injections.
- **Incorrect or contaminated standards**  
Remake the standards.
- **Incorrect or contaminated eluent**  
Remake the eluent (see [Section 3.4](#)).
- **Malfunctioning injection valve**  
Contact Technical Support for Dionex products for assistance.

## 4.9 Nonreproducible Peak Height or Retention Time

- **Column overloading**  
Dilute the sample (see [Section 3.10.3](#)).
- **Liquid leaks**  
Locate and eliminate the leaks (see [Section 4.2](#)).
- **Incomplete or imprecise filling of the sample loop**
  1. Fill the sample loop until excess sample exits the waste line.
  2. Inspect the 1 cc syringe (P/N 016388) and replace if damaged.
- **Pump not primed properly**  
Prime the pump (see [Section 3.6](#)).

## 4.10 Abnormal Retention Time or Selectivity

- **Contaminated or incorrect eluent**  
Remake the eluent, using concentrated eluent and ASTM Type I (18.2 megohm-cm) filtered and deionized water (see [Section 3.4](#)).
- **Contaminated or degraded sample**  
Take appropriate precautions when preparing and storing samples to prevent contamination and degradation (see [Section 3.10](#)).
- **Contaminated column**
  1. Clean the column as instructed in the column manual.
  2. If cleaning is unsuccessful, replace the column.

## 4.11 No Detector Response

- **Cell not properly installed**  
Check that the cell is plugged into the component mounting panel and the cell housing is screwed down so that the bottom of the housing is flush against the sheet metal panel (see [Figure 2-2](#) and [Figure 2-9](#)).



- **No flow from pump**

There are several possible causes for this issue; for more information, see [Section 4.4](#) and [Section 4.5](#).

- **Cell electronics malfunctioning**

Use the Wellness panel to test the electronics with a dummy cell. (For instructions, see [Section 5.1](#) and the Chromeleon Help.) If the conductivity reading with the dummy cell is outside the tolerance range, the electronics are malfunctioning. Contact Technical Support for Dionex products for assistance. The Dionex Easion electronics components cannot be serviced by the user.

### 4.12 High Detector Output

- **Background not suppressed by suppressor**

If **Conductivity exceeds limit** is displayed in the Chromeleon audit trail, refer to the suppressor manual for troubleshooting procedures.

- **Sample concentration too high**

Dilute the sample (see [Section 3.10.3](#)).

- **Wrong eluent or regenerant**

Check that you are using the correct eluent (see [Section 3.4](#)) and regenerant (see [Section 3.5](#)) for your system.

- **Cell out of calibration**

Contact Technical Support for Dionex products for assistance.

### 4.13 Baseline Noise or Drift

- **Flow system leak; erratic baseline**

Check all fittings and liquid lines for leaks. Tighten or, if necessary, replace all liquid line connections. Refer to *Installation of Dionex Liquid Line Fittings* (Document No. 031432) for tightening requirements.

- **Trapped gases**

Release any trapped gases in the cell by loosening the lines to and from the cell and then retightening them. Also loosen and retighten the fittings to and from the suppressor eluent ports.

- **Pump not properly primed**

Prime the pump (see [Section 3.6](#)).

- **Contaminated or incorrect eluent and/or regenerant**

Remake the eluent (see [Section 3.4](#)) and regenerant (see [Section 3.5](#)).

- **Rapid changes in ambient temperature**

If the ambient temperature does not meet the specification of 10 to 35 °C (50 to 95 °F), verify that air conditioning and heating vents are directed away from the Dionex Easion and that the Dionex Easion front door is closed.

- **Insufficient conductivity cell backpressure**

Verify that the correct backpressure coils are installed between the cell outlet and the regenerant bottle inlet. For connection instructions, refer to the Dionex Easion installation instructions.

**Standard bore systems:** Use one or two of the black backpressure coils (P/N 045877) provided in the Dionex Easion Ship Kit (P/N 067768).

Flow Rate	Number of Coils
1.5 to 3.0 mL/min	1 (black)
0.5 to 1.5 mL/min	2 (black)

**Microbore systems:** Use one or two of the red backpressure coils (P/N 045878) provided in the Microbore Tubing Kit (P/N 052324).

Flow Rate	Number of Coils
0.3 to 0.5 mL/min	1 (red)
Less than 0.3 mL/min	2 (red)

- **Insufficient system equilibration following changes to operating parameters; especially apparent when operating at high sensitivities**

Allow a longer system equilibration time (up to 3 hours) before starting to inject samples.

- **Incorrect suppressor operating conditions**  
Refer to the suppressor manual for troubleshooting procedures.
- **Cell above or below temperature**  
Contact Technical Support for Dionex products for assistance.
- **Damaged piston seal**  
Replace the piston seal (see [Section 5.8](#)).
- **DCR waste backpressure tubing not installed (or installed incorrectly)**  
Verify that the DCR waste backpressure tubing is installed on the end of the suppressor waste line. For more information, refer to the Dionex Easion installation instructions.



This chapter describes Dionex Easion service and repair procedures that users can perform. Procedures not included here, including electronics-related repair procedures, must be performed by Thermo Fisher Scientific personnel.

For assistance, contact Technical Support for Dionex products before proceeding:

- In the U.S. and Canada, call 1-800-532-4752 and select **option 2**.
- Outside the U.S. and Canada, call the nearest Thermo Fisher Scientific office.

Before replacing any part, refer to the troubleshooting information in [Chapter 4](#) to correctly identify the cause of the problem.

**IMPORTANT**

**Substituting non-Thermo Scientific/Dionex parts may impair system performance, thereby voiding the product warranty. For details, see the warranty statement in the Thermo Scientific/Dionex Terms and Conditions.**

### 5.1 Diagnostics and Calibrations

The Wellness panel in Chromeleon provides controls for performing diagnostic and calibration functions for the Dionex Easion. This section provides an overview of Wellness panel functions.

Use Wellness panel controls to perform the following procedures:

- Calibration of the pressure transducer (see [Section 5.1.2](#))
- Calibration of the flow rate (see [Section 5.1.3](#))

## 5.1.1 Wellness Panel Features

The Wellness panel provides the following features.

- System Status**
  - When the Dionex Easion is connected to Chromeleon, the green **Connected** LED is displayed. When there is no connection, the red **Disconnected** LED is displayed and all other Wellness panel controls are disabled.
  - Click the pump **On** or **Off** button to turn the pump on or off, respectively.
  - Click the **Log Serial** button to record the Dionex Easion serial number in the Chromeleon audit trail.
  - The **Calibration** or **Diagnostic** box is green while a calibration or diagnostic procedure is running.
  - The current electrochemical detector (**ECD**) conductivity, pump **Flow** rate, and total system **Pressure** are displayed.
  
- View and/or Reset Calibration Parameters**
  - Click the **Calibration Values** button to open a window that displays the current calibration values, the previous values, and the factory-set values.
  - You can reset the current calibration values to the previous or factory-set values from the window.
  
- Calibration**
  - Pressure Transducer**
    - Use the **Calibrate Offset** and **Calibrate Slope** buttons when performing the pressure transducer calibration procedure (see [Section 5.1.2](#)).
    - The **Offset** and **Slope** values and the date of the last calibration are displayed.
  - Pump Flow Rate Calibration**
    - Click the **Calibration Procedure** button to start the pump flow rate calibration procedure (see [Section 5.1.3](#)).
    - Click the **Log** button to record the calibration value in the Chromeleon audit trail.

**Diagnostics**

- The **Pump** and **Conductivity Cell Variance** values are a measure of the noise of the respective channels. These values will vary, depending on eluent, pump seal age and wear, background conductivity, and so on. The comparison of values obtained under the same conditions can be used as a relative measure of system performance.
- The **Variance**, **Minimum**, and **Maximum** readings for the last time the **Pump** and **Conductivity Cell** diagnostic tests were run are displayed.

**Dummy Cell Test**

- The dummy cell test connects a fixed resistance in place of the conductivity cell. A measured value outside the typical range of the test indicates a failure in the detector electronics.
- Click the **Log Dummy Value** button to enable the dummy cell, log the value, and then disable the dummy cell.
- Click the **Disabled** check box to enable and disable the dummy cell.

**Audit Trail**

- The Chromeleon audit trail displays an account of every event (including errors, status messages, and operational events) that occurs during Dionex Easion operation.

### 5.1.2 Calibrating the Pressure Transducer

1. To remove any air in the injection valve loop, toggle the injection valve position a few times by clicking **Load** and **Inject** on the Chromeleon ePanel. (You should hear a click when the valve position changes.)
2. Wait about 10 minutes, and then go on to [Step 3](#).
3. To open the Wellness panel, click **Wellness** on the Chromeleon ePanel (see [Figure 2-10](#)).
4. Under **Pressure Transducer**, click **Calibrate Offset**. A panel with instructions and command buttons appears.
5. Follow the instructions on the panel to complete the transducer offset calibration procedure. The new offset will be determined and then stored as the current value.

**NOTE** To open the waste valve on the front of the secondary pump head (see [Figure 5-1](#)), turn the knob one-half turn counterclockwise.



*Figure 5-1. Dionex Easion Interior Components*

6. Close the waste valve.
7. Under **Pressure Transducer**, click **Calibrate Slope**. A panel with instructions and command buttons appears.
8. Follow the instructions on the panel to complete the transducer slope calibration procedure. The new slope will be determined and then stored as the current value.
9. Turn off the pump.
10. Disconnect the pressure gauge and backpressure tubing.
11. Reconnect the pressure transducer to the pump.



### 5.1.3 Calibrating the Flow Rate

Calibrate the flow rate if the Operational Qualification or Performance Qualification flow rate accuracy and precision test fails.

**Items needed:**

- 0.076-mm (0.003-in) ID yellow PEEK tubing (P/N 049715) to create  $14 \pm 2$  MPa ( $2000 \pm 300$  psi) of backpressure (if needed)
- ASTM Type I (18.2 megohm-cm) filtered and deionized water
- Balance capable of weighing more than 10 g with 0.001 g readability
- Tared beaker

**To calibrate:**

1. To open the Wellness panel, click **Wellness** on the Chromeleon ePanel (see [Figure 2-10](#)).
2. Under **Pump Flow Rate Calibration**, click **Calibration Procedure**. A panel with instructions and command buttons appears.
3. Follow the instructions on the panel to complete the pump flow rate calibration procedure.

**NOTE** Enter the weight of the collected water in grams (to the nearest milligram).

4. Click **Log Calibration Value** to record the new calibration value in the Chromeleon audit trail. This value is stored as the current value.

## 5.2 Replacing Tubing and Fittings

The Dionex Easion is plumbed with the tubing and tubing assemblies listed below.

Tubing Size and Type	Used for...
0.125-mm (0.005-in) ID PEEK, red (P/N 044221)	Connection from pump pulse damper to pressure transducer
0.25-mm (0.010-in) ID PEEK, black (P/N 042690)	Connections between all other system components
0.50-mm (0.020-in) ID ETFE, light blue (P/N 035519)	Connection from injection port on door to injection valve
0.75-mm (0.030-in) ID PEEK, green (P/N 044777)	Connections from injection valve to waste, injection valve to pump pulse damper, and cell to regenerant bottle
1.6-mm (0.062-in) ID PTFE, natural (P/N 014157)	Connections from suppressor <b>Regen In</b> port to regenerant bottle, <b>Regen Out</b> port to waste, pump to eluent bottle, and pump to waste
Microbore Tubing Kit (P/N 052324)	Tubing for exchanging black 0.25-mm (0.010-in) ID PEEK lines with red 0.125-mm (0.005-in) ID PEEK lines (to reduce delay volumes)

- 10-32 fittings (P/N 062980) and ferrules (P/N 043276) are used for most tubing connections. For tightening requirements, refer to *Installation of Dionex Liquid Line Fittings* (Document No. 031432).
- 1/8-in fittings (P/N 052267) and ferrules (P/N 048949) are used for connections to the suppressor **Regen In** and **Regen Out** ports, as well as the eluent and regenerant bottles.
- 1/16-in fittings (P/N 052230) and ferrules (P/N 052231) are used for connections from the front door injection port to the injection valve.

### 5.3 Isolating a Restriction in the Liquid Plumbing

A restriction in the liquid plumbing will cause excessive system backpressure.

1. Begin pumping eluent through the system (including the columns).
2. Follow the Dionex Easion flow schematic (see [Figure 5-2](#)) to work backward through the system, beginning at the cell exit. One at a time, loosen each fitting and observe the pressure. The connection at which the pressure drops abnormally indicates the point of restriction.
  - If the restriction has caused such high pressure that the system cannot be operated, you must work forward through the flow schematic, adding parts one at a time until an abnormal pressure increase (and hence, the restriction) is found.
  - If the restriction is in the tubing or fitting, remove the restriction by back flushing or by replacing the tubing or fitting.

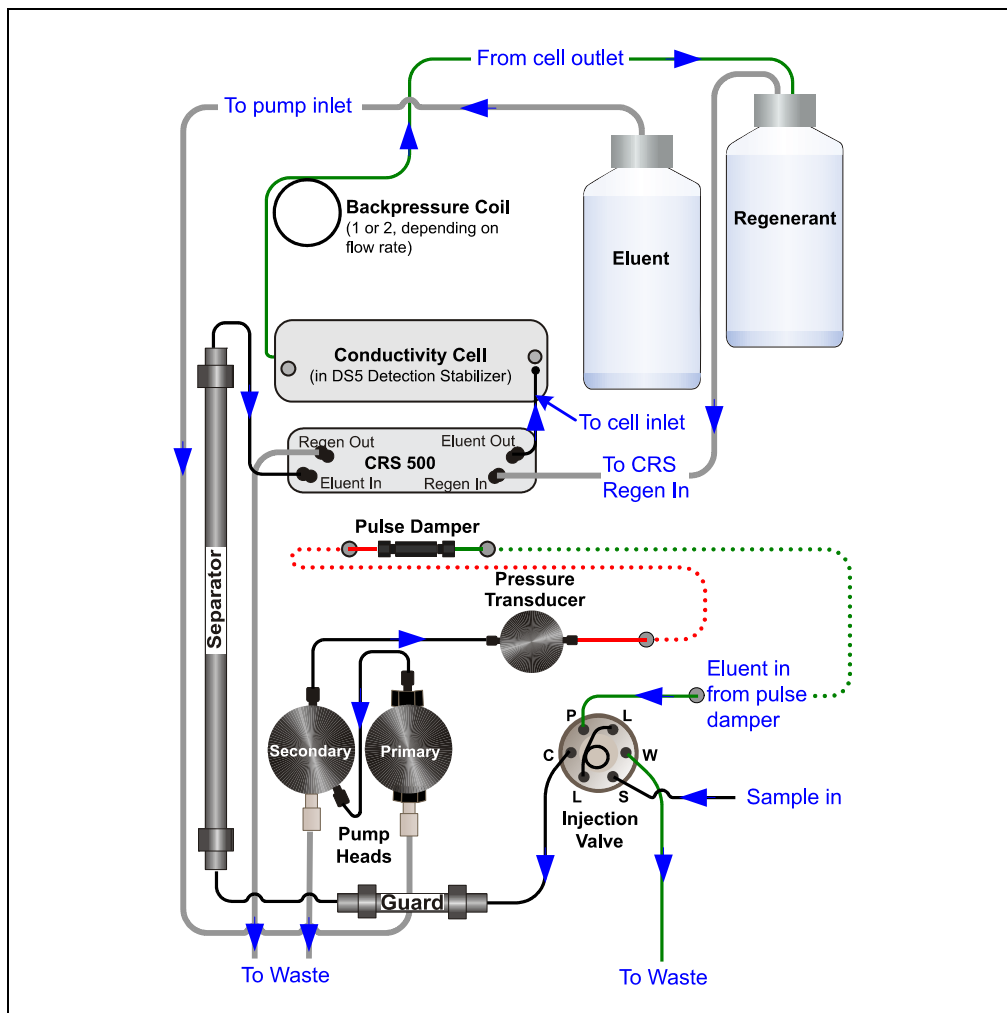

Figure 5-2. Dionex Easion Flow Schematic

## 5.4 Cleaning Eluent Bottles

Before preparing new eluent, all eluent bottles should be rinsed thoroughly (inside and out) with ASTM Type I (18.2 megohm-cm) filtered and deionized water. If a bottle still appears dirty, or if there is a slimy film on the inside, clean the bottle as instructed below.

1. Dispose of any remaining chemicals according to municipal regulations.
2. Rinse the bottle (inside and out) with ASTM Type I (18.2 megohm-cm) filtered and deionized water.
3. Rinse the inside of the bottle with isopropyl alcohol or methanol.
4. If algae or bacteria have left a slimy film on the bottle, use an algicide or disinfectant (for example, dilute hydrogen peroxide).
5. Rinse cleaning chemicals out of the bottle with ASTM Type I (18.2 megohm-cm) filtered and deionized water.
6. Dry the bottle with clean, particulate-free air.

## 5.5 Changing the Sample Loop

A 10  $\mu$ L PEEK sample loop (P/N 042949) is installed on the injection valve at the factory. Unless you are using a 2 mm column, you can replace the sample loop with another 10  $\mu$ L PEEK sample loop. When using a 2 mm column, refer to the column manual for the loop size required.

1. Click the pump **Off** button on the Chromeleon ePanel.
2. Open the Dionex Easion front door.
3. Disconnect the sample loop from ports **L** and **L** on the injection valve (see [Figure 5-3](#)).

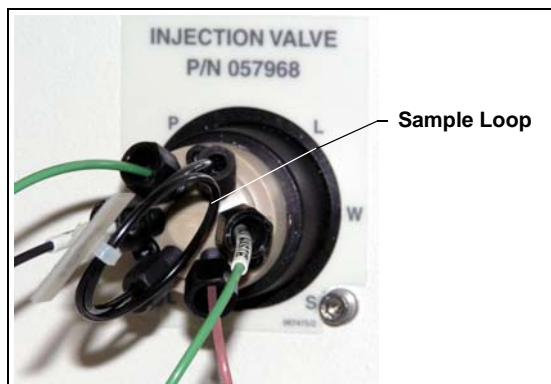

Figure 5-3. Dionex Easion Injection Valve

4. Install the new sample loop between the two ports.
5. Make sure the loop is tightly coiled, so that the door can close securely.
6. Click the pump **On** button on the Chromeleon ePanel.
7. Check for leaking fittings and tighten if required.
8. Close the Dionex Easion front door.

### 5.6 Replacing Pump Check Valves

A dirty check valve causes erratic flow rates and pressures. In addition, it may cause the pump to lose prime and/or be difficult to reprime.

Thermo Fisher Scientific recommends replacing both check valves at the same time. If new check valves are not available, clean the check valves and reinstall them (see [Section 5.7](#)).

#### To remove the old check valves:

1. Turn off the Dionex Easion power switch.
2. Disconnect the power cord.
3. Put on standard disposable laboratory rubber gloves (powder-free, particle-free, and oil-free) before disassembling the pump head.

**IMPORTANT**

**Never disassemble the pump head with bare hands. Even minute particles of dust or dirt on the check valves or piston can contaminate the inside of the pump head and result in poor pump performance.**

4. Disconnect the tube fittings from the inlet and outlet check valve assemblies on the primary pump head (see [Figure 5-4](#)).
5. Use a 1/2-inch wrench to loosen both check valve assemblies. Remove the check valve assemblies from the pump head.

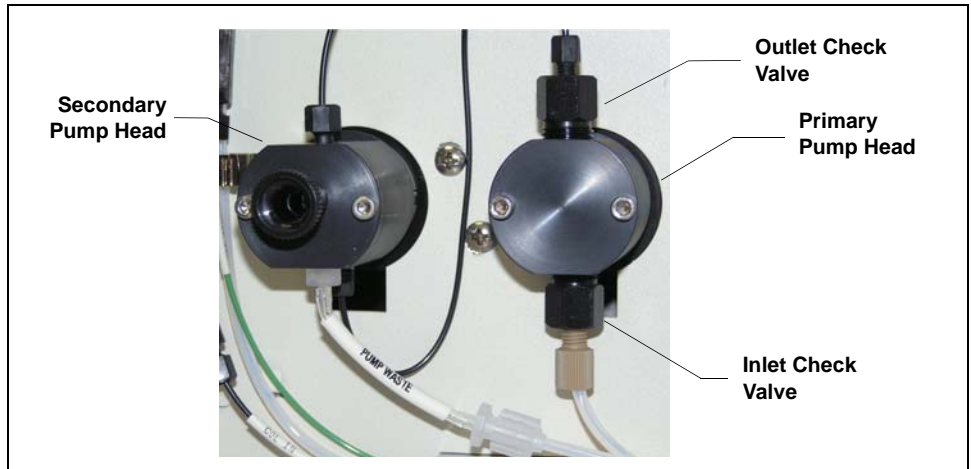

Figure 5-4. Pump Heads

**To install the new check valves:**

1. Inspect the new inlet check valve assembly (P/N 045722) to verify that the double-hole end of the cartridge is visible (see [Figure 5-5](#)).

If the double-hole end is not visible, remove the cartridge from the housing and install it correctly.

2. Inspect the new outlet check valve assembly (P/N 045721) to verify that the single-hole end of the cartridge is visible.

If the single-hole end is not visible, remove the cartridge from the housing and install it correctly.

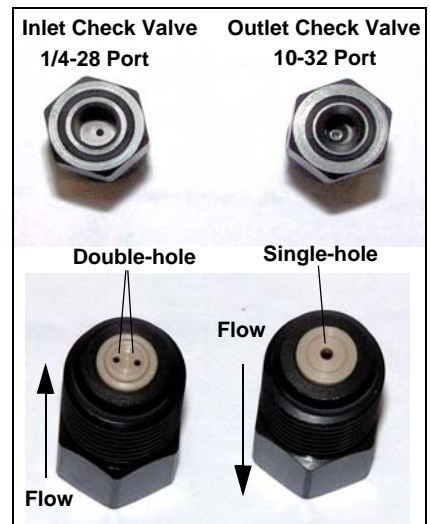

Figure 5-5. Check Valve Assemblies

**NOTE** The pump will not operate properly unless the cartridge is installed in the housing in the correct orientation. Liquid flows through the check valve in the large single hole and out the small double holes.

3. Install the inlet check valve assembly on the bottom of the primary pump head. Install the outlet check valve assembly on the top of the head. Tighten the check valves finger-tight, and then use a wrench to tighten an additional one-quarter to one-half turn.



**Overtightening may damage the pump head and check valve housing and crush the check valve seats.**

4. Reconnect the liquid lines and the power cord.
5. Turn on the Dionex Easion main power.
6. Prime the pump (see [Section 3.6](#)).
7. When the Dionex Easion is at operating pressure, check for leaks from the check valves. Tighten a check valve a *little more* only if it leaks.

## 5.7 Cleaning Pump Check Valves

If a check valve leaks or is dirty, both check valves should be replaced (see [Section 5.6](#)). However, if new check valves are not available, follow the instructions here to clean both check valves and reinstall them.

1. Follow [Step 1](#) through [Step 5](#) in the check valve replacement procedure to remove the check valve cartridges from the valve housings.
2. Place the check valve housings and cartridges in a beaker with methanol. Sonicate or agitate the parts for several minutes.
3. Rinse each check valve housing and cartridge thoroughly with filtered deionized water.
4. Follow [Step 1](#) through [Step 7](#) in the check valve replacement procedure to reinstall the check valves.



## 5.8 Replacing a Pump Piston Seal and Backup Seal

A damaged seal allows leakage past the piston, as well as leakage from the piston seal wash housing. This can cause unstable flow rates and baseline noise, and may make it difficult to prime the pump.

### Preparation:

1. Rinse the pump flow path with deionized water. Direct the flow to waste by opening the waste valve on the secondary pump head (see [Figure 5-4](#)). To open the valve, turn the knob one-half turn counterclockwise.
2. After rinsing, close the waste valve.

### To remove the pump head and piston:

1. Turn off the Dionex Easion power switch.
2. Disconnect the power cord.
3. Put on standard disposable laboratory rubber gloves (powder-free, particle-free, and oil-free) before disassembling the pump head.

**IMPORTANT**

**Never disassemble the pump head with bare hands. Even minute particles of dust or dirt on the check valves or piston can contaminate the inside of the pump head and result in poor pump performance.**

4. Disconnect all tubing connections to the pump head with the defective seal.
5. Using a 7/64-in hex key (P/N 068227), loosen the two screws on the pump head. Remove the screws, and then carefully remove the head and place it on a clean surface.
6. Slowly pull the pump head and allow it to separate from the housing. Carefully disengage the head from the piston by pulling the head straight off and away from its mounting studs.



**Lateral motion while disengaging the pump head from the piston may break the piston.**



**Un mouvement latéral pendant la séparation de la tête et du piston peut casser le piston.**



Vermeiden Sie Seitwärtsbewegungen, wenn Sie den Pumpenkopf vom Kolben lösen. Andernfalls kann der Kolben brechen.

7. Place the pump head (front end down) on a clean work surface.
8. The piston does not come off as part of the pump head assembly because it is captured by a magnetic retention system. After removing the pump head, hold the shaft of the piston (near the base), tilt the piston slightly, and pull the piston away from the pump.

Refer to [Figure 5-6](#) or [Figure 5-7](#) when disassembling and reassembling the pump head.

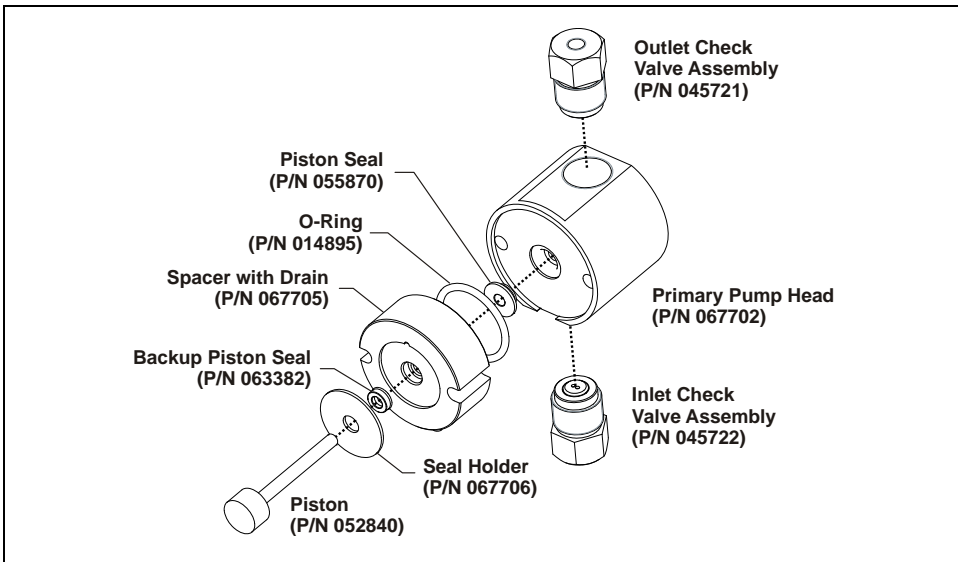

Figure 5-6. Primary Pump Head

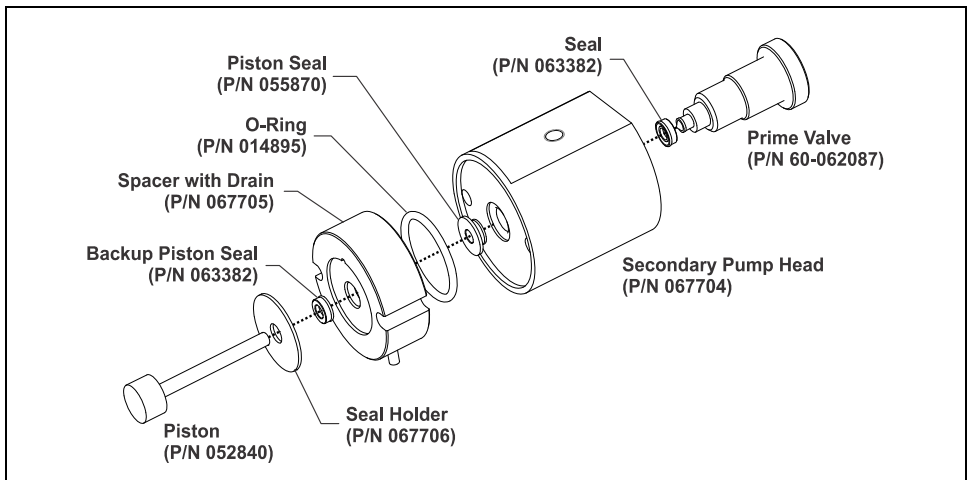
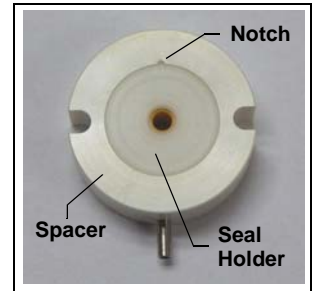

Figure 5-7. Secondary Pump Head

#### To install the new backup piston seal:

1. Lift the spacer off the pump head.
2. Remove the seal holder from the spacer, using one of the following methods:
  - With the seal holder facing up, cup the spacer in your hand and blow clean laboratory air at the spacer to dislodge the seal holder.
  - or–
  - Insert a thin object or pointed tool into the small notch on the spacer and carefully pry out the seal holder. **Be careful not to scratch the spacer.**
3. Insert a thin object (for example, the straightened end of a paper clip) into the spacer and carefully pry the backup piston seal out of the spacer. **Be careful not to scratch the spacer.**



4. To install the new backup piston seal:
  - a. Hold the new backup piston seal (P/N 063382) with the grooved side facing down, and insert the shaft of the piston through the seal.
  - b. Insert the piston into the center hole in the spacer.
  - c. Push the piston into the spacer until the top of the piston is flush with the spacer. A clicking sound indicates that the seal is correctly seated.

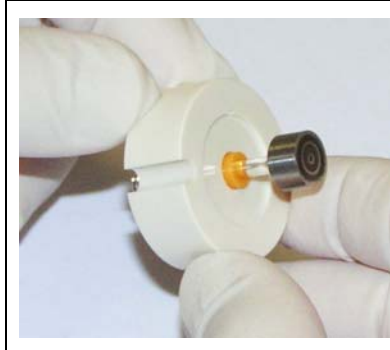
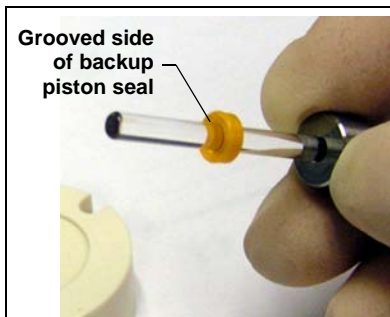

**IMPORTANT**

The backup piston seal is made of soft plastic. Do not press on the seal with anything hard or sharp, including your fingernail. If the seal is nicked or gouged, it will not seal properly and may result in leaks.

- d. Pull out the piston. The top of the seal should be flush with the surface of the spacer.
- e. Press the seal holder onto the spacer.

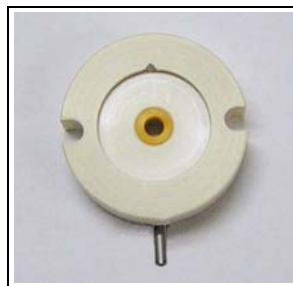

**To remove the old piston seal from the pump head:**

1. Fill the pump head cavity with deionized water by injecting the liquid through the piston opening.
2. Reinsert the piston about 3 mm (0.125 in) into the seal.

- If this is the *primary* pump head, install a 10-32 fitting plug (P/N 042772) on the outlet check valve. Tighten the plug.

If this is the *secondary* pump head, install a 10-32 fitting plug (P/N 042772) in both the inlet and outlet ports. Tighten the plugs.

- Push the piston into the pump head. (This should hydraulically unseat the seal from the head.) Remove the piston and pull off the seal.

**NOTE** If the piston seal is not removed, make sure the 10-32 fitting plug(s) are tight and add more water. Make sure the pump head contains no air bubbles, and then repeat Steps [2](#) and [4](#).

- Remove the 10-32 fitting plug(s).

#### To install the new piston seal:

- If this is the *secondary* pump head, open the waste valve knob by turning the knob one-half turn counterclockwise.
- Lubricate the seal and the pump head opening with a small amount of isopropyl alcohol to facilitate insertion.
- Push the piston through the spacer and then through the new piston seal.

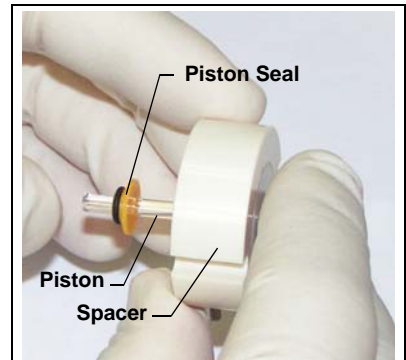

- Insert the piston and seal into the pump head.



5. To seat the seal, push down on the spacer until it is flush with the pump head. A clicking sound indicates that the seal is correctly seated.



6. Remove the spacer and piston and verify that the seal is flush with the surface of the pump head.

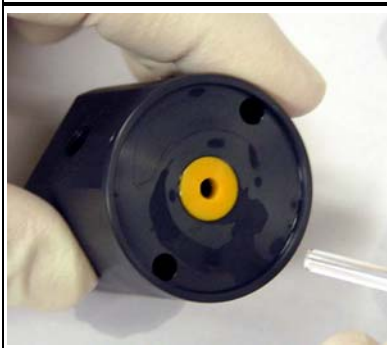

7. Verify that the O-ring is installed in the spacer.



**To reinstall the pump head and piston:**

Thermo Fisher Scientific recommends reinstalling the pump head and piston as a single assembly, so that the piston centers itself onto the magnetic follower.

1. Hold the assembled spacer and guide with the drain tube aligned vertically, and then press the spacer into the pump head until it is flush with the indented surface of the head.
2. Insert the piston so that about 6 mm (1/4 in) of the shaft remains exposed. This ensures that the magnet in the follower picks up the piston. (The follower is the cylinder that holds the piston in place as it moves in and out of the pump head assembly.)
3. Reinstall the pump head and piston assembly. Tighten the screws evenly.

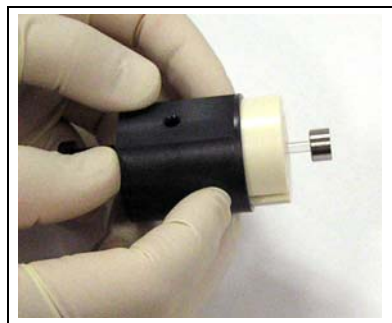
**To complete the procedure:**

1. Reconnect all liquid lines to the pump head.
2. Close the waste valve knob.
3. Turn on the Dionex Easion power switch.
4. Prime the pump (see [Section 3.6](#)).

## 5.9 Replacing a Pump Piston

Continued leaking of the piston seal after installation of a new seal (assuming the pump head is tight) indicates a dirty, scratched, or broken piston.

Follow the instructions in [Section 5.8](#) to install a new piston (P/N 052840) and piston seal (P/N 055870). Always replace the piston seal when replacing a piston.

## 5.10 Replacing the Waste Valve Seal

A damaged seal causes leakage around the base of the waste valve knob.

1. Turn off the Dionex Easion power switch.
2. To remove the waste valve from the pump head (see [Figure 5-8](#)), turn the knob counterclockwise until it is loose, and then pull the knob straight out of the cavity in the head.

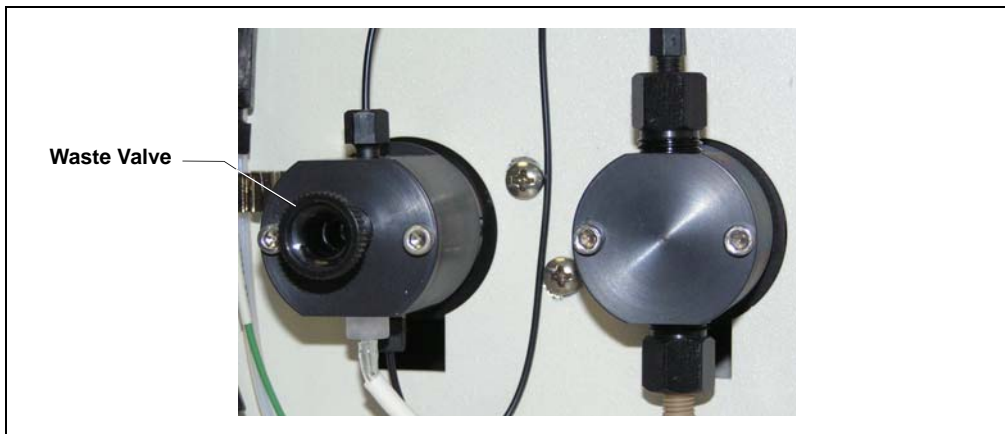

Figure 5-8. Waste and Priming Valves

3. If the seal is removed with the valve knob in [Step 2](#), pull the seal off the end of the knob (see [Figure 5-9](#)).

If the seal is *not* removed with the valve knob, insert a thin object (for example, the straightened end of a paper clip) into the cavity in the pump head and carefully pull out the seal. **Do not scratch the cavity.**

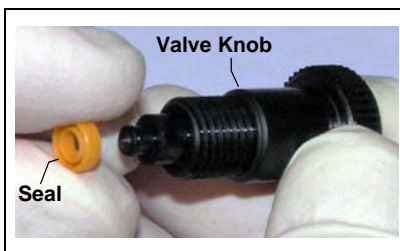

Figure 5-9. Waste Valve Seal Replacement

**IMPORTANT**

Scratches in the cavity will cause leaks around the base of the knob while the pump is being primed.



4. Orient the new seal (P/N 063382) with the grooved side away from the valve, and slide it over the end of the valve.
5. Insert the valve with the new seal into the pump head opening and turn the knob clockwise. Tighten finger-tight.
6. Turn on the Dionex Easion power switch.
7. Prime the pump (see [Section 3.6](#)).

## 5.11 Rebuilding the Injection Valve

Thermo Fisher Scientific recommends rebuilding the injection valve annually. The Injection Valve Rebuild Kit (P/N 075973) contains all the required replacement parts.

**NOTE** Substitution of non-Thermo Scientific/Dionex parts may impair valve performance and void the product warranty.

1. Click the pump **Off** button on the Chromeleon ePanel.
2. Open the front door of the Dionex Easion.
3. Disconnect each liquid line connected to the injection valve.
4. Follow the instructions provided in the Injection Valve Rebuild Kit to replace the rotor seal, isolation seal, and stator face.
5. Reconnect all liquid lines to the injection valve.
6. Close the Dionex Easion front door.
7. Click the pump **On** button on the Chromeleon ePanel.

## 5.12 Replacing the Conductivity Cell

1. Turn off the Dionex Easion power switch.
2. Disconnect the power cord.
3. Open the Dionex Easion front door.
4. Disconnect the black **ELUENT OUT** line from the **ELUENT OUT** port on the suppressor (see [Figure 5-10](#)).

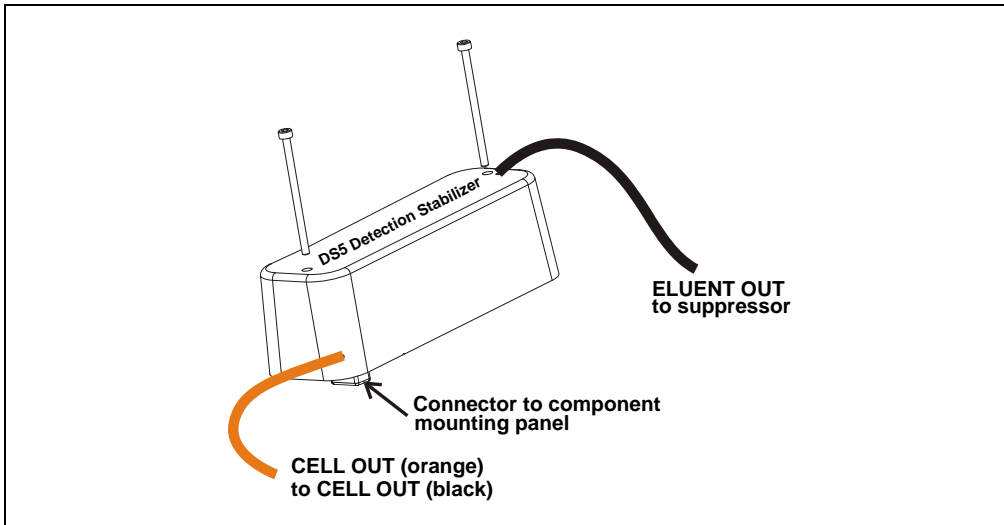

*Figure 5-10. Conductivity Cell Assembly*

5. Disconnect the orange **CELL OUT** line from the union that connects it to the black **CELL OUT** line.
6. Use an Allen wrench to remove the two screws on the top of the cell housing.
7. Remove the cell by unplugging it from the component mounting panel.
8. Plug the new conductivity cell (P/N 067761) into its mounting location.
9. Replace the screws on the top of the cell housing and tighten.
10. Attach the orange **CELL OUT** line from the cell to the union attached to the black **CELL OUT** line.
11. Attach the **ELUENT OUT** line to the **ELUENT OUT** port on the suppressor.
12. Close the Dionex Easion front door.
13. Reconnect the power cord and turn on the Dionex Easion power.

## 5.13 Replacing the Suppressor

Refer to the suppressor manual for guidance about when to replace a suppressor.

1. Click the pump **Off** button on the Chromeleon ePanel.
2. Open the front door of the Dionex Easion.
3. Disconnect the four eluent and regenerant lines from the suppressor.
4. Slide the suppressor to the left to detach it from the component mounting panel.
5. Slide the new suppressor to the right until it locks into place on the mounting panel.
6. Connect the four eluent and regenerant lines to the new suppressor.
7. Close the Dionex Easion front door.
8. Prime the pump (see [Section 3.6](#)).

## 5.14 Changing the Main Power Fuses

1. Turn off the Dionex Easion power switch.
2. Disconnect the power cord.



**HIGH VOLTAGE**—Disconnect the main power cord from its source and also from the rear panel of the Dionex Easion.



**HAUTE TENSION**—Débranchez le cordon d'alimentation principal de sa source et du panneau arrière du Dionex Easion.



**HOCHSPANNUNG**—Ziehen Sie das Netzkabel aus der Steckdose und der Netzbuchse auf der Rückseite des Dionex Easion.

3. The fuse drawer is located above the power switch (see [Figure 5-11](#)). A small tab locks the fuse drawer in place. Using a small screwdriver, press the tab *in* and *then up* to release the fuse drawer.
4. Pull the fuse drawer out of the rear panel and remove the old fuses.
5. Replace the two fuses with new fast-blow IEC 127 fuses rated 3.15 A (P/N 954745). Thermo Fisher Scientific recommends always replacing *both* fuses.

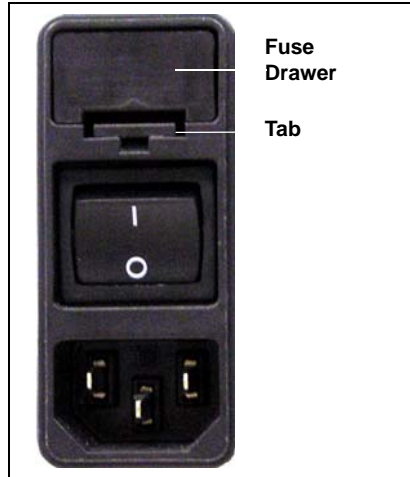

*Figure 5-11. Fuse Drawer*

6. Insert the fuse drawer into the rear panel and press until the drawer snaps into place.
7. Reconnect the main power cord and turn on the power.

### A.1 Electrical

<b>Main Power</b>	100 to 240 Vac, 50 to 60 Hz, autoranging Maximum input power: 90 W Maximum line draw: 1.5 A
<b>Fuses</b>	Two fast-blow IEC 127 fuses rated 3.15 A (P/N 954745)

### A.2 Physical

<b>Dimensions</b>	Height without bottles: 33 cm (13 in) Height with bottles and cap tubing: 60 cm (24 in) Width: 24 cm (9.5 in) Depth: 40 cm (15.75 in)
<b>Weight</b>	10 kg (22 lb)
<b>Decibel Level</b>	< 53 dBA

### A.3 Environmental

<b>Operating Temperature</b>	10 to 35 °C (50 to 95 °F)
<b>Humidity</b>	5% to 95% relative humidity, noncondensing

## A.4 Front and Rear Panel LEDs

### Front Panel LEDs

<b>Power</b>	Indicates when the power is on.
<b>Ready</b>	Indicates when the Dionex Easion is ready to acquire data; flashes if the system check fails.
<b>Run</b>	Indicates when the Dionex Easion is running/acquiring data; flashes if an error occurs.

### Rear Panel LED

<b>Link</b>	Indicates when there is communication between the Dionex Easion and Chromeleon; flashes when data is being transmitted or received.
-------------	---

## A.5 Pump

<b>Type</b>	Serial dual-reciprocating piston, microprocessor-controlled constant-stroke, variable-speed
<b>Construction</b>	Chemically inert, metal-free PEEK pump heads and flow path; compatible with aqueous eluents of pH 0 to 14 and reversed-phase solvents
<b>Operating Pressure</b>	0 to 35 MPa (0 to 5000 psi)
<b>Flow Rate Range</b>	0.00 to 5.00 mL/min, in increments of 0.01 mL/min (without changing pump heads)
<b>Flow Precision</b>	<0.1%
<b>Flow Accuracy</b>	<0.1%
<b>Pressure Ripple</b>	<1%
<b>Eluent Bottle Pressure</b>	None required

**Vacuum Degasser**      Optional with external vacuum degasser

## A.6 Injection Valve

**Injection Valve**      Two-position, six-port, electrically-activated Rheodyne valve

## A.7 Suppressors

**Chemical Suppression**      2 mm and 4 mm anion and cation

**Displacement Chemical Regeneration**      2 mm and 4 mm anion and cation

**Suppression Capacity**      Dionex ACRS 500 (4 mm): 150  $\mu\text{eq}/\text{min}$   
    Dionex ACRS 500 (2 mm): 37.5  $\mu\text{eq}/\text{min}$   
    Dionex CCRS 500 (4 mm): 150  $\mu\text{eq}/\text{min}$   
    Dionex CCRS 500 (2 mm): 37.5  $\mu\text{eq}/\text{min}$

**Void Volume**      Dionex ACRS 500 (4 mm): <50  $\mu\text{L}$   
    Dionex ACRS 500 (2 mm): <15  $\mu\text{L}$   
    Dionex CCRS 500 (4 mm): <50  $\mu\text{L}$   
    Dionex CCRS 500 (2 mm): <15  $\mu\text{L}$

**Sequential Suppression for Anions**      With a Dionex CRS 500 and a Thermo Scientific™ Dionex™ Carbonate Removal Device:

- The Dionex CRD 300 is designed for use with carbonate eluent-based chemistries.
- The Dionex CRD 200 is designed for use with hydroxide- and borate-based chemistries.

**Suppressor Wear Parts**      None; peristaltic pump and inline filters not required

## **A.8 Conductivity Detector and Flow Cell**

<b>Type</b>	Bipolar-heated conductivity cell; microprocessor-controlled digital signal processing over a range of 0 to 10,000 $\mu\text{S}/\text{cm}$
<b>Temperature Compensation</b>	Preset for accurate reading at 40 °C
<b>Cell Drive</b>	8 kHz square wave
<b>Auto Offset</b>	-9,999 to 9,999 $\mu\text{S}$
<b>Linearity</b>	1%
<b>Resolution</b>	0.0047 nS/cm
<b>Calibration</b>	Factory-calibrated before shipment to the user; calibrated in the field with memory retention and transfer
<b>Control and Data Evaluation</b>	Provided by Chromeleon software; communication with the Dionex Easion is via USB (Universal Serial Bus)
<b>Cell Body</b>	PEEK
<b>Cell Electrodes</b>	Passivated 316 stainless steel
<b>Cell Active Volume</b>	1 $\mu\text{L}$
<b>Maximum Cell Operating Pressure</b>	10 MPa (1500 psi)
<b>Cell Temperature</b>	Regulated at 40 °C
<b>Cell Chemical Compatibility</b>	Fully compatible with all typical ion chromatography eluents, including MSA



## A.9 Autosampler

<b>Automation Using Autosampler</b>	Dionex AS-DV Autosampler (or third-party autosampler)
<b>Sequential/Simultaneous Injection</b>	Dependent on autosampler capabilities
<b>Inline Sample Degassing</b>	Optional with Dionex CRD 200 or Dionex CRD 300
<b>Inline Filtration</b>	Dionex AS-DV Autosampler or inline filter
<b>High Automation Flexibility</b>	Conditionals using Chromeleon and post-run features
<b>Automated Sample Preparation</b>	Automated inline removal of alkaline earth and transition metals, surfactants, or anions, and neutralization of acidic or basic samples can be achieved using optional Dionex Guardcap vial caps

## A.10 System Software

<b>Software</b>	Chromeleon 7 Chromatography Data System; validated for use with Windows 10 or Windows 8.1
<b>Automated Procedure Wizards</b>	Standard feature
<b>System Wellness</b>	Standard feature
<b>Virtual Column Simulator</b>	<ul style="list-style-type: none"> <li>• <b>Evaluation mode:</b> Standard feature</li> <li>• <b>Isocratic and gradient modes:</b> Optional features</li> </ul>
<b>Application Templates</b>	Standard feature
<b>Automation Support for Third-Party Vendors</b>	Fully controls over 300 different instruments (including GC, HPLC, and MS) from more than 30 manufacturers
<b>Customizable System Control Panels</b>	Standard feature

<b>System Status</b>	Standard feature
<b>Virtual Channels</b>	
<b>Power Failure Protection</b>	Standard feature
<b>Sequential Injection</b>	Standard feature for independent dual-system analysis
<b>System Trigger Commands and Conditionals</b>	Standard feature
<b>Daily Audit Trail</b>	Standard feature
<b>Sample Audit Trail</b>	Standard feature
<b>Multiple Network Control and Network Failure Protection</b>	Optional feature
<b>Storage of System Calibration Settings</b>	Factory, current, and previous values stored; the user can reset current values to the factory or previous values
<b>Semiautomated System Qualification</b>	IQ/OQ/PQ procedures
<b>Customized Reporting</b>	Standard feature with unlimited report workbooks

## B • Reordering Information

---

Part Number	Item
<i>Pump</i>	
067701	Primary pump head assembly
067703	Secondary pump head assembly
045722	Inlet check valve assembly, 1/4-28
045721	Outlet check valve assembly, 10-32
055870	Piston seal
014895	O-ring
063382	Backup piston seal
067706	Seal holder
052840	Piston
<i>Sample Loop and Injection Valve</i>	
042949	10 $\mu$ L sample loop assembly
075973	Injection Valve Rebuild Kit
024305	Luer adapter fitting, 1/4-28 (for manual injections)
<i>Reagent Bottle Assemblies</i>	
062510	Eluent bottle assembly (includes stopper and cap)
068222	Anion regenerant bottle assembly (includes stopper and cap)
057713	Cation regenerant bottle assembly (includes stopper and cap)
059068	O-ring for eluent or regenerant bottle stopper
<i>Reagents</i>	
057559	Anion regenerant concentrate (75 mL of 2.0 N sulfuric acid)
057555	Anion regenerant concentrate (4-pack)
057561	Cation regenerant concentrate (100 mL of 2.06 M TBAOH)
057556	Cation regenerant concentrate (4-pack)

<b>Part Number</b>	<b>Item</b>
--------------------	-------------

### *Suppressors and Cell*

085090	Dionex ACRS 500 (4 mm) Chemically Regenerated Suppressor
085091	Dionex ACRS 500 (2 mm) Chemically Regenerated Suppressor
085092	Dionex CCRS 500 (4 mm) Chemically Regenerated Suppressor
085093	Dionex CCRS 500 (2 mm) Chemically Regenerated Suppressor
067761	Conductivity cell with DS5 Detection Stabilizer

### *Miscellaneous Items*

052324	Microbore Tubing Kit
960777	USB cable, 1.8 m (6 ft) long
954745	IEC 127 fast-blow fuses, rated 3.15 amps

### *Preventive Maintenance Kits*

088138	Dionex Easion Preventive Maintenance Kit
072678	Dionex AS-DV Preventive Maintenance Kit

## C • TTL and Relay Control

A 12-pin connector strip for TTL/relay control is located on the Dionex Easion rear panel. The connector provides two relay outputs, two TTL outputs, and four TTL inputs (see [Figure C-1](#)).

Pin Function	Description	
RELAY OUT	1	Solid State Relay Contacts Output
	2	
TTL OUT (+)	1	TTL Output 1 (1 k $\Omega$ pull up to +5, 100 mA sink)
	2	TTL Output 2 (1 k $\Omega$ pull up to +5, 100 mA sink)
TTL IN (+)	1	TTL Input 1 — Autozero
	2	TTL Input 2 — Inject/Load
	3	TTL Input 3 — Pump On/Off
	4	TTL Input 4 — Autozero
TTL GND (-)	1	Ground
	2	Ground

*Note: These are the default TTL input function assignments. Functions can be reassigned to any input.*

Figure C-1. TTL and Relay Connector



**Relay loads in excess of 200 mA or with included power supplies over 60 V may damage the relay drivers on the Dionex Easion's CPU board.**

TTL and relay outputs can be used to control functions in external devices (for example, an autosampler). Relay outputs 1 and 2 can be programmed to switch any low-voltage control. Switched current must be less than 200 mA and 60 V peak.

Relay outputs 1 and 2 can be configured to close when the pump flow is on and open when the pump flow is off, thus ensuring that a connected device is turned off when the pump flow is off. For more information, see [Section C.3](#).

When connected to a controlling device, the inputs can be programmed to perform the following Dionex Easion functions:

- Switch the injection valve position (load/inject)
- Set the conductivity to zero (autozero)
- Turn the pump on and off

## C.1 Connecting a TTL or Relay

1. Locate the 12-position connector plug (P/N 923686) (see [Figure C-2](#)) provided in the Dionex Easion Ship Kit (P/N 067768).
2. Locate the twisted pair of wires (P/N 043598) provided in the Ship Kit of the Dionex module you plan to connect to the Dionex Easion.
3. Follow these basic steps to connect the TTL or relays:

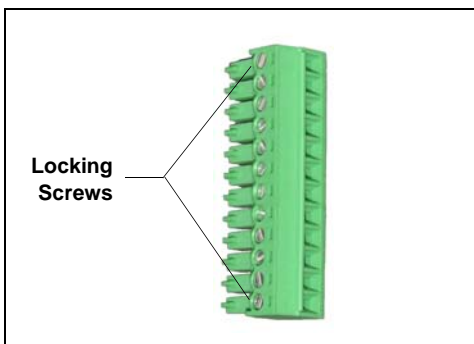

Figure C-2. 12-Position Connector Plug

- a. For each TTL or relay to be used, connect an active wire (red) and a ground wire (black) to the 12-position connector plug at the appropriate pin locations. For connector pin assignments, see either [Figure C-1](#) or the label on the Dionex Easion rear panel.

To attach a wire to the plug: Strip the end of the wire (if necessary), insert the wire into the plug, and use a screwdriver to tighten the locking screw. (You can attach multiple ground wires to a single TTL input/output ground pin.)



**When attaching wires to the connector plug, be careful not to allow stray strands of wire to short to the adjoining position on the connector.**

- b. Plug the connector into the 12-pin connector on the Dionex Easion rear panel.

- c. Connect the wires from the Dionex Easion connector plug to the TTL or relay connector pins on the other module(s). Additional connector plugs are provided with other Dionex modules.

**NOTE** Check the polarity of each connection. Be sure to connect signal wires to signal (+) pins and ground wires to ground (-) pins.

4. If you connected a TTL input, verify that the correct input control mode and function are assigned to the input. Select different settings, if necessary (see [Section C.2](#)).
5. If you connected a TTL output that you want to have turned on and off with the pump flow, select the **Flow Zero** option in the Chromeleon Instrument Configuration Manager (see [Section C.3](#)).

## C.2 Selecting TTL Input Control Modes and Functions

Follow the steps below to select a control mode and function for a TTL input.

1. Open the Chromeleon Instrument Configuration Manager.
2. In the Dionex Easion Properties dialog box, click the **TTL Inputs** tab.
3. Double-click the TTL input name (or select the name) and press the **F2** key. The Device Configuration dialog box for the selected input appears.
4. Select the preferred **Mode** and **Control Function**.
5. Click **OK**.

### TTL Input Control Modes

The Dionex Easion TTL inputs respond to four types of signals. The default control mode, **Normal Edge**, is compatible with the output signals provided by Thermo Scientific Dionex modules.

If the device connected to the Dionex Easion does not send a normal edge signal, select the appropriate control mode. Refer to the documentation provided with the controlling device, as well as the information below, to select the correct type.

- Normal Edge:* In normal edge operation, the negative (falling) edge of a signal turns on the function. For example, for the **Load/Inject** function, the negative edge switches the injection valve position to Load. For the **Pump On/Off** function, the negative edge turns on the pump. For the **Autozero** function, the negative edge performs an autozero command.

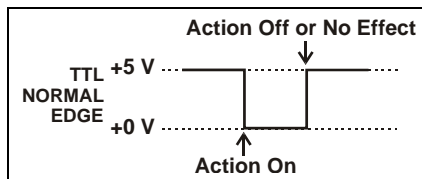

The action of the positive (rising) edge depends on the function. For example, for the **Load/Inject** function, the positive edge switches the injection valve to the Inject position. For the **Pump On/Off** function, the positive edge turns off the pump. For the **Autozero** function, the positive edge has no effect.

- Inverted Edge:* The inverted edge mode works identically to the normal edge mode except that the positive and negative edges are reversed in function.

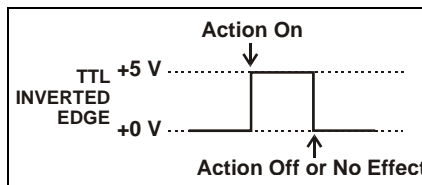

- Normal Pulse:* In normal pulse operation, the negative edge of the TTL signal is the active edge and the positive edge is ignored.

A pulse width of 50 ms or more is guaranteed to be detected. A pulse width of 4 ms or less is guaranteed to be ignored. The action for pulse widths that are greater than 4 ms and less than 50 ms is undefined.

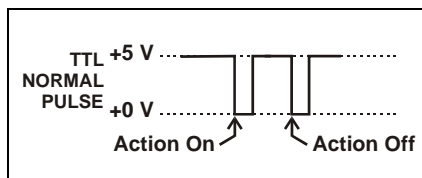

- Inverted Pulse:* The inverted pulse mode operates identically to the normal pulse mode except that the positive and negative edges are reversed in function.

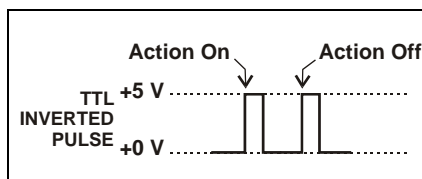



### C.3 Configuring Relay Output 1 or 2 to Respond to the Pump Flow

Follow the steps below to configure relay output 1 or 2 to open when the pump flow stops and close when the pump flow starts. The relay output can then be used to turn a connected device off and on with the pump flow.

1. Open the Chromeleon Instrument Configuration Manager.
2. In the Dionex Easion Properties dialog box, click the **State Devices** tab.
3. Select the relay output name (**Pump\_ECD\_Relay\_1** or **Pump\_ECD\_Relay\_2**) and press the **F2** key. The Device Configuration dialog box appears.
4. Select the **Flow Zero** check box.

To use the selected relay output for a different function, clear the **Flow Zero** check box. Chromeleon will then control the relay output (see [Section C.4](#)).

5. Click **OK**.

### C.4 Controlling TTL and Relay Outputs

The Dionex Easion provides two TTL outputs and two relay contacts for control of functions in external devices (for example, a Dionex AS-DV).

The TTL outputs are normally at 5 volts. Setting a TTL output to 0 volts turns on the action in the connected device.

The relay outputs can be used to switch any low-voltage control. Switched current must be less than 200 mA and 60 V peak blocking. The relay-contact closures are normally open; when the relay is closed, current flows to the connected device.



**Relay loads in excess of 200 mA or with included power supplies over 60 V may damage the relay drivers on the CPU.**

You can control the TTL and relay output states either by issuing direct control commands or by including commands in an instrument method.

#### **To directly control TTL and relay outputs:**

1. In Chromeleon, press the **F8** key to open the Command window.

2. Expand the list of commands under **Pump\_ECD** and select the TTL or relay output name.
3. Execute the command.

### **To program control of TTL and relay outputs:**

Include commands for control of the TTL and relay outputs in the Chromeleon instrument method. You can enter the commands in the Instrument Method Wizard (on the **Relay and State Devices Options** page) or in the Instrument Method Editor.

## D.1 How do I connect to the Dionex AS-DV?

For instructions on how to connect the Dionex Easion to the Dionex AS-DV, refer to the autosampler operator's manual.

## D.2 Why are the retention times moving?

Retention times can shift if the pump flow is erratic, or if the column or eluent is contaminated.

- To troubleshoot pump flow issues, see [Section 4.6](#).
- If you suspect eluent contamination: Remake the eluent, using concentrated eluent and ASTM Type I (18.2 megohm-cm) filtered and deionized water (see [Section 3.4](#)).
- If you suspect column contamination: Clean the column as instructed in the column manual.

Note that changes in ambient temperature will have an impact on peak retention times. The effect varies with the type of column installed, but it is generally more pronounced for certain cation analyses. The magnitude of the effect varies with the analyte and is proportional to the temperature changes that the column is exposed to.

## D.3 How do I adjust retention times?

Retention times are calculated during calibration. The **Use Recently Detected Retention Times** parameter in the Chromeleon Processing Method Editor (on the **General** tab page) can be used to compensate for some causes of retention time drift; for example, evaporation of volatile components in premixed solvents or an aging column. For more information, refer to the Chromeleon Help.

## D.4 When should I remake standards?

Standards are used for calibration and should always be made fresh. They have a lifetime of one week.

## D.5 When should I remake eluents?

- Eluents should be remade every two or three weeks. After refilling the eluent bottle, use the **Eluent Fill Volume** slider on the Chromeleon ePanel to reset the volume of liquid in the bottle.

**IMPORTANT**

To ensure the accuracy of the Eluent Fill Volume display, reset the volume each time the eluent bottle is filled.

- When you refill the eluent bottle, always remake the regenerant and fill the regenerant bottle with fresh regenerant.

**IMPORTANT**

The regenerant bottle must remain filled all the way to the top at all times.

## D.6 How do I shut off the system?

Click the pump **Off** button on the Chromeleon ePanel (see [Figure 2-10](#)).

–or–

Turn off the power switch on the Dionex Easion rear panel (see [Figure 2-3](#)).

## D.7 How do I store columns?

Columns should be stored in eluent. Refer to the column manual for complete instructions.

## D.8 How do I know when a column is dirty?

Refer to the troubleshooting section of the column manual.

## D.9 How do I clean a column?

Refer to the troubleshooting section of the column manual.

## D.10 Why is the conductivity high?

Possible reasons for high conductivity include:

- The suppressor needs regeneration. Refer to the troubleshooting section of the suppressor manual.
- The regenerant is exhausted and should be remade. See [Section 3.5](#) for instructions for how to prepare regenerant.
- The cell is out of calibration. Contact Technical Support for Dionex products for assistance.



## E • Introduction to Ion Chromatography (IC)

The Dionex Easion performs isocratic ion analyses using suppressed conductivity detection. An ion chromatography system such as the Dionex Easion typically consists of a liquid eluent, a high-pressure pump, a sample injector, a separator column, a chemical suppressor, and a conductivity cell. Before running a sample, the system is calibrated using a standard solution. By comparing the data obtained from a sample to that obtained from the standard, sample ions can be identified and quantitated. A PC running chromatography software converts each peak in a chromatogram to a sample concentration and produces a tabulated printout of the results.

The IC analysis consists of four stages (see [Figure E-1](#)).

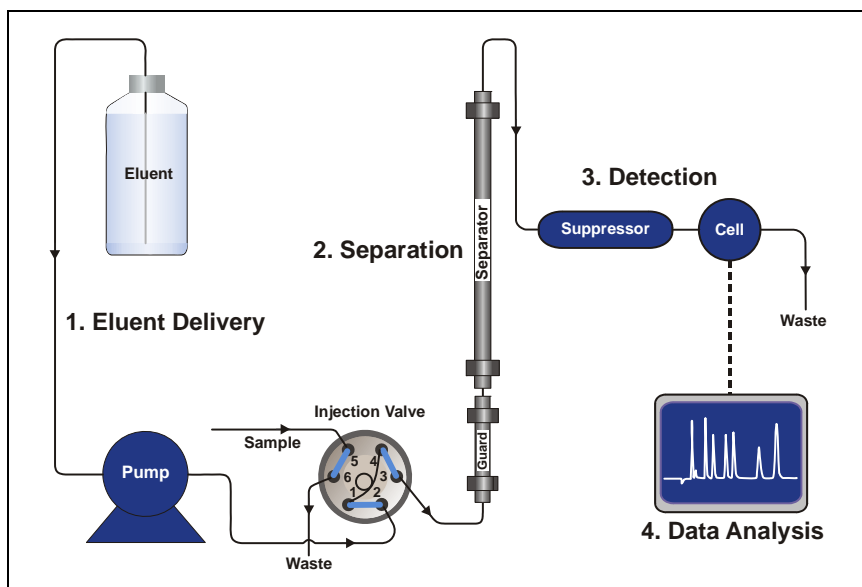

Figure E-1. Ion Analysis Process

### 1. Eluent Delivery

- Eluent, a liquid that helps to separate the sample ions, carries the sample through the ion chromatography system. The Dionex Easion is an isocratic delivery system. This means that the eluent composition and concentration remain constant throughout the run.

- Liquid sample is injected into the eluent stream either manually or automatically (if an autosampler is installed).
- The pump forces the eluent and sample through a separator column (a chemically-inert tube packed with a polymeric resin).

### **2. Separation**

- As the eluent and sample are pumped through the separator column, the sample ions are separated. In the Dionex Easion, the mode of separation is called ion exchange. This mode is based on the premise that different sample ions migrate through the IC column at different rates, depending upon their interactions with the ion exchange sites.

### **3. Detection**

- After the eluent and sample ions leave the column, they flow through a suppressor that selectively enhances detection of the sample ions while suppressing the conductivity of the eluent.
- A conductivity cell monitors and measures the electrical conductance of the sample ions as they emerge from the suppressor and produces a signal based on a chemical or physical property of the analyte.

### **4. Data Analysis**

- The conductivity cell transmits the signal to a PC running chromatography software.
- The chromatography software analyzes the data by comparing the sample peaks in a chromatogram to those produced from a standard solution. The software identifies the ions based on retention time, and quantifies each analyte by integrating the peak area or peak height. The results are displayed as a chromatogram, with the concentrations of ionic analytes automatically determined and tabulated.

**NOTE** For a glossary of chromatography terms, see [Appendix F](#).



### **Analytical Column**

Synonymous with **Separator Column**.

### **Band Spreading**

The broadening of the sample band as it travels through the column. Band spreading can also occur in the injection valve, detector cell, and interconnecting tubing.

### **Calibration Curve**

A graph showing detector response in peak height or area versus analyte concentration.

### **Capacity Factor ( $k'$ )**

The number of column volumes of eluent, pumped through the column, required to elute an analyte. Capacity factor is a dimensionless measure of retention which is independent of column length or eluent flow rate. It is calculated as follows:

$$k' = \frac{t_r - t_o}{t_o}$$

Where:  $t_r$  = retention time

$t_o$  = retention time of unretained solute (column void volume)

### **Cell Constant ( $k$ )**

A factor determined experimentally by measuring the conductance ( $G$ ) of a standard solution of known equivalent conductivity ( $\kappa$ ).

$$k = \kappa / G$$

The value of  $k$  depends upon the surface area of, and distance between, the electrode faces in the conductivity detector cell.

$$k = l / A$$

Where:  $l$  = length

$A$  = area of one electrode (the other electrode is equal to the first)

### Channeling

The preferential flow of liquid along more open, less resistant paths through the column packing. This causes **Band Spreading**.

### Column Efficiency (N)

A measure of the *narrowness* of analyte bands as they elute from the column. High efficiency is desirable because resolution between closely spaced bands improves with greater efficiency. For a symmetrical (Gaussian) peak, column efficiency can be determined by the following:

$$N = 5.54(t_1/W_{1/2})^2$$

Where:  $t_1$  = the peak retention time, in seconds

$W_{1/2}$  = the peak width at 1/2 height, in seconds

Column efficiency is proportional to column length: for a given resin and column diameter, increasing the column length increases the column efficiency.

Synonymous with **Theoretical Plates**.

### Column Selectivity (a)

Describes the relative separation of the band maxima between two adjacent peaks. Selectivity can be determined by the following:

$$a = (t_2 - t_0)/(t_1 - t_0)$$

Where:  $t_1$  and  $t_2$  = retention time of components 1 and 2, respectively

$t_0$  = retention time of unretained components (void volume)

### Concentrator Column

A short column used to retain and concentrate analytes from a measured volume of relatively clean sample. This allows large volumes of sample to be injected, lowering concentration detection limits.

### Conductivity

A measure of the ease with which electrical current flows through a liquid contained between two oppositely charged electrodes. Conductivity is a characteristic of ions in solution. Units are siemens.

### Counterion

Ions carrying a charge opposite that of the sample ions (for example,  $\text{Na}^+$ ) may be the counterion of a  $\text{Cl}^-$  analyte. These ions preserve electrical neutrality in solution.

**% Crosslink**

Divinylbenzene content in a polystyrene/divinylbenzene (PS-DVB) resin; this contributes to the mechanical strength of the resin and determines chromatographic properties.

**Equivalent Conductivity ( $\lambda$ )**

The contribution of an ionic species to the total conductivity of a solution as measured in a standard cell having electrodes 1 cm<sup>2</sup> in area and exactly 1 cm apart.

**Guard Column**

A small column that prevents poisoning of the separator column by sorbing organic contaminants and removing particulates. It is filled with the same packing as the separator column. Synonymous with **Pre-Column**.

**HETP (H)**

Height Equivalent to a Theoretical Plate. A measure of column efficiency which allows comparison between columns of different lengths.

$$\text{HETP} = H = L/N$$

Where: L = the column length (mm)

N = the number of theoretical plates

**Ion-Exchange Capacity**

The number of active ion exchange sites in a given weight or volume of resin; this is usually expressed in meq/g or meq/mL.

**Ion-Exchange Resin**

An insoluble polymer matrix containing fixed-charge exchange sites (anionic or cationic). IC resins are formed into small spherical particles (beads).

**Packing**

The material that fills a chromatographic column; usually a resin or silica-based material.

**Pellicular Resin**

A resin with a solid, nonporous core coated with a thin layer of more porous material. The exchange sites of pellicular ion-exchange resins are located only on the surface layer of the bead. These resins have a low ion-exchange capacity.

**Pre-Column**

Synonymous with **Guard Column**.

### **Regenerant**

A dilute acid or base which converts ion exchange sites in the suppressor back to the form which will suppress the eluent conductivity.

### **Resin**

See **Ion-Exchange Resin**.

### **Resolution (R)**

A measure of the separation between two sample components. It is expressed as the ratio of the distance between the two peak maxima to the mean value of the peak width at the baseline.

$$R = 2(t_2 - t_1)/(W_2 + W_1)$$

Where:  $t_1$  and  $t_2$  = the retention times of components 1 and 2, respectively

$W_1$  and  $W_2$  = the baseline width of peaks 1 and 2, respectively (measured in the same units as the retention time)

R is proportional to the square root of efficiency (N). A value of  $R = 1.5$  represents "baseline separation" of the two peaks.

### **Retention Time**

The time from injection to peak maximum; the basis for identification of a species in chromatographic analysis.

### **Separator Column**

The column used to perform a chromatographic separation; also called analytical column.

### **Siemens (S)**

Unit of conductance; the reciprocal of the electrical resistance of a solution.

### **Suppressor**

A device used to minimize eluent conductivity and convert sample species to a common form, thus increasing detection sensitivity.

### **Temperature Coefficient**

The percent of change in the conductivity of a solution with a 1 °C change in temperature. Every solution has a characteristic temperature coefficient which is determined experimentally.

### **Theoretical Plates (N)**

See **Column Efficiency**.

**Void Volume ( $V_0$ )**

The volume occupied by the eluent in a packed column. This volume includes the volume between the injection valve and the column, as well as between the column and the detector cell. Unretained components are eluted in the void volume.



## A

- Air particulate samples, 36
- Alarms, 10, 47
  - See also* Error messages
- Ambient temperature, 58
- Anion eluent, 11
- Anion regenerant, 11
  - Bottle assembly, 22
- Anion separations, 34
- AS-DV Autosampler
  - Instrument method example, 44
  - Sample loading, 41
  - Specifications, 89
- Audit trail, 10, 47, 63
  - Error messages, 48
- Auto offset requirements, 88
- Automated sample processing, 38
- Autozero, 34, 39

## B

- Background conductivity
  - High, 48, 57
  - Offsetting, 34
- Backpressure
  - Causes of excessive backpressure, 54, 67
  - Monitoring, 34
- Backpressure coils, 58
  - For microbore systems, 58
  - For standard bore systems, 58
- Backup piston seal
  - Replacing, 73
- Baseline conductivity, 34
- Baseline drift, 57
- Baseline noise, 17, 57
- Blockages
  - Liquid lines, 51, 67

## Bottle

- Eluent, 10
- Regenerant, 10
- Bottle, eluent
  - Cleaning, 69
  - Connecting, 30
  - Monitoring the liquid level, 28
- Bottle, regenerant
  - Connecting, 30

## C

- Cables
  - Power cord, 83
  - USB, 13
- Calibration, 61
  - Flow rate, 65
  - Pressure transducer, 63
- Carbonate eluent, 11
- Cation eluent, 11
- Cation regenerant, 11
  - Bottle assembly, 22
- Cation separations, 34
- Cell, 12, 22
  - Detection limit ranges, 23
  - High cell output, 57
  - Leaking, 53
  - No response, 56
  - Replacing, 81
- Check valves
  - Cleaning, 72
  - Replacing, 70 – 71
- Chromatogram
  - Monitoring, 39
- Chromeleon, 1, 23
  - Audit trail, 47
  - Audit trail error messages, 48
  - Canceling standby mode, 35

- Communication with Easion, 14, 54
- Configuring standby mode, 35
- Control modes, 24
- Eluent Fill Volume slider, 28
- Error messages, 47
- Instrument methods, 40, 43 – 44
- Processing methods, 40
- Sequences, 40
- Starting, 28
- System Wellness, 25
- User interface, 23
- Version required, 1
- Wellness panel, 61
- Columns
  - Cleaning, 100 – 101
  - Contaminated, 56
  - Separator and guard, 12
  - Storing, 100
- Commands
  - Creating an instrument method, 40
- Component mounting panel, 11, 23
- Conductivity
  - Background reading, 34
  - Baseline, 34
  - High conductivity causes, 101
  - Offsetting the background, 34
  - Temperature effect, 22
- Conductivity cell, 12, 22
  - Detection limit ranges, 23
  - High cell output, 57
  - Leaking, 53
  - Replacing, 81
  - See also* DS5 Detection Stabilizer
- Conductivity cell specifications
  - Active volume, 88
  - Cell body, 88
  - Chemical compatibility, 88
  - Electrodes, 88
  - Maximum pressure, 88
  - Temperature, 88
- Conductivity exceeds limit error, 48
- CRS 500 suppressor, 12, 20
  - See also* Suppressor

## D

- Data collection, 39
  - Cell temperature during, 22
- DCR
  - See* Displacement chemical regeneration
- Decibel level, 85
- Detection limit ranges, 23
- Detector signal plot, 39
- Detector specifications
  - Auto offset, 88
  - Calibration, 88
  - Cell drive, 88
  - Control and data evaluation, 88
  - Linearity, 88
  - Range, 88
  - Resolution, 88
  - Temperature compensation, 88
- Diagnostics, 61, 63
- Dionex Technical Support, 4, 47, 61
- Direct software control, 24
- Displacement chemical regeneration, 20
  - Anion bottle assembly, 22
  - Anion process, 20 – 21
  - Cation bottle assembly, 22
  - Cation process, 20 – 21
- Drifting baseline, 57
- DS5 Detection Stabilizer, 22
- Dummy cell, 57, 63

## E

- Easion
  - Component mounting panel, 23
  - Dimensions, 85
  - Flow rate range, 86
  - Front panel, 9
  - No USB communication, 54
  - Power-up conditions, 28
  - Regulatory compliance, 6
  - Software control, 1
  - Standby mode, 35
  - System flow path, 16



Top cover, 9  
Tubing assemblies, 66  
Weight, 85

Electrical specifications  
Fuses, 85  
Main power, 85

Electrochemical detector conductivity  
*See* Conductivity

Eluent, 11, 29  
Delivery process, 103  
Preparing, 28  
When to remake, 100

Eluent bottle, 10  
Cleaning, 69  
Monitoring the liquid level, 28

Eluent Fill Volume, 28

Environmental specifications  
Gas pressure, 85  
Humidity, 85  
Operating pressure, 85  
Operating temperature, 85

Equilibration time, 34

Error messages, 47  
Conductivity exceeds limit, 48  
Default severity levels, 48  
Flow rate calibration error, 48  
Load/inject valve error, 49  
Module data buffer overflow, 49  
Pump motor lost control, 49  
Pump pressure hardware error, 49  
Pump pressure slope calibration error, 50  
Remaining eluent below 100 mL, 50  
Remaining eluent below 200 mL, 50  
System pressure below low pressure limit, 51  
System pressure exceeds high pressure limit, 51

**F**

Fittings  
Leaking, 52  
Replacing, 66

Requirements, 66

Flashing LED, 10

Flow path, 16

Flow rate, 12  
Automatically reducing, 35  
Calibrating, 62, 65  
Standby mode, 35

Flow rate calibration error, 48

Flow rate range, 12, 86

Flow Zero option, 97

Fluid path, 16

Front panel, 9

Fuses, 14  
Changing, 83  
Requirements, 85

## G

Ghosting, 55  
Guard column, 12

## H

Heat exchanger, 22  
Humidity limits, 85

## I

Injecting samples, 19  
Chromleon commands, 44  
With a syringe, 42  
With an autosampler, 41

Injection port, 10  
Loading with a syringe, 42

Injection valve, 12, 19  
Flow schematic, 19  
Leaking, 53  
Rebuilding, 81  
Specifications, 87

Instrument methods (Chromleon)  
Autosampler control, 43 – 44  
Autosampler example method, 44

Creating instrument methods, 40  
Inverted pulse TTL input control, 96  
Ion chromatography overview, 103  
Ion exchange, 104  
Isocratic delivery system, 103

## L

### Leaks

Cell, 53  
Fittings, 52  
Injection valve, 53  
Liquid, 52  
Pressure transducer, 52  
Pump head waste valve, 52  
Suppressor, 53

### LEDs, 10

Link, 14  
Power, 10  
Ready, 10  
Run, 10

### Linearity requirements, 88

### Link LED, 14

### Liquid flow path, 16

### Liquid leaks, 52

### Load/inject valve error, 49

### Loading samples, 19, 42

With a syringe, 42  
With a vacuum syringe, 43  
With an autosampler, 41

## M

### Main power receptacle, 14

### Maintenance, 45

Daily, 45  
Ongoing, 45  
Weekly, 45  
Yearly, 45

### Manual sample processing, 38 – 39

### Methods

*See* Instrument methods (Chromeleon)

### Microbore system

Backpressure coil requirements, 58  
Microbore Tubing Kit, 58, 66  
Module data buffer overflow error, 49  
MSA eluent, 11, 29

## N

### Nitrite in samples, 36

### No detector response, 56

### Noisy baseline, 57

### Normal edge TTL input control, 96

### Normal pulse TTL input control, 96

## O

### Operating features, 9

### Operating temperature, 85

### Operation

Equilibration time, 34  
Injecting samples, 41, 43 – 44  
Loading samples, 42  
Main steps, 27  
Overview, 27  
Priming, 31  
Sample processing, 38

## P

### Panels

Component mounting panel, 11, 23  
Front panel, 9  
Rear panel, 13  
Wellness panel (Chromeleon), 61

### Parameters

Chromeleon commands, 40

### Peak ghosting

Troubleshooting, 55

### Peak height, nonreproducible

Troubleshooting, 56

### PEEK cell body, 22

- Physical specifications
    - Decibel level, 85
    - Dimensions, 85
    - Weight, 85
  - Piston
    - Replacing, 79
  - Piston seal
    - Replacing, 73 – 74
  - Plot, signal, 39
  - Power cord, 83
  - Power LED, 10
  - Power receptacle, 14
  - Power requirements, 85
  - Power switch, 14
  - Preparing samples, 35
  - Pressure
    - Monitoring, 34
  - Pressure limits, 18, 51
  - Pressure transducer, 12, 18
    - Calibrating, 62 – 63
    - Leaking, 52
  - Primary pump head, 17, 74
  - Priming, 31, 34
    - Troubleshooting, 53
    - With a syringe, 33
  - Processing methods (Chromeleon), 40
  - Processing samples, 38
    - Automatically, 38, 40
    - Manually, 38 – 39
  - Product warranty, voiding, 61
  - Programmed software control, 24
  - Pull method (sample loading), 43
  - Pulse damper, 17, 19
  - Pump, 17
    - Check valve cleaning, 72
    - Check valve replacement, 70
    - Flow rate range, 12
    - Piston seal replacement, 73
    - Primary pump head, 17
    - Priming, 31, 34
    - Priming problems, 53
    - Secondary pump head, 18
    - Troubleshooting, 53
  - Pump head waste valve
    - Leaking, 52
    - Seal replacement, 80
  - Pump motor lost control error, 49
  - Pump pressure hardware error, 49
  - Pump pressure slope calibration error, 50
  - Pump specifications
    - Construction, 86
    - Delay volume, 86
    - Eluent bottle pressure, 86
    - Eluent generation, 86
    - Flow accuracy, 86
    - Flow precision, 86
    - Flow rate range, 86
    - Gradient capabilities, 86
    - Operating pressure, 86
    - Pressure ripple, 86
    - Type, 86
    - Vacuum degasser, 86
  - Push method (sample loading), 42
- ## R
- Raw data
    - Saving, 39
  - Ready LED, 10
  - Rear panel, 13
    - Fuses, 14
    - Link LED, 14
    - Power receptacle, 14
    - Power switch, 14
    - Relay connector, 14
    - TTL connector, 14
    - USB receptacle, 13
    - Waste lines, 15
  - Regenerant, 11, 29
    - Acid concentrates, 29
    - Concentrate types, 29
    - Preparing, 29
  - Regenerant bottle, 10
    - Anion assembly, 22
    - Cation assembly, 22
    - Connecting, 30

- Regulatory compliance, 6
  - Relay control, 93
    - Rear panel connector, 14
  - Relay outputs
    - Direct control, 97
    - Instrument method control, 98
    - Responding to pump flow, 97
    - Voltage and current specifications, 93
  - Remaining eluent below 100 mL error, 50
  - Remaining eluent below 200 mL error, 50
  - Reordering information, 91
  - Replacing tubing and fittings, 66
  - Retention time
    - Adjusting, 99
    - Moving, 99
    - Troubleshooting, 56
  - Rheodyne valve, 19
  - Run LED, 10
- ## **S**
- Safety messages, 4
  - Sample loading
    - With a syringe, 42 – 43
    - With an autosampler, 41
  - Sample loop, 19
    - Changing, 69
    - Injecting, 19
    - Loading, 19, 42 – 43
  - Sample processing, 38
    - Automated, 38
    - Manual, 38 – 39
  - Samples
    - Collecting and storing, 35
    - Diluting, 36
    - Filtering, 35
    - Injecting, 41, 43 – 44
    - Loading, 41 – 43
    - Preparing, 35
    - Pretreating, 36
    - Processing, 38
  - Seal replacement, 74
  - Secondary pump head, 18, 75
  - Selectivity
    - Troubleshooting, 56
  - Separator column, 12
  - Sequences (Chromleon), 40
  - Service chase, 13
  - Service procedures, 71
    - Backup piston seal replacement, 73
    - Cell replacement, 81
    - Check valve cleaning, 72
    - Check valve replacement, 70
    - Eluent bottle cleaning, 69
    - Fuse replacement, 83
    - Injection valve rebuilding, 81
    - Piston replacement, 79
    - Piston seal replacement, 73
    - Removal of liquid line restriction, 67
    - Sample loop replacement, 69
    - Suppressor replacement, 83
    - Tubing and fitting replacement, 66
    - Waste valve seal replacement, 80
  - Signal plot, 39
  - Software control, 1
    - Modes, 24
  - Software specifications, 89
  - Spare parts, 91
  - Specifications
    - Autosampler, 89
    - Conductivity cell, 88
    - Detector, 88
    - Electrical, 85
    - Environmental, 85
    - Injection valve, 87
    - Physical, 85
    - Pump, 86
    - Supressors, 87
    - System software, 89
  - Standard bore system
    - Backpressure coil requirements, 58
  - Standards
    - When to remake, 100
  - Standby mode, 35
    - Canceling, 35
    - Configuring, 35
  - Status LEDs, 10

Sulfite in samples, 36  
Sulfuric acid concentrate, 29  
Sulfuric acid regenerant, 11  
Suppressor, 12, 20  
    Leaking, 53  
    Replacing, 83  
Suppressor specifications  
    Chemical suppression, 87  
    Displacement chemical regeneration, 87  
    Electrolytic suppression, 87  
    Sequential suppression for anions, 87  
    Suppression capacity, 87  
    Suppressor wear parts, 87  
    Void volume, 87  
Syringe injection, 42  
    Vacuum, 43  
System pressure, 18  
    Monitoring, 34  
System pressure over high pressure limit, 51  
System pressure under low pressure limit, 51  
System shutdown, 100  
System status, 62  
System Wellness, 25

## T

TBAOH concentrate, 29  
TBAOH regenerant, 11, 29  
Technical Support, 4, 47, 61  
Temperature  
    Compensating, 22  
    During data collection, 22  
    Heating the cell, 22  
    Minimizing the effect of variations, 22  
Top cover, 9  
Transducer, 12  
Troubleshooting, 56  
    Backpressure is excessive, 54  
    Baseline drift, 57  
    Baseline noise, 57  
    Cell output is high, 57  
    Detector output is high, 57  
    Diagnostics, 61

Error messages, 47  
Liquid leaks, 52  
No cell response, 56  
No detector response, 56  
No pump flow, 54  
Peak ghosting, 55  
Peak height is nonreproducible, 56  
Pressure is erratic, 54  
Pump does not start, 53  
Pump flow is erratic, 54  
Pump priming issues, 53  
Retention time is abnormal, 56  
Retention time is nonreproducible, 56  
Selectivity is abnormal, 56  
System status, 62  
TTL and relay connector, 93  
    Connection instructions, 94  
    Pin assignments, 93  
TTL and relay control  
    Rear panel connector, 14  
TTL control, 93  
TTL inputs  
    Default function assignments, 94  
TTL outputs  
    Direct control, 97  
    Instrument method control, 98  
Tubing chase, 13  
Tubing connections  
    Isolating a restriction, 51, 67  
    Replacing, 66  
    Requirements, 66

## U

USB cable, 13, 92  
    Connected incorrectly, 54  
USB receptacle, 13

## V

Valve  
    *See* Check valves

See Injection valve

See Waste valve

## **W**

Waranty, voiding, 61

Waste lines, 15

Blocked, 52

Waste valve, 18

Opening, 18, 73

Seal replacement procedure, 80

Water samples, 36

Wellness panel (Chromeleon), 61 – 62

Audit trail, 63

Diagnostics, 63

Dummy cell test, 63

Flow rate calibration, 62

Opening, 63, 65

Presssure transducer calibration, 62

System status, 62