

**Phason
PEC
Plus**



PARAMETERS

F

↓

↑

←

STAGES

VAR 1 ●

VAR 2 ●

RLY 1 ○

RLY 2 ○

RLY 3 ●

RLY 4 ○

RLY 5 ○

RLY 6 ○

ALARM ○

FUNCTIONS

A ○ GROWTH CURVE

B ○ VARIABLE STAGES

C ○ RELAYS

D ○ ACTUATORS

○ TEST

○ CONFIGURATION

1

A - Current day
B - Off at
C - Temp set point
D - Actuator stage

2

A - Curve step
B - Idle speed
C - Open/Idle band
D - Temp set point

3

A - Duration
B - Temp set point
C - Close
D - Position

4

A - Starting temp
B - Range temp
C - On
D - Differential

5

A - Group set point
C - Off





LR 61791



User manual and installation guide

Copyright 2009 Phason Inc.
All rights reserved.

Printed in Canada
31040003
2009-06-19

How to use this manual

This section is a ‘quick-reference guide’ of the manual. You can look at the chart on the next page to help you find what you are looking for. If you are not sure where to find something specific, look in the **Table of contents** at the front of the manual or the **Index** on page 96.

Below are some helpful suggestions.

- ◆ If you have not installed and configured your PEC Plus, read **Chapter 2: Installing your PEC Plus** on page 9 and **Chapter 3: Configuring your PEC Plus** on page 27.
- ◆ If you are ready to install, configure, or program your PEC Plus, use the worksheets starting in **Appendix D** on page 84.
- ◆ If you are not sure how to use the keypad or how to read the display and menus, read **Becoming familiar with the PEC Plus** on page 5.
- ◆ If you need to program your PEC Plus or adjust settings (set points, growth curves, fan speeds, etc.), read **Chapter 4: Programming the PEC Plus** on page 41.
- ◆ If you have an alarm condition or warning displayed and are not sure what it means, look at **Appendix B: Troubleshooting** on page 77.
- ◆ If you are not sure of the meaning of a term, look it up in the **Glossary** on page 73.

Quick reference guide

◇ PEC Plus overview, features, and accessories ◇ Manual overview	Chapter 1 Starting on page 1
◇ Installation instructions ◇ Equipment installation (probes, fans, actuators, and so on) ◇ Electrical ratings ◇ PEC Plus layout (map of the inside and outside of your PEC Plus)	Chapter 2 Starting on page 9
◇ Configuration instructions ◇ Zone, probe, and sensor assignments ◇ Variable and relay stage assignments	Chapter 3 Starting on page 27
◇ Programming instructions ◇ Group settings (set points and growth curves) ◇ Equipment settings (set points, fan speeds, and so on) ◇ Alarm settings	Chapter 4 Starting on page 41
◇ Status display ◇ Diagnostic tests ◇ PIN security ◇ Service and maintenance	Chapter 5 Starting on page 61
◇ Glossary ◇ Troubleshooting ◇ Factory settings ◇ Installation worksheets ◇ Configuration worksheets ◇ Settings worksheets	Appendixes Starting on page 73

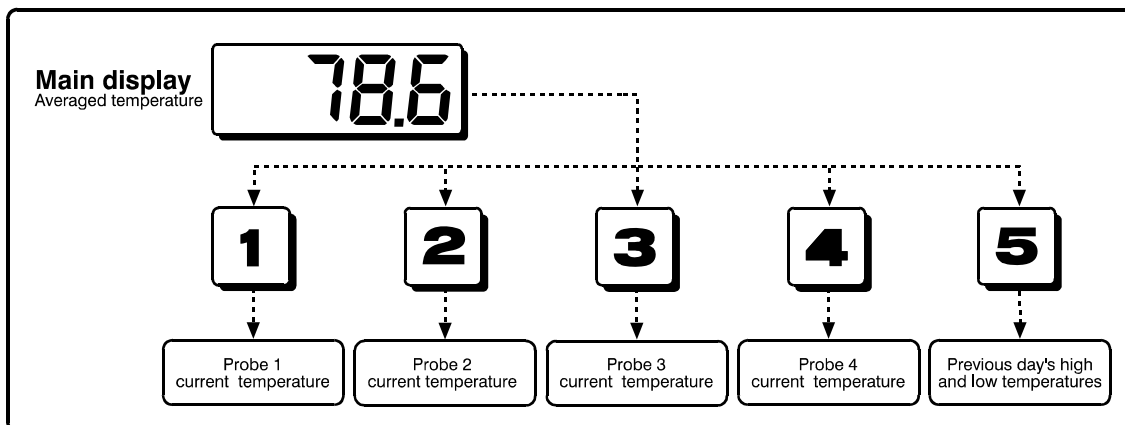

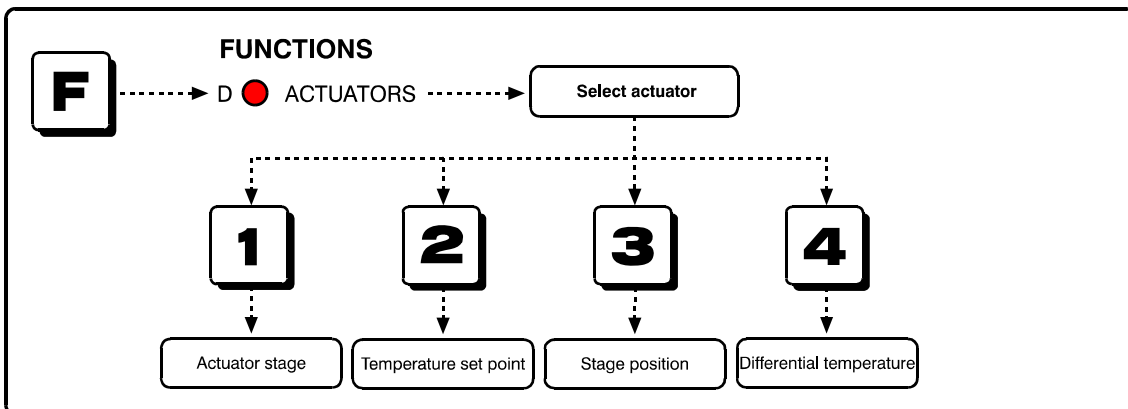
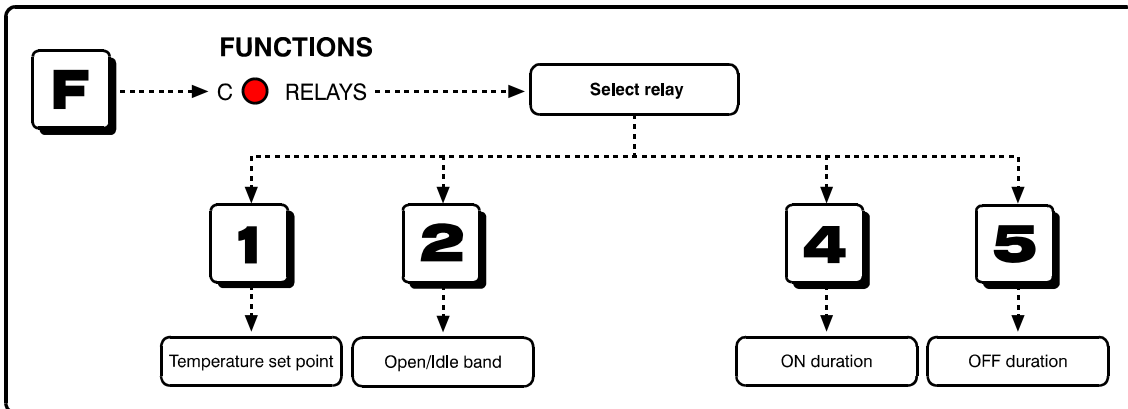
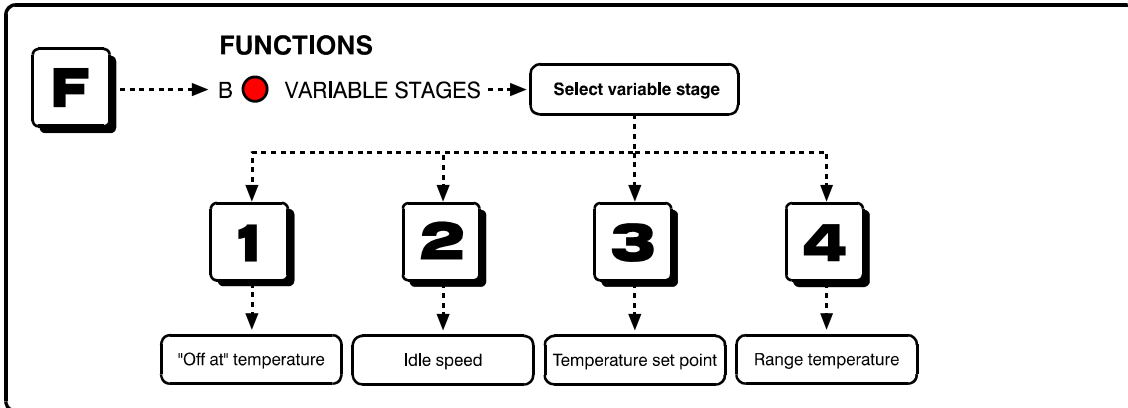
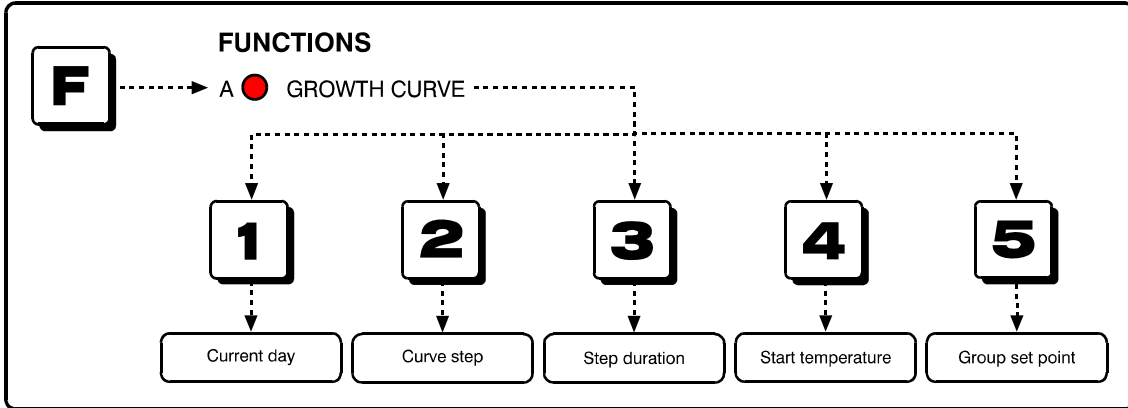

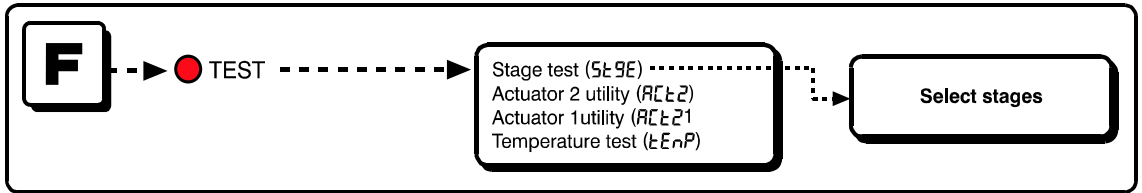
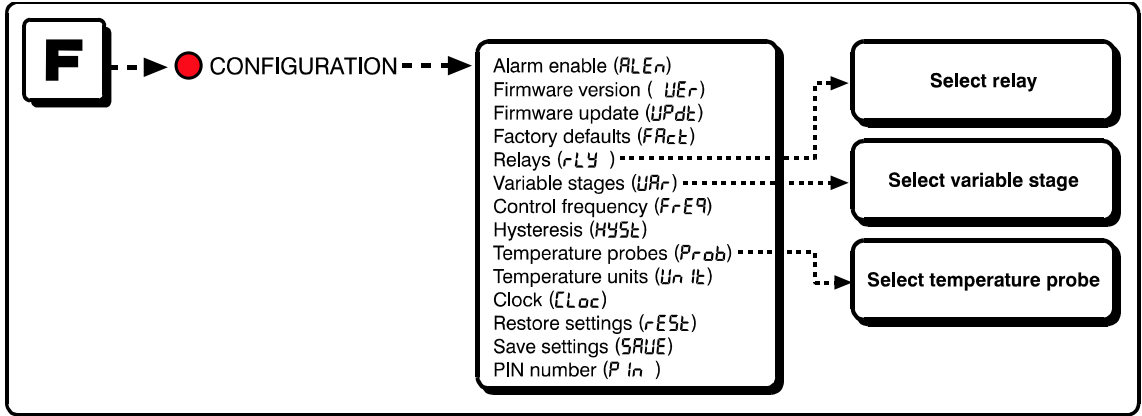

Limited warranty

This warranty applies only to the Phason PEC Plus. If you need warranty service, return the product and original proof of purchase to your dealer.

Phason Inc. (Phason) warrants the PEC Plus subject to the following terms and conditions.

This warranty is valid only to the original purchaser of the product, for two years from the manufacturing date. The manufacturing date is stated in the first eight digits of the serial number in the form year-month-day.

Phason hereby warrants that should the PEC Plus fail because of improper workmanship, Phason will repair the unit, effecting all necessary parts replacements without charge for either parts or labor.

Conditions

- ◆ Installation must be done according to our enclosed installation instructions.
- ◆ The product must not have been previously altered, modified, or repaired by anyone other than Phason.
- ◆ The product must not have been involved in an accident, misused, abused, or operated or installed contrary to the instructions in our user and/or installation manuals. Phason's opinion about these items is final.
- ◆ The person requesting warranty service must be the original purchaser of the unit, and provide proof of purchase upon request.
- ◆ All transportation charges for products submitted for warranty must be paid by the purchaser.

Except to the extent prohibited by applicable law, no other warranties, whether expressed or implied, including warranties of merchantability and fitness for a particular purpose, shall apply to the PEC Plus. Any implied warranties are excluded.

Phason is not liable for consequential damages caused by the PEC Plus.

Phason does not assume or authorize any representatives, or other people, to assume any obligations or liabilities, other than those specifically stated in this warranty.

Phason reserves the right to improve or alter the PEC Plus without notice.

Service and technical support

Phason will be happy to answer all technical questions that will help you use your PEC Plus. Before contacting Phason, check the following:

- ◆ Read this manual for information about the feature with which you are having trouble.
- ◆ If you see an alarm message and are not sure what it means, look it up in the **Alarm and error messages** table on page 77 and then follow the instructions for resolving the alarm condition.
- ◆ If you are having a problem using your PEC Plus, look in the **Troubleshooting** table on page 79 and then follow the directions for correcting the problem.
- ◆ If you still have a problem with your PEC Plus, collect the following information:
 - ◆ The serial number
 - ◆ Any messages displayed by your PEC Plus
 - ◆ A description of the problem
 - ◆ A description of what you were doing before the problem occurred

	2 Terracon Place	Phone	204-233-1400
	Winnipeg, Manitoba	Fax	204-233-3252
	Canada	E-mail	support@phason.ca
	R2J 4G7	Web site	www.phason.ca

Phason controls are designed and manufactured to provide reliable performance, but they are not guaranteed to be 100 percent free of defects. Even reliable products can experience occasional failures and the user should recognize this possibility.

If Phason products are used in a life-support ventilation system where failure could result in loss or injury, the user should provide adequate back up ventilation, supplementary natural ventilation, or an independent failure-alarm system. The user's lack of such precautions acknowledges their willingness to accept the risk of such loss or injury.

Table of contents

Chapter 1: Introducing the PEC Plus	1
Introducing the PEC Plus	1
Features	2
Optional accessories	3
About the manual	4
Becoming familiar with the PEC Plus	5
Menu layout	7
Entering a PIN	8
Chapter 2: Installing your PEC Plus	9
What you need to know before installing your PEC Plus	9
Understanding power surges and surge suppression	9
Electrical ratings	10
Precautions, guidelines, and warnings	11
PEC Plus layout	13
Mounting your PEC Plus	14
Connecting equipment to your PEC Plus	14
Connecting actuators	14
Connecting single-stage heating or cooling elements	17
Connecting curtain machines	18
Connecting variable-stage cooling elements	19
Using three-phase power	20
Connecting an alarm system	21
Connecting temperature probes	22
Extending probe cables	23
Connecting the power source	24
Finishing the installation	25
Verifying your connections	25
Closing the cover	25
Chapter 3: Configuring your PEC Plus	27
What you need to know before configuring your PEC Plus	27
Configuring the main control functions	29
Setting the clock	29
Selecting the temperature units	30
Configuring temperature probes	31
Configuring hysteresis	32
Configuring variable stages	33
Configuring relays	34
Configuring relays for actuators	34
Calibrating actuators	35
Configuring relays for curtains	36
Configuring relays for single-stage heating and cooling or duty cycles	37
Testing the configuration	39

Chapter 4: Programming the PEC Plus	41
What you need to know before programming your PEC Plus.....	41
Programming target temperatures.....	42
Programming the group set point	42
Programming the growth curve	43
Programming the stages.....	46
Programming variable stages.....	46
Programming actuators	49
Programming curtain control relays	52
Programming heating and cooling elements and duty cycles.....	54
Programming alarm settings	58
Chapter 5: Monitoring and maintaining your PEC Plus.....	61
Monitoring your PEC Plus.....	61
Displaying individual probe temperatures.....	61
Displaying high and low temperatures	62
Acknowledging alarms	62
Testing settings and equipment	63
Using stage test mode.....	63
Using temperature test mode	64
Using the actuator 1 and 2 test utilities.....	65
Using PIN security.....	66
Servicing and maintaining your PEC Plus	67
Restoring the factory defaults.....	69
Saving and restoring settings	69
Displaying the firmware version.....	71
Updating the firmware	71
Appendixes	73
Appendix A: Glossary	73
Appendix B: Troubleshooting	77
Alarm and error messages	77
Troubleshooting.....	79
Determining correct actuator feedback wiring	82
Appendix C: Factory defaults.....	83
Appendix D: Installation worksheet.....	84
Appendix E: Configuration worksheets	86
Main control function worksheet.....	86
Variable stage configuration worksheet	87
Relay configuration worksheet	88
Appendix F: Settings worksheets	89
Growth curve worksheet.....	89
Variable stage settings worksheet	90
Actuator settings worksheet	91
Curtain worksheet.....	93
Heating and cooling elements worksheet	94
Alarm settings worksheet.....	95
Index.....	96

Chapter 1: Introducing the PEC Plus

Chapter 1 introduces you to your PEC Plus and the layout of this manual. Read this chapter before reading the rest of the manual.

Topics in chapter 1 include:

- ◆ **Introducing the PEC Plus** below
- ◆ **About the manual** on page 4
- ◆ **Becoming familiar with the PEC Plus** on page 5

Introducing the PEC Plus

The PEC Plus is designed to control ventilation equipment for a single room. The eight-stage control has two variable cooling stages for controlling fans and six relay stages for controlling equipment such as actuators, curtain machines, single-speed fans, and heaters.

The control comes with a 30-foot temperature probe that is extendable to 500 feet. Automatic four-zone temperature averaging and outdoor temperature monitoring are available with additional temperature probes.

The PEC Plus automatically monitors and controls the temperature by operating ventilation equipment such as fans, heaters, inlet actuators, curtain machines, or other equipment according to your programmed settings.

The seven-step growth curve is a powerful feature that allows you to program the control to automatically adjust the temperature set points over time to control the temperature in a room or zone. This is an ideal feature to use as your animals grow and their temperature requirements change.

The PEC Plus is ideal for poultry, livestock, greenhouse, or light-industrial buildings and is compatible with most ventilation strategies: natural, forced, tunnel, and chimney ventilation.

Easy to use and program

The PEC Plus's display shows the ambient temperature and any alarm messages. During normal operation, the status LEDs show when the stages are on.

When in programming mode, the LEDs indicate which stage you are programming. The easy-to-use keypad and menu system make the PEC Plus one of the easiest controls to program. The PEC Plus' advanced and powerful features are never more than a few keystrokes away.

Security and peace of mind

The PEC Plus has a PIN (personal identification number) security system. When you enable security, users must enter the PIN before they can access a specific menu or function. This allows you to control who makes changes to your system and its settings.

The PEC Plus is compatible with most alarm systems. You can connect your PEC Plus to an alarm siren or other external alarm system. The customizable list of alarm settings allows you to choose which alarm conditions you want to be notified about.

Features

- ◆ Two variable stages for controlling fans
- ◆ Six relay stages (heat, cool, duty cycle, curtain, or actuator control)
- ◆ One alarm relay (for external alarm siren or alarm system)
- ◆ Temperature monitoring and control, with up to four-probe averaging
- ◆ Adjustable temperature settings
- ◆ Configurable seven-step growth curve
- ◆ Customizable alarm settings
- ◆ Three-second full-power-turn-on for minimizing fan ice-up
- ◆ Daily high and low temperature display
- ◆ Power-failure memory protection
- ◆ PIN security
- ◆ Four-character LED display and individual stage LEDs
- ◆ On-board diagnostics and self tests
- ◆ Thirty-foot temperature probe, extendable to 500 feet (additional probes available)
- ◆ Rugged enclosure (corrosion resistant, water resistant, and fire retardant)
- ◆ CSA approval
- ◆ Two-year limited warranty

Optional accessories

Several optional, convenient accessories are available to enhance and extend your PEC Plus.

PEC+ Saver

The PEC+ Saver is an innovative and easy-to-use product that allows you to store your PEC Plus configuration and settings.

The PEC+ Saver stores a complete copy of all a PEC Plus' configuration and settings. You can restore the configuration and settings any time, or even use them to set up new PEC Plus' in seconds!

PEC+ Saver features

- ◆ Quick and easy to use
- ◆ Portable, reliable, and safe storage of configuration and settings
- ◆ Transferable to any PEC Plus that has the same firmware version
- ◆ Compact design – fits in a pocket
- ◆ 90-day limited warranty

PEC+ Updater

The optional PEC+ Updater is an innovative and easy-to-use product that allows you to upgrade your PEC Plus's firmware.

Phason constantly improves and adds new features to their products. With the PEC+ Updater, you can upgrade the firmware in your PEC Plus as these features become available. The PEC+ Updater takes only seconds to use and can upgrade all the PEC Plus controls at your site.

PEC+ Updater features

- ◆ Quick and easy to use
- ◆ Compact design – fits in a pocket
- ◆ 90-day limited warranty

Temperature probes and extension cable

Temperature probes monitor temperatures ranging from -49 to 122°F (-45 to 50°C). The probes are available in 1, 6, 30, 75, or 150-foot cable lengths and can be extended up to 500 feet using extension cable. Extension cable is available in 500-foot lengths.



Temperature probe features

- ◆ Easy installation
- ◆ Rugged and durable design
- ◆ Weather and UV-resistant cable
- ◆ 90-day limited warranty

About the manual

The manual describes the features of your PEC Plus and how to use them. It does not describe ventilation strategies or equipment (such as fans) you can connect to your PEC Plus.

This manual uses the following styles:

- ◆ All buttons and menu commands are **bolded**.
For example: Press **Function** until the LED for GROWTH CURVE is lit.
- ◆ All LED display examples are in a seven-segment font.
For example: Press **Up** or **Down** until **Act 1** is displayed and then press **Select**.

Hint/tip



This is a hint or tip. It contains helpful information that might make it easier for you to set up or use your PEC Plus.

Note



This is a note. It contains information that may help you better understand your PEC Plus.

Caution



This is a **caution**. It contains important information that you must follow when installing or servicing your PEC Plus. Failure to follow this information can lead to damaged controls or equipment.

Warning



This is a **warning**. It contains important safety information that you must follow when installing or servicing your PEC Plus. Failure to follow this information can lead to damaged controls or equipment, electrical shocks, or severe injury.

Becoming familiar with the PEC Plus

The PEC Plus has a four-character LED display, status LEDs for each variable stage and relay, function LEDs, and 10 buttons for programming and interacting with the control.

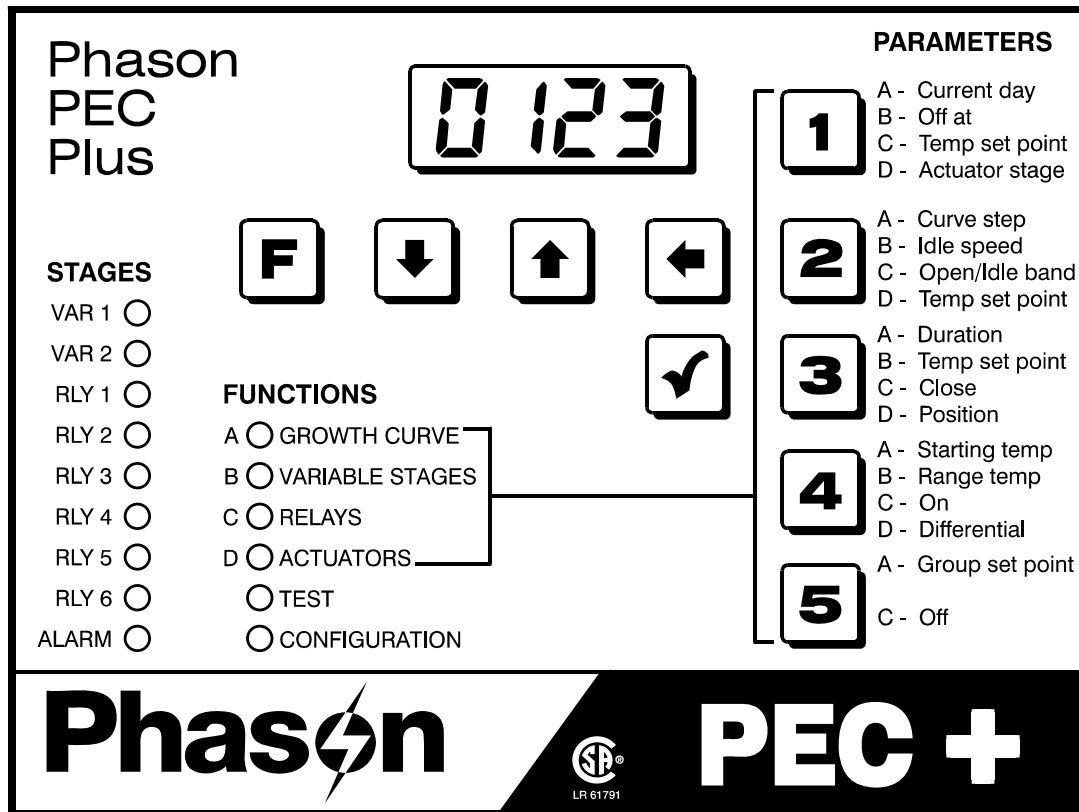

Main display

The four-character, seven-segment LED display shows ambient temperatures, alarm messages, and programming information.



NOTE

If you leave the PEC Plus in a menu or display other than the main display, the control returns to the main display after five minutes without any key presses. The only exceptions are stage test mode and temperature test mode; the control remains in these modes until you manually exit them.

Buttons

The five main control buttons (**Function**, **Down**, **Up**, **Back**, and **Select**) allow you to scroll through the function menus and enter programming information.

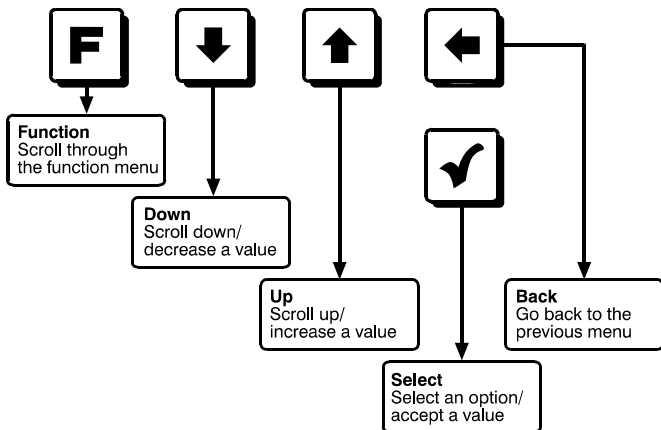

PARAMETERS

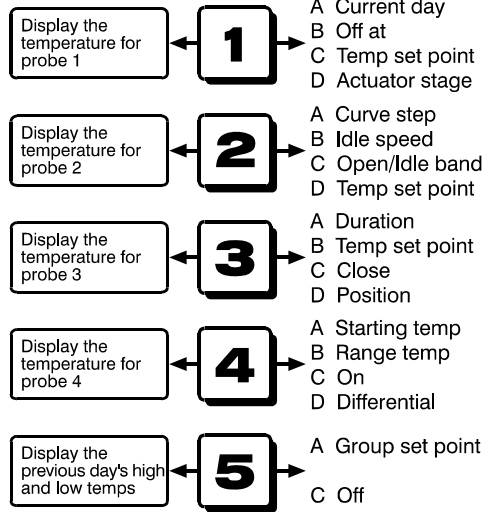

The Parameter buttons display temperature information and allow you to select which settings, or parameters, you want to program.

Status LEDs

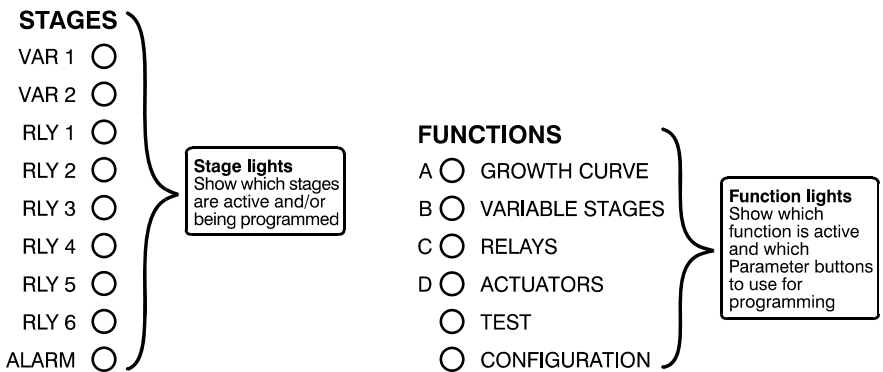

Menu layout

The table below shows the layout of the PEC Plus menu system.

<p>Growth curve >>Parameter A<<</p>	<p>Configuration</p>
<p>1 Current day 2 Curve step 3 Step duration 4 Start temperature 5 Group set point</p>	<p>Alarm enable (ALEn) High temperature (HIEn) Low temperature (LOEn) Probe damage (PDEn) Probe deviation (PDEx) Actuator 1 jam (Rc1E) Actuator 2 jam (Rc2E)</p>
<p>Variable stages >>Parameter B<<</p>	<p>Firmware version (VER) Firmware update (UPdt) Factory defaults (FRct)</p>
<p>Select variable stage 1 or 2 1 "Off at" temperature 2 Idle speed 3 Temperature set point 4 Range temperature</p>	<p>Relays (rLY) Select relay 1 to 6 Always off (OFF) Advanced duty cycle (dctZ) Actuator 1 (Rct1) – only for relays 1 and 2 Actuator 2 (Rct2) – only for relays 3 and 4</p>
<p>Relays >>Parameter C<<</p>	<p>Duty cycle heat (dctH) Duty cycle cool (dctC)</p>
<p>Select variable stage 1 or 2 1 Temperature set point 2 Idle band 4 ON duration 5 OFF duration</p>	<p>Heat (HERe) Cool (COOL) Curtain (Curt) Always on (On)</p>
<p>Actuators >>Parameter D<<</p>	<p>Variable stages (VAR) Select variable stage 1 or 2 Always off (OFF) Cool (COOL)</p>
<p>Select actuator 1 or 2 1 Actuator stage 2 Temperature set point 3 Position 4 Differential</p>	<p>Frequency (FREq) Hysteresis (HYSt) Temperature probes (Prab) Select probe 1 to 4 Probe disabled (P#oF) Probe enabled (P#on)</p>
<p>Test</p>	<p>Probe enabled for outdoor temp (P4ot) – only for probe 4</p>
<p>Stage test mode (StGE) Select variable stage or relay Actuator 2 utility (Rct2) Actuator 1 utility (Rct1) Temperature test mode (TEnP)</p>	<p>Temperature units (UnIt) Clock (CLoc) Restore settings (rEst) Save settings (SRUE) PIN number (PIn)</p>

Entering a PIN

If security is enabled, users must enter the PIN (personal identification number) before they can access the control's functions. After entering a PIN, the control will not ask again until five minutes have passed since the last key press. For more information, read **Using PIN security** on page 66.

When you are required to enter a PIN, the display shows

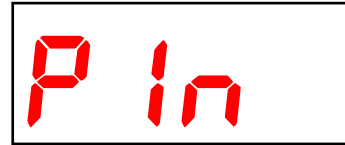

To enter a PIN

When prompted, enter the four-digit PIN using the parameter buttons.

NOTE

The display does not show the PIN as you enter it.

If you enter the PIN incorrectly, the display shows *FR IL*.

Chapter 2: Installing your PEC Plus

Chapter 2 explains how to mount, install, and connect equipment to your PEC Plus.

Topics in chapter 2 include:

- ◆ **What you need to know before installing your PEC Plus** below
- ◆ **Connecting equipment to your PEC Plus** on page 14
- ◆ **Finishing the installation** on page 25

What you need to know before installing your PEC Plus

Before installing your PEC Plus, you need to do some initial preparation:

1. Read **Understanding power surges and surge suppression** below.



If you do not install external surge suppression devices, you risk damage to the electronics inside your PEC Plus, which may cause your PEC Plus to fail.

Because it is not possible to *completely* protect this product internally from the effects of power surges and other transients, we *highly recommend* that you install external surge suppression devices. For specific recommendations, see your electrical contractor.

If you do not take these precautions, you acknowledge your willingness to accept the risk of loss or injury.

2. Using **Appendix D: Installation worksheet** on page 84, list all the equipment you want to control using this PEC Plus. Install the equipment and make your electrical connections according to the sheet.
3. Using **Appendix E: Configuration worksheets** on page 86, decide which relays and variable stages you want to use for each piece of equipment, and how you want the equipment configured. You can connect more than one piece of equipment to a single relay or stage *as long as the total current draw does not exceed* the relay or stage's limit. For more information, read **Electrical ratings** on page 10.

Understanding power surges and surge suppression

Power surges can be caused by external influences (outside the barn – for example, lightning or utility distribution problems) or they can be caused internally (inside the barn – for example, starting and stopping inductive loads such as motors).

One of the most common causes of power surges is lightning. When lightning strikes the ground, it produces an enormously powerful electromagnetic field. This field affects nearby power lines, which transmit a surge to any device connected to it, such as lights, computers, or environmental controls like your PEC Plus. Lightning does not have to actually strike a power line to transmit a surge.

Surge suppression devices offer some protection from power surges. Because it is not possible to internally protect this product completely from the effects of power surges and other transients, Phason *highly recommend* that you install external surge suppression devices. For specific recommendations, see your electrical contractor. If you do not take these precautions, you acknowledge your willingness to accept the risk of loss or injury.

Electrical ratings

Input power	120/230 VAC, 50/60 Hz
Variable stages ① (2: VARI-1, VARI-2)	10 A at 120/230 VAC, general-purpose (resistive) 7 FLA at 120/230 VAC, PSC motor 1/2 HP at 120 VAC, 1 HP at 230 VAC, PSC motor
Fuses (2: F1 and F2)	15 A, 250 VAC ABC-type ceramic
Relay stages ① (6: STG-1 to STG-6)	10 A at 120/230 VAC, general-purpose (resistive) 1/3 HP at 120 VAC, 1/2 HP at 230 VAC 360 W tungsten at 120 VAC
Alarm relay	0.4 A at 125 VAC; 2 A at 30 VDC, resistive load 0.2 A at 125 VAC; 1 A at 30 VDC, inductive load
① You can connect more than one piece of equipment to a variable stage or relay as long as they are the same type (for example, two fans) and the total current draw does not exceed the stage's limit.	

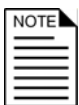

The FLA (full load ampere) rating accounts for the increase in motor current draw when the motor operates at less than full speed. Make sure the motor/equipment connected to the variable stage does not draw more than 7 FLA.

Precautions, guidelines, and warnings

Read **Servicing and maintaining your PEC Plus** on page 67.



The PEC Plus must be installed by a qualified electrician.

Before installing or servicing the PEC Plus, switch OFF the power at the source.

Install the PEC Plus and all equipment connected to it according to local electrical codes.

Mount the control on a sheltered, vertical surface, with the electrical knockouts facing down.

Use a screwdriver to tighten the screws in the enclosure. Do not use a drill or over tighten the screws; this can crack the enclosure and ruin the watertight seal.

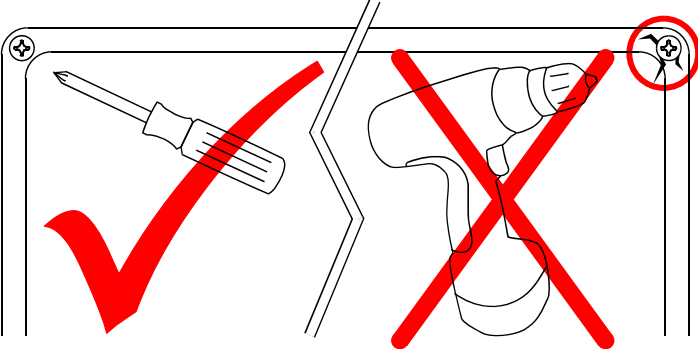



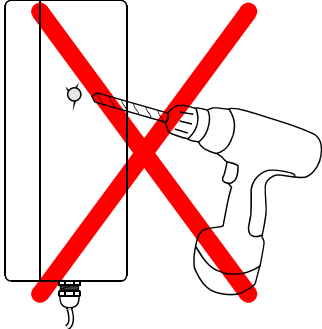

Use the electrical knockouts for bringing wires or cables into or out of the enclosure. Use watertight strain reliefs or conduit connectors at all cable-entry points.

Do not make additional holes in the enclosure; this can damage the watertight seal or control components and void the warranty.

Routing data wires

Routing data wires in the same conduit as, or beside AC power cables, can cause electrical interference, erratic readings, and/or improper control. Data wires include **all** of the following:

- ◆ Temperature probe and humidity sensor cables
- ◆ Actuator feedback (potentiometer) wires
- ◆ Data communication wires, including RS-232/RS-485
- ◆ Any cable or wire that does not provide AC power

Guidelines for routing data wires

- ◆ Do not run the wires in the same conduit as AC power cables.
- ◆ Do not run the wires beside AC power cables or near electrical equipment.
- ◆ When crossing other cables or power lines, cross them at a 90-degree angle.

If in doubt, **do not run any wire or cable that is not an AC-power wire** inside the same conduit or beside other AC-power wires.

PEC Plus layout

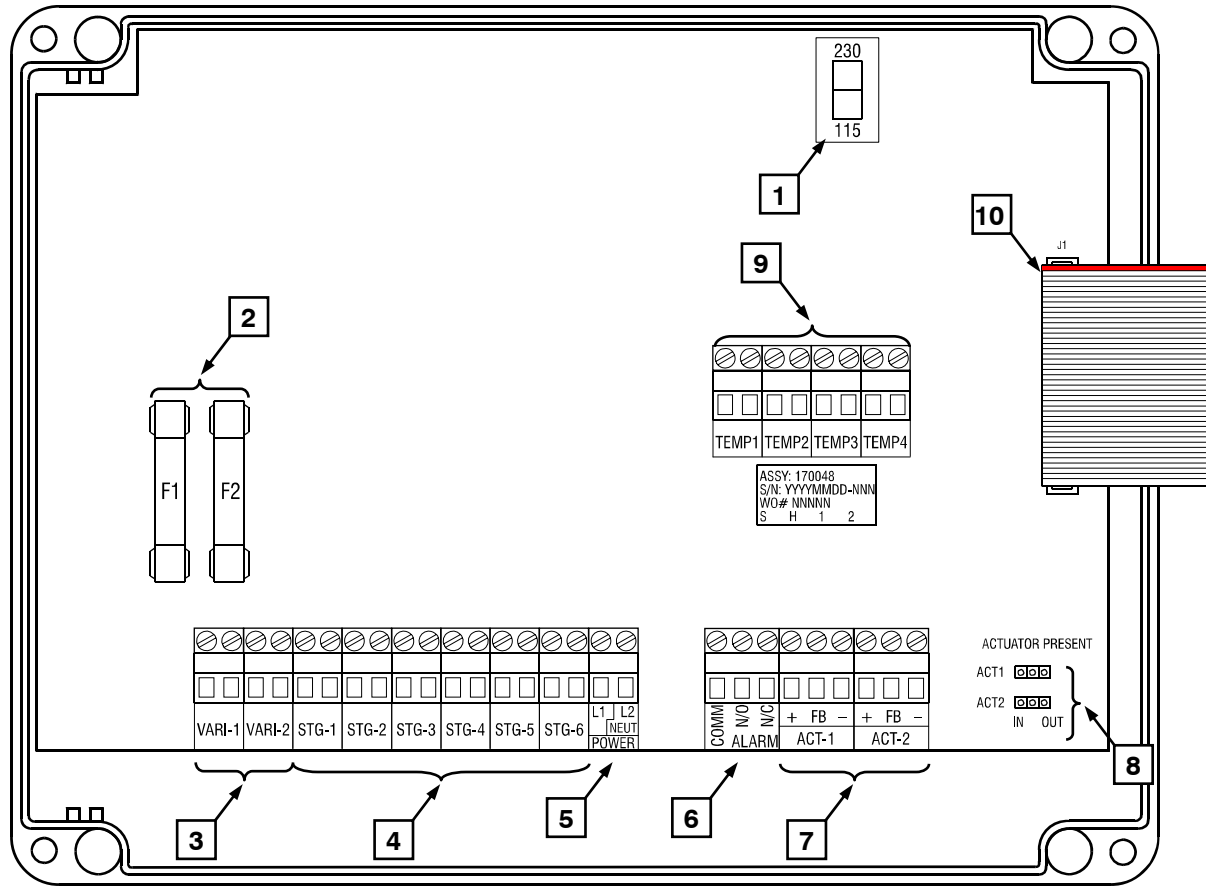

- | | |
|-----------|--|
| 1 | Voltage selection switch – set this switch to the correct voltage before installing your PEC Plus. |
| 2 | Variable stage fuses (F1, F2) – 15 A, 250 VAC ABC-type ceramic; F1 variable stage 1, F2 for stage 2. |
| 3 | Variable stage terminals (VAR1, VAR2) – connect variable speed fans to these terminals. |
| 4 | General-purpose relay terminals (RLY1 to RLY6) – connect single stage (on/off) equipment to these terminals. You can configure these relays as heat, cool, duty cycle, curtain, or actuator control. |
| 5 | Incoming power terminal – connect the incoming power (120/230 VAC, 50/60 Hz) to this terminal. |
| 6 | Alarm relay terminal – connect an external alarm system or alarm siren to this terminal. |
| 7 | Actuator feedback terminals (ACT1 and ACT2) – connect the feedback from the actuators to these terminals. |
| 8 | Actuator present pins (ACT1 and ACT2) – place the jumpers on the IN pins to enable, or on the OUT pins to disable actuator control for the corresponding actuator. |
| 9 | Temperature probe terminals (TEMP1 to TEMP4) – connect the temperature probes to these terminals. If monitoring outdoor temperatures, connect the outdoor probe to the TEMP4 terminal. |
| 10 | Display cable – make sure the ribbon cable from the display is properly connected to the socket. |

Mounting your PEC Plus

1. Select a location for your PEC Plus. Make sure you have enough cable and wire to reach all the equipment (fans, heaters, misters, curtains, etc.) that you want to control.
2. Remove the screws from the front cover and then gently lift it off.
3. Mount the enclosure to a wall using the four screws provided with the control. Insert the screws into the large holes in each corner of the box and tighten.

Connecting equipment to your PEC Plus

Follow these instructions when installing your PEC Plus and connecting equipment to it.



Use the electrical knockouts for bringing wires or cables into or out of your PEC Plus enclosure. Do not make additional holes in the enclosure; this can damage the watertight seal or control components and void the warranty.



Your PEC Plus' test modes are useful for testing your equipment after installing and configuring it. For more information, read **Testing settings and equipment** on page 63.

Connecting actuators

You can connect up to two actuators to a PEC Plus. Actuators are used for control elements that are not OFF or ON. Instead, they vary by a percentage. For example, inlets can be opened various distances from 0 percent to 100 percent.

Typically, linear actuators are connected directly to the inlets, or by cables and pulleys. Inlets are generally located in the ceiling or walls. Inlet systems are usually spring loaded to aid in closing the inlet, or counter weighted to aid in opening the inlets.



Feedback potentiometers

Each actuator you connect must have a feedback potentiometer. The feedback potentiometer, which you connect to one of your PEC Plus' two corresponding feedback terminals, lets the control know how far the actuator's arm is extended.

Most linear actuators are available with potentiometer feedback and internal adjustable limit switches. A 10,000 ohm, 10 turn feedback potentiometer is preferred, but the internal feedback potentiometer can range between 1000 and 20,000 ohms. Potentiometers outside of this range will affect the precision to which your PEC Plus can control the actuator.



If your actuator does not have a feedback potentiometer, Phason offers an Actuator Position Sensor (APS-1). For more information, contact Phason or your distributor. A system operates more precisely when using the largest amount of stroke that is feasible with the actuator. The stroke is the distance the actuator arm extends or retracts.

Actuator present pins

The actuator present pins are for calibrating the actuators. For more information, read **Calibrating actuators** on page 35.

Each actuator requires two relays: one for extending the actuator arm (opening the inlet), and one for retracting the arm (closing the inlet).

- ◆ Actuator 1 (**ACT1**) uses relay 1 to open (extend) the actuator and relay 2 to close (retract) the actuator.
- ◆ Actuator 2 (**ACT2**) uses relay 3 to open and relay 4 to close the actuator.



The ratings of the actuator must not exceed the ratings of the PEC Plus.
PEC Plus relay ratings: 10 A at 120/230 VAC, general-purpose (resistive)
1/3 HP at 120 VAC, 1/2 HP at 230 VAC
360 W tungsten at 120 VAC



Refer to **Appendix D: Installation worksheet** on page 84 when installing actuators.

To connect actuators

Connect actuators to your PEC Plus as shown below.

Refer to your actuator's installation guide for information about its power supply requirements.

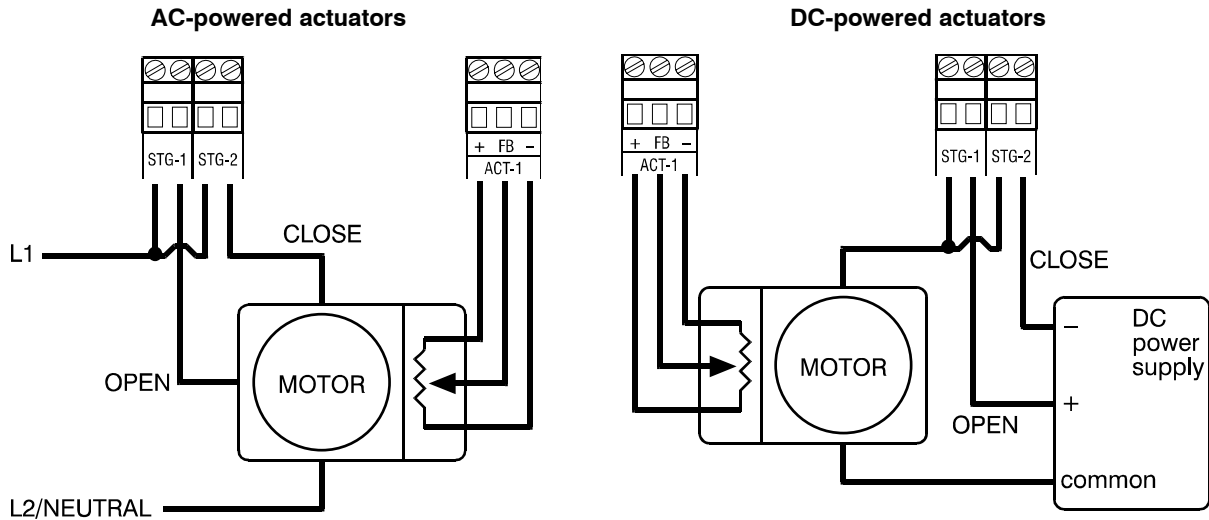

If you are unsure of the potentiometer wiring for your actuator, read **Determining correct actuator feedback wiring** on page 82.



When routing the actuator feedback wires, do not run them in or along the same conduit as AC-power lines. Follow the guidelines on page 12.

If you are measuring AC power with a digital multimeter (DMM), note that if a limit switch opens the circuit, the DMM measures voltage after the relay switch even if the relay is open.

Connecting single-stage heating or cooling elements

Heating or cooling elements include equipment such as electric heaters, furnaces, single-speed fans, and curtains.



The ratings of the equipment must not exceed the ratings of your PEC Plus' relays.

PEC Plus relay ratings: 10 A at 120/230 VAC, general-purpose (resistive)
 1/3 HP at 120 VAC, 1/2 HP at 230 VAC
 360 W tungsten at 120 VAC



Refer to **Appendix D: Installation worksheet** on page 84 and **Appendix E: Configuration worksheets** on page 86 when installing single-stage heating or cooling elements.

To connect single-stage heating or cooling elements

Connect single-speed heating or cooling elements to your PEC Plus as shown below.

Gas-fired furnace or brooder

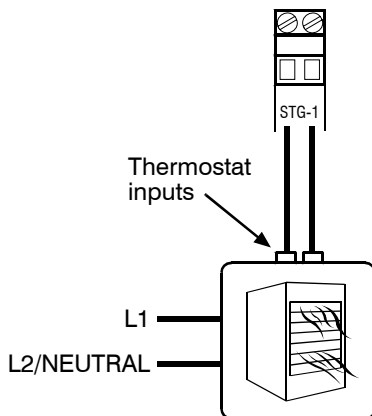

All other single-speed heating or cooling elements

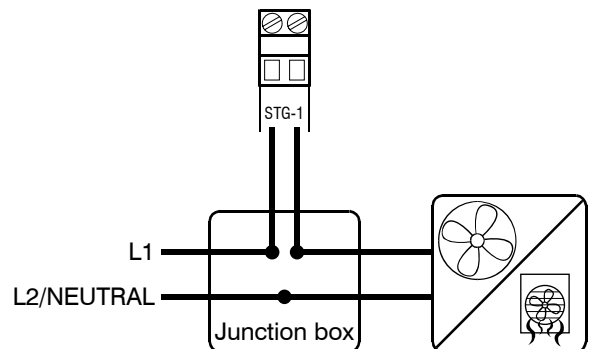

Gas furnaces using hot-surface ignition or glow plug can draw more current than indicated on their nameplate and require power contactors. For more information, read your furnace dealer.

Connecting curtain machines

Curtains are usually controlled by equipment called curtain machines (sometimes referred to as winches). Curtains are opened and closed to let in more air or less air, the idea being more air cools the building.

You can connect up to three curtain machines to your PEC Plus. Each curtain machine you connect requires two relays: one for opening the curtain, and one for closing the curtain. The relays must be side-by-side pairs. In other words, Relay 1 and 2, Relay 3 and 4, or Relay 5 and 6. The first relay will be the “open relay”; the second relay will be the “close relay”.



The ratings of the equipment must not exceed the ratings of your PEC Plus' relays.

PEC Plus relay ratings: 10 A at 120/230 VAC, general-purpose (resistive)
 1/3 HP at 120 VAC, 1/2 HP at 230 VAC
 360 W tungsten at 120 VAC



Refer to **Appendix D: Installation worksheet** on page 84 and **Appendix E: Configuration worksheets** on page 86 when installing single-stage heating or cooling elements.

To connect curtain machines

Connect curtain machines to your PEC Plus as shown below.

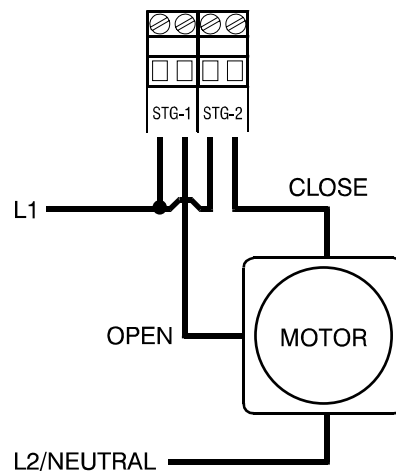

Connecting variable-stage cooling elements

Variable cooling elements include equipment such as variable-speed fans.

Only permanent split capacitor motors appropriate for variable speed control, or shaded pole motors, can be used on the variable stages.

If you are using three-phase power, connect the PEC Plus and the variable cooling equipment to the same phase. For more information, read Using three-phase power on page 20.



The ratings of the equipment must not exceed the ratings of your PEC Plus' variable stages.

Variable stage ratings: 10 A at 120/230 VAC, general-purpose (resistive)
 7 FLA at 120/230 VAC, PSC motor
 1/2 HP at 120 VAC, 1 HP at 230 VAC, PSC motor

Variable stage fuses: 15 A, 250 VAC ABC-type ceramic



Refer to **Appendix D: Installation worksheet** on page 84 and **Appendix E: Configuration worksheets** on page 86 when installing variable-stage elements.

To connect variable-stage cooling elements

Connect variable cooling elements to your PEC Plus as shown below.

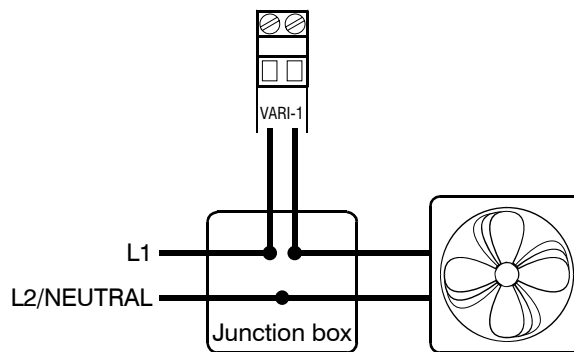

Using three-phase power

If you are connecting your PEC Plus to a three-phase system, make sure to connect the control power and the variable cooling equipment to the same phase.

Your PEC Plus must be powered from the same phases that supply the equipment. If your PEC Plus power and the variable stages are wired to different phases, the equipment will operate erratically.

Correct three-phase wiring

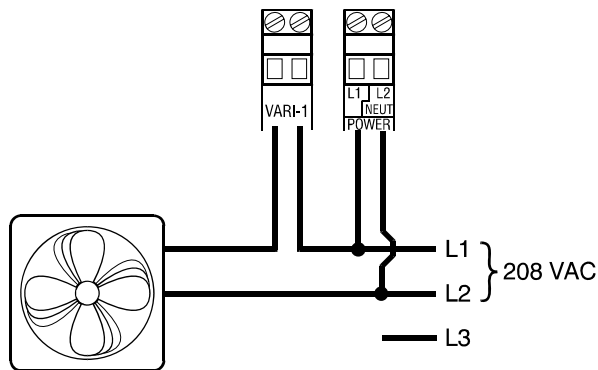

Incorrect three-phase wiring

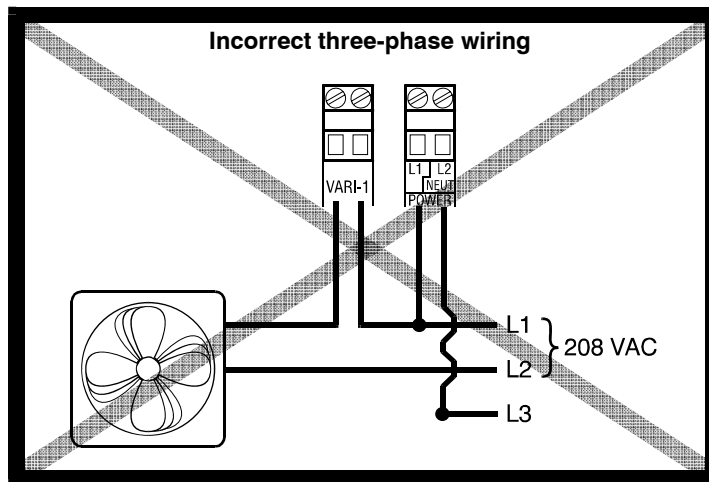

Connecting an alarm system

You can connect an alarm system to your PEC Plus' alarm terminal. An alarm system can be a siren, alarm panel, or auto-dialer. Read your system's installation guide for installation instructions and information about the type of system: *normally open* or *normally closed*. Below are the descriptions for the alarm terminal.

- ◆ **COMM:** common connection
- ◆ **N/O:** normally open; closes during alarm conditions
- ◆ **N/C:** normally closed; opens during alarm conditions

For the alarm system to sound (or dial out) during an alarm condition, you must enable the alarms. For more information, read **Programming alarm settings** on page 58.



The ratings of the siren or alarm system must not exceed the ratings of your PEC Plus' alarm relay.

Alarm relay ratings:

0.4 A at 125 VAC; 2 A at 30 VDC, resistive load
0.2 A at 125 VAC; 1 A at 30 VDC, inductive load

To connect an alarm system

- ◆ If you are connecting the alarm system to a network of PEC Plus control and your system uses a *normally open* connection (closes on alarm), connect the system as shown in the normally open diagram.

Join all the COMM connections together and all the N/O connections together. Your PEC Plus alarm relays must be in parallel with each other so any PEC Plus can trigger the alarm system when an alarm condition occurs.

- ◆ If you are connecting the alarm system to a network of PEC Plus controls and your system uses a *normally closed* connection (opens on alarm), connect the system as shown in the normally closed diagram.

Join the alarm relays in a continuous loop. Your PEC Plus alarm relays must be in series with each other so any PEC Plus can trigger the alarm system when an alarm condition occurs.

Normally open system (closed on alarm)

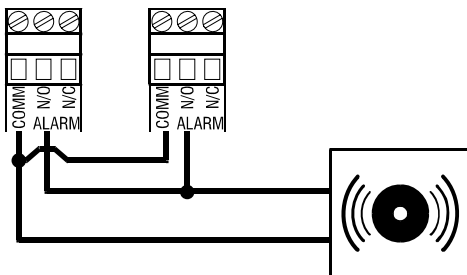

Normally closed system (open on alarm)

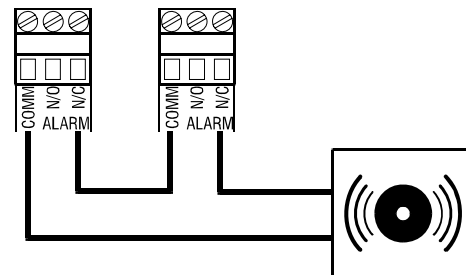

Connecting temperature probes

The PEC Plus has four temperature probe terminals, TEMP1 to TEMP4. You can connect any of Phason's standard 3K temperature probes to any of the probe terminals.

All enabled probes are averaged to provide a more balanced temperature reading in the room. Probe 4 (TEMP4) can be used to monitor outdoor temperatures. When probe 4 is configured for monitoring outdoor temperatures, it is not used for temperature averaging.



When routing the temperature probe cables, do not run them in or along the same conduit as AC-power lines. Follow the guidelines on page 12.

If you are connecting more than one probe, you must enable the additional probes. By default, probe 1 (TEMP1) is enabled and probes 2, 3, and 4 are not enabled. For more information, read **Configuring temperature probes** on page 31.



You can extend probe cables up to 500 feet. For more information, read **Extending probe cables** on page 23.

Refer to **Appendix E: Configuration worksheets** on page 86 when installing temperature probes.



Replace damaged probes as soon as possible. If there are no probes present or working properly, the PEC Plus controls the stages for a temperature half-way between the previous day's high and low temperatures.

To connect temperature probes

Follow these guidelines and connect the temperature probe as shown below.

- ◆ Do not run the probe cable in the same conduit as AC power cables
- ◆ Do not run the sensor cable beside AC power cables or near electrical equipment.
- ◆ When crossing other cables or power lines, cross them at a 90-degree angle.

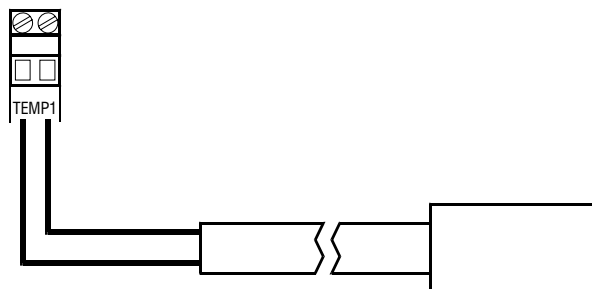

Extending probe cables

You can extend temperature probe cables to lengths of up to 500 feet. Follow the guidelines below and on page 22 when extending cables.

- ◆ Use two-wire 18 AWG jacketed cable. Phason recommends Belden # 9408, Alpha # 5052, or an equivalent. Extension cable is also available from Phason. For more information, contact your dealer or Phason.
- ◆ Join the extension cable to the temperature probe cable as shown below.
- ◆ If the unit operates erratically with the extended probe, run the cable along a different path or shorten it.

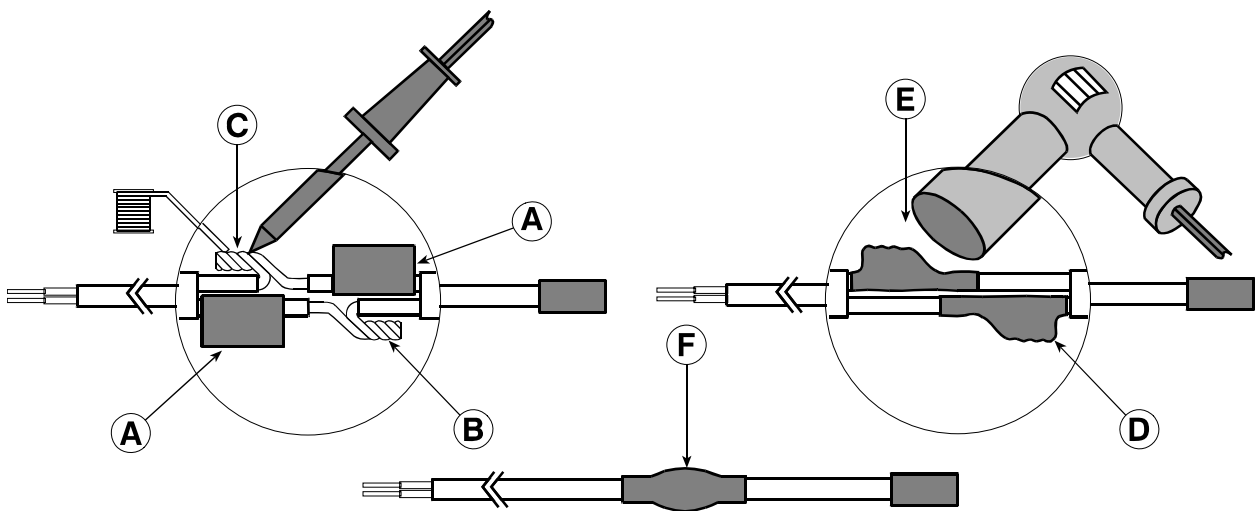

- A** Slide three pieces of heat shrink tubing over the wires: one for the red wire, one for the black wire, and one for both.
- B** Strip the ends of the wires and then twist them together.
- C** Solder the wires together using rosin-core flux solder – DO NOT use acid core solder.
- D** Slide the heat shrink tubing over the solder joints.
- E** Shrink the tubing using a heat gun.
- F** Your connection should look like this.

Connecting the power source

You can connect your PEC Plus to 120 or 230 VAC, 50 or 60 Hz power.



Before connecting the power, set the voltage selection switch to the correct voltage.

If you are using three-phase power, make sure the control power and the variable speed fans are connected to the same phase. For more information, read **Using three-phase power** on page 20.



Before connecting the incoming power, switch OFF the power at the source.

Do not switch ON the power until you have finished all wiring and verified all equipment is properly connected and free of obstructions.

To connect the incoming power source

1. Set the voltage select switch to the correct voltage setting.
2. Connect the incoming power source as shown below.

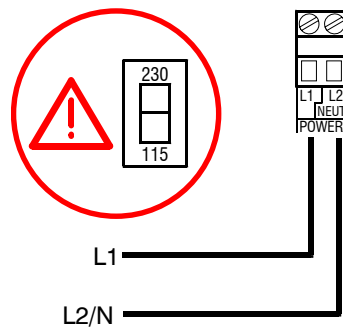

Finishing the installation

After installing and connecting equipment to your PEC Plus, you are ready to finish the installation. Before you start configuring your PEC Plus, you need to verify the connections and close the PEC Plus.

Verifying your connections

Make sure the configuration worksheets in **Appendix E** correspond to the way the equipment is connected to your PEC Plus.

It is very important that the connections and the worksheets are the same, because the next step after closing the cover is to tell your PEC Plus which equipment is connected to each terminal. It is important so you can be sure you are controlling the equipment you think you are controlling.

Closing the cover

After you have finished connecting all equipment, wiring, and cables to your PEC Plus, it's time to verify the wires are connected properly and the close the cover.

1. Make sure all the wires are properly connected to the correct terminals.
2. Make sure the voltage selection switch is in the correct setting.
3. Make sure the display cable is properly connected. For more information, read **PEC Plus layout** on page 13.
4. Place the cover on the control.
5. Switch on the power to your PEC Plus.
When you switch on the power to your PEC Plus, the display should show the temperature. If the PEC Plus display does not come on, go back to step 1. If the display shows an alarm message and or the LED for ALARM is lit, read **Programming alarm settings** on page 58.
6. Insert the four screws into the cover and then tighten them.



Do not over tighten the screws. Avoid using power screwdrivers or drills.

Chapter 3: Configuring your PEC Plus

Chapter 3 explains how to configure your PEC Plus. Configuring your PEC Plus includes telling it which equipment is connected to each terminal.

Topics in chapter 3 include:

- ◆ **What you need to know before configuring your PEC Plus** below
- ◆ **Configuring the main control functions** on page 29
- ◆ **Configuring variable stages** on page 33
- ◆ **Configuring relays** on page 34
- ◆ **Testing the configuration** on page 39

What you need to know before configuring your PEC Plus

Configuring your PEC Plus means telling it what equipment it will be controlling and how it will be controlling that equipment. For example, your PEC Plus has 6 relay stages. You need to tell the stages if they will be controlling curtains, heating or cooling elements, or actuators.

Before you begin configuring your PEC Plus, make sure:

- ◆ It has power
- ◆ All equipment has been properly connected to the correct terminals.
- ◆ You know which equipment is connected to which relays and variable stages



NOTE

This chapter does not explain set points, idle speeds, or other settings. For information about those settings, read **Chapter 4: Programming the PEC Plus** on page 41.

Configuration checklist

Because some items need to be configured before others, we recommend configuring your PEC Plus in following order. If you do not have elements of a particular type, skip that step. For example, if you do not have actuators, skip to the next step.

Configuring main control functions

- Setting the clock
- Selecting the temperature units
- Configuring temperature probes
- Configuring hysteresis

Configuring variable and relay stages

- Configuring variable stages
- Configuring relays for actuators
- Calibrating actuators
- Configuring relays for single-stage heating and cooling or duty cycles
- Configuring relays for curtains

Testing the configuration

- Testing the configuration



We recommend configuring *all* your control elements before programming the settings (temperature set points, idle speeds, and so on). Use the **Appendix E: Configuration worksheets** on page 86 to help you keep track of which equipment is connected to which relays and variable stages.

If you receive an error message during configuration, look it up in **Appendix B: Troubleshooting** on page 77 and then follow the instructions for correcting the problem.

Your PEC Plus' built-in diagnostic tests are useful for testing your equipment after installing and configuring it. For more information, read **Testing settings and equipment** on page 63.

Configuring the main control functions

Before configuring the variable and relay stages, you need to configure the main control functions. Main control functions include items such as temperature units that the PEC Plus needs to know before you configure the variable and relay stages.

Main control functions include:

- ◆ Clock/time – the PEC Plus has a clock that counts time
- ◆ Temperature units – degrees Fahrenheit or Celsius
- ◆ Temperature probes – how many and where they are connected
- ◆ Hysteresis – the number of degrees above or below the set point that equipment switches on or off

Setting the clock

The PEC Plus has a clock that keeps track of the time for the daily high and low temperatures and the growth curves.

If there is a power failure, or you need to adjust for daylight savings time, you will have to change the clock. The PEC Plus uses 24-hour time. The table below shows some common standard times and their 24-hour equivalents.

Standard time	24-hour time	Standard time	24-hour time
12:00 AM	00:00	12:00 PM	12:00
01:00 AM	01:00	01:00 PM	13:00
02:00 AM	02:00	02:00 PM	14:00
03:00 AM	03:00	03:00 PM	15:00
04:00 AM	04:00	04:00 PM	16:00
05:00 AM	05:00	05:00 PM	17:00
06:00 AM	06:00	06:00 PM	18:00
07:00 AM	07:00	07:00 PM	19:00
08:00 AM	08:00	08:00 PM	20:00
09:00 AM	09:00	09:00 PM	21:00
10:00 AM	10:00	10:00 PM	22:00
11:00 AM	11:00	11:00 PM	23:00

NOTE

The PEC Plus starts counting time as soon as it is connected to an incoming power supply.

To set the clock

1. Press **Function** until the LED for CONFIGURATION is lit.
2. Press **Up** or **Down** until **CLoc** is displayed and then press **Select**.
The display shows the current time.
3. Press **Up** or **Down** to adjust the hours and then press **Select**.
4. Press **Up** or **Down** to adjust the minutes and then press **Select**.
The control saves the time and returns to the Configuration menu
5. Press **Back** to return to the main display.

 CONFIGURATION



Selecting the temperature units



Your PEC Plus can display temperatures in either degrees Fahrenheit (°F) or degrees Celsius (°C), but not both at the same time. The factory default is °F.

If you want to change the temperature units, follow the steps below.

To select the temperature unit

1. Press **Function** until the LED for CONFIGURATION is lit.
2. Press **Up** or **Down** until **Unit** is displayed and then press **Select**.
The display shows the current temperature unit.
3. Press **Up** or **Down** to toggle between °F and °C and then press **Select**.
The control returns to the Configuration menu.
4. Press **Back** to return to the main display.

 CONFIGURATION

Configuring temperature probes

The PEC Plus has four temperature probe terminals, TEMP1 to TEMP4. You can connect any of Phason’s standard 3K temperature probes to any of the probe terminals.

By default, probe 1 (TEMP1) is enabled and probes 2, 3, and 4 are not enabled. When enabled, probes 2, 3, and 4 can be averaged to provide a more balanced temperature reading in the room. Probe 4 can be used to monitor outdoor temperatures. When probe 4 is configured for monitoring outdoor temperatures, it is not used for temperature averaging.

Averaging temperature probes

When you connect and enable more than one temperature probe to the PEC Plus, the control automatically averages the temperature readings it receives from each probe. Temperature averaging give a more balanced ‘overall’ temperature for a room.

For example, if you have a long room, you can place one probe near each end, and one in the center of the room.

Temperature probe defaults and options

Probe	Default configuration	Optional configuration	Function
Probe 1	on/enabled (P1on)	off (P1off)	Automatically averages with other enabled probes.
Probe 2	off/disabled (P2off)	on (P2on)	Automatically averages with other enabled probes.
Probe 3	off (P3off)	on (P3on)	Automatically averages with other enabled probes.
Probe 4	off (P4off)	on (P4on) outdoor (P4out)	Automatically averages with other enabled probes. Monitors outdoor temperatures. Does not average with other probes.



There must be at least one probe configured as ‘on’.

Replace damaged probes as soon as possible. If a probe is damaged, disable it until you can replace it with a new probe.

If there are no probes present or working properly, the PEC Plus controls the stages for a temperature half-way between the previous day’s high and low temperatures.

To configure temperature probes

1. Press **Function** until the LED for CONFIGURATION is lit.
2. Press **Up** or **Down** until *Pr ob* is displayed and then press **Select**.
The display shows the current configuration.
3. Press **Up** or **Down** to select a different configuration and then press **Select**.
The control returns to the Probe menu.
4. Press **Up** or **Down** to select a different configuration and then press **Select**.
The control returns to the Probe menu.
5. Repeat steps 3 and 4 for each probe you want to configure.
6. Press **Back** once to return to the Configuration menu, or twice to return to the main display.

● CONFIGURATION

Pr ob

P lon

Configuring hysteresis

Hysteresis helps prevent damage to the relays, variable stages, and the equipment connected to them by preventing the stages from switching on and off rapidly when the temperature is hovering close to the set point.

Hysteresis is the number of degrees above the set point that a heating stage or relay switches off, and the number of degrees below the set point that a cooling stage or relay switches off. For example, a household thermostat might switch on a furnace at 68 °F when the house is cooling down, but switch it off at 70 °F when the house is warming up. The difference between these two values is the hysteresis.

The default for hysteresis is 1.0 °F (0.5°C) and the range is 0.3 to 5.0°F (0.2 to 2.8°C).

To configure the hysteresis

1. Press **Function** until the LED for CONFIGURATION is lit.
2. Press **Up** or **Down** until *HYSL* is displayed and then press **Select**.
The display shows the current hysteresis.
3. Press **Up** or **Down** to adjust the hysteresis and then press **Select**.
The control returns to the Configuration menu.
4. Press **Back** to return to the main display.

● CONFIGURATION

HYSL

H 0.3

Configuring variable stages

Your PEC Plus' two variable stages (**VAR1** and **VAR2**) control elements that operate with gradually increasing voltage, such as variable speed fans.

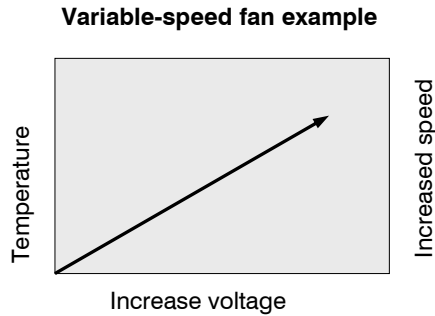

Configuring variable stages means selecting whether each stage is enabled as a cooling element, for example a fan, or is off. For more information about how variable stages work, read **Programming variable stages** on page 46.



Use the Variable stage configuration worksheet on page 87 when configuring variable stages.

To configure variable stages

1. Press **Function** until the LED for CONFIGURATION is lit.
2. Press **Up** or **Down** until **VAR-5** is displayed and then press **Select**.
The display shows **VAR-1**.
3. Press **Up** or **Down** until the stage you want to configure is displayed and then press **Select**.
The display shows the current configuration.
4. Press **Up** or **Down** to toggle between off and cool and then press **Select**.
The control returns to the Variable stage menu.
5. Press **Back** once to return to the Configuration menu, or twice to return to the main display.

CONFIGURATION

VAR-5

VAR1

VAR-1

Cool

Configuring relays

The PEC Plus has six relays that can be configured for several options.

- ◆ **Off** – the relay is always open (off). This is the default.
- ◆ **On** – the relay is always closed (on). This can be used as an override.
- ◆ **Actuator** – the relay controls a cooling element called an actuator. Actuators require one relay for opening and one for closing.
- ◆ **Curtain** – the relay controls a cooling element called a curtain machine. Curtains require one relay for opening and one for closing.
- ◆ **Cooling** – the relay controls a cooling element and switches on when the temperature rises above the temperature set point. An example of a cooling element is a single-speed fan.
- ◆ **Heating** – the relay controls a heating element and switches on when the temperature falls below the temperature set point. An example of a heating element is an electric heater.
- ◆ **Duty cycle (cooling)** – the relay controls a cooling element and switches on when the temperature rises above the temperature set point. Instead of remaining on constantly when the temperature is above the set point, the relay switches on for a duration, then off for a duration before repeating the process. An example of a duty cycle cooling element is a mister.
- ◆ **Duty cycle (heating)** – the relay controls a heating element and switches on when the temperature falls below the temperature set point. Instead of remaining on constantly when the temperature is below the set point, the relay switches on for a duration, then off for a duration before repeating the process.

Configuring relays for actuators

You can connect up to two actuators to a PEC Plus. Each actuator you connect requires two relays: one for extending the actuator arm (opening the inlet), and one for retracting the arm (closing the inlet).



Actuator 1 uses relay 1 to open (extend) the actuator and relay 2 to close (retract) the actuator.

Actuator 2 uses relay 3 to open (extend) the actuator and relay 4 to close (retract) the actuator.



Use the **Relay configuration worksheet** on page 88 when configuring relays.

NOTE

The steps below use Actuator 1 (*ACT 1*). If you are configuring a second actuator, follow the same steps using *ACT 2*.

You only need to configure one of the relay pairs. For example, if you configure relay 1 for actuator 1, the control automatically configures relay 2.

To configure relays for actuators

1. Press **Function** until the LED for CONFIGURATION is lit.
2. Press **Up** or **Down** until *rLY* is displayed and then press **Select**.
The display shows *rLY 1*.
3. Press **Up** or **Down** until the first relay you want to configure is displayed and then press **Select**.
The display shows the current configuration.
4. Press **Up** or **Down** until *ACT 1* is displayed and then press **Select**.
The control returns to the Relay menu.
5. Press **Back** once to return to the Configuration menu, or twice to return to the main display.

CONFIGURATION



RELAY1



Calibrating actuators

After configuring the actuator relays, you need to calibrate the actuators. Calibrating the actuator lets the PEC Plus know the position of the actuator when it is fully extended and fully retracted. The PEC Plus uses the limits to define the range of motion it uses to position the inlets. These limits tell the control how much to adjust when you want the actuators, for example, only 25% extended.

Because cables can stretch and equipment can come out of alignment (similar to tires on your car), we recommend resetting the limit switches and calibrating your actuators at least once each year.

Each time you place the jumper on the ACTUATOR PRESENT **IN** pins, the PEC Plus calibrates the actuator. During calibration, the actuator opens, pauses, and then closes. If the actuator is operating properly, the inlet should open completely and then close completely. After closing completely, the actuators should position according to the temperature and default settings.



Before calibrating actuators, make sure the limit switches are set and the cable and counter weights can move freely.

If the calibration procedure stops after closing the first time, or fails to position properly, the feedback signal is not connected properly. Verify that the potentiometer wiring is correct. For more information, read **Determining correct actuator feedback wiring** on page 82.

To calibrate actuators

1. Loosen the four screws in the PEC Plus enclosure and then gently remove the cover. Make sure not to disconnect the ribbon cable.
2. Remove and then replace the ACTUATOR PRESENT jumper on the **IN** pins for the actuator (ACT1 for actuator 1 and ACT2 for actuator 2).
The inlet opens completely, pauses, and then closes completely. If the procedure does not work properly, read the note above.
3. Replace the cover and then tighten the four screws.

Configuring relays for curtains

Curtains are usually controlled by equipment called curtain machines. Curtains are opened and closed to let in more air or less air, the idea being more air cools the building. Each curtain machine you connect requires two relays: one for opening the curtain, and one for closing the curtain.



Use the **Relay configuration worksheet** on page 88 when configuring relays.



Some curtain machines use a feedback potentiometer to indicate curtain position. If your curtain machine has a potentiometer, configure it as an actuator.

The relays must be side-by-side pairs. In other words, Relay 1 and 2, Relay 3 and 4, or Relay 5 and 6. The first relay will be the “open relay”; the second relay will be the “close relay”.

You only need to configure one of the relay pairs. For example, if you configure relay 4 for curtain control, the control automatically configures relay 3.

To configure relays for curtain control

1. Press **Function** until the LED for CONFIGURATION is lit.
2. Press **Up** or **Down** until **rLY** is displayed and then press **Select**.
The display shows **rLY 1**.
3. Press **Up** or **Down** until the relay you want to configure for opening the curtain is displayed and then press **Select**.
The display shows the current configuration.
4. Press **Up** or **Down** until **Cur** is displayed and then press **Select**.
The control returns to the Relay menu.
5. Press **Back** once to return to the Configuration menu, or twice to return to the main display.

CONFIGURATION

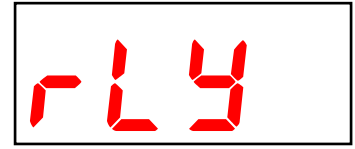

RELAY1



Configuring relays for single-stage heating and cooling or duty cycles

Relays configured for cooling can control single-speed fans, misters, or other cooling equipment that can be either on or off. The relays switch on when the temperature rises above the set point and off when it drops below.

Relays configured for heating can control equipment such as electric or gas heaters that can be either on or off. The relays switch on when the temperature drops below the set point and off when it rises above.

For more information about duty cycles, read **How normal duty cycles work** on page 55.



If you need to connect more cooling elements than you have relays available, and you are not using both variable stages, you can use an available variable stage as an ON/OFF stage (for 120/230 VAC-powered equipment only). For more information, read **Programming variable stages** on page 46.

Use the **Relay configuration worksheet** on page 88 when configuring relays.

To configure relays for single-stage heating or cooling (no duty cycle)

1. Press **Function** until the LED for CONFIGURATION is lit.
2. Press **Up** or **Down** until **rLY** is displayed and then press **Select**.
The display shows **rLY I**.
3. Press **Up** or **Down** until the first relay you want to configure is displayed and then press **Select**.
The display shows the current configuration.
4. Press **Up** or **Down** until **COOL** or **HEAT** is displayed and then press **Select**.
The control returns to the Relay menu.
5. Press **Back** once to return to the Configuration menu, or twice to return to the main display.

● CONFIGURATION

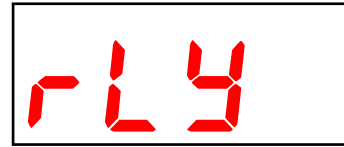

RELAY1 ●



To configure relays for single-stage heating or cooling (with duty cycle)

1. Press **Function** until the LED for CONFIGURATION is lit.
2. Press **Up** or **Down** until **rLY** is displayed and then press **Select**.
The display shows **rLY I**.
3. Press **Up** or **Down** until the first relay you want to configure is displayed and then press **Select**.
The display shows the current configuration.
4. Press **Up** or **Down** until **dtYL** (duty cycle cooling), **dtYH** (duty cycle heating), or **dtLL** (advanced duty cycle cooling) is displayed and then press **Select**.
The control returns to the Relay menu.
5. Press **Back** once to return to the Configuration menu, or twice to return to the main display.

● CONFIGURATION



RELAY1 ●



Testing the configuration

After configuring all the control elements (variable stages relays, and so on), test your PEC Plus to make sure the configuration is correct. In other words, make sure what you think is connected to a particular relay or stage *is* actually connected to that relay or stage.

You can test the configuration using the PEC Plus' test mode. Test mode allows you to operate the equipment, regardless of temperature or time. As you operate each piece of equipment, visually check to see if that equipment is doing what you tell it.

For example, when you switch on relay 1 at the PEC Plus, does the equipment you think is connected to that relay switch on?

For more information about test mode, read **Testing settings and equipment** on page 63.

Chapter 4: Programming the PEC Plus

Chapter 4 discusses how to program your PEC Plus with the settings it uses to control your equipment.

Topics in chapter 4 include:

- ◆ **What you need to know before programming your PEC Plus** below
- ◆ **Programming target temperatures** on page 42
- ◆ **Programming the stages** on page 46

What you need to know before programming your PEC Plus

Programming your PEC Plus basically means telling the equipment what you want it to do and when you want it done. For example, for a single-speed fan set for cooling, you might say: “Switch on when the temperature reaches 80°F.”

Programming checklist

Because some settings must be programmed before others, we recommend programming your PEC Plus in the following order. If you do not have elements of a particular type, skip that step. For example, if you do not have curtains, skip that step.

Programming target temperatures

- Programming the group set point
- Programming the growth curve

Programming the stages

- Programming variable stages
- Programming actuators
- Programming curtain control relays
- Programming heating and cooling elements and duty cycles
- Programming alarm settings

Before you begin programming your PEC Plus, make sure:

- ◆ It has power
- ◆ All equipment has been properly connected to the correct terminals.
- ◆ You know which equipment is connected to which relays and variable stages
- ◆ All variable and relay stages have been properly configured and tested. For more information, read **Chapter 3: Configuring your PEC Plus** on page 27.



Use **Appendix F: Settings worksheets** on page 89 when programming your PEC Plus.

Programming target temperatures

There are two options for the target temperatures:

- ◆ Growth curve
- ◆ Group set point

The PEC Plus uses one or the other. If the growth curve is enabled, the control uses the growth curve settings. If the growth curve is not enabled, the control uses the group set point.

Programming the group set point

A group set point is the target or desired temperature for the room or zone. This is the temperature that will be tracked by the individual stages. The individual set points for each variable and relay stage will be adjusted relative to the group set point for that zone. **Make sure you set the group set point before setting the individual set points.**

For example, let's say the group set point is 80°F, a variable-stage fan set point is 5 degrees higher (85°F), and a single-stage heater set point is 7 degrees lower (73°F). If you lower the group set point by 5 degrees to 75°F, the set points for the fan and heater will also be lowered by 5 degrees to 80°F and 68°F respectively.

Once a group set point is set, it remains at that temperature until you change it, or until an enabled growth curve makes an adjustment to it.

To program the group set point

1. Press **Function** until the LED for GROWTH CURVE is lit.
The display shows **PARA** (parameter A).
2. Press **1**.
The display shows the current day. If the growth curve is not enabled (if the display shows **COFF**), go to step 4.
3. Press **Up** or **Down** to set the current day to 0 and then press **Select**.
The control returns to the Parameter menu.
4. Press **5**.
The display shows the current group set point.
5. Press **Up** or **Down** to change the setting and then press **Select**.
The control returns to the Parameter menu.
6. Press **Back** to return to the main display.

 GROWTH CURVE



Programming the growth curve

A growth curve is an extension of the group set point concept. The growth curve automatically adjusts the temperature set points over time to control the temperature in a room. It is called a 'growth' curve because it adjusts the set-points as the animals 'grow'.

For example, in hog production, newborn piglets require a high temperature for comfort and health. As they grow older, they need a steadily lower temperature. Using the growth curve, you can have your PEC Plus automatically adjust the temperatures. For example, start at 76°F for 1 day, drop to 74°F for 1 day, then to 71°F for 21 days, 68°F for 14 days, and so on.

You can have up to seven steps in a growth curve. Each step has a starting temperature set point and a duration. Your PEC Plus automatically calculates the set points for the days between the steps and adjusts the set points at midnight each day. Individual set points for the variable and fixed stages are adjusted relative to the growth curve temperature for that particular day. This is an extremely powerful feature because it lets you put fan and heating strategies in place once, and then adjust them automatically over time.

For example, in the table on the right, step 2 has a duration of 10 days.

The difference between the starting set point (86.5°F) and the starting set point for the next step (85°F) is 1.5°F.

The PEC Plus divides the temperature difference by the duration $1.5 \div 10 = 0.15$ and then automatically adjusts the set point by 0.15°F each day for 10 days.

Step	Temperature (°F)	Duration (days)
1	88.0	5
2	86.5	10
3	85.0	10
4	83.5	10
5	81.0	5
6	78.0	5
7	74.0	10

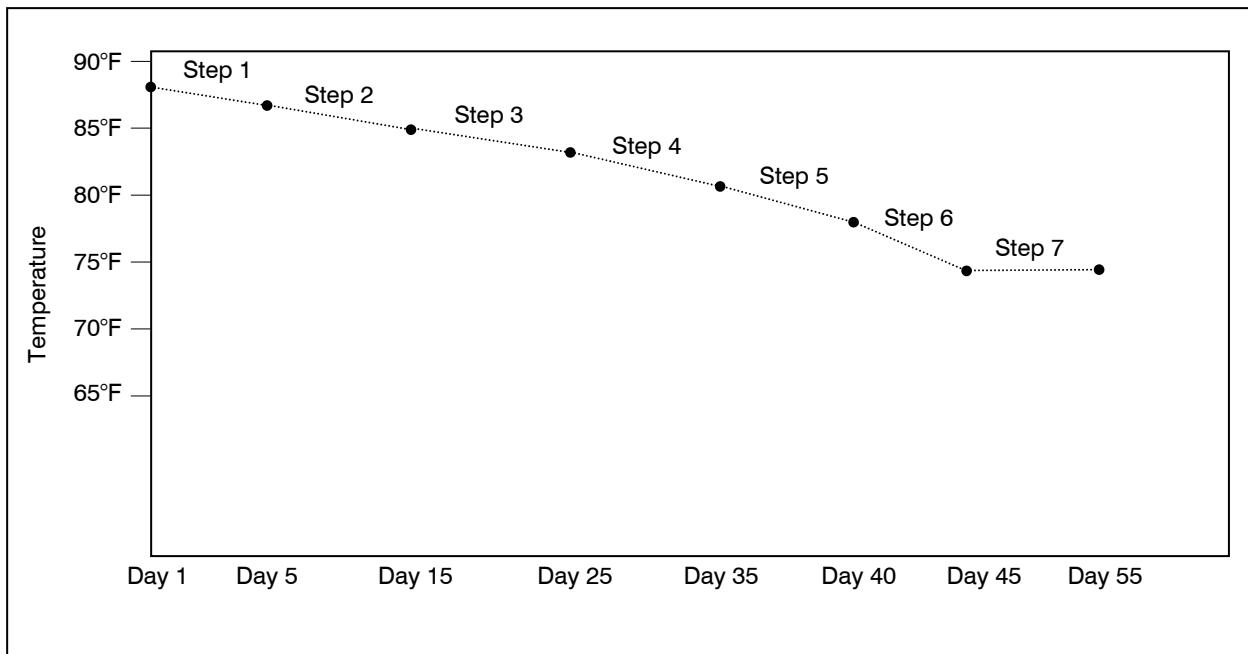

Use the **Growth curve worksheet** on page 89 when programming the growth curve.

The temperature set point must decrease as the steps increase.

Parameter	Description	Options/range	Displayed as
1 – Current day	The current day of the growth curve	0 to 365	cOFF to c365
2 – Step	The step of the growth curve you are programming	1 to 7	SLP 1 to SLP 7
3 – Duration	The duration of the step you are programming	0 to 365	d 0 to d365
4 – Start temperature	The starting temperature for the step you are programming	32.0 to 99.9°F (0.0 to 37.7°C)	t 32.0 to t99.9 t 00 to t37.7
5 – Group set point	If the growth curve is not enabled, the control uses this as the target temperature.	32.0 to 99.9°F (0.0 to 37.7°C)	t 32.0 to t99.9 t 00 to t37.7

To enable, disable, or change the current day of the growth curve

- Press **Function** until the LED for GROWTH CURVE is lit.
The display shows **PRrR** (parameter A).
- Press **1**.
The current day of the growth curve is displayed.
 - To enable (when it is disabled) or change the current day of the growth curve, press **Up** or **Down** to set the current day.
 - To disable the growth curve, press **Down** to set the current day to off.
- Press **Select** to return to the Parameter menu.
- Press **Back** to return to the main display.

 GROWTH CURVE

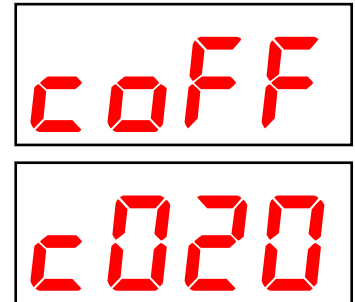

To program the growth curve

- Press **Function** until the LED for GROWTH CURVE is lit.
The display shows **PRrR** (parameter A).
- To view the current step, press **2**.
The display shows the current step.
- To choose the step you want to program, press **Up** or **Down** and then press **Select**.
The control returns to the Parameter menu.
- To view the step duration, press **3**.
The display shows the current setting.
- To change the duration, press **Up** or **Down** and then press **Select**.
The control returns to the Parameter menu.

 GROWTH CURVE

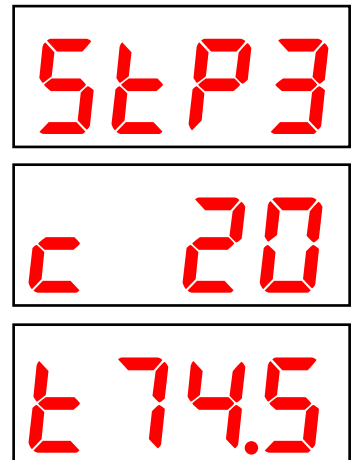

6. To view the start temperature, press **4**.
The display shows the current setting.
7. To change the start temperature, press **Up** or **Down** and then press **Select**.
The control returns to the Parameter menu.
8. Repeat steps 2 to 7 for each step you want to program.
9. Press **Back** to return to the main display.



To view the settings for a step, select the step (read steps 2 and 3 above) and then press the Parameter buttons for the settings you want to view. Repeat this for each step you want to view.

Programming the stages

Programming the stages means entering the settings such as temperature set points, idle speeds, ON/OFF times and durations, and so on. Programming the stages involves programming the settings for:

- ◆ Variable stages
- ◆ Relay stages
 - ◆ Actuators
 - ◆ Curtains
 - ◆ Heating and cooling stages, including duty cycles
- ◆ Alarms

Programming variable stages

Before setting up the variable stages, make sure you have properly configured them. For more information, read **Configuring variable stages** on page 33.

There are four settings to program for each variable stage. The diagram on the next page explains the settings and how they work together.

How variable stage cooling works

- ◆ When the temperature is below the “off at” temperature, the fan is off.
- ◆ When the temperature reaches the “off at” temperature, the fan runs at the idle speed. The fan continues to run at the idle speed until the temperature rises to the “set point” temperature.
- ◆ When the temperature is between the “set point” and “on full at” temperatures, fan speed increases or decreases proportionally with the temperature.
- ◆ When the temperature is at or above the “on full at” temperature, the fan runs at full speed.

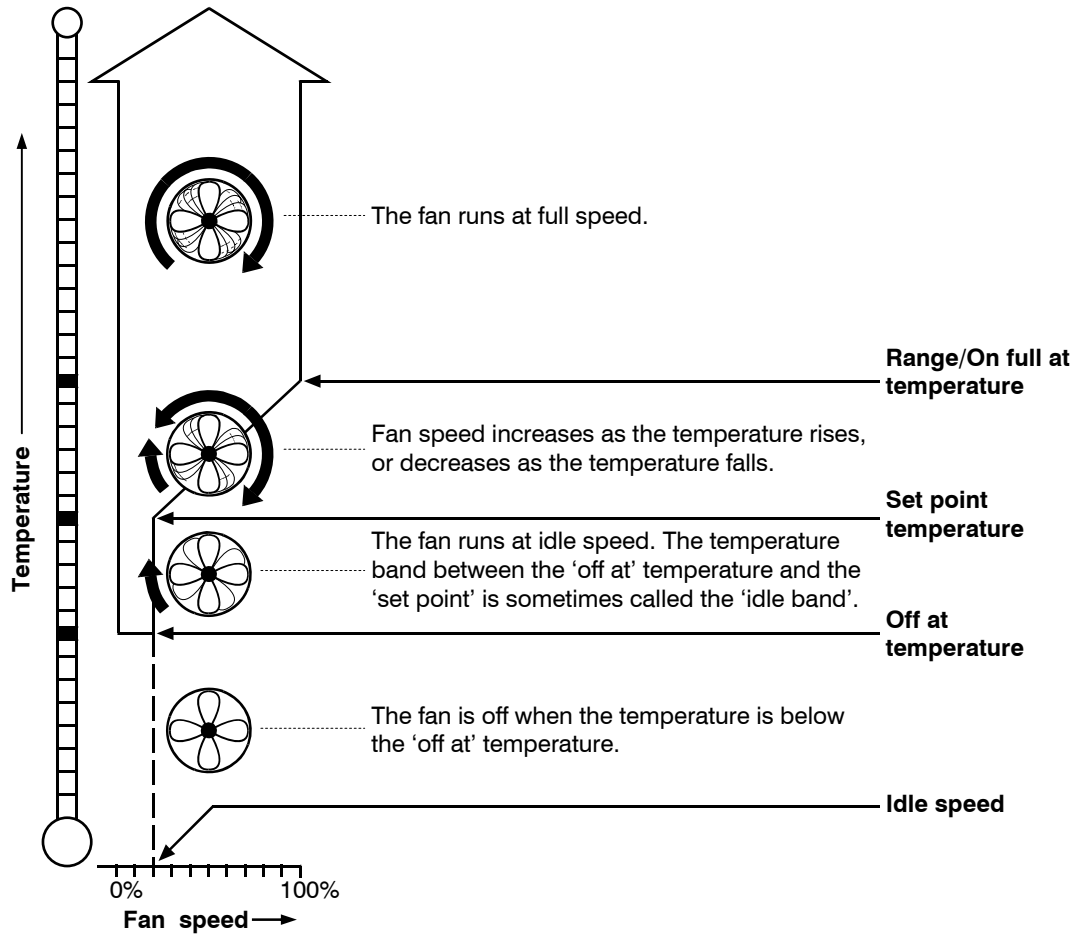



If you need to connect more cooling elements than you have relays available, and you are not using both variable stages, you can use an available variable stage as an ON/OFF stage (for 120/230 VAC-powered equipment only).

Set the idle speed to 100% and 'off at' to the temperature at which you want the stage to switch on/off. You no longer have “variable” speed or power; instead you have either full on or full off, the same as a regular cooling element. The 'set point' and 'on full at' settings have no effect when you use a variable stage this way.



Use the **Variable stage settings worksheet** on page 90 when programming variable stages.

To program variable stages

1. Press **Function** until the LED for VARIABLE STAGES is lit.
The display shows **VAR 1** (variable stage 1).
2. Press **Up** or **Down** to toggle between programming variable stage 1 and variable stage 2 and then press **Select**.
The display shows **PARb** (parameter B). The LEDs for STAGES show which stage you are programming.
3. To view the “off at” temperature, press **1**.
The display shows the current setting.
4. To change the setting, press **Up** or **Down** and then press **Select**.
The control returns to the Parameter menu.
5. To view the idle speed, press **2**.
The display shows the current setting.
6. To change the idle speed, press **Up** or **Down** and then press **Select**.
The control returns to the Parameter menu.
7. To view the temperature set point, press **3**.
The display shows the current setting.
8. To change the set point, press **Up** or **Down** and then press **Select**.
The control returns to the Parameter menu.
9. To view the range (on full at) temperature, press **4**.
The display shows the current setting.
10. To change the range temperature, press **Up** or **Down** and then press **Select**.
The control returns to the Parameter menu.
11. Press **Back** once to return to the Variable stage menu, or twice to return to the main display.

VARIABLE STAGES

VAR1



To view the settings for a step, select the step (read steps 2 and 3 above) and then press the Parameter buttons for the settings you want to view. Repeat this for each step you want to view.

Programming actuators

Before programming the actuator relays, make sure you have properly configured the relays and calibrated the actuators. For more information, read **Configuring relays for actuators** on page 34 and **Calibrating actuators** on page 35.

Each actuator has six stages. The settings for the stages include the set point temperature, position, and differential temperature.

How actuators work

- ◆ When the temperature is below the minimum set point, the actuator is closed.
- ◆ When the temperature rises to the minimum set point, the actuator moves to the minimum position.
- ◆ As the temperature rises, the actuator moves through the stages until it reaches its maximum open position. This method lets you gradually open inlets instead of fully opening them when the temperature rises above a single set point.

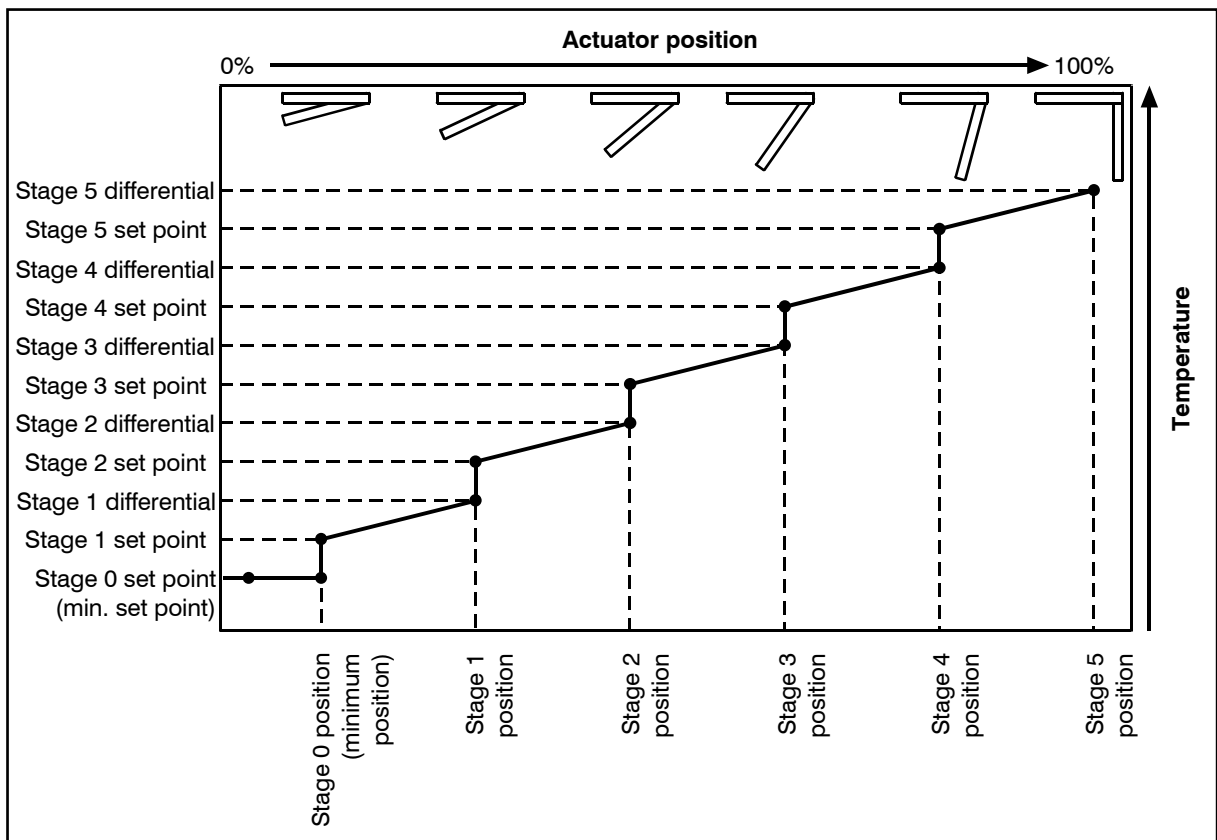

For example, you might decide to have the actuator open to 40 percent at stage 1, 60 percent at stage 2, 80 percent at stage 3, 90 percent at stage 4, and 100 percent at stage 5.

However, you don't want the actuator to open directly to 40 percent. That is why there are two temperature settings for each stage. The first setting is the stage set point. This is where the actuator starts opening. The second setting is the differential. This is where the actuator reaches the stage position.

In other words, "when the temperature is here (stage set point), I want the actuator to start opening. When the temperature reaches here (stage differential), I want the actuator to be at this position (stage position) percent."



If you press a parameter button that has no function for the relay, the display shows ----. Press **Back** to return to the previous display.

Use the **Actuator settings worksheet** on page 91 when setting up actuators.



You can use actuator control for curtain machines only if they have feedback potentiometers.

Do not use actuator control for curtain machines without potentiometers. This can burn out the curtain machines. For information about programming the PEC Plus to control curtain machines without potentiometers, read **Programming curtain control relays** on page 52.

To program actuator stages

1. Press **Function** until the LED for ACTUATORS is lit.
The display shows **ACT 1** (Actuator 1).
2. Press **Up** or **Down** to toggle between programming actuator 1 and actuator 2 and then press **Select**.
The display shows **Par d** (parameter D). The LEDs for STAGES show which relays you are programming. Relays 1 and 2 indicate actuator 1, relays 3 and 4 indicate actuator 2.
3. To view the current actuator stage, press **1**.
The display shows the current actuator stage.
4. To choose the stage you want to program, press **Up** or **Down** and then press **Select**.
The control returns to the Parameter menu.
5. To view the temperature set point, press **2**.
The display shows the current setting.
6. To change the set point, press **Up** or **Down** and then press **Select**.
The control returns to the Parameter menu.
7. To view the stage position, press **3**.
The display shows the current setting.
8. To change the stage position, press **Up** or **Down** and then press **Select**.
The control returns to the Parameter menu.

● ACTUATORS



●
RELAY2 ●

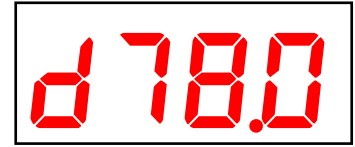
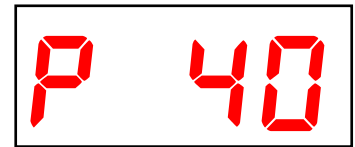
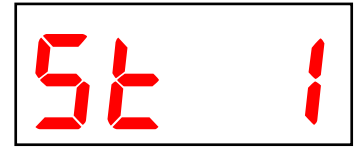

	<p>The minimum stage (stage 0) does not have a differential temperature setting. Skip steps 9 and 10 for the minimum stage.</p>
---	---

9. To view the differential temperature, press **4**.
The display shows the current setting.
10. To change the differential, press **Up** or **Down** and then press **Select**.
The control returns to the Parameter menu.
11. Repeat steps 3 to 10 for the remaining stages.
12. Press **Back** once to return to the Actuator menu, or twice to return to the main display.

Programming curtain control relays

Curtains control the temperature by adjusting the air flow into the facility. Each curtain has six settings.

- ◆ Set point – the temperature at which the curtain holds its position.
- ◆ Idle band – the buffer around the set point within which the curtains hold their position.
- ◆ Open on – the duration the curtains open during the open cycle
- ◆ Open off – the duration the curtains hold their position during the open cycle
- ◆ Close on – the duration the curtains close during the close cycle
- ◆ Close off – the duration the curtains hold their position during the close cycle

How curtains work

Curtains hold their position while the temperature is within the idle band of the set point. For example, if the set point is 80°F and the idle band is 4°F (+2°/–2°), the curtain holds its position when the temperature is between 78°F and 82°F.

If the temperature rises above the idle band (above 82°F in our example), the curtain opens for the “open on” duration. After opening, it holds its position for the “open off” duration. If the temperature is still above the idle band, the curtain again opens for the open on duration and the process repeats.

If the temperature drops below the idle band (below 78°F in our example), the curtain closes for the “close on” duration. After closing, it holds its position for the “close off” duration. If the temperature is still below the idle band, the curtain again closes for the close on duration and the process repeats.

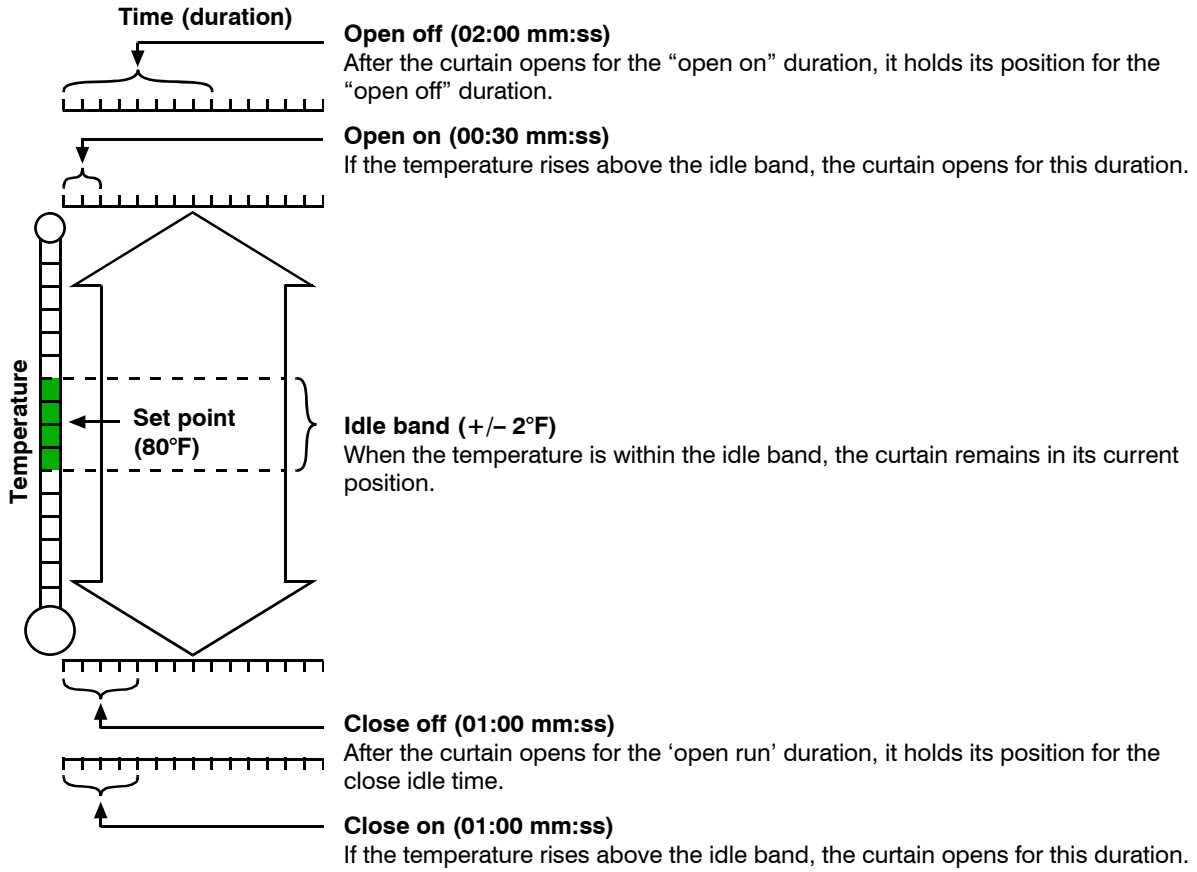

If you press a parameter button that has no function for the relay, the display shows ----. Press **Back** to return to the previous display.

Use the **Curtain worksheet** on page 93 when setting up curtains.



Before programming the curtains, make sure you have properly configured the relays. For more information, read **Configuring relays for curtains** on page 36.

The set point and idle band for both the open and close relays are programmed at the same time. When you select one of the curtain relays, both the open and close relay LEDs light up.

The ON and OFF durations are in minutes and seconds. For example, 1:30 would be 1 minute and 30 seconds.

To program curtain relays

1. Press **Function** until the LED for RELAYS is lit.
The display shows **rLY1** (Relay 1).
2. Press **Up** or **Down** to scroll to the “open” relay and then press **Select**.
The display shows **PARC** (parameter C). The LEDs for STAGES show which relays (the open and the close) you are programming.
3. To view the temperature set point, press **1**.
The display shows the current setting.
4. To change the set point, press **Up** or **Down** and then press **Select**.
The control returns to the Parameter menu.
5. To view the idle band, press **2**.
The display shows the current setting.
6. To change the idle band, press **Up** or **Down** and then press **Select**.
The control returns to the Parameter menu.
7. To view the “open on” duration, press **4**.
The display shows the current setting.
8. To change the duration minutes, press **Up** or **Down** and then press **Select**. Repeat to change the seconds.
The control returns to the Parameter menu.
9. To view the “open off” duration, press **5**.
The display shows the current setting.
10. To change the duration minutes, press **Up** or **Down** and then press **Select**. Repeat to change the seconds.
The control returns to the Parameter menu.
11. Press **Back** to return to the relay menu and then select the “close” relay.
12. Repeat steps 7 to 10 for the close relay.
13. Press **Back** once to return to the Relay menu, or twice to return to the main display.

● RELAYS

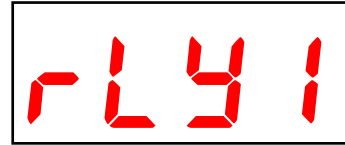

RELAY1 ●

RELAY2 ●



Programming heating and cooling elements and duty cycles

Heating and cooling elements control the temperature by switching single-stage heating equipment such as electric heaters, or cooling equipment such as misters ON or OFF. Before setting up the elements, make sure you have properly configured the relays. For more information, read **Configuring relays for single-stage heating and cooling** on page 37.

There are three types of heating and cooling element setups: standard, duty cycle, and advanced duty cycle. Programming a standard element means setting the temperature set point. Programming a duty cycle means setting the temperature set point(s) and the ON and OFF durations.

How normal duty cycles work

For heating elements

When the temperature is above the set point, the heating element is off. When the temperature drops below the set point, the element switches on for the on duration and then off for the off duration. If at any time the temperature rises above the set point, the duty cycle switches off and will not switch on again until the temperature drops below the set point.

For cooling elements

When the temperature is below the set point, the cooling element is off. When the temperature rises above the set point, the element switches on for the on duration and then off for the off duration. If at any time the temperature drops below the set point, the duty cycle switches off and will not switch on again until the temperature rises above the set point.

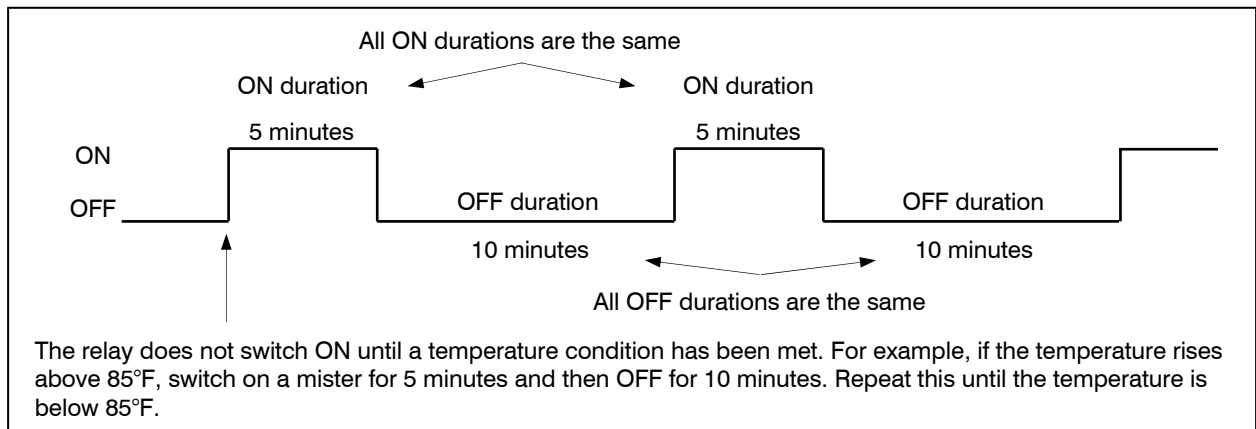

How advanced duty cycles work

Advanced duty cycles are for cooling only. Advanced duty cycles function similar to normal duty cycles. Instead of having one set point, advanced duty cycles have two set points.

- ◆ Set point 1 is the same as the set point in a normal duty cycle.
- ◆ Set point 2 is a set point that is higher than set point 1.

When the temperature is above the set point 2, the duty cycle remains on, regardless of the on/off durations. When the temperature drops below set point 2, the duty cycle starts again.



If you press a parameter button that has no function for the relay, the display shows ----. Press **Back** to return to the previous display.

Use the **Heating and cooling elements worksheet** on page 94 when setting up heating and cooling elements or based duty cycles.

If you need to connect more heating or cooling elements than you have relays, and you are not using both variable stages, you can use a variable stage as an ON/OFF stage. For more information, read **Programming variable stages** on page 46.



The ON and OFF durations are in minutes and seconds. For example, **1:30** would be 1 minute and 30 seconds.

To program standard heating or cooling relays (no duty cycle)

1. Press **Function** until the LED for RELAYS is lit.
The display shows **rLY1** (Relay 1).
2. Press **Up** or **Down** to change between programming relays 1 to 6 and then press **Select**.
The display shows **PARC** (parameter C). The LEDs for STAGES show which relay you are programming.
3. To view the temperature set point, press **1**.
The display shows the current setting.
4. To change the set point, press **Up** or **Down** and then press **Select**.
The control returns to the Parameter menu.
5. Press **Back** once to return to the Relay menu, or twice to return to the main display.

RELAYS



RELAY5



To program normal duty cycles

1. Press **Function** until the LED for RELAYS is lit.
The display shows **rLY1** (Relay 1).
2. Press **Up** or **Down** to change between programming relays 1 to 6 and then press **Select**.
The display shows **PARC** (parameter C). The LEDs for STAGES show which relays you are programming.
3. To view the temperature set point, press **1**.
The display shows the current setting.
4. To change the set point, press **Up** or **Down** and then press **Select**.
The control returns to the Parameter menu.
5. To view the ON duration, press **4**.
The display shows the current setting.
6. To change the ON duration minutes, press **Up** or **Down** and then press **Select**. Repeat to change the seconds.
The control returns to the Parameter menu.
7. To view the OFF duration, press **5**.
The display shows the current setting.
8. To change the OFF duration minutes, press **Up** or **Down** and then press **Select**. Repeat to change the seconds.
The control returns to the Parameter menu.
9. Press **Back** once to return to the Relay menu, or twice to return to the main display.

● RELAYS



RELAY3 ●



To program advanced duty cycles

1. Press **Function** until the LED for RELAYS is lit.
The display shows **rLY1** (Relay 1).
2. Press **Up** or **Down** to change between programming relays 1 to 6 and then press **Select**.
The display shows **PARC** (parameter C). The LEDs for STAGES show which relays you are programming.
3. To view temperature set point 1, press **1**.
The display shows the current setting.
4. To change set point 1, press **Up** or **Down** and then press **Select**.
The control returns to the Parameter menu.
5. To view temperature set point 2, press **2**.
The display shows the current setting.

● RELAYS



RELAY3 ●



6. To change set point 2, press **Up** or **Down** and then press **Select**.
The control returns to the Parameter menu.
7. To view the ON duration, press **4**.
The display shows the current setting.
8. To change the ON duration minutes, press **Up** or **Down** and then press **Select**. Repeat to change the seconds.
The control returns to the Parameter menu.
9. To view the OFF duration, press **5**.
The display shows the current setting.
10. To change the OFF duration minutes, press **Up** or **Down** and then press **Select**. Repeat to change the seconds.
The control returns to the Parameter menu.
11. Press **Back** once to return to the Relay menu, or twice to return to the main display.

A digital display showing the number 2.30 in red LED characters. The display is enclosed in a black rectangular border.A digital display showing the number 5.00 in red LED characters. The display is enclosed in a black rectangular border.

Programming alarm settings

In addition to the power-failure alarm, there are six other alarms. For a complete list and descriptions, look at the **Alarm settings worksheet** on page 95.

- ◆ High temperature
- ◆ Low temperature
- ◆ Probe damage
- ◆ Probe deviation
- ◆ Actuator 1 jam
- ◆ Actuator 2 jam

The alarm settings for your PEC Plus determine which alarm conditions are enabled, which are disabled, and their settings. All these work together to determine how and when the alarm relay activates (in other words, signals an alarm condition).

The alarm relay activates if an alarm condition (one that is enabled) is present for longer than the minimum duration of one minute. The one minute minimum duration prevents alarms from occurring when the temperature rises or drops for just a few seconds.

When an alarm occurs, the LED for ALARM switches on and the alarm message flashes on the display. For more information, read **Acknowledging alarms** on page 62.

How alarm settings work

Let’s say the High Temp alarm setting is 85.0°F. If the temperature rises to 86 degrees, but drops below 85 degrees 30 seconds later (before the minimum duration of 1 minute), the alarm relay does not activate.

If the temperature rises to 86 degrees and stays there for 1 minute, the alarm relay activates. The alarm relay remains active until the temperature drops below the High Temp setting.



Use the Alarm settings worksheet on page 95 when programming alarms. The worksheet contains descriptions of each setting.

To enable or disable alarms

1. Press **Function** until the LED for CONFIGURATION is lit and *ALEn* displays.
2. Press **Select**.
The display shows *Hi En* (high temperature alarm).
3. Press **Up** or **Down** to select the alarm you want to enable or disable and then press **Select**.
The display shows the current setting.
4. Press **Up** or **Down** to toggle between yes and no and then press **Select**.
The control returns to the Alarm enable menu.
5. Repeat steps 3 and 4 for each alarm you want to enable or disable.
6. Press **Back** once to return to the Configuration menu, or twice to return to the main display.

 CONFIGURATION



To program high and low temperature alarm settings

1. Press **Function** until the LED for RELAYS is lit.
The display shows **rLY 1** (Relay 1).
2. Press **Down** until the display shows **LoAL** (low temperature alarm) and then press **Select**.
The current setting flashes.
3. Press **Up** or **Down** to change the setting and then press **Select**.
The control returns to the Alarm/Relay menu.
4. Press **Down** until the display shows **Hi AL** (high temperature alarm) and then press **Select**.
The current setting flashes.
5. Press **Up** or **Down** to change the setting and then press **Select**.
The control returns to the Alarm/Relay menu.
6. Press **Back** to return to the main display.

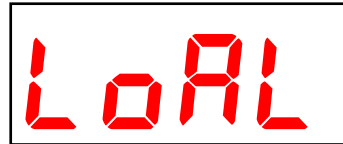
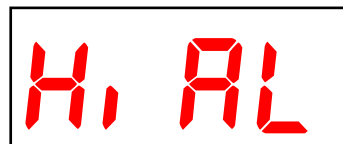
RELAYS ALARM The image shows a rectangular digital display with red LED characters. The text displayed is "LoAL", where "Lo" is in a smaller font size than "AL".The image shows a rectangular digital display with red LED characters. The text displayed is "600", with a small decimal point below the second zero.The image shows a rectangular digital display with red LED characters. The text displayed is "Hi AL", where "Hi" is in a smaller font size than "AL".

Chapter 5: Monitoring and maintaining your PEC Plus

Chapter 5 explains how to monitor the PEC Plus after you have installed, configured, and programmed it. Topics in chapter 5 include:

- ◆ **Monitoring your PEC Plus** below
- ◆ **Testing settings and equipment** on page 63
- ◆ **Using PIN security** on page 66
- ◆ **Servicing and maintaining your PEC Plus** on page 67

Monitoring your PEC Plus

Your PEC Plus displays temperature, alarm, and status information. Monitoring the control regularly gives you a better idea of what is going on in your facility.

When in normal operation, the display shows the ambient temperature. The displayed temperature is the average from all probes connected. If probe 4 is configured for outdoor temperature monitoring, its temperature is not included in the average.



For more information about probe configuration and temperature averaging, read **Configuring temperature probes** on page 31.

Displaying individual probe temperatures

The main display shows the average temperature of all probes that are connected and configured, except for outdoor probes. You can display the current temperature for any individual probe by pressing its corresponding number key. For example, to display the temperature for probe 4, press **4**.

- ◆ If an indoor probe is damaged or missing, the display shows **PbAd**.
- ◆ If an outdoor probe is damaged or missing, the display shows **---**.
- ◆ If a probe is not configured, the display shows **PoFF**.

To display individual probe temperatures

1. When the main display is showing, press the number of the probe you want to display.
The display shows the temperature.
2. Repeat step 1 for each probe temperature you want to view.
3. Press **Back** to return to the main display.

Displaying high and low temperatures

You can display the previous day's high and low temperatures. The display shows the high temperature for two seconds, followed by the low temperature for two seconds.

If the temperature is above 99.9 degrees, the temperature drops the decimal and rounds off. For example, 103.2 would be 103; 103.5 would be 104.

To display high and low temperatures

1. When the main display is showing, press **5**.
The display shows the high and low temperatures.
2. Press **Back** to return to the main display.

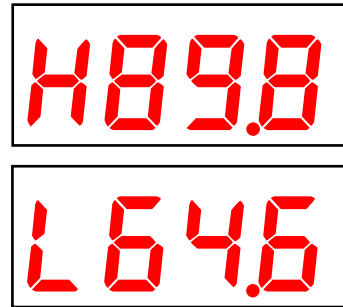

Acknowledging alarms

The alarm relay activates if an alarm condition (one that is enabled) is present for longer than the minimum duration of one minute. The one minute minimum duration prevents alarms from occurring when the temperature rises or drops for just a few seconds.

The exceptions to the one minute minimum are the actuator 1 jam and actuator 2 jam alarms. Actuator jam alarms activate immediately after the PEC Plus detects an actuator jam.

When an alarm occurs, the alarm relay activates, the LED for ALARM switches on, and the alarm message displays. If there is more than one message, after acknowledging the first alarm, the next one displays.

For example, if you had a high temperature and a probe damage alarm, the display would show **H-AL**. After acknowledging the high temperature alarm, the display would show **PdE**. When all alarms have been acknowledged, the display shows the temperature.

To acknowledge alarms

Press **Select**.

If there was only one alarm message, the PEC Plus clears the message and returns to the main display. If there are additional alarm messages, the PEC Plus displays the next message.



For a list of alarm messages, their descriptions, and possible resolutions, read **Alarm and error messages** on page 77.



Acknowledging alarms clears the alarm message; it does not deactivate the alarm relay. To deactivate the alarm relay, resolve the problem causing the alarm condition.

If you acknowledge the alarm, but do not resolve the problem causing the alarm condition, the alarm message displays again after five minutes without any key presses.

If the condition causing the alarm returns to normal (for example, the temperature drops below the high alarm setting), the alarm relay and LED deactivate, but the alarm message remains.

Testing settings and equipment

There are four test utilities.

- ◆ stage test mode
- ◆ temperature test mode
- ◆ actuator 1
- ◆ actuator 2

Using stage test mode

Stage test mode allows you to test each variable stage or relay individually.

When you enter stage test mode, all variable stages and relays switch off. You can change the output of variable stages or state of relays. Variable stages and relays (that are not assigned to actuators or curtains) remain at the state you set them until you leave stage test mode.

For example, if relay 5 is assigned as a cooling duty cycle and you switch it ON, it remains on until you leave stage test mode. If relay 1 is configured as an actuator or curtain and you switch it ON, it remains on until you change the state or you press the **Back** or **Select** button.

When you leave stage test mode, the variable stages and relays return to normal, programmed operation.



When the PEC Plus is in stage test mode, it does not operate the equipment according to the measured temperature.

The PEC Plus does not exit test mode on its own. When you are finished testing, press **Back** until the control exits test mode.

To test equipment using stage test mode

1. Press **Function** until the LED for TEST is lit.
The display shows **St 9E**.
2. Press **Select**.
All variable stages and relays switch off and the display shows **VAR 1**.
3. Press **Up** or **Down** to scroll through the variable stages and relays.
To test a variable stage or relay, press **Select**.
 - ◆ For variable stages, the display shows the output percentage.
Press **Up** or **Down** to adjust the output.
 - ◆ For relays, the display shows the relay state (on or off). Press **Up** or **Down** to change the relay state.
4. Press **Back** to return to the list of variable stages and relays.
5. Repeat steps 2 to 4 for each item you want to test.
6. When done, press **Back** twice to return to the main display.
The control returns to normal operation.

TEST

St 9E

VAR 1

VAR 1

RLY 1

RLY 1

OFF

Using temperature test mode

Temperature test mode allows you to test your equipment and programmed settings by simulating the temperature. Instead of adjusting the output of a variable stage or state of a relay, you adjust the “test temperature”.

As you increase or decrease the test temperature, the stages and relays operate according to their programmed settings and the test temperature. This gives you an idea of how your system performs

over a full range of temperatures. The variable stages and relays remain operating according to the test temperature until you exit temperature test mode.

	<p>When the PEC Plus is in temperature test mode, it does not operate the equipment according to the measured temperature.</p> <p>The PEC Plus does not exit test mode automatically. When you are finished testing, press Back until the control exits test mode.</p>
---	---

To test equipment using temperature test mode

1. Press **Function** until the LED for TEST is lit.
The display shows **5t9E**.
2. Press **Up** or **Down** until the display shows **tEnP** and then press **Select**.
The display shows the last ambient temperature (now the “test temperature”).
3. Press **Up** or **Down** to adjust the test temperature.
The variable stages and relays operate using their programmed settings according to the test temperature. When a stage or relay switches on, its LED switches on.
4. When done, press **Back** twice to return to the main display.
The control returns to normal operation.

 TEST



Using the actuator 1 and 2 test utilities

The actuator 1 and actuator 2 test utilities display the position of the actuator, according to the feedback received from the feedback potentiometer. Actuator 1 shows the value for the potentiometer connected to terminals ACT-1 on the control board and actuator 2 shows the value for the potentiometer connected to ACT-2.

If the actuator has not been calibrated, the display shows **UCAL**.

To display the actuator position

1. Press **Function** until the LED for TEST is lit.
The display shows **St GE**.
2. Press **Up** or **Down** until the display shows **ACT 1** (for actuator 1) or **ACT 2** (for actuator 2) and then press **Select**.
The display shows the position of the actuator, according to the feedback received from the potentiometer.
3. Press **Back** once to return to the Test menu or twice to return to the main display.

● TEST

Using PIN security

The PEC Plus has a PIN security feature you can use to control who makes changes to your system and its settings.

When you enable security, users must enter the PIN (personal identification number) before they can access the control's functions. After entering a PIN, you will not be asked again until five minutes have passed since the last key press.

By default, security is not enabled. When security is not enabled, the PIN is 1111. To enable security, change the PIN to a different number. The PIN can be any four-digit number, consisting of the numbers 1 to 5.

To change the PIN

1. Press **Function** until the LED for CONFIGURATION is lit.
2. Press **Up** or **Down** until **P In** is displayed and then press **Select**.
The display shows the current PIN.
3. Press **Up** or **Down** to change the digits. Press **Select** to accept the number and move to the next digit. After the fourth digit, the control returns to the Configuration menu.

● CONFIGURATION

NOTE

If the PIN has been forgotten and nobody can access the control, you will have to reset the PIN security.

To reset PIN security

1. Switch OFF the power to the PEC Plus.
2. Switch ON the power and hold the **Function** and **1** buttons during startup while the ---- is displayed.
3. When the control displays the temperature, release the buttons.
The PIN resets to 1111.

Servicing and maintaining your PEC Plus

Servicing and maintaining your PEC Plus will extend the life of the control and your equipment.



Before installing or servicing your PEC Plus, switch OFF the power at the source.

Actuator maintenance

Because cables can stretch and equipment can come out of alignment (similar to tires on your car), we recommend resetting the limit switches and calibrating your actuators at least once each year. For more information, read **Calibrating actuators** on page 35.

Cleaning

- ◆ Use caution when washing the room with a high-pressure washer.
- ◆ To clean the surface of the control, wipe it with a damp cloth.



DO NOT direct a high-pressure washer at the control.

Do not use harsh or abrasive cleaners or rub the surface of the control with your bare hands.

Moisture

Moisture will not cause problems with the control if you take proper care during installation.

1. After the first two weeks of operation, remove the cover from the unit and check inside for moisture. Be sure to turn off the power to the control before opening the cover.
2. If there is moisture present, wipe it out with a dry cloth and check the cable entry points and rubber gasket for proper sealing.
3. If the cable connectors are not sealing, apply RTV or Silicon II (non acetic acid) sealant around the cable.

Some silicone sealants release acetic acid while curing. This can cause corrosion and damage the control. Let the silicone cure completely (one to three days) with the cover open and ensure no moisture enters the control. Failure to do this might damage the control and void the warranty.

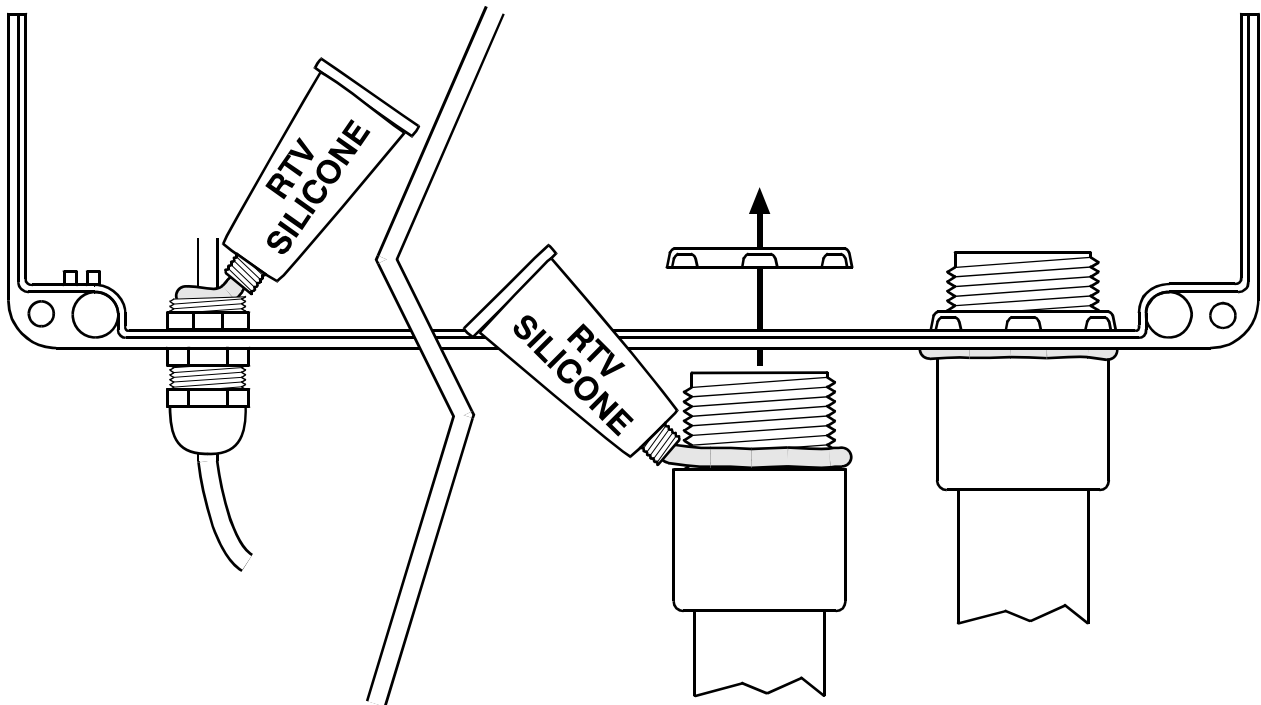

4. Open and inspect the control after two weeks to verify it is sealing properly.



Open and inspect the control for moisture once a year. Proper care and maintenance will extend the life of the control.

Restoring the factory defaults

When your PEC Plus leaves the factory, it comes with default settings and configuration. When you program your PEC Plus, you change its configuration and settings. Resetting your PEC Plus erases all the configuration and settings you programmed and restores them to what they were when the control left the factory.

For a list of the factory defaults, read **Appendix C: Factory defaults** on page 83.



Restore the factory defaults only as a last resort. It erases ALL your configuration and settings and you will have to reconfigure the control.

If you restore your PEC Plus to its factory defaults, disconnect the power to all loads and then reconfigure the control before restoring power to the loads.

To restore the factory defaults

1. Press **Function** until the LED for CONFIGURATION is lit.
2. Press **Up** or **Down** until *FACT* is displayed and then press **Select**.
The display shows *no*.
3. Press **Up** or **Down** to change the *no* to *YES* and then press **Select**.
The control restores its factory settings. When complete, the display shows *done*.
4. Press **Back** twice to return to the main display.

 CONFIGURATION

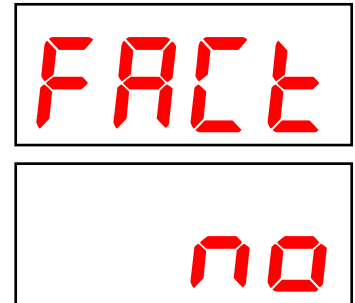

Saving and restoring settings

The PEC+ Saver is an innovative and easy-to-use product that allows you to store your PEC Plus configuration and settings.

The PEC+ Saver stores a complete copy of all a PEC Plus' configuration and settings. You can restore the configuration and settings any time, or even use them to set up new PEC Plus' in seconds!

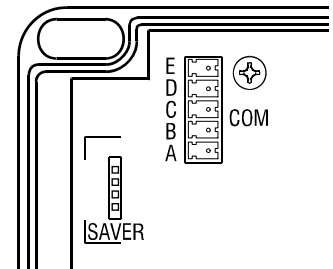

To save your settings

1. Loosen the four screws in the PEC Plus enclosure and then gently remove the cover. Make sure not to disconnect the ribbon cable.
2. Insert the PEC+ Saver into the connector marked SAVER on the inside top-left of the cover.
3. Press **Function** until the LED for CONFIGURATION is lit.
4. Press **Up** or **Down** until **SAVE** is displayed and then press **Select**. The display shows **no**. If the PEC+ Saver is not in correctly, the display shows **Err 3**.
5. Press **Up** or **Down** to change the **no** to **YES** and then press **Select**. The control saves the settings to the PEC+ Saver. When complete, the display shows **done**.
6. Press **Back** twice to return to the main display.
7. Remove the PEC+ Saver.
8. Replace the cover and then tighten the four screws.

● CONFIGURATION

SAVE

no

done

To restore your settings

1. Loosen the four screws in the PEC Plus enclosure and then gently remove the cover. Make sure not to disconnect the ribbon cable.
2. Insert the PEC+ Saver into the connector marked SAVER on the inside top-left of the cover.
3. Press **Function** until the LED for CONFIGURATION is lit.
4. Press **Up** or **Down** until **REST** is displayed and then press **Select**. The display shows **no**. If the PEC+ Saver is not in correctly, the display shows **Err 3**.
5. Press **Up** or **Down** to change the **no** to **YES** and then press **Select**. The control restores the settings from the PEC+ Saver. When complete, the display shows **done**.
6. Press **Back** twice to return to the main display.
7. Remove the PEC+ Saver.
8. Replace the cover and then tighten the four screws.

● CONFIGURATION

REST

no

done

Displaying the firmware version

Firmware is similar to operating system software for a computer. Firmware contains instructions that tell the PEC Plus how it operates. Just like computer operating systems (such as Windows™ XP) have version numbers, the firmware has a version number.

If you need to contact Phason Customer Support about your PEC Plus, you might need to provide them with the firmware version of your control. For more information about technical support, read **Service and technical support** at the front of the manual.

The PEC Plus displays the firmware version as a number in the format #.##.

To display the firmware version

1. Press **Function** until the LED for CONFIGURATION is lit.
2. Press **Up** or **Down** until **VER** is displayed and then press **Select**. The display shows the firmware version.
3. Press **Back** twice to return to the main display.

● CONFIGURATION



Updating the firmware

The optional PEC+ Updater is an innovative and easy-to-use product that allows you to upgrade your PEC Plus's firmware. Phason constantly improves and adds new features to their products. With the PEC+ Updater, you can upgrade the firmware in your PEC Plus as these features become available. The PEC+ Updater takes only seconds to use and can upgrade all the PEC Plus controls at your site.

There are two methods for updating the PEC Plus firmware: “power on” and “power off”.

- ◆ **Power on** – the power on method allows you to update the PEC Plus firmware using the menu system, without having to switch the incoming power off and then on. If the power on method fails, use the power off method.
- ◆ **Power off** – the power off method allows you to update the PEC Plus firmware by switching the incoming power off and then on. Use the power off method if the power on method fails.



The PEC+ Updater works with PEC Plus controls that have a serial number starting with 2006-10-01 or later. The updater will **not** work with serial numbers before that date.

The inside of the PEC Plus cover is where you connect the PEC+ Updater. The cover label must face the right when you plug the updater into the socket.

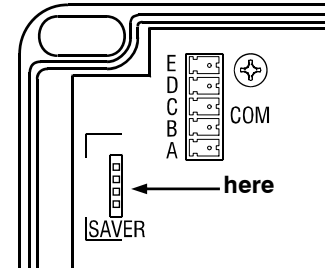

To update the firmware using the “power on” method

1. Loosen the four screws in the PEC Plus enclosure and then gently remove the cover. Make sure not to disconnect the ribbon cable.
2. Insert the PEC+ Updater into the connector marked SAVER on the inside top-left of the cover.
3. Press **Function** until the LED for CONFIGURATION is lit.
4. Press **Up** or **Down** until **UPdt** is displayed and then press **Select**. The display shows **no**.
5. Press **Up** or **Down** to change the **no** to **YES** and then press **Select**. The PEC Plus updates its firmware. During the update, the display is blank and the control beeps.

When the update is complete, the display shows **----** for a couple seconds and then shows the ambient temperature.

6. Remove the PEC+ Updater.
7. Verify that the control functions properly.
8. Replace the cover and then tighten the four screws.

● CONFIGURATION

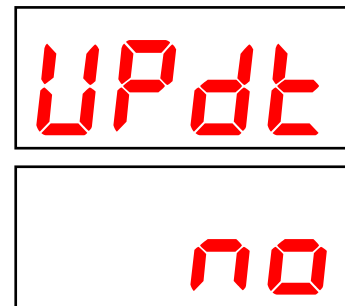

To update the firmware using the “power off” method

1. Loosen the four screws in the PEC Plus enclosure and then gently remove the cover. Make sure not to disconnect the ribbon cable.
2. Insert the PEC+ Updater into the connector marked SAVER on the inside top-left of the cover.
3. Switch off the power to the PEC Plus for at least five seconds.
4. Switch on the power to the PEC Plus.
The PEC Plus updates its firmware. During the update, the display is blank and the control beeps.

When the update is complete, the display shows **----** for a couple seconds and then shows the ambient temperature.

5. Remove the PEC+ Updater.
6. Verify that the control functions properly.
7. Replace the cover and then tighten the four screws.

Appendixes

This section contains reference information that is useful when installing, configuring, setting up, or troubleshooting your PEC Plus.

- ◆ **Appendix A: Glossary** below
- ◆ **Appendix B: Troubleshooting** on page 77
- ◆ **Appendix C: Factory defaults** on page 83
- ◆ **Appendix D: Installation worksheet** on page 84
- ◆ **Appendix E: Configuration worksheets** on page 86
- ◆ **Appendix F: Settings worksheets** on page 89

Appendix A: Glossary

AC power	Utility companies supply electrical power as alternating current, which is referred to as AC power.
actuator	<p>A device that has a mechanical arm that extends and retracts. Actuators control elements that are not OFF or ON. Instead, they vary by a percentage. For example, inlets can be open various distances from 0 to 100 percent.</p> <p>Typically, linear actuators connect directly to the inlets, or connect using cables and pulleys. Inlets are usually located in ceilings or walls. Inlet systems are often spring loaded to help close the inlets, or counter weighted to help open the inlets.</p> <p>For more information, read Connecting actuators on page 14.</p>
actuator set point	<p>When the temperature is below the minimum set point, the actuator is closed. When the temperature rises to the minimum set point, the actuator moves to the minimum position.</p> <p>As the temperature rises, the actuator has four stages it moves through until it reaches its maximum open position. This lets you gradually open inlets instead of fully opening them when the temperature rises above a single set point.</p> <p>In other words, “when the temperature is here (stage set point), I want the actuator to start opening. When the temperature reaches here (stage differential), I want the actuator to be at this position (stage position) percent.”</p> <p>For more information, read Programming actuators on page 49.</p>
control elements	Control elements are devices connected to your PEC Plus, such as fans, heaters, actuators, and so on.

curtain idle band	<p>Curtain idle band is a temperature buffer around the curtain set point. When the temperature is within the idle band, the curtains hold their position. When the temperature is outside the band, the curtains cycle open or closed.</p> <p>Idle band is one of six curtain settings. For more information, read Programming curtain control relays on page 52.</p>
curtain set point	<p>Curtain set point is the target temperature for the curtains. When the temperature is between the curtain set point and idle band limits, the curtains hold their position.</p> <p>Set point is one of six curtain settings. For more information, read Programming curtain control relays on page 52.</p>
differential	<p>The differential temperature is a setting for variable stages. When the temperature is above the differential temperature setting, the fan runs at full speed.</p> <p>For more information, read Programming variable stages on page 46.</p>
duty cycle	<p>Duty cycles are a temperature-based style of controlling heating or cooling elements using ‘on durations’ and ‘off durations’. There are two types of duty cycles, <i>normal</i> and <i>advanced</i>.</p> <p>For cooling elements, when the temperature is below the set point, the cooling element is off. When the temperature rises above the set point, the element switches on for the ‘on duration’ and then off for the ‘off duration’. If at any time the temperature drops below the set point, the duty cycle relay switches off and will not switch on again until the temperature rises above the set point.</p> <p>For heating elements, when the temperature is above the set point, the heating element is off. When the temperature drops below the set point, the element switches on for the ‘on duration’ and then off for the ‘off duration’. If at any time the temperature rises above the set point, the duty cycle relay switches off and will not switch on again until the temperature drops below the set point.</p> <p>Advanced duty cycles are for cooling only. Advanced duty cycles function similar to normal duty cycles. Instead of having one set point, advanced duty cycles have two set points.</p> <p>Set point 1 is the same as the set point in a normal duty cycle. Set point 2 is a set point that is higher than set point 1. When the temperature is above the set point 2, the duty cycle remains on, regardless of the on/off durations. When the temperature drops below set point 2, the duty cycle starts again.</p> <p>For more information, read Programming heating and cooling elements on page 54.</p>
firmware	<p>The internal program instructions of your PEC Plus.</p> <p>You can update the firmware version of your PEC Plus to the latest version using a PEC+ Updater. For more information, read Updating the firmware on page 71.</p>

group set point	<p>The group set point is the desired temperature for the zone.</p> <p>For more information, read Programming the group set point on page 42.</p>
growth curve	<p>A growth curve is an extension of the group set point concept. The growth curve automatically adjusts the temperature set points over time to control the temperature in a room or zone. It is called a ‘growth’ curve because it adjusts the set points as the animals ‘grow’.</p> <p>For more information, read Programming the growth curve on page 43.</p>
hysteresis	<p>Hysteresis is the number of degrees above the set point that a heating stage or relay switches off, and the number of degrees below the set point that a cooling stage or relay switches off.</p> <p>For example, a household thermostat might switch on a furnace at 68 °F when the house is cooling down, but switch it off at 72 °F when the house is warming up. The difference between these two values is the hysteresis.</p> <p>For more information, read Configuring hysteresis on page 32.</p>
idle at	<p>The temperature at which a variable cooling stage is at its minimum speed. Also called the temperature set point.</p> <p>For more information, read Programming variable stages on page 46.</p>
idle speed	<p>Idle speed is the percentage of full speed a variable stage fan is at when the temperature is between the “off at” and set point temperatures.</p> <p>For more information, read Programming variable stages on page 46.</p>
inlet actuator	<p>See <i>actuator</i>.</p>
inlets	<p>Inlets are shutter-like devices mounted on a wall or ceiling that control airflow in a building.</p>
minimum duration	<p>Minimum duration is the minimum amount of time and alarm condition must be present before the PEC Plus signals an alarm. The minimum duration, one minute, prevents alarms from activating when the temperature rises or drops for just a few seconds.</p> <p>For more information, read Programming alarm settings on page 58.</p>
minimum idle	<p>See <i>idle speed</i>.</p>
minimum position	<p>Minimum position is the percentage an actuator will be open when the temperature is at the minimum (stage 0) set point.</p> <p>For more information, read Programming actuators on page 49.</p>

minimum set point	<p>Minimum set point is the temperature at which an actuator is at its minimum position. When the temperature is below the set point, the actuator closes completely.</p> <p>For more information, read Programming actuators on page 49.</p>
off at	<p>Off at is a temperature setting for variable stages. When the temperature is below the off at temperature, the fan is off. When the temperature rises above the off at temperature, the fan runs at the idle speed until the temperature rises to the idle at temperature.</p> <p>For more information, read Programming variable stages on page 46.</p>
on full at	<p>For variable stages, the fan is on full (100% speed) at and above this temperature. Also called the ‘range temperature’.</p> <p>For more information, read Programming variable stages on page 46.</p>
PIN	<p>Personal identification number. A PIN is a unique four-digit number similar to a password. When security is enabled, users must enter the PIN before changing any configuration or settings. This prevents unauthorized access to the control.</p> <p>For more information, read Using PIN security on page 66.</p>
relay	<p>A relay is an electromagnetic switch that is either on (closed) or off (open).</p>
set point temperature	<p>Set point is the temperature at which a relay stage switches on or off.</p> <p>For more information, read Programming heating and cooling elements on page 54.</p> <p>See also <i>actuator set point</i> and <i>curtain set point</i>.</p>
spikes	<p>Short-term deviations or changes from a desired voltage level or signal. These deviations can cause damage to electronic devices, or cause them to malfunction. Spikes are often caused by sudden excess power, also known as ‘power surges’, or by drops in power, known as ‘brown outs’.</p> <p>For more information, read Understanding power surges and surge suppression on page 9.</p>
terminal block	<p>The part of your PEC Plus where you connect the wires for incoming power, control elements, and so on.</p> <p>For more information, read PEC Plus layout on page 13.</p>
voltage	<p>Electromotive force or potential difference, usually expressed in volts.</p>

Appendix B: Troubleshooting

- ◆ If you see an alarm message and are not sure what it means, look it up in the **Alarm and error messages** table below and then follow the instructions for resolving the alarm condition.
- ◆ If you are having a problem using your PEC Plus, see if the problem is described in the **Troubleshooting** table on page 79 and then follow the directions for correcting the problem.

Alarm and error messages

The following table lists the alarm and error messages, the possible causes, and their possible solutions. If you see a message and are not sure what it means, look it up in the table and then follow the instructions for resolving the condition.

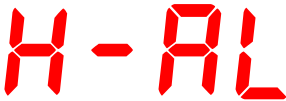
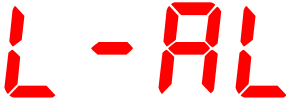
Alarm message	Possible cause	Possible solution
 High temperature alarm	The temperature has gone above the high temperature alarm point.	<ul style="list-style-type: none"> ◆ Try to lower the temperature by turning heaters down or off, or by increasing or turning on cooling elements (such as fans or misters), or by a combination of both. ◆ Check the temperature probes. ◆ Check to see if a fan has failed. ◆ Check the alarm settings. For more information, read Programming alarm settings on page 58.
 Low temperature alarm	The temperature has gone below the low temperature alarm point.	<ul style="list-style-type: none"> ◆ Try to raise the temperature by turning heaters up or on, or by decreasing or turning off cooling elements (such as fans or misters), or by a combination of both. ◆ Check the temperature probes. ◆ Check to see if a heater has failed. ◆ Check the alarm settings. For more information, read Programming alarm settings on page 58.

	<p>A temperature probe is damaged or disconnected.</p>	<ul style="list-style-type: none"> ◇ Replace or reconnect the temperature probe. The control should recover automatically.
<p>Probe damage alarm</p>	<p>If another probe is available, the control uses it. If probe averaging is on, the defective probe is excluded from the average. For more information, read Configuring temperature probes on page 31.</p>	
	<p>The difference in measured temperatures between averaged probes is greater than 18°F (10°C).</p>	<ul style="list-style-type: none"> ◇ Check the temperature probes. ◇ Check to see if a cooling or heating element has failed. ◇ Check the alarm setting. For more information, read Programming alarm settings on page 58.
<p>Probe deviation alarm</p>		
	<p>The control is attempting to open or close an inlet or other element operated by an actuator, and has not received the correct response from the positioning motor.</p>	<ul style="list-style-type: none"> ◇ Check the element controlled by the actuator to see if it is mechanically stuck. ◇ Check feedback wires for damage or improper installation. For more information, read Determining correct actuator feedback wiring on page 82. ◇ Recalibrate the actuator. For more information, read Calibrating actuators on page 35.
<p>Actuator jam alarm</p>	<p>The third digit shows which actuator (1 or 2) the alarm is for.</p>	
	<p>The temperature set points for the growth curve are increasing or overlapping. Temperature set points must decrease as the curve steps increase.</p>	<ul style="list-style-type: none"> ◇ Change the temperature set points so that they decrease. For more information, read Programming the growth curve on page 43.
<p>Error 1 - Growth curve error</p>		
	<p>The temperature set points for one of the actuators are overlapping. The differential for step 1 must be lower than the set point for step 2, and so on.</p>	<ul style="list-style-type: none"> ◇ Check the actuator settings and make sure they do not overlap. For more information, read Programming actuators on page 49.
<p>Error 2 - Actuator error</p>		
	<p>The PEC+SAVER is not in place when trying to save or restore settings</p>	<ul style="list-style-type: none"> ◇ Make sure the PEC+SAVER is inserted correctly and then try again.
<p>Error 3 - SAVER error</p>		

Troubleshooting

The following table lists some problems, possible causes, and possible solutions. If you are having a problem using your PEC Plus, see if the problem is described in the Troubleshooting table and then follow the directions for correcting the problem.

Problem	Possible cause	Possible solution
The display shows <i>P In</i> when trying to program the control	PIN security is enabled	◇ Enter the correct PIN. For more information, read Entering a PIN on page 8.
Power supply components blown out Burn marks on boards and components Motors and fans slow down or stop	Power surge, brownout, or power outage	◇ Avoid the problem in future by providing proper voltage and protection for the control.
No power and/or display	A circuit breaker at service panel is off or tripped. Incorrect wiring The display board connect cable is not plugged into the control board properly. The 115/230 VAC switch is in the wrong position	◇ Reset the circuit breaker. ◇ Correct the wiring. ◇ Plug in the display board cable. For more information, read PEC Plus layout on page 13. ◇ Switch off the power, set the switch to the correct setting, and then switch on the power. For more information, read PEC Plus layout on page 13.
Temperature does not change	There are no working temperature probes enabled or connected The control is in temperature test mode.	◇ Make sure at least one working probe is enabled. For more information, read Configuring temperature probes on page 31. ◇ If the TEST LED is on, the control is in test mode. Exit test mode. For more information, see Using temperature test mode on page 64.
Display showing unusually high or low temperature	The probe is not a Phason probe. The extension cable connected to the temperature probe is providing a poor connection Damaged probe	◇ If you have more than one probe connected, press buttons 1 to 4 to determine which probe is causing the high or low reading. ◇ Remove the probe and then install a Phason probe. ◇ Check the extension cable connection. Resolder it if necessary. ◇ Replace the temperature probe.

<p>Variable fan runs at maximum</p>	<p>Incorrect wiring</p> <p>The minimum idle speed is too high.</p> <p>The on full at setting is the same as the temperature set point.</p>	<ul style="list-style-type: none"> ◇ Correct the wiring. For more information, read Connecting variable-stage cooling elements on page 19. ◇ Decrease the minimum idle speed setting. For more information, read Programming variable stages on page 46. ◇ Adjust the temperature set point to the desired temperature. For more information, read Programming variable stages on page 46.
<p>Variable fan not running</p>	<p>Incorrect wiring</p> <p>The fuse is open or blown.</p> <p>The variable stage is configured as OFF</p> <p>The idle speed setting is too low.</p> <p>The off at temperature setting is too high.</p> <p>The temperature set point is above room temperature.</p> <p>There is no power to the fan. Faulty fan/heater Circuit breaker open</p>	<ul style="list-style-type: none"> ◇ Correct the wiring. For more information, read Connecting variable-stage cooling elements on page 19. ◇ Check why the fuse was blown and repair any problems. Replace the fuse. ◇ Configure the variable stage for cooling. For more information, read Configuring variable stages on page 33. ◇ Increase the idle speed setting. For more information, read Programming variable stages on page 46. ◇ Decrease the off at temperature setting. For more information, read Programming variable stages on page 46. ◇ Adjust the temperature set point to the desired temperature. For more information, read Programming variable stages on page 46. ◇ Switch on the power. ◇ Replace the equipment. ◇ Reset the breaker.
<p>Variable speed 1 or variable speed 2 fan switches on, runs at full speed, and then turns off. Keeps cycling.</p>	<p>The hysteresis is not high enough. The outside temperature is rising and falling quickly. This happens most often in the spring and fall.</p>	<ul style="list-style-type: none"> ◇ Adjust the hysteresis setting or overlap the variable speed 1 or variable speed 2 fan settings.

<p>Relay does not switch load on</p>	<p>Incorrect wiring</p> <p>The relay is configured as OFF.</p> <p>The set point is incorrect</p> <p>The relay is configured as cool for a heater.</p> <p>The relay is configured as heat for a fan.</p> <p>No power to the load</p> <p>Faulty equipment</p> <p>Circuit breaker open</p> <p>Blown relay</p>	<ul style="list-style-type: none"> ◇ Correct the wiring. For more information, read the appropriate installation section. ◇ Configure the relay properly. For more information, read Configuring relays starting on page 34. ◇ Adjust the setting. For more information, read the appropriate programming section. ◇ Change the configuration for the relay to heat. For more information, read the on page 37. ◇ Change the configuration for the relay to cool. ◇ Switch on the power. ◇ Replace the equipment. ◇ Reset the breaker. ◇ Solve the problem that caused the relay to blow and then replace the circuit board or use a different relay.
<p>Relay does not switch load off</p>	<p>The relay is configured as ON.</p>	<ul style="list-style-type: none"> ◇ Configure the relay properly. For more information, read Configuring relays starting on page 34.
<p>Curtain opens when it should close or closes when it should open</p>	<p>Incorrect wiring, the close and open wires are reversed.</p>	<ul style="list-style-type: none"> ◇ Correct the wiring. For more information, read Connecting curtain machines on page 18
<p>Alarm relay not operating alarm system</p>	<p>Incorrect wiring</p>	<ul style="list-style-type: none"> ◇ Correct the wiring. For more information, read Connecting an alarm system on page 21
<p>Staged heater cycles on and off</p>	<p>The heater set points are too close together with variable speed fans.</p> <p>The heater is too large for the room</p> <p>The stage is set up as a duty cycle</p>	<ul style="list-style-type: none"> ◇ Adjust the hysteresis setting. ◇ Move the temperature probe closer to the heater. ◇ Widen the set points. ◇ Replace the heater with a smaller output unit. ◇ Remove the duty cycle from the stage's settings

Determining correct actuator feedback wiring

After installing a new actuator or potentiometer, or due to age-related potentiometer wear, the actuator might not move correctly. Common symptoms include:

- ◆ The actuator oscillating back and forth
- ◆ The actuator not traveling the full stroke during calibration

The feedback potentiometer wiring must be properly connected to the control. Determining the correct wiring can be difficult on some actuators or potentiometers.

Potentiometers have three wires: positive (+), negative (-), and feedback (FB). If the feedback wire is not connected to the FB terminal on the control, the actuator will not function properly.

Because the wires are often different colors and are not always labeled the same as above, measuring the resistance between the wires is the best way to determine which wire is the feedback wire. Follow the steps below to measure the resistance and determine the correct wiring.



**Before checking the potentiometer wires, verify that the power wires are properly connected.
Test the actuator using stage test mode.**

1. Manually move the actuator away from the end of its stroke by at least a quarter of its total stroke.
2. Disconnect all three potentiometer wires from the control.
3. Number the wires 1, 2, and 3, in any order.
4. Set your ohmmeter to measure the potentiometer's maximum resistance, normally 20,000 Ω .
5. Measure and record the resistance between wires 1 and 2. _____ Ω
6. Measure and record the resistance between wires 1 and 3. _____ Ω
7. Measure and record the resistance between wires 2 and 3. _____ Ω
8. The pair of wires with the highest measured value are the positive and negative wires. Connect the wires to the positive and negative actuator terminals on the control. At this time, do not be concerned with which wire you connect to which terminal.
9. Connect the remaining wire to the feedback terminal.
10. Test the actuator using automatic mode to see if the control moves it properly. If the actuator moves in the opposite direction than it is supposed to, switch the positive and negative wires on the control.

Appendix C: Factory defaults

When your PEC Plus leaves the factory, it comes with default settings and configuration. When you configure and set up your PEC Plus, you change its settings.

Resetting your PEC Plus erases all the configuration and settings you programmed and then restores the settings to what they were when the control left the factory. For more information, read **Restoring the factory defaults** on page 69.

The table below lists the factory defaults.

Configuration		Alarm settings	
Relays 1 to 6	Off ¹	High temp	Disabled/95.0°F
Variable stages 1 and 2	Off	Low temp	Disabled/60.0°F
Temperature units	°F	Probe damage	Disabled
Probe 1	On	Probe deviation	Disabled/5°F
Probe 2	Off		
Probe 3	Off		
Probe 4	Off		
Security	Off		
Hysteresis	1.0		
¹ If the actuator present pins are in place, the defaults for the relays are: RLY1 – actuator 1 open, RLY2 – actuator 1 close, RLY3 – actuator 2 open, RLY4 – actuator 2 close.			
Variable stage settings (VAR1 and 2)			
Range (on full at)	86.0°F		
Set point	80.0°F		
Off at	75.0°F		
Idle speed/min heat	20%		
Group set point/growth curve defaults		Other setting defaults	
Current day	0/off	Actuator settings	None assigned
Step 1, 4 days	85.0°F	Curtain settings	None assigned
Step 2, 10 days	80.0°F	Duty cycle settings	None assigned
Step 3, 10 days	75.0°F	Heat/cool settings	None assigned
Step 4, 10 days	70.0°F		
Step 5, 10 days	65.0°F		
Step 6, 10 days	60.0°F		
Step 7, 20 days	60.0°F		
Group set point	75.0°F		

Appendix D: Installation worksheet

Use the worksheet on the next page to list all the equipment (fans, heaters, curtains, and so on that you want your PEC Plus to control. We recommend you make a copy of the worksheet before filling it in incase you need more than one sheet or you make a mistake.



Use the **Installation worksheet** when you fill in the **Configuration worksheets** (starting on page 86).

Input power	120/230 VAC, 50/60 Hz
Variable stages ① (2: VARI-1, VARI-2)	10 A at 120/230 VAC, general-purpose (resistive) 7 FLA at 120/230 VAC, PSC motor 1/2 HP at 120 VAC, 1 HP at 230 VAC, PSC motor
Fuses (2: F1 and F2)	15 A, 250 VAC ABC-type ceramic
Relay stages ① (6: STG-1 to STG-6)	10 A at 120/230 VAC, general-purpose (resistive) 1/3 HP at 120 VAC, 1/2 HP at 230 VAC 360 W tungsten at 120 VAC
Alarm relay	0.4 A at 125 VAC; 2 A at 30 VDC, resistive load 0.2 A at 125 VAC; 1 A at 30 VDC, inductive load

① You can connect more than one piece of equipment to a variable stage or relay as long as they are the same type (for example, two fans) and the total current draw does not exceed the stage's limit.



The FLA (full load ampere) rating accounts for the increase in motor current draw when the motor operates at less than full speed. Make sure the motor/equipment connected to the variable stage does not draw more than 7 FLA.

Stage/relay	Equipment to connect
<i>Example:</i> VAR1	36-inch variable speed fan, 2.5 FLA, 3/4 HP
VAR1	
VAR2	
RELAY1	
RELAY2	
RELAY3	
RELAY4	
RELAY5	
RELAY6	
ALARM	

Appendix E: Configuration worksheets



Use the **Installation Worksheet** on page 84 when completing the configuration worksheets.

Main control function worksheet

For each item, circle or write in the configuration.

Item	Description	Configuration
Units	The unit of measure for temperature.	<div style="display: flex; justify-content: space-around;"> °C °F </div> <p><i>Default: °F</i></p>
Probes	The configuration for each temperature probe terminal.	<div style="display: flex; justify-content: space-between;"> <div style="width: 60%;"> <p>P1: on off</p> <p>P2: on off</p> <p>P3: on off</p> <p>P4: on off outdoor</p> </div> <div style="width: 35%;"> <p><i>Default: P1-on, P2 to P4-off</i></p> </div> </div>
Hysteresis	The number of degrees above the set point that a heating stage or relay switches off, and the number of degrees below the set point that a cooling stage or relay switches off.	<p>_____ degrees</p> <p><i>Range: 0.3 to 5.0°F (0.2 to 2.8°C)</i></p> <p><i>Default: 1.0 °F</i></p>

Variable stage configuration worksheet

For each variable stage:

- ◆ Enter a description (for reference only)
- ◆ Put a check mark in the appropriate column for how to configure the relay.

Example

Stage	Description	Off	Cool
1	<i>Stage 1 fan</i>		✓
2	<i>Unused</i>	✓	

Stage	Description	Off	Cool
1			
2			

Relay configuration worksheet

For each relay:

- ◆ Enter a description (for reference only)
- ◆ Put a check mark in the appropriate column for how to configure the relay.

Relay configuration example

Relay	Description	Actuator 1 open	Actuator 1 close	Actuator 2 open	Actuator 2 close	Curtain open	Curtain close	Heat	Cool	Duty cycle (cool)	Duty cycle (heat)	Adv. duty cycle (cool)	Off	On
1	Inlet open	✓												
2	Inlet close		✓											
3	36-inch fan								✓					
4	Electric heat							✓						
5	Curtain open					✓								
6	Curtain close						✓							

Relay	Description	Actuator 1 open	Actuator 1 close	Actuator 2 open	Actuator 2 close	Curtain open	Curtain close	Heat	Cool	Duty cycle (cool)	Duty cycle (heat)	Adv. duty cycle (cool)	Off	On
1														
2														
3														
4														
5														
6														

Appendix F: Settings worksheets

Appendix F contains worksheets for you to use when programming your PEC Plus settings. Each worksheet contains a brief explanation of the information required. For more information about programming your PEC Plus, see **Chapter 4: Programming the PEC Plus** on page 41.

Growth curve worksheet

A growth curve is an extension of the group set point concept. The growth curve automatically adjusts the temperature set points over time to control the temperature in a room. It is called a “growth” curve because it adjusts the set-points as the animals “grow”.

You can have up to seven steps in a growth curve. Each step has a starting temperature set point and a duration. The PEC Plus automatically calculates the set points for the days between the steps and adjusts the set points at midnight each day. Individual set points for the variable and fixed stages are adjusted relative to the growth curve temperature for that particular day.

For more information, read **Programming the growth curve** on page 43.

Step	Temperature ^①	Duration ^②
Step 1		
Step 2		
Step 3		
Step 4		
Step 5		
Step 6		
Step 7		
^① Temperature in °F/°C, range: 0.0 to 37.7°C (32.0 to 99.9°F) ^② The duration in days; range: 001 to 365, not more than 365 total for all steps		



The temperature set point must decrease as the steps increase.

Variable stage settings worksheet

Setting	Variable 1	Variable 2
Range/On full at ①		
Set point ①		
Off at ①		
Idle speed ②		
① Temperature in °F/°C, range: 0.0 to 37.7°C (32.0 to 99.9°F)		
② Idle speed in %; range: 0 to 100 %		



If you need to connect more cooling elements than you have relays available, and you are not using both variable stages, you can use an available variable stage as an ON/OFF stage (for 120/230 VAC-powered equipment only).

Set the idle speed to 100% and 'off at' to the temperature at which you want the stage to switch on/off.

You no longer have "variable" speed or power; instead you have either full on or full off, the same as a regular cooling element. The 'set point' and 'on full at' settings have no effect when you use a variable stage this way.

Actuator settings worksheet

Each actuator has six stages. The settings for the stages include the set point temperature, position, and differential temperature.

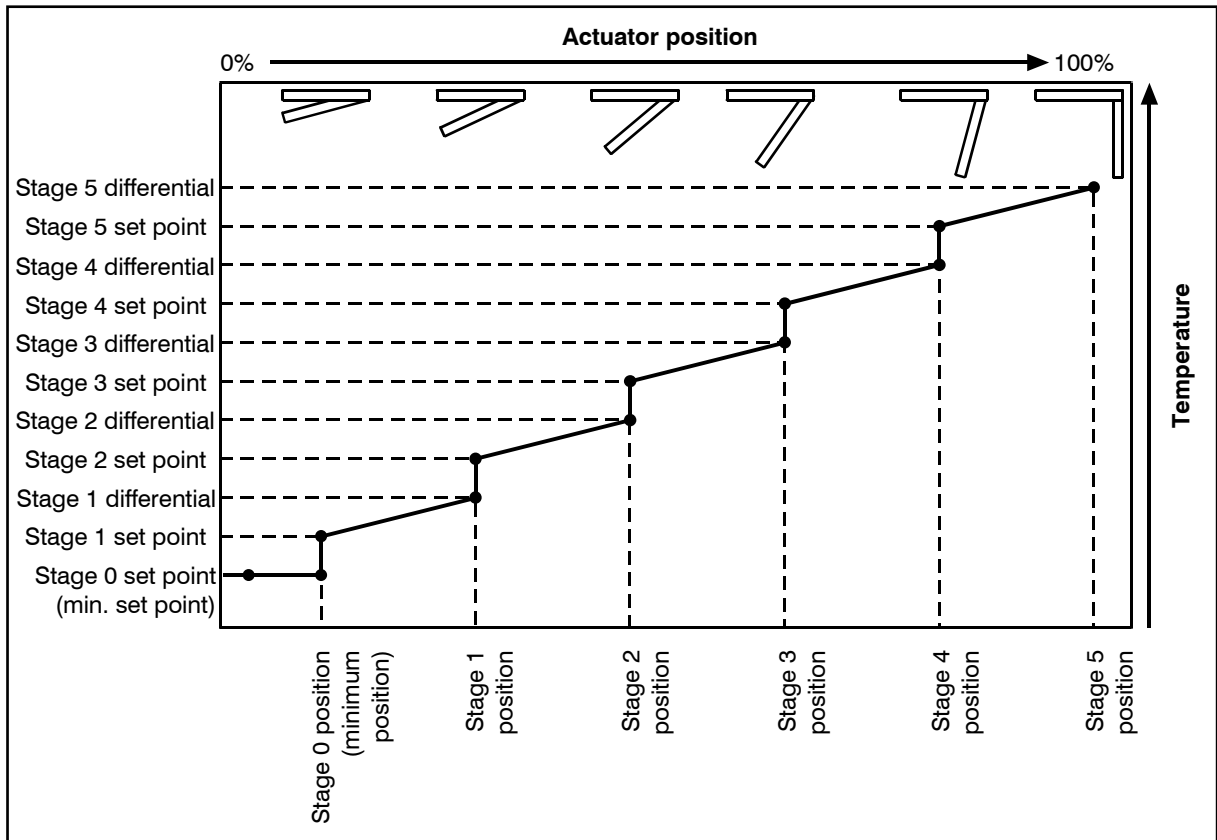

- ◆ When the temperature is below the minimum set point, the actuator is closed.
- ◆ When the temperature rises to the minimum set point, the actuator moves to the minimum position.
- ◆ As the temperature rises, the actuator moves through the stages until it reaches its maximum open position. This method lets you gradually open inlets instead of fully opening them when the temperature rises above a single set point.

In other words, “when the temperature is here (stage set point), I want the actuator to start opening. When the temperature reaches here (stage differential), I want the actuator to be at this position (stage position) percent.”

For more information, read **Programming actuators** on page 49.

Setting	Actuator 1	Actuator 2	Description
Minimum (stage 0)			
Set point ①			The temperature below which the actuator is closed
Position ②			The percentage the actuator is open when the temperature is at or above the minimum set point
Stage 1			
Set point ①			The temperature at which the actuator starts opening for stage 1
Differential ①			The temperature at which the actuator is open to stage 1 position
Position ②			The percentage the actuator is open when the temperature is at the differential
Stage 2			
Set point ①			The temperature at which the actuator starts opening for stage 2
Differential ①			The temperature at which the actuator is open to stage 2 position
Position ②			The percentage the actuator is open when the temperature is at the differential
Stage 3			
Set point ①			The temperature at which the actuator starts opening for stage 3
Differential ①			The temperature at which the actuator is open to stage 3 position
Position ②			The percentage the actuator is open when the temperature is at the differential
Stage 4			
Set point ①			The temperature at which the actuator starts opening for stage 4
Differential ①			The temperature at which the actuator is open to stage 4 position
Position ②			The percentage the actuator is open when the temperature is at the differential
Stage 5			
Set point ①			The temperature at which the actuator starts opening for stage 5
Differential ①			The temperature at which the actuator is open to stage 5 position
Position ②			The percentage the actuator is open when the temperature is at the differential
① Temperature in °F/°C, range: 0.0 to 37.7°C (32.0 to 99.9°F) ② Position in %, range: 0 to 100 %			

Curtain worksheet

Curtains control the temperature by adjusting the air flow into the facility. Each curtain has six settings.

- ◆ Set point – the temperature at which the curtain holds its position.
- ◆ Idle band – the buffer around the set point within which the curtains hold their position.
- ◆ Open on – the duration the curtains open during the open cycle
- ◆ Open off – the duration the curtains hold their position during the open cycle
- ◆ Close on – the duration the curtains close during the close cycle
- ◆ Close off – the duration the curtains hold their position during the close cycle

For more information, read **Programming curtain control relays** on page 52.

Curtain	Set point ^①	Idle band ^②	Open ON duration ^③	Open OFF duration ^③	Close ON duration ^③	Close OFF duration ^③
			:	:	:	:
			:	:	:	:
			:	:	:	:

^① Temperature in °F/°C, range: 0.0 to 37.7°C (32.0 to 99.9°F)
^② Temperature in °F/°C, range: 0.0 to 5.5°C (0.0 to 10.0°F)
^③ Duration in mm:ss, range: 0 to 59 minutes in 1 second increments

Heating and cooling elements worksheet

Heating and cooling elements control the temperature by switching single-stage heating equipment such as electric heaters, or cooling equipment such as misters ON or OFF.

There are three types of heating and cooling element setups: standard, duty cycle, and advanced duty cycle. Programming a standard element means setting the temperature set point. Programming a duty cycle means setting the temperature set point(s) and the ON and OFF durations.

For more information, read **Programming heating and cooling elements and duty cycles** on page 54.

Relay	Type		Set point ^①	Duty cycle		Set point 2 ①③
				ON duration ^②	OFF duration ^②	
Relay 1	Heat	Cool		:	:	
Relay 2	Heat	Cool		:	:	
Relay 3	Heat	Cool		:	:	
Relay 4	Heat	Cool		:	:	
Relay 5	Heat	Cool		:	:	
Relay 6	Heat	Cool		:	:	

① Temperature in °F/°C, range: 0.0 to 37.7°C (32.0 to 99.9°F)
 ② Duration in mm:ss, range: 0 to 59 minutes in 1 second increments
 ③ Advanced duty cycles only, must be lower than set point 1.

Alarm settings worksheet

The alarm settings for your PEC Plus determine which alarm conditions are enabled, which are disabled, and their settings. All these work together to determine how and when the alarm relay activates (in other words, signals an alarm condition).

The alarm relay activates if an alarm condition (one that is enabled) is present for longer than the minimum duration of one minute. The one minute minimum duration prevents alarms from occurring when the temperature rises or drops for just a few seconds.

For more information, read **Programming alarm settings** on page 58.

Alarm	Status	Setting	Description
High temperature ^① <i>H-RL</i>	ON OFF		The highest temperature to which you can safely allow your facility to rise – cannot be lower than low temperature alarm.
Low temperature ^① <i>L-RL</i>	ON OFF		The lowest temperature to which you can safely allow your facility to fall – cannot be higher than high temperature alarm.
Probe damage <i>PbRd</i>	ON OFF		Damaged or disconnected temperature probe
Probe deviation <i>PdEU</i>	ON OFF		The difference in measured temperatures between averaged probes is greater than 18°F (10°C).
Actuator 1 <i>Rc 1J</i>	ON OFF		Actuator 1 jammed
Actuator 2 <i>Rc 2J</i>	ON OFF		Actuator 2 jammed
① Temperature in °F/°C, range: 0.0 to 37.7°C (32.0 to 99.9°F)			

Index

A

AC actuators See actuators
 access code See PINs
 acknowledging alarms 62–63
 Actuator Position Sensor 15
 actuators
 actuator present pins 13, 15, 35
 calibrating 35–36, 67
 configuring 34–36, 49–51
 connecting 14–16
 feedback 13, 36, 82
 jam alarm See alarms
 maintaining See calibrating
 programming 34–36, 49–51
 testing 65–66
 advanced duty cycles See single-stage cooling/heating
 alarm systems 2, 13, 21
 alarms
 acknowledging 62–63
 configuring 58–60
 averaging See temperature, averaging

B - C

buttons 6
 calibrating actuators 35–36, 67
 Celsius display 30
 changing settings See programming
 cleaning 67
 clearing alarms 62–63
 clock 29–30
 configuration checklist 28
 configuring See also programming
 actuators 34–36, 49–51
 alarm settings 58–60
 clock 29–30
 curtains 38, 52–54
 duty cycles 37–38, 54–57

group set point 42–43
 growth curve 43–46
 hysteresis 32
 relays 34
 single-stage cooling/heating 37–38, 54–57
 temperature probes 31–32
 temperature units 30
 variable stages 33, 46–48

connecting

actuators 14–16
 alarm systems 21
 curtain machines 18
 incoming power 24
 single-stage cooling/heating elements 17
 temperature probes 22
 variable-stage elements 19

cooling element... See variable stages or single-stage cooling/heating

curtains

configuring 38, 52–54
 connecting 18
 programming 38, 52–54

D

daily temperature display 61–62
 data wires 12
 date and time 29–30
 DC actuators See actuators
 defaults See factory defaults
 degrees See temperature, units
 display 6
 display cable 13
 displaying temperatures 61–62
 duty cycles See single-stage cooling/heating

E - F

electrical ratings 10
 extending temperature probes 4, 23
 factory defaults 69
 Fahrenheit display 30
 feedback potentiometer 13, 82, 36, 82
 firmware 71–72
 furnace See single-stage cooling/heating
 fuses 10, 13

G - H

group set point 42–43
 growth curve 1, 43–46
 heating element See single-stage cooling/heating
 high temperature alarm See alarms
 high temperature display 61–62
 hysteresis 32

I

incoming power 13, 24, See also three-phase power
 individual probe temperatures 61–62
 installation guidelines 11–12
 installing See connecting

L

layout 13
 LEDs 6
 low temperature alarm See alarms
 low temperature display 61–62

M

main display 6
 maintaining the PEC Plus 67–68
 menu 7
 moisture 68
 monitoring temperatures 61–62
 mounting the control 11, 14

O - P

outdoor temperature probe See temperature probes
 parameter buttons See buttons, See buttons
 PEC Plus
 buttons 6
 diagnostic tests 39, 63–66
 features 2
 installation guidelines 11–12
 layout 13
 menu 7
 optional accessories 3–4
 PEC+ Saver 3, 69–70
 PEC+ Updater 3, 71–72
 PINs 8, 66–67, See also security
 potentiometer See feedback potentiometer
 power See incoming power or three-phase power
 power surges 9–10
 preventing moisture 68
 probe damage alarm See alarms
 probe deviation alarm See alarms
 probes See temperature probes
 programming See also configuring
 actuators 34–36, 49–51
 alarm settings 58–60
 curtains 38, 52–54
 duty cycles 37–38, 54–57
 relays 34
 single-stage cooling/heating 37–38, 54–57
 variable stages 33, 46–48
 programming checklist 41

R

real-time clock 29
 relays See also single-stage cooling/heating
 ratings 10
 terminal locations 13
 responding to alarms 62–63
 restoring factory defaults 69

R (continued)

- restoring settings 69–70
- ribbon cable 13
- routing data wires 12

S

- saving settings 69–70
- sealing See moisture
- security 2, See PINs
- selecting temperature units 30
- servicing the PEC Plus 67–68
- settings See programming
- settings saver See PEC+ Saver
- single-stage cooling/heating
 - configuring 37–38, 54–57
 - connecting 17
 - programming 37–38, 54–57
- specific probe temperatures 61–62
- stage test mode 63–64
- status LEDs 6
- surge suppression 9–10

T

- target temperatures See group set point or growth curve

temperature

- averaging 22, 31–32
- display 61–62
- set points See programming
- units 30
- temperature probes 4
 - configuring 31–32
 - connecting 13, 22
 - extending 23
- temperature test mode 64–65
- testing 39, 63–66
- three-phase power 20
- time See date and time

U - V

- units See temperature, units
- updating firmware 71–72
- variable stages
 - configuring 33, 46–48
 - connecting 13, 19
 - programming 33, 46–48
 - ratings 10
 - using as ON/OFF stages 47
- version See firmware
- voltage selection switch 13

Phason Inc.
2 Terracon Place
Winnipeg, Manitoba, Canada
R2J 4G7

Phone: 204-233-1400
Fax: 204-233-3252

E-mail: support@phason.ca
Web site: www.phason.ca