

# AN11251

## BGA7210 Operation Frequency Extension Down to 400 MHz

Rev. 1 — 11 September 2012

Application note

### Document information

Info	Content
<b>Keywords</b>	BGA7210, VGA, Frequency Extension, RF Choke, S-Parameters, Return Loss, OM7921/BGA7210 Customer Evaluation Kit
<b>Abstract</b>	The document provides the measurement results to show BGA7210 could operate well down to 400 MHz with good performance, by optimizing the RF Choke value.
<b>Ordering info</b>	Board-number: OM7921 12NC: 935294197515
<b>Contact information</b>	For more information, please visit: <a href="http://www.nxp.com">http://www.nxp.com</a>



## Revision history

Rev	Date	Description
1	20120911	Initial document

## 1. Introduction

This document describes the testing results for the frequency down to 400 MHz by optimizing the RF Choke value, the testing items include S-Parameters, linearity performance, noise figure, and so on. Measurements shown compare the performance using the original external component list (*without the shunt capacitor Csh = 0.68 pF*) with the optimized RF Choke, which proves BGA7210's excellent performance down to 400 MHz, covering low CDMA band.

The BGA7210 MMIC is an extremely linear Variable Gain Amplifier (VGA), operating from 0.7 GHz (now it's 0.4 GHz) to 3.8 GHz. The maximum gain is 30 dB. It has an attenuation range of 31.5 dB. At its minimum attenuation setting it has a maximum power output of 21 dBm, an IP3o of 39 dBm and a noise figure of 6.5 dB.

The BGA7210 has been designed and qualified for the severe mission profile of cellular base stations, but its outstanding RF performance and digital SPI interfacing flexibility make it suitable for a wide variety of applications.

## 2. Schematic Description

Figure 1 shows the simplified schematic of BGA7210 evaluation board. With the current component values, the gain roll-off at low 400 MHz frequencies. To improve this, the RF choke L2 was changed from 22 nH to 47 nH (Murata LQW 18), other components remain the same as BOM listed in datasheet. From simulations done earlier, the RF choke show the biggest influence among the external components. The reason of choosing 47 nH is for better output RL at lower frequency. 56 nH is also possible, but that will result in too much performance roll-off at high frequency.

For all measurements described here, no output matching capacitor (Csh) was used.

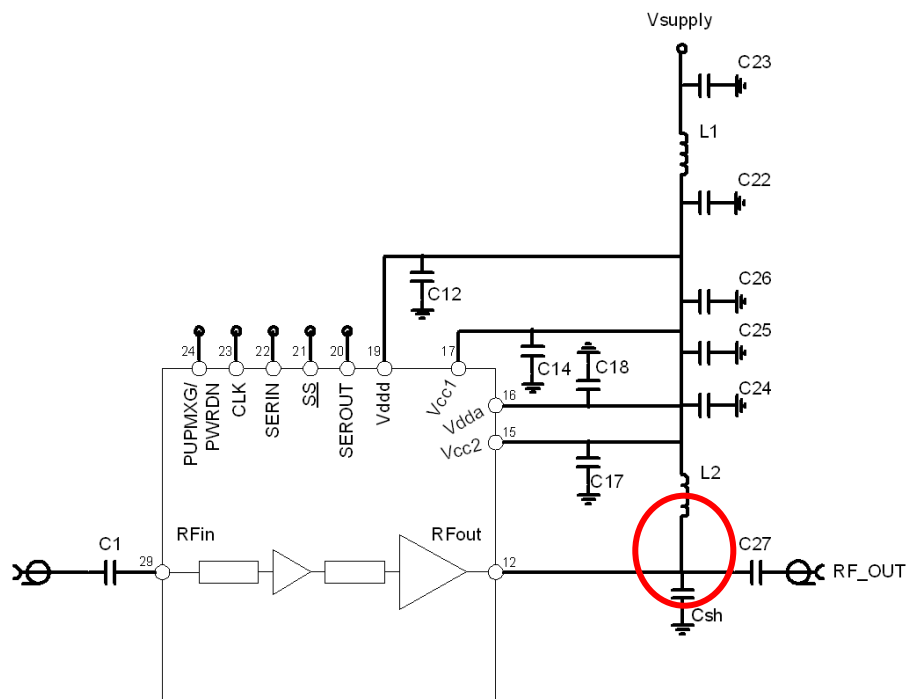

Fig 1. Simplified Schematic of BGA7210 Evaluation Board

### 3. Measurement Results

#### 3.1 S-par Comparison

Figures 2 and 3 show the s-parameter for L2=22 nH (in blue) and L2=47 nH (in red), it's observed that S21 trace with 47 nH is moving to lower frequency area. At 400 MHz, S21 improves by 0.4 dB, S22 improves by 6.5 dB while S11 and S12 have no significant difference.

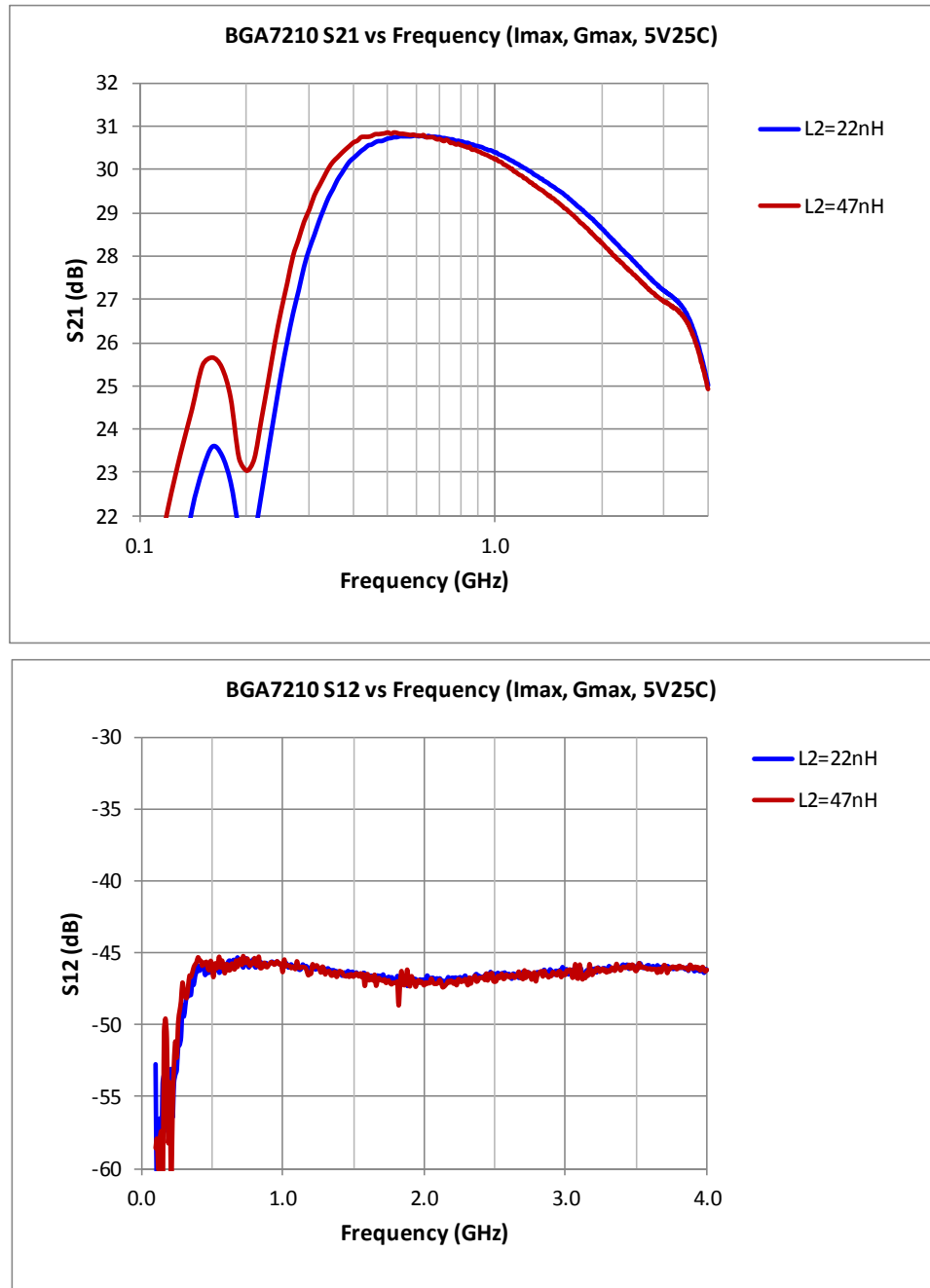

Fig 2. Comparison S21 and S12 for Two RF Choke L2 Values (Imax, Gmax)

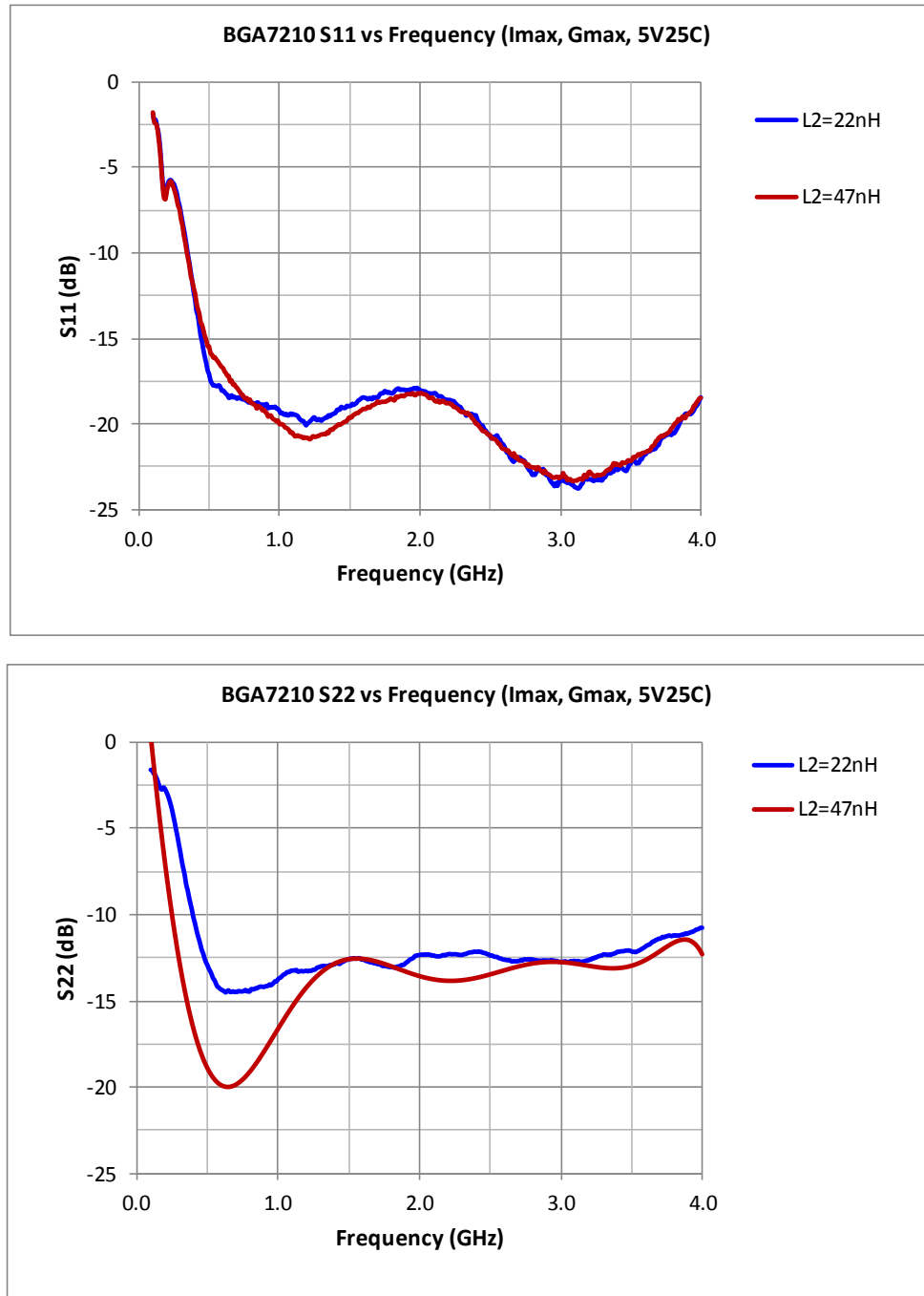

Fig 3. Comparison S11 and S22 for Two Different RF Choke Values (Imax, Gmax)

3.2 Gain Parameters vs. Attenuation

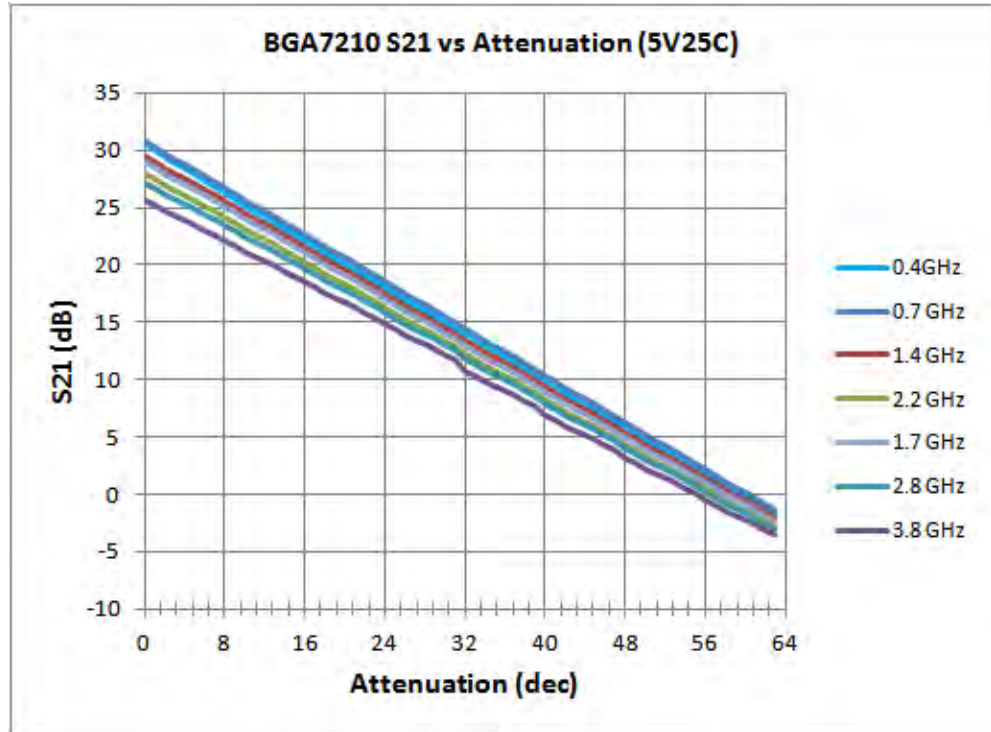

Fig 4. Gain vs. Attenuation Setting, L2=47 nH

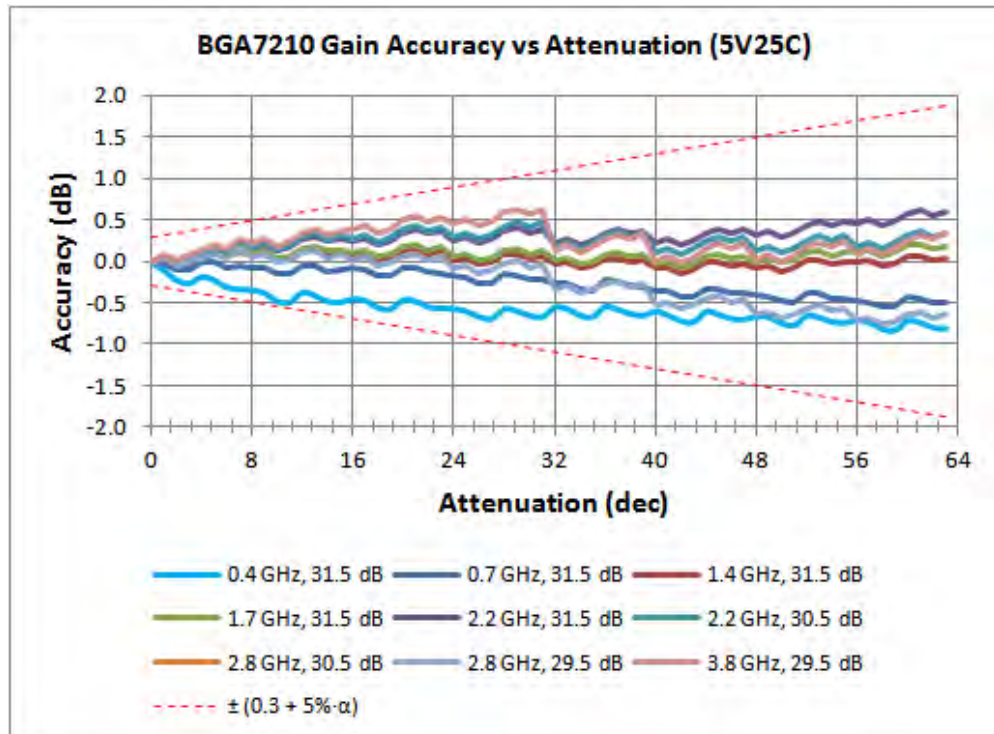

Fig 5. Gain Accuracy vs. Attenuation Setting, L2=47 nH

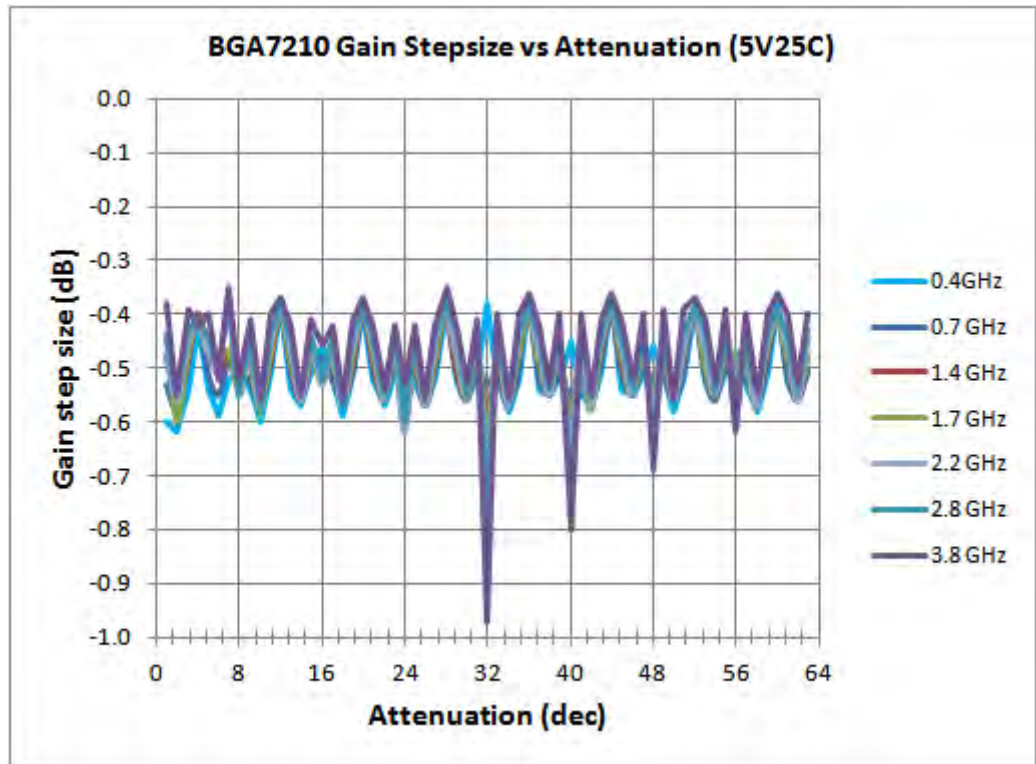

Fig 6. Gain Step Size vs. Attenuation Setting, L2=47 nH

With L2=47 nH S-parameter performance at 400 MHz of device complies with the current product specifications. No problem in monotonicity on all DSA (Digital Step Attenuator) settings and gain accuracy is within specification. No changes seen in performance at high frequencies compared to L2=22 nH.

3.3 Third Order Output Intercept Point (OIP3)

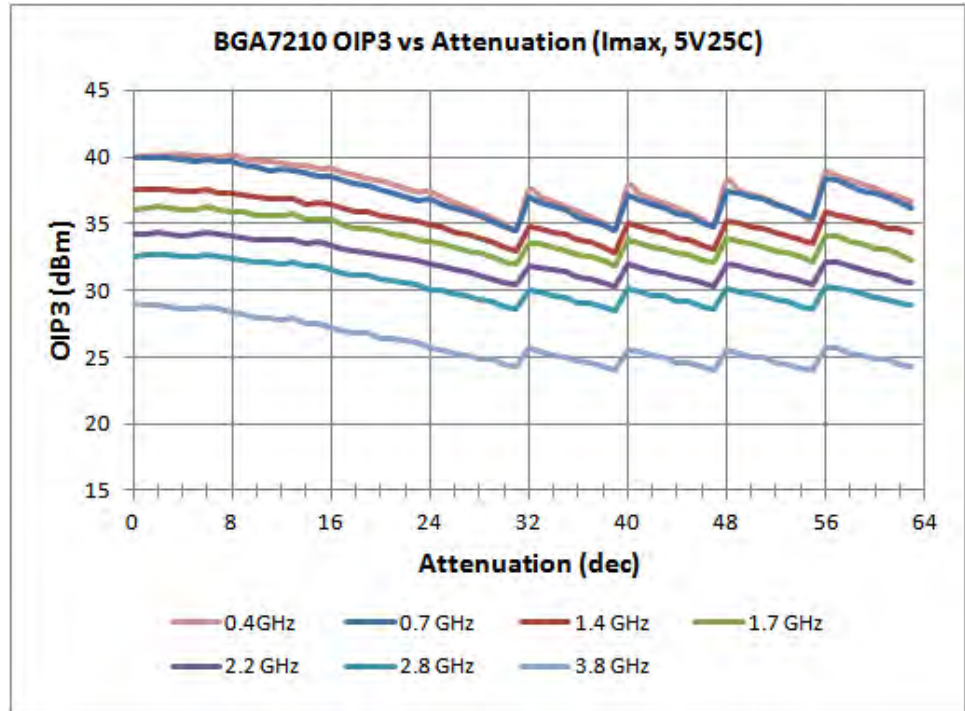

Fig 7. OIP3 vs. Attenuation Setting at I<sub>max</sub>, Pin/tone-23 dBm, F<sub>delta</sub>=10 MHz, L<sub>2</sub>=47 nH  
 At 400 MHz, BGA7210 has the same OIP3 performance as 700 MHz. Compared to results of L<sub>2</sub>=22 nH, changing L<sub>2</sub> to 47 nH has no effect on linearity performance.

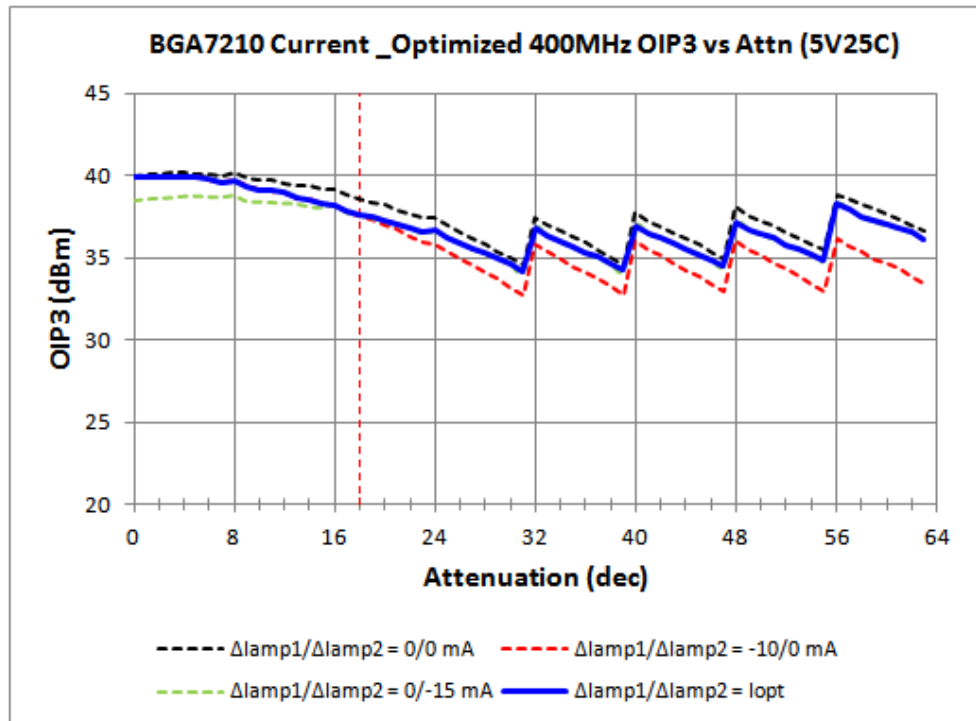

Fig 8. OIP3 vs. Attenuation Setting for Different Current Settings, L<sub>2</sub>=47 nH



Figure 8 shows that the current optimized OIP3 settings is also valid for 400 MHz. For DSA values between 0 and 17,  $\Delta I_{amp1}/\Delta I_{amp2} = -10/0$  mA was used and from DSA=18 to 63  $\Delta I_{amp1}/\Delta I_{amp2} = 0/-15$  mA was used.

### 3.4 Noise Figure

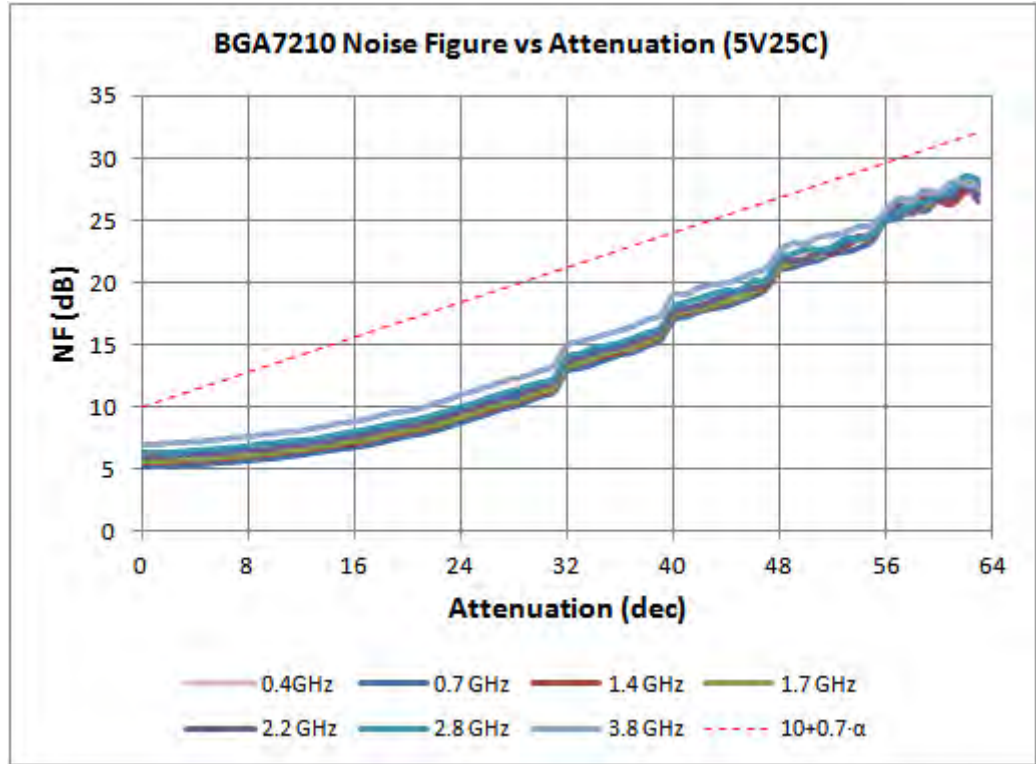

Fig 9. Noise Figure as Function of DSA Setting, L2=47 nH

Noise Figure at 400 MHz is the same as 700 MHz with 47 nH configuration.

### 3.5 Performance Summary

The table below shows the summary of the device performance at 400 MHz with L2=47 nH, and make comparison to the specification whose frequency range is from 700 ... 1400 MHz.

Table 1. BGA7210 400 MHz Performance Summary L2=47 nH

Parameter	Conditions	Specification			Measurement
		Min	Typical	Max	5V_25C
Power Gain $G_p$	DSA=0 $I_{amp1}=I_{amp2}=0$	26.0	30.0	33.0	30.6
Attenuation Range $\alpha_{max}$	$I_{amp1}=I_{amp2}=0$	28.0	31.5	35	32.3

Parameter	Conditions	Specification			Measurement
Attenuation Step Size $\Delta\alpha$	$I_{amp1}=I_{amp2}=0$	0.0	0.5	1.0	0.4 / 0.5 / 0.6
Input Return Loss $RL_{in}$	$0 \leq DSA \leq 63$ $I_{amp1}=I_{amp2}=0$		10		9.5
Output Return Loss $RL_{out}$	$0 \leq DSA \leq 63$ $I_{amp1}=I_{amp2}=0$		7		14.1
Noise Figure	DSA=0 $I_{amp1}=I_{amp2}=0$	-	6.5	8.5	5.1
	DSA=63 $I_{amp1}=I_{amp2}=0$	-	27.5	30.5	27.7
3 <sup>rd</sup> order Output Intercept Point $IP3_o$	DSA=0 $I_{amp1}=I_{amp2}=0$	34	39	-	40.0
	DSA=63 $I_{amp1}=I_{amp2}=0$	-	35	-	36.6
Output Power at 1dB Compression $P_{L(1dB)}$	DSA=0 $I_{amp1}=I_{amp2}=0$	18	21		22.6

## 4. Conclusion

BGA7210 operation frequency range could easily extend down to 400 MHz, by replacing the RF choke L2 from original 22 nH to 47 nH. According to the measurement results, all concerned product performance (such as S-parameters, linearity, noise figure and so on) at 400 MHz is even slightly better than the performance from 700 ... 1400MHz, as described in the Data Sheet. Therefore, this will make BGA7210 suitable for 400 MHz application.

## 5. Legal Information

### 5.1 Definitions

**Draft** — The document is a draft version only. The content is still under internal review and subject to formal approval, which may result in modifications or additions. NXP Semiconductors does not give any representations or warranties as to the accuracy or completeness of information included herein and shall have no liability for the consequences of use of such information.

### 5.2 Disclaimers

**Limited warranty and liability** — Information in this document is believed to be accurate and reliable. However, NXP Semiconductors does not give any representations or warranties, expressed or implied, as to the accuracy or completeness of such information and shall have no liability for the consequences of use of such information.

In no event shall NXP Semiconductors be liable for any indirect, incidental, punitive, special or consequential damages (including - without limitation - lost profits, lost savings, business interruption, costs related to the removal or replacement of any products or rework charges) whether or not such damages are based on tort (including negligence), warranty, breach of contract or any other legal theory.

Notwithstanding any damages that customer might incur for any reason whatsoever, NXP Semiconductors' aggregate and cumulative liability towards customer for the products described herein shall be limited in accordance with the Terms and conditions of commercial sale of NXP Semiconductors.

**Right to make changes** — NXP Semiconductors reserves the right to make changes to information published in this document, including without limitation specifications and product descriptions, at any time and without notice. This document supersedes and replaces all information supplied prior to the publication hereof.

**Suitability for use** — NXP Semiconductors products are not designed, authorized or warranted to be suitable for use in life support, life-critical or safety-critical systems or equipment, nor in applications where failure or malfunction of an NXP Semiconductors product can reasonably be expected to result in personal injury, death or severe property or environmental damage. NXP Semiconductors accepts no liability for inclusion and/or use of NXP Semiconductors products in such equipment or applications and therefore such inclusion and/or use is at the customer's own risk.

**Applications** — Applications that are described herein for any of these products are for illustrative purposes only. NXP Semiconductors makes no representation or warranty that such applications will be suitable for the specified use without further testing or modification.

Customers are responsible for the design and operation of their applications and products using NXP Semiconductors products, and NXP Semiconductors accepts no liability for any assistance with applications or

customer product design. It is customer's sole responsibility to determine whether the NXP Semiconductors product is suitable and fit for the customer's applications and products planned, as well as for the planned application and use of customer's third party customer(s). Customers should provide appropriate design and operating safeguards to minimize the risks associated with their applications and products.

NXP Semiconductors does not accept any liability related to any default, damage, costs or problem which is based on any weakness or default in the customer's applications or products, or the application or use by customer's third party customer(s). Customer is responsible for doing all necessary testing for the customer's applications and products using NXP Semiconductors products in order to avoid a default of the applications and the products or of the application or use by customer's third party customer(s). NXP does not accept any liability in this respect.

**Export control** — This document as well as the item(s) described herein may be subject to export control regulations. Export might require a prior authorization from national authorities.

**Evaluation products** — This product is provided on an "as is" and "with all faults" basis for evaluation purposes only. NXP Semiconductors, its affiliates and their suppliers expressly disclaim all warranties, whether express, implied or statutory, including but not limited to the implied warranties of non-infringement, merchantability and fitness for a particular purpose. The entire risk as to the quality, or arising out of the use or performance, of this product remains with customer.

In no event shall NXP Semiconductors, its affiliates or their suppliers be liable to customer for any special, indirect, consequential, punitive or incidental damages (including without limitation damages for loss of business, business interruption, loss of use, loss of data or information, and the like) arising out the use of or inability to use the product, whether or not based on tort (including negligence), strict liability, breach of contract, breach of warranty or any other theory, even if advised of the possibility of such damages.

Notwithstanding any damages that customer might incur for any reason whatsoever (including without limitation, all damages referenced above and all direct or general damages), the entire liability of NXP Semiconductors, its affiliates and their suppliers and customer's exclusive remedy for all of the foregoing shall be limited to actual damages incurred by customer based on reasonable reliance up to the greater of the amount actually paid by customer for the product or five dollars (US\$5.00). The foregoing limitations, exclusions and disclaimers shall apply to the maximum extent permitted by applicable law, even if any remedy fails of its essential purpose.

### 5.3 Trademarks

Notice: All referenced brands, product names, service names and trademarks are property of their respective owners.

## 6. Contents

---

<b>1.</b>	<b>Introduction .....</b>	<b>3</b>
<b>2.</b>	<b>Schematic Description.....</b>	<b>3</b>
<b>3.</b>	<b>Measurement Results .....</b>	<b>4</b>
3.1	S-par Comparison .....	4
3.2	Gain Parameters vs. Attenuation .....	6
3.3	Third Order Output Intercept Point (OIP3) .....	8
3.4	Noise Figure.....	9
3.5	Performance Summary .....	9
<b>4.</b>	<b>Conclusion.....</b>	<b>10</b>
<b>5.</b>	<b>Legal Information .....</b>	<b>11</b>
5.1	Definitions .....	11
5.2	Disclaimers.....	11
5.3	Trademarks.....	11
<b>6.</b>	<b>Contents.....</b>	<b>12</b>

---

Please be aware that important notices concerning this document and the product(s) described herein, have been included in the section 'Legal information'.

---

© NXP B.V.2012. All rights reserved.

For more information, visit: <http://www.nxp.com>

For sales office addresses, please send an email to: [salesaddresses@nxp.com](mailto:salesaddresses@nxp.com)

Date of release: 11 September 2012  
Document identifier: AN11251\_1