

User's Guide



Overview of Your Scanner Features

These features help you create the best possible scans, no matter what shape your original is in.



Guide to the Scanner Parts

Check this section to identify the parts of your scanner.



Placing Originals on the Scanner

Follow the steps here to place your original documents or photos on the scanner.



Scanning Your Originals

Follow the step-by-step instructions here to scan your original documents or photos using any of the available scanning methods.



Scanning Special Projects

Follow the instructions here for specific scanning projects you may need to create.



Maintenance

Follow the guidelines here to maintain and transport your scanner.



Solving Problems

If you have a problem using your scanner or its software, check here for solutions.



Technical Specifications

Check here for technical details about your scanner and its accessories.

- 2. Safety
- 2. Copyright and Trademarks
- 2. Operating System Versions

[Home](#) > Overview of Your Scanner Features

Overview of Your Scanner Features

These features help you create the best possible scans, no matter what shape your original is in.

 [Color Restoration](#)

 [Dust Removal](#)

 [DIGITAL ICE Technology and DIGITAL ICE Lite Technology](#)

 [Backlight Correction](#)

 [Text Enhancement](#)

[Home](#) > [Guide to the Scanner Parts](#)

Guide to the Scanner Parts

Check these sections to identify the parts of your scanner.

 [Scanner Parts](#)

 [Lights and Start Button](#)

[Home](#) > [Placing Originals on the Scanner](#)

Placing Originals on the Scanner

Follow the steps in the sections here to place your original documents, photos, film, or slides on the scanner.

 [Placing Documents or Photos](#)

 [Placing Film or Slides](#)

[Home](#) > [Scanning Your Originals](#)

Scanning Your Originals

Follow the step-by-step instructions in the sections here to scan your original documents, photos, film, or slides using any of the available scanning methods.

[Starting Epson Scan](#)

[Selecting an Epson Scan Mode](#)

[Changing the Scan Mode](#)

[Scanning in Full Auto Mode](#)

[Scanning in Office Mode](#)

[Scanning in Home Mode](#)

[Scanning in Professional Mode](#)

[Selecting File Save Settings](#)

[Detailed Setting Instructions](#)

[Finishing the Scan](#)

Home > Scanning Special Projects

Scanning Special Projects

Follow these instructions for specific scanning projects you may need to create.

 [Restoring Color](#)

 [Removing Dust Marks with the Dust Removal Feature](#)

 [Removing Dust and Scratch Marks from Originals Using DIGITAL ICE Technology](#)

 [Fixing Backlit Photos](#)

 [Text Enhancement](#)

 [Using the Scanner as a Copier](#)

 [Scanning to a PDF File](#)

 [Converting Scanned Documents Into Editable Text](#)

 [Scanning Color Accurate Images](#)

 [Assigning a Program to the Start Button](#)

[Home](#) > Maintenance

Maintenance

Follow the guidelines here to maintain and transport your scanner.

 [Cleaning the Scanner](#)

 [Replacing the Scanner Light Source](#)

 [Power Off Timer Setting](#)

 [Transporting the Scanner](#)

[Home](#) > Solving Problems

Solving Problems

Troubleshooting

If you have a problem using your scanner or its software, check here for solutions.

 [Scanner Problems](#)

 [Scanning Problems](#)

 [Scan Quality Problems](#)

 [Uninstalling Your Scanning Software](#)

Where To Get Help

 [Epson Technical Support](#)

 [Other Software Technical Support](#)

Home > Technical Specifications

Technical Specifications

Check here for technical details about your scanner and its accessories.

 [System Requirements](#)

 [Scanner Specifications](#)

 **Note:**

Epson offers a recycling program for end of life products. Please go to www.epson.com/recycle for information on how to return your products for proper disposal.

[Home](#) > [Safety](#)

■ Important Safety Instructions

[Restrictions on Copying](#)

Read all these instructions, and follow all warnings and instructions marked on the scanner.

- In this document, warnings, cautions, and notes indicate the following:

Warnings

must be followed carefully to avoid bodily injury.

Cautions

must be observed to avoid damage to your equipment.

Notes

contain important information and useful tips on the operation of this product.

- Place the scanner close enough to the computer for the USB cable to reach it easily. Do not place or store the scanner or the AC adapter outdoors, near excessive dirt or dust, water, heat sources, or in locations subject to shocks, vibrations, high temperature or humidity, direct sunlight, strong light sources, or rapid changes in temperature or humidity. Do not use with wet hands.
- Place the scanner and the AC adapter near an electrical outlet where the adapter can be easily unplugged.

Caution:

Be sure the AC power cord meets the relevant local safety standards.

- The AC power cord should be placed to avoid abrasions, cuts, fraying, crimping, and kinking. Do not place objects on top of the AC power cord and do not allow the AC adapter or the power cord to be stepped on or run over. Be particularly careful to keep the AC power cords straight at the end and the point where it enters the AC adapter.
- Use only the AC adapter that comes with your scanner. Using any other adapter could cause fire, electrical shock, or injury.
- The AC adapter is designed for use with the scanner with which it was included. Do not attempt to use it with other electronic devices unless specified.
- Use only the type of power source indicated on the AC adapter's label, and always supply power directly from a standard domestic electrical outlet with the AC adapter that meets the relevant local safety standards.
- When connecting this product to a computer or other device with a cable, ensure the correct orientation of the connectors. Each connector has only one correct orientation. Inserting a connector in the wrong orientation may damage both devices connected by the cable.
- Avoid using outlets on the same circuit as photocopiers or air control systems that regularly switch

on and off.

- If you use an extension cord with the scanner, make sure the total ampere rating of the devices plugged into the extension cord does not exceed the cord's ampere rating. Also, make sure the total ampere rating of all devices plugged into the wall outlet does not exceed the wall outlet's ampere rating.
- Never disassemble, modify, or attempt to repair the AC adapter, scanner, or scanner option by yourself except as specifically explained in the scanner's guides.
- Do not insert objects into any opening as they may touch dangerous voltage points or short out parts. Beware of electrical shock hazards.
- If damage occurs to the plug, replace the cord set or consult a qualified electrician. If there are fuses in the plug, make sure you replace them with fuses of the correct size and rating.
- Unplug the scanner and the AC adapter, and refer servicing to qualified service personnel under the following conditions: The AC adapter or plug is damaged; liquid has entered the scanner or the AC adapter; the scanner or the AC adapter has been dropped or the case has been damaged; the scanner or the AC adapter does not operate normally or exhibits a distinct change in performance. (Do not adjust controls that are not covered by the operating instructions.)
- Unplug the scanner and the AC adapter before cleaning. Clean with a damp cloth only. Do not use liquid or aerosol cleaners.
- If you are not going to use the scanner for a long period, be sure to unplug the AC adapter from the electrical outlet.



Warning

The film holders included with this scanner contain small parts. Keep out of the reach of children.

Restrictions on Copying

Observe the following restrictions to ensure responsible and legal use of your scanner.

Copying of the following items is prohibited by law:

- Bank bills, coins, government-issued marketable securities, government bond securities, and municipal securities
- Unused postage stamps, pre-stamped postcards, and other official postal items bearing valid postage
- Government-issued revenue stamps, and securities issued according to legal procedure

Exercise caution when copying the following items:

- Private marketable securities (stock certificates, negotiable notes, checks, etc.), monthly passes, concession tickets, etc.
- Passports, driver's licenses, warrants of fitness, road passes, food stamps, tickets, etc.



Note:

Copying these items may also be prohibited by law.

A note concerning responsible use of copyrighted materials

Epson encourages each user to be responsible and respectful of the copyright laws when using any Epson product. While some countries' laws permit limited copying or reuse of copyrighted material in certain circumstances, those circumstances may not be as broad as some people assume. Contact your legal advisor for any questions regarding copyright law.

[Home](#) > Copyright and Trademarks

Copyright and Trademarks

No part of this publication may be reproduced, stored in a retrieval system, or transmitted in any form or by any means, electronic, mechanical, photocopying, recording, or otherwise, without the prior written permission of Seiko Epson Corporation. No patent liability is assumed with respect to the use of the information contained herein. Neither is any liability assumed for damages resulting from the use of the information contained herein.

Neither Seiko Epson Corporation nor its affiliates shall be liable to the purchaser of this product or third parties for damages, losses, costs, or expenses incurred by the purchaser or third parties as a result of: accident, misuse, or abuse of this product or unauthorized modifications, repairs, or alterations to this product.

Seiko Epson Corporation and its affiliates shall not be liable against any damages or problems arising from the use of any options or any consumable products other than those designated as Original Epson Products or Epson Approved Products by Seiko Epson Corporation.

EPSON® and Perfection® are registered trademarks and EPSON Exceed Your Vision is a registered logomark of Seiko Epson Corporation.

Microsoft®, Windows®, and Windows Vista® are registered trademarks of Microsoft Corporation.

Adobe®, Adobe Reader®, Acrobat®, Photoshop®, and Photoshop Elements are either registered trademarks or trademarks of Adobe Systems Incorporated in the United States and/or other countries.

Apple®, ColorSync®, Mac®, and Mac OS® are registered trademarks of Apple Inc.

ABBYY® and ABBYY FineReader® names and logos are registered trademarks of ABBYY Software House.

PRINT Image Matching™ and the PRINT Image Matching logo are trademarks of Seiko Epson Corporation.

SilverFast® and LaserSoft Imaging® are either registered trademarks or trademarks of LaserSoft Imaging AG in the U.S. and other countries.

X-Rite® is a registered trademark of X-Rite, Incorporated.

Epson Scan Software is based in part on the work of the Independent JPEG Group.

libtiff

Copyright © 1988-1997 Sam Leffler
Copyright © 1991-1997 Silicon Graphics, Inc.

Permission to use, copy, modify, distribute, and sell this software and its documentation for any purpose is hereby granted without fee, provided that (i) the above copyright notices and this permission notice appear in all copies of the software and related documentation, and (ii) the names of Sam Leffler and Silicon Graphics may not be used in any advertising or publicity relating to the software without the specific, prior written permission of Sam Leffler and Silicon Graphics.

THE SOFTWARE IS PROVIDED "AS-IS" AND WITHOUT WARRANTY OF ANY KIND, EXPRESS, IMPLIED OR OTHERWISE, INCLUDING WITHOUT LIMITATION, ANY WARRANTY OF MERCHANTABILITY OR FITNESS FOR A PARTICULAR PURPOSE.

IN NO EVENT SHALL SAM LEFFLER OR SILICON GRAPHICS BE LIABLE FOR ANY SPECIAL, INCIDENTAL, INDIRECT OR CONSEQUENTIAL DAMAGES OF ANY KIND, OR ANY DAMAGES WHATSOEVER RESULTING FROM LOSS OF USE, DATA OR PROFITS, WHETHER OR NOT ADVISED OF THE POSSIBILITY OF DAMAGE, AND ON ANY THEORY OF LIABILITY, ARISING OUT OF OR IN CONNECTION WITH THE USE OR PERFORMANCE OF THIS SOFTWARE.



Digital ICE is a trademark of Kodak.

General Notice: Other product names used herein are for identification purposes only and may be trademarks of their respective owners. Epson disclaims any and all rights in those marks.

This information is subject to change without notice.

5/13

© 2013 Epson America, Inc.

CPD-38474

[Home](#) > Operating System Versions

■ Operating System Versions

In this manual, the following abbreviations are used.

Windows refers to Windows 8, Windows 7, Windows Vista, Windows XP, and Windows XP x64.

- Windows 8 refers to Windows 8 and Windows 8 Pro.
- Windows 7 refers to Windows 7 Home Basic, Windows 7 Home Premium, Windows 7 Professional, and Windows 7 Ultimate.
- Windows Vista refers to Windows Vista Home Basic Edition, Windows Vista Home Premium Edition, Windows Vista Business Edition, Windows Vista Enterprise Edition, and Windows Vista Ultimate Edition.
- Windows XP refers to Windows XP Home Edition, Windows XP Professional x64 Edition, and Windows XP Professional.

Mac refers to Mac OS X.

- Mac OS X refers to Mac OS X 10.5.8, 10.6.x, 10.7.x, and 10.8.x.

[Home](#) > [Overview of Your Scanner Features](#)

■ Color Restoration

Using the **Color Restoration** feature in Epson Scan, you can transform an old, faded, or badly exposed photo into one with true-to-life color and sharpness.



For instructions on using this feature, see [Restoring Color](#).

[Home](#) > [Overview of Your Scanner Features](#)

■ Dust Removal

Using the **Dust Removal** feature in Epson Scan, you can virtually “clean” the dust marks from your originals as you scan them.

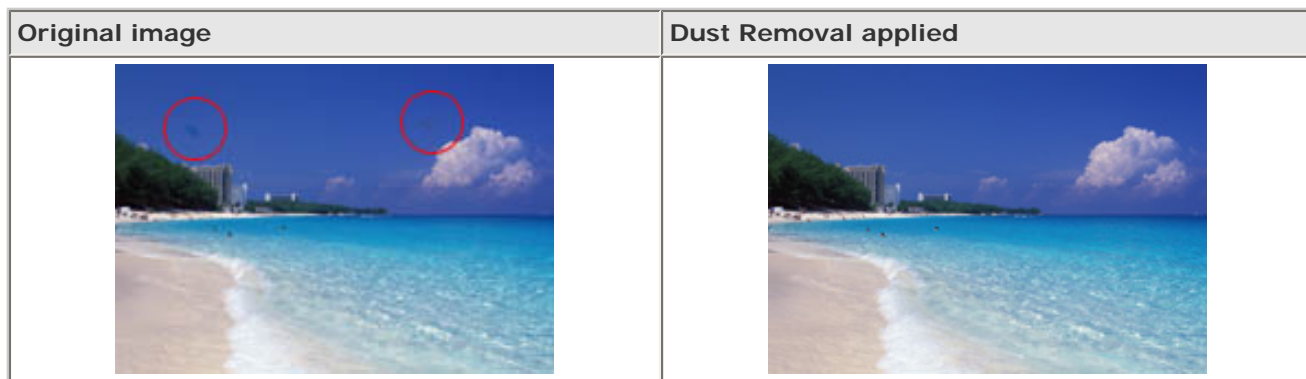



For instructions on using this feature, see [Removing Dust Marks with the Dust Removal Feature](#).

[Home](#) > [Overview of Your Scanner Features](#)

DIGITAL ICE Technology and DIGITAL ICE Lite Technology

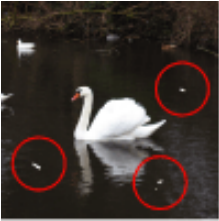
Your scanner and its Epson Scan software are equipped with the **DIGITAL ICE Technology** and **DIGITAL ICE Lite Technology** features that remove stubborn dust or scratch marks from color photos, film, or slides.

Original image	DIGITAL ICE Technology applied
	



DIGITAL ICE Technology can remove dust marks that the Dust Removal feature cannot. However, it takes longer to scan using DIGITAL ICE Technology and also uses more of your system resources. It is best to try removing dust marks using Dust Removal before using DIGITAL ICE Technology.

For instructions on using this feature, see [Removing Dust and Scratch Marks from Originals Using DIGITAL ICE Technology](#) for instructions.

[Home](#) > [Overview of Your Scanner Features](#)

■ Backlight Correction

Using the **Backlight Correction** feature in your scanning software, you can remove shadows from photos that have too much background light.

Original image	Backlight Correction applied
	

For instructions on using this feature, see [Fixing Backlit Photos](#).

[Home](#) > [Overview of Your Scanner Features](#)

■ Text Enhancement

When you scan documents, you can sharpen the text and increase accuracy by using the **Text Enhancement** feature in Epson Scan.

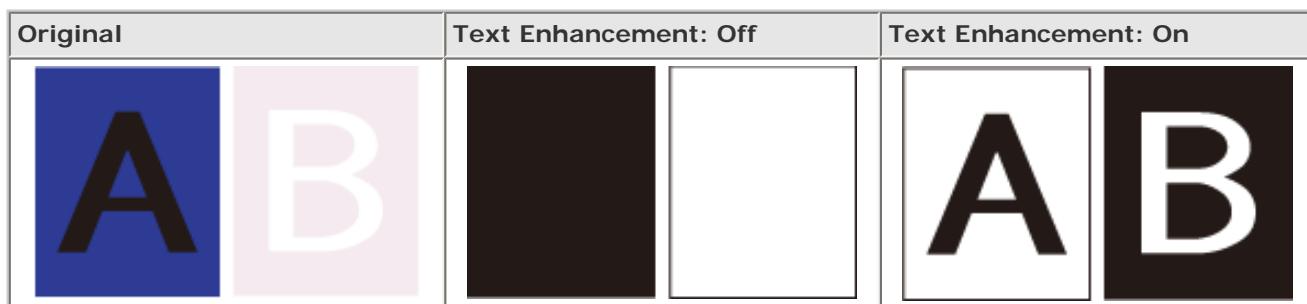

For instructions on using this feature, see [Text Enhancement](#).



[Home](#) > [Guide to the Scanner Parts](#)

Scanner Parts

 **Note:**

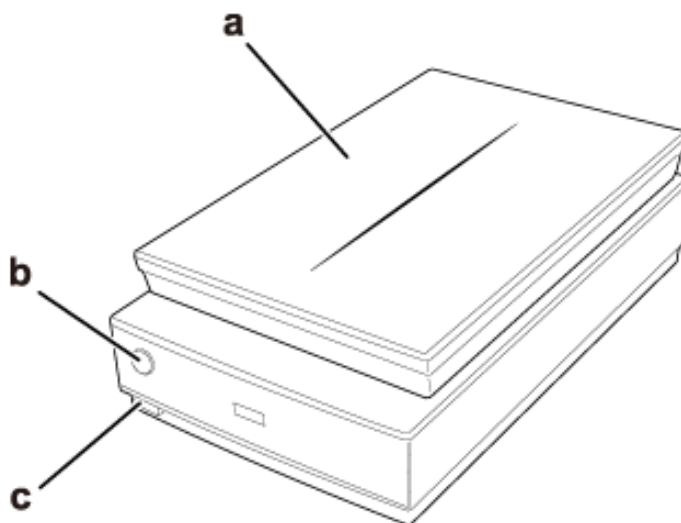
Your product may look different from the illustrations in this guide, but the instructions are the same.



- a. scanner cover
- b.  Start button
- c.  power button

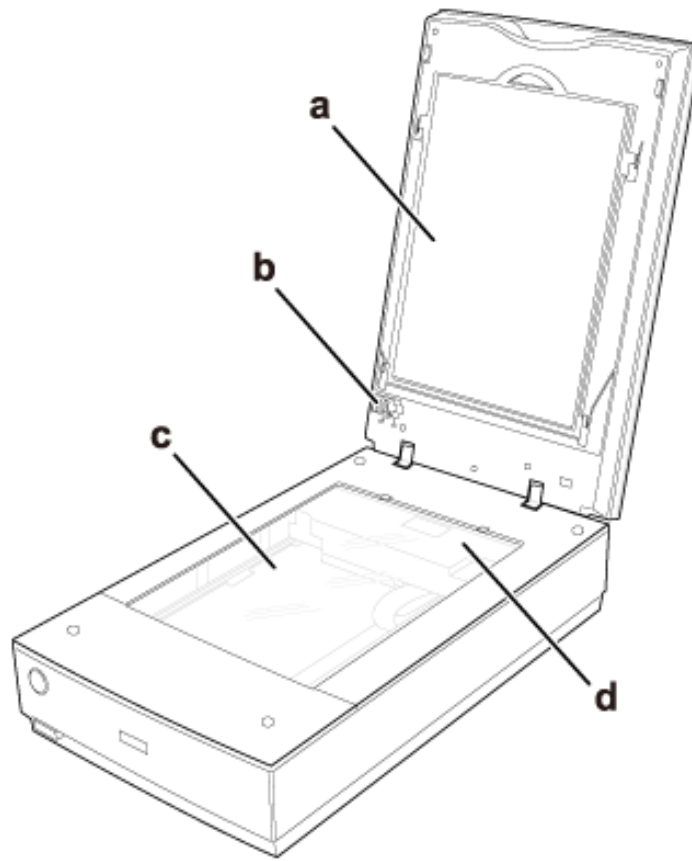

- a. document mat
- b. transparency unit transportation lock
- c. document table
- d. carriage

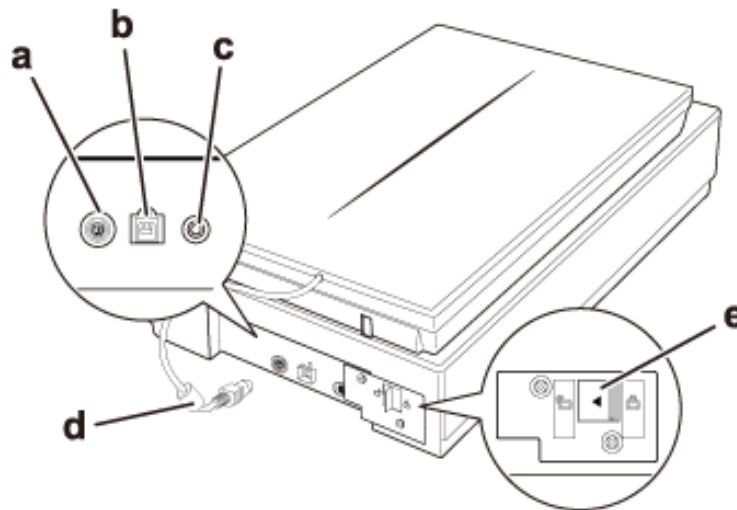

- a. option interface connector
- b. USB interface connector
- c. DC inlet
- d. cover cable
- e. scanner transportation lock

Home > Guide to the Scanner Parts

■ Lights and Start Button

☑ Lights

☑ Button



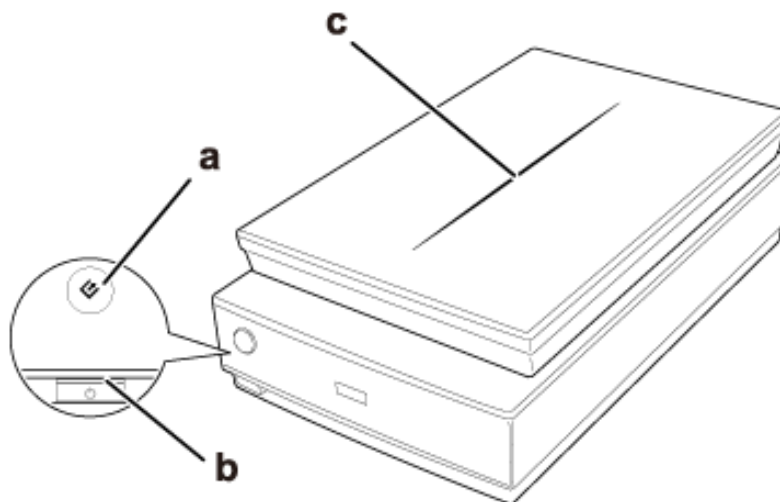



The scanner has one button for scanning operations. The scanner light indicates the scanner's status.



- a.  Start button
- b. scanner light
- c. scanner cover light

Lights

The scanner light is located above the  power button, and the scanner cover light is on the top of the scanner cover.

Light	Color	Indicator Status	Meaning
Scanner light	Green	 On	Ready to scan images.
		 Flashing	Initializing or scanning.
	Red	 Flashing	An error has occurred. See The Status Light Is Flashing for more information.
	—	 Off	The scanner is off.
Scanner cover light	Blue	 On	Scanning transparencies (such as film or slides).
	—	 Off	Scanning reflective documents (such as documents and photographs).

Button

Before using the  Start button, make sure you have installed Epson Scan.

Button	Function
 Start	Epson Scan starts.

See [Using the Scanner Button](#).

 **Note for Mac OS X 10.5.8 users:**

The  Start button is not supported. To start Epson Scan, see [Using the Epson Scan Icon](#) for instructions.

Top 

Home > Placing Originals on the Scanner

■ Placing Documents or Photos

▾ Placing Documents or Photos on the Document Table

▾ Placing Large or Thick Documents

Caution:

Do not place heavy objects on the document table glass and do not press the glass with too much force.

Placing Documents or Photos on the Document Table

1 Open the scanner cover.

Make sure the document mat is installed inside the cover. If it is not installed, see [Replacing the Document Mat](#) for instructions.

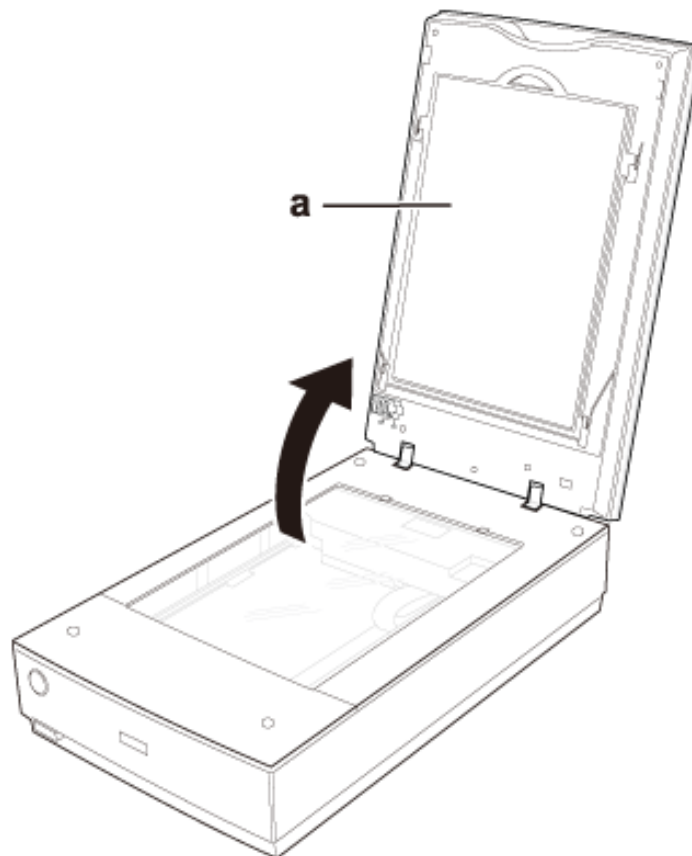

a. document mat

- 2 Place your document or photo facedown on the document table. Make sure the top of the document or photo is against the upper right corner of the document table, next to the arrow mark.

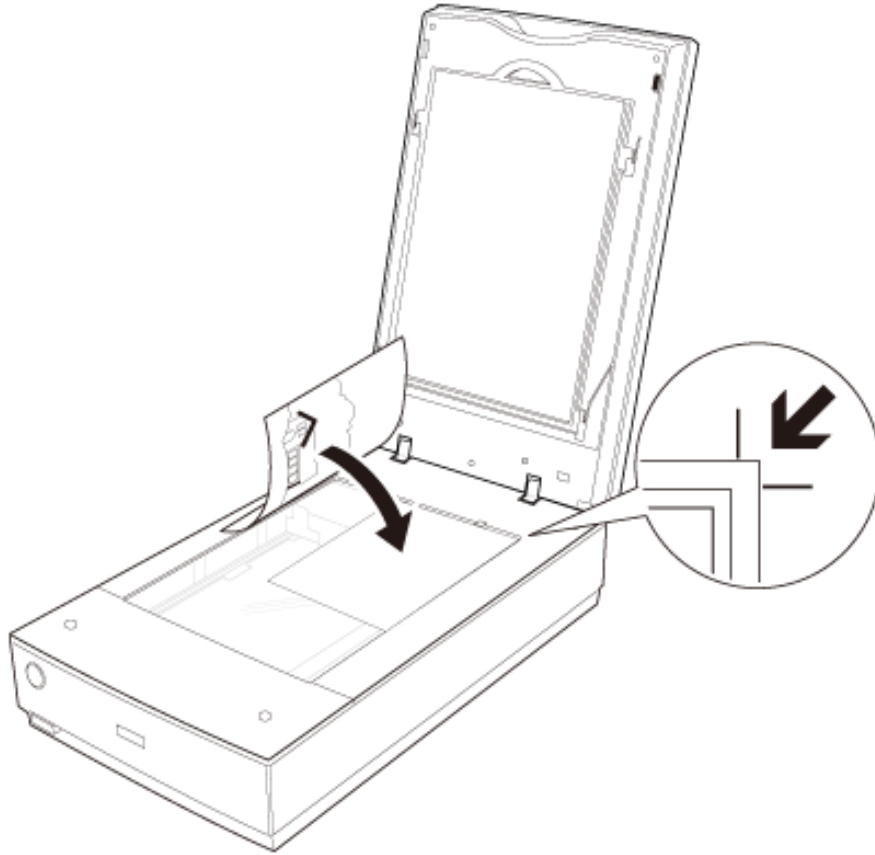

 **Note:**

If you are scanning multiple photos at once, position each photo at least 20 mm (0.8 inch) apart from the others.

- 3 Close the scanner cover gently so that your original does not move.

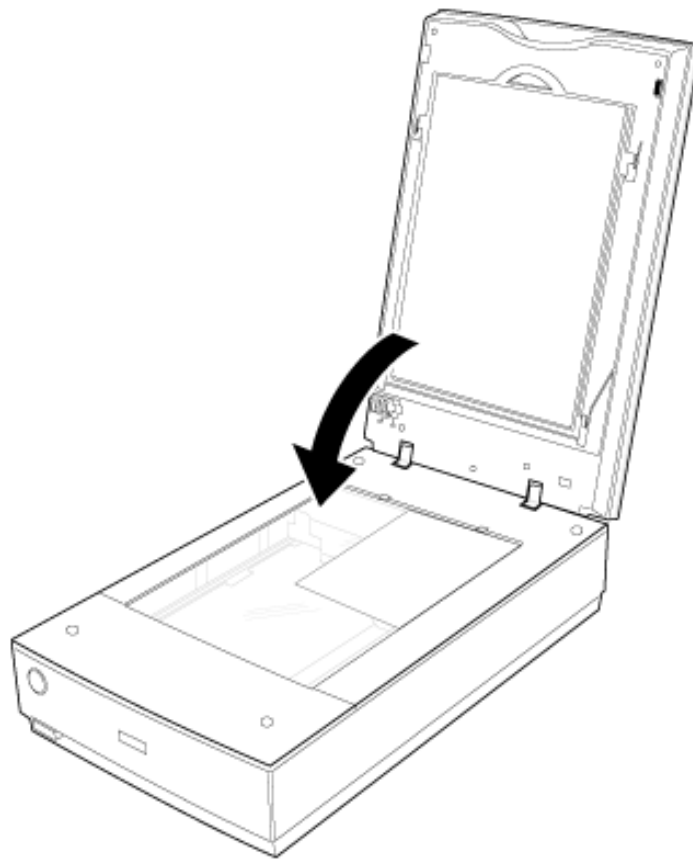

 **Note:**

- Always keep the document table clean.
- Do not leave photos on the document table for an extended period of time as they may stick to the glass.

To start scanning, see [Starting Epson Scan](#) for instructions.

Top 

Placing Large or Thick Documents

When you scan a large or thick document, you can remove the scanner cover.

1 Turn off the scanner using its  power button.

2 Disconnect the cover cable.

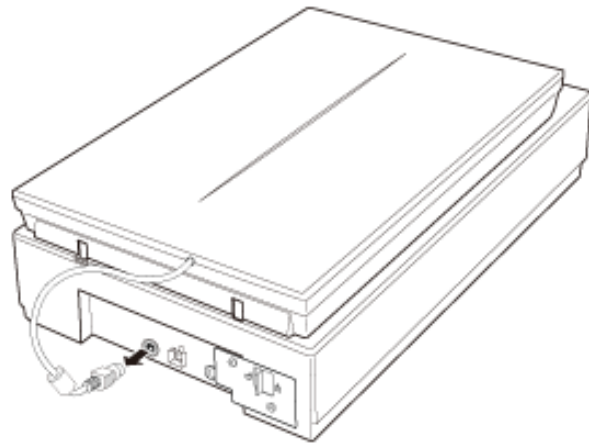

3 Open the scanner cover.

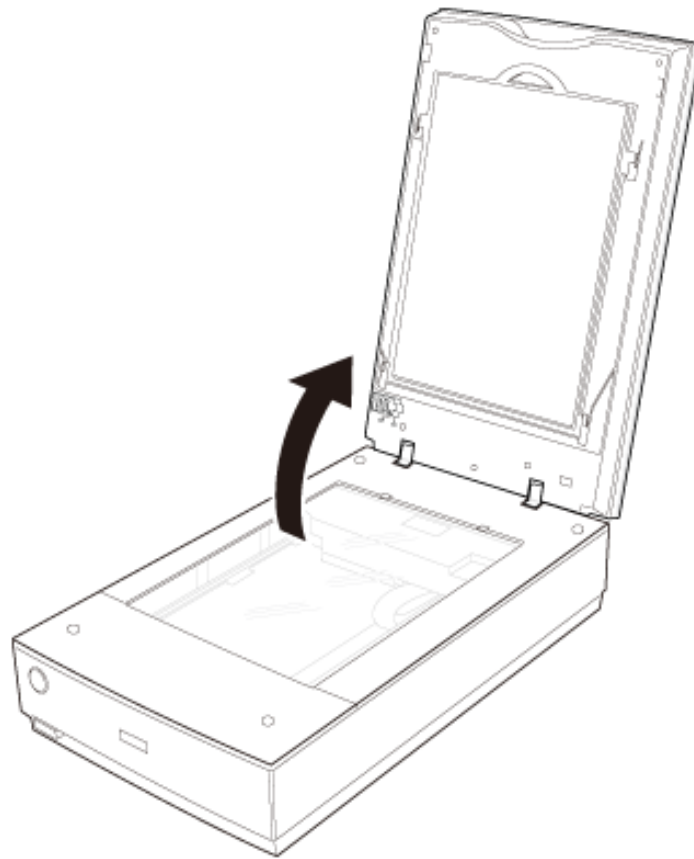

4 Pull the scanner cover straight up and off the scanner.

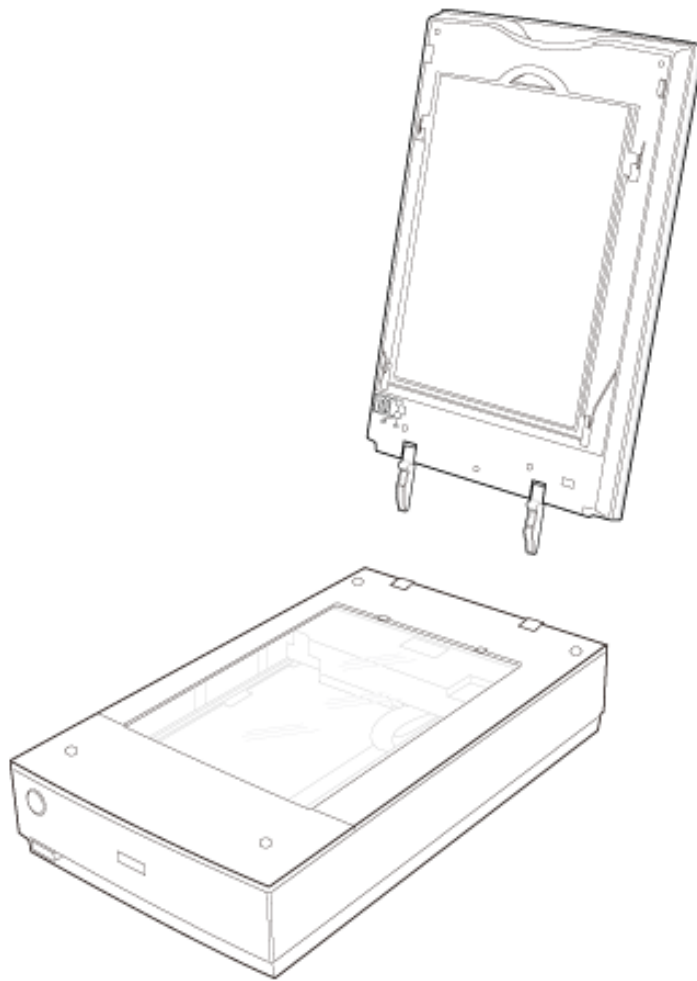

- 5 Turn on the scanner using its  power button.

 **Note:**

When scanning without the scanner cover, gently press down on your document to flatten it.

- 6 When you are finished scanning, replace the scanner cover in the reverse order that you removed it.

Home > Placing Originals on the Scanner

■ Placing Film or Slides

- ▾ Removing the Document Mat
- ▾ Placing Film in the Holder
- ▾ Placing Slides in the Holder
- ▾ Placing Film in the Film Area Guide
- ▾ Replacing the Document Mat

Removing the Document Mat

To scan film strips or slides, you need to remove the document mat from the scanner cover. This uncovers the transparency unit so your scanner can use it to scan your film or slides.

- 1 Make sure the cover cable is connected to the scanner's **OPTION** port.

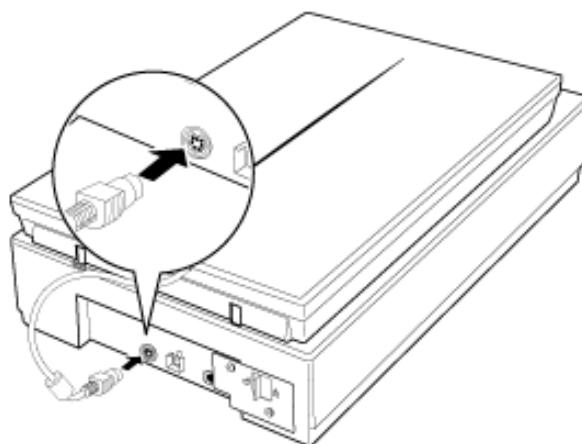

 **Note:**

Before connecting or disconnecting the cover cable, turn off the scanner using its power button.

- 2 Open the scanner cover and gently slide up the document mat to remove it. Also make sure the transparency unit transportation lock is unlocked.

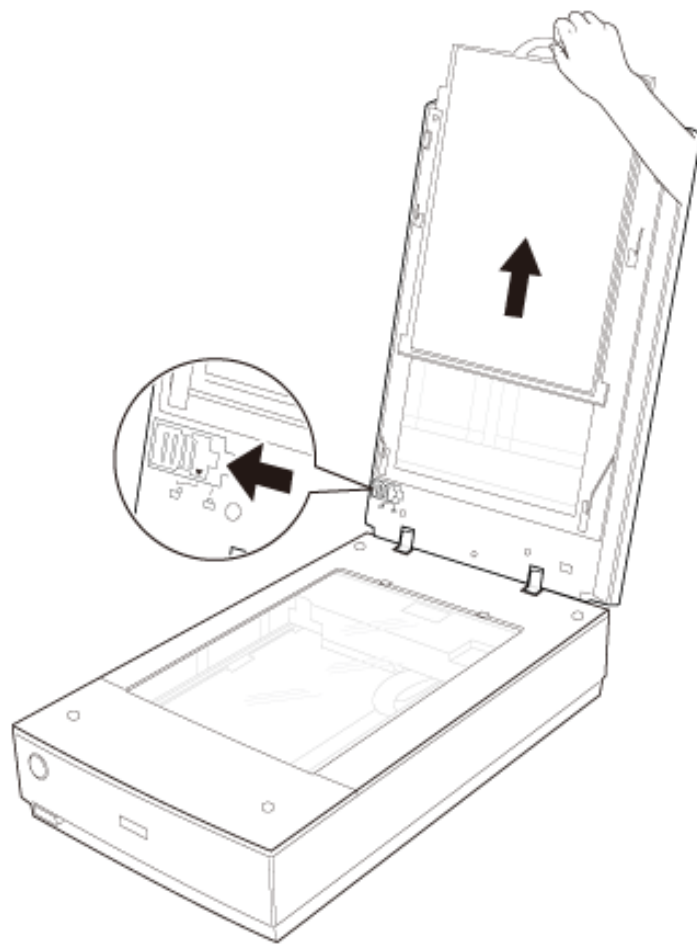

3 Use a soft cloth to wipe the transparency unit window and the document table before placing your film or slides.

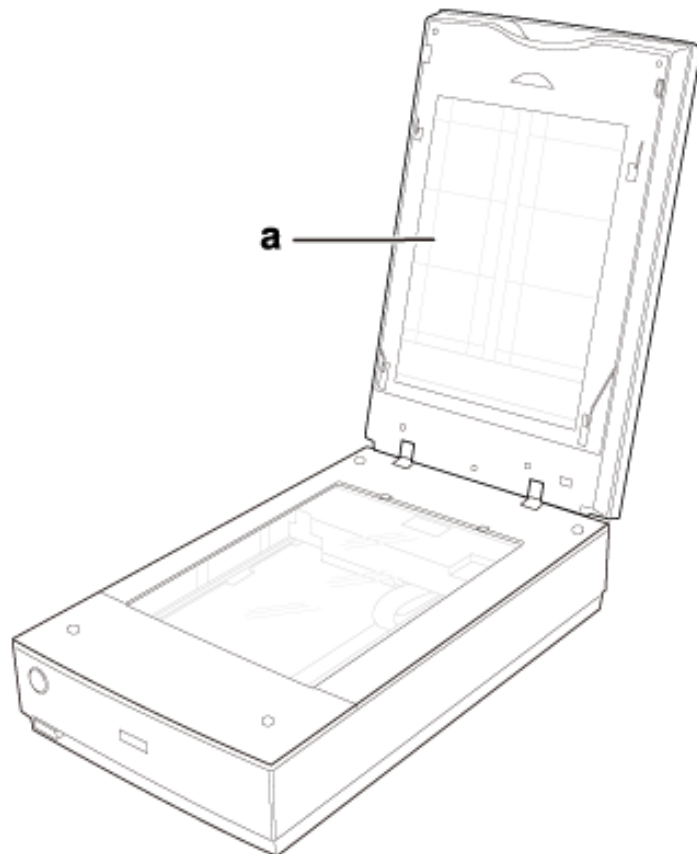

a. transparency unit window

To place film for scanning, see [Placing Film in the Holder](#).

To place slides for scanning, see [Placing Slides in the Holder](#).

Top 

Placing Film in the Holder

Placing 35 mm Film Strips

- 1 Remove the film strip cover(s) on the film holder.
- 2 Slide up to four film strips all the way into the film holder with the shiny base side facing down. Your images and any wording on the film strips should appear backwards on the side that faces up, as shown by the illustration on the film holder.

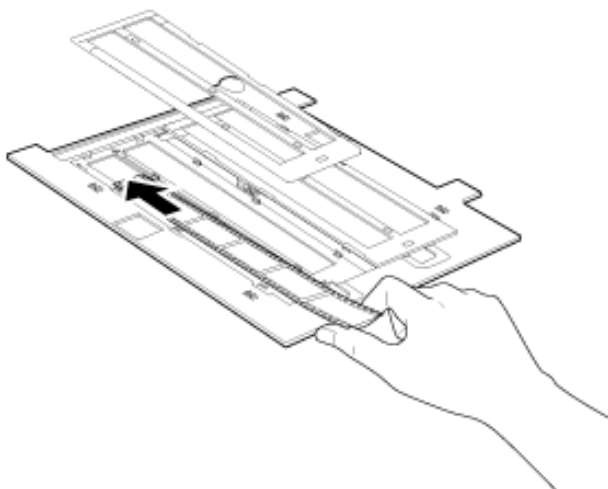

Note:

- Hold the edge of the film gently or use gloves to touch the film; otherwise you may damage the film.
- Make sure the white stickers on the back of the film holder and the areas around them are not scratched, dusty, or covered in any way. If the areas are obscured, the scanner may have trouble recognizing your film in Full Auto Mode.
- Do not cover any of the tiny holes in the film holder or the scanner may have trouble recognizing which film holder you are using.

- 3 Place the cover(s) over the film and press them down until they click. Then press down on all the edges of the covers to secure them.

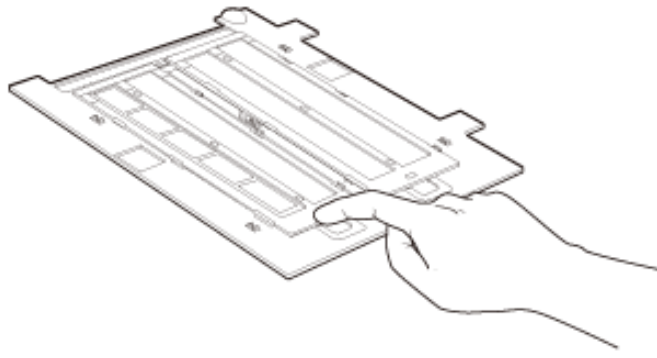

- 4 Place the film holder on the document table so that it is aligned with the upper right corner.

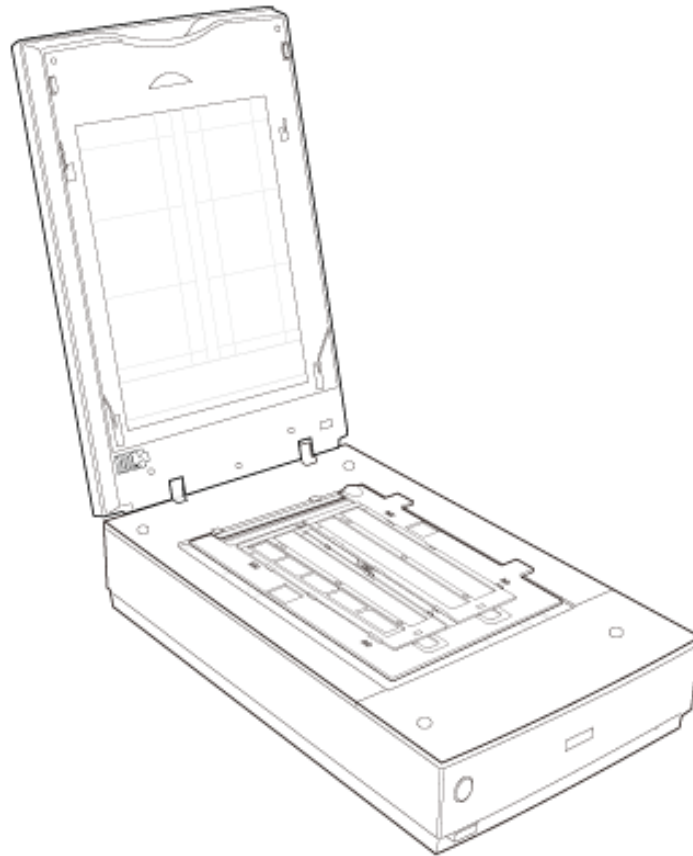

- 5 Make sure you removed the document mat. See [Removing the Document Mat](#).
- 6 Close the scanner cover.

To scan your film, see [Starting Epson Scan](#).

When you are finished scanning film, be sure to replace the document mat before scanning documents or photos. See [Replacing the Document Mat](#).

Placing Medium Format Film

- 1 Open the cover on the medium format film holder.

- 2 Slide up to two medium format film images into the film holder with the shiny base side facing down. Your images and any wording on the film should appear backwards on the side that faces up, as shown by the illustration on the film holder. Make sure the entire image frame is positioned in the film holder opening.

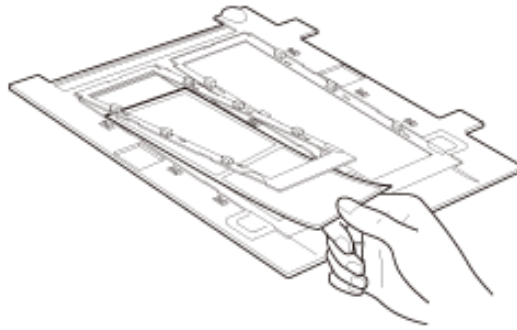

 **Note:**

- Hold the edge of the film gently or use gloves to touch the film; otherwise you may damage the film.
- Make sure the white stickers on the back of the film holder and the areas around them are not scratched, dusty, or covered in any way. If the areas are obscured, the scanner may have trouble recognizing your film in Full Auto Mode.
- Do not cover any of the tiny holes in the film holder or the scanner may have trouble recognizing which film holder you are using.

- 3 Close the cover over the film and press it down until it clicks. Then press down on all the edges of the cover to secure it.

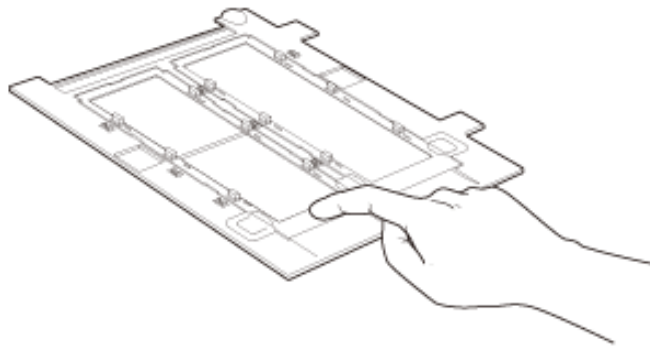

- 4 Place the film holder on the document table so that it is aligned with the upper right corner.

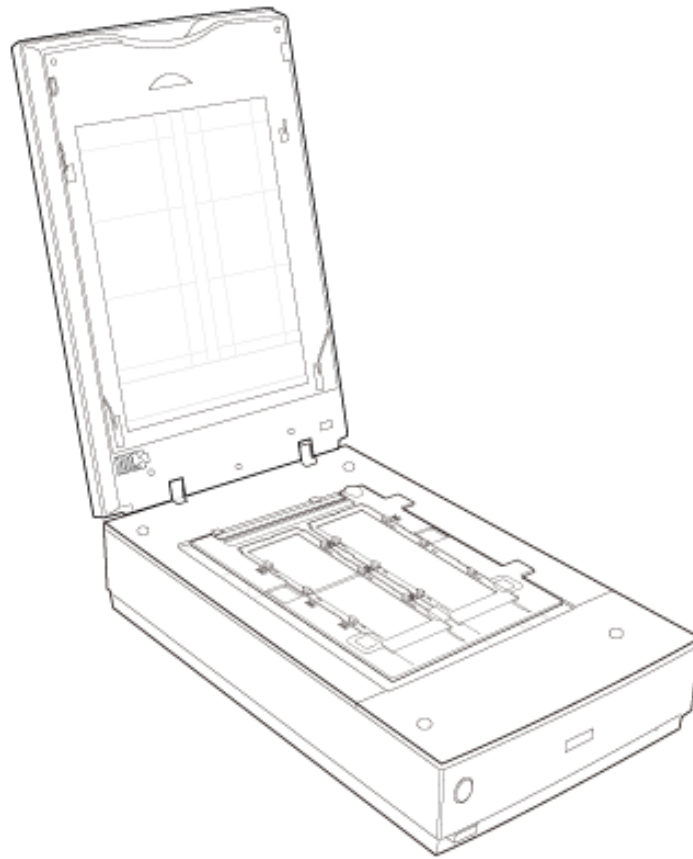

5 Make sure you removed the document mat. See [Removing the Document Mat](#).

6 Close the scanner cover.

To scan your film, see [Starting Epson Scan](#).

 **Note:**

You cannot use Full Auto Mode to scan medium format film.

When you are finished scanning film, be sure to replace the document mat before scanning documents or photos. See [Replacing the Document Mat](#).

Placing 4 × 5 inch Film

1 Open the covers on the 4 × 5 inch film holder.

2 Place the film into the film holder with the shiny base side facing down. Your images and any wording on the film should appear backwards on the side that faces up, as shown by the illustration on the film holder. Make sure the entire image frame is positioned in the film holder opening.

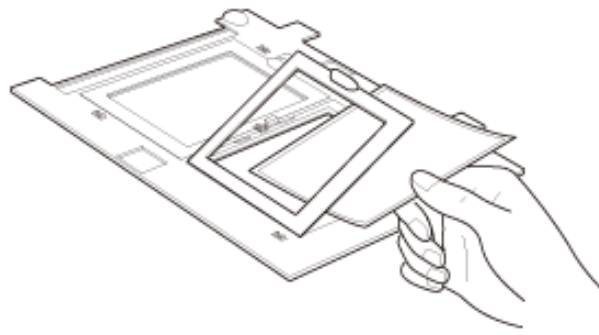

 **Note:**

- Hold the edge of the film gently or use gloves to touch the film; otherwise you may damage the film.
- Make sure the white stickers on the back of the film holder and the areas around them are not scratched, dusty, or covered in any way. If the areas are obscured, the scanner may have trouble recognizing your film in Full Auto Mode.
- Do not cover any of the tiny holes in the film holder or the scanner may have trouble recognizing which film holder you are using.

- 3** Close the cover over the film and press it down until it clicks. Then press down on all the edges of the cover to secure it.

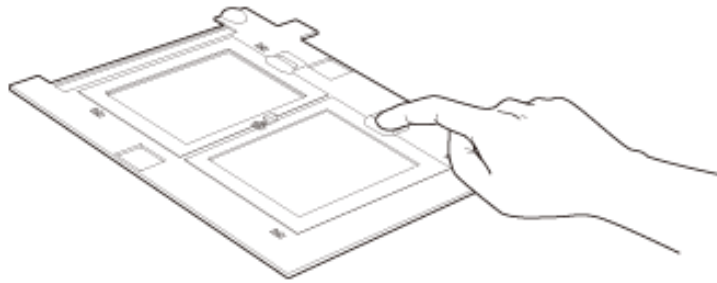

- 4** Place the film holder on the document table so that it is aligned with the upper right corner.

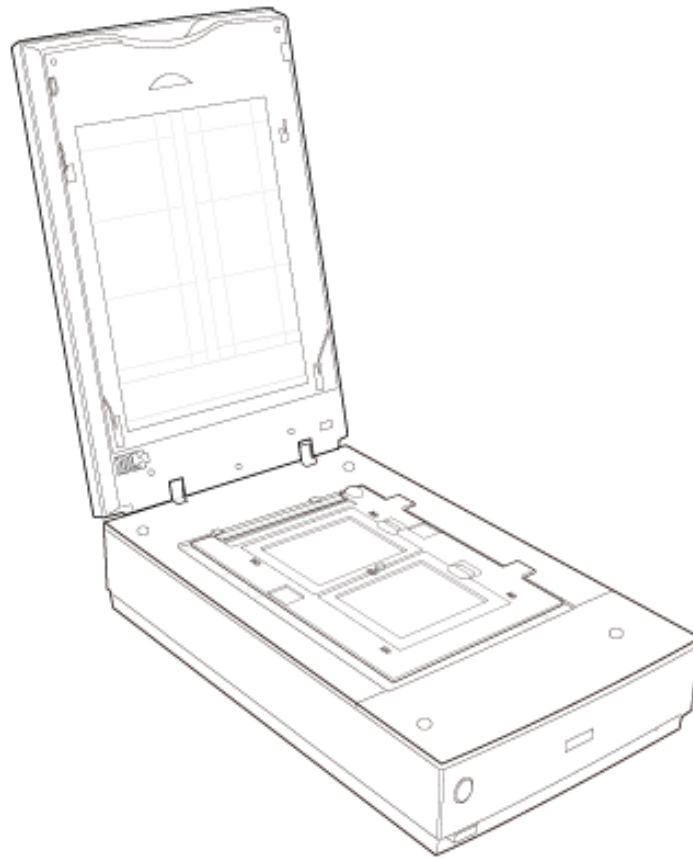

5 Make sure you removed the document mat. See [Removing the Document Mat](#).

6 Close the scanner cover.

To scan your film, see [Starting Epson Scan](#).

 **Note:**

You cannot use Full Auto Mode to scan 4 × 5 inch film.

When you are finished scanning film, be sure to replace the document mat before scanning documents or photos. See [Replacing the Document Mat](#).

Top 

Placing Slides in the Holder

You can scan up to twelve 35 mm slides at a time using the slide holder.

 **Note:**

- You cannot scan negative slides.
- Make sure the white stickers on the back on the film holder and the areas around them are not scratched, dusty, or covered in any way. If the areas are obscured, the scanner may have trouble recognizing your slides in Full Auto Mode.
- Do not cover any of the tiny holes in the film holder or the scanner may have trouble recognizing which film holder you are using.

- 1 Place up to twelve slides in the 35 mm slide holder with the shiny base side facing down. Your image should appear backwards on the side that faces up, as shown by the illustration on the film holder. The top of your images should face the open end of the film holder as shown below.

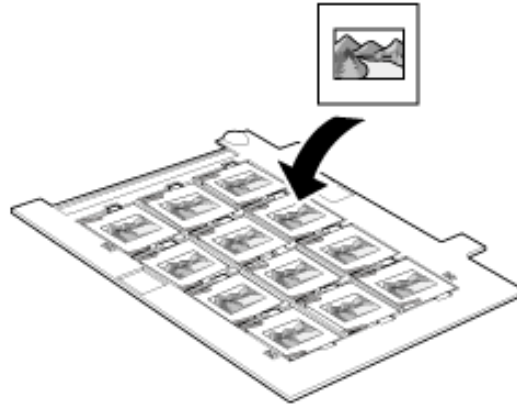

- 2 Place the film holder on the document table so that it is aligned with the upper right corner.

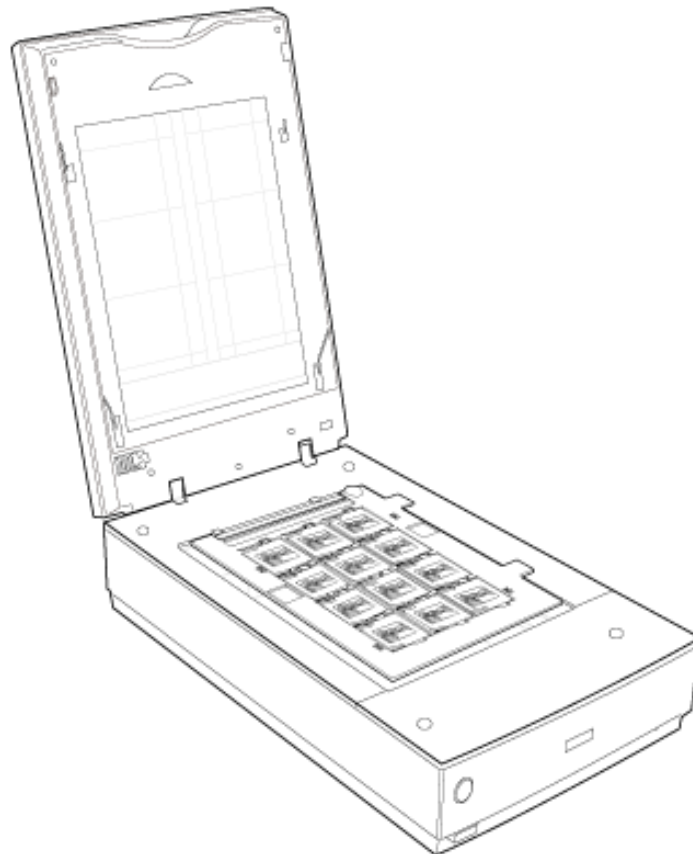

3 Make sure you removed the document mat. See [Removing the Document Mat](#).

4 Close the scanner cover.

To scan your slides, see [Starting Epson Scan](#).

When you are finished scanning slides, be sure to replace the document mat before scanning documents or photos. See [Replacing the Document Mat](#).

Top 

Placing Film in the Film Area Guide

You can scan film that cannot be placed in the film holders (up to 8 × 10 inch film) using the film area guide in Professional Mode. When scanning film using the film area guide, always select **Film (with Film Area Guide)** as the Document Type.

Note:

- You cannot use DIGITAL ICE Technology when scanning film with the film area guide.
- If you scan 8 × 10 inch film at 4800 dpi resolution and 24 bit color as the Image Type, do not save it in BMP, Tiff, or JPEG format.
- When scanning using the film area guide, striped (newton) rings may appear in your scanned images.

1 Make sure the tab on the long edge of the film area guide is on the left side.

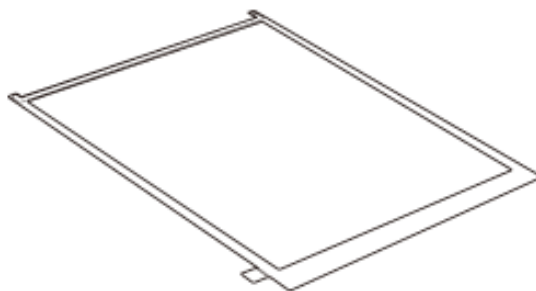

2 Fold the tab along the perforated lines as shown.

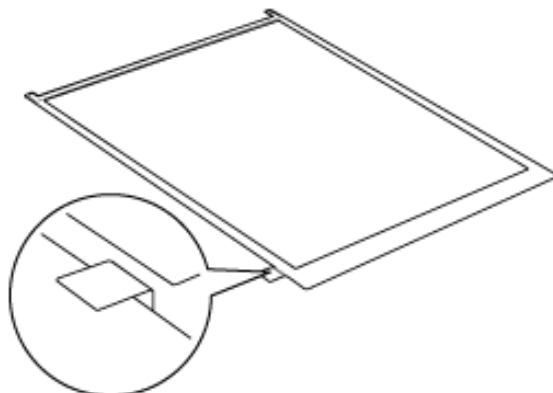

- 3 Place the film area guide on the document table with the tab facing the left side of the scanner.

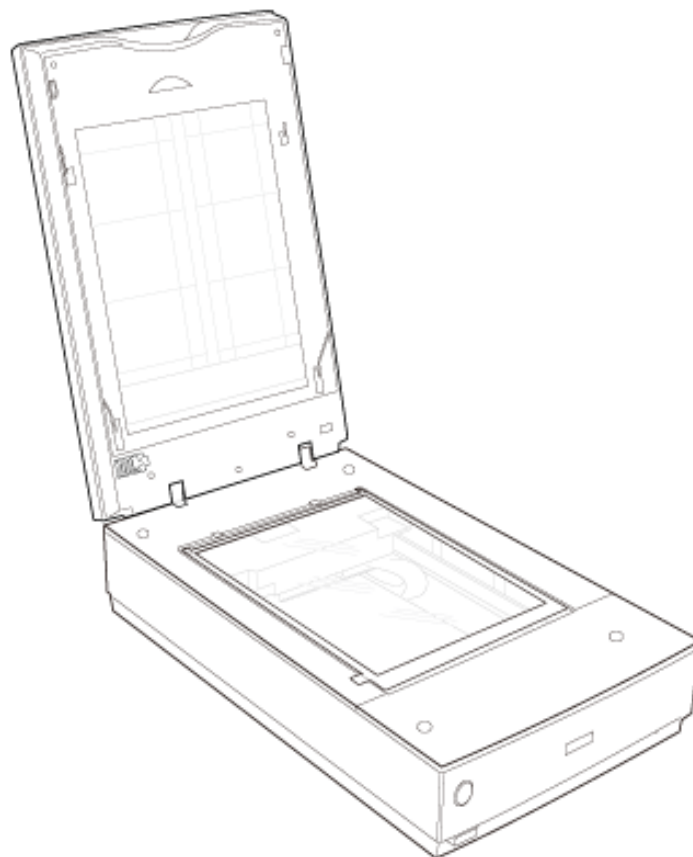

- 4 Place the film in the film area guide (up to 8 × 10 inch film) with the shiny base side facing down. Your images and any wording on the film should appear backwards on the side that faces up. Make sure the entire image frame is positioned in the film area guide opening.

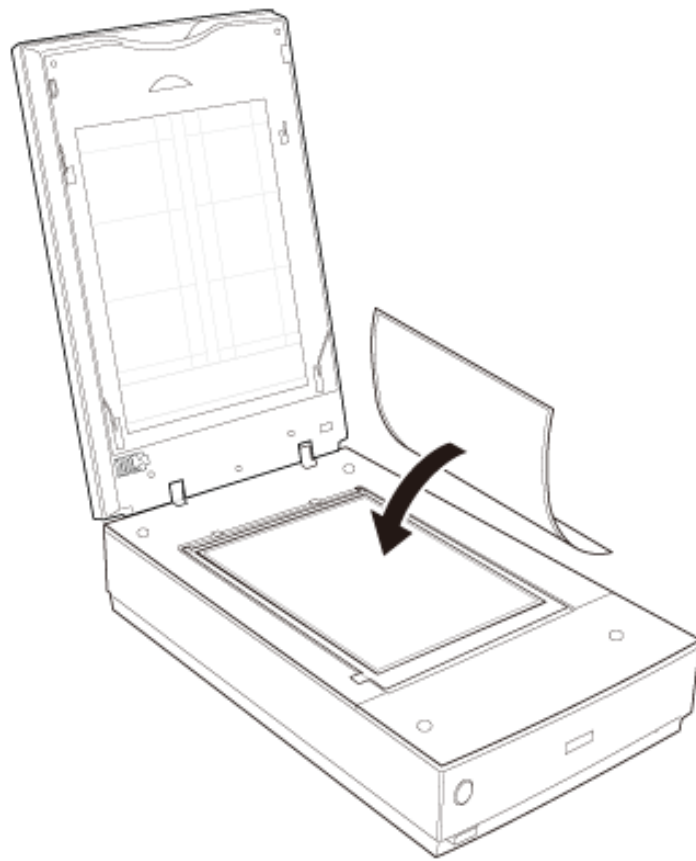

 **Note:**

Leave the part of the film area guide circled below uncovered or colors in your scans will be affected.

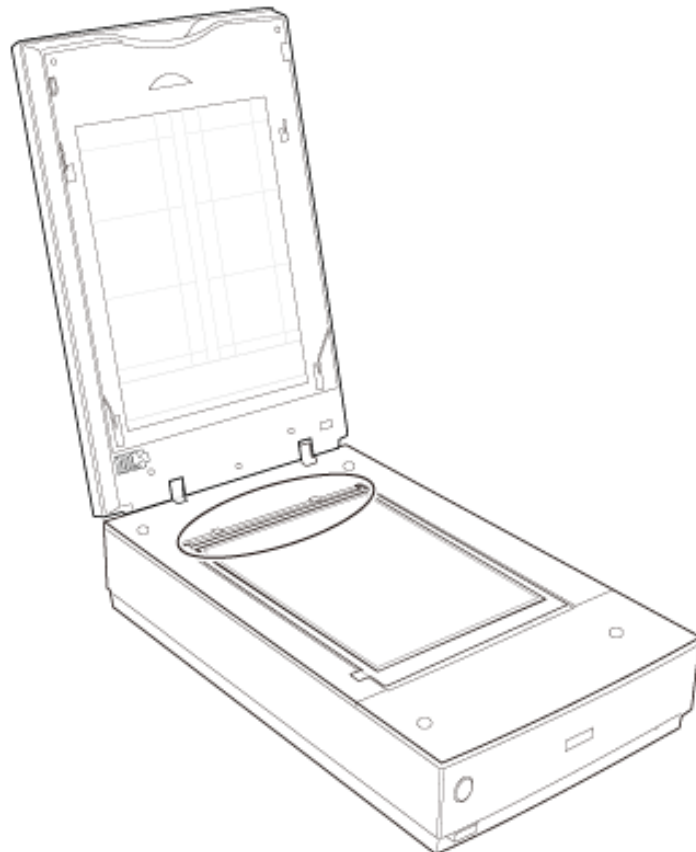

5 Make sure you removed the document mat. See [Removing the Document Mat](#).

6 Close the scanner cover.

To scan your film, see [Starting Epson Scan](#).

 **Note:**

You cannot use Full Auto Mode, Office Mode, or Home Mode when scanning film with the film area guide.

When you are finished scanning film, be sure to replace the document mat before scanning documents or photos. See [Replacing the Document Mat](#).

[Top](#) 

Replacing the Document Mat

Replace the document mat by sliding it into the notches in the scanner cover. Make sure the white surface faces outwards.

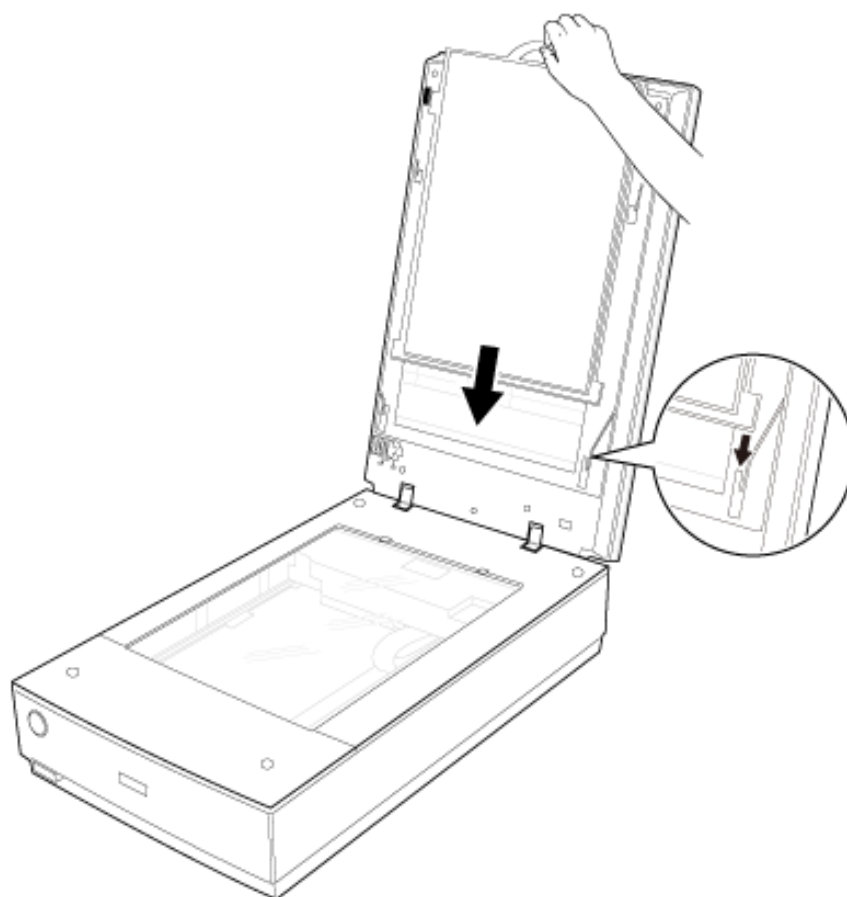

[Top](#) 

[Home](#) > [Scanning Your Originals](#)

Starting Epson Scan

- [Using the Scanner Button](#)
- [Using the EPSON Scan Icon](#)
- [Using Another Scanning Program](#)

Using the Scanner Button

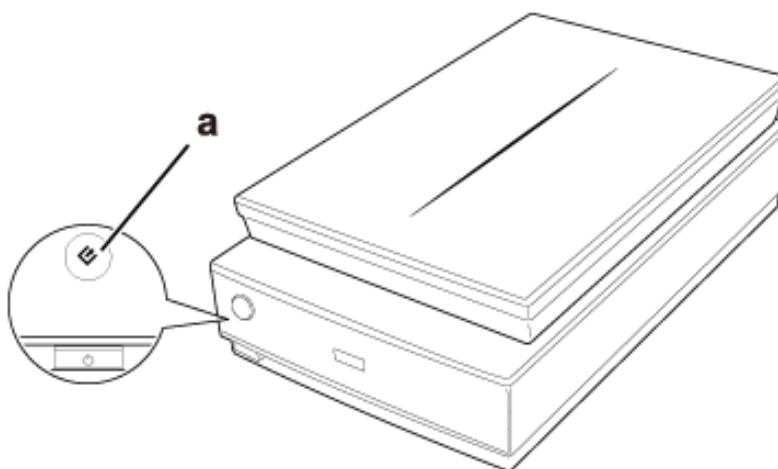

- a.  Start button

You can start Epson Scan just by pressing the  Start button on the scanner. The Epson Scan window automatically opens. See [Selecting an Epson Scan Mode](#) for instructions on selecting an Epson Scan mode.

 **Note for Mac OS X 10.5.8 users:**

The  Start button is not supported. To start Epson Scan, see [Using the Epson Scan Icon](#) for instructions.

[Top](#) 

Using the Epson Scan Icon

You can start Epson Scan by double-clicking the **EPSON Scan** icon.

Windows 8:

Double-click the **EPSON Scan** icon on the desktop.
Or, Navigate to the **Start** screen and select **EPSON Scan**.

Windows (other versions):

Double-click the **EPSON Scan** icon on the desktop.

Or, select  or **Start > All Programs** or **Programs > EPSON > EPSON Scan > EPSON Scan**.

Mac OS X:

Select **Applications > EPSON Software > EPSON Scan**.

The Epson Scan window automatically opens. See [Selecting an Epson Scan Mode](#) for instructions on selecting an Epson Scan mode.

[Top](#) 

Using Another Scanning Program

You can use any TWAIN-compliant scanning program, such as Adobe Photoshop Elements, to scan with your scanner. You open the program, select **Epson Scan**, and **scan**. When you are finished scanning, the scanned image opens in your scanning program so you can modify, print, and save it.

- 1 Start a TWAIN-compliant scanning program. Double-click the program icon on the desktop, if it is available, or do one of the following.

Windows 8:

Navigate to the **Start** screen and select the program icon.

Windows (other versions):

Select  or **Start > Programs** or **All Programs > program folder > program icon**.

Mac OS X:

Open the **Applications** in your hard drive, select the program folder, and double-click the program icon.

- 2 Select your scanner.

In some programs, you must select the scanner as the “source” first. If you see a Select Source option, select it and select your scanner there first.

Note for Windows:

Do not select a WIA option for your scanner from the Import or Acquire list; you will not be able to use all the features of your scanner.

The Epson Scan window automatically opens. See [Selecting an Epson Scan Mode](#) for instructions on selecting an Epson Scan mode.

[Top](#) 

[Home](#) > [Scanning Your Originals](#)

■ Selecting an Epson Scan Mode

Epson Scan offers several scanning modes to choose from.

- **Full Auto Mode** lets you scan quickly and easily, without selecting any settings or previewing your image. Full Auto Mode is best when you need to scan your originals at 100% size and you do not need to preview the images before scanning. You can restore faded colors or remove dust marks in Full Auto Mode. This is the default mode in Epson Scan.
 - See [Changing the Scan Mode](#) for instructions on switching to Full Auto Mode.
 - See [Scanning in Full Auto Mode](#) for instructions on making settings in Full Auto Mode.
- **Office Mode** lets you quickly select settings for scanning text documents and check their effects with a preview image.
 - See [Changing the Scan Mode](#) for instructions on switching to Office Mode.
 - See [Scanning in Office Mode](#) for instructions on making settings in Office Mode.
- **Home Mode** lets you customize some scanning settings and check their effects with a preview image.

Home Mode is best when you want to preview images of your originals before scanning them. You can size the image as you scan, adjust the scan area, and adjust many image settings, including color restoration, dust removal, and backlight correction.

 - See [Changing the Scan Mode](#) for instructions on switching to Home Mode.
 - See [Scanning in Home Mode](#) for instructions on making settings in Home Mode.
- **Professional Mode** gives you total control of your scanning settings and lets you check their effects with a preview image.

Professional Mode is best when you want to preview your image and make extensive, detailed corrections to it before scanning. You can sharpen, color correct, and enhance your image with a full array of tools, including color restoration, dust removal, and backlight correction.

 - See [Changing the Scan Mode](#) for instructions on switching to Professional Mode.
 - See [Scanning in Professional Mode](#) for instructions on making settings in Professional Mode.

Home > Scanning Your Originals

■ Changing the Scan Mode

To change the scan mode, click the arrow in the Mode box in the upper right corner of the Epson Scan window. Then, select the mode you want to use from the list that appears.

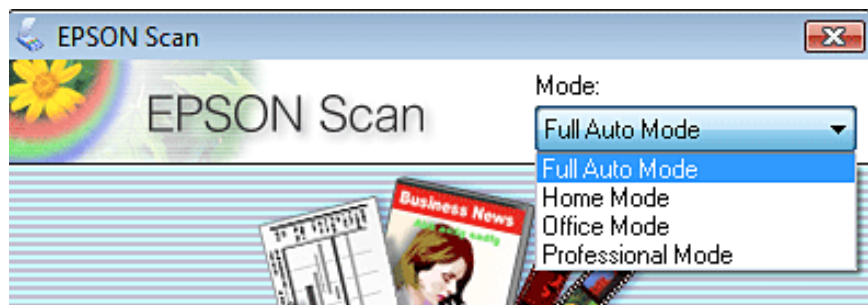

 **Note:**

The mode you select remains in effect when you start Epson Scan next time.

For instructions on scanning using these modes, see one of these sections.

Full Auto Mode: [Scanning in Full Auto Mode](#)

Office Mode: [Scanning in Office Mode](#)

Home Mode: [Scanning in Home Mode](#)

Professional Mode: [Scanning in Professional Mode](#)

Home > Scanning Your Originals

■ Scanning in Full Auto Mode

When you start Epson Scan for the first time, it runs in Full Auto Mode and displays the Epson Scan Full Auto Mode window.

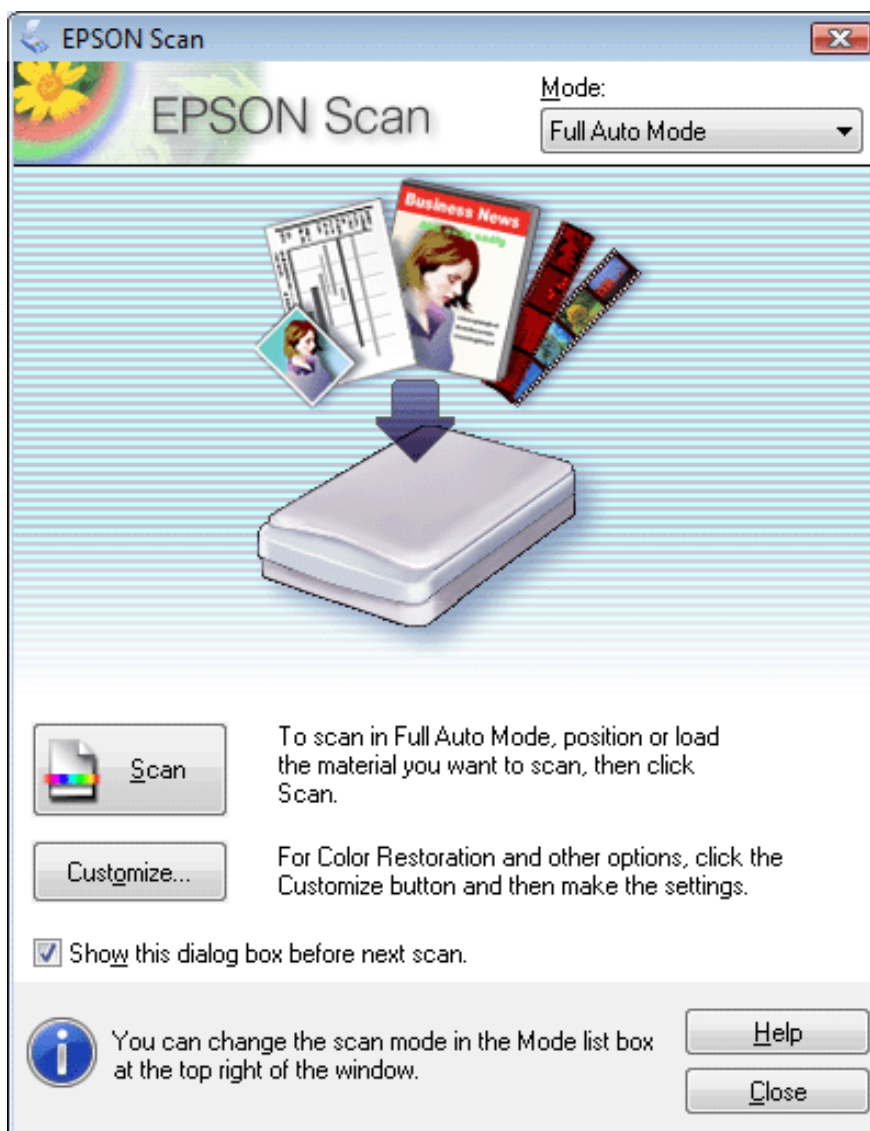

✓ Note for film or slides:

In Full Auto Mode, you can only scan 35 mm color film strips or color positive slides. To scan other types of film, use Home Mode or Professional Mode. To change the scan mode, see [Changing the Scan Mode](#).

✓ Note:

If the **Show this dialog box before next scan** check box is cleared, Epson Scan starts scanning immediately without displaying this screen. To return to this screen, click **Cancel** in the Scanning dialog box during scanning.

- 1 Place your original(s) on the document table. See one of these sections for instructions.

Documents or photos: [Placing Documents or Photos](#)

Film or slides: [Placing Film or Slides](#)

- 2 Start Epson Scan. See [Starting Epson Scan](#) for instructions.

- 3 Select **Full Auto Mode** from the Mode list. See [Changing the Scan Mode](#) for instructions.

- 4 If you want to select a custom resolution, restore faded colors, or remove dust marks, click **Customize**. You see the Customize window.

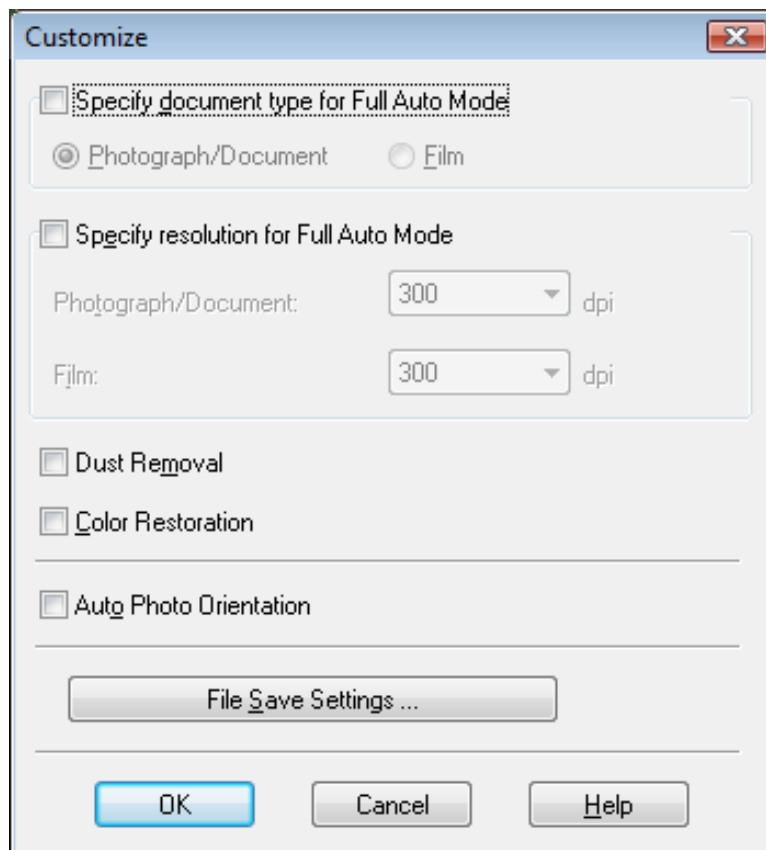

 **Note:**

If you started scanning from a TWAIN-compliant program like Adobe Photoshop Elements, the File Save Settings button does not appear.

- 5 Select your settings and click **OK**. For details on selecting the settings in the Customize window, see Epson Scan Help.

- 6 Click **Scan**. Epson Scan starts scanning in Full Auto Mode.

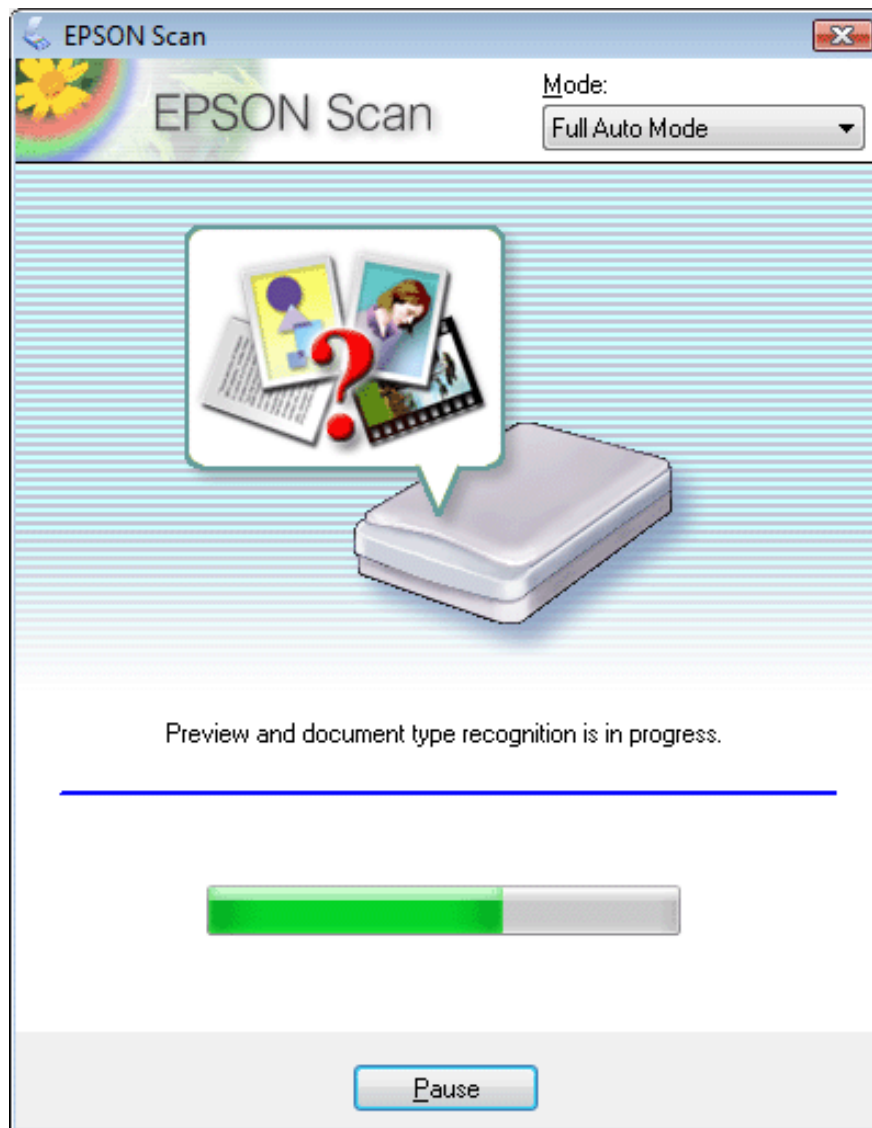

Epson Scan previews each image, detects which type of original it is, and selects the scan settings automatically. After a moment, you see a small preview of each image in the Epson Scan window.

 **Note:**

- It takes a few minutes to scan a full film strip.
- If you need to change any settings, click **Pause**. You will return to the Epson Scan Full Auto Mode window.
- If you need to cancel scanning, click **Cancel** when it appears.

What happens next depends on how you started your scan. See [Finishing the Scan](#) for instructions.

[Home](#) > [Scanning Your Originals](#)

Scanning in Office Mode

When you select Office Mode, you see the Epson Scan Office Mode window.

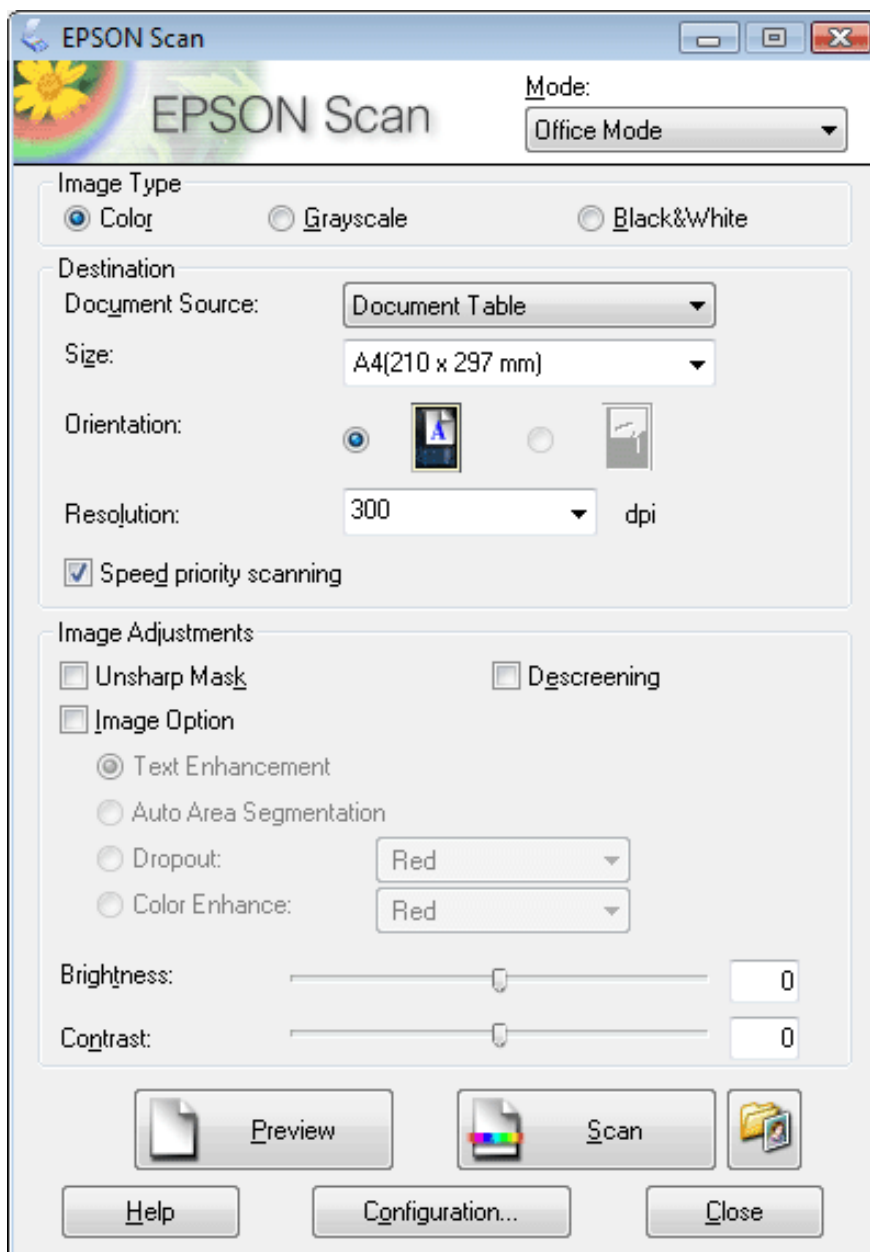

- 1 Place the original(s) on the document table. See [Placing Documents or Photos](#) for instructions.
- 2 Start Epson Scan. See [Starting Epson Scan](#) for instructions.
- 3 Select **Office Mode** in the Mode list. See [Changing the Scan Mode](#) for instructions.

- 4 Select **Color**, **Grayscale**, or **Black&White** as the Image Type setting.
- 5 Select **Document Table** as the Document Source setting.
- 6 Select the size of your original document as the Size setting.
- 7 Click the arrow to open the **Resolution** list and select an appropriate resolution for your original. See [Selecting the Scan Resolution](#) for instructions.
- 8 Click **Preview** to preview your image(s). The Preview window appears and displays your image. See [Previewing and Adjusting the Scan Area](#) for instructions.
- 9 Modify the image quality if necessary. See [Adjusting the Color and Other Image Settings](#) for instructions.
- 10 Click **Scan**.

What happens next depends on how you started your scan. See [Finishing the Scan](#) for instructions.

[Home](#) > [Scanning Your Originals](#)

■ Scanning in Home Mode

When you select **Home Mode**, you see the Epson Scan Home Mode window.

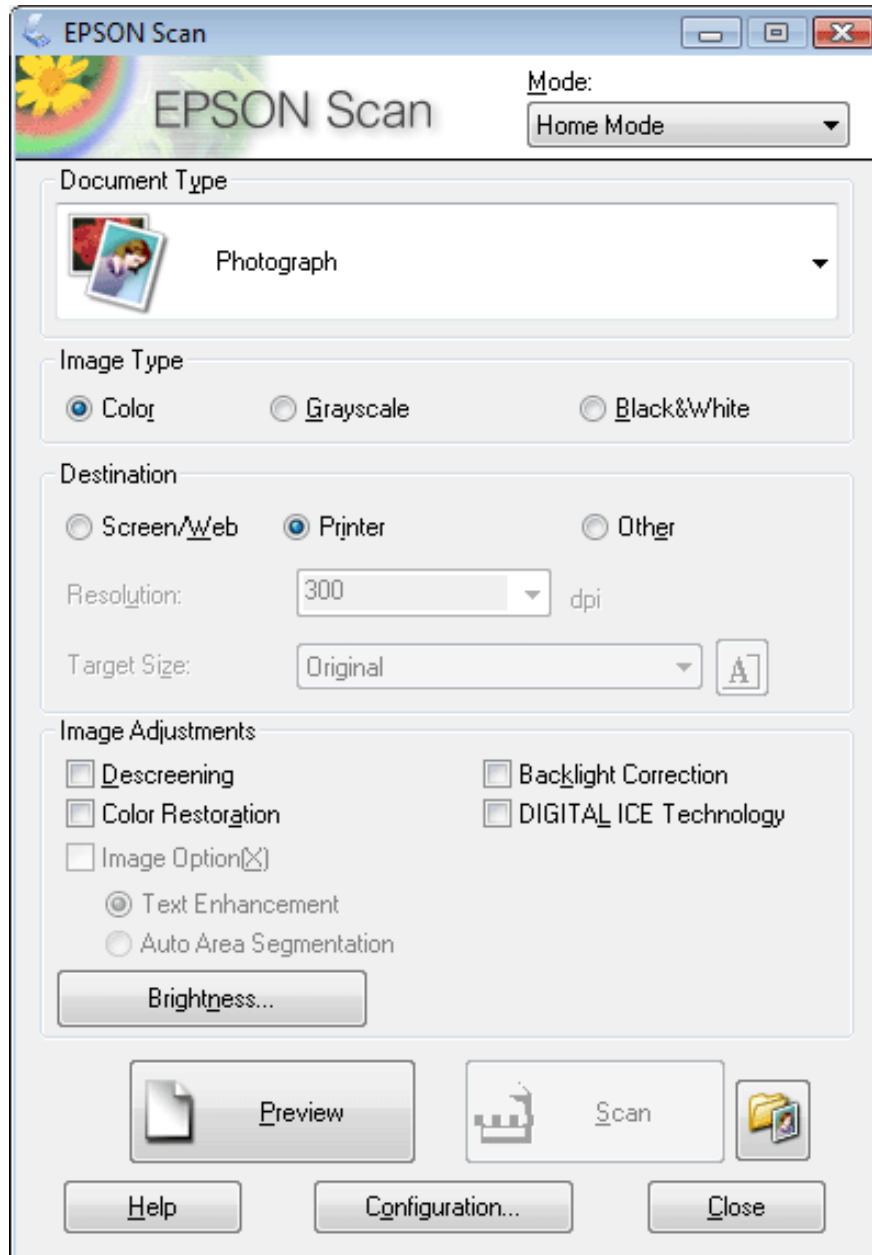

1 Place your original(s) on the document table. See one of these sections for instructions.

Documents or photos: [Placing Documents or Photos](#)

Film or slides: [Placing Film or Slides](#)

- 2 Start Epson Scan. See [Starting Epson Scan](#) for instructions.
- 3 Select **Home Mode** in the Mode list. See [Changing the Scan Mode](#) for instructions.
- 4 Click the arrow to open the **Document Type** list, and select the type of your original(s) you are scanning.
- 5 Select **Color**, **Grayscale**, or **Black&White** as the Image Type setting.
- 6 In the Destination box, click the button for the way you plan to use the scanned image(s).
 - **Screen/Web** for images you will view only on a computer screen or post on the web.
 - **Printer** for image(s) you will be printing or converting to editable text with an OCR (Optical Character Recognition) program.
 - **Other** if you want to select a specific resolution for other purposes.

Epson Scan selects a default resolution setting based on the Destination setting you select. If you selected **Other** as the Destination setting to select a specific resolution, see [Selecting the Scan Resolution](#) for instructions.
- 7 Click **Preview** to preview your image(s). The Preview window appears and displays your image(s). See [Previewing and Adjusting the Scan Area](#) for instructions.
- 8 Modify the image quality, if necessary. See [Adjusting the Color and Other Image Settings](#) for instructions.
- 9 Click the arrow to open the **Target Size** list to select the size of the scanned image(s), if necessary. You can scan your images at their original size, or you can reduce or enlarge their size by selecting Target Size. See [Selecting the Scan Size](#) for instructions.
- 10 Click **Scan**.

What happens next depends on how you started your scan. See [Finishing the Scan](#) for instructions.

[Home](#) > [Scanning Your Originals](#)

■ Scanning in Professional Mode

When you select **Professional Mode**, you see the Epson Scan Professional Mode window.

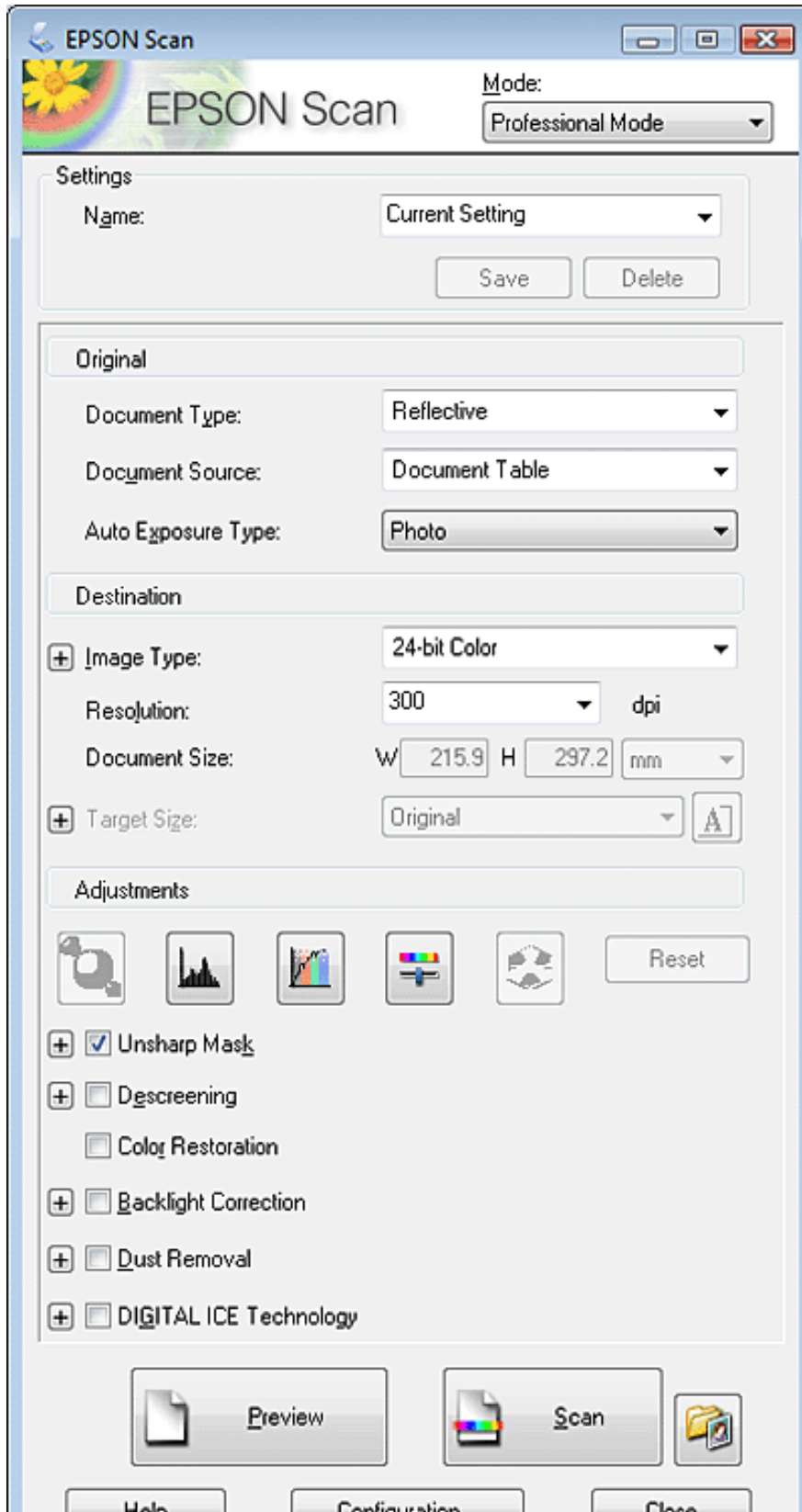

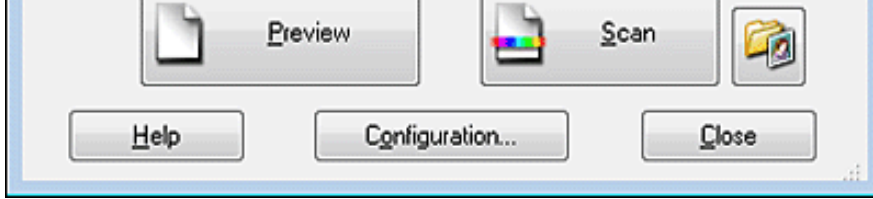

- 1 Place your original(s) on the document table. See one of these sections for instructions.

Documents or photos: [Placing Documents or Photos](#)

Film or slides: [Placing Film or Slides](#)

- 2 Start Epson Scan. See [Starting Epson Scan](#) for instructions.

- 3 Select **Professional Mode** in the Mode list. See [Changing the Scan Mode](#) for instructions.

- 4 Click the arrow to open the **Document Type** list and select **Reflective** (for scanning documents or photos) or **Film** (for scanning film or slides).

- 5 If you selected **Reflective** (for scanning documents or photos) as the Document Type setting, click the arrow in the **Auto Exposure Type** list and select **Photo** or **Document**.

If you selected **Film** (for scanning film or slides) as the Document Type, click the arrow in the **Film Type** list and select **Positive Film**, **Color Negative Film**, or **B&W Negative Film**.

- 6 Click the arrow to open the **Image Type** list and select the detailed image type you are scanning.

Image Type setting	Type of image you are scanning
48-bit Color	Color photos that you may want to modify in a 48-bit image-editing program
24-bit Color	Color photos
Color Smoothing	Color graphics, such as a chart or graph
16-bit Grayscale	Black-and-white photos with many shades of gray
8-bit Grayscale	Black-and-white photos with just a few shades of gray
Black & White	Documents with black text and/or line art

 **Note:**

If you select **8-bit Grayscale** or **Black & White**, you can also select an **Image Option** setting, as described below.

Image Option Setting	Description
None	No Image Option setting is applied.
Dropout: Red	Drops out red from the scan.
Dropout: Green	Drops out green from the scan.
Dropout: Blue	Drops out blue from the scan.
Color Enhance: Red	Enhances red in the scan.
Color Enhance: Green	Enhances green in the scan.
Color Enhance: Blue	Enhances blue in the scan.

- 7 Click the arrow to open the **Resolution** list and select an appropriate resolution for your original(s). See [Selecting the Scan Resolution](#) for instructions.
- 8 Click **Preview** to preview your image(s). The Preview window appears and displays your image(s). See [Previewing and Adjusting the Scan Area](#) for instructions on settings in the Preview window.
- 9 Click the arrow to open the **Target Size** list to select the size you want of the scanned image(s), if necessary. You can scan your images at their original size, or you can reduce or enlarge their size by selecting Target Size. See [Selecting the Scan Size](#) for instructions.
- 10 Modify the image quality, if necessary. See [Adjusting the Color and Other Image Settings](#) for instructions.
- 11 Click **Scan**.

What happens next depends on how you started your scan. See [Finishing the Scan](#) for instructions.

Home > Scanning Your Originals

Selecting File Save Settings

When you see the File Save Settings window, you can select the location, name, and format of the scanned image file.

1 Full Auto Mode: Click **Customize**, then click **File Save Settings**.

Office Mode, Home Mode, or Professional Mode: Click the  **File Save Settings** icon to the right of the Scan button.

The File Save Settings window appears.

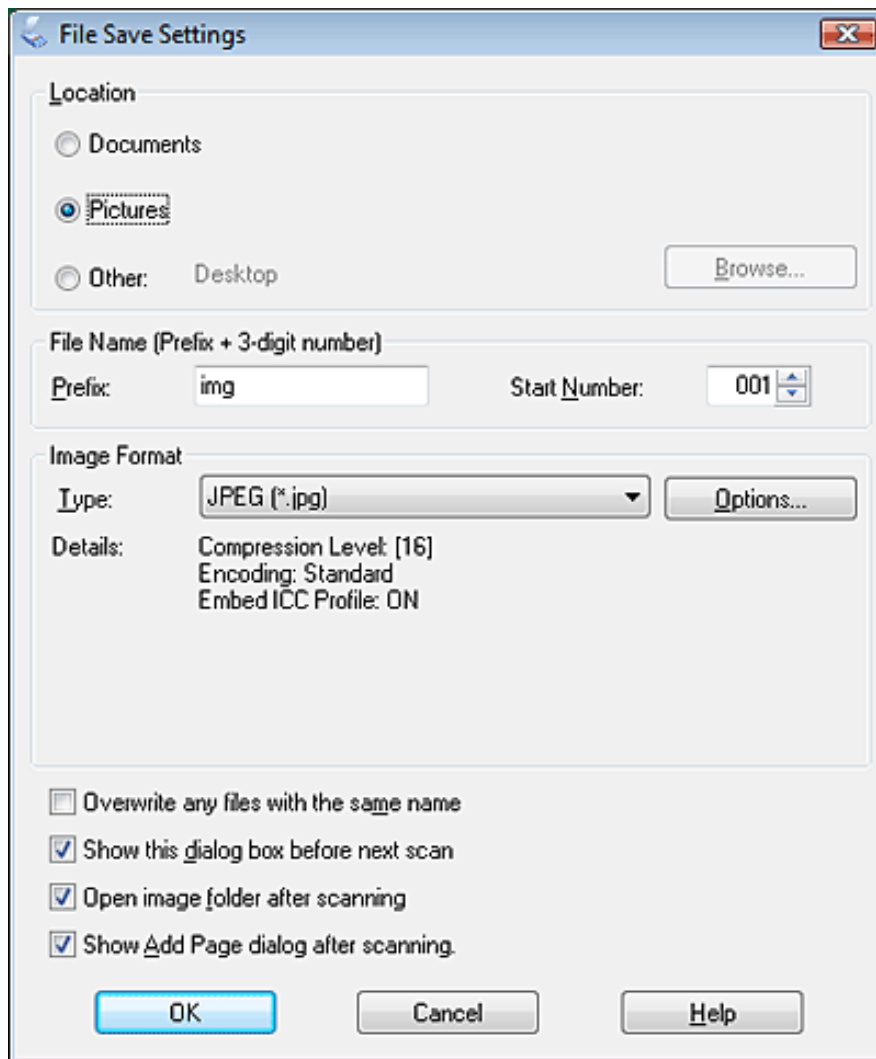

 **Note:**

If you start Epson Scan from a TWAIN-compliant program, such as Adobe Photoshop Elements, the File Save Settings button and  File Save Settings icon do not appear.

- 2 In the File Save Settings window, specify the file folder in which you want to save your scanned image. Click the **Documents** or **Pictures** radio button, or the **My Documents** or **My Pictures** radio button. If you want to select another folder, click the **Other** radio button, then click **Browse** (Windows) or **Choose** (Mac OS X) and select the folder. If you want to save your image on the desktop, simply click the **Other** radio button.

- 3 Specify a file name prefix with an alphanumeric character string. A 3-digit number is automatically added to the file name, but you can change the Start Number if you like. If you are scanning multiple images at once, each image will receive a different 3-digit number.

 **Note:**

The following characters cannot be used in the prefix.

Windows: \, /, :, _ , *, ?, ", <, > ,

Mac OS X: :

- 4 Click the arrow to open the **Type** list and select a file format as described in the following table. Depending on the format, the Options button may be available for making detailed settings.

Format (File Extension)	Description
BITMAP (*.bmp) (Windows only)	A standard image file format for Windows. Most Windows programs, including word processing programs, can read images in this format.
JPEG (*.jpg)	A compressed file format in which the Compression Level can be selected. The JPEG format lets you highly compress image data. However, the higher the compression, the lower the image quality. Any lost image quality data cannot be restored, and the quality deteriorates each time the data is saved. The TIFF format is recommended when modification and retouching are required.
Multi-TIFF (*.tif)	A TIFF format where multiple pages are saved to the same file. You can also edit the scanned images before saving them. See Epson Scan Help for details. To open Multi-TIFF files, you need a program that supports it.
PDF (*.pdf)	A document format that can be read on both Windows and Mac OS X systems (platform independent). To use PDF documents in Windows, you need Adobe Reader or Acrobat. Multi-page documents can be saved as one PDF file. When you save color or grayscale images in PDF, you can select a Compression Level.
PICT (*.pct) (Mac OS X only)	A standard image file format for Mac OS X. Most Mac OS X programs, including word processing programs, can read images in this format.
PRINT Image Matching II JPEG (*.jpg) or TIFF (*.tif)	A file format that includes PRINT Image Matching II data for enhanced quality and a wider color range. Print Image Matching II compatible printers can then print this data for brilliant, true-to-life results. (PRINT Image Matching data does not affect the way the image displays on the screen.) Available in JPEG or TIFF format.
TIFF (*.tif)	A file format created for exchanging data between many programs, such as graphic and DTP software. When scanning black & white images, you can specify the Compression type.

- 5 The check boxes at the bottom of the window give you these options.

- **Overwrite any files with the same name**
Select this option if you want to reuse the selected file name and location and overwrite previous files with the same names.
- **Show this dialog box before next scan** (Office Mode, Home Mode, or Professional Mode only)
Select this option if you want the File Save Settings window to appear automatically before you scan. If you

deselect it, you must click the  **File Save Settings** icon to open the window before clicking the **Scan** button.

■ **Open image folder after scanning**

Select this option if you want Windows Explorer or the Mac OS X Finder to automatically open the folder where your scanned image file is saved when Epson Scan finishes scanning.

■ **Show Add Page dialog after scanning**

Select this option if you want the Add Page Confirmation window to appear automatically after each scan in PDF or multi-TIFF. The Add Page Confirmation window includes the **Add page**, **Edit page**, and **Save File** buttons.

6

Click **OK**.

[Home](#) > [Scanning Your Originals](#)

■ Detailed Setting Instructions

- [Selecting the Scan Resolution](#)
- [Previewing and Adjusting the Scan Area](#)
- [Adjusting the Color and Other Image Settings](#)
- [Selecting the Scan Size](#)

Selecting the Scan Resolution

You can select a specific Resolution setting for your images. Keep in mind that higher resolution settings increase scanning time, so do not select a higher resolution than you need. See the following table to reference the appropriate resolution setting to use so that you do not have to take more time than necessary.

What you will do with the scanned image	Suggested scan resolution
Send via e-mail, upload to web, or view only on the screen	96 to 150 dpi
Convert to editable text (OCR)	400 dpi
Create searchable PDF	200 to 400 dpi
Print using ink jet printer with normal quality	150 dpi (Color or Grayscale) 360 dpi (Black & White)
Print using ink jet printer with high quality	300 dpi (Color or Grayscale) 720 dpi (Black & White)
Print using page printer	200 dpi (Color or Grayscale) 600 dpi (Black & White)
Fax	200 dpi
Enlarge after scanning at 100%	Increase Resolution setting by same amount you will increase image size after scanning. For example, if the resolution is 300 dpi, but you will increase the image size to 200%, change the resolution setting to 600 dpi.

To select the resolution setting, see one of these sections.

Full Auto Mode: [Selecting the Resolution in Full Auto Mode](#)

Home Mode: [Selecting the Resolution in Home Mode](#)

Office Mode or Professional Mode: [Selecting the Resolution in Office Mode or Professional Mode](#)

Selecting the Resolution in Full Auto Mode

You can change the resolution you want at any time. Follow these steps to select the resolution setting.

- 1 In the Full Auto Mode window, click **Customize**. The Customize window appears.

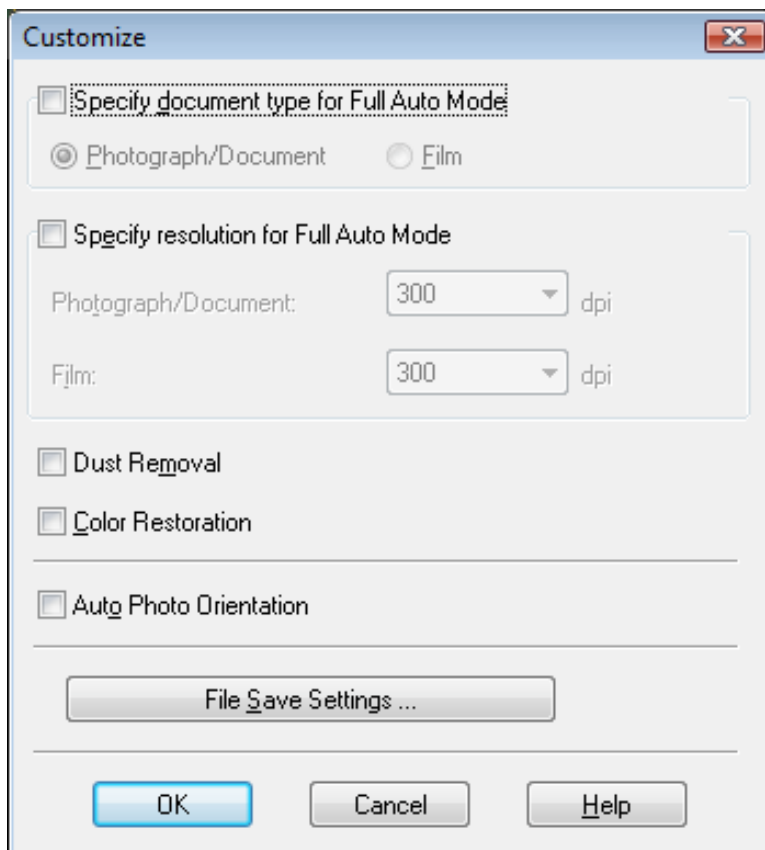

- 2 Click the **Specify resolution for Full Auto Mode** check box and select the number of dpi (dots per inch) at which you want to scan.

Selecting the Resolution in Home Mode

To change the resolution, first select **Other** as the Destination setting.

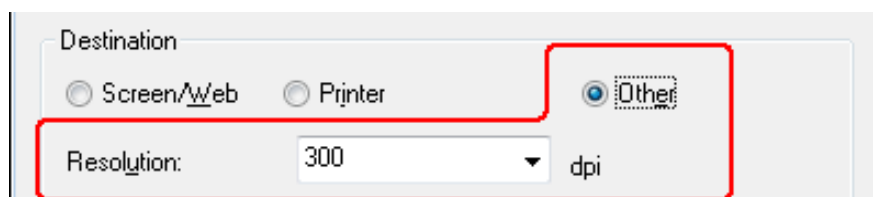

Click the arrow next to the **Resolution** list and select the number of dpi (dots per inch) at which you want to scan.

Selecting the Resolution in Office Mode or Professional Mode

You can select the resolution you want at any time.

Office Mode

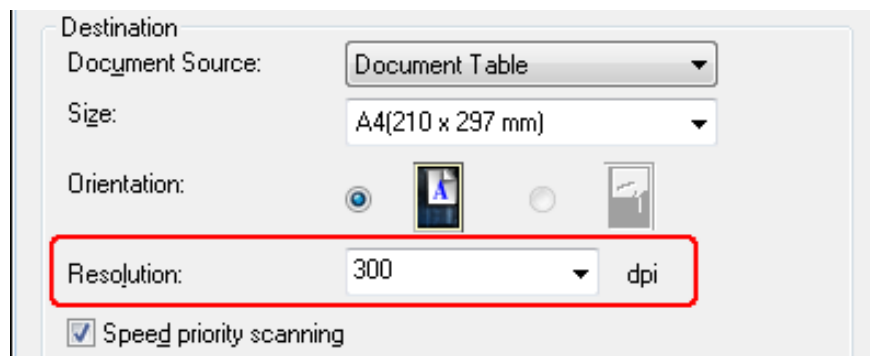

Professional Mode

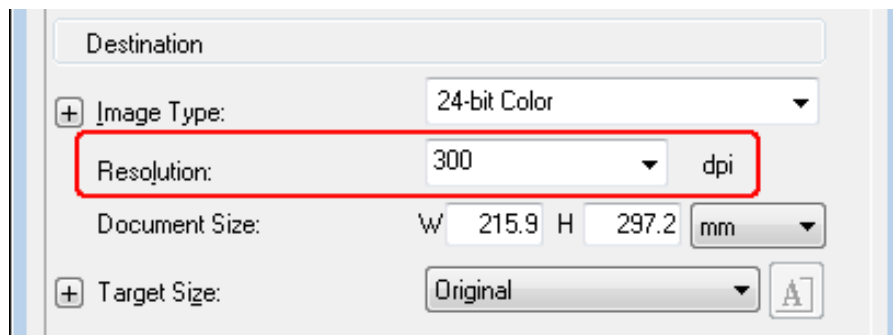

Click the arrow next to the **Resolution** list and select the number of dpi (dots per inch) at which you want to scan.

[Top](#)

Previewing and Adjusting the Scan Area

Once you have selected your basic settings and resolution, you can preview your image and select or adjust the image area of the image(s) in a Preview window on your screen. There are two types of preview.

- Normal preview displays your previewed image(s) in their entirety. You must select the scan area and make any image quality adjustments manually.
- Thumbnail preview displays your previewed image(s) as thumbnail(s). Epson Scan automatically locates the edges of your scan area, applies automatic exposure settings to the image(s), and rotates the image(s) if necessary.

To preview your image, follow the steps below.

Note:

If you are using Full Auto Mode or Office Mode, the thumbnail preview is not available.

- 1 Click **Preview**. If you want to change the preview mode, select the **Normal** or **Thumbnail** tab on Preview window if it is available.

Note:

- Depending on your document type and other settings, you may not be able to change the preview type.
- You can resize the Preview window. To resize the Preview window, click and drag the corner of the Preview window.
- If you preview with the Preview dialog not displayed, image(s) will be displayed in the default preview mode. If you preview with the Preview dialog displayed, image(s) will be displayed in the preview mode that was displayed just before previewing.
- Some of the settings that you change while previewing will be reset if you change the Preview mode.

Epson Scan prescans your image(s) and displays them in one of the following Preview windows.

Normal preview

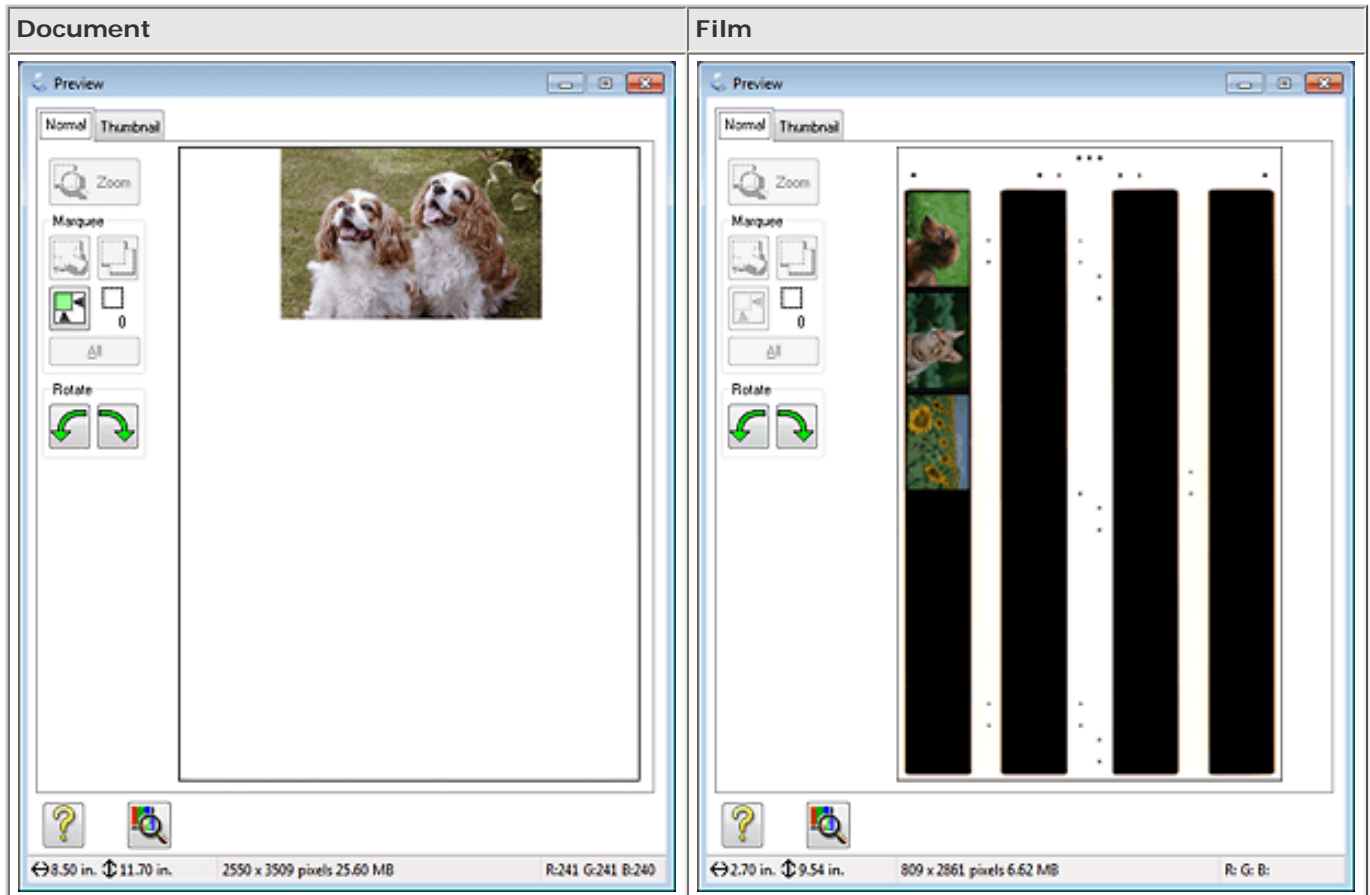

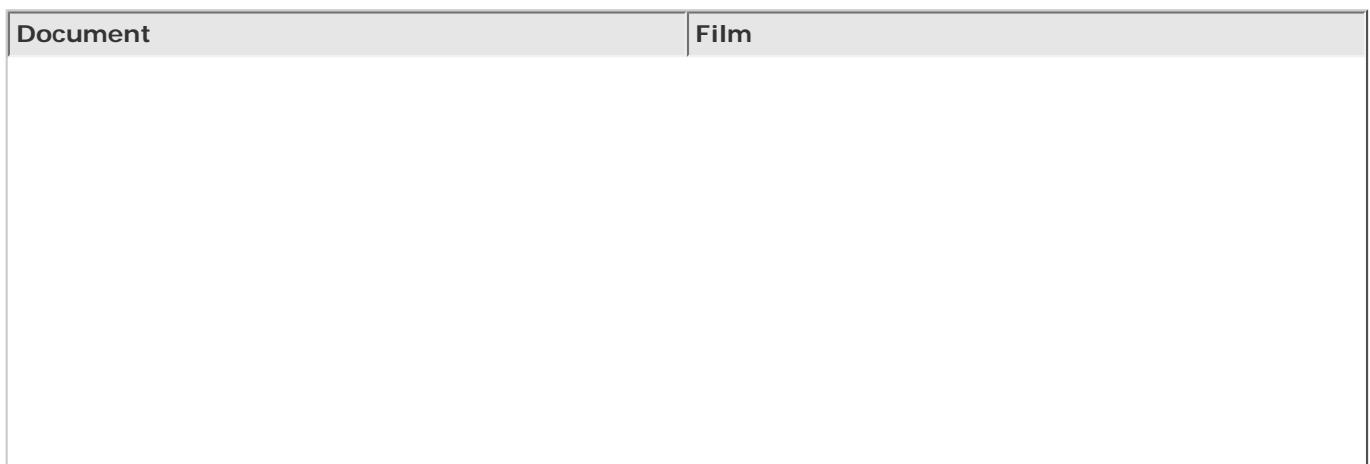

Thumbnail preview

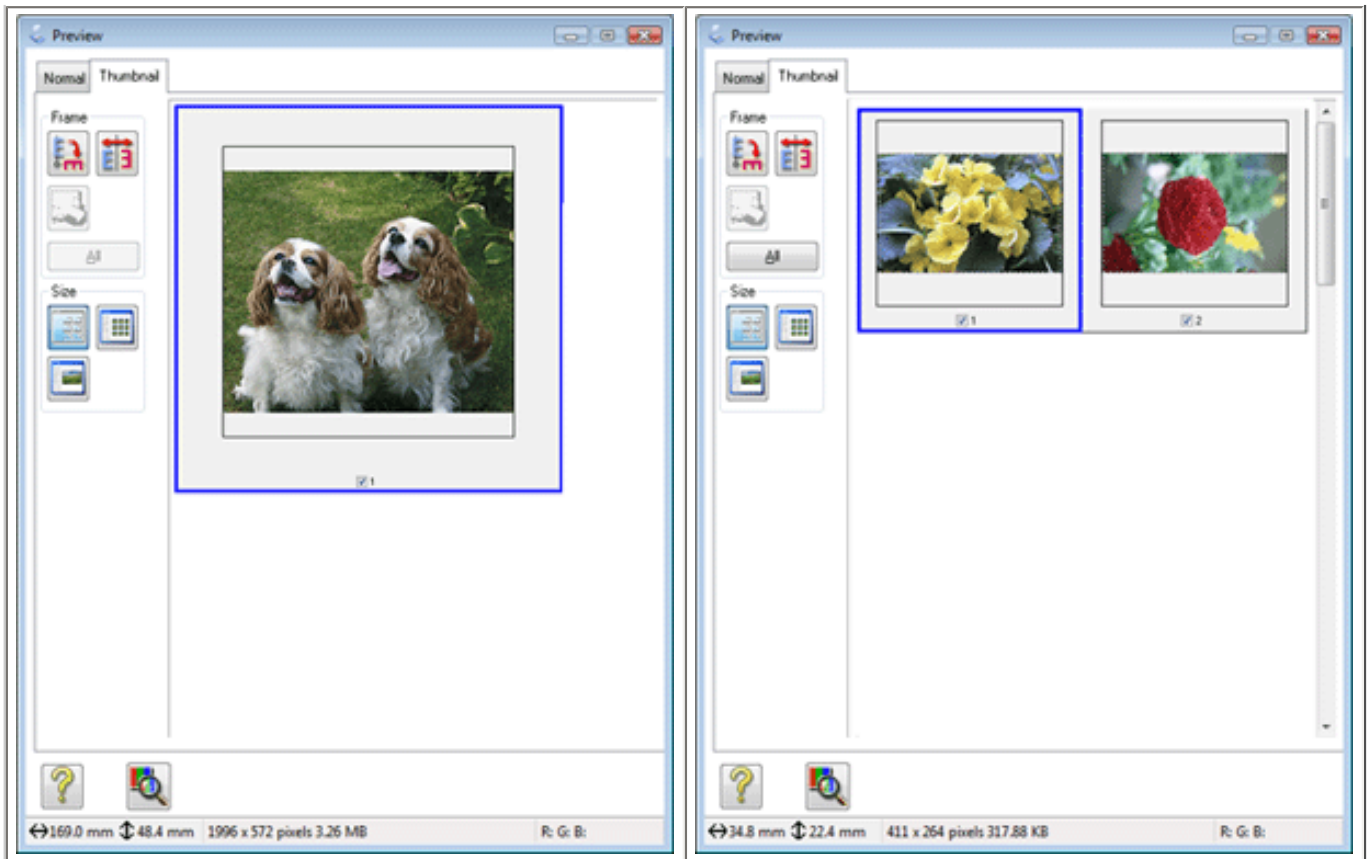



2 If you are viewing the Normal preview, you can do the following to adjust the image(s).

-  To select your scan area, click the  auto locate icon to create a marquee that marks the edges of your image area (if you have only one photo or document on the document table), or draw a marquee manually. You can move the marquee to change the scan area. See [Creating a Marquee on a Preview Image](#) for instructions.



 **Note:**

If you are going to scan at a different size than your original, you must first select your **Target Size** and automatically create a marquee that is proportioned to that size. See [Selecting the Scan Size](#) for instructions. You can then copy the marquee and place it on each image you will scan at that size.





- To enlarge or reduce the preview image in the Normal preview, resize the Preview window. The image size changes corresponding to the Preview window size.
- To zoom in on an image in the Normal preview, click inside the scan area and click the **Zoom** button.

 **Note:**

Click the **Full** button to exit Zoom display.

- To rotate an image, click the  left or  right rotate icon.
- To adjust the image quality, click the scan area(s) you want to modify and make the adjustments. See [Adjusting the Color and Other Image Settings](#) for instructions.

If you are viewing the Thumbnail preview, you can do the following to adjust the image(s).

- To zoom in on an image in the Thumbnail preview, double-click the thumbnail to zoom in.
- You can change the size of the thumbnail by clicking either the  Thumbnail <Large>,  Thumbnail <Small>, or  Full size of 1 frame button.
- To rotate an image or flip it horizontally (like a mirror image), click its thumbnail and then click the  rotation icon or  mirroring icon.

 **Note:**

If your image is not rotated correctly, see [Images are Rotated Incorrectly](#).

- To adjust the scan area to crop your image differently, you can create and move a marquee that marks the edges of your scan. See [Creating a Marquee on a Preview Image](#) for instructions.
- To adjust the image quality, click the image(s) or scan area(s) you want to modify and make the adjustments. See [Adjusting the Color and Other Image Settings](#) for instructions. If you want to apply the adjustments you have made to all of your images, click **All**.

Creating a Marquee on a Preview Image

A marquee is a moving dotted line that appears on the edges of your preview image to indicate the scan area.

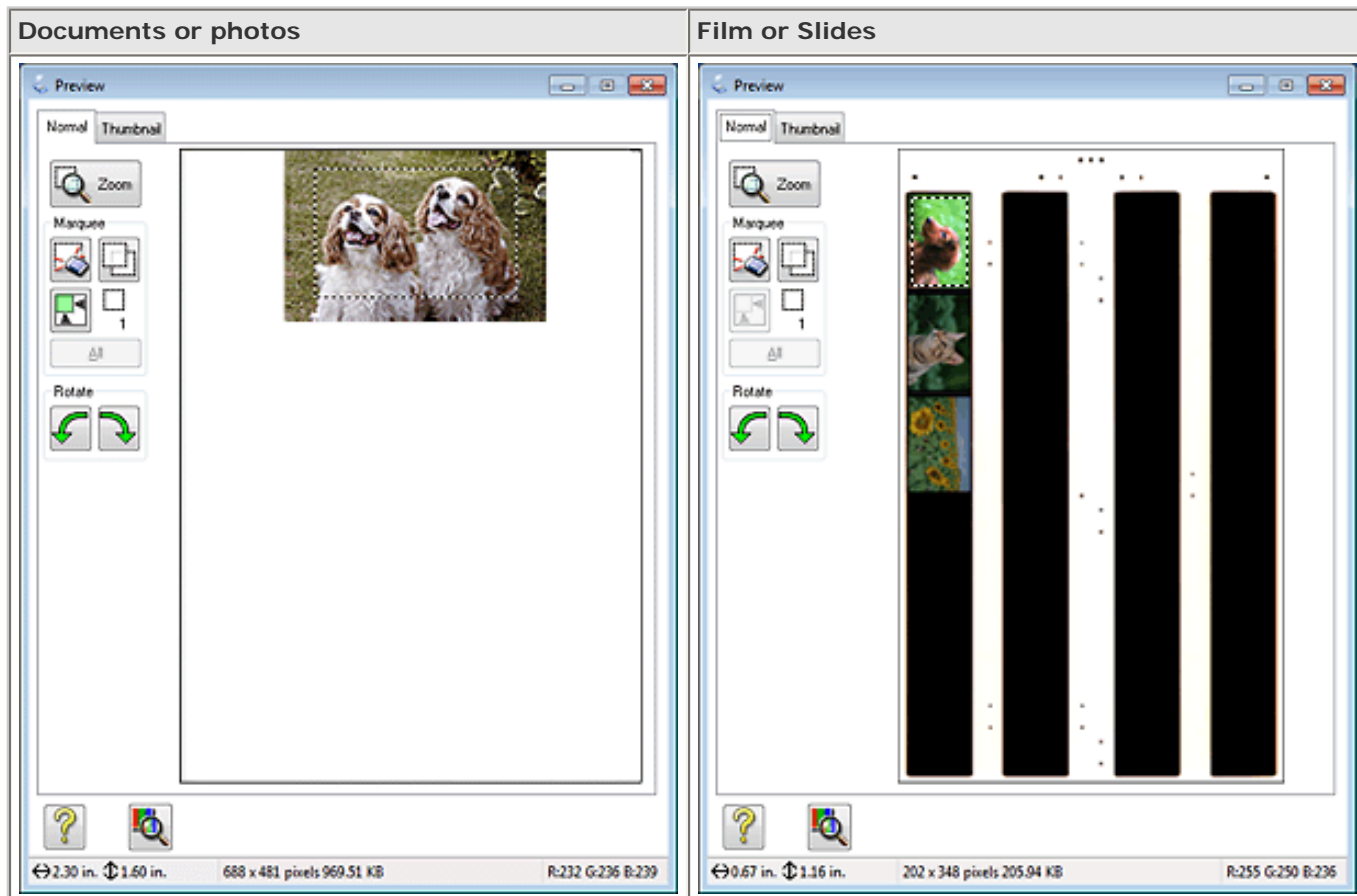

You can move the marquee and adjust its size. If you are viewing the Normal preview, you can create multiple marquees (up to 50) on each image to scan different image areas in separate scan files.

 **Note for film or slides:**

When you use the Thumbnail preview, Epson Scan automatically creates marquees around your image

(s) for you. If you need to adjust a marquee, click inside it and click the  delete marquee icon before completing the steps in this section. If you do not need to adjust any marquees, skip to [Adjusting the Color and Other Image Settings](#).

1 To draw a marquee, move your cursor over a preview image. The pointer becomes a set of cross-hairs.

 **Note:**

If you are viewing the Normal preview and you only have one photo or document on the document table, you can click the  auto locate icon to automatically draw a marquee, then skip to step 3.

2 Position the pointer in the area where you want to place the corner of your marquee and click. Hold down the mouse button and drag the cross-hairs over the image to the opposite corner of the desired scan area. Then release the mouse button. You see the moving dotted line of the marquee.



3 Do one of the following to adjust the marquee.

- To move the marquee, position your cursor inside the marquee. The pointer becomes a hand. Click and drag the marquee to the desired location.



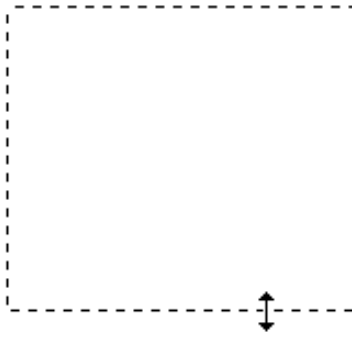

- To resize the marquee, position your cursor over the edge or corner of the marquee. The pointer becomes a straight or angled double-arrow. Click and drag the edge or corner to the desired size.



 **Note:**

- To restrict the movement of the marquee to vertical or horizontal only, hold down the **Shift** key as you move the marquee.
- To restrict the size of the marquee to the current proportions, hold down the **Shift** key as you resize the marquee.
- For best results and image exposure, make sure all sides of the marquee are located inside the preview image. Do not include any of the area around the preview image in the marquee.

4 If you are viewing the Normal preview, you can create multiple marquees (up to 50). Just draw them as described in steps 1 through 3, or click the  copy marquee icon to create additional marquees of the same size. You can move and resize all the marquees as described in step 3. To delete a marquee, click inside it and click the  delete marquee icon.

 **Note:**

If you draw multiple marquees, make sure you click **All** in the Preview window before you scan. Otherwise, only the area inside the last marquee you drew will be scanned.

Top 

Adjusting the Color and Other Image Settings

Once you have previewed your image(s) and adjusted the scan area, you can modify the image quality, if necessary. Epson Scan offers a variety of settings for improving color, sharpness, contrast, and other aspects affecting image quality. Before you make adjustments, be sure to click the image or marquee for the area you want to adjust.

To adjust the color and other image settings, see one of these sections.

Office Mode: [Making Color Adjustments and Other Image Settings in Office Mode](#)

Home Mode: [Making Color Adjustments and Other Image Settings in Home Mode](#)

Professional Mode: [Making Color Adjustments and Other Image Settings in Professional Mode](#)

Making Color Adjustments and Other Image Settings in Office Mode



The table below describes the settings available in Office Mode. For details on adjusting these settings, see Epson Scan Help.

 **Note:**

If you are scanning multiple images at the same time and you want to apply the image adjustments to all of your images or scan areas, click **All** in the Preview window before you begin making your adjustments.

Setting		Description
Unsharp Mask		Turn on to make the edges of image areas clearer for an overall sharper image. Turn off to leave softer edges. This setting is available only when the Image Type is set to Color or Grayscale.
Descreening		Removes the rippled pattern that can appear in subtly-shaded image areas, such as in skin tones. Also improves results when scanning magazine or newspaper images which include screening in their original print processes. This setting is available only when the Image Type is set to Color or Grayscale. The results of descreening do not appear in the preview, only in your scanned image.
Image Option	Text Enhancement	Enhances text recognition when scanning text documents. This setting is available when Image Option is selected. When the Image Type is set to Black&White, the results of Text Enhancement do not appear in the preview, only in your scanned image.
	Auto Area Segmentation	Makes images clearer and text recognition more accurate by separating the text from the graphics. This setting is available only when the Image Type is set to Black&White and Image Option is selected.
	Dropout	Drops out red, green, or blue in the scan. This setting is available when the Image Type is set to Grayscale or Black&White and Image Option is selected.
	Color Enhance	Enhances red, green, or blue in the scan. This setting is available when the Image Type is set to Grayscale or Black&White and Image Option is selected.
Brightness		Adjusts the overall image lightness and darkness. When the Image Type is set to Black&White, select Auto Area Segmentation to make this setting available.

Contrast	Adjusts the difference between the light and dark areas of the overall image. When the Image Type is set to Black&White, select Auto Area Segmentation to make this setting available.
Threshold	Adjusts the level at which the black areas in text and line art are delineated, improving text recognition in OCR programs. This setting is available under the following conditions: - The Image Type is set to Black&White, and Image Option is not selected. - The Image Type is set to Black&White, and Image Option and Color Enhance are selected.

 **Note:**

- To view the red, green, and blue levels at particular points in your preview image as you make adjustments, click the  densitometer icon in the Preview window and move your cursor over an image area. See Epson Scan Help for details.
- Certain settings may not be available, or may be automatically selected, depending on the type of image you are previewing and other settings you have selected.
- You can customize how certain Epson Scan settings behave by clicking **Configuration** and changing settings in the window that appears. See Epson Scan Help for details.
- To undo any image quality adjustments you make to the preview image, click **Reset** if available, turn off the settings, or preview your image again.

Making Color Adjustments and Other Image Settings in Home Mode

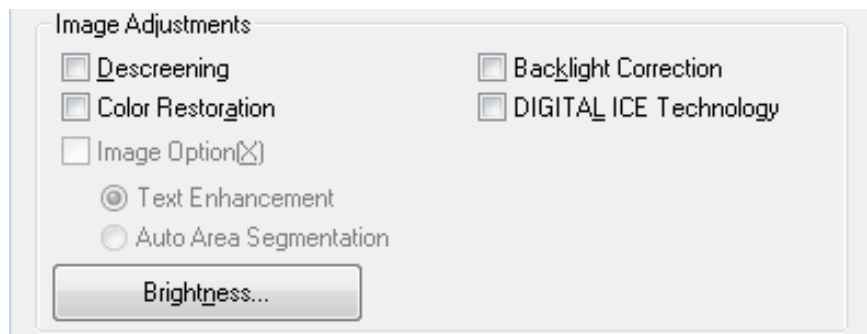

The table below describes the settings available in Home Mode. For details on adjusting these settings, see Epson Scan Help.

 **Note:**

If you are scanning multiple images at the same time and you want to apply the image adjustments to all of your images or scan areas, click **All** in the Preview window before you begin making your adjustments.

Setting	Description

Descreening		Removes the rippled pattern that can appear in subtly-shaded image areas, such as in skin tones. Also improves results when scanning magazine or newspaper images which include screening in their original print processes. This setting is available only when the Image Type is set to Color or Grayscale. The results of descreening do not appear in the preview, only in your scanned image.
Backlight Correction		Removes shadows from photos that have too much background light. This setting is available when you select Photograph as the Document Type setting and the Image Type is set to Color or Grayscale.
Color Restoration		Restores the colors in faded photos automatically. This setting is available when you select Photograph as the Document Type setting and the Image Type is set to Color or Grayscale.
DIGITAL ICE Technology		Remove dust marks that the Dust Removal feature cannot. DIGITAL ICE Technology takes longer to scan and also uses more of your system resources. This setting is available when you select Photograph, Positive Film, Color Negative Film, or B&W Negative Film as the Document Type and the Image Type is set to Color or Grayscale.
Image Option	Text Enhancement	Enhances text recognition when scanning text documents. This setting is available when you select Magazine, Newspaper, or Text/Line Art as the Document Type setting and Image Option is selected.
	Auto Area Segmentation	Makes images clearer and text recognition more accurate by separating the text from the graphics. This setting is available when you select Magazine, Newspaper, or Text/Line Art as the Document Type, the Image Type is set to Black&White, and Image Option is selected.
Brightness		Adjusts the overall image lightness and darkness. When the Image Type is set to Black&White, and Magazine, Newspaper, or Text/Line Art is set as the Document Type, select Auto Area Segmentation to make this setting available. Click Brightness to access the Brightness setting.
Contrast		Adjusts the difference between the light and dark areas of the overall image. When the Image Type is set to Black&White, and Magazine, Newspaper, or Text/Line Art is set as the Document Type, select Auto Area Segmentation to make this setting available. Click Brightness to access the Contrast setting.
Threshold		Adjusts the level at which the black areas in text and line art are delineated, improving text recognition in OCR programs. Available only when the Image Type is set to Black&White, and Image Option is not selected. Click Brightness to access the Threshold setting.



Note:

- To view the red, green, and blue levels at particular points in your preview image as you make adjustments, click the  densitometer icon in the Preview window and move your cursor over an image area. See Epson Scan Help for details.
- Certain settings may not be available, or may be automatically selected, depending on the type of image you are previewing and other settings you have selected.
- You can customize how certain Epson Scan settings behave by clicking **Configuration** and changing settings in the window that appears. See Epson Scan Help for details.
- To undo any image quality adjustments you make to the preview image, click **Reset** if available, turn off the settings, or preview your image again.

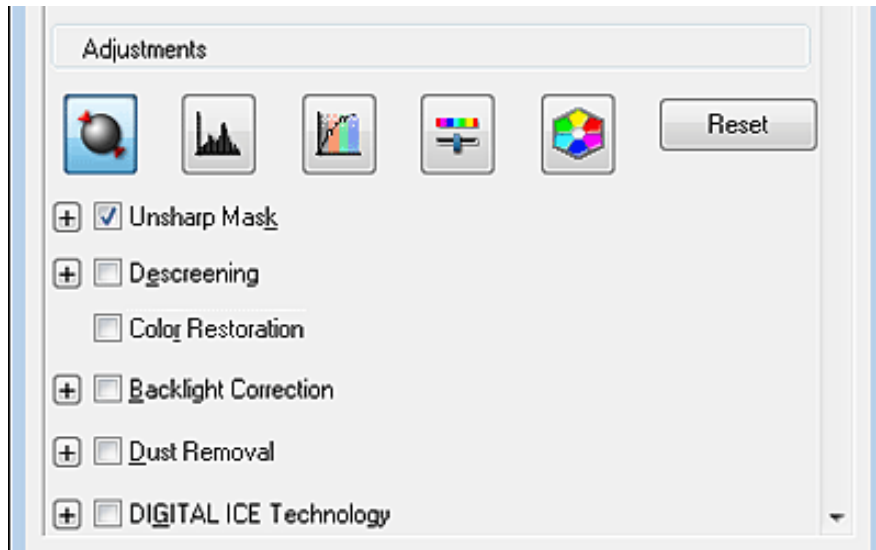

Making Color Adjustments and Other Image Settings in Professional Mode









The table below describes the settings available in Professional Mode. For details on adjusting these settings, see Epson Scan Help.

Note:

- You may need to scroll down to view the Adjustments area of the Professional Mode window.
- If you are scanning multiple images at the same time and you want to apply the image adjustments to all of your images or scan areas, click **All** in the Preview window before you begin making your adjustments.

Setting	Description
Auto Exposure	Click the  Auto Exposure icon. To turn it on continuously, click Configuration , click the Color tab and select Continuous auto exposure . You can adjust the level of exposure adjustment using the slider.
Histogram	Provides a graphical interface for adjusting highlight, shadow, and gamma levels individually. For advanced users only. Click the  Histogram Adjustment icon to access the Histogram setting.

Tone Correction	<p>Provides a graphical interface for adjusting tone levels individually. For advanced users only.</p> <p>Click the  Tone Correction icon to access the Tone Correction setting.</p>
Brightness	<p>Adjusts the overall image lightness and darkness.</p> <p>Click the  Image Adjustment icon to access the Brightness setting.</p>
Contrast	<p>Adjusts the difference between the light and dark areas of the overall image.</p> <p>Click the  Image Adjustment icon to access the Contrast setting.</p>
Saturation	<p>Adjusts the density of colors in the overall image.</p> <p>Click the  Image Adjustment icon to access the Saturation setting.</p>
Color Balance	<p>Adjusts the balance of red, green, and blue colors in the overall image.</p> <p>Click the  Image Adjustment icon to access the Color Balance settings.</p>
Color Palette	<p>Provides a graphical interface for adjusting mid-tone levels, such as skin tones, without affecting the highlight and shadow areas of the image. For advanced users only. See Using the Color Palette Feature (for Professional Mode Only) for more information.</p> <p>Click the  Color Palette icon to use the Color Palette settings.</p>
Unsharp Mask	<p>Turn on to make the edges of image areas clearer for an overall sharper image. The level of sharpness is adjustable. Turn off to leave softer edges.</p> <p>This setting is available when the Image Type is set to 48-bit Color, 24-bit Color, 16-bit Grayscale, or 8-bit Grayscale.</p>
Descreening	<p>Removes the rippled pattern that can appear in subtly shaded image areas, such as skin tones. Also improves results when scanning magazine or newspaper images that include screening in their original print processes. The results of descreening do not appear in the preview, only in your scanned image. The level of descreening is adjustable.</p> <p>This setting is available when the Image Type is set to 48-bit Color, 24-bit Color, Color Smoothing, 16-bit Grayscale, or 8-bit Grayscale.</p>
Color Restoration	<p>Restores the colors in faded photos automatically.</p> <p>This setting is available when you select Photo as the Auto Exposure Type setting and the Image Type is set to 48-bit Color, 24-bit Color, 16-bit Grayscale, or 8-bit Grayscale.</p>
Backlight Correction	<p>Removes shadows from photos that have too much background light. The level of backlight correction is adjustable.</p> <p>This setting is available when you select Photo as the Auto Exposure Type setting and the Image Type is set to 48-bit Color, 24-bit Color, 16-bit Grayscale, or 8-bit Grayscale.</p>
Dust Removal	<p>Removes dust marks from your originals automatically. The results of Dust Removal do not appear in the preview, only in your scanned image. The level of dust removal is adjustable.</p> <p>This setting is available when you select Photo as the Auto Exposure Type setting and the Image Type is set to 48-bit Color, 24-bit Color, 16-bit Grayscale, or 8-bit Grayscale.</p>
Digital ICE Technology and DIGITAL ICE Lite Technology	<p>Remove dust marks that the Dust Removal feature cannot. DIGITAL ICE Technology takes longer to scan and also uses more of your system resources.</p> <p>This setting is available under the following conditions:</p> <ul style="list-style-type: none"> - You select Reflective as the Document Type and the Auto Exposure Type is set to Photo. - You select Film as the Document Type.
Threshold	<p>Adjusts the level at which the black areas in text and line art are delineated, improving text recognition in OCR programs. This setting is available only when you select Black & White as the Image Type setting.</p>

 **Note:**

- To view red, green, and blue levels at particular points in your preview image as you make adjustments, click the  densitometer icon in the Preview window and move your cursor over an image area. See Epson Scan Help for details.
- Certain settings may not be available, or may be automatically selected, depending on the type of image you are previewing and other settings you have selected.
- You can customize how certain Epson Scan settings behave by clicking **Configuration** and changing settings in the window that appears. See Epson Scan Help for details.
- To undo any image quality adjustments you make to the preview image, click **Reset** if available, turn off the setting, or preview your image again.

Top 

Selecting the Scan Size

You can scan your images at their original size, or you can reduce or enlarge their size as you scan them. You do this using the **Target Size** setting.

If you are going to scan your image to a specific size, you should select the **Target Size** setting after previewing it, but before adjusting your scan area indicated by creating a marquee. This sets the scan area to correct proportions so your image will not be cropped unexpectedly.

To select the scan size, see one of these sections.

Home Mode: [Selecting the Scan Size in Home Mode](#)

Professional Mode: [Selecting the Scan Size in Professional Mode](#)

Selecting the Scan Size in Home Mode

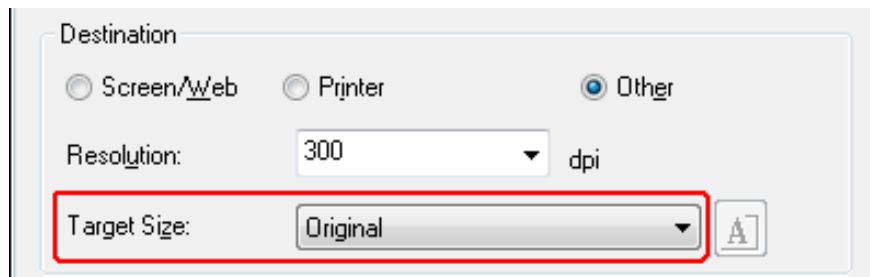

- 1 You can select a predefined scan size from the **Target Size** list. Click the arrow to open the list and select the size you want. A marquee (dotted line) proportioned for that size appears on your preview image.

Documents or photos

Film or Slides

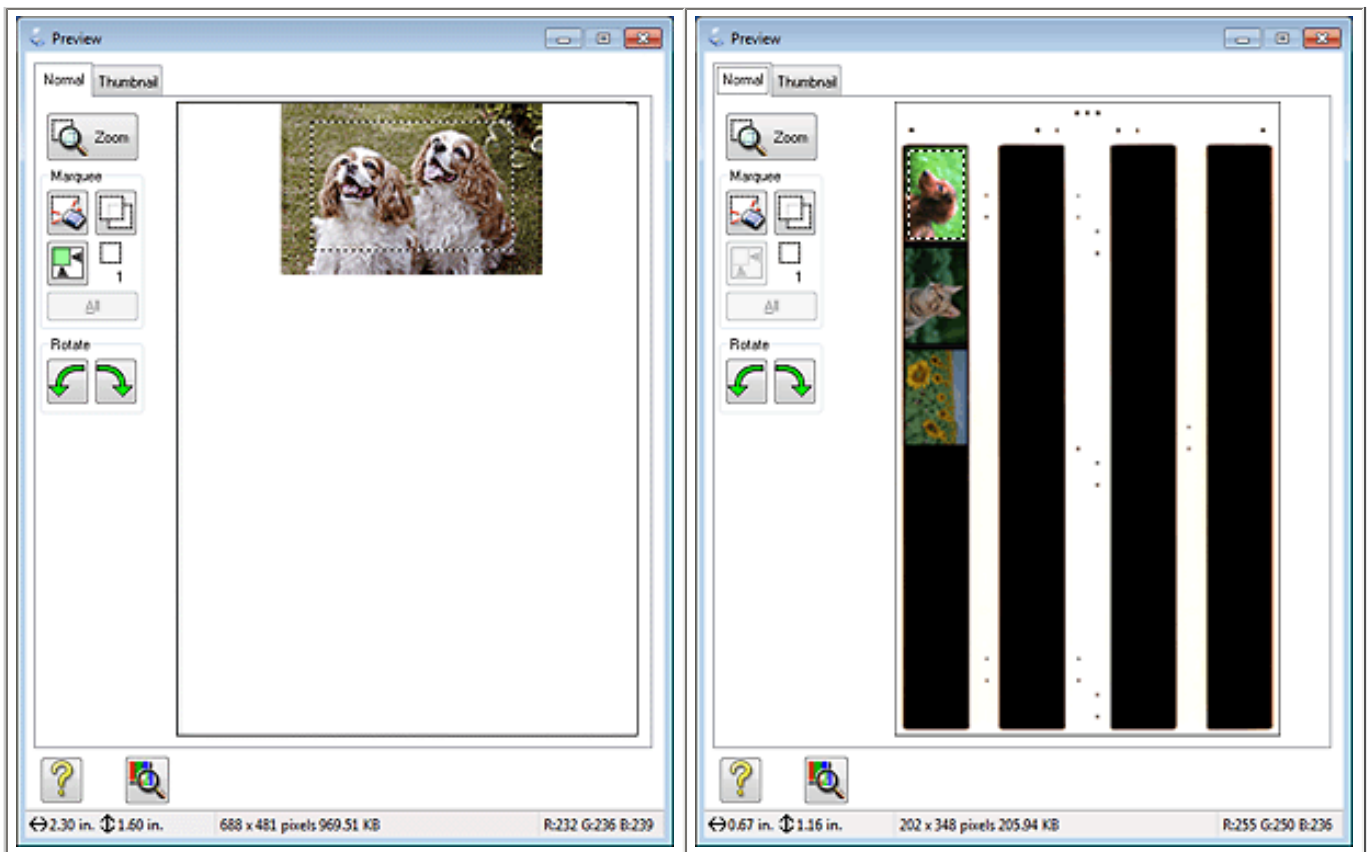

- 2 If you need to create a scan size that is not in the Target Size list, you can create a custom size. Click the arrow to open the list and select **Customize**. You see the Target Size window.

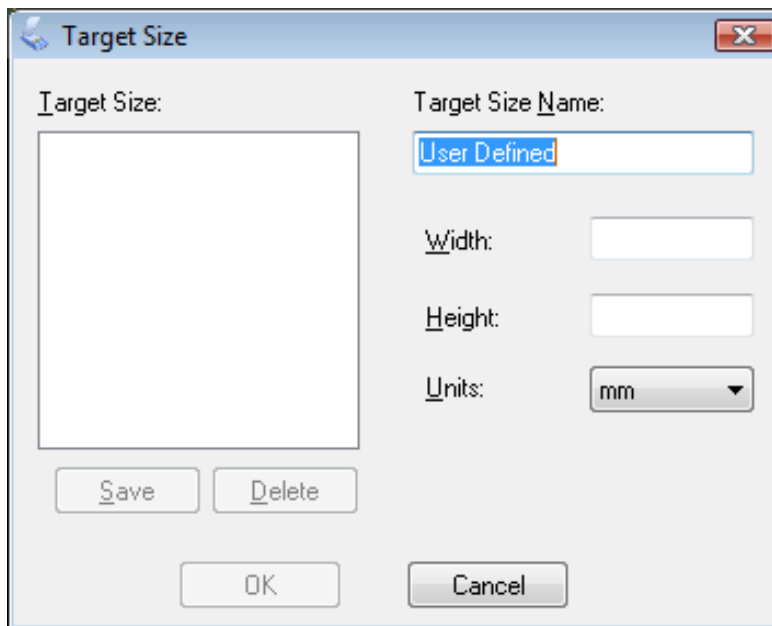

- 3 Type a name for your custom size, enter the size, click **Save**, then click **OK**. Your new size appears in the Target Size list.
- 4 Once you have selected your scan size, you can click and drag the marquee to the area in the image you want to scan. For details, see [Creating a Marquee on a Preview Image](#). The marquee proportions are retained as you adjust it.

If you need to rotate the marquee for a landscape or portrait image without changing its aspect ratio, click the



orientation icon.

 **Note:**



The  orientation icon is not available if you selected **Original** as the Target Size setting.

Selecting the Scan Size in Professional Mode

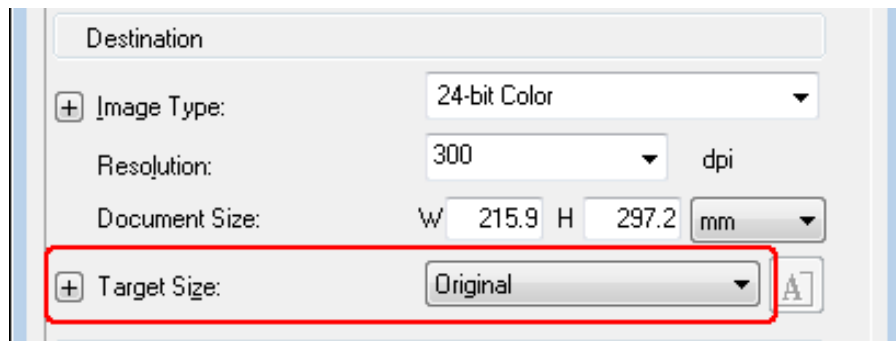

- 1 You can select a predefined scan size from the Target Size list. Click the arrow to open the list and select the size you want. A marquee (dotted line) proportioned for that size appears on your preview image.

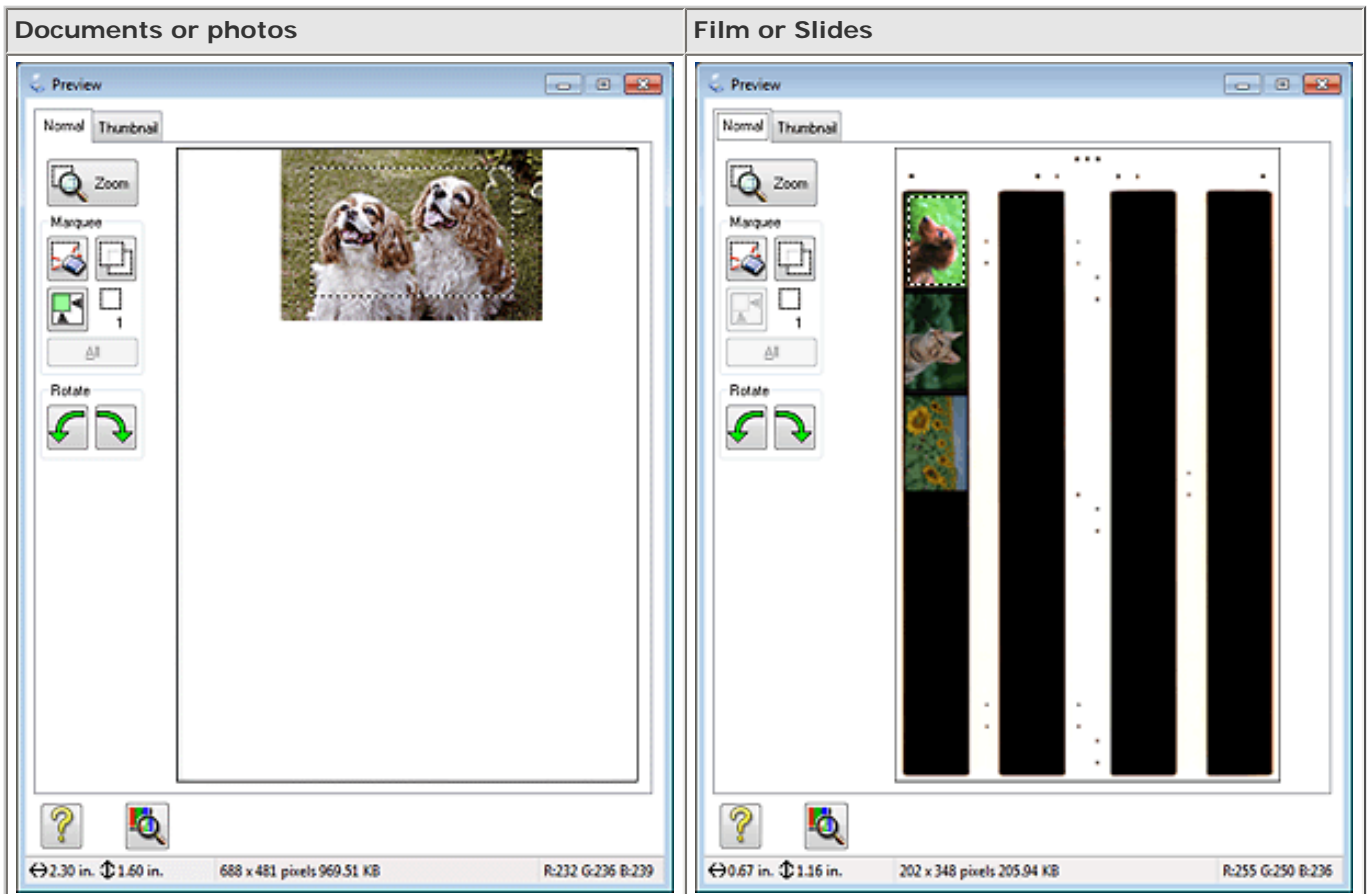

- 2 If you need to create a scan size that is not in the Target Size list, you can create a custom size. Click the arrow to open the list and select **Customize**. You see the Target Size window.

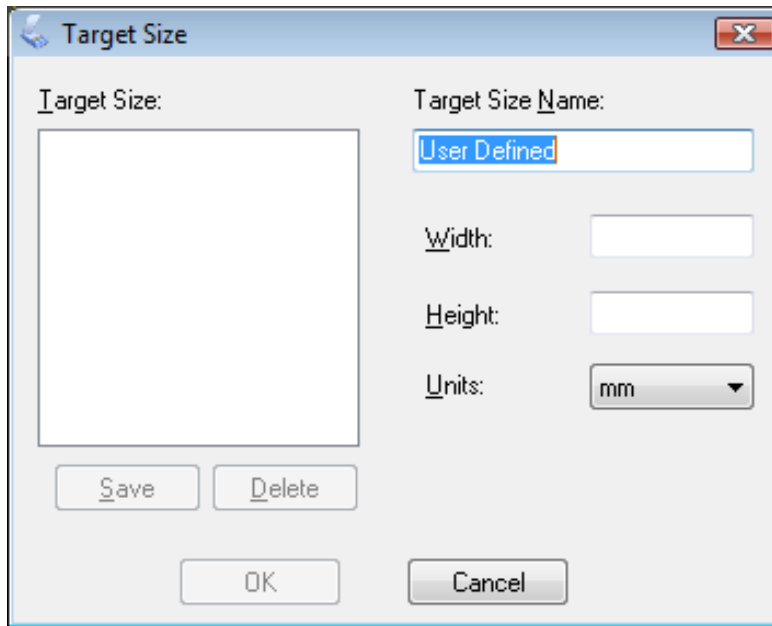

- 3 Type a name for your custom size, enter the size, click **Save**, then click **OK**. Your new size appears in the Target Size list.
- 4 You can fine-tune the size using additional tools. Click the + (Windows) or ► (Mac OS X) button next to **Target Size** to display these tools.

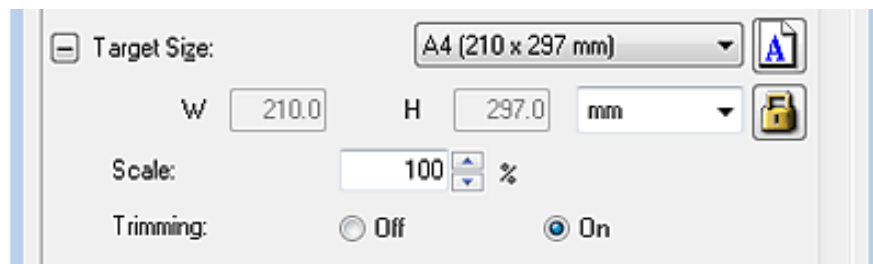

- To size your image by a certain percentage, adjust the **Scale** value.
- To change the way your image is cropped, turn **Trimming** on or off. See Epson Scan Help for details.

■ To unlock the proportions of your scan size, click the  lock icon. Then adjust the marquee or enter new width/height measurements.

- 5 Once you have selected your scan size, you can click and drag the marquee to the area in the image you want to scan. For details, see [Creating a Marquee on a Preview Image](#). The marquee proportions are retained as you adjust it.

If you want to rotate the marquee for a landscape or portrait image without changing its aspect ratio, click the  orientation icon.

 **Note:**

The  orientation icon is not available if you selected **Original** as the Target Size setting.

[Home](#) > [Scanning Your Originals](#)

■ Finishing the Scan

What happens after you scan depends on how you started your scan.

Full Auto Mode:

- If you started your scan by running Epson Scan from the EPSON Scan icon or by pressing the Start button on the scanner, your scanned image is saved in the file format and location you selected in the File Save Settings window. If you did not select any settings in the File Save Settings window, it is saved as a JPEG file in Pictures or My Pictures. 
- If you started your scan from a TWAIN-compliant program such as Adobe Photoshop Elements, your scanned image opens in the program window. If Epson Scan does not automatically close after scanning, click **Close** to exit the Epson Scan window and view your image in the program window.

Office Mode, Home Mode, or Professional Mode:

- If you started your scan by running Epson Scan from the EPSON Scan icon or by pressing the Start button on the scanner, you see the File Save Settings window. This lets you select the name and location of your saved scan files. See [Selecting File Save Settings](#) for details. After you select these settings, Epson Scan starts scanning. 
- If you started your scan from a TWAIN-compliant program such as Adobe Photoshop Elements, your scanned image(s) opens in the program window. If Epson Scan does not automatically close after scanning, click **Close** to exit the Epson Scan window and view your image(s) in the program.

Home > Scanning Special Projects

Restoring Color

- [Color Restoration in Full Auto Mode](#)
- [Color Restoration in Home Mode](#)
- [Color Restoration in Professional Mode](#)
- [Using the Color Palette Feature \(for Professional Mode Only\)](#)

Using the **Color Restoration** feature in Epson Scan, you can transform old, faded, or badly exposed photos into ones with true-to-life color and sharpness. You can restore printed photos, film, or slides automatically as you scan them.

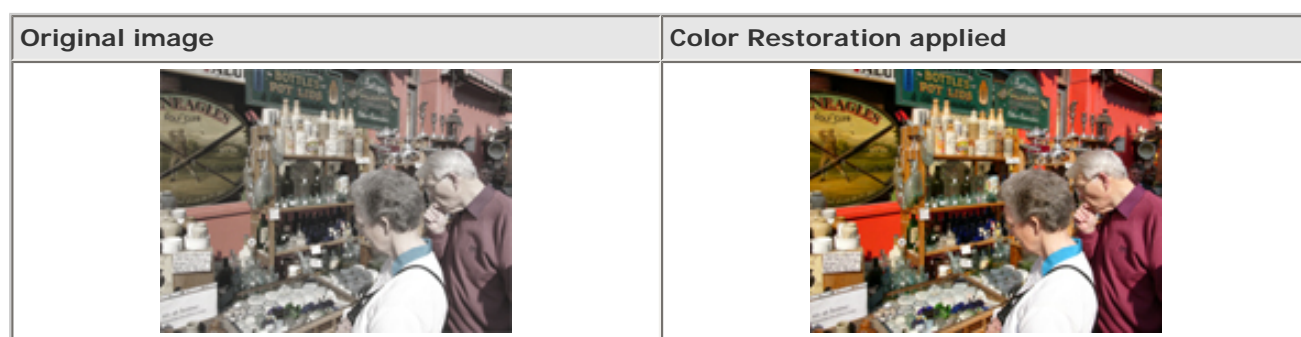

See one of these sections for instructions on restoring colors.

Full Auto Mode: [Color Restoration in Full Auto Mode](#)

Office Mode: This feature is not available in Office Mode. Change the scan mode to Full Auto Mode, Home Mode, or Professional Mode. See [Changing the Scan Mode](#) for instructions.

Home Mode: [Color Restoration in Home Mode](#)

Professional Mode: [Color Restoration in Professional Mode](#)

Color Restoration in Full Auto Mode

- 1 Place your original(s) on the document table. See one of these sections for instructions.

Documents or photos: [Placing Documents or Photos](#)

Film or slides: [Placing Film or Slides](#)

Note for film or slides:

You can scan only 35 mm color film strip or color positive slides in Full Auto Mode. To scan other types of film, use Home Mode or Professional Mode. To change the scan mode, see [Changing the Scan Mode](#).

- 2 Start Epson Scan. See [Starting Epson Scan](#) for instructions.

3 In the Full Auto Mode window, click **Customize**. The Customize window appears.

4 Click the **Color Restoration** check box.

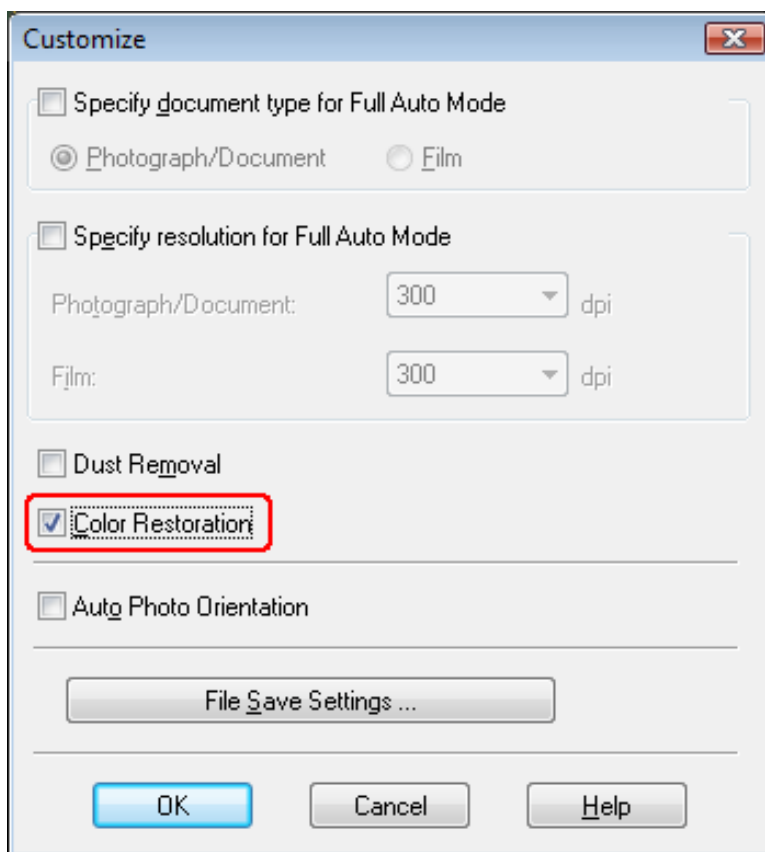

5 If you want to select the file save settings, click **File Save Settings**. See [Selecting File Save Settings](#) for instructions.

 **Note:**

If you started Epson Scan from a TWAIN-compliant program like Adobe Photoshop Elements, the File Save Settings button does not appear.

6 When you finish making all the necessary settings, click **OK** to return to the Full Auto Mode window.

7 Click **Scan**.

What happens next depends on how you started Epson Scan. See [Finishing the Scan](#) for instructions.

[Top](#) 

Color Restoration in Home Mode

1 Place your original(s) on the document table. See one of these sections for instructions.

Documents or photos: [Placing Documents or Photos](#)

Film or slides: [Placing Film or Slides](#)

- 2 Start Epson Scan. See [Starting Epson Scan](#) for instructions.
- 3 In the Home Mode window, select the **Document Type**, **Image Type**, and **Destination** settings. For details, see [Scanning in Home Mode](#).
- 4 Click **Preview** to preview your image(s), then select your scan area. See [Previewing and Adjusting the Scan Area](#) for details.
- 5 Click the **Color Restoration** check box.

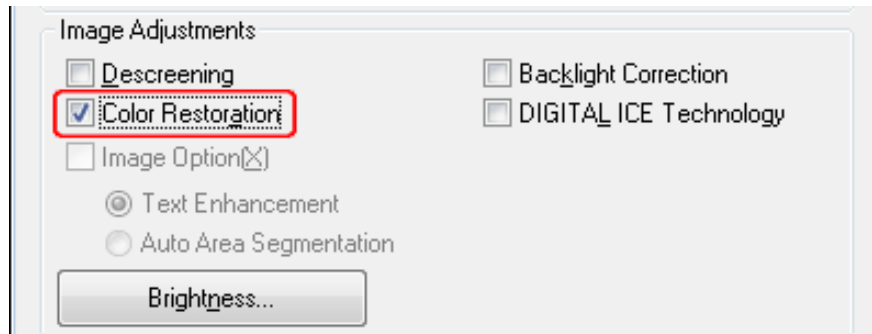

Note:

If you are scanning multiple images at the same time and you want to apply the Color Restoration feature to all of your images or scan areas, click **All** in the Preview window before you click the check box.

- 6 Make any other necessary image adjustments. See [Adjusting the Color and Other Image Settings](#) for details.
- 7 Size your image(s) as necessary. See [Selecting the Scan Size](#) for details.
- 8 Click **Scan**.

What happens next depends on how you started Epson Scan. See [Finishing the Scan](#) for instructions.

Top 

Color Restoration in Professional Mode

- 1 Place your original(s) on the document table. See one of these sections for instructions.

Documents or photos: [Placing Documents or Photos](#)

Film or slides: [Placing Film or Slides](#)

- 2 Start Epson Scan. See [Starting Epson Scan](#) for instructions.

- 3 In the Professional Mode window, select the **Document Type**, **Document Source**, **Auto Exposure Type** (for scanning documents or photos) or **Film Type** (for scanning film or slides), **Image Type**, and **Resolution** settings. For details, see [Scanning in Professional Mode](#).
- 4 Click **Preview** to preview your image(s), then select your scan area. See [Previewing and Adjusting the Scan Area](#) for details.
- 5 Scroll down to the Adjustments area and click the **Color Restoration** check box.

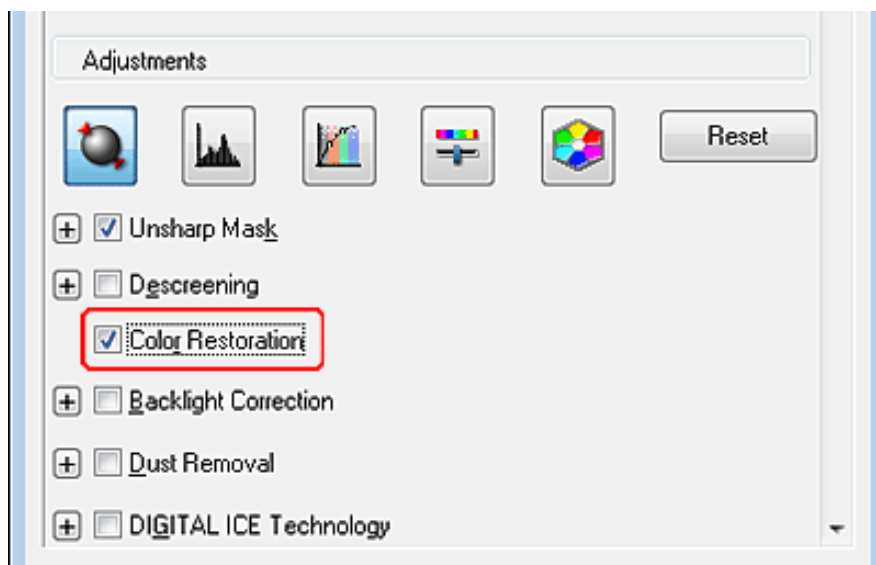

 **Note:**

If you are scanning multiple images at the same time and you want to apply the Color Restoration feature to all of your images or scan areas, click **All** in the Preview window before you click the check box.

- 6 Make any other necessary image adjustments. See [Adjusting the Color and Other Image Settings](#) for details.
- 7 If you want to make more precise color adjustments, click the  Color Palette icon. See [Using the Color Palette Feature \(for Professional Mode Only\)](#) for instructions.
- 8 Size your image(s) as necessary. See [Selecting the Scan Size](#) for details.
- 9 Click **Scan**.

What happens next depends on how you started Epson Scan. See [Finishing the Scan](#) for instructions.

Top 

Using the Color Palette Feature (for Professional Mode Only)

Follow the steps in these sections to fine-tune the colors in your image using the Color Palette feature in Professional Mode.

This feature is available only after previewing your images, so make sure to click **Preview** to activate this feature.

Sampling a Color from an Image

- 1 Click the  Color Palette icon.

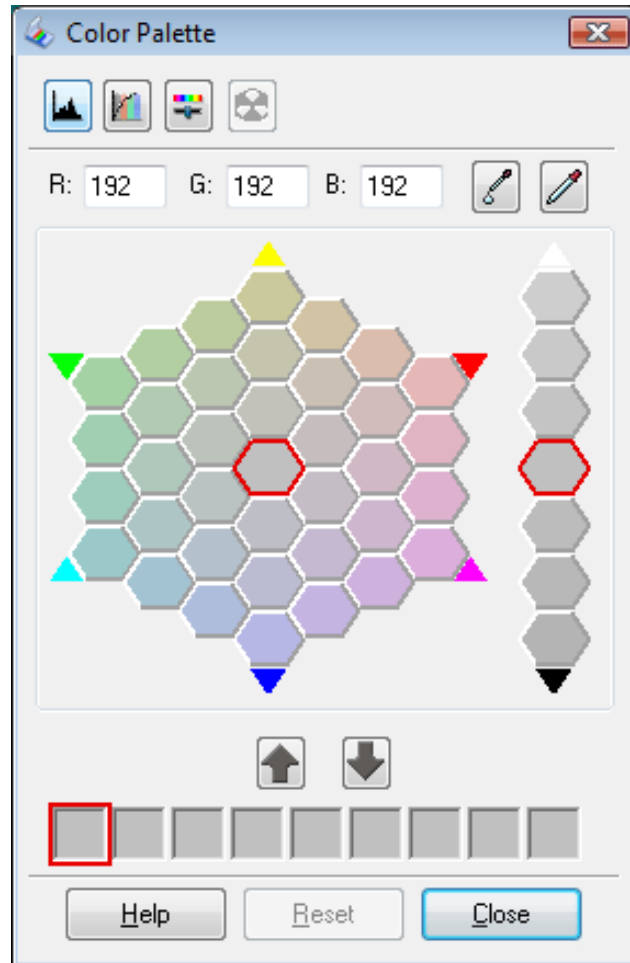

- 2 Click the  color extractor icon. Your cursor changes to an eye dropper.

- 3 In the Preview window, click on the color in your image that needs adjustment.

The color you selected is moved to the center cell in the Color Palette window with variations in hue in the surrounding cells.

- 4 Select the cell that contains the hue you would like to use to adjust the color in your image. This color now becomes the color of the center cell and the color change is reflected in your image.

Note:

You can also use the cells to the right of the adjustment area to change the brightness, if necessary.

- 5 If you want to continue adjusting the color, repeat step 4.

If you want to save the color for future scans, click the  save icon. The color appears in the save area.

 **Note:**

To load a previously saved color, select the color and click the  apply to palette icon.

6 When you are finished adjusting the color, click **Close** to return to the Professional Mode window.

For further details on using the Color Palette feature, see Epson Scan Help.

Applying a Color to an Image

1 Click the  Color Palette icon.

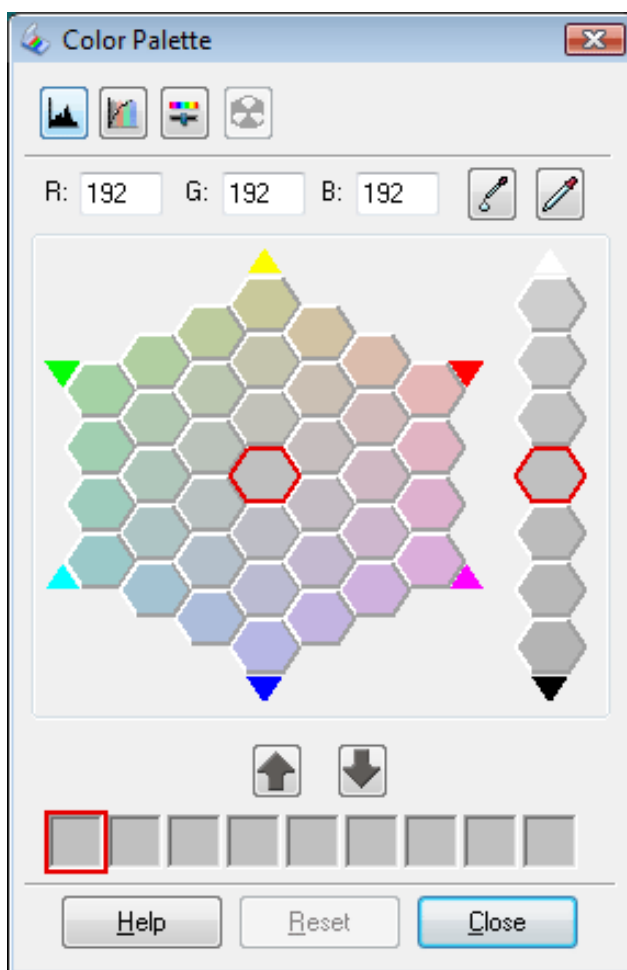

2 Select the cell that contains the hue you would like to use to adjust the color in your image. This color now becomes the color of the center cell.

 **Note:**

You can also use the cells to the right of the adjustment area to change the brightness, if necessary.

3 Click the  color applicator icon. Your cursor changes to a droplet.

4 In the Preview window, click on the color in your image that needs adjustment. The color change is reflected in your image.

5 If you want to continue adjusting the color, repeat steps 2 through 4.

If you want to save the color for future scans, click the  save icon. The color appears in the save area.

 **Note:**

To load a previously saved color, select the color and click the  apply to palette icon.

6 When you are finished adjusting the color, click **Close** to return to the Professional Mode window.

For further details on using the Color Palette feature, see Epson Scan Help.

Home > Scanning Special Projects

Removing Dust Marks with the Dust Removal Feature

 [Dust Removal in Full Auto Mode](#)

 [Dust Removal in Professional Mode](#)

Using the **Dust Removal** feature in Epson Scan, you can virtually “clean” the dust marks from your originals as you scan them.



 **Note:**

- Before scanning your originals, carefully remove any dust that you can see on them.
- Do not use Dust Removal to scan your originals that do not contain dust or scratch marks; otherwise your scanned image may be distorted or blurred.
- The Dust Removal feature is available for Full Auto Mode or Professional Mode only (it is not available for Home Mode). To remove dust marks from color film or slides in Home Mode, use the DIGITAL ICE Technology feature as described in [Removing Dust and Scratch Marks from Originals Using DIGITAL ICE Technology](#).
- If you still have dust marks after using the Dust Removal feature, try scanning it again using DIGITAL ICE Technology as described in [Removing Dust and Scratch Marks from Originals Using DIGITAL ICE Technology](#).
- This feature is not available if **DIGITAL ICE Technology** check box is selected.

See one of these sections for instructions on removing dust marks from your original(s).

Full Auto Mode: [Dust Removal in Full Auto Mode](#)

Office Mode: This feature is not available in Office Mode. Change the scan mode to Full Auto Mode or Professional Mode. See [Changing the Scan Mode](#) for instructions.

Home Mode: This feature is not available in Home Mode. Change the scan mode to Full Auto Mode or Professional Mode. See [Changing the Scan Mode](#) for instructions.

Professional Mode: [Dust Removal in Professional Mode](#)

Dust Removal in Full Auto Mode

- 1 Place your original(s) on the document table. See one of these sections for instructions.

Documents or photos: [Placing Documents or Photos](#)

Film or slides: [Placing Film or Slides](#)

 **Note for film or slides:**

You can only scan 35 mm color film strip or color positive slides in Full Auto Mode. To scan other types of film, use Home Mode or Professional Mode. To change the scan mode, see [Changing the Scan Mode](#).

- 2 Start Epson Scan. See [Starting Epson Scan](#) for instructions.

- 3 In the Full Auto Mode window, click **Customize**. The Customize window appears.

- 4 Click the **Dust Removal** check box.

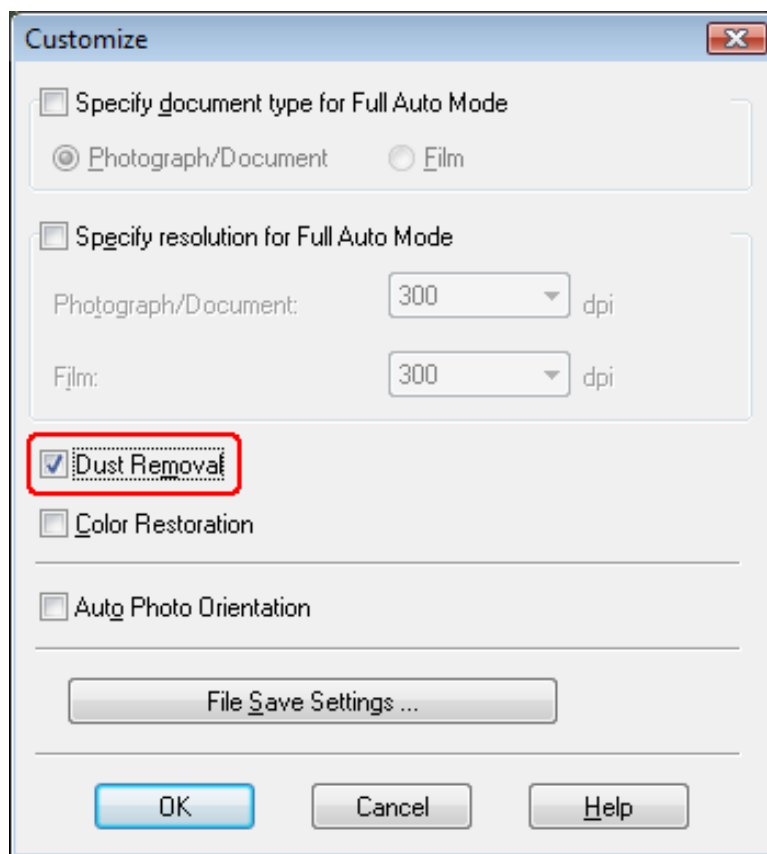

- 5 If you want to select the file save settings, click **File Save Settings**. See [Selecting File Save Settings](#) for instructions.

 **Note:**

If you started Epson Scan from a TWAIN-compliant program like Adobe Photoshop Elements, the File Save Settings button does not appear.

6 When you finish making all the necessary settings, click **OK** to return to the Full Auto Mode window.

7 Click **Scan**.

What happens next depends on how you started Epson Scan. See [Finishing the Scan](#) for instructions.

[Top](#) 

Dust Removal in Professional Mode

1 Place your original(s) on the document table. See one of these sections for instructions.

Documents or photos: [Placing Documents or Photos](#)

Film or slides: [Placing Film or Slides](#)

2 Start Epson Scan. See [Starting Epson Scan](#) for instructions.

3 In the Professional Mode window, select the **Document Type**, **Document Source**, **Auto Exposure Type** (for scanning documents or photos) or **Film Type** (for scanning film or slides), **Image Type**, and **Resolution** settings. For details, see [Scanning in Professional Mode](#).

4 Click **Preview** to preview your image(s), then select your scan area. See [Previewing and Adjusting the Scan Area](#) for details.

5 Scroll down to the Adjustments area and click the **Dust Removal** check box. If you want to increase or decrease the level of the dust removal effect, click the + (Windows) or  (Mac OS X) button next to the option and select a setting in the **Level** list.

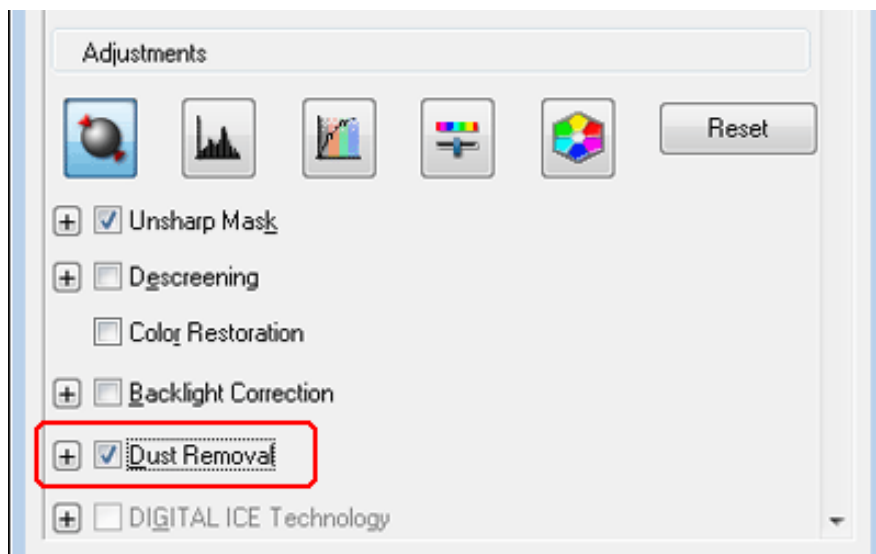

 **Note:**

- The result of the Dust Removal does not appear in the image(s) in the Preview window.
- If you are scanning multiple images at the same time and you want to apply the Dust Removal feature to all of your images or scan areas, click **All** in the Preview window before you click the check box.
- This feature is not available if **DIGITAL ICE Technology** check box is selected.

6 Make any other necessary image adjustments. See [Adjusting the Color and Other Image Settings](#) for instructions.

7 Size your image(s) as necessary. See [Selecting the Scan Size](#) for instructions.

8 Click **Scan**.

What happens next depends on how you started Epson Scan. See [Finishing the Scan](#) for instructions.

[Top](#) 

[Home](#) > [Scanning Special Projects](#)

■ Removing Dust and Scratch Marks from Originals Using DIGITAL ICE Technology

- [DIGITAL ICE Technology Specifications](#)
- [Using DIGITAL ICE Technology in Home Mode](#)
- [Using DIGITAL ICE Technology in Professional Mode](#)

Your scanner and its Epson Scan software are equipped with the **DIGITAL ICE Technology** and **DIGITAL ICE Lite Technology** features that remove stubborn dust or scratch marks from color photos, film, and slides.

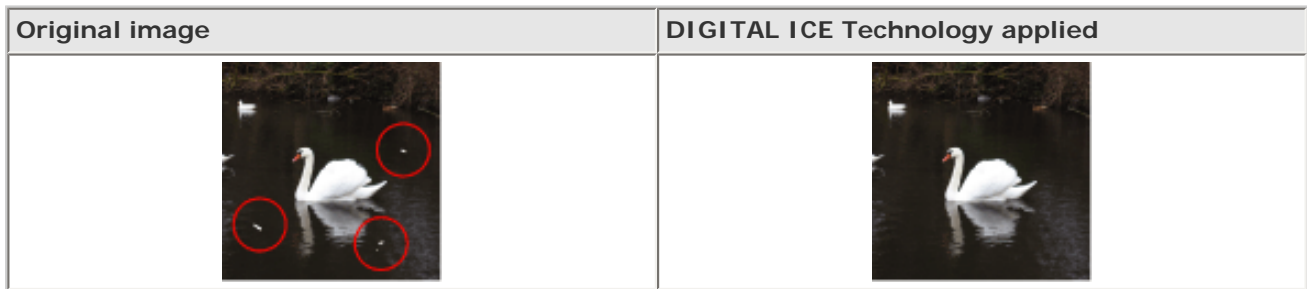

DIGITAL ICE Technology can remove dust marks that the Dust Removal feature cannot. However, it takes longer to scan using DIGITAL ICE Technology and also uses more of your system resources. It is best to try removing dust marks using Dust Removal before using DIGITAL ICE Technology. See [Removing Dust Marks with the Dust Removal Feature](#) for details.

 **Note:**

- You cannot use Dust Removal and DIGITAL ICE Technology at the same time.
- Do not use DIGITAL ICE Technology to scan photos, film, or slides that do not contain dust or scratch marks; otherwise your scanned image(s) may be distorted or blurred.
- You cannot use DIGITAL ICE Technology when scanning film with the film area guide.
- Images scanned with DIGITAL ICE Technology may appear softer than your original images.
- DIGITAL ICE Lite Technology is for scanning film and slides only.

Before using DIGITAL ICE Technology, make sure your system meets the requirements in [DIGITAL ICE Technology Specifications](#).

DIGITAL ICE Technology Specifications

To use DIGITAL ICE Technology, your system memory and hard disk space must meet the requirements in the table below. DIGITAL ICE Technology needs additional resources to process and store your scanned images at the sizes and resolutions specified here.

Original type	Resolution *	Hard disk space	System memory
4 × 6-inch (10.2 × 15.2 cm) photograph	600 dpi	157 MB	185 MB
	4800 dpi	626 MB	370 MB

A4 size photograph	600 dpi	631 MB	255 MB
	4800 dpi	2524 MB	510 MB
35 mm film or slide	150 dpi	1 MB	8 MB
	300 dpi	1 MB	15 MB
	600 dpi	4 MB	30 MB
	1200 dpi	16 MB	59 MB
	2400 dpi	63 MB	117 MB
	3600 dpi	142 MB	175 MB
	12800 dpi	251 MB	233 MB
Medium format film (6 × 20 cm)	150 dpi	4 MB	34 MB
	300 dpi	8 MB	70 MB
	600 dpi	29 MB	139 MB
	1200 dpi	116 MB	277 MB
	2400 dpi	464 MB	553 MB
	3600 dpi	1042 MB	830 MB
	12800 dpi	1853 MB	1106 MB
4 × 5 inch film	150 dpi	4 MB	36 MB
	300 dpi	13 MB	72 MB
	600 dpi	51 MB	144 MB
	1200 dpi	202 MB	287 MB
	2400 dpi	805 MB	573 MB
	3600 dpi	1811 MB	859 MB
	12800 dpi	3219 MB	1145 MB

* This is the actual scan resolution used by DIGITAL ICE Technology, which is higher than the scan resolution you specify in Epson Scan. Make sure your system resources meet these increased requirements.

You can use DIGITAL ICE Technology on the following types of film or slides.

Original	DIGITAL ICE Technology	DIGITAL ICE Lite Technology
Photograph (reflective)	Yes	No
Color negative film	Yes	Yes
Color positive film or slides	Yes *	Yes
Monochrome negative film	No **	No
Monochrome positive film or slides	No	No

* Kodachrome film is not supported.

** Only chromogenic monochrome negative film is supported.

 **Note:**

- It may take much longer to scan and for your software to respond to clicking **Cancel** if you have insufficient system resources.
- If you place your original on the document table at an angle, DIGITAL ICE Technology may require even more system memory to process your images. Be sure to place your original straight on the document table.

See one of these sections for instructions on using DIGITAL ICE Technology.

Full Auto Mode: This feature is not available in Full Auto Mode. Change the scan mode to Home Mode or Professional Mode. See [Changing the Scan Mode](#) for instructions.

Office Mode: This feature is not available in Office Mode. Change the scan mode to Home Mode or Professional Mode. See [Changing the Scan Mode](#) for instructions.

Home Mode: [Using DIGITAL ICE Technology in Home Mode](#)

Professional Mode: [Using DIGITAL ICE Technology in Professional Mode](#)

[Top](#) 

Using DIGITAL ICE Technology in Home Mode

- 1 Place your original photo, film, or slide on the document table. See one of these sections for instructions.
Photos: [Placing Documents or Photos](#)
Film or slides: [Placing Film or Slides](#)
- 2 Start Epson Scan. See [Starting Epson Scan](#) for instructions.
- 3 In the Home Mode window, select the **Document Type**, **Image Type**, and **Destination** settings. For details, see [Scanning in Home Mode](#).
- 4 Click **Preview** to preview your image(s), then select your scan area. See [Previewing and Adjusting the Scan Area](#) for details.
- 5 Click the **DIGITAL ICE Technology** check box.

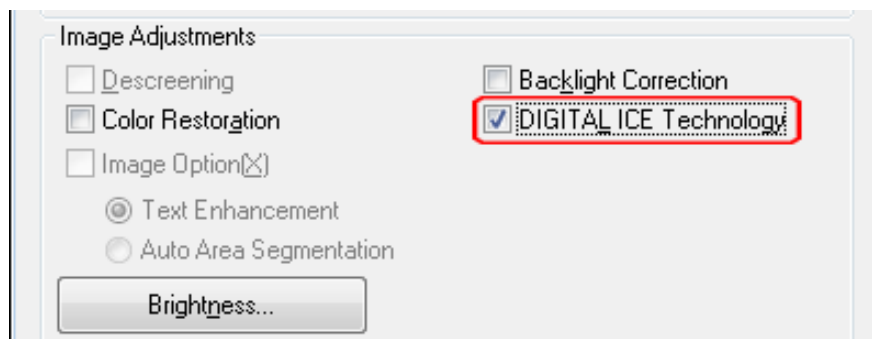

 **Note:**

The results of DIGITAL ICE Technology do not appear in the images in the Preview window, but apply to all of them. You must scan the images to see the effects.

- 6 Make any other necessary image adjustments. See [Adjusting the Color and Other Image Settings](#) for instructions.
- 7 Size your image(s) as necessary. See [Selecting the Scan Size](#) for instructions.

- 8 Click **Scan** to scan and remove dust and scratch marks in your image(s).

What happens next depends on how you started Epson Scan. See [Finishing the Scan](#) for details.

[Top](#) 

Using DIGITAL ICE Technology in Professional Mode

- 1 Place your original photo, film, or slide on the document table. See one of these sections for instructions.
Photos: [Placing Documents or Photos](#)
Film or slides: [Placing Film or Slides](#)
- 2 Start Epson Scan. See [Starting Epson Scan](#) for instructions.
- 3 In the Professional Mode window, select the **Document Type**, **Auto Exposure Type** (for scanning documents or photos), **Film Type** (for scanning film or slides), **Image Type**, **Resolution**, and **Document Size** settings. For details, see [Scanning in Professional Mode](#).
- 4 Click **Preview** to preview your image(s), then select your scan area. See [Previewing and Adjusting the Scan Area](#) for details.
- 5 Scroll down to the Adjustments area and click the **DIGITAL ICE Technology** check box.

If you want to decrease the level of the **DIGITAL ICE Technology** correction effect when scanning film or slides, click the + (Windows) or ▼ (Mac OS X) button next to the option and select the **DIGITAL ICE Lite Technology - Speed** setting in the **Mode** list.

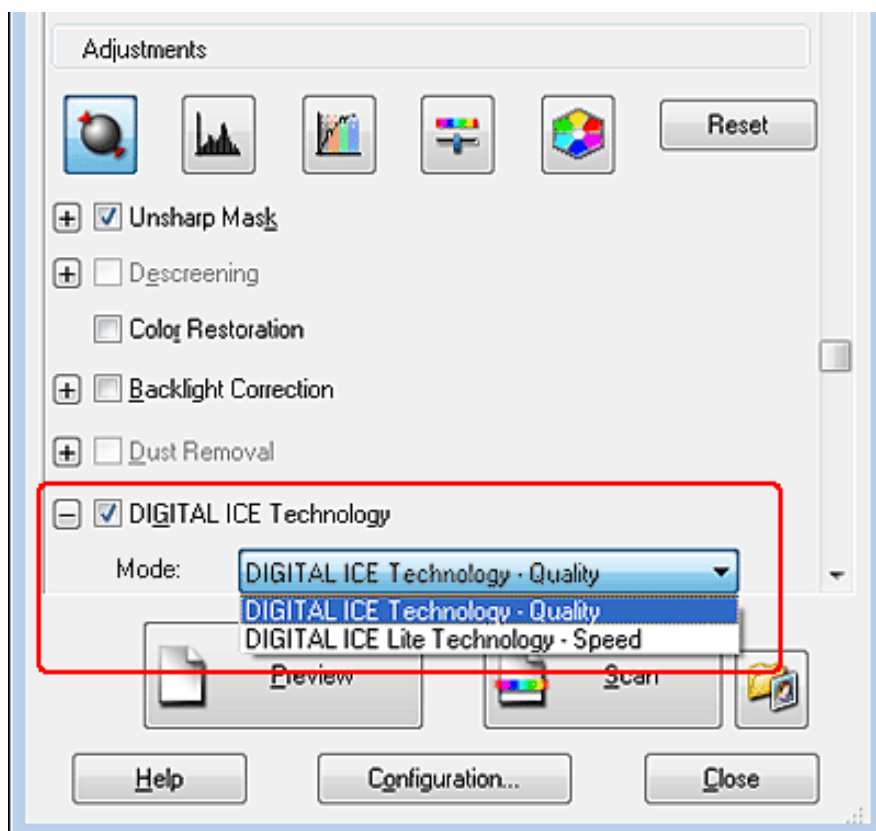

If you want to increase the level of the **DIGITAL ICE Technology** correction effect when scanning photos, click the + (Windows) or ▼ (Mac OS X) button next to the option and select the **High** setting in the **Mode** list.

 **Note:**

The results of DIGITAL ICE Technology do not appear in the images in the Preview window, but apply to all of them. You must scan the images to see the effects.

- 6** Make any other necessary image adjustments. See [Adjusting the Color and Other Image Settings](#) for instructions.
- 7** Size your image(s) as necessary. See [Selecting the Scan Size](#) for instructions.
- 8** Click **Scan** to scan and remove dust and scratch marks in your image(s).

What happens next depends on how you started Epson Scan. See [Finishing the Scan](#) for details.

Top 

Home > Scanning Special Projects

■ Fixing Backlit Photos

☑ [Backlight Correction in Home Mode](#)

☑ [Backlight Correction in Professional Mode](#)

Using the **Backlight Correction** feature in Epson Scan, you can remove shadows from photos that have too much background light. You can fix printed photos, film, or slides automatically as you scan them.

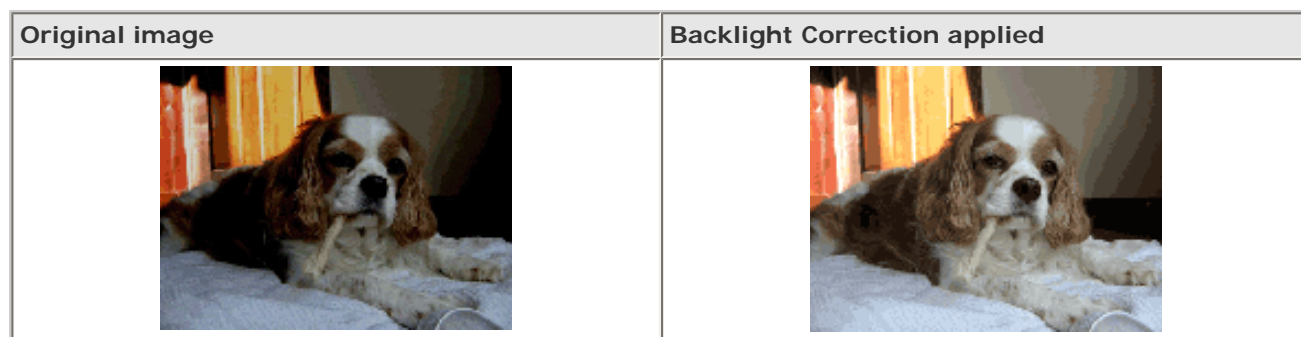

See one of these sections for instructions on fixing backlit photos.

Full Auto Mode: This feature is not available in Full Auto Mode. Change the scan mode to Home Mode or Professional Mode. See [Changing the Scan Mode](#) for instructions.

Office Mode: This feature is not available in Office Mode. Change the scan mode to Home Mode or Professional Mode. See [Changing the Scan Mode](#) for instructions.

Home Mode: [Backlight Correction in Home Mode](#)

Professional Mode: [Backlight Correction in Professional Mode](#)

Backlight Correction in Home Mode

- 1 Place your original(s) on the document table. See one of these sections for instructions.
Documents or photos: [Placing Documents or Photos](#)
Film or slides: [Placing Film or Slides](#)
- 2 Start Epson Scan. See [Starting Epson Scan](#) for instructions.
- 3 In the Home Mode window, select the **Document Type**, **Image Type**, and **Destination** settings. For details, see [Scanning in Home Mode](#).
- 4 Click **Preview** to preview your image(s), then select your scan area. See [Previewing and Adjusting the Scan Area](#) for details.
- 5 Click the **Backlight Correction** check box.

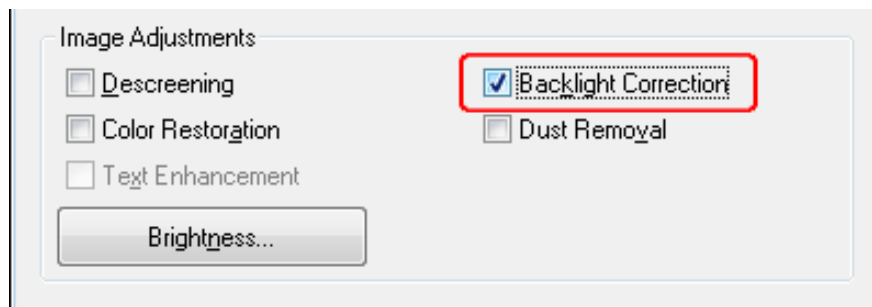

 **Note:**

If you are scanning multiple images at the same time and you want to apply the Backlight Correction feature to all of your images or scan areas, click **All** in the Preview window before you click the check box.

- 6 Make any other necessary image adjustments. See [Adjusting the Color and Other Image Settings](#) for details.
- 7 Size your image(s) as necessary. See [Selecting the Scan Size](#) for details.
- 8 Click **Scan**.

What happens next depends on how you started Epson Scan. See [Finishing the Scan](#) for instructions.

Top 

Backlight Correction in Professional Mode

- 1 Place your original(s) on the document table. See one of these sections for instructions.
Documents or photos: [Placing Documents or Photos](#)
Film or slides: [Placing Film or Slides](#)
- 2 Start Epson Scan. See [Starting Epson Scan](#) for instructions.
- 3 In the Professional Mode window, select the **Document Type**, **Document Source**, **Auto Exposure Type** (for scanning documents or photos) or **Film Type** (for scanning film or slides), **Image Type**, and **Resolution** settings. For details, see [Scanning in Professional Mode](#).
- 4 Click **Preview** to preview your image(s), then select your scan area. See [Previewing and Adjusting the Scan Area](#) for details.
- 5 Scroll down to the Adjustments area and click the **Backlight Correction** check box. If you want to increase or decrease the level of the backlight correction effect, click the + (Windows) or  (Mac OS X) button next to the option and select a setting in the **Level** list.

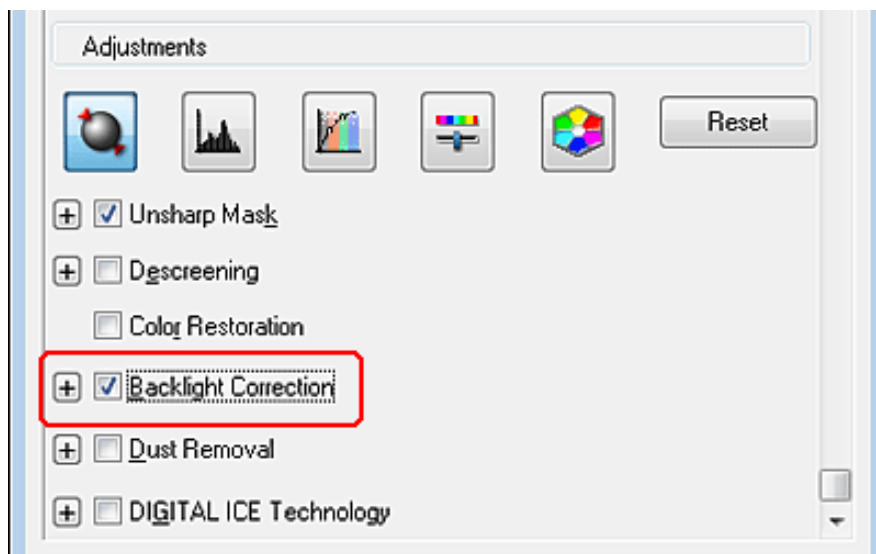

 **Note:**

If you are scanning multiple images at the same time and you want to apply the Backlight Correction feature to all of your images or scan areas, click **All** in the Preview window before you click the check box.

- 6** Make any other necessary image adjustments. See [Adjusting the Color and Other Image Settings](#) for details.
- 7** Size your image(s) as necessary. See [Selecting the Scan Size](#) for details.
- 8** Click **Scan**.

What happens next depends on how you started Epson Scan. See [Finishing the Scan](#) for instructions.

Home > Scanning Special Projects

■ Text Enhancement

⌵ [Text Enhancement in Office Mode](#)

⌵ [Text Enhancement in Home Mode](#)

When you scan documents, you can sharpen the text and increase accuracy by using the **Text Enhancement** feature in Epson Scan.

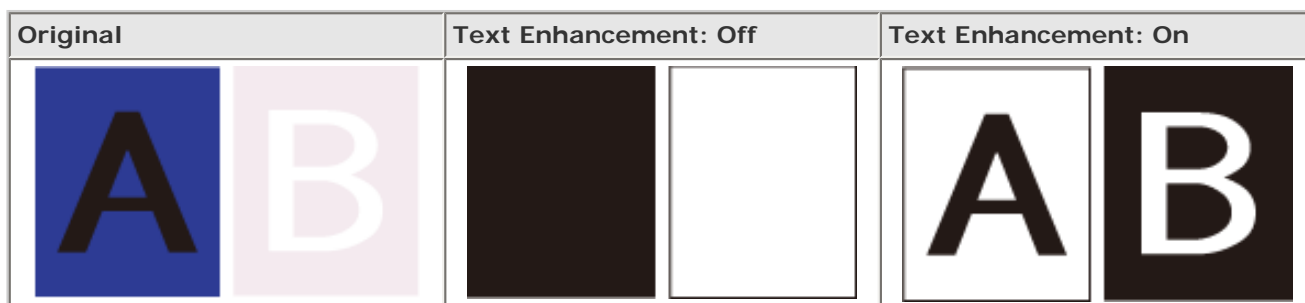

Note:

You can enhance text only when you scan using a resolution of 600 dpi or less.

See one of these sections for instructions on text enhancement.

Full Auto Mode: This feature is not available in Full Auto Mode. Change the scan mode to Home Mode or Office Mode. See [Changing the Scan Mode](#) for instructions.

Office Mode: [Text Enhancement in Office Mode](#)

Home Mode: [Text Enhancement in Home Mode](#)

Professional Mode: This feature is not available in Professional Mode. Change the scan mode to Home Mode or Office Mode. See [Changing the Scan Mode](#) for instructions.

Note:

The instructions in these sections are for scanning to a PDF file, but text enhancement is also effective when you convert scanned documents into editable text. See [Converting Scanned Documents Into Editable Text](#) for details.

Text Enhancement in Office Mode

1 Place your document on the document table. See [Placing Documents or Photos](#) for instructions.

2 Start Epson Scan. See [Starting Epson Scan](#) for instructions.

- 3 In the Office Mode window, select the **Image Type**, and Destination settings. For details, [Scanning in Office Mode](#).
- 4 Click the **Image Option** check box, and then select **Text Enhancement**.

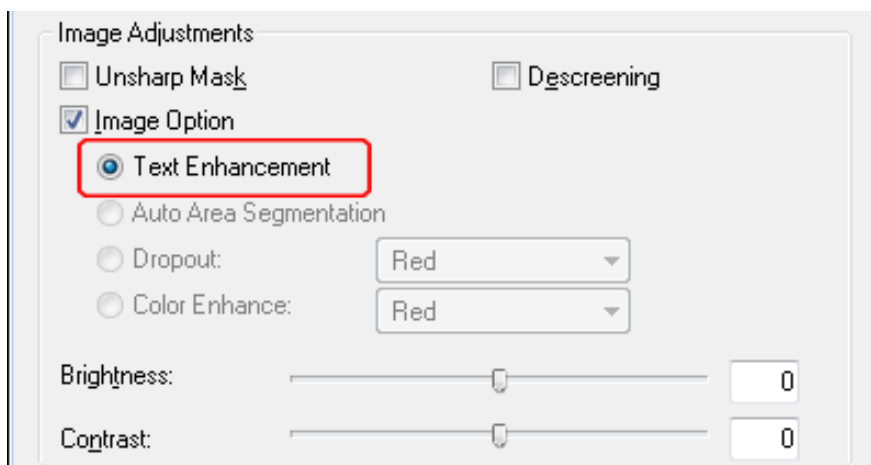

- 5 Click **Preview** to preview your document, then select your scan area. For details, see [Previewing and Adjusting the Scan Area](#).
- 6 Make any other necessary image adjustments. See [Adjusting the Color and Other Image Settings](#) for details.
- 7 Click **Scan**. The File Save Settings window appears.
- 8 Select File Save and PDF settings as necessary. See [Scanning to a PDF File in Office Mode](#) for details.
- 9 Click **OK**.

Top 

Text Enhancement in Home Mode

- 1 Place your document on the document table. See [Placing Documents or Photos](#) for instructions.
- 2 Start Epson Scan. See [Starting Epson Scan](#) for instructions.
- 3 In the Home Mode window, select the **Document Type**, **Image Type**, and **Destination** settings. For details, see [Scanning in Home Mode](#).
- 4 Click the **Image Option** check box, and then select **Text Enhancement**.

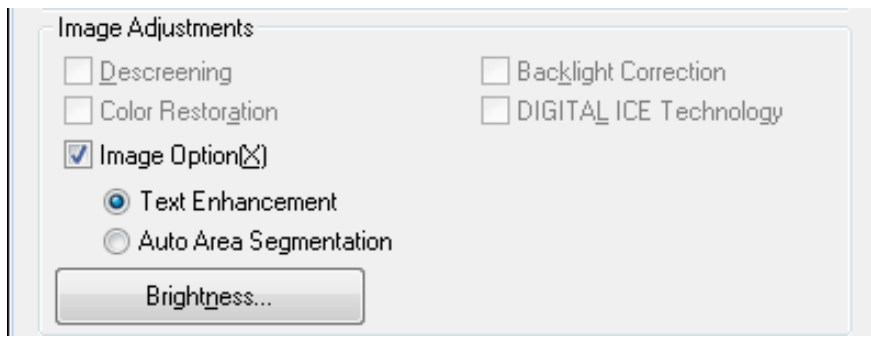

- 5 Click **Preview** to preview your document, then select your scan area. For details, see [Previewing and Adjusting the Scan Area](#).
- 6 Make any other necessary image adjustments. See [Adjusting the Color and Other Image Settings](#) for details.
- 7 Size your image(s) as necessary. See [Selecting the Scan Size](#) for details.
- 8 Click **Scan**. The File Save Settings window appears.
- 9 Select File Save and PDF settings as necessary. See [Scanning to a PDF File in Home Mode](#) for details.
- 10 Click **OK**.

Home > Scanning Special Projects

Using the Scanner as a Copier

You can use your scanner along with a printer connected to your computer just like you would use a copy machine. You can even enlarge and reduce, restore faded colors, remove dust, enhance text, and adjust image brightness and contrast as you copy.

- 1 Place your original(s) on the document table. See one of these sections for instructions.

Documents or photos: [Placing Documents or Photos](#)

Film or slides: [Placing Film or Slides](#)

- 2 Start the Copy Utility.

■ **Windows 8:**

Navigate to the **Start** screen and select **Copy Utility**.

■ **Windows (other versions):**

Select  or **Start > Programs** or **All Programs > Epson Software > Copy Utility**.

■ **Mac OS X:**

Select **Applications > Epson Software > Copy Utility**, and double-click the **Copy Utility** icon.

You see the Copy Utility window.

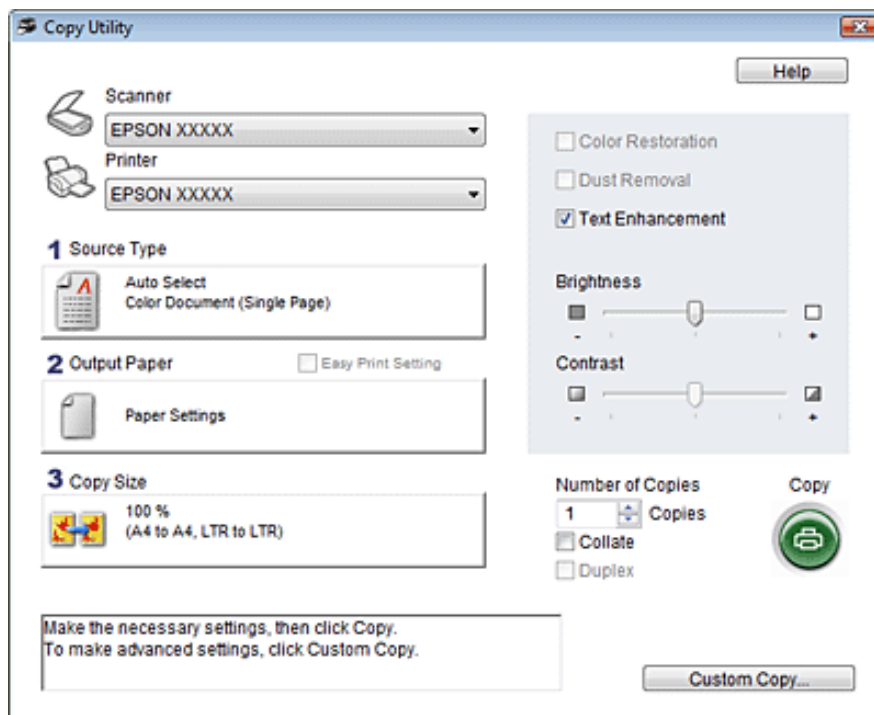

- 3 Select your scanner from the **Scanner** list at the top of the window.

- 4 Select your printer from the **Printer** list.

- 5 Click the **Source Type** box, select the type of original(s) you are copying, and click **OK**. See the table below for guidance.

Source Type setting	Type of document
Color Document (Single Page)	One-page color documents containing text or text and graphics, such as a flyer.
Black & White Document (Single Page)	One-page black and white documents containing text or text and graphics, such as a letter.
Color Document (Multiple Pages)	Multiple page color documents containing text or text and graphics, such as a brochure.
Black & White Document (Multiple Pages)	Multiple page black and white documents containing text or text and graphics, such as a manual.
Photo	Color or black-and-white photographs.
Negative Film	Color negative film strips.
Positive Film	Color positive slides or positive film strips.

- 6 Click the **Output Paper** box, select the type and size of paper you loaded in your printer, and click **OK**.

 **Note:**

If you are printing on certain Epson printers, you see the printer settings window. See your printer documentation for instructions on selecting settings.

- 7 If you want to enlarge or reduce your image(s) as you copy it, click the **Copy Size** box, select the enlargement/reduction, and click **OK**.

 **Note:**

If you are printing on an Epson printer that supports borderless printing, you can select options for **Margins** (borders) or **No Margins** (borderless).

- 8 If you are copying a faded photo and want to restore the colors, click the **Color Restoration** check box. It is available only when the Source Type is **Photo**, **Negative Film**, or **Positive Film**.
- 9 If you need to remove dust marks as you copy, click the **Dust Removal** check box. It is available only when the Source Type is **Negative Film** or **Positive Film**.
- 10 If you are copying a color or black-and-white document, you can improve the definition of text and line art by leaving the **Text Enhancement** check box checked. It is available only when the Source Type is **Color Document (Single Page)**, **Black & White Document (Single Page)**, **Color Document (Multiple Pages)**, or **Black & White Document (Multiple Pages)**.
- 11 If you need to adjust the lightness or darkness of your original(s) or adjust the contrast between them as you copy, click the slider beneath the **Brightness** and/or **Contrast** settings. Contrast is only adjustable when the Source Type is **Photo**, **Negative Film**, or **Positive Film**.
- 12 Click the arrow in the **Number of Copies** box to select the number of copies you want, if necessary.

13 When you are ready to scan and print, click **Copy**.



Note:

If you want to preview your scan before printing it or select additional copy settings, click **Custom Copy** at the bottom of the window. Click **Help** in the Copy Utility for instructions on using the Custom Copy features.

[Home](#) > [Scanning Special Projects](#)

■ Scanning to a PDF File

-  [Scanning to a PDF File in Office Mode](#)
-  [Scanning to a PDF File in Home Mode](#)
-  [Scanning to a PDF File in Professional Mode](#)

Using Epson Scan, you can create a PDF file with the following features.

Scanning multiple document pages into a single PDF file: You can scan multiple document pages and save them in a single PDF file.

Creating a searchable PDF file: You can create a PDF file with search functionality, so that you can look for words in the file. (This feature may not be available in some countries.)

Specifying the number of pages in a single PDF file: You can specify the maximum number of pages that can be included in one PDF file. For example, if you are scanning a 20-page document, and specify the page number to be included in one PDF as 4, 5 PDF files are automatically created.

Note:

You need ABBYY FineReader (included with your scanner) to use some of these features. If you have installed your scanning software as described in the *Start Here* sheet, it has already been installed. (ABBYY FineReader may not be available in some countries.)

See one of these sections to start scanning to a PDF file.

Full Auto Mode: Select **PDF** as the Image Type setting in the File Save Settings window. See [Scanning in Full Auto Mode](#) for instructions. If you want to scan multiple document pages into one PDF file, change the scan mode to Office Mode, Home Mode or Professional Mode. See [Changing the Scan Mode](#) for instructions.

Office Mode: [Scanning to a PDF File in Office Mode](#)

Home Mode: [Scanning to a PDF File in Home Mode](#)

Professional Mode: [Scanning to a PDF File in Professional Mode](#)

Scanning to a PDF File in Office Mode

- 1** Place your document on the document table. See [Placing Documents or Photos](#) for instructions.
- 2** Start Epson Scan. See [Starting Epson Scan](#) for instructions.
- 3** In the Office Mode window, select the **Image Type**, **Document Source**, **Size**, and **Resolution** settings. For details, [Scanning in Office Mode](#).
- 4** Click **Preview** to preview your image(s), then select your scan area. For details, see [Previewing and Adjusting the Scan Area](#).

- 5 Make any other necessary image adjustments. See [Adjusting the Color and Other Image Settings](#) for details.
- 6 Click **Scan**. The File Save Settings window appears.
- 7 Select **PDF** as the Type setting. The current Paper Size, Orientation, Margin, and other settings are displayed below it.

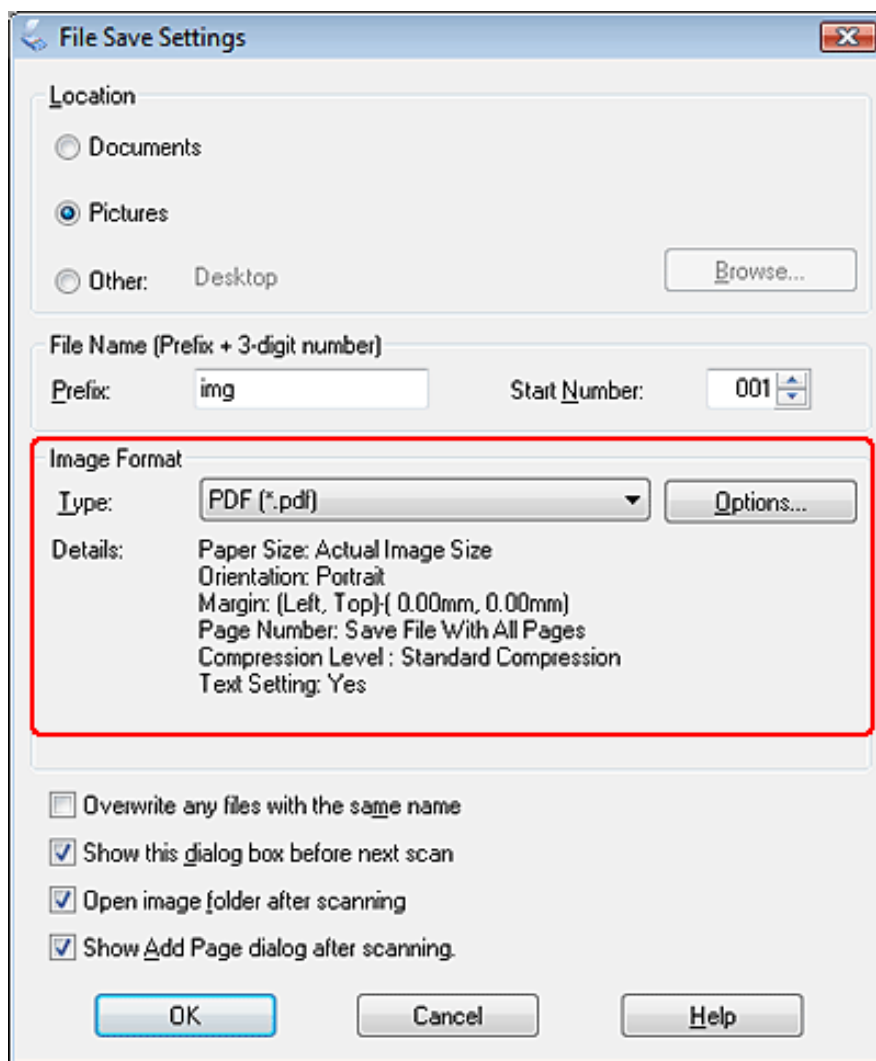

- 8 Click **Options**. You see the EPSON PDF Plug-in Settings window.

To create a searchable PDF file, click the **Text** tab, select the **Create searchable PDF** check box, then select your language from the **Text Language** list.

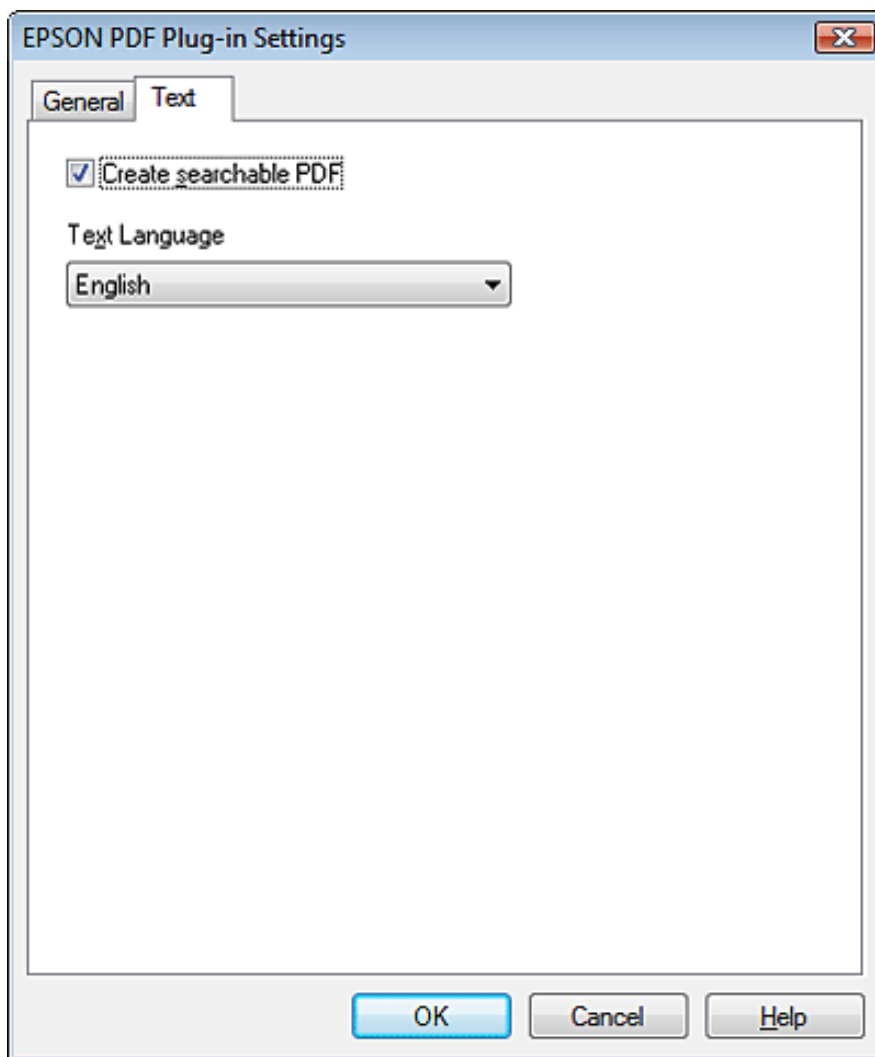

 **Note:**

The Text tab is available only when ABBYY FineReader is installed. If ABBYY FineReader is not available in your country, you will not see the Text tab.

To specify the maximum number of pages that can be included in one PDF file, click the **General** tab and adjust the **Select number to make file** setting.

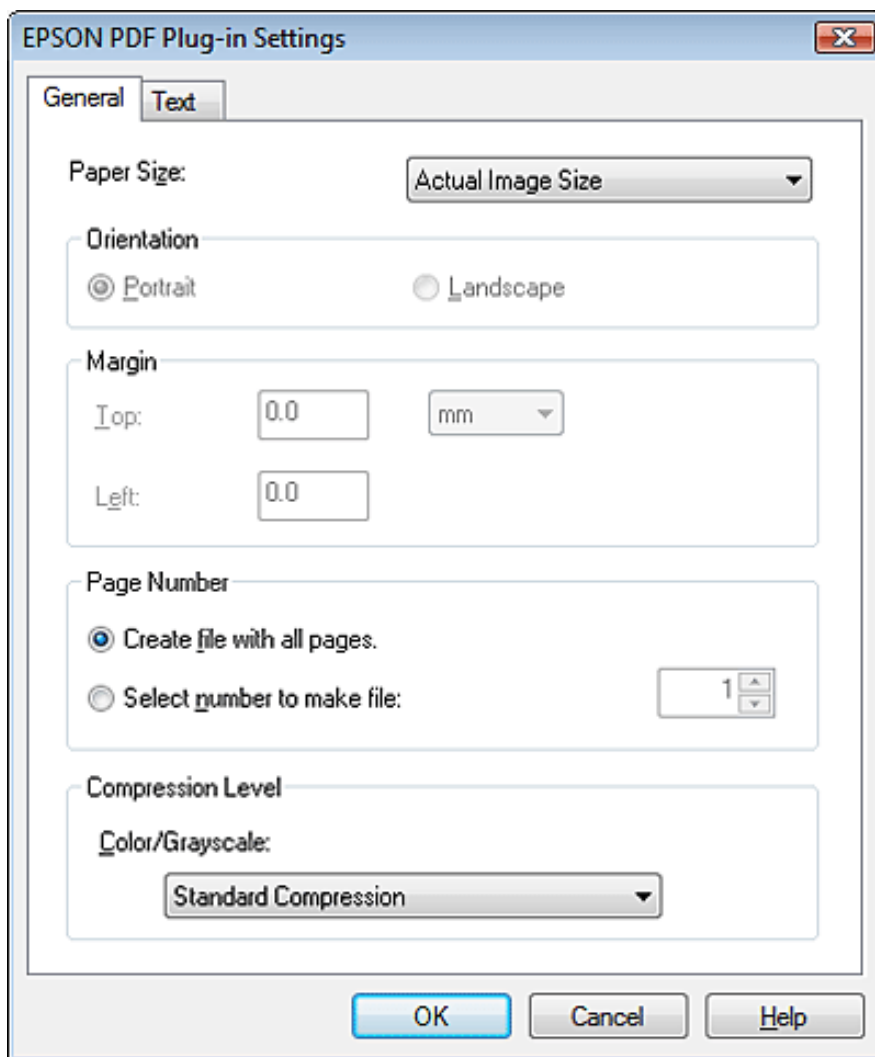

For other settings in the EPSON PDF Plug-in Settings window, see Epson Scan Help for details.

- 9 Select the settings that match your document and click **OK**. You return to the File Save Settings window.
- 10 Make any other file save settings, and click **OK**. Epson Scan scans your document and displays the window below.

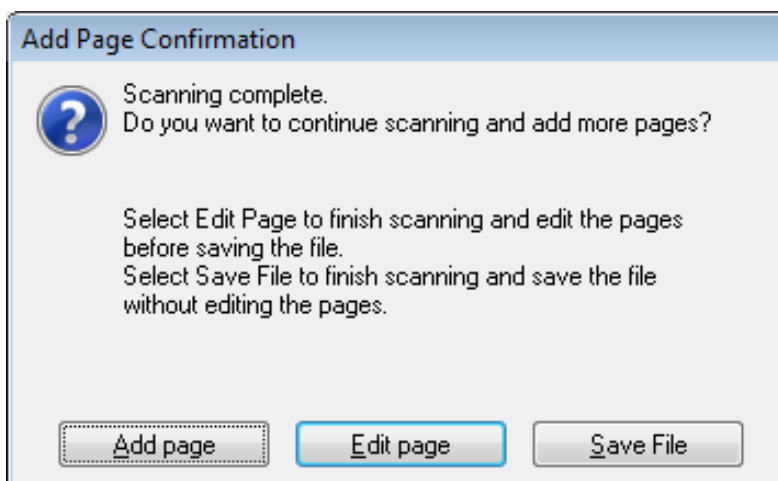

 **Note:**

If you deselect the **Show Add Page dialog after scanning** check box in the File Save Settings window, this window does not appear and Epson Scan automatically saves your document.

11 Select one of the following options.



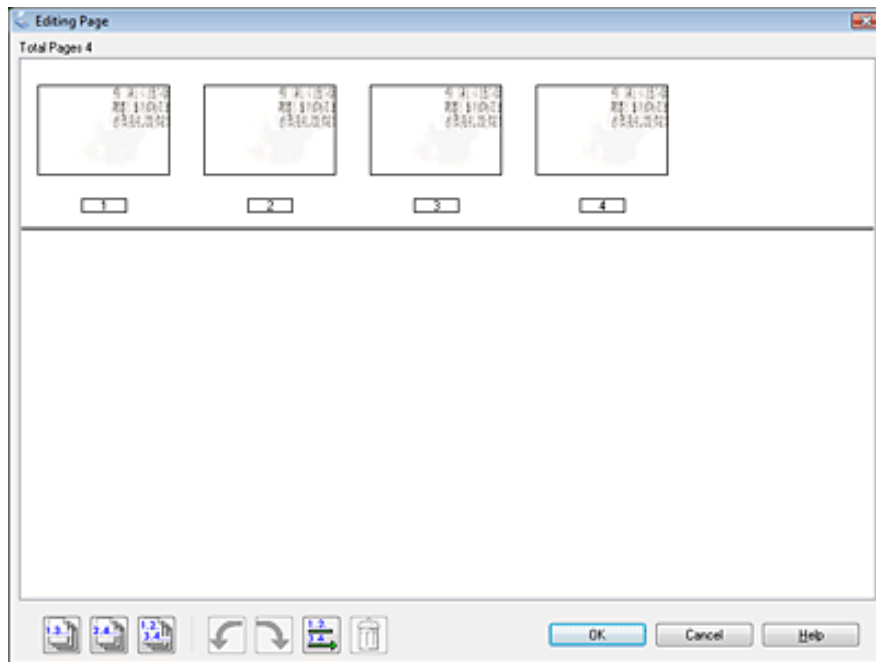

- **Add page:** Click this button to scan the next page of your document. Replace the first page on the document table with the next page, and click **Scan**. Repeat this step for each page in your document. When you are finished, click **Edit page** and go to step 12.
- **Edit page:** Click this button if you have scanned all the necessary pages so you can edit the scanned pages before saving them in one PDF file. Then go to step 12.
- **Save File:** Click this button when you are ready to finish scanning and save the scanned pages into one PDF without editing them. Then go to step 14.



12 You see the Editing Page window displaying thumbnail images of each scanned page.



Use the tools below the Editing Page window to select, rotate, reorder, and delete pages.

If you want to include all the document pages in your PDF files as they currently look, go to step 13.

If you want to rotate pages, click the pages, or use the  odd pages,  even pages, or  all pages icon to select the pages, then click the  left or  right rotate icon to rotate them.

If you want to delete pages, click the pages, or use the  odd pages, or  even pages icon to select the pages, then click the  delete icon to delete them.

 **Note:**

The  delete icon is not available when all pages are selected.

For further details on the tools in the Editing Page window, see Epson Scan Help.

13 When you have finished editing your pages, click **OK**. The pages are saved in one PDF file in Pictures, My Pictures, or the location you selected in the File Save Settings window, and you return to the Office Mode window.

14 Click **Close** to exit Epson Scan.

Top 

Scanning to a PDF File in Home Mode

1 Place your document on the document table. See one of these sections for instructions.

Documents or photos: [Placing Documents or Photos](#)

Film or slides: [Placing Film or Slides](#)

2 Start Epson Scan. See [Starting Epson Scan](#) for instructions.

3 In the Home Mode window, select the **Document Type**, **Image Type**, and **Destination** settings. For details, see [Scanning in Home Mode](#).

4 Click **Preview** to preview your image(s), then select your scan area. For details, see [Previewing and Adjusting the Scan Area](#).

5 Make any other necessary image adjustments. See [Adjusting the Color and Other Image Settings](#) for details.

6 Size your image as necessary. See [Selecting the Scan Size](#) for details.

7 Click **Scan**. The File Save Settings window appears.

8 Select **PDF** as the Type setting. The current Paper Size, Orientation, Margin, and other settings are displayed below it.

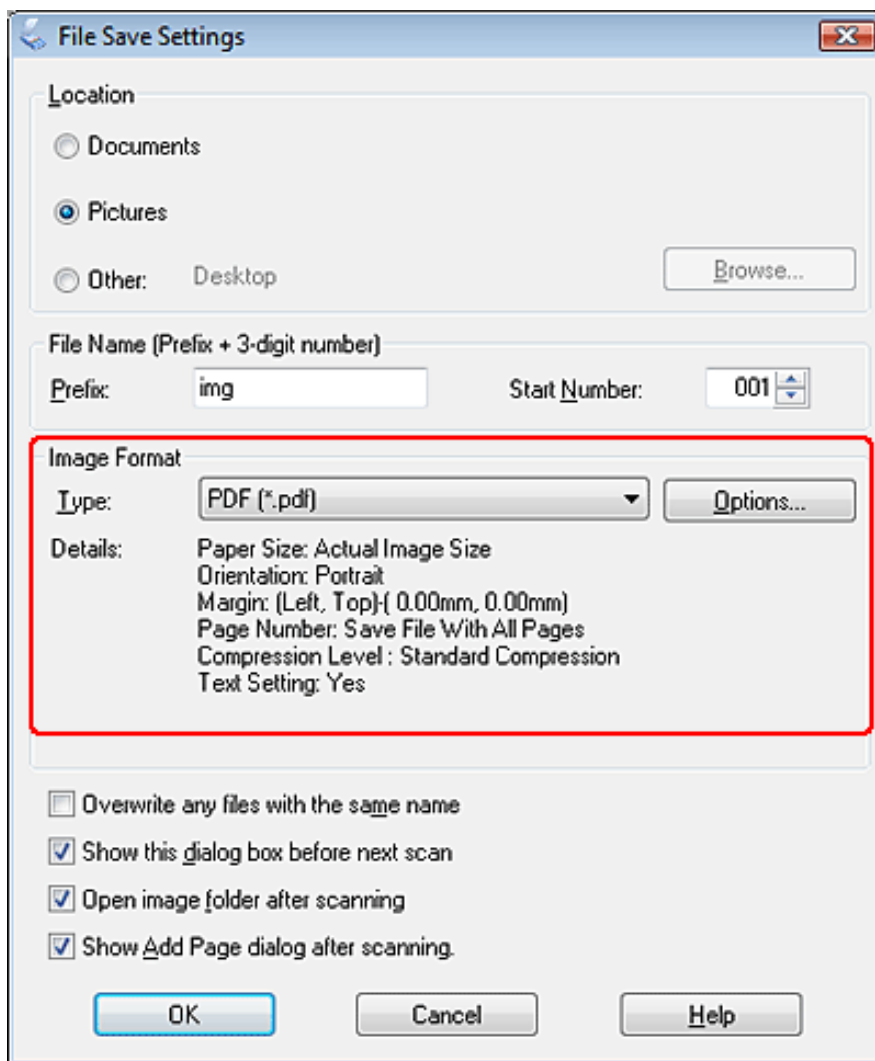

9 Click **Options**. You see the EPSON PDF Plug-in Settings window.

To create a searchable PDF file, click the **Text** tab, select the **Create searchable PDF** check box, then select your language from the **Text Language** list.

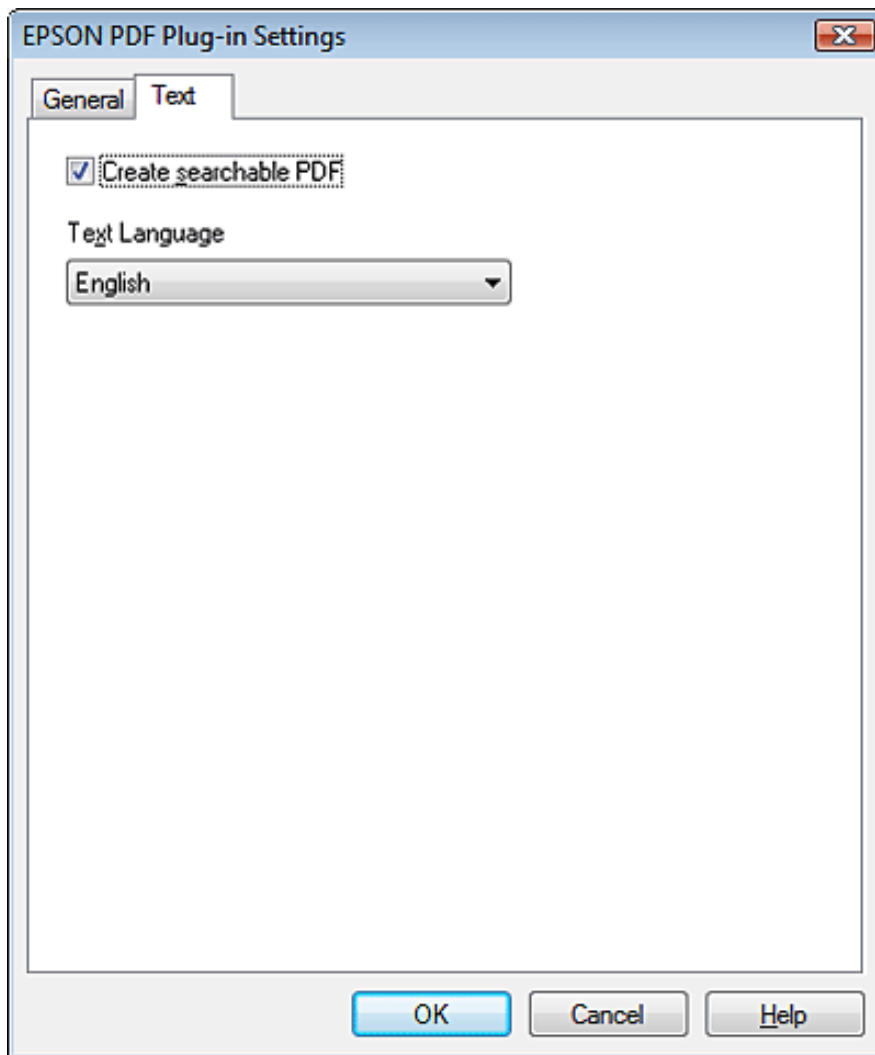

 **Note:**

The Text tab is available only when ABBYY FineReader is installed. If ABBYY FineReader is not available in your country, you will not see the Text tab.

To specify the maximum number of pages that can be included in one PDF file, click the **General** tab and adjust the **Select number to make file** setting.

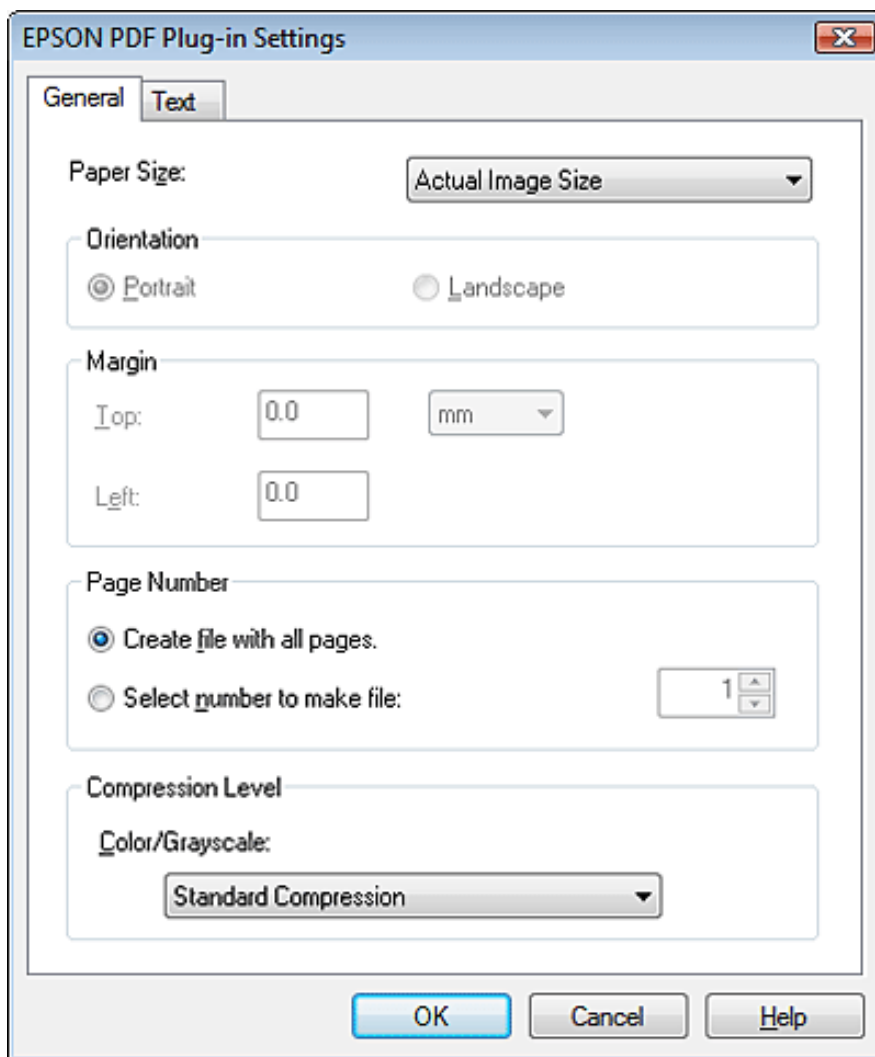

For other settings in the EPSON PDF Plug-in Settings window, see Epson Scan Help for details.

- 10 Select the settings that match your document and click **OK**. You return to the File Save Settings window.
- 11 Make any other file save settings, and click **OK**. Epson Scan scans your document and displays the window below.

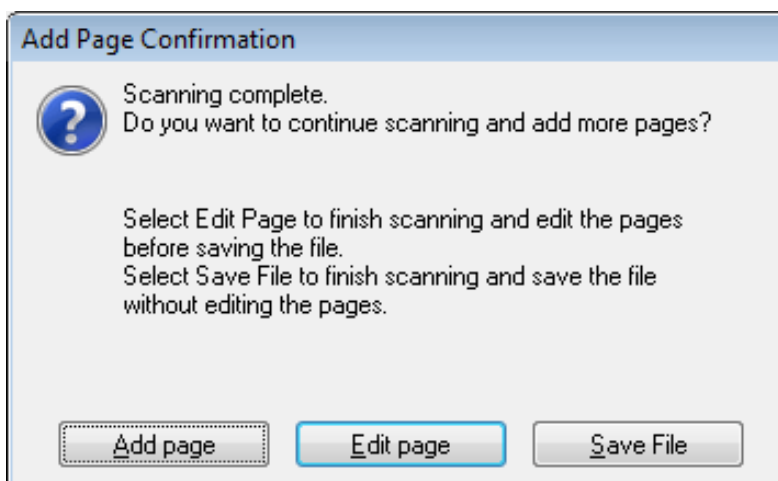

 **Note:**

If you deselect the **Show Add Page dialog after scanning** check box in the File Save Settings window, this window does not appear and Epson Scan automatically saves your document.

12 Select one of the following options.



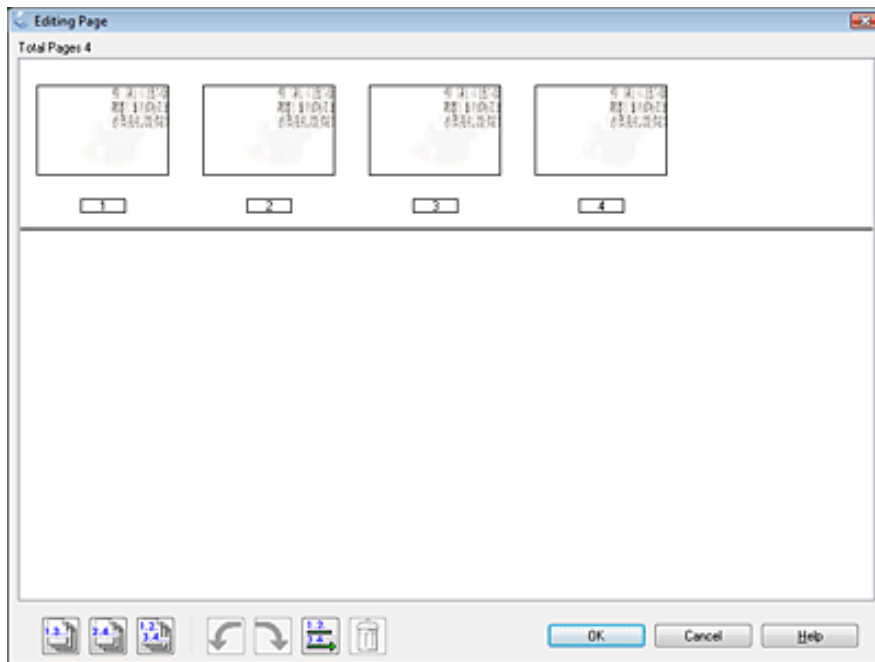

- **Add page:** Click this button to scan the next page of your document. Replace the first page on the document table with the next page, and click **Scan**. Repeat this step for each page in your document. When you are finished, click **Edit page** and go to step 13.
- **Edit page:** Click this button if you have scanned all the necessary pages so you can edit the scanned pages before saving them in one PDF file. Then go to step 13.
- **Save File:** Click this button when you are ready to finish scanning and save the scanned pages into one PDF without editing them. Then go to step 15.



13 You see the Editing Page window displaying thumbnail images of each scanned page.



Use the tools below the Editing Page window to select, rotate, reorder, and delete pages.

If you want to include all the document pages in your PDF files as they currently look, go to step 14.

If you want to rotate pages, click the pages, or use the  odd pages,  even pages, or  all pages icon to select the pages, then click the  left or  right rotate icon to rotate them.

If you want to delete pages, click the pages, or use the  odd pages or  even pages icon to select the pages, then click the  delete icon to delete them.

 **Note:**

The  delete icon is not available when all pages are selected.

For further details on the tools in the Editing Page window, see Epson Scan Help.

14 When you have finished editing your pages, click **OK**. The pages are saved in one PDF file in Pictures, My Pictures, or the location you selected in the File Save Settings window, and you return to the Home Mode window.

15 Click **Close** to exit Epson Scan.

Top 

Scanning to a PDF File in Professional Mode

1 Place your document on the document table. See one of these sections for instructions.

Documents or photos: [Placing Documents or Photos](#)

Film or slides: [Placing Film or Slides](#)

2 Start Epson Scan. See [Starting Epson Scan](#) for instructions.

3 In the Professional Mode window, select the **Document Type**, **Document Source**, **Auto Exposure Type**, **Image Type**, and **Resolution** settings. For details, see [Scanning in Professional Mode](#).

4 Click **Preview** to preview your image(s), then select your scan area. For details, see [Previewing and Adjusting the Scan Area](#).

5 Make any other necessary image adjustments. See [Adjusting the Color and Other Image Settings](#) for details.

6 Size your image as necessary. See [Selecting the Scan Size](#) for details.

7 Click **Scan**. The File Save Settings window appears.

8 Select **PDF** as the Type setting. The current Paper Size, Orientation, Margin, and other settings are displayed below it.

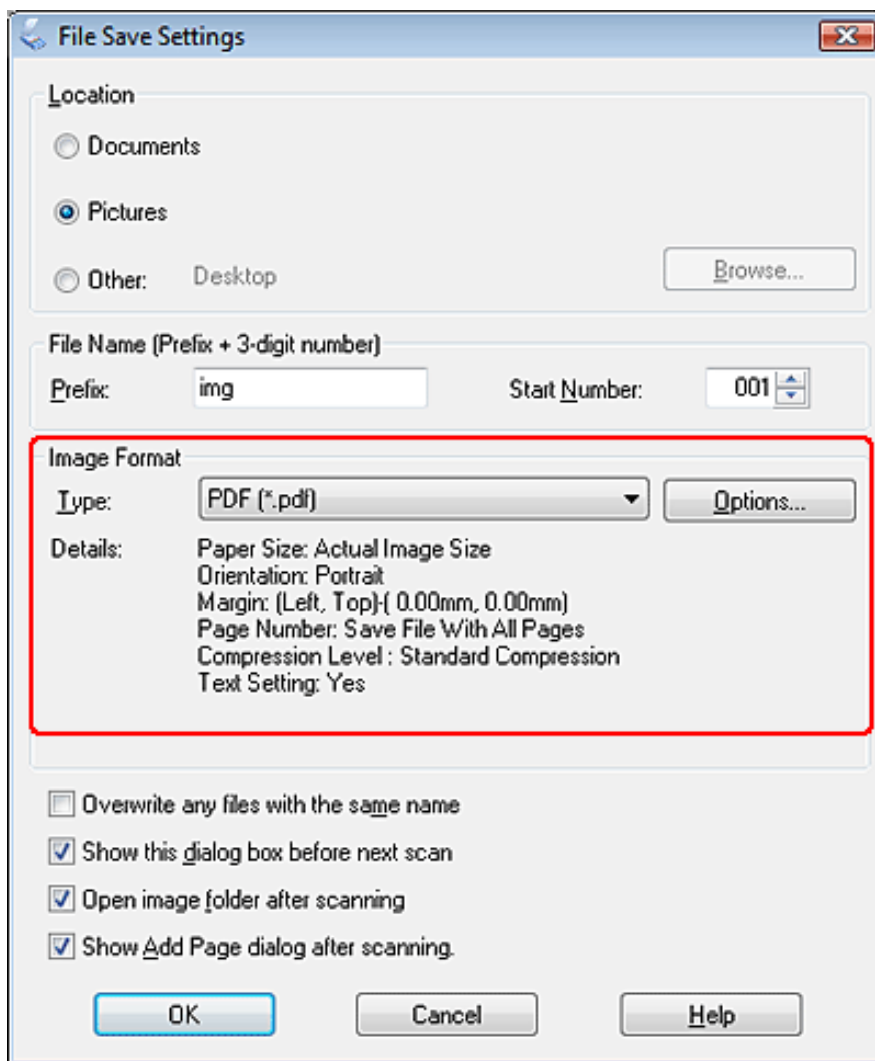

9 Click **Options**. You see the EPSON PDF Plug-in Settings window.

To create a searchable PDF file, click the **Text** tab, select the **Create searchable PDF** check box, then select your language from the **Text Language** list.

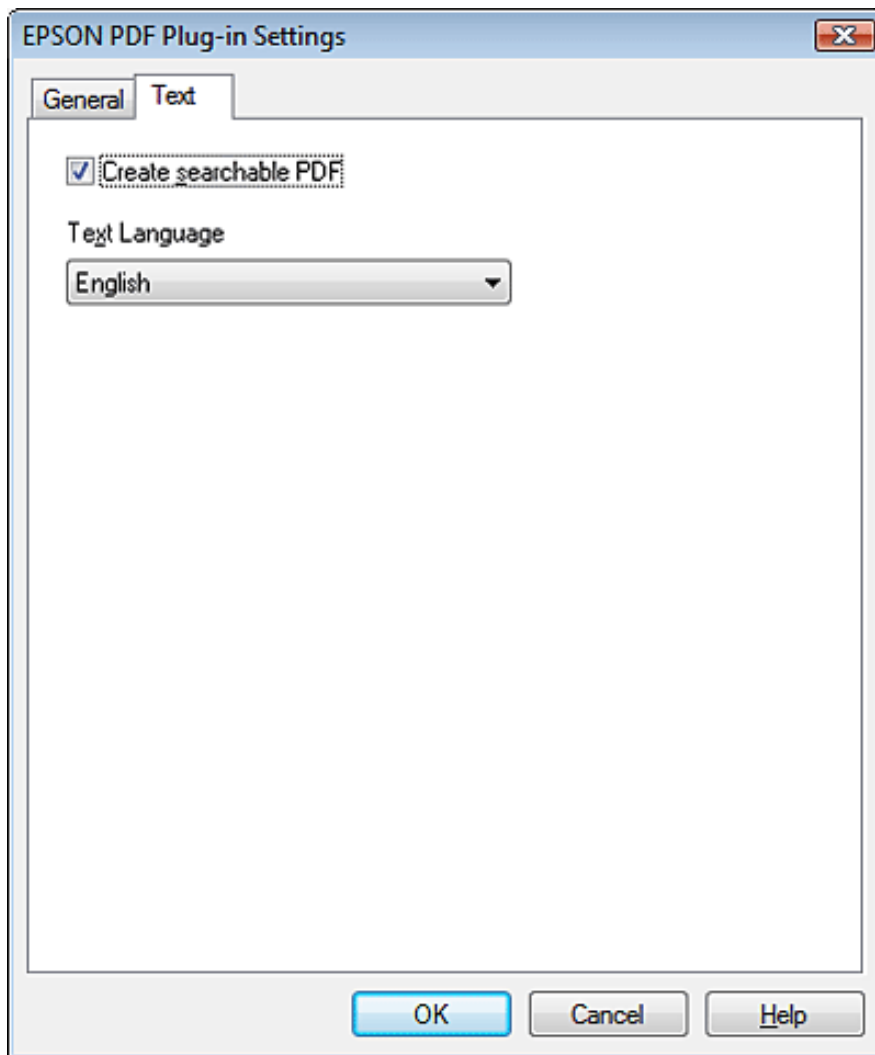

 **Note:**

The Text tab is available only when ABBYY FineReader is installed. If ABBYY FineReader is not available in your country, you will not see the Text tab.

To specify the maximum number of pages that can be included in one PDF file, click the **General** tab and adjust the **Select number to make file** setting.

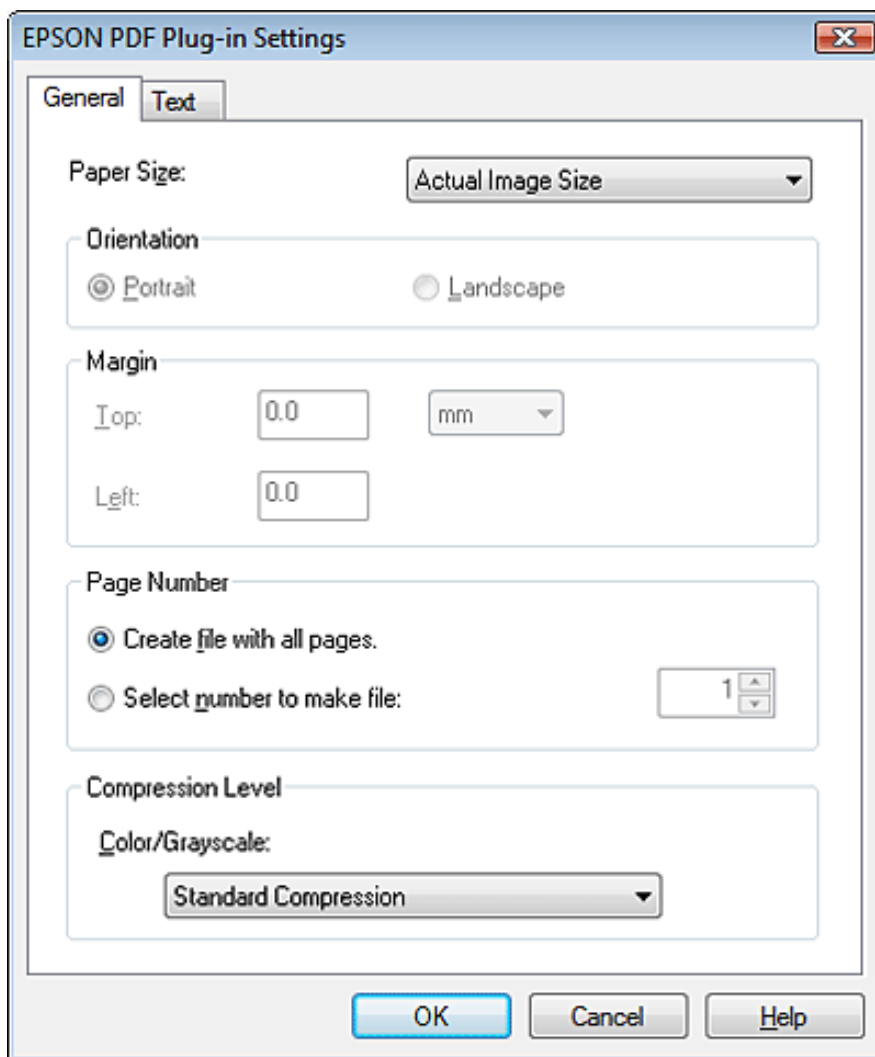

For other settings in the EPSON PDF Plug-in Settings window, see Epson Scan Help for details.

- 10 Select the settings that match your document and click **OK**. You return to the File Save Settings window.
- 11 Make any other file save settings, and click **OK**. Epson Scan scans your document and displays the window below.

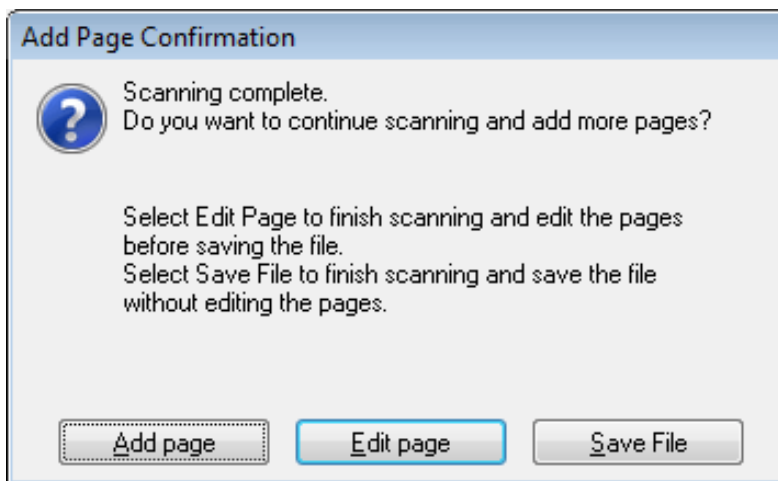

 **Note:**

If you deselect the **Show Add Page dialog after scanning** check box in the File Save Settings window, this window does not appear and Epson Scan automatically saves your document.

12 Select one of the following options.



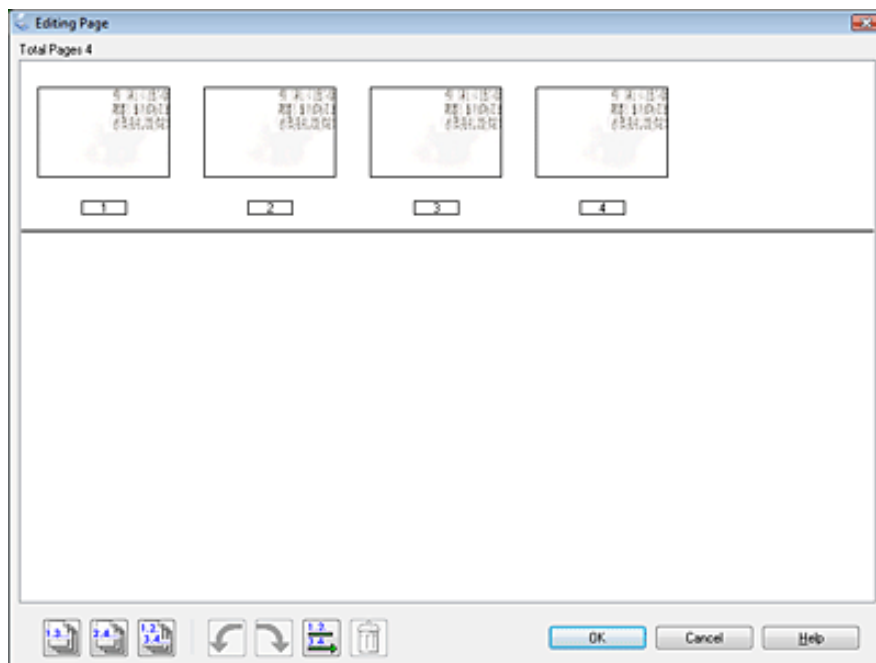

- **Add page:** Click this button to scan the next page of your document. Replace the first page on the document table with the next page, and click **Scan**. Repeat this step for each page in your document. When you are finished, click **Edit page** and go to step 13.
- **Edit page:** Click this button if you have scanned all the necessary pages so you can edit the scanned pages before saving them in one PDF file. Then go to step 13.
- **Save File:** Click this button when you are ready to finish scanning and save the scanned pages into one PDF without editing them. Then go to step 15.



13 You see the Editing Page window displaying thumbnail images of each scanned page.



Use the tools below the Editing Page window to select, rotate, reorder, and delete pages.

If you want to include all the document pages in your PDF files as they currently look, go to step 14.

If you want to rotate pages, click the pages, or use the  odd pages,  even pages, or  all pages icon to select the pages, then click the  left or  right rotate icon to rotate them.

If you want to delete pages, click the pages, or use the  odd pages or  even pages icon to select the pages, then click the  delete icon to delete them.

 **Note:**

The  delete icon is not available when all pages are selected.

For further details on the tools in the Editing Page window, see Epson Scan Help.

14 When you have finished editing your pages, click **OK**. The pages are saved in one PDF file in Pictures, My Pictures, or the location you selected in the File Save Settings window, and you return to the Professional Mode window.

15 Click **Close** to exit Epson Scan.

[Top](#) 

[Home](#) > [Scanning Special Projects](#)

Converting Scanned Documents Into Editable Text

- [Converting into Editable Text in Office Mode](#)
- [Converting into Editable Text in Home Mode](#)
- [Converting into Editable Text in Professional Mode](#)

You can scan a document and convert the text into a format that you can edit with a word processing program. This process is called OCR (Optical Character Recognition). To scan and use OCR, you need to use an OCR program, such as the ABBYY FineReader program that came with your scanner.

Note:

ABBYY FineReader may not be included in some countries.

OCR software cannot recognize or has difficulty recognizing the following types of documents or text:

- Handwritten characters
- Items that have been copied from other copies
- Faxes
- Text with tightly spaced characters or line pitch
- Text that is in tables or underlined
- Cursive or italic fonts, and font sizes less than 8 points

See one of these sections to scan and convert text using ABBYY FineReader.

Office Mode: [Converting into Editable Text in Office Mode](#)

Home Mode: [Converting into Editable Text in Home Mode](#)

Professional Mode: [Converting into Editable Text in Professional Mode](#)

Converting into Editable Text in Office Mode

Windows

- 1** Place your document on the document table. See [Placing Documents or Photos](#) for details.
- 2** Do one of the following to start ABBYY FineReader.

Windows 8:

Navigate to the **Start** screen and select **ABBYY FineReader 9.0 Sprint**.

Windows (other versions):

Select  or **Start** > **Programs** or **All Programs** > **ABBYY FineReader 9.0 Sprint** > **ABBYY FineReader 9.0 Sprint**.

You see this window:

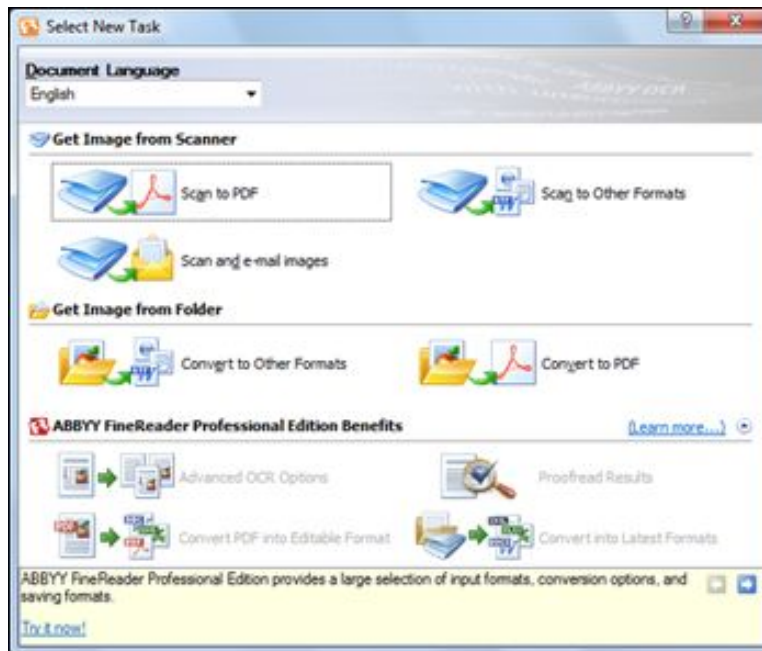

- 3 Select the language used in the document you are going to scan as the **Document Language** setting.
- 4 Click either the **Scan to Other Formats** icon or the icon that corresponds with the program you want to scan to.
- 5 If you see the Select Scanner window, select your product and click **OK**.

 **Note:**

Do not select a WIA option for your product; it will not work correctly.

- 6 Select your scan settings.
- 7 Click **Preview** and adjust the area you want to scan, if necessary.
- 8 Click **Scan**.

 **Note:**

For each additional page that you want to scan, place the document on the document table and click **Scan**.

- 9 When you are finished scanning, click **Close**. Your document is scanned and processed into editable text, then you see the Save As window.

- 10 Select a name and a file format for your document and click **Save**. The file is saved and then opened in an application associated with the file type you selected, if available on your system.

Top 

Mac OS X

- 1 Place your document on the document table. See [Placing Documents or Photos](#) for details.
- 2 Select **Applications > ABBYY FineReader Sprint 8.0**.

You see this window:



- 3 Select your scanner from the **Get Images From** list.
- 4 Select the language used in the document you are going to scan as the **Document Language** setting.
- 5 Click the icon for the type of document you want to scan to. Epson Scan starts in the last mode you used.
- 6 Change the scan mode to **Office Mode** if necessary. See [Changing the Scan Mode](#) for instructions.
- 7 Select **Color, Grayscale, or Black&White** as the Image Type setting.
- 8 Select the size of your original document as the Size setting.

- 9 Select **300** as the Resolution setting.
- 10 Click **Preview** to preview your document. The Preview window appears and displays your document. See [Previewing and Adjusting the Scan Area](#) for instructions.
- 11 Modify the image quality if necessary. See [Adjusting the Color and Other Image Settings](#) for instructions.
- 12 Click **Scan**. Your document is scanned and processed into editable text.

 **Note:**

If the characters in your text are not recognized very well, you can improve recognition by selecting the **Text Enhancement** check box or adjusting the **Threshold** setting. See [Adjusting the Color and Other Image Settings](#) for instructions.

- 13 When you see the Document Conversion window with the finished message, click **Close** in the Epson Scan window.
- 14 Follow the instructions in ABBYY FineReader Help to edit and save your document.

Top 

Converting into Editable Text in Home Mode

Windows

- 1 Place your document on the document table. See [Placing Documents or Photos](#) for details.
- 2 Do one of the following to start ABBYY FineReader.

Windows 8:

Navigate to the **Start** screen and select **ABBYY FineReader 9.0 Sprint**.

Windows (other versions):

Select  or **Start > Programs** or **All Programs > ABBYY FineReader 9.0 Sprint > ABBYY FineReader 9.0 Sprint**.

You see this window:

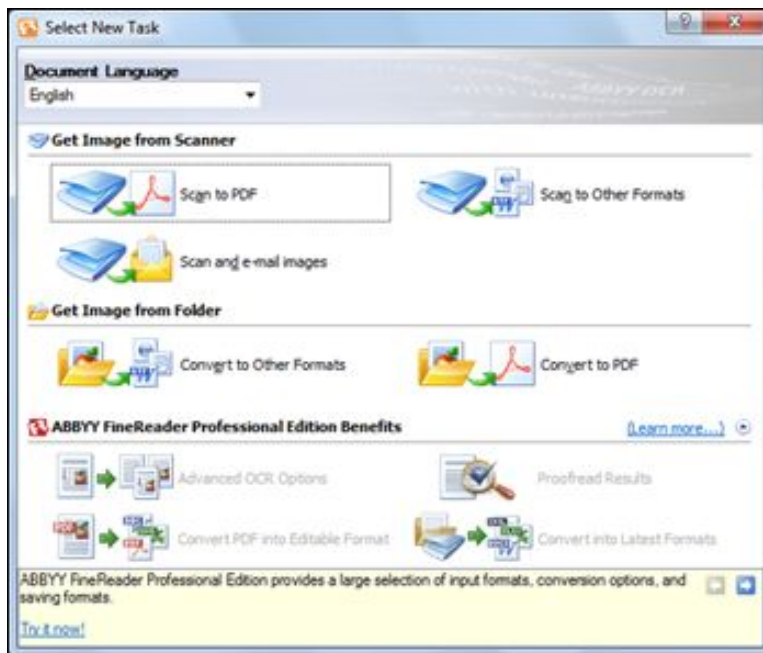

- 3 Select the language used in the document you are going to scan as the **Document Language** setting.
- 4 Click either the **Scan to Other Formats** icon or the icon that corresponds with the program you want to scan to.
- 5 If you see the Select Scanner window, select your product and click **OK**.

 **Note:**

Do not select a WIA option for your product; it will not work correctly.

- 6 Select your scan settings.
- 7 Click **Preview** and adjust the area you want to scan, if necessary.
- 8 Click **Scan**.

 **Note:**

For each additional page that you want to scan, place the document on the document table and click **Scan**.

- 9 When you are finished scanning, click **Close**. Your document is scanned and processed into editable text, then you see the Save As window.
- 10 Select a name and a file format for your document and click **Save**. The file is saved and then opened in an application associated with the file type you selected, if available on your system.

Mac OS X

- 1 Place your document on the document table. See [Placing Documents or Photos](#) for details.
- 2 Select **Applications > ABBYY FineReader Sprint 8.0**.

You see this window:



- 3 Select your scanner from the **Get Images From** list.
- 4 Select the language used in the document you are going to scan as the **Document Language** setting.
- 5 Click the icon for the type of document you want to scan to. Epson Scan starts in the last mode you used.
- 6 Change the scan mode to **Home Mode** if necessary. See [Changing the Scan Mode](#) for instructions.
- 7 Select **Magazine**, **Newspaper**, or **Text/Line Art** as the Document Type setting.
- 8 Select **Black&White** or **Color** as the Image Type setting.
- 9 Select **Printer** or **Other** as the Destination setting.

 **Note:**

If you select **Other**, select **300** as the Resolution setting.

- 10 Click **Preview** to preview your document. The Preview window appears and displays your document. See [Previewing and Adjusting the Scan Area](#) for instructions.
- 11 Modify the image quality if necessary. See [Adjusting the Color and Other Image Settings](#) for instructions.
- 12 Click **Scan**. Your document is scanned and processed into editable text.

 **Note:**

If the characters in your text are not recognized very well, you can improve recognition by selecting the **Text Enhancement** check box or adjusting the **Threshold** setting. See [Adjusting the Color and Other Image Settings](#) for instructions.

- 13 When you see the Document Conversion window with the finished message, click **Close** in the Epson Scan window.
- 14 Follow the instructions in ABBYY FineReader Help to edit and save your document.

Top 

Converting into Editable Text in Professional Mode

Windows

- 1 Place your document on the document table. See [Placing Documents or Photos](#) for details.
- 2 Do one of the following to start ABBYY FineReader.

Windows 8:

Navigate to the **Start** screen and select **ABBYY FineReader 9.0 Sprint**.

Windows (other versions):

Select  or **Start > Programs** or **All Programs > ABBYY FineReader 9.0 Sprint > ABBYY FineReader 9.0 Sprint**.

You see this window:

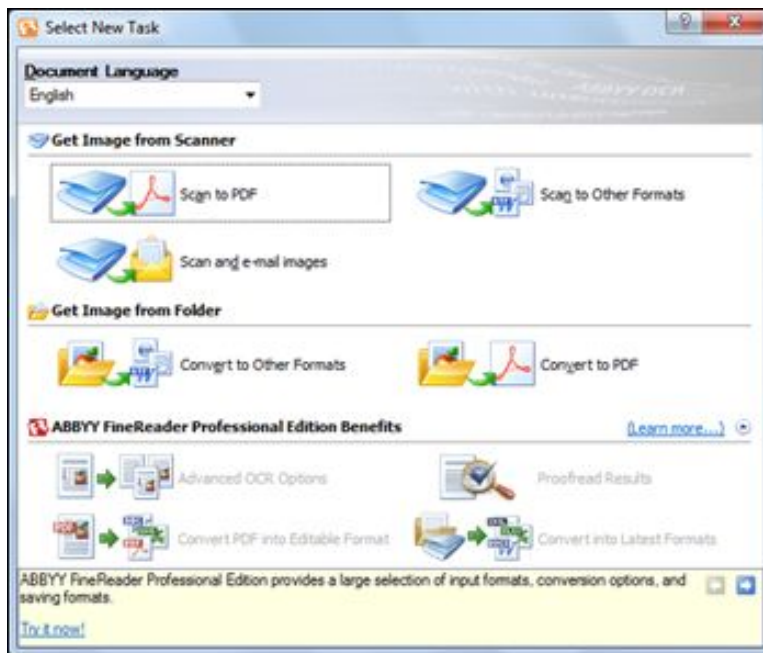

- 3 Select the language used in the document you are going to scan as the **Document Language** setting.
- 4 Click either the **Scan to Other Formats** icon or the icon that corresponds with the program you want to scan to.
- 5 If you see the Select Scanner window, select your product and click **OK**.

 **Note:**

Do not select a WIA option for your product; it will not work correctly.

- 6 Select your scan settings.
- 7 Click **Preview** and adjust the area you want to scan, if necessary.
- 8 Click **Scan**.

 **Note:**

For each additional page that you want to scan, place the document on the document table and click **Scan**.

- 9 When you are finished scanning, click **Close**. Your document is scanned and processed into editable text, then you see the Save As window.
- 10 Select a name and a file format for your document and click **Save**. The file is saved and then opened in an application associated with the file type you selected, if available on your system.

Mac OS X

- 1 Place your document on the document table. See [Placing Documents or Photos](#) for details.
- 2 Select **Applications > ABBYY FineReader Sprint 8.0**.

You see this window:



- 3 Select your scanner from the **Get Images From** list.
- 4 Select the language used in the document you are going to scan as the **Document Language** setting.
- 5 Click the icon for the type of document you want to scan to. Epson Scan starts in the last mode you used.
- 6 Change the scan mode to **Professional Mode** if necessary. See [Changing the Scan Mode](#) for instructions.
- 7 Select **Reflective** as the Document Type setting.
- 8 Select **Document** as the Auto Exposure Type setting.
- 9 Select **Black & White, 24-bit Color, or 48-bit Color** as the Image Type setting.

- 10 Select **300** as the Resolution setting.
- 11 Click **Preview** to preview your document. The Preview window appears and displays your document. See [Previewing and Adjusting the Scan Area](#) for instructions.
- 12 Modify the image quality if necessary. See [Adjusting the Color and Other Image Settings](#) for instructions.
- 13 Click **Scan**. Your document is scanned and processed into editable text.

 **Note:**

If the characters in your text are not recognized very well, you can improve recognition by selecting the **Text Enhancement** check box or adjusting the **Threshold** setting. See [Adjusting the Color and Other Image Settings](#) for instructions.

- 14 When you see the Document Conversion window with the finished message, click **Close** in the Epson Scan window.
- 15 Follow the instructions in ABBYY FineReader Help to edit and save your document.

Home > Scanning Special Projects

Scanning Color Accurate Images

- 1 Start Epson Scan, select **Home Mode** or **Professional Mode**, select the appropriate scan settings, then click **Preview** to prescan your image and adjust the marquee. For details, see one of these sections.

Home Mode: [Scanning in Home Mode](#)

Professional Mode: [Scanning in Professional Mode](#)

 **Note:**

You cannot use Full Auto Mode or Office Mode for color management.

- 2 Click **Configuration**, then click the **Color** tab and select **ICM** (Windows) or **ColorSync** (Mac OS X).

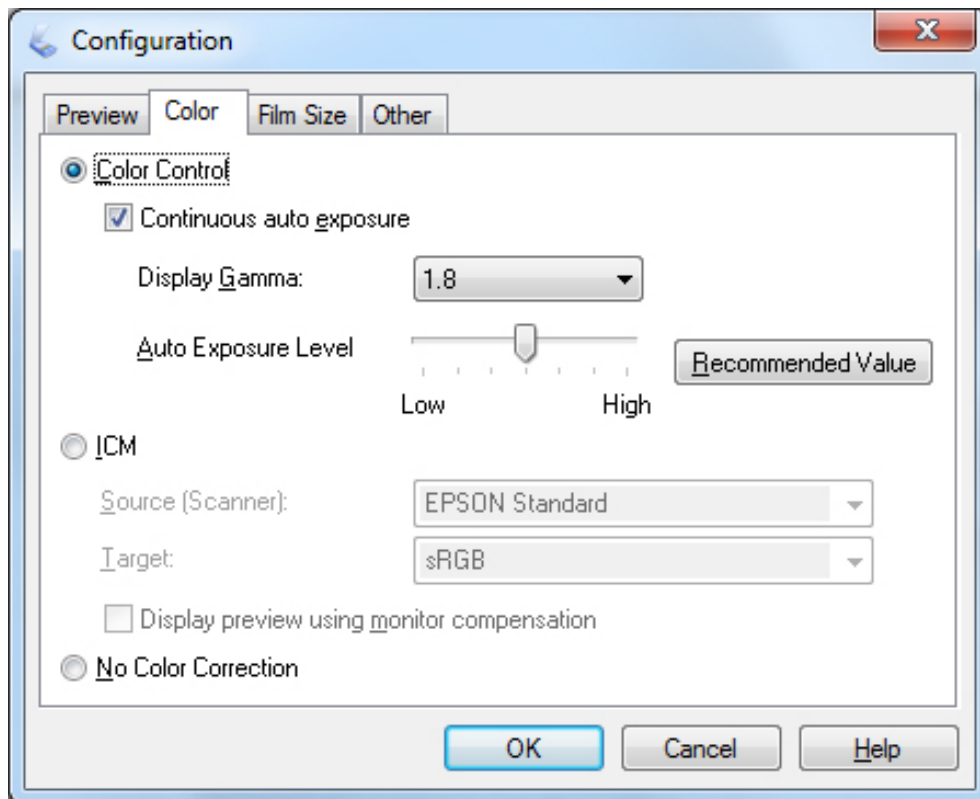

- 3 For the Source (Scanner) setting, select **EPSON Standard**. If you have color management software and created a custom ICC profile, select it as the Source (Scanner) setting.

 **Note:**

When creating a custom ICC profile for the scanner, be sure to place the profile in the following folder.

- Windows: C:\Windows\System32\spool\drivers\color
- Mac OS X: hard disk drive\Library\ColorSync\Profiles

4 For the Target setting, select **Adobe RGB**.

 **Note for Windows:**

If you do not see the Adobe RGB option, select **sRGB**.

5 Select **Display preview using monitor compensation**, then click **OK** to return to the Epson Scan window.

6 Click **Scan**.

What happens next depends on how you started your scan. See [Finishing the Scan](#) for instructions.

 **Note:**

You can also optimize the color accuracy of your images using a photo-editing application, such as Adobe Photoshop Elements. For help using Adobe Photoshop Elements, click the **Help** button in the software, see the software documentation, or see [Other Software Technical Support](#).

Home > Scanning Special Projects

■ Assigning a Program to the Start Button

▾ [Assigning a Project Program in Epson Event Manager to the Start Button](#)

By default, the  Start button opens Epson Scan when you press it.

Assigning a Project Program in Epson Event Manager to the Start Button

You can assign the  Start button to open a program in the Epson Event Manager to make scanning your projects even quicker.

 **Note for Mac OS X 10.5.8 users:**

The  Start button is not supported. To start Epson Scan, see [Using the Epson Scan Icon](#) for instructions.

1 Do one of the following to start Epson Event Manager:

Windows 8:

Navigate to the **Start** screen and select **Event Manager**.

Windows (other versions):

Select  or **Start** > **Programs** or **All Programs** > **Epson Software** > **Event Manager**.

Mac OS X:

Select **Applications** > **Epson Software**, and double-click the **Launch Event Manager** icon.

You see the Button Settings tab in Epson Event Manager.

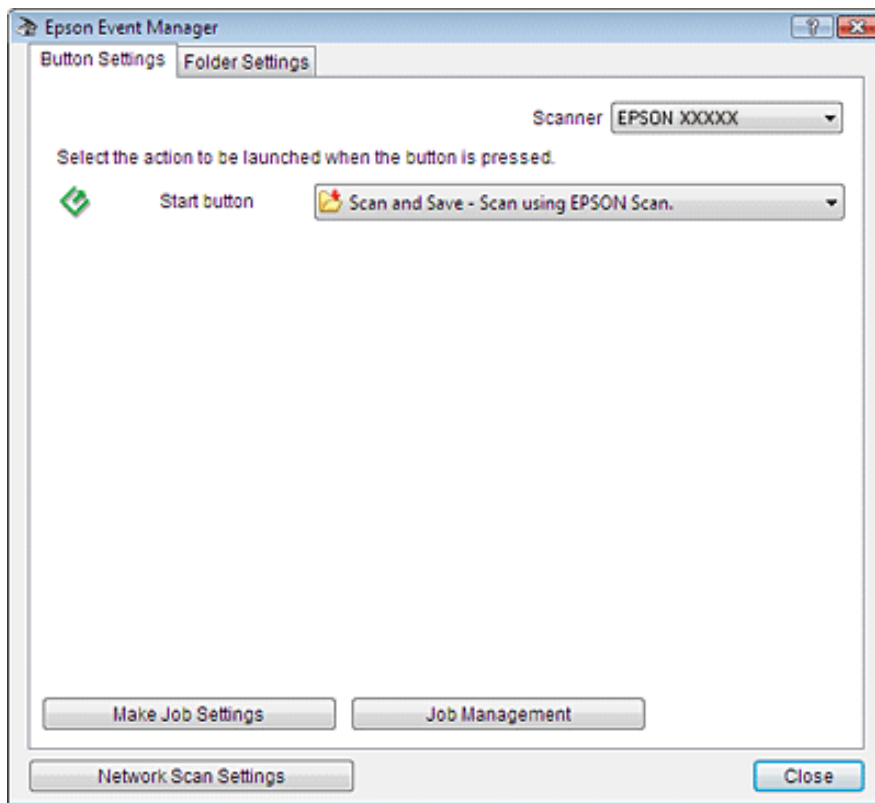

- 2 Click the arrow in the list next to the button name, then select the action you want to assign.
- 3 Click **Close** to close the Epson Event Manager window.

Now whenever you press the  Start button, the action you selected occurs.

 **Note:**

If you need help using Epson Event Manager, do one of the following.

Windows: Click the  icon in the upper right corner of the screen.

Mac OS X: Click **Help** from menu, then **Epson Event Manager Help**.

[Home](#) > [Maintenance](#)

Cleaning the Scanner

To keep your scanner operating at its best, clean it periodically using the following procedure.

Caution:

- Do not press the glass surface of the document table with any force.
- Be careful not to scratch or damage the glass surface of the document table, and do not use a hard or abrasive brush to clean it. A damaged glass surface can decrease the scan quality.
- Never use alcohol, thinner, or corrosive solvent to clean the scanner. These chemicals can damage the scanner components and the case.
- Be careful not to spill liquid into the scanner mechanism or electronic components. This could permanently damage the mechanism and circuitry.
- Do not spray lubricants inside the scanner.
- Never open the scanner case.

- 1 Turn off the scanner using its power button.
- 2 Unplug the AC power cord from the scanner.
- 3 Disconnect the USB cable from the scanner.
- 4 Clean the outer case with a cloth dampened with mild detergent and water.
- 5 If the glass surface of the document table gets dirty, clean it with a soft dry cloth. If the glass surface is stained with grease or some other hard-to-remove material, use a small amount of glass cleaner and on a soft cloth to remove it. Wipe off all remaining liquid.

Caution:

Do not spray glass cleaner directly scanner glass.

- 6 Remove the document mat and clean the transparency unit window as described in step 5.

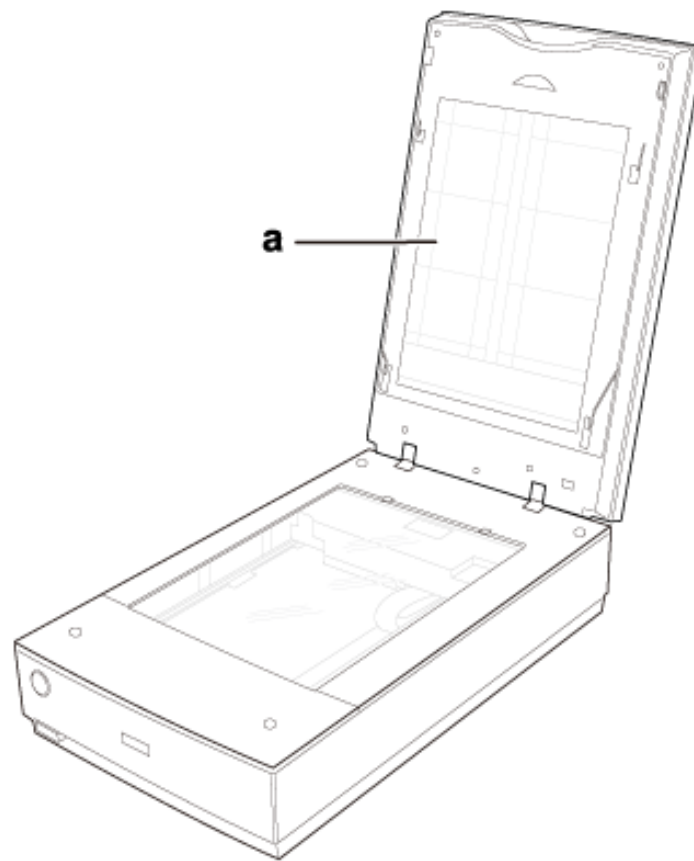

a. transparency unit window

Make sure that no dust builds up on the surface of the document table or the transparency unit window. Dust can cause spots in your scanned images.

[Home](#) > [Maintenance](#)

■ Replacing the Scanner Light Source

The luminosity of the scanner light source declines over time. If the light source breaks or becomes too dim to operate normally, the scanner stops working and the Status light rapidly flashes. When this happens, the light source assembly must be replaced by a professional. For details, [contact Epson](#).

[Home](#) > [Maintenance](#)

■ Power Off Timer Setting

The product turns off automatically if no operations are performed for the selected period. You can adjust the time before power off occurs. Any increase will affect the product's energy efficiency. Please consider the environment before making any change.

Follow the steps below to adjust the time.

- 1 Make sure that the scanner is connected to your computer and that the scanner is turned on.
- 2 Start Epson Scan Settings.

Windows 8:

Navigate to the **Start** screen and select **EPSON Scan Settings**.

Windows (other versions):

Select  or **Start > All Programs or Programs > EPSON > EPSON Scan > EPSON Scan Settings**.

Mac OS X:

Select **Applications > EPSON Software > EPSON Scan Settings**.

- 3 Click **Power Off Timer**.
- 4 Set the Power Off Timer, and then click **OK**.

Note:

If you want to turn off the Power Off Timer, set the Power Off Timer to **0**.

[Home](#) > [Maintenance](#)

■ Transporting the Scanner

Before transporting the scanner for a long distance or storing it for an extended period of time, you need to lock the scanner's carriage and transparency unit to prevent damage.

- 1 Plug in the scanner, turn on the scanner using its power button, and wait until the carriage moves to the home position (near the cover hinge). While the scanner light is green, turn off the scanner using its power button.
- 2 Open the scanner cover and slide the transparency unit transportation lock to the locked position. Then close the scanner cover.

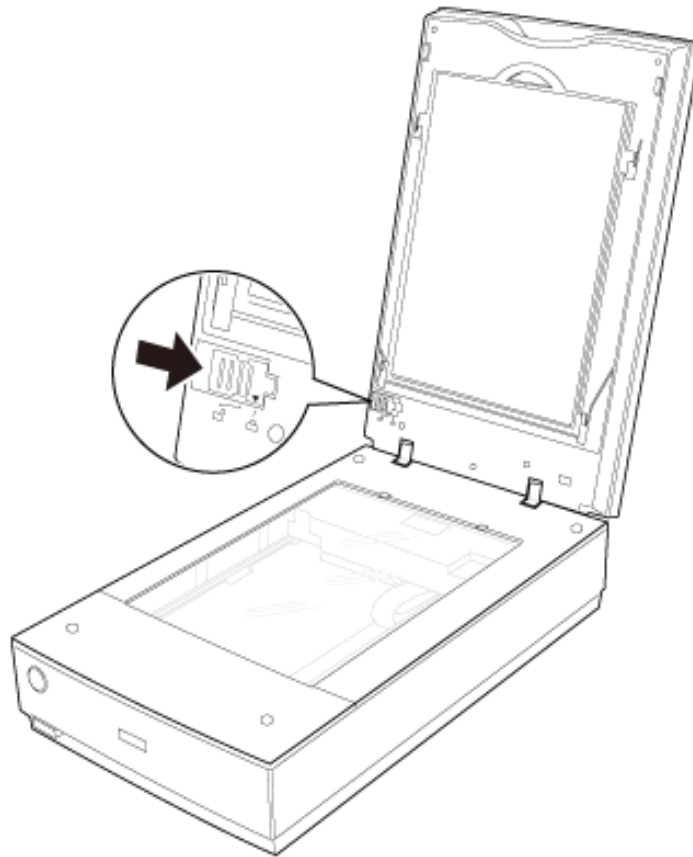

- 3 Disconnect the scanner's USB cable from your computer.
- 4 Disconnect the scanner's cover cable.

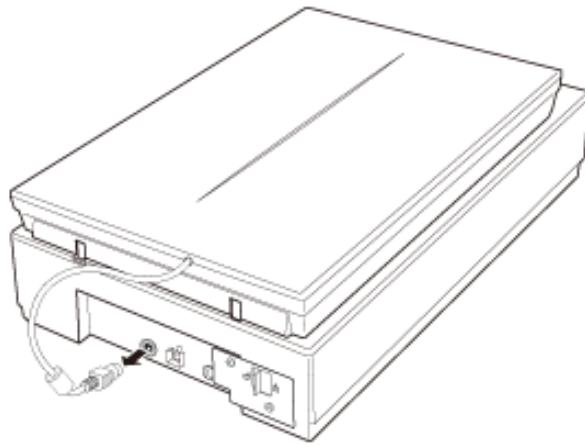



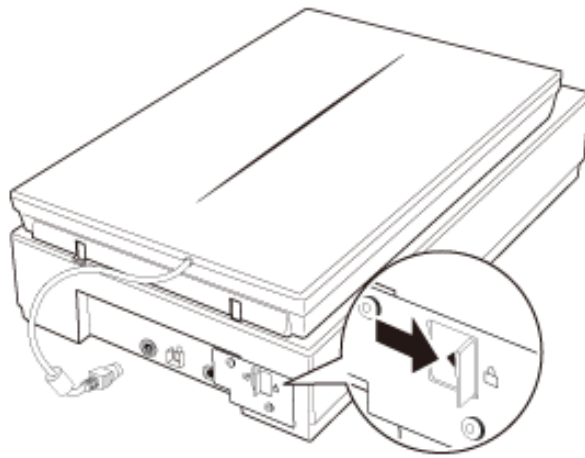

- 5** On the back of the scanner, slide the transportation lock to the locked position to secure the scanner carriage.



- 6** Attach the protective materials that came with the scanner, then repack the scanner in its original box or a similar box that fits the scanner snugly.







Home > Solving Problems

Scanner Problems

-  [The Status Light Is Flashing](#)
-  [The Scanner Does Not Turn On](#)
-  [The Scanner Turns Off](#)
-  [You Cannot Start Epson Scan](#)
-  [Pressing a Scanner Button Does Not Start the Correct Program](#)

The Status Light Is Flashing

The scanner light is located above the  power button, and the scanner cover light is on the top of the scanner cover.

Light	Color	Indicator Status	Meaning
Scanner light	Green	 On	Ready to scan images.
		 Flashing	Initializing or scanning.
	Red	 Flashing	<p>An error has occurred.</p> <ul style="list-style-type: none"> ■ Make sure the scanner is connected to your computer properly. See the <i>Start Here</i> sheet for instructions on connecting the scanner to your computer. ■ Make sure the scanner software is fully installed. See the <i>Start Here</i> sheet for instructions on installing the scanner software. ■ Make sure the scanner and/or the transparency unit transportation lock is unlocked. If it is locked, slide the lock to the unlock position. ■ Turn off the scanner using its power button, then turn it on again. If the scanner light is still flashing red, the scanner may be malfunctioning, or the scanner light source may need to be replaced. Contact Epson for details.
	—	 Off	The scanner is off.
Scanner cover light	Blue	 On	Scanning transparencies (such as film or slides).
	—	 Off	Scanning reflective documents (such as documents and photographs).

Top 

The Scanner Does Not Turn On

- Make sure your scanner's AC adapter is securely connected to the scanner and a working electrical outlet.
- Make sure the electrical outlet works. If necessary, test it by plugging in another electrical device and turning it on.

Top 

The Scanner Turns Off

- The Power Off Timer may be set. For more details, see [Power Off Timer Setting](#).

Top 

You Cannot Start Epson Scan

- Wait until the green status light stops flashing to indicate that the scanner is ready to scan.
- Make sure the scanner is turned on.
- Turn off the scanner and computer, then check the USB cable connection between them to make sure it is secure.
- Use the USB cable that came with your scanner.
- Connect the scanner directly to the computer's USB port or through one USB hub only. The scanner may not work properly when connected to the computer through more than one USB hub.
- Make sure your computer supports USB.
- If you are using any TWAIN-compliant program, such as Adobe Photoshop Elements, make sure that the correct scanner is selected as the Scanner or Source setting.
- If you upgraded your computer's operating system, you need to reinstall Epson Scan. Uninstall Epson Scan as described in [Uninstalling Your Scanning Software](#), then reinstall it as described in the *Start Here* sheet.

For Windows only:

Make sure your scanner's name appears under Imaging device without a (?) or an exclamation (!) mark in the Device Manager window. If the scanner's name appears with one of these marks or as an Unknown device, uninstall Epson Scan as described in [Uninstalling Your Scanning Software](#), then reinstall it as described in the paper manual.

Top 

Pressing a Scanner Button Does Not Start the Correct Program

- Make sure Epson Scan is installed correctly.
- **Windows:** Click the **Events** tab in your scanner's Properties window and make sure **Take no action** is not selected. Also, make sure the desired button is selected in the Select an event list box, and **Start this program** is selected.
- **Mac OS X 10.5.8:** The  Start button is not supported. To start Epson Scan, see [Using the Epson Scan Icon](#) for instructions.

Top 

[Home](#) > [Solving Problems](#)

■ Scanning Problems

- [▾ You Cannot Scan Using the Thumbnail Preview](#)
- [▾ You Have Trouble Adjusting the Scan Area in the Thumbnail Preview](#)
- [▾ Negative Film Preview Images Look Strange](#)
- [▾ You Cannot Scan Multiple Images at One Time](#)
- [▾ You Cannot Scan in Full Auto Mode](#)
- [▾ Scanning Takes a Longer Time](#)
- [▾ You Cannot Scan Film or Slides](#)

You Cannot Scan Using the Thumbnail Preview

- If you are using Full Auto Mode and Office Mode, the thumbnail preview is not available. Change the scan mode to Home Mode or Professional Mode. See [Changing the Scan Mode](#) for instructions.
- If you are scanning images with a very dark or bright background, use normal preview and create marquees on the area you want to scan. See [Previewing and Adjusting the Scan Area](#) for instructions.
- If you are scanning a film strip including both panoramic and regular size images, the panoramic images are not previewed. For the panoramic images, use normal preview and create marquees on the area you want to scan. See [Previewing and Adjusting the Scan Area](#) for instructions.
- If you are scanning a large size document, use normal preview and create marquees on the area you want to scan. See [Previewing and Adjusting the Scan Area](#) for instructions.
- Make sure the **Document Type** setting (Home Mode) or **Document Type** and **Film Type** settings (Professional Mode) are correct. See [Scanning in Home Mode](#) or [Scanning in Professional Mode](#) for instructions.
- Click **Configuration**, select the **Preview** tab, and adjust the thumbnail cropping area using the **Thumbnail Cropping Area** slider.
- If you are scanning in Home Mode and Illustration, Magazine, Newspaper or Text/Line Art is selected as Document Type, the thumbnail preview is not available.

[Top](#) 

You Have Trouble Adjusting the Scan Area in the Thumbnail Preview

- Create a marquee or adjust the existing marquee to select the area you want to scan. See [Creating a Marquee on a Preview Image](#) for instructions.
- Click **Configuration**, select the **Preview** tab, and adjust the thumbnail cropping area using the **Thumbnail Cropping Area** slider.
- Use the normal preview and create marquees on the area you want to scan. See [Previewing and Adjusting the Scan Area](#) for instructions.

[Top](#) 

Negative Film Preview Images Look Strange

- Make sure the **Document Type** setting (Home Mode) or **Film Type** settings (Professional Mode) are set correctly for your film. See [Scanning in Home Mode](#) or [Scanning in Professional Mode](#) for instructions.
- If you are in normal preview, the dark area around the film and the frame of the film holder is perceived as white. This alters the exposure and causes images to appear darker. Create marquees on the image area you want to scan, then click **Zoom** to preview the area. See [Previewing and Adjusting the Scan Area](#) for instructions.
- Use thumbnail preview instead of normal preview. See [Previewing and Adjusting the Scan Area](#) for instructions.

Top 

You Cannot Scan Multiple Images at One Time

Position photos at least 0.8 inch (20 mm) apart from each other on the document table.

Top 

You Cannot Scan in Full Auto Mode

- If you are scanning images with a very dark or bright background, switch to Office Mode, Home Mode, or Professional Mode. To change the scan mode, see [Changing the Scan Mode](#). Then, use normal preview and create marquees on the area you want to scan. See [Previewing and Adjusting the Scan Area](#) for instructions.
- If you are scanning a large size document, such as Letter, switch to Office Mode, Home Mode, or Professional Mode. To change the scan mode, see [Changing the Scan Mode](#). Then, use normal preview and create marquees on the area you want to scan. See [Previewing and Adjusting the Scan Area](#) for instructions.

Top 

Scanning Takes a Longer Time

- Try scanning your original at a lower resolution setting to speed up scanning. See [Selecting the Scan Resolution](#) for instructions.
- Computers with USB 2.0 (high speed) ports can scan faster than those with USB 1.1 ports. If you are using a USB 2.0 port with your scanner, make sure it meets the system requirements. See [System Requirements](#) for details.
- If you scan using DIGITAL ICE Technology function, scanning takes a longer time.

Top 

You Cannot Scan Film or Slides

- Make sure the document mat is removed from the scanner cover. See [Removing the Document Mat](#) for instructions.
- Make sure your film or slides are placed in the film holder correctly and the film holder is properly positioned on the document table. See [Placing Film or Slides](#) for instructions.

- Make sure the **Document Type** setting (Home Mode) or **Film Type** settings (Professional Mode) are set correctly for your film/slide type. See [Scanning in Home Mode](#) or [Scanning in Professional Mode](#) for instructions.
- Make sure the cover cable is securely connected to the scanner's **OPTION** port.

[Top](#) 

Home > Solving Problems

Scan Quality Problems

- ⌵ The Edges of Your Original Are Not Scanned
- ⌵ You See Only a Few Dots in Your Scanned Image
- ⌵ A Line or Line of Dots Always Appears in Your Scanned Images
- ⌵ Straight Lines in Your Image Come Out Crooked
- ⌵ Your Image Is Blurred
- ⌵ Colors Are Patchy or Distorted at the Edges of Your Image
- ⌵ Your Scanned Image Is Too Dark
- ⌵ An Image on the Back of Your Original Appears in Your Scanned Image
- ⌵ Ripple Patterns Appear in Your Scanned Image
- ⌵ Characters Are Not Recognized Well When Converted into Editable Text (OCR)
- ⌵ Scanned Colors Differ From the Original Colors
- ⌵ Striped Rings Appear in Your Scanned Image of Film or Slides Images
- ⌵ Images are Rotated Incorrectly

The Edges of Your Original Are Not Scanned

- If you are scanning in Full Auto Mode, or using thumbnail preview in Home Mode or Professional Mode, move the document about 0.2 inch (5.1 mm) away from the top or bottom edges or 0.21 inch (5.3 mm) away from the side edges of the document table to avoid cropping.
- If you are scanning using normal preview in Office Mode, Home Mode, or Professional Mode, move the document about 0.08 inch (2.1 mm) away from the top or bottom edges or 0.1 inch (2.3 mm) away from the side edges of the document table to avoid cropping.

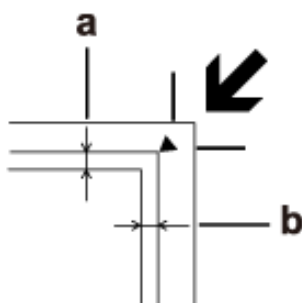

Top ⌵

You See Only a Few Dots in Your Scanned Image

- Make sure the document or photo is placed facedown on the document table. See [Placing Documents or Photos](#) for details.
- When scanning with the **Black&White** setting in Office Mode or Home Mode, or the **Black & White** setting in Professional Mode, change the **Threshold** setting. See [Adjusting the Color and Other Image Settings](#) for

instructions.

Top 

A Line or Line of Dots Always Appears in Your Scanned Images

The document table or transparency unit window may need cleaning. See [Cleaning the Scanner](#).

If you still have the problem, the document table or transparency unit window may be scratched. [Contact Epson](#).

Top 

Straight Lines in Your Image Come Out Crooked

Make sure the document lies perfectly straight on the document table.

Top 

Your Image Is Blurred



- Make sure the document or photo lies flat on the document table. Also make sure your document or photo is not wrinkled or warped.
- Make sure you do not move the document or photo, or your scanner while scanning.
- Make sure the scanner is placed on a flat, stable surface.
- Select **Unsharp Mask** check box in Office Mode or Professional Mode window. See [Adjusting the Color and Other Image Settings](#) for instructions.
- Adjust the **Auto Exposure** setting in Professional Mode window. See [Adjusting the Color and Other Image Settings](#) for instructions.
- Click **Configuration**, select the **Color** tab, and select **Color Control** and **Continuous auto exposure**. See Epson Scan Help for details.
- Click **Configuration**, select the **Color** tab, and click **Recommended Value** to return the Auto Exposure setting to the default. See Epson Scan Help for details.
- Increase the resolution setting. See [Selecting the Scan Resolution](#) for instructions.

If you are not satisfied with the quality of scanned film images after trying all the solutions above, you can adjust the height between the film holder and the document table. See the instructions below to increase or decrease the space between the film holder and document table. The default height between the film holder and document table is 0.12 inch (3 mm).

- Remove and rotate the film height adjusters on the back of the film holder so that the arrow on the adjusters face the + symbol on the bottom of the film holder. This increases the height between the film holder and document table to 0.14 inch (3.5 mm).

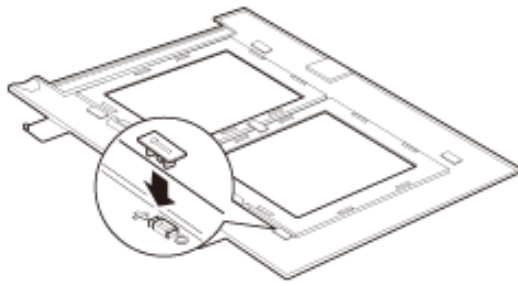

- Remove all of the film height adjusters on the back of the film holder to decrease the height between the film holder and the document table to 0.1 inch (2.5 mm).

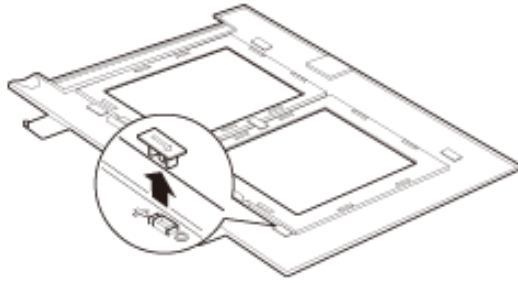

To return the film holder to its default height, 0.12 inch (3 mm), place the film height adjusters so that the arrow on the adjusters face the  symbol on the bottom of the film holder.

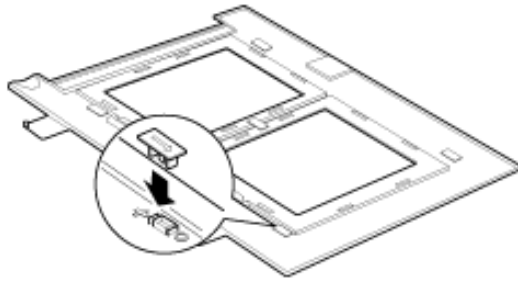

[Top](#) 

Colors Are Patchy or Distorted at the Edges of Your Image



If your document is very thick or curled at the edges, cover the edges with paper to block external light as you scan.

[Top](#) 

Your Scanned Image Is Too Dark



- If your original is too dark, try using the **Backlight Correction** feature in Home Mode or Professional Mode. See [Fixing Backlit Photos](#) for instructions.
- Check the **Brightness** setting in Office Mode, Home Mode, or Professional Mode. See Epson Scan Help for details.
- Click **Configuration**, select the **Color** tab, and change the **Display Gamma** setting to match your output device, such as a monitor or printer. See Epson Scan Help for details.
- Click **Configuration**, select the **Color** tab, and select **Color Control** and **Continuous auto exposure**. See Epson Scan Help for details.
- Click **Configuration**, select the **Color** tab, and click **Recommended Value** to return the Auto Exposure setting to the default. See Epson Scan Help for details.
- Click the  Histogram Adjustment icon in Professional Mode to adjust the brightness.
- Check the brightness and contrast settings of your computer monitor.

[Top](#) 

An Image on the Back of Your Original Appears in Your Scanned Image

If your original is printed on thin paper, images on the back may be visible to the scanner and appear in your scanned image.

- Try scanning the original with a piece of black paper placed on the back of it.
- Also check the scanning software settings such as image type and image adjustment.
- Try using the Text Enhancement function.
See [Scanning in Home Mode](#) or [Scanning in Professional Mode](#) for instructions.

[Top](#) 

Ripple Patterns Appear in Your Scanned Image

A ripple or cross-hatch pattern (called moiré) may appear in a scanned image of a printed document. It is caused by interference from the differing pitches in the scanner's screen and the halftone screen in your original.

Original image	Descreening applied



- Select the **Descreening** check box in Office Mode, Home Mode, or Professional Mode. In Professional Mode, select an appropriate **Screen Ruling** for the Descreening and deselect the **Unsharp Mask** setting. See [Adjusting the Color and Other Image Settings](#) for instructions.
- Select a lower resolution setting. See [Selecting the Scan Resolution](#) for instructions.

 **Note:**

You cannot remove ripple patterns when you are scanning film or monochrome images, or scanning using a resolution higher than 600 dpi.

Top 

Characters Are Not Recognized Well When Converted into Editable Text (OCR)

- Make sure the document lies perfectly straight on the document table.
- In Office Mode or Home Mode, select the **Text Enhancement** check box.
- Adjust the **Threshold** setting.
 - **Office Mode** or **Home Mode**: Select **Black&White** as the Image Type setting. Then try adjusting the **Threshold** setting. See [Converting Scanned Documents Into Editable Text](#) for instructions.
 - **Professional Mode**: Click the + (Windows) or ► (Mac OS X) button next to **Image Type** and make the appropriate Image Option setting. Then try adjusting the **Threshold** setting. See [Converting Scanned Documents Into Editable Text](#) for instructions.
- Check your OCR software manual to see if there are any settings you can adjust in your OCR software.

Top 

Scanned Colors Differ From the Original Colors

- Make sure the **Image Type** setting is correct. See [Scanning in Office Mode](#), [Scanning in Home Mode](#), or [Scanning in Professional Mode](#) for instructions.
- Click **Configuration**, select the **Color** tab, and change the **Display Gamma** setting to match your output device, such as a monitor or printer. See Epson Scan Help for details.
- Adjust the **Auto Exposure** setting in Professional Mode. Also try selecting a different **Tone Correction** setting. See [Adjusting the Color and Other Image Settings](#) for instructions.
- Click **Configuration**, select the **Color** tab, and select **Color Control** and **Continuous auto exposure** in the Color menu. See Epson Scan Help for details.
- Click **Configuration**, select the **Color** tab, and click **Recommended Value** to return the Auto Exposure setting to the default. See Epson Scan Help for details.

- Click **Configuration**, select the **Preview** tab, and turn on the **Quality Preview** setting in the Preview menu. See Epson Scan Help for details.
- Make sure to enable the **Embed ICC Profile** setting. In the File Save Settings window, select **JPEG** or **TIFF** as the Type setting. Click **Options**, then select the **Embed ICC Profile** check box. To access the File Save Settings window, see [Selecting File Save Settings](#).
- Check the color matching and color management capabilities of your computer, display adapter, and software. Some computers can change the palette of colors on your screen. See your software and hardware manuals for details.
- Use the color management system for your computer: ICM for Windows, or ColorSync for Mac. Add a color profile that matches your monitor to improve on-screen color matching. Exact color matching is very difficult. Check your software and monitor documentation for information on color matching and calibration.

 **Note:**

- In Home Mode, when Illustration, Magazine, Newspaper, Text/Line Art is selected for the document type, EPSON sRGB is embedded even if another ICM/ColorSync setting is selected.
- In Office Mode, EPSON sRGB is embedded even if another ICM/ColorSync setting is selected.
- In Professional Mode, when Document is selected for the Auto Exposure type, EPSON sRGB is embedded even if another ICM/ColorSync setting is selected.

- Printed colors can never exactly match the colors on your monitor because printers and monitors use different color systems: monitors use RGB (red, green, and blue) and printers typically use CMYK (cyan, magenta, yellow, and black).

Top 

Striped Rings Appear in Your Scanned Image of Film or Slides Images

A ring-shaped pattern of stripes (called a Newton ring) sometimes appears on scanned images of transparent materials. This may occur if the film is curled.

Place the film or slides with the base side facing up and preview using thumbnail preview. Then flip the previewed image

by clicking the  mirroring icon in the Preview window. See [Adjusting the Color and Other Image Settings](#) for instructions.

Top 

Images are Rotated Incorrectly

- Make sure the documents or photos are placed on the document table correctly. See [Placing Documents or Photos](#) for instructions.
- Make sure the film or slides are placed in the film holder correctly and the film holder is properly positioned on the document table. See [Placing Film or Slides](#) for instructions.
- If you are scanning using thumbnail previews in Home Mode or Professional Mode, select the image and click the  rotation icon to rotate it. See [Previewing and Adjusting the Scan Area](#) for instructions.
- Try disabling or enabling the **Auto Photo Orientation** setting.
 - **Full Auto Mode:** Click **Customize**, and select or deselect **Auto Photo Orientation**.
 - **Home Mode or Professional Mode:** Click **Configuration**, select the **Preview** tab, and select or deselect **Auto Photo Orientation**.

 **Note:**

- The Auto Photo Orientation feature will not work when you scan newspaper or magazine pages, documents, illustrations, or line art. The feature will also not work when you scan images that are 2 inches (5.1 cm) or smaller on any side.
- The Auto Photo Orientation feature may not work correctly if the faces in your image are very small or not looking straight ahead, or if the faces are of infants. The feature may also not work correctly if you scan an indoor image that contains no faces, an outdoor image in which the sky is not at the top, or any image containing bright spots or objects in locations other than the top of your image.

[Home](#) > [Solving Problems](#)

■ Uninstalling Your Scanning Software

 [For Windows](#)

 [For Mac OS X](#)

You may need to uninstall and then re-install your scanner software to solve certain problems or if you upgrade your operating system.

For Windows



Note:

- For Windows 8, Windows 7, and Windows Vista, you need an administrator account and password if you log on as a standard user.
- For Windows XP, you must log on to a Computer Administrator account.

1 Turn off the scanner.

2 Disconnect the scanner's USB cable from your computer.

3 Do one of the following.

Windows 8: Navigate to the **Start** screen, right-click, select **All apps**, and select **Control Panel**.

Windows (other versions): Click  or **Start** and select **Control Panel**.

4 Do one of the following.

Windows 8, Windows 7, and Windows Vista: Select **Uninstall a program** from the Programs category.

Windows XP: Select **Add or Remove Programs**.

5 Select the software you want to uninstall such as Epson Scan or another application from the list displayed.

6 Do one of the following.

Windows 8 and Windows 7: Click **Uninstall** or **Uninstall/Change**.

Windows Vista: Click **Uninstall** or **Uninstall/Change**, and then click **Continue** in the User Account Control window.

Windows XP: Click **Remove** or **Change/Remove**.

7 When the confirmation window appears, click **Next**, **Yes**, or **OK**.

8 Follow the on-screen instructions.

In some cases, a message may appear to prompt you to restart your computer. If so, make sure **I want to restart my computer now** is selected and click **Finish**.

9 To re-install your product software, see the *Start Here* sheet for instructions.

Top 

For Mac OS X

In most cases, you do not need to uninstall your product software before re-installing it. However, you can download the Uninstaller utility from the Epson support website to uninstall your product software as described here.

 **Note:**

- To uninstall applications you must log on to a Computer Administrator account. You cannot uninstall programs if you log on as a Limited account user.
- If you find that re-installing your product software does not solve a problem, [contact Epson](#).

1 To download the Uninstaller utility, visit the Epson download site ([U.S. downloads](#) or [Canadian downloads](#)).

2 Follow the instructions on the screen to install the Uninstaller utility.

3 Quit all applications currently running on your Mac.

4 Double click the **Uninstaller** icon.

5 Select the checkbox for each software program you want to uninstall.

6 Click **Uninstall**.

7 Follow the on-screen instructions to uninstall the software.

8 To re-install your product software, see the *Start Here* sheet for instructions.

Top 

[Home](#) > [Solving Problems](#)

■ Epson Technical Support

-  [Internet Support](#)
-  [Speak to a Support Representative](#)
-  [Purchase Accessories](#)

Internet Support

Visit Epson's support website at www.epson.com/support (U.S.) or www.epson.ca/support (Canada) and select your product for solutions to common problems. You can download drivers and documentation, get FAQs and troubleshooting advice, or e-mail Epson with your questions.

[Top](#) 

Speak to a Support Representative

Before you call Epson for support, please have the following information ready:

- Product name
- Product serial number (located on a label on the product)
- Proof of purchase (such as a store receipt) and date of purchase
- Computer configuration
- Description of the problem

Then call:

(562) 276-4382 (U.S.) or (905) 709-3839 (Canada), 6 AM to 8 PM, Pacific Time, Monday through Friday, and 7 AM to 4 PM, Pacific Time, Saturday

Days and hours of support are subject to change without notice. Toll or long distance charges may apply.

 **Note:**

For help using any other software on your system, see the documentation for that software or [Other Software Technical Support](#).

[Top](#) 

Purchase Accessories

You can purchase genuine Epson accessories from an Epson authorized reseller. To find the nearest reseller, call 800-GO-EPSON (800-463-7766). Or you can purchase online at www.epsonstore.com (U.S. sales) or www.epson.ca (Canadian sales).

[Home](#) > [Solving Problems](#)

■ Other Software Technical Support

-  [Adobe Photoshop Elements](#)
-  [LaserSoft Imaging SilverFast](#)
-  [X-Rite i1Profiler](#)
-  [ABBYY FineReader](#)

Adobe Photoshop Elements

(800) 833-6687

www.adobe.com/support

[Top](#) 

LaserSoft Imaging SilverFast

(941) 312-0690

www.silverfast.com

www.silverfast.com/problemreport/en.html

[Top](#) 

X-Rite i1Profiler

(800) 248-9748

www.xrite.com/support/i1Profiler

[Top](#) 

ABBYY FineReader

(408) 457-9777

www.abbyy.com

support@abbyyusa.com

[Top](#) 

[Home](#) > [Technical Specifications](#)

System Requirements

[Windows System Requirements](#)[Mac System Requirements](#)

Make sure your system meets the requirements in these sections before using it with your scanner.

Windows System Requirements

System	Microsoft Windows 8, Windows 7, Windows Vista, Windows XP
Interface	USB 2.0 (Type-B standard Connector)
Display	Color monitor with 1024 × 768 screen resolution or higher, and 24-bit (Full Color) color (Color and tone reproduction are subject to the display capability of your computer system, including the video card, display monitor, and software. See your system documentation for details.)

[Top](#) 

Mac System Requirements

System	Mac OS X 10.5.8, Mac OS X 10.6.x, Mac OS X 10.7.x, or Mac OS X 10.8.x. Fast User Switching on Mac OS X is not supported.
Interface	Mac USB
Display	Color monitor with 1024 × 768 screen resolution or higher, and millions of colors (Color and tone reproduction are subject to the display capability of your computer system, including the video card, display monitor, and software. See your system documentation for details.)

 **Note:**

Epson Scan does not support the UNIX File System (UFS) for Mac OS X. You must install Epson Scan on a disk or in a partition that does not use UFS.

[Top](#) 

[Home](#) > [Technical Specifications](#)

Scanner Specifications

-  [General](#)
-  [Mechanical](#)
-  [Electrical](#)
-  [Environmental](#)
-  [Interfaces](#)
-  [Standards and Approvals](#)

 **Note:**

Specifications are subject to change without notice.

General

Scanner type	Flatbed color
Photoelectric device	Color CCD line sensor
Effective pixels	40800 × 56160 pixels at 4800 dpi Scanning area may be restricted if resolution setting is large.
Document size	Reflective: 8.5 × 11.7 inches (216 × 297 mm) A4 or US letter size Transparent: 8 × 10 inches (203.2 × 254 mm) (four 35 mm film strips [6 frames each], twelve 35 mm slides, two medium format 6 × 20 cm film frames or two 4 × 5 inch film frames)
Scanning resolution	4800 dpi (main scan: optical resolution by 6 line CCD with 122,400 pixels) 6400 dpi (main scan: optical resolution by 6 line CCD with 113,280 pixels) 9600 dpi with Micro Step
Output resolution	25 to 12,800 dpi (1 dpi steps)
Image data	16 bits per pixel per color internal 16 bits per pixel per color external (maximum)
Interface	One Hi-Speed USB/USB port
Light source	White cold cathode fluorescent lamp IR LED

 **Note:**

Optical resolution is the maximum scan resolution of the CCD elements, using the definition of ISO 14473. ISO 14473 defines optical resolution as the fundamental sampling rate of the scan sensor.

Mechanical

Dimensions	Width: 19.8 inches (503 mm) Depth: 12.1 inches (308 mm) Height: 6.0 inches (152.5 mm)
Weight	Approx. 14.5 lb (6.6 kg)

Electrical

Note:

Check the label on the AC adapter or on the back of the scanner for voltage information.

Scanner

Rated voltage	DC 24 V
Rated input current	1.3 A
Power consumption	32 W Operating 21 W Ready Mode 4 W Sleep Mode 0.5 W Power off

AC Adapter

	100-120 V model	220-240 V model
AC adapter model	A411B	A411E
Rated input voltage	AC 100 to 120 V	AC 220 to 240 V
Rated input current	1.0 A	0.5 A
Rated input frequency	50 to 60 Hz	
Rated output voltage	DC 24 V	
Rated output current	1.3 A	

Note:

The AC adapter model varies in certain locations.

Environmental

Temperature	Operating	41 to 95 ° F (5 to 35 ° C)
	Storage	-13 to 140 ° F (-25 to 60 ° C)
Humidity	Operating	10 to 80%, without condensation
	Storage	10 to 85%, without condensation
Operating conditions		Ordinary office or home conditions. Avoid operating the scanner in direct sunlight, near a strong light source, or in extremely dusty conditions.

[Top](#) 

Interfaces

USB Interface

Interface type	Universal Serial Bus Specification Revision 2.0
Electrical standard	Full Speed mode (12 Mbits per second) and Hi-Speed mode (480 Mbits per second) of Universal Serial Bus Specification Revision 2.0.
Connector type	One Type B port

[Top](#) 

Standards and Approvals

Scanner

EMC	FCC Part 15 Subpart B Class B CAN/CSA-CEI/IEC CISPR22 Class B
-----	--

AC Adapter

Safety	UL60950-1 CAN/CSA-C22.2 No. 60950-1
EMC	FCC Part 15 Subpart B Class B CAN/CSA-CEI/IEC CISPR22 Class B

Default Delay Times for Power Management for Epson Products

This product will enter sleep mode after a period of nonuse. The time interval has been set at the factory for energy efficiency and cannot be modified by the consumer.