

Dept 2612

DUAL-BEAM OSCILLOSCOPE TYPE 502

INSTRUCTION MANUAL



TEKTRONIX, INC.

MANUFACTURERS OF CATHODE-RAY AND VIDEO TEST INSTRUMENTS

Sunset Highway and Barnes Road • P. O. Box 831 • Portland 7, Oregon, U. S. A.

Phone: CYPRESS 2-2611 • Cables: Tektronix



PREFACE

We have tried to provide you with the best instrument we can. In doing this we sometimes make changes in our products after the instruction manuals have been printed. Many changes are made to give you the benefit of the latest circuit improvements developed in our engineering department, and to accommodate improved components as they become available. Our Test and Calibration Engineers sometimes hand tailor the circuits to provide optimum individual performance.

When a particular instrument is changed in any manner, its manual is corrected accordingly. That is why the instrument serial number is written on the title page of this manual. If you need repair parts for an instrument, refer to the manual that belongs to that particular instrument.

This manual begins with a list of Specifications, so that you will know the characteristics of your instrument. The second section provides information on cooling and connecting the power transformer for various input voltages. The third section gives you some of the principle ways in which you can operate your instrument. Next is the Circuit Description, where the circuitry of your instrument is described in a detailed form. The Maintenance and Recalibration sections are last. Here you will find information on troubleshooting and repairing your instrument and on carrying out a recalibration of the instrument, if necessary, in the field.

We hope that you will find your instruction manual useful. Refer to it often. We welcome comments.

Tektronix, Inc.

Copyright © 1959 by Tektronix, Inc.,
Portland, Oregon. Printed in the
United States of America. All rights
reserved. Contents of this publica-
tion may not be reproduced in any
form without permission of the copy-
right owner.

CONTENTS

SPECIFICATIONS	SECTION 1
Vertical-Deflection System. Horizontal Deflection System. Other Characteristics.	
PRELIMINARY INSTRUCTIONS	SECTION 2
Cooling. Power Requirements. Fan Connections. Fuse Requirements.	
OPERATING INSTRUCTIONS	SECTION 3
Input Selection. Input Coupling. Input Connections. Use of Probes. Triggered Operation. Free-Running Operation. Magnifier. External Horizontal Input. Voltage Measurement. Time Measurement. Frequency Measurement. DC Balance Adjustment. Auxiliary Functions. Functional Description of Controls, Indicators, and Connectors.	
CIRCUIT DESCRIPTION	SECTION 4
Introduction. Vertical Deflection Amplifiers. Time-Base Trigger. Time-Base Generator. Power Supply. CRT Circuit. Calibrator.	
MAINTENANCE	SECTION 5
Preventive Maintenance. Removal and Replacement of Parts. Replacement Parts. Troubleshooting.	
RECALIBRATION PROCEDURE	SECTION 6
Introduction. Equipment Required. Low-Voltage Power Supply. Calibrator. CRT Circuit. Horizontal Amplifier. Time-Base Generator. Vertical Amplifier. Triggering Circuit.	
PARTS LIST, BLOCK DIAGRAM and SCHEMATICS	SECTION 7
ABBREVIATIONS & WARRANTY, PROBE, ACCESSORIES FOR TEKTRONIX INSTRUMENTS and SHORT FORM CATALOG	



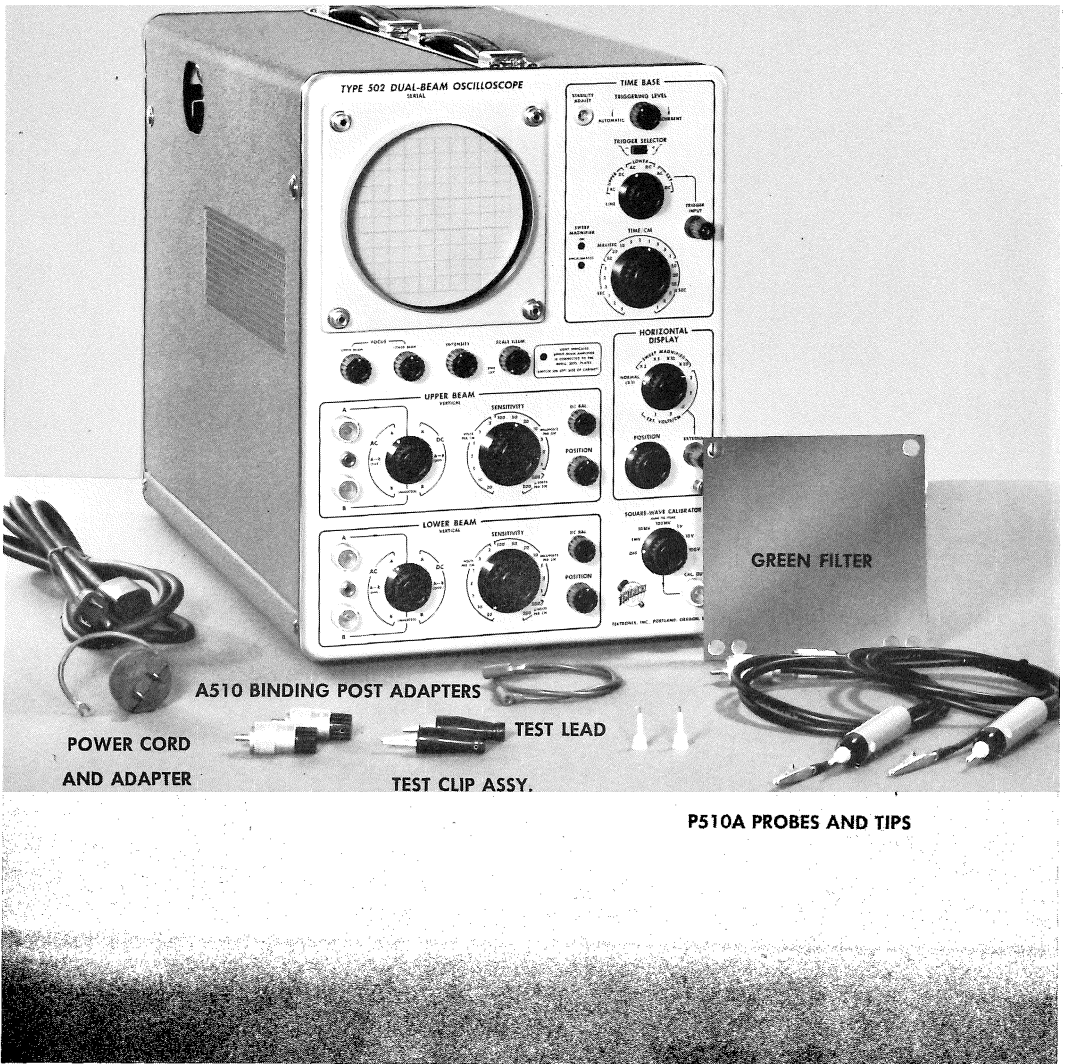

Ⓐ

Fig. 1-1. Type 502 Oscilloscope with accessories.

SPECIFICATIONS

The Tektronix Type 502 Oscilloscope provides linear dual-beam displays with a wide range of sweep rates combined with high input sensitivity. In addition, the Type 502 may be used to provide dual-beam X-Y displays at medium sensitivities, and single-beam X-Y displays at high sensitivities. Vertical amplifiers for both beams may be operated with single-ended inputs for conventional operation, or with differential inputs for cancellation of common-mode signals. The wide range of operational modes available, make the Type 502 adaptable to a great many industrial and scientific applications.

VERTICAL- DEFLECTION SYSTEM

Characteristics at each input terminal

Direct connection—1 megohm paralleled by 47 μmf . With P510A probe—10 megohms paralleled by 14 μmf .

Deflection factors

Sixteen calibrated deflection factors from 200 $\mu\text{v/cm}$ to 20 v/cm accurate within 3%.

Frequency response

Frequency response characteristics of the Type 502 vary with settings of the SENSITIVITY controls. Typical readings are as follows:

200 $\mu\text{v/cm}$	100 kc	1.6
5 mv/cm	200 kc	.8
50 mv/cm	400 kc	.4
.2 v/cm	1 mc	.16

Differential input rejection ratio

The rejection ratios specified below apply if the signal voltage at the Input connector does not exceed specified limits. The signal limits for dc-coupling are ± 2 volts with respect to ground for settings of the SENSITIVITY control from 200 $\mu\text{v/cm}$ to .2 v/cm , ± 20 volts with respect to ground for settings from .5 v/cm to 2 v/cm , and ± 200 volts with respect to ground for settings from 5 v/cm to 20 v/cm . For ac coupling, the signal limits are 2 volts peak-to-peak from 200 $\mu\text{v/cm}$ to .2 v/cm , 20 volts peak-to-peak from .5 v/cm to 2 v/cm , and 200 volts peak-to-peak from 5 v/cm to 20 v/cm . From 200 $\mu\text{v/cm}$ to 1 mv/cm , the rejection ratio is approximately 1000-to-1, decreasing to 100-to-1 at 0.2 v/cm , and to 25-to-1 in the range from .5 v/cm to 20 v/cm .

HORIZONTAL-DEFLECTION SYSTEM

Sweep rates

Twenty-one calibrated sweep rates from 1 $\mu\text{sec/cm}$ to 5 sec/cm . Accuracy typically within 1% of full scale; in all cases, within 3% of full scale.

Magnifier

Expands sweep 2, 5, 10, or 20 times. Calibration of magnified sweep rates accurate within

3% for sweep speeds which do not exceed the maximum calibrated rate of 1 $\mu\text{sec/cm}$.

Unblanking

DC coupled.

Triggering signal requirements

Internal—a signal producing 2 mm vertical deflection on either the upper or lower beam.



External—0.2 volts to 10 volts of either polarity.

Triggering signal sources

Upper beam, lower beam, external, or line.

Input characteristics at TRIGGER INPUT connector

AC coupled—1 megohm in series with 0.01 μ f and paralleled by approximately 33 μ mf.

DC coupled—1 megohm shunted by approximately 33 μ mf.

Horizontal input

With upper beam amplifier connected to crt horizontal deflection plates.

Deflection factors of 200 μ v/cm to 20 v/cm in 16 steps.

With external input connected to horizontal amplifier.

Deflection factors of 0.1 v/cm to 2 v/cm in 5 steps.

Input characteristics at EXTERNAL connector

1 megohm shunted by approximately 70 μ mf.

OTHER CHARACTERISTICS

Cathode-ray tube

Type T60P2—P1, P7, and P11 phosphors optional. Accelerating potential—3 kv minimum.

Voltage calibrator

Square wave output at approximately 1 kc. Six calibrated voltage steps from 1 mv to 100 volts peak-to-peak. Accuracy—within 3%.

Graticule

Edge lighted—marked in 10 vertical and 10 horizontal 1 cm divisions with 2 mm markings on the baselines.

Power requirements

Line voltage—105 to 125 volts, or 210 to 250

volts, 50-60 cycles.

Power—Approximately 300 watts.

Mechanical specifications

Ventilation—filtered, forced-air.

Construction—Aluminum-alloy chassis and three-piece cabinet.

Dimensions—23 $\frac{1}{2}$ " long, 11 $\frac{1}{4}$ " wide, 15" high.

Weight—52 pounds.

Accessories included

2—Type P510A attenuator probes

2—Type A510 binding post adapters

1—Green filter

1—Instruction Manual



PRELIMINARY INSTRUCTIONS

Cooling

A fan maintains safe operating temperature in the Type 502 Oscilloscope by circulating air through a filter and over the components. Therefore, the instrument must be placed so that the air intake is not blocked. The air filter must be kept clean to permit adequate air circulation. If the interior temperature should rise too high, for some reason, a thermal cutout switch will disconnect the power and keep it disconnected until the temperature drops to a safe value.

IMPORTANT: For proper air circulation, the bottom and side panels must be in place. Be sure the bottom panel is installed according to directions.

Power Requirements

The regulated power supplies in the Type 502 will operate with line voltages from 105 to 125

volts, at 117 nominal line volts, or from 210 to 250 volts at 234 nominal line volts. Proportionate line voltage variations apply when other nominal line voltage primary connections are made. For maximum dependability and long life the voltage should be near the center of this range.

Voltages outside of these limits, or poor line-voltage waveforms, may cause hum or jitter on the trace and may cause unstable operation. Be sure to check for proper line voltage if indications such as these are present.

The Type 502 is equipped with a special power transformer. This transformer has a group of primary terminals which allows you to connect the primary windings for use on six different input voltages. The line voltage for which your transformer is connected is indicated on the metal tag at the rear of the instrument. Fig. 2-1 shows the primary connections for all the input voltages.

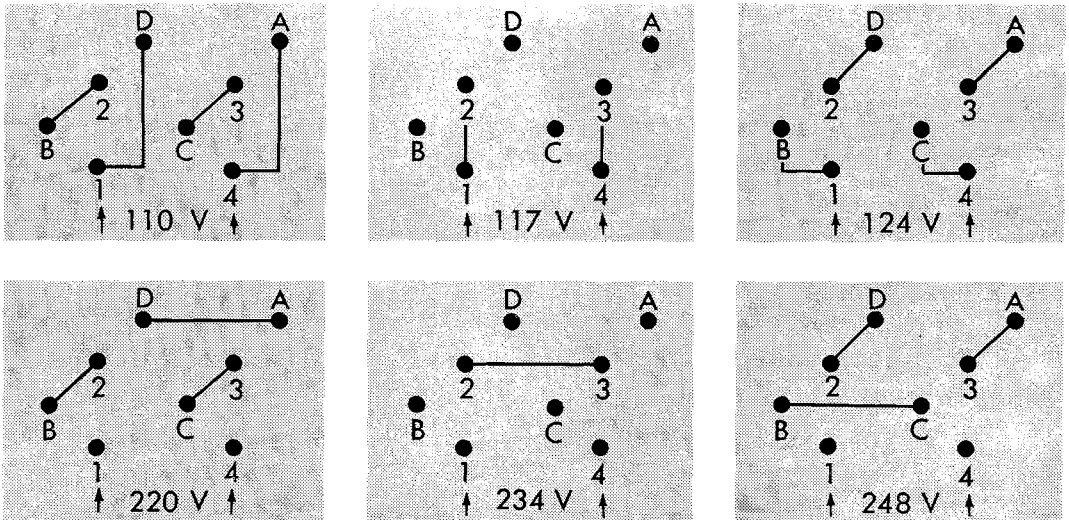

Fig. 2-1. The power transformer has two extra windings permitting nominal primary voltages of 110, 117, 124, 220, 234 or 248 volt, 50 or 60 cycle operation.



Fan Connections

The manner in which the fan is wired depends on the line voltage. For 110-124 volt operation, the fan is connected as shown in Fig. 2-2(a). For 220-248 volt operation, the fan is connected as shown in Fig. 2-2(b).

Fuse Requirements

Use a 3 amp., 3AG, Fast-Blo fuse for 110, 117 or 124 volt 60 cycle operation; for 50 cycles use a 3.2 amp., 3AG, Slo-Blo fuse. For 220, 234 or 248 volt, 60 cycle operation, use a 1.5 amp., 3AG, Fast-Blo fuse; for 50 cycles use a 1.6 amp., 3AG, Slo-Blo fuse.

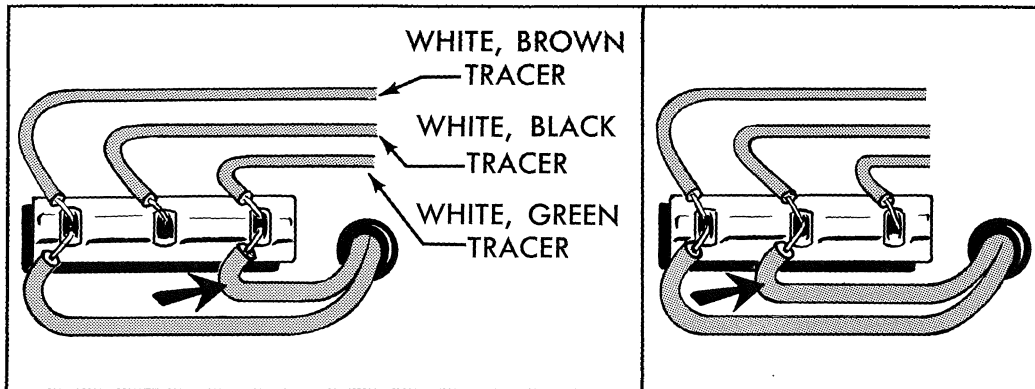
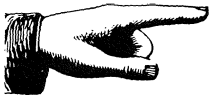
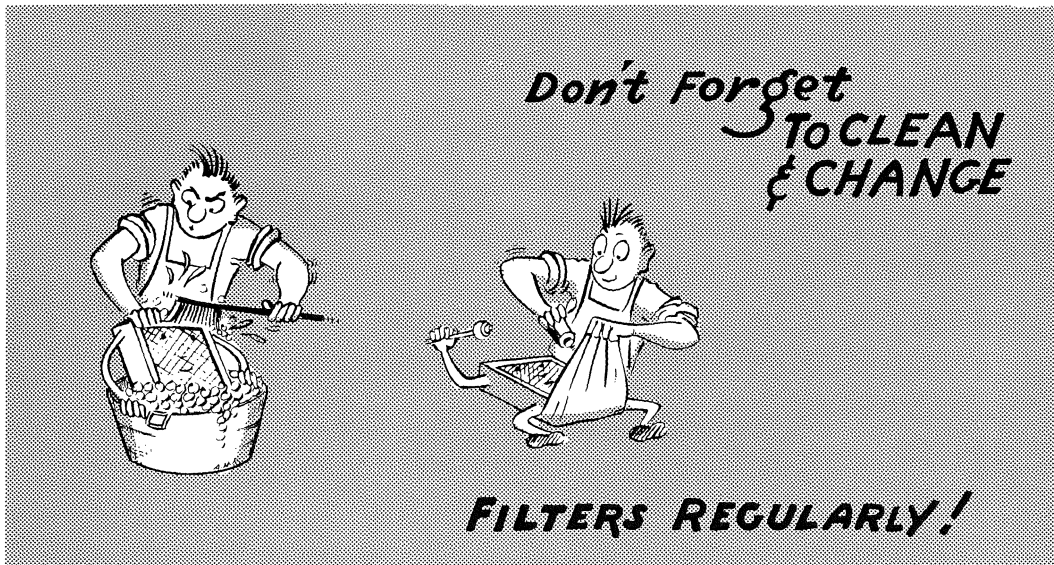

Fig. 2-2 (a). Fan connection for 110-124 volt input.

Fig. 2-2 (b). Fan connection for 220-248 volt input.



REMEMBER . . .



OPERATING INSTRUCTIONS

INPUT SELECTION

On the Type 502 Oscilloscope, you can connect single-ended inputs to either the "A" or "B" input connectors of the lower or upper beam amplifiers by rotating the input selector switches to the corresponding positions. The choice of input connections will depend upon the display desired. Waveforms applied to input "B" are displayed in an inverted position on the face of the crt while waveforms applied to input "A" are displayed in the normal upright position. If you are not aware of this difference in the input connectors, it is probable that you will improperly evaluate the results obtained from an input to the "B" connector.

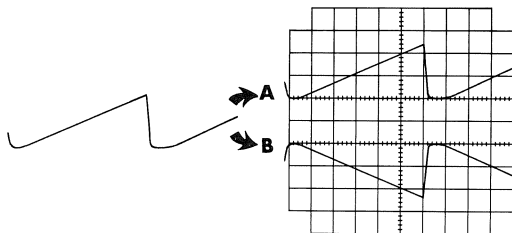

Fig. 3-1. Inputs to the vertical amplifiers.

Waveforms applied to input connector A are displayed in the upright position, while waveforms applied to input connector B are inverted.

Differential inputs must be connected to both the "A" and "B" input connectors of one amplifier. In the A and B positions of the input selector switch, the corresponding waveforms are displayed on the crt. In the A-B (DIFF) position, the "B" input is algebraically subtracted from the "A" input and the difference is displayed. This feature permits you to eliminate common mode signals, and to observe a waveform which is peculiar to one input.

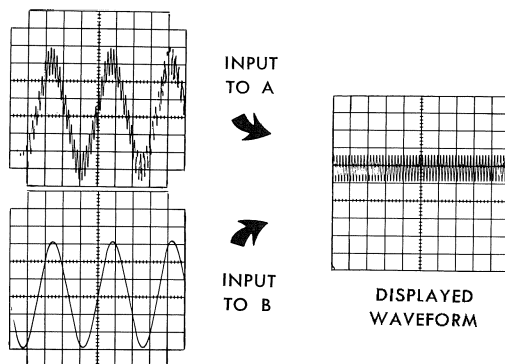

Fig. 3-2. Rejection of a common mode signal by the differential amplifier.

The waveform applied to input connector B is algebraically subtracted from the waveform applied to input connector A and the difference waveform is displayed on the screen of the crt.

INPUT COUPLING

Input signals to the vertical amplifiers can be either ac or dc coupled by placing the input selector switch in the corresponding positions. DC coupling applies both the ac and dc components of the input signal to the vertical amplifier circuits. This permits you to measure the dc voltage level as well as the amplitude of the ac

component. It is sometimes neither necessary nor desirable to display the dc component however, and in such cases ac coupling should be used. With ac coupling, a capacitor is placed in series with the input connector to block the dc component while at the same time allowing the ac component to be displayed.



INPUT CONNECTIONS

Here are some precautions you should observe in connecting your oscilloscope to the signal source.

1. Avoid errors in readings due to stray electric or magnetic coupling between circuits, particularly in the leads connected to the input connector. In general, unshielded leads of appreciable length are unsuited for this use. When shielded leads are used, the shields should be grounded to the oscilloscope chassis and to the chassis of the equipment being tested. Coaxial cables are recommended for many purposes. Special care must be taken in the high sensitivity ranges of the oscilloscope due to the low signal level and high amplifier gain.

2. As nearly as possible, simulate actual operating conditions in the equipment being tested. The equipment should have a load on it which is approximately equal to the load encountered in normal operation.

3. Consider the effect of loading upon the signal source due to the input circuit of the oscilloscope. The circuit at the input connectors can be represented by a resistance of 1 megohm shunted by a capacitance of $47 \mu\text{mf}$. With a few feet of shielded cable, the capacitance may well be $100 \mu\text{mf}$ or more. In many cases, the effects of these resistive and capacitive loads are not negligible, and to minimize them, you might want to use a probe in the manner described in the next section.

USE OF PROBES

An attenuator probe lessens both capacitive and resistive loading while at the same time reducing sensitivity. When making amplitude measurements with an attenuator probe, be sure to multiply the observed amplitude by the attenuation factor of the probe (marked on the probe).

Type P510A Probes are furnished as accessories to the Type 502 oscilloscope. These probes are easily identified by their black, molded-plastic nose. Connected to the input connectors of the oscilloscope, these probes present input characteristics of 10 megohms shunted by $14 \mu\text{mf}$ and have an attenuation factor of 10. The maximum voltage which may be applied to the probe is 600 volts. Exceeding this rating, either in peak ac volts or dc volts, may result in damage to the components inside the probe body.

If the waveform being displayed has rapidly rising or falling voltages, it is generally necessary to clip the probe ground lead to the chassis of the equipment being tested. Select a ground point near the point of measurement.

Before using a probe, always check that it is correctly compensated. An adjustable capacitor in the probe body compensates for variations in input capacitance from one instrument to another. To insure the accuracy of pulse and transient measurements, this adjustment should be checked frequently.

To properly compensate the probe, set the SQUARE-WAVE CALIBRATOR control for a suitable amplitude. Touch the probe tip to the CAL. OUT connector and adjust the oscilloscope controls to display several cycles of the waveform. Adjust the probe capacitor for the best possible square wave.

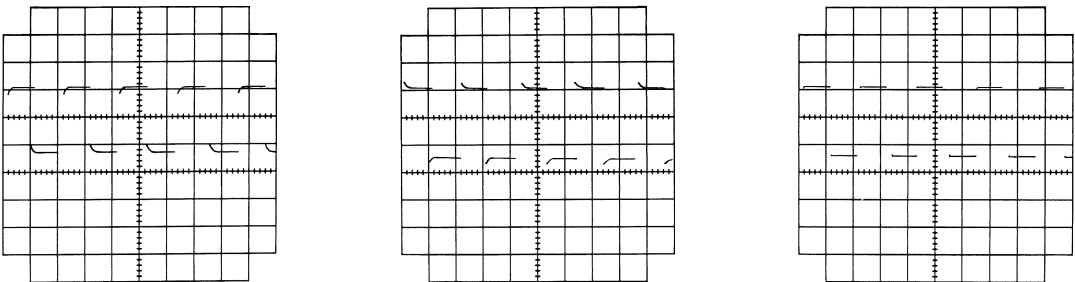

Fig. 3-3. Compensating the probe.

When the variable capacitor in the probe body has been adjusted properly, the Calibrator waveform will be undistorted.

TRIGGERED OPERATION

In order to obtain a stable display of some recurrent waveform, it will be necessary for you to trigger the horizontal sweep at the correct instant of time. This will insure that the sweep will start at the same point on the observed waveform for each cycle of operation. The sweep should be triggered either by some waveform bearing a fixed time relationship to the observed waveform or by the observed waveform itself. Either method will produce the desired stable display. If the waveform which is applied to the upper beam and the waveform which is applied to the lower beam have a definite time relationship to each other it is possible to trigger from either beam and obtain simultaneously a stable display of both waveforms.

The following instructions tell you how to select the proper triggering signal for various applications of your oscilloscope. These instructions also provide information about the advantages and limitations of each triggering mode. You should attempt to become thoroughly familiar with all of the various triggering modes in order that you may obtain maximum use from your instrument. A thorough knowledge of the triggering modes will allow you a greater selection of triggering methods when you are confronted with a definite triggering problem.

How to select the triggering signal source.

1. To trigger the sweep from the waveform displayed on the upper beam, set the TRIGGER SELECTOR switch at UPPER AC or UPPER DC.
2. To trigger the sweep from the waveform displayed on the lower beam, set the TRIGGER SELECTOR switch at LOWER AC or LOWER DC.
3. To trigger the sweep at the power line frequency, set the TRIGGER SELECTOR switch at LINE. You would normally use this mode of triggering when you are observing a waveform which bears a fixed time relationship to the power-line frequency.
4. To trigger the sweep from some external waveform bearing a definite time relationship to the observed waveform, connect the external waveform to the TRIGGER INPUT connector and set the TRIGGER SELECTOR switch at EXT AC or EXT DC. External triggering provides definite advantages over other modes of triggering in certain cases. With external triggering, the triggering signal generally remains essentially con-

stant in amplitude and shape. It is thereby possible to observe the shaping and amplification of a signal by each stage of a circuit without resetting the triggering controls for each observation. Also time and phase relationships between the waveforms at different points in the circuit can be seen. If, for example, the external triggering signal is derived from the waveform at the input to a circuit, the time relationship and phase of the waveforms at each point in the circuit are automatically compared to the input signal by the display presented on the face of the crt.

How to select the triggering mode.

Automatic Mode

Automatic triggering is obtained by rotating the TRIGGERING LEVEL control fully counter-clockwise to the AUTOMATIC position. This mode provides a preset triggering level which is set to allow triggering at the average voltage point of the applied waveform. Also, the sweep runs at approximately a 50 cycle rate when no triggering signals are applied. Automatic triggering can be used with triggering signals obtained from the LINE, UPPER, LOWER, or EXT positions of the TRIGGER SELECTOR switch, but for most waveforms, it is useful only for triggering at frequencies above approximately 50 cycles. Automatic triggering saves considerable time in observing a series of waveforms since it is not necessary to reset the triggering level for each observation. For this reason, it is the mode that is normally used. Other modes are normally used only for special applications or where stable triggering is not attainable in the automatic mode.

DC Mode

The dc mode is selected in the UPPER DC, LOWER DC, and EXT DC positions of the TRIGGER SELECTOR switch. This mode of triggering is particularly useful in triggering from waveforms which are not adaptable to the ac mode, such as random pulse trains or very low frequency waveforms. Random pulse trains pose a special problem in the ac mode since the random occurrence of the input waveforms causes the average voltage level to shift. This in turn may cause the triggering level to shift to an unstable point. This problem is not encountered in the dc mode since the triggering point is determined only by instantaneous voltages.



Note: In this illustration of the TRIGGERING LEVEL control, the AUTOMATIC and RECURRENT positions are not shown. The "UPPER Region" and "LOWER Region" shown in the illustration do not actually appear on the front panel, but are assumed here to aid in understanding the operation of the TRIGGERING LEVEL control.

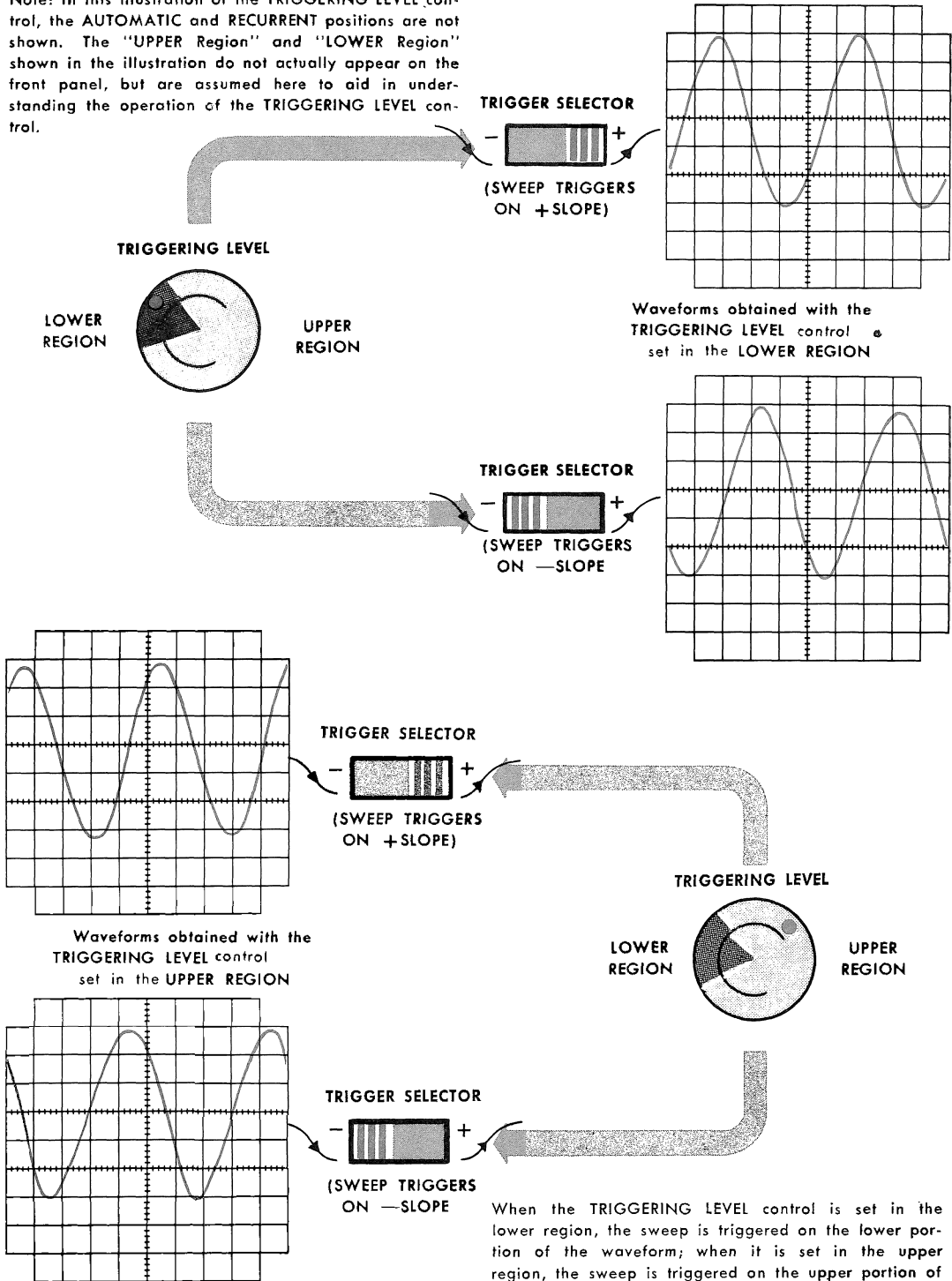

Fig. 3-4. Effects of TRIGGERING LEVEL and TRIGGER SELECTOR control settings.

When the TRIGGERING LEVEL control is set in the lower region, the sweep is triggered on the lower portion of the waveform; when it is set in the upper region, the sweep is triggered on the upper portion of the waveform. The TRIGGER SELECTOR switch determines whether the sweep is triggered on the rising (+ slope) portion, or the falling (-slope) portion of the waveform.

In the dc mode, when the triggering signal is obtained from either the lower or the upper beam amplifiers, varying the respective vertical position controls will change the triggering point. For this reason, you may find it necessary to readjust the TRIGGERING LEVEL control when you change the vertical position of the trace. If you desire to eliminate this effect, you can use the ac mode providing the triggering signal is otherwise suitable for this mode of operation. In the dc mode, the dc level of external triggering signals will also effect the triggering point. Generally, when the triggering signal is small compared to its dc level, the ac mode should be used.

AC Mode

The ac mode is selected in the LINE, LOWER AC, UPPER AC, and EXT AC positions of the TRIGGER SELECTOR switch. This mode provides stable triggering on virtually all types of waveforms. As a general rule, however, the ac mode is unsatisfactory for triggering with low amplitude waveforms at frequencies below approximately 15 cycles. This figure will vary depending upon the amplitude and shape of the triggering waveform and should not therefore be set as an absolute standard. Triggering at frequencies below 15 cycles can be accomplished when higher amplitude triggering signals are used.

In the ac mode, the triggering point depends on the average voltage level of the triggering signals. If the triggering signals occur at random, the average voltage level will vary causing the triggering point to also vary. This shift of the triggering point may be enough so that it is impossible to maintain a stable display. In such cases you should use the dc mode.

How to select triggering slope.

If you wish to trigger the sweep on the rising (positive slope) portion of the triggering waveform, place the TRIGGER SELECTOR switch at +. If you wish to trigger on the falling (negative slope) portion of the triggering waveform, place the TRIGGERING SELECTOR switch at —.

How to set the triggering level.

In the ac and dc triggering modes, the TRIGGERING LEVEL control determines at which point on the triggering signal that the sweep is triggered. Using this control, the sweep can be continuously triggered at any point on the waveform so long as the slope of the waveform is great enough to provide stable triggering. In the DC mode, the sweep cannot be triggered with any degree of stability at the top of a square wave, for example, because the time that the voltage remains constant is comparatively long. As a result, the sweep triggers at random points along the top of the square wave producing considerable trace jitter.

You can use the same method to set the TRIGGERING LEVEL control for either the ac or dc mode. After selecting the triggering slope, rotate the TRIGGERING LEVEL control fully counterclockwise to the AUTOMATIC position. Then rotate the TRIGGERING LEVEL control clockwise until the sweep no longer triggers. Continue to rotate the control in the clockwise direction until the sweep again triggers and a stable display is obtained. Further rotation of the control in the clockwise direction causes the sweep to trigger at more positive points on the triggering waveform. See Figure 3-4.

FREE-RUNNING OPERATION

With the Type 502, you can get a periodic, free-running sweep, independent of any external triggering or synchronizing signal by rotating the TRIGGERING LEVEL control fully clockwise to the

RECURRENT position. This permits you to observe the upper- and lower-beam traces without an input signal.



MAGNIFIER

To expand a particular part of the display horizontally, first use the Horizontal POSITION control to position that part of the display so that it falls at the center of the graticule. Then turn the HORIZONTAL DISPLAY switch to the magnification desired. The portion of the display at the center of the graticule will then be

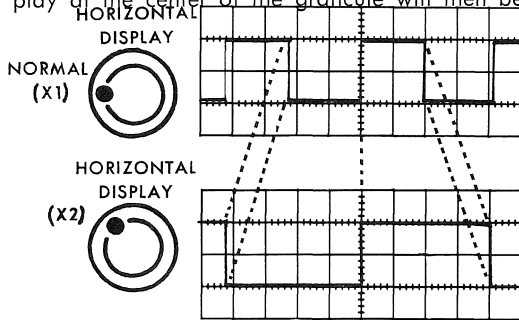

Fig. 3-5. Magnified sweep.

The portion of the waveform at the vertical centerline remains stationary as the sweep is magnified. The displayed waveform is expanded left and right from the centerline. The lower waveform is a two times magnification of the upper waveform.

expanded 2, 5, 10, or 20 times depending on the setting of the HORIZONTAL DISPLAY switch. At the same time, the SWEEP MAGNIFIER ON indicator lamp will light, indicating that the display has been expanded. Any portion of the original unmagnified display can then be shown by rotating the Horizontal POSITION control.

In magnified sweep operation, the sweep speed is multiplied by the magnification. This means that the time per centimeter indicated by the TIME/CM switch must actually be divided by the magnification to obtain the correct time required for the sweep to move one centimeter. For example, if the TIME/CM switch is set at 5 MILLISEC, and the magnifier is set at 5X, the true time per centimeter is 5 milliseconds divided by 5, or 1 millisecond per centimeter.

Magnified sweep rates are all calibrated within 3% accuracy so long as their true time per centimeter is 1 microsecond or more. Sweep speeds faster than this are uncalibrated and may be nonlinear. The SWEEP MAGNIFIER UNCALIBRATED indicator lamp lights whenever the maximum calibrated sweep speed is exceeded to indicate that the sweep is uncalibrated.

EXTERNAL HORIZONTAL INPUT

On the Type 502, it is possible to horizontally deflect one or both of the spots across the screen by means of some externally derived waveform, rather than by means of the internal sweep circuits. This permits the oscilloscope to be used for either single or dual-beam X-Y curve tracing.

For single-beam applications where equal horizontal and vertical-deflection factors are desirable, the upper-beam amplifier can be switched to the crt horizontal-deflection plates by placing the HORIZ. DEF. PLATE SELECTOR switch at the UPPER BEAM AMP. position. This type of operation provides 200 $\mu\text{v}/\text{cm}$ to 20 v/cm sensitivity

and differential input for both horizontal and vertical deflection. The lower beam is used for this function while the upper beam is automatically positioned off of the screen. A panel light indicates when the upper-beam amplifier is connected to the horizontal-deflection plates.

For dual-beam applications, an external waveform can be applied to the horizontal amplifier by connecting the waveform to the EXTERNAL jack. The horizontal deflection sensitivity is controlled by the setting of the HORIZONTAL DISPLAY switch.



VOLTAGE MEASUREMENT

Accurate voltage measurements of inputs to the vertical amplifiers can be made using the calibrated deflection factor feature of the Type 502. The following instructions tell you how to use the oscilloscope for this purpose and how to obtain the greatest possible accuracy in your measurements. It is important that proper techniques be used in order that errors are not introduced in the results.

During voltage measurements, you should always display the waveform across as much of the crt face as is possible since, as a general rule, the accuracy of your measurements will increase as the vertical size of the displayed waveform is increased. In measuring voltages, it is important to remember that the width of the trace may be appreciable part of the overall measurement and care should be used that the trace width is not included in the vertical deflection readings that you obtain. You should consistently make all your readings from one side of the trace. If the bottom side of the trace is used for one reading, it should be used for all succeeding readings.

How to measure the ac component of a waveform.

For measuring the ac component of a waveform, ac coupling is normally used since it is usually not advantageous to display the dc component of the waveform being measured. AC component voltage measurements can usually be made with dc coupling also, but there is normally no particular advantage in doing so. To obtain peak-to-peak voltage measurement, perform the following steps:

1. Through the use of graticule, measure the vertical distance in centimeters from the level of the positive peak to the level of the negative peak.
2. Multiply the setting of the SENSITIVITY control by the distance measured to obtain the indicated voltage.
3. Multiply the indicated voltage by the attenuation factor of the probe you are using to obtain the true peak-to-peak voltage.

As an example of this method, assume that using a 10X probe and a sensitivity of 1 volt per centimeter, you measure a total vertical distance between peaks of 4 centimeters. In this case then, 4 centimeters times 1 volt per centimeter

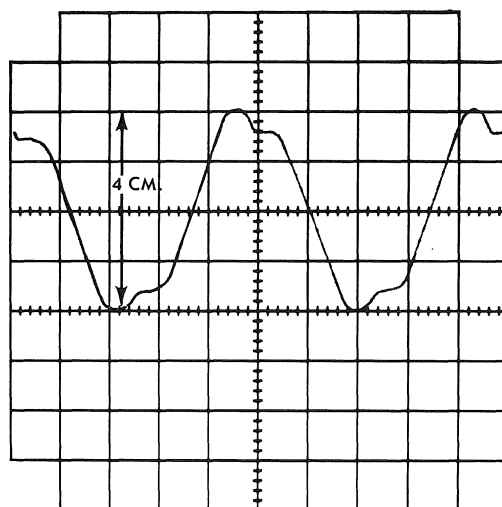

Fig. 3-6. Voltage measurement of the ac component of a waveform.

The vertical distance between peaks is multiplied by the setting of the SENSITIVITY control and by the probe attenuation factor to obtain the voltage measurement.

gives you an indicated voltage of 4 volts peak-to-peak. The indicated voltage times the probes attenuation factor of 10 then gives you the true peak-to-peak amplitude of 40 volts. The peak-to-peak sinusoidal voltage can then be converted to peak, rms, or average voltage through use of standard conversion factors.

How to measure instantaneous voltages.

The method used to measure instantaneous voltages is very similar to the method described previously for ac component voltage measurements except that for instantaneous voltage measurements, a reference line must be established on the crt screen. The actual voltage measurement is taken with respect to this reference line. If, for example, the voltage measurement is to be made with respect to +100 volts, the reference line would correspond to +100 volts. In the following procedure the method is given for establishing this reference line as ground since measurements with respect to ground are by far the most common type made. The same general method may be used to measure voltage with respect to any other potential, however, so long as that potential is used to establish the reference line.



CAUTION

To prevent saturation of the vertical amplifiers, the peak voltage to ground at any amplifier input connector must not exceed 200 volts on the 5, 10, and 20 VOLTS PER CM ranges; 20 volts on the .5, 1, and 2 VOLTS PER CM ranges; and 2 volts on all other ranges.

To obtain a voltage measurement with respect to ground, perform the following steps:

1. To establish the reference line, touch the probe tip to the oscilloscope ground terminal, and rotate the TRIGGERING LEVEL control fully clockwise to the RECURRENT position.
2. Vertically position the trace to a convenient point on the face of the crt. (This point will depend upon the polarity and amplitude of the input signal, but it should always be chosen so that the trace lies along one of the major divisions of the graticule. The graticule division corresponding to the position of the sweep is known as the ground reference line. (Do not adjust the vertical positioning control after this reference point has been established.)
3. Remove the probe tip from ground and connect the probe to the signal source. Adjust the TRIGGERING LEVEL control for a stable display.
4. Measure the vertical distance in centimeters from the point to be measured to the ground reference line by use of the graticule.
5. Multiply the setting of the SENSITIVITY control by the distance measured to obtain the indicated voltage.
6. Multiply the indicated voltage by the attenuation factor of the probe you are using to obtain the true voltage with respect to ground.

As an example of this method, assume that you are using a 10X probe and a sensitivity of .2 volts per centimeter and that after setting the reference line at the bottom of the graticule, you

measure a distance of 8 centimeters to the point you wish to measure. In this case then, 8 centimeters times .2 volts per centimeter gives you an indicated voltage of 1.6 volts. Since the voltage point is above the ground reference line, the polarity is indicated to be positive. The indicated voltage times the probes attenuation factor of 10 then gives you the true voltage of positive 16 volts.

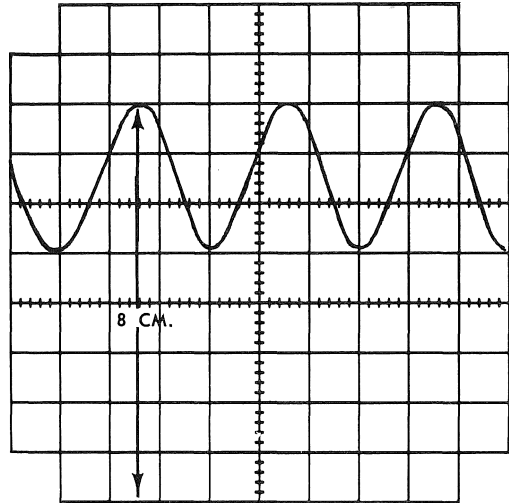

Fig. 3-7. Measuring the instantaneous voltage.

The vertical distance from the point of measurement to a pre-established reference line is multiplied by the setting of the SENSITIVITY control and by the attenuation factor of the probe to obtain the voltage measurement.

You should remember in determining the polarity of voltages measured in this fashion that inputs applied to the "B" input connectors are inverted on the face of the crt. Consequently, the apparent polarity of these inputs is opposite the true polarity. To prevent possible confusion as to polarity it is usually best to use the "A" input connectors for voltage measurements with respect to ground.

TIME MEASUREMENT

Accurate elapsed time or time interval measurements can be made by utilizing the calibrated timebase feature of the Type 502 Oscilloscope. The sweeps are calibrated so that the beams are deflected across the screen at known rates. Since the beam travels completely across the screen in a known period of time, the time re-

quired for the beam to travel any portion of that distance can be determined. By measuring the horizontal distance between points on the displayed waveform, and by knowing the sweep rate, you can determine the time interval between the two points. You should use the same precautions in finding the horizontal distance as

were used in finding the vertical distance for voltage measurements. The method for measuring a time interval is as follows:

1. Using the graticule, measure the horizontal distance in centimeters between the points whose time interval you wish to find.
2. Multiply the distance measured by the setting of the TIME/CM control to obtain the apparent time interval.
3. Divide the apparent time interval by the magnification indicated by the setting of the HORIZONTAL DISPLAY switch to obtain the correct time interval.

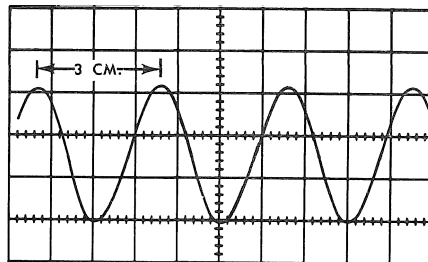

Fig. 3-8. Measuring the time interval (period) of one complete cycle of a periodically recurrent waveform. The horizontal distance in centimeters of one complete cycle (in this case 3 centimeters) is multiplied by the setting of the TIME/CM control and is divided by the setting of the sweep magnification to obtain the time interval. The frequency of the waveform is the reciprocal of its time interval.

FREQUENCY MEASUREMENT

The frequency of a periodically recurrent waveform can be determined if the time interval (period) of one complete cycle of the waveform is known. This time interval can be measured by

means of the procedure described in the preceding paragraph. The frequency of a waveform is the reciprocal of its time interval.

DC BALANCE ADJUSTMENT

If the trace moves vertically as the SENSITIVITY control is rotated, this indicates a need to readjust the DC BAL control. This control is used to compensate for any dc unbalance in the vertical amplifier. This unbalance will be particularly noticeable on the high sensitivity ranges of the SENSITIVITY control. To adjust the DC BAL control, ground the oscilloscope input, place the SENSITIVITY control at 20 VOLTS PER CM, and rotate the TRIGGERING LEVEL control to the RECURRENT position. Set the DC BAL control at mid range and position the sweep so that it lies

under the proper base line. Rotate the SENSITIVITY control to the 200 μ VOLTS PER CM position, pausing at each range to adjust the DC BAL control so that the trace remains on the base line. (If the DC BAL control does not have sufficient range, it will be necessary to readjust the appropriate COARSE DC BAL control located inside the instrument. See the Calibration Procedure, Section 6.) The trace should now remain stationary as the SENSITIVITY control is turned through its entire range of positions.

AUXILIARY FUNCTIONS

Calibrator

The calibrator is a source of accurately calibrated square waves at a frequency of approximately 1 kilocycle ($\pm 30\%$). The output amplitude is accurate within 3% of the SQUARE-WAVE CALIBRATOR switch settings for no load conditions. The primary function of the calibrator is to provide a convenient method for check-

ing the calibration of the vertical-deflection system and for adjusting the probes. It can be used for other purposes, however, if certain limitations are kept in mind.

NOTE

All output impedance figures given for the calibrator are made with the assumption that the output cathode follower is conducting.



The output impedance of the calibrator varies with the output-voltage setting. It is as low as 10 ohms in the 1 MV position of the SQUARE-WAVE CALIBRATOR switch and as high as 1.8 kilohms in the 10 V position. In the 100 V position, the output impedance is approximately 170 ohms when the circuit is loaded by a resistance

TABLE I

Approximate Output Impedance	SQUARE-WAVE CALIBRATOR switch setting
*170 ohms	100 V
1.8 kilohms	10 V
200 ohms	1 V
900 ohms	100 MV
100 ohms	10 MV
10 ohms	1 MV

*Do not load with less than 4 kilohms.

Trace-brightness (intensity) modulation

To couple markers or other signals into the crt cathodes for trace-brightness modulation, disconnect the ground strap at the rear of the instrument and apply the signal between the CRT CATH binding post and GND. This will simultaneously apply the signals to the upper and lower beam cathodes. At normal brightness, positive signals of about 25 volts will cut the beams off. Always replace the ground strap when you are not intensity modulating the beams.

Graticule illumination

The graticule lighting control, labeled SCALE ILLUM, can be adjusted to suit the lighting conditions of the room. A green filter is supplied with the instrument which can be used for increased contrast. This filter should be mounted next to the crt screen so it does not block the light from the graticule lines.

The graticule of the Type 502 Oscilloscope can be illuminated so that it appears to have either red or white graticule markings. The markings can be quickly changed from white to red or from red to white by removing the graticule cover and inverting the graticule. As a general rule, white graticule lines are superior to red for photographic purposes.

Direct connection to crt plates

In some applications, it may be desirable to connect a signal directly to one or more sets of

of not less than four kilohms. When the switch is at any position other than 100 V, the output may be loaded with any impedance without damaging the components. See Table 1 for the approximate output impedance for each position of the SQUARE-WAVE CALIBRATOR switch.

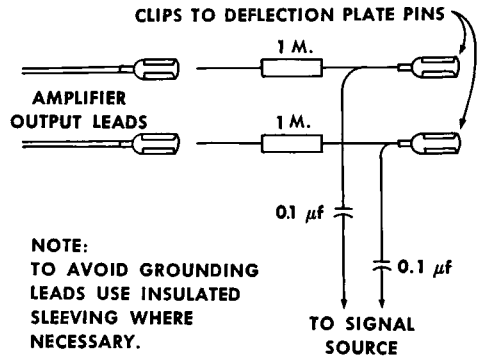

Fig. 3-9. Typical circuit for ac coupling to the crt deflection plates.

crt deflection plates—bypassing the internal oscilloscope amplifiers. This can be done in the Type 502 if certain precautions are observed. One of these precautions is to maintain the average dc voltage on the deflection plates at approximately +225 volts. If the average voltage is not maintained at approximately +225 volts, the crt display may be defocused.

For many applications, ac coupling of the signal to the deflection plates is permissible. It has the advantage of allowing the use of frontpanel controls to position the display and permits the display of signals not having the required average voltage level. A diagram of this method of coupling is shown in Figure 3-9. Here, the leads from the oscilloscope amplifier are removed and a resistor is connected between each lead and its respective crt pin. A good value for this resistor in most cases is 1 megohm. The vertical deflection plate pins are located on the sides of the crt neck and the horizontal deflection plate pins are located on the top of the neck.

A convenient method for connecting the resistors to the crt pins is to use clips removed from standard miniature tube sockets. Before connecting the resistors to the leads from the amplifier, slip a piece of insulated sleeving (spaghetti) over the wire. Then, after making the connections, draw the sleeving back over the insulated resistor pigtail. This will prevent the leads from accidentally shorting to the chassis. The crt pins are



easily bent and you must exercise care when making these connections to avoid breaking the pins.

CAUTION

Do not allow the leads from the oscilloscope amplifiers to touch the chassis when the power is on. A short circuit of this type can damage the amplifier circuits.

If it is desired to couple the signal directly to the crt plates (dc coupling), it will be necessary

to supply positioning voltages from the signal source. These voltages must also satisfy the requirement of an average level of +225 volts, mentioned previously. To dc couple the signal to the deflection plates, remove the leads from the crt pins and fold them back, out of the way. Taping the ends of the wires will prevent accidental shorting to the chassis. Connect the external signal source to the pins of the crt.

The vertical deflection factor of the crt is approximately 13 volts per centimeter. The horizontal deflection factor is approximately 17 volts per centimeter.

FUNCTIONAL DESCRIPTION OF CONTROLS, INDICATORS, AND CONNECTORS

TIME BASE

TRIGGERING LEVEL. Selects the voltage point on the triggering waveform where the horizontal sweep is triggered. This control also selects automatic triggering (AUTOMATIC position) or allow the sweep to free-run (RECURRENT position).

TRIGGER SELECTOR slope. Determines whether triggering occurs on the rising portion (+ slope) or on the falling portion (-slope) of the triggering waveform.

TRIGGER SELECTOR. Selects the triggering signal from the upper beam, the lower beam, the line, or from an external signal applied

at the TRIGGER INPUT connector. The control also selects either the ac or dc mode.

TIME/CM. Selects the desired horizontal sweep speed from a choice of twenty-one sweep rates.

SWEEP MAGNIFIER ON. Indicates that the sweep magnifier is on.

SWEEP MAGNIFIER UNCALIBRATED. Indicates that the horizontal sweep is uncalibrated since the sweep rate is in excess of the 1 μ sec/cm maximum calibrated sweep rate.

TRIGGER INPUT. Input connector for external triggering signals.

HORIZONTAL DISPLAY

HORIZONTAL DISPLAY. Selects 1, 2, 5, 10, or 20 times horizontal magnification of the displayed waveform. Also controls horizontal sensitivity for external inputs applied at the EXTERNAL connector.

POSITION. Positions both the upper and lower beams horizontally.

EXTERNAL. Input connector for external signals which are applied to the horizontal amplifier.



UPPER-AND LOWER-BEAM VERTICAL

SENSITIVITY. Selects the sensitivity of the vertical amplifier.

DC BAL. Used to balance the vertical amplifier on the high sensitivity ranges of the SENSITIVITY control.

POSITION. Positions the trace vertically.

Input Selector. Connects inputs from selected input connector(s) to the vertical amplifier

and also selects either ac or dc coupling of the input signal.

A. One of two input connectors to the vertical amplifier. Inputs applied to this connector are displayed in the upright position.

B. One of two input connectors to the vertical amplifier. Inputs applied to this connector are displayed in an inverted position.

MISCELLANEOUS

UPPER BEAM FOCUS. Used to focus the upper beam.

LOWER BEAM FOCUS. Used to focus the lower beam.

INTENSITY. Controls the intensity of both the upper and lower beams.

SCALE ILLUM. Controls the illumination of the graticule and is the power switch for the instrument.

Upper Beam Amplifier Connection Indicator. When lit, this light indicates that the upper beam amplifier output is connected to the horizontal deflection plates.

SQUARE-WAVE CALIBRATOR. Controls the amplitude of the calibration voltage applied at the CAL OUT connector.

CAL. OUT. Output connector for the calibration voltage selected by the SQUARE-WAVE CALIBRATOR switch.

HORIZ DEF PLATE SELECTOR. In the TIME BASE AMP position, this switch connects the output of the horizontal amplifier to the

horizontal deflection plates for normal operation. When the switch is in the UPPER BEAM AMP position, the upper beam vertical amplifier output is connected to the horizontal deflection plates.

GAIN ADJ FOR HORIZ MODE. Gain adjustment control for the upper beam vertical amplifier when the amplifier is connected to the horizontal deflection plates. This control provides compensation for differences between the vertical and horizontal deflection factors of the crt.

CRT CATHODE. Connector at the rear of the instrument for application of beam-intensity modulation voltages. The intensity modulation signals are simultaneously applied to cathodes of both guns. When not in use, this connector should be jumpered to the GND connector with the grounding strap provided.

GND. Connector on the rear of the instrument which is used to provide a ground connection to the CRT CATHODE connector.



CIRCUIT DESCRIPTION

INTRODUCTION

The Type 502 is a dual-beam, high-gain, narrow-band oscilloscope employing a T60-type dual-gun cathode-ray tube. The instrument has identical Vertical Deflection Amplifiers, one for the Upper Beam and one for the Lower. Simultaneous horizontal deflection of both beams is provided by a single Time-Base Generator and Horizontal Sweep Amplifier circuit.

The Type 502 circuitry is arranged so that the instrument can be used in any of several configurations. It may be used as a conventional single-beam oscilloscope by applying an input signal to either of the Vertical Deflection Amplifiers.

It may be used to examine two waveforms simultaneously by applying input signals to both Vertical Amplifiers. Both deflection amplifiers may be used in a differential mode, to examine the difference between, or the algebraic sum of, two signals. The Upper Beam Deflection Amplifier can be connected to the horizontal deflection plates, so that the instrument may be employed as single-beam X-Y oscilloscope. And, by means of the EXTERNAL horizontal-input connector, the instrument may be used as a dual-beam X-Y oscilloscope, with both traces plotted on the same X scale.

VERTICAL DEFLECTION AMPLIFIERS

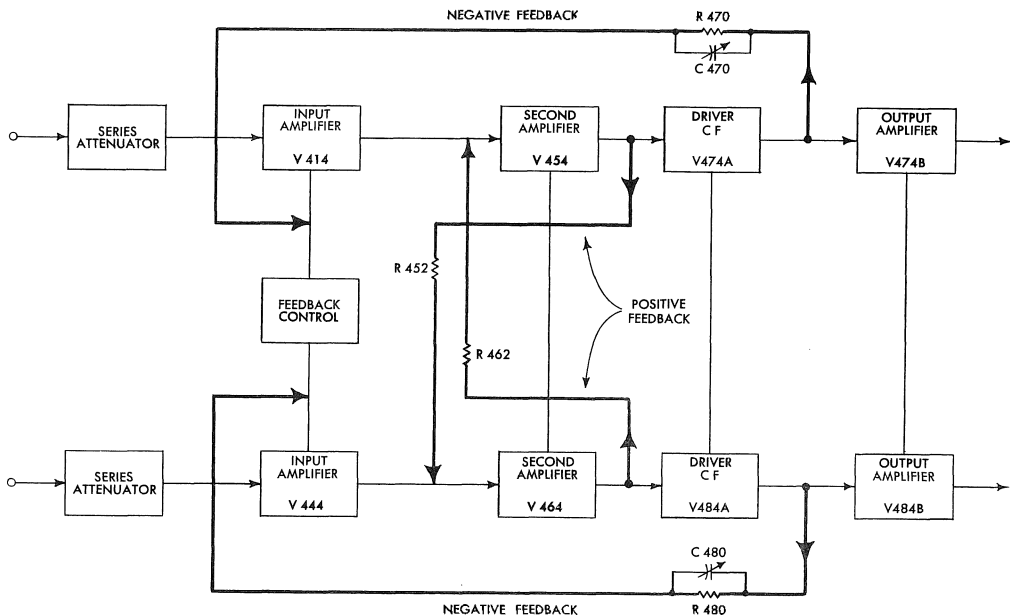

Fig. 4-1. Block diagram of the Vertical Amplifier, illustrating the feedback loops.



The Upper Beam and the Lower Beam Vertical Deflection Amplifiers are identical, so the description that follows applies to both.

General Description

The push-pull Vertical Amplifier consists of three stages of amplification, the Input Amplifier, the Second Amplifier and the Output Amplifier, and a cathode-follower stage to drive the Output Amplifier. The overall gain of the Amplifier is controlled by two feedback networks, one providing negative feedback and the other positive feedback (see Fig. 4-1). The Input Amplifier is a cathode-coupled paraphase amplifier (it may also be operated differentially) whose gain is controlled by negative feedback from the cathodes of the Driver C.F. stage. The Second Amplifier has a positive feedback network that extends from the plate circuit on one side to the grid circuit on the other; this configuration makes this stage an almost "infinite-gain" amplifier. The result of both feedback networks is an amplifier having a sensitivity of 200 microvolts/centimeter.

The Input Circuit

The Input Selector switch SW403 determines the mode of operation for the Amplifier. When in any of the three positions marked AC the signal is ac-coupled through C400 (for Input A) and/or C401 (for Input B). When in any of the three positions marked DC the input capacitor (C400 or C401) is bypassed and the signal is dc-coupled to the Input stages.

The sensitivity of the Vertical Amplifier, as mentioned previously, is 200 microvolts per centimeter. However, by means of attenuation and degeneration networks, the vertical deflection factor can be increased to 20 volts per centimeter.

Either of two attenuation networks can be connected in series with the Input connectors of the Vertical Amplifiers, one attenuates the signal by a factor of 10, the other by 100. For dc and low frequency signals, these networks are resistance dividers, and the degree of attenuation is proportional to the ratio of the resistance values. The reason for this is that the impedance of the capacitors, in this range of frequencies, is so high that their effect in the circuit is negligible. For higher-frequency signals, however, the impedance of the capacitors is less and their effect in the circuit is more pronounced. Near the upper-frequency range of the Amplifier the impedance of the capacitors becomes so low, com-

pared to the resistance of the circuit, that the attenuators become capacitance dividers. For these frequencies the degree of attenuation is inversely proportional to the capacitance ratio.

In addition to providing the proper degree of attenuation, the resistance values of the attenuators are chosen so as to provide the same input resistance, regardless of the setting of the SENSITIVITY switch. For example, in the "straight through" positions of the Input Selector switch (200 $\mu\text{v}/\text{cm}$ to .2-v/cm), the 1-megohm grid resistors...R410 for Input A and R440 for Input B... constitute the input resistance of the Vertical Amplifiers. In the range from .5v/cm to 2v/cm, the X10 Attenuator is connected into the input circuit. The resistor in the low end of the divider...R406E for Input A and R407E for Input B... shunts the grid resistor to create an equivalent resistance of 100 K ohms. This 100-K equivalent resistance is then in series with the resistor in the high side of the divider (900 K ohms) to produce a total input resistance of 1 megohm. The X100 attenuator works in the same manner. The 10.1-K resistor at the lower end of the divider shunts the 1-meg grid resistor to form an equivalent resistance of 10 K ohms. This equivalent resistance is then in series with the 990-K resistor in the upper side of the divider to create a total input resistance of 1 megohm.

The capacitance values in the attenuators are also selected to provide a constant input capacitance...47 μmf ...regardless of the setting of the SENSITIVITY control. In the "straight through" positions of the switch, the total input capacitance is equal to the capacitance of C410 (or C440 for Input B) plus the tube and stray capacitance. C410 is then adjusted so that the total input capacitance is 47 μmf .

When the X100 attenuator is connected into the circuit, C406L (or C407L for Input B) shunts the 47 μmf capacitance. This value of capacitance is then reduced to a very small value by series capacitor C406J (or C407J). The capacitor at the input to the attenuator then shunts this small capacitance, and is adjusted to make the total capacitance 47 μmf . The X10 attenuator is designed in the same manner, except that stray capacity forms the lower branch of the divider.

Since the attenuator networks are frequency-compensated voltage dividers, a constant attenuation ratio is maintained from DC to the upper-frequency limits of the Vertical Amplifiers.

The Input Amplifier

When the Input Selector switch is in the A position (either AC- or DC-coupled) the grid of



V414 is connected to the input circuit and the grid of V444 is returned to ground either through the switch or through one of the series attenuator networks. When in position B (AC or DC), V444 is the input tube and V414 is the grounded-grid tube. With either of these configurations, the Input Amplifier is a cathode coupled, paraphase amplifier; it converts a single-ended input signal to a push-pull output signal.

The cathode resistor R408 plays an important role in determining the amount of negative feedback applied to the Input Amplifier stage. As mentioned previously, this feedback voltage comes from the cathodes of the Driver C.F. stage (actually, from the output of the Second Amplifier stage). The feedback is applied through a divider consisting of R470 on one side and R408, and R480 on the other side and R408. The smaller the value of R408 the greater the drop across the series resistors (R470 and R480) and the less the negative feedback applied to the Input Amplifier stage. Conversely, the greater the value of R408 the greater the drop across it and the greater the negative feedback. Thus, for very small input voltages, when the SENSITIVITY switch is set so that the resistance of R408 is quite small, there is very little negative feedback and the Input Amplifier operates with high gain. When the SENSITIVITY switch is set to accommodate larger input voltages the resistance of R408 is increased. This means that there is a greater amount of negative feedback and the gain of the Input Amplifier is decreased.

The switch diagram appearing at the bottom of the circuit diagram shows the makeup of R408. R408M is in the circuit for all positions of the SENSITIVITY switch. In the .2, 2 and 20 VOLTS/CM positions of the switch, R408M alone makes up the resistance of R408. In all other positions of the switch, R408M is shunted by at least one other resistor. In the 200 μ VOLTS/CM position R408M is shunted by both R408A and C408A; in the 50 and 100 MILLIVOLTS/CM positions, and in the 5 and 10 VOLTS/CM positions, it is shunted by both a resistor and an R-C network. The total value of R408 is determined by the degree to which R408M is shunted. The greater the shunting of R408M the smaller the value of R408 and the greater the gain of the Input Amplifier stage. Conversely, the less the shunting of R408M the greater the value of R408 and the smaller the gain of the stage.

The cathodes of the Input Amplifier stage are "long-tailed" to the -150 volt supply through 90-K resistors. With the grids of the Input Amplifier at ground potential, the cathodes will operate very close to ground (actually, a couple of

volts positive to bias the stage). The approximately 150-volt drop across the 90-K cathode resistors (R427 and R428) provides a constant supply of cathode current to stabilize the performance of the 6AU6 Input Amplifier tubes.

In order for the Input Amplifier stage to remain in a state of DC balance, there must be no DC voltage drop across R408 when there is no input signal. This means that the difference in potential between the two cathodes must always be zero, regardless of the value of R408. In order to provide for equal cathode voltages under this condition, the screen voltage of the two tubes can be varied with respect to each other with the COARSE DC BAL. control R431 and the DC BAL. control R433. Any change in voltage at the screens will be reflected to the cathodes by a factor of $1/\mu$ (the screen grid μ) and thus the cathode voltages can be equalized.

Vertical positioning of the crt beam is accomplished through the action of the POSITION control R421. This is a dual control, connected between -150 volts and ground. It is wired so that as the voltage between ground and the movable arm in one side increases, the voltage between ground and the movable arm in the other decreases. Any change in the setting of this control tends to produce a change in the voltage at the cathodes of the tubes. However, the negative feedback circuit reacts quickly to prevent any change in the cathode voltage, and as a result a change in the voltage at the cathodes of the Driver C.F. is produced. This change in voltage, at the cathodes of the Driver C.F., is amplified by the Output Amplifier and appears as a change in the positioning voltage at the vertical-deflection plates.

When the Input Selector switch is set to the A-B position both grids of the Input Amplifier are connected to the Input circuit. With this configuration the Input Amplifier is connected for differential operation. Two input voltages are required, and the push-pull output voltage is proportional to the difference between the two input voltages.

The .2 MV/CM DIFF. BAL. control R435 adjusts the plates of the Input Amplifier for equal voltages when common mode signals are applied to the grids. This control is equally effective in all positions of the SENSITIVITY switch, but is primarily adjusted in the high-sensitivity position (200 μ VOLTS/CM). The .2 V/CM DIFF. BAL. control R424 provides additional differential balance for the low-sensitivity ranges, and is most effective when the SENSITIVITY switch is in the .2 VOLTS/CM position.



The Second Amplifier and Driver C.F. stage.

The push-pull output from the Input Amplifier stage is amplified in the Second Amplifier and coupled through the Driver C.F. stage to the Output Amplifier. As mentioned previously, the positive feedback from the plate circuit on one side of the amplifier to the grid circuit on the other makes this stage an infinite gain amplifier. However, the amplifier does not oscillate due to the overall negative feedback.

The .2 MV/CM GAIN ADJ. control R456, located between the two cathodes, sets the small-signal gain of the Vertical Amplifier. This control is most effective when the SENSITIVITY switch is in the 200 μ VOLTS PER CM position. The FEED-BACK BAL. control R455 balances the negative feedback from both sides of the Driver C.F. stage; this control is also most effective when the SENSITIVITY switch is in the 200 μ VOLT PER CM position.

The Driver C.F. is the load for the Second Amplifier. Its grid circuit provides the necessary high impedance with low capacitance to maintain the gain of the Second Amplifier; its cathode circuit provides a very low impedance to drive the input capacitance of the Output Amplifier. The low output impedance of the cathode circuit also provides an excellent point from which to obtain the negative feedback for the Input Amplifier stage.

The Output Amplifier.

The Output Amplifier is the stage that drives the vertical-deflection plates in the crt. The gain of this stage can be adjusted by means of the .2 V/CM GAIN ADJ. control R488. This control is most effective when the SENSITIVITY switch is in the .2 VOLTS PER CM position. The variable capacitor C489 adjusts the high-frequency response of the amplifier, and is used principally to provide a constant output capacitance.

By means of the HORIZ. DEF. PLATE SELECTOR switch SW489 the Upper-Beam Vertical Amplifier can be connected to the horizontal-deflection plates in the crt. With this configuration the instrument can be used as a single-beam X-Y oscilloscope. The GAIN ADJ. control R489 is used to increase the gain of the Amplifier slightly, necessary for this application.

Trigger Pickoff

When internal triggering of the Time-Base Generator is desired (TRIGGER SELECTOR in either of the UPPER or LOWER positions) a sample of the vertical-output signal is used to develop the triggering pulse. This sample, obtained from the plate circuit of V484B, is coupled through a frequency-compensated voltage divider to V493, a cathode-follower which drives the Time-Base Trigger circuitry. The INT. TRIG. DC LEVEL ADJ. control R495 is adjusted to set the cathode voltage to zero when triggering in the DC mode and with the beam positioned at its respective zero-center graticule line.

TIME-BASE TRIGGER

The Time-Base Trigger circuit consists of a triggering-signal amplifier V24 and a rectangular-pulse multivibrator (Schmitt Trigger) circuit V45. The function of the trigger circuitry is to produce a negative-going rectangular pulse at the plate of V45B whose repetition rate is the same as that of the triggering signal. This negative step is then differentiated to produce a very sharp negative spike (trigger) to trigger the Time-Base Generator in the proper time sequence. A positive spike is also produced by the differentiation process, but this spike is not used.

The signal from which the rectangular output is produced may emanate from one of four sources. When the TRIGGER SELECTOR switch is in the LINE position, a 6.3-volt signal at the power line frequency is used for this application. When the switch is in the UPPER or LOWER posi-

tion (AC or DC), the signal is obtained from Upper- or Lower-Beam Vertical Amplifier, respectively. In the EXT position (AC or DC), the signal is obtained from an external source through a front-panel connector (TRIGGER INPUT). In any of the DC positions of the TRIGGER SELECTOR switch the signal is coupled directly from its source to the Slope switch SW20. In any of the AC positions, the signal is coupled through C10.

Although the output of the Trigger Multi is always a negative rectangular pulse, the start of the pulse may be initiated by either the rising (positive-going) or falling (negative-going) portion of the triggering signal. To see how this is accomplished the operation of the Trigger Multi will be described first.

In the quiescent state, that is, ready to receive a signal, V45A is conducting and its plate volt-



age is down. This holds the grid of V45B below cutoff, since the two circuits are dc-coupled. With V45B in a state of cutoff its plate voltage is up, hence no output is being produced.

A negative-going signal is required at the grid of V45A to force the Trigger Multi into its other state in which a triggering pulse can be produced. However, since the signal at the grid of V45A is an amplification of the triggering signal, it contains both negative- and positive-going portions.

The negative-going portion of the signal will drive the grid of V45A in the negative direction, and the cathodes of both tubes will follow the grid down. At the same time the plate voltage of V45A starts to rise, which causes the grid voltage of V45B to rise. With the grid of V45B going up and its cathode going down, V45B starts to conduct. As V45B starts conducting its cathode starts going up; hence the cathode of V45A starts going up. With the grid of V45A down and its cathode up, V45A cuts off. And since V45B is conducting its plate voltage drops, creating a negative step in the output. This transition occurs very rapidly, regardless of how slowly the grid signal of V45A falls.

When the signal at the grid of V45A starts in the positive direction, just the opposite chain of events will occur. V45A will start conducting again, which in turn will drive the grid of V45B below cutoff. This will cause the voltage at the plate of V45B to rise, which in turn will complete the negative step-voltage output from the Trigger Multi circuit.

The Trigger-Input Amplifier V24 amplifies the triggering signal that in turn is used to drive the Trigger Multi. The amplified signal is always taken from the plate of V24B, but the grid of either tube (V24A or V24B) can be connected to the input circuit. When the Slope switch SW20 is in the — position the grid of V24A is connected to the input circuit and the grid of V24B is connected to a bias source adjustable by means of the TRIGGERING LEVEL control R17. With this configuration V24 is a cathode-coupled amplifier, and the signal at the output plate is in phase with the signal at the input grid. The circuit operation is then as follows: With the Slope switch in the — position, triggering of the Time-Base Generator will occur on the falling (negative-going) portion of the triggering signal. Recalling that a negative-going signal is required at the grid of V45A to drive the Trigger Multi into the other state of its bistable operation, this signal must be of the same polarity as the original signal at the input circuit.

However, when it is desired to trigger the Time-Base Generator on the rising or positive-going portion of the triggering signal, the signal at the grid of V45A must be opposite in polarity to that at the input circuit. This is accomplished by placing the Slope switch in the + position. With this arrangement the grid of V24B is connected to the input circuit and the grid of V24A is connected to the bias source. This eliminates V24A from the amplifier circuit and V24B becomes a plate-loaded amplifier. The output waveform will therefore be opposite in polarity to the grid waveform.

The TRIG. LEVEL CENT. control R24 determines the division of current through both tubes, and is adjusted so that the quiescent voltage at the plate of V24B lies in the center of the hysteresis of the Trigger Multi. The TRIGGERING LEVEL control R17 is adjusted to vary the bias on the tube to which it is connected. This in turn varies the quiescent voltage at the plate of V24B about the level established by the TRIG. LEVEL CENT. control. By adjusting the TRIGGERING LEVEL control, the operator can select the point on the waveform at which he wishes to trigger the Time-Base Generator.

When the Time-Base Trigger circuit is switched into the automatic mode of triggering (TRIGGERING LEVEL) control turned full left, the Automatic switch SW17 converts the Trigger Multi from a bi-stable configuration to a recurrent (free-running) configuration. (This is not to be confused with the action of the Recurrent switch, shown on the Time-Base Generator diagram, which causes the Sweep-Gating Multi to free-run.) This is accomplished by coupling the grid circuit of V45B to the grid circuit of V45A via R32. In addition, the dc-coupling between the Trigger Input Amplifier and the Triggering Multi is removed when the switch is in this position.

The addition of R32 to the circuit causes the Triggering Multi to free-run in the absence of a triggering signal. For example, assume the grid of V45A is just being driven into cutoff. The voltage at the plate of V45A starts to rise, carrying with it the voltage at the grid of V45B. Since the two grids are coupled through R32, this causes the voltage at the grid of V45A to start rising. The time-constant of the R32-C31 network is such that it takes about .01 second for the voltage at the grid of V45A to rise exponentially from its starting point, below cutoff, to a point where plate current can start.

As V45A starts to conduct its plate voltage drops, which in turn lowers the voltage at the grid of V45B. The voltage at the grid of V45A



then starts dropping exponentially. When this grid drops below cutoff again, the circuit has completed one cycle of its approximately 50-cycle waveform.

With the circuit configuration just described, the horizontal sweep can be triggered with repetitive signals, over a wide range of frequen-

cies, without readjustment. When not receiving triggers, the sweep continues at approximately a 50-cycle rate. Thus, in the absence of any triggering signal the sweep generates a base line which indicates that the instrument is adjusted to display any signal that might be connected to the vertical deflection system.

TIME-BASE GENERATOR

The Time-Base Trigger produces a negative-going rectangular waveform which is coupled to the Time-Base Generator circuit. This waveform is differentiated in the grid circuit of V135A to produce sharp negative-going triggering pulses to trigger the Time-Base Generator in the proper time sequence. As mentioned previously, positive-going pulses are also produced in the differentiation process, but these are not used in the operation of the circuit.

The Time-Base Generator consists of three main circuits: A bistable sweep-gating multivibrator, a Miller runup circuit, and a hold-off circuit. The Sweep-Gating Multi circuit consists of V135A, V145A and the cathode-follower V135B. The essential components in the Miller runup circuit are the Miller Runup Tube V161A, the Runup C.F. V161B, the On-Off Diodes V152, the Timing Capacitor C160 and the Timing Resistor R160. The hold-off circuit consists of the Hold-Off C.F.'s V183A and V145B, the Hold-Off capacitor C180 and the Hold-Off Resistors R181 and R180, A or B (shown on the Timing Switch diagram).

In the quiescent state V135A is conducting and its plate voltage is down. This cuts off V145A through the cathode-follower V135B, the voltage divider R141-R143 and the cathode resistor R144.

The quiescent stage of the Miller Runup Tube is determined by a dc network between plate and grid. This network consists of the neon lamp B167, the grid-cathode impedance of the Runup C.F., and the On-Off Diodes. The purpose of this dc network is to establish a voltage at the plate of the Miller Runup Tube of such a value that the tube will operate above the knee, and thus over the linear region, of its characteristic curve.

In the quiescent state the grid of the Miller Tube rests at about -2 volts. There is about a 1-volt drop in the On-Off Diodes, about 25-volts bias on the Runup C.F., and about a 60-volt drop across the neon lamp. This establishes a quiescent voltage of about $+32$ volts at the plate of the Miller Tube.

A negative trigger pulse, arriving at the grid of V135A, will then cause the Sweep-Gating Multi to switch rapidly to its other state. That is, V135A will be cutoff and V145A will start to conduct. As V145A conducts its plate voltage, and the voltage at the plates of the On-Off Diodes, goes down. This cuts off the diodes, which permits the grid of the Miller tube and the cathode of the Runup C.F. to seek their own voltages.

The grid of the Miller Tube starts negative, since it is connected to the -150 -volt supply through the Timing Resistor. The plate of the Miller Tube then starts positive, carrying with it the grid and cathode of the Runup C.F. This raises the voltage at the top of the Timing Capacitor, which in turn raises the voltage at the grid of the Miller Tube and prevents the grid from going negative. The gain of the Miller Tube is about 200; this means that a 150-volt change in the plate voltage will maintain the grid voltage constant, within three-quarters of a volt, through the plate-to-grid feedback network.

The Timing Capacitor C160 starts charging with current from the -150 -volt supply. Since the voltage at the grid of the Miller Tube remains essentially constant, the voltage drop across the Timing Resistor and hence the charging current through it remains essentially constant. Hence, C160 charges linearly and the voltage at the cathode of the Runup C.F. rises linearly. Any departure from a linear rise in the voltage at this point will produce a change in the voltage at the grid of the Miller Tube in such a direction as to correct for the error.

The linear rise in voltage at the cathode of the Runup C.F. V161B is used as the sweep time base. Timing Capacitor C160 and Timing Resistor R160 are selected by means of the TIME/CM switch SW160. The Timing Resistor determines the current that charges the Timing Capacitor. By means of the Timing Switch, both the size of the capacitor being charged and the current



charging the capacitor can be selected to cover a wide range of sweep speeds. Thus, the timing circuit determines the speed at which the spot moves across the crt.

The length of the sweep, that is, the distance the spot moves across the crt, is determined by the setting of the SWP. LENGTH control R176. As the sweep voltage rises linearly at the cathode of V161B, there will be a linear rise in the voltage at the arm of the SWP. LENGTH control. This will increase the voltage at the grid and cathode of V183A and at the grid and cathode of V145B. As the voltage at the cathode of V145B rises the voltage at the grid of V135A will rise. When the voltage at this point rises to a point that V135A comes out of cutoff, the Sweep-Gating Multi will rapidly revert to its original state with V135A conducting and V145A cutoff. The voltage at the plate of V145A will then rise, carrying with it the voltage at the plates of the On-Off Diode V152. The diodes then conduct and the lower-half (V152B) provides a discharge path for the Timing Capacitor through R147 and R148, and through the resistance in the cathode circuit of V161B. The plate voltage of the Miller Tube now falls linearly, under feedback conditions essentially the same as when it generated the sweep portion of the waveform, except for a reversal of direction.

The resistance through C160 discharges is much less than that through which it charges (the Timing Resistor). The capacitor current for this period will therefore be much larger than during the sweep portion, and the plate of the Miller Tube will return rapidly to its quiescent voltage. This produces the retrace portion of the sweep sawtooth, during which time the crt beam returns rapidly to its starting point.

The Hold-Off Circuit prevents the Time-Base Generator from being triggered during the retrace interval. In addition, the Hold-Off allows a finite time for the Time-Base circuits to regain a state of equilibrium after the completion of a sweep.

During the trace portion of the sweep sawtooth the Hold-Off Capacitor C180 charges through V183A as a result of the rise in voltage at the cathode of V183A. At the same time the grid of V135A is being pulled up, through the cathode-follower V145B, until V135A comes out of cutoff and starts conducting. As mentioned previously, this is the action that initiates the re-

trace. At the start of the retrace interval C180 starts discharging through the Hold-Off Resistor. The time-constant of this circuit is long enough, however, so that during the retrace interval, and for a short period of time after the completion of the retrace, C180 holds the grid of V135A high enough so that it cannot be triggered. However, when C180 discharges to the point that the cathode-follower V145B is cutoff, it loses control over the grid of V135A and the grid returns to the level established by the STABILITY ADJUST R111. The amount of hold-off time required is determined by the sweep speed, i.e., by the size of the Timing Capacitor. For this reason the TIME/CM switch changes the time-constant of the Hold-Off Circuit simultaneously with that of the Timing Circuit.

The STABILITY ADJUST R11 regulates the dc level at the grid of V135A. This control should be adjusted so that the voltage at the grid of V135A is just high enough to prevent the circuit from free-running. Adjusted in this manner, a sweep can only be produced when a negative trigger pulse, from the Time-Base Trigger circuit, can drive the grid of V135A below cutoff. However, should a free-running sweep be desired, the TRIGGERING LEVEL control can be turned full right; this closes the RECURRENT switch and connects the grid circuit of V135A to the -150-volt supply. This permits the grid of V135A to fall to cutoff immediately upon removal of the hold-off voltage, at which point the next sweep is initiated.

The positive rectangular pulse appearing at the cathode of V135B is coupled to the grid circuits of the crt. This pulse, whose start and duration are coincident with the trace portion of the sweep sawtooth, unblanks the crt and permits the trace to be observed.

The Time-Base Generator is inoperative when the Upper-Beam Vertical Amplifier is connected to the horizontal-deflection plates. One section of the HORIZ. DEF. PLATE SELECTOR switch SW489 is located in the cathode circuit of the Sweep-Gating Multi, and immobilizes this circuit for the application just described. The same circuit is immobilized, and in the same manner, when the HORIZONTAL DISPLAY switch is set to any of the EXT. ranges. With this arrangement the horizontal sweep voltage is obtained through a front-panel EXTERNAL connector rather than from the Time-Base circuits.



HORIZONTAL AMPLIFIER

The Horizontal Amplifier consists of an input cathode-follower, a cathode-coupled input-amplifier stage, and a plate-loaded output amplifier to drive the horizontal deflection plates in the crt.

The HORIZONTAL DISPLAY switch SW331 determines whether the input waveform is received from the Time-Base Generator or from an external source. When this switch is in either the NORMAL or the SWEEP MAGNIFIED position, the waveform is received from the Time-Base Generator. With this configuration the sweep sawtooth is coupled to the Input C.F. via the frequency-compensated voltage divider R311-R312. The Horizontal POSITIONING control R398 supplies a manually adjustable dc voltage to the grid of the Input C.F. V183B for horizontal positioning of the crt beam. The Input C.F. isolates the Miller Circuit from the Horizontal Amplifier and provides a low-impedance source to drive the switch capacitances and the Input Amplifier.

The Horizontal Amplifier is controlled by feed-

back networks much the same as the Vertical Amplifiers. This is illustrated in Fig. 4-2. A negative feedback loop extends from the plate circuit of the Output Amplifier to the cathode circuit of the Input Amplifier. The Output Amplifier, on the other hand, has a positive feedback loop between the plate circuit on one side and the grid circuit on the other.

The Input Amplifier is a cathode-coupled paraphase amplifier, and converts the positive-going sawtooth voltage, obtained from the Time-Base Generator, to a push-pull output sawtooth voltage. The gain of the Input Amplifier is determined by the amount of resistance connected between the two cathodes, which in turn determines the degree of negative feedback applied to the stage. In the NORMAL position of the HORIZONTAL DISPLAY switch R331 is not in the circuit and the cathode resistance is composed of R334 in parallel with the series combination of R336, R337 and R338. In any of the SWEEP MAGNIFIED positions, one of the R331 resistors is switched into the cathode circuit and shunts the total cathode resistance to a lower value.

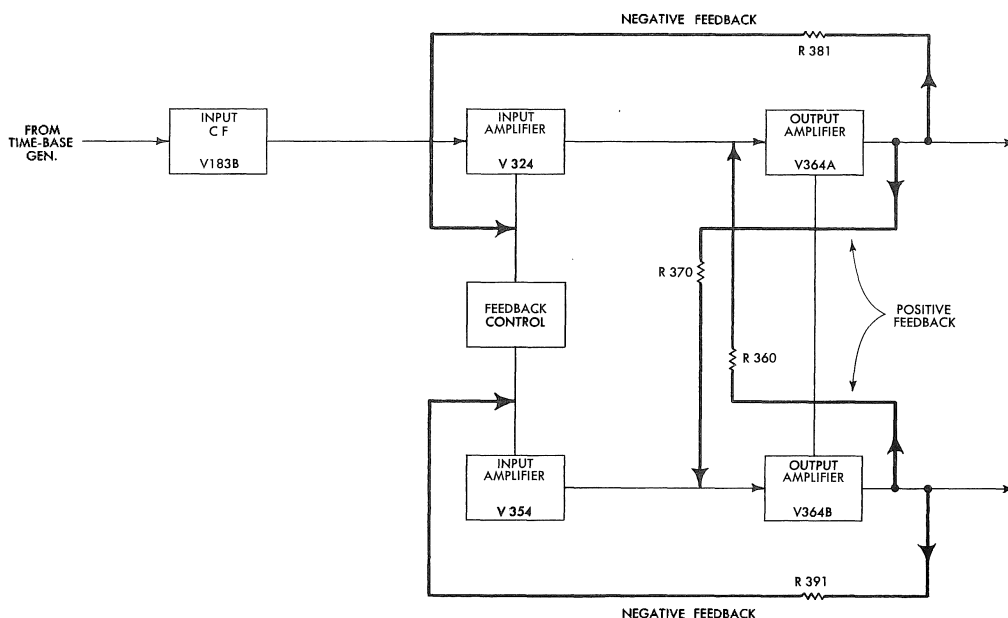

Fig. 4-2. Block diagram of the Horizontal Amplifier, illustrating the feedback loops.



This decreases the amount of negative feedback applied to the stage and consequently increases the gain of the stage.

The function of the MAG. REGIS. control R337 is to insure that the waveform will be expanded symmetrically about the center of the crt when the HORIZONTAL DISPLAY switch is changed from NORMAL to any of the SWEEP MAGNIFIED positions. This control dc-balances the amplifier so that the horizontal positioning of the beam will not be affected, when the beam is positioned in the center of the crt, as the value of R331 is changed. The 1X CAL. control R357 adjusts the plate-to-plate gain of the stage slightly to compensate for any circuit nonsymmetry. This control is most effective when the HORIZONTAL DISPLAY switch is in the NORMAL position.

The Output Amplifier, by virtue of its positive feedback network, is an extremely high-gain stage. The gain of the stage can be varied over

a limited range, however, with the 20X CAL. control R368 which varies the amount of cathode degeneration. This control is most effective when the HORIZONTAL DISPLAY switch is in the X20 SWEEP MAGNIFIED position.

When the HORIZONTAL DISPLAY switch is in any of the EXT. VOLTS/CM positions, the sweep voltage is coupled directly from the front-panel EXTERNAL connector to the grid circuit of the Input Amplifier. This action changes the configuration of the amplifier slightly. The Input C.F. is disconnected from the circuit which changes the dc level at the cathodes of the Input Amplifier slightly. To compensate for this change an EXT. HORIZ. DC BAL. control R341 is adjusted to equalize the cathode voltages.

Also, when using external sweep, the Horizontal POSITIONING control is disconnected from the input circuit and connected between the plates of the Output Amplifier.

POWER SUPPLY

Plate and filament power for the tubes in the 502 Oscilloscope is furnished by a single power transformer T602. The primary has two equal tapped windings; these may be connected in parallel for 105- to 125-volt operation, or in series for 210- to 250-volt operation. The three main full-wave power supplies furnish regulated voltages of -150 , $+100$ and $+350$ volts. The $+350$ -volt supply also has an unregulated output of about $+485$ volts for the high-voltage power supply for the crt. It is unnecessary to regulate this supply as the high-voltage power supplies have their own regulation circuits. In addition to the three main power supplies, a transistorized full-wave supply furnishes a regulated -6.2 -volt output for the heaters in the Input Amplifier tubes in the Upper and Lower Beam Vertical Amplifiers.

Reference voltage for the -150 -volt supply is furnished by a gas-diode voltage-reference tube V639. This tube, which has a constant voltage drop, establishes a fixed potential of about -70 volts at the grid of V636B, one-half of a difference amplifier. The grid potential for the other half of the difference amplifier, V636A, is obtained from a divider consisting of R621, R622 and R623. R622, the -150 ADJ. determines the percentage of total voltage that appears at the grid of V636A and thus determines the total voltage across the divider. When this control is pro-

perly adjusted the output is exactly -150 volts.

Should the loading on the supply tend to change the output voltage, the voltage at the grid of V636A will change in proportion, and an error voltage will exist between the two grids of the difference amplifier. The error signal is amplified by V636B, whose plate is dc-coupled to the grid of the series tube V637. The error voltage appearing at the grid of V637 will change the drop across the tube and hence change the voltage at the plate of the tube. The change in voltage at the plate of V637, which will be in a direction to compensate for the change in the output voltage, is coupled by the impedance of the rectifier V602 back to the output and thus pulls the output voltage back to its established -150 volts. C623 improves the gain of the feedback loop and thus increases the response of the circuit to sudden changes in the output voltage.

The -150 -volt supply serves as a reference for the $+100$ -volt supply. The divider R671-R673 establishes a voltage of essentially zero at the grid of the amplifier V666B. (The actual voltage at this grid will be equal to the bias voltage required by the stage.) If the loading should tend to change the output voltage an error voltage will appear at the grid of V666B. This error voltage will be amplified and will appear at the grid of the series tube V677. The cathode of V677 will follow the grid and hence the output



voltage will be returned to its established value of +100 volts. C671 improves the response of the circuit to sudden changes in the output voltage.

A small sample of the unregulated bus ripple appears at the screen of V666B through R662. The ripple signal which appears at the screen (which acts as an injector grid) will produce a ripple component at the grid of V677 which will be opposite in polarity to the ripple appearing at the plate of V677. This tends to cancel the ripple at the cathode of the tube, and hence reduces the ripple on the +100-volt bus. This same circuit also improves the regulation of the supply in the presence of line voltage variations.

The +350-volt supply functions in the same manner as the +100-volt supply. Rectified voltage from the cathode of V722 is added to the voltage supplying the +100-volt regulator to supply voltage for the +350-volt regulator. As

mentioned previously, the +350-volt supply also furnishes an unregulated output of about +485 volts for the crt high-voltage supply.

The -6.2-volt supply works in essentially the same manner as the vacuum-tube supplies. The divider R648-R649 establishes a reference voltage at the base of V644. If we now assume that the output tends to go more negative, the emitter of V644 will also go more negative since it is strapped directly to the output. The collector of V644 will then go more positive, carrying with it the base of V634. The collector of V634 will then go up, carrying with it the base of V647. The series-regulator transistor V647 is essentially an emitter-follower, so the emitter will follow the base. Hence, the emitter of V647 also goes up. This increase in the voltage at the emitter of V647 will be coupled through the rectifier SR642 back to the output and will thus pull the output back up to its specified value.

CRT CIRCUIT

A single 60-Kc Hartley oscillator circuit furnishes energy for the two power supplies that provide accelerating voltages for the crt. The main components of the Oscillator circuit are V800 and a portion of the primary of T801 tuned by C807.

The two half-wave rectifier circuits employ capacitor-input filters. Separate supplies are required for the grid and cathode circuits of the crt in order to provide dc-coupled unblanking to the crt grids.

V822 supplies about -2900 volts for the cathodes of the crt. V862 supplies about -3100 volts for the grids (the actual voltage depends on the setting of the INTENSITY control.)

In order to maintain a constant deflection sensitivity in the crt, and thereby maintain the calibration of the instrument, it is necessary that the accelerating potentials in the crt remain constant. This accomplished by regulating the two supplies by comparing a sample of the cathode voltage to the regulated -150-volt supply. This sample voltage, obtained from the arm of the H.V. ADJ. control R826, is applied to the grid of V814A; the cathode of this tube is connected to the -150-volt regulated supply. The error volt-

age is amplified by V814A and V814B; the output of V814B varies the screen voltage of the Oscillator tube and thus controls its output.

Unblanking

As mentioned previously, dc-coupled unblanking is accomplished by employing separate high-voltage supplies for the grids and cathodes. The cathode supply is tied to the +350-volt supply. The grid supply, on the other hand, is not tied to any other supply and is therefore floating. The unblanking pulses from the Time-Base Generator are transmitted to the grids of the crt via the floating grid supply.

The stray capacitance in the circuit makes it difficult to move the floating supply fast enough to unblank the crt in the required time. To overcome this, an isolation network composed of R864, C868 and R868 for one grid circuit, and R864, C866 and R866 for the other, is employed. By this arrangement, the fast leading edge of the unblanking pulse is coupled directly to the grids of the crt via C866 and C868. For short-duration unblanking pulses (at the faster sweep rates) the power supply itself is not appreciably moved. For longer unblanking pulses, at the



slower sweep-rates, however, the stray capacitance of the circuit is charged through R864. This holds the grids at the unblanked potential for the duration of the unblanking pulse.

Each gun of the crt has its own FOCUS and ASTIGMATISM control. A single control R841

adjusts the geometry of the display, and a single INTENSITY control controls the brilliancy of both beams. An INT. BAL control R860 balances one grid voltage against the other so that the INTENSITY control will have an equal effect on both beams.

CALIBRATOR

The Calibrator is a square-wave generator whose approximately 1-Kc output is available at a front-panel connector labeled CAL. OUT. It consists of a Multivibrator V873A-V875 connected so as to switch the cathode-follower V873B between two operating states—cutoff and conduction.

During the negative portion of the multivibrator waveform the grid of V873B is driven well below cutoff and the cathode rests at ground potential. During the positive portion of the

waveform the grid rises to slightly less than +100 volts. By means of the CAL. ADJ. R879 the grid voltage can be adjusted so that the cathode voltage is exactly +100 volts when the SQUARE-WAVE CALIBRATOR knob is turned to the OFF position.

The Cal. Out C.F. has a precision voltage divider for its cathode resistor. By means of the SQUARE-WAVE CALIBRATOR switch six calibrated peak-to-peak voltages, from 1 millivolt to 100 volts, are available.



MAINTENANCE

PREVENTIVE MAINTENANCE

Air Filter

The Type 502 Oscilloscope is cooled by air drawn into the instrument through a washable filter constructed of adhesive coated aluminum wool. If this filter is allowed to become dirty, it will restrict the flow of air and may cause the instrument to overheat. You should inspect, and clean if necessary, the filter every three or four months. If the filter is damaged, you should replace it as soon as possible to prevent dust being drawn into the instrument.

To remove the loose dirt in the filter, rap the filter gently on a hard surface. Then wash the filter briskly from the dirty side with hot water or if necessary with hot, soapy water. After rinsing and drying thoroughly, coat the filter with "Handi-Koter" or "Filtercoat", products of the Research Products Corporation. These products are generally available from air-conditioner suppliers.

Fan Motor

To protect the fan motor bearings, they should be lubricated every three or four months with a few drops of light machine oil.

Visual Inspection

You should visually inspect the entire oscilloscope every few months for possible circuit defects. These defects may include loose or broken connections, damaged binding posts, improperly seated tubes, scorched wires or resistors, missing tube shields, or broken terminal strips as well as many others. For most of these troubles, the remedy is apparent, but particular care must be taken when scorched components are detected. Scorched parts are often the result of other, less apparent, defects in the circuit. Therefore, it is essential that you determine the cause of overheating before replacing scorched parts in order to prevent damage to the new components.

Recalibration

The Type 502 Oscilloscope is a stable instrument, and will provide many hours of trouble-free operation. To insure the reliability of measurements obtained on the 502, we suggest that you recalibrate the instrument after each 500 hours of operation (or every six months if used intermittently). A complete step-by-step procedure for recalibrating the instrument is presented in the Recalibration Procedure section of this manual.

REMOVAL AND REPLACEMENT OF PARTS

The procedures required for replacement of most parts in the Type 502 are obvious. Detailed instructions for their removal are therefore not required. Other parts, however, can best be removed if a definite procedure is followed. Instructions for the removal of some of these parts are contained in the following paragraphs. Because of the nature of the instrument, replacement of certain parts will require that you recalibrate portions of the oscilloscope in order to insure the proper operation of this instrument. Refer to Section 6 for recalibration procedures.

Removal of Panels

The panels of the Type 502 Oscilloscope are held in place by small screwhead fasteners. To remove the side panels, use a screwdriver to rotate the fasteners approximately two turns counterclockwise; then pull the upper portion of the panels outward from the carrying handles. To remove the bottom panel, lay the instrument on its side, rotate the fasteners approximately two turns counterclockwise, and pull off the panel. In order to prevent damage to the finish of the side panels, you should remove them be-



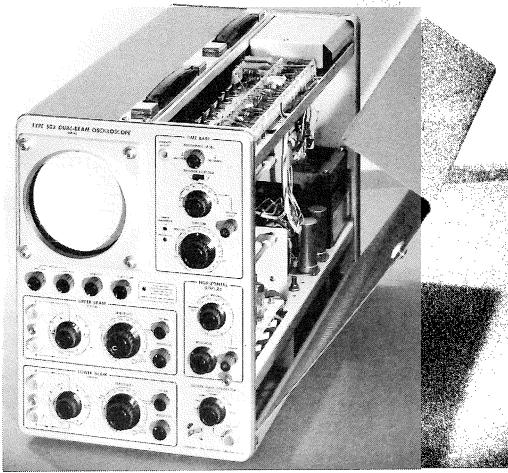

Fig. 5-1. Removal of the instrument side panels.

fore laying the instrument on its side. The bottom panel should then be removed last. Panels are replaced by reversing the order of their removal.

Replacement of the Cathode-ray Tube

To remove the cathode-ray tube, first disconnect the tube socket and all leads connected to the neck of the tube. Loosen the tube clamp at the base of the crt and remove the graticule cover. Pull the crt straight out through the front panel. When the new crt is in place, the leads may be properly connected to the neck of the tube by following the color code information provided on the tube shield. After replacement of a crt, it will be necessary for you to recalibrate the oscilloscope.

Replacement of Switches

Methods for removal of defective switches are, for the most part, obvious and only a normal amount of care is required. Single wafers are normally not replaced on the switches used in the Type 502 and if one wafer is defective, the entire switch should be replaced. Switches may be ordered from Tektronix either wired or unwired as desired.

Tube Replacements

Care should be taken both in preventive and corrective maintenance that tubes are not replaced unless they are actually causing a definite circuit malfunction. Many times during routine maintenance it will be necessary for you to remove tubes from their sockets. It is important that these tubes be returned to the same sockets

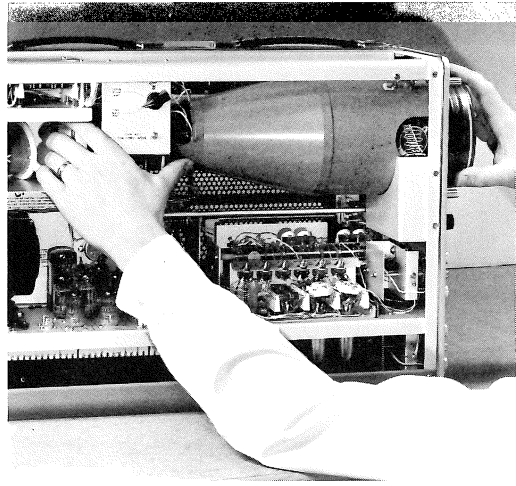

Fig. 5-2. The method for removal and replacement of the crt.

unless they are actually defective. Replacement or switching of tubes will many times necessitate recalibration of the instrument. If tubes do require replacement, it is recommended that they be replaced by previously checked high quality tubes. Low noise tubes used in the instrument should be replaced by equivalent tubes.

Soldering Precautions

In the production of Tektronix instruments, a special silver-bearing solder is used to establish a bond to the ceramic terminal strips. This bond may be broken by repeated use of ordinary tin-lead solder, or by the application of too much heat. However, occasional use of ordinary solder will not break the bond if too much heat is not applied.

It is advisable that you have a stock of solder containing about 3% silver if you frequently perform work on Tektronix instruments. This type of solder is used quite often in printed circuitry and should be readily available. It may also be purchased directly from Tektronix in one-pound rolls (order by part number 002-664).

Because of the shape of the terminals on the ceramic terminal strips you may wish to use a wedge-shaped tip on your soldering iron. A tip such as this allows you to apply heat directly to the solder in the terminals thereby reducing the heat required to melt the solder. Since excessive heat can destroy the bond of the terminal to the ceramic material, it is important to use as little heat as possible. Also, the wedge-shaped tip is desirable from a convenience stand-point, since it is easier to work on the ceramic strips with this type of tip.

REPLACEMENT PARTS

Standard Parts

Replacements for all parts used in the Type 502 Oscilloscope can be purchased directly from Tektronix at current net prices. However, since most of the components are standard electronic parts, they can generally be obtained locally in less time than required to obtain them from the factory. Before ordering or purchasing parts, be sure to consult the parts list to determine the tolerance required. The parts list gives the values, tolerances, and Tektronix part numbers of all components used in the instrument.

Special Parts

In addition to the standard parts discussed in the previous paragraph, special parts are also used. These parts are manufactured, or specially selected by Tektronix, or are made especially for Tektronix by other manufacturers. Special parts are distinguished in the parts list by an asterick preceding the Tektronix part number. These parts and all mechanical parts should be ordered from Tektronix since they will normally be difficult or impossible to obtain from other sources. Special parts may be obtained either from the factory or from the local Tektronix Field Engineering Office.

Since the production of your instrument, some of the Tektronix-manufactured components may have been superceded by improved components. The part number of these new components will not be listed in your manual. If you order a Tektronix-manufactured part, and it has been superceded by an improved component, the new part will be shipped in place of the part ordered. Your local Tektronix Field Engineering Office has knowledge of these changes and may call you if a change in your purchase order is necessary.

Replacement information sometimes accom-

panies the improved component to aid in its installation.

Duplicate Parts

The Type 502 contains virtually identical vertical amplifiers for the upper and lower beams. Parts contained in both of these amplifiers carry the same part numbers and reference designations. In the parts list, these components are listed only once although in actuality two are used. These parts are distinguished from others in the parts list by a dagger immediately following the reference designation.

Parts Ordering Information

You will find a serial number on the frontispiece of this manual. This is the serial number of the instrument for which this manual was prepared. Be sure that the number on the manual matches the serial number of the instrument when ordering parts from the manual.

Each part in this instrument has a 6-digit Tektronix part number. This number together with a description of the part, will be found in the parts list. When ordering parts, be sure to include both the description of the part and the part number. For example, a certain resistor would be ordered as follows: R160A, 100k, 1/2 w, Fixed, Precision, 1%, part number 309-045, for Type 502 Oscilloscope number _____. When parts are ordered in this manner, we are able to fill your orders promptly, and delays that might result from transposed numbers in the part number are avoided.

NOTE

Always include the instrument TYPE and SERIAL NUMBER in any correspondence concerning this instrument.



TROUBLESHOOTING

GENERAL INFORMATION

This section is included to provide you with information about the Type 502 Oscilloscope that will enable you to more efficiently troubleshoot the instrument in the event of equipment failure. During troubleshooting work, you should correlate information contained in this section with information obtained from other sections of this manual. We have not attempted to give detailed step by step procedures for finding the cause of specific troubles, but rather have attempted to outline a general troubleshooting guide. This guide provides a means for determining the probable defective circuit or part from the symptoms observed rather than from detailed voltage or resistance measurements.

Although the Type 502 Oscilloscope is a complex instrument, it can conveniently be thought of as consisting of a number of interrelated basic circuits as shown on the block diagram contained in the diagram section of the manual. Each of these basic circuits performs a specific part of the overall circuit operation required to place a display on the face of the crt. If any one of these circuits should fail, a definite symptom of this failure will be apparent. By investigating the possible causes of this symptom by means of systemized circuit checks, it is possible to determine which circuit or circuits are at fault. After determining which circuit is defective, additional checks will allow you to isolate the trouble to a particular part.

Before proceeding with troubleshooting of the instrument, make sure that any apparent trouble is actually due to a malfunction within the oscilloscope, and not due to improper control settings. Instructions for the operation of the instrument are contained in the "Operating Instructions" section of this manual. If, after reviewing the Operating Instructions, you determine that control settings are not at fault, you should next check the calibration of the suspected circuit according to the procedures contained in the "Recalibration Procedure" section of the manual. A calibration check will not only correct any troubles due to improper calibration, but will often also aid in isolating the faulty stage in cases where an actual trouble does exist. After checking control settings and calibration, if the trouble still exists, you should then go to a more detailed troubleshooting analysis. Specific

troubleshooting procedures are given later in this section.

Separate schematic diagrams of each circuit are contained in the rear portion of this manual together with a block diagram which provides an overall picture of instrument operation. The reference designation of each electronic component of the instrument is shown on the circuit diagrams as well as important voltages and waveforms. The following chart lists the reference designations associated with each circuit.

All numbers	Time-Base Trigger less than 100
100 series	Time-Base Generator and Timing Switch
300 series	Horizontal Amplifier
400 series	Upper and Lower Beam Vertical Amplifiers
600 and 700 series	Low Voltage Power Supply
800 series	CRT Circuits and Calibrator

Switch wafers shown on the schematic diagrams are coded to indicate the position of the wafer on the actual switches. The number portion of the code refers to the wafer number on the switch assembly, wafers being numbered from the front of the switch to the rear, and the letters F and R indicate whether the front or the rear of the wafer is used to perform the particular switching function. Photographic details of these switches are also shown on the same fold-out page as the corresponding schematic diagram. These photographs are provided as parts location guides.

All wiring used in the Type 502 Oscilloscope is color coded to facilitate circuit tracing. In addition, primary power, filament, and regulated power supply output leads are distinguished by specific color codes. All regulated power supply output leads follow the standard RETMA code. The -150 volt bus wire is coded brown-green-brown; the +100 volt bus is coded brown-black-brown; and the +350 volt bus is coded orange-green-brown. The widest stripe identifies the first color of the code.



Change In Deflection Sensitivity

A change in the deflection sensitivity of the instrument is indicated if the deflection, both vertical and horizontal, is either greater or less than the value indicated by the front panel settings. This can be caused by a change in the gain of both vertical amplifiers and the Hori-

zontal Amplifier, due to improper outputs of the Low-Voltage Power Supply. Or, it can be caused by a change in the crt sensitivity, due to improper output voltages of the high voltage power supply. If either the low or high voltage power supplies require adjustment, these adjustments should be made in accordance with the recalibration procedures given in this manual.

PART II: CIRCUIT TROUBLESHOOTING

This portion of the Troubleshooting Procedure contains information for locating a defective stage within a given circuit. Once the stage at fault is known, the component(s) causing the trouble can be located by tube and component substitution, voltage and resistance measurements, or by short and continuity checks.

Tube failure is the most prevalent cause of circuit failure. For this reason, the first step in troubleshooting any circuit is to check for defective tubes, preferably by direct substitution. Do not depend on tube testers to adequately indicate the suitability of a tube for use in the instrument. The criterion for usability of a tube is whether or not it works satisfactorily in the in-

strument. Be sure to return any tubes found to be good to their original socket. If this procedure is followed, less recalibration of the instrument will be required upon completion of the servicing.

If replacement of a defective tube does not correct the trouble, then check that components which are associated with the tube have not been damaged. Shorted tubes will often overload plateload and cathode resistors. These components can often be located by a visual inspection of the circuit. If no damaged components are apparent, however, it will be necessary to make measurements or other checks within the circuit to locate the trouble.

Troubleshooting The Low-Voltage Power Supply

Proper operation of every circuit in the Type 502 Oscilloscope depends on proper operation of the Low-Voltage Power Supply. The regulated voltages must remain within their specified tolerances for the instrument to maintain its calibration.

For no output voltage

If the graticule lamps and the fan do not operate when the power switch is turned on, check the power switch, the fuse, and the line voltage. If your instrument is wired for 234-volt operation, also check the thermal cutout switch. (If your instrument is wired for 117-volt operation, the fan will run even though the thermal cutout switch may be open.) If the fuse is not blown and the line voltage is correct, next check the primary windings of the power transformer.

If both the graticule lamps and the fan operate correctly, the primary circuit of the power trans-

former is operating normally and the trouble lies somewhere in the secondary circuits.

If only one of the outputs of the Low-Voltage Power Supply is zero, the trouble is probably due to a defective rectifier, series regulator, or power transformer secondary winding, although this trouble can also be caused by a short across the output. To determine which circuit element is defective, measure the secondary voltage of the transformer and the voltage at the output of the rectifier. The cause of the trouble can be determined by the voltage readings obtained.

For failure of the regulated power supplies to regulate at the correct voltages.

If any or all of the supplies fail to regulate at the proper voltages, first check the line voltage. The supplies are designed to regulate between 105 and 125 volts (or 210 and 250 volts), with the design center at 117 volts (or 234 volts), rms.



Improper line voltage may cause one or all of the supply voltages to be off.

All the low voltage power supplies are dependant upon the -150 volt supply for regulation, and consequently, a change in the regulation point of all the supplies is indicative of a defective -150 volt supply. If the output voltage of the -150 volt supply is off by only a small amount, it may be possible to readjust the -150 ADJ control for the proper voltage. In any event it will be necessary to recalibrate the instrument according to the procedures given in the Recalibration section of this manual.

In case of the failure of a single power supply to regulate properly, check the following:

1. Line voltage
2. Transformer voltage
3. Output voltage of the rectifier
4. Tubes or transistors
5. Loading

Important power supply voltages are marked on the power supply schematic diagram. These voltages may be used to perform checks on the power supply operation. One cause of improper regulation by a power supply is incorrect loading of the supply. To check power loading, shut off the power and check the resistance of the power supply output bus to ground. The -150 -volt bus should read approximately 5,000 ohms, the $+100$ -volt bus approximately 5,000 ohms, and the $+350$ -volt bus approximately 11,000 ohms.

If none of the preceding checks determine the cause of the trouble, the cause of the improper regulation is probably a change in value of one or more of the resistors or capacitors composing the voltage divider networks. The resistance networks in the grid circuits of V746B, V666B, and V636A and the base circuit of V644 are particularly critical since they determine the output voltage of their respective power supplies. Use resistance checks to isolate the defective part or parts. The following information may be used as quick index to troubleshooting the Low-Voltage Power Supply.

If the output voltage is high with excessive ripple, check:

1. For high line voltage
2. The amplifier tubes and transistors (V746, V666, V636, V644, and V634).
3. For insufficient loading

If the output voltage is high with normal ripple, check:

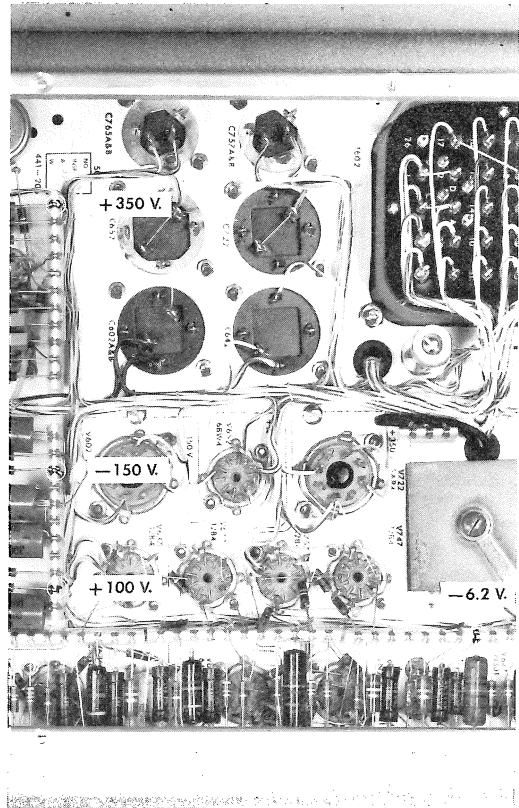

Fig. 5-4. Low voltage power supply test points.

1. For proper resistance values in the dividers (R751 and R753; R671 and R673; R621, R622, and R623; and R648 and R649)

If the output voltage is low with excessive ripple, check:

1. For low line voltage
2. The series regulator tube (V747, V757, V677, V637, or V647)
3. For excessive loading
4. Open or leaky filter capacitors
5. Rectifiers (V722, V652, V602, or SR642)

If the output voltage is low with normal ripple, check:

1. The resistance values in the dividers
2. The capacitors across the dividers

If the output voltage is normal with excessive ripple, check:

1. Filter capacitors at the output of the rectifiers and at the regulated output
2. AC bypass capacitors in the grid circuits of the regulator amplifiers
3. Regulator amplifiers screen grid circuits

INITIAL PROCEDURES

As mentioned previously, the first checks that should be made in the event of an apparent trouble are for proper control settings and correct calibration. The next check for any type of trouble should be for proper operation of the regulated power supplies. Correct operation of every circuit in the oscilloscope depends on proper output voltages from the regulated power supplies. Due to the circuit configuration employed in the Type 502, it is possible for an incorrect power supply voltage to affect one circuit more than the others. When all but one circuit in the oscilloscope is functioning properly, there is a tendency to overlook the power supply as a source of the trouble and to concentrate on the circuit where the trouble apparently exists. In cases of this type, valuable time can be saved by checking the power supplies first. If the output and ripple voltages of the regulated power

supplies are correct, use the trouble symptoms and the following Circuit Isolation information to locate the defective circuit.

WARNING

Be careful of power supply voltages. Under certain conditions, they can be dangerous to human life. Outputs of the Low Voltage Power Supply are particularly dangerous due to their high current capabilities.

When working on the instrument with the power on, you should work with only one hand at a time, being careful that the other hand does not touch the metal frame of the instrument. If possible, stand on an insulated surface, and use insulated tools and probes.

PART 1: CIRCUIT ISOLATION

This portion of the Troubleshooting Procedure lists most of the troubles that can be caused by a circuit failure in the Type 502 Oscilloscope. It also describes checks that can be made to isolate the faulty circuit or circuits. In some cases, simple front panel checks can determine which circuit is defective, but in other cases internal checks and/or measurements are required.

The following troubleshooting information is subdivided according to the various types of troubles. Upon detecting an apparent trouble, you can use the symptoms of this trouble to locate the proper subdivision. After determining which circuit is at fault, you can then refer to Part II, where the procedure for troubleshooting within the circuit is given.

Either the Upper or Lower Beam Not Visible On CRT

The inability to display either the upper or lower beam on the face of the crt may be due to an unbalance in the corresponding vertical amplifier or to a defect in the crt circuit.

To determine which circuit is at fault, short

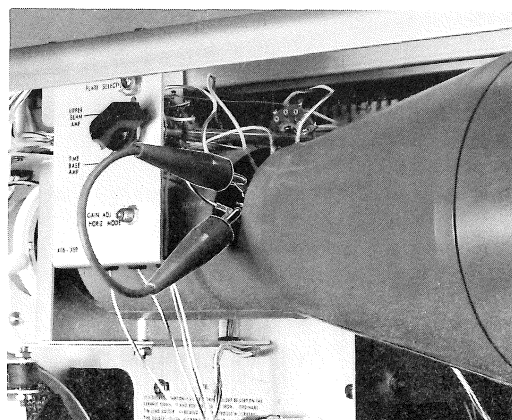

Fig. 5-3. Checking for unbalance in the upper beam vertical amplifier by shorting the vertical deflection plates together.

the applicable vertical deflection plates together at the neck of the crt. Be careful that the pins are not shorted to the crt shield. If the beam returns to the crt face, the trouble is due to an unbalanced vertical amplifier. If the beam does not reappear, the trouble is located in the crt circuit.



Neither Beam Visible On CRT

If neither beam is visible, either both electron guns are cutoff, or both beams are deflected off the face of the crt. These troubles probably will be caused either by the Horizontal Amplifier or the CRT Circuit. To determine which circuit is at fault, short the horizontal deflection plates together at the neck of the crt being careful that the pins are not shorted to the crt shield. If the beams return to the crt face, (you may have to readjust the vertical POSITION controls) the trouble is due to an unbalanced horizontal amplifier. If the beams do not reappear, the trouble is due to a defective crt circuit.

Insufficient Vertical Deflection, Waveform Distortion, or Low Differential Input Rejection Ratio

These troubles are all caused by a defective vertical amplifier. Refer to that section of Part II of the troubleshooting procedure.

Insufficient or No Horizontal Deflection

Either of these conditions can be produced by the Time-Base Generator or the Horizontal Amplifier. If the sweep is shortened, but the timing is not affected, the trouble is probably in the Time-Base Generator. If both the sweep length and the timing are affected, the trouble is probably in the Horizontal Amplifier.

As an additional check to determine which circuit is defective, place the HORIZONTAL DISPLAY switch at 1 EXT VOLTS/CM and the SQUARE-WAVE CALIBRATOR switch at 10V. Connect the calibrator output to the EXTERNAL input connector. Both beams should now be deflected horizontally a total of 10 centimeters. If the deflection is correct, the trouble is probably in the Time-Base Generator, however, the Horizontal Amplifier input cathode follower stage, V183B, should also be checked. If the deflection is not correct, the trouble is in the Horizontal Amplifier.

Nonlinear Horizontal Sweep

The linearity of the horizontal-deflection circuit can be checked by connecting a marker generator or the calibrator output to a vertical input of the oscilloscope. If the sweep is linear, the markers or calibrator waveforms should be spaced equidistant along the sweep. A nonlinear sweep can be caused by either the Time-Base Generator or the Horizontal Amplifier.

To check the Time-Base Generator, connect a jumper from an input of the oscilloscope to pin 3 of V161 being careful that the lead does not touch the chassis at any time. Set the SENSITIVITY control at 20 volts per cm, and rotate the TRIGGERING LEVEL control fully clockwise to the RECURRENT position. Set the TIME/CM switch at 1 MILLISEC. You should then obtain a stable diagonal trace. This trace represents a plot of the output from the Time-Base Generator (applied to the Y axis) and the output of the Horizontal Amplifier (applied to the X axis). If the slope of this trace is constant, this indicates that both voltages rise at the same rate and the lack of linearity is due to a trouble occurring in the Time-Base Generator. If the slope is not constant, the horizontal amplifier is distorting the constant slope sawtooth waveform from the Time-Base Generator.

Improper Sweep Timing

If the timing is off in some, but not all, positions of the TIME/CM switch, one of the timing resistors or timing capacitors has changed in value. By comparing the switch positions in which the timing is incorrect with the timing switch diagram, you will be able to tell which components are common to these positions.

If the timing is off in all positions of the TIME/CM switch, the Horizontal Amplifier is probably the circuit at fault although it is important that both the low and high voltage power supplies be checked. Check to see if the timing circuits can be recalibrated in accordance with the instructions presented in the Recalibration Procedure. If the circuits cannot be adjusted for correct timing, then refer to the section on troubleshooting the Horizontal Amplifier in Part II.

Improper Triggering

If improper triggering results from triggering signals obtained from only one of the vertical amplifiers, the trigger pickoff circuit of that amplifier is probably at fault. If the sweep triggers incorrectly with signals obtained from both vertical amplifiers as well as external triggering signals the trouble can be caused by either the Time-Base Trigger circuit or the Time-Base Generator circuit. If the trace can be turned on and off by switching the TRIGGERING LEVEL control into and out of the RECURRENT position, the Time-Base Trigger is probably causing the trouble; if the trace cannot be turned off with the TRIGGERING LEVEL control, the Time-Base Generator is likely at fault.



stant network which will affect the low frequency response of the circuit.

High frequency response can be affected considerably by an improperly adjusted probe. Consequently, in any case of high frequency distortion you should first check the probe adjustment. Refer to the Operating Instructions for the compensation procedure. Other factors which can affect the high frequency response of the vertical amplifier are mainly related to the high frequency compensation networks.

An overshoot waveform shown accentuated in Fig. 5-6 is the result of excessive high frequency

compensation. This can be caused by a tube condition known as cathode interface. If this type of distortion is detected, you should check the tubes in the amplifier. If tube replacement does not completely correct the trouble, you should then check the adjustment and operation of the high frequency compensation circuits.

For improper triggering

Improper triggering can be caused by a defective trigger pickoff circuit. The trouble may be caused either by a faulty cathode follower, V493 or by a defective component in the circuit.

Troubleshooting The Time-Base Trigger

If the trouble occurs in some but not all positions of the TRIGGER SELECTOR switch, the trouble is likely due to a defective TRIGGER SELECTOR switch or input coupling circuit. If the trouble occurs in all positions of the TRIGGER SELECTOR switch, either the trigger amplifier or the trigger multivibrator will be at fault. You should check tubes V24 and V45.

NOTE

All voltages in this section are measured with a 20,000 ohms-per-volt voltmeter.

To determine which stage is defective, rotate the TRIGGERING LEVEL control fully counterclockwise to the AUTOMATIC position. With no triggering signal, the sweep should appear on the crt. If the sweep does not appear, the trigger multivibrator is defective. If the sweep does appear, either the trigger amplifier or the trigger multivibrator may be at fault.

A check on the trigger amplifier circuit may be made as follows. With the TRIGGERING LEVEL control still in the AUTOMATIC position, measure the voltage at the plate, pin 6, of V24B. This voltage should be approximately +85 volts. If the voltage is incorrect, the trigger amplifier circuit is defective. The trouble will probably exist in the resistors or switches of the circuit.

If the voltage measured is correct, rotate the TRIGGERING LEVEL control completely through its range while monitoring the voltage at pin 6 of V24B. The voltage should vary between approximately 40 and 135 volts. An incorrect voltage range indicates a defective trigger amplifier or TRIGGERING LEVEL control. If the voltage range is correct, the trouble will be in the trigger multivibrator. A trouble in the multivibrator will probably be due to defective resistors. The voltage divider network between the plate of V45A and the grid of V45B is particularly critical.

Troubleshooting The Time-Base Generator

For free-running operation

If the Time-Base Generator free runs when the TRIGGERING LEVEL control is not in the RECURRENT or AUTOMATIC positions, this is due to astable operation of the sweep gating multivibrator. This trouble will probably be due to defective resistors in the grid circuit of V135A (resistors R129, R130, or R111) or in the grid circuit of V145A (resistors R141 or R143).

For no horizontal sweep

If the Time-Base Generator is not producing a sawtooth waveform when the TRIGGERING LEVEL control is in the RECURRENT position, some defect in the circuit is causing the output to remain at some fixed voltage. A clue to the cause of this trouble can be obtained by measuring the plate voltage of the Miller tube, V161A.



The voltage reading obtained will probably be either approximately +300 volts, or approximately +30 volts. A reading of +300 volts indicates that the Miller stage has runup and has not been reset, while a reading of +30 volts indicates that the Miller stage is not being allowed to runup. The condition that actually exists will depend on the type of trouble occurring in the circuit. The two conditions of plate voltage will be handled separately in the following paragraphs.

1. High Voltage

If the voltage at the plate of the Miller tube, V161A, is high, the tube is cutoff. This can result from any one of the following conditions: (1) On-Off Diodes do not conduct, (2) Sweep-Gating Multivibrator does not reset, (3) Hold-Off Cathode Followers do not reset the Sweep-Gating Multivibrator and (4) Runup Cathode Follower does not drive the Hold-Off Cathode Follower. The defective stage can be detected by a series of systematic voltage measurements. When an improper voltage reading is obtained, this will indicate the defective stage.

Check the voltage at the grid of the Miller tube. If the reading is only a few volts negative, the On-Off Diodes are probably conducting normally and can be eliminated as a possible cause of the trouble. If the voltage is more negative than -50 volts, however, the diodes are not conducting. Check V152 and resistors R147 and R148.

Measure the voltage at the output of the Time-Base Generator (pin 3 of V161B). If this voltage is approximately +250 volts, the Runup Cathode Follower stage may be assumed to be operating correctly. If this voltage is low, however, the stage is defective and its grid and cathode circuits should be checked.

Next, measure the grid to cathode voltage of the Hold-Off Cathode Followers, V183A and V145B. Both of these readings should be approximately -4 volts if the cathode followers are operating correctly. If either or both of these voltages are incorrect, check the hold-off capacitor and the resistors in the cathode circuits of the two stages.

If the previous checks gave correct results, the voltage at the grid of V135A should be sufficient to reset the multivibrator (more positive than -35 volts). If this is so, and the multivibrator

still does not reset, the trouble must lie in that stage. Check the voltages at the plates of V135A, V135B, and V145A, and the resistors in the cathode circuit of V135B.

2. Low voltage

Low voltage at the plate of the Miller tube indicates that the tube is conducting quite heavily and is not being allowed to perform its normal runup operation. If this trouble exists on only a few ranges of the TIME/CM switch the trouble is likely to be an open timing resistor. If the trouble exists on all ranges of the TIME/CM switch, the trouble is probably due to a defective Sweep-Gating Multivibrator stage.

To check the Sweep-Gating Multivibrator, monitor the voltage at the junction of R114 and R126 and adjust the STABILITY ADJUST control for a reading of -70 volts on the voltmeter. With this voltage, the Sweep-Gating Multivibrator and the sweep should free run. If the multivibrator does not switch, check the resistances which make up the stage.

If the voltage at the junction of resistors R114 and R126 remains relatively constant as the STABILITY ADJUST control is rotated, a defect in cathode follower V145B may be causing the stage to effectively regulate the voltage at this point. If such is the case, the probable cause of this condition is a shorted holdoff capacitor. If the voltage does not adjust to the proper level, check the resistors in the grid circuit of V135A.

For nonlinear sweep

A nonlinear sweep voltage will be generated if the current charging the Timing Capacitor does not remain constant. If the nonlinearity exists at all sweep rates, a defective Miller tube is the probable cause of the trouble. If the nonlinearity occurs only at certain sweep rates, the Miller tube or a leaky Timing Capacitor is the probable cause.

For insufficient horizontal deflection

If the horizontal trace starts at the left-hand side of the screen, but does not extend to the right-hand side, the Hold-Off circuit is resetting the Sweep Gating Multivibrator before the sweep is complete. If the sweep cannot be adjusted to normal length with the SWP LENGTH control R176, the resistance in the cathode circuit of V161B should be checked.



Troubleshooting The CRT Circuit

For troubles which affect both beams

The intensity, calibration, focus, and geometry of the crt display depend on the proper operation of the high-voltage power supply in the CRT Circuit. In general, troubles occurring in the high-voltage power supply will produce similar effects on both beams.

If no high voltage (or insufficient high voltage) is available from either the grid or cathode supplies, a defective oscillator circuit or excessive loading is probably the cause. The oscillator can be quickly checked by placing a neon bulb in the field of the high voltage transformer T801. If the bulb glows, the oscillator is operating and the trouble is likely to be in the secondary windings of T801 if there is no high voltage, or in the regulator circuit (V814) if the high voltage is abnormally low. It is unlikely that both rectifier tubes would simultaneously be defective.

If the neon bulb does not glow in the transformer field, the oscillator is not operating. If replacement of the oscillator tube V800 and the regulator tube V814 does not clear up the trouble, check the components of the oscillator circuit including the primary and secondary windings of transformer T801.

If the proper output voltage is obtained from at least one of the high voltage supplies, the oscillator circuit need not be checked. In this case, you can check the rectifier and components associated with the inoperative supply. If the proper output voltages are obtained from both power supplies and the circuit is still not operating correctly, check the voltage dividers which control the intensity and focus of the beams. If these are also normal, the trouble will likely be the crt itself or its cathode circuit. Badly mis-focused and distorted displays can be caused by

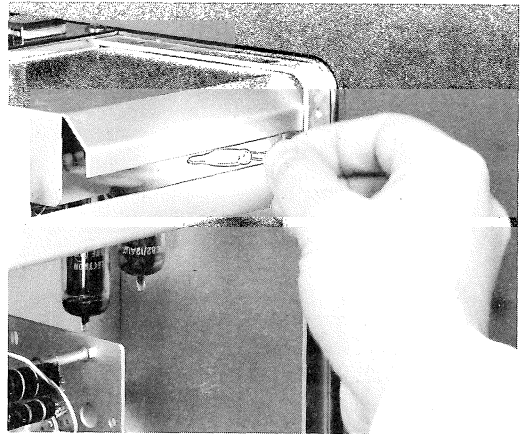

Fig. 5-5. Checking operation of the high voltage oscillator circuit by means of a neon bulb placed in the field of the high voltage transformer.

an open GEOM ADJ control or a loose connection at the neck of the crt.

If the high voltage appears to be abnormal, as evidenced by decreased or increased horizontal and vertical deflection sensitivity, the regulator circuit (V814) should be checked. If this tube or any component of this circuit is changed, the setting of the HV ADJ control (R824) should be checked and adjusted if necessary according to the procedure given in the recalibration section of this manual.

For troubles which affect only one beam

Troubles which affect only one beam will generally be caused by defects in the intensity and focus voltage dividers, by the Astigmatism controls, or by the crt. These parts (except for the crt) can be checked by voltage and resistance measurements. If the circuit checks out satisfactorily, replace the crt.

Troubleshooting the Vertical Amplifiers

For no spot or trace

As mentioned earlier in the Troubleshooting Procedure, if a trace (or spot) is visible when the vertical deflection plates are externally shorted

together, but disappears when the short is removed the vertical amplifier is in a state of dc unbalance. To determine the cause of this condition, short the plates of the output stage (V474B and V484B) together. If the trace does not ap-



pear, one side of the circuit, between the output stage and the crt, is open. A continuity check with an ohmmeter is perhaps the best way to determine which side is open. On the upper beam vertical amplifier check particularly the connections at the HORIZ DEF PLATE SELECTOR switch, SW489.

If the trace does appear, however, when the plates of the output stage are shorted together, the circuit between this point and the crt pin connections is normal. The trouble then lies somewhere in the vertical amplifier ahead of the

plate circuit of the output stage. To locate the defective stage, move the shorting strap back, point by point, between corresponding points on opposite sides of the circuit. As you short between the points, in turn, the spot should return on the screen as each connection is made. You may have to readjust the POSITION control when shorting between grids of the input stage. When you reach a point where the spot does not return to the screen, the stage immediately following this point is at fault. The trouble may be caused by a defective tube, resistor, or capacitor.

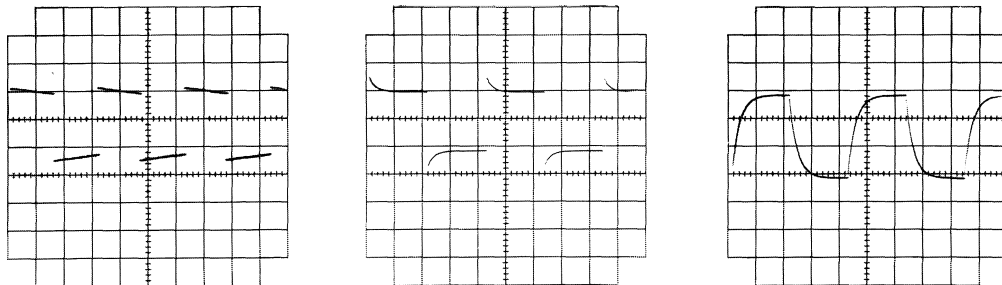

Fig. 5-6. Frequency distortion. (a) Low frequency distortion of a 20 cycle square wave due to attenuation of the low frequency components of the waveform. (b) High frequency distortion of a 1200 cycle square wave due to excessive boost of the high frequency components of the waveform. (c) High frequency distortion of a 1200 cycle square wave due to attenuation of the high frequency components of the waveform.

For insufficient or no vertical deflection

Insufficient vertical deflection indicates a change in the gain characteristics of the Vertical Amplifier. If the change is small, the Vertical Amplifier can usually be recalibrated for gain. Refer to the Recalibration Procedure for this.

If the change in gain is more pronounced, or if there is no vertical deflection at all, the tubes should be first checked. Then check for components which will affect the gain of both sides of the amplifier without unbalancing the amplifier. Such parts are common cathode resistors in the difference amplifier stages, or plate dropping resistors which are common to both sides of the amplifier.

Insufficient vertical deflection will also be caused if the upper or lower frequency limit of the amplifier is exceeded.

For waveform distortion

Waveform distortion can be divided into two categories...low frequency and high frequency. If a square wave is applied to an input of the

oscilloscope, the type of distortion can be determined by the shape of the displayed waveform. High frequency distortion will primarily affect the leading edge and trailing edge of the applied square wave while low frequency distortion will primarily affect the mid-portion of the waveform.

Waveforms showing low frequency distortion and two types of high frequency distortion are shown in figure 5-6. The shape of these waveforms will vary widely however, with the cause of the distortion and the frequency of the applied wave. A nominal amount of low frequency distortion is normal for very low input frequencies when ac coupling is used, and a nominal amount of high frequency distortion is normal at the upper frequency limits of the instrument. It is only when this distortion is excessive in the normal frequency range of the instrument that it constitutes a trouble.

Low frequency distortion is usually caused by a change in the time constant of the input coupling circuit. If tubes become gassy however, their resultant grid current will establish a time con-

Troubleshooting the Horizontal Amplifier

For no trace or spot

If both beams are visible when the horizontal deflection plates are externally shorted together, but disappear when the short is removed, the horizontal amplifier is in a state of unbalance. The procedure for troubleshooting the Horizontal Amplifier is somewhat the same as that explained previously for troubleshooting the Vertical Amplifiers for unbalance. Corresponding points on opposite sides of the Horizontal Amplifier circuit should be progressively shorted together until a point is reached where the beams do not return to the face of the crt. The stage immediately following this point is the one which is defective. Check for open resistors in the cathode and plate circuits.

For insufficient or no horizontal deflection

If the gain of the Horizontal Amplifier decreases, the trace will not extend to the left and

right sides of the crt screen. In addition, the sweep timing will no longer be calibrated on any range of the TIME/CM switch. If the change in sweep timing and sweep length is slight, it may be possible to correct this trouble by adjusting the high voltage and the X1 CAL and X20 CAL controls according to the instructions contained in the Recalibration Procedure.

If the decrease in gain of the Horizontal Amplifier is more pronounced, or if there is no sweep at all, check for components which will affect the gain but not the balance of the amplifier. The input cathode follower, V183B, should be checked as one of the first steps. Also, the common resistances in the cathodes of the difference amplifier stages should be checked.





RECALIBRATION PROCEDURE

INTRODUCTION

The following paragraphs outline the procedure used to recalibrate the Type 502 Oscilloscope. The instrument should not require frequent recalibration, but occasional adjustments will be necessary when tubes and other components are changed. Also, a periodic recalibration is desirable from the standpoint of preventative maintenance.

Apparent troubles occurring in the instrument are often actually the result of improper calibration of one or more circuits. Consequently this section of the manual should be used in conjunction with the Maintenance section during troubleshooting work. If a trouble occurs in the instrument, you must first be sure that the trouble is not due to improper calibration before proceeding with more detailed troubleshooting.

In the instructions that follow, the steps are arranged in the proper sequence for a complete recalibration of the instrument. Each numbered step contains the information required to make one adjustment or a series of related adjustments.

In each recalibration step only the required information is given. Controls are assumed to be set at the positions they were in during the previous step unless specific instructions are given to change their settings or unless different settings are required to obtain a suitable display on the face of the crt. All test equipment, except for input signal sources, and all jumpers are disconnected at the end of each step unless instructions are given to the contrary. Input signal voltages should remain connected to the instrument

until specific instructions are given to disconnect them or until another input signal is applied to the same input connector.

The location of the adjustment controls is given on the pull out sheets immediately following the Recalibration Procedure section.

If a single control requires adjustment, and the particular control is known, it can often be adjusted without necessitating a recalibration of the entire instrument provided the control does not interact with other adjustments. In such cases the control is adjusted in the normal manner as described in the applicable step of the Recalibration Procedure. It will be necessary, however, for you to refer to the recalibration steps immediately preceding the adjustment you wish to make to determine the proper settings for the controls not mentioned in that step. Due to the interaction between adjustments in the horizontal and vertical amplifiers, single adjustments in these circuits usually cannot be made. When amplifier adjustments are required, the entire amplifier should be recalibrated. In addition, if either the -150-volt supply or the high voltage power supply is adjusted, the entire instrument must be recalibrated.

If you find that a circuit is out of calibration, but you are not aware of which particular adjustment will correct the difficulty, it is usually best to recalibrate the entire circuit. For your convenience, all the recalibration adjustments are subdivided into their respective circuits so that any one circuit can easily be recalibrated.

EQUIPMENT REQUIRED

The following equipment or its equivalent is necessary for a complete recalibration of the Type 502 Oscilloscope.

1. DC voltmeter (sensitivity of at least 5000 ohms per volt) with corrected readings within 1% for 100, 150, and 350 volts and within 3% for 2900 volts. Be sure your meter is accurate; few portable test meters have the required accuracy, particularly after a period of use.
2. Accurate rms-reading ac voltmeter, 0-150 volts

(0-250 or 0-300 volts for 210- to 250-volt operation).

3. Variable autotransformer (Powerstat, Variac, etc.) having a rating of at least 500 watts.
4. Time-mark generator, Tektronix Types 180 or 181. If neither of these instruments is available, it will be necessary to substitute a time-mark generator having markers at 1 microsecond, 10 microsecond, 100 microsecond, and 1 millisecond intervals.



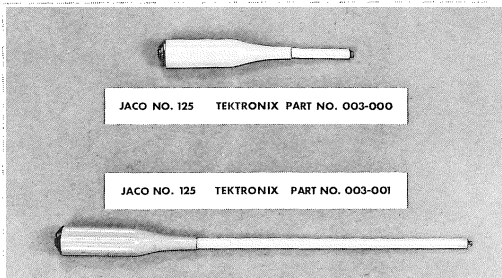

Fig. 6-1. Tools required for calibrating the Type 502 Oscilloscope.

5. Square-wave generator, Tektronix Type 105. If a Type 105 Square-Wave Generator is not available, it will be necessary to substitute a square-wave generator with the following specifications: (1) output frequencies of 200 cycles,

1 kilocycle, and 10 kilocycles, (2) risetime no more than 20 millimicroseconds, and (3) output amplitude variable between approximately 40 millivolts and approximately 100 volts.

6. Oscilloscope, Tektronix Type 316. If a Type 316 Oscilloscope is not available, it will be necessary to substitute an oscilloscope with the following specifications: (1) calibrated vertical deflection factors from .01 to 10 volts per division and (2) bandpass of dc to 10 megacycles.

7. Tektronix Type P52, 52-ohm Coaxial Cable.

8. Tektronix Type B52-R, 52-ohm Termination Resistor.

9. Tektronix Type CS47, 47 μmf Input Capacitance Standardizer.

10. Tektronix Type B52-T10, 52-ohm T-Pad.

11. Alignment tools.

LOW-VOLTAGE POWER SUPPLY

Preliminary.

Rotate the INTENSITY control fully counterclockwise and connect the power cord and the ac voltmeter to the output of the autotransformer. Rotate the SCALE ILLUM control clockwise to the On position and adjust the autotransformer for an output of 117 volts (or 234 volts). Allow the instrument to warm up for several minutes before proceeding with the recalibration adjustments. During recalibration, periodically check the input voltage to the instrument and adjust the autotransformer as necessary to maintain the voltage at 117 or 234 volts except when the power supply regulation is being checked.

CAUTION

Do not reset the -150 ADJ control unless the power supply voltages are actually out of tolerance or you are planning to perform a complete recalibration of the instrument.

1. -150 ADJ. Connect the dc voltmeter to the output of the -150 -volt power supply. (Power-supply output test points are shown in Fig. 5-4.) Set the -150 ADJ control for a reading of -150 volts. Check that the outputs of the $+100$ - and $+350$ -volt supplies are within the specified $\pm 3\%$ tolerances. If either the $+100$ - or $+350$ -volt supplies are out of tolerance, reset the -150 ADJ control slightly until all power supply voltages are within tolerances.

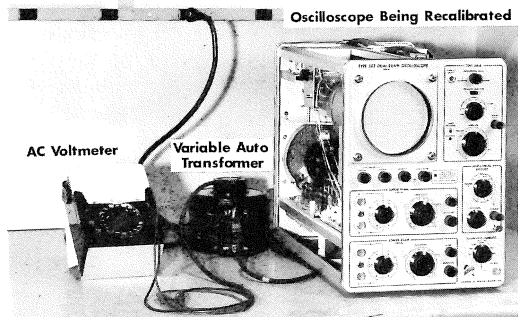

Fig. 6-2 Input power connections for the oscilloscope being recalibrated.

Vary the output of the autotransformer between 105 and 125 volts (or between 210 and 250 volts) to check the regulation of the low-voltage power supplies. The power supplies must regulate within $\pm 3\%$ of their correct voltages. Place the SQUARE-WAVE CALIBRATOR switch in the OFF position and the HORIZONTAL DISPLAY switch in the 2 EXT VOLTS/CM position. Using the test oscilloscope, check the ripple voltage at the output of each power supply when the autotransformer is adjusted for 117 volts. Ripple voltages at the output of all the low-voltage power supplies except the $+350$ -volt supply should be approximately 5 millivolts. Ripple voltage at the output of the $+350$ -volt supply should be approximately 10 millivolts.

CALIBRATOR

2. R879, Calibrator Adjust. Connect the dc voltmeter to the junction of R885 and the cathode of V873 at the point where resistor R885 is connected to the SQUARE-WAVE CALIBRATOR switch. (Refer to Fig. 6-3.) Adjust the Calibrator Adjust control, R879, for a reading of +100 volts on the dc voltmeter.

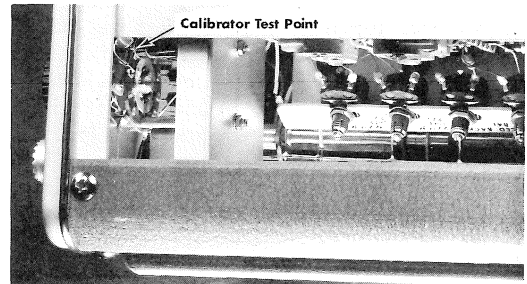

Fig. 6-3. Location of the Calibrator test point.

CRT CIRCUIT

3. HV ADJ. Connect the dc voltmeter to the HV TEST POINT marked on the shield at the left rear of the instrument. Set the HV ADJ control for a reading of -2900 volts on the dc voltmeter.

4. CRT Alignment. Adjust the oscilloscope controls to obtain a sweep and position one of the traces under a horizontal division of the graticule near the vertical center of the crt. Loosen the clamp at the base of the crt, and using the plastic handle provided at the base, rotate the crt until the trace runs parallel to the horizontal divisions of the graticule. Push the crt forward against the graticule and tighten the crt clamp.

5. GEOM ADJ. Place both Input Selector switches in the A DC position and connect 1-millisecond time markers to both A inputs. Rotate the TIME/CM control to the 1 MILLISEC position and the HORIZONTAL DISPLAY switch to the NORMAL (X1) position. Adjust the two SENSITIVITY controls so that the markers cover the entire screen vertically. Position the two traces so that only the vertical portions of the markers are displayed on the face of the crt and adjust the TRIGGERING LEVEL control to obtain a stable display. Set the GEOM ADJ control for minimum curvature of the vertical lines at the sides of the crt. Disconnect the time markers.

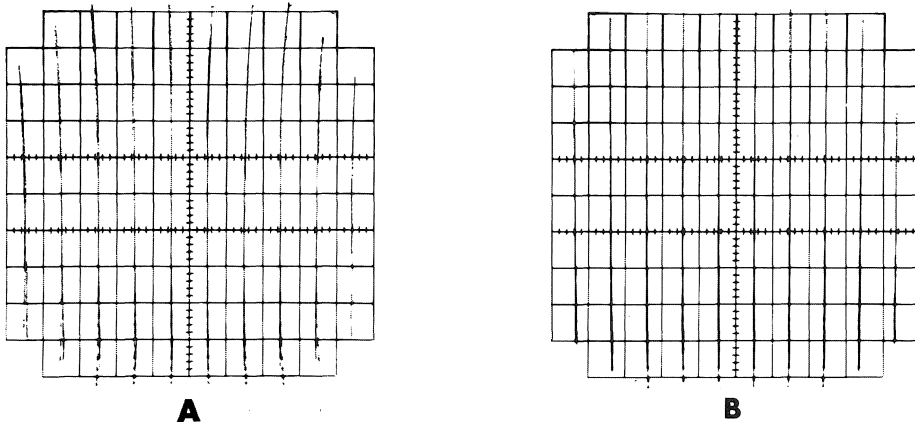

Fig. 6-4. Adjustment of the GEOM ADJ control.

In waveform A the GEOM ADJ control is improperly set causing bowing of the vertical lines. In waveform B the bowing of the vertical lines has been reduced to a minimum by the proper adjustment of the GEOM ADJ control.



6. Astigmatism. Place the HORIZONTAL DISPLAY switch in the 2-EXT VOLTS/CM position, and rotate both the UPPER BEAM and LOWER FOCUS controls fully clockwise. Position both beams onto the screen, and adjust the ASTIG UPPER and ASTIG LOWER controls so that both defocused spots are as nearly circular as is possible. Adjust the UPPER BEAM and LOWER BEAM FOCUS controls so that both spots are in sharp focus.

7. INT BAL. Adjust the oscilloscope controls to obtain a sweep and display both beams on the face of the crt. Roughly adjust the INT BAL control so that both beams appear to have the same intensity. For a fine adjustment, rotate the INTENSITY control counterclockwise until the traces are just visible. Adjust the INT BAL control until both traces have the same intensity.

HORIZONTAL AMPLIFIER

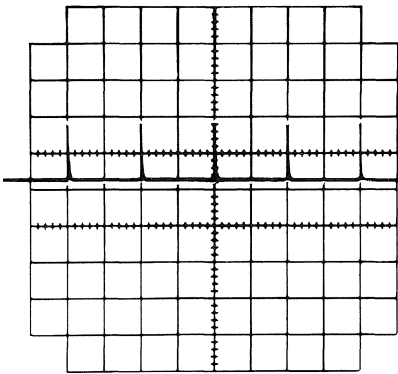

Fig. 6-5. Adjustment of the X20 control.

The X20 CAL control is adjusted in step 8 of the recalibration procedure for the correct magnified sweep rate. The control should be set so that markers occur at 2 centimeters intervals.

8. X20 CAL. Place the TIME/CM control at 1 MILLISEC and the HORIZONTAL DISPLAY switch at X20. Apply 100 μ sec markers to the upper beam vertical input. Adjust the X20 CAL control for one 100 μ sec marker per 2 cm.

9. X1 CAL. Set the HORIZONTAL DISPLAY switch at NORMAL (X1) and apply 1 millisecond markers to the upper beam vertical input. Adjust the X1 CAL control for one 1 millisecond marker per centimeter. Disconnect the markers.

10. NORM/MAG REGIS. Place the HORIZONTAL DISPLAY switch in the X20 position and position the start of the upper trace under the vertical centerline of the graticule. Rotate the HORIZONTAL DISPLAY switch to NORMAL (X1) and adjust the NORM/MAG REGIS control so that the start of the sweep again lies under the vertical centerline of the graticule. Repeat adjustments 8, 9, and 10 until all are set correctly.

11. EXT HORIZ AMPL DC BAL. Rotate the HORIZONTAL DISPLAY switch through the EXT VOLTS/CM positions and adjust the EXT HORIZ AMPL DC BAL control so that there is no horizontal shift of the spots as the HORIZONTAL DISPLAY switch is rotated.

12. C311. Set the TIME/CM switch at 1 μ SEC and the HORIZONTAL DISPLAY switch at NORMAL (X1). Rotate the TRIGGERING LEVEL control to the RECURRENT position. Connect a probe from a test scope set for dc coupling to pin 1 of V324. Adjust C311 so that the bottom portion of the waveform displayed on the test oscilloscope is flat.

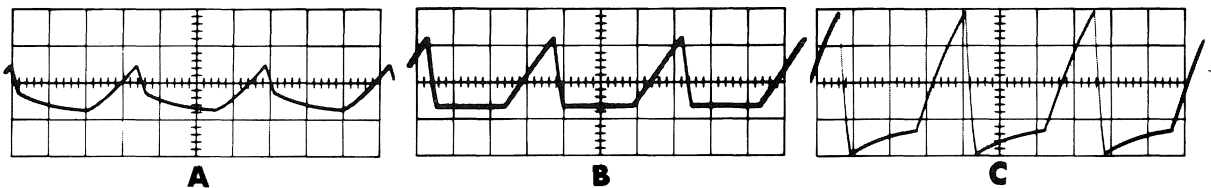

Fig. 6-6. Adjustment of C311.

Waveforms A and C result from improper settings of C311. Capacitor C311 should be adjusted so that waveform B is obtained on the test oscilloscope.

TIME-BASE GENERATOR

13. 10 μ Second Sweep Timing (C160C). Place the TIME/CM switch in the 10 μ SEC position and the HORIZONTAL DISPLAY switch in the NORMAL (X1) position. Apply 10 μ second time markers to the vertical input and adjust C160C for 1 marker per centimeter.

14. 1 μ Second Sweep Timing (C160A). Place the TIME/CM switch in the 1 μ SEC position and apply 1 μ second markers to the vertical input. Adjust C160A for 1 marker per centimeter. Disconnect the markers.

VERTICAL AMPLIFIER

NOTE

Adjustments 15 through 29 apply to both the vertical amplifiers. Complete recalibration of one amplifier before proceeding to the other.

15. COARSE DC BAL. Rotate the TRIGGERING LEVEL control to the RECURRENT position and the DC BAL control to midrange. Ground the vertical input terminal. Place the SENSITIVITY control in the 5 VOLTS PER CM position, and position the trace to the appropriate horizontal centerline. Adjust the COARSE DC BAL control so that the trace does not shift vertically as the SENSITIVITY switch is rotated between the 5 VOLTS PER CM and 2 VOLTS PER CM positions.

16. DC BAL. Leave the vertical input terminal grounded as in step 15. After adjusting the COARSE DC BAL control, rotate the SENSITIVITY switch to the 200 μ VOLTS PER CM position and adjust the DC BAL control so that the trace lies behind the appropriate horizontal centerline.

17. .2V/CM DIFF BAL. Set the SQUARE-WAVE CALIBRATOR switch at 1V and apply the calibrator output to both A and B input connectors of the vertical amplifier. Place the SENSITIVITY control in the .2 VOLTS PER CM position and the Input Selector switch in the DC A-B (DIFF.) position. Set the TIME/CM switch at 1 MILLISEC. Position the trace so that it lies behind the appropriate horizontal centerline. Adjust the .2V/CM DIFF BAL control for minimum vertical deflection.

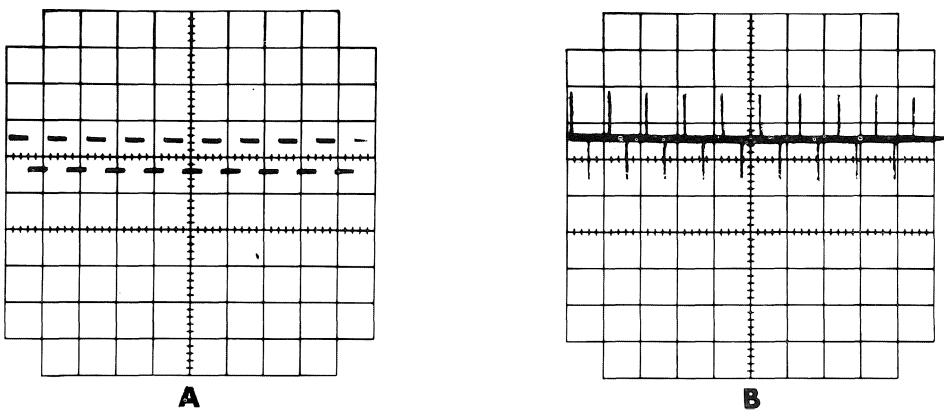

Fig. 6-7. Adjustment of the .2MV/CM DIFF BAL control.

If the .2MV/CM DIFF BAL control is slightly misadjusted, a waveform similar to waveform A will be obtained. Waveform B shows a typical display obtained when the control is adjusted properly.



18. **.2MV/CM DIFF BAL.** Place the SENSITIVITY switch in the 200 μ VOLTS PER CM position and position the trace so that it lies behind the appropriate horizontal centerline. Adjust the .2MV/CM DIFF BAL control for minimum vertical deflection. Repeat steps 17 and 18 until both adjustments are correct.

19. **.2V/CM GAIN ADJ.** Apply 1-volt signals from the calibrator to input A of the vertical-amplifier. Set the Input Selector switch in the A DC position and the SENSITIVITY switch in the .2 VOLTS PER CM position. Set the .2V/CM GAIN ADJ for 5 centimeters of vertical deflection.

20. **.2MV/CM GAIN ADJ.** Apply 1-millivolt signals from the calibrator to input A of the vertical amplifier. Place the SENSITIVITY switch in the 200 μ VOLTS PER CM position. Set the .2MV/CM GAIN ADJUST for 5 centimeters of vertical deflection. Repeat steps 19 and 20 until both adjustments are correct.

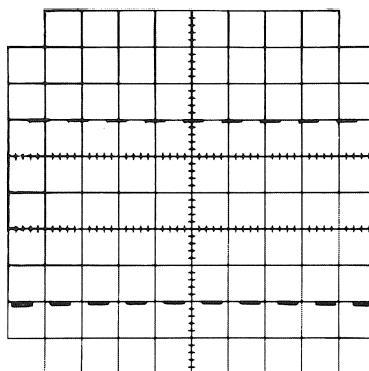

Fig. 6-8. Setting the .2V/CM GAIN ADJ control.
In step 19 of the recalibration procedure, the .2V/CM GAIN ADJ control is adjusted for 5 centimeters of vertical deflection.

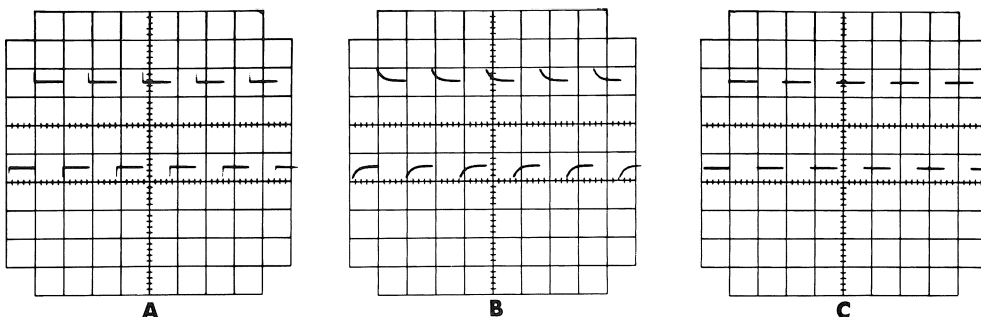

Fig. 6-9. Adjustment of the high frequency compensating capacitors.
Waveforms A and B are typical waveforms resulting from misadjusted capacitors. All capacitors in steps 21 through 28 of the recalibration procedure should be adjusted to obtain waveforms having a minimum of distortion. Waveform C shows the display obtained with properly adjusted capacitors.

21. **C410.** Apply 1-kc square-waves from the Type 105 Square-Wave Generator to input connector A of the vertical amplifier through the CS47 Capacitance Standardizer. Place the SENSITIVITY switch in the .2 VOLTS PER CM position. Adjust C410 for an undistorted square-wave.

22. **C440.** Apply 1-kc square-waves from the Type 105 to input connector B of the vertical amplifier through the CS47 Capacitance Standardizer. Place the Input Selector switch in the B DC position and adjust C440 for an undistorted square-wave.

23. **C406A and C406C.** Apply 1-kc square-waves from the Type 105 to input connector A

of the vertical amplifier through the CS47 Capacitance Standardizer. Place the Input Selector switch in the A DC position and the SENSITIVITY switch in the 2 VOLTS PER CM position. Adjust the output of the Type 105 for approximately 3 cm of vertical deflection. Adjust C406A and C406C for an undistorted square-wave.

24. **C406G and C406J.** Place the SENSITIVITY switch in the 5 VOLTS PER CM position and adjust the Type 105 output for approximately 3 cm of vertical deflection. Adjust C406G and C406J for an undistorted square-wave.

25. **C407A and C407C.** Connect 1-kc square-waves from the Type 105 to input connector B of the vertical amplifier through the CS47 Capacitance Standardizer. Place the Input Selector



switch in the B DC position and the SENSITIVITY switch in the 2 VOLTS PER CM position. Set the Type 105 output amplitude for approximately 3 centimeters of vertical deflection. Adjust C407G and C407J for an undistorted square-wave.

27. C470 and C489. Place the SENSITIVITY switch in the .2 VOLTS PER CM position and the TIME/CM switch in the 50 μ SEC position. Apply 10-kc square-waves from the Type 105 to input A of the vertical amplifier through the Type B52-R Terminating Resistor and place the Input Selector switch in the A DC position. Adjust C470 and C489 for the best possible square-wave.

28. C480. Apply 10-kc square-waves from the Type 105 to input B of the vertical amplifier through the B52-R Terminating Resistor and place the Input Selector switch in the B DC position. Adjust C480 for the best possible square-wave. Adjustments 27 and 28 interact and the final settings for C470, C480, and C489 should be made so that the displayed waveform appears the same when the input square-waves are applied to either the A or B input connector.

NOTE

For the FEEDBACK BAL adjustment it will be advantageous if you shield the vertical amplifiers by placing a metal plate at the side of the amplifier. The amplifiers are normally shielded by the side panels.

29. FEEDBACK BAL. Apply 200-cycle square-waves from the Type 105 to the A and B input connectors through Type B52-T10 T-pads and Type CS47 Capacitance Standardizers. (The capacitance standardizers must be connected to the oscilloscope input connectors.) Place the SENSITIVITY switch in the 200 μ VOLTS PER CM position and the TIME/CM switch in the 1 MILLI-

SEC position. Ignore the noise on the displayed square-waves and adjust the FEEDBACK BAL control for the least distorted square-wave for both the A, DC and B DC positions of the Input Selector switch.

30. GAIN ADJ FOR HORIZ MODE. Place the HORIZ DEF PLATE SELECTOR switch in the UPPER BEAM AMP position and place the UPPER BEAM SENSITIVITY switch in the 1 VOLTS PER CM position. Place the Input Selector switch in the A DC position and connect 10 volts of Calibrator signal to the A input connector of the upper beam amplifier. Adjust the GAIN ADJ FOR HORIZ MODE control for 10 centimeters of horizontal deflection.

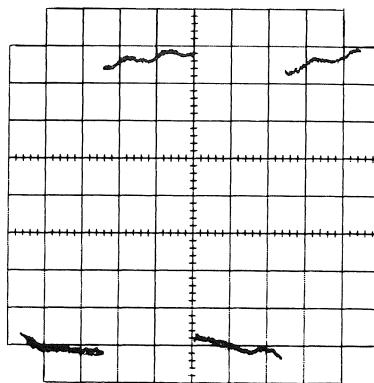

Fig. 6-10. Adjustment of the FEEDBACK BAL control. The waveform shown is typical of the waveforms obtained when the FEEDBACK BAL control is adjusted properly. The vertical amplifier is shielded by a small metal plate to reduce the noise level. Note that it is not usually possible to completely eliminate distortion of the square wave. The adjustment is made for minimum distortion.

TRIGGERING CIRCUIT

31. TRIG LEVEL CENT. Place the HORIZ DEF PLATE SELECTOR switch in the TIME BASE AMP position, the UPPER-BEAM SENSITIVITY switch in the 1 VOLTS PER CM position, and the TRIGGERING LEVEL control at midrange. Connect 100 millivolts of Calibrator signal to input A of the upper beam vertical amplifier and place the TRIGGER SELECTOR switch in the UPPER AC position. Ground the junction of R15 and C13 (See Fig. 6-11.) by placing a jumper between that point and the chassis. Adjust the TRIG. LEVEL

CENT control so that the sweep will trigger correctly with the TRIGGER SELECTOR Slope switch in either the + or - positions.

32. STABILITY ADJUST. Disconnect the Calibrator signal, remove the jumper from the junction of R15 and C13 to ground, and place the TRIGGERING LEVEL control in the AUTOMATIC position. Connect a meter from the wiper arm of the STABILITY ADJUST potentiometer to ground. Rotate the STABILITY ADJUST control clockwise from the fully counterclockwise position. Note



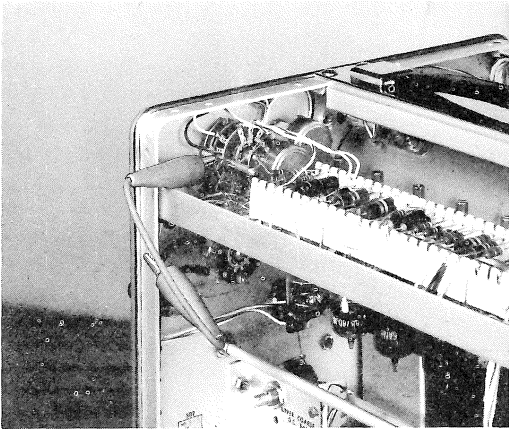

Fig. 6-11. Grounding the junction of R15 and C13. For adjustment of the TRIG LEVEL CENT and DC TRIG ADJ controls, the junction of R15 and C13 is grounded as shown.

the voltage when the trace first appears on the face of the crt. Continue to rotate the STABILITY ADJUST control clockwise until the trace brightens and again note the voltage. Set the STABILITY ADJUST control so that the voltage reading is midway between the two voltages previously noted.

33. Upper Beam DC TRIG ADJ. Position the TRIGGERING LEVEL control to midrange and place a jumper from the junction of R15 and C13 to ground. Place the UPPER BEAM SENSITIVITY switch in the .5 VOLTS PER CM position and apply 100 mv of Calibrator signal to input A of the upper beam vertical amplifier. Position the upper beam trace under the upper horizontal centerline. Place the TRIGGER SELECTOR switch in the UPPER DC position and set the DC TRIG ADJ control so that the sweep will trigger on either the + or - positions of the TRIGGER SELECTOR Slope switch.

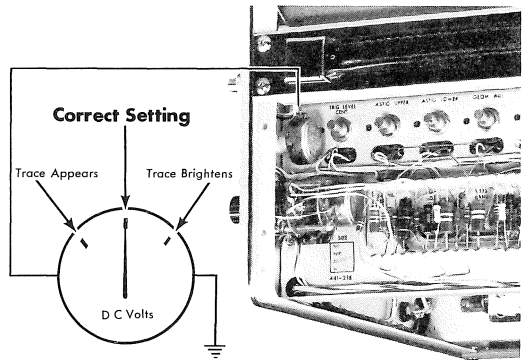

Fig. 6-12. Adjustment of the STABILITY ADJUST control.

The STABILITY ADJUST control is set for a meter reading that is midway between the reading obtained when the trace first appears and the reading obtained when the trace brightens.

34. Lower Beam DC TRIG ADJ. Leave the jumper connected as in step 33. Place the Lower Beam Input Selector switch in the A DC position and the LOWER BEAM SENSITIVITY switch in the .5 VOLTS PER CM position. Connect 100 MV of Calibrator signal to input A of the lower beam vertical amplifier. Place the TRIGGER SELECTOR switch in the LOWER AC position and position the lower trace under the lower horizontal centerline. Place the TRIGGER SELECTOR switch in the LOWER DC position and set the DC TRIG ADJ so that the sweep triggers properly on both the + and - settings of the TRIGGER SELECTOR Slope switch. Disconnect the jumper and the Calibrator signal.

35. SWP LENGTH. Place the TIME/CM switch in the 1 MILLISEC position and the TRIGGERING LEVEL control in the RECURRENT position. Adjust the SWP LENGTH control for a total sweep length of 10.5 centimeters.

PARTS LIST

For an explanation of the abbreviations used in this parts list, see the indexed sheet marked ABBREVIATIONS & WARRANTY. It is recommended that those components marked with an asterisk in front of the Part Number be purchased from the factory or from a Tektronix Field Engineering Office.

LAMPS

					Tektronix Part Number
B167		Neon, Type NE-2			150-002
B331N		Neon, Type NE-2			150-002
B331M		Neon, Type NE-2			150-002
B490		Neon, Type NE-2			150-002
B601		Incandescent, Type 47			150-001
B602		Incandescent, Type 47			150-001

CAPACITORS

						Tektronix Part Number
C10	.01 μf	Cer.	Fixed	500 v		283-002
C13	.005 μf	Cer.	Fixed	500 v		283-001
C24	.001 μf	Cer.	Fixed	500 v		283-000
C31	.01 μf	PTM	Fixed	400 v		285-510
C44	22 μf	Cer.	Fixed	500 v		281-510
C131	22 μf	Cer.	Fixed	500 v		281-510
C141	6.8 μf	Cer.	Fixed	500 v	10%	281-541
C160A	3-12 μf	Cer.	Var.	500 v		*281-007
C160B	82 μf	Mica	Fixed	500 v	5%	283-534
C160C	4.5-25 μf	Cer.	Var.	500 v		*281-010
C160D**	.001 μf	} Special Timing Series Manufactured by Tektronix. Order replacements from the factory or through your Tektronix Field Engineer.				291-007
C160E	.01 μf					
C160F	.1 μf					
C160G	1 μf					
C167	.001 μf	Cer.	Fixed	500 v		283-000
C180A	82 μf	Cer.	Fixed	500 v	10%	281-528
C180B	.001 μf	PTM	Fixed	600 v		285-501
C180C	.01 μf	PTM	Fixed	400 v		285-510
C180D	.1 μf	PTM	Fixed	400 v		285-526
C181	82 μf	Cer.	Fixed	500 v	10%	281-528
C311	4.5-25 μf	Cer.	Fixed	500 v		281-010
C312	56 μf	Cer.	Fixed	500 v		281-521
C350	.005 μf	Cer.	Fixed	500 v		283-001
C400†	.1 μf	Manufactured by Tektronix				285-556
C401†	.1 μf	Manufactured by Tektronix			295-054	285-556

**This timing capacitor can be ordered separately. When ordering, note the color band painted on the end of the capacitor. If the capacitor has a white color band, order 291-008A. If the capacitor has a black color band, order 291-008B.

†There are two parts of this description in your instrument; one in each of the Vertical Amplifiers.



Capacitors (continued)

C406A	7-45 $\mu\mu f$	Cer.	Var.	500 v		*281-012
C406C	1.5-7 $\mu\mu f$	Cer.	Var.	500 v		*281-005
C406G	7-45 $\mu\mu f$	Cer.	Var.	500 v		*281-012
C406J	1.5-7 $\mu\mu f$	Cer.	Var.	500 v		*281-005
C406L	330 $\mu\mu f$	Cer.	Fixed		10%	281-546
C407A	7-45 $\mu\mu f$	Cer.	Var.			*281-012
C407C	1.5-7 $\mu\mu f$	Cer.	Var.			*281-005
C407G	7-45 $\mu\mu f$	Cer.	Var.			*281-012
C407J	1.5-7 $\mu\mu f$	Cer.	Var.			*281-005
C407L	330 μf	Cer.	Fixed		10%	281-546
C410†	4.5-25 $\mu\mu f$	Cer.	Var.			*281-010
C440†	4.5-25 $\mu\mu f$	Cer.	Var.			*281-010
C470†	1.5-7 $\mu\mu f$	Cer.	Var.			*281-005
C480†	1.5-7 $\mu\mu f$	Cer.	Var.			*281-005
C489†	4.5-25 $\mu\mu f$	Cer.	Var.			*281-010
C491†	3.3 $\mu\mu f$	Cer.	Fixed			281-534
C602A	80 μf	} EMC	Fixed	450 v		290-092
C602B	10 μf					
C623	.01 μf	PTM	Fixed	400 v		285-510
C633	.01 μf	PTM	Fixed	400 v		285-510
C635	.1 μf	PTM	Fixed	100 v		285-555
C642	4000 μf	EMC	Fixed	15 v	-20 +50%	290-091
C644	6.25 μf	EMT	Fixed	300 v		290-025
C645	6.25 μf	EMT	Fixed	300 v	-20 +50%	290-025
C652	2x40 μf	EMC	Fixed	450 v	-20 +50%	290-043
C671	.01 μf	PTM	Fixed	400 v		285-510
C685	6.25 μf	EMT	Fixed	300 v		290-025
C686	6.25 μf	EMT	Fixed	300 v		290-025
C722	2x40 μf	EMC	Fixed	450 v		290-042
C751	.01 μf	PTM	Fixed	600 v		285-511
C757A,B	2x20 μf	EMC	Fixed	450 v		290-037
C765A,B	2x20 μf	EMC	Fixed	450 v		290-037
C800	.001 μf	PTM	Fixed	600 v		285-501
C805	.01 μf	PTM	Fixed	400 v		285-510
C807	.0030 μf	Mica	Fixed	500 v	10%	283-538
C808	.1 μf	PTM	Fixed	600 v		285-528
C820	.047 μf	PTM	Fixed	400 v		285-519
C822	.0068 μf	PTM	Fixed	5000 v		285-509
C824	.047 μf	PTM	Fixed	400 v		285-519
C836	.0068 μf	PTM	Fixed	5000 v		285-509
C839	.0068 μf	PTM	Fixed	5000 v		285-509
C850	.0068 μf	PTM	Fixed	5000 v		285-509
C866	.0068 μf	PTM	Fixed	5000 v		285-509
C868	.0068 μf	PTM	Fixed	5000 v		285-509
C871	330 $\mu\mu f$	Mica	Fixed	500 v	10%	283-518
C876	330 $\mu\mu f$	Mica	Fixed	500 v	10%	283-518

†There are two parts of this description in your instrument; one in each of the Vertical Amplifiers.



FUSES

Tektronix
Part Number

F601	4 Amp., Fast-Blo (for 117-v, 60-cycle operation)	159-017
	3.2 Amp., Slo-Blo (for 117-v, 50-cycle operation)	159-026
	2 Amp., Fast-Blo (for 234-v, 60-cycle operation)	159-021
	1.6 Amp., Slo-Blo (for 234-v, 50-cycle operation)	159-003

RESISTORS

Tektronix
Part Number

R10	1 meg	1/2 w	Fixed	Comp.	10%	302-105
R13	220 k	1/2 w	Fixed	Comp.	10%	302-224
R15	1 meg	1/2 w	Fixed	Comp.	10%	302-105
R17	500 k	2 w	Var.	Comp.	20%	*311-034
R18	120 k	1/2 w	Fixed	Comp.	10%	302-124
R21	100 Ω	1/2 w	Fixed	Comp.	10%	302-101
R23	47 k	1 w	Fixed	Comp.	10%	304-473
R24	500 Ω	2 w	Fixed	Comp.		311-005
R26	33 k	1/2 w	Fixed	Comp.	10%	302-333
R27	100 Ω	1/2 w	Fixed	Comp.	10%	302-101
R29	200 k	1/2 w	Fixed	Comp.	5%	301-204
R32	2.7 meg	1/2 w	Fixed	Comp.	10%	302-275
R33	100 Ω	1/2 w	Fixed	Comp.	10%	302-101
R36	22 k	2 w	Fixed	Comp.	10%	306-223
R39	400 k	1/2 w	Fixed	Film	1%	*309-126
R42	100 Ω	1/2 w	Fixed	Comp.	10%	302-101
R44	390 k	1/2 w	Fixed	Film	1%	*309-056
R47	2.7 k	1/2 w	Fixed	Comp.	5%	301-272
R48	680 Ω	1/2 w	Fixed	Comp.	10%	302-681
R51	3.9 k	1/2 w	Fixed	Comp.	10%	302-392
R111	250 k	2 w	Var.	Comp.		*311-032
R114	100 k	1/2 w	Fixed	Comp.	10%	302-104
R126	100 k	1/2 w	Fixed	Comp.	10%	302-104
R129	27 k	1/2 w	Fixed	Comp.	5%	301-273
R130	47 k	1/2 w	Fixed	Comp.	5%	301-473
R131	4.7 k	1/2 w	Fixed	Comp.	10%	302-472
R134	39 k	1/2 w	Fixed	Comp.	5%	301-393
R136	120 k	2 w	Fixed	Comp.	10%	306-124
R137	100 Ω	1/2 w	Fixed	Comp.	10%	302-101
R141	68 k	1 w	Fixed	Film	1%	*310-054
R143	43.4 k	1/2 w	Fixed	Film	1%	*309-176
R144	18 k	2 w	Fixed	Comp.	10%	306-183
R146	100 Ω	1/2 w	Fixed	Comp.	10%	302-101
R147	2.2 k	1/2 w	Fixed	Comp.	10%	302-222
R148	180 k	1/2 w	Fixed	Comp.	10%	302-184
R160A	1 meg	1/2 w	Fixed	Film	1%	*309-014
R160B	2 meg	1/2 w	Fixed	Film	1%	*309-023
R160C	5 meg	1/2 w	Fixed	Film	1%	*309-087
R160D	10 meg	1/2 w	Fixed	Film	1%	*309-095
R160E	10 meg	1/2 w	Fixed	Film	1%	*309-095



Ⓐ

Resistors (continued)

R160F	15 meg	1 w	Fixed	Film	2%	*310-061
R160G	15 meg	1 w	Fixed	Film	2%	*310-061
R161	100 Ω	1/2 w	Fixed	Comp.	10%	302-101
R166	150 k	2 w	Fixed	Comp.	10%	306-154
R167	1.5 meg	1/2 w	Fixed	Comp.	10%	302-155
R168	4.7 k	1/2 w	Fixed	Comp.	10%	302-472
R169	100 Ω	1/2 w	Fixed	Comp.	10%	302-101
R174	27 k	2 w	Fixed	Comp.	10%	306-273
R176	10 k	2 w	Var.	Comp.	20%	*311-016
R178	15 k	1 w	Fixed	Comp.	10%	304-153
R180A	470 k	1/2 w	Fixed	Comp.	10%	302-474
R180B	4.7 meg	1/2 w	Fixed	Comp.	10%	302-475
R181	4.7 meg	1/2 w	Fixed	Comp.	10%	302-475
R183	100 Ω	1/2 w	Fixed	Comp.	10%	302-101
R311	1 meg	1/2 w	Fixed	Film	1%	*309-014
R312	900 k	1/2 w	Fixed	Film	1%	*309-111
R314	200 k	1/2 w	Fixed	Film	1%	*309-051
R315	100 Ω	1/2 w	Fixed	Comp.	10%	302-101
R317	100 k	1/2 w	Fixed	Comp.	10%	302-104
R320	1 meg	1/2 w	Fixed	Film	1%	*309-014
R321	100 Ω	1/2 w	Fixed	Comp.	10%	302-101
R324	560 k	1/2 w	Fixed	Comp.	5%	301-564
R331A	50 k	1/2 w	Fixed	Film	1%	*309-090
R331C	12.5 k	1/2 w	Fixed	Film	1%	*309-228
R331E	5.55 k	1/2 w	Fixed	Film	1%	*309-229
R331G	2.63 k	1/2 w	Fixed	Film	1%	*309-230
R331J	16.69 k	1/2 w	Fixed	Film	1%	*309-231
R331M	100 k	1/2 w	Fixed	Comp.	10%	302-104
R331N	100 k	1/2 w	Fixed	Comp.	10%	302-104
R334	154 k	1/2 w	Fixed	Film	1%	*309-234
R336	56.5 k	1 w	Fixed	Film	1%	*310-065
R337	¹⁵ 10 k	2 w	Var.	Comp.	20%	*311-016 045
R338	50 k	1 w	Fixed	Film	1%	*310-086
R341	250 k	2 w	Fixed	Comp.	20%	311-032
R343	470 k	1/2 w	Fixed	Comp.	10%	302-474
R344	3.9 k	1/2 w	Fixed	Comp.	10%	302-392
R351	100 Ω	1/2 w	Fixed	Comp.	10%	302-101
R354	560 k	1/2 w	Fixed	Comp.	5%	301-564
R356	34 k	1/2 w	Fixed	Film	1%	*309-129
R357	20 k	2 w	Var.	Comp.		*311-018
R358	34 k	1/2 w	Fixed	Film	1%	*309-129
R360	300 k	1/2 w	Fixed	Comp.	5%	301-304
R361	100 Ω	1/2 w	Fixed	Comp.	10%	302-101
R364	30 k	8 w	Fixed	WW	5%	308-105
R365	82 k	2 w	Fixed	Comp.	5%	305-823
R368	5 k	2 w	Var.	Comp.	20%	*311-011
R370	300 k	1/2 w	Fixed	Comp.	5%	301-304
R371	100 Ω	1/2 w	Fixed	Comp.	10%	302-101
R374	30 k	8 w	Fixed	WW	5%	308-105
R376	82 k	2 w	Fixed	Comp.	5%	305-823



Resistors (continued)

R381	220 k	1/2 w	Fixed	Film	1%	*309-052
R383	200 k	1/2 w	Fixed	Comp.	5%	301-204
R385	22 k	1/2 w	Fixed	Comp.	10%	302-223
R386	22 k	1/2 w	Fixed	Comp.	10%	302-223
R391	220 k	1/2 w	Fixed	Film	1%	*309-052
R393	200 k	1/2 w	Fixed	Comp.	5%	301-204
R395	22 k	1/2 w	Fixed	Comp.	10%	302-223
R396	22 k	1/2 w	Fixed	Comp.	10%	302-223
R398	2x50 k	2 w	Var.	Comp.	20%	*311-111
R406C	900 k	1/2 w	Fixed	Film	1%	*309-111
R406E	111 k	1/2 w	Fixed	Film	1%	*309-046
R406J	990 k	1/2 w	Fixed	Film	1%	*309-013
R406L	10.1 k	1/2 w	Fixed	Film	1%	*309-034
R407C	900 k	1/2 w	Fixed	Film	1%	*309-111
R407E	111 k	1/2 w	Fixed	Film	1%	*309-046
R407J	990 k	1/2 w	Fixed	Film	1%	*309-013
R407L	10.1 k	1/2 w	Fixed	Film	1%	*309-034
R408A	50 Ω	1/2 w	Fixed	Film	1%	*309-128
R408B	125 Ω	1/2 w	Fixed	Film	1%	*309-240
R408C	250 Ω	1/2 w	Fixed	Film	1%	*309-178
R408D	505.4 Ω	1/2 w	Fixed	Film	1%	*309-203
R408E	1.28 k	1/2 w	Fixed	Film	1%	*309-241
R408F	2.63 k	1/2 w	Fixed	Film	1%	*309-230
R408G	5.55 k	1/2 w	Fixed	Film	1%	*309-229
R408H	16.69 k	1/2 w	Fixed	Film	1%	*309-231
R408J	50 k	1/2 w	Fixed	Film	1%	*309-090
R408K	193 k	1/2 w	Fixed	Film	1%	*309-243
R410	1 meg	1/2 w	Fixed	Film	1%	*309-014
R411	1 k	1/2 w	Fixed	Comp.	10%	302-102
R413	560 k	1/2 w	Fixed	Comp.	10%	301-564
R414	150 k	1/2 w	Fixed	Film	1%	*309-049
R420	1.2 meg	1/2 w	Fixed	Comp.	10%	302-125
R421†	2x250 k		Var.	Comp.	±20%	*311-114
R422	1.2 meg	1/2 w	Fixed	Comp.	10%	302-125
R423†	100 k	1/2 w	Fixed	Comp.	10%	302-104
R424†	100 k	0.2 w	Var.	Comp.	±20%	*311-088
R425†	100 k	1/2 w	Fixed	Comp.	10%	302-104
R427	90 k	1/2 w	Fixed	Film	1%	*309-195
R428	90 k	1/2 w	Fixed	Film	1%	*309-195
R430†	3.9 k	1/2 w	Fixed	Comp.	10%	302-392
R431†	10 k		Var.	WW		311-015
R432†	22 k	1/2 w	Fixed	Comp.	10%	302-223
R433†	5 k		Var.	Comp.	20%	*311-223
R434†	22 k	1/2 w	Fixed	Comp.	10%	302-223
R435†	50 k	0.2 w	Var.	Comp.		*311-125

†There are two parts of this description in your instrument; one in each of the Vertical Amplifiers.



Resistors (continued)

R440†	1 meg	1/2 w	Fixed	Film	1%	*309-014
R441†	1 k	1/2 w	Fixed	Comp.	10%	302-102
R443†	560 k	1/2 w	Fixed	Comp.	5%	301-564
R444†	150 k	1/2 w	Fixed	Film	1%	*309-049
R450†	47 k	2 w	Fixed	Comp.	10%	306-473
R451†	1 k	1/2 w	Fixed	Comp.	10%	302-102
R452†	5 meg	1/2 w	Fixed	Film	1%	*309-087
R453†	15 k	2 w	Fixed	Comp.	10%	306-153
R454†	30 k	1/2 w	Fixed	Comp.	5%	301-303
R455†	5 k	0.2 w	Var.	Comp.	±20%	*311-067
R456†	1 k	0.2 w	Var.	Comp.	±20%	*311-084
R457†	22 k	1/2 w	Fixed	Comp.	5%	301-223
R458†	22 k	1/2 w	Fixed	Comp.	5%	301-223
R461†	1 k	1/2 w	Fixed	Comp.	10%	302-102
R462†	5 meg	1/2 w	Fixed	Film	1%	*309-087
R464†	30 k	1/2 w	Fixed	Comp.	5%	301-303
R470†	90 k	1/2 w	Fixed	Film	1%	*309-195
R471†	1 k	1/2 w	Fixed	Comp.	10%	302-102
R472†	22 k	1 w	Fixed	Comp.	10%	304-223
R473†	1 k	1/2 w	Fixed	Comp.	10%	302-102
R474†	27k	2 w	Fixed	Comp.	5%	305-273
R476†	18 k	1/2 w	Fixed	Comp.	5%	301-183
R477†	20 k	8 w	Fixed	WW	5%	308-011
R480†	90 k	1/2 w	Fixed	Film	1%	*309-195
R481†	1 k	1/2 w	Fixed	Comp.	10%	302-102
R482†	22 k	1 w	Fixed	Comp.	10%	304-223
R483†	1 k	1/2 w	Fixed	Comp.	10%	302-102
R484†	27 k	2 w	Fixed	Comp.	5%	305-273
R486†	18 k	1/2 w	Fixed	Comp.	5%	301-183
R488†	2.5 k	0.2 w	Var.	Comp.	±20%	*311-120
R489	5 k	0.2 w	Var.	Comp.	±20%	*311-067
R490	68 k	1/2 w	Fixed	Comp.	10%	302-683
R491†	3.5 meg	1/2 w	Fixed	Film	1%	309-086
R492†	1.84 meg	1/2 w	Fixed	Film	1%	*309-021
R494†	220 k	1/2 w	Fixed	Comp.	10%	302-224
R495†	50 k	0.2 w	Var.	Comp.	±20%	*311-125
R499†	47 k	1/2 w	Fixed	Comp.	10%	304-473
R601	50 Ω		Var.	WW	±20%	*311-057
R618	1 k	1/2 w	Fixed	Comp.	10%	302-102
R619	1 meg	1/2 w	Fixed	Comp.	10%	302-105
R621	68 k	1 w	Fixed	Film	1%	*310-054
R622	10 k		Var.	WW	±20%	*311-015
R623	50 k	1 w	Fixed	Film	1%	*310-086
R630	33 k	1/2 w	Fixed	Comp.	10%	302-333
R631	1 meg	1/2 w	Fixed	Comp.	10%	302-105

†There are two parts of this description in your instrument; one in each of the Vertical Amplifiers.



Resistors (continued)

R632	1 k	1/2 w	Fixed	Comp.	10%	302-102
R633	1 meg	1/2 w	Fixed	Comp.	10%	302-105
R635	18 k	1/2 w	Fixed	Comp.	10%	302-183
R636	1 meg	1/2 w	Fixed	Comp.	10%	302-105
R637	1.5 k	25 w	Var.	WW	5%	*308-040
R639	33 k	1/2 w	Fixed	Comp.	10%	302-333
R642	100 k	1/2 w	Fixed	Comp.	10%	302-104
R643	100 k	1/2 w	Fixed	Comp.	10%	302-104
R644	100 Ω	1/2 w	Fixed	Comp.	10%	302-101
R645	100 Ω	1/2 w	Fixed	Comp.	10%	302-101
R646	15 Ω	2 w	Fixed	Comp.	10%	306-150
R647	15 Ω	2 w	Fixed	Comp.	10%	306-150
R648	1.8 k	1/2 w	Fixed	Film	1%	*309-030
R649	42.226 k	1 w	Fixed	Film	10%	*310-068
R650	47 Ω	1/2 w	Fixed	Comp.	10%	302-470
R651	47 Ω	1/2 w	Fixed	Comp.	10%	302-470
R659	1 k	1/2 w	Fixed	Comp.	10%	302-102
R660	47 k	1/2 w	Fixed	Comp.	10%	302-473
R661	47 k	1/2 w	Fixed	Comp.	10%	302-473
R662	1.8 meg	1/2 w	Fixed	Comp.	10%	302-185
R665	<i>27</i> 56 k	<i>2</i> 1 w	Fixed	Comp.	10%	<i>306-273</i> 304-563
R666	1 meg	1/2 w	Fixed	Comp.	10%	302-105
R668	1 k	1/2 w	Fixed	Comp.	10%	302-102
R669	1 meg	1/2 w	Fixed	Comp.	10%	302-105
R671	143 k	1 w	Fixed	Film	1%	*310-088
R673	220 k	1 w	Fixed	Film	1%	*310-055
R685	100 Ω	1/2 w	Fixed	Comp.	10%	302-101
R686	100 Ω	1/2 w	Fixed	Comp.	10%	302-101
R722	100 k	1/2 w	Fixed	Comp.	10%	302-104
R739	1 k	1/2 w	Fixed	Comp.	10%	302-102
R740	27 k	1/2 w	Fixed	Comp.	10%	302-273
R741	470 k	1/2 w	Fixed	Comp.	10%	302-474
R742	270 k	1 w	Fixed	Comp.	10%	302-274
R745	56 k	1 w	Fixed	Comp.	10%	304-563
R746	2.2 meg	1/2 w	Fixed	Comp.	10%	302-225
R747	1 k	1/2 w	Fixed	Comp.	10%	302-102
R748	1 k	1/2 w	Fixed	Comp.	10%	302-102
R749	2.2 meg	1/2 w	Fixed	Comp.	10%	302-225
R751	400 k	1 w	Fixed	Film	1%	*310-094
R753	174 k	1/2 w	Fixed	Film	1%	*309-151
R756	1 k	1/2 w	Fixed	Comp.	10%	302-102
R757	2.25 k	20 w	Fixed	WW	5%	308-064
R765	100 Ω	1/2 w	Fixed	Comp.	10%	302-101
R766	100 Ω	1/2 w	Fixed	Comp.	10%	302-101
R800	56 k	1 w	Fixed	Comp.	10%	304-563
R805	33 k	1/2 w	Fixed	Comp.	10%	302-333
R806	3.9 k	1/2 w	Fixed	Comp.	10%	302-392
R808	<i>1.2</i> 12 k	2 w	Fixed	Comp.	10%	306-122
R809	470 k	1/2 w	Fixed	Comp.	10%	302-474
R820	1 k	1/2 w	Fixed	Comp.	10%	302-102



Resistors (continued)

R825	1.8 meg	1 w	Fixed	Comp.	10%	304-185	
R826	1 meg		Var.	Comp.		*311-039	
R827	3.3 meg	2 w	Fixed	Comp.	10%	306-335	
R828	3.3 meg	2 w	Fixed	Comp.	10%	306-335	
R829	3.3 meg	2 w	Fixed	Comp.	10%	306-335	
R831	5 meg		Var.	Comp.		*311-121	
R832	5 meg		Var.	Comp.		*311-121	
R836	2.2 meg	2 w	Fixed	Comp.	10%	306-225	
R837	4.7 k	1/2 w	Fixed	Comp.	10%	302-472	
R839	1 meg	1/2 w	Fixed	Comp.	10%	302-105	
R840	100 k		Var.	Comp.		*311-026	
R841	100 k		Var.	Comp.		*311-026	
R844	100 k		Var.	Comp.		*311-026	
R852	8.2 meg	1 w	Fixed	Comp.	10%	304-825	
R853	8.2 meg	1 w	Fixed	Comp.	10%	304-825	
R854	8.2 meg	1 w	Fixed	Comp.	10%	304-825	
R959	15 meg	2 w	Fixed	Comp.	10%	306-156	
R859	15 meg	2 w	Fixed	Comp.	10%	306-156	
R860	1 meg		Var.	Comp.	±20%	*311-123	
R862	2 meg	2 w	Var.	Comp.		*311-043	
R864	56 k	1/2 w	Fixed	Comp.	10%	302-563	
R866	1 meg	1/2 w	Fixed	Comp.	10%	302-105	
R868	1 meg	1/2 w	Fixed	Comp.	10%	302-105	
R870	150 k	1/2 w	Fixed	Comp.	10%	302-154	
R871	3.3 meg	1/2 w	Fixed	Comp.	10%	302-335	
R872	1 k	1/2 w	Fixed	Comp.	10%	302-102	
R874	68 k	1/2 w	Fixed	Comp.	10%	302-683	
R875	2.2 meg	1/2 w	Fixed	Comp.	10%	302-225	
R876	1 k	1/2 w	Fixed	Comp.	10%	302-102	
R878	33 k	1 w	Fixed	Comp.	10%	304-333	
R879	10 k		Var.	Comp.		*311-016	
R880	<i>68</i> 100 k	1/2 w	Fixed	Comp.	10%	<i>302-683</i> 302-104	
R883	100 Ω	1/2 w	Fixed	Comp.	10%	302-101	
R884	204 Ω	1/2 w	Fixed	Film	1%	309-237	
R885	18 k	1 w	Fixed	Film	1%	310-066	
R886	1.8 k	1/2 w	Fixed	Film	1%	309-030	
R887	9 k	1/2 w	Fixed	Film	1%	309-235	
R888	900 Ω	1/2 w	Fixed	Film	1%	309-236	
R889	90 Ω	1/2 w	Fixed	Film	1%	309-238	
R890	10 Ω	1/2 w	Fixed	Film	1%	309-096	
R899	0.25 Ω	Manufactured by Tektronix					308-090

RECTIFIERS

Tektronix
Part Number

SR642

1-500 ma plate/leg

*106-001



SWITCHES

		Tektronix Part Number
		Wired Unwired
SW10	Trigger Selector	*262-177 *260-233
SW17	Triggering Level	*262-178 *260-235
SW20	Trigger Selector Slope	*260-212
SW160	Time/Cm	*262-171 *260-240
SW331	Horizontal Display	*262-172 *260-236
SW403A	Input Selector	*262-179 *260-238
SW403B	Input Selector	*262-190 260-238
SW407†	Sensitivity	*262-175 *260-239
SW489	Output Selector	*262-180 *260-237
SW601	Power Off*	*311-057
SW870	Calibrator	*262-176 *260-234
TK601	Thermal Cutout, 123° F, ±5%	*260-246

*Part of Scale Illumination Potentiometer

TRANSFORMERS

		Tektronix Part Number
T602	L.V. Power Transformer	*120-117
T801	H.V. Transformer	*120-114

VACUUM TUBES

		Tektronix Part Number
V24A,B	6DJ8	154-187
V45A,B	6DJ8	154-187
V135A,B	6AN8	154-078
V145A,B	6AN8	154-078
V152	6AL5	154-016
V161A,B	6AN8	154-016 <i>078</i>
V183A,B	6DJ8	154-187
V324	6AU6	154-022
V354	6AU6	154-022
V364A,B	6DJ8	154-187
V414†	6AU6	<i>157</i> 154-056
V444†	6AU6	<i>157</i> 154-056
V454†	6AU6	154-022
V464†	6AU6	154-022
V474A,B†	12AT7	Telefunken tubes are recommended. 154-039
V484A,B†	12AT7	Telefunken tubes are recommended. 154-039
V493	6AU6	154-022
V602†	5AR4	154-168
V634	2N214	(Transistor) 151-004
V636A,B	6AN8	154-078

†There are two parts of this description in your instrument; one in each of the Vertical Amplifiers.



Vacuum tubes (continued)

V637	12B4		154-044
V639	5651		154-052
V644	2N214	(Transistor)	151-004
V647	2N301	(Transistor)	151-001
V652	6BW4		154-119
V66A,B	6AN8		154-078
V677	12B4		154-044
V722	5AR4		154-168
V746A,B	6AN8		154-168
V747	12B4		154-044
V757	12B4		154-044
V800	6CZ5		154-167
V814A,B	12AU7		154-041
V822	5642		154-051
V859	T60P2	(CRT)	154-144
		<i>T502 P2</i>	
V862	5642		154-051
V873A,B	6AN8		154-078
V875	6AU6		154-022



MISCELLANEOUS PARTS LIST

	Tektronix Part Number
Air filter	*378-010
Binding post, 5 way	129-036
Binding post, metal, (ground), 3/8" x 5/8" cap	129-020
Binding post, metal, (ground) 3/8" x 5/16" cap	129-035
Bind post adapters, A510	013-004
Carrying handle	*367-001
Carrying handles and top support bar	*381-067
Ceramic post, slotted, 1/2 inch	*129-009
Ceramic strip, 3/4" by 3 notches, 3/8 spacing	*124-065
Ceramic strip, 3/4" by 4 notches, 3/8 spacing	*124-012
Ceramic strip, 3/4" by 9 notches, 1/8" spacing	*124-071
Ceramic strip, 3/4" by 9 notches, 3/8" spacing	*124-066
Ceramic strip, 3/4" by 11 notches, 3/8" spacing	*124-016
Fan blade	*369-013
Fan motor, shielded	*147-020
Fuseholder	352-002
Graticule cover	*200-025
Graticule, 10 div. vert. x 10 div. horiz., double base line	*331-047
Graticule light filter, green	*378-503
Graticule light shield	*337-187
Graticule mounting nut, knurled	*210-424
Graticule spacer, neoprene washer	*210-816
Ground strap, CRT cathode	386-427
Holder, neon, double	*352-006
Holder, neon, single	*352-008
Knob, black: TRIGGER SELECTOR, HORIZONTAL DISPLAY, (HORIZ.) POSITION, SQUARE-WAVE CALIBRATOR, (VERT.) AC-DC	*366-028
Knob, black: FOCUS, INTENSITY, SCALE ILLUM., TRIGGERING LEVEL, (VERT.) POSITION	*366-033



MISCELLANEOUS PARTS LIST (continued)

Knob, black: SENSITIVITY, TIME/CM	*366-060
Knob, black: DC BAL.	*366-066
Knob, bar, black: HORIZ. DEF. PLATE SELECTOR	366-068
Power cord adapter, two to three way	103-013
Power cord, 3 wire, 18 gauge	161-008
Power receptacle, 3 wire	131-090
Probe clip assy.	*344-005
Probe grounding assy.	*175-014
Probe tip, straight shank	*206-009
Receptacle, coax, UHF, modified: A, B, CAL. OUT	*131-064
Receptacle insulator, nylon	*406-244
Receptacle washer, fiber	210-812
Ring, CRT alignment	*354-066
Rod coupling, $\frac{3}{4}$ "	376-005
Rod, extension, alum. $\frac{1}{4}$ " x 9 $\frac{15}{16}$ "	384-545
Rod, extension, alum., $\frac{1}{4}$ x $\frac{127}{16}$ "	384-546
Rod, extension, alum., $\frac{1}{4}$ x 14"	384-547
Socket, graticule light	136-035
Socket, transistor, 4 pin	136-050
Socket, STM7G, 7 pin	136-008
Socket, 7 pin, shielded	136-010
Socket, STM9G, 9 pin	136-015
Socket, CRT, STM14, 14 pin	136-019
Shock mount, vertical chassis	*348-022
Shock mount, fan	*348-008
Test lead	*012-031



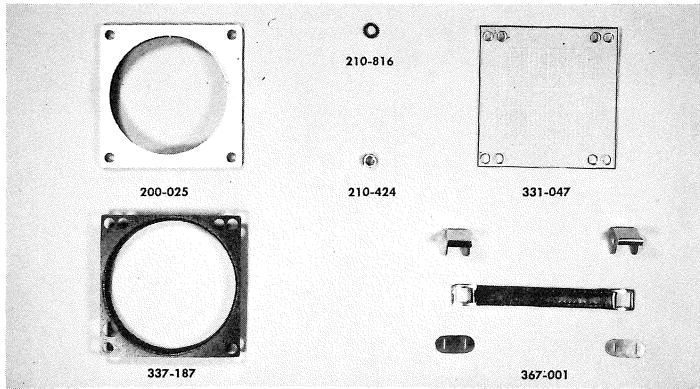

Graticule Assy. and carrying Handle.

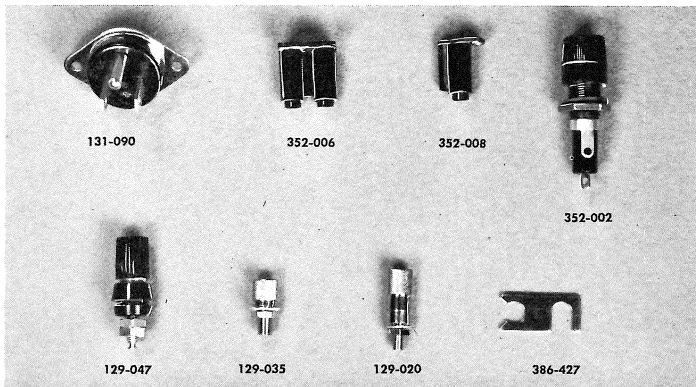

Power Receptacle, Neon Holders, Fuse Holder, Binding Posts and CRT Cathode Ground Strap.

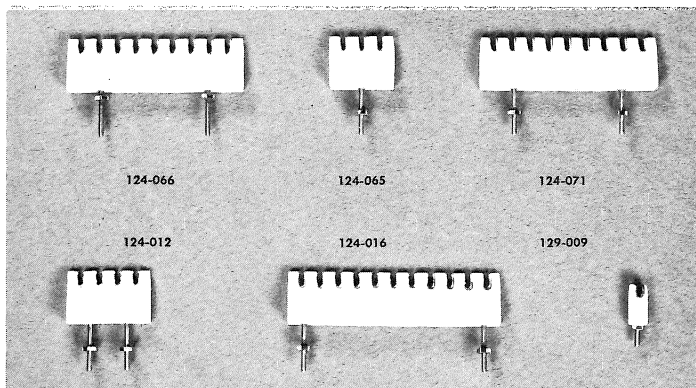

Ceramic Strips and Ceramic Post.



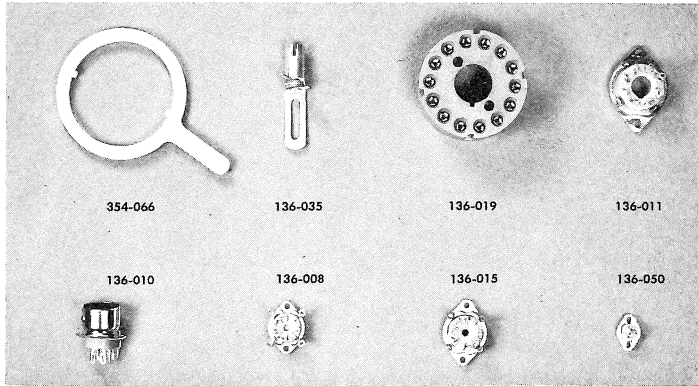

CRT Alignment Ring. Graticule Light, CRT, Tube and Transistor Sockets.

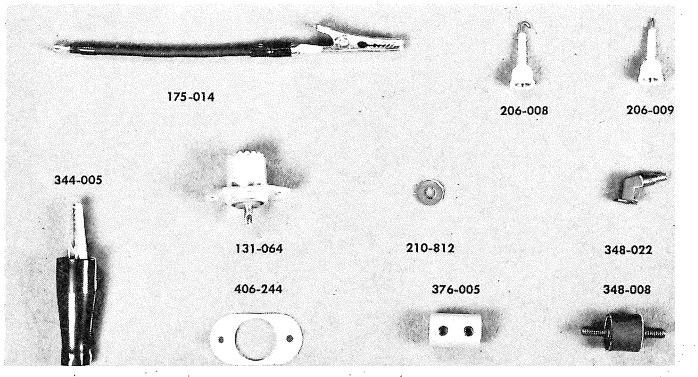

Grounding Assy., Tips and Clip Assy. for Probes. Coax Receptacle Assy., Control Rod Coupling and Shockmounts.

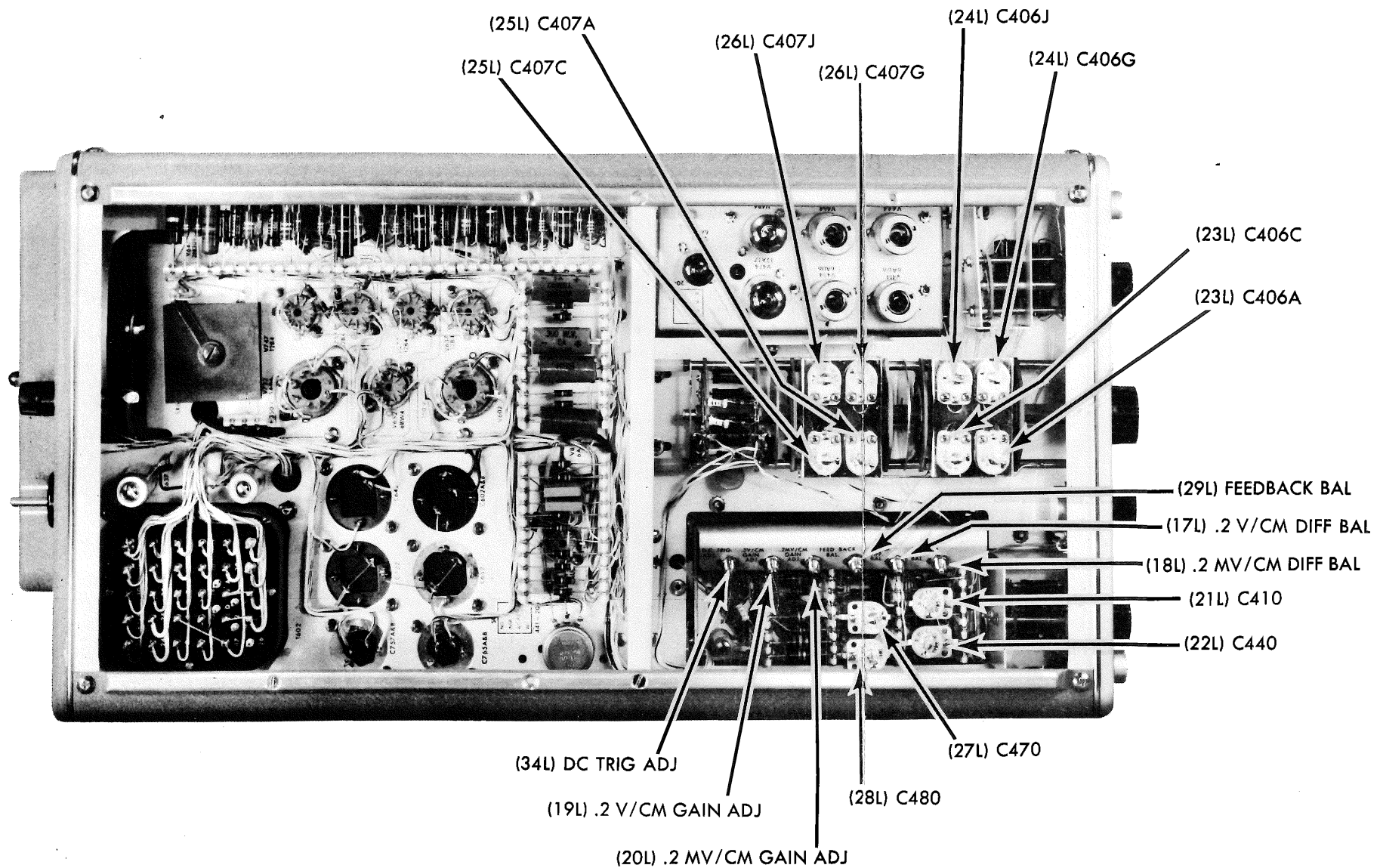

NOTE

The numbers in parenthesis in the call-outs indicate the particular step in the Recalibration Procedure when the control is set. The letters L and U following the step number indicate whether the adjustment is for the Upper-Beam Amplifier or for the Lower-Beam Amplifier.

Fig 6-13 Type 502 Oscilloscope, top and bottom views showing the location of Recalibration controls.

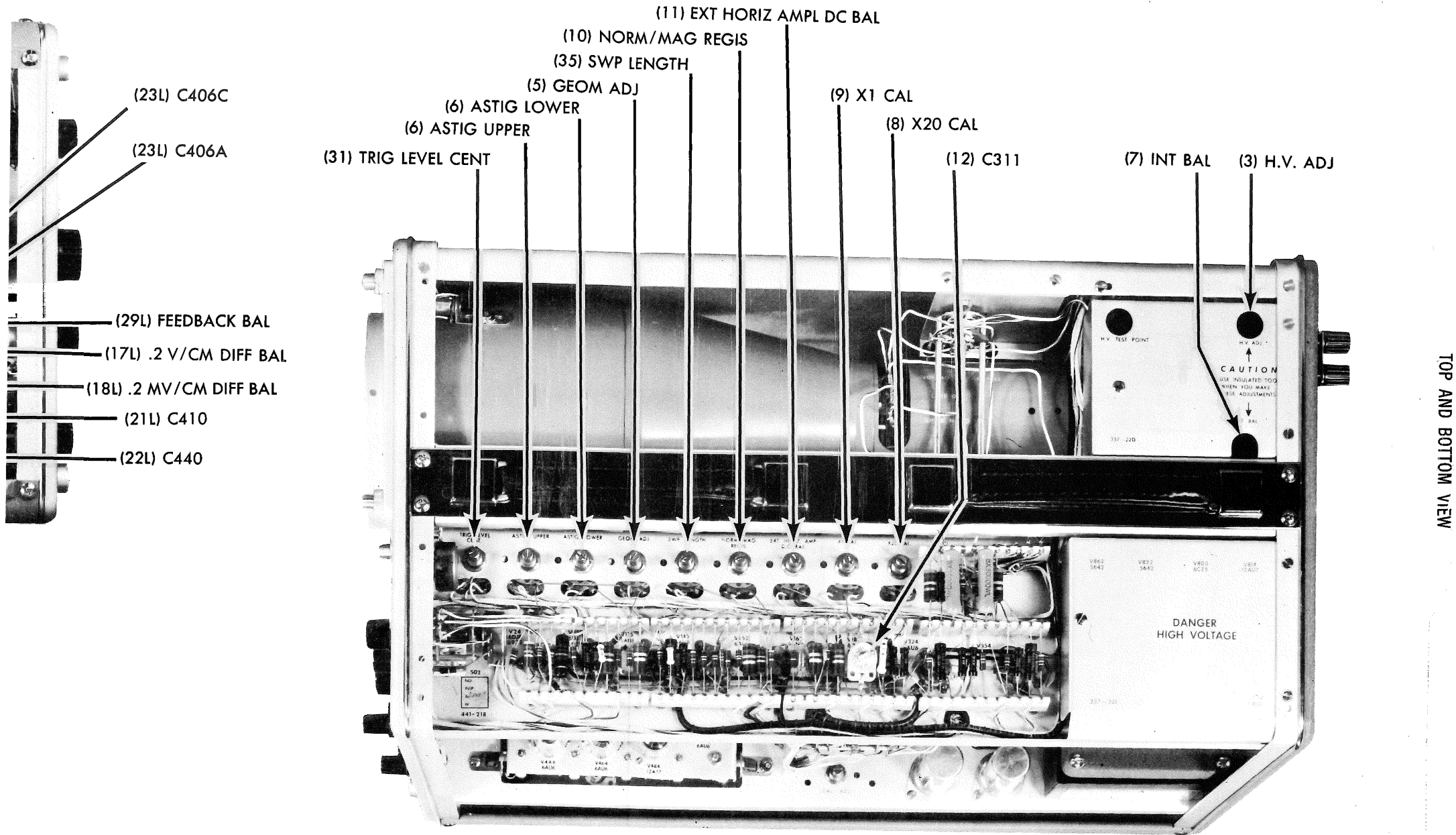

TOP AND BOTTOM VIEW

Fig 6-13 Type 502 Oscilloscope, top and bottom views showing the location of Recalibration controls.

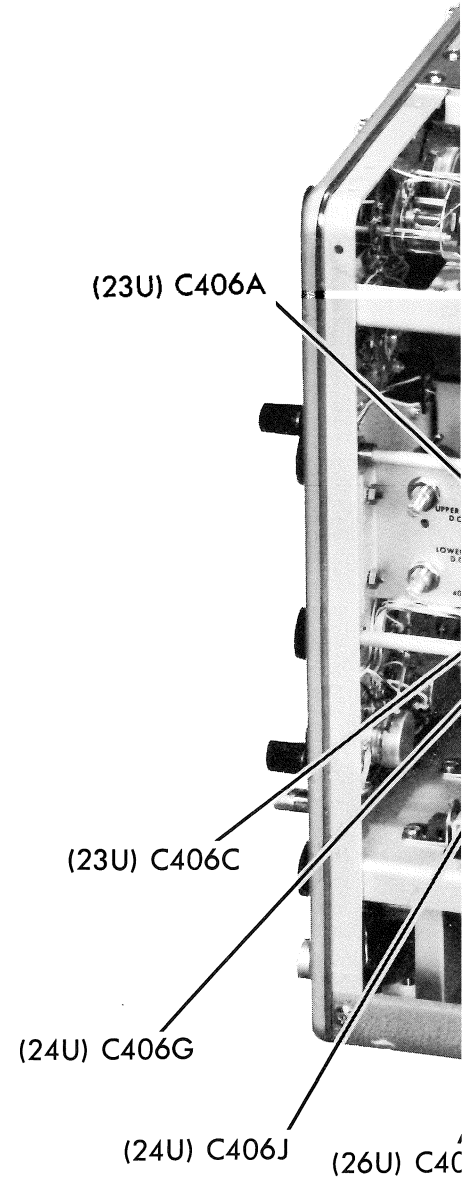
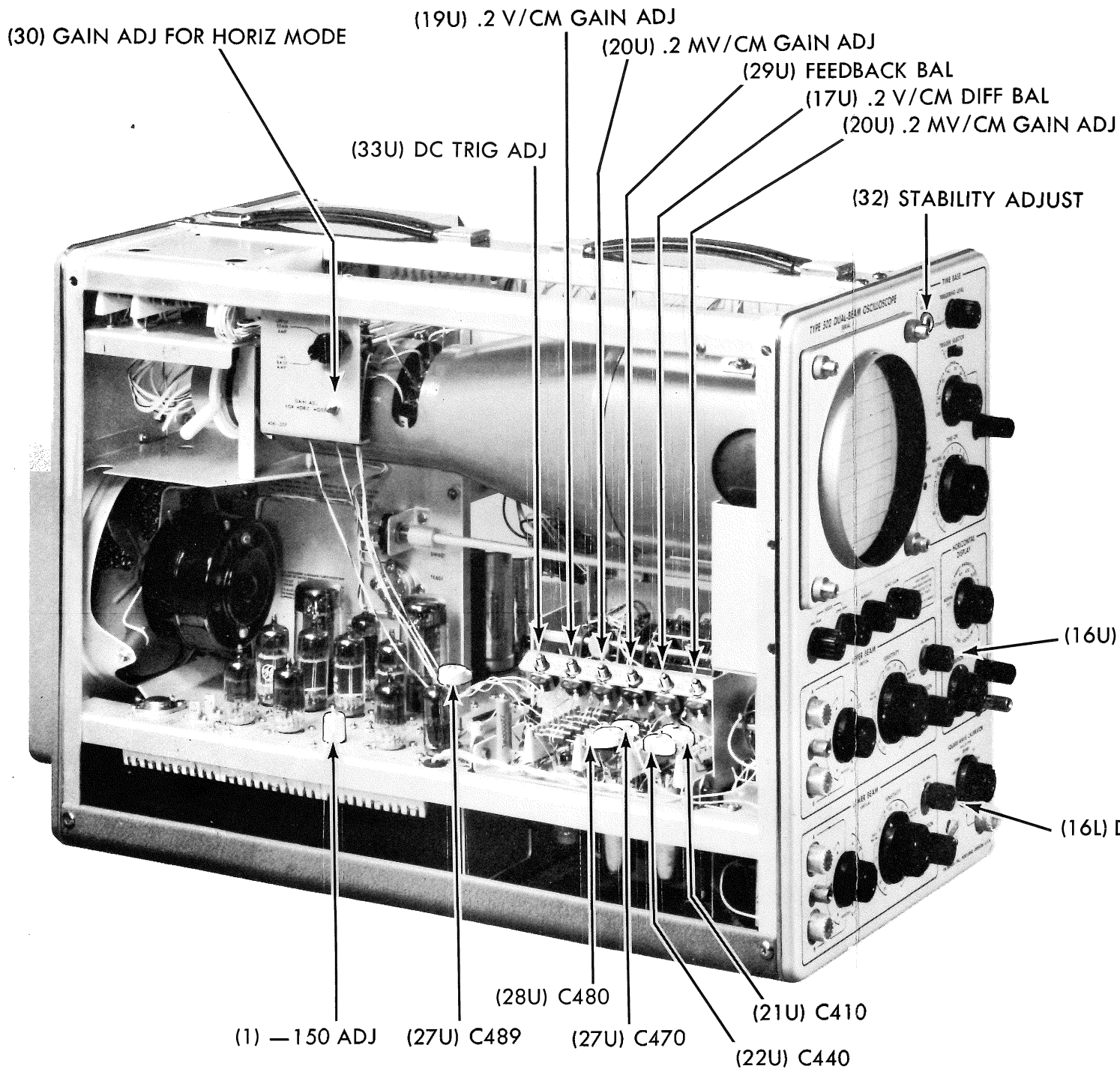

NOTE

The numbers in parenthesis in the call-outs indicate the particular step in the Recalibration Procedure when the control is set. The letters L and U following the step number indicate whether the adjustment is for the Upper-Beam Amplifier or for the Lower-Beam Amplifier.

Fig 6-14 Type 502 Oscilloscope, right and left views showing the location of Recalibration controls.

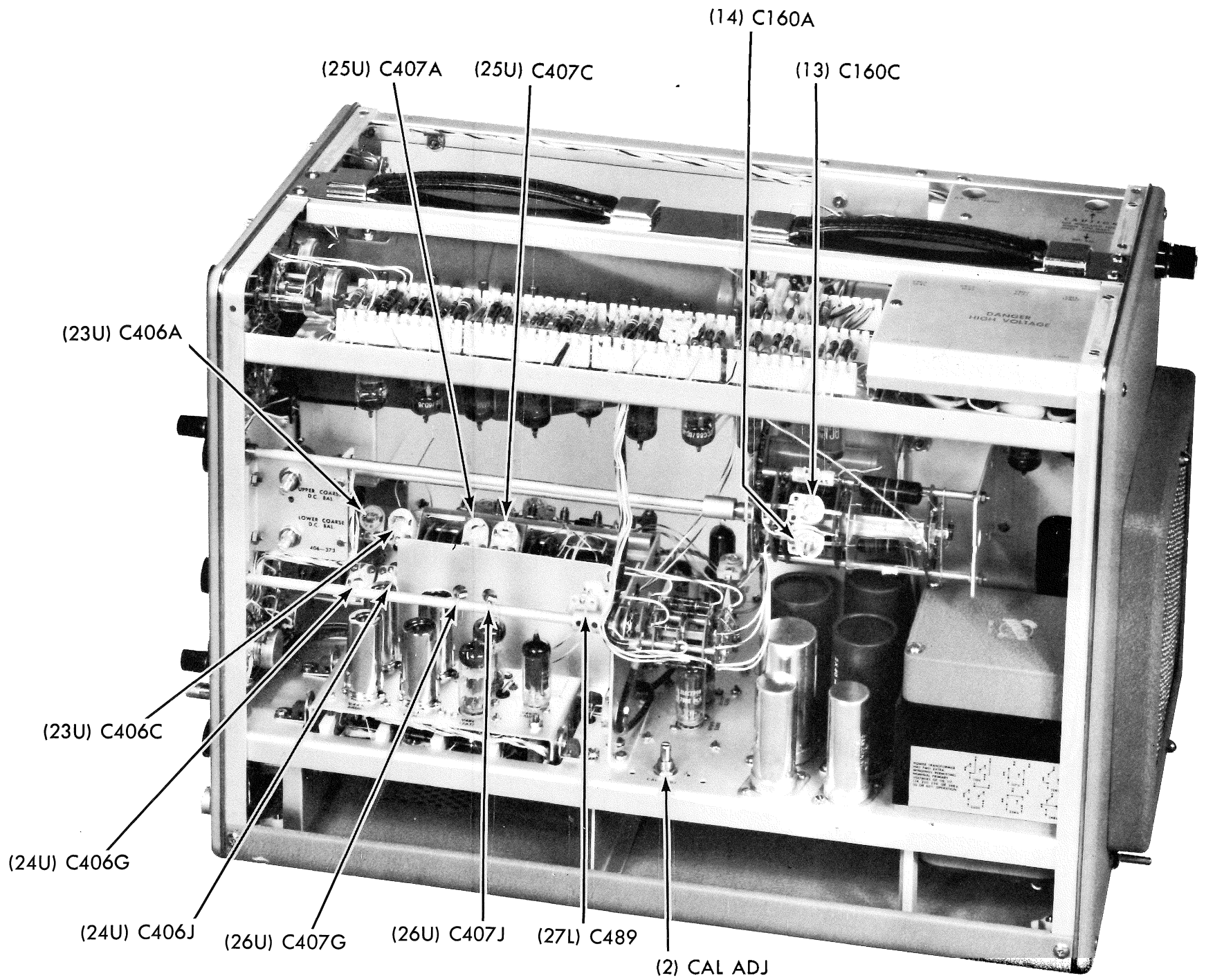

)J

) DC BAL

) DC BAL

Fig 6-14 Type 502 Oscilloscope, right and left views showing the location of Recalibration controls.

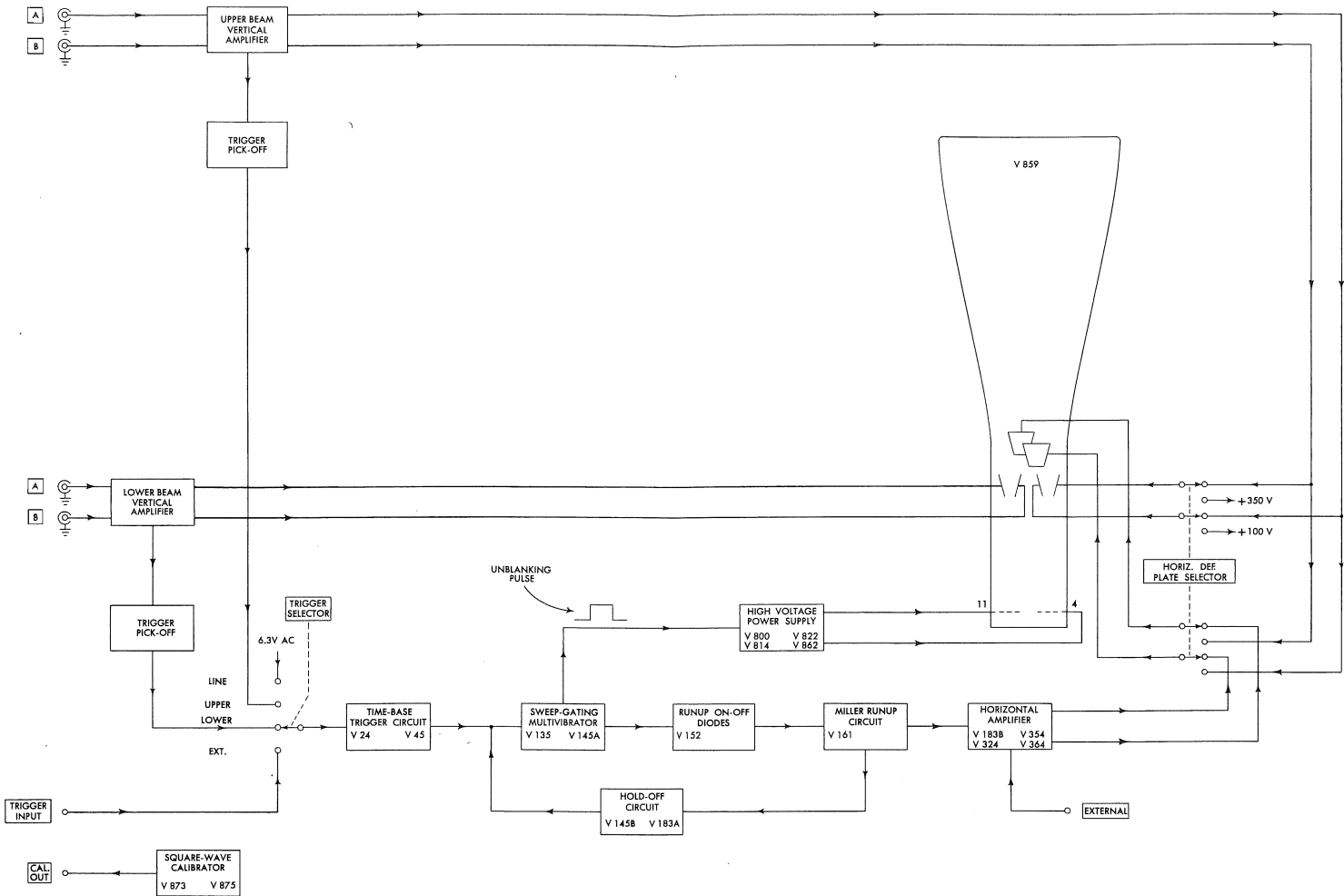

TYPE 502 OSCILLOSCOPE

A

BLOCK DIAGRAM

SWITCH DETAIL

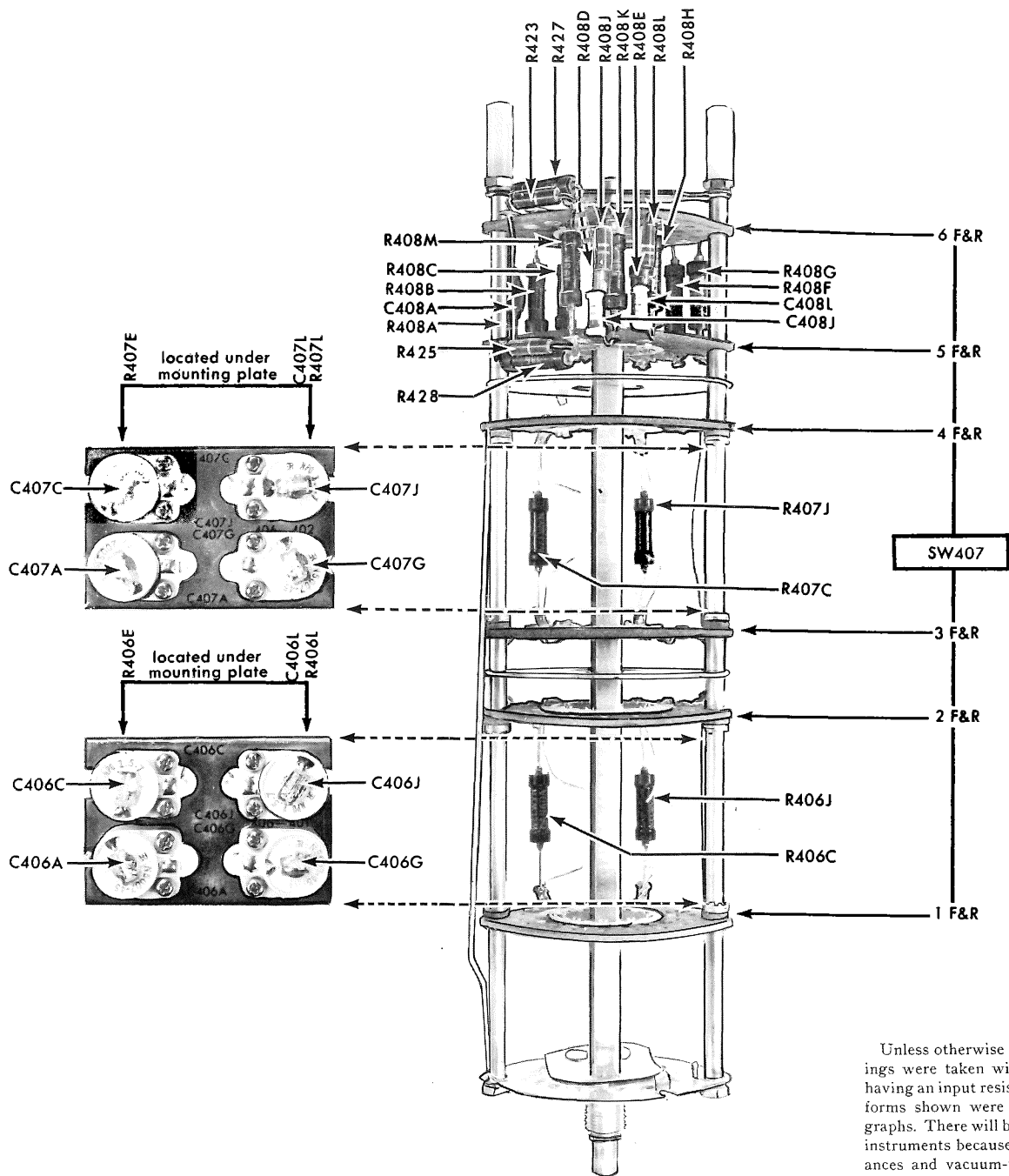

NOTE

Unless otherwise specified, all of the voltage readings were taken with a dc vacuum-tube voltmeter having an input resistance of 11 megohms. The waveforms shown were reproduced from actual photographs. There will be considerable variation between instruments because of normal manufacturing tolerances and vacuum-tube characteristics. Therefore, the significance of any discrepancies observed should be determined by referring to the circuit diagram.

All readings are in volts unless otherwise specified. Where two voltage readings are given, they represent the voltage as read by a voltmeter under two sets of conditions, and, as such, do not indicate the peak-to-peak excursion of voltage at the point.

SENSITIVITY SWITCH

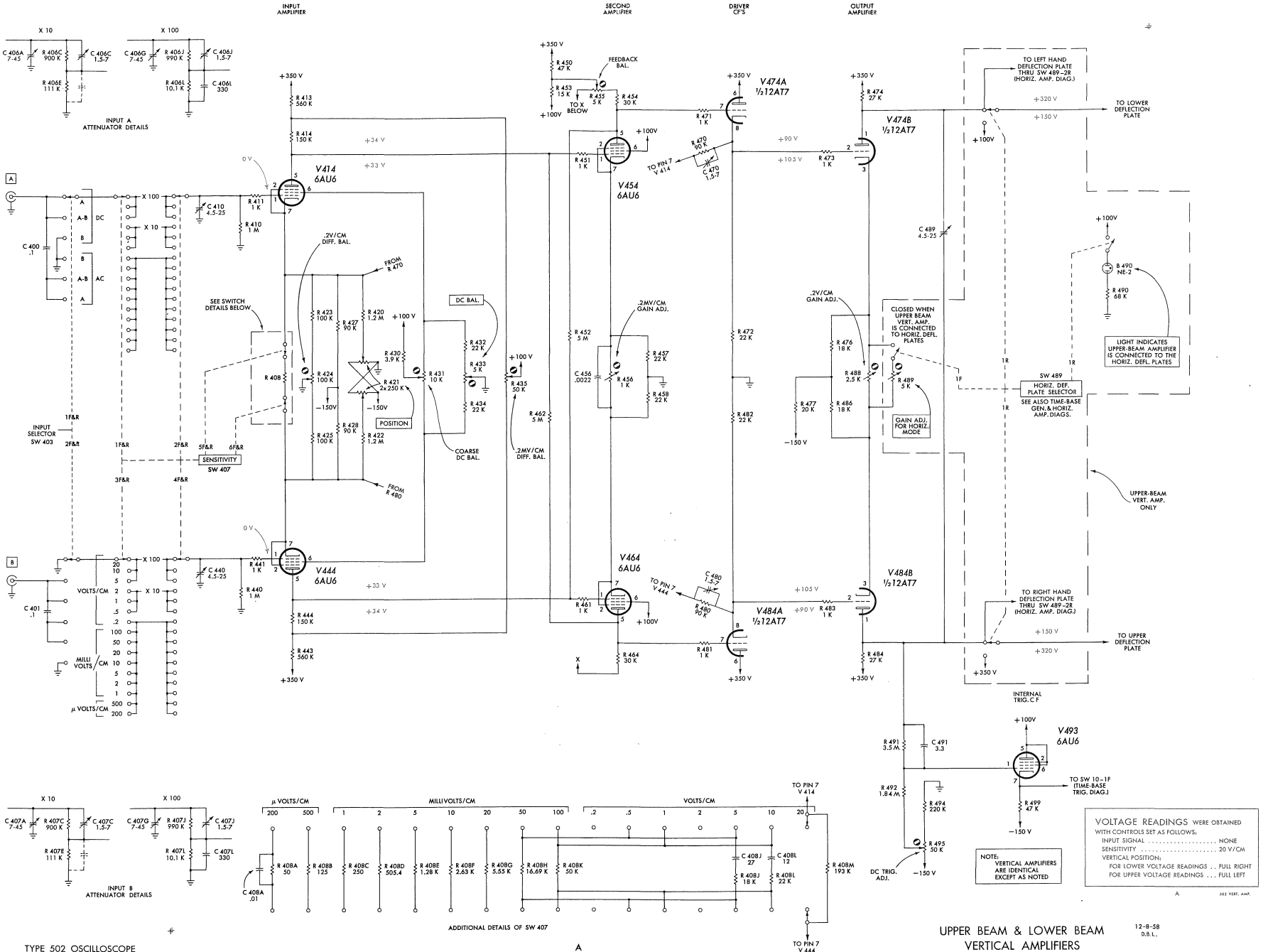

TYPE 502 OSCILLOSCOPE

A

UPPER BEAM & LOWER BEAM
VERTICAL AMPLIFIERS

12-9-58
D.B.L.

VOLTAGE READINGS WERE OBTAINED WITH CONTROLS SET AS FOLLOWS:
 INPUT SIGNAL NONE
 SENSITIVITY 20 V/CM
 VERTICAL POSITION FULL RIGHT
 FOR LOWER VOLTAGE READINGS ... FULL RIGHT
 FOR UPPER VOLTAGE READINGS ... FULL LEFT

NOTE:
 VERTICAL AMPLIFIERS ARE IDENTICAL EXCEPT AS NOTED

NOTE

Unless otherwise specified, all of the voltage readings were taken with a dc vacuum-tube voltmeter having an input resistance of 11 megohms. The waveforms shown were reproduced from actual photographs. There will be considerable variation between instruments because of normal manufacturing tolerances and vacuum-tube characteristics. Therefore, the significance of any discrepancies observed should be determined by referring to the circuit diagram.

All readings are in volts unless otherwise specified. Where two voltage readings are given, they represent the voltage as read by a voltmeter under two sets of conditions, and, as such, do not indicate the peak-to-peak excursion of voltage at the point.

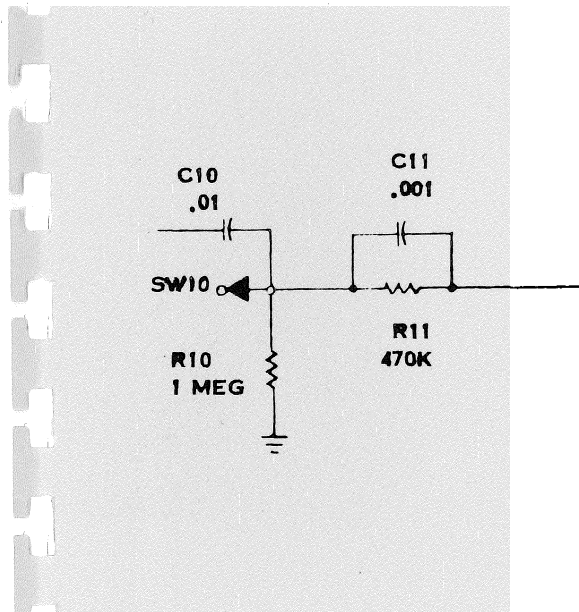

MODIFICATION NOTICE FOR
TYPE 502
EFFECTIVE SERIAL NO 624

ADD C11 .001 μ F 500V DISCAP 283-000
R11 470K 1/2W FIXED COMP 10% 302-474

MODIFICATION NO 2165
PARTS LIST AND SCHEMATIC
MARCH 18, 1959

WAVEFORMS AND VOLTAGE READINGS
WERE OBTAINED WITH CONTROLS SET AS FOLLOWS:
TRIGGERING LEVEL AUTOMATIC
TRIGGER SELECTOR:
FOR WAVE FORMS —LINE
FOR VOLTAGE READINGS —EXT., DC

A 500 TRIG.

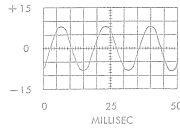

SW17
AUTOMATIC
GANGED WITH R 17
TRIGGERING LEVEL
CONTROL
SEE ALSO
TIME-BASE
GEN. DIAG.

TRIGGER INPUT AMPLIFIER TRIGGER MULTIVIBRATOR

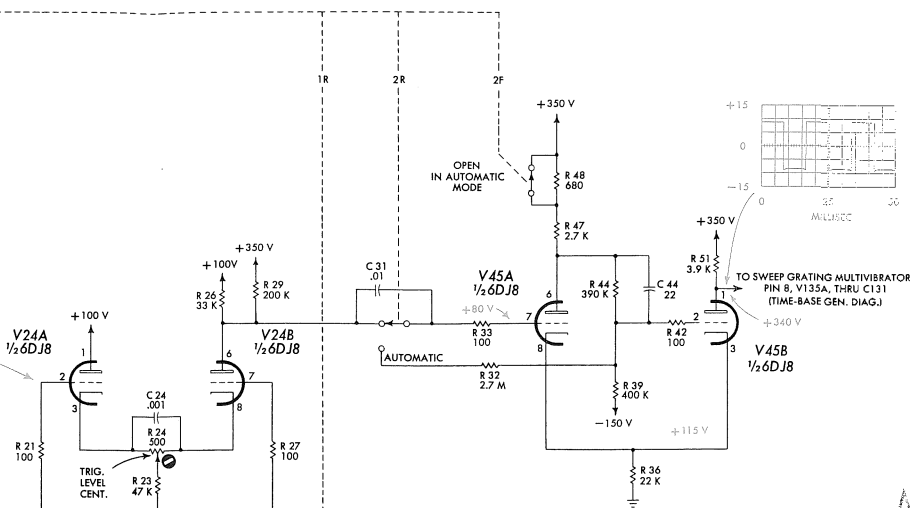

See parts list for late component-value changes

MODIFIED INSTRUMENT
The instrument for which this manual was prepared has been modified. A special sheet has been inserted in the manual containing information relative to this section.

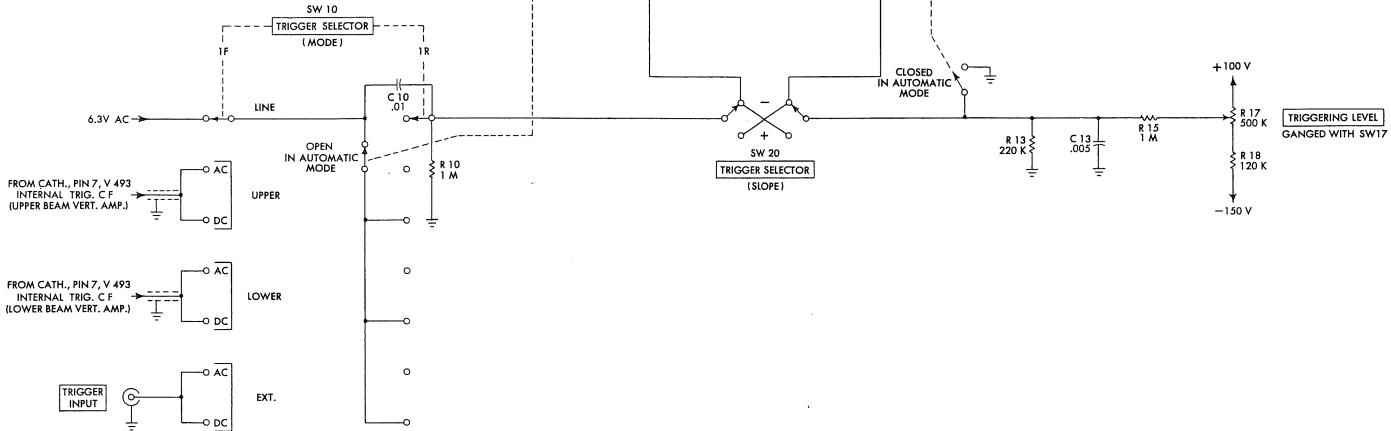

UPPER BEAM
VERT. AMP.

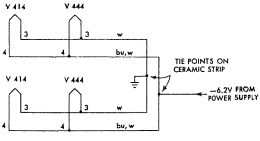

UPPER BEAM
VERT. AMP.

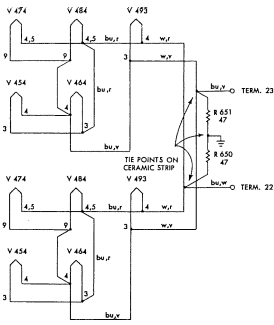

PRIMARYS CONNECTED
FOR 234 V AC OPERATION

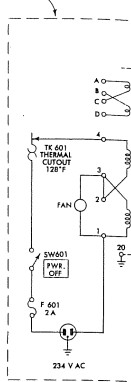

UPPER BEAM & LOWER BEAM VERTICAL CHASSIS

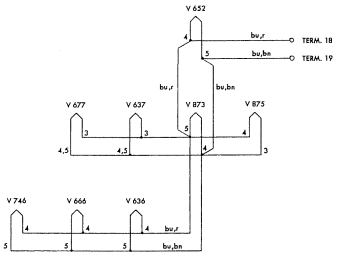
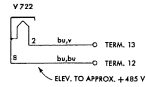
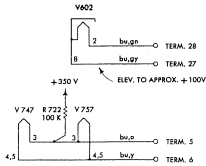

POWER SUPPLY CHASSIS

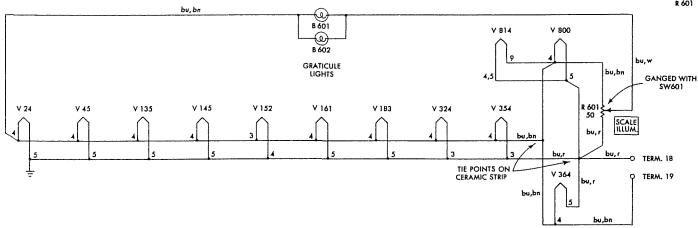
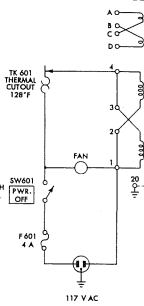

SWEEP CHASSIS

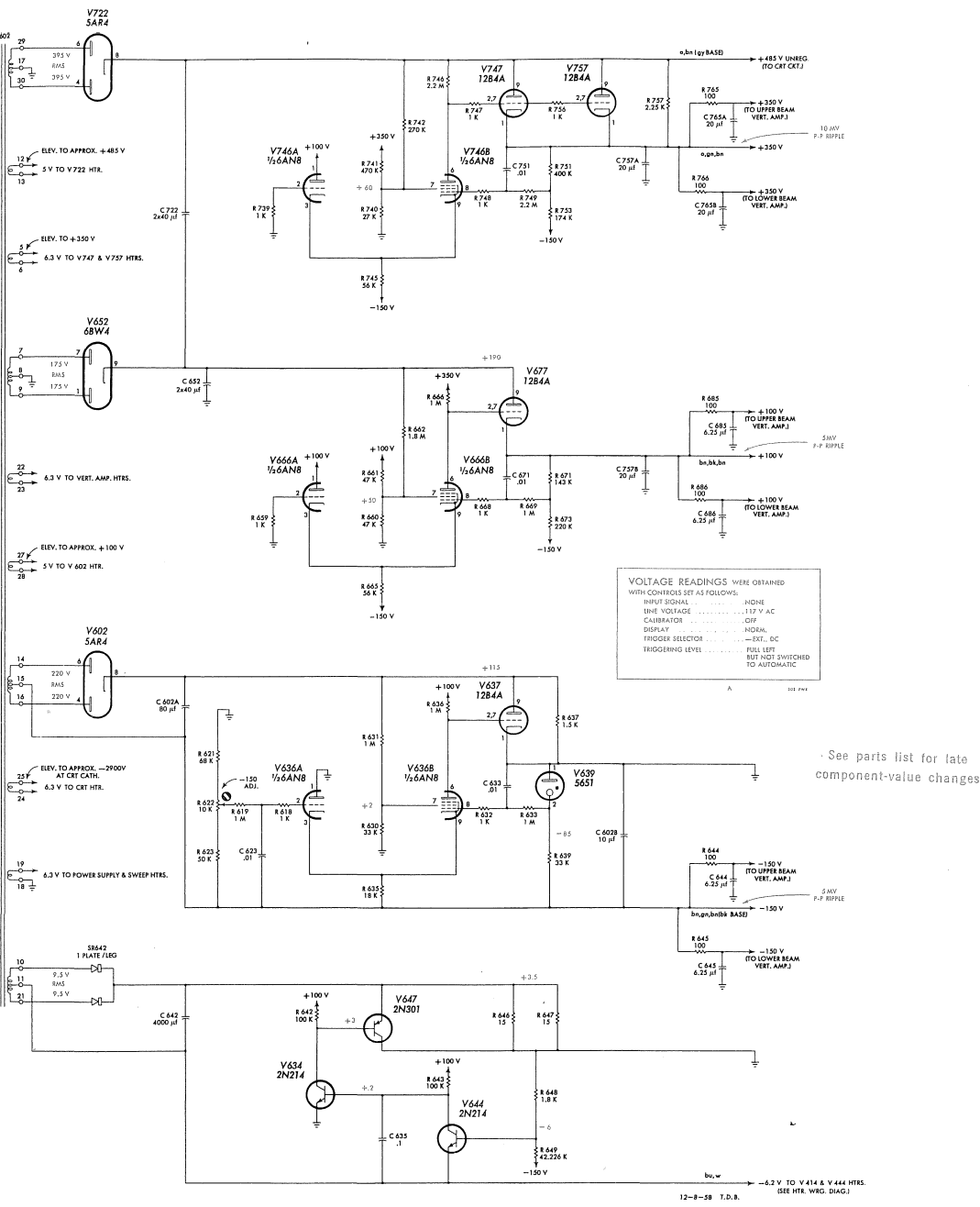

VOLTAGE READINGS WERE OBTAINED WITH CONTROLS SET AS FOLLOWS:
 INFO SIGNAL OFF
 SINE VOLTAGE 117 V AC
 CALIBRATION OFF
 DISPLAY INDIAL
 FRICTION SELECTOR EXT. DC
 TRIGGERING LEVEL FULL LEFT
 BUT NOT SWITCHED TO AUTOMATIC

See parts list for late component-value changes

12-B-58 T.D.B. (SEE HTR, WKG. DIAG.)

POWER SUPPLY

NOTE

Unless otherwise specified, all of the voltage readings were taken with a dc vacuum-tube voltmeter having an input resistance of 11 megohms. The waveforms shown were reproduced from actual photographs. There will be considerable variation between instruments because of normal manufacturing tolerances and vacuum-tube characteristics. Therefore, the significance of any discrepancies observed should be determined by referring to the circuit diagram.

All readings are in volts unless otherwise specified. Where two voltage readings are given, they represent the voltage as read by a voltmeter under two sets of conditions, and, as such, do not indicate the peak-to-peak excursion of voltage at the point.



Primary connections are on the lower terminal board. Secondary connections are on the upper terminal board. The drawing at the left shows the terminal-board connections. Not all of the terminals are used.

TOP VIEW

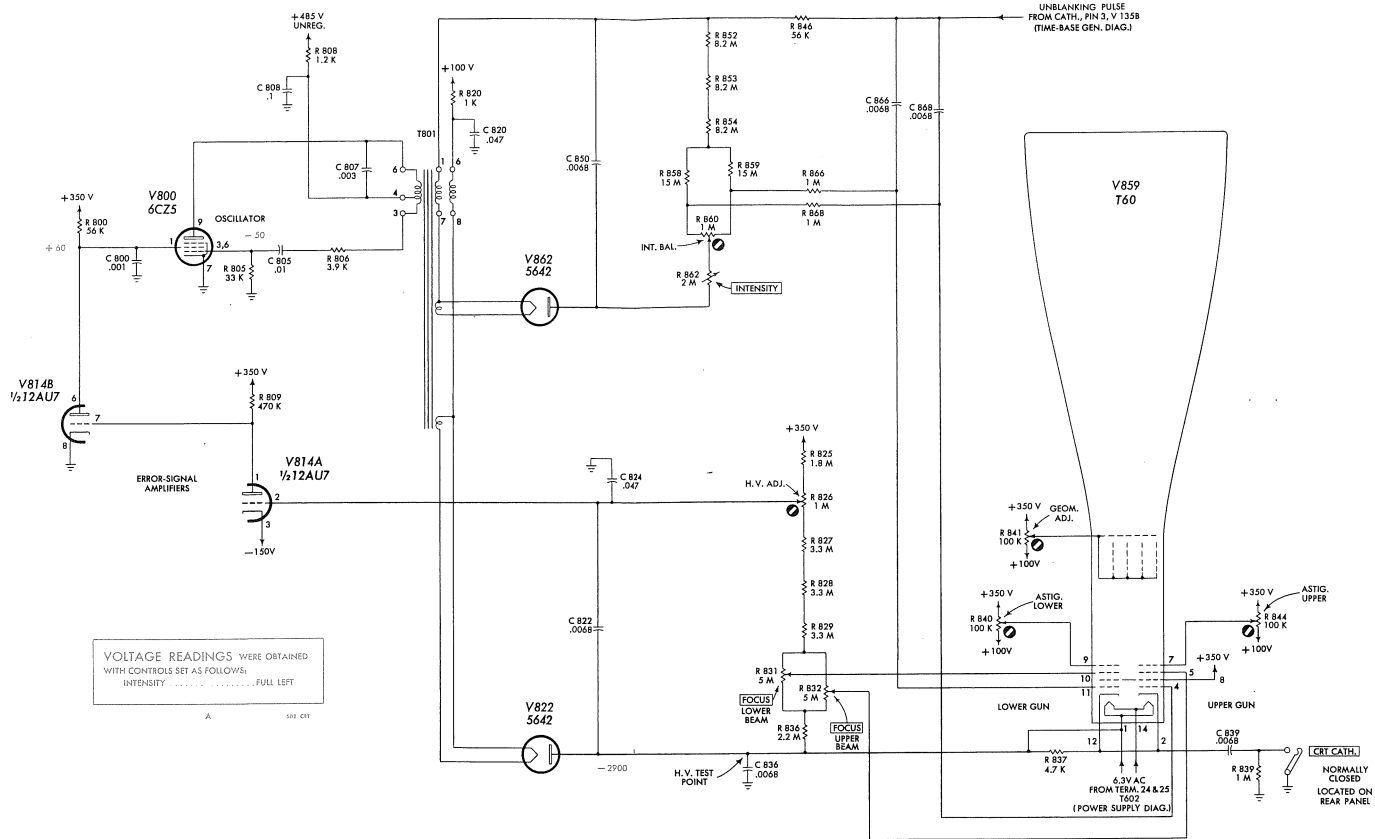

VOLTAGE READINGS WERE OBTAINED WITH CONTROLS SET AS FOLLOWS:
 INTENSITY FULL LEFT

See parts list for tube component-value changes

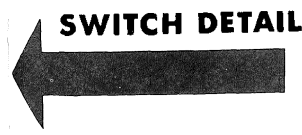
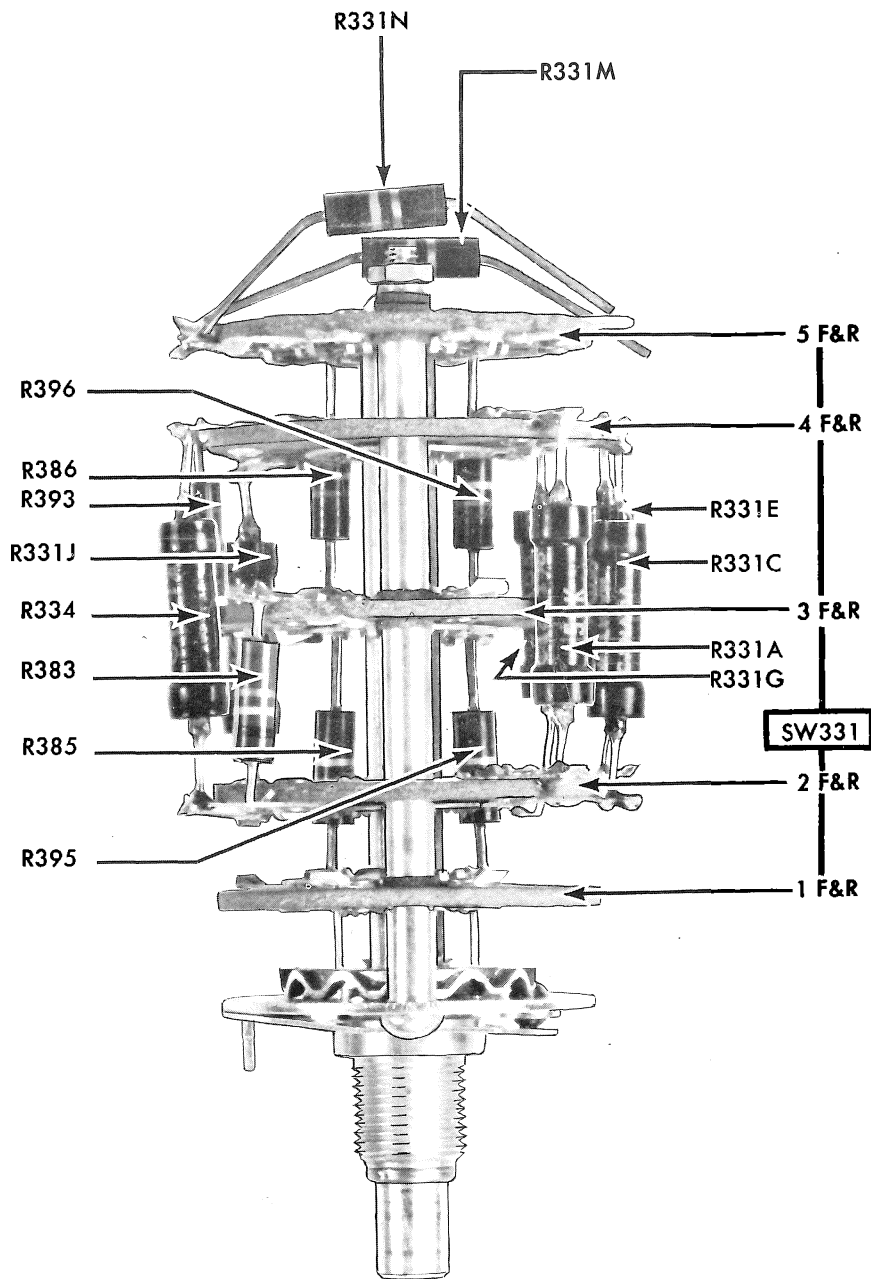

HORIZONTAL DISPLAY SWITCH

Right-side View

NOTE

Unless otherwise specified, all of the voltage readings were taken with a dc vacuum-tube voltmeter having an input resistance of 11 megohms. The waveforms shown were reproduced from actual photographs. There will be considerable variation between instruments because of normal manufacturing tolerances and vacuum-tube characteristics. Therefore, the significance of any discrepancies observed should be determined by referring to the circuit diagram.

All readings are in volts unless otherwise specified. Where two voltage readings are given, they represent the voltage as read by a voltmeter under two sets of conditions, and, as such, do not indicate the peak-to-peak excursion of voltage at the point.

VOLTAGE READINGS WERE OBTAINED WITH CONTROLS SET AS FOLLOWS:
 HORIZONTAL DISPLAY NORMAL
 TRIGGER SELECTOR EXT., DC
 TRIGGERING LEVEL FULL LEFT BUT NOT SWITCHED TO AUTOMATIC

HORIZONTAL POSITION:
 FOR LOWER VOLTAGE READINGS FULL RIGHT
 FOR UPPER VOLTAGE READINGS FULL LEFT

A 502 HORIZ AMP

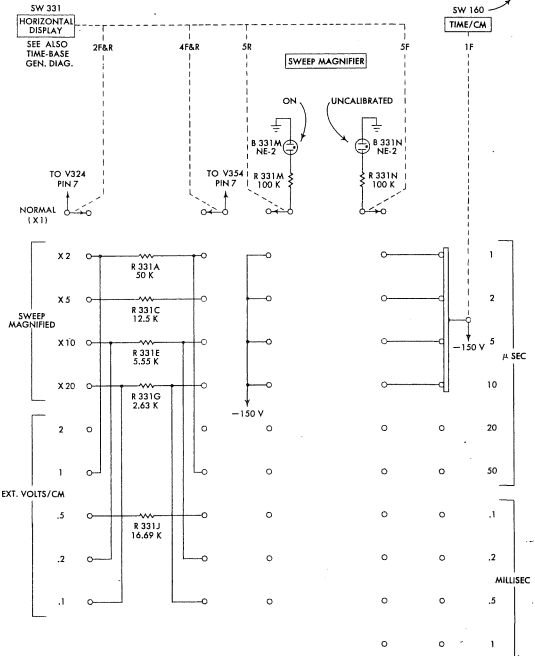

ADDITIONAL DETAILS OF SW 331 & SW 160

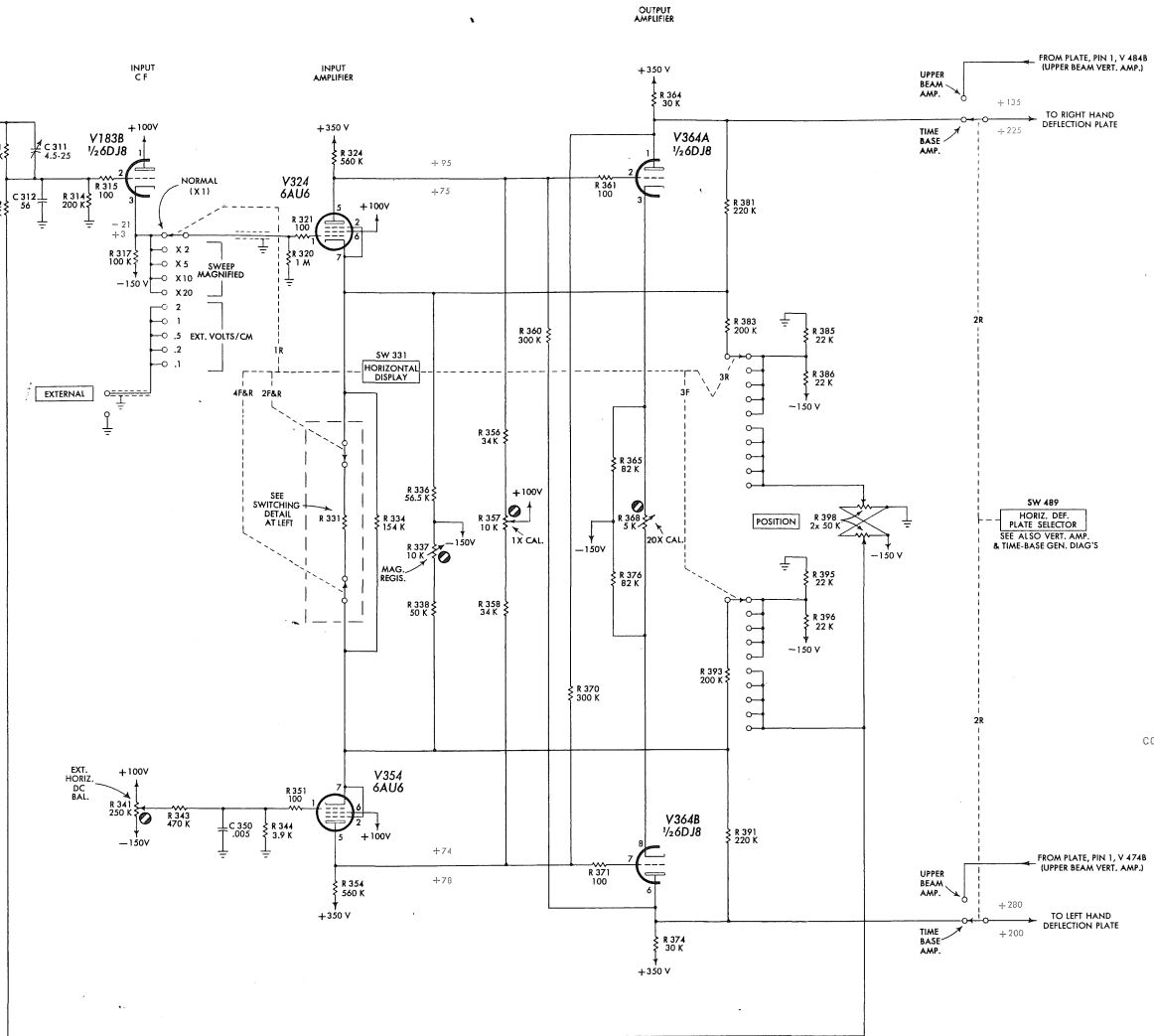

See parts list for lat's component-value changes

NOTE

Unless otherwise specified, all of the voltage readings were taken with a dc vacuum-tube voltmeter having an input resistance of 11 megohms. The waveforms shown were reproduced from actual photographs. There will be considerable variation between instruments because of normal manufacturing tolerances and vacuum-tube characteristics. Therefore, the significance of any discrepancies observed should be determined by referring to the circuit diagram.

All readings are in volts unless otherwise specified. Where two voltage readings are given, they represent the voltage as read by a voltmeter under two sets of conditions, and, as such, do not indicate the peak-to-peak excursion of voltage at the point.

NOTE

Unless otherwise specified, all of the voltage readings were taken with a dc vacuum-tube voltmeter having an input resistance of 11 megohms. The waveforms shown were reproduced from actual photographs. There will be considerable variation between instruments because of normal manufacturing tolerances and vacuum-tube characteristics. Therefore, the significance of any discrepancies observed should be determined by referring to the circuit diagram.

All readings are in volts unless otherwise specified. Where two voltage readings are given, they represent the voltage as read by a voltmeter under two sets of conditions, and, as such, do not indicate the peak-to-peak excursion of voltage at the point.

← SWEEP-GATING MULTIVIBRATOR →

WAVEFORMS AND VOLTAGE READINGS

WERE OBTAINED WITH CONTROLS SET AS FOLLOWS:

- HORIZONTAL DISPLAY NORMAL
- TRIGGER SELECTOR EXT., DC
- TIME/CM 0.1 MILLISEC
- TRIGGERING LEVEL

- FOR WAVEFORMS RECURRENT
- FOR LOWER VOLTAGE READINGS RECURRENT
- FOR UPPER VOLTAGE READINGS FULL LEFT
BUT NOT SWITCHED
TO AUTOMATIC

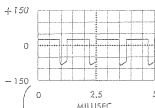

+65
+145
UNBLANKING PULSE
TO CRT GRIDS, PINS 4 & 11
(CRT DIAG.)

A 502 TIME BASE

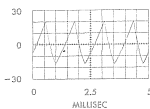

TRIGGER PULSE
FROM PLATE, PIN 1, V 45B
(TIME-BASE TRIG. DIAG.)

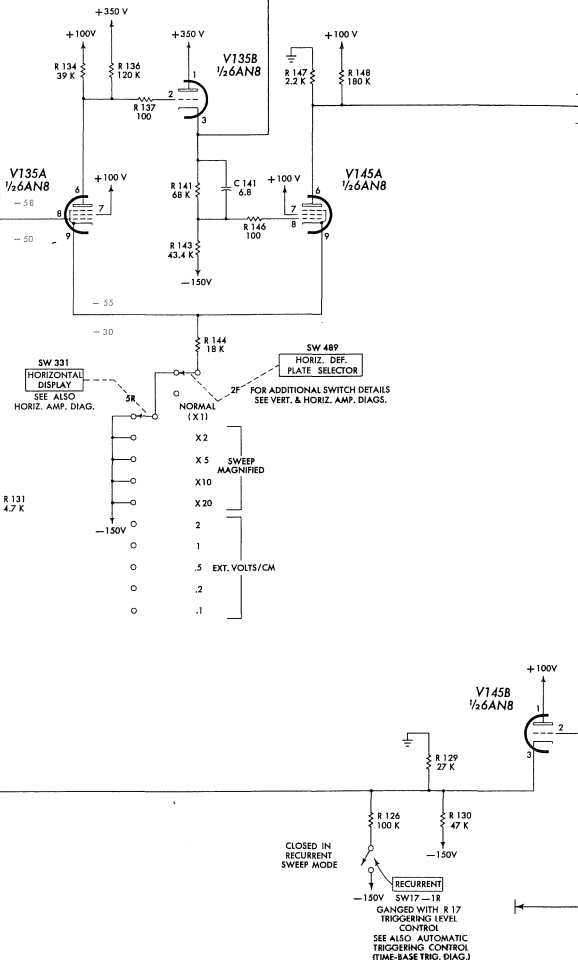

TYPE 502 OSCILLOSCOPE

MILLER RUNUP
CIRCUIT

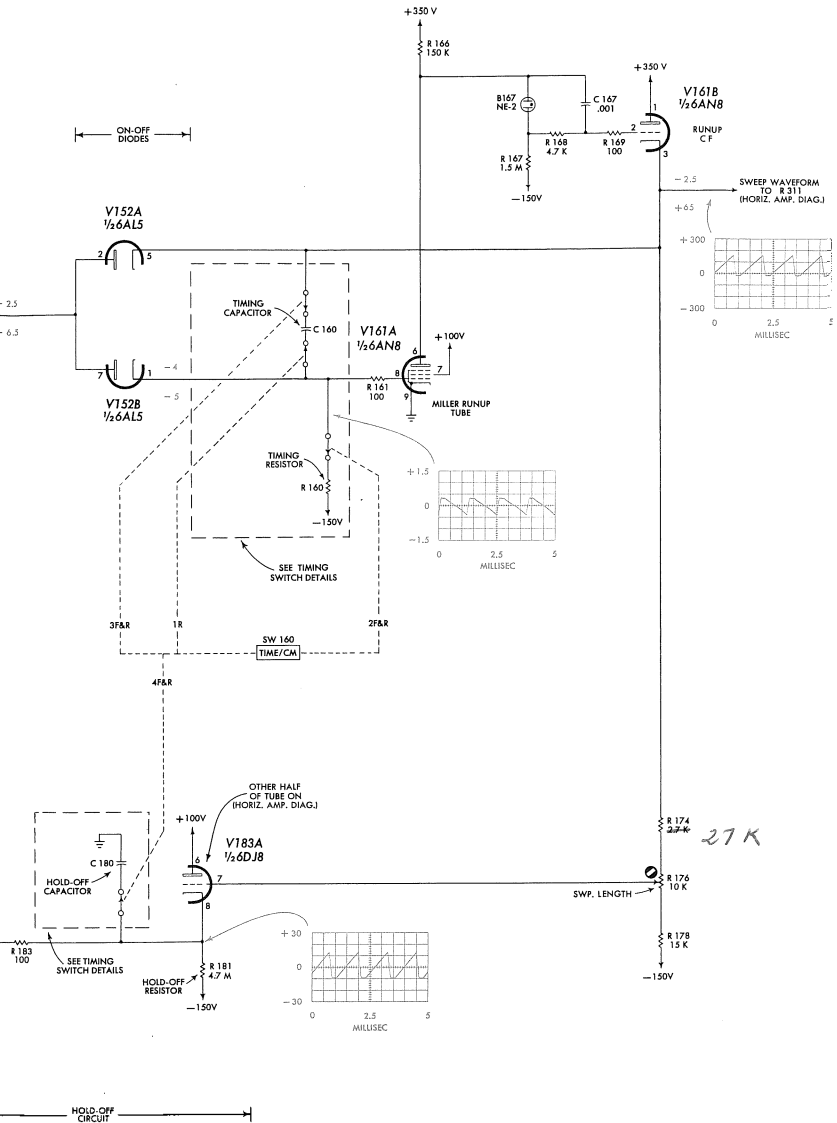

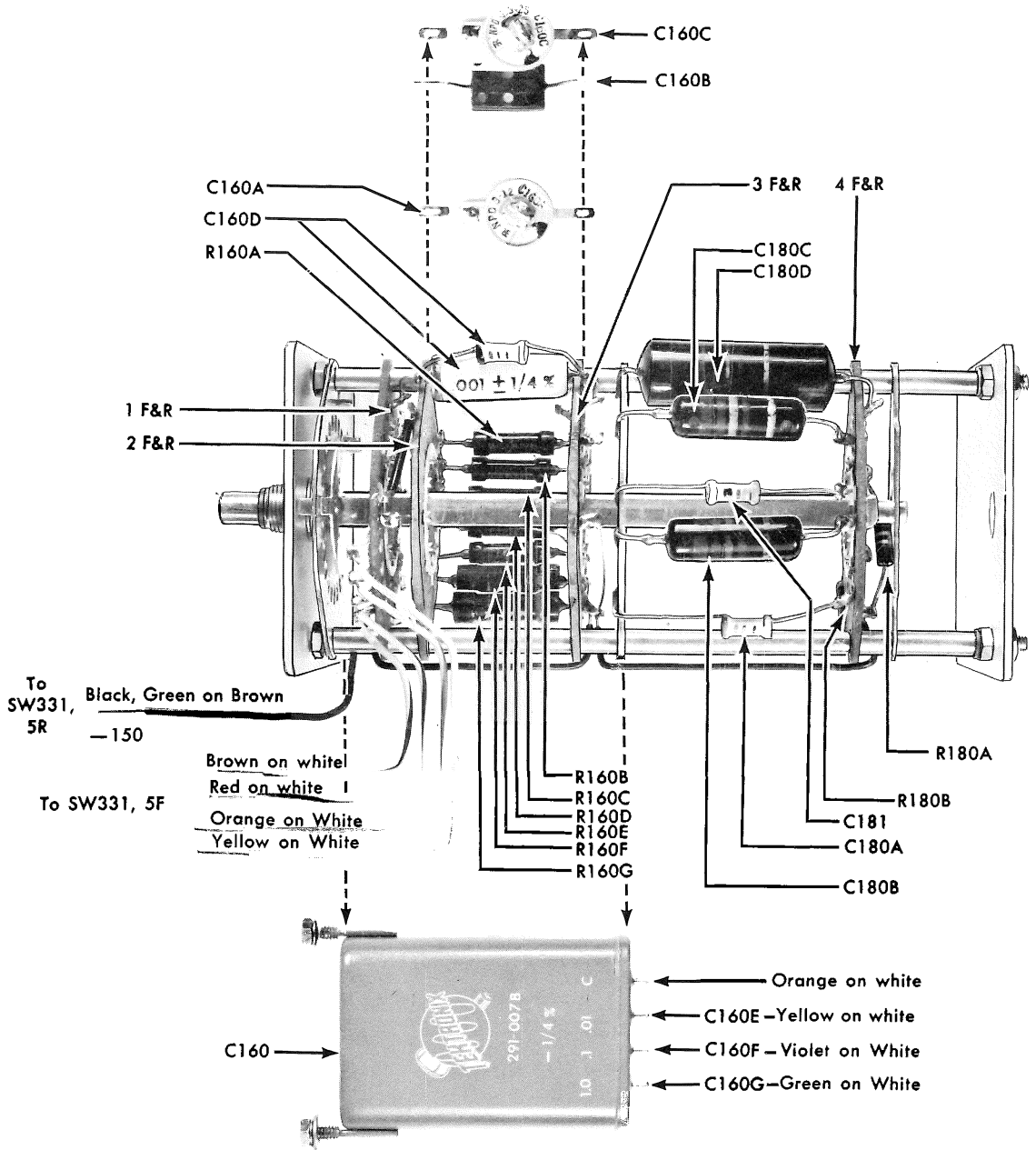

SW160

TIME/CM SWITCH
Right-side View

— TIMING RESISTORS —

— TIMING CAPACITORS —

— HOLD-OFF CAPACITORS & RESISTORS —

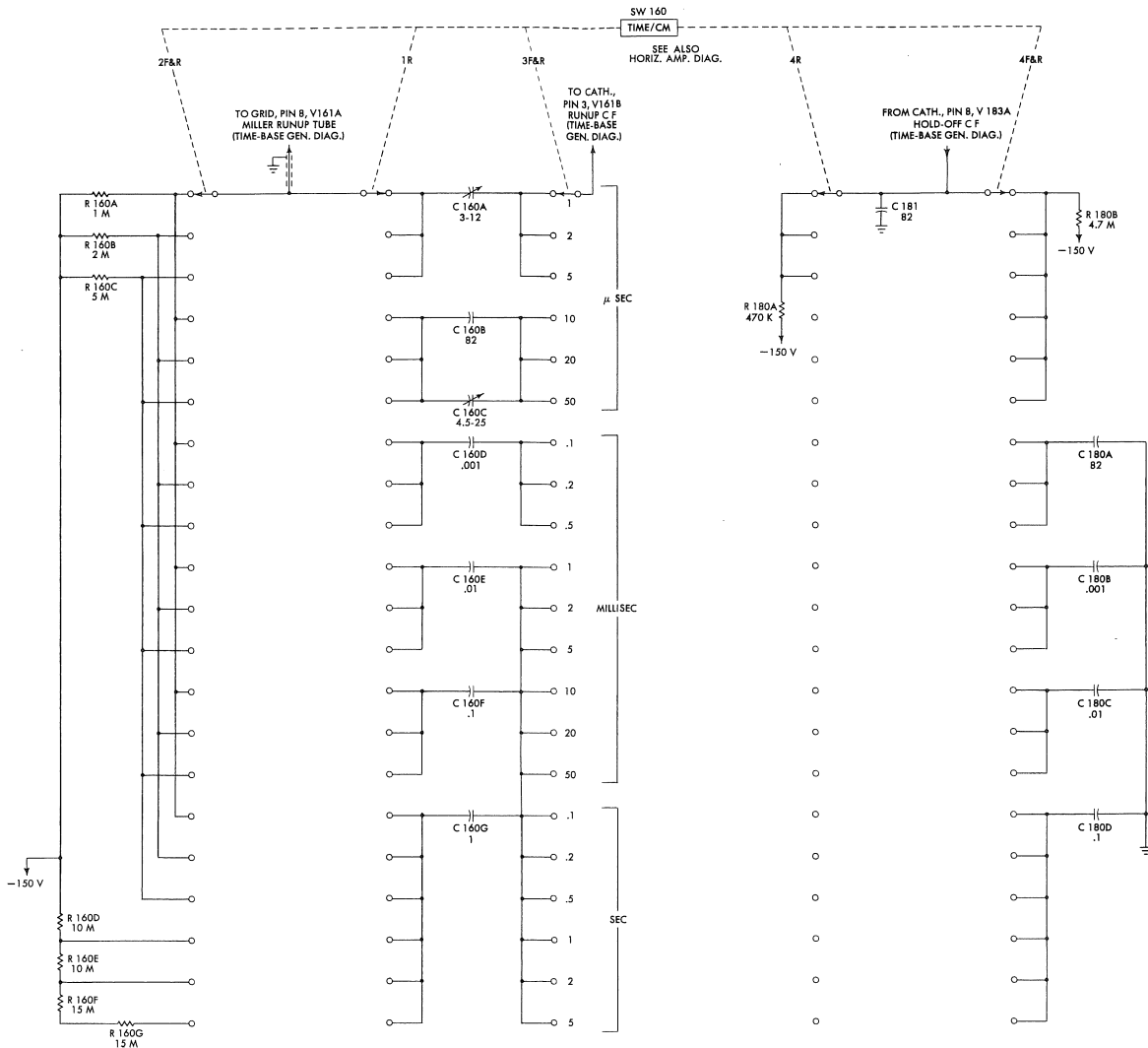

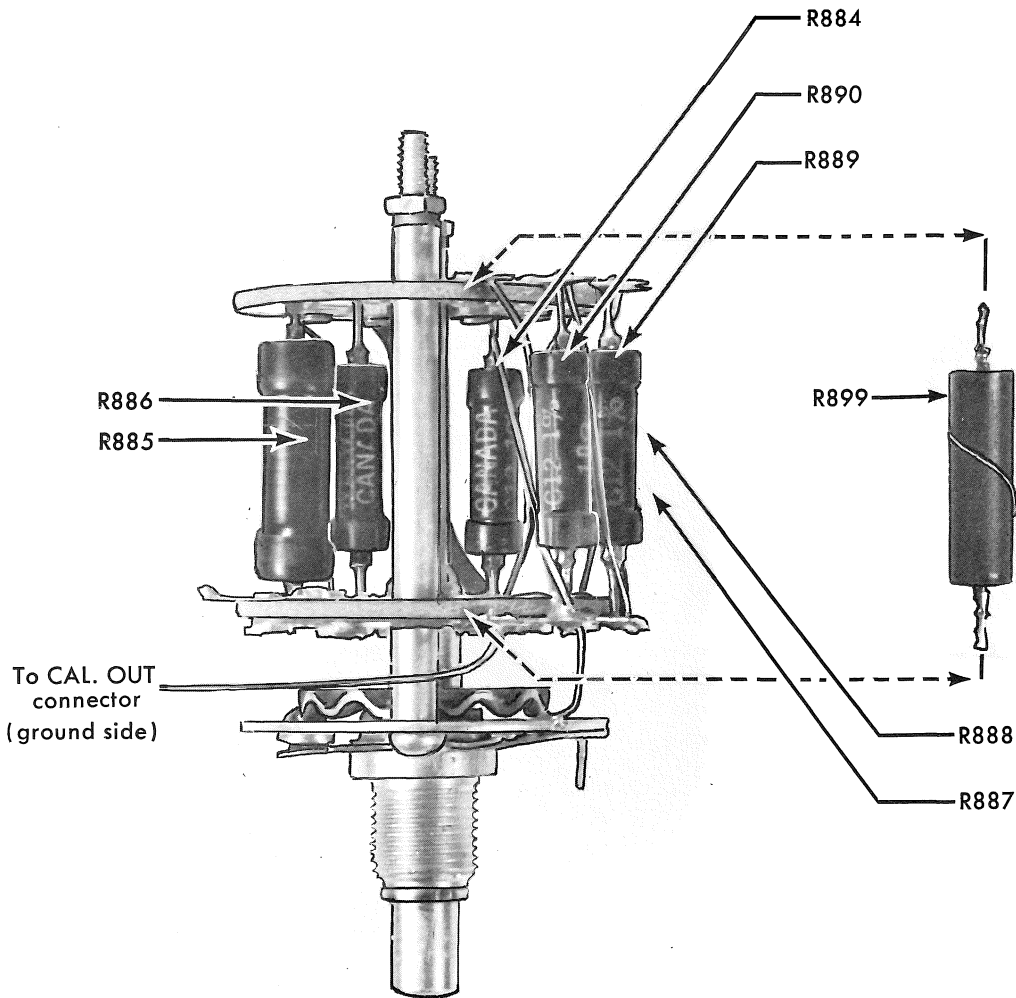
SWITCH DETAIL

CALIBRATOR SWITCH
Bottom View

NOTE

Unless otherwise specified, all of the voltage readings were taken with a dc vacuum-tube voltmeter having an input resistance of 11 megohms. The waveforms shown were reproduced from actual photographs. There will be considerable variation between instruments because of normal manufacturing tolerances and vacuum-tube characteristics. Therefore, the significance of any discrepancies observed should be determined by referring to the circuit diagram.

All readings are in volts unless otherwise specified. Where two voltage readings are given, they represent the voltage as read by a voltmeter under two sets of conditions, and, as such, do not indicate the peak-to-peak excursion of voltage at the point.

←————— CALIBRATOR MULTIVIBRATOR —————→

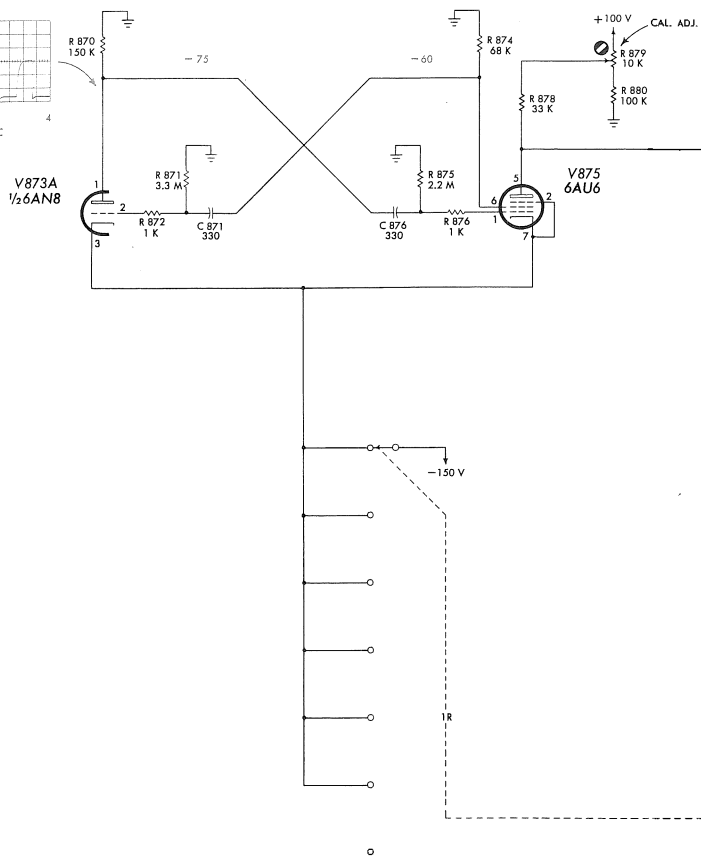
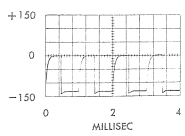

TYPE 502 OSCILLOSCOPE

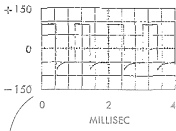

CAL. OUT
CF

WAVEFORMS AND VOLTAGE READINGS*
WERE OBTAINED WITH CONTROLS SET AS FOLLOWS:
SQUARE-WAVE CALIBRATOR 100 V
*VOLTAGE READINGS MAY VARY WITH CALIBRATOR
DUTY CYCLE

A 597 GA.

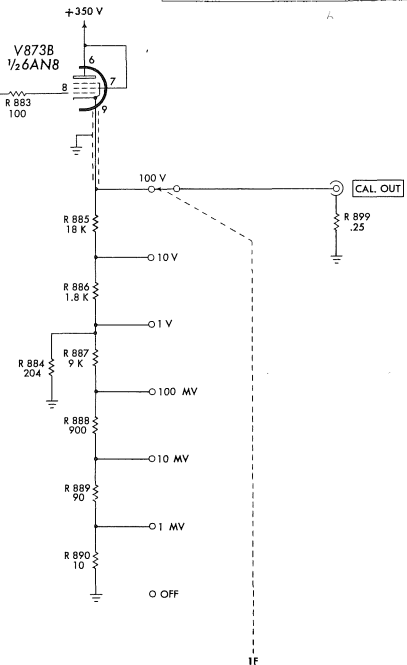

SW 870
SQUARE-WAVE
CALIBRATOR

See parts list for late
component-value changes

CALIBRATOR

ABBREVIATIONS USED IN OUR PARTS LISTS

Cer.	ceramic	m	milli
Comp.	composition	Ω	ohm
EMC	electrolytic, metal cased	Poly.	polystyrene
EMT	electrolytic, metal tubular	Prec.	precision
f	farad	PT	paper tubular
h	henry	Tub.	tubular
k	thousands of ohms	v	working volts dc
meg	megohms	Var.	variable
μ	micro	w	watt
$\mu\mu$	micromicro	WW	wire wound
	GMV		guaranteed minimum value

ABBREVIATIONS USED IN OUR CIRCUIT DIAGRAMS

Resistance values are in ohms. The symbol k stands for thousands. A resistor marked 2.7 k has a resistance of 2,700 ohms. The symbol M stands for million. For example, a resistor marked 5.6 M has a resistance of 5.6 megohms.

Unless otherwise specified on the circuit diagram, capacitance values marked with the number 1 and numbers greater than 1 are in $\mu\mu\text{f}$. For example, a capacitor marked 3.3 would have a capacitance of 3.3 micromicrofarads. Capacitance values marked with a number less than 1 are in μf . For example, a capacitor marked .47 would have a capacitance of .47 microfarads.

Inductance values marked in mh are in millihenrys. Inductance values marked in μh are in microhenrys.

Your instrument **WARRANTY** appears on the reverse side of this sheet.

SERIAL NO. 1152

IMPORTANT

Include the INSTRUMENT TYPE and the above SERIAL NUMBER in any correspondence regarding this instrument. The above serial number must match the instrument serial number if parts are to be ordered from the manual. Your help in this will enable us to answer your questions or fill your order with the least delay possible.



WARRANTY

All Tektronix instruments are fully guaranteed against defective materials and workmanship for one year. Should replacement parts be required, whether at no charge under warranty or at established net prices, notify us promptly, including sufficient details to identify the required parts. We will ship them pre-paid (via air if requested) as soon as possible, usually within 24 hours.

Tektronix transformers, manufactured in our own plant, carry an indefinite warranty.

All price revision and design modification privileges reserved.

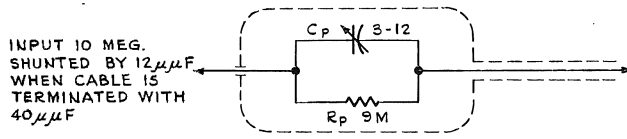
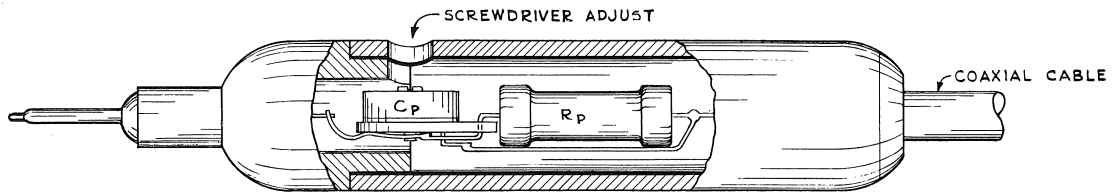

C_p 3-12 μF GER. VAR. 500V
 R_p 9 MEG. 1W FIXED PREC. 1%

RBH
1-13-55

TEKTRONIX TYPE P510A PROBE

ACCESSORIES

Operational Accessories TYPE 123 PREAMPLIFIER

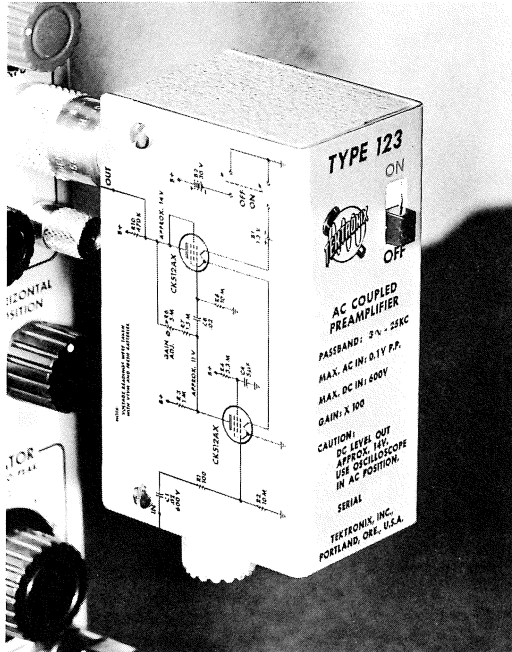

Compact

3 5/8" high, 1 1/2" wide, 2-3/16" deep.

Weighs only 10 ounces.

Voltage Gain

Accurately set at 100 times.

Passband

Within 2% from 15 cycles to 6 kc.
Within 3 db from 3 cycles to 25 kc.

Maximum Input Signal

0.1 v peak-to-peak.

Hum-Free Low-Level Amplification

Powered by miniature batteries.

GENERAL DESCRIPTION

The Tektronix Type 123 Preamplifier is a compact, light-weight, battery-operated amplifier for use in applications where a gain of 100 without additional hum signal is desired. Passband is 3 cycles to 25 kc. Etched

wiring, miniature tubes and small batteries are combined in a unit about the size of 2 king-size cigarette packages. Where reduced high-frequency response is permissible, ground-loop hum pickup can be virtually eliminated by mounting the Type 123 close to the circuit under observation. Coaxial connectors permit the Type 123 to be connected directly to an oscilloscope or other instrument, and at reduced high-frequency response, in a connecting cable, or even for use as a probe. Shock-mounted chassis reduces the effects of microphonics, shift, and drift.

Applications of the Type 123 are confined to the audio range; for example, observing hum levels, transducer pre-amplifier, and other low-level applications where a gain of 100 is desired.

CHARACTERISTICS

Voltage Gain—Gain is 100, adjustable with screw-driver calibration control.

Passband—Within 3 db from 3 cycles to 25 kc. Within 2% from 15 cycles to 6 kc.

Battery Powered—A small mercury cell supplies the filament voltage and a miniature 30 v battery is the source of plate voltage. Life of the mercury cell is approximately 100 hours. Low plate current, 75 microamps, assures plate-supply battery life of more than 100 hours.

Noise Level—The maximum noise level with the input grounded is less than 7.5 microvolts, rms.

Output Signal Level—DC level of output is approximately +15 v.

Maximum Input Signal—Maximum input signal for linear amplification is 0.1 v, peak-to-peak.

Input Impedance—10 megohms.

Effective Output Impedance—31 kilohms.

Vacuum Tube Complement—Two Type 512AX sub-miniature filament-type pentodes.

MECHANICAL SPECIFICATIONS

Construction—Aluminum-alloy cover and etched-wiring chassis.

Finish—Photo-etched anodized front panel.

Dimensions—3 5/8" high, 4 1/8" including coaxial connector; 1 1/2" wide; 2-3/16" deep, 3 3/4" including coaxial connector.

Weight—10 ounces.

Power Requirements—One 1.345 v mercury cell and one 30 v miniature battery, included with the instrument.

Price \$50

Includes: 1—Mercury cell
1—B battery

ACCESSORIES

Operational Accessories TYPE 124 TELEVISION ADAPTOR

Line Selection

Sync separator and delayed trigger circuitry permit triggering the oscilloscope at any selected line of a field.

Field Shift

Push button provides instant shift to corresponding line or lines in opposite field.

Gated Time Markers

Intensity markers of 1 μ sec, 0.1 μ sec, 0.05 μ sec and 0.005 H (200 per television line).

APPLICATIONS

The Type 124 adapts any triggered wide-band oscilloscope to the observation of the television composite video signal. Greatly increases the usefulness of the oscilloscope in television development and maintenance work.

GENERAL DESCRIPTION

The delayed-trigger output of the Type 124 is continuously variable from zero to 25 milliseconds after receipt of a vertical sync pulse. By adjusting the delay, an oscilloscope can be triggered at the start of any desired line in a field. Panel push button provides instant shift to opposite field. Triggering occurs at half the television vertical rate. Duration of the output pulse is less than 1 μ sec, and amplitude is 2 v positive. Triggering may be accomplished by the composite video signal of either polarity, 0.5 v minimum to 20 v maximum, peak to peak, or a 60-cycle sine wave.

The time-marker generator requires a positive gate of 20 v minimum to 50 v maximum, peak to peak. Markers are supplied for the duration of the gate. Time-marker intervals are 1 μ sec, 0.1 μ sec, 0.05 μ sec, and 0.005 H (200 per television line). Amplitude is continuously variable from zero to 30 v. Phase control permits positioning the markers on the trace.

To make use of the time-marker output of the Type 124, the oscilloscope should have a positive gate output and a CRT cathode terminal.

VACUUM TUBE COMPLEMENT

Trigger inverter and output CF	6BQ7A
Sync separator and dc restorer	12BZ7
Phantastron	6BH6
Trigger coupling diode	6AL5
Bistable multivibrator	6U8

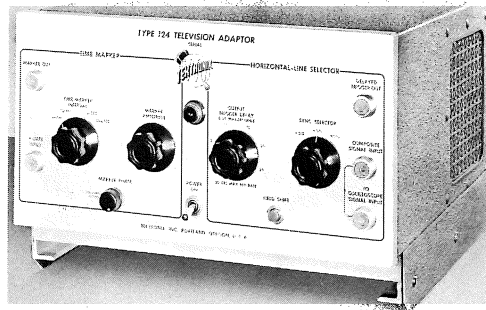

Cathode-coupled amplifier	12BZ7
Bistable multivibrator	12BZ7
Time-marker oscillator	6AK5
Gating CF and pulse shaping amplifier	6BQ7A
Time-marker output amplifier	6BQ7A
Rectifier	6AX5
Rectifier	6X4
Regulator amplifiers	2 6AU6
Regulator series tubes	2 12B4
Voltage reference	OA2

MECHANICAL SPECIFICATIONS

Ventilation—forced-air cooling.

Mounting frame—provides secure mounting to the top of Tektronix 5" Oscilloscopes.

Connecting cables—the four connecting cables supplied with the Type 124 are designed for use with Tektronix Oscilloscope Types 511, 511A, 513, 514, and 514A. Cable extensions will be necessary in many cases when the Type 124 is used with other triggered wide-band oscilloscopes.

Size—6 3/4" high, 12 3/4" wide, 12 1/2" deep.

Weight—21 lbs.

Construction—aluminum alloy.

Finish—photo-etched anodized panel, wrinkle-finished cabinet.

Power requirements—105-125 v or 210-250 v, 50-60 cycles, 120 watts.

Price **\$295**

Includes: 1—FM124 Mounting frame (014003)
4—Connecting cables
1—Instruction manual

Price f.o.b. Portland, Oregon.

ACCESSORIES

Operational Accessories TYPE 126 POWER SUPPLY

Output Voltages

- + 300 v dc, unregulated.
- + 225 v dc, regulated, 45 ma maximum.
- + 150 v dc, regulated, 5 ma maximum.
- 170 v dc, regulated, 30 ma maximum.
- 6.3 v ac, unregulated, 4 amps maximum.

Small — Adds only 2½" in height to Type 360 Indicator.

Electronic Voltage Regulation

GENERAL DESCRIPTION

The Tektronix Type 126 Power Supply supplies the required voltages and currents necessary to power one Type 360 Indicator or any one of the Type 160-Series Waveform Generators. The Type 126 mounts beneath the unit to be powered, and includes a cabinet to house both the Type 126 and the powered unit.

A Type 126 Power Supply combined with a Type 360 Indicator makes a practical, compact slave unit for any Tektronix oscilloscope. (The oscilloscope has the necessary sweep sawtooth and unblanking pulse for the Type 360 Indicator available at front-panel connectors.)

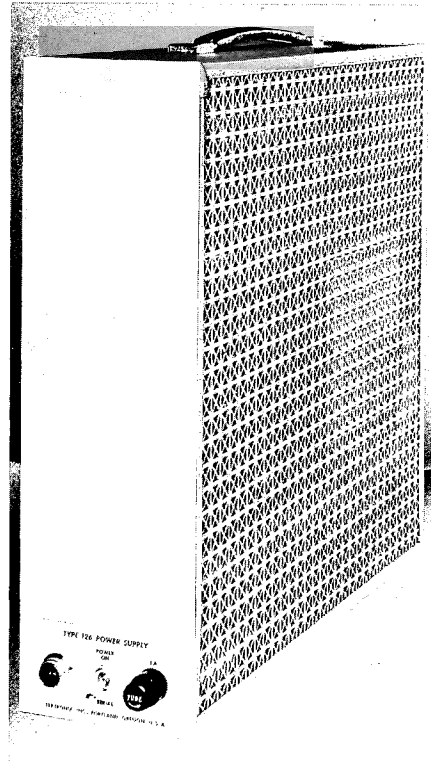
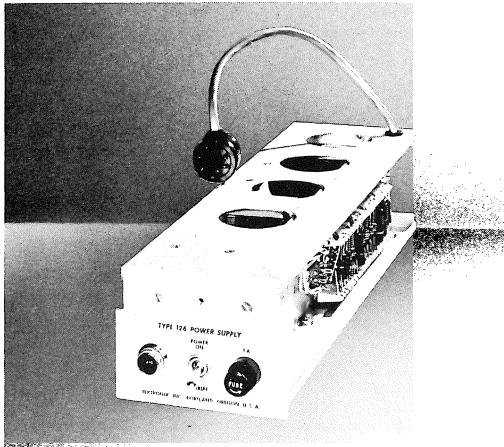

VACUUM TUBE COMPLEMENT

Rectifiers	2	6BW4
Regulator amplifier		6AU6
Regulator amplifier and voltage regulator CF		6AN8
Series regulators	2	12B4
Voltage reference		5651

MECHANICAL SPECIFICATIONS

Construction — Aluminum alloy.

Finish — Photo-etched anodized panel, blue wrinkle cabinet.

Dimensions — 4 1/8" wide, 15 1/2" deep, cabinet height 14 3/4".

Weight — 10 1/2 pounds.

Power Requirements — 105-125 or 210-250 v, 50-60 cycles, 50 watts.

Price \$100

Includes: 1—Instruction manual

ACCESSORIES

Operational Accessories

SCOPE-MOBILE



The Tektronix Type 500 Scope-Mobile is a sturdy, mobile support for Tektronix 5" Oscilloscopes. Convenient observation of the crt face is achieved by a 20-degree backward tilt of the top surface. Auxiliary equipment can be mounted in the enclosed vented space behind the blank front panel. A drawer, felt-lined and operating on roller bearings, provides handy storage for probes, cables, manuals, etc. An open shelf, topped with tough linoleum, is located at the bottom. Power input and three convenience outlets are mounted at the rear. Total weight is 42 pounds. Dimensions are 18½" wide, 39" high and 30" deep. \$97.50

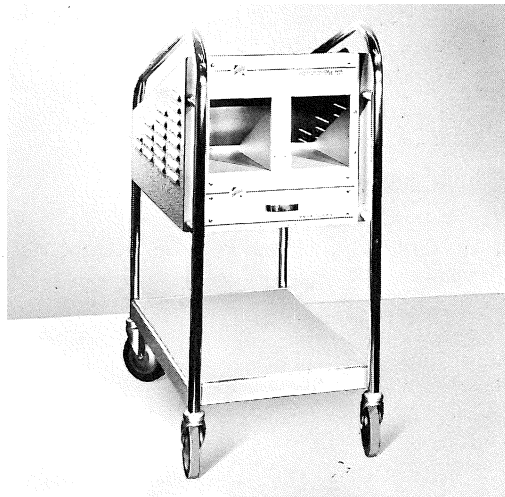

The Tektronix Type 500/53 Scope-Mobile is the Type 500 with a Type 53 Scope-Mobile front-panel installed. This front-panel has two supporting cradles to accommodate the Type 53 and 53/54 Plug-In Preamplifiers used in the Type 530 and Type 540-Series Oscilloscopes. In all other characteristics the Type 500/53 is identical to the Type 500. 108.00

Type 53 Scope-Mobile Panel — converts the Type 500 into a Type 500/53 Scope-Mobile by replacing the standard blank panel. 10.50

VIEWING HOODS

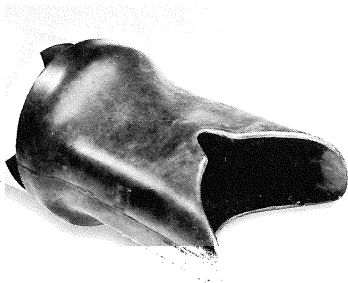

H510 Viewing Hood, for Tektronix 5" Oscilloscopes. Includes molded rubber eye-piece and aluminum light shield 4.50

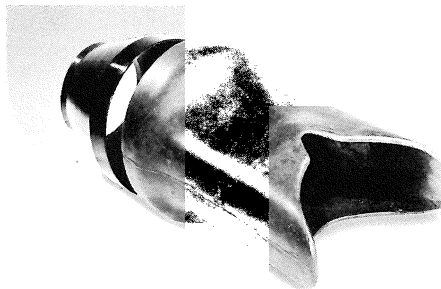

H310 Viewing Hood, for Tektronix 3" Oscilloscopes. Includes molded rubber eye-piece and spun-aluminum light shield 4.50

ACCESSORIES

Operational Accessories

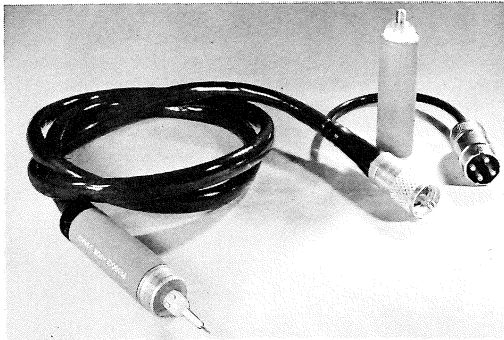

P500CF Cathode-Follower Probe—For use with Types 524D and 524AD Oscilloscopes. Presents low capacitance with minimum attenuation. Input impedance is 40 megohms paralleled by 4 μmf , gain 0.8 to 0.85. Input to probe is ac-coupled, limiting its low-frequency response to 5 cycles. Amplitude distortion is less than 3% on unidirectional signals up to 5 volts. 10x attenuator head is included with probe, and should be used on signals exceeding a few volts to minimize amplitude distortion. With the attenuator head attached, the probe input impedance is approximately 10 megohms paralleled by 2 μmf . Probe output level is 11 v positive, making it necessary to use the ac-coupled position of the oscilloscope AC-DC switch. Probe cable is 42" long. 64.00

A modification kit is available to equip the Type 524D Oscilloscope with a front-panel probe-power connector. Modification Kit K524-1021A. 5.00

TERMINATIONS, PADS, ATTENUATORS

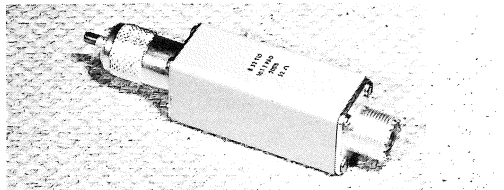

B52-R	52-ohm terminating resistor, 1.5 w . .	8.50
B52-L5	52-ohm 'L' pad, 5 to 1 voltage ratio, 1.5 w	8.50
B52-L10	52-ohm 'L' pad, 10 to 1 voltage ratio, 1.5 w	8.50
B52-75L	Minimum-loss pad, 52 ohms to 75 ohms	11.50
B52-170L	Minimum-loss pad, 52 ohms to 170 ohms	11.50

B52-T10	52-ohm 'T' pad, 10 to 1 voltage ratio, 1.5 w	11.50
B75-R	75-ohm terminating resistor, 1.5 w . .	8.50
011 023	75-ohm terminating resistor for Type 525, 0.5 w	4.00
B75-L5	75-ohm 'L' pad, 5 to 1 voltage ratio, 1.5 w	8.50
B75-L10	75-ohm 'L' pad, 10 to 1 voltage ratio, 1.5 w	8.50
B75-T10	75-ohm 'T' pad, 10 to 1 voltage ratio, 1.5 w	11.50
B93-R	93-ohm terminating resistor, 1.5 w . .	8.50
B93-L5	93-ohm 'L' pad, 5 to 1 voltage ratio, 1.5 w	8.50
B93-L10	93-ohm 'L' pad, 10 to 1 voltage ratio, 1.5 w	8.50
B93-52L	Minimum-loss pad, 93 ohms to 52 ohms, 1.5 w	11.50
B93-T10	93-ohm 'T' pad, 10 to 1 voltage ratio, 1.5 w	11.50
B170-R	170-ohm terminating resistor, 1.5 w . .	8.50
B170-A	170-ohm π -attenuator, using 2% precision resistors, 1 to 64 db in 1 db steps, 0.25 w	45.00

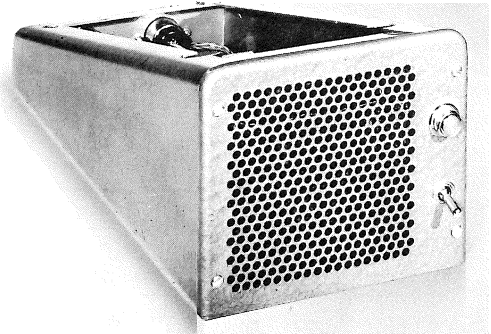

FB 310 Fan Base—for Type 310 Oscilloscope. Provides filtered, forced-air ventilation to assure safe operating temperature when the Type 310 Oscilloscope is being used continuously over long periods, or in hot or limited-ventilation areas. The fan base tilts the oscilloscope to a convenient viewing angle. For use on 105-125 v, 60 cycle only. 25.00

FB 310-S1 Fan Base—for use on 210-250 v, 50 to 60 cycles only. 25.00

ACCESSORIES

Operational Accessories

PROBES

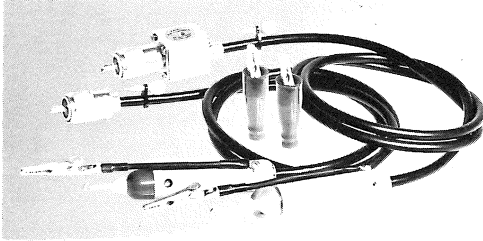

P400-Series Low-Capacitance Probes—This series of low-capacitance probes preserves the transient response of Tektronix fast-rise instruments. The P400-Series probes are free of overshoot and ringing and have relatively uniform high-frequency response. With exception of the P450-L, these probes can be used on other instruments having input capacitances from 20 to 50 $\mu\mu\text{f}$. General physical characteristics of the P400-Series probe are identical to the P510A probe. Color-coding of the plastic nose indicates attenuation ratio. Probes have 42" cable with coaxial connector and are rated at 600 v peak-to-peak. Two interchangeable Tektips—a straight tip and a hooked tip—each adding less than 0.5 $\mu\mu\text{f}$ to the input capacitance, and an alligator clip assembly are supplied with the probes.

P405, P410, P420	10.50
P450, P450-L, P4100	12.50
Replacement Tektips, each	.25

P400-SERIES PROBE SPECIFICATION

Probe	Attenuation Ratio	Resistance (Megohms)	Capacitance		DB Loss at 30 MC
			Minimum*	Maximum†	
P405	5:1	5	12 $\mu\mu\text{f}$	19 $\mu\mu\text{f}$	1-2
P410	10:1	10	8 $\mu\mu\text{f}$	11 $\mu\mu\text{f}$	1
P420	20:1	10	5.5 $\mu\mu\text{f}$	7 $\mu\mu\text{f}$	1
P450	50:1	10	3.5 $\mu\mu\text{f}$	3.5 $\mu\mu\text{f}$	1
P450-L	50:1	10	2.5 $\mu\mu\text{f}$		1
P4100	100:1	10	2.5 $\mu\mu\text{f}$	2.5 $\mu\mu\text{f}$	1

*When connected to instruments with 20- $\mu\mu\text{f}$ input capacitance.

†When connected to instruments with input capacitances up to 50 $\mu\mu\text{f}$.

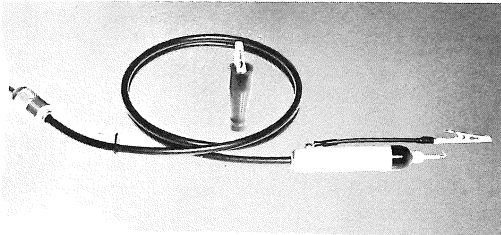

P510A Attenuator Probe provides an attenuation of ten times when used with Tektronix oscilloscopes and amplifiers. The P510A is small and streamlined, and pre-

sents an input impedance of 10 megohms paralleled by 14 $\mu\mu\text{f}$. The probe is completely insulated — made of high-impact-strength fiberglass-reinforced alkyd — and has an internal brass shield. Two interchangeable Tektips—a straight tip and a hooked tip, and an alligator clip assembly are furnished. Probe has a 42" cable with coaxial connector, and is rated at 600 v peak-to-peak.

P510A 8.50

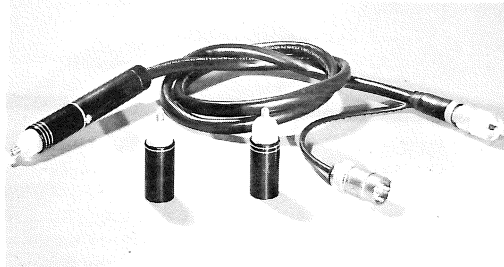

P170CF Cathode Follower Probe was developed for use with the Type 517 Oscilloscope. The cathode-follower tube is a 5718 triode whose cathode load is the 170-ohm termination of the preamplifier grid line in the Type 517. Plate and heater voltages for this tube are provided at a four-terminal socket on the panel of the oscilloscope. The signal is attenuated by 2 times when using the P170CF. The input impedance of the probe will depend on the attenuator head being used, also since transit time in the cathode-follower tube is involved, it will decrease appreciably at the higher frequencies. When the probe is used without an attenuator head, the input looks like 12 megohms shunted by 5 $\mu\mu\text{f}$. The probe cable is 42" long. Probe complete with 3 attenuator heads 86.00

REPLACEMENT ATTENUATOR HEADS

PAX-I Attenuator Head for P170CF, attenuation can be varied between 4 times and 40 times. 11.00

PAX-II Attenuator Head for P170CF, attenuation can be varied between 20 times and 200 times. 11.00

PAX-III Attenuator Head for P170CF, attenuation can be varied between 200 times and 2000 times. 11.00

P170CF can be used with the Type 513 Oscilloscope, but low-frequency response will suffer somewhat, depending on the attenuator head being used. It is necessary to terminate the 170-ohm cable at the oscilloscope input. B170R terminating resistor is designed for this. (See terminations.) A rectifier kit, KP170CF, is recommended for installation in Type 513 to rectify the 6.3 volt heater supply.

KP170CF DC Filament Kit for Type 513. 4.50

ACCESSORIES

Operational Accessories

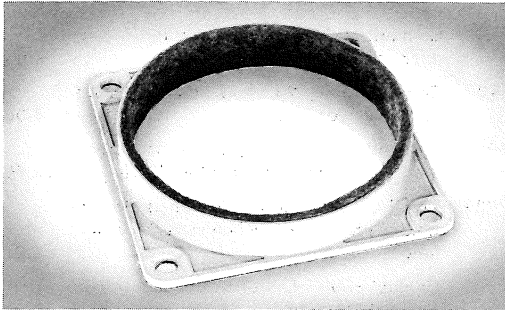

BE510 Bezel, for mounting camera on Tektronix 5" oscilloscopes. Dimensions— $5\frac{7}{8}$ " square; ring $\frac{7}{8}$ " deep, diameter $5\frac{5}{8}$ " outside, $5\frac{1}{8}$ " inside. Die-cast construction, wrinkle finish, felt lined. 4.50

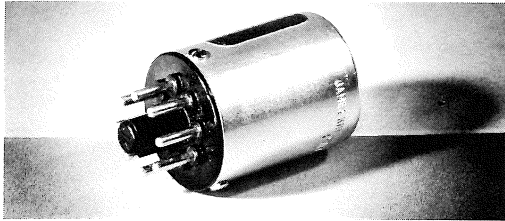

CO181A Crystal-Oven Combination—A 1-mc crystal mounted in a temperature-stabilized oven. Directly interchangeable with standard crystal. Plugs into crystal socket of the Type 181—no wiring changes necessary. Provides a frequency stability of 2 ppm over a 24-hour period 27.00

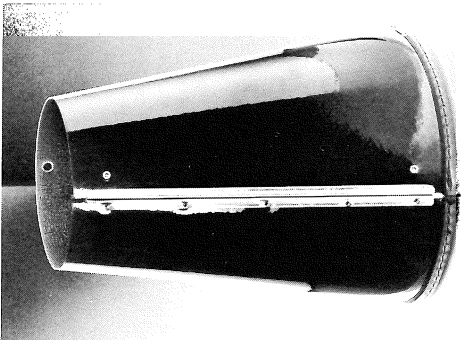

HC 310 Collapsible Viewing Hood, for Tektronix 3" Oscilloscopes. It is made of black acrylic plastic with handy fastening arrangement. Will fit into side pocket of Type 310 carrying case. Tek no. 016-010 3.50

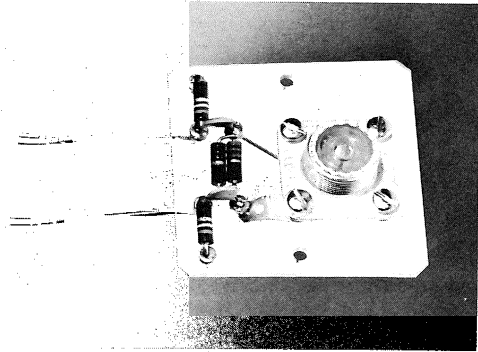

DP 52 Deflection Plate Connector, for Type 530 and 540-Series Oscilloscopes. A convenient means of making a connection directly to the cathode-ray tube vertical-deflection plates. Function of the vertical positioning control is still retained. The connector is designed for use with a 52-ohm cable.

For instruments with serial numbers below 5001,
Tek no. 013-006 5.00

For instruments with serial numbers 5001 and above,
Tek no. 013-007 5.00



CC 310 Canvas Carrying Case, for Tektronix Type 310 Oscilloscope. The case has a zipper fastener along the top and one end. The other end is padded for extra protection for knobs and cathode-ray tube. A side pocket holds probes, power cords, etc. Color is forest green with olive-drab carrying straps. Tek no. 253-541 12.00

ACCESSORIES

Operational Accessories

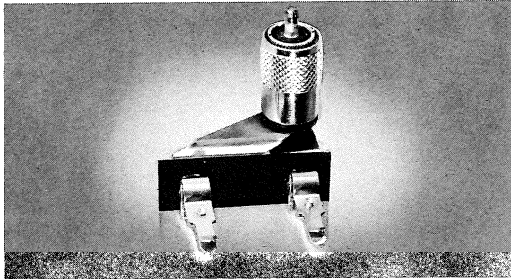

F30 Production Test Fixture, for use with the Type 130 L,C Meter. Speeds sorting and testing of capacitors and inductors 3.00

COAXIAL CABLES

P52 Coaxial cable, 52 ohms nominal impedance, 42" long 4.00

P75 Coaxial cable, 75 ohms nominal impedance, 42" long 4.00

P93 Coaxial cable, 93 ohms nominal impedance, 42" long 4.00

P93A Coaxial output cable, 93 ohms, terminated with variable attenuator, 42" long. 13.50

P93B Coaxial output cable, 93 ohms, terminated with 1/2-watt 93-ohm resistor, 42" long 5.00

P170 Coaxial cable, 170 ohms nominal impedance, 42" long 9.50

MISCELLANEOUS

A100 Adapter, clip lead. 2.00

A510 Adapter, binding post. 2.00

FA160 Frame, mounting, for Type 122 and Type 160-Series units. 5.00

ACCESSORIES

Test Accessories

Type 107 Square-Wave Generator

Risetime

Less than 3 millimicroseconds into a terminated 52-ohm cable.

Frequency Range

Approximately 400 kc to 1 mc, uncalibrated.

Output Voltage

0.1 to 0.5 v, approximately, when cable is terminated in 52 ohms.

GENERAL DESCRIPTION

The Tektronix Type 107 Square-Wave Generator is basically intended as a Test Accessory for the Type 540-Series Oscilloscopes. For examination of high-frequency response, a square wave having a risetime faster than that of the amplifier being tested is necessary. The Type 540-Series Oscilloscopes with the Type 53/54K Plug-In Preampifier have a combination risetime of 12 millimicroseconds. The Type 107, with its risetime of 3 millimicroseconds, provides a suitable square wave for checking and adjusting the high-frequency response of the Type 540-Series Oscilloscopes and Type 53/54 Wide-Band Preampifiers.

CHARACTERISTICS

Risetime—Less than 3 millimicroseconds when the output 52-ohm cable is terminated.

Frequency Range—A front-panel control varies the frequency over an uncalibrated range of approximately 400 kc to 1 mc.

Output Voltage—When the output cable is terminated the output voltage range is approximately 0.1 v to 0.5 v. If the cable is not terminated, the voltage range is 0.2 v to 1 v.

Output Trigger—An output trigger signal is available at a coaxial connector at the rear of the instrument.



Waveform—Special design consideration has been placed on the shape of the positive portion of the waveform. Therefore, only this portion should be used in transient response testing.

VACUUM TUBE COMPLEMENT

Multivibrator	6BQ7A
Amplifier	12BY7
Shaper amplifier	12BY7
Driver amplifier	12BY7
Output amplifier	6AU6
Rectifiers	2 6BW4
Output voltage regulator	OA2

MECHANICAL SPECIFICATIONS

Ventilation—Forced-air ventilation assures safe operating temperature.

Construction—Aluminum-alloy chassis and cabinet.

Finish—Photo-etched panel, wrinkle-finished cabinet.

Dimensions—11" long, 6 3/4" wide, 10 1/2" high.

Weight—13 pounds.

Power Requirements—105-125 v or 210-250 v, 50-60 cycles, 100 watts.

Price \$165

- Includes: 1—P52, 52-ohm 42" coaxial cable
1—B52-R, 52-ohm terminating resistor
1—B52-T10, 52-ohm 'T' pad
1—Instruction manual

ACCESSORIES

Test Accessories

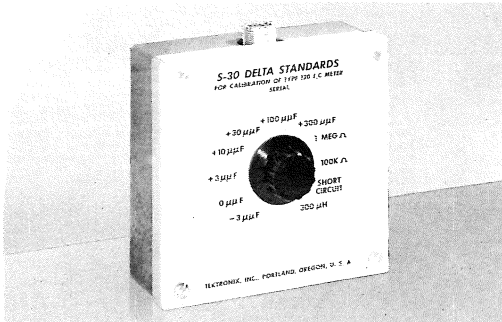

015-001 (S30) Delta Standards, for calibration of the Type 130 L/C Meter. The unit provides accurately adjusted steps of capacitance and inductance, selected by a rotary selector switch. Values of the capacitance steps correspond to the full-scale adjustments required on the five scales of the Type 130. Two resistors of identical manufacture and similar capacitance, values of 1 megohm and 0.1 megohm, are provided for the resistance compensation adjustment. A 300- μ h standard permits proper adjustments of the inductance ranges 22.00

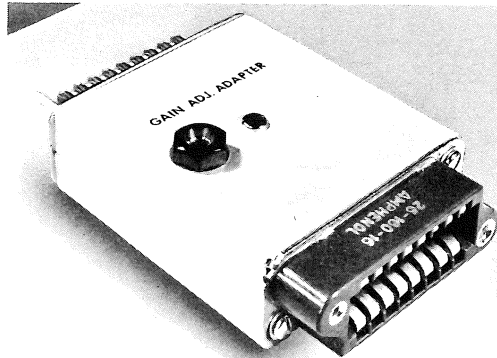

013-005 (EP53A) Gain Set Adapter—Permits an external calibrating signal to bypass the plug-in preamplifier, for calibrating the sensitivity of the main amplifier of Type 530 and 540-Series Oscilloscopes. 5.00

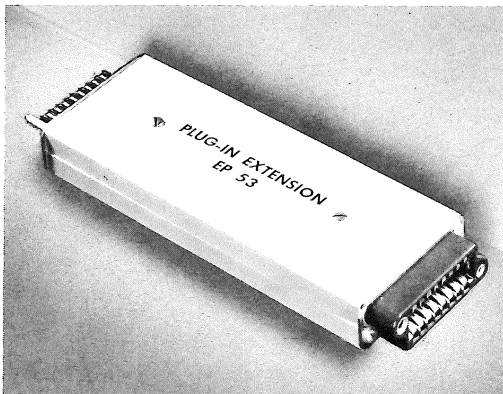

013-002 (EP53) Plug-in Extension — Allows the plug-in preamplifier unit for the Type 530 and Type 540-Series Oscilloscopes to be operated partially out of its housing. 5.00



011-021 (CS 47) Input Capacitance Standardizer—For use with Type 53 and Type 53/54 Plug-In Preamplifiers having an input capacitance of 47 μ f. With this accessory the input capacitance of each preamplifier can be standardized to 47 μ f, eliminating the necessity for probe readjustment when used with different plug-in preamplifiers 11.50

011-022 (CS 20) Input Capacitance Standardizer—Similar to 011-021 (CS 47), for use with the Type 53/54C and Type 53/54K Plug-In Preamplifiers having 20 μ f input capacitance 11.50

ACCESSORIES

Replacement Parts

GRATICULES

386-395	Unruled, for Type 310.....	1.00
386-312	Unruled, for Type 315.....	1.00
331-027	Quarter-inch divisions, 8 divisions vertically, 10 horizontally, for Type 310 and 360	1.50
331-005	Quarter-inch divisions, 8 divisions vertically, 10 horizontally, for Type 315... ..	1.50
386-326	Unruled, fits Types 511A, 512, 513, 514, 514A, 524D, 524AD.....	1.00
331-023	Centimeter ruling, 4 centimeters vertically, 10 horizontally, for Types 511A with 5CP CRT.....	1.50
331-024	Centimeter ruling, 4 vertically, 10 horizontally, for Type 514 with 5CP CRT, 513 with T51PA CRT.....	1.50
331-006	Centimeter ruling, 6 centimeters vertically, 10 horizontally, for Type 512 with 5CP CRT, Types 514A, 524D, 524AD and Type 511A with 5ABP CRT	1.50
331-010	Centimeter ruling, 8 centimeters vertically, 10 horizontally, for Type 512 with 5ABP CRT.....	1.50
331-007	Centimeter ruling, 4 centimeters vertically, 8 horizontally, for Type 513 with 5XP CRT	1.50
331-008	Centimeter ruling, 4 centimeters vertically, 8 horizontally, for Type 517....	9.50
331-009	TV RMA style ruling for percentage measurements, for Types 524D and 524AD	1.50
331-035	Ruling in percentages, -40 to +100, for Type 525.....	1.50
331-026	Centimeter ruling, 8 centimeter vertically, 10 horizontally, for Type 532... ..	1.50
331-016	Centimeter ruling, 6 centimeters vertically, 10 horizontally, for Types 531 and 535.....	1.50
331-025	Centimeter ruling, 4 centimeters vertically, 10 horizontally, for Types 541 and 545.....	1.50
331-028	Division ruling, 10 divisions vertically, 10 horizontally, for Type 570.....	1.50

CATHODE-RAY-TUBE LIGHT FILTERS

378-511	3" Amber (for Type 310 and 360)....	.50
378-509	3" Green (for Type 310 and 360)....	.50
378-510	3" Blue (for Type 310 and 360)....	.50
378-506	3" Amber (for Type 315D).....	.50

378-505	3" Green (for Type 315D).....	.50
378-507	3" Blue (for Type 315D).....	.50
378-501	(F510-3) 5" Amber.....	.90
378-503	(F510-5) 5" Green.....	.90
378-504	(F510-6) 5" Blue.....	.90

AC POWER CORDS

161-004	(COP 16-8) No. 16 wire, 8' long....	2.40
161-003	(COP 18-1) No. 18 wire, 1' long....	.85
161-001	(COP 18-8) No. 18 wire, 8' long....	1.50
161-007	(COP 18-8) Right angle.....	1.50

PATCH CORDS

Two series of patch cords are available. The Series-PC patch cords have a male and female banana-type connector on each end for the purpose of "stacking" the connectors. The Series-W530 patch cords have single banana plugs on each end. Both series are available in red or black and in 18 inch and 6 inch lengths.

012-013	Type W-530B, black, 18"	1.00
012-023	Type PC-6B, black, 6"	1.25
012-024	Type PC-6R, red, 6"	1.25
012-028	Type W-531B, black, 6"	1.00
012-029	Type W-531R, red, 6"	1.00
012-031	Type PC-18R, red, 18"	1.25

SPECIAL CORDS AND LEADS

012-007	(W112R) Red output lead for Type 112	1.00
012-008	(W112B) Black output lead for Type 112	1.00
012-009	(W122) Battery power lead for Type 122	7.50
012-014	(W130B) Black output lead for Type 130	1.00
012-015	(W130R) Red output lead for Type 130	1.00
012-016	(W160-20) 20" inter-unit power cable for Type 160-Series.....	2.00
012-017	(W160-10) 10" inter-unit power cable for Type 160-Series.....	2.00
012-012	(W517) Inter-unit power cable for Type 517.....	9.50

MISCELLANEOUS

011-018	Attenuator unit, for Type 190A.....	19.00
010-003	P93C Probe, for Type 130.....	2.00
014-003	FM 124 Mounting frame, for Type 124.	5.00

ACCESSORIES

Replacement Parts

INSTRUCTION MANUALS			
104A	1.50	514 or 514D	2.75
105	1.75	514A or 514AD	3.00
112	1.50	515	4.00
121	1.50	517 or 517A	4.50
122	1.50	524D or 524AD	5.00
124	1.75	525	4.50
126	1.50	531	4.50
130	1.50	532	4.50
160 or 160A	1.50	535	5.00
161	1.50	536	5.00
162	1.50	541	4.50
163	1.50	545	5.00
180	2.00	53A or 53/54A	1.50
181	1.75	53B or 53/54B	1.50
190A	1.50	53C or 53/54C	1.50
310	3.50	53/54D	1.50
315D	4.00	53/54E	1.50
316	4.00	53G or 53/54G	1.50
360	1.75	53/54K	1.50
511A or 511AD	2.75	53/54L	1.50
512	2.75	53/54T	1.50
513 or 513D	2.75	570	4.50
		575	5.00

APPROXIMATE SHIPPING WEIGHTS

INSTRUMENT TYPE	NET WEIGHT IN POUNDS	DOMESTIC PACKED IN POUNDS	EXPORT PACKED		VOLUME IN CU. FT.
			WEIGHT IN POUNDS	KILOGRAMS	
104A	22	32	53	24	5
105	35 1/2	49	65	30	5
112	32	49	75	51	7
121	18 1/2	24	45	20	4
122	5 1/2	9	16	7	1
130	9	17	38	17	4
160 Series	33	56	74	34	7
160A	21	28	50	22	4
161	3 1/2	7	14	6	1
162	3 1/2	7	14	6	1
163	3 1/2	7	14	6	1
FA-160	1 1/4	3			
180	37	49	66	30	5
181	17 1/2	24	49	22	7
190A	24	35	55	25	5
310	23 1/2	30	49	22	4
316	35	47	65	30	4
360	9	17	32	15	4
515	40	66	88	40	7
517A					
Indicator Unit	76	101	127	58	9
Power Supply	72	83	105	48	5
Scopemobile	42	62	67	30	7
524AD	61	84	117	53	8
Viewing Hood	1 1/4	4	11	5	1
525	54	86	101	46	9
531	61 1/2	80	105	48	8
532	52	73	94	43	8
535	65	85	110	50	8
536	57	83	103	47	8
541	61 1/2	80	103	47	8
545	65	85	111	50	8
53/54A	3 1/2	10	12	5	1
53/54B	3 1/2	10	12	5	1
53/54C	5 1/2	12	14	6	1
53/54D	4	11	14	6	1
53/54E	4 1/2	12	14	6	1
53/54G	4 1/2	12	14	6	1
53/54K	3 1/2	10	12	5	1
53/54L	4 1/2	12	14	6	1
53/54T	5	12	14	6	1
570	75	96	116	53	8
575	70	96	116	53	8
124	21	32	58	26	5
500	42	53	62	28	7

GENERAL INFORMATION

Terms and Shipment

For domestic orders, placed in accordance with the normal Tektronix marketing practices, our terms are net thirty days. Shipping delay may be prevented by establishing credit at the time of placing your order. When desirable, COD shipments can be arranged. Normally all prices and original quotations are f.o.b. factory.

Unless otherwise specified on your order, shipment will be made via Motor Freight. If another carrier is specified, shipment will be made at full valuation unless your order instructs differently. In case air shipment and full valuation are desired, please specify whether Air Express or Air Freight. Lacking specification, Air Freight and full valuation will be chosen.

Export Orders

To provide our overseas customers with instruments at prices based on eminently fair exchange rates, assistance in ordering, and most important, service after receipt of their instruments, Tektronix has established authorized distributors in many overseas countries. To take advantage of these services, available **ONLY** through your **AUTHORIZED TEKTRONIX DISTRIBUTOR**, and to eliminate the necessity of paying a premium for our instruments, please direct all inquiries and orders to the **TEKTRONIX DISTRIBUTOR** in your country. Customers in a country not presently served by an authorized Tektronix distributor are asked to send all inquiries and orders directly to Tektronix, Inc., Portland, Oregon.

Delivery

Acceptance of purchase orders is indicated by our acknowledgement, and estimated shipment time is given from date of acknowledged acceptance. Every effort is made to meet the estimated shipment date, but there is the possibility that circumstances beyond our control might make it impossible to meet the quoted schedules.

Field Maintenance

Tektronix Field Maintenance is provided as a service to our customers. Work is expedited whether or not the instrument is in warranty.

Should replacement parts be required, whether at no charge under warranty or at established net prices, notify us promptly, including sufficient details to identify the required parts. We will ship them transportation paid (via air to meet emergencies, if requested) as soon as possible, usually within 24 hours.

Requests for repairs or replacement parts should include type number and serial number and should be directed to the Tektronix Field Office or Representative in your area. In an emergency, please wire or phone Field Engineering, Tektronix, Inc., Portland, Oregon. This procedure will assure you the fastest possible service.

If an instrument must be returned to the factory for repairs, notify Field Engineering directly or through your Tektronix Field Office or Representative, **indicating type number and serial number**, and you will be notified at once as to procedure to be followed. **PLEASE DO NOT RETURN AN INSTRUMENT BEFORE RECEIVING DIRECTIONS.** Instruments and parts returned from countries other than the United States **must be accompanied by an invoice** to clear through customs.

It is standard practice for Tektronix to incorporate improvements in production instruments as they are developed in our laboratories. When it is feasible to add such improvements in the field, modification kits are made available to those who wish to modernize their own instruments.

For customers who have large quantities of Tektronix instruments and wish to equip their maintenance departments with factory-tested components, integrated kits of parts are available. Kits are designed to cover expected needs of a group of ten instruments of the same type.

Warranty

All Tektronix instruments are fully guaranteed against defective materials and workmanship for one year. Tektronix transformers, manufactured in our own plant, carry an indefinite warranty.

Any questions with respect to the warranty mentioned above should be taken up with your Tektronix Field Engineer.

Overseas Warranty Replacements

The same general warranty policies above apply; however, surface shipment will be made prepaid C.I.F. port of unloading. Customers requesting air shipment for emergency replacements will be invoiced for one-half of the shipment charges and Tektronix will assume the remainder of these charges C.I.F. airport of destination.

TEKTRONIX FIELD SERVICES

Tektronix Customers are urged to take advantage of the many field services available to them through Tektronix Field-Engineering Offices, Engineering Representatives, and Overseas Engineering Organizations. Some of these services are described below.

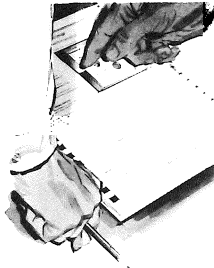
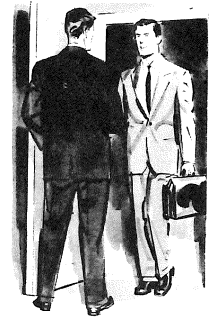

Ordering—There are many types of oscilloscopes, each designed for a specific application area. Your Field Engineer can help you select the one best suited to your present and future needs, and he will be happy to arrange a demonstration of the instrument...in your application if you so desire.

If you are a Purchasing Agent or Buyer, your Field Engineer or his secretary can help you with information on prices, terms, shipping estimates, and best method of transportation on instruments, accessories, and replacement parts.

Operation—Your Tektronix Oscilloscope can be most useful to you when you are familiar with all control functions. Your Field Engineer will be glad to demonstrate the use of your instrument in various applications to help you become more familiar with its operation. If your instrument is to be used by several engineers, your Field Engineer will be happy to conduct informal classes on its operation in your laboratory.

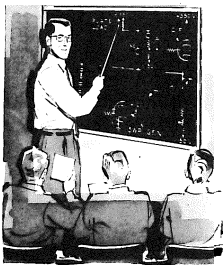

In a large laboratory, your Field Engineer can be of service to your maintenance engineers by conducting informal classes on test and calibration procedures, trouble-shooting techniques, and general maintenance.

Maintenance—Tektronix willingly assumes much of the responsibility for continued efficient operation of the instruments it manufactures. If you should experience a stubborn maintenance problem, your Field Engineer will gladly help you isolate the cause. Often a telephone discussion with him will help you get your instrument back into operation with minimum delay. If yours is a

If you are responsible for the maintenance of a large quantity of Tektronix Instruments, ask your Field Engineer about the free factory training course in maintenance and calibration.

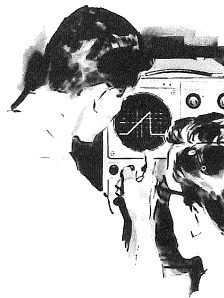

Applications—Perhaps the answers you need in a specific application can be obtained faster and easier through use of your Tektronix Oscilloscope. Your Field Engineer can help you find out, and if use of your oscilloscope is indicated, help you with procedures. He may also be able to suggest many time-saving uses for your oscilloscope in routine checks and measurements.

Instrument Reconditioning

—An older Tektronix Oscilloscope, properly reconditioned, can give you many additional years of service. Your Field Engineer will gladly explain the advantages and limitations of factory reconditioning, and make the necessary arrangements if you decide in favor of it.

Many major repair and recalibration jobs can be performed at a nearby Field Repair Station. Ask your Field Engineer about this at-cost service to Tektronix customers.

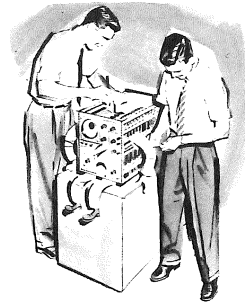

Communications—Your Field Engineer is a valuable communication link between you and the factory. He knows the exact person to contact in each circumstance, and he can reach that person fast and easily. Let him help speed your communications with the factory on any problem related to your Tektronix Instruments.

Tektronix, Inc., P. O. Box 831, Portland 7, Oregon

Telephone: CYPRESS 2-2611 TWX—PD 311 Cable: TEKTRONIX

AN OREGON CORPORATION

Field Engineering Offices

ALBUQUERQUE*	Tektronix, Inc., 127C Jefferson St. N. E., Albuquerque, New Mexico	TWX—AQ 96	AMherst 8-3373
ATLANTA	Tektronix, Inc., 3272 Peachtree Road, N. W., Atlanta 5, Georgia	TWX—AT 358	CEdar 3-4484
BALTIMORE*	Tektronix, Inc., 724 York Road, Towson 4, Maryland	TWX—TOWSON MD 535	VAlley 5-9000
BOSTON*	Tektronix, Inc., 18 Austin St., Newtonville 60, Massachusetts	TWX—NEWTON MASS 940	LaHell 7-2212
BUFFALO	Tektronix, Inc., 961 Maryvale Drive, Buffalo 25, New York	TWX—WMSV 2	SPring 7861
CHICAGO*	Tektronix, Inc., 7514 W. North Ave., Elmwood Park 35, Illinois	TWX—RIVER GROVE ILL 1395	Gladstone 6-7930
CLEVELAND	Tektronix, Inc., 3353 Edgecliff Terrace, Cleveland 11, Ohio	TWX—CV 352	Clearwater 2-2121 Pittsburgh Area: ZEnith 0212
DALLAS*	Tektronix, Inc., 6211 Denton Drive, P. O. Box 35104, Dallas 35, Texas	TWX—DL 264	Fleetwood 2-4087
DAYTON	Tektronix, Inc., 3601 South Dixie Drive, Dayton 39, Ohio	TWX—DY 363	AXminster 3-4175
DENVER	Hytronic Measurements, Inc., 1295 South Bannock Street, Denver 23, Colorado	TWX—DN 863	PEarl 3-3701
DETROIT*	Tektronix, Inc., 27310 Southfield Road, Lathrup Village, Michigan	TWX—SOUTHFIELD MICHIGAN 938	Elgin 7-0040
ENDICOTT*	Tektronix, Inc., 3214 Watson Blvd., Endwell, New York	TWX—ENDICOTT NY 290	ENdicott 8-8291
HOUSTON	Tektronix, Inc., 2605 Westgrove Lane, Houston 27, Texas	TWX—HO 743	MOhawk 7-8301, 7-8302
KANSAS CITY	Tektronix, Inc., 5920 Nall, Mission, Kansas	TWX—MISSION KAN 1112	RAndolph 2-6522/3 St. Louis Area: ENterprise 6510
LOS ANGELES AREA			
East L. A.	Tektronix, Inc., 5441 East Beverly Blvd., East Los Angeles 22, California	TWX—MTB 7762	RAYmond 3-9408
*West L. A.	Tektronix, Inc., 11681 San Vicente Blvd., West Los Angeles 49, California	TWX—WEST LOS ANGELES CAL 6698	BRadshaw 2-1563 GRanite 3-1105
MINNEAPOLIS	Tektronix, Inc., 3100 W. Lake Street, Minneapolis 16, Minnesota	TWX—MP 983	WAInut 7-9559
NEW YORK CITY AREA			
*New York City and Long Island served by:			
	Tektronix, Inc., 840 Willis Avenue, Albertson, L. I., New York	TWX—G CY NY 1416	Pioneer 7-4830
Westchester County, Western Connecticut, Hudson River Valley served by:			
	Tektronix, Inc., 49 Pondfield Road, Bronxville 8, New York	TWX—BRONXVILLE NY 1207	DEerfield 7-3771
*Northern New Jersey served by:			
	Tektronix, Inc., 412 Chestnut Street, Union, New Jersey	TWX—UNVL 82	MURdock 8-2222
ORLANDO	Tektronix, Inc., 205 East Colonial Drive, Orlando, Florida		GArden 5-3483
PALO ALTO*	Tektronix, Inc., 701 Welch Road, Palo Alto, California	TWX—PALO ALTO CAL 112	DAvenport 6-8500
PHILADELPHIA	Tektronix, Inc., 7709 Ogontz Ave., Philadelphia 50, Pennsylvania	TWX—PH 930	WAverly 4-5678
PHOENIX	Tektronix, Inc., 2415 E. McDowell Road, Phoenix, Arizona	TWX—PX 52	BRidge 5-9762
PORTLAND	Hawthorne Electronics, 700 S. E. Hawthorne Blvd., Portland 14, Oregon		BElmont 4-9375
SALT LAKE CITY	Hytronic Measurements, Inc., 2022 South Main St., Salt Lake City 15, Utah	TWX—SU 563	INgersoll 6-4924
SAN DIEGO	Tektronix, Inc., 1900 Rosecrans Street, P. O. Box 6157, San Diego 6, California	TWX—SD 6341	ACademy 2-0384
SEATTLE	Hawthorne Electronics, 101 Administration Bldg., Boeing Field, Seattle, Washington	TWX—SE 798	PArkway 5-1460
ST. PETERSBURG	Tektronix, Inc., 2330 Ninth Street South, St. Petersburg 5, Florida		ORange 1-6139
SYRACUSE*	Tektronix, Inc., 313 Nottingham Road, Syracuse 10, New York	TWX—SS 423	GRanite 2-3339
TORONTO*	Tektronix, Inc., 3 Finch Ave., East, Willowdale, Ontario, Canada		Toronto, BAldwin 5-1138
WASHINGTON D. C.*	Tektronix, Inc., 9619 Columbia Pike, Annandale, Virginia	TWX—FALLS CHURCH VA 760	Clearbrook 6-7411

* REPAIR CENTERS

Overseas Representatives

ARGENTINA	Ricma Argentina S. A., Sarmiento 309-Tercer Piso, Casilla Correo 2824, Buenos Aires, Argentina	Gerencia: 31-3990
AUSTRALIA	Electronic Industries Imports Pty. Ltd., 90 Grote St., Adelaide, S.A., Australia	LA-5295
	Electronic Industries Imports Pty. Ltd., 52 Bowen St., Brisbane, Qld., Australia	B-6462
	Electronic Industries Imports Pty. Ltd., 139-143 Bouverie St., Carlton, N. 3, Melbourne, Australia	FJ-4161/8
	Electronic Industries Imports Pty. Ltd., 68 Railway Pde., West Perth, W.A., Perth, Australia	BA-8587/9686
	Electronic Industries Imports Pty. Ltd., 713 Parramatta Rd., Leichhardt, NSW, Sydney, Australia	LM-6327
AUSTRIA	Inglomark Markowitsch & Company, Marienhilfer Strasse 133, Wien 15, Austria	54-75-85-SERIE
BELGIUM	Regulation-Mesure, S.P.R.L. 22, rue Saint-Hubert, Bruxelles, Belgium	70.79.89
BRAZIL	Consulting & Suppliers Company for South America Inc., 61 Broadway, New York 6, New York	BOwling Green 9-0610
	Importacao Industria E Comercio Ambriex S. A., Av. Graca Aranha 57-510 Rio De Janeiro, Brazil	42-7990, 42-7291
	Palmar Ltda., Rua 7 de Abril 252, Sao Paulo, Brazil	34-4497
CUBA	Laboratorios Meditron, Calle B No. 56 Vedado, Habana, Cuba	F-5970
DENMARK	Tage Olsen A/S, Centrumsgaarden, Room 133, 6D, Vesterbrogade, Kobenhavn V, Denmark	Palae 1369, Palae 1343
ENGLAND	Livingston Laboratories Ltd., Retcar Street, London N.19, England	Archway 6251
FINLAND	Into O/Y, 11 Meritullinkatu, Helsinki, Finland	62 14 25, 53 125
FRANCE	Maurice I. Parisier & Co., 741-745 Washington St., New York 14, N. Y.	Algonquin 5-8900
	Relations Techniques Intercontinentales, 134 Avenue de Malakoff, Paris 16, France	Passy 08-36, Kleber 54-82
INDIA	Electronic Enterprises, 46, Karani Building, Opp. Cama Baug., New Charni Road, Bombay 4, India	75376
ISRAEL	Landseas Products Corp., 48 West 48th Street, New York 36, New York	COlumbus 5-8323
	Landseas Eastern Co., P. O. Box 2554, Tel Aviv, Israel	66890
ITALY	Silverstar, Ltd., 21 Via Visconti Di Modrone, Milan, Italy	792.791/709.536
JAPAN	Midairya Electric Co., Ltd., 3-2-Chome, Kyobashi, Chuo-ku, Tokyo, Japan	Kyobashi (56) 1786, 7415, 7416, 7439
NETHERLANDS	C. N. Rood, n. v., 11-13 Cort van der Lindenstraat, Rijswijk, Z.H., Netherlands	The Hague 98.51.53
NORWAY	Morgenstjerne & Company, Collets Gate 10, Oslo, Norway	60 17 90
SWEDEN	Erik Ferner AB, Bjornsonsgatan 197, Bromma, Stockholm, Sweden	870140
SWITZERLAND	Omni Ray AG, Dufoursstrasse 56, Zurich 8, Switzerland	(051) 34-44-30
UNION OF		
SOUTH AFRICA	Prolea Holdings, Ltd., 42, Faraday Street, Wemmer, Johannesburg, Union of South Africa	33-4762/3
URUGUAY	Compania Uruguaya De Rayos X y Electromedicina S. A. Mercedes 1300, Yaguaron 1449, Montevideo, Uruguay	8 58 29 91 27 62
WEST GERMANY	Rohde & Schwarz Vertriebs, GmbH, Berlin W30, Augsburgstrasse 33, West Germany	1 33 80
	Rohde & Schwarz Vertriebs, GmbH, Hannover, Schillerstrasse 23, West Germany	25202
	Rohde & Schwarz Vertriebs, GmbH, Karlsruhe, Kriegstrasse 39, West Germany	215341
	Rohde & Schwarz Vertriebs, GmbH, Koln, Habsburger-Ring 2-12, West Germany	4 46 38
	Rohde & Schwarz Vertriebs, GmbH, Munchen 9, Auerfeldstrasse 22, West Germany	59 52 65
	Rohde & Schwarz Vertriebs, GmbH, Munchen 9, Brienerstrasse 23, West Germany	

Other OVERSEAS areas please write or cable directly to the Export Department, Portland, Oregon, U.S.A.