

Air-to-Water Heat Pumps + Boilers

A Dynamic Duo

Electrically powered heat pumps, available in many varieties, will play an increasingly important role in heating and cooling buildings around the world.

Heat pumps used for building heating capture low-grade heat from solar-resupplied sources such as outside air and soil several feet below the earth's surface. They convert vast amounts of otherwise unusable low-temperature energy into heat at sufficient temperatures to warm buildings or heat domestic water.

Electrically powered heat pumps also dovetail nicely with large-scale renewable sources of electrical energy, such as utility-scale photovoltaic systems, large wind turbine farms, or combined heat & power (CHP) systems operating on biogases produced from agricultural or municipal waste.

The Past:

The "classic" heat pump for residential heating and cooling debuted in North America during the 1960s. Major HVAC equipment manufacturers developed markets for these early generation "air-to-air" heat pumps. These systems had two major subassemblies — an outdoor condenser unit and an indoor air handler — which were connected by a refrigeration line set and wiring.

Early generation air-to-air heat pumps were not able to maintain efficient operation at low outdoor air temperatures. It was not uncommon to turn off an early generation air-to-air heat pump when outdoor temperatures dropped to or below 20°F. At that point, an auxiliary heat source, such as a furnace or electric strip heating elements within the indoor air handler, were turned on to supplement or completely take over the building's heating load.

This inability to provide sufficient performance at low outdoor temperatures was the "Achilles heel" of early generation air-to-air heat pumps. This established a long-held perception that air-source heat pumps could not be used in cold winter climates.

Fortunately, this performance limitation is quickly changing. Advances in refrigeration technology, including inverter drive variable-speed compressors and a process known as enhanced vapor injection (EVI), now allow air-source heat pumps to operate at very low outdoor temperatures, typically down to -13°F (-25°C).

Many of the largest global providers of heating and cooling hardware now offer "cold-climate" versions of air-to-air heat pumps. The most common configuration is called a ductless air-to-air heat pump system. A single outdoor unit connects to multiple indoor wall-mounted cassettes, each supplied by its own refrigeration line set. Each indoor unit can operate independently, allowing for zoning.

Figure 1

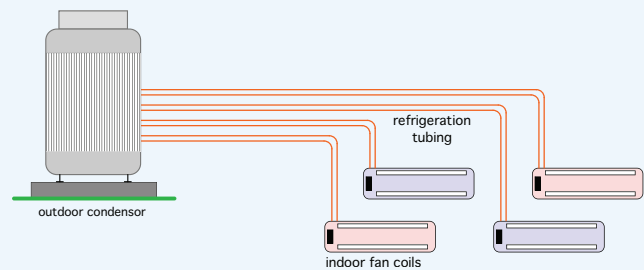

Although cold-climate ductless heat pumps represent a growing market, they still rely on *forced air delivery* for heating and cooling. As such, they don't offer the potential to combine their high thermal efficiencies with the unsurpassed comfort provided by a well-designed hydronic distribution system. Furthermore, most ductless heat pump systems lack the ability to supply ancillary loads such as domestic water heating or pool/spa heating.

Heat Pumps + Hydronics:

Modern hydronics technology is well known for its versatility. A wide variety of heat sources can be used individually or in combinations to create heated water from a variety of possible energy sources. This versatility allows for optimal use of energy sources in ways that typically reduce the cost of heat that would otherwise be delivered from a single source.

Water Is Better Than Air:

We've discussed how air-to-air heat pumps capture heat from low-temperature outdoor air and transfer that heat to an interior forced air stream. We've also discussed the versatility of hydronic distribution systems. Imagine a scenario where the thermal performance and installation advantages of air-source heat pumps is combined with the benefits of a *hydronic* distribution system. The result would be an "air-to-water" heat pump. It would absorb low-temperature heat from outside air, but deliver higher temperature heat to a stream of water (or water/antifreeze solution) rather than a stream of air. This concept greatly extends the potential applications for air-source heat pumps.

Some air-to-water heat pumps are capable of producing leaving water temperatures of 130+°F, even when the source is cold outdoor air. This allows for the use of a wide range of hydronic heat emitters, such as radiant floors, radiant walls, radiant ceiling panels, panel radiators, fan-coil convectors and even contemporary low-temperature fin-tube baseboard. It also allows the heat pump system to be configured to provide most, if not all, of the energy needed for domestic water heating. With a suitable heat exchanger, heat from an air-to-water heat pump can also be used to heat a swimming pool or maintain the water temperature in a spa.

SpacePak offers two versions of air-to-water heat pumps.

The Solstice SE, shown in Figure 2, is a 2-stage heat pump available with either a nominal 3-ton (36,000 Btu/hr) total rated heat output, or a nominal 5-ton (60,000 Btu/hr) total rated output. The Solstice SE heat pump can operate in ambient temperatures as low as 15°F.

Figure 2



The Solstice Extreme, shown in Figure 3, is a single-stage heat pump with nominal 4-ton (48,000 Btu/hr) rated output, and is capable of operating in ambient temperatures as low as -13°F.

Figure 3



Air-to-Water Heat Pump Basics:

Most air-to-water heat pumps operate on a vapor compression cycle. This cycle, as it would occur when an air-to-water heat pump operates in heating mode, is shown in Figure 4.

Figure 4

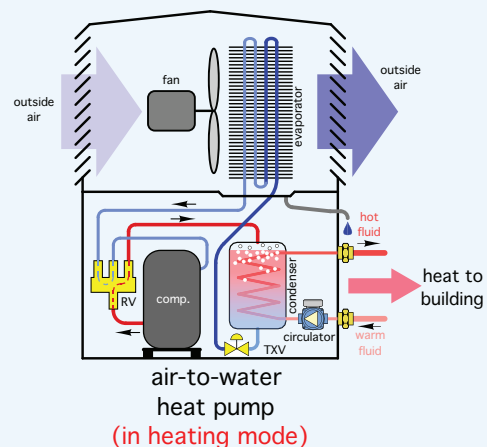

Liquid refrigerant at a low temperature passes through a heat exchanger called the *evaporator*, seen near the top of figure 4. It absorbs heat from outside air, which is blown across the evaporator by a fan. The absorbed heat causes the refrigerant to change from liquid to vapor. This vapor passes through a reversing valve and on to an electrically driven compressor. Its pressure and temperature are greatly increased as it passes through the compressor. The hot refrigerant vapor passes to another heat exchanger called the *condenser*. A stream of water passes through the other side of this heat exchanger. The hot refrigerant vapor transfers heat to the water, and in the process, condenses from vapor back to liquid. The liquid refrigerant then passes through a thermal expansion valve (labelled as TXV in Figure 4) where its pressure and temperature are reduced to the condition where this cycle description began. The refrigerant contained within the heat pump is constantly flowing through this cycle whenever the heat pump is operating.

The desired result of operating an air-to-water heat pump in heating mode is a stream of heated water (or water-based antifreeze solution) that circulates to other hardware within the building. This heat will eventually be used for space heating, domestic water heating or other heating loads.

Reverse Cycle Chilling:

Many air-to-water heat pumps, including the *Solstice SE* and *Solstice Extreme* from SpacePak, can also provide cooling. In this mode, heat is absorbed from a stream of water (or water-based antifreeze solution) flowing through the heat pump, and then rejected to outside air.

In cooling mode operation, the functions of the two heat exchangers described above are reversed. The heat exchanger that served as the evaporator in the heating mode becomes the condenser in cooling mode. The heat exchanger that was the condenser in heating mode become the evaporator in cooling mode. The change in function is created by the reversing valve seen in the lower left corner of the heat pump in Figure 5.

Figure 5

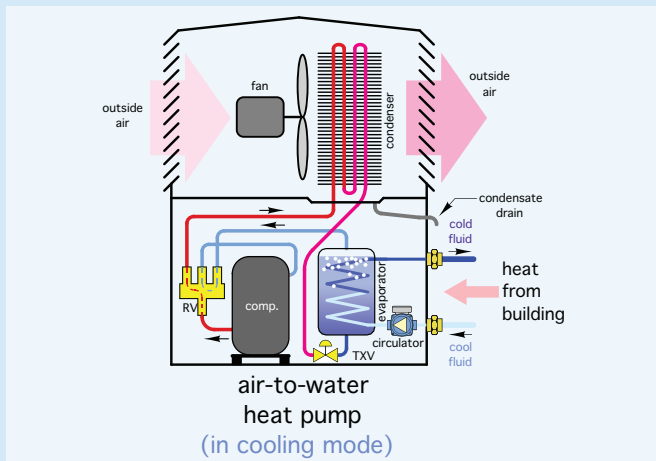

The desired result of operating an air-to-water heat pump in cooling mode is a stream of chilled water (or water-based antifreeze solution) that circulates to other hardware within the building. This chilled fluid will eventually be used for cooling and dehumidification.

Heating Capacity & COP:

The two performance measures for heat pumps operating in heat mode are coefficient of performance (COP) and heat capacity. COP is the ratio of the heat output rate divided by the energy input rate to operate the heat pump, as shown in Figure 6. The higher the COP, the more usable heat output produced for a given rate of energy input.

Figure 6

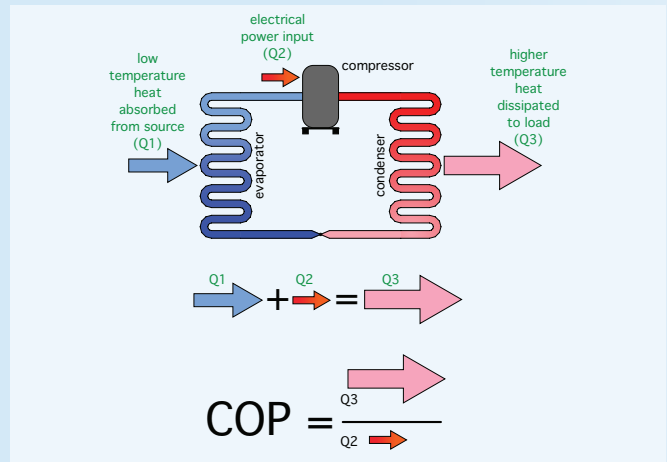

The higher the COP of a heat pump, the better. Much of the balance of the system will be designed with this goal in mind.

Heating capacity is simply the rate at which the heat pump can deliver heat to the load.

The COP and heating capacity of any heat pump depend on the temperature of the source, which in this case is outdoor air. As the outdoor air temperature decreases, so does the heat pump's heat capacity. Figure 7 shows the relationship between heating capacity, COP and outdoor air temperature for one model of the *Solstice SE* heat pump.

Figure 7

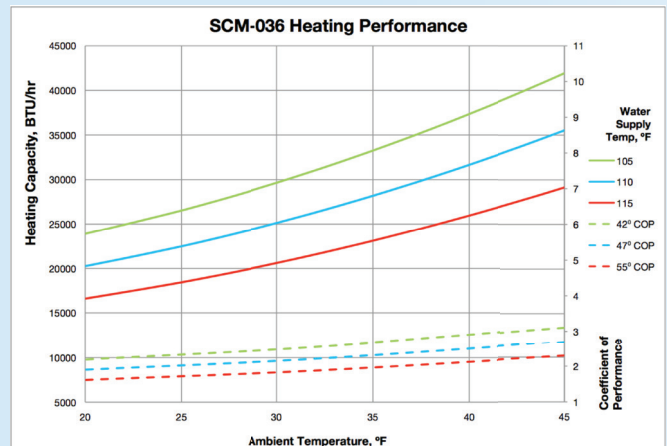

When the outdoor temperature is 45°F, and the *Solstice SE* is supplying 110°F water to a load, its heating capacity is about 36,000 Btu/hr, and its COP is about 2.7. However, if the outdoor temperature is 20°F, and the water temperature to the load remains at 110°F, the heating capacity decreases to 20,000 Btu/hr, and the COP decreases to about 2.0.

Figure 8 shows the relationship between heating capacity, COP and outdoor air temperature for a *Solstice Extreme* heat pump.

Figure 8

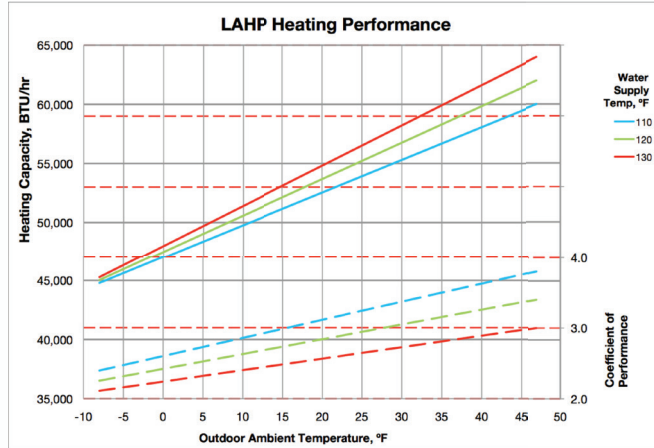

The heating capacity and COP of the Solstice Extreme also decrease at lower outdoor air temperatures. However, the Solstice Extreme heat pump can remain in operation to significantly lower outdoor temperatures compared to the Solstice SE. This makes the Solstice Extreme model especially well-suited to cold-climate applications.

The Emerging Potential for Air-to-Water Heat Pumps:

Most North American heating professionals are familiar with ductless air-to-air heat pumps. Most have also heard of geothermal heat pumps. Still, many North American heating professionals are *not* familiar with air-to-water heat pumps.

This is not the case in other markets, such as Asia and Europe, where a strong market exists. In 2014, the global market for air-to-water heat pumps totaled over 1.7 million units! The Chinese market alone represented almost 1 million units sold in 2014. The European market was 232,000 units, with France as the #1 market, followed by Germany and the UK. The North American market was a tiny fraction of global sales.

Still, several indicators suggest that the air-to-water heat pump market has significant growth potential for North America:

1. The growing market for Net Zero Energy homes:

A net zero energy (NZE) home produces at least as much energy as it consumes during an average year. To reach this goal, a typical NZE house is very well insulated. The heating energy used by such a house is often 1/3 or less than that used by a similar size house constructed 30 years ago. NZE houses also need a sizable solar photovoltaic array on the roof or on a ground mount frame to generate electrical energy.

Net metering laws — where they exist — allow owners of photovoltaic systems to sell surplus electrical power back to the utility at full retail rate. Thus, surplus kilowatt hours produced on

a sunny summer day can be “parked” on the electrical grid, and reclaimed to run a heat pump on a cold winter night with no technical or economic penalty. This is an ideal scenario that can be leveraged through use of air-to-water heat pumps.

One common approach to heating and cooling NZE homes is to install 2 or 3 high wall cassettes (e.g., the indoor portion of a ductless air-to-air heat pump system) in central areas, *and leave interior doors open for distribution of the heated or cooled air.*

Proponents of this approach stress their belief that no interior comfort distribution system, such as ducting or piping, is needed. One reference states that if all interior doors are left open in a well-insulated house, interior air temperatures will stabilize at not less than 2°F below the air temperature where the indoor cassette is located. This reference also states that if bedroom doors are closed at night, bedroom temperature may drop 5°F below the temperature where the indoor unit of the heat pump is located.

Should these constraints be accepted without reservation? Designers who are only concerned with matching heat input to space heat loss, without regard to comfort, would likely say yes. However, those who appreciate the superior comfort that’s possible using modern hydronics technology would view this approach as far less than ideal. They understand that buildings can be both energy efficient and very comfortable.

The alternative is to retain the thermal efficiency of the low-ambient air-source heat pump, *but switch to hydronics for the balance of system, and enjoy optimal comfort.*

Use a low-temperature hydronic delivery system such as a heated ceiling or floor to allow good thermal performance from the air-to-water heat pump, *and proper distribution of heat throughout the building, doors open or closed.*

Cooling can be handled by *chilled water* flowing through a central air handler, such as shown in Figure 9, or multiple smaller air handlers, such as the *SpacePak Air Cell* shown in Figure 10.

Figure 9



Figure 10



Both of these air handlers are equipped with condensate drip pans for use in chilled-water cooling systems.

2. Air-to-water heat pumps are significantly less expensive to install compared to geothermal heat pumps:

This is especially true if vertical boreholes are required for the earth loop, which, in some areas, can cost over \$3,000 *per ton of heat pump heating capacity* for drilling, pipe insertion and grouting. Additional cost is incurred for connecting multiple vertical piping loops and routing them back to the location of the heat pump. Replacement of any affected pavements or landscaping also must be factored into the cost of installing a geothermal heat pump system. Thus, the cost of installing a 3-ton rated vertical geothermal earth loop and piping it back into the building could easily exceed \$10,000. Earth loops are not needed for air-to-water heat pumps.

3. Diminishing returns based on differences in COP:

The published COPs of some water-to-water geothermal heat pumps may be higher than those of some air-source heat pumps. For example, one currently available water-to-water heat pump has a published COP of 3.0, based on 30°F entering source fluid (water/antifreeze mixture) and a leaving load water temperature of 112°F. The Solstice SE air-to-water heat pump has a listed COP of about 2.1 when operating in under similar conditions (e.g., 30°F ambient air temperature and a leaving load water temperature of 110°F). If one directly compares the COPs of these two heat pumps, the water-to-water heat pump seemingly has a significant advantage.

However, such a comparison is — as the saying goes — “comparing apples to oranges.” The COP of the water-to-water geothermal heat pump does not factor in the electrical power required by well pumps or hydronic circulators to maintain source water flow through the heat pump. This power can be significant even in residential-sized systems. For example, there are pumping modules for geothermal heat pump applications that have four circulators operating in series, with a total input power requirement of over 1200 watts! When this additional power is factored into the

performance evaluation, the COP of the water-source heat pump will be reduced.

Consider, for example, the above-referenced geothermal water-to-water heat pump. At 30°F entering fluid temperature and 112°F leaving load water temperature, the heat pump’s COP is 3.0. This is based on a heat output of 26,100 Btu/hr and electrical power input of 2.56 kW, as shown below:

$$COP = \frac{\left[\frac{\text{heat output} \left(\frac{\text{Btu}}{\text{hr}} \right)}{\text{heat pump power input} \left(\frac{\text{Btu}}{\text{hr}} \right)} \right]}{\left[\frac{26,100 \frac{\text{Btu}}{\text{hr}}}{2.56 \text{ kW} \left(\frac{3413 \frac{\text{Btu}}{\text{hr}}}{1 \text{ kW}} \right)} \right]} = 3.0$$

Now, consider that a pumping module with a power input of 900 watts is used to provide flow through this heat pump and its associated earth loop. The *effective* COP of the heat pump + pumping module would be:

$$COP_{\text{effective}} = \frac{\left[\frac{\text{heat output} \left(\frac{\text{Btu}}{\text{hr}} \right)}{\text{heat pump+pump power input} \left(\frac{\text{Btu}}{\text{hr}} \right)} \right]}{\left[\frac{26,100 \frac{\text{Btu}}{\text{hr}}}{[2.56 \text{ kW} + 0.9 \text{ kW}] \left(\frac{3413 \frac{\text{Btu}}{\text{hr}}}{1 \text{ kW}} \right)} \right]} = 2.21$$

This “effective COP” represents the ratio of the heat output divided by the *total* input power required to operate the geothermal heat pump and its earth loop. In this case, it is significantly lower than the heat pump’s published COP (as a standalone device), and just slightly above that of the Solstice SE heat pump operating under comparable conditions.

Under these same conditions (e.g., outdoor temperature = 30°F and leaving load water temperature = 110°F), the COP of the *Solstice Extreme* heat pump is approximately 3.3.

The COPs of air-to-water heat pumps *include* the electrical power required to operate the fan(s) in the outdoor unit.

It’s also important to remember that owners don’t *pay* for COP. They pay for the kilowatt-hours of electrical energy used to operate the heat pump. As home heating loads become smaller due to better thermal envelopes, the difference in annual heating cost between heat pumps operating at seasonal average COPs that differ by perhaps 1.0 or less, decreases. The incrementally lower operating cost of the higher performance heat pump may not amortize a significantly higher installation cost within the expected life of the system.

For example: A well-insulated home with a design heat loss of 25,000 Btu/hr based on an outdoor temperature of 0°F and indoor temperature of 70°F, and located in a 7000°F-day climate, would have an estimated annual heating

requirements of about 39 MMBtu/year. If this load were supplied using a geothermal heat pump with a seasonal average COP of 3.3 (which includes the power required to operate the earth loop circulators), in a location where electrical energy is priced at \$0.12 per kWhr, the annual heating cost would be about \$416. If the same 39 MMBtu/year were supplied from a low-ambient air-to-water heat pump with a seasonal average COP of 2.5, the annual heating cost would be about \$549. The difference, \$133 per year, would not be able to amortize what could easily be a \$5,000-\$10,000 higher installation cost (after factoring in the 30% federal income tax credit currently available in the U.S. for geothermal heat pumps) within the design life of the equipment.

4. In the U.S., the 30% federal tax credits on geothermal heat pump systems are scheduled to end as of December 31, 2016:

This will remove a significant purchasing incentive for geothermal heat pumps, forcing them to compete against other types of heat pumps in an unsubsidized market.

5. As home space-heating loads get smaller, the domestic water heating load becomes an increasingly higher percentage of the total annual heating energy requirement.

Some estimates put the DHW load at 25-30 percent of the total annual energy requirement in a well-insulated modern home.

Most ductless air-to-air heat pumps *cannot* provide domestic water heating, but a properly configured air-to-water heat pump can.

A standard electric water heater providing domestic water heating in a situation where an air-to-air heat pump cannot, delivers heat at a COP of 1.0. If that energy was instead attained through an air-to-water heat pump, it could likely be delivered at a COP averaging 2.5 over the year. For a family of four, needing 60 gallons per day of water heated from 50-120°F, and assuming electrical energy priced at \$0.12 per kWhr, the *savings* in annual domestic water heating cost between these scenarios is \$269 per year.

Heat Pump + Boiler:

In very cold climates, where there can be several consecutive days of sub 0°F weather, there are brief periods when the heating capacity of an air-to-water heat pump may fall short of the heating load. Lack of sufficient heating capacity might also occur during periods of high demand, such as recovery from temperature setbacks. Under these conditions, a supplemental heat source can provide the extra heat needed. Since a hydronic distribution system will be used with an air-to-water heat pump, a boiler is the natural choice for the supplemental heat source.

Having a boiler in the system also provides a backup heat source if the heat pump is not operational. The relatively low electrical power required by most gas- and oil-fired boilers allows them, as well as the hydronic distribution system, to operate from modestly sized standby generators during power outages.

In retrofit applications, an air-to-water heat pump might also be added to a system that already has a boiler. It often makes sense to retain that boiler as part of the renovated system.

There are several possible ways to control how the heat pump and boiler are used in the system. The design approach should consider the cost of energy provided by the heat pump versus that provided by the boiler. The objective is to use as much of the lower cost energy as possible, and only use higher-cost energy when necessary. It's also important to consider the lowest outdoor air temperature at which the heat pump should be operated.

One common approach uses the heat pump to supply the heating load until the outdoor temperature drops to the point where the heat pump's heating capacity is insufficient to meet the load. This occurs when the outdoor temperature drops lower than the "balance point" temperature, as shown in Figure 11.

Figure 11

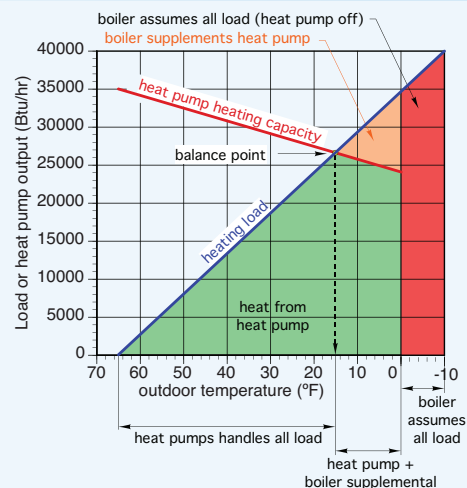

At outdoor temperatures below the balance point the auxiliary boiler is turned on to supplement the heat pump.

When the outdoor temperature drops to a point where the heat pump should not be operating (based on manufacturer's specifications), it is turned off, and the auxiliary boiler assumes the full heating load.

The "balance point" in Figure 11 corresponds to an outdoor temperature of about 15°F. The supplemental heat provided by the boiler is shown by the orange area in Figure 11. When the outdoor temperature drops to 0°F, the heat pump is turned off, and the auxiliary boiler assumes the full heating load.

Heat supplied by the heat pump is typically less expensive than that supplied by the boiler, especially if the boiler operates on electricity, propane or fuel oil. Thus, the goal is to minimize boiler operation. The extent to which this can be done depends on the heating capacity of the air-to-water heat pump relative to the design load. It also depends on how the heating capacity of the heat pump drops off with decreasing outdoor temperature. Selecting a higher capacity air-to-water heat pump, relative to the design load, moves the balance point to the right, decreasing the energy contribution of the boiler. However, it also increases installed system cost. The more expensive the boiler's fuel is compared to the heat supplied by the heat pump, on a \$/MMBtu basis, the further the balance point, in Figure 11, should be moved to the right. This minimizes the energy contribution of the more expensive fuel.

Figure 12 represents the energy sharing between an air-to-water heat pump and auxiliary boiler in a different way.

Figure 12

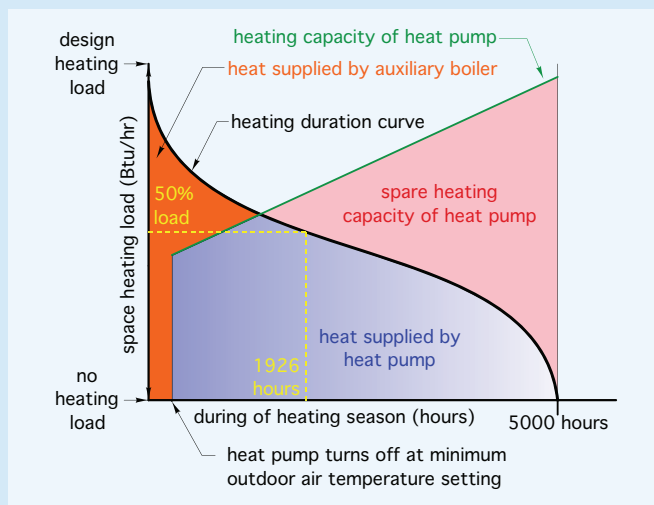

The heating duration curve in Figure 12 represents the severity of the heating load versus the number of hours that the load is equal to or above a given percentage of design load. For example, the heating load being represented is equal to or above 50% of design load about 1926 hours per year, as shown by the yellow lines. This graph also assumes that a typical cold-climate heating season lasts 5000 hours per year, which is just under 7 months.

The mathematical areas under the heating duration curve represent the total space heating energy required for the season. The exact shape of the heating load duration curve varies from one climate location to another. However, the curve's general shape remains similar to that shown in Figure 12.

The heating duration curve shows that the number of hours of severely cold weather, when the heating load is at or close to design load, are very limited compared to the hours where the heating load is a smaller percentage of design load. *This implies that even though supplemental heating is needed during very cold weather, the heat pump supplies the vast majority of the total seasonal heating energy requirement.* For the situation represented in Figure 12, the heat pumps supply about 84% of the total seasonal heating energy, with the remaining 16% supplied by the boiler.

Figures 11 and 12 also show that the air-to-water heat pump has spare heating capacity during much of the year. This capacity can be directed to other loads, such as domestic water heating, pool heating, and possibly even limited areas of snow melting during the warmer months of winter.

Although there are situations where the Solstice SE or Solstice Extreme air-to-water heat pump can be the sole heat source for a system, there are many benefits associated with combining either heat pump with a boiler. They include:

1. The boiler can serve as a "peaking tool" to provide high heat output when necessary. Although the heat pump supplies the vast majority of the space heating and domestic water heating energy, the boiler stands ready to assist when heat loads are greater than normal. One example is the combined heating load associated with warming a house to normal occupied temperature following a night setback, while simultaneously supplying the peak domestic water heating load for several morning showers.
2. The heat pump can be selected with a heating capacity significantly smaller than the design load. This is helpful in applications where a single-speed heat pump selected for the design heating load would be significantly oversized for the cooling load.
3. The boiler serves as a secondary heat source to provide full or partial backup if the heat pump is not operating.
4. The boiler's electrical power demand is relatively small compared to the heat pump. This makes it more feasible to operate the heating system from a modestly sized emergency generator during power outages.
5. The heat pump can take advantage of time-of-use electrical rates. In areas where time-of-use electrical rates are available, it is possible to operate the heat pump when off-peak rates are in effect, and avoid high on-peak rates by using the boiler as the sole heat source during "on-peak" times. This approach works best when significant thermal storage is available in the system.

System Schematics:

This section provides examples of air-to-water heat pump systems represented as piping schematics, electrical schematics and a description of operation. The examples given are representative only. These designs may require modifications to suit the specifics of a given project and local mechanical system codes.

We'll start by looking at a system that uses a 2-stage *SpacePak Solstice SE* heat pump as the system's sole heat source and chiller. Once the basics of this system are explained, we'll add a boiler, as well as the ability to provide domestic hot water.

A piping schematic for the heat pump only system is shown in Figure 13.

The entire system is assumed to be filled with an antifreeze solution. This eliminates the need for a heat exchanger between the outdoor heat pump and the balance of the system, which improves the heat pump's heating and cooling performance.

When the heat pump is operating in heating mode, a motorized diverter valve is energized to direct heated antifreeze solution from the heat pump to the buffer tank, the heat emitters, or both, depending on the current flow rate to the heat emitters. If none of the heat emitters require flow, all flow from the heat pump passes into the buffer tank. If the flow to the heat emitters is less than the flow from the heat pump, the *difference* in these flow rates passes into the buffer tank. If the flow required by the heat emitters is greater than the flow from the heat pump, the *difference* in these flows comes out of the upper side connection of the buffer tank.

Figure 13

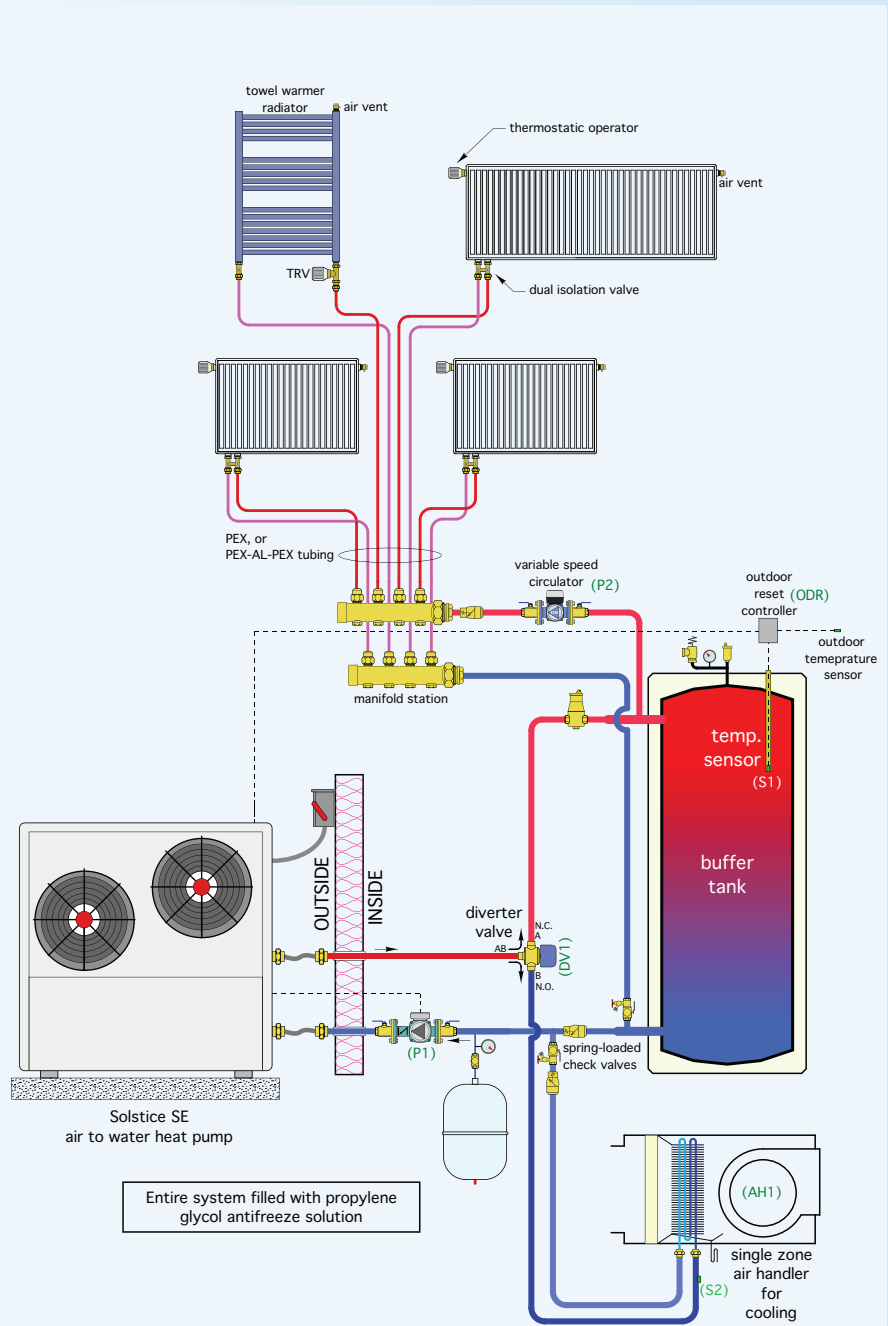
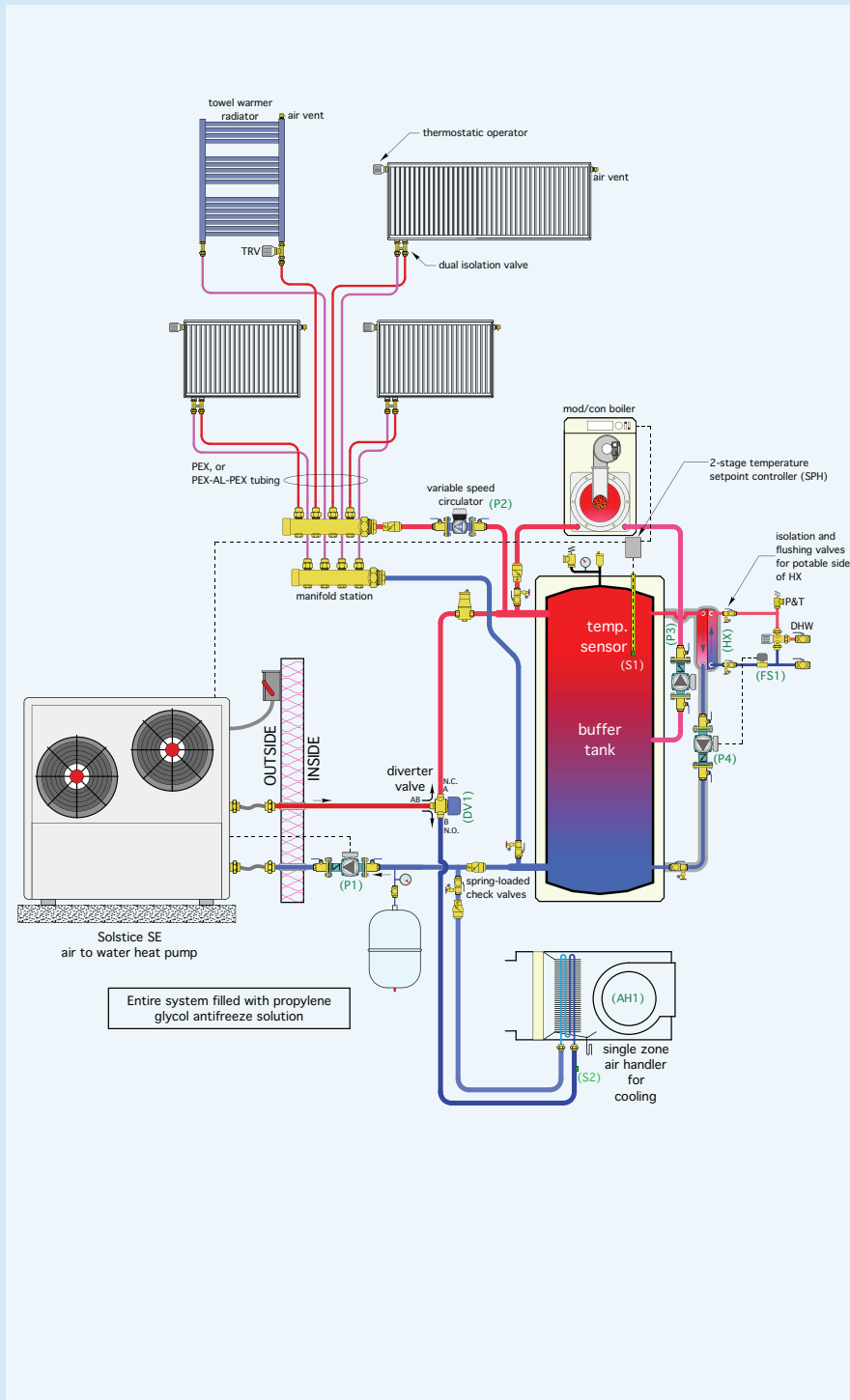

Figure 14



The buffer tank is piped in a “2-pipe” configuration. This reduces the flow velocity into and out of the tank when a load circuit is operating at the same time as the heat pump. Lower flow velocities improve temperature stratification within the buffer tank. This piping configuration also allows the tank to provide hydraulic separation between the heat pump circulator (P1) and the variable-speed distribution circulator (P2). The headers seen on the left side of the buffer tank should be as short as possible and generously sized to minimize head loss, thus encouraging hydraulic separation.

Space heating is provided by several panel radiators, each of which is equipped with a thermostatic radiator valve. Each radiator is supplied by a homerun circuit of 1/2" PEX tubing routed from a single manifold station. Flow to all radiators is provided by a variable-speed pressure-regulated circulator, which automatically adjusts its speed based on the flow required by the distribution system. The radiators have been selected so that they can supply the design heating load of the spaces they serve when supplied with water at 120°F.

The heat pump is enabled to operate in heating mode whenever the outdoor temperature is below 50°F

When the heat pump operates as a chiller, the diverter valve is off, and chilled fluid is routed directly to the air handler using circulator (P1). The air handler has been sized to deliver the stage 1 cooling capacity of the heat pump when operating at a supply fluid temperature of 45°F. It is equipped with a drip pan and drain to collect and dispose of condensate. In cooling mode, the rate of heat transfer between the air handler and heat pump are matched. Thus, there is no need to involve the buffer tank in cooling mode operation. This simplifies the piping and controls.

Adding A Boiler:

Figure 14 is a modification of Figure 13, adding a modulating/condensing boiler to the system. The system in Figure 14 also includes components to allow for on-demand production of domestic hot water.

The boiler's function is to maintain the upper portion of the buffer tank at a temperature suitable for domestic water heating and space heating, assuming that the heat pump, at times, is unable to do so based on a high load, or if the heat pump is operating in cooling mode. For the system shown in Figure 14, the upper portion of the buffer tank is maintained between 120 and 130°F.

This system uses an external brazed-plate stainless steel heat exchanger to extract heat from the thermal mass of the buffer tank and transfer it to domestic water. The hardware involved is seen on the right side of the buffer tank. The flow switch (FS1) closes its contacts whenever there is a domestic hot water demand of 0.6 gpm or higher. This energizes the coil of a relay, which switches 120 VAC to circulator (P4). Hot water from the upper portion of the buffer tank is circulated through the primary side of heat exchanger (HX), while cold domestic water passes in the opposite (counterflow) direction through the secondary side of the heat exchanger.

Because the heat exchanger has been sized for a 5°F approach temperature difference under the design domestic hot water flow rate, the DHW leaving the heat exchanger should be no more than 5°F cooler than the water at the top of the buffer tank. Thus, for a DHW supply temperature of 120°F the water at the top of the tank only needs to be maintained at 125°F. This is within the operating range of the heat pump. It also allows the mod/con boiler to operate in condensing mode, and thus, at high efficiency when it is used to maintain temperature in the buffer tank.

The boiler is operated by the *second* stage of the 2-stage temperature setpoint controller. This controller continuously monitors the temperature at sensor (S1) in the upper portion of the tank. When this temperature drops to or below 120°F, the *first* stage contacts in the 2-stage controller close. This turns on the heat pump in heating mode, and also turns on circulator (P1). If the

first stage heat input to the buffer tank is not producing an adequate rate of temperature increase at sensor (S1), the second stage contacts in the 2-stage controller close, which turns on the boiler and circulator (P3). Under this condition, both the heat pump and boiler supply heat to the system. That heat can be delivered to any active

space-heating circuit, or pass into the buffer tank, if no space-heating load is active. When the temperature at sensor (S1) climbs to 130°F, both the heat pump and boiler are turned off.

Figure 15 shows one possible electrical control schematic for the system shown in Figure 14.

Figure 15

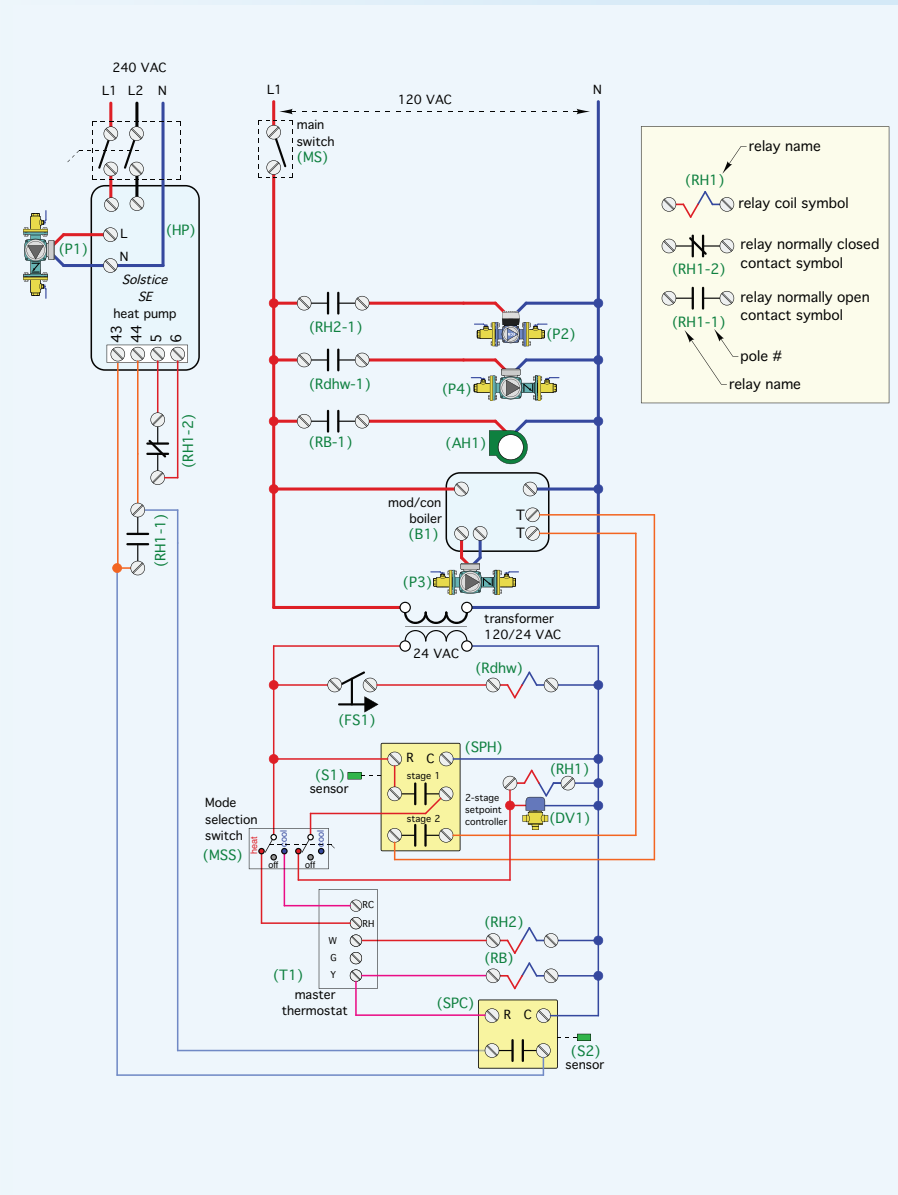

This control system uses “hard-wired” logic in combination with readily available, reliable and simple controllers. This helps ensure that replacement controllers, should they ever be needed, could be quickly obtained from multiple sources.

The wiring to the heat pump terminals is slightly different between the Solstice SE and Solstice Extreme heat pump. Designers and installers should verify the exact control inputs needed by the heat pump used.

Description of Operation:

The following is a description of operation for the system shown in Figures 14 and 15.

Controller Settings:

2-stage temperature setpoint controller (SPH) (used for heating mode only)

*Stage 1 contacts close at 120°F and open at 130°F
(e.g., 125°F setpoint with 10°F differential centered on setpoint)*

*Stage 2 contacts close at 116°F and open at 130°F
(e.g., 123°F setpoint with 7°F differential centered on setpoint)*

1-stage temperature setpoint controller (SPC) (used for cooling mode only)

*Contacts close at 60°F and open at 45°F
(e.g., 50°F setpoint with 20°F differential centered on setpoint)*

Heat Source Operation (heating mode): When the main switch (MS) is closed, power is available to the line voltage and low voltage portions of the electrical system.

For space heating operation, the (DPDT) mode selection switch must be set to heat. This passes 24 VAC to the RH terminal of the master thermostat (T1).

24 VAC is applied to power up the 2-stage setpoint controller (SPH). This controller (SPH) measures the temperature at sensor (S1) in the upper portion of the thermal storage tank. If that temperature is below the user-set stage 1 setpoint (in this case 125°F), minus half the user-set differential (in this case, half the differential is 5°F), then the stage 1 contacts in (SPH) close. This allows 24 VAC to pass from the stage 1 contacts in the (SPH) controller to energize the diverter valve (DV1) and relay coil (RH1). Relay contact (RH1-1) closes between terminal 43 and 44 on the Solstice SE heat pump, turning it on. Relay contact (RH1-2) opens between terminals 5 and 6 on the Solstice SE heat pump, allowing it to operate in heating mode. An internal relay within the heat pump turns on circulator (P1). Heat from the heat pump flows to the upper header of the buffer tank. The heat pump and these associated devices continue to operate as described until sensor (S1) in the buffer tank climbs to a temperature of 130°F, or if the master thermostat (T1) stops calling for heat.

If, during a call for space heating from master thermostat (T1), the temperature at sensor (S1) in the upper portion of the buffer tank drops to 115°F, the stage 2 contacts in the setpoint controller (SPH)

close. These contacts complete a low-voltage circuit powered through the boiler, and enable the boiler to operate in a fixed upper temperature mode. The boiler turns on circulator (P3) through an internal relay. The boiler continues to operate until the buffer tank sensor (S1) reaches a temperature of (130°F), at which point the boiler turns off, and so does circulator (P3). Note: The boiler will operate in this mode regardless of whether the mode selection switch is set to heat or cool. This allows the boiler to maintain a suitable temperature in the buffer tank for domestic water heating, even when the heat pump is operating as a chiller.

Space Heating Distribution: When master thermostat (T1) calls for heat, 24 VAC passes from its W terminal to energize the coil of relay (RH2). Contact (RH2-1) closes to pass 120 VAC to circulator (P2). This circulator is set to operate in constant differential pressure mode to provide the necessary flow to any panel radiator that does not have its thermostatic valve fully closed. Circulator (P2) automatically varies its speed to maintain approximately constant differential pressure across the manifold station serving the panel radiators. The thermostatic valves on each radiator can be used to limit heat input as desired.

Domestic Water Heating Mode: Whenever there is a demand for domestic hot water of 0.6 gpm or more, flow switch (FS1) closes. This passes 24 VAC to energize the coil of relay (Rdhw). Contact (Rdhw-1) closes to pass 120 VAC to circulator (P4). Heated antifreeze solution from the upper portion of the buffer tank will flow through the primary side of heat exchanger (HX), and transfer heat to the cold domestic water flow through the secondary side of the heat exchanger (HX). When the demand for domestic hot water drops to 0.4 gpm or less, flow switch (FS1) opens. This turns off relay (Rdhw) and circulator (P4). All domestic hot water leaving the system passes through a thermostatic mixing valve to limit the water temperature to the distribution system.

Cooling Mode: For cooling operation, the mode selection switch (MSS) must be set to cool. This passes 24 VAC to the RC terminal of the master thermostat. If the master thermostat is set for cooling operation, and calls for cooling, 24 VAC is passed to its Y terminal. From the Y terminal, 24 VAC passes to energize the coil of relay (RB). A normally open set of contacts (RB-1) close to pass 120 VAC to the air handler (AH1), turning it on. 24 VAC also passes from the Y terminal of the master thermostat to energize cooling setpoint controller (SPC). Once energized, (SPC) monitors the temperature of sensor (S2) on the inlet pipe to the air handler. If that temperature is above 60°F, the contacts in (SPC) close. This completes a circuit between terminals 43 and 44 in the Solstice SE heat pump, turning it on in cooling mode. The heat pump turns on circulator (P1) through its internal relay. All necessary devices for cooling operation are now active. The system remains in cooling operation until either the cooling demand is removed at thermostat (T1), or the temperature at sensor (S2) on the air handler inlet drops to 45°F, at which point the heat pump, circulator (P1) and air handler (AH1) turn off.

Summary

Modern air-to-water heat pumps, such as the Solstice SE and Solstice Extreme models offered by SpacePak, are an emerging renewable energy source in North America. Their thermal performance can approach that of a geothermal heat pump system, but at a fraction of the installed cost, and at much reduced complexity. They are ideal for net zero energy homes that produce their own electrical energy using solar photovoltaic systems. Beyond heating and cooling buildings, air-to-water heat pumps can supply heat for ancillary loads such as domestic water heating, pool heating, or even limited areas of snow melting. Combining an air-to-water heat pump with a boiler provides many benefits, and it is easily accomplished using modern hydronics technology.



www.spacepak.com