

Inspiron 3505

Service Manual



Notes, cautions, and warnings

 **NOTE:** A NOTE indicates important information that helps you make better use of your product.

 **CAUTION:** A CAUTION indicates either potential damage to hardware or loss of data and tells you how to avoid the problem.

 **WARNING:** A WARNING indicates a potential for property damage, personal injury, or death.

Chapter 1: Working inside your computer	6
Before working inside your computer.....	6
Safety instructions.....	6
Electrostatic discharge—ESD protection.....	7
ESD field service kit	7
Transporting sensitive components.....	8
After working inside your computer.....	9
Chapter 2: Removing and installing components	10
Recommended tools.....	10
Screw list.....	10
Major components of Inspiron 3505.....	11
Base cover.....	13
Removing the base cover.....	13
Installing the base cover.....	15
Battery.....	17
Lithium-ion battery precautions.....	17
Removing the battery.....	18
Installing the battery.....	18
Solid-state drive.....	19
Removing the M.2 2230 solid-state drive.....	19
Installing the M.2 2230 solid-state drive.....	20
Removing the M.2 2280 solid-state drive.....	21
Installing the M.2 2280 solid-state drive.....	22
Wireless card.....	23
Removing the wireless card.....	23
Installing the wireless card.....	24
I/O board.....	26
Removing the I/O board.....	26
Installing the I/O board.....	27
Coin-cell battery.....	28
Removing the coin-cell battery.....	28
Installing the coin-cell battery.....	28
Hard drive.....	29
Removing the hard drive.....	29
Installing the hard drive.....	30
Memory modules.....	32
Removing the memory module.....	32
Installing the memory module.....	32
Speakers.....	33
Removing the speakers.....	33
Installing the speakers.....	34
Heat sink.....	35
Removing the heat sink.....	35

Installing the heat sink.....	36
Fan.....	37
Removing the fan.....	37
Installing the fan.....	37
Power button with optional fingerprint reader.....	38
Removing the power-button with optional fingerprint reader.....	38
Installing the power-button with optional fingerprint reader.....	39
Fingerprint-reader board.....	40
Removing the fingerprint-reader board.....	40
Installing the fingerprint-reader board.....	41
Display assembly.....	42
Removing the display assembly.....	42
Installing the display assembly.....	44
Display bezel.....	45
Removing the display bezel.....	45
Installing the display bezel.....	46
Display panel.....	47
Removing the display panel.....	47
Installing the display panel.....	49
Camera.....	51
Removing the camera.....	51
Installing the camera.....	52
Touchpad.....	53
Removing the touchpad.....	53
Installing the touchpad.....	54
System board.....	55
Removing the system board.....	55
Installing the system board.....	57
Power-adapter port.....	60
Removing the power-adapter port.....	60
Installing the power-adapter port.....	61
Palm-rest and keyboard assembly.....	62
Removing the palm-rest and keyboard assembly.....	62
Installing the palm-rest and keyboard assembly.....	63

Chapter 3: Drivers and downloads..... 64

Chapter 4: System setup..... 65

Entering BIOS setup program.....	65
Navigation keys.....	65
One time boot menu.....	66
System setup options.....	66
Updating the BIOS in Windows	69
Updating BIOS on systems with BitLocker enabled.....	70
Updating your system BIOS using a USB flash drive.....	70
Flashing the BIOS from the F12 One-Time boot menu.....	71
System and setup password.....	74
Assigning a system setup password.....	74
Deleting or changing an existing system setup password.....	75

Clearing CMOS settings.....	75
Clearing BIOS (System Setup) and System passwords.....	75
Chapter 5: Troubleshooting.....	76
Locate the Service Tag or Express Service Code of your Dell computer	76
System-diagnostic lights.....	76
SupportAssist diagnostics.....	77
Recovering the operating system.....	77
Flashing BIOS (USB key).....	78
Flashing the BIOS.....	78
WiFi power cycle.....	78
Flea power release.....	79
Chapter 6: Getting help and contacting Dell.....	80

Working inside your computer

Before working inside your computer

About this task

 **NOTE:** The images in this document may differ from your computer depending on the configuration you ordered.

Steps

1. Save and close all open files and exit all open applications.

2. Shut down your computer. Click **Start** >  **Power** > **Shut down**.

 **NOTE:** If you are using a different operating system, see the documentation of your operating system for shut-down instructions.

3. Disconnect your computer and all attached devices from their electrical outlets.

4. Disconnect all attached network devices and peripherals, such as keyboard, mouse, and monitor from your computer.

 **CAUTION:** To disconnect a network cable, first unplug the cable from your computer and then unplug the cable from the network device.

5. Remove any media card and optical disc from your computer, if applicable.

Safety instructions

Use the following safety guidelines to protect your computer from potential damage and to ensure your personal safety. Unless otherwise noted, each procedure included in this document assumes that you have read the safety information that shipped with your computer.

 **WARNING:** Before working inside your computer, read the safety information that is shipped with your computer. For more safety best practices, see the Regulatory Compliance home page at www.dell.com/regulatory_compliance.

 **WARNING:** Disconnect your computer from all power sources before opening the computer cover or panels. After you finish working inside the computer, replace all covers, panels, and screws before connecting your computer to an electrical outlet.

 **CAUTION:** To avoid damaging the computer, ensure that the work surface is flat, dry, and clean.

 **CAUTION:** To avoid damaging the components and cards, handle them by their edges, and avoid touching the pins and the contacts.

 **CAUTION:** You should only perform troubleshooting and repairs as authorized or directed by the Dell technical assistance team. Damage due to servicing that is not authorized by Dell is not covered by your warranty. See the safety instructions that is shipped with the product or at www.dell.com/regulatory_compliance.

 **CAUTION:** Before touching anything inside your computer, ground yourself by touching an unpainted metal surface, such as the metal at the back of the computer. While you work, periodically touch an unpainted metal surface to dissipate static electricity which could harm internal components.

CAUTION: When you disconnect a cable, pull it by its connector or its pull tab, not the cable itself. Some cables have connectors with locking tabs or thumbscrews that you must disengage before disconnecting the cable. When disconnecting cables, keep them evenly aligned to avoid bending the connector pins. When connecting cables, ensure that the ports and the connectors are correctly oriented and aligned.

CAUTION: Press and eject any installed card from the media-card reader.

NOTE: The color of your computer and certain components may appear differently than shown in this document.

Electrostatic discharge—ESD protection

ESD is a major concern when you handle electronic components, especially sensitive components such as expansion cards, processors, memory DIMMs, and system boards. Very slight charges can damage circuits in ways that may not be obvious, such as intermittent problems or a shortened product life span. As the industry pushes for lower power requirements and increased density, ESD protection is an increasing concern.

Due to the increased density of semiconductors used in recent Dell products, the sensitivity to static damage is now higher than in previous Dell products. For this reason, some previously approved methods of handling parts are no longer applicable.

Two recognized types of ESD damage are catastrophic and intermittent failures.

- **Catastrophic** – Catastrophic failures represent approximately 20 percent of ESD-related failures. The damage causes an immediate and complete loss of device functionality. An example of catastrophic failure is a memory DIMM that has received a static shock and immediately generates a "No POST/No Video" symptom with a beep code emitted for missing or nonfunctional memory.
- **Intermittent** – Intermittent failures represent approximately 80 percent of ESD-related failures. The high rate of intermittent failures means that most of the time when damage occurs, it is not immediately recognizable. The DIMM receives a static shock, but the tracing is merely weakened and does not immediately produce outward symptoms related to the damage. The weakened trace may take weeks or months to melt, and in the meantime may cause degradation of memory integrity, intermittent memory errors, etc.

The more difficult type of damage to recognize and troubleshoot is the intermittent (also called latent or "walking wounded") failure.

Perform the following steps to prevent ESD damage:

- Use a wired ESD wrist strap that is properly grounded. The use of wireless anti-static straps is no longer allowed; they do not provide adequate protection. Touching the chassis before handling parts does not ensure adequate ESD protection on parts with increased sensitivity to ESD damage.
- Handle all static-sensitive components in a static-safe area. If possible, use anti-static floor pads and workbench pads.
- When unpacking a static-sensitive component from its shipping carton, do not remove the component from the anti-static packing material until you are ready to install the component. Before unwrapping the anti-static packaging, ensure that you discharge static electricity from your body.
- Before transporting a static-sensitive component, place it in an anti-static container or packaging.

ESD field service kit

The unmonitored Field Service kit is the most commonly used service kit. Each Field Service kit includes three main components: anti-static mat, wrist strap, and bonding wire.

Components of an ESD field service kit

The components of an ESD field service kit are:

- **Anti-Static Mat** – The anti-static mat is dissipative and parts can be placed on it during service procedures. When using an anti-static mat, your wrist strap should be snug and the bonding wire should be connected to the mat and to any bare metal on the system being worked on. Once deployed properly, service parts can be removed from the ESD bag and placed directly on the mat. ESD-sensitive items are safe in your hand, on the ESD mat, in the system, or inside a bag.
- **Wrist Strap and Bonding Wire** – The wrist strap and bonding wire can be either directly connected between your wrist and bare metal on the hardware if the ESD mat is not required, or connected to the anti-static mat to protect hardware that is temporarily placed on the mat. The physical connection of the wrist strap and bonding wire between your skin, the ESD

mat, and the hardware is known as bonding. Use only Field Service kits with a wrist strap, mat, and bonding wire. Never use wireless wrist straps. Always be aware that the internal wires of a wrist strap are prone to damage from normal wear and tear, and must be checked regularly with a wrist strap tester in order to avoid accidental ESD hardware damage. It is recommended to test the wrist strap and bonding wire at least once per week.

- **ESD Wrist Strap Tester** – The wires inside of an ESD strap are prone to damage over time. When using an unmonitored kit, it is a best practice to regularly test the strap prior to each service call, and at a minimum, test once per week. A wrist strap tester is the best method for doing this test. If you do not have your own wrist strap tester, check with your regional office to find out if they have one. To perform the test, plug the wrist-strap's bonding-wire into the tester while it is strapped to your wrist and push the button to test. A green LED is lit if the test is successful; a red LED is lit and an alarm sounds if the test fails.
- **Insulator Elements** – It is critical to keep ESD sensitive devices, such as plastic heat sink casings, away from internal parts that are insulators and often highly charged.
- **Working Environment** – Before deploying the ESD Field Service kit, assess the situation at the customer location. For example, deploying the kit for a server environment is different than for a desktop or portable environment. Servers are typically installed in a rack within a data center; desktops or portables are typically placed on office desks or cubicles. Always look for a large open flat work area that is free of clutter and large enough to deploy the ESD kit with additional space to accommodate the type of system that is being repaired. The workspace should also be free of insulators that can cause an ESD event. On the work area, insulators such as Styrofoam and other plastics should always be moved at least 12 inches or 30 centimeters away from sensitive parts before physically handling any hardware components
- **ESD Packaging** – All ESD-sensitive devices must be shipped and received in static-safe packaging. Metal, static-shielded bags are preferred. However, you should always return the damaged part using the same ESD bag and packaging that the new part arrived in. The ESD bag should be folded over and taped shut and all the same foam packing material should be used in the original box that the new part arrived in. ESD-sensitive devices should be removed from packaging only at an ESD-protected work surface, and parts should never be placed on top of the ESD bag because only the inside of the bag is shielded. Always place parts in your hand, on the ESD mat, in the system, or inside an anti-static bag.
- **Transporting Sensitive Components** – When transporting ESD sensitive components such as replacement parts or parts to be returned to Dell, it is critical to place these parts in anti-static bags for safe transport.

ESD protection summary

It is recommended that all field service technicians use the traditional wired ESD grounding wrist strap and protective anti-static mat at all times when servicing Dell products. In addition, it is critical that technicians keep sensitive parts separate from all insulator parts while performing service and that they use anti-static bags for transporting sensitive components.

Transporting sensitive components

When transporting ESD sensitive components such as replacement parts or parts to be returned to Dell, it is critical to place these parts in anti-static bags for safe transport.

Lifting equipment

Adhere to the following guidelines when lifting heavy weight equipment:

 **CAUTION: Do not lift greater than 50 pounds. Always obtain additional resources or use a mechanical lifting device.**

1. Get a firm balanced footing. Keep your feet apart for a stable base, and point your toes out.
2. Tighten stomach muscles. Abdominal muscles support your spine when you lift, offsetting the force of the load.
3. Lift with your legs, not your back.
4. Keep the load close. The closer it is to your spine, the less force it exerts on your back.
5. Keep your back upright, whether lifting or setting down the load. Do not add the weight of your body to the load. Avoid twisting your body and back.
6. Follow the same techniques in reverse to set the load down.

After working inside your computer

About this task

 **CAUTION:** Leaving stray or loose screws inside your computer may severely damage your computer.

Steps

1. Replace all screws and ensure that no stray screws remain inside your computer.
2. Connect any external devices, peripherals, or cables you removed before working on your computer.
3. Replace any media cards, discs, or any other parts that you removed before working on your computer.
4. Connect your computer and all attached devices to their electrical outlets.
5. Turn on your computer.

Removing and installing components

NOTE: The images in this document may differ from your computer depending on the configuration you ordered.

Recommended tools

The procedures in this document may require the following tools:

- Phillips screwdrivers #0/#1
- Plastic scribe

Screw list

NOTE: When removing screws from a component, it is recommended to note the screw type, the quantity of screws, and then place them in a screw storage box. This is to ensure that the correct number of screws and correct screw type is restored when the component is replaced.

NOTE: Some computers have magnetic surfaces. Ensure that the screws are not left attached to such surfaces when replacing a component.

NOTE: Screw color may vary with the configuration ordered.

Table 1. Screw list



















Component	Secured to	Screw type	Quantity	Screw image
Base cover	Palm-rest and keyboard assembly	M2.5x6	7	
Base cover	Palm-rest and keyboard assembly	Captive (M2.5x2.5+5)	2	
Battery	Palm-rest and keyboard assembly	M2x3	3	
M.2 thermal shield	Palm-rest and keyboard assembly	M2x2.2	1	
M.2 thermal shield	Palm-rest and keyboard assembly	Captive	1	
M.2 2230 solid-state drive	M.2 thermal shield	M2x2	1	
I/O board	Palm-rest and keyboard assembly	M2x4	3	
Display panel	Display assembly	M2x2.5	2	
Display panel	Display assembly	M2.5x2.5	6	
Fan	Palm-rest and keyboard assembly	M2.5x5	2	

Table 1. Screw list (continued)

Component	Secured to	Screw type	Quantity	Screw image
Hard-drive assembly	Palm-rest and keyboard assembly	M2x3	3	
Hard-drive bracket	Hard drive	M3x3	4	
Heat sink	System board	Captive	4	
Display hinges	Palm-rest and keyboard assembly	M2.5x6	6	
Power button	Palm-rest and keyboard assembly	M2x3	2	
System board	Palm-rest and keyboard assembly	M2x4	1	
Touchpad	Palm-rest and keyboard assembly	M2x2	2	
Touchpad bracket	Palm-rest and keyboard assembly	M2x2	3	
Wireless-card bracket	System board	M2x3	1	

Major components of Inspiron 3505

The following image shows the major components of Inspiron 3505.

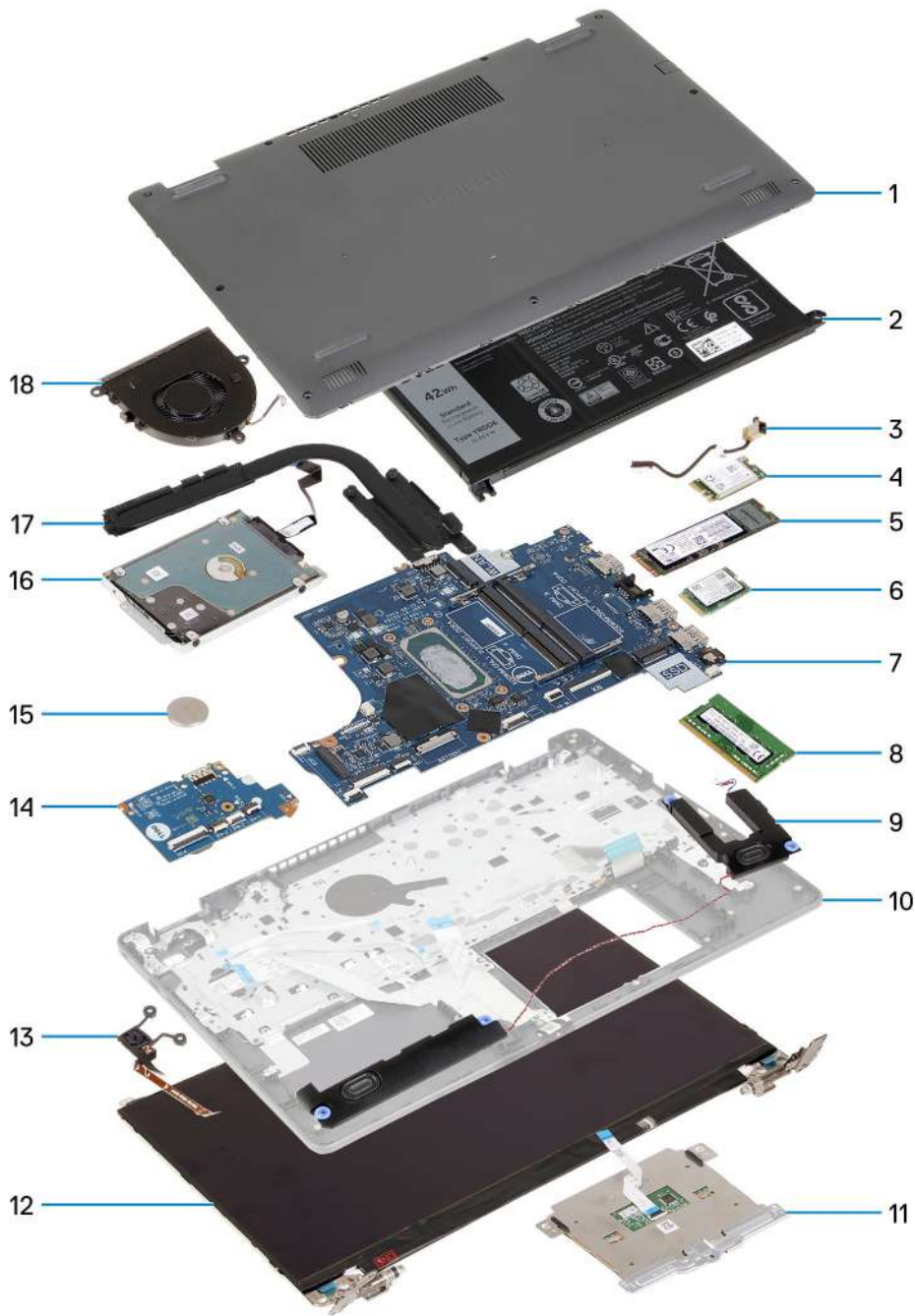

1. Base cover
2. Battery
3. Power-adaptor port
4. Wireless card
5. M.2 2280 solid-state drive, if installed
6. M.2 2230 solid-state drive, if installed
7. System board
8. Memory module
9. Speakers
10. Palm-rest and keyboard assembly
11. Touchpad
12. Display assembly
13. Power button with optional fingerprint reader
14. I/O board
15. Coin-cell battery

- 16. Hard drive
- 17. Heat sink
- 18. Fan

NOTE: Dell provides a list of components and their part numbers for the original system configuration purchased. These parts are available according to warranty coverages purchased by the customer. Contact your Dell sales representative for purchase options.

Base cover

Removing the base cover

Prerequisites

1. Follow the procedure in [Before working inside your computer](#).

About this task

NOTE: Before removing the base cover, ensure that there is no micro-SD card installed in the micro-SD card slot on your computer.

The following images indicate the location of the base cover and provides a visual representation of the removal procedure.

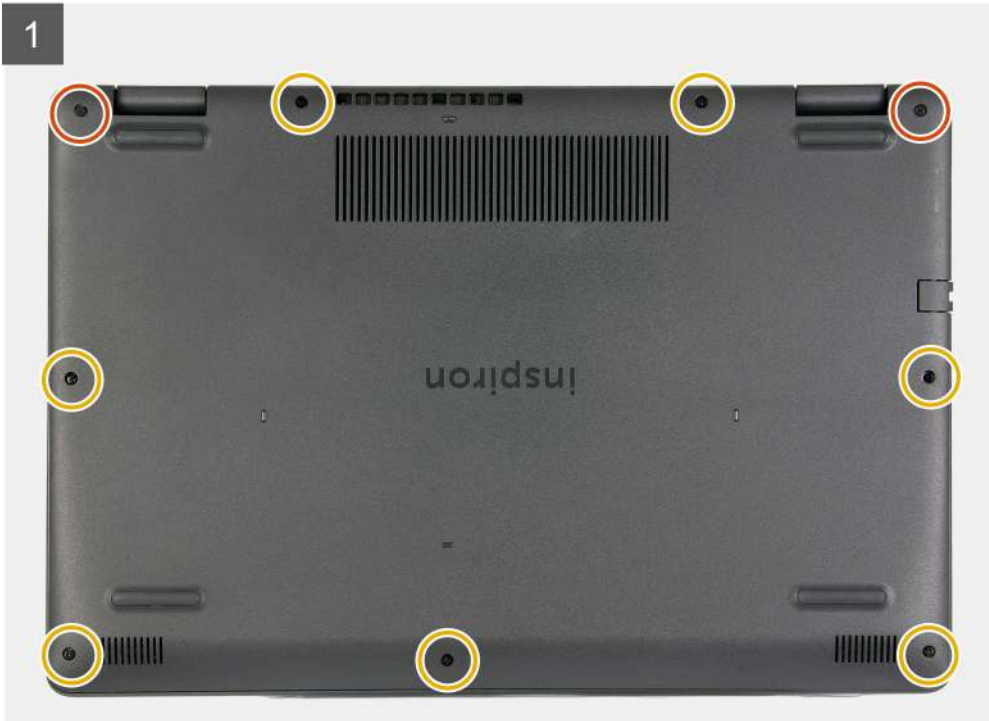

4



Steps

1. Remove the seven screws (M2.5x6) that secure the base cover to the palm-rest and keyboard assembly.
2. Loosen the two captive screws (M2.5x2.5+5) that secure the base cover to the palm-rest and keyboard assembly.
3. Using a plastic scribe, pry the base cover from the bottom left and continue to work on the sides to open the base cover.
4. Lift and slide the base cover off the palm-rest and keyboard assembly.
5. Disconnect the battery cable from the system board and turn the computer over.
6. Press and hold the power button for 15 seconds to ground the computer and drain the flea power.

Installing the base cover

Prerequisites

If you are replacing a component, remove the existing component before performing the installation process.

About this task

The following images indicate the location of the base cover and provides a visual representation of the installation procedure.

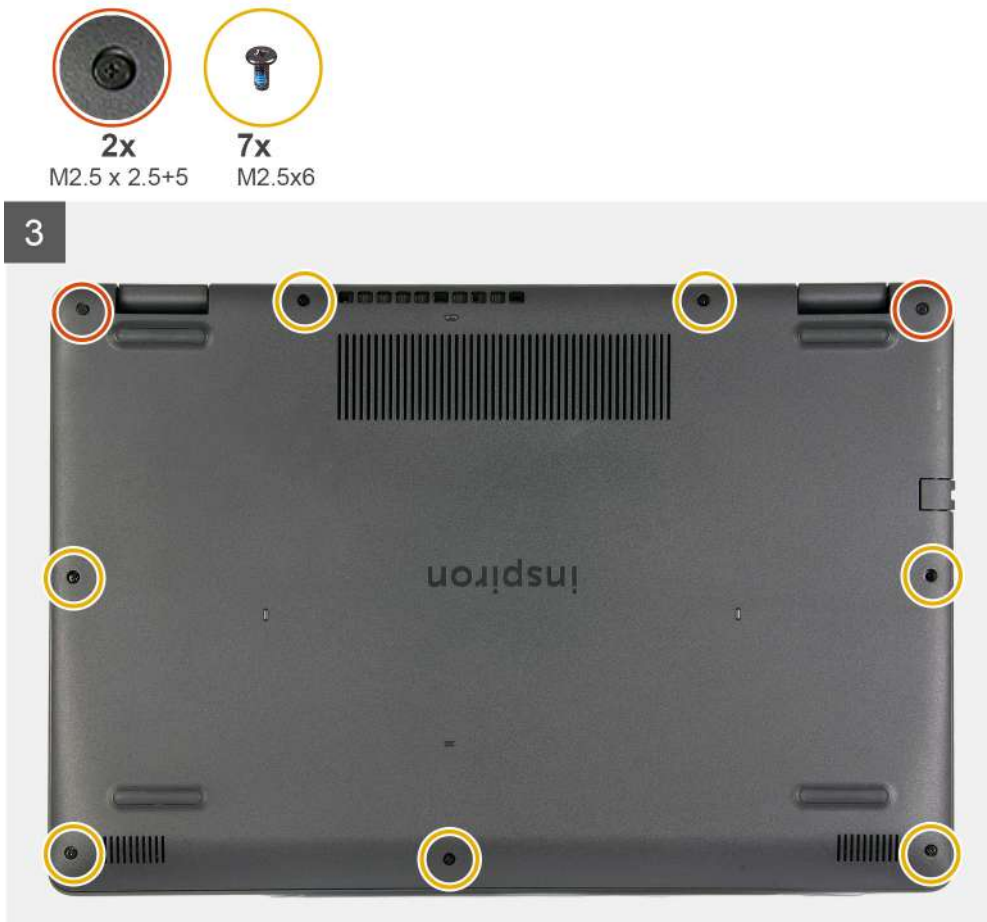

Steps

1. Connect the battery cable to the connector on the system board.
2. Place and snap the base cover into place on the palm-rest and keyboard assembly.
3. Tighten the two captive screws (M2.5x2.5+5) that secure the base cover to the palm-rest and keyboard assembly.
4. Replace the seven screws (M2.5x6) that secure the base cover to the palm-rest and keyboard assembly.

Next steps

1. Follow the procedure in [After working inside your computer](#).

Battery

Lithium-ion battery precautions

⚠ CAUTION:

- Exercise caution when handling Lithium-ion batteries.
- Discharge the battery completely before removing it. Disconnect the AC power adapter from the system and operate the computer solely on battery power—the battery is fully discharged when the computer no longer turns on when the power button is pressed.
- Do not crush, drop, mutilate, or penetrate the battery with foreign objects.
- Do not expose the battery to high temperatures, or disassemble battery packs and cells.
- Do not apply pressure to the surface of the battery.
- Do not bend the battery.

- Do not use tools of any kind to pry on or against the battery.
- Ensure any screws during the servicing of this product are not lost or misplaced, to prevent accidental puncture or damage to the battery and other system components.
- If the battery gets stuck inside your computer as a result of swelling, do not try to release it as puncturing, bending, or crushing a lithium-ion battery can be dangerous. In such an instance, contact Dell technical support for assistance. See www.dell.com/contactdell.
- Always purchase genuine batteries from www.dell.com or authorized Dell partners and resellers.

Removing the battery

Prerequisites

1. Follow the procedure in [Before working inside your computer](#).
2. Remove the [base cover](#).

About this task

The following images indicate the location of the battery and provides a visual representation of the removal procedure.

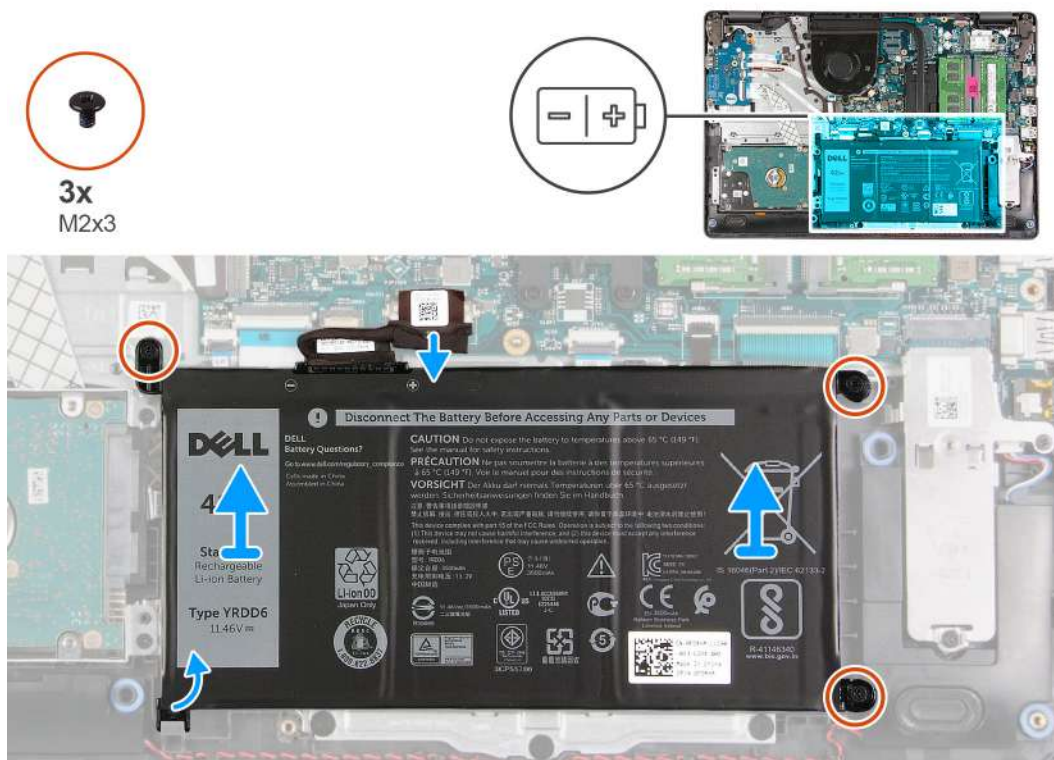

Steps

1. Disconnect the battery cable from the system board, if applicable.
2. Remove the three screws (M2x3) that secure the battery to the palm-rest and keyboard assembly.
3. Slide and lift the battery off the palm-rest and keyboard assembly.

Installing the battery

Prerequisites

If you are replacing a component, remove the existing component before performing the installation process.

- M.2 2230 solid-state drive + 2230 mounting bracket
- M.2 2280 solid-state drive

The following images indicate the location of the M.2 2230 solid-state drive and provides a visual representation of the removal procedure.

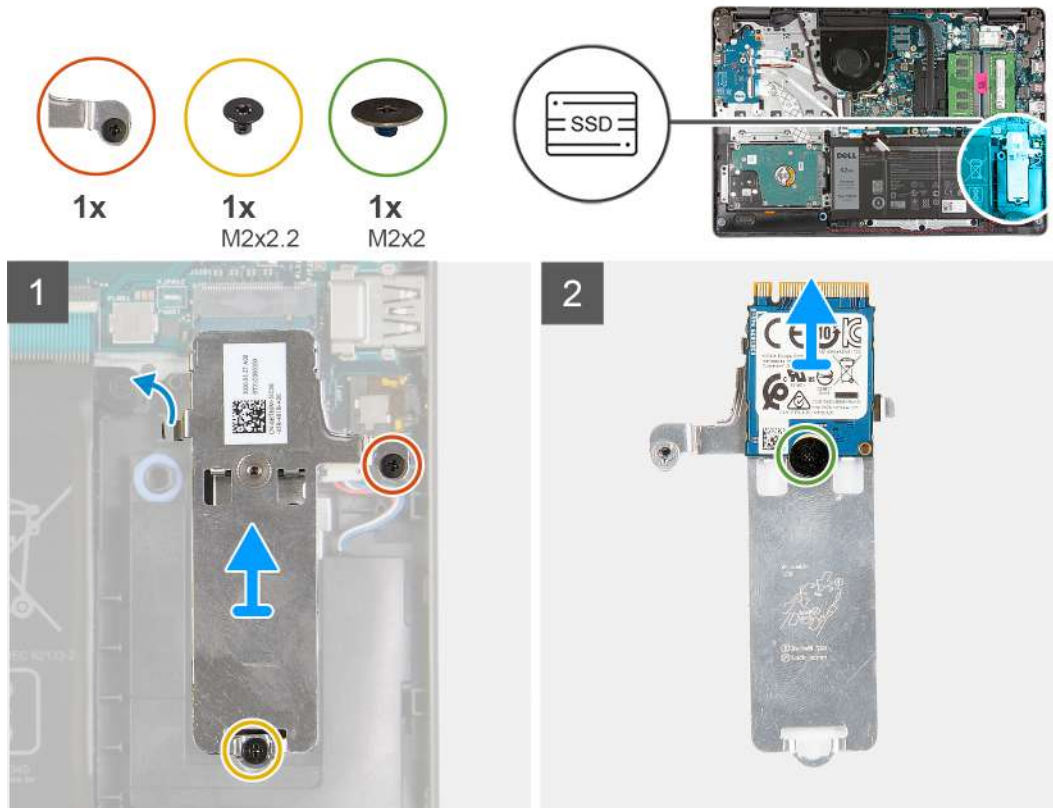

Steps

1. Remove the screw (M2x2.2) that secures the M.2 thermal shield to the palm-rest and keyboard assembly.
2. Loosen the captive screw that secures the M.2 thermal shield to the palm-rest and keyboard assembly.
3. Slide and remove the M.2 thermal shield off the palm-rest and keyboard assembly.
4. Remove the screw (M2x2) that secures the M.2 2230 solid-state drive to the screw mount on the M.2 thermal shield.
5. Lift the M.2 2230 solid-state drive off the M.2 thermal shield.

Installing the M.2 2230 solid-state drive

Prerequisites

If you are replacing a component, remove the existing component before performing the installation process.

About this task

NOTE: This procedure applies if you are installing a M.2 2230 solid-state drive.

NOTE: The M.2 card installed on your computer will depend on the configuration ordered. Supported card configurations on the M.2 card slot:

- M.2 2230 solid-state drive + 2230 mounting bracket
- M.2 2280 solid-state drive

The following images indicate the location of the M.2 2230 solid-state drive and provides a visual representation of the installation procedure.



Steps

1. Place the M.2 2230 solid-state drive on the M.2 thermal shield.
2. Align the screw hole on the M.2 2230 solid-state drive to the screw mount on the M.2 thermal shield.
3. Replace the screw (M2x2) that secures the M.2 2230 solid-state drive to the M.2 thermal shield.
4. Align the notch on the M.2 2230 solid-state drive with the tab on the M.2 card slot on the system board.
5. Slide the M.2 2230 solid-state drive and M.2 thermal shield into the M.2 card slot on the palm-rest and keyboard assembly.
6. Align the screw holes on the M.2 thermal shield to the screw holes on the palm-rest and keyboard assembly.
7. Replace the screw (M2x2.2) that secures the M.2 thermal shield to the palm-rest and keyboard assembly.
8. Tighten the captive screw that secures the M.2 thermal shield to the palm-rest and keyboard assembly.

Next steps

1. Install the [base cover](#).
2. Follow the procedure in [After working inside your computer](#).

Removing the M.2 2280 solid-state drive

Prerequisites

1. Follow the procedure in [Before working inside your computer](#).
2. Remove the [base cover](#).

About this task

- NOTE:** This procedure applies only to computers shipped with a M.2 2280 solid-state drive installed.
- NOTE:** The M.2 card installed on your computer will depend on the configuration ordered. Supported card configurations on the M.2 card slot:
 - M.2 2230 solid-state drive + 2230 mounting bracket

- M.2 2280 solid-state drive

The following images indicate the location of the M.2 2280 solid-state drive and provides a visual representation of the removal procedure.

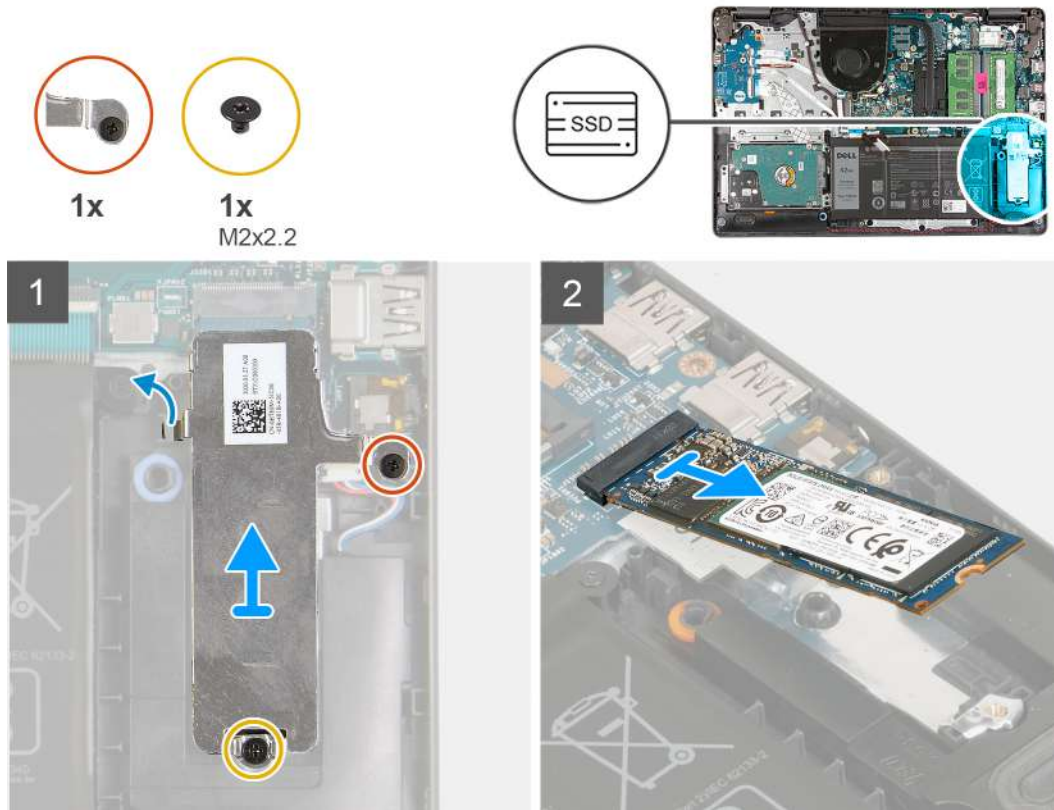

Steps

1. Remove the screw (M2x2.2) that secures the M.2 thermal shield to the palm-rest and keyboard assembly.
2. Loosen the captive screw that secures the M.2 thermal shield to the palm-rest and keyboard assembly.
3. Lift the M.2 thermal shield from the palm-rest and keyboard assembly.
4. Slide and remove the M.2 2280 solid-state drive from the M.2 card slot on the system board.

Installing the M.2 2280 solid-state drive

Prerequisites

If you are replacing a component, remove the existing component before performing the installation process.

About this task

NOTE: This procedure applies if you are installing a M.2 2280 solid-state drive.

NOTE: The M.2 card installed on your computer will depend on the configuration ordered. Supported card configurations on the M.2 card slot:

- M.2 2230 solid-state drive + 2230 mounting bracket
- M.2 2280 solid-state drive

The following images indicate the location of the M.2 2280 solid-state drive and provides a visual representation of the installation procedure.



1x



1x
M2x2.2

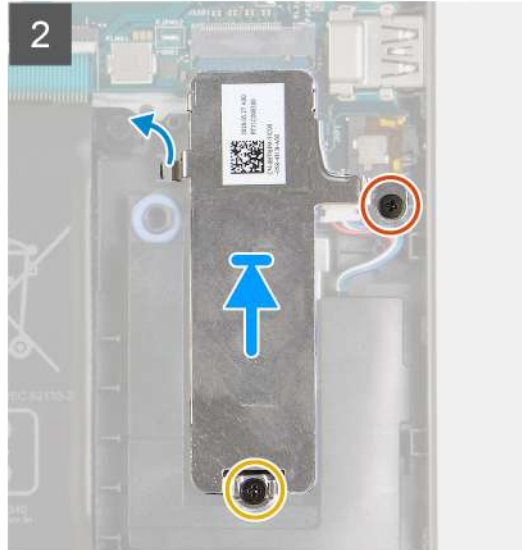

Steps

1. Align the notch on the M.2 2280 solid-state drive with the tab on the M.2 card slot on the system board.
2. Slide the M.2 2280 solid-state drive into the M.2 card slot on the system board.
3. Place the the M.2 thermal shield on the M.2 2280 solid-state drive.
4. Align the screw holes on the M.2 thermal shield with the screw holes on the palm-rest and keyboard assembly.
5. Replace the screw (M2x2.2) that secures the M.2 thermal shield to the palm-rest and keyboard assembly.
6. Tighten the captive screw that secures the M.2 thermal shield to the palm-rest and keyboard assembly.

Next steps

1. Install the [base cover](#).
2. Follow the procedure in [After working inside your computer](#).

Wireless card

Removing the wireless card

Prerequisites

1. Follow the procedure in [Before working inside your computer](#).
2. Remove the [base cover](#).

About this task

The following images indicate the location of the wireless card and provides a visual representation of the removal procedure.



1x
M2x3



Steps

1. Remove the screw (M2x3) that secures the wireless-card bracket to the system board.
2. Lift the wireless-card bracket off the system board.
3. Disconnect the antenna cables from the wireless card.
4. Slide and remove the wireless card from the M.2 card slot on the system board.

Installing the wireless card

Prerequisites

If you are replacing a component, remove the existing component before performing the installation process.

About this task

The following images indicate the location of the wireless card and provides a visual representation of the installation procedure.



1x
M2x3



Steps

1. Connect the antenna cables to the wireless card.

The following table provides the antenna-cable color scheme for the wireless card supported by your computer.

Table 2. Antenna-cable color scheme

Connectors on the wireless card	Antenna-cable color
Main (white triangle)	White
Auxiliary (black triangle)	Black

2. Slide the wireless card into the M.2 card slot on the system board.
3. Place the wireless-card bracket on the wireless card.
4. Replace the screw (M2x3) that secures the wireless-card bracket to the system board.

Next steps

1. Install the [base cover](#).
2. Follow the procedure in [After working inside your computer](#).

I/O board

Removing the I/O board

Prerequisites

1. Follow the procedure in [Before working inside your computer](#).
2. Remove the [base cover](#).

About this task

The following images indicate the location of the I/O board and provides a visual representation of the removal procedure.



3x
M2x4

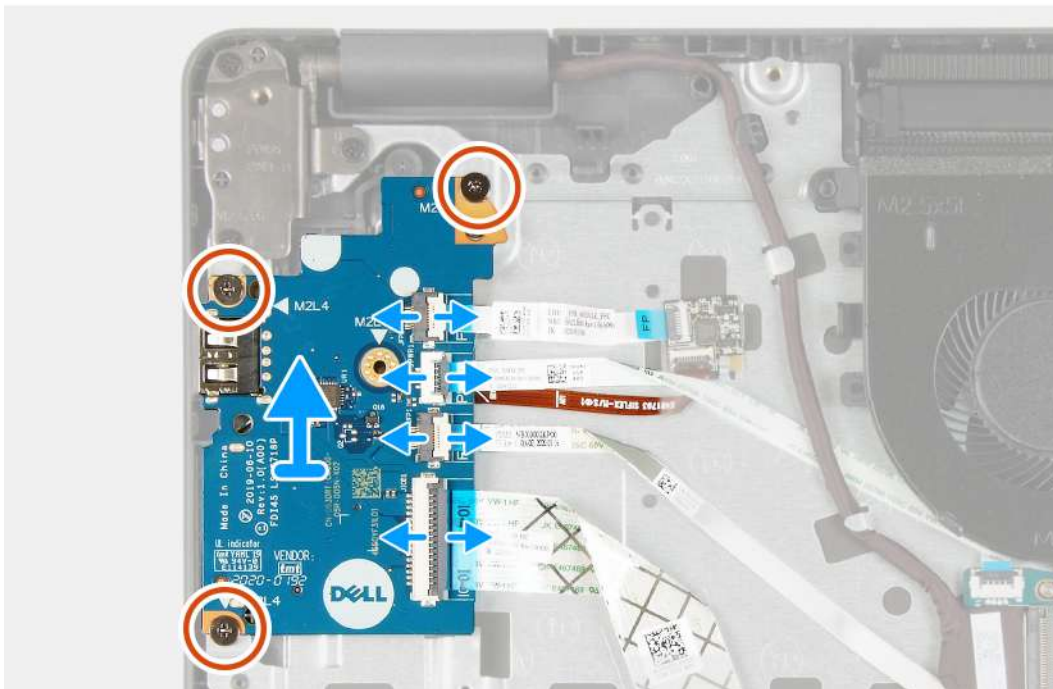

Steps

1. Open the latch and disconnect the fingerprint-reader board cable from the I/O board, if applicable.
2. Open the latch and disconnect the I/O-board power cable from the I/O board.
3. Open the latch and disconnect the fingerprint-reader cable from the I/O board, if applicable.
4. Open the latch and disconnect the I/O-board cable from the I/O board.
5. Remove the three screws (M2x4) that secure the I/O board to the palm-rest and keyboard assembly.
6. Lift the I/O board off the palm-rest and keyboard assembly.

Installing the I/O board

Prerequisites

If you are replacing a component, remove the existing component before performing the installation process.

About this task

The following images indicate the location of the I/O board and provides a visual representation of the installation procedure.



3x
M2x4

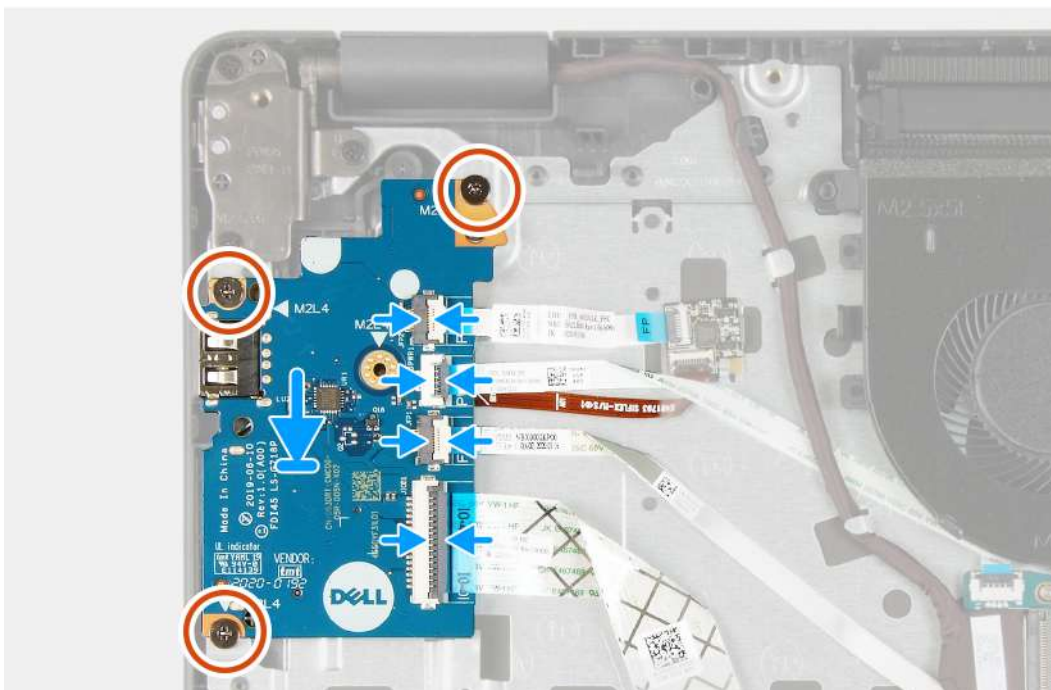

Steps

1. Place the I/O board on the palm-rest and keyboard assembly.
2. Align the screw holes on the I/O board to the screw holes on the palm-rest and keyboard assembly.
3. Replace the three screws (M2x4) that secure the I/O board to the palm-rest and keyboard assembly.
i **NOTE:** When replacing the screws, only replace the screws in the locations shown in the image.
4. Connect the fingerprint-reader board cable to the connector on the I/O board and close the latch, if applicable.
5. Connect the I/O-board power cable to the connector on the I/O board and close the latch.
6. Connect the fingerprint-reader cable to the connector on the I/O board and close the latch, if applicable.
7. Connect the I/O-board cable to the connector on the I/O board and close the latch.

Next steps

1. Install the [base cover](#).
2. Follow the procedure in [After working inside your computer](#).

Coin-cell battery

Removing the coin-cell battery

Prerequisites

1. Follow the procedure in [Before working inside your computer](#).
2. Remove the [base cover](#).
3. Remove the [I/O board](#).

About this task

The following images indicate the location of the coin-cell battery and provides a visual representation of the removal procedure.

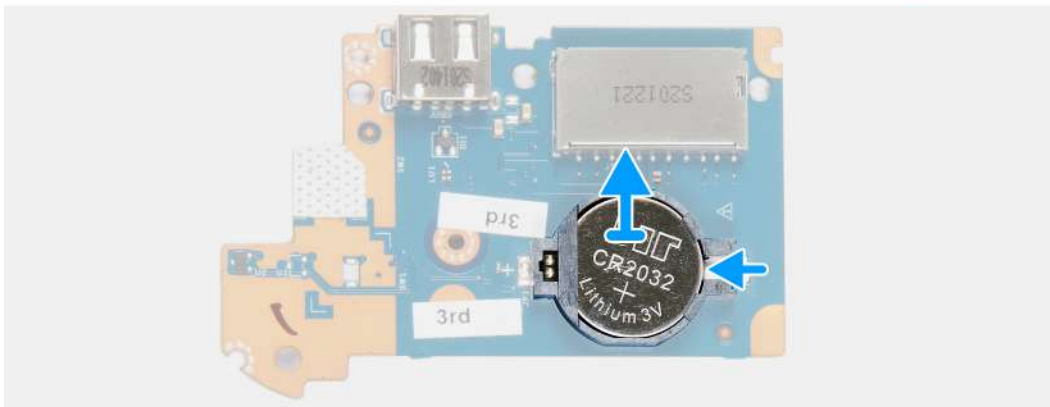
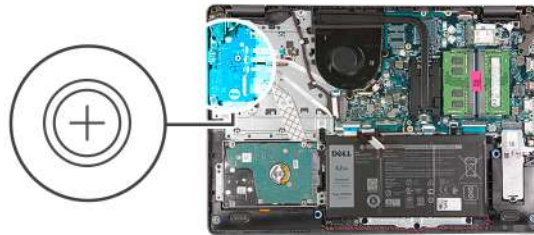

Steps

1. Flip the I/O board over.
2. Push on the securing clip to release the coin-cell battery from its holder on the I/O board.
3. Lift the coin-cell battery from its holder on the I/O board.

Installing the coin-cell battery

Prerequisites

If you are replacing a component, remove the existing component before performing the installation process.

About this task

The following images indicate the location of the coin-cell battery and provides a visual representation of the installation procedure.

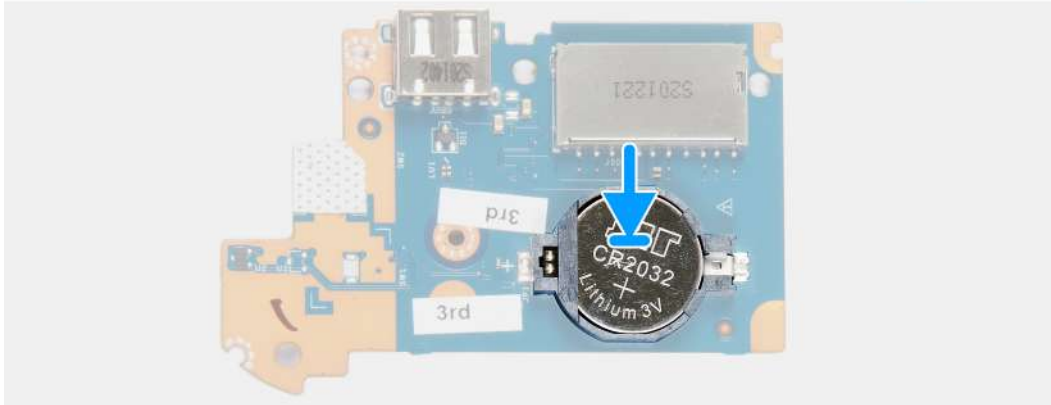

Steps

1. Place the coin-cell battery into the coin-cell battery holder on the I/O board with the plus sign facing up.
2. Press down on the coin-cell battery to lock it in place in the coin-cell battery holder.
3. Turn the I/O board over.

Next steps

1. Install the [I/O board](#).
2. Install the [base cover](#).
3. Follow the procedure in [After working inside your computer](#).

Hard drive

Removing the hard drive

Prerequisites

1. Follow the procedure in [Before working inside your computer](#).
2. Remove the [base cover](#).
3. Remove the [battery](#).

About this task

The following images indicate the location of the hard drive and provides a visual representation of the removal procedure.

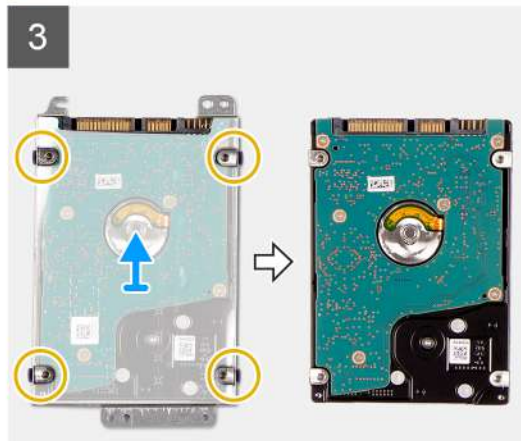
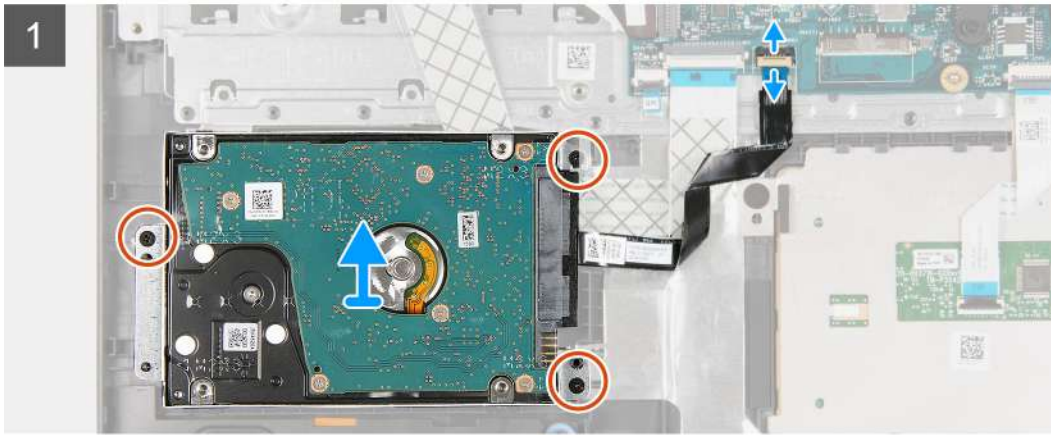

Steps

1. Disconnect the hard-drive cable from the system board.
2. Remove the three screws (M2x3) that secure the hard-drive assembly to the palm-rest and keyboard assembly.
3. Lift the hard-drive assembly along with its cable from the palm-rest and keyboard assembly.
4. Disconnect the hard-drive cable from the hard drive.
5. Remove the four screws (M3x3) that secure the hard-drive bracket to the hard drive.
6. Slide and remove the hard-drive bracket from the hard drive.

Installing the hard drive

Prerequisites

If you are replacing a component, remove the existing component before performing the installation process.

About this task

The following images indicate the location of the hard drive and provides a visual representation of the installation procedure.

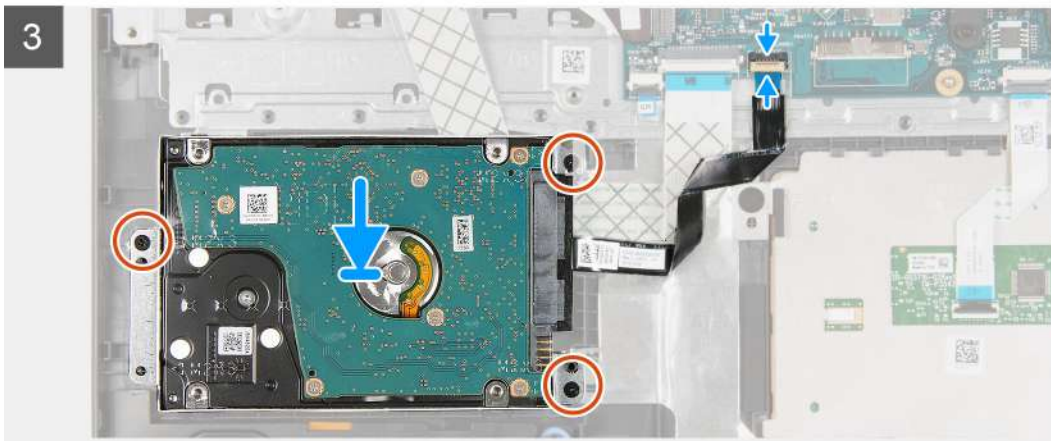
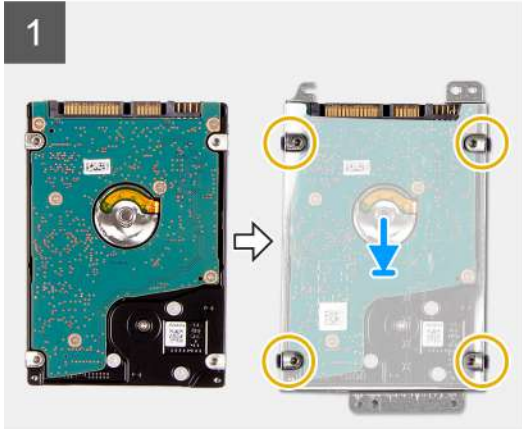

Steps

1. Place and slide the hard drive into the hard-drive bracket.
2. Align the screw holes on the hard-drive bracket with the screw holes on the hard drive.
3. Replace the four screws (M3x3) that secure the hard-drive bracket to the hard drive.
4. Connect the hard-drive cable to the hard drive.
5. Place the hard-drive assembly on the palm-rest and keyboard assembly.
6. Align the screw holes on the hard-drive assembly to the screw holes on the palm-rest and keyboard assembly.
7. Replace the three screws (M2x3) that secure the hard-drive assembly to the palm-rest and keyboard assembly.
8. Connect the hard-drive cable to the connector on the system board.

Next steps

1. Install the [battery](#).
2. Install the [base cover](#).
3. Follow the procedure in [After working inside your computer](#).

Memory modules

Removing the memory module

Prerequisites

1. Follow the procedure in [Before working inside your computer](#).
2. Remove the [base cover](#).

About this task

NOTE: Depending on the configuration ordered your computer may come shipped with one or two memory module installed.

The following images indicate the location of the memory module and provides a visual representation of the removal procedure.

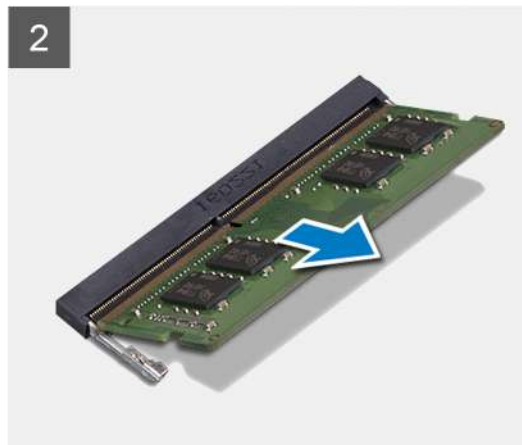
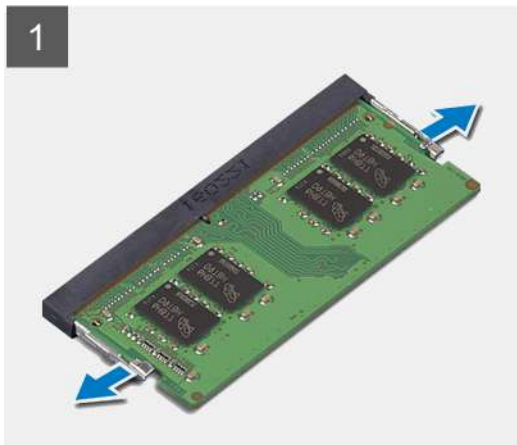

Steps

1. Use your fingertips to carefully spread apart the securing-clips on each end of the memory-module slot until the memory module pops up.
2. Lift at an angle and remove the memory module from its slot on the system board.
3. Repeat the procedure above for the second memory module, if applicable.

Installing the memory module

Prerequisites

If you are replacing a component, remove the existing component before performing the installation process.

About this task

The following images indicate the location of the memory module and provides a visual representation of the installation procedure.

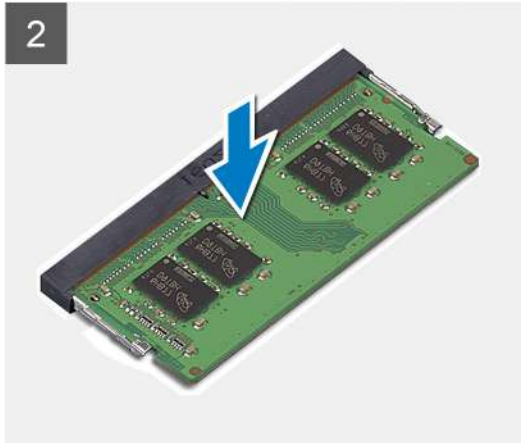
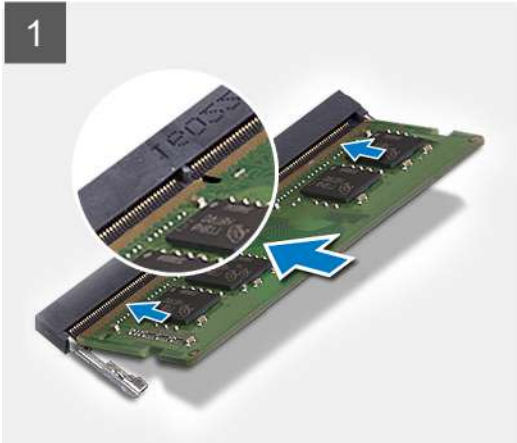

Steps

1. Align the slot on the memory module with the notch on the memory module slot on the system board.
2. Slide the memory module into the slot on the system board.
3. Press down on the memory module to snap it into place.
4. Ensure that the securing clips have locked the memory module into place.

NOTE: If the securing clips are not locking the memory module into place remove the memory module from the slot and repeat steps 1 to 3.

5. Repeat the procedure above for the second memory module, if applicable.

Next steps

1. Install the [base cover](#).
2. Follow the procedure in [After working inside your computer](#).

Speakers

Removing the speakers

Prerequisites

1. Follow the procedure in [Before working inside your computer](#).
2. Remove the [base cover](#).
3. Remove the [M.2 2230 solid-state drive](#), if applicable.
4. Remove the [M.2 2280 solid-state drive](#), if applicable.

About this task

The following images indicate the location of the speakers and provides a visual representation of the removal procedure.

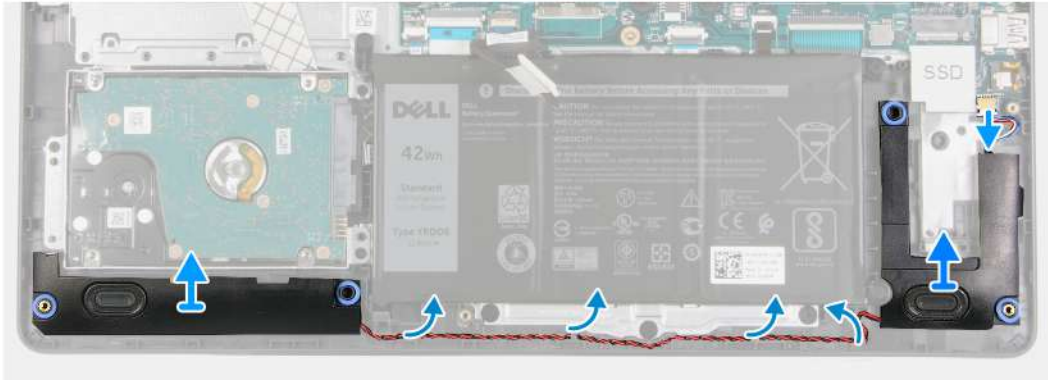

Steps

1. Disconnect the speaker cable from the system board.
2. Remove the speaker cable from the routing guides on the palm-rest and keyboard assembly.
3. Lift the speakers along with its cable off the palm-rest and keyboard assembly.

Installing the speakers

Prerequisites

If you are replacing a component, remove the existing component before performing the installation process.

About this task

The following images indicate the location of the speakers and provides a visual representation of the installation procedure.

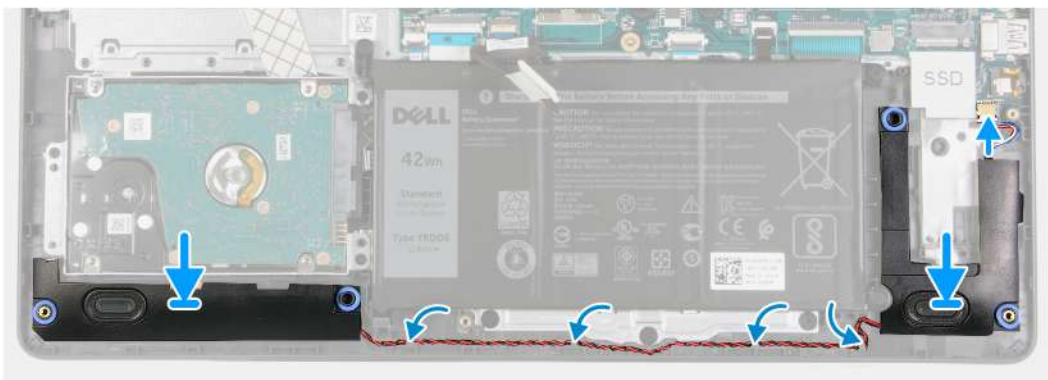
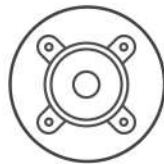

Steps

1. Using the alignment posts, place the speakers on the palm-rest and keyboard assembly.
i **NOTE:** Ensure that the alignment posts are threaded through the rubber grommets on the speaker.
2. Route the speaker cable through the routing guides on the palm-rest and keyboard assembly.
3. Connect the speaker cable to the system board.

Next steps

1. Install the [M.2 2230 solid-state drive](#), if applicable.
2. Install the [M.2 2280 solid-state drive](#), if applicable.
3. Install the [base cover](#).
4. Follow the procedure in [After working inside your computer](#).

Heat sink

Removing the heat sink

Prerequisites

1. Follow the procedure in [Before working inside your computer](#).
2. Remove the [base cover](#).

About this task

- i** **NOTE:** The heat sink may become hot during normal operation. Allow sufficient time for the heat sink to cool before you touch it.
- i** **NOTE:** For maximum cooling of the processor, do not touch the heat transfer areas on the heat sink. The oils in your skin can reduce the heat transfer capability of the thermal grease.

The following images indicate the location of the heat sink and provides a visual representation of the removal procedure.

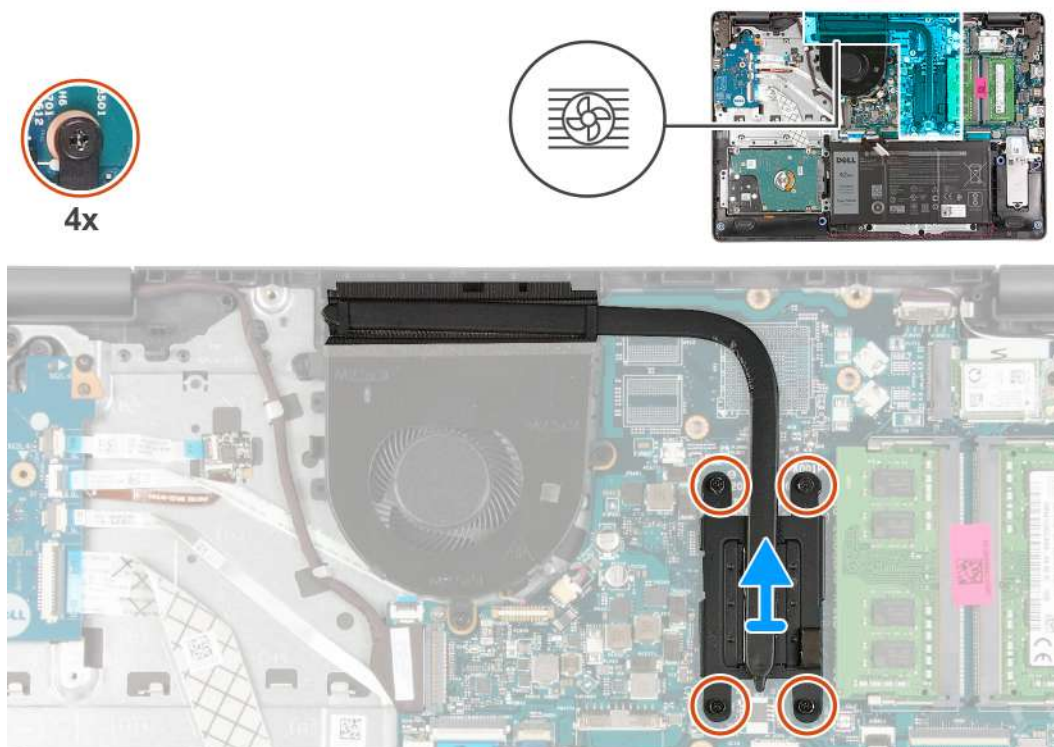

Steps

1. In reverse sequential order (4>3>2>1) loosen the four captive screws that secure the heat sink to the system board.
i **NOTE:** The number of screws varies depending on the configuration ordered.
2. Lift the heat sink from the system board.

Installing the heat sink

Prerequisites

If you are replacing a component, remove the existing component before performing the installation process.

About this task

- i** **NOTE:** If either the system board or the heat sink is replaced, use the thermal grease provided in the kit to ensure that thermal conductivity is achieved.

The following images indicate the location of the heat sink and provides a visual representation of the installation procedure.

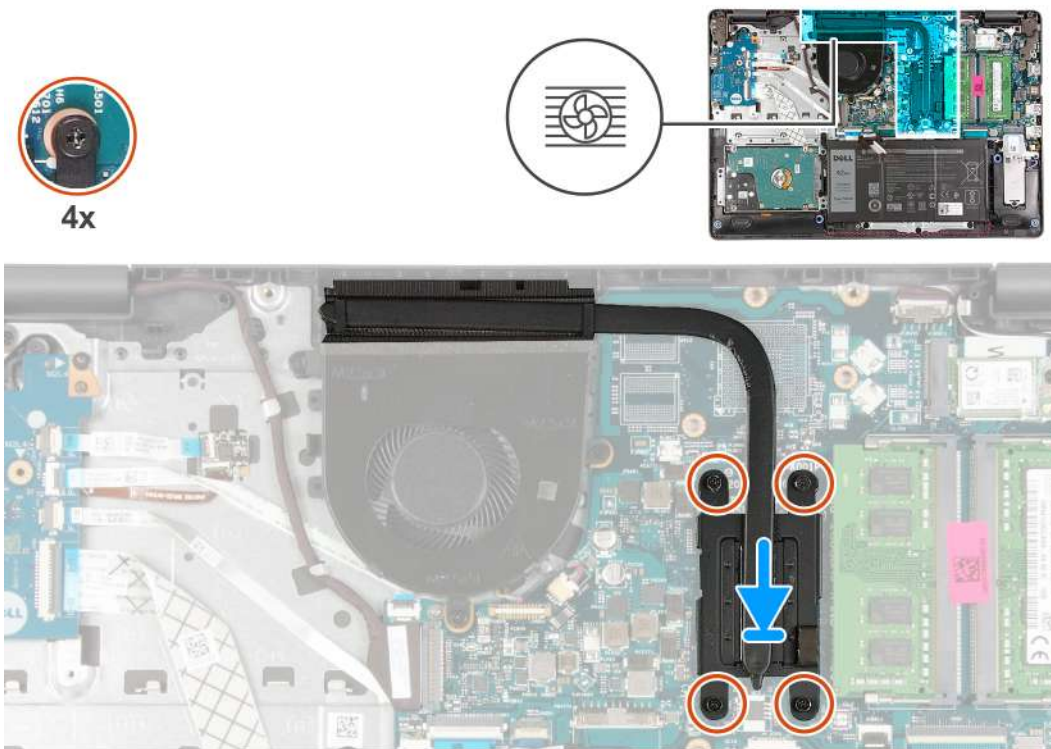

Steps

1. Place the heat sink on the system board.
2. In sequential order (1>2>3>4) tighten the four captive screws that secure the heat sink to the system board.
i **NOTE:** The number of screws varies depending on the configuration ordered.

Next steps

1. Install the [base cover](#).
2. Follow the procedure in [After working inside your computer](#).

Fan

Removing the fan

Prerequisites

1. Follow the procedure in [Before working inside your computer](#).
2. Remove the [base cover](#).

About this task

The following images indicate the location of the fan and provides a visual representation of the removal procedure.

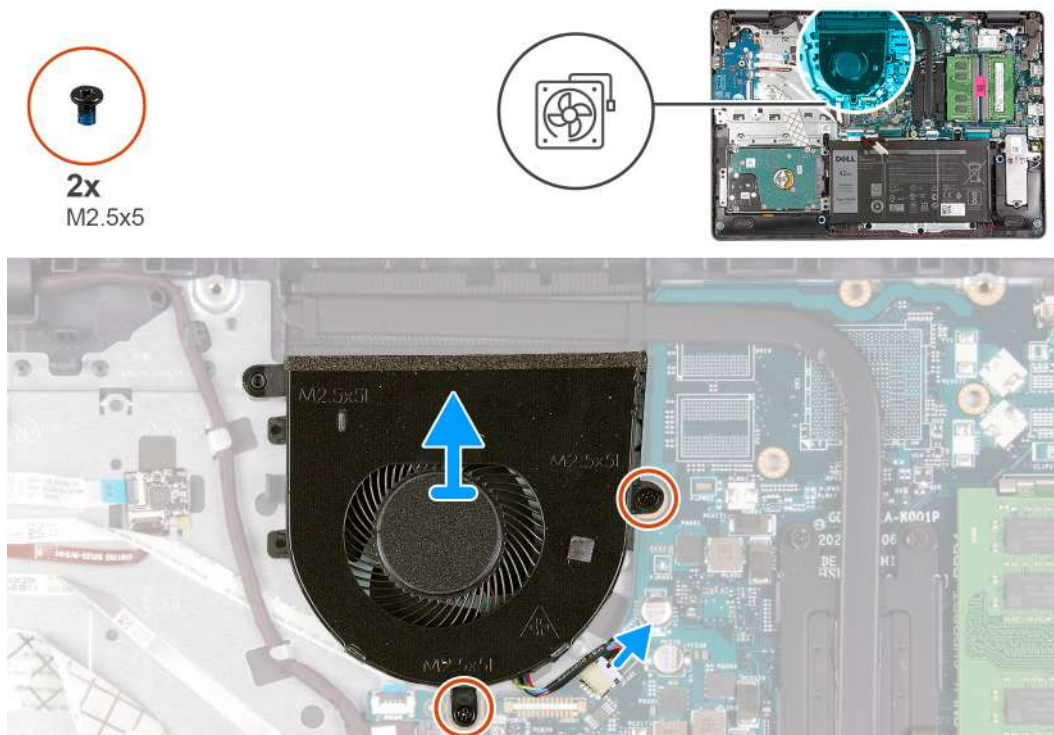

Steps

1. Remove the two screws (M2.5x5) that secure the fan to the palm-rest and keyboard assembly.
2. Disconnect the fan cable from the system board.
3. Lift the fan from the palm-rest and keyboard assembly.

Installing the fan

Prerequisites

If you are replacing a component, remove the existing component before performing the installation process.

About this task

The following images indicate the location of the fan and provides a visual representation of the installation procedure.

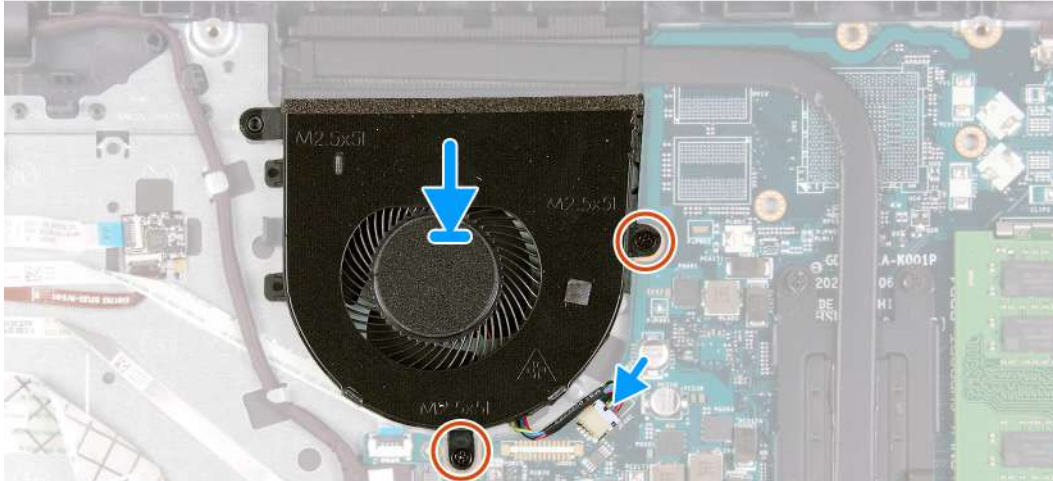

Steps

1. Place the fan on the palm-rest and keyboard assembly.
2. Align the screw holes on the fan to the screw holes on the palm-rest and keyboard assembly.
3. Replace the two screws (M2.5x5) that secure the fan to the palm-rest and keyboard assembly.
4. Connect the fan cable to the connector on the system board.

Next steps

1. Install the [base cover](#).
2. Follow the procedure in [After working inside your computer](#).

Power button with optional fingerprint reader

Removing the power-button with optional fingerprint reader

Prerequisites

1. Follow the procedure in [Before working inside your computer](#).
2. Remove the [base cover](#).
3. Remove the [I/O board](#).

About this task

The following images indicate the location of the power-button with optional fingerprint reader and provides a visual representation of the removal procedure.



2x
M2x3

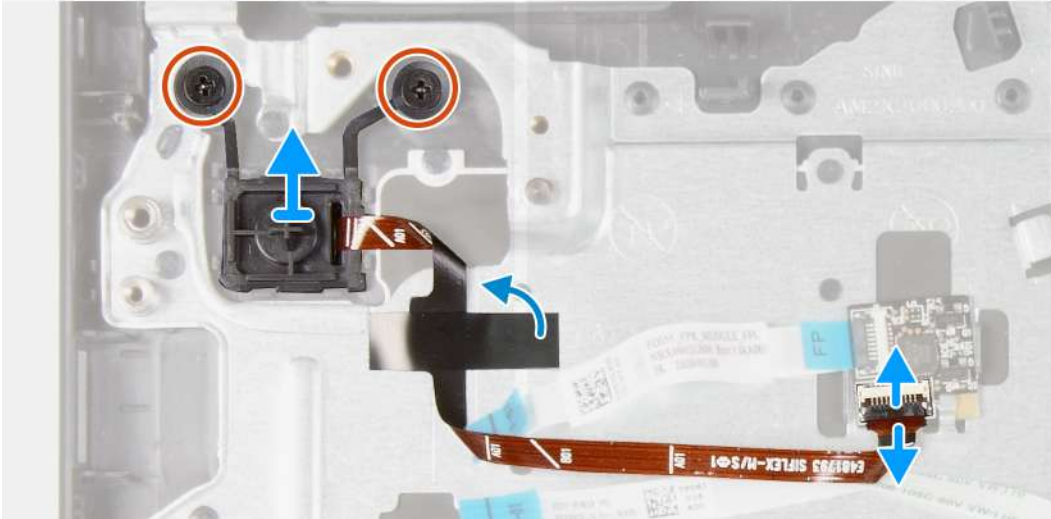

Steps

1. Remove the two screws (M2x3) that secure the power-button with optional fingerprint reader to the palm-rest and keyboard assembly.
2. Open the latch and disconnect the power-button cable from the fingerprint-reader board, if applicable.
(i) NOTE: This step is only applicable if your computer was shipped with the optional fingerprint reader.
3. Peel the Mylar that secures and grounds the power-button cable to the palm-rest and keyboard assembly, if applicable.
(i) NOTE: This step is only applicable if your computer was shipped with the optional fingerprint reader.
4. Lift the power-button, along with its cable, off the palm-rest and keyboard assembly.

Installing the power-button with optional fingerprint reader

Prerequisites

If you are replacing a component, remove the existing component before performing the installation process.

About this task

The following images indicate the location of the power-button with optional fingerprint reader and provides a visual representation of the installation procedure.



2x
M2x3

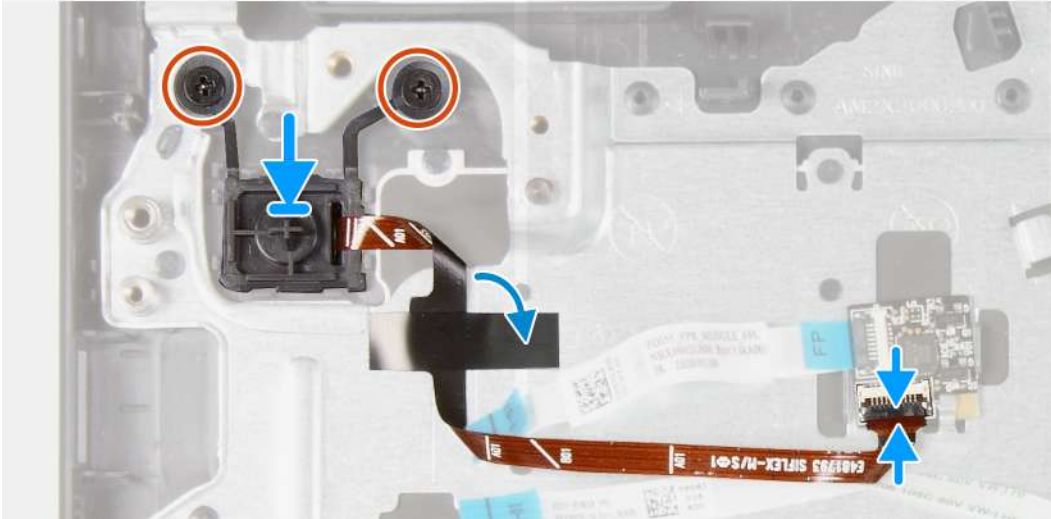

Steps

1. Using the alignment posts, place the power-button into its slot on the palm-rest and keyboard assembly.
2. Replace the two screws (M2x3) that secure the power-button to the palm-rest and keyboard assembly.
3. Connect the power-button cable to the fingerprint-reader board and close the latch, if applicable.
i **NOTE:** This step is only applicable if your computer was shipped with the optional fingerprint reader.
4. Adhere the Mylar that secures and grounds the power-button cable to the palm-rest and keyboard assembly, if applicable.
i **NOTE:** This step is only applicable if your computer was shipped with the optional fingerprint reader.

Next steps

1. Install the [I/O board](#).
2. Install the [base cover](#).
3. Follow the procedure in [After working inside your computer](#).

Fingerprint-reader board

Removing the fingerprint-reader board

Prerequisites

1. Follow the procedure in [Before working inside your computer](#).
2. Remove the [base cover](#).

About this task

- i** **NOTE:** The fingerprint-reader board is an optional component and will only be installed in systems shipped with a fingerprint reader.

The following images indicate the location of the fingerprint-reader board and provides a visual representation of the removal procedure.



Steps

1. Open the latch and disconnect the power-button cable from the fingerprint-reader board.
2. Open the latch and disconnect the fingerprint-reader board cable from the fingerprint-reader board.
3. Slide and remove the fingerprint-reader board from the securing clip on the palm-rest and keyboard assembly.

Installing the fingerprint-reader board

Prerequisites

If you are replacing a component, remove the existing component before performing the installation process.

About this task

The following images indicate the location of the fingerprint-reader board and provides a visual representation of the installation procedure.



Steps

1. Place and slide the fingerprint-reader board under the securing clip on the palm-rest and keyboard assembly.
2. Connect the fingerprint-reader board cable to the fingerprint-reader board and close the latch.
3. Connect the power-button cable to the fingerprint-reader board and close the latch.

Next steps

1. Install the [base cover](#).
2. Follow the procedure in [After working inside your computer](#).

Display assembly

Removing the display assembly

Prerequisites

1. Follow the procedure in [Before working inside your computer](#).
2. Remove the [base cover](#).
3. Remove the [wireless card](#).

About this task

The following images indicate the location of the display assembly and provides a visual representation of the removal procedure.



6x
M2.5x6

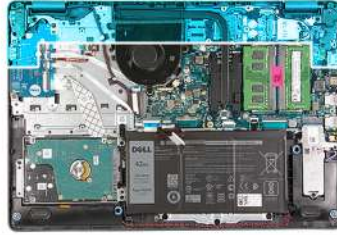

1

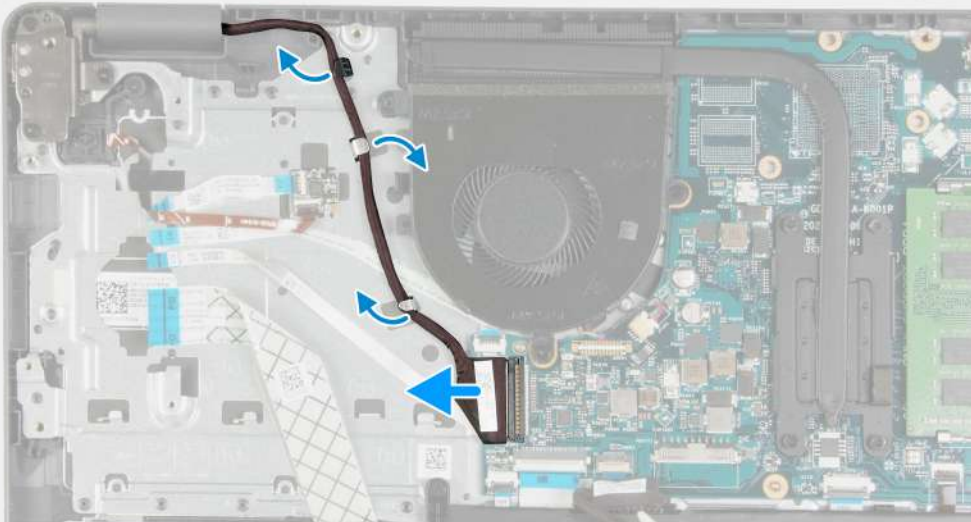

2

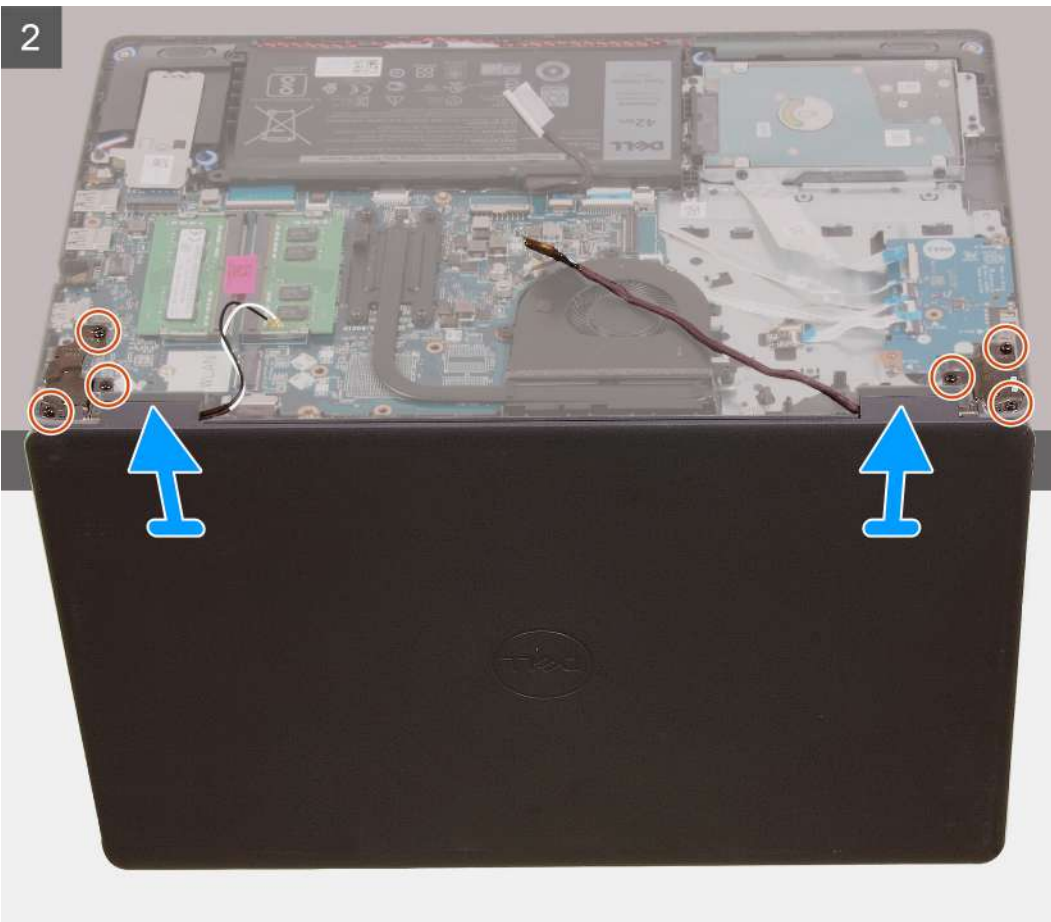

Steps

1. Disconnect the display cable from the system board.
2. Remove the display cable from the routing guides on the palm-rest and keyboard assembly.
3. Open the display and place the computer with the lid open at the edge of a stable elevation with the display hanging downwards.
4. Remove the six screws (M2.5x6) that secure the display hinges to the palm-rest and keyboard assembly.
5. Lift the display assembly from the palm-rest and keyboard assembly.

Installing the display assembly

Prerequisites

If you are replacing a component, remove the existing component before performing the installation process.

About this task

The following images indicate the location of the display assembly and provides a visual representation of the installation procedure.



6x
M2.5x6



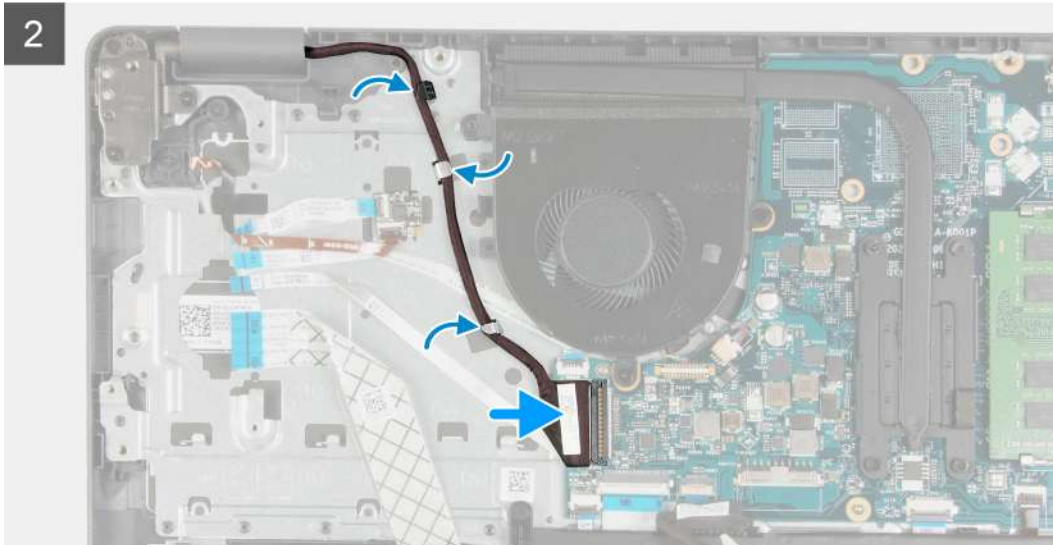

Steps

1. Place the display assembly on the palm-rest and keyboard assembly.
2. Align the screw holes on the display hinges with the screw holes on the palm-rest and keyboard assembly.
3. Replace the 6 screws (M2.5x6) that secure the display hinges to the palm-rest and keyboard assembly.
4. Route the display cable through the routing guides on the palm-rest and keyboard assembly.
5. Connect the display cable to the connector on the system board.

Next steps

1. Install the [wireless card](#).
2. Install the [base cover](#).
3. Follow the procedure in [After working inside your computer](#).

Display bezel

Removing the display bezel

Prerequisites

1. Follow the procedure in [Before working inside your computer](#).
2. Remove the [base cover](#).
3. Remove the [wireless card](#).
4. Remove the [display assembly](#).

About this task

The following images indicate the location of the display bezel and provides a visual representation of the removal procedure.

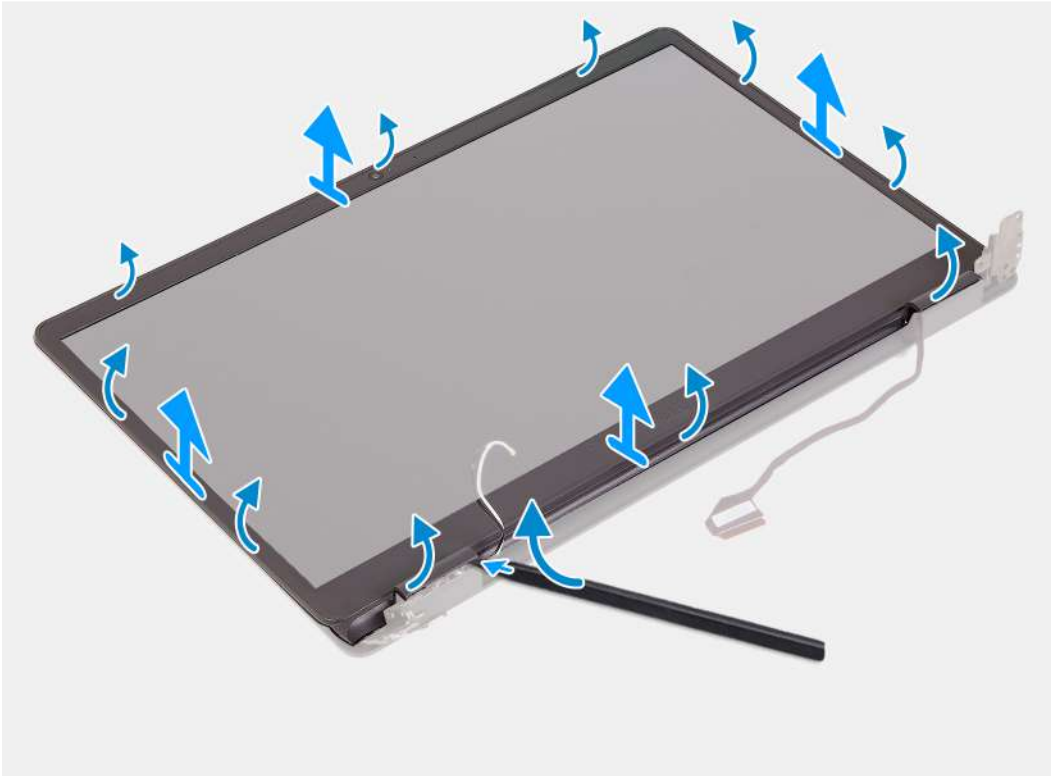

Steps

1. Using a plastic scribe, pry the the display bezel from the display assembly at the location shown.
2. Work around the edge of the display assembly to pry the display bezel from the display assembly.
3. Lift the display bezel from the display assembly.

Installing the display bezel

Prerequisites

If you are replacing a component, remove the existing component before performing the installation process.

About this task

The following images indicate the location of the display bezel and provides a visual representation of the installation procedure.

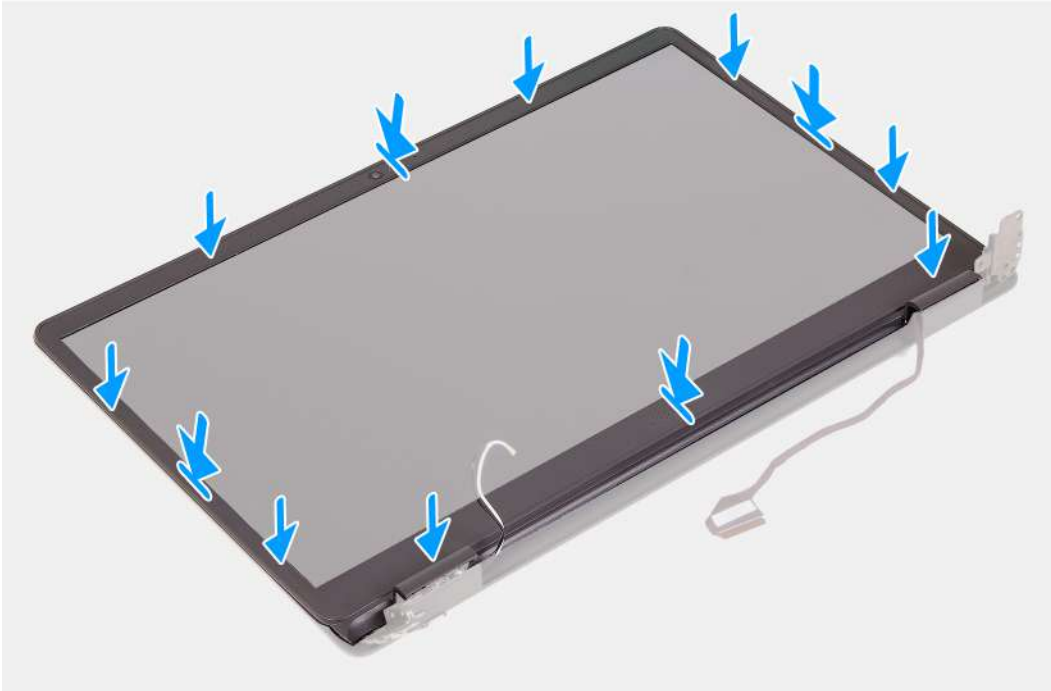

Steps

1. Place the display panel and display assembly on a clean and flat surface.
2. Place the display bezel on the display assembly.
3. Align the tabs on the display bezel to the slots on the display assembly.
4. Press down on the display bezel and snap the display bezel in place.

Next steps

1. Install the [display assembly](#).
2. Install the [wireless card](#).
3. Install the [base cover](#).
4. Follow the procedure in [After working inside your computer](#).

Display panel

Removing the display panel

Prerequisites

1. Follow the procedure in [Before working inside your computer](#).
2. Remove the [base cover](#).
3. Remove the [wireless card](#).
4. Remove the [display assembly](#).

5. Remove the [display bezel](#).

About this task

The following images indicate the location of the display panel and provides a visual representation of the removal procedure.



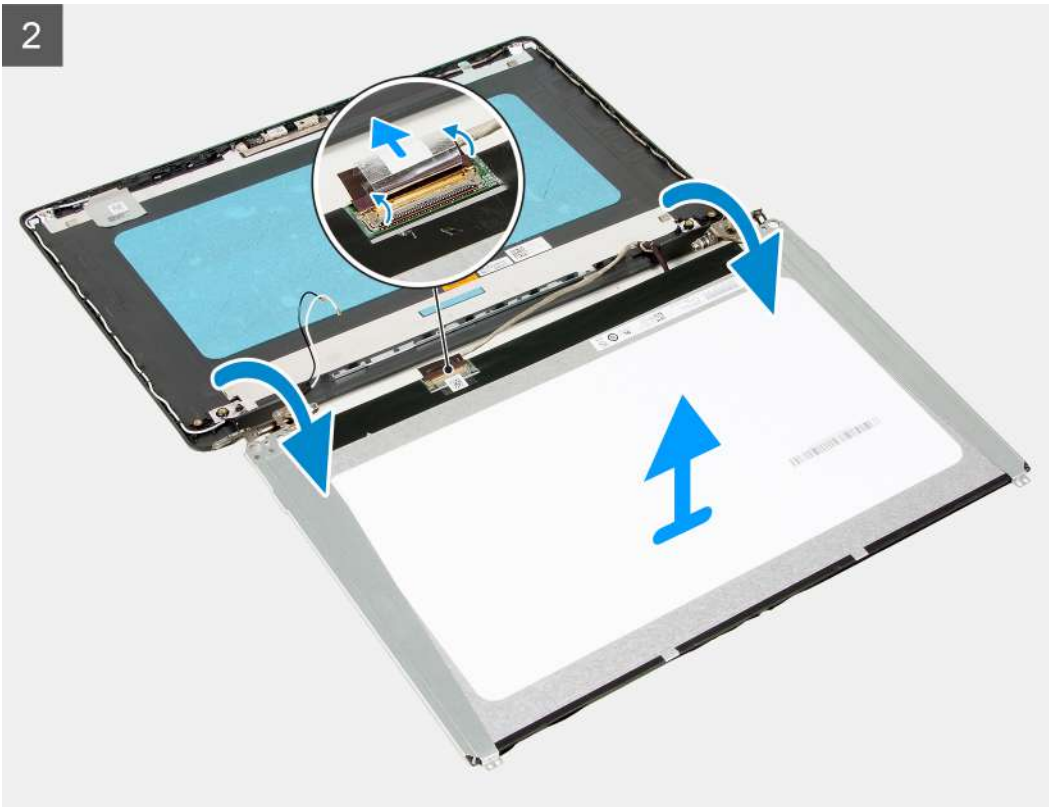

Steps

1. Remove the six screws (M2.5x2.5) that secure the display panel to the display assembly.
2. Remove the two screws (M2x2.5) that secure the display panel to the display assembly.
3. Lift and rotate the display panel forward.

NOTE: Ensure that the display panel has a smooth and clean surface to rest on to prevent damage.

4. Disconnect the display cable from the display panel.
5. Peel the tape that secures the display-cable connector latch to the display panel.
6. Lift the display-cable latch and disconnect the display cable from the display panel.
7. Lift the display panel off the display assembly.

NOTE: The display brackets are shipped together with the display panel, do not remove the display brackets from the display panel.

Installing the display panel

Prerequisites

If you are replacing a component, remove the existing component before performing the installation process.

About this task

The following images indicate the location of the display panel and provides a visual representation of the installation procedure.



6x
M2.5x2.5



2x
M2x2.5

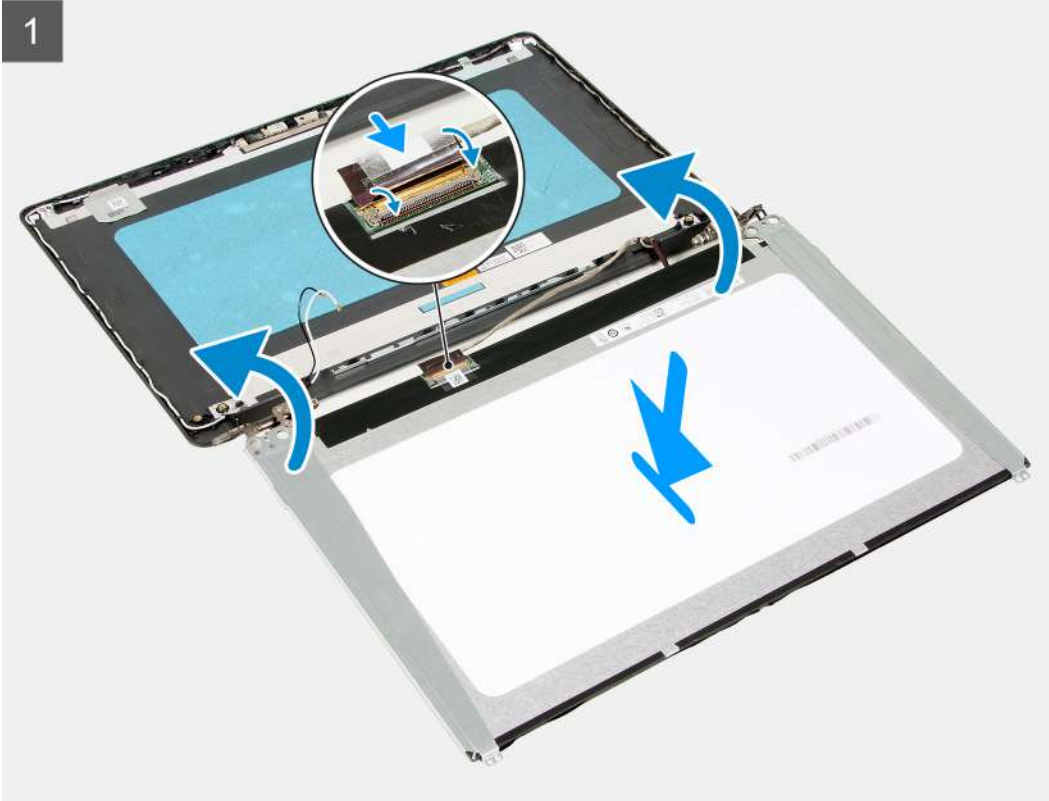

2



Steps

1. Place the display panel and display assembly on a clean and flat surface.
2. Connect the display cable to the connector on the display panel and close the latch.
3. Adhere the tape that secures the display-cable connector latch to the display panel.
4. Lift and rotate the display panel, then place the display panel on the display assembly.
5. Align the screw holes on the display panel to the screw holes on the display assembly.
6. Replace the six screws (M2.5x2.5) that secure the display panel to the display assembly.
7. Replace the two screws (M2x2.5) that secure the display panel to the display assembly.

Next steps

1. Install the [display assembly](#).
2. Install the [wireless card](#).
3. Install the [base cover](#).
4. Follow the procedure in [After working inside your computer](#).

Camera

Removing the camera

Prerequisites

1. Follow the procedure in [Before working inside your computer](#).
2. Remove the [base cover](#).
3. Remove the [wireless card](#).
4. Remove the [display assembly](#).
5. Remove the [display bezel](#).
6. Remove the [display panel](#).

About this task

The following images indicate the location of the camera and provides a visual representation of the removal procedure.

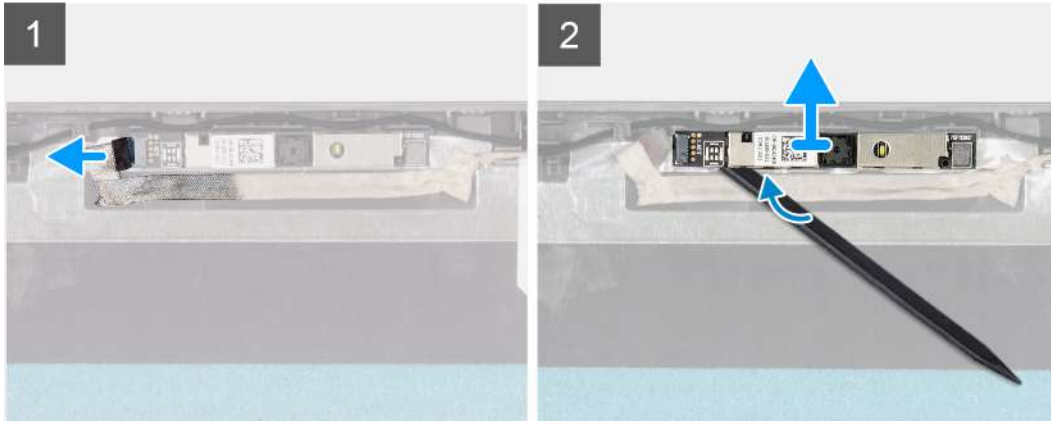
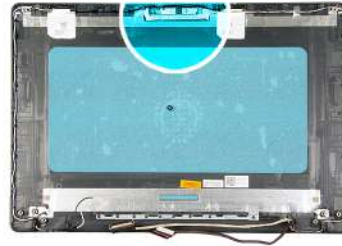

Steps

1. Using the pull tab, disconnect the camera cable from the camera.
2. Using a plastic scribe, pry the camera from the display assembly.
3. Lift the camera off the display assembly.

Installing the camera

Prerequisites

If you are replacing a component, remove the existing component before performing the installation process.

About this task

The following images indicate the location of the camera and provides a visual representation of the installation procedure.

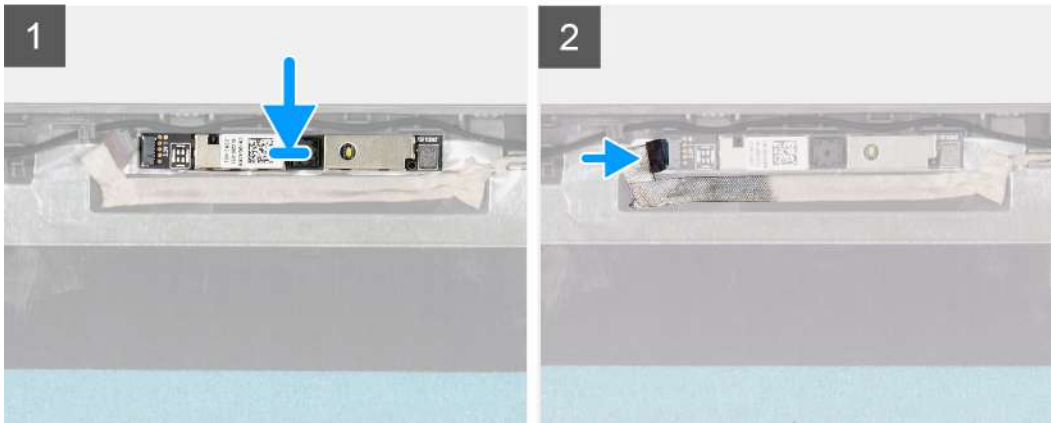
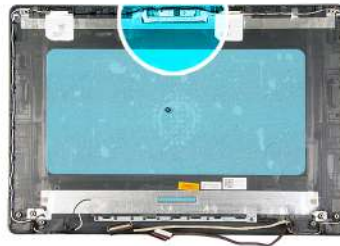

Steps

1. Adhere the camera in its slot on the display assembly.
2. Connect the camera cable to the camera.

Next steps

1. Install the [display panel](#).
2. Install the [display bezel](#).
3. Install the [display assembly](#).
4. Install the [wireless card](#).
5. Install the [base cover](#).
6. Follow the procedure in [After working inside your computer](#).

Touchpad

Removing the touchpad

Prerequisites

1. Follow the procedure in [Before working inside your computer](#).
2. Remove the [base cover](#).
3. Remove the [battery](#).

About this task

The following images indicate the location of the touchpad and provides a visual representation of the removal procedure.



5x
M2x2

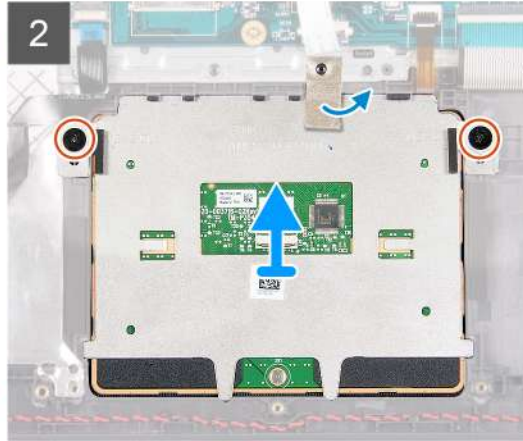
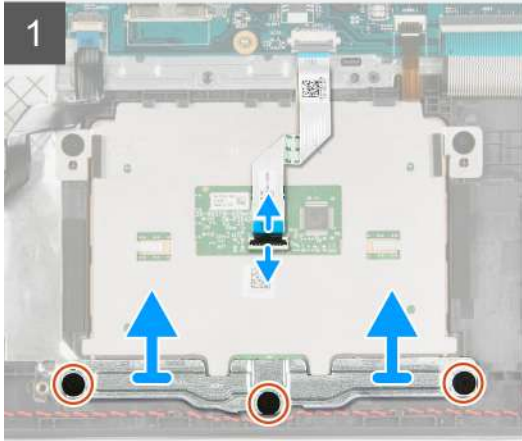

Steps

1. Open the latch and disconnect the the touchpad cable from the touchpad.
2. Remove the three screws (M2x2) that secure the touchpad bracket to the palm-rest and keyboard assembly.
3. Lift the touchpad bracket off the touchpad.
4. Remove the two screws (M2x2) that secure the touchpad to the palm-rest and keyboard assembly.
5. Peel the tape that secures the touchpad to the palm-rest and keyboard assembly.
6. Lift the touchpad off the palm-rest and keyboard assembly.

Installing the touchpad

Prerequisites

If you are replacing a component, remove the existing component before performing the installation process.

About this task

The following images indicate the location of the touchpad and provides a visual representation of the installation procedure.



5x
M2x2

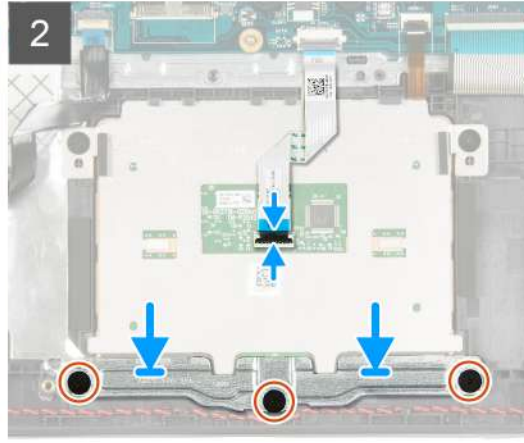
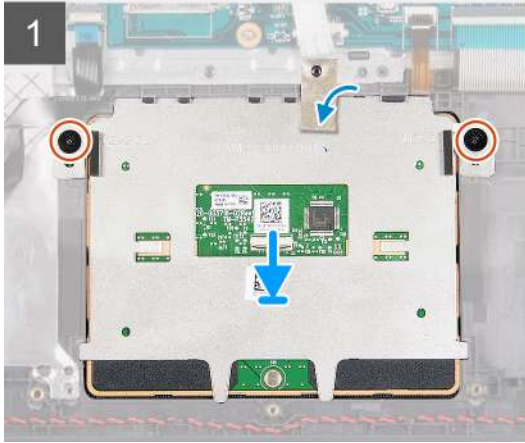

Steps

1. Place the touchpad into its slot on the palm-rest and keyboard assembly.
2. Align the screw holes on the touchpad to the screw holes on the palm-rest and keyboard assembly.
3. Turn the computer over and open the display to ensure that the touchpad is equally aligned on all sides.
4. Close the display and place the computer in the position shown.
5. Replace the two screws (M2x3) that secure the touchpad to the palm-rest and keyboard assembly.
6. Adhere the tape that secures the touchpad to the palm-rest and keyboard assembly.
7. Place the touchpad bracket on the touchpad.
8. Align the screw holes on the touchpad bracket to the screw holes on the palm-rest and keyboard assembly.
9. Replace the three screws (M2x3) that secure the touchpad bracket to the palm-rest and keyboard assembly.
10. Connect the touchpad cable to the touchpad and close the latch.

Next steps

1. Install the [battery](#).
2. Install the [base cover](#).
3. Follow the procedure in [After working inside your computer](#).

System board

Removing the system board

Prerequisites

1. Follow the procedure in [Before working inside your computer](#).
2. Remove the [base cover](#).
3. Remove the [M.2 2230 solid-state drive](#), if applicable.
4. Remove the [M.2 2280 solid-state drive](#), if applicable.
5. Remove the [memory module](#).
6. Remove the [fan](#).
7. Remove the [heat sink](#).
8. Remove the [wireless card](#).

9. Remove the [display assembly](#).

About this task

The following image indicates the connectors on the system board.

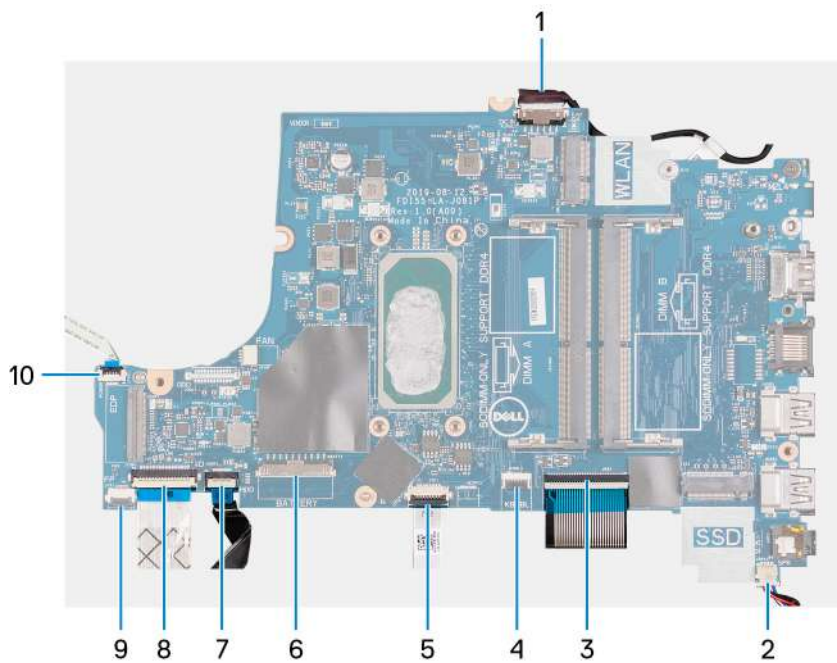

1. Power-adapter port cable
2. Speaker cable
3. Keyboard cable
4. Keyboard-backlight cable
5. Touchpad cable
6. Battery cable
7. Hard-drive cable
8. I/O-board cable
9. Fingerprint-reader cable
10. Power-button cable

The following images indicate the location of the system board and provides a visual representation of the removal procedure.



1x
M2x4

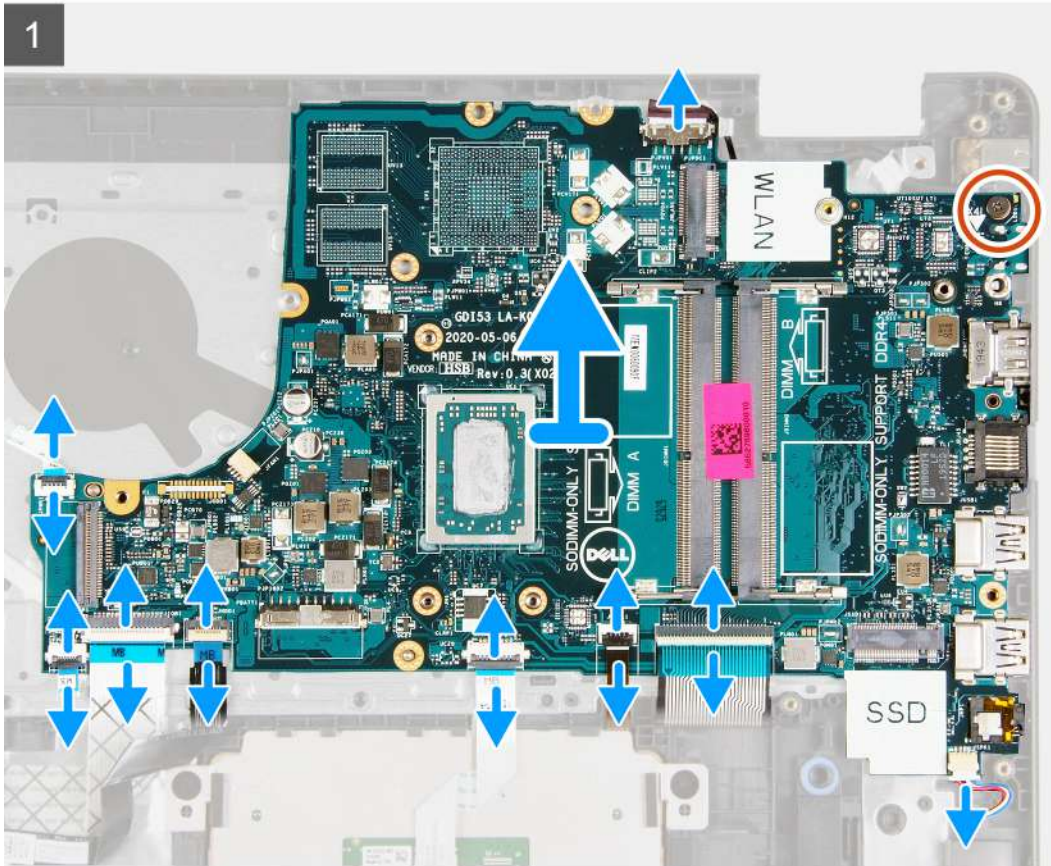
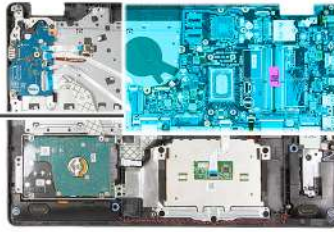

Steps

1. Disconnect the power-adapter port cable from the system board.
2. Disconnect the fan cable from the system board.
3. Open the latch and disconnect the fingerprint-reader cable from the system board, if applicable.
4. Open the latch and disconnect the I/O-board cable from the system board.
5. Open the latch and disconnect the hard-drive cable from the system board, if applicable.
6. Open the latch and disconnect the touchpad cable from the system board.
7. Open the latch and disconnect the keyboard-backlight cable from the system board, if applicable.
8. Open the latch and disconnect the keyboard cable from the system board.
9. Disconnect the speaker cable from the system board.
10. Remove the screw (M2x4) that secures the system board to the palm-rest and keyboard assembly.
11. Lift the system board off the palm-rest and keyboard assembly.

Installing the system board

Prerequisites

If you are replacing a component, remove the existing component before performing the installation process.

About this task

The following image indicates the connectors on the system board.

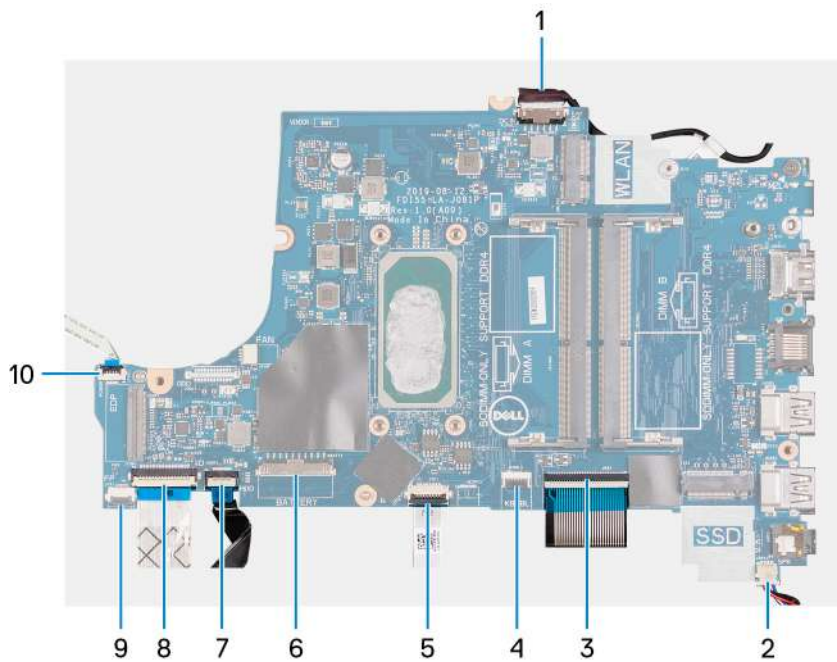

1. Power-adapter port cable
2. Speaker cable
3. Keyboard cable
4. Keyboard-backlight cable
5. Touchpad cable
6. Battery cable
7. Hard-drive cable
8. I/O-board cable
9. Fingerprint-reader cable
10. Power-button cable

The following images indicate the location of the system board and provides a visual representation of the installation procedure.



1x
M2x4

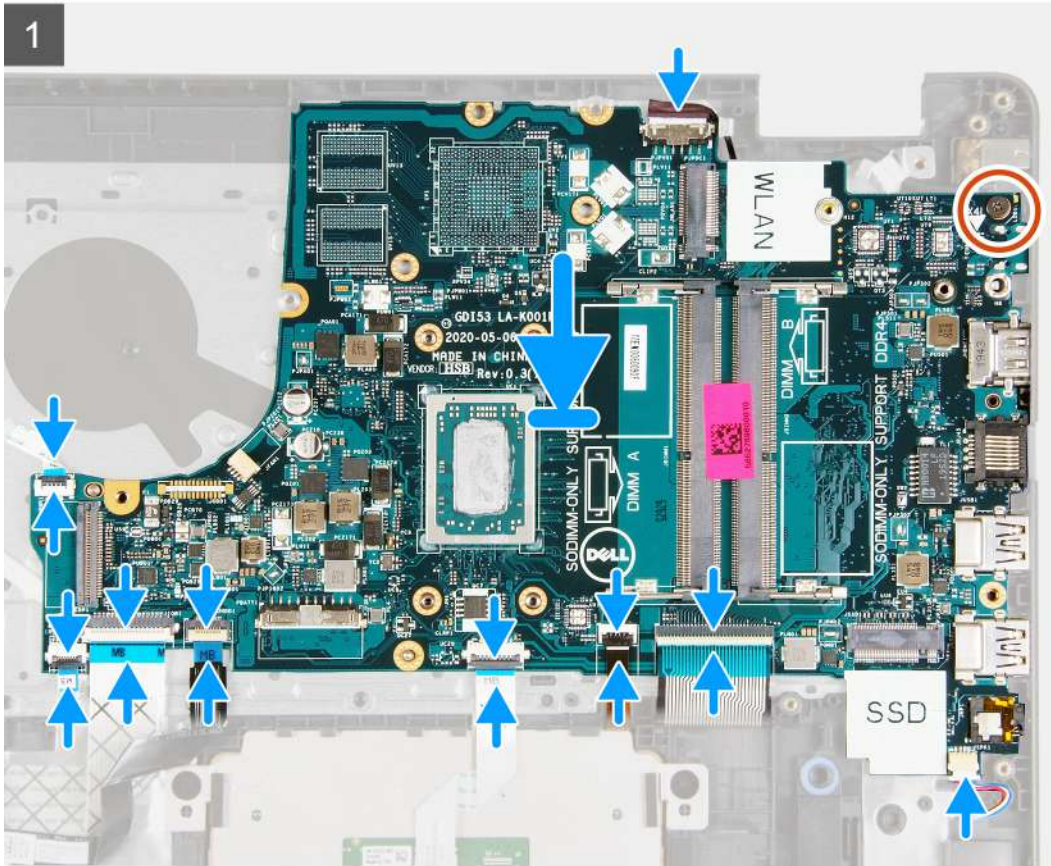
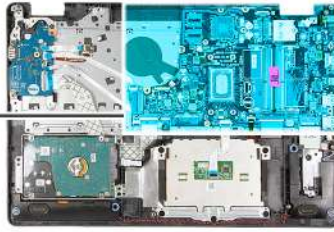

Steps

1. Place the system board on the palm-rest and keyboard assembly.
2. Align the screw hole on the system board to the screw hole on the palm-rest and keyboard assembly.
3. Replace the screw (M2x4) that secures the system board to the palm-rest and keyboard assembly.
4. Connect the speaker cable to the system board.
5. Connect the keyboard cable to the connector on the system board and close the latch.
6. Connect the keyboard-backlight cable to the connector on the system board and close the latch, if applicable.
7. Connect the touchpad cable to the connector on the system board and close the latch.
8. Connect the hard-drive cable to the connector on the system board and close the latch, if applicable.
9. Connect the I/O-board cable to the connector on the system board and close the latch.
10. Connect the fingerprint-reader cable to the connector on the system board and close the latch, if applicable.
11. Connect the fan cable to the system board.
12. Connect the power-adaptor port cable to the system board.

Next steps

1. Install the [display assembly](#).
2. Install the [wireless card](#).
3. Install the [heat sink](#).
4. Install the [fan](#).

5. Install the [memory module](#).
6. Install the [M.2 2230 solid-state drive](#), if applicable.
7. Install the [M.2 2280 solid-state drive](#), if applicable.
8. Install the [base cover](#).
9. Follow the procedure in [After working inside your computer](#).

Power-adapter port

Removing the power-adapter port

Prerequisites

1. Follow the procedure in [Before working inside your computer](#).
2. Remove the [base cover](#).
3. Remove the [M.2 2230 solid-state drive](#), if applicable.
4. Remove the [M.2 2280 solid-state drive](#), if applicable.
5. Remove the [fan](#).
6. Remove the [wireless card](#).
7. Remove the [display assembly](#).
8. Remove the [system board](#).

 **NOTE:** The system board can be removed along with the heat sink.

About this task

The following images indicate the location of the power-adapter port and provides a visual representation of the removal procedure.

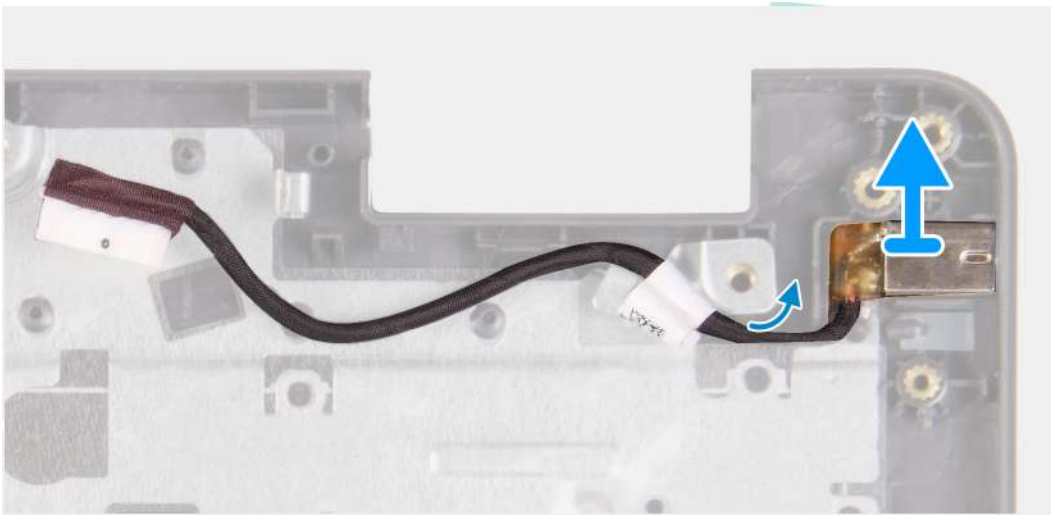

Steps

Lift the power-adapter port from its slot on the palm-rest and keyboard assembly.

Installing the power-adapter port

Prerequisites

If you are replacing a component, remove the existing component before performing the installation process.

About this task

The following images indicate the location of the power-adapter port and provides a visual representation of the installation procedure.

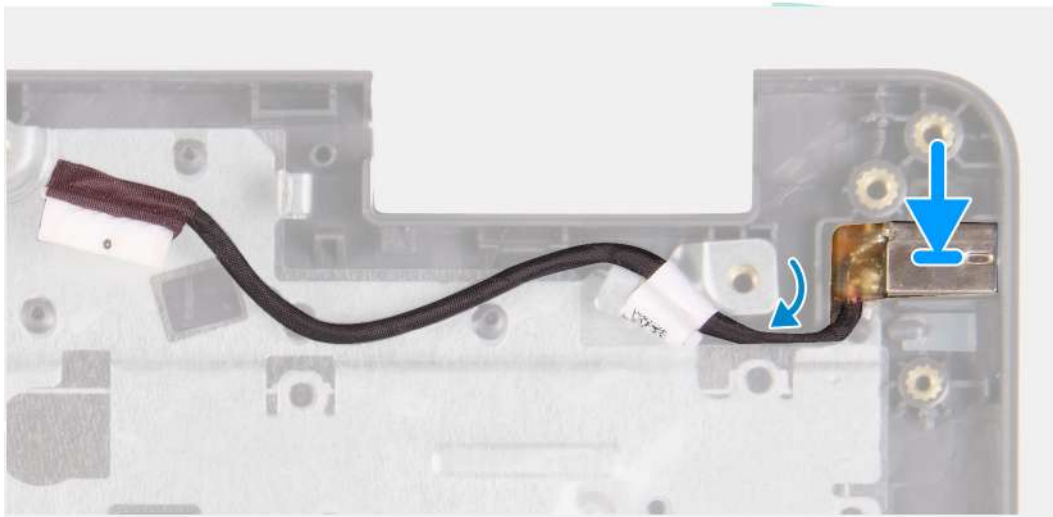

Steps

Place the power-adapter port into its slot on the palm-rest and keyboard assembly.

Next steps

1. Install the [system board](#).
2. Install the [display assembly](#).
3. Install the [wireless card](#).
4. Install the [fan](#).
5. Install the [M.2 2230 solid-state drive](#), if applicable.
6. Install the [M.2 2280 solid-state drive](#), if applicable.
7. Install the [base cover](#).
8. Follow the procedure in [After working inside your computer](#).

Palm-rest and keyboard assembly

Removing the palm-rest and keyboard assembly

Prerequisites

1. Follow the procedure in [Before working inside your computer](#).
2. Remove the [base cover](#).
3. Remove the [M.2 2230 solid-state drive](#), if applicable.
4. Remove the [M.2 2280 solid-state drive](#), if applicable.
5. Remove the [hard drive](#).
6. Remove the [fan](#).
7. Remove the [wireless card](#).
8. Remove the [display assembly](#).
9. Remove the [fingerprint-reader board](#).
10. Remove the [touchpad](#).
11. Remove the [speakers](#).
12. Remove the [I/O board](#).
13. Remove the [power-button with optional fingerprint reader](#).
14. Remove the [system board](#).
i **NOTE:** The system board can be removed along with the heat sink.
15. Remove the [power-adapter port](#).

About this task

The following images indicate the location of the palm-rest and keyboard assembly and provides a visual representation of the removal procedure.



Steps

After performing the pre-requisites you are left with the palm-rest and keyboard assembly.

Installing the palm-rest and keyboard assembly

Prerequisites

If you are replacing a component, remove the existing component before performing the installation process.

About this task

The following images indicate the location of the palm-rest and keyboard assembly and provides a visual representation of the installation procedure.



Steps

Place the palm-rest and keyboard assembly on a flat and clean surface and perform the post-requisites to install the palm-rest and keyboard assembly.

Next steps

1. Install the [power-adapter port](#).
2. Install the [system board](#).
3. Install the [power-button with optional fingerprint reader](#).
4. Install the [I/O board](#).
5. Install the [speakers](#).
6. Install the [touchpad](#).
7. Install the [fingerprint-reader board](#).
8. Install the [display assembly](#).
9. Install the [wireless card](#).
10. Install the [fan](#).
11. Install the [hard drive](#).
12. Install the [M.2 2230 solid-state drive](#), if applicable.
13. Install the [M.2 2280 solid-state drive](#), if applicable.
14. Install the [base cover](#).
15. Follow the procedure in [After working inside your computer](#).

Drivers and downloads

When troubleshooting, downloading or installing drivers it is recommended that you read the Dell Knowledge Based article, Drivers and Downloads FAQ [SLN128938](#).

System setup

CAUTION: Unless you are an expert computer user, do not change the settings in the BIOS Setup program. Certain changes can make your computer work incorrectly.

NOTE: Depending on the computer and its installed devices, the items listed in this section may or may not be displayed.

NOTE: Before you change BIOS Setup program, it is recommended that you write down the BIOS Setup program screen information for future reference.

Use the BIOS Setup program for the following purposes:

- Get information about the hardware installed in your computer, such as the amount of RAM and the size of the hard drive.
- Change the system configuration information.
- Set or change a user-selectable option, such as the user password, type of hard drive installed, and enabling or disabling base devices.

Entering BIOS setup program

Steps

1. Turn on your computer.
2. Press F2 immediately to enter the BIOS setup program.

NOTE: If you wait too long and the operating system logo appears, continue to wait until you see the desktop. Then, turn off your computer and try again.

Navigation keys

NOTE: For most of the System Setup options, changes that you make are recorded but do not take effect until you restart the system.

Table 3. Navigation keys

Keys	Navigation
Up arrow	Moves to the previous field.
Down arrow	Moves to the next field.
Enter	Selects a value in the selected field (if applicable) or follow the link in the field.
Spacebar	Expands or collapses a drop-down list, if applicable.
Tab	Moves to the next focus area. NOTE: For the standard graphics browser only.
Esc	Moves to the previous page until you view the main screen. Pressing Esc in the main screen displays a message that prompts you to save any unsaved changes and restarts the system.

One time boot menu

To enter **one time boot menu**, turn on your computer, and then press F2 immediately.

NOTE: It is recommended to shutdown the computer if it is on.

The one-time boot menu displays the devices that you can boot from including the diagnostic option. The boot menu options are:

- Removable Drive (if available)
- STXXXX Drive (if available)

NOTE: XXX denotes the SATA drive number.

- Optical Drive (if available)
- SATA Hard Drive (if available)
- Diagnostics

NOTE: Choosing **Diagnostics**, will display the **ePSA diagnostics** screen.

The boot sequence screen also displays the option to access the System Setup screen.

System setup options

NOTE: Depending on your computer and its installed devices, the items listed in this section may or may not appear.

Table 4. System setup options—Main menu

Main

System Time	Displays the current time in hh:mm:ss format.
System Date	Displays the current date in mm/dd/yyyy format.
BIOS Version	Displays the BIOS version.
Product Name	Displays the model number of your computer.
Service Tag	Displays the service tag of your computer.
Asset Tag	Displays the asset tag of your computer.
CPU Type	Displays the processor type.
CPU Speed	Displays the processor speed.
CPU ID	Displays the processor identification code.
CPU Cache	
L1 Cache	Displays the processor L1 cache size.
L2 Cache	Displays the processor L2 cache size.
L3 Cache	Displays the processor L3 cache size.
First HDD	Displays the type of hard drive installed.
M.2 PCIe SSD	Display the M.2 PCIe SSD device information of the computer.
AC Adapter Type	Displays the type of AC adapter.
System Memory	Displays the size of memory installed.
Memory Speed	Displays the speed of memory.
Keyboard Type	Displays the type of keyboard installed on the computer.

Table 5. System setup options—Advanced menu

Advanced	
PowerNow! Enable	Enables or disables the dynamic frequency scaling and power-saving technology for the AMD processor. Default: Enabled
Virtualization	Enables or disables the Virtualization technology. Default: Enabled
Integrated NIC	Enables or disables the on-board LAN controller. Default: Enabled
USB Emulation	Enables or disables the USB emulation feature. This feature defines how the BIOS, in the absence of a USB-aware operating system, handles USB devices. USB emulation is always enabled during POST. i NOTE: You cannot boot any type of USB device (floppy, hard drive, or memory key) when this option is off. Default: Enabled
USB Wake Support	Allows you to enable USB devices to wake the computer from standby or to disable the USB wake support feature. i NOTE: If USB PowerShare is enabled, a device connected to the USB PowerShare connector may not wake the computer. i NOTE: To enable wake support for the fingerprint reader the USB Wake Support needs to be enabled in the BIOS. To enable USB wake support, complete the steps in the knowledge base article SLN321473 . Default: Disabled
SATA Operation	Allows you to configure the operating mode of the integrated SATA hard drive controller. Default: AHCI
Adapter Warnings	Allows you to choose if the computer should display warning messages when you use AC adapters that are not supported by your computer. Default: Enabled
Function Key Behavior	Allows you to set function key or multimedia key as the default function key behavior. Default: Multimedia key
Keyboard Illumination	Selects the operating mode of the keyboard illumination feature. Default: Bright
Keyboard Backlight with AC	Selects the timeout value for the keyboard backlight when an AC adapter is plugged into the computer. Default: 1 minute
Keyboard Backlight with Battery	Selects the timeout value for the keyboard backlight when the computer is running on battery power. Default: 1 minute
Battery Health	Displays the battery health.
Camera	Enables or disables the camera.

Table 5. System setup options—Advanced menu (continued)

Advanced	
Battery Charge Configuration	<p>Default: Disabled</p> <p>Set the battery charge settings with a preselected custom charge start and stop.</p> <p>Default: Adaptive</p>
Advanced Battery Charge Configuration	<p>Enable Advanced Battery Charge Configuration from the beginning of the day to a specified work period.</p> <p>Default: Disabled</p>
Maintenance	
Data Wipe on next boot	<p>Enables or disables data wipe on the next boot.</p> <p>Default: Disabled</p>
BIOS Recovery from Hard Drive	<p>Enables the user to recover from certain corrupted BIOS conditions from a recovery file on the user primary hard drive or an external USB key.</p>
BIOS Auto-Recovery	<p>Enables BIOS to automatically recover BIOS without user actions.</p> <p>Default: Disabled</p>
SupportAssist System Resolution	
Auto OS Recovery Threshold	<p>Controls the automatic boot flow for SupportAssist System Resolution Console and for the Dell OS Recovery tool.</p> <p>Default: 2</p>
SupportAssist OS Recovery	<p>Enables or disables the boot flow for the SupportAssist OS Recovery tool in the even of certain system errors.</p> <p>Default: Disabled</p>

Table 6. System setup options—Security menu

Security	
Admin Password Status	Displays if the administrator password is clear or set.
System Password Status	<p>Displays if the system password is clear or set.</p> <p>Default: Not Set</p>
Service Tag	Set your system's Service Tag.
Admin Password	Allows you to set the administrator password. The administrator password controls access to the system setup utility.
System Password	Allows you to set the system password. The system password controls access to the computer at boot.
Password Change	<p>Allows you to permit or deny system password or HDD password changes.</p> <p>Default: Permitted</p>
Firmware TPM	<p>Enable or disable the firmware TPM.</p> <p>Default: Enabled</p>
PPI Bypass for Clear Command	<p>Allows you to control the TPM Physical Presence Interface (PPI). When enabled, this setting will allow the OS to skip BIOS PPI user prompts when issuing the Clear command. Changes to this setting take effect immediately.</p>

Table 6. System setup options—Security menu (continued)

Security	
UEFI Firmware Capsule Updates	Default: Disabled Enables or disables BIOS updates through UEFI capsule update packages.
WINDOWS SMM SECURITY MITIGATIONS TABLE (WSMT)	Default: Enabled Enables or disables configuration of platform features on Dell Client Systems with WSMT-enabled BIOS.
Secure Boot	Default: Enabled Enables or disables Secure Boot.

Table 7. System setup options—Boot menu

Boot	
File Browser Add Boot Option	Allows you to add boot options.

Table 8. System setup options—Exit menu

Exit	
Exit Saving Changes	Allows you to exit system setup and save your changes.
Save Change Without Exit	Allows you to save your changes without exiting the BIOS setup.
Exit Discarding Changes	Allows you to exit the BIOS setup without saving the changes.
Load Optimal Defaults	Allows you to restore default values for all system setup options.
Discard Changes	Allows you to load previous values for all system setup options.

Updating the BIOS in Windows

Prerequisites

It is recommended to update your BIOS (System Setup), when you replace the system board or if an update is available.

About this task

 **NOTE:** If BitLocker is enabled, it must be suspended before updating the system BIOS, and then re-enabled after the BIOS update is completed.

Steps

1. Restart the computer.
2. Go to www.dell.com/support.
 - Enter the **Service Tag** or **Express Service Code** and click **Submit**.
 - Click **Detect Product** and follow the on-screen instructions.
3. If you are unable to detect or find the Service Tag, click **Choose from all products**.
4. Choose the **Products** category from the list.

 **NOTE:** Choose the appropriate category to reach the product page.

5. Select your computer model and the **Product Support** page of your computer appears.
6. Click **Get drivers**, and then click **Drivers and Downloads**.
The Drivers and Downloads section is displayed.
7. Click **Find it myself**.
8. Click **BIOS** to view the BIOS versions.
9. Identify the latest BIOS file and click **Download**.
10. Select your preferred download method in the **Please select your download method below** window, and then click **Download File**.
The **File Download** window appears.
11. Click **Save** to save the file on your computer.
12. Click **Run** to install the updated BIOS settings on your computer.
Follow the on-screen instructions.

Updating BIOS on systems with BitLocker enabled

 **CAUTION:** If BitLocker is not suspended before updating the BIOS, the next time you reboot the system it will not recognize the BitLocker key. You will then be prompted to enter the recovery key to progress and the system will ask for this on each reboot. If the recovery key is not known this can result in data loss or an unnecessary operating system re-install. For more information on this subject, see Knowledge Article: <https://www.dell.com/support/article/sln153694>

Updating your system BIOS using a USB flash drive

About this task

If the computer cannot load into Windows but there is still a need to update the BIOS, download the BIOS file using another computer and save it to a bootable USB flash drive.

 **NOTE:** You must use a bootable USB flash drive. For more information, see the knowledge base article [SLN143196](#).

Steps

1. Download the BIOS update .exe file to another computer.
2. Copy the .exe file onto the bootable USB flash drive.
3. Insert the USB flash drive into the computer that requires the BIOS update.
4. Restart the computer and press F12 when the Dell logo appears to display the One Time Boot Menu.
5. Using arrow keys, select **USB Storage Device** and press Enter.
6. The computer restarts to a Diag C:\> prompt.
7. Run the file by typing the complete filename and press Enter.
8. The BIOS Update Utility is displayed. Follow the on-screen instructions.



Figure 1. DOS BIOS Update Screen

Flashing the BIOS from the F12 One-Time boot menu

Updating your system BIOS using a BIOS update.exe file copied to a FAT32 USB key and booting from the F12 one time boot menu.

About this task

BIOS Update

You can run the BIOS update file from Windows using a bootable USB key or you can also update the BIOS from the F12 One-Time boot menu on the system.

Most Dell systems built after 2012 have this capability and you can confirm by booting your system to the F12 One-Time Boot Menu to see if BIOS FLASH UPDATE is listed as a boot option for your system. If the option is listed, then the BIOS supports this BIOS update option.

NOTE: Only systems with BIOS Flash Update option in the F12 One-Time Boot Menu can use this function.

Updating from the One-Time Boot Menu

To update your BIOS from the F12 One-Time boot menu, you will need:

- USB key formatted to the FAT32 file system (key does not have to be bootable)
- BIOS executable file that you downloaded from the Dell Support website and copied to the root of the USB key
- AC power adapter connected to the system
- Functional system battery to flash the BIOS

Perform the following steps to execute the BIOS update flash process from the F12 menu:

CAUTION: Do not power off the system during the BIOS update process. Powering off the system could make the system fail to boot.

Steps

1. From a power off state, insert the USB key where you copied the flash into a USB port of the system .
2. Power on the system and press the F12 key to access the One-Time Boot Menu, Highlight BIOS Update using the mouse or arrow keys then press **Enter**.

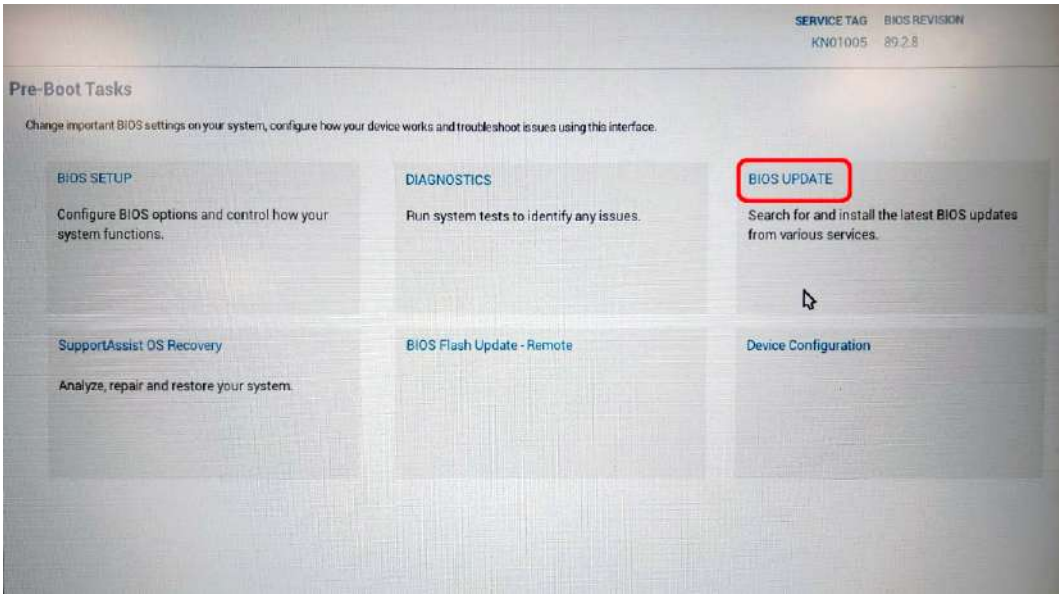

3. The flash BIOS menu will open, and then click the **Flash from file**.

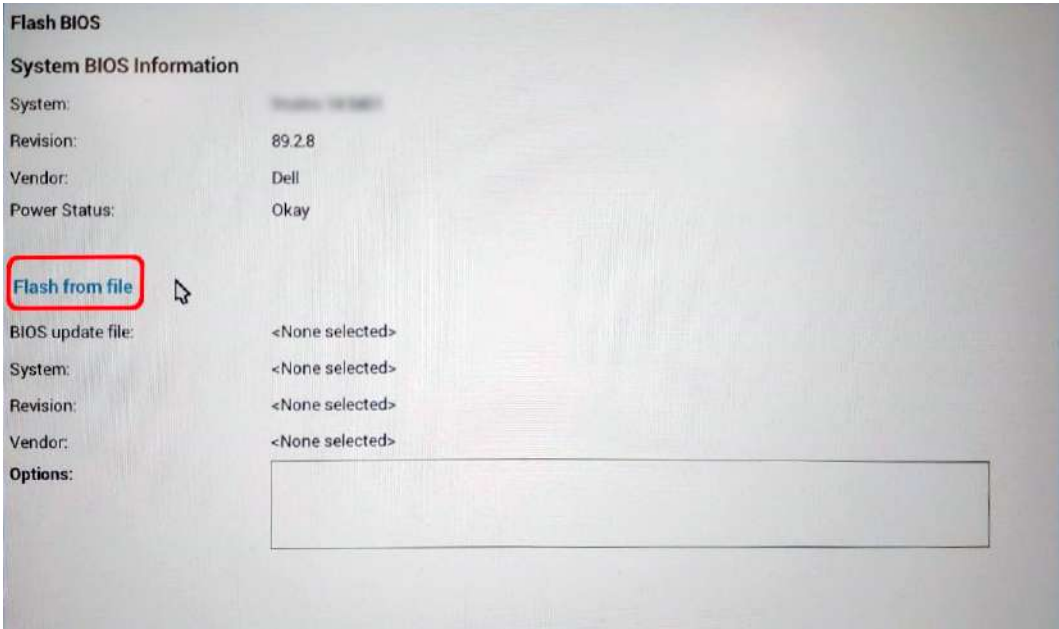

4. Select external USB device.

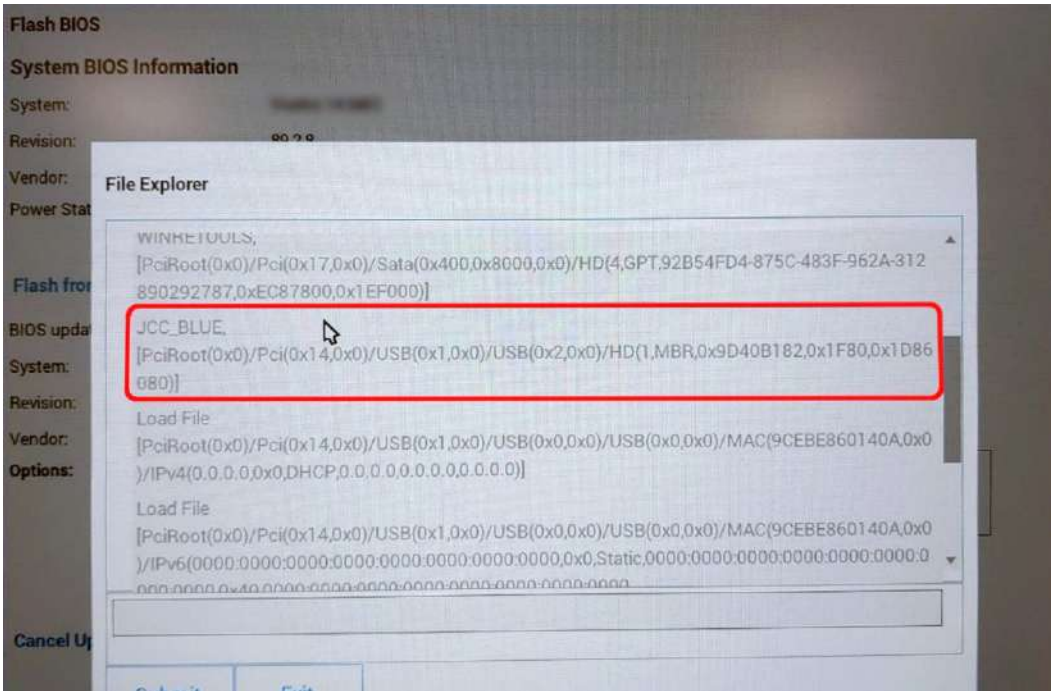

5. Once the file is selected, Double click the flash target file, then press submit.

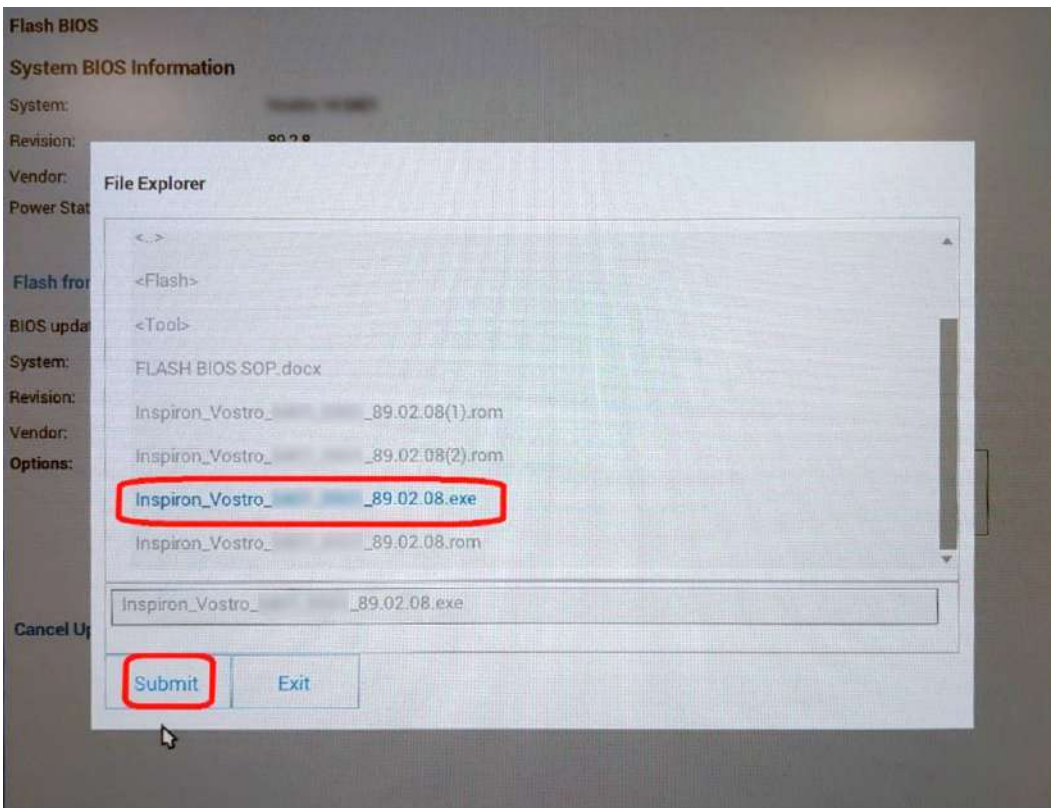

6. Click the **Update BIOS** then system will reboot to flash the BIOS.

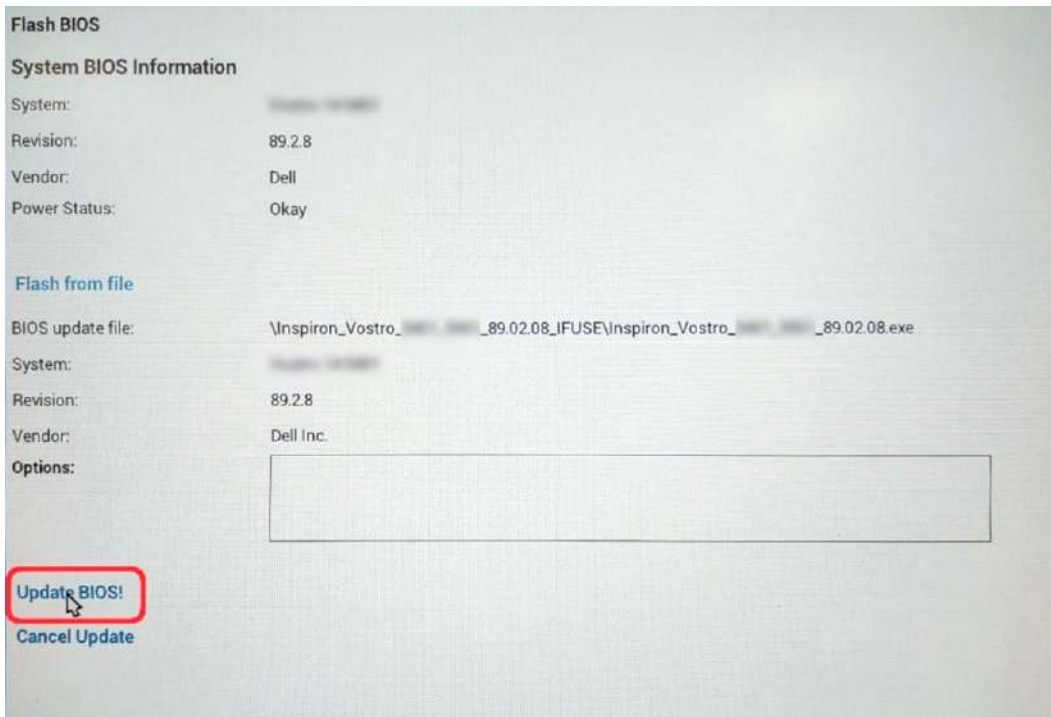

7. Once complete, the system will reboot and the BIOS update process is completed.

System and setup password

Table 9. System and setup password

Password type	Description
System password	Password that you must enter to log in to your system.
Setup password	Password that you must enter to access and make changes to the BIOS settings of your computer.

You can create a system password and a setup password to secure your computer.

CAUTION: The password features provide a basic level of security for the data on your computer.

CAUTION: Anyone can access the data that is stored on your computer if it is not locked and left unattended.

NOTE: System and setup password feature is disabled.

Assigning a system setup password

Prerequisites

You can assign a new **System or Admin Password** only when the status is in **Not Set**.

About this task

To enter the system setup, press F12 immediately after a power-on or reboot.

Steps

1. In the **System BIOS** or **System Setup** screen, select **Security** and press Enter. The **Security** screen is displayed.
2. Select **System/Admin Password** and create a password in the **Enter the new password** field.

Use the following guidelines to assign the system password:

- A password can have up to 32 characters.
 - The password can contain the numbers 0 through 9.
 - Only lower case letters are valid, upper case letters are not valid.
 - Only the following special characters are valid: Space, ("), (+), (.), (-), (.), (/), (:), ([), (\), (]), (`).
3. Type the system password that you entered earlier in the **Confirm new password** field and click **OK**.
 4. Press F10 to save the changes.
The computer restarts.

Deleting or changing an existing system setup password

Prerequisites

Ensure that the **Password Status** is Unlocked (in the System Setup) before attempting to delete or change the existing System password. You cannot delete or change an existing System password, if the **Password Status** is Locked.

About this task

To enter the System Setup, press F12 immediately after a power-on or reboot.

Steps

1. In the **System BIOS** or **System Setup** screen, select **System Security** and press Enter.
The **System Security** screen is displayed.
2. In the **System Security** screen, verify that **Password Status** is **Unlocked**.
3. Select **System Password**, update, or delete the existing system password, and press Enter or Tab.
 **NOTE:** If you change the System password, reenter the new password when prompted. To delete the System and/or Setup password, key in a blank entry into the password window and hit enter.
4. Press F10 to save the changes.
The computer restarts.

Clearing CMOS settings

About this task

 **CAUTION:** Clearing CMOS settings will reset the BIOS settings on your computer.

Steps

1. Remove the [base cover](#).
2. Disconnect the battery cable from the system board.
3. Remove the [coin-cell battery](#).
4. Wait for one minute.
5. Replace the [coin-cell battery](#).
6. Connect the battery cable to the system board.
7. Replace the [base cover](#).

Clearing BIOS (System Setup) and System passwords

About this task

To clear the system or BIOS passwords, contact Dell technical support as described at www.dell.com/contactdell.

-  **NOTE:** For information on how to reset Windows or application passwords, refer to the documentation accompanying Windows or your application.

Troubleshooting

Locate the Service Tag or Express Service Code of your Dell computer

Your Dell computer is uniquely identified by a Service Tag or Express Service Code. To view relevant support resources for your Dell computer, we recommend entering the Service Tag or Express Service Code at www.dell.com/support.

For more information on how to find the Service Tag for your computer, see [Locate the Service Tag for your Dell Laptop](#).

System-diagnostic lights

Power and battery-status light

The power and battery status light indicates the power and battery status of the computer. These are the power states:

Solid white:Power adapter is connected and the battery has more than 5% charge.

Amber:Computer is running on battery and the battery has less than 5% charge.

Off:

- Power adapter is connected, and the battery is fully charged.
- Computer is running on battery, and the battery has more than 5% charge.
- Computer is in sleep state, hibernation, or turned off.

The power and battery-status light may blink amber or white according to pre-defined "beep codes" indicating various failures.

For example, the power and battery-status light blinks amber two times followed by a pause, and then blinks white three times followed by a pause. This 2,3 pattern continues until the computer is turned off, indicating no memory or RAM is detected.

The following table shows different power and battery-status light patterns and associated problems.

NOTE: The following diagnostic light codes and recommended solutions are intended for Dell service technicians to troubleshoot problems. You should only perform troubleshooting and repairs as authorized or directed by the Dell technical assistance team. Damage due to servicing that is not authorized by Dell is not covered by your warranty.

Table 10. Diagnostic-light LED codes

Diagnostic light codes (Amber, White)	Problem description
2,1	Processor failure
2,2	System board: BIOS or ROM (Read-Only Memory) failure
2,3	No memory or RAM (Random-Access Memory) detected
2,4	Memory or RAM (Random-Access Memory) failure
2,5	Invalid memory installed
2,6	System-board or chipset error
2,7	Display failure - SBIOS message
3,1	Coin-cell battery failure

Table 10. Diagnostic-light LED codes (continued)

Diagnostic light codes (Amber, White)	Problem description
3,2	PCI, video card/chip failure
3,3	Recovery image not found
3,4	Recovery image found but invalid
3,5	Power-rail failure
3,6	System BIOS Flash incomplete
3,7	Management Engine (ME) error

Camera status light: Indicates whether the camera is in use.

- Solid white—Camera is in use.
- Off—Camera is not in use.

Caps Lock status light: Indicates whether Caps Lock is enabled or disabled.

- Solid white—Caps Lock enabled.
- Off—Caps Lock disabled.

SupportAssist diagnostics

About this task

The SupportAssist diagnostics (previously known as ePSA diagnostics) performs a complete check of your hardware. The SupportAssist diagnostics is embedded in the BIOS and is launched by it internally. The SupportAssist diagnostics provides a set of options for particular devices or device groups. It allows you to:

- Run tests automatically or in an interactive mode.
- Repeat tests
- Display or save test results
- Run thorough tests to introduce additional test options and provide extra information about the failed device(s)
- View status messages that indicate if the tests are completed successfully
- View error messages that indicate if problems were encountered during the test

 **NOTE:** Some tests are meant for specific devices and require user interaction. Ensure that you are present in front of the computer when the diagnostic tests are performed.

For more information, see [SupportAssist Pre-Boot System Performance Check](#).

Recovering the operating system

When your computer is unable to boot to the operating system even after repeated attempts, it automatically starts Dell SupportAssist OS Recovery.

Dell SupportAssist OS Recovery is a standalone tool that is preinstalled in all Dell computers installed with Windows 10 operating system. It consists of tools to diagnose and troubleshoot issues that may occur before your computer boots to the operating system. It enables you to diagnose hardware issues, repair your computer, back up your files, or restore your computer to its factory state.

You can also download it from the Dell Support website to troubleshoot and fix your computer when it fails to boot into their primary operating system due to software or hardware failures.

For more information about the Dell SupportAssist OS Recovery, see *Dell SupportAssist OS Recovery User's Guide* at www.dell.com/support.

Flashing BIOS (USB key)

Steps

1. Follow the procedure from step 1 to step 7 in "[Flashing the BIOS](#)" to download the latest BIOS setup program file.
2. Create a bootable USB drive. For more information see the knowledge base article [SLN143196](#) at www.dell.com/support.
3. Copy the BIOS setup program file to the bootable USB drive.
4. Connect the bootable USB drive to the computer that needs the BIOS update.
5. Restart the computer and press **F12** when the Dell logo is displayed on the screen.
6. Boot to the USB drive from the **One Time Boot Menu**.
7. Type the BIOS setup program filename and press **Enter**.
8. The **BIOS Update Utility** appears. Follow the instructions on the screen to complete the BIOS update.

Flashing the BIOS

About this task

You may need to flash (update) the BIOS when an update is available or when you replace the system board.

Follow these steps to flash the BIOS:

Steps

1. Turn on your computer.
2. Go to www.dell.com/support.
3. Click **Product support**, enter the Service Tag of your computer, and then click **Submit**.
 **NOTE:** If you do not have the Service Tag, use the auto-detect feature or manually browse for your computer model.
4. Click **Drivers & downloads > Find it myself**.
5. Select the operating system installed on your computer.
6. Scroll down the page and expand **BIOS**.
7. Click **Download** to download the latest version of the BIOS for your computer.
8. After the download is complete, navigate to the folder where you saved the BIOS update file.
9. Double-click the BIOS update file icon and follow the instructions on the screen.

WiFi power cycle

About this task

If your computer is unable to access the internet due to WiFi connectivity issues a WiFi power cycle procedure may be performed. The following procedure provides the instructions on how to conduct a WiFi power cycle:

 **NOTE:** Some ISPs (Internet Service Providers) provide a modem/router combo device.

Steps

1. Turn off your computer.
2. Turn off the modem.
3. Turn off the wireless router.
4. Wait for 30 seconds.
5. Turn on the wireless router.
6. Turn on the modem.
7. Turn on your computer.

Flea power release

About this task

Flea power is the residual static electricity that remains on the computer even after it has been powered off and the battery has been removed. The following procedure provides the instructions on how to conduct flea power release:

Steps



1. Turn off your computer.
2. Disconnect the power adapter from your computer.
3. Press and hold the power button for 15 seconds to drain the flea power.
4. Connect the power adapter to your computer.
5. Turn on your computer.

Getting help and contacting Dell

Self-help resources

You can get information and help on Dell products and services using these self-help resources:

Table 11. Self-help resources

Self-help resources	Resource location
Information about Dell products and services	www.dell.com
My Dell	
Tips	
Contact Support	In Windows search, type Contact Support , and press Enter.
Online help for operating system	www.dell.com/support/windows www.dell.com/support/linux
Troubleshooting information, user manuals, setup instructions, product specifications, technical help blogs, drivers, software updates, and so on.	www.dell.com/support
Dell knowledge base articles for a variety of computer concerns.	<ol style="list-style-type: none"> 1. Go to https://www.dell.com/support/home/?app=knowledgebase. 2. Type the subject or keyword in the Search box. 3. Click Search to retrieve the related articles.
Learn and know the following information about your product: <ul style="list-style-type: none"> • Product specifications • Operating system • Setting up and using your product • Data backup • Troubleshooting and diagnostics • Factory and system restore • BIOS information 	See <i>Me and My Dell</i> at www.dell.com/support/manuals . To locate the <i>Me and My Dell</i> relevant to your product, identify your product through one of the following: <ul style="list-style-type: none"> • Select Detect Product. • Locate your product through the drop-down menu under View Products. • Enter the Service Tag number or Product ID in the search bar.

Contacting Dell

To contact Dell for sales, technical support, or customer service issues, see www.dell.com/contactdell.

 **NOTE:** Availability varies by country and product, and some services may not be available in your country.

 **NOTE:** If you do not have an active internet connection, you can find contact information on your purchase invoice, packing slip, bill, or Dell product catalog.