

BOWFLEX Xceed™

OWNER'S MANUAL

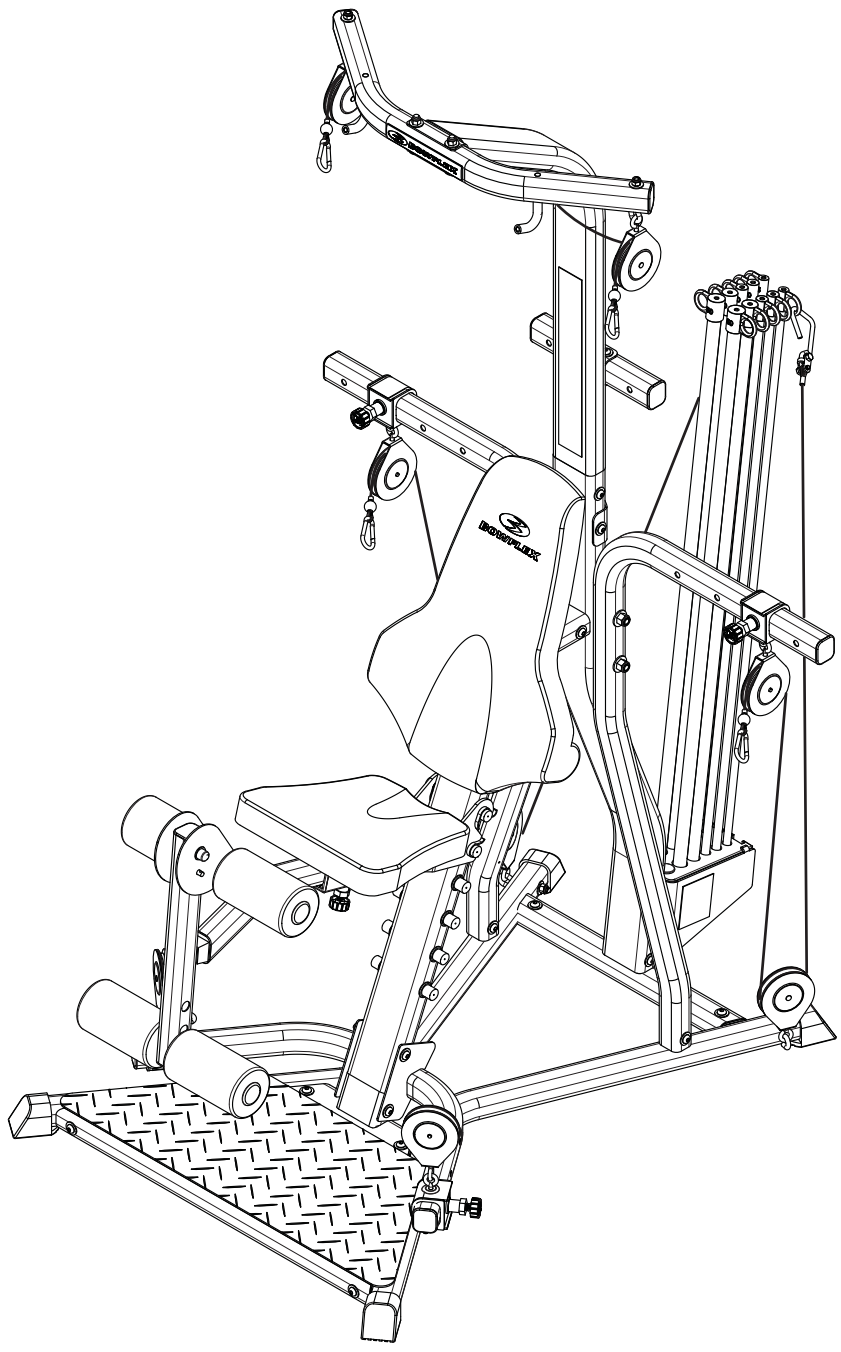

Congratulations / Registration

CONGRATULATIONS on your commitment to improving your health and fitness! With the Bowflex Xceed™ home gym, you have everything you need to exceed all of your physical fitness, strength, and health expectations!

The Bowflex Xceed™ home gym's exceptional resistance and quality is unmatched by any other single piece of home fitness equipment available. You will not believe the amazing results your body will get with the Bowflex Xceed™ home gym!

Please take your time to read through the entire manual and follow it carefully before attempting to use your Bowflex Xceed™ home gym. Also locate and read all warning labels that are posted on the machine. It's important to understand how to properly perform each exercise before you do so using Power Rod™ Resistance.

With all of the fitness choices available today, finding the best workout equipment for your needs can be very confusing. Everyone at Nautilus would like to thank you for selecting the Bowflex Xceed™ home gym.

The Bowflex Xceed™ home gym is the finest home fitness product available, and you're just about to prove it to yourself.

To validate warranty support, keep the original proof of purchase and record the following information:

Serial Number _____

Date of Purchase _____

If purchased in US/Canada: To register your product warranty, go to: www.bowflex.com/register or call 1 (800) 605-3369.

If purchased outside US/Canada: To register your product warranty, contact your local distributor.

For details regarding product warranty or if you have questions or problems with your product, please contact your local Bowflex distributor. To find your local distributor, go to: www.nautilusinternational.com

Nautilus, Inc., 5415 Centerpoint Parkway, Groveport, OH 43125 USA, www.NautilusInc.com - Customer Service: North America (800) 605-3369, csnls@nautilus.com | outside U.S. or Canada: www.nautilusinternational.com | Printed in China | © 2018 Nautilus, Inc. | ® indicates trademarks registered in the United States. These marks may be registered in other nations or otherwise protected by common law. Bowflex, the Bowflex logo, Bowflex Xceed, Power Rod, Nautilus, Schwinn, and Universal are trademarks owned by or licensed to Nautilus, Inc. Nut Thins® is a trademark of their respective owner.

ORIGINAL MANUAL - ENGLISH VERSION ONLY

Important Safety Information	2	Crossover Narrow Pulldowns w/ Hand Grips	35
Safety Warning Labels and Serial Number	3	Seated Lat Pulldowns	36
Product Specifications	5	Seated Wide Lat Pulldowns	36
Regulatory Approvals	5		
Features	6	Arm Exercises:	
Operations	8	Triceps Pushdown w/ Hand Grips	37
Define Your Goals	11	Triceps Hammer Pushdown	37
		Triceps Pushdown w/ Bent Lat Bar	38
The Workouts:		Triceps Extension	38
The 20 Minute Better Body Workout	14	Hammer Triceps Extension	39
Advanced General Conditioning	14	Cross Triceps Extension	39
20 Minute Upper / Lower Body	15	Triceps Kickback	40
Body Building	16	Hammer Triceps Kickback	40
Circuit Training Anaerobic / Cardiovascular	17	Resisted Dip	41
True Aerobic Circuit Training	18	Biceps Curl	41
Strength Training	19	Concentration Biceps Curl	42
		Reverse Curl	42
Chest Exercises:		Barbell Biceps Curl	43
Bench Press	20	Reverse Barbell Biceps Curl	43
Chest Fly	20	Seated Biceps Curl	44
Decline Bench Press	21	Seated Biceps Hammer Curl	44
Incline Bench Press	21	Wrist Extension	45
		Wrist Curl	45
Shoulder Exercises:		Abdominal Exercises:	
Reverse Fly	22	Trunk Rotation	46
Crossover Reverse Fly	22	Seated (resisted) Oblique Abdominal Crunch	46
Crossover Rear Deltoid Rows	23	Seated (resisted) Abdominal Crunch	47
Crossover High Rear Deltoid Rows	23		
Lateral Shoulder Raise	24	Leg Exercises:	
Forearm Lateral Shoulder Raise	24	Leg Extension	48
Front Shoulder Raise	25	Squat	48
Seated Shoulder Press	25	Standing Hip Extension (knee bent)	49
Shoulder Rotator Cuff (internal)	26	Standing Hip Extension (knee extended)	49
Shoulder Rotator Cuff (external)	26	Leg Kickback	50
Shoulder Extension	27	Hip Flexion	50
Shoulder Shrug	27	Dead Lift	51
Scapular Protraction	28	Stiff Leg Dead Lift	51
Scapular Depression	28	Standing Hip Adduction	52
Scapular Retraction	29	Standing Hip Abduction	52
		Calf Raise	53
Back Exercises:		Muscle Chart	54
Standing Shoulder Pullover w/ Bent Lat Bar	30	Exercise Log	55
Standing Shoulder Pullover w/ Hand Grips	30	Maintenance	56
Narrow Pulldowns w/ Bent Lat Bar	31		
Narrow Pulldowns w/ Hand Grips	31	Bowflex Body Weight Loss Guide	57
Bent Over Row	32	Warranty	65
Crossover Bent Over Row	32		
Seated Lat Rows	33		
Crossover Seated Lat Rows	33		
Standing Low Back Extension	34		
Reverse Grip Pulldowns	34		
Crossover Wide Pulldowns w/ Hand Grips	35		

Important Safety Instructions

 This icon means a potentially hazardous situation which, if not avoided, could result in death or serious injury.

Obey the following warnings:

 Read and understand all Warnings on this machine.

 Read and understand the complete Owner's Manual. Keep Owner's Manual for future reference.

Read and understand all Warnings on this machine. If at any time the Warning labels become loose, unreadable or dislodged, replace the labels. If purchased in US/Canada, contact Customer Service for replacement labels. If purchased outside US/Canada, contact your local distributor for them.

- Children must not be let on or near to this machine. Moving parts and other features of the machine can be dangerous to children.
- Not intended for use by anyone under 14 years of age.
- Consult a physician before you start an exercise program. Stop exercising if you feel pain or tightness in your chest, become short of breath, or feel faint. Contact your doctor before you use the machine again.
- Before each use, examine this machine for loose parts or signs of wear. Inspect all cables, pulleys and their connections, making sure they are properly secured and attached, and show no signs of visible wear or damage. Do not use if found in this condition. If purchased in US/Canada, contact Customer Service for repair information. If purchased outside US/Canada, contact your local distributor for repair information.
- Maximum user weight limit: 300 lb. (136 kg). Do not use if you are over this weight.
- This machine is for home use only.
- Do not wear loose clothing or jewelry. This machine contains moving parts. Do not put fingers or other objects into moving parts of the exercise equipment.
- Always wear rubber soled athletic shoes when you use this machine. Do not use the machine with bare feet or only wearing socks.
- Set up and operate this machine on a solid, level, horizontal surface.
- Do not operate this machine outdoors or in moist or wet locations.
- Keep at least 36" (0.9m) on each side of the machine clear. This is the recommended safe distance for access and passage around and emergency dismounts from the machine. Keep third parties out of this space when machine is in use.
- Do not over exert yourself during exercise. Operate the machine in the manner described in this manual.
- Never attempt to exercise with more resistance than you can safely and comfortably handle.
- Do not use Dumbbells or other weight equipment to incrementally increase the weight resistance. Use only the weight resistance that came with your gym.
- Rods are under tension. Be careful when connecting the Selector Hook to the Rod. Correctly engage the Selector Hook to the Rod End. Be sure there is a solid connection before releasing the Rod.
- Never stand directly over the top of the rods. Stay off to the side while you attach the rods.
- Correctly adjust and safely engage all Positional Adjustment Devices. Make sure that the Adjustment Devices do not hit the user.
- Keep clear of Power Rod™ movement path during operation. Keep any bystanders clear of machine and Power Rod™ movement path during operation.

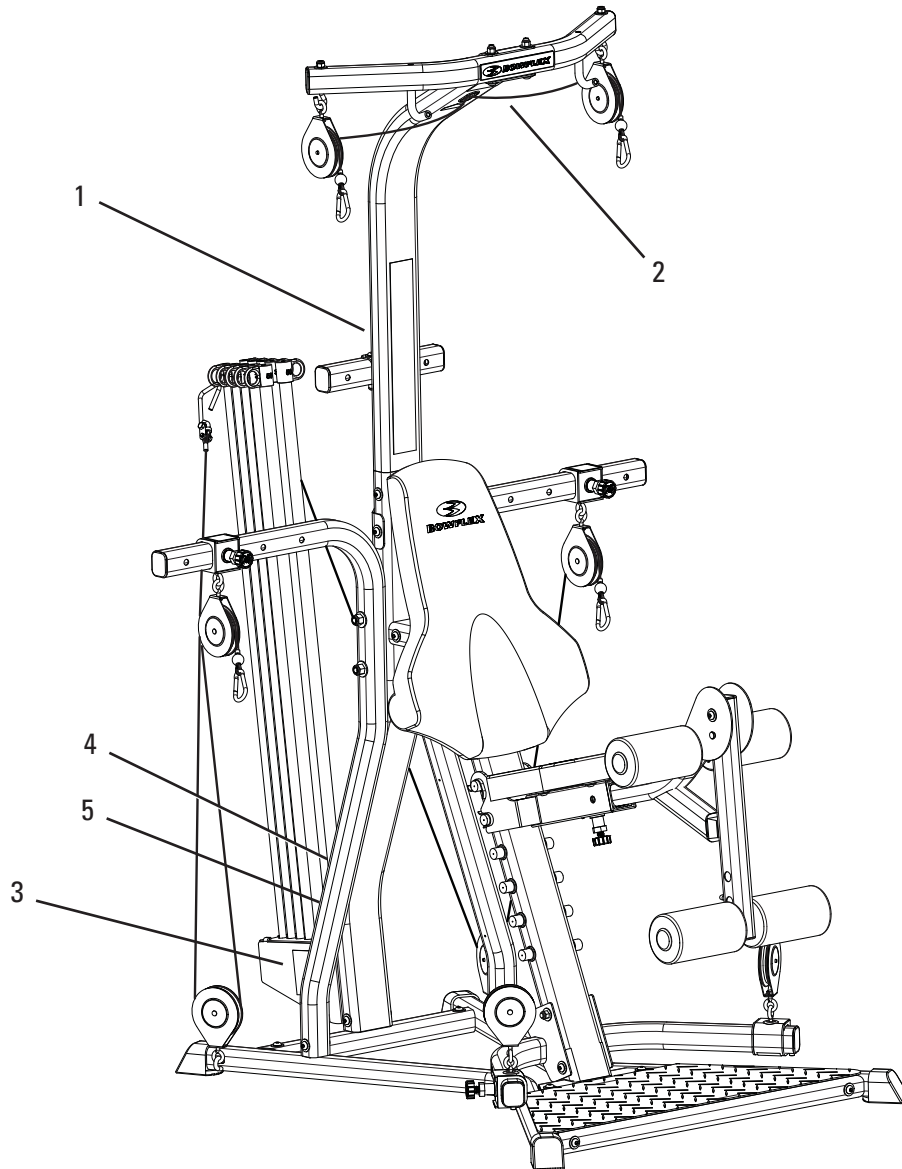

	Type	Description
1	WARNING	<ol style="list-style-type: none"> 1. Keep children and pets away from this machine at all times. 2. Prior to use, read and understand the User's Guide, including all Warnings which may or may not be present on this machine. 3. Before each use check all snap hooks, cables and pulleys for wear and proper function. Tighten all fasteners as necessary. Do not use if any parts are in need of repair. 4. Use Caution when you use this equipment or serious injury can occur. 5. This machine is for Residential use only. 6. The Maximum User Weight for this machine is 300 pounds (136 KG). 7. Replace any Warning label that becomes damaged, illegible or is removed. 8. Not intended for use by anyone under 14 years of age.

Type		Description
2	[NOTICE]	Do not hang from bar.
		Ne pas pendre de la barre.
		Nicht von der Stange hängen.
		No cuelgue de la barra.
3	CAUTION	At all times, stay out of the paths of moving rods.
	MISE EN GARDE	Restez toujours à l'écart des tiges mobiles.
	VORSICHT	Halten Sie stets Abstand zu beweglichen Stangen.
	PRECAUCIÓN	En todo momento, manténgase alejado del trayecto de las barras móviles.
4	Product Specifications	Product specifications and regulatory information
5	Serial Number	Record this number in the Serial Number field at the beginning of this manual.

Product Specifications

Product Weight	157 lbs. (71 kg)
Product Dimensions	53" (135 cm) long x 49" (124 cm) wide x 82" (208 cm) high
Workout Area	125" (317.5 cm) long x 121" (307.3 cm) wide
Number of Exercises	Over 60
Power Rod™ Resistance	210 units of resistance
Power Rod™ Upgradability	310 units of resistance 410 units of resistance
User Weight Limit	300 lbs. (136 kg)



DO NOT dispose of this product as refuse. This product is to be recycled. For proper disposal of this product, please follow the prescribed methods at an approved waste center.

Features

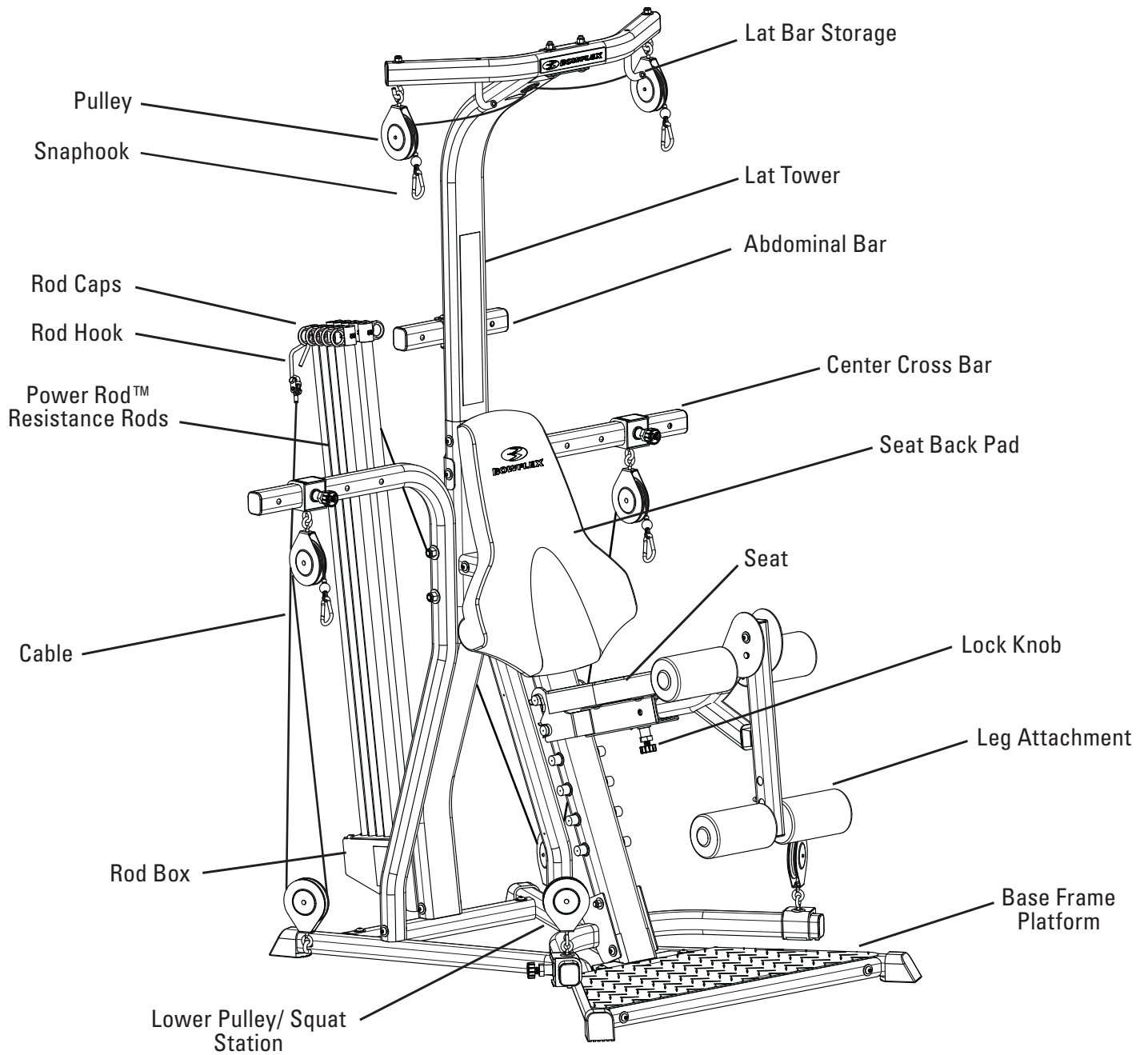

Adjusting and Understanding the Resistance

Power Rod™ units are made from a special composite material. The rods are sheathed with a protective black coating. Each rod is marked with a resistance rating on the “Rod Cap”

The Bowflex Xceed™ home gym comes with 210 units of resistance provided by the Rod Pack. The full resistance is divided among a 5, two 10s, a 30, and a 50 unit rod on each side of the machine, for a combined total of 210 units.

Note: Power Rod™ Resistance Rods are manufactured using nylon composite material. The weight resistance measurements are estimates and resistance can vary based on environmental and usage patterns and other factors. Rod resistance will normally degrade over time and after extensive usage. If you have any questions regarding the resistance of your Power Rod™ Resistance Rods, contact Customer Service (if purchased in US/Canada) or your local distributor (if purchased outside US/Canada) for assistance.



If you upgraded to 310 units of resistance or 410 units of resistance you will have an additional one or two 50 unit rods, respectively.

Connecting the Power Rod™ Unit to the Cables

You may use one rod or several rods in combination, to create your desired resistance level.

To hook multiple rods up to one cable, bend the closest rod toward the cable and place the cable hook through that rod cap. You can then hook up the next closest rod through the same cable hook.

Hooking up the closest rod first prevents rods from crossing over the top of one another.

⚠ When you attach the Power Rod™ units do not stand directly looking above the top of the rods. Stay off to the side while you attach the rods.

Be sure to maintain a firm grip on the rods when handling them since they are under tension.

When You Are Not Using Your Home Gym

Disconnect the cables from the Power Rod™ unit when you are not using your home gym. Use the Rod Binding Strap included with your machine to bind all the rods together at the top. You can also place your cables and grips through the strap to keep them out of the way. Leaving the rods and cables under tension could cause injury if a rod were inadvertently released.

⚠ Keep the cables and Power Rod™ units bound with the rod binding strap when not in operation, and be sure and remove the binding strap before beginning any exercises using the rods.

To order an additional set of 50 unit rods, please contact Customer Service (if purchased in US/Canada) or your local distributor (if purchased outside US/Canada).

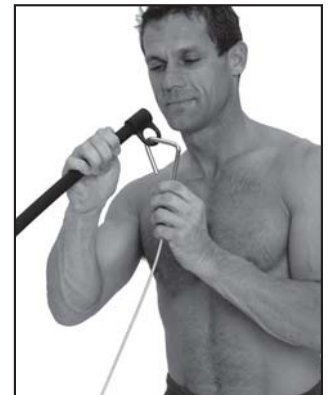

The Bowflex Xceed™ Home Gym Pulley Positions

With the versatility to perform over 65 different exercises, the Bowflex Xceed™ home gym easily transitions from one exercise to another. Below is a guide to the five different pulley positions you will use to optimally perform your workout routine.



Position One:
Standard Position – most common. Active pulleys are on center cross bar.



Position Two:
Lat Pulldown Position. Active pulleys are on Lat Tower.



Position Three (optional):
Leg Extension Position. Active pulleys are on the squat pulley frame.



Position Four:
Squat position. Active pulleys are on squat pulley frame and on center cross bar.



Position Five:
Abdominal Crunch position. Active pulleys are on Lat Tower.



Position Six:
Rowing position. Active pulleys are on squat pulley frame.

The Bowflex Xceed™ Home Gym Cable Routing

As you use your home gym, you will connect the cables and pulleys in a variety of ways to perform the exercises. Refer to the illustrations below for proper cable routing.

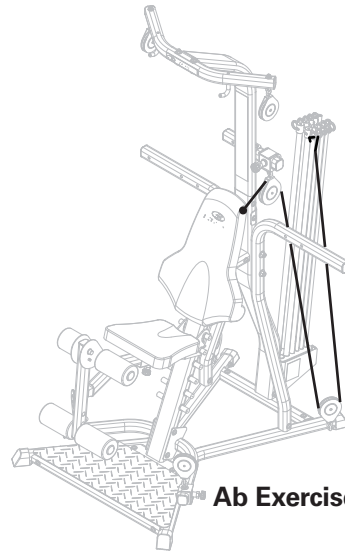

Ab Exercises



Chest Exercises

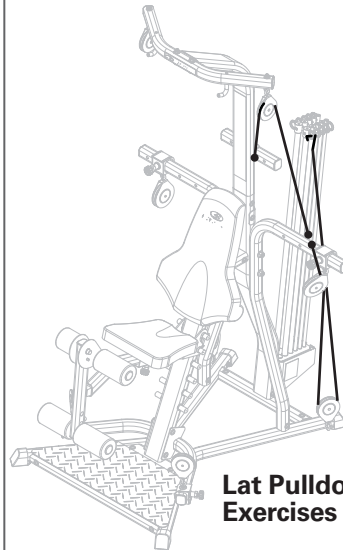

Lat Pulldown Exercises

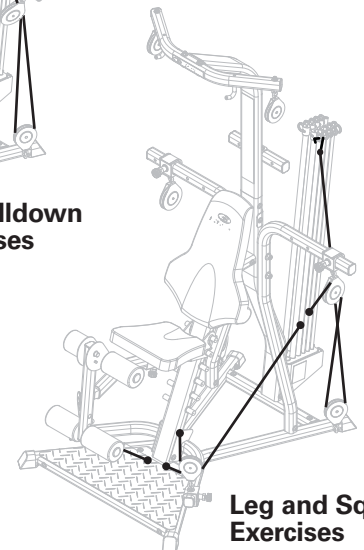

Leg and Squat Exercises

- ⚠ **Keep your body weight centered on the machine, seat or base frame platform while exercising.**
- When using the machine for standing leg exercises, always hold the Lat Tower of the machine for stability.**
- Do not make any adjustments to the seat while sitting on it. Do not stand on the seat.**
- All exercises in this manual are based on the calibrated resistance and capacity levels of this machine. Only exercises included in this manual or in written materials authorized and supplied by Bowflex™ are recommended for operation with this machine.**

Handgrips and Straps

The handgrips fit snugly around your wrist, ankle, or instep. Attach grips to cables by snapping the cable clip onto the D-ring.

Standard Grip:

Grasp the handle and cuff together to form a grip without inserting your hand through the cuff portion. Most exercises utilize this grip. The Standard Grip also is used for Hammer Grip exercises, when you need to hold the hand grip vertically for greater wrist support.

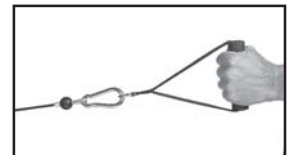

Hand Cuff Grip:

Slip your hand through the cuff so that the foam pad rests on the back of your hand. Then grasp the remainder of the grip that is sitting in your palm. This method of gripping is great for exercises like front shoulder raises or any exercise where your palm is facing down.



Ankle Cuff Grip:

The cuff opening can be made larger to accommodate the ankle. Simply insert your hand in the cuff and slide it away from the handle. Insert your foot or ankle and tighten the grip by sliding the handle back toward the cuff.



Arch Cuff Grip:

The cuff opening can also fit securely over the arch of your foot. For this grip, insert your foot through the cuff until it is around the arch of your instep, and tighten the cuff around your heel to secure the grip.



Abdominal Crunch Shoulder Harness:

Attach the snap hooks to the D-rings on both ends of the harness. Place the harness on your shoulders letting the handles hang over your chest. Grab both handles. With high resistance, a cross arm opposite-handle grip may be used.

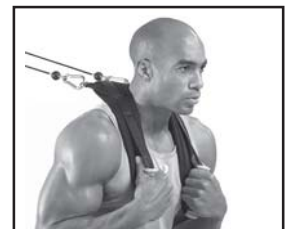

Lat Pulldown Bar

The Lat Pulldown Bar enhances exercises that work back, shoulders and triceps muscles.

Leg Extension Attachment

The leg extension attachment enables you to work the major muscle groups in the legs.

Abdominal Crunch Shoulder Harness

The ab harness gives you the ability to strengthen the muscles of the abdomen by safely adding resistance to abdominal exercises. When using the ab harness, relocate the pulleys from the chest bar to the short abdominal bar.

Squat Bar

The Squat Bar enhances exercises that work back, shoulders and triceps muscles.

Safety

⚠ Before using the grips, straps, Lat Bar, or Ab Harness, make sure that all fasteners are in place and tightened.

Make sure that auxiliary cables for the Lat Bar and Leg Extension are securely fastened to the primary cables on the unit.

Always use the lock knob on the slider to secure pulleys. Do not allow pulleys to change position during any exercise.

Always use the bar holders to support the Lat Bar or remove the bar when not in use.

When removing the Lat Bar from the bar holders, be prepared for it to fall before the cables fully support it. Injury may occur.

When using the Lat Bar, be sure to keep your hands dry enough to make a secure grip with it for the entire exercise. If your grip begins to become compromised, safely hang the Lat Bar in the bar holders and dry your hands. Do not allow the Lat Bar to slip from your grip during an exercise.

Do not hang from the Lat Tower nor attempt to perform “chin ups” from the bar.

Never pull on the bar unless there is resistance attached to it.

Always use the Lock Knob to secure the attachment to your Bowflex Xceed™ home gym.



Your body will do what you train it to do. That's why it's important to define your goals and focus them. Here are some fitness components that will help you define your goals and choose your fitness program.

Muscle Strength is the maximum force that you can exert against resistance at one time. Your muscle strength comes into play when you pick up a heavy bag of groceries or lift a small child. It is developed when a localized muscle is worked both positively (concentric) and negatively (eccentric) at a resistance – great enough so you can perform only five to eight repetitions of the exercise before the muscle fails. Each set of repetitions is followed by a rest interval that typically runs three times longer than the set. Later, between exercise sessions, the muscle overcompensates for the stress and usually increases in both strength and size.

Muscle Endurance is the ability to perform repeated contractions. It comes into play when you cross-country ski or work on your feet all day. Endurance training addresses the slow twitch, endurance muscle fibers, which depend on oxygen for energy. To develop muscle endurance, use low resistance and high repetitions – about 15-20 repetitions in each set, three sets to each exercise, working the muscle only to fatigue.

Muscle Power is the combination of strength and speed of the muscular contraction. This is often misinterpreted as A) being directly associated with certain skill or sport and/or B) meaning that you must move fast. Load is actually a more important factor than speed when attempting to improve power. When training to achieve muscular power, pick a resistance that fatigues you in the 3-5 repetition range. When performing these reps, it is more important to think of contracting the muscles faster rather than attempting to move faster. Performing sport simulation exercises usually results in a deterioration of the motor pattern or skill. The bio-mechanically sound method of improving power in your sport is to train for power using the correct joint movements, as described in this manual. Then practice the skill associated with your sport, learning to apply this newly achieved power.

Body Composition is the ratio of fat weight (fat) to lean weight (muscles, bones and tissue). As you age, the ratio shifts. The fat weight increases and the lean weight decreases. Training for muscle strength will generally increase muscle size and aerobic conditioning will help burn extra calories. Performing these two forms of exercise, either at different times or together, will create the greatest changes in body fat weight.

Balanced Strength and alignment are the result of equal strength developed in all parts of the body. It comes into play in your standing and sitting posture, and in your ability to perform just about any activity safely and effectively. An over-development of the back will round the shoulders; weak or stretched abdominals can cause lower back pain. You want a balance of muscle strength in front and back. In addition, you need a balance of strength between your middle, lower and upper body.

Flexibility is the ability of a muscle or group of muscles to move the joint through a full range of motion. Flexibility comes into play when you execute an overhand serve or stretch for the top shelf in the kitchen. It is a cooperative movement of opposite muscle groups. When a muscle contracts, its opposite muscle group must relax for the action to occur. Increased flexibility means an increased range of motion, made possible by this simultaneous contracting and relaxing. Good flexibility is important in protecting the body from injury and can be achieved through the balanced strength training programs that are included in this manual.

Cardiovascular Endurance is the ability of the heart and lungs to supply oxygen and nutrients to exercising muscles over an extended period of time. It comes into play when you jog a mile or ride a bike. It is a critical component of overall fitness and health. You may want to design your own personal program specifically geared to your goals and lifestyle. Designing a program is easy, as long as you follow the below guidelines.

Design Your Own Program

Understand fitness and its components. Improperly designed programs can be dangerous. Take some time to review this manual as well as other fitness guides.

Know your current fitness level. Before you start any fitness program you should consult a physician who will help you determine your current abilities.

Identify your goals. Goals are critical to choosing and designing an exercise program that fits and enhances your lifestyle, but so is strategy. It's important not to rush the process and try to accomplish too much too soon. That will lead to setbacks and discouragement. Instead, set a series of smaller achievable goals.

Select complementary exercises. Be sure to pair exercises that address compound joint movements and single joint movements. In addition, select exercises that address complimentary muscle groups.

Put first things first. During each session, first work muscle groups that need the most training.

Remember your cardiovascular component. Any fitness program must contain a cardiovascular fitness component to be complete. So complement your resistance training with aerobic exercise such as walking, running, or bicycling.

Training variables. When designing your own program there are several variables that, when mixed properly, will equal the right fitness formula for you. In order to find out the best formula, you must experiment with several combinations of variables.

The variables are as follows:

- **Training Frequency:** The number of times you train per week. We recommend daily activity but not daily training of the same muscle group.
- **Training Intensity:** The amount of resistance used during your repetition.
- **Training Volume:** The number of repetitions and sets performed.
- **Rest Intervals:** The time you rest between sets and the time you rest between workouts.

Once you've established a base of fitness, follow these basic principles:

- **Isolate Muscle Groups:** Focus work on specific muscle groups.
- **Progressive Loading:** The gradual systematic increase of repetitions, resistance and exercise period.

Working Out

A workout begins in your mind's eye. With concentration and visualization you can approach your workout with a positive, constructive attitude. A good pre-workout mental routine is to sit and relax, so that you can focus on what you are about to do and think about achieving your end goal.

Warming Up

We recommend that you warm up by doing light stretching and performing light exercises on the Bowflex Xceed™ home gym.

Your Routine

The workout portion of your fitness routine is the series of exercises devoted to your particular goals. Remember, make sure to have fun!

Cool Down

An essential part of the exercise routine is the cool down. Gradually reduce the level of exercise intensity so that blood does not accumulate in one muscle group, but continues to circulate at a decreasing rate. Remember to gradually move yourself into a relaxed state.

Breathing

The most important part of breathing during exercise is, quite simply, that you do it. Breathing in or out during the actual performance is not dependent upon the direction of air flow relative to exertion. It is, in fact, a mechanical process that changes the position of your spine as your rib cage moves. Here are some tips for breathing:

- 1) Be cautious when you are concentrating or exerting effort. This is when you will probably hold your breath. **DO NOT** hold your breath. Do not exaggerate breathing. Depth of inhalation and exhalation should be natural for the situation.
- 2) Allow breathing to occur, naturally, don't force it.

The Workouts

20 Minute Better Body Workout

Frequency: 3 Days Per Week (M-W-F) Time: About 20 Minutes

Start by performing one set of each exercise. Warm up with a light resistance that you can perform easily for 5 -10 reps without fatiguing. Focus on practicing and learning your technique before increasing the resistance. Then move to a more challenging resistance that you can perform no less than 10 reps and no more than 15 reps without your form deteriorating. As you become stronger, you can advance to two sets for each exercise. Complete all sets of each exercise before moving on to the next one. Rest 30 to 45 seconds between sets. Move slowly on each rep. Use a pace that would allow you to stop the movement instantly at any point in the rep. Count three seconds up and three seconds down and work to fatigue during each set.

Body Part	Exercise	Sets	Reps
Chest	Bench Press	1-2	10-15
Back	Seated Lat Rows	1-2	10-15
Shoulders	Crossover Rear Deltoid Rows	1-2	10-15
Arms	Biceps Curl	1-2	10-15
	Triceps Pushdown	1-2	10-15
Legs	Leg Extension	1-2	10-15
Trunk	Standing Low Back Extension	1-2	10-15
	Seated Abdominal Crunch	1-2	10-15

Advanced General Conditioning

Frequency: 4 Days Per Week (M-T-TH-F) Time: About 35-45 Minutes

When you are proficient in performing the exercise techniques of the above routine and are no longer realizing results, or have become just plain bored, it is time to change your program. You can increase your training with this "split system" routine that works opposing muscle groups on different days. To do this, you'll increase your resistance when you can perform 12 reps perfectly, and you'll increase your volume by performing more sets and more exercises. Move slowly on each rep. Use a pace that would allow you to stop the movement instantly at any point in the rep. Count three seconds up and three seconds down and work to fatigue during each set.

Day 1 & 3

Body Part	Exercise	Sets	Reps
Chest	Bench Press	1-3	10-12
Shoulders	Seated Shoulder Press	1-3	10-12
Arms	Triceps Pushdown	1-3	10-12
	Biceps Curl	1-3	10-12
Legs	Leg Extension	1-3	10-12

Day 2 & 4

Body Part	Exercise	Sets	Reps
Back	Seated Lat Rows	1-3	10-12
	Seated Lat Pulldowns	1-3	10-12
Shoulders	Crossover Rear Deltoid Row	1-3	10-12
Arms	Biceps Curl	1-3	10-12
	Reverse Curl	1-3	10-12
Trunk	Standing Low Back Extension	1-3	10-12
	Seated Abdominal Crunch	1-3	10-12

20 Minute Upper/Lower Body

Frequency: 4 Days Per Week (M-T-TH-F) Time: About 20 Minutes

This program provides you with a quick and effective workout that combines muscle conditioning with some cardiovascular benefits. Do this routine when you are limited in time or just want a variation to your normal routine. Perform this program training 2 days, resting 1 to 2. Perform all exercises to near failure, stopping at the point that your technique starts to deteriorate. Rest only 20-30 seconds between sets. As you get stronger, increase the number of sets you perform. Move slowly on each rep. Use a pace that would allow you to stop the movement instantly at any point in the rep. Count three seconds up and three seconds down.

DAY 1 & 3

Body Part	Exercise	Sets	Reps
Chest	Bench Press	1-3	12-15
Back	Seated Lat Rows	1-3	12-15
Shoulders	Crossover Rear Deltoid Rows	1-3	12-15
Arms	Biceps Curl	1-3	12-15
	Triceps Extension	1-3	12-15

DAY 2 & 4

Body Part	Exercise	Sets	Reps
Legs	Leg Extension	1-3	12-15
	Standing Hip Extension	1-3	12-15
	Standing Hip Abduction	1-3	12-15
	Standing Low Back Extension	1-3	10-12
Trunk	Seated Abdominal Crunch	1-3	10-12

Body Building

Frequency: 3 Days On, 1 Day Off

Time: About 45-60 Minutes

Body building requires focused concentration and dedication to training, as well as proper eating habits. Train each muscle group to failure before moving on to the next exercise. Do not neglect any muscle group. If needed, include an aerobic activity to increase your caloric expenditure and help to reduce your body fat levels to achieve a defined muscular look. Rest 30-60 seconds between each set and exercise. Focus on proper form. Tighten the muscle before you move, squeeze the muscle as you move, cramp the muscle at the point of full contraction, and resist the movement as you lower the weight. Move slowly on each rep. Use a pace that would allow you to stop the movement instantly at any point in the rep. Count three seconds up and three seconds down and work to fatigue during each set.

DAY 1

Body Part	Exercise	Sets	Reps
Chest	Bench Press	2-4	8-12
	Chest Fly	2-4	8-12
Shoulders	Seated Shoulder Press	2-4	8-12
	Crossover Rear Deltoid Row	2-4	8-12
	Lateral Shoulder Raise	2-4	8-12
	Shoulder Shrug	2-4	8-12

DAY 2

Body Part	Exercise	Sets	Reps
Back	Seated Lat Row	2-4	8-12
	Seated Lat Pulldowns	2-4	8-12
Arms	Biceps Curl	2-4	8-12
	Reverse Curl	2-4	8-12
	Triceps Pushdown	2-4	8-12
	Triceps Extension	2-4	8-12

DAY 3

Body Part	Exercise	Sets	Reps
Legs	Squat	2-4	8-12
	Leg Extension	2-4	8-12
	Standing Hip Extension	2-4	8-12
	Standing Low Back Extension	2-4	8-12
Trunk	Seated Abdominal Crunch	2-4	8-12
	Seated Oblique Abdominal Crunch	2-4	8-12

Circuit Training – Anaerobic/Cardiovascular

Frequency: 2-3 Times Per Week

Time: About 20-45 Minutes

Circuit training is a great way to achieve the benefits of strength training and cardiovascular training in one quick, challenging routine. The idea is to move quickly from exercise to exercise, taking only as much rest between sets as it takes to set up the next exercise (less than 20 seconds). One circuit equals one set of each exercise. Initially, start with completing one round of Circuit 1. Then add an additional round of the same circuit. Once you reach three rounds of Circuit 1, add one round of Circuit 2. Add additional rounds of Circuit 2 as your fitness level increases. Repeat process with Circuit 3. Do not let your heart rate exceed 220 minus your resting heart rate. Perform each rep of each exercise slowly and with perfect technique. Count three seconds up and three seconds down.

Circuit 1

Body Part	Exercise	Reps
Chest	Bench Press	8-12
Legs	Squat	8-12
Back	Seated Lat Row	8-12
Trunk	Seated Abdominal Crunch	8-12

Circuit 2

Body Part	Exercise	Reps
Shoulders	Seated Shoulder Press	8-12
Legs	Leg Extensions	8-12
Back	Seated Lat Pulldowns	8-12
Trunk	Standing Low Back Extension	8-12
Arms	Biceps Curl	8-12

Circuit 3

Body Part	Exercise	Reps
Shoulders	Crossover Rear Deltoid Rows	8-12
Arms	Triceps Pushdown	8-12
Trunk	Seated Oblique Crunch	8-12

True Aerobic Circuit Training

Frequency: 2-3 Times Per Week Time: About 20-60 Minutes

Circuit training is a great way to achieve the benefits of strength training and cardiovascular training in one quick, challenging routine. By returning to an aerobic exercise between each set you are increasing your aerobic capacity, endurance and burning fat as energy. The idea is to move quickly from exercise to exercise, taking only as much rest between sets as it takes to set up the next exercise (less than 20 seconds). One circuit equals one set of each exercise. Initially, start with completing one round of Circuit 1. Then add an additional round of the same circuit. Once you reach three rounds of Circuit 1, add one round of Circuit 2. Add additional rounds of Circuit 2 as your fitness level increases. Do not let your heart rate exceed 220 minus your resting heart rate. Perform each rep of each exercise slowly and with perfect technique. Count three seconds up and three seconds down.

Any type of aerobic exercise can be used for this routine. Some examples are: jumping jacks, jogging in place or stair climbing.

Circuit 1

Body Part	Exercise	Reps
Chest	Bench Press	8-12
Aerobic Exercise	30 – 60 Seconds	
Legs	Squat	8-12
Aerobic Exercise	30 – 60 Seconds	
Back	Seated Lat Rows	8-12
Aerobic Exercise	30 – 60 Seconds	
Trunk	Seated Abdominal Crunch	8-12
Aerobic Exercise	30 – 60 Seconds	

Circuit 2

Body Part	Exercise	Reps
Shoulders	Seated Shoulder Press	8-12
Aerobic Exercise	30 – 60 Seconds	
Legs	Leg Extension	8-12
Aerobic Exercise	30 – 60 Seconds	
Back	Seated Lat Pulldowns	8-12
Aerobic Exercise	30 – 60 Seconds	
Trunk	Standing Low Back Extension	8-12
Aerobic Exercise	30 – 60 Seconds	
Arms	Biceps Curl	8-12

Strength Training

Frequency: 3 Days Per Week (M-W-F) Time: About 45-60 Minutes

This program is designed to emphasize overall strength development. This is an advanced routine to be used only after you have progressed from the advanced general conditioning routine and only after you have perfected your exercise techniques. Work each set to near exhaustion. If you can perform more than 5 to 8 reps, you should increase your resistance 5 pounds and decrease your reps to 5. Rest 60 – 120 seconds between each set and exercise. Focus on proper form. Tighten the muscle before you move, squeeze the muscle as you move, cramp the muscle at the point of full contraction, and resist the movement as you lower the weight. Move slowly on each rep. Use a pace that would allow you to stop the movement instantly at any point in the rep. Count two seconds up and four seconds down and work to fatigue during each set.

Day 1

Body Part	Exercise	Sets	Reps
Chest	Bench Press	2-4	5-8
	Chest Fly	2-4	5-8
Shoulders	Seated Shoulder Press	2-4	5-8
	Crossover Rear Deltoid Rows	2-4	5-8
	Shoulder Shrug	2-4	5-8

Day 2

Body Part	Exercise	Sets	Reps
Back	Seated Lat Row	2-4	5-8
	Seated Lat Pulldowns	2-4	5-8
Arms	Biceps Curl	2-4	5-8
	Reverse Curl	2-4	5-8
	Triceps Pushdown	2-4	5-8
	Triceps Extension	2-4	5-8

Day 3

Body Part	Exercise	Sets	Reps
Legs	Squat	2-4	5-8
	Leg Extension	2-4	5-8
	Standing Low Back Extension	2-4	8-12
Trunk	Seated Abdominal Crunch	2-4	5-8

Chest Exercises

Bench Press – Shoulder Horizontal Adduction (and Elbow Extension)

Muscles worked:

Chest muscles (pectoralis major). Also involves front shoulder muscles (anterior deltoid and triceps, located on the back of the upper arm).

Position:

Seated – facing outward

Accessory:

Hand Grips

Pulleys:

Center Cross Bar – wide position

Before you begin:

Remove Leg Extension and adjust seat height. The pulleys should be in the wide position.

Key Points:

- Maintain a 90° angle between upper arms and torso throughout exercise.
- Limit range of motion so elbows do not travel behind shoulders.
- Keep shoulder blades pinched together and maintain good spinal alignment.



START

- Sit and grasp hand grips.
- Straighten arms to front.
- Be sure arms are directly in line with cables, palms facing down and wrists straight.
- Raise chest and pinch shoulder blades together. Maintain a very slight, comfortable, arch in lower back.



ACTION

- Slowly move elbows out, simultaneously bending arms, keeping forearms in line with cables.
- Stop when upper arms are straight out to the sides, level with shoulders.
- Slowly press forward, moving hands toward center. Return to start position with arms straight to front at shoulder width. Keep chest muscles tightened.

Chest Fly – Shoulder Horizontal Adduction (Elbow Stabilized)

Muscles worked:

Emphasizes chest muscles (pectoralis major). Involves front shoulder muscles (anterior deltoid).

Position:

Seated – facing outward

Accessory:

Hand Grips

Pulleys:

Center Cross Bar – wide position

Before you begin:

Remove Leg Extension and adjust seat height. The pulleys should be in the wide position.

Key Points:

- Maintain 90° angle between upper arms and torso throughout exercise.
- Limit range of motion so elbows do not travel behind shoulders.
- Keep shoulder blades pinched together and maintain good spinal alignment.



START

- Sit and grasp hand grips.
- Straighten arms to front.
- Be sure arms are directly in line with cables, palms facing in and wrists straight.
- Raise chest and pinch shoulder blades together. Maintain a slight, comfortable, arch in lower back.



ACTION

- Slowly move arms inward, maintaining the elbows in a slightly bent position throughout movement.
- Stop when upper arms are straight out in front, level with shoulders.
- Slowly return to start position. Keep chest muscles tightened during motion.

Decline Bench Press – Shoulder Horizontal Adduction (and Elbow Extension)

Muscles worked:

Chest muscles (pectoralis major). Also involves front shoulder muscles (anterior deltoid) and triceps.

Position:

Seated (seat in lowest position) facing outward

Accessory:

Hand Grips

Pulleys:

Center Cross Bar – standard position

Before You Begin:

Remove Leg Extension and adjust seat to lowest setting.

Key Points:

- Maintain 90° angle between upper arms and torso at the bottom of the motion, and slightly less than 90° at the top of the motion.
- Limit range of motion so elbows do not travel behind shoulders.
- Keep shoulder blades pinched together and maintain good spinal alignment.

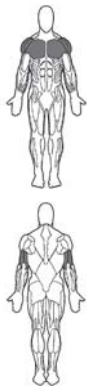

START

- Sit and grasp hand grips with cable and grip positioned beneath forearm.
- Lower arms 5-6 inches from standard bench press position.
- Straighten arms to front.
- Be sure arms are directly in line with cables, palms facing down and wrists straight.
- Raise chest and pinch shoulder blades together. Keep a gentle arch in lower back.



ACTION

- Slowly move elbows outward, simultaneously bending arms, keeping forearms in line with cables at all times.
- Stop when upper arms are straight out to sides, 10° below shoulders.
- Slowly press forward, moving hands toward center. Return to start position, arms straight at shoulder width, hands just above knees in line with cables. Keep chest muscles tightened..

Incline Bench Press – Shoulder Horizontal Adduction (and Elbow Extension)

Muscles worked:

Chest muscles (pectoralis major), especially upper portion. Also involves front shoulder muscles (anterior deltoid) and triceps.

Position:

Seated – facing outward

Accessory:

Hand Grips

Pulleys:

Center Cross Bar – wide position

Before You Begin:

Remove Leg Extension and adjust seat height.

Key Points:

- Upper arms will be 90° from sides of torso at the bottom of movement and slightly more than 90° from the front of torso at the top.
- Limit range of motion so elbows do not travel behind shoulders.
- Keep shoulder blades pinched together and maintain good spinal alignment.

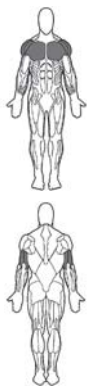

START

- Sit and grasp hand grips.
- Straighten arms to front.
- Raise arms 6-8 inches above regular bench press position.
- Keep arms in line with cables, palms down, wrists straight.
- Raise chest and pinch shoulder blades together. Keep a slight, comfortable, arch in lower back.



ACTION

- Slowly move elbows out, simultaneously bending arms. Keep forearms in line with cables.
- Stop when upper arms are out to sides, 10° above shoulders.
- Slowly press forward, moving hands toward center. Return to start position, with arms straight to front at shoulder width and in line with cables.

Shoulder Exercises

Reverse Fly – Shoulder Horizontal Abduction (Elbows Stabilized)

Muscles worked:

Back portion of shoulder muscles (rear deltoids, rear portion of middle deltoids).

Position:

Standing – facing machine

Seat:

Removed

Accessory:

Hand Grips

Pulleys:

Center Cross Bar – narrow position

Before You Begin:

Remove Leg Extension. The pulleys should be in the narrow position.

Key Points:

- Maintain a 90° angle between upper arms and sides of torso throughout exercise.
- Keep shoulder blades pinched together and maintain good spinal alignment.



START

- Stand on platform.
- Grasp hand grips with palms facing floor, arms nearly straight.
- Stand up straight and bend over slightly from hips until arms are in front of body at a 90° angle to torso.
- Lift chest and pinch shoulder blades together.



ACTION

- Maintaining the same slight bend in arms, move elbows out and back, keeping a 90° angle between upper arms and sides of torso.
- Move until elbows are slightly behind shoulders, then slowly reverse the motion, keeping rear shoulder muscles tightened.

Crossover Reverse Fly – Shoulder Horizontal Abduction (Elbows Stabilized)

Muscles worked:

Back portion of shoulder muscles (rear deltoids, rear portion of middle deltoids).

Position:

Standing – facing machine

Accessory:

Hand Grips

Pulleys:

Center Cross Bar – narrow position

Before You Begin:

- Remove seat and leg extension. The pulleys should be in the narrow position.

Key Points:

- Maintain 90° angle between upper arms and sides of torso throughout exercise.
- Keep shoulder blades pinched together and maintain good spinal alignment.



START

- Stand on platform.
- Cross arms in front of body and grasp hand grips (right grip in left hand and vice versa) with palms facing floor and arms nearly straight.
- Stand up straight and bend over slightly from hips until arms are in front of body at a 90° angle to torso.
- Lift chest and pinch shoulder blades together.



ACTION

- Maintaining same slight bend in arms, move elbows out and back, crossing cables as you pull arms back.
- Keep a 90° angle between upper arms and sides of torso.
- Move until elbows are slightly behind shoulders, then slowly reverse motion keeping rear shoulder muscles tightened.

Crossover Rear Deltoid Rows – Elbow Flexion

Muscles worked:

Back portion of shoulder muscles (rear deltoids, rear portion of middle deltoids).

Position:

Standing – facing machine

Accessory:

Hand Grips

Pulleys:

Center Cross Bar – narrow position

Before You Begin:

Remove Leg Extension and seat. Center Cross Bar Pulleys should be in narrow position.

Key Points:

- Maintain a 90° angle between upper arms and sides of torso.
- Keep shoulder blades pinched together and maintain good spinal alignment.
- To work one arm at a time, place non-working hand on top of bench for additional stabilization.



START

START

- Stand on platform.
- Cross arms in front of body and grasp hand grips (right grip in left hand and vice versa) with palms facing down and arms nearly straight.
- Bend over slightly from hips (not spine) and raise arms in front of body, 90° to torso.
- Lift chest, stand up straight with spine in good alignment and tighten trunk muscles.



FINISH

ACTION

- Allowing arms to bend as you go, move elbows outward and backward keeping a 90° angle between upper arms and sides of torso.
- Always point forearms in the direction of cables.
- Move until elbows are slightly behind shoulders, then slowly reverse motion. Keep rear shoulder muscles tightened during entire motion.

Crossover High Rear Deltoid Rows – Elbow Flexion

Muscles worked:

Back portion of shoulder muscles (rear deltoids, rear portion of middle deltoids).

Position:

Standing – facing machine

Accessory:

Hand Grips

Pulleys:

Lat Tower

Before You Begin:

Remove Leg Extension and seat.

Key Points:

- Keep shoulder blades pinched together and maintain good spinal alignment.



START

START

- Stand on platform, with knees slightly bent.
- Cross arms and grab hand grips with palms facing down, arms straight (right hand on left hand grip and vice versa).
- Stand up straight and slightly lean back from hips.
- Lift chest and pinch shoulder blades together.



FINISH

ACTION

- Allowing arms to bend as you go, move elbows out and back keeping a 90° angle between upper arms and sides of torso.
- Always point forearms in direction of cables.
- Move until elbows are slightly behind shoulders, then slowly reverse motion. Keep rear shoulder muscles tightened.

Lateral Shoulder Raise – Shoulder Abduction (Elbows Stabilized)

Muscles worked:

Side shoulder muscles (middle deltoids), top muscle of rotator cuff (supraspinatus) and upper trapezius muscles.

Position:

Standing – facing outward

Accessory:

Hand Grips

Pulleys:

Squat Pulley Frame – use squat straps

Before You Begin:

Remove Seat and Leg Extension

Key Points:

- DO NOT swing arms upward or move trunk.

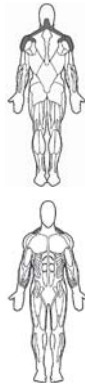

START



FINISH

START

- Stand on platform facing outward. Grasp hand grips with palms facing each other.
- Attain good spinal posture and bend forward slightly at hip (15 to 20°) by keeping spine straight and sticking rear end out. Do not bend at waist.
- Let arms hang directly in line with cables.
- Elevate shoulders slightly toward back of head.

ACTION

- Raise arms out to sides to nearly shoulder level.
- Keep side of arm/elbow facing out/up throughout movement.
- Slowly bring arms into start position without relaxing.

Seated Forearm Lateral Shoulder Raise – Elbows Stabilized

Muscles worked:

Side shoulder muscles (middle deltoids), top muscle of rotator cuff (supraspinatus) and upper trapezius muscles.

Position:

Seated – facing outward

Accessory:

Hand Grips over elbows

Pulleys:

Squat Pulley Frame – narrow position

Before You Begin:

Remove Seat and Leg Extension

Key Points:

- DO NOT swing arms upward or move trunk.

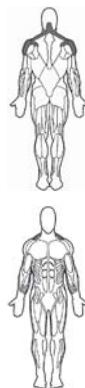

START



FINISH

START

- Slide hand grips over forearms until grip is cradled in elbow.
- Let upper arms hang in line with cables and bend elbows 90°.
- Elevate shoulders slightly toward the back of your head.
- Raise chest and pinch shoulder blades together.
- Maintain a slight, comfortable, arch in lower back.

ACTION

- Raise arms out to sides to almost shoulder level.
- Keep side of forearms/elbows facing out/up throughout movement.
- Slowly bring arms to start position without relaxing.

Front Shoulder Raise – Shoulder Flexion (Elbow Stabilized)

Muscles worked:

Front part of shoulder muscles (front deltoids) and front part of middle deltoids.

Position:

Standing – facing outward

Accessory:

Hand Grips

Pulleys:

Squat Pulley Frame

Before You Begin:

Remove Leg Extension and seat. Use platform pulleys.

Key Points:

- Keep chest lifted and abdominals tightened throughout entire motion and maintain good spinal alignment.
- Do not increase arch in lower back while lifting arms.

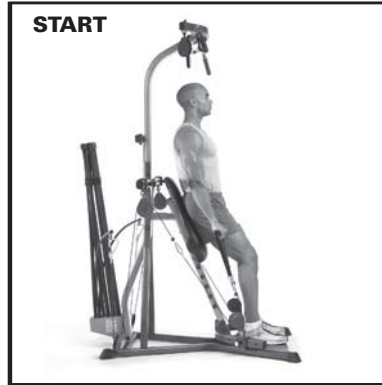

START



FINISH

START

- Stand on platform facing outward with knees slightly bent. You may want to lean back against bench.
- Keep chest up, abs tight and maintain a slight arch in lower back.
- Grasp hand grips with palms facing machine and arms straight at sides.

ACTION

- Arms may be moved alternately or together.
- Keeping arms straight, move them forward, then up to shoulder height.
- Slowly return arms beside torso and repeat.

Seated Shoulder Press – Shoulder Adduction (and Elbow Extension)

Muscles worked:

Front portion of shoulder muscles (front deltoids and front part of middle deltoids), upper back muscles (upper trapezius), and triceps.

Position:

Seated – facing outward

Accessory:

Hand Grips

Pulleys:

Center Cross Bar – wide position

Before You Begin:

Remove Leg Extension and adjust seat height.

Key Points:

- Keep abdominals tight throughout entire motion and maintain good spinal alignment.
- Do not let the arch increase in the lower back while pressing up.

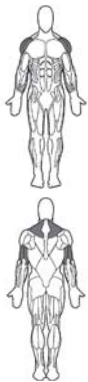

START



FINISH

START

- Sit facing outward, knees bent and feet flat on floor.
- Keep chest up, abs tight and maintain a slight arch in lower back.
- Grasp hand grips with palms facing away from machine.
- Raise hand grips to just above shoulder level, keeping palms facing forward.

ACTION

- Straighten arms overhead, focusing on moving elbows up and in toward head.
- Slowly return to starting position keeping tension in front shoulder muscles.

Shoulder Rotator Cuff – Internal Rotation

Muscles worked:

Front rotator cuff muscle (subscapularis).

Position:

Standing – facing left or right

Accessory:

Hand Grips

Pulleys:

Center Cross Bar -wide position

Before You Begin:

Remove Seat and Leg Extension

Key Points:

- Motion should be slow and controlled.
- Do not rotate spine to get additional range of motion. Try for pure rotation of shoulder joint. More is not better!
- Use light resistance only. Pick a resistance that you can perform 12-15 perfect reps.

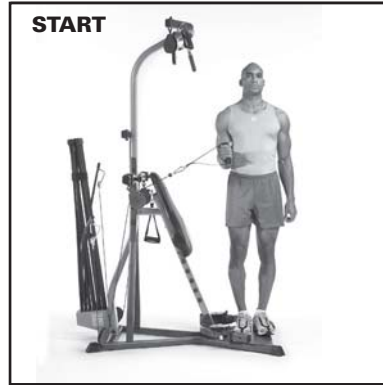

START

START

- Stand on platform with one side toward machine. Maintain good spinal alignment.
- Grasp hand grip with arm closest to machine and draw upper arm into side, keeping elbow bent 90°.
- Distance yourself from tower to eliminate slack in cable.
- Use very light resistance.

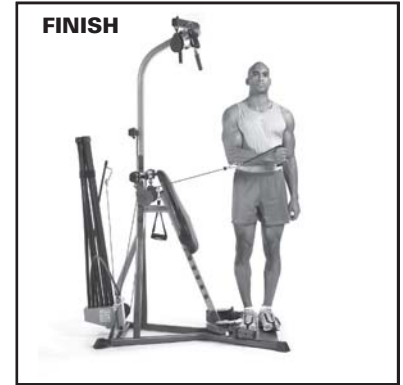

FINISH

ACTION

- Rotate forearm toward abdomen, keeping elbow by side.
- Slowly return to start position.

Shoulder Rotator Cuff – External Rotation

Muscles worked:

Rear portion of rotator cuff (infraspinatus, teres minor muscles).

Position:

Standing – facing left or right

Accessory:

Hand Grips

Pulleys:

Center Cross Bar – wide position

Before You Begin:

Remove Leg Extension and seat.

Key Points:

- Motion should be slow and controlled.
- Do not rotate spine to get additional range of motion. Try for pure external rotation of shoulder joint. More is not better!
- Use light resistance only. Pick a resistance that allows you to perform 12-15 reps.



START

START

- Stand on platform with one side toward machine. Maintain good spinal alignment.
- Using arm furthest from rods, reach across body, grasp hand grip nearest you and draw arm back into side. Keep elbow bent 90°.
- Allow forearm to rest against abdomen and elbow against side, taking out some of the slack or in cables.



FINISH

ACTION

- Rotate forearm away from abdomen and out to side, keeping elbow/upper arm by side.
- Slowly return to start position.

Shoulder Extension – Elbows Stabilized

Muscles worked:

Upper back (latissimus dorsi, teres major, rear deltoid muscles), muscles between shoulder blades (middle trapezius, rhomboid muscles) and triceps.

Position:

Standing – facing machine

Accessory:

Hand Grips

Pulleys:

Center Cross Bar – narrow position

Before You Begin:

Remove Leg Extension and seat.

Key Points:

- Do not lose spinal alignment, keep chest lifted.
- Keep lats tightened throughout entire motion.
- Release shoulder blades at end of each rep. Initiate new rep by retracting shoulder blades.



START

START

- Stand on platform, facing machine, knees slightly bent, feet flat on floor.
- Grasp hand grips with palms facing floor.
- Tighten trunk muscles to stabilize spine while maintaining a slight arch in lower back.



FINISH

ACTION

- Initiate by pinching shoulder blades together.
- Continue movement by moving hands in an arc, down and back toward hips.
- Slowly return to start position.

Shoulder Shrug – Scapular Elevation

Muscles worked:

Upper trapezius and associated smaller muscles of region.

Position:

Standing – facing machine

Accessory:

Hand Grips

Pulleys:

Squat Pulley Frame

Before You Begin:

Remove Leg Extension and seat.

Key Points:

- Do not bend neck backward or forward while raising shoulders.
- Do not slouch upon lowering shoulders.
- Keep spine in good alignment through entire motion.
- Make sure both shoulders raise evenly.
- For variation, bend forward slightly from hips, not spine.



START

START

- Stand on platform facing machine.
- Reach down and grasp hand grips with palms facing away.
- Let arms hang, extending toward pulleys.



FINISH

ACTION

- Raise shoulders toward back of head, making sure neck/head does not move.
- Slowly reverse motion, keeping upper trapezius muscles tight.

Scapular Protraction – Elbows Stabilized

Muscles worked:

Serratus anterior muscles, the muscles on the side of the rib cage.

Position:

Seated – facing outward

Accessory:

Hand Grips

Pulleys:

Center Cross Bar – narrow position

Before You Begin:

Remove Leg Extension and adjust seat height.

Key Points:

- Maintain a 90° angle between upper arms and torso throughout the exercise.
- Keep elbows straight.
- Do not slouch forward in the upper spine to further the motion. Maintain a very slight arch in lower back at all times.



START

- Sit grasp hand grips.
- Lie head back on bench and straighten arms to front.
- Be sure arms are in line with cables, palms facing down and wrists straight.
- Raise chest and pinch shoulder blades. Maintain a slight, comfortable, arch in lower back.



ACTION

- Keeping arms straight and pointing in the same direction of cables, slowly move shoulder blades forward off bench.
- Slowly return to start position.
- Movement is subtle and only occurs in shoulder.

Scapular Depression

Muscles worked:

Develops lower trapezius muscles, which stabilize and move shoulder blades.

Position:

Seated – facing outward

Accessory:

50" Bent Lat Bar

Pulleys:

Lat Tower

Before You Begin:

Remove Leg Extension and adjust seat height.

Key Points:

- Do not lose spinal alignment, keep chest lifted.



START

- Sit facing outward, knees bent, feet flat on floor.
- Grasp 50" Bent Lat Bar.
- Tighten trunk muscles to stabilize spine while maintaining a slight arch in lower back.



ACTION

- Keeping arms straight, slide shoulder blades toward hips.
- When shoulder blades are fully depressed, slowly return to start position.
- Movement is subtle and only occurs in shoulder.

Scapular Retraction

Muscles worked:

Develops muscles between shoulder blades (trapezius and rhomboids).

Position:

Seated on floor, facing machine

Accessory:

Hand Grips

Pulleys:

Squat Pulley Frame

Before You Begin:

Remove Leg Extension and Seat

Key Points:

- Do not bend torso forward.
- Do not lose spinal alignment, keep chest lifted.
- Do not pull with arm muscles.



START

- Sit on floor facing machine.
- Grab hand grips with palms facing each other.
- Place heels against end of platform, bend hips and knees, arms straight.
- Lift chest, sit up straight with spine in good alignment and tighten trunk muscles.



ACTION

- Keeping arms straight, slowly pinch shoulder blades together.
- When shoulder blades are fully retracted, slowly return to start position.

Standing Shoulder Pullover – with Bent Lat Bar (Elbows Stabilized)

Muscles worked:

Upper back (latissimus dorsi, teres major, rear deltoid muscles). Also involves chest (pectoralis major muscles) and triceps.

Position:

Standing – facing machine

Accessory:

50" Bent Lat Bar

Pulleys:

Lat Tower

Before You Begin:

Remove Seat and Leg Extension

Key Points:

- Do not lose spinal alignment. Relax neck, keep chest lifted, abs tight and maintain a very slight arch in lower back.
- Keep lats tightened throughout entire motion.
- Release shoulder blades at end of each rep. Initiate new rep by depressing shoulder blades.

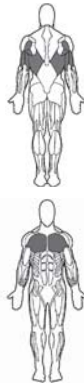

START

- Stand on platform.
- Keep knees slightly bent and feet flat on platform.
- Extend arms overhead and grasp 50" Bent Lat Bar, palms facing down.
- Tighten abs to stabilize spine while maintaining a slight arch in lower back.



ACTION

- Move hands in an arc down toward legs.
- End with arms by sides, pressing shoulder blades down, completely tightening lats.
- Control the return to start position by slowly moving arms overhead and releasing shoulder blades.

Standing Shoulder Pullover – with Hand Grips (Elbows Stabilized)

Muscles worked:

Upper back (latissimus dorsi, teres major, rear deltoid muscles). Also involves chest (pectoralis major muscles) and triceps.

Position:

Standing – facing machine

Accessory:

Hand Grips

Pulleys:

Lat Tower

Before You Begin:

Remove Seat and Leg Extension:

Key Points:

- Do not lose spinal alignment. Relax neck, keep chest lifted, abs tight and maintain a very slight arch in lower back.
- Keep lats tightened throughout entire motion.
- Release shoulder blades at end of each rep. Initiate new rep by depressing shoulder blades.

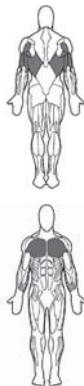

START

- Stand on platform.
- Keep knees slightly bent and feet flat on platform.
- Extend arms overhead and grasp Hand Grips, palms facing down.
- Tighten abs to stabilize spine while maintaining a slight arch in lower back.



ACTION

- Move hands in an arc down toward legs.
- End with arms by sides, pressing shoulder blades down, completely tightening lats.
- Control the return to start position by slowly moving arms overhead and releasing shoulder blades.

Narrow Pulldowns with Bent Lat Bar – Shoulder Extension (with Elbow Flexion)

Muscles worked:

Latissimus dorsi, teres major and rear deltoid, which make up the large pulling muscles of upper back. Also involves biceps group.

Position:

Seated – facing machine

Accessory:

50" Bent Lat Bar

Pulleys:

Lat Tower

Before You Begin:

Remove Leg Extension

Key Points:

- Do not lose spinal alignment.
- Keep lats tightened throughout entire motion.

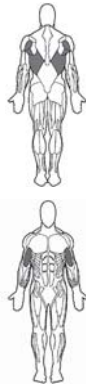

START

- Grasp 50" Bent Lat Bar, palms facing down, and sit facing machine.
- Position thighs under pulleys. Sit upright with arms extending up. You may position hips under pulleys, but you must lean back slightly from the hips.
- Maintain good spinal alignment, chest lifted, abs tight and slight arch in lower back.



ACTION

- Pull shoulder blades down and together while drawing elbows down to front, and then in, toward sides of body.
- At end of motion, arms should be near (not touching) sides, shoulder blades fully depressed toward hips, and forearms in line with cables (not forward).
- Slowly return to start position. Allow arms and shoulder blades to move up, w/o relaxing muscles.

Narrow Pulldowns with Hand Grips – Shoulder Extension (with Elbow Flexion)

Muscles worked:

Latissimus dorsi, teres major and rear deltoid, which make up the large pulling muscles of upper back. Also involves biceps group.

Position:

Seated – facing machine

Accessory:

Hand Grips

Pulleys:

Lat Tower

Before You Begin:

Remove Leg Extension

Key Points:

- Do not lose spinal alignment.
- Keep lats tightened throughout entire motion.

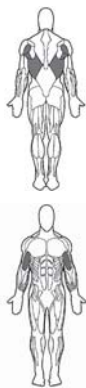

START

- Grasp Hand Grips, palms facing down, and sit facing machine.
- Position thighs under pulleys and sit upright with arms extending up. You may position hips under pulleys but you must lean back slightly from the hips.
- Maintain good spinal alignment, chest lifted, abs tight and a slight arch in lower back.



ACTION

- Pull shoulder blades down and together while drawing elbows down and then in, toward sides of body.
- At end of motion, arms should be near (not touching) sides, shoulder blades fully depressed toward hips and forearms in line with cables (not forward).
- Slowly return to start position. Allow arms and shoulder blades to move up fully, without relaxing muscles.

Bent Over Row

Muscles worked:

Latissimus dorsi, teres major and rear deltoid, which make up the large pulling muscles of upper back. Also involves biceps group.

Position:

Standing – facing machine

Accessory:

Hand Grips

Pulleys:

Squat Pulley Frame

Before You Begin:

Remove Seat and Leg Extension

Key Points:

- Do not bend neck backward or forward while raising bar.
- Do not slouch when lowering hand grips.
- Keep spine in good alignment through entire motion.

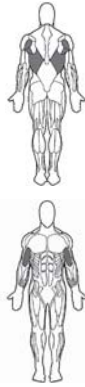

START

- Stand on platform. Reach down and grasp hand grips, palms facing backward.
- Let arms extend in direction of pulleys.
- Keep back flat and knees bent.



ACTION

- Move elbows back as you bring hand grips to a point below chest.
- Slowly reverse motion. Keep knees bent and back flat.

Crossover Bent Over Row

Muscles worked:

Back portion of shoulder muscles (rear deltoids, rear part of middle deltoids).

Position:

Standing – facing machine

Accessory:

Hand Grips

Pulleys:

Squat Pulley Frame

Before You Begin:

Remove Seat and Leg Extension

Key Points:

- Do not bend neck backward or forward while raising bar.
- Do not slouch when lowering hand grips.
- Keep spine in good alignment through entire motion.



START

- Stand on platform.
- Cross arms and reach down and grasp hand grips, palms facing back.
- Let arms extend in direction of pulleys.
- Keep back flat and knees bent.



ACTION

- Move elbows back as you bring hand grips to a point below chest.
- Slowly reverse motion. Keep knees bent and back flat.

Seated Lat Rows – Shoulder Extension (and Elbow Flexion)

Muscles worked:

Latissimus dorsi, teres major and rear deltoid muscles, which make up the large pulling muscles of upper back. Also involves biceps.

Position:

Seated on ground, facing machine

Accessory:

Hand Grips

Pulleys:

Squat Pulley Frame

Before You Begin:

Remove Leg Extension and Seat

Key Points:

- Do not bend torso forward at any point.
- Do not lose spinal alignment – keep chest lifted.
- Release shoulder blades at end of each rep and initiate new rep by pinching shoulder blades.

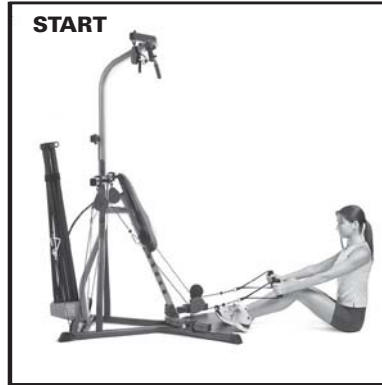

START

- Grab hand grips with palms facing each other.
- Place heels against end of platform, bend knees comfortably.
- Sit up straight with spine in good alignment.



ACTION

- Pinch shoulder blades together.
- Pull upper arms down and back, brushing past sides of the body while keeping forearms pointing in direction of cable.
- Slowly return to start position.

Crossover Seated Lat Rows – Shoulder Extension (and Elbow Flexion)

Muscles worked:

Latissimus dorsi, teres major and rear deltoid muscles, which make up large pulling muscles of upper back. Also involves biceps.

Position:

Seated on the ground, facing machine

Accessory:

Hand Grips

Pulleys:

Squat Pulley Frame

Before You Begin:

Remove Leg Extension

Key Points:

- Do not bend torso forward at any point.
- Do not lose spinal alignment, keep chest lifted.
- Release shoulder blades at end of each rep. Initiate new rep by pinching shoulder blades.



START

- Cross arms and grasp hand grips (right grip in left hand and vice versa) with palms facing each other.
- Place heels against end of platform, bend knees comfortably.
- Sit up straight, spine in good alignment.



ACTION

- Pinch shoulder blades together.
- Pull upper arms down and back, brushing past sides of body while keeping forearms pointing in direction of cable.
- Slowly return to start position.

Standing Low Back Extension – with Hip Extension

Muscles worked:

Muscles in lower back (erector spinae, deep spinal muscles), lower back muscles, gluteus maximus and hamstrings.

Position:

Standing – facing outward

Accessory:

Hand Grips

Pulleys:

Squat Pulley Frame – standard position

Before You Begin:

Remove Seat and Leg Extension

Key Points:

- Keep chest lifted and a very slight arch in lower back at all times.
- Move from hips only, not waist. Do not increase or decrease the arch in lower back during the movement.



START

START

- Stand facing out.
- Slide hand grips up over forearms to elbows.
- Bend knees comfortably, cross arms in front of chest and pull hand grips tightly to chest.
- Lift chest, tighten trunk muscles and arch lower back slightly. Pinch shoulder blades together slightly.
- Lean forward from hips, slightly letting out tension in the cables.



FINISH

ACTION

- Keep chest lifted, move entire torso up as a unit by pivoting at hips.
- Slowly return to start position without slouching or changing spinal alignment.

Reverse Grip Pulldowns – Lat Tower – Shoulder Extension (with Elbow Flexion)

Muscles worked:

Latissimus dorsi, teres major and rear deltoid. Also involves biceps group.

Position:

Seated – facing machine

Accessory:

Hand Grips

Pulleys:

Lat Tower

Before You Begin:

Remove Leg Extension

Key Points:

- Do not lose spinal alignment.
- Keep lats tightened throughout entire motion.



START

START

- Grasp hand grips with an under-hand grip, at a comfortable width, then sit on seat.
- Position thighs under pulleys and sit upright with arms extending up. You may position hips under pulleys but you must lean back slightly from the hips (not the waist).
- Maintain good spinal alignment, chest lifted, abs tight, and a slight arch in lower back.



FINISH

ACTION

- Pull shoulder blades down and together while drawing elbows down to sides, then in, toward body.
- At end of motion, arms should be drawn near sides (although may not be touching sides), shoulder blades fully depressed towards hips and forearms in line with direction of cables.
- Slowly return to start position allowing arms and shoulder blades to move up, without relaxing muscles.

Crossover Wide Pulldowns – Shoulder Extension (with Elbow Flexion)

Muscles worked:

Latissimus dorsi, teres major and rear deltoid. Also involves chest (pectoralis major) muscles and triceps muscles.

Position:

Seated – facing machine

Accessory:

Hand Grips

Pulleys:

Lat Tower

Before You Begin:

Remove Leg Extension

Key Points:

- Do not lose spinal alignment.
- Keep lats tightened throughout entire motion.
- Do not lean backward as you pull.

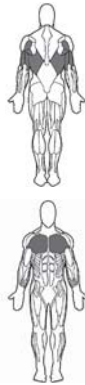

START

START

- Cross arms, then grasp hand grips with palms facing forward (right grip in left hand and vice versa). Sit on seat.
- Position thighs under pulleys and sit up with arms extending upward. You may position hips under pulleys but you must lean back from hips (not waist).
- Maintain good spinal alignment, chest up, abs tight and a slight arch in lower back.



FINISH

ACTION

- Pull shoulder blades down and together while drawing elbows out, away from sides.
- At end of motion, arms should be drawn away from sides, shoulder blades fully depressed toward hips, and forearms in line with direction of cables.
- Slowly return to start position. Allow arms and shoulder blades to move fully up, without relaxing muscles.

Crossover Narrow Pulldowns – Shoulder Extension (with Elbow Flexion)

Muscles worked:

Latissimus dorsi, teres major and rear deltoid. Also involves biceps group.

Position:

Seated – facing machine

Accessory:

Hand Grips

Pulleys:

Lat Tower

Before You Begin:

Remove Leg Extension

Key Points:

- Do not lose spinal alignment.
- Keep lats tightened throughout entire motion.

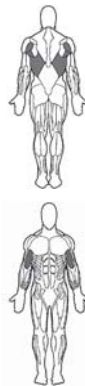

START

START

- Cross arms, then grasp hand grips with palms facing down (left grip in right hand and vice versa). Sit on seat.
- Position thighs under pulleys and sit up with arms extending upward. You may position hips under pulleys but you must lean back from hips (not waist).
- Maintain good spinal alignment, chest lifted, abs tight and a slight arch in lower back.



FINISH

ACTION

- Pull shoulder blades down and together while drawing elbows down to sides, and then in, toward body.
- At end of motion, arms should be drawn near sides (although not touching sides), shoulder blades fully depressed toward hips and forearms up, in line with cables.
- Slowly return to start position allowing arms and shoulder blades to move fully up, without relaxing muscles.

Seated Lat Pulldowns – Shoulder Adduction (with Elbow Flexion)

Muscles worked:

Latissimus dorsi, teres major and rear deltoid. Also involves biceps group.

Position:

Seated – facing machine

Accessory:

Hand Grips

Pulleys:

Lat Tower

Before You Begin:

Remove Leg Extension

Key Points:

- Maintain good spinal alignment, chest lifted, abs tight and a slight arch in lower back.
- Keep lats tightened throughout entire motion.
- Do not let grips touch chest.

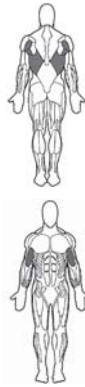

START

- Hold arms out to sides at shoulder height. Bend elbows 90°, hands slightly less than elbow width.
- Grasp hand grips at same width as above, then sit down with arms extending upward.
- You may position hips under pulleys but only lean back slightly from hips (not the waist).



ACTION

- Pull shoulder blades down and together while drawing elbows down to sides, then in, toward trunk.
- At end of motion, arms should be drawn near sides (not touching sides), shoulder blades fully depressed toward hips and forearms up in line with cables.
- Slowly return to start position. Allow arms and shoulder blades to move up, w/o relaxing muscles.

Seated Wide Lat Pulldowns – Shoulder Adduction (with Elbow Flexion)

Muscles worked:

Latissimus dorsi, teres major and rear deltoid. Also involves biceps group.

Position:

Seated – facing machine

Accessory:

50" Bent Lat Bar

Pulleys:

Lat Tower

Before You Begin:

Remove Leg Extension

Key Points:

- Do not lose spinal alignment.
- Keep lats tightened throughout entire motion.
- If you can't complete the exercise with hands in the wide position, bring hands closer together.

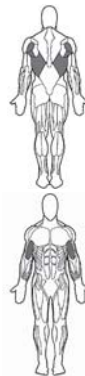

START

- Grasp 50" Bent Lat Bar at a comfortable, wide grip, then sit with arms extending up.
- You may position hips under pulleys but you must lean back slightly from hips (not the waist).
- Maintain good spinal alignment, chest lifted, abs tight and a slight arch in lower back.



ACTION

- Pull shoulder blades down and together while drawing elbows down to sides, then in, toward trunk.
- 50" Bent Lat Bar may not touch chest, but, at end of motion, arms should be drawn near sides (not touching sides), shoulder blades fully depressed toward hips and forearms up in line with cables.
- Slowly return to start position, Allow arms and shoulder blades to move fully upward, without relaxing muscles.

Triceps Pushdown – Elbow Extension

Muscles worked:

Triceps muscles.

Position:

Standing – facing machine

Accessory:

Hand Grips

Pulleys:

Lat Tower

Before You Begin:

Remove Seat and Leg Extension

Key Points:

- Keep upper arms motionless.
- Keep wrists straight.
- Tighten triceps throughout exercise and control motion on the way up.
- Maintain good posture by keeping chest lifted and abs tight. Maintain a very slight arch in the lower back.

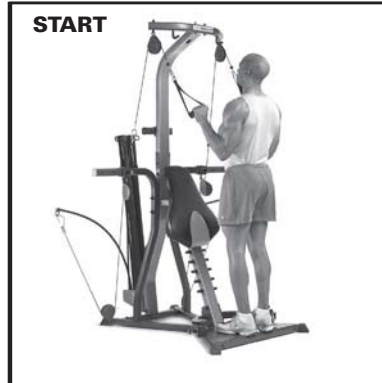

START

START

- Stand on platform.
- Grasp hand grips at shoulder width, palms down.
- Bring arms down to sides, elbows straight. This is Start Position.
- Bend over slightly from hips, so shoulders are directly over hands. Lift chest and tighten abs to stabilize spine. Maintain a slight arch in lower back.



FINISH

ACTION

- Keep upper arms stationary and elbows next to sides of torso. Slowly allow elbows to bend, moving hands in arcing motion away from legs and up.
- Stop at 90°.
- Think about tightening triceps. Slowly reverse arcing motion and straighten arms fully.

Triceps Hammer Pushdown – Elbow Extension

Muscles worked:

Triceps muscles.

Position:

Standing – facing machine

Accessory:

Hand Grips in “Hammer Grip”

Pulleys:

Lat Tower

Before You Begin:

Remove Seat and Leg Extension

Key Points:

- Keep upper arms motionless.
- Keep wrists straight.
- Tighten triceps throughout exercise and control motion on the way up.
- Maintain good posture by keeping chest lifted and abs tight. Maintain slight arch in lower back.



START

START

- Stand on platform.
- Grasp hand grips at shoulder width, with grips in vertical hammer position.
- Bring arms down to sides, elbows straight. This is Start Position.
- Bend over slightly from hips, so shoulders are directly over hands. Lift chest and tighten abs to stabilize spine. Maintain a slight arch in lower back.



FINISH

ACTION

- Keep upper arms stationary and elbows next to sides of torso. Slowly allow elbows to bend, moving hands in arcing motion away from legs and up.
- Stop at 90°.
- Think about tightening triceps. Slowly reverse arcing motion and straighten arms fully.

Triceps Pushdown – with Bent Lat Bar (Elbow Extension)

Muscles worked:

Triceps muscles.

Position:

Standing – facing machine

Accessory:

50" Bent Lat Bar

Pulleys:

Lat Tower

Before You Begin:

Remove Leg Extension and Seat

Key Points:

- Keep upper arms motionless.
- Keep wrists straight.
- Tighten triceps throughout exercise and control motion on the way up.
- Maintain good posture by keeping chest lifted, abs tight. Maintain a very slight arch in lower back.



START

- Stand on platform.
- Grasp 50" Bent Lat Bar at shoulder width, palms down.
- Bring arms down to sides, elbows straight. This is Start Position.
- Bend over from hips, so shoulders are over hands. Lift chest and tighten abs to stabilize spine while maintaining a slight arch in lower back.



ACTION

- Keep upper arms stationary and elbows next to sides of torso. Slowly allow elbows to bend, moving hands in arcing motion away from legs and up.
- Stop at 90°.
- Think about tightening triceps. Slowly reverse arcing motion and straighten arms fully.

Triceps Extension – Elbow Extension

Muscles worked:

Triceps muscles.

Position:

Seated – facing outward

Accessory:

Hand Grips

Pulleys:

Center Cross Bar – narrow position

Before You Begin:

Remove Leg Extension and adjust seat height.

Key Points:

- Keep upper arms/shoulders motionless.
- Keep wrists straight.
- Tighten triceps throughout exercise and control motion on the way down.



START

- Bend knees and place feet flat on floor.
- Reach behind and grasp one or both of the hand grips, palms facing away.
- Keep elbows above shoulders, directly in line with cables, palms facing out, wrists straight.
- Raise chest and pinch shoulder blades together. Maintain a slight, comfortable, arch in lower back.



ACTION

- Keep upper arm stationary. Slowly straighten elbows allowing hands to move in arcing motion above head.
- Slowly reverse arcing motion until elbows are bent again.

Hammer Triceps Extension – Elbow Extension

Muscles worked:

Triceps muscles.

Position:

Seated – facing outward

Accessory:

Hand Grips in “Hammer Grip”

Pulleys:

Center Cross Bar – narrow position

Before You Begin:

Remove Leg Extension and adjust seat height.

Key Points:

- Keep upper arms/shoulders motionless.
- Keep wrists straight.
- Tighten triceps throughout exercise and control the motion on the way down.



START

START

- Bend knees. Place feet flat on platform.
- Reach behind and grasp one or both of the hand grips in the vertical hammer grip position.
- Keep elbows above shoulders, directly in line with cables, palms facing down, wrists straight.
- Raise chest and pinch shoulder blades together. Maintain a slight, comfortable, arch in lower back.



FINISH

ACTION

- Keep upper arm stationary. Slowly straighten elbows, allowing hands to move in arching motion above head.
- Slowly reverse arching motion until elbows are bent again.

Cross Triceps Extension

Muscles worked:

Triceps muscles.

Position:

Seated – facing outward

Accessory:

Hand Grips in “Hammer Grip”

Pulleys:

Center Cross Bar – narrow position

Before You Begin:

Remove Leg Extension

Key Points:

- Keep upper arm motionless.
- Keep wrist straight.
- Tighten triceps throughout exercise and control motion on the way down.
- Keep knees bent and feet flat on floor.



START

START

- Reach over shoulder and grasp a hand grip. Using the Hammer Grip, bend elbow until hand is in front of chest, palm down.
- Lay head back against bench and straighten arm to front.
- With free hand, lightly grasp back of arm near elbow, to stabilize working arm.
- Raise chest and pinch shoulder blades together. Maintain a slight arch in lower back.



FINISH

ACTION

- Keep upper arm stationary. Bend elbow, moving hand in arcing motion across chest.
- Stop motion when arm is straight, then slowly reverse arc motion until elbow is back in start position.

Triceps Kickback

Muscles worked:

Triceps muscles.

Position:

Standing – facing machine

Accessory:

Hand Grips

Pulleys:

Center Cross Bar – narrow position

Before You Begin:

Remove Seat and Leg Extension

Key Points:

- Maintain spinal alignment.
- Keep arm at side and wrist straight throughout entire motion.
- Tighten triceps throughout exercise and control motion.
- Keep palms facing upward.



START

START

- Stand on platform.
- Keep chest lifted and maintain a slight arch in lower back.
- Support yourself with one arm on the horizontal bar and grasp a hand grip with free hand, palm facing backward.
- Draw elbow back so upper arm is beside body, elbow bent approximately 90°.



FINISH

ACTION

- Straighten elbow while keeping upper arm completely still.
- When arm is straight, slowly return to start position.

Hammer Triceps Kickback

Muscles worked:

Triceps muscles.

Position:

Standing – facing machine

Accessory:

Hand Grips in “Hammer Grip”

Pulleys:

Center Cross Bar – narrow position

Before You Begin:

Remove Seat and Leg Extension

Key Points:

- Maintain spinal alignment.
- Keep arm at side and wrist straight throughout motion.
- Tighten triceps throughout exercise and control motion.
- Maintain Hammer Grip throughout exercise.



START

START

- Stand on platform.
- Keep chest lifted and maintain a slight arch in lower back.
- Support yourself with one arm on horizontal bar and grasp a hand grip in the vertical hammer grip position with free hand, palm facing in.
- Draw elbow back so upper arm is beside body and elbow bent approximately 90°.



FINISH

ACTION

- Straighten elbow while keeping upper arm completely still.
- When arm is straight, slowly return to start position.

Resisted Dip – Elbow Extension

Muscles worked:

Triceps muscles.

Position:

Standing – facing outward

Accessory:

Hand Grips

Pulleys:

Lat Tower

Before You Begin:

Remove Seat and Leg Extension

Key Points:

- Keep back straight and knees slightly bent.
- Keep the abdominals tight throughout the entire motion and maintain good spinal alignment.



START

START

- Stand on the platform facing away from machine. Reach back and grab hand grips with thumbs on inside toward body.
- Cable should be between arm and body.
- Upper arms should be at a 90° angle from torso.



FINISH

ACTION

- Straighten arms down, focusing on moving elbows down and inward toward hips.
- Slowly return to start position keeping tension in back shoulder muscles.

Biceps Curl – Elbow Flexion (in Supination)

Muscles worked:

Biceps muscles.

Position:

Standing – facing machine

Accessory:

Hand Grips

Pulleys:

Squat Pulley Frame

Before You Begin:

Remove Seat and Leg Extension

Key Points:

- Keep elbows at sides.
- Keep wrists straight.
- Keep trunk muscles tight and maintain a very slight arch in lower back.



START

START

- Stand on platform.
- Bend down and grasp hand grips with palms forward.
- Stand with upper arms by sides. Lift chest, tighten abs and maintain a slight arch in lower back.



FINISH

ACTION

- Curl hand grips forward, then up, and then in toward shoulders while keeping elbows at sides and upper arms completely still.
- Slowly lower to start position by performing the same arcing motion.

Concentration Biceps Curl – Elbow Flexion (in Supination)

Muscles worked:

Biceps muscles.

Position:

Standing – right or left side facing machine

Accessory:

Hand Grips

Pulleys:

Squat Pulley Frame

Before You Begin:

Remove Seat and Leg Extension

Key Points:

- Keep elbow pointing toward floor at all times.
- Keep wrist straight.
- Bend at hips, not at the waist.
- Keep back straight, chest up and maintain a very slight arch in lower back.



START

- Stand on platform, one side toward machine.
- With hand closest to Power Rod™ resistance rods, grasp hand grip.
- Keeping back straight, bend at hips and knees, until trunk is parallel to floor. Place uninvolved hand on thigh to help stabilize.



ACTION

- Curl hand grip away from cable, then up toward shoulder while keeping upper arm completely motionless and elbow pointing toward the floor at all times.
- Slowly return to start position performing the same arc of motion.

Reverse Curl – Elbow Flexion (in Pronation)

Muscles worked:

Deep arm muscle(brachialis).
Also the front forearm muscle (brachioradialis) and biceps.

Position:

Standing – facing machine

Accessory:

Hand Grips

Pulleys:

Squat Pulley Frame – with squat straps

Before You Begin:

Remove Seat and Leg Extension

Key Points:

- Keep elbows at sides.
- Keep wrists straight.
- Keep trunk muscles tight and maintain a very slight arch in lower back.



START

- Stand on platform.
- Bend down and grasp hand grips with palms facing backward.
- Stand with arms by sides.
- Lift chest, tighten abs and maintain slight arch in lower back.



ACTION

- Keeping palms facing down, slowly curl hand grips forward, then up, then in toward shoulders while keeping elbows at sides and upper arms completely still.
- Slowly lower to start position.

Barbell Biceps Curl – Elbow Extension

Muscles worked:

Biceps muscles.

Position:

Standing – facing machine

Accessory:

Squat Bar – with squat straps

Pulleys:

Squat Pulley Frame

Before You Begin:

Remove Seat and Leg Extension

Key Points:

- Keep elbows at sides.
- Keep wrists straight.
- Keep trunk muscles tight and maintain a very slight arch in lower back.



START

START

- Stand on platform.
- Bend down and grasp squat bar with palms facing forward.
- Stand with upper arms by sides (although not pressed tightly). Lift chest, tighten abs and maintain a slight arch in lower back.



FINISH

ACTION

- Curl squat bar forward, then up, and then in toward shoulders while keeping elbows at sides and upper arms completely still.
- Slowly lower to start position by performing same arcing motion.

Reverse Barbell Biceps Curl – Elbow Extension

Muscles worked:

Biceps muscles.

Position:

Standing – facing machine

Accessory:

Squat Bar – with squat straps

Pulleys:

Squat Pulley Frame

Before You Begin:

Remove Seat and Leg Extension

Key Points:

- Keep elbows at sides.
- Keep wrists straight.
- Keep trunk muscles tight and maintain a very slight arch in lower back.



START

START

- Stand on platform.
- Bend down and grasp squat bar with palms facing down.
- Stand with upper arms by sides (although not pressed tightly). Lift chest, tighten abs and maintain a very slight arch in lower back.



FINISH

ACTION

- Curl wrists back to bring squat bar forward, then up, and then in toward shoulders while keeping elbows at sides and upper arms completely still.
- Slowly lower to start position by performing same arcing motion.

Seated Biceps Curl – Elbow Flexion (in Supination)

Muscles worked:

Biceps muscles.

Position:

Seated – facing outward

Accessory:

Hand Grips

Pulleys:

Squat Pulley Frame

Before You Begin:

Remove Leg Extension

Key Points:

- Do not rock upper body while bending elbow.
- Keep wrists straight.
- Keep chest lifted, trunk muscles tight and maintain a very slight arch in lower back.



START

- Grasp hand grips, arms at sides with forearms near thighs.
- Maintain correct spinal alignment.



ACTION

- Curl forearms toward upper arms, keeping upper arms completely still.
- Slowly return to start position without relaxing biceps.

Seated Biceps Hammer Curl – Elbow Flexion

Muscles worked:

Biceps muscles and brachioradialis.

Position:

Seated – facing outward

Accessory:

Hand Grips in “Hammer Grip”

Pulleys:

Squat Pulley Frame

Before You Begin:

Remove Leg Extension

Key Points:

- Do not rock upper body while bending elbow.
- Keep wrists straight.
- Keep chest lifted, trunk muscles tight and maintain a very slight arch in lower back.



START

- Grasp hand grips in vertical hammer grip position, arms at sides, forearms near thighs.
- Maintain correct spinal alignment.



ACTION

- Curl forearms toward upper arms, keeping upper arms completely still.
- Slowly return to start position without relaxing biceps.

Wrist Extension

Muscles worked:

Back and top parts of forearms.

Position:

Standing – facing machine

Accessory:

Hand Grips

Pulleys:

Squat Pulley Frame

Before You Begin:

Remove Seat and Leg Extension

Key Points:

- Move slowly and keep tension in back of forearms at all times.
- Perform this exercise one arm at a time to make it easier to focus and isolate the back of forearms, or perform it with both arms simultaneously to save time.

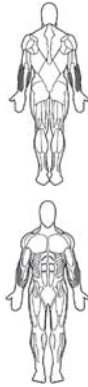

START

START

- Stand on platform, knees slightly bent.
- Grasp hand grips, palms facing down. Rest mid-forearms against sides with elbows flared out.
- Raise chest, tighten trunk muscles and maintain a slight arch in lower back.



FINISH

ACTION

- Slowly curl back of fists toward forearms.
- Slowly return to start position.

Wrist Curl – with Wrist Flexion

Muscles worked:

Front part of forearms. Also increases the strength of grip and isometrically challenges biceps muscles.

Position:

Standing – facing machine

Accessory:

Hand Grips

Pulleys:

Squat Pulley Frame Removed

Before You Begin:

Remove Seat and Leg Extension

Key Points:

- Move slowly and keep tension in front of forearm at all times.
- Do not increase or decrease bend in arms, perform the entire motion at wrist.
- Do not rock body. Keep chest lifted, abs tight and maintain a slight arch in lower back.



START

START

- Stand on platform.
- Bend down and grasp hand grips, palms facing forward, fingertips down.
- Stand with upper arms and elbows by sides.
- Lift chest, tighten trunk muscles and maintain a slight arch in lower back.
- Bend arms 90°, palms up. Hold position throughout entire exercise. 45

Owner's Manual



FINISH

ACTION

- Slowly curl fists towards front of forearms.
- Keeping forearms still, slowly let fists return to start position.

Abdominal Exercises

Trunk Rotation

Muscles worked:

Most of trunk muscles. Note: rotation is limited in the spine and should be performed with minimal resistance, in proper alignment.

Position:

Seated, facing outward left or right

Accessory:

Hand Grips

Pulleys:

Center Cross Bar – standard position

Before You Begin:

Remove Leg Extension

Key Points:

- Keep chest lifted and maintain good spinal alignment with a slight arch in lower back.
- Keep hands centered in front of middle of chest and shoulder blades pinched together. Make sure all of motion occurs in torso.
- Move only as far as muscles will take you and eliminate uncontrolled momentum.

! Failure to perform this exercise correctly could result in injury. Use only low weight rods.



START

START

- Sitting sideways on seat with one side facing machine, grasp hand grip closest to you with both hands.
- Raise both arms up to shoulder level, centered in front of middle chest.
- Keep elbows slightly bent.
- Lift chest, pinch shoulder blades together, tighten abs and maintain a slight arch in lower back.



FINISH

ACTION

- Tighten entire ab area and slowly rotate rib cage/arms away from cables (30 – 40°), as if rotating with a rod through middle of spine.
- Slowly return to start position.

Seated (Resisted) Oblique Abdominal Crunch

Muscles worked:

External obliques on resistance side and internal obliques on opposite side.

Position:

Seated – facing outward

Accessory:

Abdominal Crunch Shoulder Harness

Pulleys:

Abdominal bar

Before You Begin:

Remove Leg Extension

Key Points:

- Allow exhalation up and inhalation down, don't exaggerate it.
- Do not lift head/chin. Head should follow rib motion, not lead, allowing you to maintain normal neck posture.
- Tighten abs throughout range of motion. Do not let abs relax until set is over.
- MOVING SLOWLY to eliminate momentum is critical.



START

START

- Place seat in lowest position.
- Attach the Abdominal Crunch Shoulder Harness by snapping a hook to each of the D rings. Place the harness on your shoulders letting the handles hang over your chest. Grab both handles. With high resistance, a cross arm opposite-handle grip may be used.
- Lower back can start flat or in a normal arch, knees and hips bent, feet flat on floor.



FINISH

ACTION

- Tighten abs before you move, focusing on area from side of ribs to front of pelvis on the same side.
- Slowly move diagonally, rotating and curling torso, with the side of ribs directed toward front of pelvis.
- Move as far as you can, without moving hips or lower back from bench.
- Slowly reverse motion returning to start position without resting.

Seated (Resisted) Abdominal Crunch – Spinal Flexion

Muscles worked:

Abdominal area including upper and lower front abs (rectus abdominus) and side abs (obliques).

Position:

Seated – facing outward

Accessory:

Abdominal Crunch Shoulder Harness

Pulleys:

Abdominal bar

Before You Begin:

Remove Leg Extension

Key Points:

- Allow exhalation up and inhalation down, but don't exaggerate it.
- Do not lift head/chin. Your head should follow rib motion, not lead, allowing you to maintain normal neck posture.
- Tighten abs throughout range of motion. Do not let abs relax until set is over.
- MOVING SLOWLY to eliminate momentum is critical.



START

- Attach the Abdominal Crunch Shoulder Harness by snapping one hook to each of the D rings. Place the harness on your shoulders letting the handles hang over your chest. Grab both handles. With high resistance, a cross arm opposite-handle grip may be used.
- Lower back can start out flat or in normal arch, knees and hips bent and feet flat on floor.



ACTION

- Tighten abs and curl only torso, slowly moving ribs toward hips. Move as far as you can without moving hips or neck. LOWER BACK SHOULD NOT LOSE CONTACT WITH BENCH when fully crunched.
- Slowly reverse motion returning to start position without relaxing.

Leg Extension

Muscles worked:

All muscles on front of upper thigh (quadriceps muscle group).

Position:

Seated – facing outward

Accessory:

Leg Extension

Pulleys:

Squat Pulley Frame

Before You Begin:

Adjust seat height

Key Points:

- Use slow controlled motion. Do not “kick” into extension.
- Do not let knees rotate out during exercise. Keep kneecaps pointing up and forward.



START

START

- Sit on seat facing away from machine with knees near pivot point and lower roller pads on shins.
- Adjust thighs to hip width, pointing knee caps to front.
- Grasp sides of seat.
- Sit up straight with chest lifted, abs tight and a slight arch in lower back.



FINISH

ACTION

- Tighten quads and straighten legs by moving feet forward, then upward until legs are completely straight and kneecaps are pointing up toward the ceiling.
- Slowly return to start position keeping tension in quads during movement.

Squat

Muscles worked:

All muscles of legs and buttocks (gluteus maximus).

Position:

Standing – facing outward

Accessory:

Squat Bar – with squat straps

Pulleys:

Squat Pulley Frame

Before You Begin:

Remove Seat and Leg Extension

Key Points:

- Make sure you do not bend waist or lower back.
- Keep abs tight throughout entire exercise.
- Keep knees pointed straight out in front of you.
- Never step off platform while under resistance.



START

START

- Stand on platform, feet shoulder width apart.
- Squat down and place squat bar across shoulders. Adjust strap on bar to make sure you have resistance at start of movement.
- Keep spine in good posture, with chest lifted, abs tight and maintain a very slight arch in lower back.



FINISH

ACTION

- Slowly rise to standing position. Keep knees slightly bent.
- Slowly return to start position. Do not allow knees to exceed a 90° angle.

Standing Hip Extension – Knee Bent

Muscles worked:

Buttocks area (gluteus maximus).

Position:

Standing – facing machine

Accessory:

Hand Grip on arch

Pulleys:

Squat Pulley Frame

Before You Begin:

Remove Seat and Leg Extension

Key Points:

- Make sure all motion occurs at hip, NOT waist or lower back.
- Keep abs tight throughout entire exercise.
- Maintain exactly the same bend in the knee of moving leg throughout entire exercise.



START

START

- Secure hand grip around arch of foot. Keep this leg bent at approximately 90°.
- Hold onto seat back pad to stabilize yourself.
- Keep spine in good posture, chest lifted, abs tight. Maintain a slight arch in lower back.



FINISH

ACTION

- Tighten glutes. Extend hip by moving entire leg backward.
- Slowly move leg as far as you can, without allowing ANY movement to occur at waist.
- Slowly return to start position.

Standing Hip Extension – Knee Extended

Muscles worked:

Buttocks area (gluteus maximus).

Position:

Standing – facing machine

Accessory:

Hand Grip on arch

Pulleys:

Squat Pulley Frame

Before You Begin:

Remove Seat and Leg Extension

Key Points:

- Make sure all motion occurs at hip, NOT waist or lower back.
- Keep abs tight throughout entire exercise.
- Keep leg in same position – slightly away from body's midline through entire exercise.



START

START

- Secure hand grip around arch of foot. Move leg very slightly away from midline – enough to move leg freely.
- Very slightly bend knee of support leg.
- Hold onto seat back pad to stabilize yourself.
- Keep spine in good posture, chest lifted, abs tight. Maintain a slight arch in lower back.



FINISH

ACTION

- Tighten glutes. Extend hip by moving entire leg backward.
- Slowly move leg as far as you can, without allowing ANY movement to occur at waist.
- Slowly return to start position.

Leg Kickback – Hip and Knee Extension

Muscles worked:

Buttocks area (gluteus maximus).

Position:

Standing – facing machine

Accessory:

Hand Grip on arch

Pulleys:

Squat Pulley Frame

Before You Begin:

Remove Seat and Leg Extension

Key Points:

- Do not allow waist, lower back or supportive hip to move.
- Keep abs tight throughout entire exercise.



START

- Secure cuff around arch of foot. Keep this leg bent at approximately 90°.
- Hold onto seat back pad to stabilize yourself.
- Keep spine in good posture, chest lifted, abs tight. Maintain a slight arch in lower back.



ACTION

- Extend entire leg backward, straightening knee.
- Slowly move leg as far as you can, without allowing ANY movement to occur at waist.
- Slowly return to start position.

Hip Flexion – Knee Flexion

Muscles worked:

Muscles on front of hips (iliopsoas, rectus femoris).

Position:

Standing to the left or right of machine facing away

Accessory:

Hand Grip on ankle

Pulleys:

Squat Pulley Frame

Before You Begin:

Remove Seat and Leg Extension

Key Points:

- Make sure all motion occurs at hip, NOT waist or lower back.
- Keep chest lifted and trunk muscles tight throughout entire exercise.
- Allow lower leg to hang in the direction of cable at all times.



START

- Use Center Cross Bar as a stabilizer.
- Secure a hand grip around one of ankles.
- Straighten, but do not lock, knee of support leg.
- Keep spine in good posture, chest lifted, abs tight. Maintain a slight arch in lower back.



ACTION

- Lift knee up and in toward torso.
- Allowing knee to bend as you move, bring knee up as far as you can, without allowing ANY movement to occur at waist or lower back.
- Slowly return to start position without resting leg muscles.

Dead Lift

Muscles worked:

Buttocks area (gluteus maximus).

Position:

Standing – facing outward

Accessory:

Squat Bar

Pulleys:

Squat Pulley Frame

Before You Begin:

Remove Seat and Leg Extension

Key Points:

- Make sure to keep back flat – do not arch.
- Lift with legs, not your back or arms.
- Keep knees bent and head up.



START

- Facing away from machine, grip squat bar using one hand with an underhand grip and the other hand with an overhand grip.
- Keep legs bent at 90°. Bend over 30-45° from hips (not waist).
- Keep spine in good posture, chest lifted, abs tight. Maintain a slight arch in lower back.



ACTION

- Push up with legs.
- Slowly move up until you are in the standing position.
- Slowly return to start position.

Stiff Leg Dead Lift

Muscles worked:

Buttocks area (gluteus maximus) and hamstrings.

Position:

Standing – facing outward

Accessory:

Squat Bar

Pulleys:

Squat Pulley Frame

Before You Begin:

Remove Seat and Leg Extension

Key Points:

- Make sure to keep your back flat – do not arch.
- Your motion is entirely at the hips NOT the waist.
- Keep knees slightly bent and head up.
- Use light weight.



START

- Stand on platform. Grasp squat bar with palms facing down.
- Keep legs very slightly bent.
- Bend 90° from hips (not waist).
- Keep spine in good posture, chest lifted and abs tight. Maintain a slight arch in lower back.



ACTION

- Push hips forward.
- Slowly move trunk up until you are in standing position. Glutes should be tight when reaching standing position.
- Slowly return to start position.

Standing Hip Adduction

Muscles worked:

Insides of thighs (adductor muscle groups). Also, the outside of hip (gluteus medius) on support leg.

Position:

Stand to left or right of machine – facing outward

Accessory:

Hand Grip over ankle

Pulleys:

Squat Pulley Frame

Before You Begin:

Remove Seat and Leg Extension

Key Points:

- Do not use exercise for losing fat from thighs. Use it to develop hip strength and stability.
- Do not cross attached leg in front of standing/support leg. Use a small range of motion. More is not better.
- Keep spine straight and hips level. Try not to raise hips when raising leg to side or drop the hip when returning to start position.

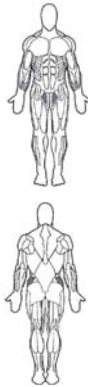

START

- Stand to one side of platform with one side near machine. Slide a hand grip over ankle nearest machine (inside leg).
- Stand straight, lift chest, tighten abs and maintain a slight arch in lower back.
- Adjust position away from machine so there is room to move attached leg toward pulley.



ACTION

- Slowly allow attached leg to move in toward support leg (30-45°), keeping hips and spine still.
- Slowly draw leg back to start position.

Standing Hip Abduction

Muscles worked:

Sides of hips (gluteus medius), especially on the standing/support side.

Position:

Stand to left or right of machine – facing outward

Accessory:

Hand Grip over ankle

Pulleys:

Squat Pulley Frame

Before You Begin:

Remove Seat and Leg Extension

Key Points:

- Do not use this exercise for losing fat from hips. It will not make hips smaller. Use it to develop hip strength and stability.
- Use a small range of motion. More is not better.
- Keep spine straight and hips level. Try not to raise hips when raising leg to side or drop the hip when returning to the side.



START

- Stand to one side of platform with one side near machine. Slide hand grip to ankle furthest from machine (outside leg).
- Stand up straight, lift chest, tighten abs and maintain a slight arch in lower back.
- Adjust position so there is some resistance in cables.



ACTION

- Slowly move attached leg out to side away from pulley (30-45°), keeping hips and spine still.
- Slowly return to start position without relaxing muscles.

Calf Raise – Ankle Plantarflexion (Knee Stabilized)

Muscles worked:

Lower leg or calf (gastrocnemius, soleus).

Position:

Standing – facing machine

Accessory:

Hand Grips

Pulleys:

Squat Pulley Frame

Before You Begin:

Remove Seat and Leg Extension

Key Points:

- Do not lose contact between the balls of feet and the frame as you push.
- Do not change hip or knee position, ONLY ankle motion should be allowed.



START

- Stand with toes on platform and heels hanging over edge.
- Use hand grips in both hands as resistance and a balance stabilizer.
- Lift chest, tighten abs and maintain a slight arch in lower back.



ACTION

- Slowly press balls of feet into platform and lift heels up.
- Slowly return to start position.

Muscle Chart

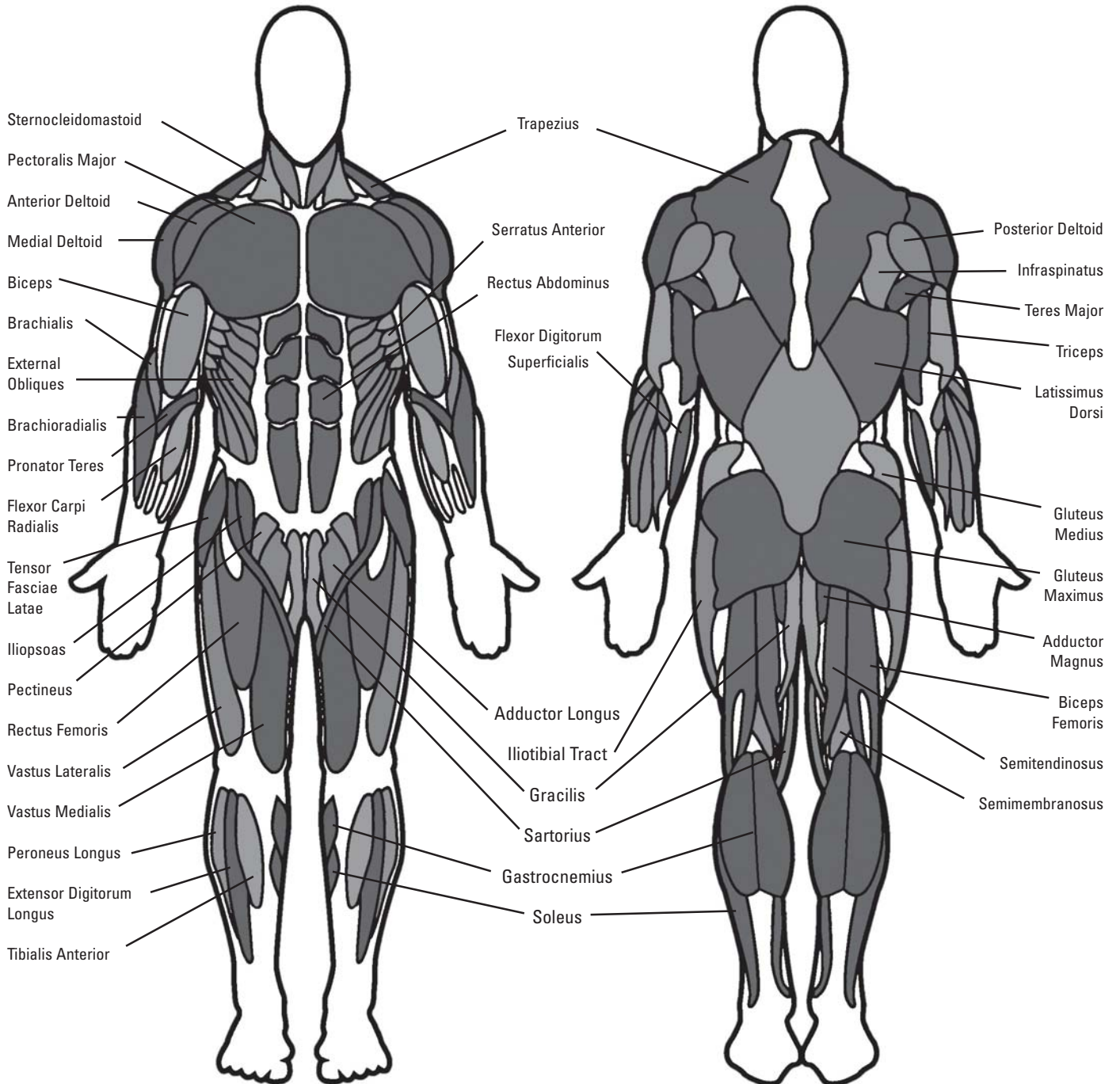

Please feel free to make copies of this chart to continue your exercise log.

EXERCISE		DATE	DATE	DATE	DATE	DATE	DATE
	Sets						
	Reps						
	Resistance						
	Sets						
	Reps						
	Resistance						
	Sets						
	Reps						
	Resistance						
	Sets						
	Reps						
	Resistance						
	Sets						
	Reps						
	Resistance						
	Sets						
	Reps						
	Resistance						
	Sets						
	Reps						
	Resistance						
	Sets						
	Reps						
	Resistance						
	Sets						
	Reps						
	Resistance						
	Sets						
	Reps						
	Resistance						
	Sets						
	Reps						
	Resistance						

Inspect your machine for any worn or loose components prior to use. Tighten or replace any worn or loose components prior to use. Pay close attention to cables, straps, or harness and their connections.

Review all warning notices.

 **The safety and integrity designed into a machine can only be maintained when the equipment is regularly examined for damage and repaired. It is the sole responsibility of the owner to ensure that regular maintenance is performed.**

Worn or damaged components shall be replaced immediately or the equipment removed from service until the repair is made.

Only manufacturer supplied components shall be used to maintain/repair the equipment.

Clean the bench with a non-abrasive household cleaner after each use. This will keep it looking new. Do not use automotive cleaner, which can make the bench too “slick.”

Introduction and Overview

Welcome to the Bowflex™ Body Weight Loss Guide. This guide is designed to be used with your Bowflex™ equipment and will help you:

- Lose weight and get lean
- Improve your health and wellness
- Increase your energy and vitality

⚠️ Consult a physician before you start an exercise program or a new health and diet plan. Stop exercising if you feel pain or tightness in your chest, become short of breath, or feel faint. Contact your doctor before you use the machine again. Use the values calculated or measured by the machine's computer for reference purposes only. The heart rate displayed on the console is an approximation and should be used for reference only.

By focusing on the main three elements of the Bowflex™ Body Weight Loss Guide- quality, balance, and consistency- you'll be able to reach and maintain your weight loss and fitness goals for the next six weeks and beyond.

- **Quality** – The emphasis of this plan is on eating more whole foods and getting the most nutrients from your calories as possible. Making the majority of your diet from foods that have a single ingredient (for example fruits, vegetables, fish, lean protein, eggs, beans, nuts, and whole grains) provides the vitamins, minerals, fiber, protein, and healthy fats your body needs.
- **Balance** – Each of the meals and snacks in this guide have a source of fiber or smart carbohydrate, protein, and healthy fat to keep your energy levels consistent throughout the day to fuel your workouts. By having this balance you'll feel fuller longer, which is critical to weight loss success.
- **Consistency** – Getting about the same number of calories each day is important for your metabolism and your mindset. If you overdo it one day, don't try to make up for it the next day by not eating or cutting your calories drastically. Get right back on track by following this guide!

Results & Expectations

Results will vary depending on your age, starting weight, and exercise level but on average you may lose 1-3 lbs per week and experience increased energy levels.

5 Tips for Long-Term Success

1. **Keep a food log** including hunger levels and water intake. Free online food logs and mobile apps are available at www.myfitnesspal.com and www.loseit.com
2. **Weigh and/or take measurements weekly** – no more and no less. Weighing weekly rather than daily or every other day is best. You'll track your progress and keep yourself in check without getting discouraged if the scale doesn't move for a few days. And remember, weight is just a number and it's influenced by muscle gain as well as fat loss. Feeling how your clothes fit can often be a better indicator of progress as your body adapts to exercise and nutrition changes.
3. **Measure portions** – To avoid portion creep, use measuring cups and spoons for grains (rice, pasta, cereal), beans, nuts, oils, and dairy. Use the Portion Sizes Guide for other foods.
4. **Plan ahead** – Make a meal plan for the week or log your food a day in advance. Planning sets you up for success, especially for social events and eating out.
5. **Practice your desired long-term habits** – It's easy to justify poor eating choices when you're only focused on the short term. Focus on the long term satisfaction of a slimmer, healthier you rather than the temporary gratification you'll get from splurging.

How to Use this Guide

- **Eat breakfast within 90 minutes of waking up and balance your meals and snacks throughout the day**
 - Don't go longer than 5-6 hours without eating
 - If you're not used to eating breakfast, start out small with a piece of fruit and have something else 1-2 hours later. Your body adapts to not eating breakfast, but as soon as you start eating early in the day and cutting back on dinner portions you'll notice your hunger will increase. This is a good sign your metabolism is working!
- **Mix and match meal options**
 - Select 1 option from the appropriate meal plan (male or female) for breakfast, lunch, and dinner, paying close attention to portion sizes
 - Select 1-2 snack options per day
 - You have the option to substitute one snack for one treat under 150 calories
 - Use the meal plan, sample options, and grocery list to create your own meals for more variety

- You can swap out any type of protein, vegetables or smart carbs for the suggested meal options. For example:
 - Turkey for tuna
 - Any fish or seafood for chicken
 - Cooked vegetables instead of salad
- **Eat your calories**
 - Cut out high calorie beverages like soda, juices, coffee drinks, and alcohol
 - Stick with water, unsweetened tea, and coffee. Aim for a minimum of 64oz (1.9 liters) of water per day to stay well hydrated
- **If you're still hungry after or in between meals:**
 - Have a glass of water and wait 15-20 minutes. Many times we mistake thirst (or even boredom!) for hunger. Wait out the initial urge to eat and sometimes it will pass.
 - If you're still hungry after waiting 15-20 minutes have a snack or mini-meal with fruit, vegetables, and protein.

If your goal is muscle gain or strength:

- Use the same meal plan but increase portion sizes in the same ratios to increase the total number of calories you eat every day. For example, increase portion sizes of protein and smart carbs at meals by 50%. Adding a snack is another option to meet your body's increased calorie needs in order to gain muscle and strength.
- Focus on post-workout nutrition by having one of your snacks within 30 minutes after you complete your workout. Make sure to have a combination of carbohydrates such as fruit with protein (yogurt, milk, or protein powder) to promote muscle growth and recovery. Chocolate milk is also a great option.

Meal Plan Overview

The female meal plan provides about 1400 calories, and the male plan provides about 1600 calories, of high quality nutrition to not only help you lose weight and feel great but get the most out of your calories. The vitamins, minerals, and antioxidants from eating mostly whole foods help support optimal health. These calorie levels will result in healthy weight loss for the majority of people. Keep in mind that everyone's metabolism is very different depending on age, height, weight, activity level, and genetics. Pay close attention to your weight, hunger levels, and energy and adjust your calories if needed.

Follow these guidelines if you're over 55:

- If you're over 55, you need fewer calories because your metabolism slows as you age. Stick with three meals with one optional snack per day.

Follow these guidelines if you're under 25:

- If you're under 25 you may need more calories. Add another snack if you feel low on energy or are extremely hungry.

Breakfast

Breakfast includes a smart carb, fruit, and a source of protein, which will also have fat. With a balance of carbohydrates and fiber from the smart carb and fruit combined with protein and fat, you'll energize your day and help control hunger levels throughout the day.

Snacks

Each snack is a balance of carbohydrates and protein to keep your blood sugar more consistent, which means you won't experience hunger and energy level spikes and drops.

This happens when you have a high carb-only snack like chips, candy, soda, crackers, or pretzels.

Lunch and Dinner

Lunch combines filling fiber from vegetables and smart carbs with a lean, or low-fat, protein. The healthy fat can come either from the protein added during cooking (nuts on a salad) or as a dressing or sauce (such as oil and vinegar salad dressing).

Here's an overview of what an ideal day looks like:
(See Portion Size Guide for proper serving sizes)

Breakfast

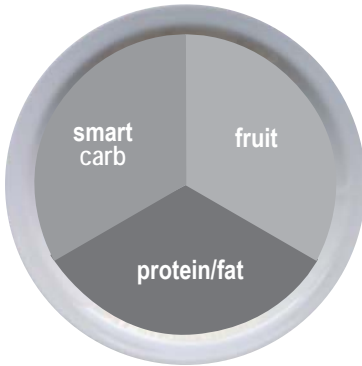

Snack #1

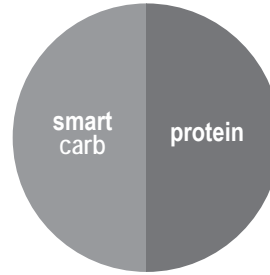

Lunch

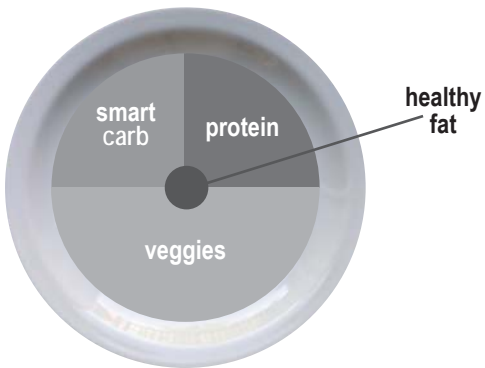

Snack #2

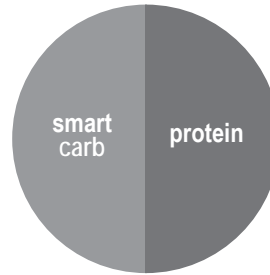

Dinner

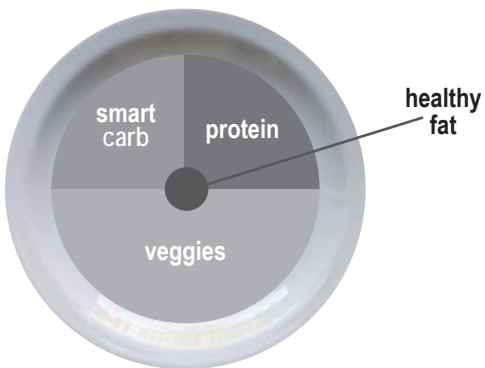

Breakfast Options	Fruit	Smart Carb	Protein/Fat
Fruit and Nut Oatmeal Cook plain oats in water. Top with fruit, nuts, milk, cinnamon, and honey.	Berries or banana	Plain oats (Regular or quick-cook)	Nuts and milk
Egg Muffin Cook egg/s. Toast bread and top with 1 slice of cheese, 1 slice of ham, and tomato.	Tomato	English muffin or sandwich thin	Egg, ham, and cheese
Yogurt Power Parfait Top yogurt with fruit. Sprinkle with 1 serving of nuts, 2-3 tbsp wheat germ, or ground flaxseed, 1 tbsp oats, and cinnamon.	Chopped fruit of your choice	Oats, wheat germ, and ground flaxseed	Plain non-fat Greek yogurt and nuts
On the Go PB & Apple Sandwich Toast bread. Spread on peanut butter, thin slices of ½ an apple, and 1 teaspoon of honey.	Sliced apple	Sandwich thin, bread, or bagel thin	Peanut butter

Lunch & Dinner Options	Lean Protein	Smart Carb	Veggies
Pork Loin, Sweet Potato & Green Beans	Grilled or baked pork loin	Baked Sweet Potato	Green Beans
Chicken Stir Fry Flavor with 2 tablespoon teriyaki sauce	Chicken breast or boneless skinless thigh	Brown or wild rice	Mixed stir fry vegetables (fresh or frozen)
Steak Tacos with Side Salad (3 for males, 2 for females) Top with salsa, cilantro, and sprinkle of shredded cheese	Flank or sirloin steak	Corn tortillas	Salad
Whole Wheat Pasta with Shrimp or Cannellini Beans & Marinara Sauce	Shrimp (frozen or fresh) or cannellini beans	Whole wheat pasta	Steamed broccoli
Bunless Burgers with Oven Fries, Corn, & Salad Grill burgers. Bake sliced potatoes on sprayed cookie sheet for 25-30 minutes @ 425°F.	93% lean ground beef or turkey	Oven baked fries	Corn on the cob + side salad
Tuna & Avocado Wrap with Vegetable Soup Use 3oz of tuna (1 can). Top with lettuce, tomato, avocado, and mustard.	Tuna	High-fiber wrap	Vegetable soup (homemade or low-sodium canned)

Snack Options	
Smart Carb	Protein
1 medium apple	10-15 almonds
Baby carrots	2 tbsp hummus
1 serving of crackers*	1 string cheese
Energy or protein bar with <200 calories*	

*See www.Bowflex.com/Resources for brand recommendations

Optional Treats

You have the choice of replacing Snack #2 with a 100-150 calorie treat. You can have an optional treat every day but for optimal health it is recommended to limit small splurges to 3-4 times per week. Use the approach that works best for you. Here are a few examples:

- ½ cup lowfat ice cream
- 1 small bag of baked potato chips
- 4oz of wine or 12oz light beer
- 3 cups of air-popped or light popcorn

Sample 3 Day Plan

Based on each of the meal options listed above, a typical 3 day plan could look like this:

	Day 1	Day 2	Day 3
Breakfast	Egg muffin	Power yogurt parfait	Fruit + nut oatmeal
Snack 1	Apple with almonds	Nut Thins® + string cheese	Baby carrots and hummus
Lunch	Tuna & avocado wrap with soup	Leftovers from dinner- day 1	Leftovers from dinner- day 2
Optional Snack 2 or Treat	½ cup ice cream bar	Energy bar	100 calorie bag of light popcorn
Dinner	Shrimp pasta	Chicken stir fry	Bunless burgers

Portion Size Guide

Each of the items listed are for one serving

MALE	FEMALE
PROTEIN	
2 eggs 5oz chicken, fish, lean meat, or tofu 2/3 cup beans or lentils* 1 cup greek yogurt* 1.5oz cheese*	1 egg 3oz chicken, fish, or lean meat 1/2 cup beans or lentils* 1/2 cup greek yogurt* 1.5oz cheese*
HEALTHY FAT	
2 Tblspn peanut or nut butter* 2 tspn olive, flax, or walnut oil 1/4 cup of nuts 1/3 medium avocado	1 tblspn peanut or nut butter* 1 tspn olive, flax or walnut oil 1/8 cup or 2 tablespoons of nuts (approx. 15 almonds) 1/4 medium avocado
SMART CARB	
1 cup cooked grains (1/2 cup raw): oats, brown rice, quinoa, pasta 1 medium sweet or regular potato 2 corn tortillas 1 slice of bread (or 2 light slices equaling 120 calories or less) 1 english muffin, sandwich thin, or high-fiber wrap	1/2 cup cooked (1/4 cup raw) grains 1/2 medium sweet potato or regular potato 2 corn tortillas 1 slice of bread (or 2 light slices equaling 120 calories or less) 1 english muffin, sandwich thin, or high-fiber wrap
FRUIT	
1 medium apple, orange, or pear 1 small banana (length of your hand) 1 cup berries or chopped fruit 1/4 cup dried fruit (fresh or frozen is optimal)	
Vegetables* You can have unlimited vegetables except for peas and corn; stick with 1/2 cup serving	
2 cups spinach or lettuce = 2 cupped hands 1 cup raw vegetables 1/2 cup cooked vegetables 6oz low sodium vegetable juice	
OPTIONAL TREATS	
1/2 cup lowfat ice cream 1 small bag of baked potato chips 1oz dark chocolate 4oz of wine or 12oz light beer 3 cups air-popped or light popcorn	

* some foods are a combination of protein and carbs or protein and fat



1 cup = baseball



1/2 cup = lightbulb



1 oz or 2 tbsp = golf ball

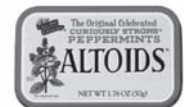

1/4 cup nuts = Altoids tin



3 oz chicken or meat = deck of cards



1 medium potato = computer mouse



1 medium piece of fruit = tennis ball



1 - 1/2 oz cheese = 3 dice

Grocery List

BREAD & GRAINS			
100% whole wheat bread Sprouted grain breads Light or whole wheat english muffins Sandwich or bagel thins Corn or low-carb whole wheat tortillas High-fiber wraps Plain oats: 1 minute or old fashioned Whole grains: brown rice, bulgar, barley, quinoa, couscous	Tips: Look for 100% whole wheat as the first ingredient. Look for 4g of fiber per slice or 5g per 2 slices of light or diet bread. Aim for bread with less than 100 calories per slice.		
DAIRY & DAIRY ALTERNATIVES	CRACKERS, SNACKS & ENERGY BARS		
Plain non-fat greek yogurt Kefir (yogurt like drink) Organic low-fat milk Enriched almond or soy milk Cheese: feta, parmesan, mozzarella, light havarti, provolone, swiss, string cheese, or single serving packages	<table border="1"> <tr> <td> Any unsalted nuts or seeds Air-popped or light popcorn Edamame in the pod </td> <td> Energy bars Crackers Hummus </td> </tr> </table>	Any unsalted nuts or seeds Air-popped or light popcorn Edamame in the pod	Energy bars Crackers Hummus
Any unsalted nuts or seeds Air-popped or light popcorn Edamame in the pod	Energy bars Crackers Hummus		
	Tips: Limit crackers, pretzels, and chips to 2-3 servings per week. Always pair with protein such as hummus, cheese, or nuts. Look for energy bars with less than 200 calories and 20g of sugar and at least 3g of protein and 3g of fiber. Look for crackers with less than 130 calories and 4g or less of fat per serving.		
MEAT, FISH, POULTRY & PROTEIN	FATS & OILS		
Wild game Salmon, halibut, tuna, tilapia, shrimp, catfish, scallops, or crab Pork loin, pork chops, or pork roast Chicken or turkey breast or thighs (no skin) Eggs and 100% egg whites Lean beef: sirloin, chuck, round, tenderloin, 93% lean (organic and grass fed is best) Canned salmon or tuna (in water) Nitrate-free, reduced sodium ham, turkey, chicken, or roast beef lunch-meat Any type of bean, dry or canned low-sodium varieties Tofu and tempeh	Avocado Olive, grapeseed, walnut, sesame, or flaxseed oil Butter/spreads: look for products free of trans fats and partially hydrogenated oils on the ingredient list.		
	Tips: Light olive oil refers to the flavor, not the calorie content. Always measure oil and butter. Even if a fat is considered healthy, it's still very high in calories and portions need to be controlled.		
	DRESSINGS, CONDIMENTS & SAUCES		
	Vinegars: rice, wine, balsamic All fresh or dried herbs and spices Mustard Salsa and chili sauce Marinara sauce with no high-fructose corn syrup Lemon and lime juice Bottled minced garlic and ginger Low-sodium soy sauce		
	Tips: Look for products free of MSG, added colors, and high fructose corn syrup. Look for sauces under 50 calories per serving. Avoid cream based sauces and dressings like ranch, bleu cheese, and alfredo.		
FROZEN FOODS			
All vegetables without sauce All fruit Grains and grain medleys			

All fruits and vegetables, fresh and frozen, are great choices. Since every meal has one or both, your shopping cart should reflect this.

Keep It Going

Tips for continued weight loss and maintaining changes

- **Keep weighing yourself weekly**, even after you've reached your goal weight
- **Continue keeping a food log.** If you have your meal plan well-established, log your food every other week to keep yourself on track. Don't feel like you have to do it every day.
- **Prepare for plateaus.** The scale might not budge for a few weeks or even months after some initial weight loss. This is normal and to be expected. It's the body's natural process for adjusting to your new lower weight. Stay focused on your long-term goal, celebrate your successes and changes, and mix up your workouts to help overcome the plateau.
- **Calorie adjustments for maintaining weight loss.** Once you've reached your goal weight, you can increase your calories 100-200 per day as long as your activity level stays the same
- **Treat yourself.** Have a non-food reward for each goal you hit such as a massage, a new outfit, or an outing with friends and family
- **Use the resources below** to find new recipes, get expert advice, and support to stay motivated

Resources

Downloadable Resources from Bowflex™ Website (www.Bowflex.com/Resources)

- Grocery Shopping List for Fridge (Blank Form)
- 7 Day Meal Planning Form
- Additional Dinner Options
- Pre and Post Workout Fueling Guide

Questions & Support

- Ask questions, post suggestions, and connect with our online Bowflex™ Dietitian on the Bowflex Facebook page

Recipes

- www.wholeliving.com
- www.eatingwell.com
- www.whfoods.org
- www.livebetteramerica.org

Online food logs

- www.myfitnesspal.com
- www.loseit.com

Who Is Covered

This warranty is valid only to the original purchaser and is not transferable or applicable to any other person(s).

What Is Covered

Nautilus, Inc. warrants that this product is free from defects in materials and workmanship, when used for the purpose intended, under normal conditions, and provided it receives proper care and maintenance as described in the Product's Assembly and Owner's manual. This warranty is good only for authentic, original, legitimate machines manufactured by Nautilus, Inc. and sold through an authorized agent and used in the United States or Canada.

Terms

Warranty terms for products purchased in US/Canada are as stated below.

- Frame 1 year
- Parts 60 days
- Rods 5 years

For warranty & service of products purchased outside US/Canada, please contact your local distributor. To find your local international distributor, go to: www.nautilusinternational.com

How Nautilus Will Support the Warranty

Throughout the terms of the warranty coverage, Nautilus, Inc. will repair any machine that proves to be defective in materials or workmanship. Nautilus reserves the right to replace the product in the event a repair is not possible. When Nautilus determines replacement is the correct remedy, Nautilus may apply a limited credit reimbursement toward another Nautilus, Inc. brand Product, at our discretion. This reimbursement may be prorated based on length of ownership. Nautilus, Inc. is not responsible for dealer labor or maintenance charges beyond the applicable warranty period(s) stated herein. Nautilus, Inc. reserves the right to substitute material, parts or products of equal or better quality if identical materials or products are not available at the time of service under this warranty. Any replacement of the product under the terms of the Warranty in no way extends the original Warranty period. Any limited credit reimbursement may be prorated based on length of ownership. THESE REMEDIES ARE THE EXCLUSIVE AND SOLE REMEDIES FOR ANY BREACH OF WARRANTY.

What You Must Do

- Retain appropriate and acceptable Proof of Purchase.
- Operate, maintain, and inspect the product as specified in the Product Documentation (Assembly, Owner's Manuals, etc.).
- Product must be used exclusively for the purpose intended.
- Notify Nautilus within 30 days after detecting an issue with the product.
- Install replacement parts or components in accordance with any Nautilus instructions.
- Perform diagnostic procedures with a trained Nautilus, Inc representative if requested.
- This warranty does not cover in home repair costs (labor, etc) or related charges.

What Is Not Covered

- Damage due to abuse, tampering or modification of the Product, failure to properly follow assembly instructions, maintenance instructions, or safety warnings as stated in the Product Documentation (Assembly, Owner's Manuals, etc), damage due to improper storage or the effect of environmental conditions such as moisture or weather, misuse, mishandling, accident, natural disasters, power surges.
- A machine placed or used in a commercial or institutional setting. This includes gyms, corporations, work places, clubs, fitness centers and any public or private entity that has a machine for use by its members, customers, employees or affiliates.
- Damage caused by exceeding maximum user weights as defined in Products Owner's Manual or on the warning label.
- Damage due to normal usage and wear and tear.
- This warranty does not extend to any territories or countries outside the United States and Canada.

How to Obtain Warranty Support

For Products purchased directly from Nautilus, Inc. contact the Nautilus office listed on the Contacts page of the Product's Owner's manual. You may be required to return the defective component to a specified address for repair or inspection, at your expense. Standard ground shipping of any warranty replacement parts will be paid by Nautilus, Inc. For products purchased from a retail outlet, you may be asked to contact your retailer for warranty support.

Exclusions

The preceding warranties are the sole and exclusive express warranties made by Nautilus, Inc. They supersede any prior, contrary or additional representations, whether oral or written. No agent, representative, dealer, person or employee has the authority to alter or increase the obligations or limitations of this warranty. Any implied warranties, including the WARRANTY OF MERCHANTABILITY and any WARRANTY OF FITNESS FOR A PARTICULAR PURPOSE, are limited in duration to the term of the applicable express warranty provided above, whichever is longer. Some states do not allow limitations on how long an implied warranty lasts, so the above limitation may not apply to you.

Limitation of Remedies

EXCEPT AS OTHERWISE REQUIRED BY APPLICABLE LAW, THE PURCHASER'S EXCLUSIVE REMEDY IS LIMITED TO REPAIR OR REPLACEMENT OF ANY COMPONENT DEEMED BY NAUTILUS, INC. TO BE DEFECTIVE UNDER THE TERMS AND CONDITIONS STATED HEREIN. IN NO EVENT WILL NAUTILUS, INC. BE LIABLE FOR ANY SPECIAL, CONSEQUENTIAL, INCIDENTAL, INDIRECT OR ECONOMIC DAMAGES, REGARDLESS OF THE THEORY OF LIABILITY (INCLUDING, WITHOUT LIMITATION, PRODUCT LIABILITY, NEGLIGENCE OR OTHER TORT) OR FOR ANY LOST REVENUE, PROFIT, DATA, PRIVACY OR FOR ANY PUNITIVE DAMAGES ARISING OUT OF OR RELATED TO THE USE OF THE FITNESS MACHINE EVEN IF NAUTILUS, INC. HAS BEEN ADVISED OF THE POSSIBILITY OF SUCH DAMAGES. THIS EXCLUSION AND LIMITATION SHALL APPLY EVEN IF ANY REMEDY FAILS OF ITS ESSENTIAL PURPOSE. SOME STATES DO NOT ALLOW THE EXCLUSION OR LIMITATION OF CONSEQUENTIAL OR INCIDENTAL TYPE DAMAGES SO THE ABOVE LIMITATION MAY NOT APPLY TO YOU.

State Laws

This warranty gives you specific legal rights. You may also have other rights, which vary from state to state.

Expirations

If the warranty has expired, Nautilus, Inc. may assist with replacements or repairs to parts and labor, but there will be a charge for these services. Contact a Nautilus office for information on post-warranty parts and services. Nautilus does not guarantee availability of spare parts after expiration of warranty period.

International Purchases

If you purchased your machine outside of the United States consult your local distributor or dealer for warranty coverage.

