

MARCH

15 CENTS

# Popular Electricity Magazine

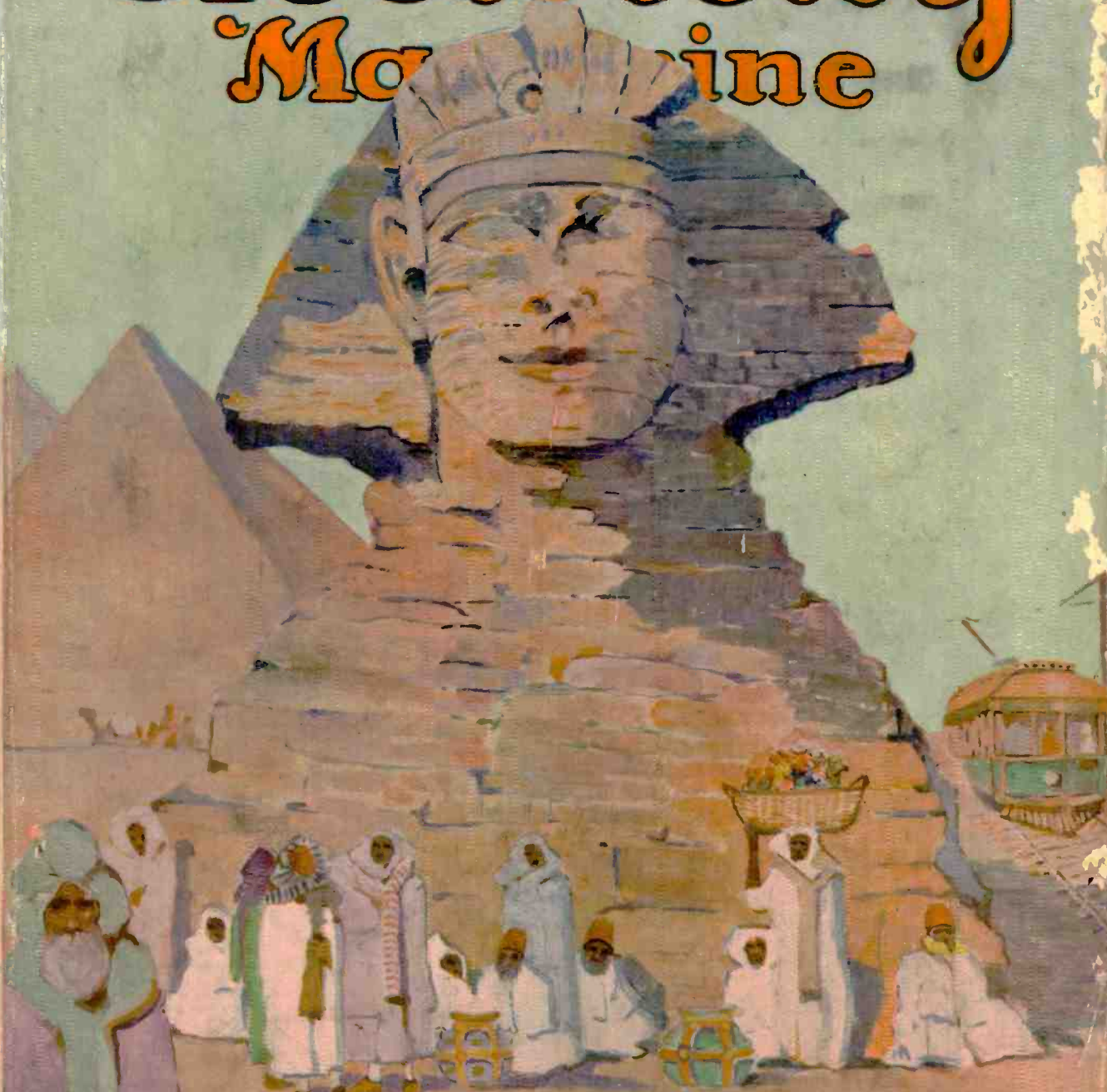

Trolley Cars in  
Remote Places

W. H. RAYNOLD  
1912

# LAW University Instruction At Home

Learn law in the greatest law school for home study in the world. Many brilliant lawyers studied law at home. Resolve NOW to take advantage of our remarkable offer to give you a complete three years' course without charge. Read the offer, then clip the coupon at the bottom of the page and send it to us at ONCE.

## Superior Advantages of Our School

We have ten years of successful experience in teaching law by correspondence. We have a large and distinguished faculty and staff of special lecturers—men whose prominence insures efficient service. We are the only school that actually combines the case and text book method of instruction—same as *Harvard, Columbia, Michigan and other big universities*. Our course is adapted for men who want to prepare for the practice of law, or for men who want legal knowledge for business purposes. We have the simple, easy and direct method of law instruction. Our course has brevity and conciseness—takes only your spare time.

## Our Great Scholarship Offer

At this particular time we offer you a tuition credit valued at \$100 absolutely without charge. This tuition credit entitles you to a complete three years' course in our School—Lectures, Faculty Talks, Examinations and the services of our Consulting Department. We are doing this for advertising purposes. The offer is open for a limited time *only*. Take advantage of this remarkable opportunity NOW. Get your tuition in a great law school—the greatest in the world—without a cent of cost to you. Your only expense will be for text and postage. This offer is limited so get particulars at once—mail the coupon now—this very day.



## We Furnish This Magnificent LAW LIBRARY With Every SCHOLARSHIP

This magnificent set of law books, complete in twelve volumes, covers all the subjects of law. It is written so you can understand every detail of the most complex law problems. The original cost of this library was over \$50,000.00. Constant revision insures everything being strictly up-to-date. With the aid of these splendid volumes you will grasp the subject of law in a surprisingly short time.

**BUSINESS LAW COURSE** We have a course for those who do not intend to practice law, but who want a knowledge of law for business purposes. You should know the law even if you never expect to practice at the bar. Ignorance of the law excuses no one. No knowledge more important or practical. To know the law is a liberal education in itself. It sharpens the reason, broadens the mind and perfects the memory. Knowing law is the best guarantee of success in any business.

### We Guarantee

To coach free any graduate failing to pass bar examination. Our course covers all branches of American Law and includes same studies as leading Law Schools.

### Mail Coupon Today

Put your name and address on this coupon and send it to us today. It will bring our big 130-page catalog **FREE**. In it is a splendid article on "The Importance of a Law Education." We will also tell you of our special scholarship offer. Remember, this offer entitles you to a complete three-year course in our school *absolutely without charge*. Offer is limited—send coupon now.

American Correspondence School of Law  
Manhattan Building, Dept. 1403 Chicago, Ill.

## Information Coupon

American Correspondence School of Law, Dept. 1403, Manhattan Bldg., Chicago, Ill.

Gentlemen: Without any obligations on me whatsoever, please send me your catalogue and particulars of your scholarship offer.

Name.....  
Address.....

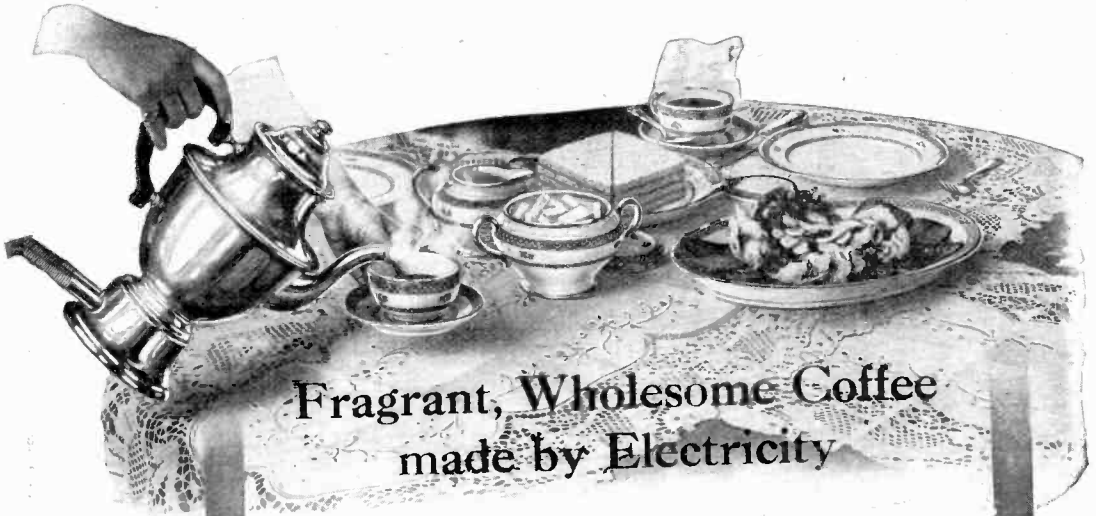

## Fragrant, Wholesome Coffee made by Electricity

Make coffee as it should be made—clear, appetizing, wholesome—free from the tannic acid of boiled coffee, but retaining all the delicate aroma and distinctive flavor of perfect coffee. Make coffee the electric way with the new popular priced

# ELECTRIC Coffee Pot

In it you can percolate any amount of coffee, from two to eight cups, equally well, simply by connecting the attaching plug to any electric socket. Enough coffee for the usual meal requires only a cent's worth of electricity.

This New Coffee Pot is easy to operate, easy to clean, handsome in design and finish, and of the same high quality as our urn types that cost twice as much.

Besides its noticeable beauty and undeniable utility, the moderate price of \$10 enables any home to enjoy its perfect coffee.

Get this G-E Coffee Pot from electric shops, stores carrying electrical goods or any lighting company. If you cannot find it readily, write us and our nearest dealer will supply you without delay.

## General Electric Company

*Largest Electrical Manufacturer in the World*

Dept 30 H.

Schenectady, N. Y.

*The  
Guarantee  
of  
Excellence  
in  
Goods  
Electrical*



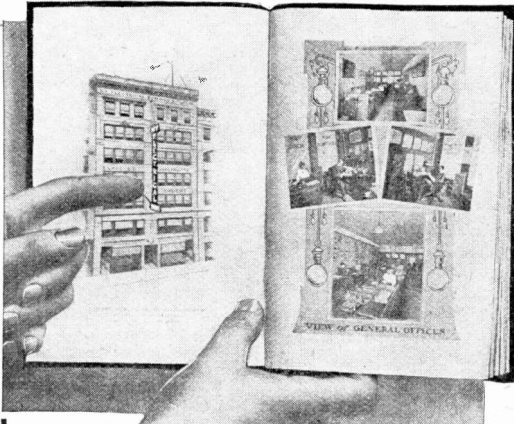

Write for this **FREE BOOK**

It may mean the opening wedge to the opportunity of your life

**T**HE New York Electrical School teaches men practical electricity and shows them the way to earn big money by becoming expert electricians. No profession has a more splendid future than electricity.

We teach our students how to become master electricians by painstakingly drilling them in the actual work they will be called upon to do when they accept a situation at big pay. Each scholar is personally taught from the day he enters, and individual instruction is given in all practical branches of the work. Students are first taught the simpler electrical work and as they gradually progress they are taken from department to department until finally they can completely equip a building from the blue prints the students themselves have drawn. When they receive their certificate they are ready to go out in the world with a profession that will never forsake them. Not a correspondence school—you "Learn by Doing."

## Good Electricians Are Always in Demand

and the money they earn is often twice as much as other men earn from ordinary trades.

**Write for Our Free Catalog and Get Full Particulars**

It is more than likely that this is your opportunity. There is no work that a man can do from which he will get more pleasure and profit than from electrical work. Write to-day.

**The New York Electrical School**  
40 West 17th Street, New York

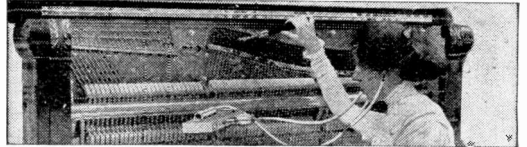

## PIANO TUNING PAYS

Learn the most independent of all professions. You can learn quickly and easily by devoting your spare time for a few weeks to our correspondence system. Our wonderful invention the TUNE-A-PHONE eliminates all guess work and assures success with or without a knowledge of music. We furnish full size action model and necessary tools. You can earn \$5 to \$15 per day, travel in any civilized country, see the world and regulate your own hours for business. School chartered by State. Diploma granted. Guaranteed as represented or tuition refunded. Write today for free illustrated book and valuable information.

NILES BRYANT SCHOOL 151 Art Institute, Battle Creek, Mich.

## LEARN TO RUN AND REPAIR AUTOS

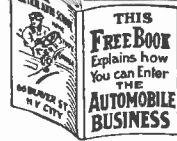

TWO COMPLETE COURSES FOR PRICE OF ONE. Standard Course and New 1913 Advanced Course. TWO MODELS. MOVING PICTURES of Auto Engine—over 994 Pages, and 1713 Charts and Diagrams included. Other schools ask MORE for O.A. out-of-date courses. We teach you at HOME to earn BIG MONEY. Diplomas issued and graduates assisted to positions. Great demand for Auto Experts. Our 38 page book with Employment Plan, sample lessons, many charts and diagrams FREE. Write for 1—NOW.

PRACTICAL AUTO SCHOOL, 68M, Beaver Street, New York City

## ARTISTS, CARTOONISTS, ILLUSTRATORS



earn \$40 a week up to \$450. "Vet" Anderson, internationally known caricaturist, cartoonist and illustrator, teaches caricaturing, cartooning and illustrating by most thorough up-to-date correspondence methods. Comic artists and cartoonists on newspapers earn as high as \$30,000 a year. Learn to draw work that is salable. Inspect other schools, then come to ours and learn right. There are no "ifs" and "ands" about our courses—you can succeed if you will. Send 6 cents in stamps for our handsomely illustrated catalogue to cover cost of postage.

"Vet" Anderson School of Illustrating, Inc.  
92 PARK PLACE, NEWARK, N. J.

## TELEGRAPHY The Only Trade that is steady employment and good wages. not Crowded. It insures ambitious. We are official instructors for the Western Union Telegraph Co., and the only school instructing Western Union employes. Largest attendance of any Telegraph school; also authorized school for Illinois Central Railroad Company. Agency course free. Practical instructors: main line wires. Employment furnished to earn expenses if desired. State your age.



James School of Telegraphy, P.E. 313 S. La Salle St., Chicago, Ill.

## UNCLE SAM IS BEST EMPLOYER;

pay is high and sure; hours short; places permanent; promotions regular; vacations with pay; thousands of vacancies every month; all kinds of pleasant work everywhere; no lay-offs; no pull needed; common education sufficient. Special money back guarantee if you write today for booklet D-1069. IT IS FREE.

EARL HOPKINS, WASHINGTON, D. C.

GET A BETTER PLACE



**WRITE US A STORY**

## OH! FOR A MEMORY

Your efficiency in any line of work depends, not on what you have learned, but on what you remember. A ready, dependable memory is the key to success in life. Our Memory and Mind Training is simple, speedy, sure; makes you quick and confident in thought and speech. Our free booklet, "West's Ideal Memory System," tells how, gives proof; also, how to obtain free the masterful book, "Public Speaking."

The Nat. Press Ass'n, Dept. 42, Indianapolis, Ind.

To Sell on Commission—2c to 5c a Word

Manuscripts read, criticized, revised, and typed. Story-Writing and Journalism taught by mail. Free booklet, "Writing for Profit" tells how, gives proof. NATIONAL PRESS ASSOCIATION Dept. 42, Indianapolis, Ind.

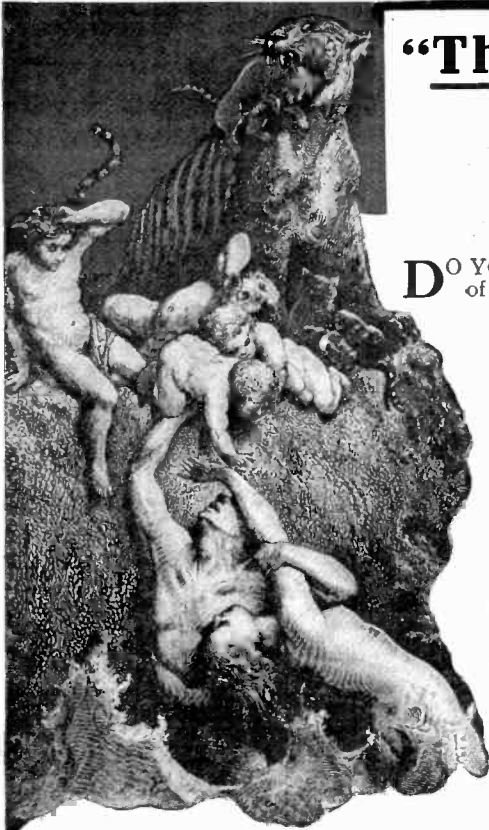

# “The Chaldean Story of the Flood”

## Dug Up From the Ruins of Ancient Chaldea

**D**O YOU KNOW that there has been dug up from the ruins of old Chaldea a complete story of the Flood—the same in every detail as Moses' account in Genesis—and that it was written thousands of years before his version appeared? Hardly one in a million has ever had an opportunity of seeing this startling story—**HAVE YOU?** But it is one of the many thousand curiously interesting accounts in

## The Library of Original Sources

now for the first time available to the general public. Up to the present this remarkable Library has only been sold by subscription, but by taking over the *entire unsold edition* from the publishers we secured it at an *absolutely unheard of bargain*. Therefore we are able to offer the few remaining sets to Popular Electricity Magazine readers.

### AT LESS THAN IT COST TO MAKE THEM

Send us the attached coupon **AT ONCE**, and we will tell you how to get the Library on **EASY MONTHLY PAYMENTS**, and mail you **FREE** a book of rare documents. Remember there are only a limited number of sets, so act quickly. Mail the coupon **NOW**. You assume no obligation. No salesman will call. The book is **FREE**.

**THIS MARVELOUS WORK** is revolutionizing modern thought. It's turning upside down old notions and ideas. It gives the authoritative, rock-bottom sources of our knowledge on ALL SUBJECTS OF HUMAN INTEREST from the earliest civilization down to today—the inside facts which the average person has never even heard of.

**OVER 100 RESEARCH SPECIALISTS** spent 10 years gathering the contents of this great work. Ancient and remote and forgotten civilizations in all parts of the globe were uncovered, and age-buried hieroglyphics on monuments, tablets, sun-baked bricks and palimpsests yielded their secrets; untracing workers ransacked the hidden literature of every age, ancient, medieval and modern, to find the "original documents" that shaped the civilizations and influenced the thought and life of the world. Nothing like it has ever been attempted or thought of before. You'll be amazed at the wealth of information this unique library contains.

**DO YOU KNOW** that the old Egyptians, 5000 years B. C., had a Bible which they called the "Book of the Dead"?—Do you know that the Assyrian sacred literature gives the story of the Creation?—Do you know that books and newspapers were printed in Asia thousands of years before printing was invented by Gutenberg?—Do you know that Columbus wrote a journal of his voyages to the new world and that it has been found, translated and published?—**DID YOU EVER READ** the Ball and Tyler Rebellion? Luther's "Ninety-Five Theses"?—which he nailed to the church door—or Machiavelli's "Prince"?

**YOU'LL FIND THEM ALL**—and thousands of others equally as curious and important—in the Library of Original sources. Every document is in the exact words of the original, translated; every contribution is from the actual eyewitness or person who took part; every idea is in the words of the thinker, investigator, discoverer or inventor.

**JACK LONDON SAYS:**—"It is a whole library in itself. I certainly never could spare these books from my shelves."

**10 sumptuous, massive volumes, bound in rich, deep red Morocco; full page illustrations. Pure silk headbands, printed in large, clear type on handmade paper, gold tops—a vertible triumph of the bookmaker's art.**

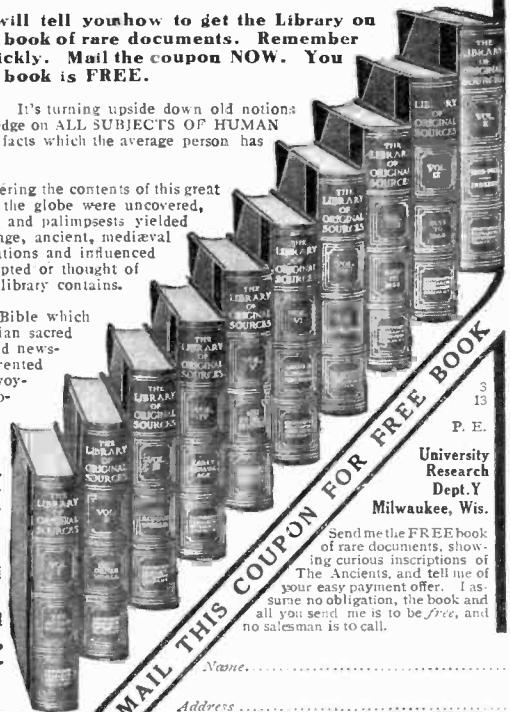

**MAIL THIS COUPON FOR FREE BOOK**

Name.....  
Address.....

3 13  
P. E.  
University Research Dept. Y  
Milwaukee, Wis.

Send me the **FREE** book of rare documents, showing curious inscriptions of The Ancients, and tell me of your easy payment offer. I assume no obligation, the book and all you send me is to be *free*, and no salesman is to call.

# Be a Doctor of Chiropractic

## The New Drugless Healing Science OF SPINAL ADJUSTMENT

A Dignified, Profitable Profession Easily Learned at Home. Steady Demand for Practitioners Everywhere—Our Students Surprisingly Successful.

### Make \$3000 to \$5000 a Year

Your income as a Chiropractor can be this much or more year after year. At the same time you will be serving suffering humanity. Dr. Walter made \$500 the third month after starting; R. M. Johnson has added over \$3,000 a year to his income; Vern Sharpsteen makes \$40.00 a day. In addition, this fascinating profession is building up for these former students of ours a splendid social and professional reputation.

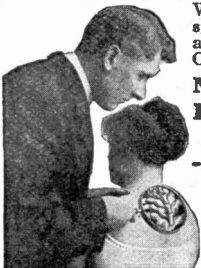

We taught these men in their spare time by correspondence, and in class, to be Doctors of Chiropractic—the

### NEW DRUGLESS HEALING SCIENCE of Spinal Adjustment

—and thereby made them independent for life. We will guarantee to teach you with equal success. A common school education is all you need to begin—our simplified training does the rest.

Sample lesson sheets and illustrated book giving full instructions how to get into this well-paid, uncrowded profession at once—mailed

# FREE

National School of Chiropractic, Dept. 142, 1553 W. Madison St., Chicago

## HAPPY MARRIED LIFE Realize happiness, strength and power through exact knowledge of SEX SCIENCE

This book is the life work of the well known physician,

Dr. J. H. Greer

who has studied world wide conditions and gives in this book, "Sex Science," the results of 20 years' study. It is written in non-medical terms—any one can understand it.



Every young man should read it.

Every married man should read it.

Every young woman should read it.

Every married woman should read it.

All in one volume—indexed. Price, cloth bound, \$1.00, Postpaid. Money Back if not Satisfied. Hicks Publishing Co., Dept. F, 64 W. Randolph St., Chicago, Ill.



## FRENCH—GERMAN SPANISH—ITALIAN

Is Easily and Quickly Mastered by the

### LANGUAGE PHONE

Combined with the Rosenthal Method of Practical Linguistry

This is the natural way to learn a foreign language. You hear the living voice of a native Professor pronounce each word and phrase. He speaks as you desire—slowly or quickly, night or day, for minutes or hours at a time. It is a pleasant, fascinating study; no tedious rules or memorizing. It is not expensive—all members of the family can use it. You simply practice during spare moments at convenient times, and in a surprisingly short time you speak, read and understand a new language.

Send for Booklet and Terms for Easy Payment

### THE LANGUAGE PHONE METHOD

946 Putnam Building, 2 West 45th Street, New York



### YOU CAN EASILY MAKE \$30 TO \$50 PER WEEK

as a Chauffeur, Mechanic or All Around Automobile Man.

#### SEND TODAY

for our free illustrated book with information regarding our method of up-to-date simplified instructions. Free made to all students. We assist you to secure position.

"Perfectly simple, you can do it, if you can."

N. Y. SIMPLEX AUTO SCHOOL, 149 Broadway, N. Y.

## Railway Mail Clerk Exam MAY 3rd

Let Me Prepare You. Write NOW for Free Booklet 92

ARTHUR R. PATTERSON, Civil Service Expert

Former U. S. Civil Service Secretary-Examiner

Rochester, N. Y.

THE OLDEST AND BEST

# AUTOMOBILE SCHOOL

Incorporated for \$10,000.00. The largest, best equipped and MOST RELIABLE automobile school in the country. Unlimited practical instruction on everything pertaining to automobiles. We guarantee to make a chauffeur, repairman, tester, salesman and demonstrator out of you in a short time or we will Refund Your Money. We have arranged with several of the large factories to employ our graduates. We have successful graduates in nearly every State in the Union.

### COME TO DETROIT, THE "AUTOMOBILE CENTER," AND LEARN THE BUSINESS

67 out of every 100 autos in the country are made in Detroit's 35 auto factories

Address Dept. E MICHIGAN STATE AUTOMOBILE SCHOOL 11-13-15-17 Selden Ave., Near Woodward, Detroit



THE POPULAR EDUCATIONAL FOOD CAMPAIGN

# Health

THE NEW BRAINY DIET SYSTEM

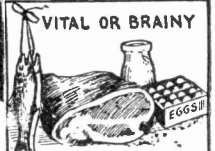

BLOOD PURIFIERS OR LAXATIVES



The everyday BRAINY or LIFE-GIVING foods are the most strengthening, healing forces in nature. They promote the highest efficiency in brain workers. When correctly combined they maintain health permanently.

Wrongly combined foods ferment and poison the system, causing rheumatism, appendicitis, apoplexy, etc., lack of appetite, and frequently death. The different foods causing expectoration, catarrh, fevers, night sweats, coughing, etc., are specified in the instructive booklet. Fat people have reduced one pound daily by a DIGESTIBLE brainy diet of everyday foods, gaining strength, without fasting, or exercises. Thin people gain flesh by the DIGESTIBLE weight-producing foods.

#### NO FOODS SOLD

People write: "My brain power and general efficiency have been nearly doubled this year by selecting brainy foods. I have made a fortune in real estate, and the credit is honestly yours."

#### "THE NEW BRAINY DIET SYSTEM"

Chapters on Diet vs. Drugs, Effects of Foods, Foods for Singers

G. H. BRINKLER

Food Expert, Dept. 19C

Washington, D. C.

For our Mutual Advantage mention Popular Electricity when writing to Advertisers.



## I Can Make You a Convincing Speaker

says Grenville Kleiser (former Yale Instructor). He rids you of timidity—gives you confidence in yourself—develops your power and personality. Give him fifteen minutes of your time daily—at home—and he will speedily teach you how to

**Sell Goods—Make Political Speeches—Address Board Meetings—Deliver After-Dinner Speeches—Propose Toasts—Converse and Tell Stories Entertainingly**

If you can't talk to the point, you can't carry conviction—you can't win! If you want to be a winner, write to-day for the free book, "Talking to Win," which tells all about this helpful Mail Course, and proves its value.

**FUNK & WAGNALLS COMPANY, Dept. 675 NEW YORK**

### COPY THIS SKETCH

and let me see what you can do with it. You can earn \$20.00 to \$125.00 or more per week, as illustrator or cartoonist. My practical system of personal individual lessons by mail will develop your talent. Fifteen years successful work for newspapers and magazines qualifies me to teach you.

Send me your sketch of Governor Wilson with 6c in stamps and I will send you a test lesson plate, also collection of drawings showing possibilities for YOU.

**The Landon School of Illustrating and Cartooning**  
1451 Schofield Building, Cleveland, O.



## MUSIC TAUGHT FREE

### AT YOUR OWN HOME

*By the Oldest and Most Reliable School of Music in America—Established 1895*

Piano, Organ, Violin, Mandolin, Guitar, Banjo, etc. Beginners or advanced players. One lesson weekly. Illustrations make everything plain. Only expense 2c per day to cover cost of postage and music used. Write for FREE booklet which explains everything in full.

**AMERICAN SCHOOL OF MUSIC, 38 Lakeside Bldg., CHICAGO**

### LEARN JEWELRY ENGRAVING

in your own home. Earn \$20.00 to \$50.00 weekly. Personal instructions. Write for free booklet.

**CHICAGO ENGRAVING SCHOOL, 614 Athenaeum Building, Chicago**

### LEARN TO REPAIR AND RUN AUTOMOBILES

**Big Money in Auto Business**

Travel, get good pay, run garage or auto livery. FREE illustrated book tells all. You can learn in a few weeks at home or in our shops. Write for information today.

**KANSAS CITY AUTOMOBILE SCHOOL**  
Largest and Best Equipped School in the World  
(Conducted by CLIFF HOGAN)  
2157 East Fifteenth Street  
KANSAS CITY, MO.



## A Course of Lessons —in— Drugless Healing [Mechano-Therapy]

# FREE!

Not one cent to pay either now or later—no obligations of any kind or nature. Just your simple request will bring you this valuable and interesting course of 62 lessons by return mail *without cost.*

This is the *first time* such an offer has ever been made. It may be the *only time.* We cannot urge you too strongly to accept this exceptional opportunity *without a moment's hesitation.*

This offer is *strictly limited.* As soon as a certain number of courses have been mailed, we shall be compelled to withdraw the offer. So don't wait a minute. Send your acceptance *right away.*

- ### These Free Lessons Teach You
- |                           |                        |
|---------------------------|------------------------|
| How to Treat Headache     | How to Treat Catarrh   |
| How to Treat Neuralgia    | How to Treat Epilepsy  |
| How to Treat Constipation | How to Treat Hay Fever |
| How to Treat Indigestion  | How to Treat Paralysis |
| How to Treat a Sprain     | How to Treat Pleurisy  |
| How to Treat Dyspepsia    | How to Treat Asthma    |
| How to Treat Rheumatism   | How to Treat Gout      |
| How to Treat Lumbago      | How to Treat Jaundice  |

Besides dozens of other important health subjects which every one should know. Every single step explained and pictured so plainly that you cannot fail to understand.

### WHY We Are Making This Offer

We want the public to know the *real truth* about Drugless Healing. We want you to convince yourself by a practical demonstration just what a wonderful new curative force may be placed at your command.

Besides, these free lessons will demonstrate just how thoroughly, how easily and in what a surprisingly short time you can master this wonderful new profession, at home or in class, without interfering with your regular occupation the slightest.

If you want to earn \$2500 to \$8000 a year, if you want an established profession that is pleasant, dignified and remarkably profitable, if you want to become master of your own and others' health and happiness then send for the Free Course and see what Drugless Healing has to offer you.

Hundreds of successful graduates in every quarter of the world demonstrate the wonderful efficiency of our methods. What about yourself? Are you satisfied? Are you contented—healthy—happy in your work—making all the money you want? If not, get posted on Drugless Healing right away.

**Remember: This Offer is Limited**

Write NOW for FREE Course of Lessons

Don't wait to think it over. Don't hesitate at a chance like this. Get the facts—the real truth—learn what you can do—what you can earn as a Mechano-Therapist. The Free 62-Lesson Course and our free book explain all. Send just the coupon or a postal or letter right away.

**American College of Mechano-Therapy**  
Dept. 759  
81 W. Randolph St. Chicago, Ills.

**American College of Mechano-Therapy**  
Dept. 759  
81 West Randolph St. CHICAGO, ILLS. (116)

Without cost or obligation, please send me by mail, prepaid, your free book and the course of 62 lessons in Drugless Healing.

Name.....  
Address.....

# Practical Electrical Education

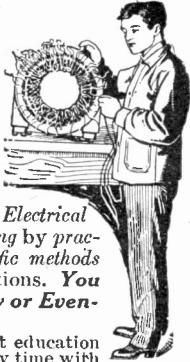

**W**E teach all branches of Electrical Science and Engineering by practical work and scientific methods under practical working conditions. You may enter at any time—Day or Evening Classes.

No matter what your present education is you can enter this school at any time with full assurance of a thorough training and graduate an expert. We will start you at the point you are competent to begin and you will advance as quickly as your own efforts and ability warrant. Positions secured for students and graduates. Many now well employed. Names on request. Full particulars and interesting catalogue free. Get it and see what real electrical education is.

**Write Right Now—Clip The Coupon**

**SCHOOL OF ENGINEERING OF MILWAUKEE**  
161-171 Michigan St. Milwaukee, Wis.

Send me without obligations on my part your 40 page Book of Valuable Electrical Facts Worth Knowing.

NAME .....

ADDRESS .....

.....

## FREE BOOK ON MOTORING



Explains how we can start YOU in the Auto Business as Repairman, Chauffeur, Salesman or Auto Mechanician with **DYKE'S NEW IDEA WORKING MODEL SYSTEM** of teaching by mail and our new idea **EMPLOYMENT PLAN**. Let us tell you the names of some of our students and the salaries they are drawing today—more than you are making.

ing. Don't miss it—Send for Booklet NOW! *The original and only system of its kind.* Dyke's School of Motoring, Box 2, Row Bldg., St. Louis, Mo.



## Y. M. C. A. Auto School

7th & Walnut, Cincinnati, Ohio

Gentlemen:—Please send me your catalog telling about 5 weeks course of Repairing, Driving and Lectures, which you say will fit me for a good position as Chauffeur or Repairman.

Name.....

Address.....

*Cut This Out and Mail To-day*

For our Mutual Advantage mention Popular Electricity when writing to Advertisers.



## LET HIM GIVE YOU A Real Command of English

It will take only some of your spare moments at home; no repellent grammar-study; each lesson as clear as daylight, and inspiring to the highest degree. Commence now—let Grenville Kleiser (former Yale Instructor) teach you through his Mail Course in Practical English, how to

- Enlarge Your Stock of Words—
- Use the Right Word in the Right Place—
- Write Tactful, Forceful Letters, Advertisements, Stories, Sermons, etc.
- Become an Engaging Conversationalist—
- Enter Good Society—
- Be a Man of Culture, Power, and Influence in Your Community.

Good English is absolutely necessary to the highest success in life. What material benefit is it to have good ideas if you can not express them adequately—if you can not make others see them as you do!

We will send by mail full particulars of this famous Course. No cost, no obligation to you—but ask for them to-day, on a post-card.

**FUNK & WAGNALLS COMPANY, Dept. 674 NEW YORK**

## LAW STUDY AT HOME BECOME AN LL.B.

Only recognized resident law school in U. S. Conferring Degree of Bachelor of Laws—LL. B.—by correspondence. Only law school in U. S. conducting standard resident school and giving same instruction, by mail. Over 450 class-room lectures. Faculty of over 30 prominent lawyers. Guarantees to prepare graduates to pass bar examination. Only law school giving Complete Course in Oratory and Public Speaking. School highly endorsed and recommended by Gov. Officials, Business Men, Noted Lawyers and Students. Send today for Large Handsomely Illustrated Prospectus. Special courses for Business Men and Bankers.

**MILTON COLLEGE OF LAW, 1167 Ellsworth Bldg., Chicago, Ill.**

## Do You Like to Draw?

That's all we want to know

Now we will not give you any grand prize or a lot of free stuff if you answer this ad. Nor do we claim to make you rich in a week. But if you are anxious to develop your talent with a successful cartoonist, so you can make money, send a copy of this picture with 6c in stamps for portfolio of cartoons and sample lesson plate, and let us explain.

**THE W. L. EVANS SCHOOL OF CARTOONING**  
325 Ball Bldg., Cleveland, O.



## WANTED—SALESMEN AND SALESWOMEN

Hundreds of good positions now open paying from \$1,000.00 to \$5,000.00 a year. No former experience required to get one of them. We will teach you to be a high grade Traveling Salesman or Saleswoman by mail in eight weeks and assist you to secure a good position where you can earn good wages while you are learning Practical Salesmanship. Write today for full particulars, and testimonials from hundreds of men and women we have recently placed in good positions; also list of good positions open. Address (nearest office) Dept. 130,

**NATIONAL SALESMEN'S TRAINING ASSOCIATION**  
Chicago New York Kansas City San Francisco New Orleans Toronto

## WIRELESS TELEGRAPHY

An EVENING Course in Continental Operating, Wireless Engineering (including actual construction of apparatus), and Drafting. Certificate or Diploma courses. Our graduates are now with Marconi Wireless Telegraph Company of America, Western Union, and Postal Companies.

Catalogue "T" Free  
**EAST SIDE Y. M. C. A. Telegraph School 161 E. 96th St., New York**



**FREE AUTOMOBILE**

To Students who qualify. Ride orders in "Coe Flyer"—6 cylinder—6 passenger car. We teach you to make big money in automobile business. Easy lessons—free model—no experience necessary. First lesson FREE to everyone answering this ad.



C. A. Coey's  
School of Motoring  
Dept. 12G  
1424-1426 Michigan Av.  
CHICAGO, ILL.

**I TEACH SIGN PAINTING**

SHOW CARD WRITING OR LETTERING by mail and guarantee success. Only field not overcrowded. My instruction is unequalled because practical, personal and thorough. Easy terms. Write for large catalogue.

CHAS. J. STRONG, Founder  
DETROIT SCHOOL OF LETTERING  
Department 113 Detroit, Mich.  
"Oldest and Largest School of its Kind"  
"Thoroughly equipped Residence School"

**UNCLE SAM WANTS YOU**



**Over 2000 Railway Mail Clerks to Be Appointed for Parcels Post Examinations Everywhere May 3rd**

Every second week off duty at full salary. Rapid advancement to higher Government Positions. No "Layoffs" because of STRIKES, FINANCIAL FLURRIES or THE WHIMS OF SOME PETTY BOSS. THE POSITION IS YOURS FOR LIFE. Country residents and city residents stand the same chance for immediate appointment. Common sense education sufficient. Political influence NOT REQUIRED.

We are Preparing Candidates Absolutely Free of Charge Write immediately for schedule showing the places of the May 3rd examinations. Don't delay. Every day you lose means the loss of just so much coaching before the rapidly approaching examinations.

**FREE COACHING COUPON**

FRANKLIN INSTITUTE, Dept. M 115, Rochester, N. Y. The coupon, properly filled out, entitles the sender to free sample questions, a free copy of our valuable book, "GOVERNMENT POSITIONS AND HOW TO OBTAIN THEM," and to consideration for FREE COACHING for the Civil Service Examination here checked.

... Railway Mail Clerk	(\$900 to \$1800)	... Customs Positions	(\$600 to \$1500)
... Postoffice Clerk	(\$600 to \$1200)	... Internal Revenue	(\$700 to \$1800)
... Postoffice Carrier	(\$600 to \$1200)	... Stenographer	(\$800 to \$1500)
... Rural Mail Carrier	(\$500 to \$1100)	... Clerk in the Department	(\$800 to \$1500)

Name.....  
Address.....  
*Use this before you use it. Write plainly.*



**TELEGRAPHY TAUGHT**

In the shortest possible time. The Omnigraph Automatic Transmitter combined with standard key and sounder. Sends you telegraph messages at any speed just as an expert operator would. Five styles, \$2 up; circular free. OMNIGRAPH MFG. CO. 39 H Cortlandt Street New York



**TEACH BY MAIL**  
WRITE FOR MY FREE BOOK  
"HOW TO BECOME A GOOD PENMAN"  
and beautiful specimens. Your name elegantly written on a card if you enclose stamp. Write today. Address F. W. Tamblin, 437 Meyer Bldg., Kansas City, Mo.

**SHORTHAND IN 30 DAYS**

We absolutely guarantee to teach shorthand complete in only thirty days. You can learn in spare time in your own home, no matter where you live. No need to spend months as with old systems. Boyd's Syllabic System is easy to learn—easy to write—easy to read. Simple, Practical, Speedy. Sure. No ruled lines—no positions—no shading as in other systems. No long lists of word signs to confuse. Only nine characters to learn and you have the entire English language at your absolute command. The best system for stenographers, private secretaries, newspaper reporters and railroad men. Lawyers, ministers, teachers, physicians, literary folk and business men and women may now learn shorthand for their own use. Does not take continual daily practice as with other systems. Our graduates hold high grade positions everywhere. Send to-day for booklets, testimonials, etc.  
CHICAGO CORRESPONDENCE SCHOOLS  
949 Chicago Opera House Block, Chicago, Ill.

**Get there—Yourself!**

Don't stop to envy the successful man. Study and ambition have placed him where he is to-day—and YOU have the same chance! Study at Home!



**Drafting Pays Big Salaries**  
Machine Drafting, Machine Design, Structural and Architectural Drafting and Design, Builders' Courses, Plan Reading, Estimating, Contractors' Courses, Etc. Regular and short courses. Students study blue prints of buildings and machinery in actual construction. Low tuition, easy payment. Free employment bureau. Free outfit to all Home Study students. Study at home in leisure hours; work is same as in our college day and evening classes. Both resident and correspondence courses. State which you want.  
CHICAGO TECHNICAL COLLEGE  
609 Athenaeum Building, Chicago, Ill.

**LEARN TELEGRAPHY**

(Wire and Wireless) and Station Agency Work

These three branches of study taught in a more thorough, complete and comprehensive manner than by any other school in America. We have graduated more successful students—secured them better positions at more pay than any other institution. Established 38 years.

**Easy, Interesting Work—Good Wages—Excellent Future**

Greatest demand for Agents and Operators in 25 years; big demand for Wireless Operators also. Railroad, Wireless and Telegraph Officials endorse us and employ our graduates. We own and occupy exclusively two of the largest and most modern buildings devoted to telegraph instruction. Equipped with Western Union and R. R. Train Dispatcher's Wires and Complete Wireless Station, all representing an investment of more than \$25,000.00. Expert Teachers, Low Tuition—which will be refunded if position is not secured when qualified. Living expenses may be earned while learning. Our correspondence courses if desired. Write me today, personally, for FREE Illustrated Catalog and Testimonials.

GEO. M. DODGE, President  
Dodge's Telegraph, Railway & Wireless Institute, 21st Street, VALPARAISO, IND.

Send Today for FREE Catalog Now!

For our Mutual Advantage mention Popular Electricity when writing to Advertisers.

# Special Offer!

## This \$25.00 Tuition Credit in Drafting and Designing FREE!

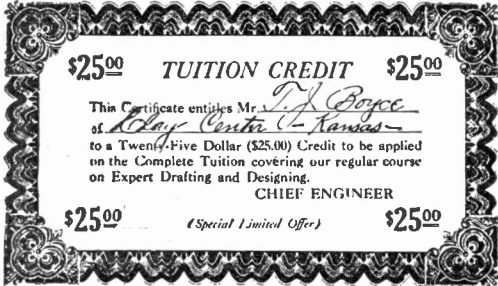

### Offer Limited—Write at Once!

Most wonderful opportunity for men ambitious to succeed! Learn to be an expert draftsman right in your own home. Keep your present position—just devote your spare moments to this work. Send the free coupon right away for free book and complete information.

## Be a Draftsman! Earn \$75 to \$200 per Month

That's what men earn who possess the training we give you on this most liberal offer. Big companies pay handsome salaries to get the right kind of men. The work is light, profitable and interesting. You are paid for what you know, not the quantity of hard work you do. Our practical method of instructions enables you to become an expert draftsman and designer in an amazingly short time. Learn just as

quickly and easily at home as in the drafting room. Expert draftsmen and designers give you "personal" instructions.

### Guarantee

We guarantee to instruct you until placed in a position paying from \$75 to \$200 per month. Our Employment Bureau places students in positions—FREE!

**\$17.50 set of Drawing Instruments FREE!**

If you write at once we will give you in addition to the tuition a magnificent set of drawing instruments valued at \$17.50, handy size leather bound pocket case. You can use this set of instruments for years—when you are occupying a high salaried position as expert draftsman.

### FREE COUPON

**Chief Engineer**  
Room 525  
Engineering Building  
Chicago, Ill.

DEAR SIR: Without any obligations on me please send me your free book and complete information about your great \$25 free tuition credit offer.

NAME.....

ADDRESS.....

### Mail This Coupon

Don't pass this exceptional opportunity! Be one of the men whose services are always in demand at a big salary. If you write at once you will receive this \$25 tuition credit free! Send the coupon for our free book and details of this great offer. No obligations—so send it immediately.

**Chief Engineer**  
Room 525  
Engineering Bldg.  
CHICAGO ILL.

# ELECTRICITY



CONDENSED COURSE IN ELECTRICAL ENGINEERING

## Complete in One Year Bliss Electrical School

Studies restricted to theoretical and practical electricity, mechanical drawing and necessary engineering work. Teaches simplicity, concentration, hard work. For young men of energy and character, 20 years of greatest success. Graduates hold first-class positions. Opens Sept. 24. Write for new catalog.

12 Takoma Ave., WASHINGTON, D. C.

## BE A BANKER



Learn a profession that will give you standing and independence. Splendid opportunities. Pleasant work, short hours, all holidays off, yearly vacation with pay, good salary. Diploma in six months. Text books by Edgar G. Alkorn. Catalog free.

AMERICAN SCHOOL OF BANKING, 139 McLene Bldg., Columbus, Ohio

## LEARN WATCHMAKING AND ENGRAVING



Earn while learning. Most practical watch school. Individual instructions. Graduates in great demand. Book free.

CHICAGO SCHOOL OF WATCHMAKING  
65 E. Van Buren Street Chicago

## INDIA KARACHI BEST OPPORTUNITY

Do you want a good connection with India in the lines you manufacture? Send your lowest quotations and samples to the

EASTERN ELECTRIC & TRADING CO. KARACHI

## FOREIGN SUBSCRIBERS

Readers of this magazine living in the United States are particularly interested in knowing of the progress of electricity in other lands. Very careful consideration will be given to articles which you may send us describing the uses of electricity in your country. Good photographs are especially desired, with two or three hundred words describing some odd or unusual application of electric current. Good rates are paid for acceptable contributions. Send for our little pamphlet "What to Write and How to Write It."

POPULAR ELECTRICITY MAGAZINE  
54 W. Lake Street, Chicago, Ill. Editorial Dept.

## Humidity Gauge

### A Simple Test of the Air Showing The Amount of Steam It Contains

The Instruments commonly sold to test humidity are so unreliable that most persons who undertake to use humidity for health and efficiency in cold weather, give it up without success.

The wet and dry bulb instruments are usually 20 per cent wrong in the low percentages. What the common observer wishes to know is whether he has enough humidity in the house for comfort and health in cold weather. Our gauge will give the information accurately.

The Humidity Gauge is a simple device for exhibiting at a glance the condition of the air as to its humidity by the color of the ribbons. By uncovering the leaves of the gauge one may readily find the shade which matches the color of the ribbons and find printed on the color sheet the percent of saturation or relative humidity of the air.

Price 35 Cents, Postpaid

Copyrighted and Sold by

**The Little Chronicle Company**  
542 S. Dearborn St., Chicago, Ill.



## Stop Forgetting!

Good memory is absolutely essential to success, for memory is power. Be successful—Stop Forgetting! Begin your real training at once.

The Dickson Method of Memory Training makes you "Forget Proof," develops concentration, will, self-confidence, quick thought, ready speech. Write today for my free book, "How to Remember"—faces, names, studies, also how to secure FREE, a copy of my \$2.00 DeLuxe book, "How to Speak in Public." Address Dickson Memory School, 929 Auditorium Bldg., Chicago.

## Any Electrical Book on the Market

Can be obtained through our Book Department  
Tell us your wants  
**POPULAR ELECTRICITY PUBLISHING CO.**  
54 W. Lake St. Chicago, Ill.



## Handy Electrical Dictionary

"Just Fits The Vest Pocket"

Designed to meet the needs of the beginner, and at the same time furnish a compact, reliable reference for the electrical worker and expert.

224 pages—"Plain English" definitions of over 4,800 electrical terms and phrases—7 pages of diagrams

**Everyone Interested in Electricity Needs it**

Price, Cloth, 25c  
Full leather, full gilt, 50c

**Popular Electricity Publishing Co. Book Dept.**  
54 WEST LAKE STREET CHICAGO, ILLINOIS

*Just Off the Press*

# House Wiring

By THOMAS W. POPPE  
ELECTRICAL ENGINEER AND CONTRACTOR

Absolutely new and up to the minute, describing and illustrating all up-to-date methods of installing Electric Light Wiring according to the latest rulings of the National Board of Fire Underwriters. All systems of wiring are covered, including the three-wire system now so much in use. Practical diagrams and illustrations are given to show just how the work is done.

## It Solves All Problems

**FOR THE PRACTICAL WIREMAN OR AMATEUR**

and in fact contains all the essential information for the successful wiring of a building.

Among the subjects covered are—Planning and laying out the work—Locating the Meter—Meter Connections—Feed Wires—Switches—Plug Receptacles—Brackets—Ceiling Fixtures—Flexible Conduit System—Rigid Conduit System—Steel Armored Cable System—Knob and Tube System—Various Switching arrangements explained and diagrammed—The easiest method of testing Three and Four-way circuits explained and illustrated—Current carrying capacity of Wires—Etc.

108 Pages, 74 Illus. Flexible Cloth Cover, Pocket Size

**PRICE, FIFTY CENTS POSTPAID**  
Money refunded if not satisfactory

**POPULAR ELECTRICITY BOOK DEPARTMENT**  
54 W. Lake St., Chicago, Ill.

# SPECIAL LAW SCHOLARSHIP OFFER NOW OPEN!

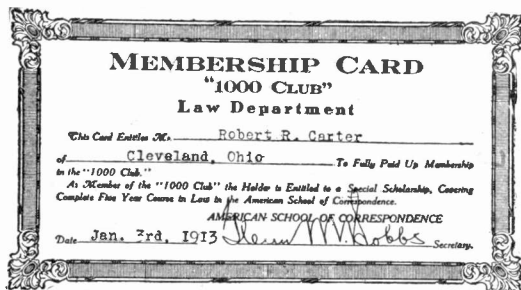

## Join The "1000 Club"! Get Your Instruction in our Great Law School F-R-E-E!!

First 1000 students to enroll in 1913 receive SPECIAL SCHOLARSHIPS! Write at once for free membership in the "1000 Club"! Send no money. As a member of "1000 Club" you receive scholarship covering complete five-year course in law—also your choice of special course. This great offer is limited—mail the coupon immediately for full particulars.

## The University Brought Right to Your Home.

No need to give up your present position. Learn the law right at home on this great offer just as easily and thoroughly as though you attended a resident law school.

Our graduates as successful in passing bar examinations as the graduates of the best resident schools.

Our course indorsed by renowned educators and lawyers. American School of Correspondence chartered by law as an educational institution—the same as your State University. Instruction papers prepared by famous law authors. Course prepares for Bar in ANY STATE.

## We Furnish Fifty-Six Textbooks with Every Special Scholarship!

Not twelve or fifteen—but fifty-six. Written in clear, concise manner—neatly bound—handy size. You receive any "individual" or "personal" instruction necessary.

**Business Law.** Our complete course in General Law is most valuable to business men. On this great offer you can also specialize in subjects such as Commercial and Business Law, Banking and Trust Law, Real Estate Law, etc. Even though you do not expect to become a practicing lawyer—get full details of this great offer. Only cost to members of "1000 Club" is for textbooks and postage.

## Mail this Special Coupon Immediately

Write for school catalogue and full particulars of this Special Scholarship offer. You assume no obligations whatever in sending the coupon. Remember the Club is limited to 1000 members. You must hurry if you want to be one of those to receive this scholarship! Sign and mail the coupon immediately.

**Special Scholarship Coupon**

**AMERICAN SCHOOL OF CORRESPONDENCE**  
Chicago Illinois

American School of Correspondence  
CHICAGO, ILLINOIS

Without any obligations on me whatever, please send me your school catalogue and complete information of your "1000 Club" offer. Pop. Elec. 3-13.

NAME .....

ADDRESS .....

For our Mutual Advantage mention Popular Electricity when writing to Advertisers.

# WIRELESS ENGINEERING COURSE



You can secure the entire course by subscribing to The Marconigraph. It is running serially, a lesson in each issue.

by the world famous expert  
**H. SHOEMAKER**  
RESEARCH ENGINEER of the  
**MARCONI COMPANY**

If you are a serious experimenter and hope to do something big in wireless work you must first master fundamental principles.

## FIRST LESSON IN THE DECEMBER NUMBER OF THE MARCONIGRAPH

A full size, 48-page, illustrated monthly magazine of Wireless Telegraphy, published by  
**MARCONI PUBLISHING CORPN., 458 Fourth Avenue, NEW YORK CITY**

**FREE** The subscription price of The Marconigraph is a Dollar a Year (Canada, \$1.35.) The first hundred persons who cut out and mail this advertisement together with money order for one year's subscription will receive *absolutely free* the December, January and February issues. Subscription to the magazine will commence with the March number. All the back numbers, containing the Wireless Engineering Course from the beginning, and The Marconigraph for one year—all for a Dollar! Only the first 100 replies received will participate in this offer—don't delay! To secure the back numbers free this advertisement must accompany subscription order.

## Books That Really Teach



the things you want to know, and in a simple, practical way that you can understand.

Our illustrated catalogue will be SENT FREE upon request, tells all about the Practical Mechanical Books for Home Study that we publish.

Write today for this up-to-date and complete illustrated Catalogue and popular price list. **IT IS FREE.**

- EASY ELECTRICAL EXPERIMENTS AND HOW TO MAKE THEM.** By L. P. Dickinson, 220 Pages, 110 illustrations, 12mo, Cloth. Price..... **\$1.00**
- FIRST STEPS IN ELECTRICITY, OR ELECTRICITY FOR BEGINNERS.** By W. Jerome Harrison, 283 Pages, 114 illustrations, Pocket Size, Cloth. Price..... **\$1.00**
- OPERATORS' WIRELESS TELEGRAPH AND TELEPHONE HANDBOOK.** By Victor H. Laughter, 210 Pages, fully illustrated, and with six additional full-page half-tone illustrations showing the installation of "Wireless" on the U. S. War Ships and Ocean Liners, Cloth. Price..... **\$1.00**
- THE HANDY VEST POCKET ELECTRICAL DICTIONARY.** By Wm. L. Weber, M. E. Cloth, Red Edges, Indexed..... **\$0.25**  
Full Leather, Gold Edges, Indexed..... **.50**

For sale at all Book Stores or sent Postage paid on receipt of price by

**FREDERICK J. DRAKE & CO.**  
Publishers of Self-Educational Books  
Dept. 10, 1325 Michigan Ave. CHICAGO, U. S. A.

## 60 EXPERIMENTS IN ELECTRICITY

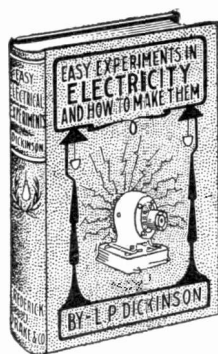

For the Amateur or Experimenter

Written in simple, easily understood language, fully illustrated with cuts and working drawing.

This is one of the most valuable works ever published.

Presents a wonderfully interesting and entertaining series of electrical experiments, giving full directions for constructing apparatus required with inexpensive materials and tools easily obtained.

Shows you how to make all kinds of batteries, electric bells, rheostats, condensers, large and small induction coils, an electrophorus, an automatic circuit closer, how to construct and use telegraph and telephone instruments, measure electrical resistance and pressure and make and use galvanometers and voltmeters.

Gives detailed directions for building a 1-20 horse power motor, explaining exactly how to make each of the various parts and assemble them correctly. Shows you how to do electro-plating at home, design a small dynamo, build an electric engine, an electric locomotive, a model fire alarm telegraph, make simple arc lamps, and light lamps by electricity. Also how to make an electric bomb, electric grosscope and other electrical toys, etc., etc.

204 pages. Handsomely stamped cloth covers.

Price Only **\$1.00** Postpaid

**Popular Electricity Book Department**  
54 West Lake Street Chicago, Ill.

“Here is the Answer”

in **WEBSTER'S  
NEW  
INTERNATIONAL  
DICTIONARY**  
The *Merriam* Webster

Even as you read this magazine you likely question the meaning of some *new* word. A friend asks: “What is *white coal*?” You seek the location of the *Levant* or the pronunciation of *jujutsu*. Who was *Becky Sharp*? Is *Hongkong* a city or an island? etc.

You

Often long for a quick, up-to-date, accurate answer. This **NEW CREATION** is an encyclopedia, equivalent in type matter to a 15 volume set. It answers all kinds of questions with final authority.

**INDIA PAPER EDITION:** →

Printed on thin, opaque, strong, expensive India Paper imported for this edition. Has an excellent printing surface resulting in remarkably clear impressions of type and illustrations. What a satisfaction to own the *new Merriam Webster* in a form so light and so convenient to use! One half the thickness and weight of the Regular Edition. Weight only 7 lbs. Size 12¾ x 9¾ x 2¾ inches.

**REGULAR EDITION:** →

Printed on strong book paper of the highest quality. Weight 14¾ lbs. Size 12¾ x 9¾ x 5 inches. Both Editions are printed from the same plates and indexed.

400,000 Words, 6000 Illustrations. 2700 Pages. The only dictionary with the *new divided page*,—characterized as “A Stroke of Genius.”

WRITE for specimen pages, illustrations, etc. FREE set of pocket maps if you name this magazine.

**G. & C. MERRIAM COMPANY, SPRINGFIELD, MASS., U. S. A.**

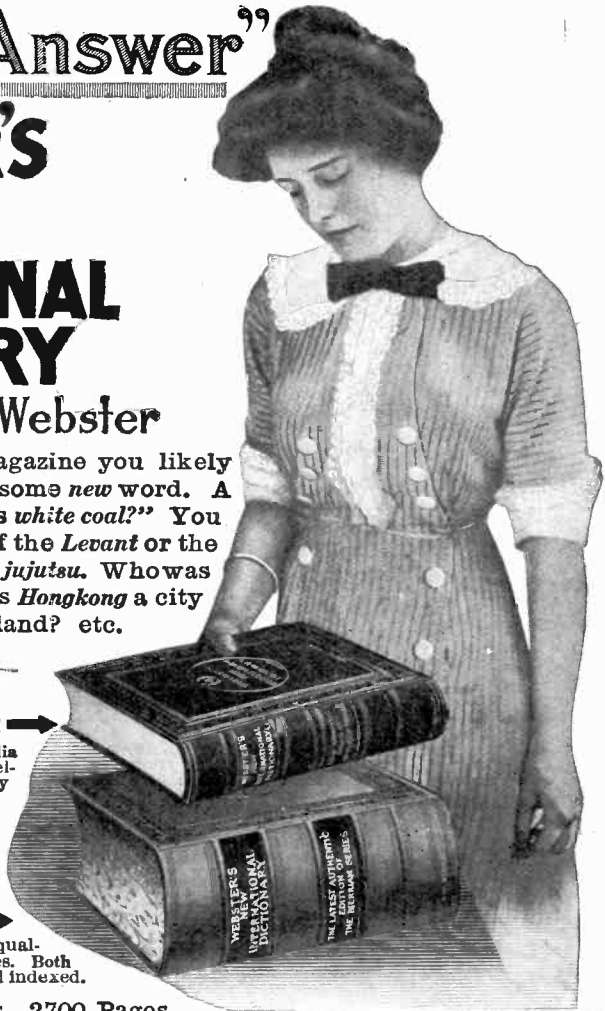

Per Advt. in Popular Electricity  
Send Sample pages, maps, etc.

Name.....

Address.....

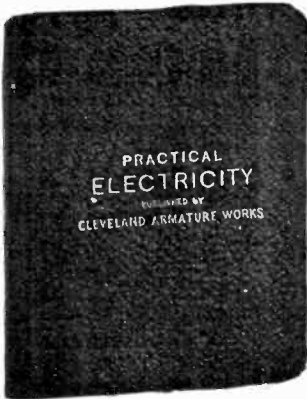

**A School Within Itself**

- designing, care and operation of a dynamo or motor, and I chapter on electric automobiles, outlining their construction, care and operation, and all about storage batteries and how to handle them. Each subject is carefully written and to the point. After a student studies a subject, he is questioned on that subject in such a manner as to bring clearly to his mind the points he needs to know regarding same. A **DICTIONARY** in back of book will enable him to learn the meaning of any electrical word, term or phrase used in this book, as well as hundreds of others in common use. All required tables necessary in the study are in it. **TABLE OF SUBJECTS:**
- |  |   |  |
|--|---|--|
| <b>CHAPTER</b><br>I—Wiring.<br>II—Electric Batteries, Electro Plating.<br>III—Magnetism.<br>IV—The Magnetic Circuit.<br>V—Magnetic Traction.<br>VI—Magnetic Leakage.<br>VII—Energy in Electric Circuit.<br>VIII—Calculation of Size of Wire for Magnetizing Coils. | <b>CHAPTER</b><br>IX—Calculation of EMF's in Electric Machines.<br>X—Counter EMF.<br>XI—Hysteresis and Eddy Currents.<br>XII—Armature Reaction.<br>XIII—Sparking.<br>XIV—Winding of Dynamos and Motors.<br>XV—Proper Method of Connecting Dynamos and Motors—Self Excitation. | <b>CHAPTER</b><br>XVI—Diseases of Dynamos and Motors, their symptoms and how to Cure Them.<br>XVII—Arc and Incandescent Lamps.<br>XVIII—Measuring Instruments.<br>XIX—Alternating Current.<br>XX—Automobiles.<br>A dictionary of over 1500 Electrical Words, Terms and Phrases, giving a brief meaning of all which are in common use. |
|--|---|--|

There are XX chapters in all. XIX carrying you from the fundamental principles of electricity on through the various branches to a point where the careful student comprehends the complete designing, care and operation of a dynamo or motor, and I chapter on electric automobiles, outlining their construction, care and operation, and all about storage batteries and how to handle them. Each subject is carefully written and to the point. After a student studies a subject, he is questioned on that subject in such a manner as to bring clearly to his mind the points he needs to know regarding same. A **DICTIONARY** in back of book will enable him to learn the meaning of any electrical word, term or phrase used in this book, as well as hundreds of others in common use. All required tables necessary in the study are in it. **TABLE OF SUBJECTS:**

**\$2.00 Per Copy—Sixth Edition—30,000 Copies Sold**

The offer we make of refunding money if book is not satisfactory upon examination is an UNUSUAL ONE in connection with the sale of a book. But we have no fear of its return. Your decision will be what thousands of others have been. Money would not buy it if it could not be duplicated. We could print testimonials by the hundreds. It is best to order and be your own judge of its merits.

**CLEVELAND ARMATURE WORKS, 4730 St. Clair Ave., Cleveland, Ohio**  
Armatures and Fields Wound, Commutators Filled **AMERICA'S GREATEST REPAIR WORKS**

For our Mutual Advantage mention Popular Electricity when writing to Advertisers.



## Save Your Eyesight and Have a Better Light

When you read or write at night, you want a lamp that will give you a full mellow light upon your work while your eyes remain in restful shadow. The rays must be strong and steady—no flickering dimness to strain your eyesight or try your nerves. You can have all this if you use the Electric Student Lamp—a clear, soft light right where you want it—that will save your eyes.

## The Electric Student Lamp is Ideal for Home and Office Work

Electric  
Shop,  
Chicago, Ill.

I am enclosing \$2.25 for which please send me the Electric Student Lamp advertised in Popular Electricity. If not entirely satisfactory, my money will be returned.

Name.....

St. or P. O. Box.....

City.....

You will find it the ideal lamp for night work at your office or home. It can be instantly adjusted to any angle to suit your convenience. It is furnished with a metal shade, cord and plug and can be attached to any electric light socket. The price of this Student Lamp, illustrated above, with complete equipment, is \$2.25. You should have it now for use during the long nights. Use this coupon and order today.

**ELECTRIC SHOP, CHICAGO**  
Michigan and Jackson Boulevards  
*Over 2,000 Things Electrical*

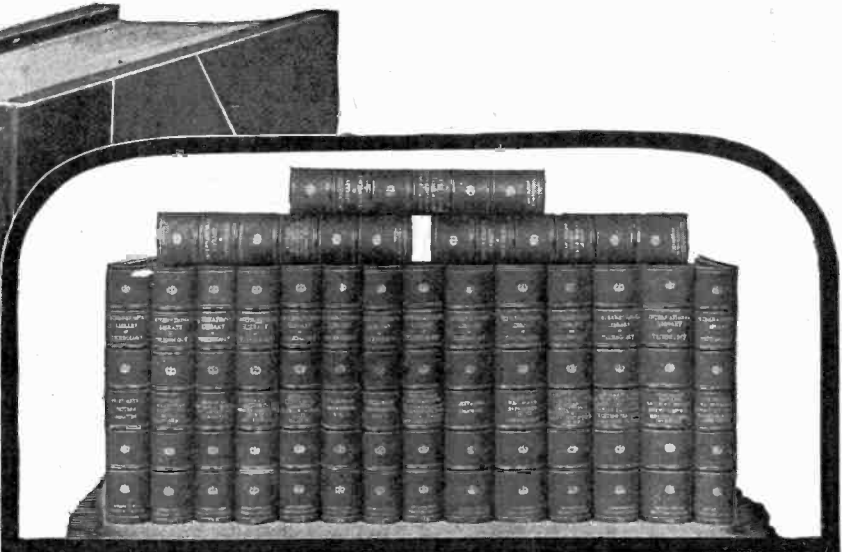
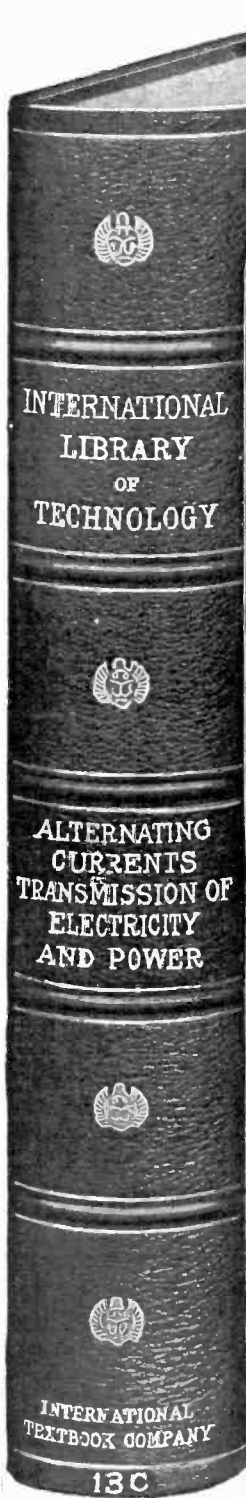

## The Greatest Electrical Library in the World

The Electrical Engineering Library is part of the International Library of Technology that cost \$1,500,000 in its original preparation. It contains the knowledge given from the life experience of some of the best electrical engineering experts in the country, edited in a style that nineteen years of experience in publishing home-study textbooks has proved easiest to learn, to remember, and to apply. There is no other reference work in the world that so completely meets the needs of the electrician as the Electrical Engineering Library. The volumes are recommended by the highest authorities and are used in nearly all the leading universities and colleges. They treat of practical electrical methods, starting from the simplest problems and comprehensively covering every branch of the work. Not only can they be used to great advantage by superintendents, foremen, and engineers as an authoritative guide in their work, but since they can be so clearly understood, even by persons having no knowledge of higher mathematics, they can be used by all classes of electricians that are desirous of advancing to higher positions. The Electrical Library contains 17 volumes durably and handsomely bound in three-fourths red morocco, stamped and numbered in gold. The books are printed on a high-grade book paper, and the type is large and easy to read. Each volume is 6 by 9 inches in size. If you wish to know more about the most practical electrical library in the world, send the coupon NOW.

### International Textbook Co. Box 1102, Scranton, Pa.

Please send, without further obligation to me, full particulars in regard to your Library of Technology, with special reference to the Electrical Library.

Name \_\_\_\_\_

St. & No. \_\_\_\_\_

City \_\_\_\_\_ State \_\_\_\_\_

For our Mutual Advantage mention Popular Electricity when writing to Advertisers.

# Our Supreme Offer, Starting Now, of Our Latest, Greatest Business Books, Untold Value, at 60 Cents Each

## How to Sell Goods

—How to ginger up a sales force—How to drum business in dull seasons—How to route, handle and check salesmen—How to train, develop and coach a sales force—How to win the dealer's cooperation and support—How to meet objections and how to be a good "closer"—How to handle wholesalers and retailers to the best advantage—How to judge a good salesman—How to work the "big stick" plan of selling goods to retailers—How to analyze your proposition and pick out its selling points—How to make the consumer influence dealer to buy your goods—How to get out of the ranks of the "clerks" and become a real salesman—And hundreds of other vital pointers and plans for clerks, salesmen, retailers, wholesalers, manufacturers, mail order houses, etc.

## How to Buy at Rock Bottom

—How to know a nicey when stock is on the loose—How to keep track of promises, agreements, deliveries, etc.—How to play one salesman against another and take advantage of every opportunity to get a lower price—How to keep the master the ins and outs of the buyer's position so that you can meet the crack salesman in every line on equal terms—How to devise a simple system which will bring to your notice automatically all data, prices, etc., about a given article—How to formulate a complete purchasing and record system for a mail order house, a factory, or a retail, or wholesale business—And other priceless pointers on purchasing that business men should know about

## How to Collect Money

—How to judge credits—How to collect by mail—How to handle "touchy" customers—How to be a good collector and how to hire one—How to organize a credit and collections department—How to avoid dishonest buyers from the safe risks—How to get quick, accurate, inside information on customer's ability to pay—How to write smooth, diplomatic letters that bring in the most without giving offense—How to devise a simple and effective system of insuring prompt and periodical collections of all your accounts—And valuable information obtainable in no other way, for credit men, collectors, accountants and every business man interested in this vital department.

## How to Advertise an Business

—How to plan and lay out an advertising campaign—How to judge and select the right media to reach any given class—How to write, refine, illustrate, display, place, and check advertisements—How to develop a crisp, hand-drawing, eye-selling style of expression—How to prepare bold, original head lines—How to conduct a magazine campaign—How to "drive home" its effect on dealers, wholesalers and consumers simultaneously—How to make a small appropriation count—How to advertise for queries and turn them into sales—And an infinite variety of other practical points on every phase of advertising.

## How to Meet and Handle Men

—How to develop strong individual personality—How to approach and impress a man—How to attract, interest, persuade, conciliate and convince men—How to break down the walls of reserve and prejudice in an interview and turn enemy into cordiality and respect—How to pick men—How to weigh, judge, analyze ability in a prospective employee—How to train and coach new employees—How to inspire men with desperate determination and unswerving loyalty to work, to think, to act, even to fight in your behalf—How to keep your hands clean—How to get along with an entire working force, making each man feel your special interest in him—And section after section meeting and managing, directing and controlling, inspiring and enthusing all sorts and dispositions of human nature.

Yours, the Mighty Total Experience of Generations in Thousands of Businesses in Ten Powerful Volumes, almost FREE

## 1497 Vital Business Secrets

Here are the plans, the rules, the answers of business which put men right in their struggle for success

If you only knew! If you could only realize that this offer places within your reach the knowledge which will straighten out snarls in your business life, make the way plain. Here are 1,497 real money methods, proved by thousands of businesses for every business man, big or small, steel man or grocer, manager or bookkeeper. Since the first edition, this remarkable Business Man's Library has been purchased by 39,463 concerns and by many of the greatest business men living.

One little sentence in one of these books may break down a barrier between you and success

## 60-Cent Price the Result of 10 Years of Striving

A short time ago many thousands paid us \$27 for a set of books similar to these, but we were impatient that more thousands, who could not afford them at that price, might obtain them. We find that the first edition sales absorbed practically all of the editorial cost, so that we need make the price of this edition only on the raw product—paper, printing, binding and shipping—and the mere cost of telling you about them. We searched the world for a light, strong paper to take good printing, to reduce binding and shipping expenses—and we found it in Germany. Then we reduced the margin on plates, binding and packing. Offering 30,000 sets of these Business Man's Libraries at 60 cents a volume, now means practically giving away complete business experience which 999 out of 1000 persons could not ordinarily obtain after long years of up-hill work.

The things which have cost men dearly in fortunes and careers are made plain to you in the brilliant pages of business secrets. Out of the success-struggles of modern business, the failures as well as the monumental achievements, comes this message to millions, as the answer to daily questions, doubts, ignorance—at a price which does not approach the value of many a single paragraph. **This is the greatest offer we can possibly foresee for this decade.**

These books present 2,079 pages jammed full of new ways of making money told by the Master Minds of Business. This set is a guide to the man in the private office, and to the worker it gives the short cuts to better days, larger salaries and eventual success. Why waste years plodding and blundering along, spoiling opportunities and wasting chances when you can get inside knowledge of business, of the executive board, the departments, the factory, of financing and selling and advertising? What power can hold you back from accepting this offer at only 6 cents a day spread over only four months?

Is a small self-limited job keeping you from seeing and knowing? Find out from 112 great, big men—not mere writers, but national business men, whose names inspire admiration and confidence—Alexander H. Revell, Founder and President of the great firm bearing his name; Sears, Roebuck & Company's Comptroller; Montgomery Ward & Company's Buyer; John V. Farwell & Company's Credit Man; Sherwin-Williams Company's President; and 107 others. Let them place at your disposal the crystallized experience of the whole world of business.

Then add the help which you will get from SYSTEM, which stands pre-eminent, the Magazine of Business, with 260 to 356 pages in every issue [and 750,000 regular readers. Whether you own your own business or are employed—SYSTEM will show you new ways of saving time and cutting out drudgery. It has helped hundreds to better salaries, bigger profits that would have been impossible, undreamed of, without SYSTEM. Read our offer now and accept priceless help at trilling cost—less than you pay for caffeine or cigars, distributed over four months only.

**Our Supreme Offer:** We offer you for 6 cents a day, term only four months, these 10 substantial volumes, published in an attractive light-weight paper, full cloth bound with covers in four colors—suitable for any library or desk. And this 6-cent offer includes an 18 months' subscription to SYSTEM (price \$3.00). That's \$9.00 only in all, spread out thin over four months. Your check or money order, or a dollar bill, today will start the books to you tomorrow, transportation charges fully prepaid, and give you SYSTEM for eighteen months. One dollar now and \$2.00 a month until \$9 is paid. (West of the Rockies, \$10; Canada, \$11). Long before the first month is out, these books will have a chance to be put into your pocket many times their cost. Send without delay as this Edition is going to disappear the fastest of any we ever put out. Simply tear this ad out now, say, "I accept your offer in Popular Electricity, March, 1913", write your name and address on a piece of paper, pin all together with your dollar and send to **SYSTEM, Wabash Ave. and Madison St., Chicago**

## How to Manage a Business

—How to keep track of stock—How to figure and charge estimates—How to check deliveries and mistakes—How to get the most out of those under an around you—How to size up the money-making possibilities of new ventures—How to detect and eliminate needless items of expense and waste—How to get up blanks, forms, records and simple systems for the kinds of businesses—How to devise a perpetual inventory system that will tell you every day the value of all material on hand—How to turn a losing business into a profitable one—How to make a profitable business more profitable. And countless other things that every man in an executive position needs in his daily work.

## How to Get Money by Mail

—How to write ads—How to begin a letter—How to turn inquiries into orders—How to formulate a convincing argument—How to get your reader to ACT at once—How to cover for the kinds of business men can't reach—How to keep tabs on results of all mail work—How to key the business on all mail sales—How to prepare an enclosure for a business-getting letter—How to supplement the efforts of salesmen with live, business-getting letters—How to answer file and follow up inquiries from advertisements and those which come in the regular course of business. And page after page of practical working detail—not only for mail order firms, but particularly helpful to those not making a specialty of mail order business.

## How to Stop Cost Leaks

—How to detect waste—How to make an inventory—How to figure overhead expenses—How to systematize an entire store—How to cut out red tape in a simple cost system—How to keep close watch on material and supplies—How to apportion the right number of employees to a specific job—How to decide between piece-work, day wages and bonus systems—How to keep tab on productive value of each machine and employ—How to figure depreciation, burden, individual expense, upkeep, profit, loss and cost.

And chapter after chapter of priceless plans for practically every kind of business in which an accurate cost system is essential to money-making success.

## How to Get and Hold a Position

—How to seek a position and get it—How to answer a want ad., in person or by letter—How to compose a letter of application—How to secure the highest market price in selling your services—How to prepare and apply for advancement—How to quickly gain and hold your employer's confidence—How to master the entire routine, the science, the duties, the problems of an executive, a department head, a general manager—How to study the work of the man above you, without offending or antagonizing him.

Not good advice merely, but practical, down-to-the-earth instruction in the branches of business that will enable the ambitious employe to actually earn more—have more—be more.

## Office and Accounting Methods

—How to keep office accounts—How to keep a simple and complete record and accounting system—How to take loose bills and receipts and actually devise a system that will give you your monthly statement on a single card—How to make a simple system that will give you a daily report of your business combined with the use of the leaf in handling transactions—How to manage and systematize an office—How to speed up an office force to top-notch efficiency—How to keep exact office costs—How to handle a business and keep an accurate record, with complete inventory, receiving and shipping blanks and forms for each. How, in fact, to enjoy peace of mind, comfort and satisfaction, in the certainty that there are no faulty methods throughout your entire office organization.

For our Mutual Advantage mention Popular Electricity when writing to Advertisers.



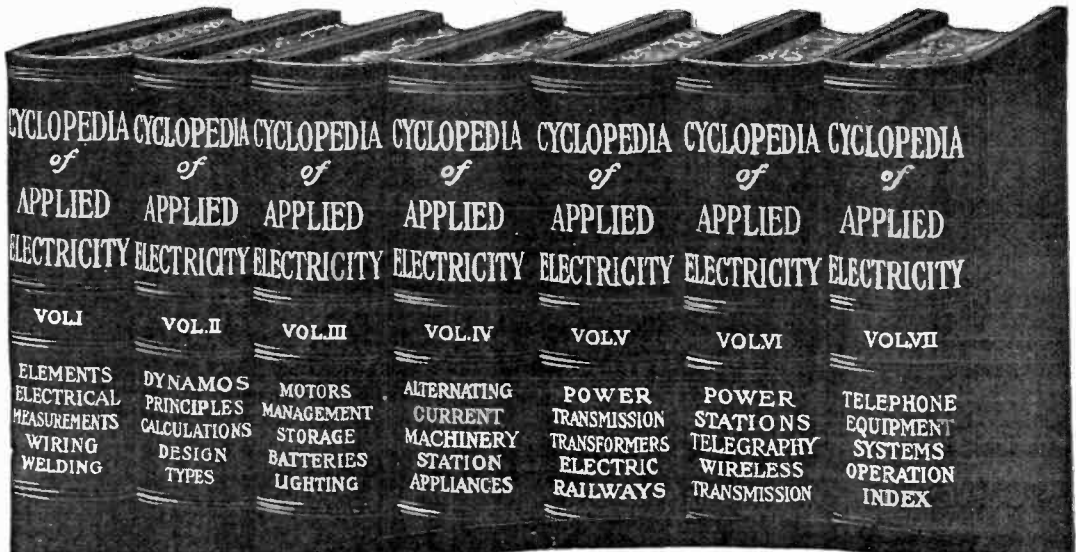

**Seven Big Volumes of  
ELECTRICAL KNOWLEDGE**

**The Greatest Electrical Library Ever Published at Almost Half Price**

This seven volume set of electrical books—the most complete and up-to-the-minute reference work of its kind ever published—now offered at a discount of almost 50%. You, whether student, worker or expert, can gain from these books an intimate knowledge of your work—knowledge which will eventually mean success and higher pay. The work of thirty-two experts, this library is recognized as a standard reference work by technical schools, libraries and practical men throughout the country. It is the accumulated knowledge of the whole electrical world, a store of information from which you can continually draw knowledge—power.

**The American School's Cyclopedias of**

**APPLIED ELECTRICITY**

Contains 3,200 pages, 7x10 inches; 2,600 illustrations, full page plates, diagrams, etc.; hundreds of valuable tables and formulas; carefully cross-indexed for quick, easy reference. The books are substantially bound in half red morocco, gold stamped, and are printed in large clear type on special quality paper.

**Important Subjects Covered by These Great Books**

Theory, Calculation, Design and Construction of Generators and Motors—Electrical Measurements—Electric Wiring—Electric Welding—Types of Generators and Motors—Management of Generators and Motors—Storage Batteries—Electric Lighting—Alternating-Current Machinery—Station Appliances—Power Stations—Power Transmission—Central Station Engineering—Electric Railways, including Single-Phase—The Electric Telegraph—Telephone Equipment, Systems and Operation—Wireless Telegraph and Telephone—Telautograph, Telephonograph, etc.

**This Complete Cyclopedias Sent Free**

The complete seven volumes, not a sample volume, will be sent, express prepaid, for seven days' free examination; returnable at our expense if the books do not contain the information you want. If you keep them, pay \$2.00 seven days after receipt and then \$2.00 a month until you have paid the special introductory price of \$19.80. The regular price of this great Cyclopedias is \$35.00. Just fill in and mail the coupon. It won't cost you a cent to examine the books. We know they'll be worth many times their cost to you. Mail the coupon now and you'll receive your books promptly.

**\$12.00 Consulting Membership Free**

With every set is included a year's Consulting Membership, regular value \$12.00, entitling you to the free advice of a staff of Electrical Engineers. This will give you practical help in handling working problems which are too specific to be taken up in detail in the Cyclopedias. There will be no limit to this service. A single problem solved for you might be worth more than the first cost of the books.

**AMERICAN SCHOOL OF CORRESPONDENCE  
CHICAGO, U. S. A.**

Pop.  
Elect.  
3-18

A. S. of C.

**7-DAY EXAMINATION COUPON**

NAME .....

ADDRESS .....

OCCUPATION .....

EMPLOYER .....

Please send me Cyclopedias of Applied Electricity for seven days' free examination. I will send \$2.00 within seven days and \$2.00 a month until I have paid \$19.80; otherwise I will notify you and hold the books subject to your order. Title not to pass until fully paid.

For our Mutual Advantage mention Popular Electricity when writing to Advertisers.

EDWARD P. RUSSELL

WALTER S. BREWSTER

G. L. PENISTON

# RUSSELL, BREWSTER & CO.

Successors to

EDWARD L. BREWSTER &amp; CO.

## BANKERS AND BROKERS

116 W. ADAMS STREET

CHICAGO

New York Office  
111 BroadwayMembers New York Stock Exchange  
Chicago Stock Exchange

We recommend to investors the following high-grade Preferred Stocks and Bonds

### Public Service Company of Northern Illinois

\*FIRST AND REFUNDING MORTGAGE 5% GOLD BONDS.

Due October 1st, 1956. Interest payable April 1st and October 1st.

Price to net better than 5%

\*6% CUMULATIVE PREFERRED STOCK.

Tax exempt in Illinois. Earnings largely in excess of dividend requirements. Interest payable quarterly.

Price to net nearly 6%

\* Listed on Chicago Stock Exchange.

### Illinois Northern Utilities Company

FIRST AND REFUNDING MORTGAGE 5% GOLD BONDS.

Due April 1st, 1957. Interest payable April 1st and October 1st.

Price to net better than 5%

6% CUMULATIVE PREFERRED STOCK.

Tax exempt in Illinois. Dividends payable quarterly.

Price to net nearly 6½%

### United Light & Railways Company

FIRST AND REFUNDING MORTGAGE 5% GOLD BONDS.

Due June 1st, 1932. Interest payable June 1st and December 1st.

Price to net better than 5½%

6% CUMULATIVE FIRST PREFERRED STOCK.

Earnings nearly three times dividend requirements. Dividends payable quarterly.

Price to net nearly 7%

### Federal Sign System (Electric)

7% CUMULATIVE PREFERRED STOCK.

Earnings more than double dividend requirements. Dividends payable quarterly.

Price 100 and accrued dividends, with a bonus of 25% Common

Stock Voting Trust Certificates.

### Middle West Utilities Company

6% CUMULATIVE PREFERRED STOCK.

Carries a bonus of 25% of common stock. Dividends payable quarterly. Price to net better than 6¼%.

We shall be pleased to furnish circulars regarding the above or give further information on these and other securities. Correspondence invited.



# FREE

## This \$15 Drawing Outfit

But you must write at once. Offer expires in 30 days. I make this most exceptional great offer only to a limited number of selected students.—Just think of it! A complete, regular Draftsman's \$15 Working Outfit with high grade Imported German Silver Set of

**INSTRUMENTS—ALL FREE**

# Be a Draftsman!

Draw \$125 to \$175 per month at once

There is an urgent demand always for skilled draftsmen. Our companies are issuing calls every day for men to fill positions paying from \$125.00 to \$175.00 per month. Many positions paying \$75 to \$100 per week always open. Work is light, pleasant and profitable. Unlimited opportunities for expert draftsmen and designers. Mail coupon for valuable book, "Successful Drafting." It explains how you can become a skilled draftsman in a short time. It's free — Just think:



### Chief Draftsman Will instruct you personally

A most wonderful opportunity for a limited and selected number of ambitious men! For over twenty years I have been doing the highest paying expert drafting work. I am Chief Draftsman of a large and well known company. Long ago I saw the urgent demand for practical, trained draftsmen and I organized my practical method for ambitious men whom I trained personally. Each month the demand for practical, trained draftsmen is growing—higher salaries are being paid right along. Never before have we felt the need as we do today for men who really know practical drafting — the way I am training my students. At this time I can accommodate a few more men (from the ages of 16 to 40) in my spare time. If you write me at once I will send you my book, "Successful Drafting," with full particulars—all free. But you must write to me—or send coupon now.

### I Guarantee

To instruct you until competent and placed in a position at a regular salary, paying from \$125.00 to \$175.00 per month and furnish you free \$15 Working Outfit at once.

**Earn Big Money at once while Learning at home**

Yes, my friend, you can make big money at once right at home from the very start,—as much as \$5 to \$10 per day. I will pay you while learning.

**FREE Outfit Coupon**

## Mail Free Coupon Now



**Chief Draftsman: ENGINEERS' EQUIPMENT CO. Div. 1403 CHICAGO, ILL.**

Without any obligation on me, please mail your book "Successful Draftsmanship" and full particulars of your liberal "Personal Instruction" offer to a few students. It is understood that I am obligated in no way whatever.



Mail this Free Coupon at once and I will send you my book "Successful Draftsmanship" and full particulars—all FREE. I will send my book if you write at once, absolutely free—also particulars about my offer to a few ambitious men who want to make from \$2,500 to \$5,000 a year. No obligations whatever on you in sending the coupon.

Address **Chief Draftsman**  
Division 1403, Engineers' Equipment Co., (Inc.)  
CHICAGO, ILL.

NAME.....

ADDRESS.....

Name .....

Address .....

ARROW MOTOR CO., 2825 W. 19th St.,  
Dept. 1403 Chicago, Ill.

Gentlemen, Without any obligation on me please send me your new catalog with complete information about your wonderful Aviation Type Motor used on the Arrow. Also tell about your Rock-Bottom, Easy Payment Price Offer.

**FREE  
Coupon**

**The New 1913**  
**← ARROW →**

**With The Wonderful  
AVIATION  
TYPE  
MOTOR**

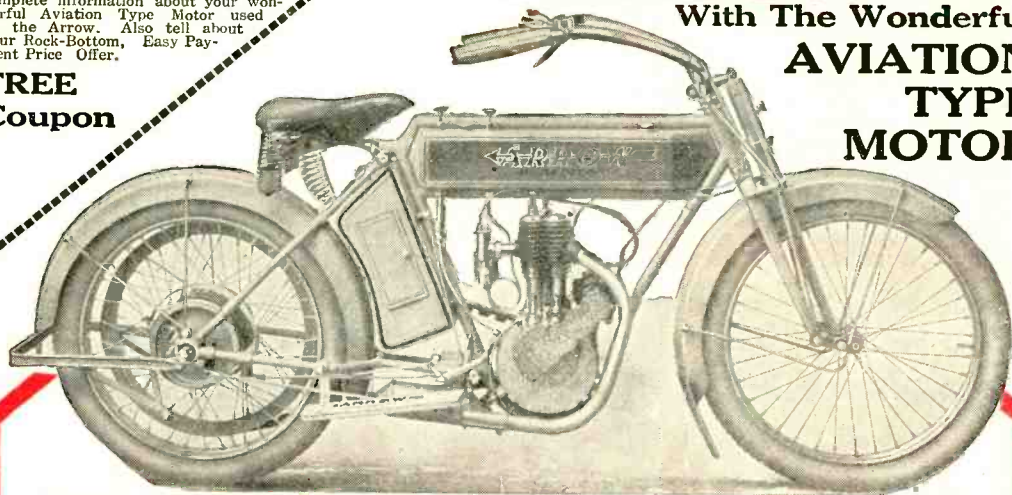

**\$1250** And the Celebrated Arrow  
Per Month Motorcycle Is **YOURS**

Yes, that is all we ask you to pay for the wonderful new style Arrow. \$12.50 a month. Never before was such an offer made on any motorcycle.

We make this offer because we know that the Arrow is superior to all other motorcycles in design and mechanical construction. We sell direct. No extra middlemen's profits for you to pay. The engine used on the Arrow has been selected after thousands of miles of trying road work and its superiority has been proven in every point. The marvelous aviation type motor gives 20 per cent better speed and efficiency than any other motorcycle made—and with no greater gasoline consumption.

There is style and dash in every curve of the Arrow. Every piece and part is backed up with our five year ironclad guarantee. Just imagine speeding over the roads with a great Arrow—driven by the Aviation Type Motor. You whirl at the rate of the express—then by a touch you reduce the speed to a crawl. It responds instantly to your will.

*Here at last is the Perfect Motorcycle.*

## The Arrow's Famous Aviation Type Motor

A motor just like the bird men use! That's why it's called the aviation type motor. You know how perfect the motor on an aeroplane must be—how it must be subject to change at the slightest touch. That's the kind of a motor we have put into the ARROW.

The AVIATION TYPE MOTOR is the most powerful motor put into any motorcycle, yet it is the most easily controlled. You can hardly hear it running across the street.

Every feature of the ARROW is the latest and most up-to-date that could be secured. Nothing has been spared to make this the "greatest of them all."

## Ride It While You Are Paying For It

There is no need for you to wait until you have

all the money before you buy a motorcycle. We will ship the wonderful ARROW to you and let you pay for it a little at a time. We give you an IRON-CLAD GUARANTEE that we will replace free of charge any part of the ARROW that breaks within five years because of defective workmanship.

You run no risk in buying an ARROW.

### Dealer's Credit To You If You Write Quick

This offer is to quickly place ARROWS in every locality. We give you the same terms we allow to dealers, just requiring a part payment with plenty of time to pay the rest. Send for free catalog today—don't wait.

**Send The Free Coupon Now** Just put your name and address on the coupon and mail it at once. Even though you are not thinking of buying a motorcycle right now send and get our catalog and full particulars. Mail the coupon right away, while our rock-bottom, easy payment price offer is still open. Write quick.

**THE ARROW MOTOR CO., Dept. 1403 2825 W. 19th St., Chicago, Ill.**

# Electricity Pays Big Money

Get out of the underpaid class. Get into the most fascinating of all professions. **Learn electricity.** In this great field there are thousands and thousands of opportunities. Big money is being paid. Men in demand everywhere.



## You Can Learn It

Yes, we can teach you electricity and guarantee that you will be perfectly competent to hold down one of the big jobs. Our school is the oldest, largest, and best equipped trade school in America. Our instructors are all practical men—expert in their trades. We teach you quickly, easily and thoroughly by actual work. Tools instead of books.

## Don't be Satisfied with Small Pay

The money you now earn won't satisfy you forever. The cost of living is going up. You must increase your earnings. Send the free coupon today for full particulars.

## We Teach You Any of These Trades They Pay You \$5.00 to \$8.00 a Day

**Electricity** The greatest field for advancement in the world today. Thousands of skilled electrical men needed. Wages high—work steady. Wonderful opportunities to make big salaries. Electricity is destined to become the greatest of all industries.

**Plumbing** Easy work—short hours—big pay. It is almost impossible now to learn the trade as an apprentice. Even then it will take you years and perhaps you will never thoroughly master it. Plumbers are always in demand.

**Moving Picture Operating** This is practically a new business and good operators are so scarce that unusually high wages are being paid. Exceptional opportunities to get in business for yourself.

**Mechanical Drawing** There is always a big demand for good mechanical draftsmen. Engineering firms, contractors, railroads, steel companies, etc., etc., pay big money for trained draftsmen. In our school you can get just the sort of training that you need—practical work—the kind that firms demand before they pay big money.

**Bricklaying** A highly paid, fine, healthy, outdoor occupation. Builders are always on the watch for skilled bricklayers. Exceptional opportunity to work into the contracting business where there is no limit to the money you can make.

## Send the FREE Coupon

Just put your name and address on the free coupon now. We will send you at once our handsome catalog and full particulars of the great special offer we are now making. We will send you a handsome illustration of our school, and tell you all about the exceptional opportunities that are open for men in the trades you can learn in our school. Come to Chicago. Learn a trade in the oldest, largest and best equipped trade school in the world. Exceptional opportunity for culture and education. Our handsome catalog and full particulars will be mailed to you free. All you need to do is to put your name and address in the free coupon or on a letter or a post card. But do it now—immediately, while we are still making this great special offer.

Address: L. L. COOKE, Director  
**Coyne National Trade Schools**  
Dept. 1403, 39 to 51 E. Illinois St., Chicago, Ill.

### Free Tools and Material

You have nothing extra to pay in this school. All your tools and materials are furnished free—absolutely free. You do not pay a penny for tools or materials. Send the free coupon.

### Free Coupon

L. L. Cooke, Director  
**Coyne National  
Trade Schools**  
Dept. 1403

39 to 51 E. Illinois St., CHICAGO, ILL.

Gentlemen: Without any obligations on me, please send me your school catalog and full particulars of this special offer to men—all FREE.

NAME .....

ADDRESS .....

My Name is .....

My Address is .....

Town..... State.....

MEARS EAR PHONE CO., Suite 1403  
45 West 34th Street, NEW YORK, N. Y.

Gentlemen: Please mail me, free and post-paid, your Mears Ear Phone Booklet and particulars of Special Introductory and Free Trial Offer on new model 4-Tone Mears Ear Phone.

*If you live in or near New York call at our office and present this coupon for a free demonstration.*

Tear Off Here

*In the  
Hollow of  
Your Hand!***HEAR!**

Deaf People Now Hear Distinctly, Clearly, Perfectly with the

**NEW 4-TONE MEARS Ear Phone**

The great, new electrical marvel for the deaf. Perfect hearing at last! This remarkable invention has four different sound strengths, four different adjustments, instantly changed by a touch of the finger. You regulate the instrument by a tiny switch to meet any condition of your ear or to hear any sound—low pitched conversation near you or sounds from any distance. The whole range of hearing of the healthy, natural ear is covered by this new 4-Tone Special Model Mears Ear Phone.

**SPECIAL!**

Write at once for our Introductory Offer on this new wonder. To advertise and quickly introduce this greatest of all inventions for the deaf, we are going to sell the first lot of these new **four-tone** phones **DIRECT** from our laboratory to users at the jobbers' lowest net price. This offer applies only to the first lot finished—a limited number. Write today—send the coupon—and you can save more than one-half the retail price. A few dollars, **payable on easy terms, if desired**, secures you complete relief from your affliction. Here is your opportunity if you need help for your hearing. Write for it. Do it now and save both Wholesaler's and Retailer's profits.

**Ten Days' Trial  
FREE**

Ask about our great free trial offer. Send the coupon above. Test this perfected instrument on your own ears, under any conditions of service for ten days. **Nothing to pay for the trial.** If it does not please you, send it back at our expense.

The Mears Ear Phone is the only scientific and perfect hearing device for the deaf. Already 14,000 Single Tone Mears Ear Phones have been sold.

**Free Booklet on Request. Send Above Coupon**

The Mears Ear Phone book explains all the causes of deafness; tells how to stop the progress of the malady and how to treat it. Send for Free Book and our great Special Introductory Offer. Tear off the coupon above and mail it NOW.

**MEARS EAR PHONE CO.** Suite 1403 45 WEST 34th STREET NEW YORK, N. Y.

For our Mutual Advantage mention Popular Electricity when writing to Advertisers.

# WANTED

## Signal Engineers

**\$125 to \$300  
Per Month**

Thousands of men needed. Railroads are constantly searching for competent Signal Engineers. They are paying big money. Here's your chance to get into the profession that is calling for trained men and is paying big money. Just a few hours a day in your own home is all that is necessary. Send the coupon for full particulars.

**\$300 a Month for YOU**

**Free Equipment**

Exceptional opportunities now in the great field of Signal Engineering. The railroads have absolutely no way to train men for these important positions. Consequently they are always in need of men and are willing to pay huge sums for their services. Without Signal Engineers the railroads can not operate. They hold the safety of thousands of lives and millions of dollars in the hollow of their hands. You can get just the sort of training that you need. We teach you by practical work. As soon as you get your diploma there will be a job waiting for you somewhere. Exceptional opportunities for those who start to study immediately. Send the coupon for full particulars.

To every student who enrolls immediately we will send absolutely free and prepaid the complete equipment. You could not possibly buy it anywhere for less than \$13.50. This outfit includes a miniature locomotive, standards, tracks, block signals, lamps, etc., etc. Put the outfit on your table and you will have a miniature railway system before you. You do the actual work right at home. You dispatch trains, watch them reach their destination, switch them, sidetrack them, just exactly the same way as if you had a whole railway system at your finger tips. Send the free coupon for full particulars.

### Big Signal Engineer's Book Free

If you send in your name and address right away we will send you absolutely free and prepaid, the new big Signal Engineer's Book. Tells you all about the profession and the exceptional opportunities that are now open for Signal Engineers everywhere. Absolutely no obligations of any kind in sending for the book. We are distributing it now in order to interest men in the study of Signal Engineering. But you must write at once—now, as the supply of free books is limited.

#### Special Offer

At this time we are able to make by special arrangement a special offer to men who are interested in the study of Signal Engineering. Send the coupon for full particulars.

**Be  
A  
Signal  
En-  
gineer**

**Send the  
Free  
Coupon  
NOW**

### Send the Free Coupon

Just put your name and address in the free coupon. Absolutely no obligations of any kind. We will send you absolutely free and prepaid full particulars of the great special offer we are now making and the handsome new big Signal Engineers' book. See for yourself the wonderful possibilities in this profession. See what hundreds of other men have accomplished. You can do exactly the same thing. The first step is to put your name and address in the free coupon or on a letter or a post card. But do it now—immediately, while we are making this great special offer.

Department of Signaling  
Desk 1403  
493 Cass St., Chicago, Ill.

Name.....

Address.....

**FREE  
Coupon**

**Dept. of Signaling  
Desk 1403**

**493 Cass St., Chicago, Ill.**

Gentlemen:—Without any obligations or expense to me whatever, please mail your free book and complete information. Tell me about special offer.

For our Mutual Advantage mention Popular Electricity when writing to Advertisers.

Name .....

Address .....

**Fort Wayne  
Correspondence School**  
Dept. 1403. Fort Wayne, Ind.

Please send me free and prepaid your book on Meter Engineering and full particulars of the great special offer.

**Free Coupon**



# Be the Boss Get in the New Profession

Thousands of men are needed. The new profession that is **paying big money** wants you and needs you. Here is your opportunity to get into it **now**. You don't need to leave your present employment. Just a few hours a day **in your own home**, and soon get your diploma and you are a full-fledged Meter Engineer.

## Be a Meter Engineer

The profession of Electrical Meter Engineering is now in its infancy. It is calling for men. The Central Electric Stations **must** have Meter Engineers, because without them they cannot operate. Thousands of positions now open. Over 400,000 new meters are going to be installed next year. Just think of the vast army of men that will be needed. And besides, Meter Engineers now are so scarce that the Central Stations are willing to pay huge sums for competent men. **YOU** can get into the profession. It is calling you.

## A \$3,000 Job for YOU

Electrical Meter Engineering is one of the best paying professions in the electrical industry. We can show you hundreds of men who are making better than \$3,000 each year. **How**

### Special

For a limited time we are making a special reduced price offer in order to induce men to start the study of Meter Engineering right away. Write for full particulars at once.

**would you like to have a \$3,000 a year job six months from now?** Just put your name and address on the free coupon and get full particulars absolutely free. Send coupon now—**today**.

## Send the Coupon for FREE Book

Do not delay an instant. Just put your name and address on the coupon and mail it to us at once. We will send you absolutely FREE and postpaid, our new book on Meter Engineering. It tells you all about the New Profession and about our school. It tells you how you can learn to become a Meter Engineer in your own home during your spare time. Absolutely no obligations of any kind. Just your name and address is enough. But write today—now—immediately while we can still make this great special offer.

**Fort Wayne Correspondence School, Dept. 1403, Fort Wayne, Ind.**



# Vibration Is Life!

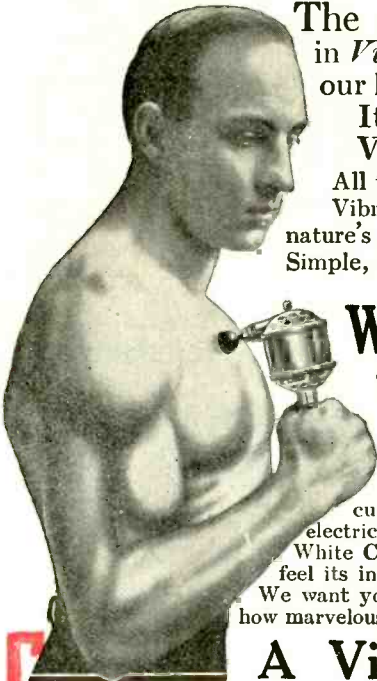

The secret of the ages has been discovered in *Vibration*. Scientists tell us that we owe not only our health but our very life to this wonderful force.

It is the greatest force in the world.

Vibration gives life—vigor, strength.

All the exhilarating joys of youth are yours through vibration.

Vibration is the most marvelous curative agent known. It is nature's own remedy for illness and disease. It cures like magic. Simple, sure and inexpensive. Send the free coupon.

## Wonderful White Cross Electric Vibrator on FREE TRIAL

Yes—the genuine White Cross Electric Vibrator, the wonderful instrument that gives you the three greatest natural curative forces in the world—Vibration, Faradic and Galvanic electricity. We want to prove to you at our expense what the great White Cross Electric Vibrator will do for you. We want you to actually feel its invigorating, health-giving thrill coursing through your own body. We want you to see for yourself how quickly it removes pains and aches—how marvelously it cures. We take all the risk.

## A Vibrating Chair FREE

With the White Cross Vibrator you can make a perfect vibrating chair out of any chair. A chair which will give you the same results as the chairs used in the biggest hospitals and sanitariums. You cannot do this with any other vibrator in the world. **Swedish Movement** right in your own home. You can give yourself the very same treatment for which specialists and sanitariums charge from \$2.00 to \$3.00 each. The nervous, irritable, worn-out man or woman will obtain quicker and more permanent benefit from a few minutes each day in the vibrating chair than from hundreds of dollars worth of medicine.



### Treat These Diseases

- Rheumatism.
- Headache, Backache, Constipation.
- Kidney Disease.
- Lumbago, Catarrh, Scalp Diseases.
- Skin Diseases.
- Deafness, Weak Eyes, General Debility, Nervousness

## Valuable Book "Health and Beauty" NOW SENT FREE

This wonderful book describes the human body in health and disease so plainly and clearly that anyone can understand. It tells how to get healthy and beautiful and how to keep so. This book tells you what vibration will do for you and how you can get the **White Cross Electric Vibrator** sent to your home for an actual free trial.



Send This Coupon Today

### FREE BOOK COUPON

Lindstrom, Smith Co.

218 S. Wabash Ave. Chicago, Ill. Desk 1403

Without obligation on me please send me free your special reduced price offer, Free Book "Health and Beauty," treatment of disease by vibration and electricity, and complete catalogue.

### Send The Free Coupon

Get this valuable free book at once. No matter how healthy you may be now the time will come when you will need this book **badly**. It may save your life or the life of some of your loved ones. Learn all about our offer—the most astounding and generous offer ever made. Don't wait. Don't delay. Sign the coupon **NOW**. This book is absolutely free and prepaid. No obligations of any kind.

**Lindstrom, Smith Co.**

218 S. Wabash Avenue Chicago, Ill. Desk 1403

SIGN THIS COUPON AND MAIL TODAY

Name.....

Address.....

NAME .....

ADDRESS .....

**FREE BOOK and EARNING  
WHILE LEARNING OFFER  
COUPON**

**Chief Draftsman,  
Division 1403  
Engineer's Equipment Co.  
Chicago, Ill.**

Without any obligations on me whatsoever, please mail your book "Successful Draftsmanship" and full particulars of your liberal "Personal Instruction" offer to a few students. It is understood that I am obligated in no way whatever.

# DRAW BIG MONEY!

**Yes: \$125 to \$175 Per Month to Start**

I know you would like to draw such a salary and more, and you positively will earn this amount easy when you are a thorough

## Practical Trained Draftsman and Designer

The constant demand for my trained men always exceeds the supply. Many positions paying \$75 to \$100 per week remain open on account of the shortage of the proper men to fill them. Some weeks over 250 positions paying the highest salary in all parts of the country are open and I would like to prove this to you by sending you one of my regular weekly lists of open positions.



## Chief Draftsman Will Train You Personally and Instruct You Properly

On practical Drafting room work UNTIL you are absolutely competent in every respect as a first class Draftsman and UNTIL you are placed in a permanent paying position at a salary paying at least \$125 per month. This is a most exceptional opportunity for just a limited few selected ambitious men, between the ages of 16 and 40, whom I will train personally and give individual instructions as required in order to fill the constant demand for properly trained men in this line.

**Absolutely FREE!** this Complete \$15 Draftsman's Working Outfit  
If You Write to Me **AT ONCE**

By sending the FREE COUPON on top of this page for my most liberal FREE OFFER for the \$15.00 Draftsman's Working Outfit, and also for my special offer to

**Earn Big Money at Once  
While Learning at Home**

Yes, my friend you can make big money at once right at home from the very start—as much as **\$5 to \$10 per day**. I will pay you while learning.



I give EACH of my students my own PERSONAL ATTENTION—therefore, I limit the number of my students and if you desire such an opportunity then get busy NOW and WRITE TO ME AT ONCE. Don't wait until tomorrow, but do it TO-DAY. You can earn much more than I charge for my spare time and personal training. This is not a money making correspondence school. We NEED good men to fill good paying positions and my practical working training is the result of the most urgent need for draftsmen. With my twenty-two years' experience as Chief Draftsman in handling men, I know exactly how urgent good men are needed all the time, and I will give you the benefit of my twenty-two years' experience at this work and will make you as high grade a man as you desire to be. You can draw \$125 to \$175 per month and steadily keep on going higher, as many good men draw \$5,000 per year in this line. You can do the same if you will grasp this opportunity.

**Remember:** You can be earning good money while you are learning at home to do the practical Drafting room work.

**Mail FREE COUPON** at once for my book "Successful Draftsmanship," also list of open positions and for the free offer to be earning good money at once while you are learning at home. This offer is positively limited and in order to benefit thereby you must act AT ONCE—not tomorrow but TO-DAY.

Address: **Chief Draftsman** Engineer's Equipment Co., (Inc.)  
Division 1403, CHICAGO, ILL.

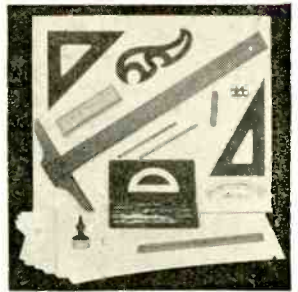

### I Guarantee

To instruct you UNTIL competent and placed in a permanent paying position at a regular Draftsman's salary of at least \$125 to \$175 per month and guarantee to furnish you free the complete Draftsman's Working Outfit at once from the start.

# POPULAR ELECTRICITY MAGAZINE

In Plain English

HENRY WALTER YOUNG, Editor

Vol. V

March, 1913

No. 11

## CONTENTS

	Page		Page
New York's Grand Central Terminal.....	1137	A Versatile Small Motor.....	1220
Tantalum.....	1142	Electricity as an Invigorator.....	1221
Electric Frost Prevention.....	1143	Thoughts for Housewives.....	1221
Novel Life Raft.....	1143		
Building the Trolley in the Remote Places of the Earth.....	1144	<b>Junior Section</b>	
Radium in Yellowstone Park.....	1148	To Take Your Photograph.....	1222
Rivadavia—the Great Argentine Battleship.....	1150	The Power of a Meteor.....	1222
Concrete Poles Molded in Sections.....	1150	Aiming and Firing a Heavy Gun.....	1223
An Electrical Fancy.....	1151	Strange Electric Storm.....	1223
Dr. Infrroit's Radiographic Laboratory.....	1151	An Archimedes Tower.....	1224
Hornum Lighthouse.....	1152	Odd Static Generator.....	1225
Economy of Electric Wire.....	1152	Short Circuits Produced by Birds.....	1225
Illuminated Speed Indicator.....	1153	And Their Friends Were Led to.....	1226
The Daughter of Heaven.....	1154	Controlling Finger.....	1226
White and Black Coal.....	1159	Fishing Up a Cable.....	1227
Ratheneau Medal.....	1159	Handling a Carnival Crowd in Manila.....	1227
"Eating Electricity".....	1160		
Canadian Farmers Use Niagara Power.....	1161	<b>Popular Electricity Wireless Club</b>	
Microradiographs.....	1162	Experimental 300 Meter Wave Sets.....	1228
The Revealing Ray.....	1163	Receiving Stations on the Ground.....	1231
How the Swiss Exploit their Scenery.....	1165	Nine New Wireless Stations for Canada.....	1232
Charles Boursell—French Inventor of the Telephone.....	1169	Washington Greets Honolulu.....	1232
Washing Cars by Electric Power.....	1169	Increased Cost of Living in France.....	1233
Electric Motors in Track Switching.....	1169	The Universal Hour.....	1233
Underground Transportation for Parcel Post.....	1170		
The Electricity of Drops of Water.....	1171	<b>For Practical Electrical Workers</b>	
A Telephone Credit Check System.....	1173	Telephone Wiring.....	1234
Street Lights Along the Curb.....	1173	Fault Finder.....	1240
In Recognition of Faithful Friends.....	1174	Why Shunt Motors Speed Up.....	1240
Piecing Out Daylight to Hasten Plant Growth.....	1175	Office Bell.....	1241
Revealing Power of Light.....	1176	Drying Telephone Cables.....	1241
Searchlight Attachment for Pistol.....	1176	Dining Table Outlets.....	1241
The Tree of Light.....	1177	Hotel Clerk's Private Exchange Board.....	1242
An Electric-Sanitation Plant in Brazil.....	1177	How Brass for Fixtures is Made.....	1242
The Sun as Light-buoy Tender.....	1180	Combined Direct and Indirect Fixture.....	1243
Electricity Building at Panama-California Exposition.....	1180	Tobacco Jar Humidor.....	1243
The Diamond Electric Sign.....	1181	The "Winking Willies".....	1244
Electric Incubator and Brooder.....	1181	Barber Pole as a Lamp Post.....	1245
Lighting the Bastille Column.....	1182	Double Appeal for Customers.....	1245
Electric Advertising in Shanghai.....	1182	Advertising in Waste Space.....	1245
Troubleman's Portable Searchlight.....	1183		
Mount Wilson Observatory.....	1184	<b>Miscellaneous</b>	
Money-in-the-Slot Restaurant.....	1185	Electrical Securities.....	1246
Warm Meals for the Horse.....	1186	List of Selected Bonds Showing Income Yield.....	1249
Automatic Compasses for Ships.....	1186	Buying Stocks and Bonds on the Instalment Plan.....	1250
Neomical Lighting in a Pumping Plant.....	1187	Unique Lamp Exhibit.....	1251
Thawing Frozen Water Pipes.....	1187	Science Extracts from Foreign Journals.....	1252
From Ingot to Wire.....	1188	Keeping Tab on an Electric Wagon.....	1254
Construction of the 1915 Exposition Begins.....	1194	New Books.....	1254
Radiation from Potassium.....	1197		
The Rotating Spiral.....	1197	<b>Electric Current at Work</b>	
Safe Opened with a Tuning Fork.....	1198	Photographing Microscopic Objects.....	1255
Telephone Extension Bell.....	1199	A Revolutionary Improvement in Plate Printing.....	1255
Measuring Temperature from a Distance.....	1199	Emergency Extension Plug.....	1256
Police Call System.....	1201	The Ozonator.....	1257
Diver's Outfit Equipped with Telephone.....	1201	Motor Driven Hack Saw.....	1258
Public Entertaining Revolutionized.....	1202	Telephone Slug Holder.....	1258
"Talking Movies," Edison's Newest Invention.....	1204	Stethoscope to Detect "Valve Slap".....	1259
High Tension Roof Wiring.....	1206	Automatic Electric Generator for Country Homes.....	1259
Why Tungsten Lamps Are Better than Carbon Ones.....	1207	The Bond Tester.....	1260
Classes in Pulmotor Practice.....	1208	Electric Lantern.....	1260
Suction Cup Fixture Holder.....	1209	Battery Switch.....	1261
Electric Drilling in the Oil Fields.....	1209	Automobile Tire Pump.....	1261
Electrical Men of the Times. Ernest Freeman.....	1210	Moving Pictures by Incandescent Lamp.....	1262
Telephones in the Vatican.....	1212	A New Electric Vapor Lamp.....	1262
Missoula's Lane of Light.....	1213	Steam, Electricity and Coal.....	1262
		Trolley Wire Frees Captive Baloon.....	1262
		The International Candle.....	1262
		Short Circuits.....	1263
<b>Electrical Interests of Women</b>			
A Lesson in Values.....	1214		
The Permanent Hair Waver.....	1216		
Captured Coffee.....	1218		
Recipe Box Aid to the Housewife.....	1218		
Clock That Needs No Winding.....	1219		

**RENEWALS** When your subscription expires, you will find a renewal blank enclosed here. You should fill out and return with remittance at once to avoid missing a number. Positively no copies will be mailed on any subscription after same expires unless renewed, and we cannot agree to begin subscriptions with back numbers. The date on wrapper of your magazine shows issue with which your subscription ends. The extension on this date to period covered by renewal is sufficient receipt. If any other is desired it should be requested at time of renewal.

**CHANGE OF ADDRESS** Notify us promptly of any change in your address, giving both the old and new location. Since our mailing list for each issue closes the 5th of the preceding month (i. e., list for April closes March 5th), changes received after the 5th must necessarily take effect with issue for second month following. Postmaster as well as Publisher should always be notified of changes in order to forward mail sent to old address.

ISSUED MONTHLY BY POPULAR ELECTRICITY PUBLISHING CO., Commercial Bldg., Chicago, Ill.  
 YEARLY SUBSCRIPTION, \$1.50; CANADIAN, \$1.85; FOREIGN, \$2.25; SINGLE COPY, 15 CENTS

No additional copies will be sent after expiration of subscription except upon renewal.

Entered as Second Class Matter April 14, 1908, at the Post Office at Chicago. Under Act of March 3, 1879.

Copyright, 1913, by Popular Electricity Publishing Co.

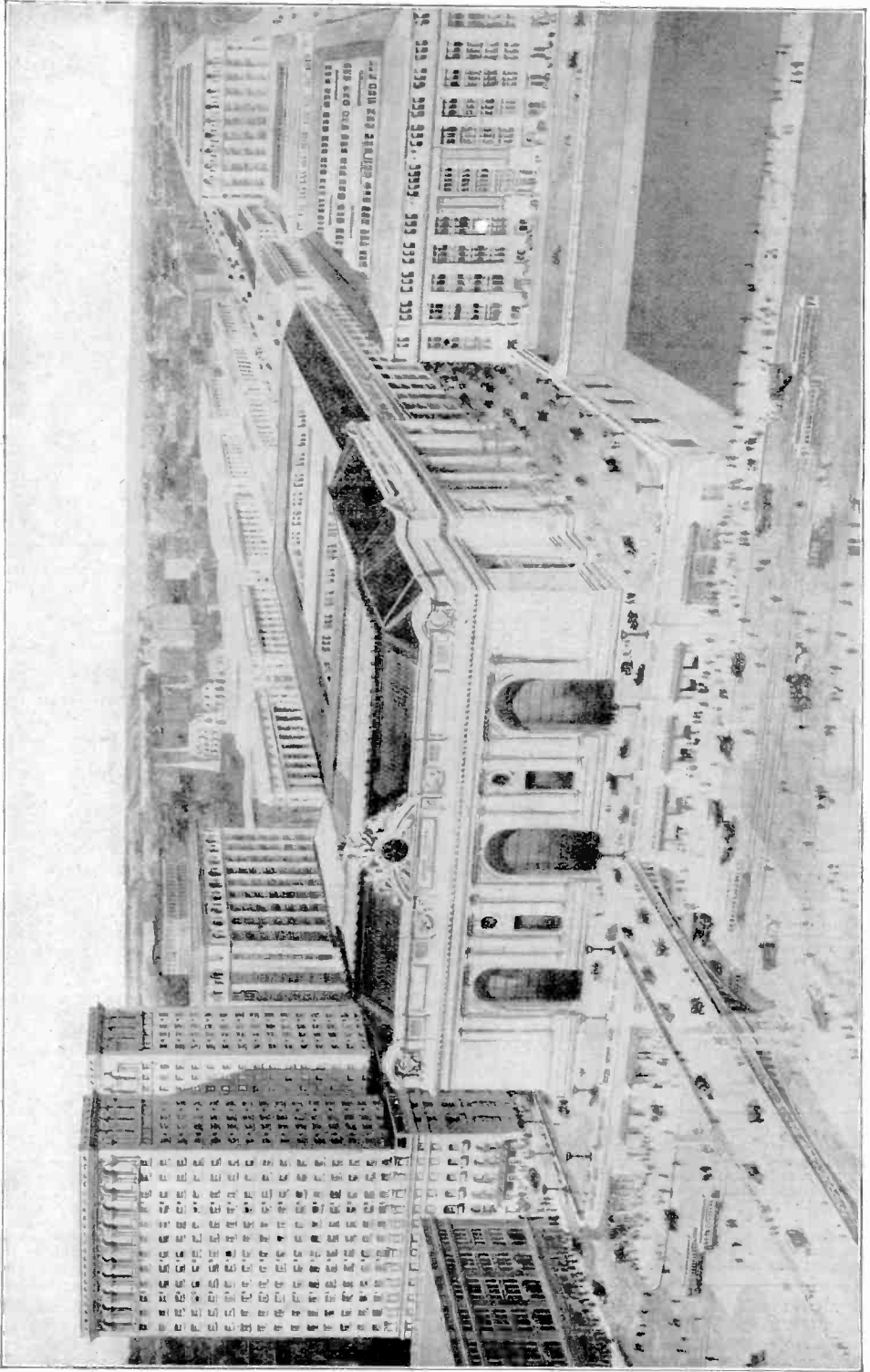

THE GRAND CENTRAL STATION NEW YORK AND ITS SURROUNDINGS — FROM THE ARCHITECT'S DRAWING



VOL. V.

MARCH, 1913

No. 11

## New York's Grand Central Terminal

By FRANK PARKER STOCKBRIDGE

Why not call New York's new Grand Central terminal the "Electric Station?" There is everything to justify it. There is not another railroad terminal in the world, and the Grand Central is the very latest and finest of its kind, where electricity is put to so many uses. Electricity was but an infant in the old Grand Central station nine years ago. Since then it has grown into the giant that dominates everything, does everything. From snaking the heavy trains in and out to washing the dishes in the kitchen, electricity does it all. Gas has been eliminated entirely, even for the purposes of cooking. The current has been made to do many new and novel things in such an eminently practical way that the telling of them is worth while.

Electricity starts to work away down under the terminal, where a "sump" pump automatically removes such water as may collect below the sewer line.

The incoming and outgoing trains are drawn by electric locomotives. All the switches and signals are operated electrically, and the signals are lighted by the same current.

Announcement of the departure and arrival of trains is made at 30 different points through the new application of an old principle in electricity.

Drinking water for the terminal is purified by a jump spark.

Freight elevators, baggage trucks, fans, ventilators and the usual office equipment are all electric. So are the clocks.

The electric current is used in copying blue prints and its helps to test concrete.

Incandescent and flaming arc lamps furnish the light.

An electric pump forces hot water through the radiators that heat the buildings. Cars standing on the tracks are heated by steam during the winter, but in case of emergency they can be heated by electricity as well.

During the better part of the year the current that does the many and manifold things about the terminal is generated at Port Morris, the main station. Current at 11,000 volts is carried from that point down to the substation at Fiftieth Street, where the alternating current is transformed by rotary converters to a direct current. A second method of obtaining power is by generating the current with steam driven turbines at Fiftieth Street. This is done during the cold months, when the exhaust from the turbines is used for heating purposes.

Probably the most interesting feature of the electrical equipment to the layman is the manner in which the departure and arrival of trains is announced throughout every part of the terminal reserved for the use of patrons of the road. Many

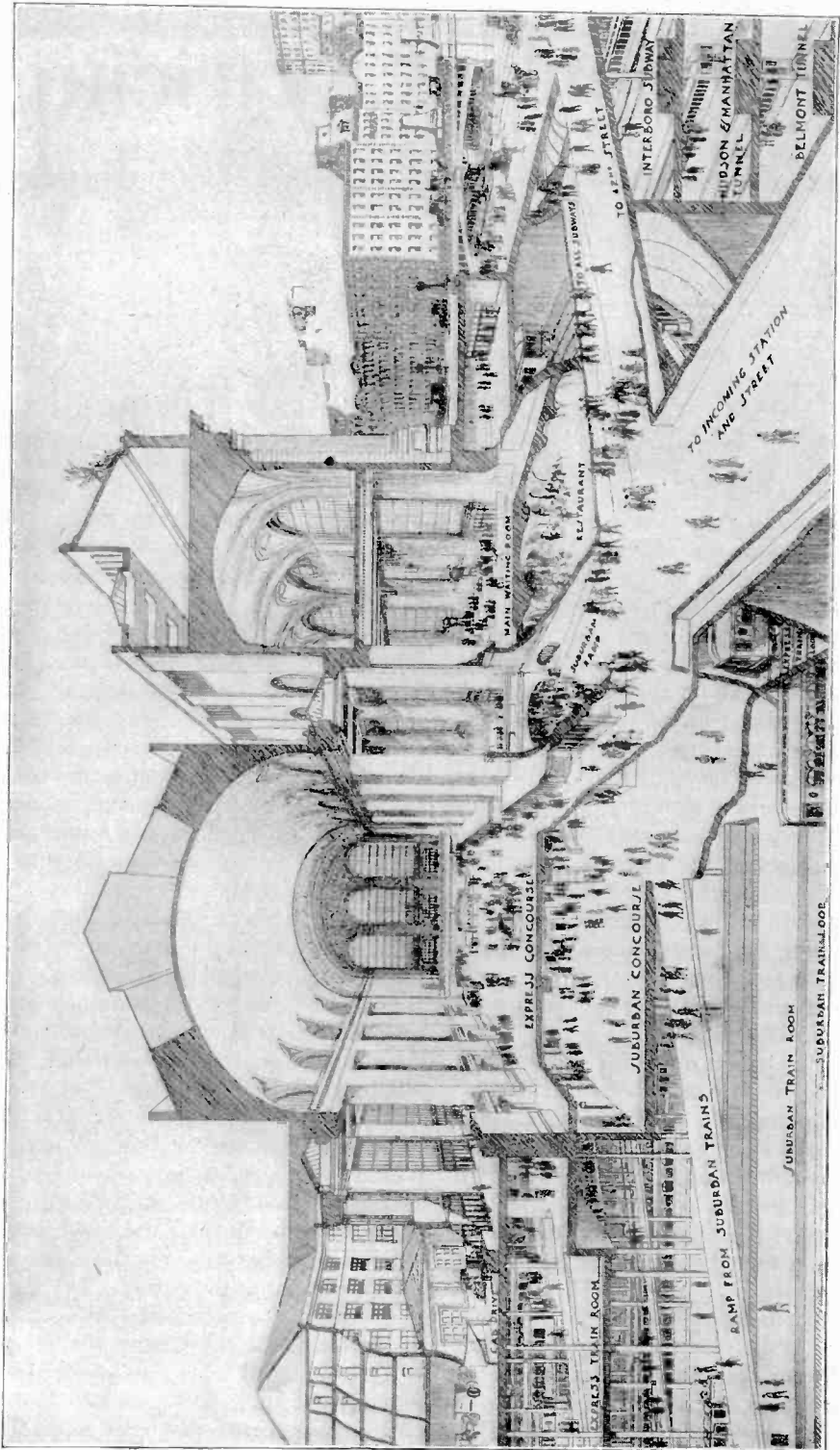

A SECTIONAL VIEW OF NEW YORK'S GRAND CENTRAL TERMINAL

of those who have followed the directions of the voice seemingly coming from the wall are under the impression that the contrivance is a combination of telephone and megaphone. It is neither, but something different from anything in use for the same purpose anywhere else in the world. The marvelous results obtained by the operation of the announcer are achieved through the new application of an old principle in electricity.

The announcer consists, first, of a mouthpiece similar in appearance to the ordinary telephone transmitter. But it differs vastly from the telephone transmitter in the important particular that it contains no induction coil. The transmitter also is unlike anything else of the kind in the fact that it is surrounded by a water jacket, through which a tiny stream of cold water flows constantly, cooling the carbon, which would otherwise become packed with the heat of the heavy current employed for operation. The transmitter is cooled in the same way in which the cylinders of an internal combustion engine are kept from heating.

This cooling of the carbon in the transmitter is made necessary by the fact that a current of 110 volts is used in operating the announcer. The ordinary telephone requires only a small fraction of this amount of voltage, and the current passing through it is correspondingly small. But it is through the employment of the heavy voltage that the remarkable results are obtained. The voltage is so equalized and the circuits so balanced on the Wheatstone principle that the sound of the human voice is intensified many times. And there is no limit to the number of points to which wires may be run for the transmission of sound from the central point.

In the main waiting room of the terminal, in the smoking room, in the room reserved for women and on the concourses a series of horns, all resembling the phonograph horn, are in position against the walls. These horns are connected with the central station. When

the operator is ready to announce the departure of trains he simply steps to the transmitter and speaks into it in an ordinary tone. Simultaneously there is heard throughout the terminal a giant voice telling all about the trains that are about to depart. Some 30 horns are in use at the present time and more will be added as necessity requires.

What is of almost equal interest is the manner in which the drinking water distributed through the terminal and offices of the company is purified. Not only is the water plant run by electricity, but every impurity in the water is killed absolutely by the employment of an electric spark. The layman would say, after seeing the plant in operation, that the water was so purified and vitalized by means of the electric spark that its properties as a life giving fluid were vastly enhanced.

The water purifying plant is situated on the fourth floor of the main office building. Ordinary city water enters through a main feed pipe and runs to a pressure tank. Thence it is forced through sixteen stone filters fastened to the rear wall. From these filters the water goes to the purifying outfit. The contractors who are erecting the terminal, and whose operation extend all over the country, say it is the first water purifying plant of its kind they have ever installed.

Actual purification of the water is accomplished when the current is turned on in a series of cells, somewhat longer and of about the same diameter of the ordinary dry battery. The cells are set up in batteries of twelve each and there are three such batteries in operation, the whole being enclosed in a wooden box with a door in front. Inside of each cell there are two electrodes, set far enough apart to produce a jump spark. Ten thousand volts are used to make the spark, though the amperage is very low.

When the door of the box is opened the pungent odor of ozone assails the nostrils. It is this ozone, created by the

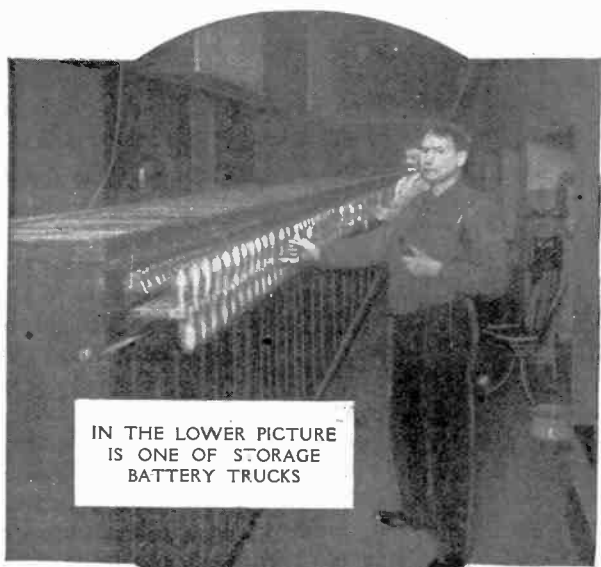

THE BRAIN OF THE ELECTRICAL, INTERLOCKING SIGNAL SYSTEM. THE HUNDREDS OF SIGNALS ARE HERE CONTROLLED, EACH BY ITS INDIVIDUAL LEVER.

IN THE LOWER PICTURE IS ONE OF STORAGE BATTERY TRUCKS

THE DIRECTOR OF SWITCHING AND SIGNAL TOWERS SITS IN AN OFFICE OF THE TERMINAL YARDS WITH A TRACK INDICATOR IN FRONT OF HIM





spark, that does the trick of killing the impurities in the water. The box is connected with three injectors through which the water passes, and as the water rushes along enough ozone is drawn into it to accomplish the purification, which is done by the ozone killing all organic matter. There is nothing but pure water left, when water and ozone come together in that fashion. If anything should get by without being absolutely destroyed, there is another filter to catch any residue before the water passes into the receiving tank from which it is distributed throughout the buildings.

pulse is started which automatically throws a switch which starts up the machinery. When the supply gets beyond the normal the same switch shuts off the machinery. The pipes in the tank are covered with ice and frost. The

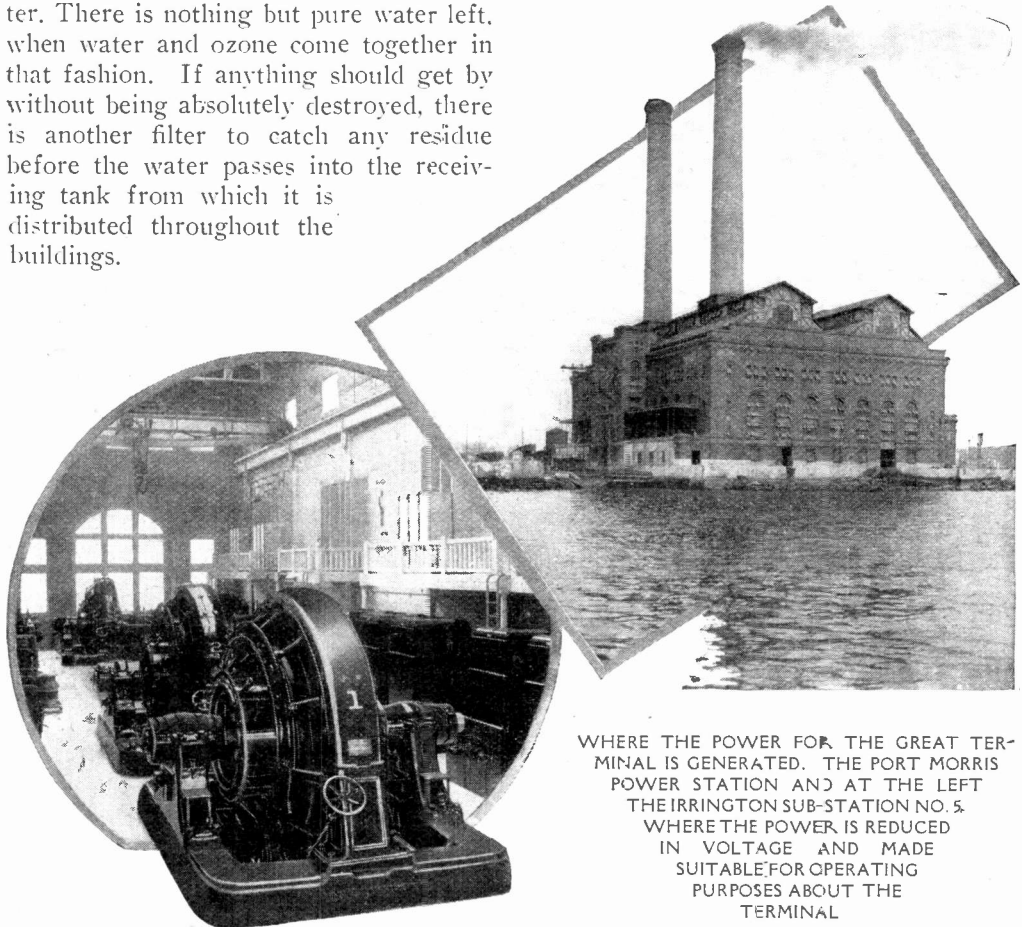

WHERE THE POWER FOR THE GREAT TERMINAL IS GENERATED. THE PORT MORRIS POWER STATION AND AT THE LEFT THE IRRINGTON SUB-STATION NO. 5 WHERE THE POWER IS REDUCED IN VOLTAGE AND MADE SUITABLE FOR OPERATING PURPOSES ABOUT THE TERMINAL

The tank to which the pure water finally finds its way looks for all the world like a huge icebox, which it is, in a sense. A 20 ton refrigerating outfit of the single expansion type completes the work of preparing the water for consumption. The refrigerator is run by a motor and the supply of water is regulated, as the whole plant is controlled, by electric devices that work automatically. If the supply of water gets below a normal point an electric im-

purified water, being forced through the buildings under pressure, passes through the tank many times.

But the novel uses of electricity in the new terminal do not end with the features already referred to. An odd trick was the substitution of storage batteries for the operation of electric bells and buzzers instead of employing the usual dry batteries. Dry batteries scattered about the offices were an eyesore to the officers of the company and so two large

storage batteries were installed on the fourth floor. The batteries are charged by two rotary converters. From these batteries also power is obtained to keep the clocks running regularly and properly.

Electricity is even employed to test the concrete used in the construction work both in the terminal and all along the road. A "cement laboratory" is in operation in the main office building, where different combinations of cement and sand are tested before the proportions of each that shall be used for different purposes are decided on. A small motor is used to shake fine sieves through which cement is passed before being mixed with sand. The fineness of these may be judged from the fact that in some of the screens there are 10,000 holes to the square inch. For a man to stand and shake a screen like that would cost too much money. The little motor does the work economically and right.

In the same laboratory electricity is utilized to heat ovens in which the briquettes of sand and cement are baked or steamed. Both dry heat and steam heat are employed to prepare the briquettes for the pressure test to which they are subjected later. The current furnishes the heat that makes the steam.

Near the cement laboratory is located the blue print shop, where electricity is again the important factor in operation. Blue prints, of which there are many new ones every day, are copied on a slow moving roller of some eighteen inches diameter that is turned by an electric motor. The original blue print prepared by the architect is placed in the printing machine with a sheet of copying paper beneath it. The roller carries both close to arc lights of 1,000 candlepower each and the trick is done after the copy has been given a bath in a solution that fixes the lines on the prepared copy paper.

In the commissary department, where much of the cooking is done for the dining cars on through trains, electricity is employed exclusively. There are elec-

tric ovens where meats and fowls are roasted, electric ranges on which many things are cooked. The humble griddles are heated in the same way and finally ice cream is frozen in great electric refrigerators. An electric dish washer cleans the crockery and kitchen utensils.

The baggage trucks used in the terminal carry two tons each and are driven by storage batteries of twelve cells each, making 24 volts to each cell. They scoot around with big piles of baggage, doing swiftly and quietly what many men would be required to do in a much longer interval of time.

Truly, the new Grand Central terminal, when it is finally completed a year hence, might well be termed the "electric station."

---

### Tantalum

Tantalum, that curious substance of which more or less use is made in the construction of filaments for electric lamps, is pure white and as hard as the best steel. When hot, it can be rolled, hammered and drawn out into wire. Its tensile strength exceeds that of steel. For lamp filaments it is drawn into wire hardly more than one five-hundredth of an inch in diameter. Its electrical resistance is much less than that of carbon, so that the filaments have to be much longer than the ordinary carbon filaments when they are used with the usual 110 volt lamps.

Tantalum melts at 2,300° C. Tungsten melts at 3,030° C. Like tantalum, it has a much lower resistance than does carbon.

In connection with tantalum deposits, there is reported the finding of a new mineral in the gold washings of the Ural Mountains. Analysis shows that it consists of 98.5 per cent tantalum, 1.5 per cent niobium, and .001 per cent manganese. It may therefore be regarded as consisting practically of native tantalum. The mineral occurs in very minute quantities, and is apparently an isolated formation.

## Electric Frost Prevention

An electric heater for the protection of orange groves from frost is being tried out in the groves about Riverside, California, this winter

The device is being used on a small scale to cover sixteen trees in the belt which was affected by frost last year. Overhead wires have been strung above the trees and connections made with the heaters. The current will be turned on when required and careful observations made with thermometers to test the difference in temperature. Of course it is

house when any particular area is threatened by frost. By the use of the motorcycle patrol and the telephone, it is possible for the orange growers to receive a warning in time to start the smudges, or pots of burning oil under the trees, and thus prevent the great damage that a single freezing night could do.

## Novel Life Raft

The picture indicates the construction of a form of an individual lifeboat or life raft and its method of operation. It is equipped with an electric light as

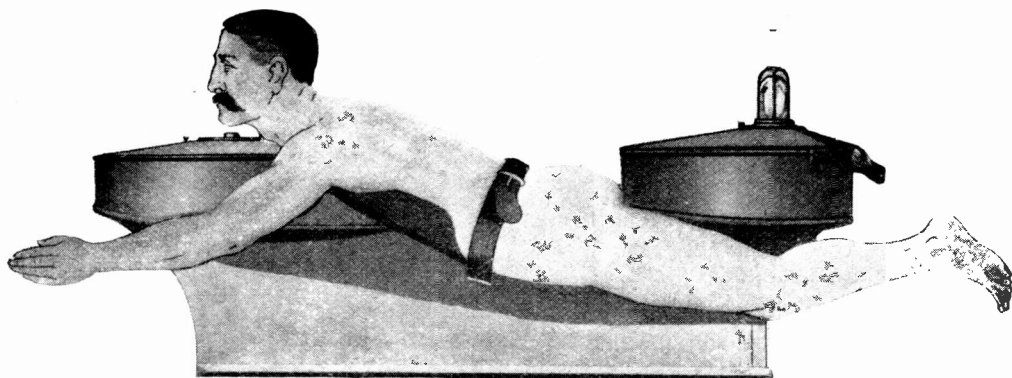

AN INDIVIDUAL LIFEBOAT OR RAFT WITH ELECTRIC BEACON

understood that in frost prevention it is not the rise in temperature alone that makes the difference, but the circulation or agitation of the air which a comparatively slight inequality of temperature can cause. It is stated that the value of this device promises to be so great that free current has been provided for the experiment by the Board of Public Utilities.

Another way in which electricity helps the orange grower is by the use of a complete telephone system around the Pomona, California, citrus groves. This telephone connects the homes of the growers with numerous stations among the orange groves which are visited at frequent intervals during the winter nights by a motorcycle rider who observes the thermometers at various points and promptly telephones the owner's

noted in the rear and a compass in front. It was devised by Philipp Lentz of Berlin-Lichterfelde and measures  $1\frac{1}{2}$  meters in length. It is so designed that the user may have free use of his arms and legs for propelling the apparatus and can readily steer the craft by the aid of the compass.

He is fastened to the device by a single strap over his back which he can easily reach. The intermittent electric light is intended to aid in his rescue by showing the location of the apparatus in the dark.

The signal electric light consists of a ten candlepower tungsten lamp operated by a storage battery. A small electric motor is provided which automatically switches the electric light into circuit for two seconds with a pause of four seconds between the flashes.



## Building the Trolley in the

You know that Oolong tea comes from Formosa. But do you know that there are 400 miles of electric railways in operation and under construction throughout the island? Do you know that primitive Formosa through the invasion of the trolley has become up to date, bustling, commercial? Let us see how the change came about:

The smoke was still drifting from Japanese guns; China was still groaning from its ill-fated war, when the little men of Nippon turned their faces toward Formosa. They knew the island was rich. They knew that these riches could not be obtained until the head-hunters had been driven away. So the Japanese landed their brown faced soldiers and drove the native bandits back into the mountains. Also, being able to shoot very straight they kept them there. The first obstacle out of the way, the Japanese conceived the idea of laying a system of electric railways over the island. So they began to build, using Keelung, the capital, as a center and tapping the remote corners of Formosa. The plan was to establish an electric service between the great sugar and camphor districts, the rapidly growing bamboo pulp factories and the natural outlet for commerce.

For a while the Japanese had a hard time building their line. No sooner had they raised trolley poles and put cars in operation than the head-hunters sneaked down. By night they came, excited with the plan of an old chief. A renegade Englishman had given it to him. And the plan was to cripple traffic by cutting down the poles. As the story goes the savages

cut the poles but with them brought down a "live wire." Now even a savage's skin isn't tough enough to stand a "live wire." And after the chief had seen ten of the strongest warriors fall to the ground electrocuted, he concluded that it would

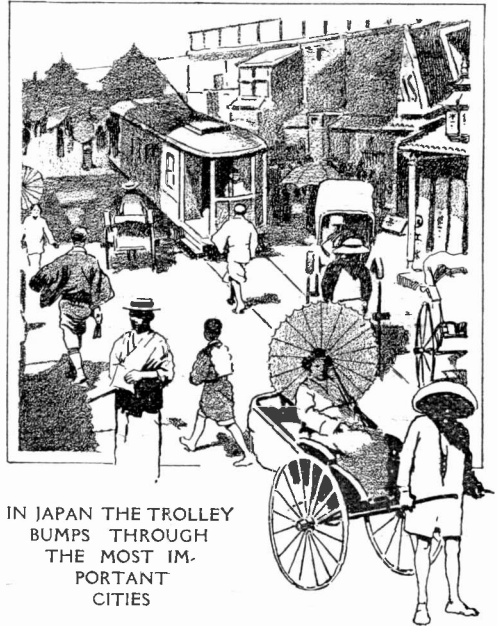

IN JAPAN THE TROLLEY  
BUMPS THROUGH  
THE MOST IM-  
PORTANT  
CITIES

be a good thing not to cut down any more trolley poles.

And in a similar manner the trolley has sought the remote places of the earth, so let us follow the story more or less geographically.

Unlike Formosa the impetus for the trolley in Hawaii came from the West. In the Island Beautiful, Formosa, the Japanese were the builders. In Hawaii they were Americans. To-day Honolulu has a very up-to-date electric system. One of



## Remote Places of the Earth

its branches winds out of the town curving and climbing until it reaches the crest of the Punch Bowl, 500 feet above the sea. Not only is it popular with tourists but the residents favor it as well; and by residents I mean the natives as well as the foreign born. For the natives are very easy going, indolent, dreamy. They hail such effortless transportation as the trolley car as a gift from the God of the volcano Kileiu.

In the Philippines the story of the trolley is the story of a hard construction fight. As soon as Spain had been defeated an American engineering company sent its forces to the islands and built the Manila Electric Railroad. They found things very unsettled. The Philippines, more backward than Cuba, were stagnant so far as modern engineering went. An old system had to be torn down. Not only did the indifference of the people have to be overcome but certain climatic conditions presented serious obstacles. No sooner had the engineers begun work than they found that heavy dampness corroded the rails. Overcoming this by generous coatings of asphaltum paint they faced another difficulty. White ants were destroying the wooden ties. So the ants' party was spoiled by covering the rails with jodelite. That took away their appetite. Then it was found that the familiar tubular steel trolley poles were rapidly rusted in the Philippine air. Poles of native wood had to be substituted.

Then, shut out from the ties, the ants began eating the cars. So ordinary wood was dispensed with. Expensive teak had

to be employed. And worst of all, the construction and excavating was done by the natives, whose habits make it necessary for the man employing them to watch closely.

No sooner had the Manila Electric Railroad begun to pay wages than the natives disappeared. As soon as they had a little money they quit their jobs and gambled. Those who remained used the luncheon hour to get into games. Their earnings paid for excitement instead of food. So the builders stationed lunchmen along the line, sold excellent and very tempting food at low prices—and won. To-day the Manila Electric Railroad has about 40 miles of track. Some of it runs through the suburbs, which means through a jungle. Here malaria and snakes lie on either side of the rails. Re-



THE CHINAMAN NEVER USES A WHEELBARROW BUT INSISTS ON A WICKER BASKET



FEARED THAT THE NOISE OF THE MOTORS  
MIGHT DISTURB THE CALM OF THE  
SACRED ELEPHANTS

pair work is costly. Yet since 1905 the line has been running continuously and at a profit. The native admires it chiefly for one thing—it enables him to reach the race track near Manila quickly.

Of course you would expect well equipped lines in progressive Australia. There are excellent systems at Melbourne, Perth and Kalgoorlie. Indeed the trolley has ever penetrated far-off Auckland. New Zealanders are as familiar with it as New Yorkers. This sounds stranger if you take a map of the world and see where Auckland is—one might call it the edge of the earth over which the doubters believed Columbus would fall.

But going up the Pacific we again meet the Japanese, the same busy trolley promoters who turned Formosa from a paradise of head-hunters into a paradise of money chasers.

In Japan the electric trolley hums through most of the important cities. It has forced the "ricksha" from the more traveled highways. It has robbed the native atmosphere of ancient charm and local color. Still it has facilitated transportation, helped bring the Empire up to date; helped the Japanese to make money faster, which is his second ambition. The first, as you know, is to make his empire the greatest of the world.

By way of emphasizing her up-to-date-ness, her desire to hold her own in an age of mechanical progress, Japan has built an electric railway in Dalmy, that seaport of southern Manchuria torn from the grip of the Russian bear. Before Japan brought the trolley, Dalmy lived in another century. But Japan is no respecter of another country's traditions. For ages Corea, hermit of the Asiatic, resisted every innovation from the western world. Then flushed with her victory over Russia, Japan pushed some of the innovations down the throat of the ancient nation. To-day Corea has a trolley, running out of Chemulpo. It is planned to extend the tracks 25 miles inland to the ancient capital of Seoul. Of course, this is being done very much against the will of Corea. But what is the will of a dead kingdom? Still one cannot help wondering what the natives think of electricity, of the unseen force that speeds rattling cars over the dusty roads where once only shuffling coolies and lazy ponies toiled.

Even China has surrendered to electricity. Many of her large seaports are now networks of trolley track. Not so long ago conservative Hankow agreed to spend \$20,000,000 on new and electrified transportation. Lines are being built everywhere. Still the natives persist in using the most primitive implements in carrying on the work. Often a trolley line in China must cross shaky ground, rice paddies, marshes. Piling must be done. Still you rarely see a modern pile driver in China. What you do see is a

yellow faced coolie setting the pile into position, gripping it with big bamboo poles and strapping these poles together. Then other coolies, chattering excitedly, cling to the outstretched bamboo and by sheer weight force the pile into the mud. Then they hammer aided by a big stone, held firmly between two timbers. Also in carting away dirt the Chinaman never uses a wheelbarrow. He insists upon his inefficient wicker basket. Another difficulty that trolley constructors had to fight in China is superstition. I mean a particular superstition. It is called "Feng-Shui." Now that is Chinese for what might be translated into "the symmetry of local topography." That is to say the Chinaman believes that the earth depends upon a balance. If he imagines a particular locality is not balanced properly he builds pagodas to establish the proper poise. And if he thinks the ground is balanced properly he is careful to place his house in such a position so as not to destroy the balance. Also he observes it in burying his dead so that they



HINDUS USING GRUBBING HOES AND CARRYING THE DIRT AWAY IN BOWLS

may enjoy repose without the earth teetering and bothering them. It isn't good for a foreigner to ignore that superstition.

Once a party of American engineers plotted the survey of their trolley in such a way that it threatened the local "Feng-Shui." The American gunboat that came to their rescue arrived just in time.

The trolley has even invaded the Malay peninsula. Here the chief difficulty is in furnishing accommodations for the various classes. Of course caste rules in the Orient. The lower class natives have welcomed the trolley lines. Still they have yet to adjust themselves to new habits which the new transportation demands. When a native travels he invariably carries excess baggage. A farmer bears heavily laden baskets or balances vegetables, poultry and pigs from a long bamboo pole. Of course the natives insist upon carrying all their truck into the trolley cars—which is embarrassing.

Siam was one of the first of the eastern countries to encourage the trolley. About eight years ago some American high in the favor of the White Elephant obtained a concession for a trolley line in Bangkok. Previously bullock carts furnished transportation for those who did not



THE ROYAL HEAD OF THE LAND ORDERED THAT THE POLICE WEAR TROUSERS

walk or ride in the boats of the muddy Meinam and its canal like tributaries. It was some time before the Americans dared begin work. The natives feared that the noise of the motors might disturb the calm of the sacred elephants. These objections overcome, the road was built.

Even then it innocently caused trouble. Up to that time the native police had dressed very simply. They wore a cloth around their waist, a hat and a smile. This wasn't considered in keeping with an electric railroad. So the royal head of the land ordered that the police wear trousers. The trousers came, were put on and so amused the people that great crowds gathered, blocking traffic on the electric line and causing unheard of excitement. The next day the trousers were removed and the police and the electric cars moved freely.

It would be easy to go on and tell how the motor invaded Bombay, how they dug 44 miles of track with Hindus using grubbing hoes and carrying away the dirt in bowls. It would be interesting to know how ancient Bagdad is building its electric line; how a trolley now runs from Cairo to the ruins of Heliopolis with the gray pyramids looking on; how they no longer close the gates at sundown in the Holy City of Jerusalem; how a trolley line is going where only camels and donkeys went before. To some the clanging of a gong, the whirr of the motor near those sacred walls may be a desecration. But the trolley has become a part of the Holy Land. Pilgrims are now using its cars to explore the streets of the Holy City. Modernity has pushed out the traditional archaism of Jerusalem.

The trolley has gone through South Africa from Cape Town to Camps Bay, and they broke the road through heavy rock, laid their tracks 800 feet above the sea and provided a wonderful view of Table Bay. The black natives became enamored of it, sold anything to get the necessary fare for a ride in one of the wonderful cars.

There is the story of Durban in Natal.

Here they have an electric line owned by the municipality—a line that conducts a street car parcels delivery, carrying small packages at a very moderate rate. We have, therefore, something to learn from Durban.

And there is the tale of a thousand miles of trolley track in remote parts of Russia. Down in the small town of the Baltic provinces it has provided transportation for the poor. Farther north it has brought the people of the wheat districts closer one to the other.

You would think that the limit had been reached but you don't know the persistence of electricity. For centuries old Popocatepetl has lifted its peak two miles into the heavens. The Mexicans are proud of it. Its summit is far above the snow line. But soon an English syndicate will lay the tracks of a trolley up its slopes, climb them as easily as the trolley climbed Vesuvius, bring to the volcano top what it has never felt before—the mighty pulsing of electricity high above the snows.

So far has the trolley spread—penetrated the remote places.

### Radium in Yellowstone Park

Recent investigations at the Yellowstone Park hot springs show that the travertin of the ancient terraces contains little radium as compared with that found in the terraces of later formation. The reason is thought to lie in the fact that the hot water has separated the radium from the uranium in the rocks and deposited it in the terraces where it gradually decays and disappears when not replaced by fresh supplies from beneath.

Certain of the travertin terraces are overlain by glacial boulders and it is thought that this fact affords a means of estimating the date of the last glacial invasion of the region of the Yellowstone Park. Assuming a uniform action of the springs, they make this date 20,000 years ago.



## RIVADAVIA—THE GREAT ARGENTINE BATTLESHIP

A new record for size and power of armament of battleships is made every few months. For a fleeting moment this record is held by the Rivadavia, the new Argentine battleship now almost completed at the Fore River Works, Quincy, Mass. It will be turned over to the Argentine government complete in every respect down to dishes, table linen and silver and the piano in the officers' quarters.

Twenty-seven thousand tons is the displacement of this monster fighting machine, and throughout its vast bulk the workings of electricity are found in all phases of its intricate organization. The lights, signals, telephones, ammunition hoists, gun firing and controlling mechanism, searchlights and a hundred and one are operated by electricity for the simple reason that it is the most safest and surest form of energy to use in the restricted spaces the terrific dynamic forces that lie dormant in the hull in the form

A plant of 1,650 kilowatts capacity (2,200 will be required to supply all this electrical energy. two main stations in duplicate, each fitted with erators capable of generating all the power re- action and located within the armored case- will also be a third installation, operated by heavy oil motors of sufficient power to illu- minate the ship and also handle some of the guns for practice.

The large fire control or cage mast, from which the gunfire is directed, will have electric signals and telephones, communicating di- rectly with the gun turrets as

other devices efficient, and amongst of explosives. horsepower) There will be turbo-gen- quired in mate. There

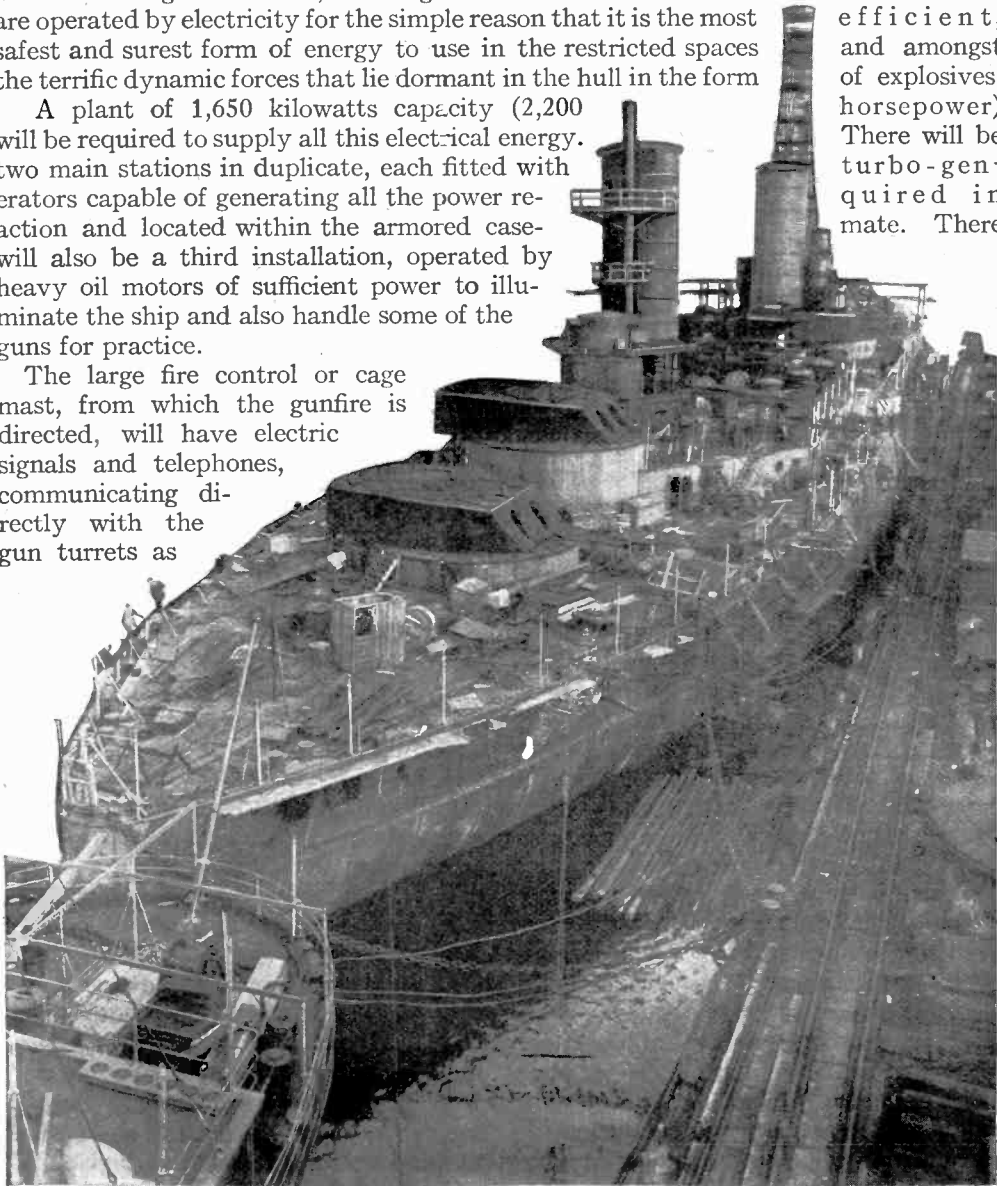

well as with the engine room and other parts of the ship. Intercommunicating telephones are everywhere, and there will be submarine signal apparatus.

Below the waterline the ship will be protected with a double bottom transverse and longitudinal bulkheads, dividing the vessel into watertight compartments, fitted with electrically driven centrifugal pumps.

In the work of building this ship, hoisting the huge parts into place, giant electric cranes, one of them the largest on the Atlantic coast, if not in the country, were used.

### Concrete Poles Molded in Sections

A device here shown and on the market will do much it is claimed to simplify the erection of concrete poles for transmission and telephone lines besides making possible the transportation of poles in sections to points away from railroads.

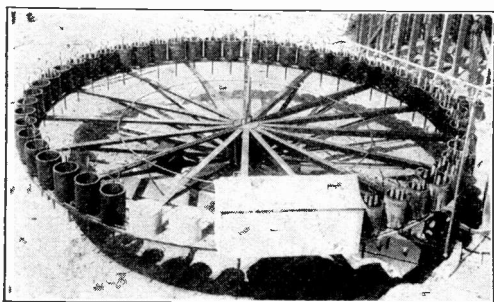

MACHINE FOR MOLDING CONCRETE POLE SECTIONS

A wheel like, iron structure carries a series of molds of different sizes to the number of 54 upon its periphery. In the molds are formed concrete pole sections nine inches long varying in diameter from seven to eleven inches. In erecting poles these sections are placed one upon the other, those of lesser diameter being used as the top of the pole is approached. Through four holes in every section steel rods are passed to hold the built up pole together. Poles may be lengthened or shortened at any time by adding or taking away sections.

### An Electrical Fancy

The following is a free translation of a sketch in a Parisian paper wherein is neatly satirized the astonishing progress of electrical science. This sketch pictures Edison in his laboratory, hearing the news of a declaration of war between the United States and Great Britain. A young man, his assistant, rushes in, pale and out of breath and exclaims:

"War is declared! It is terrible!"

"Ah," says Edison. "War is declared, eh? And where is the British Army at this moment?"

"Embarking, sir."

"Embarking where?"

"At Liverpool."

"At Liverpool—yes. Now, my friend, would you please join the ends of those two wires hanging there against the wall? That's right. Now bring them to me. Good! And be kind enough to press the button."

The assistant, wondering and half-amused, presses the button.

"Very well," says the inventor. "Now do you know what is taking place at Liverpool?"

"The British Army is embarking, sir."

The inventor pulls out his watch and glances at the time. "There is no British Army," he says, coolly.

"What!" exclaims the assistant.

"When you touched that button you destroyed it."

"This is frightful!"

"It is not frightful—it is science. Now every time that a British expedition embarks at any port, come and tell me—tell me at once. Ten seconds afterwards, such an expedition will simply be out of existence, that is all."

"There doesn't seem to be any reason why America should be afraid of its enemies after this, sir."

"I am inclined to share your views," says Edison smiling slightly. "But in order to avert any future trouble, I think it would be best to destroy England altogether."

"To—to destroy England, sir?"

"Kindly touch button number four there."

The assistant touches it. The inventor counts ten.

"—eight, nine, ten—it is all over. There is no more England!"

"Oh! Oh!" exclaims the young man.

"Now we may proceed quietly with our work," says the great man. "And if we should ever be at war with any other nation, you have only to notify me. I have an electric button connecting with every foreign country which will destroy it when pressed. In ten minutes I could destroy every country in the world, the United States included. Be careful, now, that you don't touch any of those buttons accidentally—you might do a lot of damage!"

clusively to experiments with radium, and has constructed for himself a radiographic laboratory in which to perform his experiments. It is dangerous work that this scientist has undertaken, and sooner or later it may mean his death. He has already felt its effects. Radium, it is well known, when one is exposed to its rays constantly in experimental work, creates a skin disease which gradually penetrates the flesh until the affected member has to be amputated to save the rest of the body. This wonderful mineral, which has such curative powers, can also be very destructive at times. Dr. Infroit first lost a finger. Then a hand was amputated. He was attacked by the disease back in 1908. But since then he has never faltered in his work. He did not stop his experiments even until his hand was healed. Now he has decided to give up his entire time, and perhaps his life to experiments in the cause of humanity and scientific knowledge. The illustration shows him in his radiographic laboratory with two assistants.

### Dr. Infroit's Radiographic Laboratory

Dr. Infroit, the Paris scientist, for 29 years head of the laboratory at Salpêtrière is henceforth to devote himself ex-

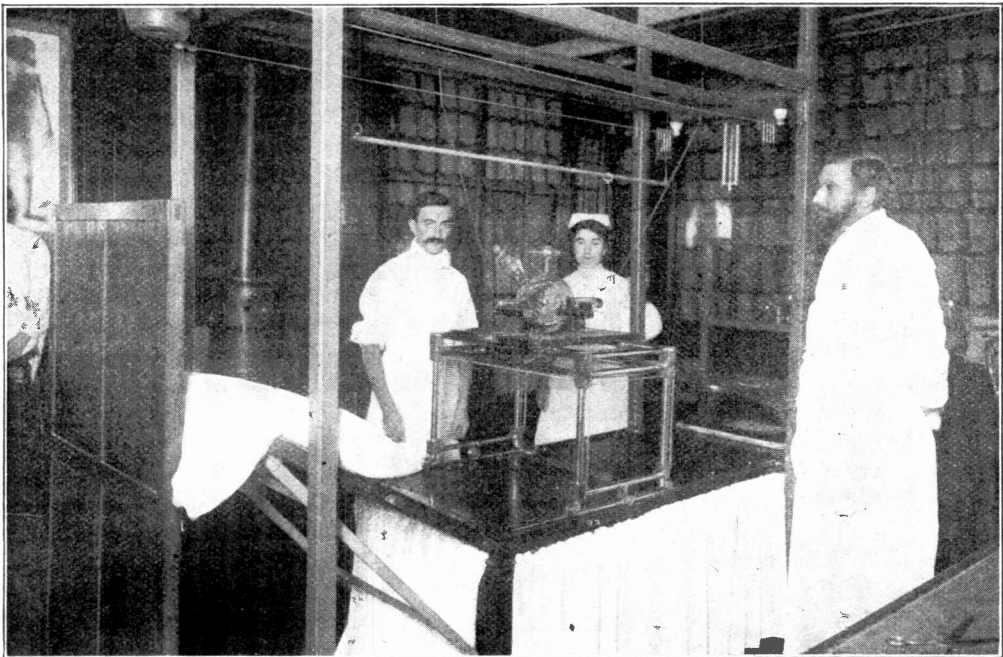

DR. INFROIT IN HIS RADIOGRAPH LABORATORY

## Hornum Lighthouse

One of the finest of the world's electrically equipped lighthouses stands on the coast of Germany. The tower of the Hornum lighthouse is of steel and from it shine two electric lights with a third light for range purposes in a secondary structure half a mile distant.

Inside the main tower are installed on the ground floor duplicate twelve horse-

service lamp should be broken the current automatically (by the short circuit caused by the broken lamp) turns the table on which the two lamps are mounted and throws the spare one into focus and lights it. The main light in the tower is an arc lamp. The difference between this lamp and the ordinary arc lamp is in the arrangement of the carbons. The positive carbon is horizontal while the negative carbon is placed in an inclined

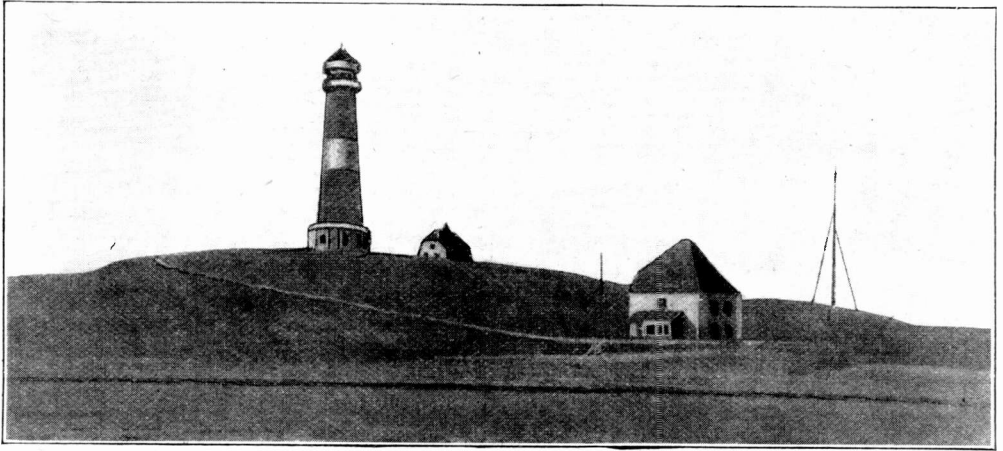

HORNUM LIGHTHOUSE

power Diesel engines direct connected to duplicate generators. This plant is used to charge a battery of 100 storage cells on the floor above and is accomplished in six hours. The battery will then run the three lights for ten hours.

The floor above the battery is fitted up as a bedroom, and the floor above this is the watch room with a telltale switchboard and a telephone to the engine room and keeper's dwelling. There is also an automatic device by which the generating set on the ground floor can be stopped either from the watch room or battery room. Above the watch room the secondary light shines from the main tower, the rear light of the range, the front light being about half a mile away. The front and rear lights each consist of two 150 candlepower incandescent electric lamps, the one in service and the second directly behind (not in service). In case the

position to the positive, the two forming an angle of 70 degrees. For the lighting effect only the crater of the positive carbon is taken into consideration. The positive crater is clear of the negative carbon entirely, so that the total amount of light given out may radiate. Automatic mechanism in the form of shutters cuts off the light in groups of two flashes alternating with groups of four flashes repeating again in 30 seconds.

### Economy of Electric Ware

Electric ware is not only convenient, sanitary and safe, but is economical as well. The electric toaster stove requires 500 watts or one-half kilowatt. If the rate is ten cents per unit or kilowatt hour, you can cook on the toaster stove a full hour for five cents. The electric heating pad consumes 55 watts.

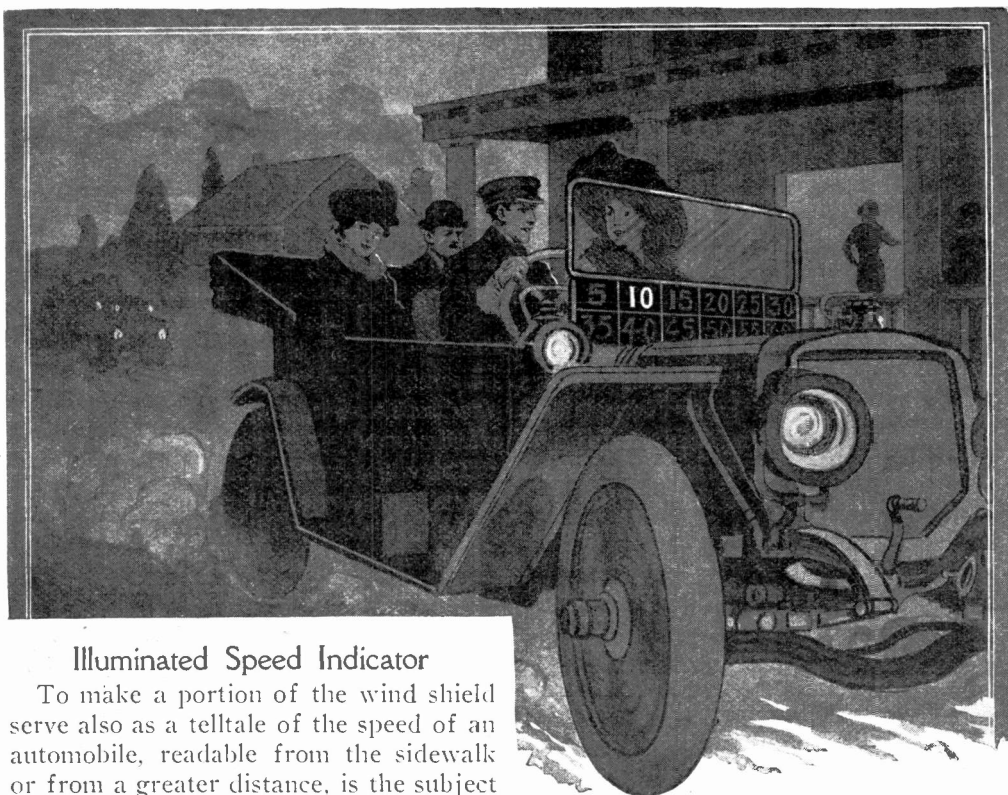

### Illuminated Speed Indicator

To make a portion of the wind shield serve also as a telltale of the speed of an automobile, readable from the sidewalk or from a greater distance, is the subject of a patent issued to Forest Lee Cantrall, Ivy, Calif.

The lower part of the shield proper consists of compartments upon the glass front on which are numbers in successively increasing values beginning with five. In each compartment is an electric lamp backed by a reflector. Under the needle of the speedometer are electrical contacts so arranged that as the needle moves over the scale to indicate the speed these contacts are closed one at a time through a battery thus lighting up the proper lamp and displaying the number showing the speed.

### Mineralized Carbon Lamp Electrodes

Arc lamps with mineralized carbons have been in use for some time in France and are believed to be more efficient than any other lamp yet invented; that is, they give more light per unit of energy consumed. As they yield a spectrum more nearly like that of the sun than

other artificial lights, they may prove valuable in many ways where other lights are unsatisfactory.

They have had, however, a serious disadvantage, as the vapors from the burning carbon have been found to condense on the interior of the globe and thus obstruct the radiation of the light. This has been recently overcome by the adoption of a double, closed globe, such that one part is used for the glowing carbons while the other part acts as a condensing chamber. With this arrangement it is found that the formation of the gases is lessened on account of the limited air supply, and what does form is condensed in the lower chamber. The fumes are principally fluoride of calcium and nitrous vapors resulting from the direct combination, at the temperature of the arc, of the nitrogen and oxygen of the air. These vapors are more abundant in lamps with mineralized carbons than in ordinary lamps, on account of the higher temperature of the arc.



Through the curtain there percolated low rumblings, explosions, a confusing sound as of many bodies moving, gruff heralds of battle. Then there came a pause, a lull in the firing, absolute silence as if the voice of destruction were taking breath for some greater effort yet to come.

In the darkened theater people began to show uneasiness. One heard whisperings, shifting of feet. The audience, strangely affected by this unseen disaster, waited nervously for the curtain to rise. And then of a sudden it shot up, curled its

## The Daughter

By EDWARD

soft folds into the flies, exposed a dimly lighted stage and on it a grim picture. There behind the footlights lay the battlements of Nankin—red battlements with the dead and dying of the Ming army strewn about them. Now in the black reaches of the sky one saw flashes of fire, splitting forks of yellow and red, heard shells burst filling the air with their terrible crashing. Then the wall began to fall in, great blocks of stone tumbling down upon the stage pinning men as they fell. And the din continued, the bursting shells, the rattle of musketry, the waving of signal fires.

How long this lasted I cannot say. All sense of time had gone. Only could one think of the falling battlements, the thunder of cannon, the spreading smoke, the cries of the soldiers of Ming. And then The Daughter of Heaven, empress of a lost dynasty, a little woman armored in gold, in allegiance for whom her loyal subjects had risen in revolt,

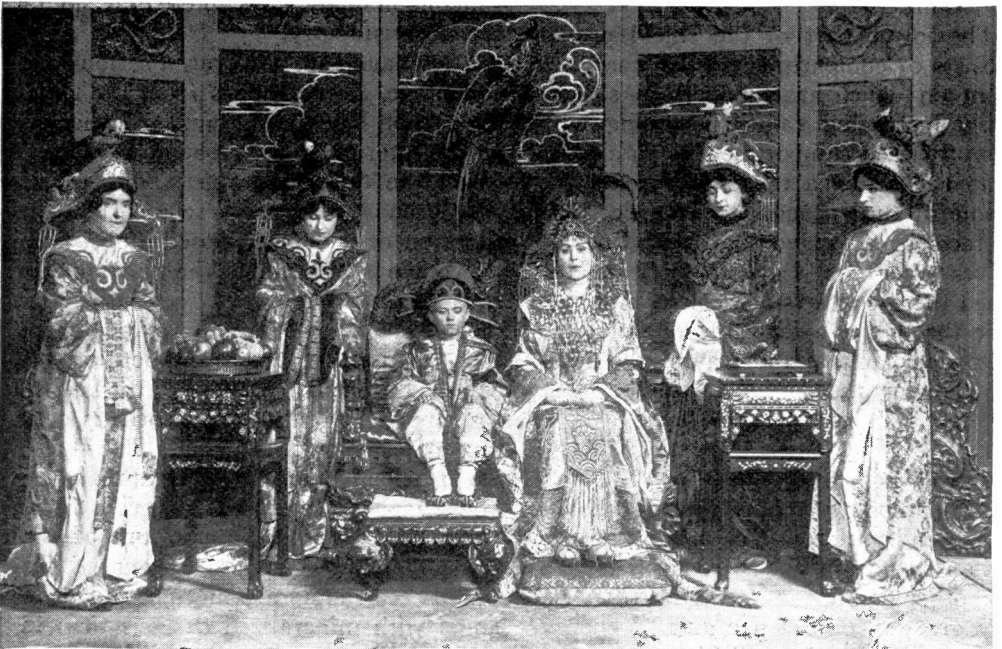

VIOLA ALLEN AS THE DAUGHTER OF HEAVEN, AND HER ATTENDANTS AT THE MING THRONE

# of Heaven

LYELL FOX

crossed the stage. I saw her pick up a torch and hold it overhead. Her soldiers had gathered around her. The day was lost. The Manchus were carrying all before them. Soon they would come swarming over the battlements. And the loyal Mings were pleading of her a last dispensation, begging a favor. She, their Empress, must light with her own hands the funeral pyre upon which they would all burn. They prostrated themselves before her.

And then I noticed a great pile of logs off in a corner of the stage over at the end of the wall. They looked like railroad ties piled up beside a track. Silently The Daughter of Heaven approached them. I saw her torch ignite, suddenly bursting into flame. I saw her thrust it deftly among the logs, lighting them all with swift precision. And then she tossed the torch into the middle of the pyre and escaping by a secret passage that ran under the city, left the

scene. So much for the little woman in the armor of gold,

Now a puff of grayish smoke issued from between the stacked logs. Then it thickened, more and more of it, darker and darker until it swirled and eddied in an ecstasy of destruction. Through it one caught a glow of red, faintly visible. Then the

glow brightened, spread and spread until it licked at the end of a huge block of wood and ran down it—fire, suddenly born now active and alive. Brighter and brighter it glared, encompassing all until the pyre had become a roaring car-



WHEN THE FORBIDDING RED LIGHT PLAYS OVER THE PAVILION AT NANKIN

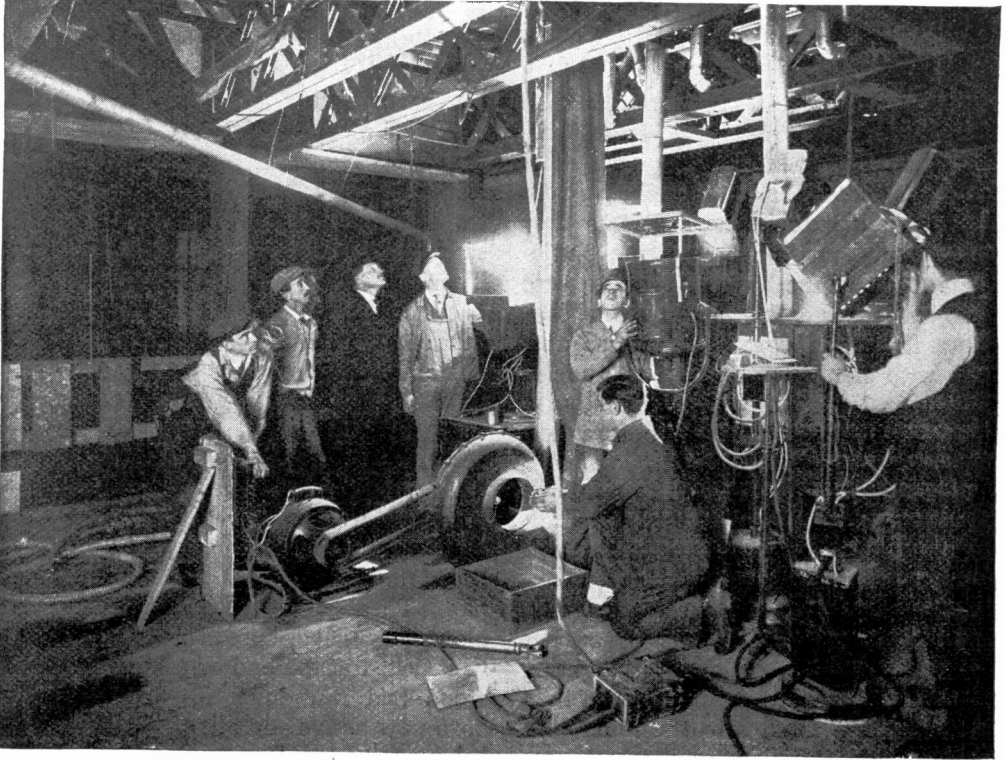

A PECULIAR GROUPING OF PIPES, REFLECTORS, FANS, MOTORS AND LIGHTS—THE "FIRE" MACHINE

nage, red with fire, gray with smoke. It hissed, it crackled, it moaned. And into the hell of it I saw the soldiers of Ming, one by one fling themselves upon the logs and lie still. The curtain fell.

It was to discover the illusion, to spoil the effect that the scene had for me that I went to the Century Theater the next afternoon. I was to see the big scene of *The Daughter of Heaven* from a viewpoint that would forever spoil for me the illusions of the theater. And so I invaded that magic land of behind the scenes, was conducted through many mysterious passages and finally found myself standing in a cellar sort of a room such as one finds in an empty warehouse. Just below a trap in the stage it was and as I passed through a little door I saw before me a peculiar grouping of pipes, reflectors, electric fans, motors and lights.

I learned that the peculiar machine

was most intricate. The pipes were for smoke. At the bottom of each was placed a chemical smoke pot that subsequently made grayish clouds issue from the pyre above. I saw a big circular piece of amber gelatine which when played upon by the powerful electric light would produce the color of fire. I saw thick silken brushes, imitations of feathers, orange colored, hanging like the plumes of some huge hat. I saw powerful bellows that driven by large electric motors would send the feathers swirling around, bright in the glare of the pyre—bellows that created the impression of whirling fire. And these motors made the smoke eddy too. Everything depended upon them. Even the gusts of confetti that thrown into the air, were caught in the breeze of six electric fans and made to whirl round and round like flying sparks—even they relied upon the big motors.



And that was the fire-colored light, whirling feathers and confetti, smoke pipes and pots, bellows, fans, a motor. And it came to me how surprisingly it all depended upon electricity.

My guide's name was Bierwald, "Bennie" they called him. I met him at the Tyler offices up in the Century Theater. As you may know it is the firm of George Tyler & Co., that produced *The Daughter of Heaven*; also *The Garden of Allah* which last year opened a new era in impressionistic staging. And Bierwald is their master electrician—an artist in lights, a painter who paints with candlepower instead of with a palette and brush.

I was fortunate in having him as my guide. He took a delight in explaining the illusions he had created. It seemed as if I were a little boy, and he, an old man grinning and saturnine, was saying over and over—

"There isn't any Santa Claus! There isn't any Santa Claus!"

It began before the first curtain had risen. The stage was set for a scene called "A Chinese Love Song." It had no bearing on the plot. It was just a picture that created a mood. I saw the soft landscape of a river dancing in moonlight of a glowing oriental sky rich in purple, of fireflies twinkling in the foliage of a wood. It was very vague, dim, indistinct; yet surprisingly beautiful.

That was because the picture was soft. There were no stiff wing pieces. The audience gazed upon it through a curtain of gauze and even the moonlit water was different. I was going to ask Bierwald about it, when there came from just behind me a low whirring, the subdued sound of machinery. I turned and saw a "Kinemacolor" apparatus. On the drop it was creating an actual picture of water in moonlight—a greenish, yellow flow that brought out the rare quality of the scene.

"I thought they always did moonlight and water by a stiff magic lantern sort of an arrangement," I said to Bierwald.

"I thought they just projected it from the wings."

"They do," he replied, "but not here. That kinemacolor stunt cost the producers an extra thousand dollars."

And that, too, was made possible by electricity. I saw the wires leading to the machine.

We hadn't walked two feet before my foot caught in something in the floor and I realized that not only was *The Daughter of Heaven* different but the Century itself was different from any theater I have ever seen. My foot had caught in an open space in the floor—a complete circle as I afterwards found. For the stage revolves and that was the slot. Underneath it are the great motors that turn it—turn it and the weight of all the heavy scenery in place above. And I saw that while the audience was gazing upon the moonlit water a swarm of scene shifters were transforming the other half of the stage into "The Council Room at Pekin." So massive is the production, so intricate the scenery, that only on a revolving stage could it be done full justice. Without the arrangement whereby one set can be put in place while the other is being played upon the delay between acts would be so long that the audience would become restless—maybe bored.

Three stories under the ground we followed a staircase and there saw the huge switchboards that control all the lights in the house, the huge motors and the engine room. Then when I felt as if I had been through some huge power plant Bierwald led me up an exceedingly narrow spiral staircase, told me to go ahead and hung back himself. The next moment I found myself in a queer little compartment, its ceiling so low that one had to stand half crouched. I saw a man seated before a little shelf on which were many electric switches. He smiled and whispered for me to look around over my shoulder. I did and was astonished to find myself gazing into the face of a big Chinaman!

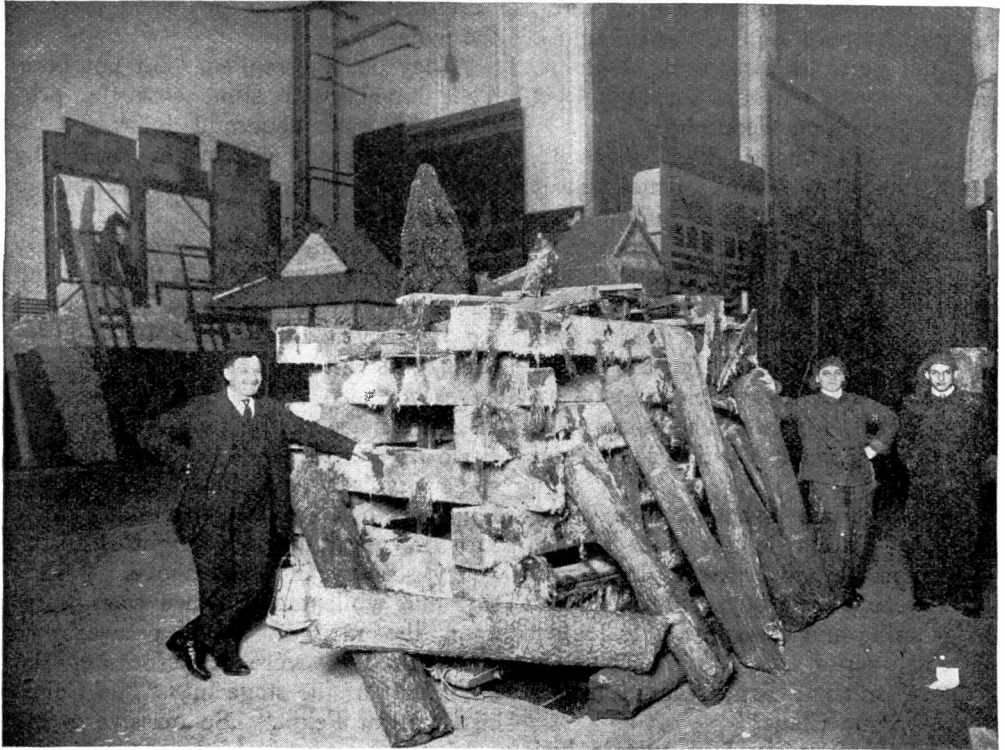

THE FUNERAL PYRE—STANDING BESIDE IT, IN THE FOREGROUND, IS BIERWALD, THE STAGE MAGICIAN

I was under the stage, in a little depression, just behind the footlights, in an open trap that was screened from the audience by the footlight reflectors. And here, I learned, sat the man who painted in the picture with the colors that Bierwald had devised. He was at the master switchboard from which every lighting effect is made. In every other theater this board is located in the wings. Here it is in midstage where its occupant can view his picture perfectly with no strained or inaccurate view so often caused by the angle of the wings.

By the time we got back to the wings the stage hands were finishing their work on the battlements of Nankin—the same as we first saw at the opening of this article. I saw the torch that the Empress had ignited. At the end was a cluster of tiny glass bulbs painted red. She had lighted them by pressing an electric button on the handle. Not even

the smallest of properties could escape this dominance of electricity.

Over at the left of the stage the director of the battle took his seat in the "prompt entrance." Near him swarmed the Chinese soldiers—real jabbering Chinamen obtained from New York's Chinatown and demanding four times the pay of the ordinary "supe." But having seen the battle from in front, from below, I asked Bierwald to take me behind the back drop—a black square lighted from the wings with a reddish glow.

Here we found a number of batteries strewn about. We saw men kneeling beside them ready to press the buttons that would send a flash of electricity up through the long vinelike black wires and explode the bombs. Held in glass faced boxes, these were fastened to the drop. Then Bierwald told me that the bombs were different from the ordinary.

He said they were placed in boxes, one side of which was ground glass. On the glass was painted the picture of a bomb bursting. Behind it were the magnesium bombs exploded by the electric wires. So was a very wonderful effect created, an actual explosion heard—a picture of what a real bomb looks like, revealed to the audience.

And when I began to wonder if some uncanny electrical forces were not pushing in the battlements and tumbling their *papier maché* blocks on the stage, Bierwald overwhelmed me by explaining the last scene of the play.

It is the throne room at Pekin. The Daughter of Heaven, slowly dying from the poison she had taken, is sitting on the throne of the hated Manchus. The Emperor—the lover from whom tradition had parted her—is waiting below with his nobles. At the sight of her dead, the emperor lights the great jars filled with incense and burns a funeral farewell. Instantly the electric blower gets busy under the stage and forcing a cloud of perfumed smoke through a pipe empties it out into the jar and sends it drifting lazily into the air. And the curtain falls with the Tsin emperor and his nobles prostrating themselves before the pale and still Empress of the Mings.

As it has begun so has the drama ended with its significant effect, electrical.

Afterwards Bierwald took me up into his workshop and told me the secret.

"Our whole system of stage lighting," he said, "is new. It is new because it is impressionistic and creates moods. It is the method we began with the 'Garden of Allah' and which we are carrying out here on a larger scale. We colored scenes for instance, harsh red, a color that may not be in Nature. We did it so the audience would feel the sense of disaster.

"We colored a moonlight scene with a strange greenish tone just to produce in the minds of the audience the spirit of the play. We use a peculiar purple in the last act to give intense emotion, grief. We do this to 'get over' the spirit of the

play. It may not be true to Nature but we contend that to create moods, to hold people's minds by the psychology of color, by their skillful variations is a vastly bigger, more important and more intelligent thing than to set a stage with real doors, real Turkish rugs, real lamps, and all the other clutter of the school they call realistic!"

---

### White and Black Coal

The French call the power derived from waterfalls *houille blanche*—"white coal;" and a singular combination of the power derived from white and black coal has been effected at Etupes, in eastern France. At that point electric conductors coming from the coal mines of Ronchamp, eighteen miles north of Etupes, meet similar conductors coming from the waterfalls of Le Refrain, 24 miles south of Etupes. The current derived from the mines is of 30,000 volts, and that from the waterfalls of from 30,000 to 50,000 volts. At Etupes the power is combined in a large plant, provided with transformers and distributors and sent out to run shops, light lamps and so forth. It is estimated that ultimately this alliance of white and black coal will furnish 50,000 horsepower.

---

### Rathenau Medal

Dr. Emil Ratheneau, a lifelong friend of Mr. Edison and head of the Allgemeine Elektrizitäts Gesellschaft (General Electric Company of Germany), has placed a medal in the hands of the American Museum of Safety, New York, to be given each year for the best device for safeguarding life in the electrical industry. The medal, which goes this year to Mr. Edison, bears upon one side a picture of Dr. Ratheneau and the words "Emil Ratheneau, 70 years old, Dec. 11, 1908," in commemoration of which the medal was founded. The other side bears four German words meaning "for merit and fidelity."

## “Eating Electricity”

An Interview with Prof. Bergonie, Discoverer of the Worth of High Frequency Current as a Body Builder

By FRANK L. HALSEY

When my chief in London cabled me, his Paris correspondent, “See Prof. Bergonie, Bordeaux, eats electricity,” I was, to say the least, a trifle startled. A man who eats electricity, indeed! Was he then some son of Jove who for the mere pleasure of it nibbled at his father’s thunderbolts—lunched off the lightning? My vision conjured up a man of great build, of god-like stature as the ancients imagined it, while the train bore me on toward the town that held the marvelous personage. Bordeaux is a far cry from Mount Olympus and so when set down in its streets, I felt that perhaps after all it was no semi-immortal whom I was to visit, but a scientist.

Such a man did I actually find Prof. Bergonie, seated in his office-laboratory, somewhat taciturn but keen as one of his own electric sparks. There was nothing of the immortal about him; he was a man of average size and with no particularly distinguishing feature, a man whom you would pass on the street without a thought of what was stirring behind the rather broad and high forehead. Is this the man who derives nourishment from the lightning, I asked myself. I set about to learn how, and why.

Prof. Bergonie was courteous. “You are a journalist, Mr. Halsey? Ah yes. And you want to know how I ‘eat electricity’? That is rather obscure; it does not at all convey the purpose of my recent discovery. That purpose is to supply the body with a great quantity of heat without overtaxing the digestive organs which Nature designed to serve that function. In the first excitement of the newspaper world when I made known my method of supplying this heat, it was stated—you will pardon me—with not unusual exaggeration that I had discovered how to do

away with food entirely, furnishing by means of electricity all the nutritive benefits derived from animal and vegetable matter. That is simple nonsense. Following that line of thought—their own, mind you, not mine—the journalists made me say that an electric current of 1,000 volts is equal in food value to a porterhouse steak. Think what my confrères in the Academy of Science must have thought of me to see that statement apparently emanating from me.”

The professor broke off his narrative to rise and pace about in some excitement; finally he halted before my chair.

“What I told the Academy” he resumed, “was that diathermy, the method of applying a current of low tension and high frequency as discovered by Prof. D’Arsonval could be made to partly supplant food, by supplying the body with a great quantity of heat. The daily food of a normal person furnishes about 3,000 calories, the calorie being the unit of heat. By applying D’Arsonval’s current with an intensity of from two to three amperes and at a voltage of from 1,000 to 2,000 about 1,000 calories an hour can be supplied.

“The current traverses the body without provoking the least pain. Imagine what that will mean to those whose digestive organs are out of order and who still are in need of their daily heat supply. A man cannot force his stomach and the supplementary digestive tracts beyond a certain point. If for any reason those organs are incapable of furnishing the necessary amount of calories, he loses weight and his case is diagnosed as one of malnutrition. He may be drugged into some semblance of a normal condition but the action of the medicines is quite as likely to merely shift the seat of his

trouble. That is where the electrical applications solve the problem."

"But, Professor," I interjected, "can you give me a proof, a concrete example of the good to be derived from your method?"

"Most certainly I can. At first I had experimented with the applications upon myself, but being in a normal condition at the time I could not be positive of any good that accrued to me from them. Possibly I felt improved to some slight extent but I could have laid it as well to atmospheric exhilaration as to the electricity. Therefore I sought among my medical friends for word of a patient who would be willing to gain possible relief and no harm from the experiments. I was fortunate. A man living here in Bordeaux had sought aid from a physician. He was of average height but when stripped was thin almost to the point of emaciation. What was more he continued to lose weight and naturally was in a weakened condition. He declared that his appetite was good and that he ate large quantities of meat but he always felt very cold. When sent to me he had scarcely strength enough to walk.

"Here was the very subject I desired. I began the applications at once. Each one lasted 40 minutes, during which time the patient absorbed 1,700 calories. You will understand that this was an extreme case and therefore called for a lower amperage and higher voltage than I would usually recommend. At the end of the series of treatments I was rejoiced to see that the patient's weight had increased considerably and that he had far more energy. Moreover, he was eating far less than when he came to me. Is not that a proof that to a large extent electricity can replace food."

Prof. Bergonie smiled.

"I am not trying to urge the elimination of all food and the replacing of soup, meat and vegetables by a purée of amperes and a filet of volts," he declared. "for in that case I would be flying for my life before a horde of enraged

market men. It is an impossible thought that electricity can ever fulfill all the functions of food but I will say this in all seriousness: the time is not very far distant, in fact we will both probably live to see it, when all troubles arising from insufficient food, the disorders of metabolism, will disappear before a reasonable application of the high frequency current."

I left Prof. Bergonie with the pleasant impression of a man who knows he is on the right track toward being of help to humanity and rejoices that he can ease the ailments of troubled humanity. In view of his ideas, though, could I resist the thought that his background of working tables with battery jars and generators on them might be a prophecy of the dining tables of the future?

---

### Canadian Farmers use Niagara Power

The farmers in the central sections of Ontario, Canada, have joined hands with the Hydro-Electric Power Commission to solve their rural difficulties in a rough but effective way. In one county the commission has commenced the construction of a trunk line, but the farmers will build the branches under expert supervision. The swamps will yield the poles and the farmers will haul them out and do the digging and erection. Upon such a coöperative contract the rural communities have entered with eagerness and some of the farms will be equipped with electrical power by the beginning of next summer.

An instance of how the propaganda has taken hold is the extension of a dairy farm near Beaverton to accommodate 210 cows, all of which will be milked by electricity. The owner milks 75 by that method at present and his neighbors are preparing to discard the old hired man arrangement as quickly as the government can bring them the condensed energy of Niagara Falls.

The Hydro-Electric Commission of

Ontario was organized on application of a hundred or more municipalities and financed with public money. The commission undertakes the construction of all transmission lines throughout the province, while the municipalities are responsible for construction and distribution within their own borders; in other words the commission is the wholesaler and the towns and cities the retailers. Recent legislation has placed in the hands of the commission almost autocratic powers of control over the municipalities, such as their rates of charge, the standardizing of equipment, the disposal of surplus profits and other points whereby the efficiency of the commission shall not be jeopardized by carelessness or incompetence of local bodies.

### Microradiographs

M. Pierre Goby's new X-ray method is likely to work a revolution in microscopic work, as this is the first time that the rays have been applied so as to show up the internal structure of minute specimens, although we are familiar with the

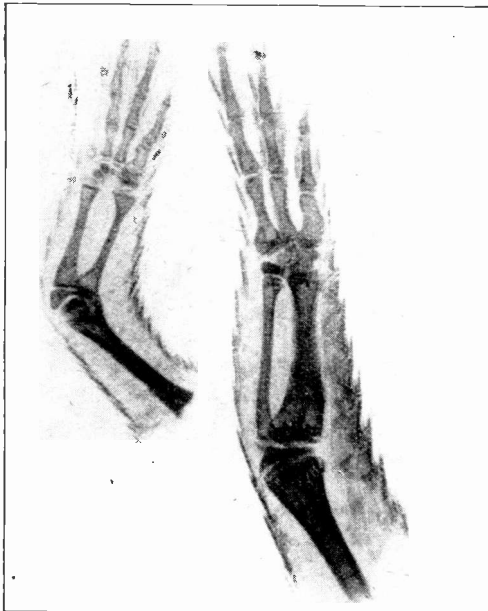

FROM A MICRORADIOGRAPH OF THE FORE AND REAR MEMBERS OF A SMALL LIZARD

results which are obtained with ordinary sized objects. He uses a special electric apparatus for producing the X-rays, and combines this with microscope devices in such a way that the rays show the otherwise invisible parts within the minute objects. It would be difficult and in the ma-

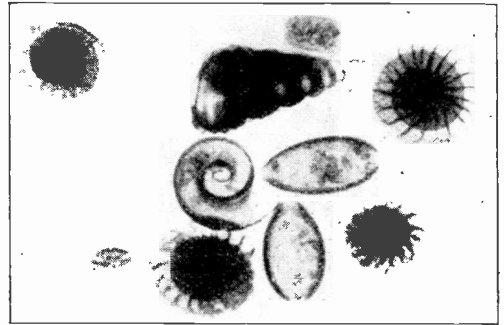

A PINCH OF SAND FROM THE SEASHORE CONTAINS MINUTE SHELLS. A MICRORADIOGRAPH SHOWS THE REMAINS OF LIVING ANIMALS

majority of cases impossible to see the structure in any other way.

As an example, take a pinch of fine sand from the seashore. Putting it under the microscope we often find that it is made up of very minute shells which could not be detected by the eye. But M. Goby's apparatus now allows us to go farther and see the inside structure of the shells or other remains of living animals and he even discovers new species in this way where naturalists could not detect any difference from a simple outside examination of the specimens. The structure of the objects often reveals a regular design which is very attractive.

Not only can the X-rays be used with microscopic specimens, but even small animal specimens can be examined by magnifying them, say up to 20 diameters. For instance, we illustrate some of the parts of a very small lizard from the south of France, and it would be hard to observe these by the ordinary X-ray method. Now the parts, such as the minute bones and other details, are very distinct. The inventor is working on his apparatus at Grasse, France, and promises a more complete description later.



*Courtesy of The Illustrated London News*

## THE REVEALING RAY

This picture from a sketch by a newspaper correspondent with the Turkish Army, vividly portrays victorious Turkish infantry, preceded by the revealing ray of a powerful searchlight, entering the village of Papas Burgas at midnight, on Nov. 17 of last year just as the Bulgarian forces were withdrawing. After the day's battle had silenced the Bulgarian batteries, the Turks secretly placed a searchlight on a hill overlooking the town and at midnight as it flashed down upon the startled village the ghostly, unheard-of scene here depicted took place.



THE FAMOUS AERIAL ELECTRIC CABLEWAY IN THE TYROL IN WHICH  
SIXTEEN PEOPLE MAY RIDE AT ONCE FROM ONE STATION TO ANOTHER  
2700 FEET HIGHER UP



# How the Swiss Exploit Their Scenery

By FRANK C. PERKINS

It is said that many of the Swiss people who love their mountains and enjoy the beauty and grandeur of the Alpine scenery regard with disfavor the commercialization of these things as exemplified by the scaling of mountains by trolley cars, building mountain hotels and stretching great lines of aerial cableway among the giant precipices. They cannot be blamed for taking this view of the matter, but at the same time they should remember that these modern facilities for travel—brought about very largely by electric power from the glacier fed lakes—enable tens of thousands of people to view the wonders of the Alps who could not do so if it were only possible with the aid of Alpinestock and hobnailed shoes.

After all it is the tumbled peaks, the stupendous distances, the great, silent masses of ice in glittering splendor lying so peacefully miles and miles away up in the air that grip one. A hotel or two, a few hundred yards of track or even a grotesque, cable-slung car in the foreground is of small consequence. It is a simple matter to change one's point of view a little to cut out of sight these man made contrivances and then again gaze at crag piled upon crag, as elemental in their grandeur as the day they were tossed up from the level.

Frequently in the past these pages have contained descriptions and illustrations of the great work which is being done in "electrifying the Alps." But the story is one which does not grow stale so long as pictures of these regions can be presented. To picture the Matterhorn, the Jungfrau or the great Grindelwald glacier hardly needs excuse though they have been seen and studied many times before. And it is pleasurable at the same time to look forward to the day when either the government or private enterprise shall make our own Rockies, per-

haps as splendid in every way, just as accessible as the Swiss Alps. It is scarcely fitting that to tread great glaciers and be inspired by snow capped peaks so many of the people of this country should first go through a period of seasickness to view other people's scenery.

One way the Swiss have of making mountain climbing easy and attractive to visitors is shown on the opposite page. This is a famous aerial electric cableway in the Tyrol. Sixteen people may ride in the car at one time. From the lower station you are drawn up by a hauling cable, winding over huge drums driven by motors, and step out at the other station over 2,700 feet higher up. And all through the journey you view the most entrancing scenes at the same time that you are thus easily overcoming the most difficult bit of mountain climbing in the region, if you were to attempt it afoot.

Over on the next page (No. 3) is a more distant view of a similar cableway, at a point on the Wetterhorn on the way up to the Grindelwald glacier. The little station to which the car is ascending is known as the Station Enge. But the highest cableway in all Switzerland provides tourists with easy access to the top of the Vigiljoch. The difference in level between the two stations is 3,800 feet and the total length along the incline considerably over a mile.

The famous Jungfrau, a favorite with tourists, is now much more accessible, by means of the electric railway which winds gradually up to the Station Eisiner 10,273 feet above sea level. View No. 1 shows a section of this interesting railway.

The Zermatt-Gornergratt mountain railway carries passengers a long way up the lonely Matterhorn. View No. 2 shows one of the rustic stations erected at intervals along this line. So artistic is its conception and so in harmony with its surroundings that one cannot believe

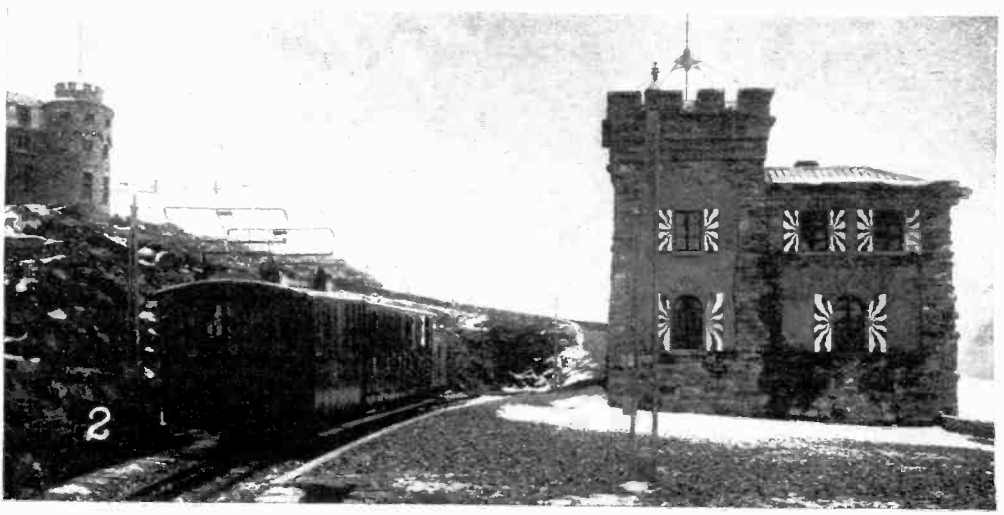

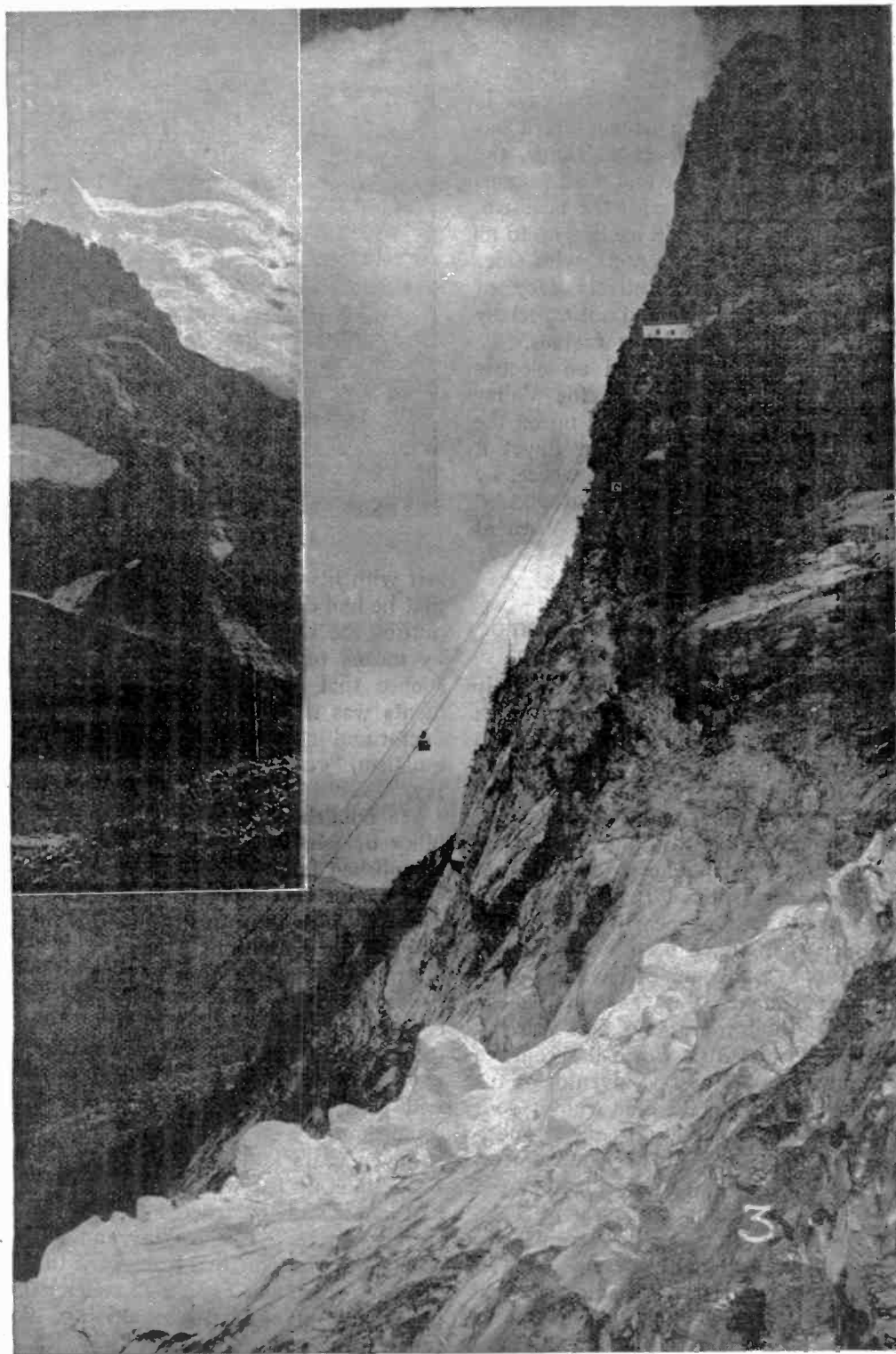

seriously that it is any great blot upon the natural scenery.

With the development of electric cable, rack and pinion and aerial railways in Switzerland, attention of engineers has been directed towards Mont Blanc, the highest peak in Europe and most famous in the Alpine ranges, with the beautiful valley of the Chamounix leading up to its base. On both French and Swiss sides Mont Blanc is comparatively easy of ascent toward the base and not especially abrupt even in the higher regions.

There has been installed an electric rack and pinion road from the Valley of Fayet and Chamounix well up on the side of the mountain. From Fayet it ascends to St. Gervais, from where, by an incline road on a grade of sixteen degrees, it reaches the Col de Vova at an altitude of 5,500 feet.

### Charles Bourseul—French Inventor of the Telephone

*Le Petit Journal* of Paris recently commented upon the death of a French inventor, Charles Bourseul, who died in comparative obscurity, yet who had more title to national recognition by the French people than many recipients of the Legion of Honor. Bourseul was the inventor of a telephone antedating that of Alexander Graham Bell.

As in the case of nearly all great inventions there have been a number of claimants to the honor of having invented the telephone. But, as with Edison and the incandescent lamp, and Marconi and the wireless, the world has come to recognize in Bell the real inventor of the telephone, for he is the man who made it a practicable possibility. Still it is interesting to read of this French claimant.

It was in 1854 that Bourseul, employed in the department of Posts and Telegraphs, asked the French government to take and use his discovery. His superiors did not understand it, and regarded him as crack brained, a man who fooled away his time instead of occupying him-

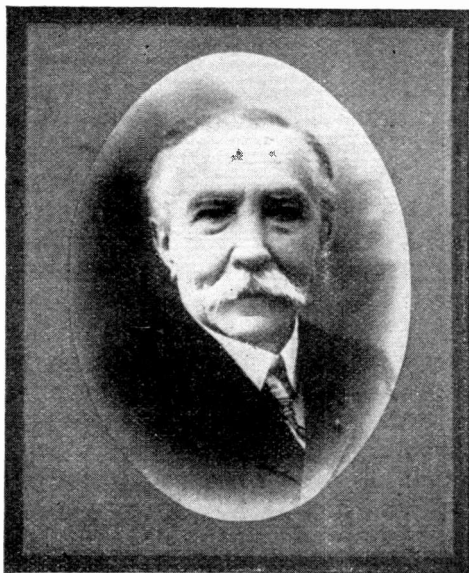

CHARLES BOURSEUL

self with his work. He told the officials that he had discovered a means of transmitting the human voice a long distance by means of electricity. The only response that he obtained to his statements was that he had better consult a doctor and in an equivalent French colloquialism, "get rid of the bats in his belfry."

He published his belief in the possibility of what has now become an accomplished fact in the following words:

"Imagine that a person speaks near to a plate which is of such flexibility that none of the vibrations of the voice are lost; imagine also that this plate establishes and interrupts successively the communication with a voltaic pile; under these circumstances it will be possible to have at a distance another plate which will make the same vibrations at the same time."

Seven years later, in 1851, a German, Reiss, took up the work where Bourseul had left it and constructed the first telephone. In 1876 Elisha Gray and Prof. Alexander Graham Bell brought it to its present perfection, Prof. Bell, after long litigation winning final recognition as the practical inventor.

### Washing Cars by Electric Power

A convenient method of washing the sides of electric box cars is in use in the Seattle, Wash., Electric Railway Company's shops. As shown in the accompanying drawing, the washing apparatus consists of a vertical cylindrical brush piped with water from the shop mains, and driven by a small electric motor mounted on two cross timbers at the top. A car is washed by running it upon a track at the side of the revolving brush, the brush being swung against the windows and panels while a stream of water passes through the space between the bristles. The largest semi-convertible car can be washed in this way in a few moments, and the company obtains a decided saving in labor compared with the old method of hand washing with pole type brushes.

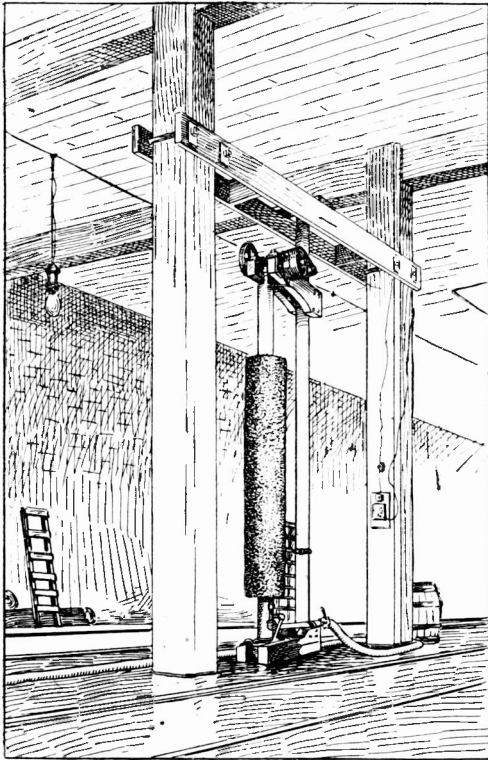

MACHINE FOR SCRUBBING CAR SIDES AND WINDOWS

### Electric Motors in Track Switching

Electricity is rapidly gaining ground in the latest railroad work in connection with the movement of track switches. It

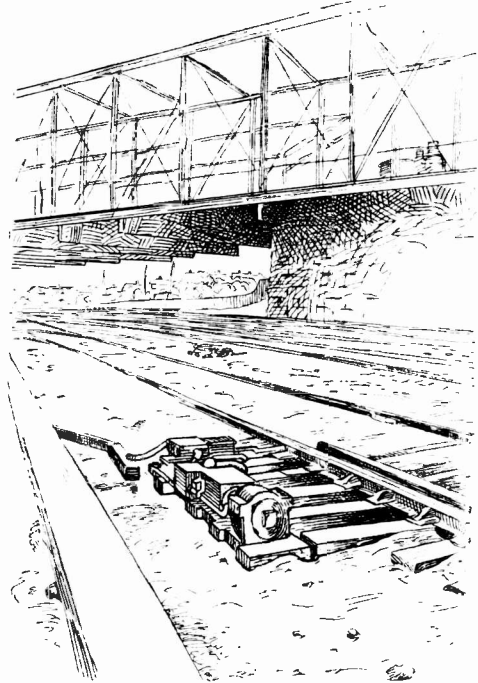

MOTOR OPERATED TRACK SWITCH

is free from the troubles encountered in forcing compressed air through hundreds of yards of pipe. In cold weather especially, electricity saves time at points of congested traffic.

In a typical installation on the Boston & Albany Railroad at Allston, Mass., shown in the accompanying illustration, the motors are located with the switch operating mechanism in the depressed space between tracks and are supplied with electric current from the local central station service. The apparatus works well in the snowy weather of a New England winter. The operator in the switch tower simply pushes the button or pulls a small lever; this starts the motor, which may be made to run in either direction, and the latter opens or closes the switch as the case may be.

## Underground Transportation for Parcel Post

The establishment of the Parcel Post in the United States creates many new problems for the post office department to solve. One of the most important of these is that of transporting this bulky mail in the large cities between the main post offices and railroad depots. The rational solution of this problem as worked out by practical post office officials is to connect the more important post offices and depots by tunnels and to thus transport this volume of mail underground.

A system designed to solve this prob-

lem is now being demonstrated in Cambridge, near Massachusetts Ave. and the Charles River, and in the rear of Riverbank Court. This system has been installed by the American Pneumatic Service Company. This Cambridge demonstration plant greatly resembles a small scenic railroad; not so small at that, since it is approximately 1,500 feet long. This resemblance is due to trestle work which has been installed in order to provide on this flat river front grades and curves such as would be necessary in actual construction beneath the streets. On this trestle work, and running along the ground from it, is a continuous row of cast iron hoops, which in turn are connected by rails. A complete circuit, resembling a hollow square with round corners is formed by this construction, except that in one corner cast iron pipe, such as would be used in the street, cover up these hoops. The line starts and ends in a long building which contains the power plant, starting and stopping mechanisms, testing instruments, etc.

This plant can perhaps best be described as representing a tunnel 1,500 feet long and 30 inches in diameter, through which pass automatic electric trolley cars and trains that require no attendants while passing beneath the surface of the street and which on reaching their

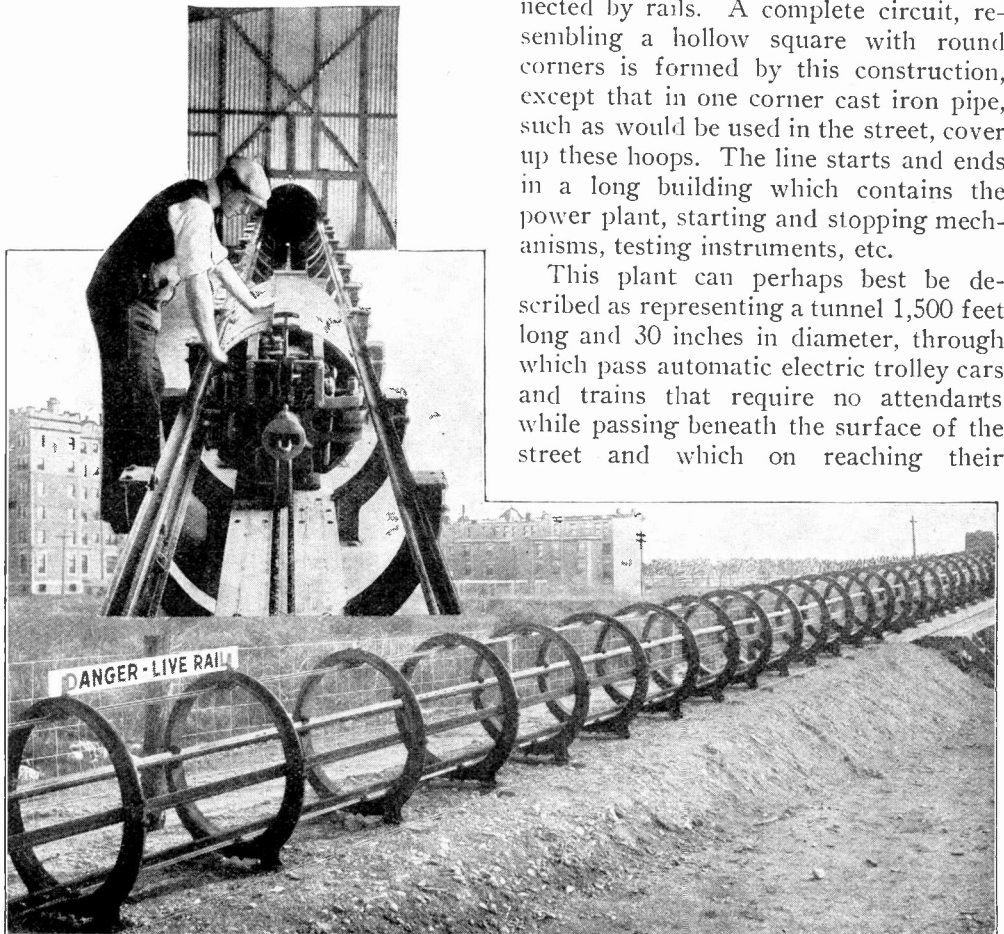

SECTION OF THE TUBE FRAME OF THE ELECTRIC MAIL CARRIER. ABOVE, THE OPERATOR IS ABOUT TO START A CAR BY PULLING THE CONTACTOR AGAINST THE LIVE RAIL

*Copyright Boston Photo News Co.*

proper station automatically come to a stop. The diameter of this tunnel, 30 inches, is just the height of an ordinary table. A workman could, if necessary, to make repairs, crawl into such a tunnel. The system can, however, be of any diameter. It is designed in particular to cover the field up to a size tunnel in which it would be possible to have motormen on the trolley cars.

The first striking point about the system is that it is automatic, for after the trolley car is once started it needs no further attention either to keep it going or to stop it at its proper station. The second point that immediately impresses you is that this is a mono-rail system; in other words, the trolley car runs on a single rail instead of on two as is the case with most railroads. In addition to this single rail, there is a guide rail on each side of the tunnel to keep the trolley car from tipping over, and a trolley rail on top which acts as a trolley wire and brings the electric power to the car.

The proposed method of building this tunnel is also interesting, as well as most simple. It is expected, with the 30 inches diameter tunnel at least, that in most instances it will consist of ordinary 30 inch cast iron water pipe laid in an open trench. Inside this pipe will be fastened the rails upon which the cars and trains will travel. It is believed that this form of construction will prove very simple and in addition will give a strong and permanent tunnel. Ordinarily two such pipes would be laid in order to give service in both directions as on a double track railroad.

The trolley car is a very substantial looking vehicle. It is about seven feet long and its inside, which is protected by a cover, would easily take in a small man or a boy. It is designed to carry four pouches of mail. The car is shaped something like a torpedo and has bumpers at each end. The motor is outside, although the gears running from it to the driving wheels are enclosed. The car has a sliding trolley contactor. The car also

has a reversing switch which permits it to be sent in either direction and a mechanism for moving the car under its own power, but at very slow speed while it is in stations or on sidings.

The motor is of a special design and is the most important part of the car. It is so wound that it has practically a constant speed at all loads and when going up and down grades. This characteristic is, of course, necessary to prevent cars overtaking each other while in the tunnel. The motor is started by a switch which automatically releases itself when the car reaches a certain speed.

Stopping the car by itself, and without the aid of an attendant, is a very simple process. It is similar to that used on the roller coasters seen at amusement resorts. At the end of the line and perhaps for 30 or 40 feet wooden skids are placed just above the mono-rail. There are also wooden skids on the bottom of the car. The car comes into the station, the current is lead off the trolley bar at a certain point and the car strikes the skids and gradually and easily comes to rest.

---

### The Electricity of Drops of Water

When a liquid jet divides itself into drops in the air, it is known that these drops are charged positively, the air being charged negatively. This effect has been used by Lord Kelvin as a means of creating electrical charges; it is utilized also for measuring atmospheric electricity.

Dr. von Bernalak, of the University of Heidelberg, in an article in *Annalen der Physik*, gives us opinion that this production of electrical charges is intimately connected with the formation of drops infinitely small which accompany the principal drops. He establishes the fact that if the number of these secondary drops is increased so as to produce rapidly the large primary drops at the outlet of a tube which has its lower end enlarged, the total amount of the charge is considerably augmented.

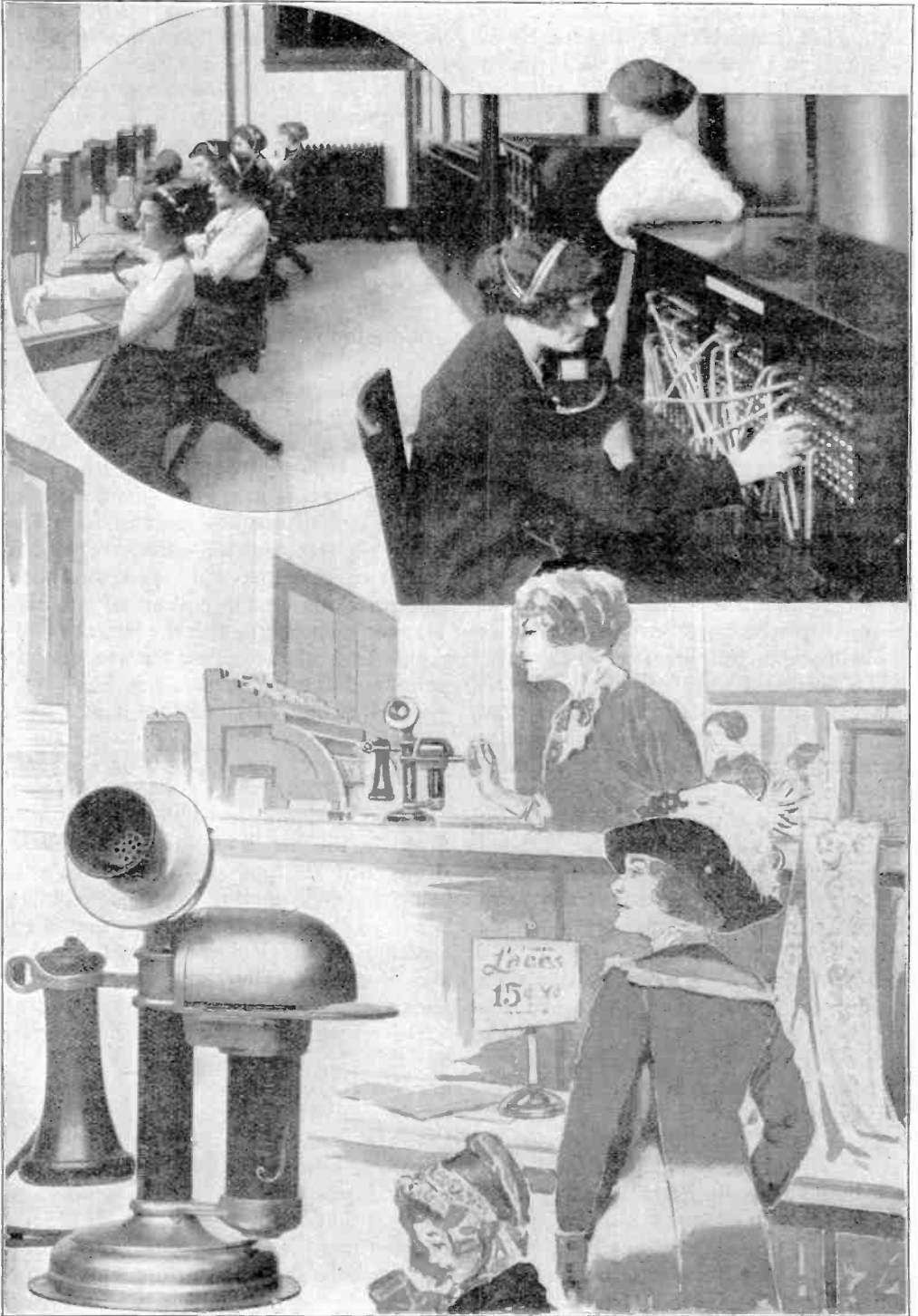

THE TELEPHONE CREDIT CHECK SYSTEM IN OPERATION



### A Telephone Credit Check System

In large department stores where goods are sold on credit, a system is necessary for checking the credit standing of customers at the time of the purchase. A system for this purpose was recently installed in the new Rothschild department store, Chicago. The two requisites, speed and accuracy, are attained by means of telephones placed at wrapping desks throughout the store. These telephones are fitted with a special electrical stamp controlled by a separate circuit which permits an o. k. from the credit office being printed on the inserted sales slip. In the credit department is located a switchboard controlled by an operator who switches the calls received to the girl handling the particular section of the alphabet in which a customer's name is located. The credit files in the form of card indexes are conveniently located in front of each girl and to each is assigned one of the six divisions. For example, girl No. 1 has charge of all calls from A to D, etc.

phone standard, calls for authorization clerk No. 5, hangs up her receiver and resumes her duties.

In the credit room the operator switches the call to clerk No. 5 and a lamp is lighted in the board at her desk, which indicates that a credit is ready to be passed upon. The lamp remains lighted until the call is answered. Clerk No. 5 then calls the inspector, who gives the name and address of the customer and the amount of sale. The inspector then hangs up the receiver. Referring to her cards, clerk No. 5 ascertains the customer's credit standing and if found satisfactory presses a key which prints an o. k. on the sales slip which was inserted in the instrument down at the sales counter. If there is a question about charge, the customer is asked to call at the office of the credit manager, where it can be properly adjusted.

### Street Lights Along the Curb

A plan to aid in finding house numbers at night and at the same time to illuminate the street by throwing the light from the curb directly over the surface of the roadway is here illustrated.

Within a metal hood open upon the side towards the street is an incandescent lamp. The hood is secured to the cement curbing by bolts embedded in it. The interior of the hood is lined with a reflecting material and upon the base of the hood facing the street is a beveled edge for the street number. The hood is arranged so that the lamp is locked



CURB STREET LIGHTS AND HOUSE NUMBERS

If a customer, S, desires to have a purchase charged to her account, the cashier-inspector at the station where the goods are bought inserts a sales slip under the little hood attached to the tele-

in. The lights may be replaced in a staggered position as shown affording a light free from shadows at the street surface. The idea is patented by Thomas S. Brown, Hemet, Cal.

### In Recognition of Faithful Friends

The homeless cat, the stray dog and the injured horse have received a recognition of their devotion to humanity in the opening of a hospital for them at East Twenty-fourth Street and Avenue A, New York City.

The hospital, which is a three story building, was built by the Society for Prevention of Cruelty to Animals, is provided with everything necessary to care for its patients, including even a roof garden for their exercise, and affords an example of the modern applications of electricity.

According to the *Edison Monthly*,<sup>6</sup> a sick or injured horse is brought to the hospital in a specially built ambulance. An electric elevator conveys ambulance and horse to an upper floor where an electric one-ton hoist upon an electric trolley lifts the animal clear of the floor if need be and conveys it to the operating room. A \$1,200 operating table with ad-



CONVALESCING UNDER THE ELECTRIC BLANKET

justing mechanism enables the surgeon to place the horse in any desired position. This room is lighted by 44 electric lights and contains operating tables for handling dogs and cats.

Cats and dogs are kept each in neat clean cages properly lighted by electricity and even provided with electric warming pads where needed. A place is also arranged in which to keep dogs suspected of rabies.

In the horse ward are box stalls, all lighted by electricity, and also a "threshing stall" with sixteen inches of peat moss on the concrete floor where a horse suffering from colic may be confined.

As in hospitals for human beings, there is a contagious ward, with electric lights shaded to protect the eyes of the dumb patients from the effects of the glare.

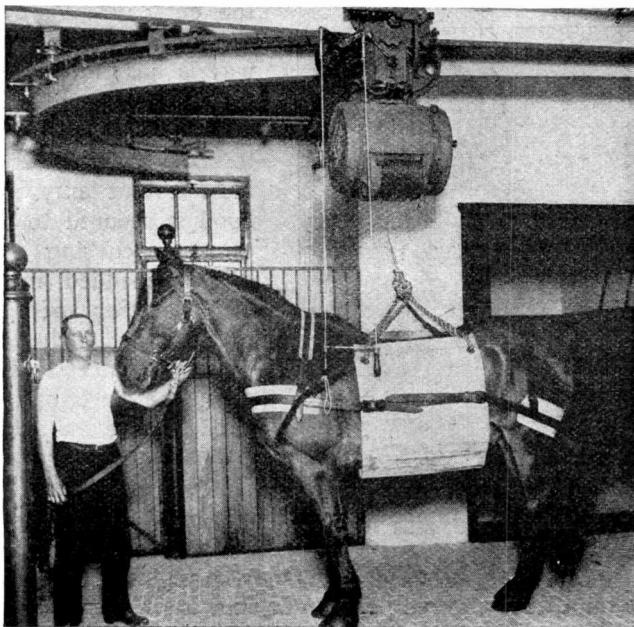

FROM ELEVATOR TO OPERATING ROOM BY TROLLEY

## Piecing Out Daylight to Hasten Plant Growth

Experiments have been made at the Cornell (N. Y.) Experimental Station, at the West Virginia Station and by W. W. Rawson, a well known vegetable grower of Boston, to determine whether electric light, either arc or incandescent, can be

flaming arcs can be seen in the daylight picture.

Regarding results Mr. F. E. Mojonier of the company says, "The daylight picture shows in the foreground a bed of lettuce transplanted a week before this picture was taken. The night picture shows the same bed of lettuce taken from almost the same spot sixteen days after

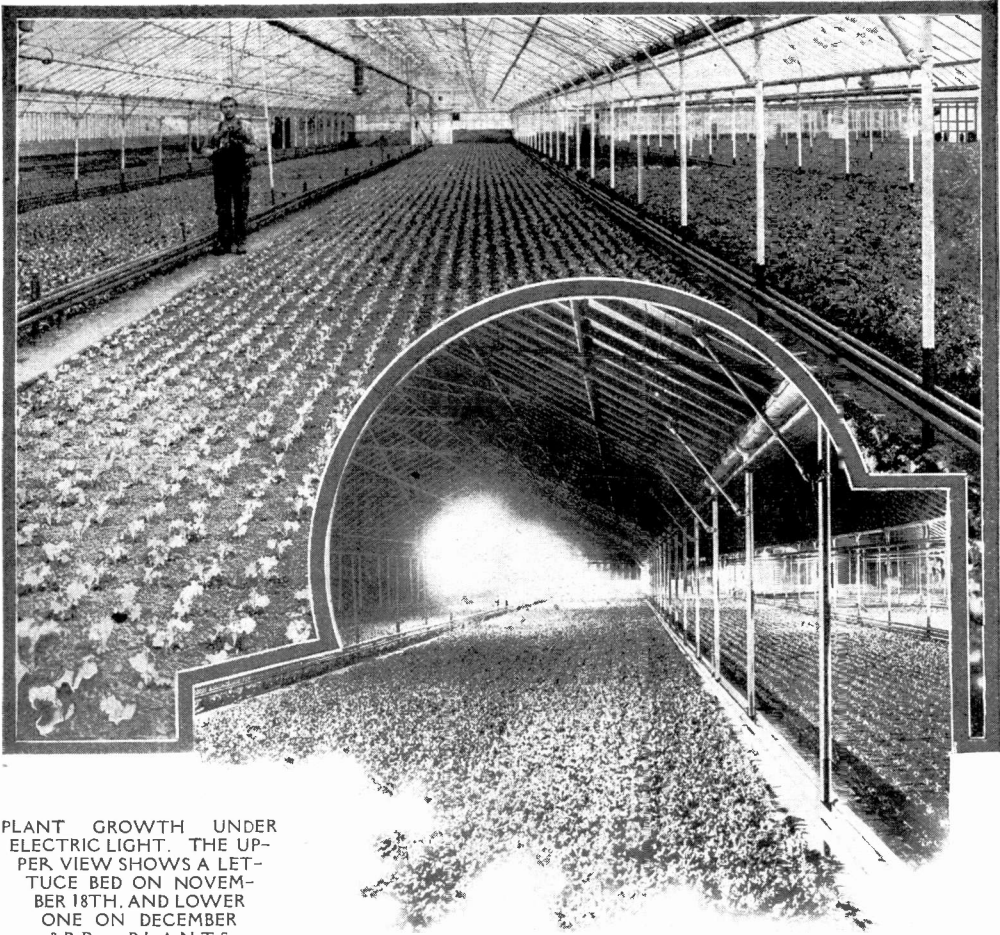

PLANT GROWTH UNDER ELECTRIC LIGHT. THE UPPER VIEW SHOWS A LETTUCE BED ON NOVEMBER 18TH, AND LOWER ONE ON DECEMBER 3RD. PLANTS GROW DAY AND NIGHT

advantageously used upon lettuce to piece out the sunlight in midwinter, and the accompanying pictures show the interior of the Walla Walla Hothouse Vegetable Company, Walla Walla, Wash., where excellent results are also being attained. A partial view of six

the first picture. During this period the lights were turned on continuously at night and the great growth secured must be attributed to the effect of the light, as from my experience it is impossible to make such a growth in winter in that time when the days are short and often

dark, without the aid of the lights. We also installed," says Mr. Mojonner, "sixteen 500 candlepower Mazda lamps in another part of the houses to test the relative merit of the two systems. While lettuce grows rapidly under the influence of the Mazda lamps it is inclined to be more spindling and light weight than that grown under the flaming arcs. We account in part for this by the considerable quantity of carbonic gas thrown from the arcs which is absent in the Mazda installation. This gas is a food for vegetation and is promptly taken up."

Referring to the other experiments, Mr. Rawson saves a week upon each of his three winter crops by the use of three ordinary street arc lamps hung over a house 370 by 33 feet. At Cornell the effects upon lettuce have been marked in all tests and the gains in maturity have been as much as two weeks.

### Revealing Power of Light

It has been pointed out that not only the direction and intensity of light, but its color, must be considered in estimating its power to reveal fine details. Experiment shows that most persons are shortsighted for blue and violet light. When patterns are illuminated alternately with red, green and blue light, it is found that for ease of seeing minute details, blue and green light are preferable to green for short distances, but that at greater distances red light gives the best results.

### Searchlight Attachment for Pistol

A lighting attachment for a pistol, consisting of a battery, electric lamp and a push button for controlling the light, has been patented by Clifford A. Lewis of Portland, Oregon.

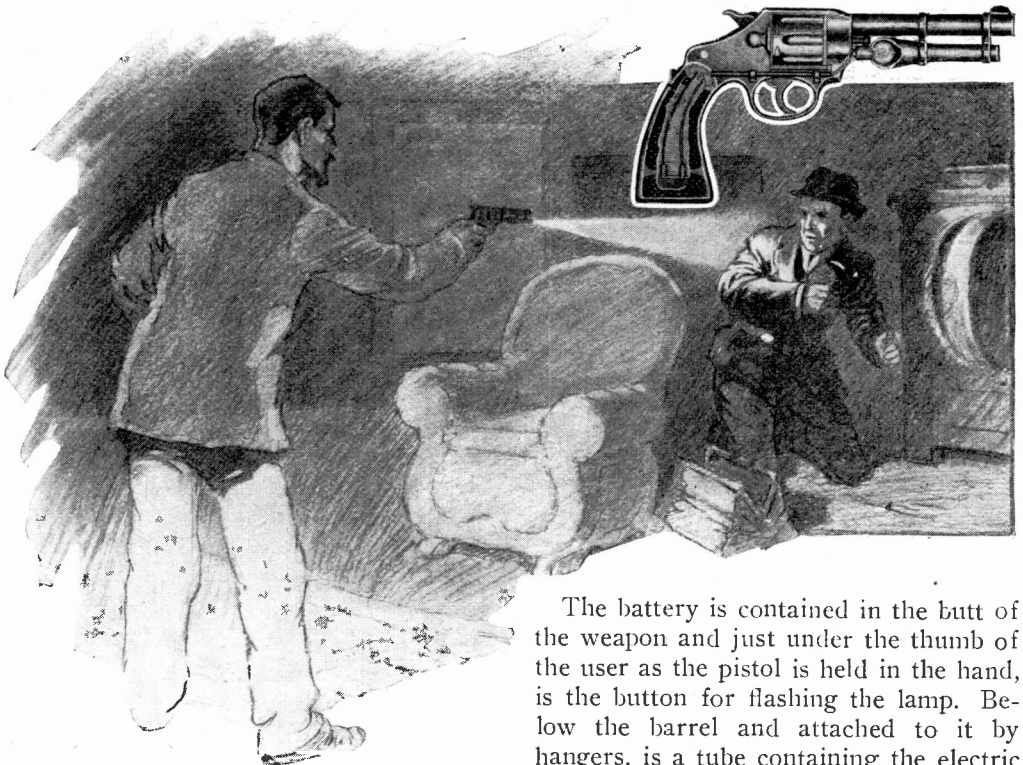

THE PISTOL SEARCHLIGHT AND ITS EVIDENT ADVANTAGE

The battery is contained in the butt of the weapon and just under the thumb of the user as the pistol is held in the hand, is the button for flashing the lamp. Below the barrel and attached to it by hangers, is a tube containing the electric lamp and a lens for directing the rays of light.

## The Tree of Light

With a tree and a carol, the Christmas spirit was revived in New York, and thousands of dwellers in that busy city where sentiment is supposed to lie dormant paused in their hustle and bustle

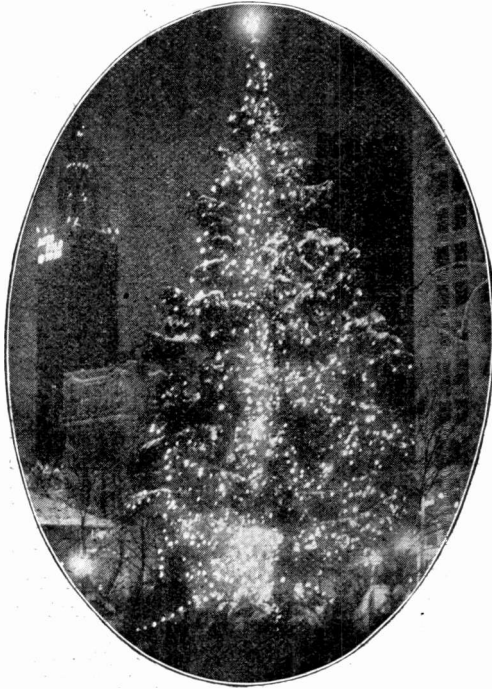

AN OUTDOOR CHRISTMAS TREE

to gaze at a thing of beauty that blazed against a background of park elms and tall buildings. It was the "tree of light," conceived in the mind of one who would provide cheer for those in whom the spirit of Christmas might need awakening and all the holiday week it gleamed in the darkened park.

The outdoor Christmas tree was a gift in every sense. The tree, a 60 foot balsam, was presented by the Adirondack Club, its transportation was donated by the railroad company, it was erected by an interested New Yorker, the wiring was a gift and the illumination was provided by the lighting company. Even the soloists, the choral societies, and the band gave their services free.

Late in the afternoon of Christmas Eve the "tree of light" was ready. Long before the appointed hour, Madison Square Park was thronged. People had come from all over the city and hundreds paused on their way home. There were shoppers with their arms filled with bundles and tired girls who had waited upon them, but they all stood patiently until the trumpeters sounded the fanfare from Parsifal. High at the top of the evergreen appeared the faint glow of a star, symbolical of the Star of Bethlehem of 2000 years ago. Slowly, as its message seemed borne upon the great throng, it gained in brilliancy until at last it burst forth in all its glory. For several minutes it ruled the darkness, and then the great tree seemed to spring to life as cluster after cluster of vari-colored globes shed their radiance from the branches.

At first the crowd stood in awed silence, then a burst of applause swept over the throng and as the choir burst into "Holy Night," the carol was taken up until a thousand voices were united with those of the singers on the platform. The program continued until one o'clock, when the lights were turned off. Each succeeding evening until New Year's, the tree gleamed from dusk till midnight.

## An Electro-Sanitation Plant in Brazil

A remarkable electro-sanitation plant has been in use in the city of Santos, Brazil, for about one year and is reported to be highly efficient and economical in operation. The building has a beautiful parklike surrounding and the power house which stands beside it is of an ornate architecture that resembles that of an amusement pavilion or exposition hall. In reality the sanitation plant is used to render the sewage of the city odorless and innocuous and it accomplishes its purpose so admirably that there is not the slightest nuisance involved in its operation. Although one half million gallons of raw sewage flow through this build-

ing daily in open troughs there is no odor perceptible. This is because of the instantaneous action of the electrolytic treatment which it receives, a process that deodorizes it instantly.

The operation is simple and the apparatus is not expensive to install. The main features are two uncovered troughs containing a series of electrodes, metal plates set on edge with about  $\frac{3}{4}$  inch space between the anodes and cathodes. The proper wiring is connected from the sides of the troughs and the power is obtained from the adjacent power house.

An electric current of from two to three volts and from 700 to 800 amperes is maintained and the electrolysis not only

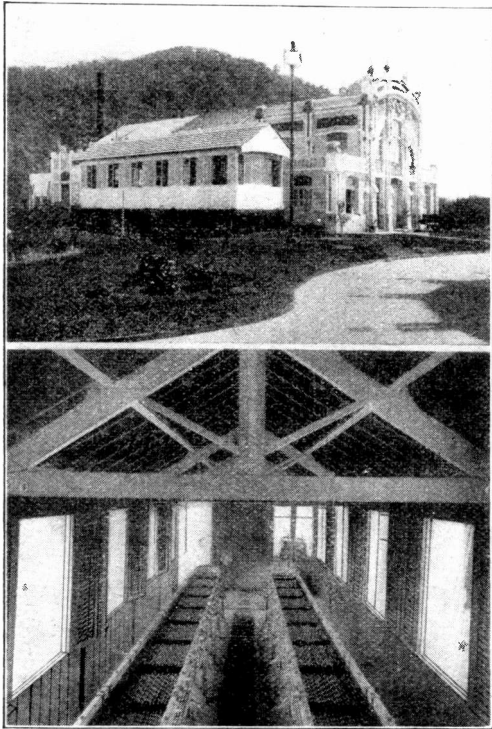

ELECTRO-SANITATION PLANT IN THE CITY OF SANTOS, BRAZIL

destroys all offensive odor but kills all disease germs, including the typhoid bacteria. The fertilizing properties of the liquid are not diminished by this process, which suggests an enormously profitable method of soil renewal.

The cost of this plant was about \$10,000 and the cost of operation is very slight, about \$10 or less per million gallons treated. The only labor required is the inspection of the electrical apparatus and the cleaning of the plates by reversing the current a few times a day.

### The Sun as Lightbuoy Tender

It is announced that a feature of the Panama Canal will be a number of acetylene lighted buoys marking the channel entrance, and these will be extinguished by the sun rising in the morning and automatically lighted when the sun goes down and darkness comes on.

There are two systems proposed as shown in the illustration. One is that of Gustaf Dalen, the Swedish physicist. This is mechanical. Briefly, the warmth of the sun at dawn, falling on a rod which rests on a lever, expands that rod and so moves the lever which closes the gas valve. At night the rod, getting cooler, contracts, and so opens the valve and lets the gas pass, to be lit by a small jet always left burning. The rod can be adjusted according to the temperature conditions of any country.

The other system proposed, which is electrical, is that of Ernest Ruhmer. It was briefly described in the March 1912 issue of this magazine. It depends upon the substance selenium for its operation. Selenium has the property of being highly resistant to the flow of electric current when in the dark but becomes a good conductor under the influence of light. It is placed in a battery circuit in the buoy in such a manner that when the sun rises and strikes the selenium cell current flows through the circuit and operates an electro-magnetic device which turns off the gas. When darkness comes the selenium becomes highly resistant, cuts off the flow of current, and, the electro-magnet being released, the gas flows again and is lighted by a small permanent jet as in the case of the Dalen system.

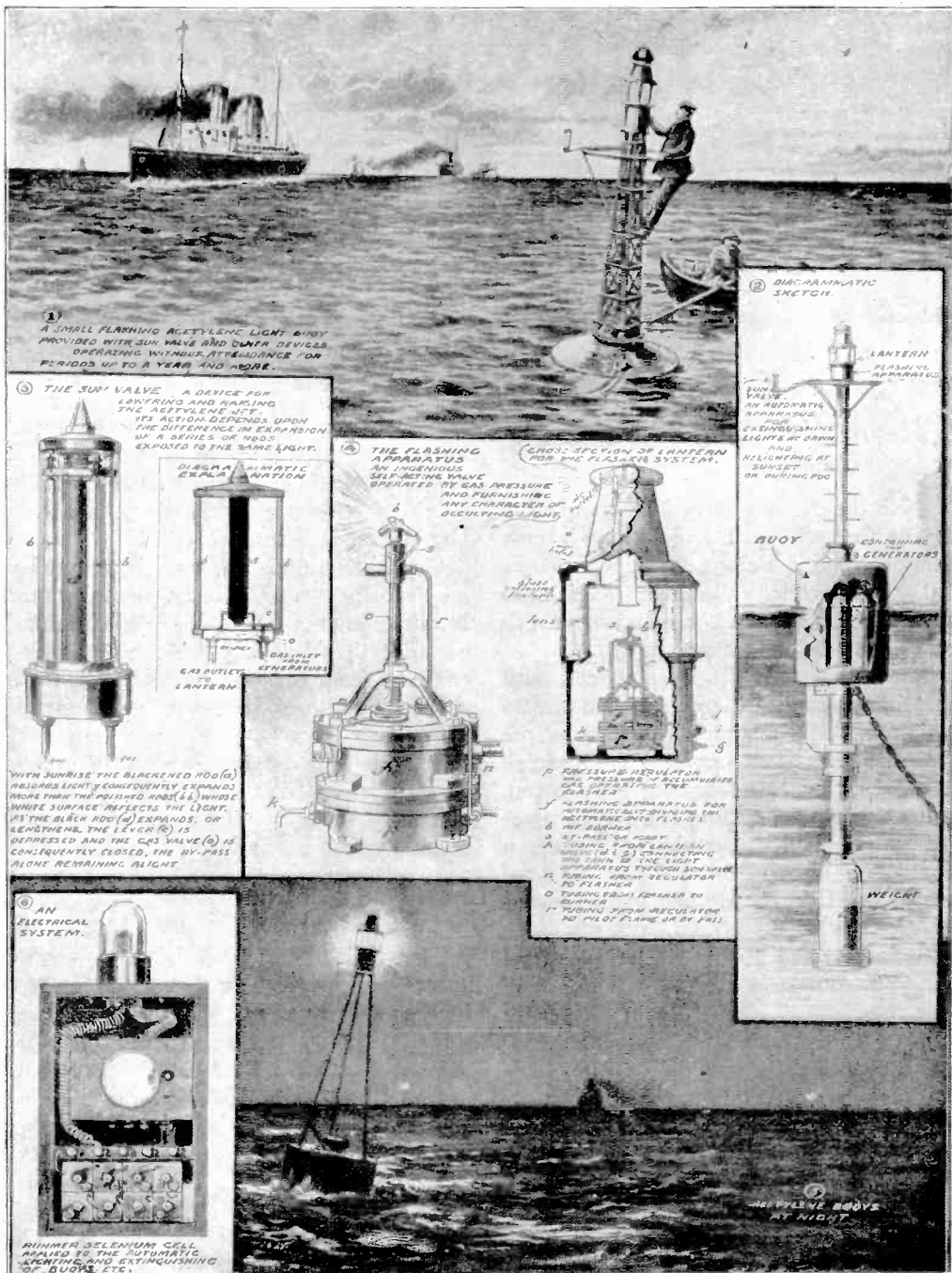

1 A SMALL FLASHING ACETYLENE LIGHT BUOY PROVIDED WITH SUN VALVE AND OTHER DEVICES OPERATING IN FULL AUTOMATISM FOR PERIODS UP TO A YEAR AND MORE.

5 THE SUN VALVE A DEVICE FOR LOCKING AND RARIFYING THE ACETYLENE MIXTURE. ITS ACTION DEPENDS UPON THE DIFFERENCE IN EXPANSION OF A SERIES OF RODS EXPOSED TO THE SAME LIGHT.

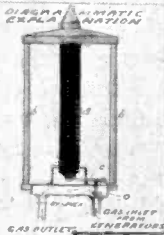

6 THE FLASHING APPARATUS AN INGENUOUS SELF-ACTING VALVE OPERATED BY GAS PRESSURE AND FURNISHING ANY CHARACTER OF OCCULTING LIGHT.

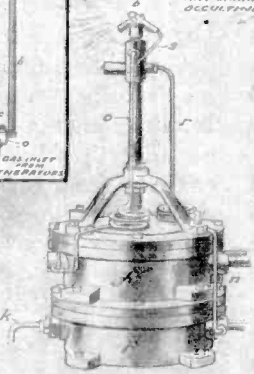

7 CROSS SECTION OF LANTERN FOR THE FLASHING SYSTEM.

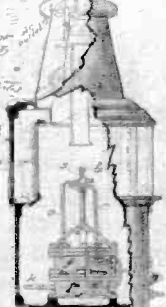

8 DIAGNOSTIC SKETCH.

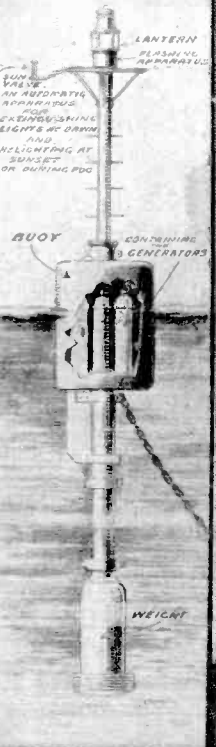

9 AN ELECTRICAL SYSTEM.

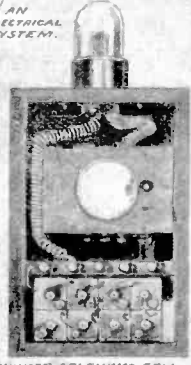

MINNER SELENIUM CELL APPLIED TO THE AUTOMATIC LIGHTING AND EXTINGUISHING OF BUOYS, ETC.

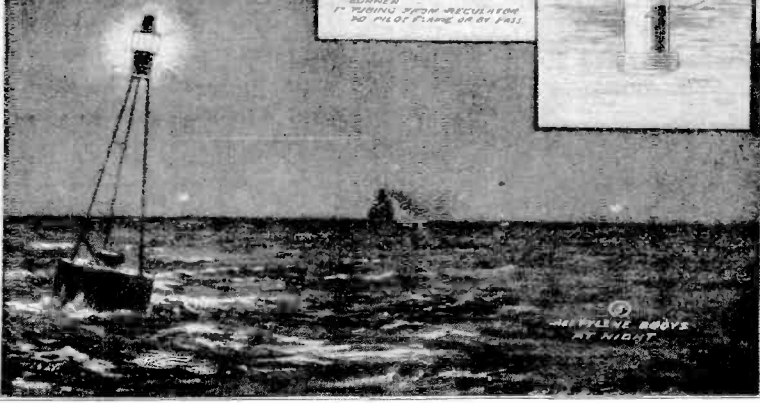

10 BUOY AT NIGHT.

By Courtesy of the Illustrated London News

TWO TYPES OF ACETYLENE BUOYS PROPOSED TO MARK THE ENTRANCE TO THE PANAMA CANAL. BOTH ARE CONTROLLED BY THE LIGHT OF THE SUN—ONE BY AN ELECTRICAL DEVICE EMBODYING THE SELENIUM CELL

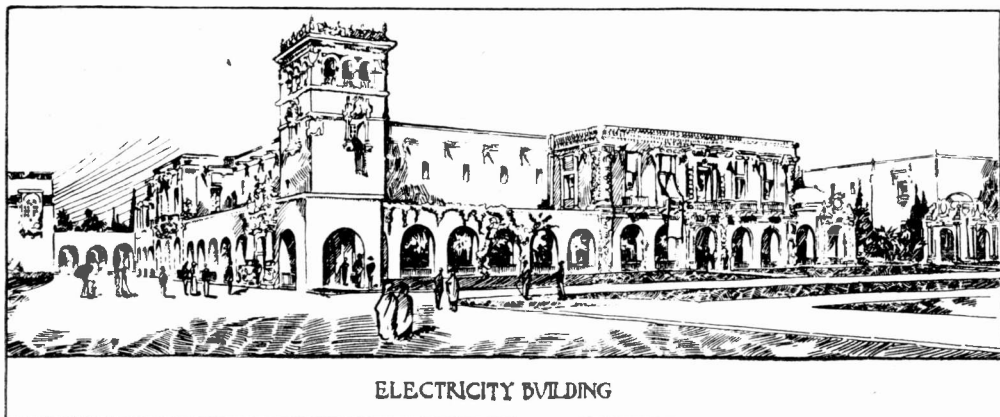

ELECTRICITY BLDING

### Electricity Building at Panama-California Exposition

With the expectation of its completion by the first of April, 1913, there is now being erected in Balboa Park, San Diego, Cal., the Electricity Building which is to be a part of the Panama-California exposition to be held there in 1915.

The structure is 250 by 300 feet, with balconies here and there and with towers which will be covered with vines by the time the exposition opens. The Spanish colonial style of architecture is followed, and, in fact, the building is modeled after the palace which Comte de Heras, a Spanish nobleman, erected for his own use in the City of Mexico in the seventeenth century.

It is planned to have the electrical building contain an exhibit which will give the history of the use of electricity from the beginning of its adaptation to man's use down to date. As far as possible every electrical discovery and every instrument or device which has been developed will be shown, the progress from the beginning being shown year by year in regular sequence. As a result of this every visitor to the building will obtain a comprehensive idea of the multifold uses to which man has put electricity.

The latest models of electric vehicles and boats will be shown, along with all kinds of electric motors, lighting, heating and medical apparatus. Upon the ex-

terior the building is to be a study in lights at night and is expected to far surpass even the famous electric tower which was such a feature at the Pan-American Exposition in Buffalo in 1901.

Great progress is being made, it may be incidentally stated, in the preparations for the Panama-California Exposition at San Diego, which is to be distinct in every way from the world's fair to be held at San Francisco the same year. It is planned to open the gates on January 1st, 1915 and to keep the exposition going until the end of the year. This arrangement is possible by reason of the equable climate which San Diego enjoys.

### The Diamond Electric Sign

The "Diamond" electric sign is the latest French idea in this line and it uses letters made up of cut glass pieces cut like gems. When different colored light is thrown through the clear glass pieces, it makes them glow and sparkle like so many diamonds, and the effect is a striking one. The method of working is very clear. On the front board the cut glass gems are set in holes so as to make up the letters, clear glass being used in all cases so as to allow different colored light to pass.

Back of the board is a revolving drum with translucent glass faces, each face being of a different color, and inside the drum are incandescent lamps placed



along a row. When the drum revolves, the colors are thrown upon the glass gems in varied fashion, so that the gems appear to flash with a changing glow and thus produce a flaming effect which is very striking.

A small motor or clockwork rotates the drum, and the inventors point to the use of a low current for lighting the few lamps employed, so that a good sign can be had at a low cost for current, this being much less than where the letters are made up of lamps. If need be, the

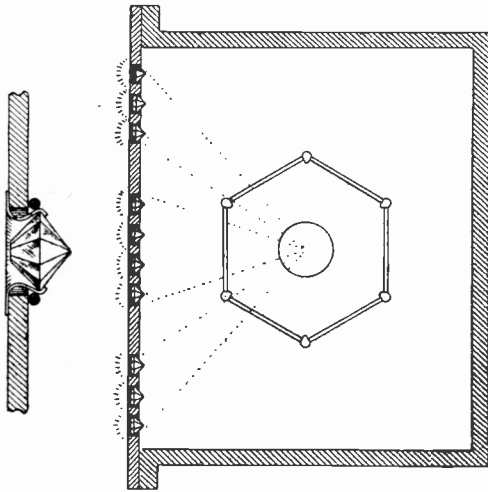

THE DIAMOND ELECTRIC SIGN

sign can be put out and lighted at intervals, by the revolving device. Even in daytime the sun strikes on the diamond faces and gives a very brilliant effect.

### Electric Incubator and Brooder

An electric incubator and brooder which is finding much favor in Germany is described in *Mitteilungen* the publication of the Berliner Elektrizitäts-Werke. With this incubator it is possible to approach very closely the results of natural incubation, and thus reach a very favorable result (80 per cent) in the hatching of chickens from artificially incubated eggs.

The heat produced by an electric current is made in this apparatus to regulate

itself to a fraction of a degree. In this way a practically uniform hatching temperature is maintained, which is seldom reached by other artificial methods. This incubator requires no attention beyond the daily turning and airing of the eggs. As a consequence of the automatic heat regulation by the shutting off of the current when the desired temperature is attained, the consumption of electricity is reduced to a minimum, and since the energy is calculated according to power and heating charges, the expense is very small.

The brooder, like the incubator, is built on the principle of making the most economical use of the heat of the current, thereby keeping down the cost of operation. In combination with an electric

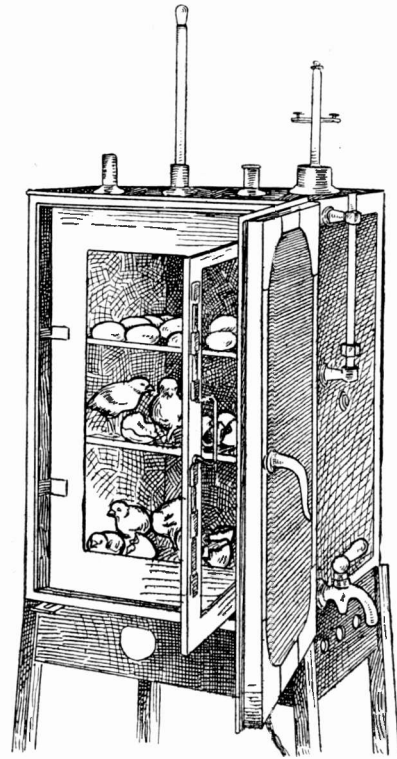

BROODER AND INCUBATOR BUILT TO MAKE THE MOST ECONOMICAL USE OF HEAT

lamp the brooder keeps the chickens comfortable and warm and consequently a very large per cent of those hatched can be reared, whether in winter or spring.

### Lighting the Bastille Column

The 14th of July is the French independence day, and corresponds in idea with our own Fourth of July. This date commemorates the taking of the Bastille

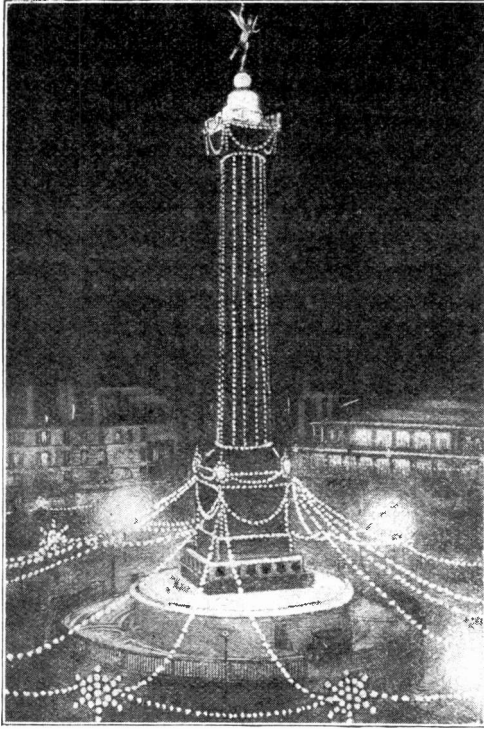

THE FAMOUS BASTILLE COLUMN AT NIGHT

during the Revolution and it is also a time of general merrymaking in the streets of Paris, especially at night when the open air balls in the public squares and the illuminations all over town make an attractive scene. Electric illumination naturally heightens the effect, such as the lighting of the famous Bastille column which the photograph shows. On the top of the column the figure of Victory, which appears to be small, but is in reality of colossal size, is brilliantly lighted up by the lamps placed around the platform and the decoration is made up of long rows of lamps running from top to bottom, together with numerous garlands. On the whole this is one of the most in-

teresting examples of electric illumination to be seen in the city.

### Electric Advertising in Shanghai

Shanghai, the commercial metropolis of China, has seen such changes in the few months which have intervened since the conservative Chinese empire was changed into a modern republic that it is difficult to realize what the city was a year ago. Space forbids a description of these changes, and indeed this page is not the fitting vehicle therefor, but all those interested in electrical science and its application to modern commercial needs will be interested to learn that John Chinaman, emerging from his Rip Van Winkle slumbers, bids fair to rank with,

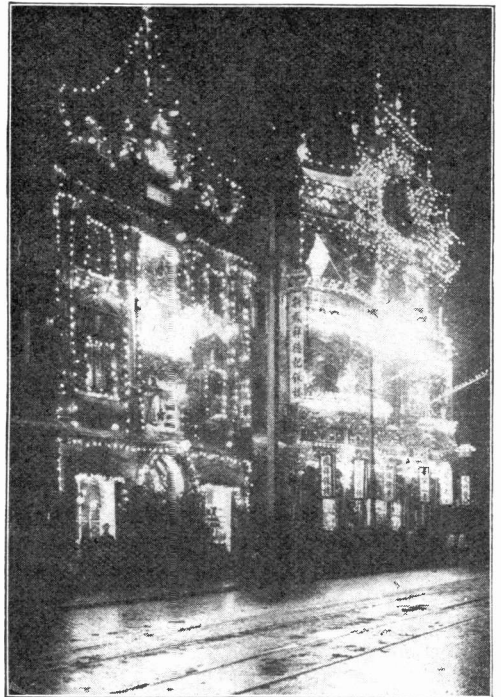

VIEW IN SHANGHAI—THE CHINESE IDEA OF ILLUMINATED BUILDING FRONTS

if not excel, the most up-to-date nations of the world in connection with the adaptation of electricity to this form of advertising.

Shanghai has a foreign population of over 13,000. In the international and French Settlements there are 300,000 Chinese, and in the Chinese city itself about 540,000. The total trade of the port for the year 1911 amounted to \$153,000,000 in gold, and thus it will be readily understood what the possibilities are for the retail trader.

The Nanking Road, leading from the business section to the residential district, is the principal foreign thoroughfare. For eighteen out of the 24 hours it is thronged with pedestrians—of all nationalities, but principally Chinese—and vehicular traffic. All the principal shops are congregated there, among which are the silversmiths' stores. Three of these places have recently been rebuilt, and have been fitted up in the most elegant and up-to-date manner in order to display their wares to the best advantage.

Not content with internal decoration, the exteriors have been decked, regardless of expense, in a manner which would appear strange to people of other lands, as can be judged from the accompanying picture.

The photograph here reproduced shows the premises of two dealers, in another part of the same road, illuminated. The more pretentious of the two has 2,000 sixteen candlepower electric lights, the other 1,500. These are worked in among the fantastic decorations, some of them of an allegorical nature and operated by clockwork.

Questioned as to whether the results warranted such an expenditure, the enterprising proprietor of one of the stores remarked, "Maskee how much he cost. Can catchee plenty tlade so fashion."

Needless to say, the nightly display attracts crowds of Celestials, who stand open mouthed and dumb watching the free show, obstructing the traffic, and affording the pickpockets an easy mode of livelihood.

It is stated that the illuminations will be continued indefinitely although the cost is heavy even for a single night.

### Troubleman's Portable Searchlight

A portable light that will enable the troubleman to examine the wires on a transmission line at night means quicker location of trouble.

The portable searchlight here shown is fed from a tank with gas at 250 pounds pressure, the tank being carried on the back of the troubleman. The lamp will burn for 70 hours on one charge of gas.

It is possible with this light to see clearly the wires at the top of the highest poles. It furnishes sufficient light from the

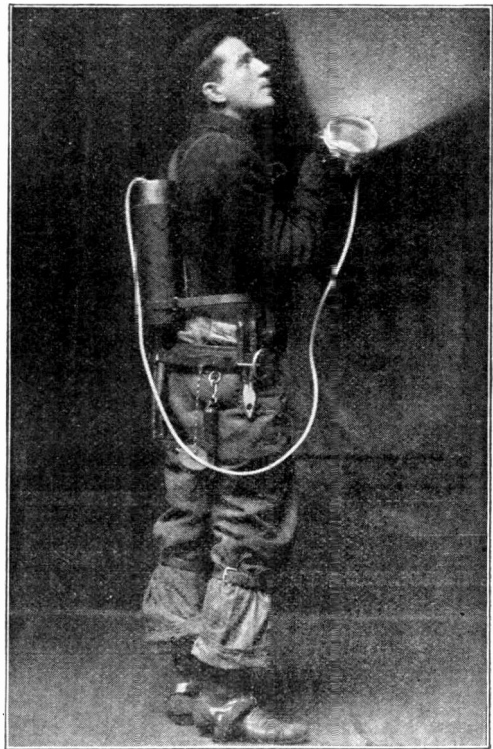

TROUBLEMAN WITH A SEARCHLIGHT

ground for the re-fusing of transformers and the replacing and repairing of lines at once, no matter how dark and stormy the night, with the minimum amount of danger to the man doing the work. As a very large percentage of line troubles occur at night the value of this outfit can be readily appreciated.

## Mount Wilson Observatory

Electricity is one of the most important auxiliaries in the work of the modern astronomer and the range of its applications in this field is nothing less than surprising. The Mount Wilson Solar Observatory, in southern California, is one of the most noted installations of this kind in the world, and the accompanying photographs show two or three applications of special interest. The largest telescope on Mt. Wilson is a 60 inch re-

made for the manufacture of a new mirror, and when the telescope is completed and set up in its new home on the summit of the mountain, it will be capable of being turned at many angles by small motors responsive to the hand of the observer. The great tube's range of motion is shown in the accompanying view of a model frame which the mechanics of the observatory staff have prepared in studying the possible mountings of the instrument.

The observatory maintains an im-

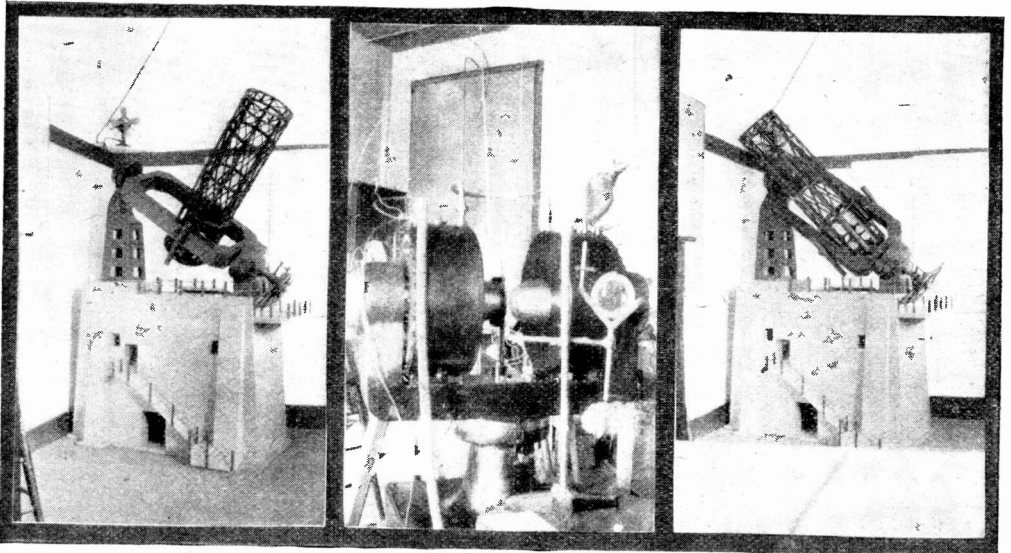

TWO VIEWS OF A MODEL OF A 100 INCH TELESCOPE MOUNTING.—MOUNT WILSON OBSERVATORY. IN THE CENTER IS A GIANT ELECTRO-MAGNET IN THE OBSERVATORY LABORATORY. FOR STUDY RELATING TO THE SOLAR MAGNETIC FIELD

flector, and when this was hauled up the mountain in parts a few years ago a gasoline-electric truck had to be impressed into service and an old, ten mile trail 30 inches wide rebuilt into a ten foot roadway.

The observatory is planning to erect a 100 inch telescope on the mountain, and this is to be the largest glass of its kind in the world. Recently it was discovered that the glass being ground for this purpose in the Pasadena laboratory of the institution was not flawless and many months of hard and delicate work came to naught. Arrangements have been

important laboratory in the city of Pasadena where exhaustive experiments are carried on in the comparison of phenomena noted in the heavens with the results of spectroscopic and other observations made within doors. The accompanying view shows one of the most powerful electro-magnets in the world in use in this laboratory, the magnet being built in two parts and water cooled. When fully excited the coils of this magnet absorb about sixteen kilowatts or about 20 horsepower of electrical energy. By its use many of the conditions of the solar magnetic field have been simulated.

### Money-in-the-Slot Restaurant

Mr. Edison predicts automatic or money-in-the-slot stores and the "Automat Lunch" at 1557-63 Broadway, New York, which now feeds 10,000 people daily, goes far towards verifying his prophetic vision.

Passing under a big electric sign and through a doorway surrounded by a \$6,000 stained glass window, mechanical coin devices in connection with drums and enclosures that contain foods and drinks to suit any palate are found. Hunger

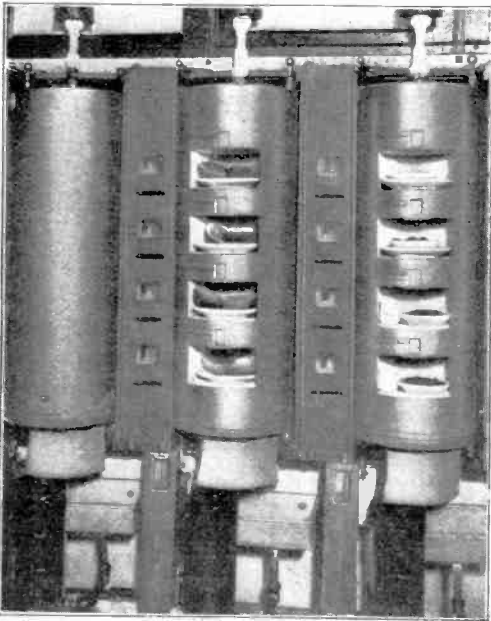

COOLING CABINET FOR FOOD PREPARED AND READY TO SERVE

may be appeased by inserting a coin of proper value and either turning a knob or pulling a lever. Through glass windows the customer can inspect the food he is to pay for.

The drums containing the ice cream are kept chilled by a surrounding jacket through which cold brine circulates. Hot machines circulate hot water through a jacket. Ten hot and cold liquid machines containing orders of tea, coffee, milk, buttermilk, etc., are operated by electric

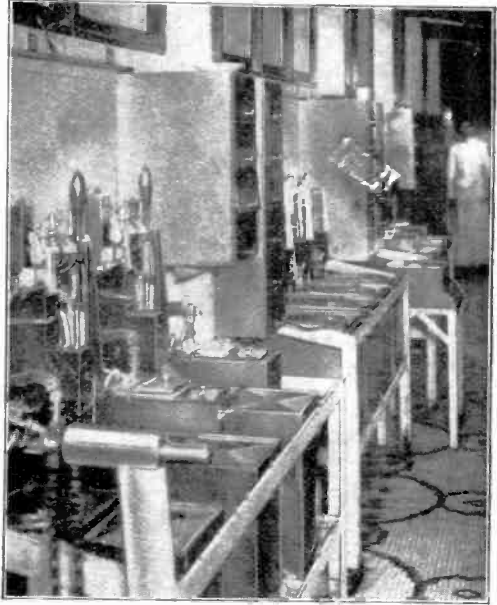

HOT AND COLD LIQUID MACHINE OPERATED ON THE COIN-IN-THE-SLOT PRINCIPLE

pumps which measure the proper amount at each helping. Even the cream is poured into the cup before the coffee.

Three motor driven ice machines in the

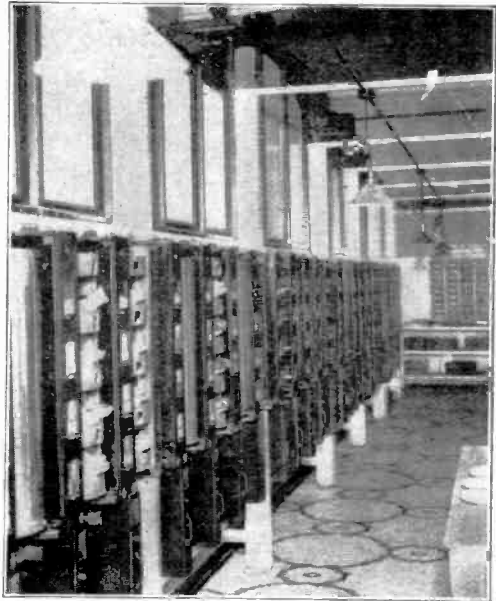

REAR OF THE FOOD CABINET FROM WHICH THE DISHES COME FORTH WHEN A COIN IS DROPPED IN THE SLOT

basement constitute the refrigerating plant and two electrically operated dish washing machines on the top floor take care of the soiled dishes sent up by an electric conveyor. Tungsten lamps are used for lighting and 22 electric fans provide ventilation.

Although the tile floor, ornamental columns and glistening machines are inviting, there are those who are still a bit shy and these may find beneath the main floor a room where 240 people may be served in the old "Order, please" way.

### Warm Meals for the Horse

In the cold, windy days of winter, the horse is called upon to face the sleet and storm, and this faithful beast appreciates a warm supper after such a day's work as much as does his driver.

In the preparation of this feed the

and water and a connection by a length of flexible cord and a plug made with the nearest light outlet. In two or three minutes' time the feed is warm and is far better for the horse than an ice cold supper.

### Automatic Compasses for Ships

There is a form of compass that automatically registers the route followed by a ship. It is a matter of practical experience in navigation that the steersman often varies from the course set for him in advance, and sometimes the final effects of these variations may become serious. The Heit compass preserves a record of all the departures made by the ship from the set course from one end of the voyage to the other, and this record may be consulted at any time. The compass is connected with an electric apparatus in such a way that once every

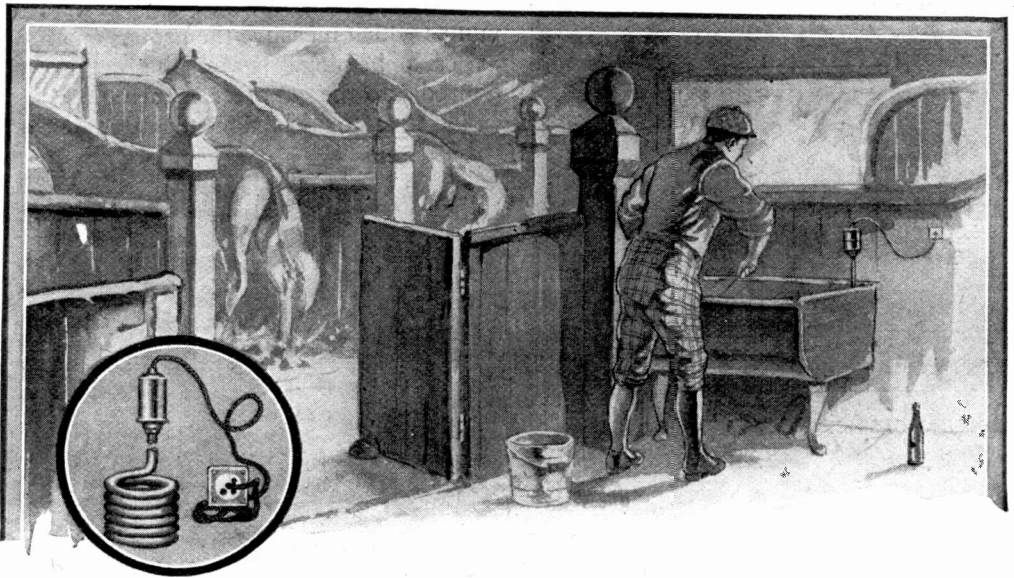

THE ELECTRIC HEATER IS A VALUABLE ADDITION TO THE STABLE EQUIPMENT

electric heater comes into convenient service as most livery and boarding stables are lighted by electricity. The American heater suitable for this purpose consists of a metal coil within which is contained the heater wire. The coil may be set into a pail or trough of feed

minute the angle made by the ship's course with the magnetic meridian is recorded by means of an electric contact.

The records are made on a moving roll of paper, whose motion is so timed that the hour and minute of the contact are

automatically indicated. Thus the ship's captain has continually before his eyes a chart of the course he has traversed.

### Economical Lighting in a Pumping Plant

An inexpensive method of providing electric lighting is employed in a large pumping station in the East. The plant contains two steam driven pumps of 11,000,000 gallons combined daily capacity, but no small engines. To avoid the inconvenience of installing the latter a fifteen inch Peiton water wheel was purchased and direct coupled to a small dynamo. The water wheel is operated on

lamps. The equipment requires practically no attention, and the cost of operation is trifling in comparison with the expense of purchasing current or of running and maintaining a steam or oil engine set for illumination service.

### Thawing Frozen Water Pipes

A portable emergency electrical equipment for thawing out frozen water pipes was made at Fort Leavenworth Army Post last winter and used successfully all winter. After several frozen pipes had to be uncovered the apparatus shown mounted upon the wagon was used. There are two transformers which were

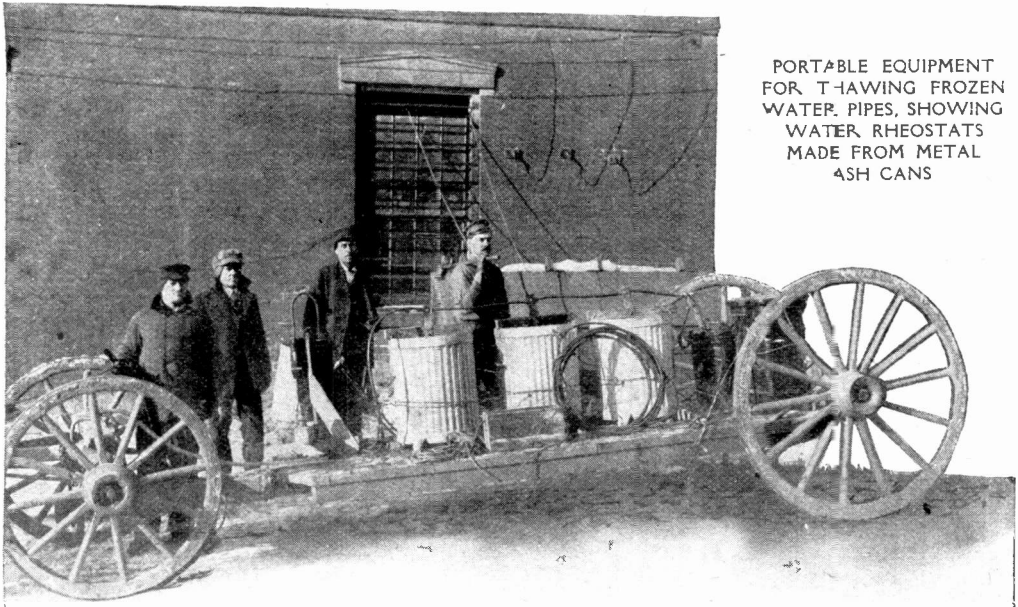

PORTABLE EQUIPMENT FOR THAWING FROZEN WATER PIPES, SHOWING WATER RHEOSTATS MADE FROM METAL ASH CANS

about 100 pounds pressure per square inch taken from the pumping mains and after the water passes through the wheel it is returned to the station well so that none is wasted. The city reservoir provides sufficient head to run the unit even when the main pumping engines are shut down.

About ninety 40 watt tantalum incandescent lamps are supplied from the unit, the full load each night being about 75

connected to the nearest high voltage pole line through fuses. Current through the piping, which was connected to the 110 volt side of the transformers, was regulated by water rheostats made from large metal ash cans.

The most stubborn case in  $\frac{3}{4}$  inch pipes required thirteen minutes and 127 amperes to thaw out. A two inch pipe took 34 minutes and 327 amperes. In all cases the pipes became smoking hot.

# From Ingot to Wire

By H. Bedford-Jones

Americans have learned the lesson that many heads are better than one. Instead of one man putting all his energy into a whole factory system, many men concentrate each on his own department. All important questions now-a-days are settled by committees—not by single individuals.

Sixty years ago there was a canal at Worcester, Mass. The railroad came and the canal went out of business. But it is still of use in the world. Its bed serves as a dipping tank for the American Steel & Wire Company; its water serves to cool the steel and iron of the mills. Each night the mill workers go home along what was once the towpath. Such is the evolution of business in theory and practice. One-man-power would never have harnessed that canal; it would have been too busy harnessing details.

The one hundred and two acres of the Worcester mills in actual use are under various heads. Each of the north, central and south works is a mammoth industry in itself. I had seen cable works and steel mills before, but when I left the general offices and started out to inspect things, I was amazed. Here I encountered the primeval industry, the giant at the bottom of the refined factories higher up in the scale. Here I found men who really worked by the sweat of their brows, and added to it all the other sources of perspiration possible. In the annealing room, standing on the floor gratings, watching the men shifting huge cranes of metal from baths of cleansing acid into annealers and heating ovens, my thoughts went back to Dante. But they did not stop there. They went a good deal farther back than Dante before I got through.

There is a tremendous fascination about copper, the shimmering red-gold

metal of many hues. The workmen felt it just as much as I did. I stood looking at the piles of copper wire fresh from the annealers, and the foreman came over holding up a coil admiringly.

"Ain't she a peach, eh?" he exclaimed. "You ought to see her when the ovens are opened!"

I did, and it certainly was beautiful. Outside, in the yard, were row upon row, car upon car, of dull gray coils from the rod mill. These went into the acid baths and came out from the washing gleaming rose-pink. They went into the annealers and came out gold-red, more beautiful than gold—"Mary Garden copper" we called it. It was quite a compliment to Mary, not to the copper.

Softened and rendered ductile by the annealing, the coils of wire, both steel and copper, go to the drawing rooms. Here they are drawn smaller and smaller, to go back time after time to the annealing rooms. Rigid specifications demand rigid care and supervision. If the wire is drawn to a greater tension than its ductile capacity will permit it is ruined. Often it is annealed half a dozen times in process, to remove the internal strains produced by drawing.

The beauty of copper wire is by no means an end in itself. It is a means to an end. In the annealing process unless properly manipulated, scale is very apt to form and any oxidization would seriously impair the efficacy of the future product. The metal, while at the high temperature necessary for proper annealing, if kept from all contact with the air will come out as bright as if just polished.

The wire goes to the drawing rooms in various sizes, and the exact specifications must be known beforehand. This latter statement applies all through the whole establishment. The exact use and speci-



fications of the future completed product are known before it goes to the factory. This is borne in mind through every process and for this reason the Worcester plant specializes in special products.

drum. Speech is impossible here. The roaring of the machinery and the dull rumble of whirring wheels is hardly observable until you attempt to talk. Then you notice it. And what a variety of

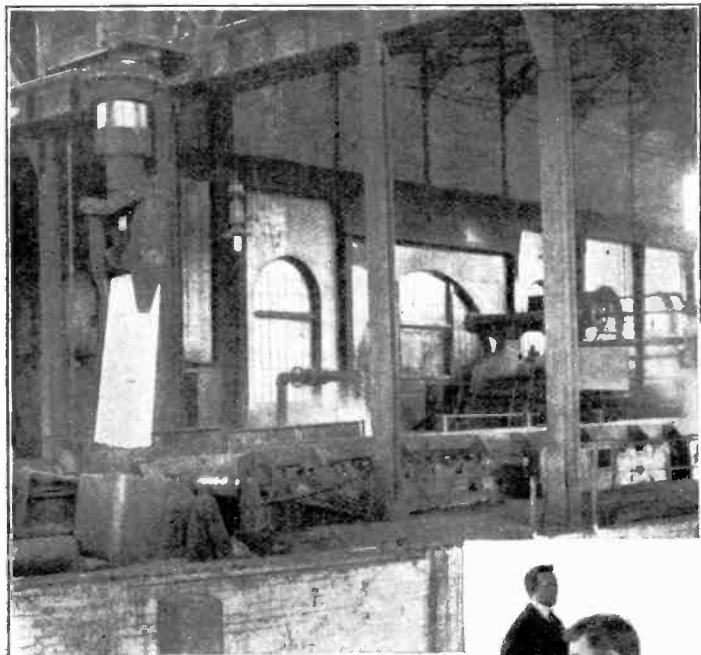

THE TITANIC FINGER FOLLOWS US WITH UNERRING SPEED, BEARING A WHITE-HOT INGOT

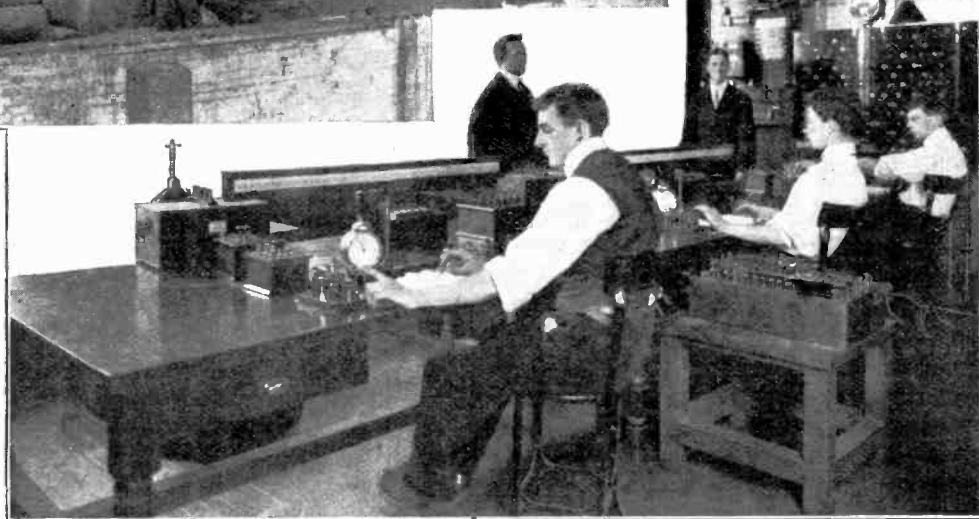

THE LABORATORIES ARE ESSENTIAL FEATURES OF THE PLANT AND ARE OF NO LITTLE INTEREST TO THE VISITOR

A coil of wire may be given a few drafts, or it may be given many, both making the same size in the end; but the physical characteristics of the two finished wires will be entirely dissimilar.

I followed on after the coils, each one growing longer and finer, from drum to

noises there are in different parts of the plant! Stepping out of the blooming mill into the engine room, you are tempted to think that all noise has been left behind. Then you find that instead of the crash and plunge of tons of white-hot metal there is a simple, silent burr of

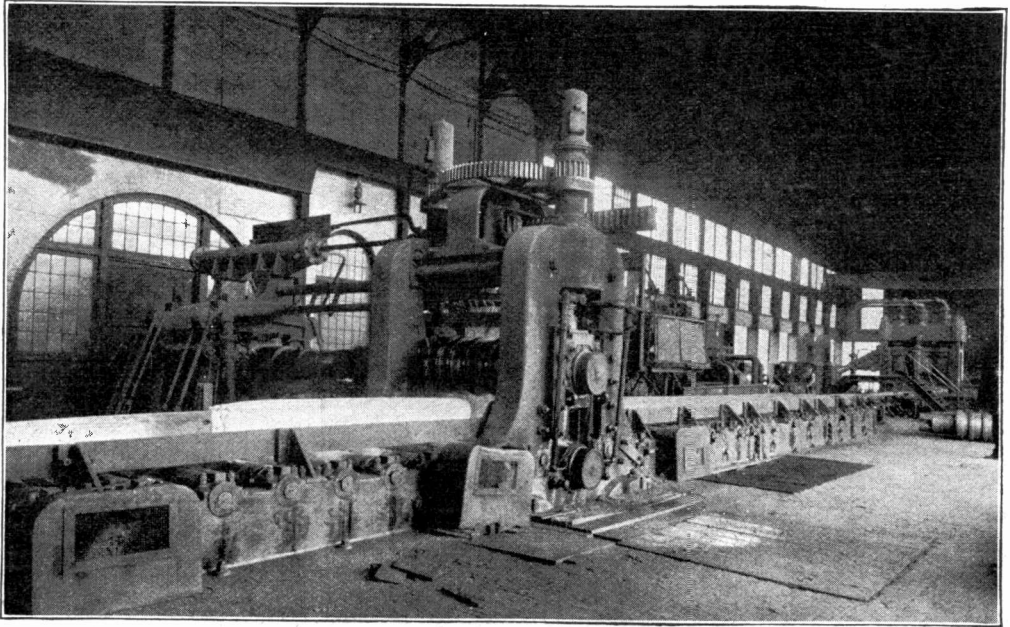

THE BEGINNING OF A WIRE—RECEIVING SIDE OF A BLOOMING MILL

engines here which renders all other sound mute. Fortunately, the wire process needed but little oral explanation. Smaller and smaller grew the wire, longer and longer, until at last it came to the diamond dies. And before my eyes was worked a miracle.

Three-fifths of a mile of copper wire was fed into the machine. The wire traveled at the rate of 500 feet a minute, but was rolled up at the end over five times as fast as it was unrolled at the start. In fact, the three-fifths mile became three and one-tenth miles, going through nine drafts in this single machine, from roll to roll, in less than half an hour. Its diameter began with .0641 inch and finished at .0285 inch. Three thousand feet were made into 16,000 feet.

The diamond centers of these dies are marvelous pieces of microscopic work which must be able to stand the steady rush of heavy work and the wear and jar of constantly passing wire, while remaining absolutely perfect. They wear out in time, of course; as the holes in the diamonds become larger, the die is

passed on to the next larger wire and replaced by a new one made in the shops. Each diamond center is bored, then firmly bedded in nickel, which in turn is centered in the brass die. Then the microscopic hole is finally bored and rounded, to the size of a wire that is almost a copper hair.

This is a Titan among factories. There is far more in its bounds, it seems to the visitor, than in other plants of equal acreage. As a steel and copper plant it is enormous. As a wire producer it is enormous. As a spring mill, a cable works, an insulating plant, a railroad system—in each detail it is enormous. In the south works alone there are nineteen miles of railroad tracks. The amount of material on hand must run up into the millions at each inventory; its monetary value is probably far greater than most people would suppose, owing to the great costliness of the materials—rubber, copper, silk and all the rest.

But let it not be imagined that here is copper only. Copper wire plays but a very small part in the whole general scheme of things. The making of steel

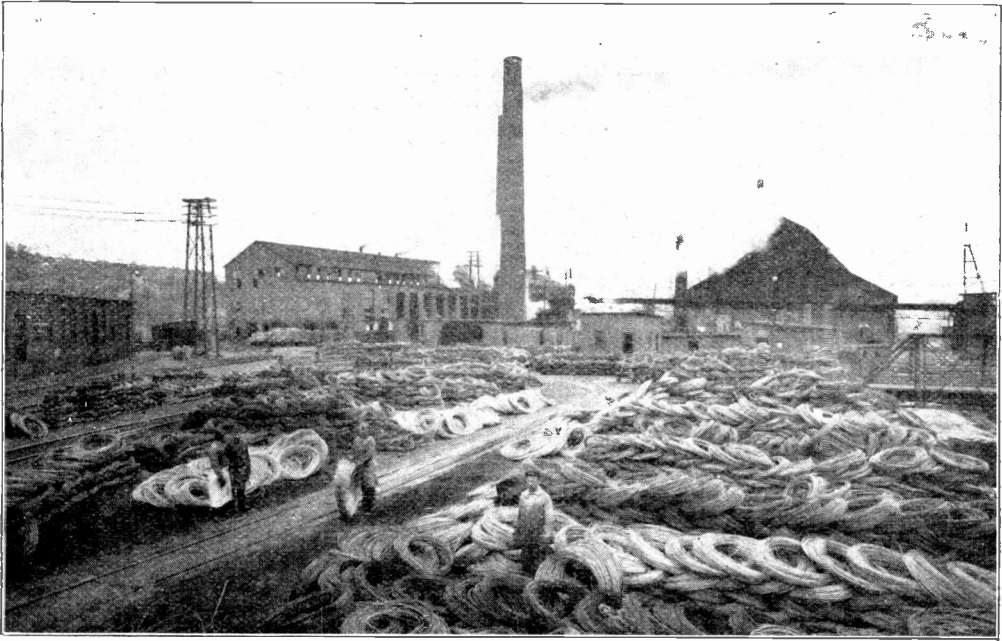

THERE IS A TREMENDOUS FASCINATION ABOUT COPPER, THE SHIMMERING RED-GOLD METAL OF MANY HUES

is always a mammoth project: here, it is a humanly interesting one. As one of my guides pointed out, it is entirely analogous to human life itself. From the scrap heap it goes through various formative processes, is turned out to perform its work in the world, and in course of time returns to the scrap heap. And this scrap heap is a wonder.

As I stood and gazed up at it, while the overhead crane and the giant electro-magnet carried tons of metal from place to place, I could pick out nearly everything from swords to ploughshares in the pile before me. Here were parts of battleship armor, cog-wheels from shops and machines, farm machinery, garden tools, automobile scrap, car couplers—everything which is manufactured from certain grades of iron comes back here to the scrap heap from the Hebraic hands of the city. This is a morgue of dead ambitions, a charnel house of genius. All of these scraps, from big to little, were products of human brains and energies, once vital and in their turn energizing the world.

But the electro-magnet takes hold on them, their individuality gone, and shifts them on to cars for another reincarnation, tons of them at a time. This giant magnet works like nothing so much as a dry sponge picking up drops of water. A man could do it with his fingers, a drop at a time; but as the sponge is pressed down the water runs to it and all is over. Tons of this scrap were lifted by the single magnet; as it went up and over the ground the iron scraps ran to it, stood on end to greet it, and were finally carried on and away by it until they were absorbed in the general mass.

The steel furnaces are terrific—great masses of metal and fire brick lost in the dull steel rafters above, surrounded by smoke whorls and smudge in which move the figures of puny men, impotent yet all-potent, handling everything by a switch here, a lever there. The coruscating steel is poured into the ingot moulds, car after car of them which move on in endless procession. One of these furnaces is significant. It is electric—it does away with fuel. Rather, it makes

steel out of the energy of falling water, for it is run by hydro-electric current, the three electrodes heating and purifying all. In days to come the electric furnace may do away with the fuel problem, in factory and in home, and we of today are witnessing the beginnings of a new era, over the horizon of which we can as yet but dimly see.

But the ingots are cooling, and we must go on. Stripped of the moulds, each ingot weighs two tons or more. The cars take them into the blooming mill, and here the ingots are carried about, tossed and played with, like the jackstraws of a child. All about us are white hot furnace pits. Overhead travel giant cranes, between each a prehensile finger tip that folds up into itself uncannily, grotesquely. Very carefully but with exceeding speed the long finger shoots down and grips a red hot two-ton ingot. Over us it whirls and then down into a glowing pit where the ingot is dropped for greater heating. Then the finger delicately cools its nails in water before lifting more, so we go upstairs to watch the next operation.

Before we can reach the top the titanic finger follows us with unerring speed, bearing a white hot ingot. This it deposits in a holder, and the play of the gods is begun. The mighty mass of steel is tossed about hither and thither on a line of rollers and upshooting hands that grip and whirl it, until it travels down to us and enters the presses.

These are controlled by four men on a platform above. The glowing ingot is pulled forward and back through the rolls, and we seek a reason for the action. Half a dozen times this is repeated, the ingot undergoing no appreciable change; but suddenly we notice that the metal is longer, thinner. Then the rolls clamp down and as the white hot end appears one can see it crumple up and come through, half its former size.

The metal resists this, twisting, quivering and curling in a frantic effort to get away from those unflinching rolls and

omnipresent hands of steel. But those hands show no mercy, the rolls bear it ever onward, and soon the luminant metal has become a giant's jackstraw which is tossed around and whirled back and forth until it is drawn into a seemingly thin rail of red hot steel.

Then down the trackway to the lesser rolls, where it is finally cut up into four-foot lengths called billets. These lengths are pushed on to the cars and loaded mechanically—and we emerge into the blessed free air once more, thanking fate that it is not our lot to lose the blue sky and the winds of heaven for the dim rafters of the blooming mill.

The steel billets are taken to the rod mills and reheated and rerolled. Now one begins to see that wire comprises much more than a mere strand of metal. It may be of all shapes, all sizes. Wire is shipped out to be brass coated and rolled into tubular steel for beds; other wire is shaped, sectionally, like a star. This goes to watch and clock makers, is cut off into narrow slices, and these become the cogwheels in our cheap timepieces. Wire is not all cylindrical by any means. Trolley wire, for instance, is grooved in various ways and shapes; and there are turned out over 500 different shapes of wire, used for every purpose under heaven.

So onward goes the stubby billet of steel. As the size of the rod or wire decreases the speed at which it travels increases, until in the end the four-foot billet has become a quarter of an inch thick and a quarter mile long. Then it is coiled, still red hot, over drums and passed on to the next room, where it is loaded on cars to be held until the wire mills are ready for it.

But within my given limits of space it is impossible to amply describe this immense place. It has so many ramifications, there are so many special products and special processes employed, that this entire issue could be filled with a mere generalized description of the place.

One of the interesting features is the

utilization of the by-products. In various European countries hot slag is blown into thin threads of cottony material, and this is later woven into a cloth-like substance which being a non-conductor of heat is used for many purposes. But here the hot slag is thrown into cold water, and the resultant explosion leaves it in the form of a powder which is ground and used extensively in the making of cement. Another by-product is sulphate of iron, of which thousands of tons a year are sent out. The various acid cleaning solutions become charged with this, and it is carefully saved, being used as a weed exterminator and water purifier.

The insulation of the wires and cables is extremely interesting. In other articles I have described the stranding of a cable and the braid insulation, placed on the wire by braiding machines and thousands of flying shuttles. Besides this, the rubber insulation is also made here at Worcester. There are two methods of doing this.

The rubber is sent through the rollers, or calenders, as they are called, and comes out in thin strips of rubber sheeting. This is then wrapped about the wire by means of special machines, which leaves a thin seam along the entire length. Later, the vulcanizing process, which develops the characteristics of the rubber and gives it life, does to the insulated wire essentially what the heating process does to steel. The second method is to press the rubber tightly about the wire, just as lead is pressed about a cable, in a complete sheathing. The completed wire of the first process shows no trace of a seam after the vulcanizing, which effectually welds the whole.

A very elaborate equipment is in use for tinning and galvanizing wire. Copper conductors are often tinned, and telegraph wire is nearly always galvanized. The absolute perfection demanded by trade specifications makes a corresponding perfection necessary in the making.

The principle of this process is the passing a wire through an acid tank which cleanses it, then through a vat to wash off the acid, then through a flux and lastly into the molten tin or zinc. It is easy to make the metal adhere to the surface as a whole, but it is hard to cover the wire with a uniform thickness of bright metal which will neither crack nor peel, and the resultant machinery and operations are ingenious and interesting in the extreme.

Naturally the laboratories are essential features of the plant, and are of no little interest to the visitor. Here small models and samples of all kinds may be made, which could not possibly be turned out of the huge shop machines. For example, I saw a few inches of a sample sub-ocean cable—strand after strand of steel wires and saturated insulations, enclosing the all-essential core in its heart; and beside this lay a bit of the first Atlantic cable—primitive, if you like, but none the less an epoch maker in the world's progress.

This is the American Steel & Wire Company, in an infinitesimal degree. There are many places about it I have not visited, there were mills and shops I had not even time to go through, or the space in which to describe them. And all this is the labor of men in the mass. Every trifling detail of the whole place has been worked out by some unnamed man or men, and involves a dozen other more trifling details which had first to be worked out. Component work is marvelous in itself; individual work is marvelous as showing the strength of an individual. But the individual work, however great or far reaching, must surround itself with other individuals and become mass work if it is to meet with success. That is why great men surround themselves with greater men. That is why American business will stand in the forefront of world progress for ages to come.



THE GREAT WELCOME SIGN ON THE UNION FERRY BUILDING. IT IS 600 FEET FROM END TO END. THE TOWER ABOVE CONTAINS OVER 4,000 LAMPS

## Construction of the 1915 Exposition Begun

By RUSH KIRBY

That group of enterprising citizens known as the Exposition Company has carried the development of the Panama-Pacific Exposition to such a point that general preparedness is an accomplishment of the past. Actual construction has begun. In fact, the first building, one of the minor affairs of the great structures contemplated, is now occupied by exposition organizations such as the Police Department, Commander of the Guards, Emergency Hospital, etc. Daily, scenes of construction are now witnessed which effectively dispell all fear of the undertaking, becoming a sluggish enterprise, and weekly, one might almost say, foreign envoys arrive and select sites for pavilions and exhibits. Experts say San Francisco is a whole year ahead of previous expositions in preparation. General plans for fourteen principal exhibit palaces are ready. The contract is let for grading the site of Machinery Hall, the largest edifice to be constructed, and bids for its construction are called for. The contracts for grading the railway yards and for the improvement of Fulton Basin the contemplated yacht harbor—are also let. Twenty-two foreign nations have accepted invitation to participate, while five have their flags flying over sites chosen and dedicated for their edifices.

Nineteen states likewise have their colors flying over chosen locations. Eight hundred leading exhibitors of the world have applied for space, which is some seven hundred over those of similar periods. Two thousand concessions have filed application—something unprecedented. And all this before active campaign has begun.

Persons not directly connected with the exposition work see but little of the vast amount of activity engaged in by the Exposition Company. It is a casual stroll over the great area about to blossom into a fairyland that opens the eyes of the visitor. Indeed, the evidences of unequalled spirit and progress are not only convincing but their magnitude is so impressive that one enthusiastically wishes San Francisco God speed and good luck and experiences a yearning to join in. And through it all again, as the eye sweeps over the scene, there is observed stretching across the sky line, extending from the forest of houses on the hills, over the site and down to the water's edge, a line of tall poles whose cross-arms bear power transmission wires, for, be it known, the services of electricity have become imperative and today this line conveys the first electric power to be employed on the fair grounds.

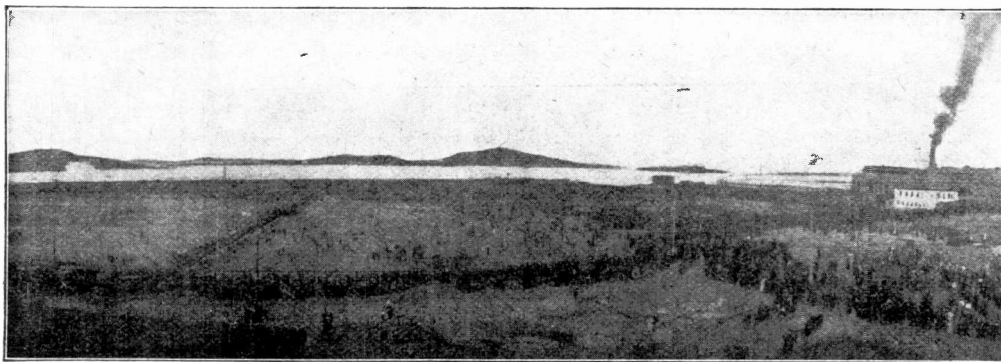

BREAKING GROUND FOR MACHINERY HALL, THE LARGEST BUILDING TO BE ERECTED AT THE 1915 EXPOSITION. THE STRUCTURE WILL EXTEND FROM THE CENTER OF THE MASS OF PEOPLE ALMOST TO THE WATER'S EDGE. IT WILL CONTAIN 8,000,000 FEET OF LUMBER, ENOUGH TO FLOOR 200 ACRES, OR 64 CITY BLOCKS. A PERSON WILL TRAVEL A DISTANCE OF ONE MILE IN WALKING AROUND IT, AND TWO MILES OF DECORATIVE CORNICES WILL BE USED IN ORNAMENTS IT

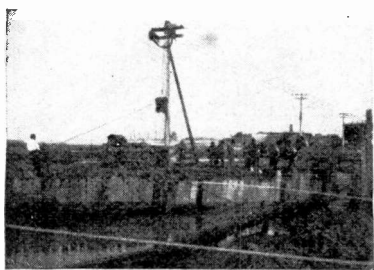

BRINGING THE FIRST ELECTRIC CURRENT INTO THE FAIR GROUNDS

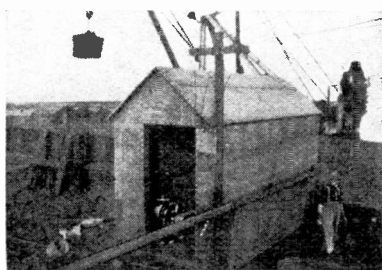

FIRST MOTOR TO OPERATE ON THE GROUNDS. PUMP HOUSE ON A FILL NEAR THE WATER'S EDGE

A trivial event may seem the installation of this transmission line with its transformers and motors, yet when, on Thursday evening, November 14, 1912, as the setting sun slowly sank out in the great sea of red, the electrician at the pump-house down on the fill near the shoreline

"plugged in the juice" on a ten horsepower motor and started the whir and hum so familiar to mortals who frequent the electrical world, he put into operation the forerunner of the vast amount of that mystic energy that will ere long be raising beam to pinnacle, re-

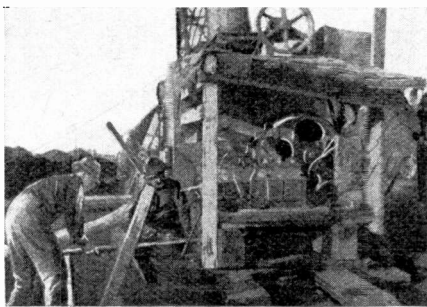

MOTOR OPERATED CONCRETE MIXER BEGINNING THE SEWER WORK

cording the vigil of the nightwatch and toiling day by day on a most ambitious undertaking.

Passing at twilight into the heart of the city and down to the foot of Market Street where the great Union Ferry Building rears its tall tower, we observe that not only does the traveler just

entering the portals of the city, but the busy San Franciscan himself pause and gaze upward to watch the tall pinnacle flash into light as the hours of illumination are begun. It is then that the eyes fall upon the dazzling white numerals above the great clock and cause the ob-

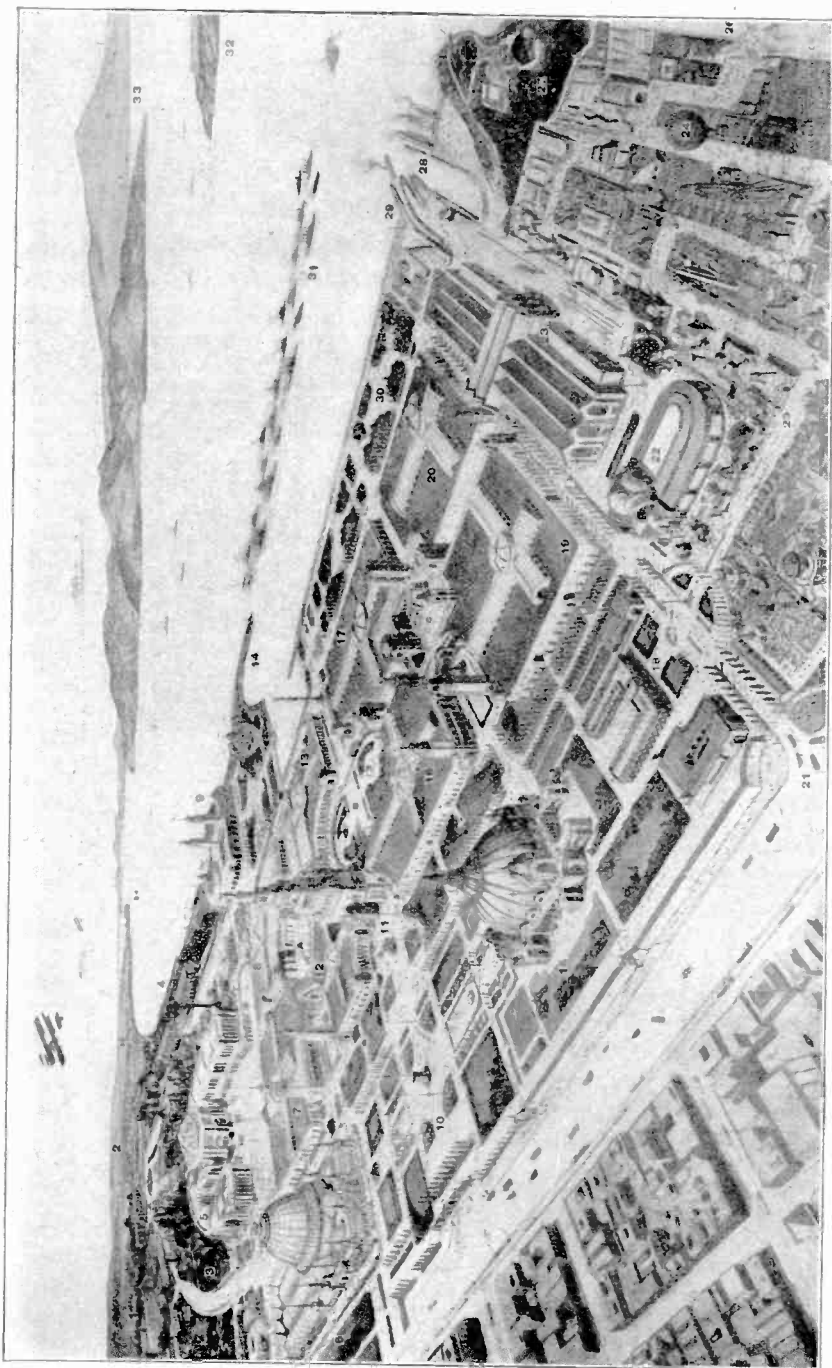

Copyrighted by the Souvenir Publishing Co., San Francisco

BIRDSEYE VIEW OF THE PANAMA-PACIFIC INTERNATIONAL EXPOSITION

To be held in San Francisco, California, February 20th to December 4th, 1915.—Drawn from the official diagrams and plans

- 1—Foreign Governments Building. 2—Live Stock Exhibit. 3—U. S. Government Building. 4—State Buildings. 5—Fine Arts Building. 6—Horticulture Building. 7—Education Building. 8—Food Products Building. 9—California Commerc Building. 10—Grand Main Entrance. 11—Grand Central Tower. 12—Liberal Arts Building. 13—Agriculture Building. 14—Facit Harbor. 15—Festival Hall. 16—Manufactures Building. 17—Transportation Building. 18—J. P. Service Building. 19—Varred Industries Building. 20—Mining and Metallurgy Building. 21—Fillmore St. Entrance. 22—Motor Transportation Building. 23—Machinery Building. 24—Joy City. 25—The Joy Way. Zig-zag Street through the Concessions. 26—Van Ness Ave. Entrance. 27—Fort Mason. 28—Ferry Boat Landing. 30—Grand Marine View Esplanade. 31—Warship Anchorage. 32—Alcatraz Is. U. S. Military Prison. 33—Mt. Tamalpais. The Most Scenic One Day R. R. Trip in the World. 34—Fort Winfield Scott guarding the Golden Gate. 35—Presidio. U. S. Military Reservation. a—West Court of Four Seasons. b—Central Grand Court. c—Festival East Court.



server to forget the world and its cares and behold visions of the coming wonders of the exposition.

The illumination of the tower on the ferry building, combined with that of the structural steel invitation at its base extending for some 600 feet along the roof and built of eight foot letters, is part of an extensive plan to give publicity to the coming exposition, though this building throughout is controlled solely by the State Harbor Commission. In this decorative achievement is seen vividly the powerful and far reaching effect electricity has in the art of exploitation. Some 4200 eight and sixteen candlepower lamps are set in the lines of the tower alone. The numerals comprising the "1915," placed both on the land and bay sides, burn in tungsten white and stand out beautifully, showing well the advantage of tungsten over carbon in lamp filaments. Only 60 watt lamps were used here. The hour-points on the dial of the huge clock are set with sixteen candlepower carbon ruby lamps. The voltage maintained throughout the system is 120.

The great sign conveying California's invitation to the world faces the bay and all the transbay region wherein lie the cities of Oakland, Berkeley, Alameda and Richmond, from which direction travelers come and go in their visits to the city. On clear nights, this invitation and tower, when illuminated, can be observed 20 to 50 miles away, though the letters become indistinguishable at about 20. The entire combination undoubtedly constitutes the largest steel electric sign in the world.

### Radiation from Potassium

It is possible, judging from the experiments of Mons. E. Henriot, that potassium should be added to the short list of substances known to possess the property of radio-activity. The observed amount of radiation is small, but Mons. Henriot thinks that it is not due to the presence of traces of some of the recognized radio-active substances,

but must arise from the potassium itself or from some unknown body associated with it.

### The Rotating Spiral

A curious movement can be obtained by the use of a small rotating bar magnet. The end of the small magnet runs up for a short distance above a table and below is a clockwork or other device which rotates the magnet as a shaft. A small motor can also be used. On the table is placed a spiral of iron wire and this is kept drawn against the magnet, but as the magnet revolves, the spiral also sets up a movement which acts about like a gear movement between these two pieces, since the magnet always adheres to the spiral so as to keep on driving it.

When at the end of the spiral, the mag-

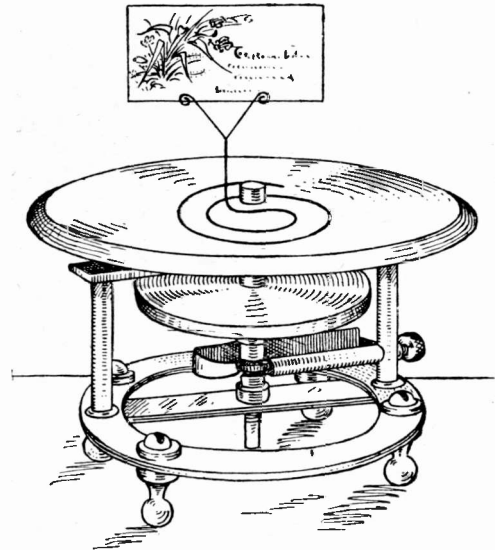

ROTATING SPIRAL

net does not let go, but passes around to the outside of the wire, so that the motion keeps up without stopping as long as the magnet revolves. It is an easy matter to curve the end of the wire so as to make it take an upright position, and a card can be mounted on it. The card now keeps up a continual motion and will serve very well for use in a show window owing to the curious effect it produces.

## SAFE OPENED WITH A TUNING FORK

Mr. Thorne Baker, the electrical expert and investigator of the *London Daily Mirror*, who has done some highly ingenious and interesting "stunts" in electrical experimenting, has perfected a safe which can only be opened with a tuning fork. The safe is made of chilled steel with the regulation knob on the door. But close inspection shows that this knob has no combination or timelock. Attached to it, however, on the inside, are electro-magnets connected by wires with a circuit of dry batteries. These are in turn connected with another set of dry batteries, which are wired to a curious looking apparatus that looks like a carpenter's mitre-box, with a double row of numbers down the inside of the channel. Across this is a gauge, attached to which is an ordinary violin bridge. Over this fret is stretched a music wire of metal, drawn taut to a binding post and passing through this to form a coil below it and outside the tuning box and thence down into the dry batteries.

This mitre box is really a musical scale, set by numbers so that the tone can be gauged up or down by two's as may be desired, to meet the needs of a new combination, or a new

tuning fork, if it is desired to thus change the combination or opening note. The music wire, which may be a guitar, banjo or violin string, is selected and gauged to synchronize with the tuning

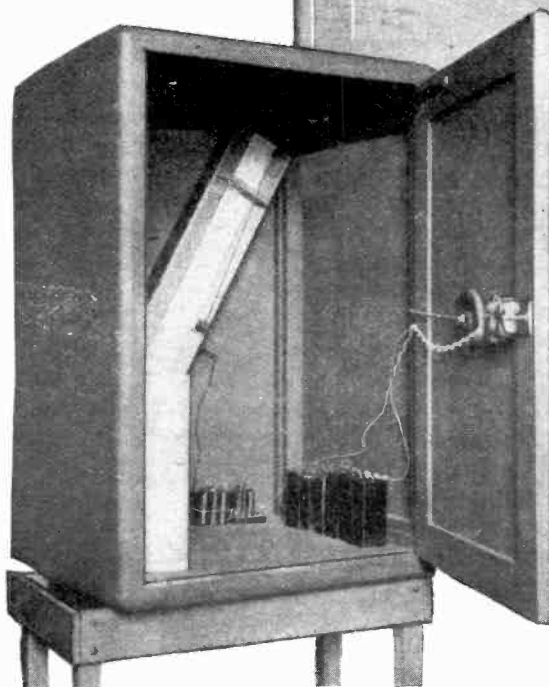
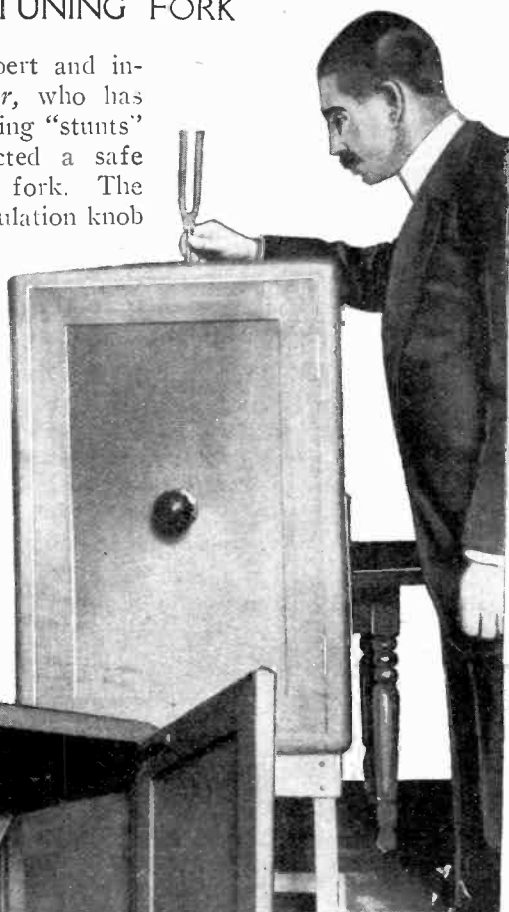

THE LOCK MECHANISM WHEN SET CAN BE OPENED ONLY BY A TUNING FORK HAVING A PARTICULAR RATE OF VIBRATION

fork used. When the tuning fork is struck and placed to the top of the safe, the wire inside catches the vibration from the fork and vibrates in sympathy. This vibration passes through the bind-

ing post into the outside coil and thence down into the small circuit of dry batteries, mechanically closing this circuit. An electric current is thus started which passes on and is made to close the larger circuit of dry batteries which starts a stronger current moving. This stronger current acts through wires directly on the electromagnets that throw the bolts of the concealed lock. Once these are thrown, the door may be pulled open.

After the tuning fork and wire are set to the same gauge, no other tuning fork will have any effect whatever upon the lock. As no two tuning forks are exactly alike in pitch, it is obvious that only one tuning fork in the world could open the safe, once it is closed and locked, and only the person possessing the fork could have access to the safe. However, once it is opened, it can be reset to accord with another tuning fork, whereupon the original one is useless.

### Telephone Extension Bell

It is frequently the case that the telephone bell cannot be heard at all required locations, an extension bell often being necessary. A simple and an easily installed extension device on the market is here illustrated. The circuit closer is

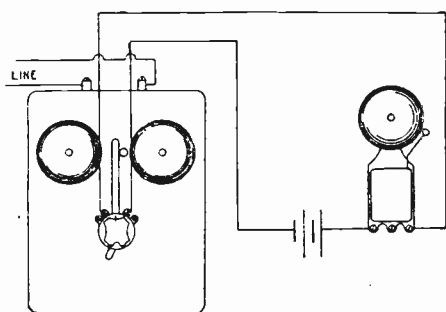

EXTENSION BELL

placed just below the bells on the telephone box and so adjusted that when the bell rings, its hammer will move the circuit closer lever that in turn releases a contact maker which closes the local circuit of the extension bell.

### Measuring Temperature from a Distance

Electrical pyrometers are now coming into industrial use in all kinds of processes, for instance in annealing or hardening furnaces, pottery and cement kilns, enameling ovens, glass works, also for use in finding the heat of furnace gases or steam, or liquid baths. In fact we might enumerate endless uses for them.

The Cambridge Scientific Instrument Works bring out several interesting kinds of pyrometers. One kind uses a thermo-electric couple mounted inside a protecting tube of porcelain or the like, for inserting it where it is needed. Wires lead to an indicating instrument which gives the amount of current, that is, the number of degrees of heat. In a second type the tube contains an electric resistance wire carrying a small current from a battery and connected to a measuring device. As the wire increases in resistance under heat, each heat gives a different current, so that the instrument either indicates or records the degrees of heat in the furnace.

An interesting apparatus works on the Féry principal. Here an open tube with a thermo-couple stands on a tripod near the mouth of the furnace so as to receive the heat rays. The readings are made on a separate instrument, as before. In the upper illustration (see next page) is a Féry pyrometer used at the Sèvres porcelain works near Paris. All these instruments allow of finding the temperature very accurately, and upon this often depends the success of many kinds of industrial processes.

In the lower illustration is shown a pyrometer designed by Charles Burton Thwing. The operator stands at a distance from the furnace door and points a tube at the opening. Inside the tube is a thermo-couple which is affected by the radiated heat. A current is formed in the couple, which is in proportion to the temperature to which the parts are subjected.

USING A PYROMETER, OF THE FERY TYPE TO TAKE THE TEMPERATURE OF THE INTERIOR OF A PORCELAIN KILN



PORTABLE RADIATION PYROMETER, DESIGNED BY CHARLES BURTON THWING—DETERMINING THE TEMPERATURE IN AN OPEN HEARTH STEEL FURNACE

### Police Call System

A police call system in operation at Bismarck, N. D., while very simple in make-up is found thoroughly practical and worthy of adoption by small cities.

An electric light circuit is strung throughout that portion of the business and residence districts within the patrol limits. At various corners incandescent lamps are mounted in conspicuous places, mostly on electric light and telephone poles, both of which by the way are impressed into service to carry the circuit.

Current is led to this circuit from either a switch in the police station or from a pendent switch which hangs just above the operator's head in the local telephone

exchange. It can be readily seen that by these means a call for police gets prompt attention as the operator can push the button in the pendent switch in an instant and then inform the chief of police of the location, and the patrolman seeing the lights flash on immediately calls headquarters or if near by goes there at once with little loss of time.

### Diver's Outfit Equipped with Telephone

The diver in the picture is rigged out in a diving apparatus equipped with a telephone so that at all times he is in communication with his assistants. The apparatus does away with a tube and pump for supplying the diver with air, by having oxygen and air in pressure tanks carried on the diver's back and capable of supplying him with fresh air for from two to three hours. This equipment was recently utilized to descend 70 feet below the surface to inspect the salt water intake pipe of the electric power plant of Lubeck, Germany.

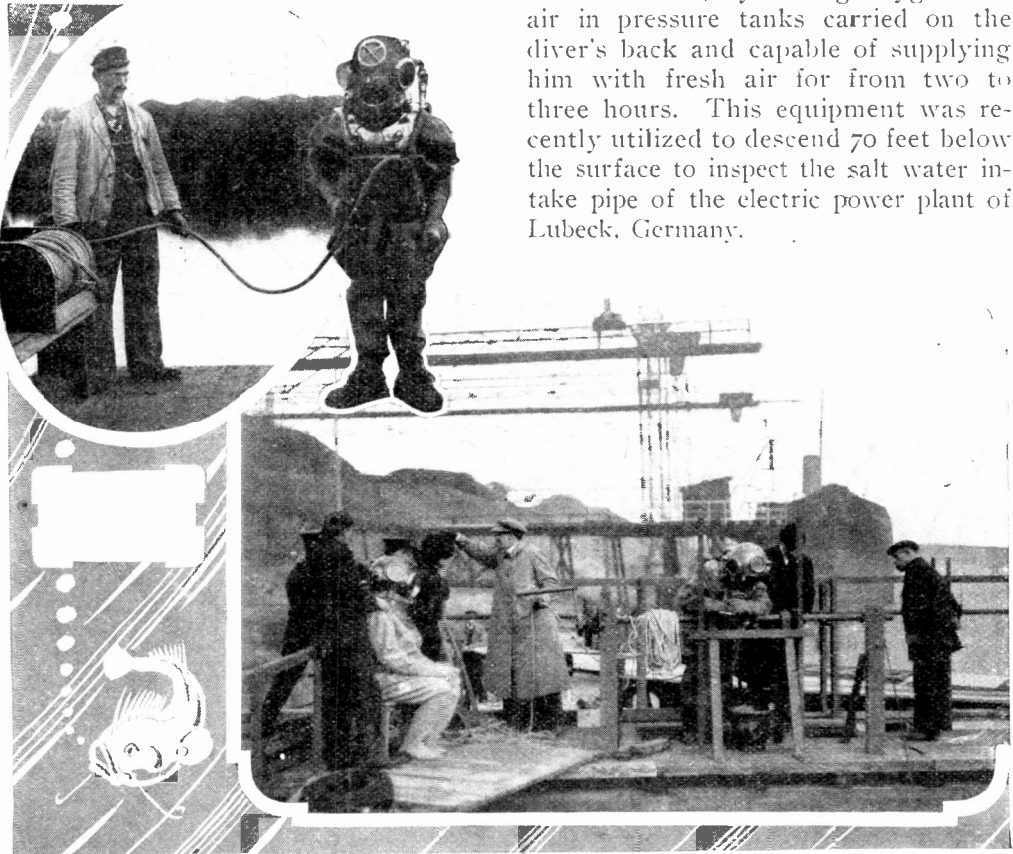

DIVER WITH DRAGER'S SELF CONTAINED APPARATUS PREPARING TO INSPECT THE SALT WATER INTAKE OF THE POWER PLANT AT LUBECK, GERMANY

# Public Entertaining Revolutionized

By ROBERT GRAU

The great slump that has taken place in the patronage of the playhouses in the country has been such that few of the men, who still tempt fate with the production of plays, longer regard the situation with equanimity and the spectacle is now on view of the most important of these producers being intimately associated with the motion picture industry. Not only is Daniel Frohman extensively interested in the film industry but his more celebrated brother, Charles, has announced his entrance into the field of the silent drama.

In the next two months perhaps the two largest theatrical and vaudeville corporations are to adopt a mode of procedure in the conduct of the hundreds of playhouses they control that is likely to thoroughly revolutionize the field of the theater and change the theatrical map from coast to coast.

The two corporations are the John Cort Amusement Company, which owns, leases or controls 200 playhouses west of Chicago and the United Booking Offices of New York, which with its allies represents 90 per cent of the vaudeville theaters of high grade in the United States and Canada.

It is not that these two representatives of vast amusement interests are to create an upheaval by a change of policy that is causing so much excitement on New York's "Rialto," for thousands of players and singers have been reconciled to the tremendous encroachment resulting from the amazing vogue of the photo-play. What has been feared and in some instances prophesied is that the day is near when the distinctly theatrical managers will tire of paying prodigious salaries to actors in the flesh and that they will welcome any genuine solution of the problems confronting them.

The writer, in a previous article, ventured to prophesy that within two years the talking picture would come forth in a manner that would constitute the greatest menace to the older methods of public entertaining yet

recorded (and the playhouse has had to withstand many encroachments); but what worries the thespians who congregate on the "Rialto" is not so much that the talking picture is to be revealed in its latest and perfected form, but that the men who control half of the amusement output in America are to substitute for players and singers in the flesh in their theaters the



DANIEL FROHMAN, THE FAMOUS THEATRICAL PRODUCER, IS NOW ALSO INTIMATELY ASSOCIATED WITH THE MOVING PICTURE INDUSTRY



ADOLPH ZUKOR, WHO, IN CONJUNCTION WITH FROHMAN, HAS INTRODUCED THE WORLD'S GREATEST PLAYERS TO THE FIELD OF THE PHOTO PLAY

two nearest methods of synchronization by which operas, plays and spectacles will be reproduced on the screen precisely as seen and heard in theaters and opera houses, but with science simulating voice, action and color.

These two managerial interests have not acted without deliberation in this momentous procedure.

Many serious conferences have been had and such vital issues as "the increased cost of living" and "reduced prices of admission" as well as "reduced salaries" were discussed from every angle. Final action was taken by both of the big concerns only when coöperation was denied by the players who alone could have prevented the upheaval by accepting lower salaries. And now comes the vital part.

John Cort and his associates have secured the exclusive rights for the Kitsee talking pictures, which are operated on wholly different lines from all previous efforts at synchronization. At the public or rather semi-public exhibition given in New York this remarkable device was voted perfect. The modus operandi has not been made public.

The United Booking Offices have effected an arrangement with Thomas Alva Edison for the exhibition exclusively, in its theaters, of the Edison speaking pictures on which the Wizard of Menlo Park has been working for many years.

When asked what he thought of the talking picture at the time of a demonstration (January 3, 1913) Mr. Edison spoke thus:

"Is it perfect? By no means, nothing that I know of is perfect; every man needs a doctor once in a while to fix him up, so anything I may invent would not be equal to a human being.

"But the way now is clear to the presentation of plays, musical comedies, operas, spectacles and other modes of public entertainment through the kinetophone; moreover it is now possible to duplicate what we call the two dollar show for five cents.

"The poor man, with a family of six, has my sympathy. He earns \$2.75 a day and he can't pay the regular theater prices, and there are 1,000 such men to the man who can afford to go to the modern opera house or any other high grade playhouse. We are already near perfection, and the time is near when the whole thing that is aimed at will

be accomplished, and the people of Poodunk will be able to see as good plays and operas for five and ten cents as the metropolitan playgoer can see at any price. The best of literature and the best of music and drama now can be presented to the poorest persons



MARCUS LOEW, OWNER OF 30 MOVING PICTURE THEATERS IN OR NEAR NEW YORK; UNKNOWN SIX YEARS AGO, AND NOW A MULTI-MILLIONAIRE

all over the world and simultaneously.

"I have been working and thinking of this invention for 34 years. I took it up now and then and dropped it temporarily, and now, with the aid of one of the men in my plant here, we have reached a stage where we are satisfied of the ultimate outcome."

With existing conditions as they are it is not unlikely that public entertain-

ing is about to witness an upheaval. None who have observed the vast improvement which has characterized the progress of the motion picture in its appeal to the public will need to be convinced of the importance of the new era which will be ushered in when all of the above named parties inaugurate what is to be called, so I understand, "The Theatre of Science."

## "Talking Movies," Edison's Newest Invention

Thomas A. Edison tells of his Kinetophone, which produces words and sounds in synchronism with Moving Pictures

By E. LESLIE GILLIAMS

For several years the great electrical wizard has been promising the "talking movies." If anyone else had been working on it the public would have been sceptical as to a satisfactory result. But the American people have faith in Edison's accomplishing the seeming impossible, and he has never disappointed them. The present invention is his newest proof of his ability to "make good." There is only one imaginable class of people who will not thank the inventor for his latest marvel. They are the barn storming actors. For their resentment there is good reason, for it is readily imagined that in a short time there will be no more barn stormers because no one will be willing to pay for second class acting when the foremost stars are performing before the machine and can be seen and heard for a dime.

But one person can properly tell about the kinetophone. That is the inventor himself. He was found at the Edison plant in West Orange, N. J.

"Mr. Edison is upstairs in the laboratory," said Miller Hutchison, his chief engineer and personal assistant, as he led the way.

It is three flights to the "insomnia ward," as Edison's workshop is called. The wizard of electricity was ready for

questions, and he discussed his ambition freely. Now and then, as he talked, his gray eyes lit up and he rubbed his silvered hair enthusiastically.

"What does your new invention do?" he was asked.

"It delivers at the exact instant of occurrence on the film any sound made at the moment such action took place. Every word uttered by the actors is recorded and delivered in time with the action; the creaking of a gate, a whistle, the noise of hoof beats, even the click of cocking a revolver, comes apparently from the screen and in unison with the motion."

"How is it done?"

"Well, it never could have been worked out without the aid of electricity. The phonograph, which is placed behind the screen, is wired to the picture machine, which may be a hundred yards away. By electrical control the speed of the talking part acts as a brake on the film, so that neither can get ahead of the other. There are special records which run as long as the film lasts. Other records can be made to come into place successively, and the performance may be carried out through a whole play. Whole operas will be rendered and the films can even be colored by hand.



"Small towns whose yearly taxes would not pay for three performances of the Metropolitan Opera Company can see and hear the greatest stars in the world for ten cents. And it will pay because of the volume of business.

"Actors will have to leave the legitimate stage to work for the 'movies' in order to get any money. This is all the better for them. They can live in one place all the year round; thus they will be able to lead a normal home life. I can see nothing in the future but big studios, centralized perhaps in New York, employing all the actors all the year round and at a better figure than they now get.

"We want democracy in our amusements. It is safe to say that only one out of every 50 persons in the United States has any real right to spend the price asked for a theater ticket. What chance has the working man for amusement whose income is from two to three dollars a day? No chance at all."

"How long did it take to work out the plan for talking motion pictures?" was asked.

"Thirty-seven years," replied Edison slowly. "It is all of that time since I made a motion picture show inside a box, by dropping a succession of drawings rapidly.

"I have thought of the talking movies and wrote of my ambition ever since. I would take the thing up and work at it for a time, drop it for several years, and then take it up again. I got the device perfected to a certain extent and then one of the men in my plant here worked it out still further.

"The great difficulties in the development of the kinetophone have been twofold. First, there was the obstacle of having the voice and the picture synchronize. Second, there was the difficulty of having a phonograph that would record the voices of the actors on different parts of the stage.

"The question of synchronism has been solved by the invention of a device

that keeps the pictures to the fraction of a second in time with the words or music. The second has been solved by the invention of a delicate instrument that catches the voices of the players on different parts of the stage. The recording needle is more delicate than that formerly used and it catches the words of the player without recording the echo that formerly gave much trouble and made the voice vague.

"In making a talking picture, the actor performs exactly as he does upon the dramatic stage and his every word and action are simultaneously recorded. The action is taken in the usual method of sixteen pictures per second on the negative film, from which the finished positives are printed. The sound is taken on a large cylinder of soft wax, from which the commercial records are molded of indestructible material.

"The strangest thing of all," explained Edison, laughingly, "is that the players become embarrassed at the combination of a phonograph and motion picture camera. It is hard for them to get used to them.

"When the play is reproduced the projector of the pictures is separated from the phonograph. One is at the rear of the hall, the other behind the canvas in the front of the hall. Both are connected by electric wires, however, and the synchronizer is attached to the projector.

"The point is that the man who runs the projector cannot, even if he wishes to, turn the pictures on faster than the words. An electrical device prevents that. He may slow down too much, but an indicator immediately shows the fact to him."

The writer was invited by Mr. Edison to witness an exhibition of the invention in the perfectly equipped little theater attached to the Edison plant. First when the pictures were turned on a lecturer appeared who bowed, but there was not a sound until he opened his mouth.

Then the words flowed forth appar-

ently from the picture. Behind the canvas, however, was a megaphone attached to the phonograph, from which the words really came. Behind the spectators was the projector for the reel of pictures.

The lecturer explained the intricacies of the invention. To show the actual synchronizing of time and action he dashed a plate to the floor. It appeared so real it made one of the spectators sitting in the front row jump in dismay. The lecturer played a bugle, and the swelling of his cheeks kept perfect time with the sound. He blew a police whistle, called in dogs which barked loudly, adding still more to the effect of action and sound. A violinist played a melody, and then a young woman sang, and to the ordinary observer the synchronism was perfect.

Part of a light opera was given next. A scene from "The Chimes of Normandy" was presented with lightness and delicacy of tone and music and vivid acting. That was followed by a song from "Il Trovatore." Then the quarrel between Brutus and Cassius in "Julius Caesar" was acted in a way that showed the actors and the synchronizer on the Kinetophone followed Shakespeare's advice of suiting "the action to the word."

The quarrel is so thrilling, that any lover of Shakespeare can find himself holding onto his seat entirely oblivious to the fact that only a man made machine is portraying the fierce anger of the Roman officer.

To light comedy the kinetophone turned next, giving a short sketch called "The Politician," with slang, rough vocies and gayety, showing still other phases of the new invention. Again the spectators were able to judge how the voices of the players were reproduced in keeping with their actions. The last reel showed "Dick, the Highwayman." It was full of action, daring and shooting, but at no time was there any apparent difference between the gestures and the voices.

It was observed, however, that the players apparently made an unusual effort to speak distinctly. M. R. Hutchison, Edison's chief engineer, said, however, that the phonograph catches words less distinctly articulated and that the gestures had been emphasized to prove the synchronism of the gestures and the words.

In all of these pictures the spectator was impressed by not only the perfect synchronism, but the remarkable illusion. When the actors were up-stage and walked down-stage, their voices increased in volume and in proportion to their photographed figures, and seemed to come from the right or left of the stage, as they were situated. The strange part is that one ceased to think of the phonograph and kinetoscope and his entire attention is held by the action of the piece, and he enjoys every thrill exactly as he would in a theater.

---

### High Tension Roof Wiring

The increasing use of electric power transmission at potentials of from 60,000 to 100,000 volts has necessitated great improvements in the design of generating plants and substations, as the circuits of such installations literally carry chained lightning. The accompanying illustration shows the care which is now taken in building plants of this kind to provide for the proper mechanical support and thorough insulation of the incoming and outgoing line conductors. In the case shown, which is the roof of one of the Deerfield River plants of the New England Power Company, the 60,000 volt lines are dead-ended at strain insulators fastened into the wall of the station and from these dead-ends taps are taken as shown, to high tension insulators mounted on angle irons with latticed cross bracing to provide a firm support under heavy wind conditions. Horizontal leads are then run across the top of the roof at a height well above the head of the tallest man, and taps are

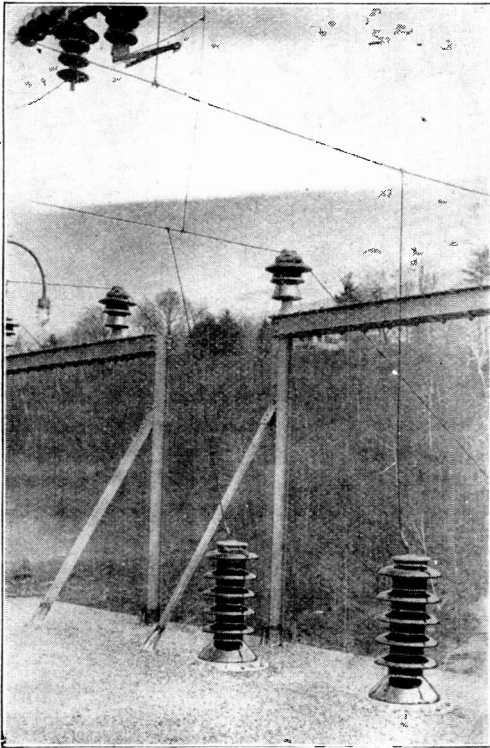

HIGH TENSION ROOF WIRING

made from these horizontals to disconnecting switches, lightning arresters and to the transformers in the station below through five-part insulating bushings. The size of these bushings, their wide spacing, and the protection of the legs of the standards supporting the insulators all emphasize the extraordinary care which must be taken to give the safest and best quality of service when dealing with such high potentials.

### Why Tungsten Lamps Are Better Than Carbon Ones

The amount and quality of light emitted by a hot piece of metal or any other substance depends on the temperature, therefore the hotter it is the better will be its light giving qualities. We can make either kind of filament get as hot as we wish by making it of the proper size and length, for a given voltage. But the carbon fila-

ment will evaporate like a piece of camphor if it gets much over 1800 degrees, whereas the tungsten filaments will not evaporate until they are hot enough to melt. The evaporated carbon will collect on the inner surface of the globes and spoil the lamps by blackening them, and the blackened surfaces will weaken the light. The tungsten lamps will therefore work at a higher temperature than the carbon and will give more light for the same amount of electric energy, because of the fact that at very high temperatures the energy wasted in heat is less than at low temperatures.

To make this last point clear we must remember that light and heat are similar forms of energy; that is, they are merely wave motion of the ether. The difference between light and heat is that the light is heat vibrations that are rapid enough to be perceived by the eye. The slowest heat vibrations that can be seen give us the impression of red; the fastest ones give the impression of violet. Each color corresponds to a different speed of heat vibration beginning with red, thus: red, orange, yellow, green, blue, violet.

White light is a mixture of all the colors and its quality depends on the relative amounts of each. Carbon lamps, being colder than tungsten, have too little blue and violet in proportion to the red and yellow, hence the yellow appearance.

Also the proportion of the total visible heat radiation (light) to the invisible (heat) is less for the colder carbon filament than for the tungsten because we see that the higher frequencies (faster vibrations) disappear first, as the filament becomes cold. Suppose we start at white heat and gradually cool the filament. At first it gives off some light, say five per cent, and a great deal of heat. The heat we consider wasted since we want a light and not a heater. When it is

cooled to red heat it gives off much less heat but what it does give is all wasted energy since the small amount of red light is useless. The carbon filament may not give off any more heat than the tungsten, but the light it gives would be less and hence it is more wasteful. A red-hot horse shoe would not give off as much light as a white-hot nail but it might give off more heat, and require more coal to heat it.

There is another advantage of the tungsten lamps, which is that they will give better light on circuits where the pressure or voltage is not steady. If the pressure of a 110 volt circuit falls to 100 for any reason the carbon lamps will become so dim as to be

rent is greatly weakened. Tungsten, however, is a better conductor when cold than when hot and when the temperature falls because of the weakened pressure the resistance will become less and will therefore tend to keep the amount of current flow constant in spite of the diminished pressure.

### Classes in Pulmotor Practice

Much is heard these days of the pulmotor, which has rendered such marked service in saving the lives of persons overcome by gas. A great many of the electric lighting companies in the larger cities now give free "pulmotor service," after witnessing the successful results attending the initial experiments in this



A CLASS IN PULMOTOR PRACTICE

almost useless, while the tungstens are scarcely affected at all. This is due to the fact that carbon has a higher electrical resistance when cold than when hot and when the temperature falls because of the weak pressure the resistance increases so that the cur-

direction last spring, by the Commonwealth Edison Company of Chicago.

Originally the idea of an electric light company keeping such a device on hand was to render first aid in cases of electric shock, but these cases are few and far between as compared with cases of as-

phyxiation and we find the electric light companies in a very humanitarian way assuming the burden of rendering first aid to gas victims.

A thousand men in New York have been trained in the use of the pulmotor. The men are the workers in the electrical construction, the operating and the distribution departments of The New York Edison Company and their familiarity with the use of this mechanical life saver is due to the fact that special classes for their instruction have been held since late in October.

First the men who install electrical apparatus in the stations were taught, then the men who are in charge of the generating apparatus and finally the men who work on high tension cables of the distribution system were taught. Twelve men constituted a class and they met at all hours of the day. Some assembled in the early morning, some later in the day and some in the evening—it depended on the shift in which the men worked, for it was the desire of the company to reach them during the working hours rather than call them together in their own time.

Three company physicians had charge of the instruction, which included not only the use of the pulmotor but of one of the older methods of artificial respiration; that is, by the application of pressure to the back. After the men had been told under what circumstances the application of artificial respiration was proper—that is, in cases of electric shock, gas poisoning, suffocation from smoke and apparent drowning—they were shown and given practical instruction in the Schaeffer prone pressure method.

The mechanism of the pulmotor was then explained, the men being told how to ascertain the amount of oxygen remaining in the cylinder and how to replace an exhausted for a full tank, after which the instructor showed the machine on an unconscious man. After this demonstration the class paired off for practical work, one man acting as the

victim while the other put the machine in operation.

The introduction of the pulmotor in New York followed the Electrical Exposition of last October, when two victims of illuminating gas were resuscitated. There are now machines in every sub-station and the Waterside generating stations of the Edison company as well as in several hospitals.

### Suction Cup Fixture Holder

An electric fixture to which is attached a little rubber suction cup that can be pressed against a window, a mirror or against any other smooth surface and by atmospheric pressure holds the fix-

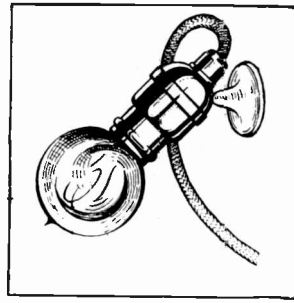

FIXTURE HOLDER

ture in position is a recent useful novelty on the market. With the Hand-E-Lite fixture is twelve feet of silk cord. The device is so small that it can be stowed away in the traveler's smallest handbag ready for service in a moment's time.

### Electric Drilling in the Oil Fields

The use of electricity in the oil fields has recently been tried out on the property of the Midway Pacific Company and has been proven a success. Well No. 2 was put down by electric power at a saving of \$5,000 over the cost of drilling No. 1 on the same property, which was done by the old method.

There was a great economy in time as well and in every way the experiment proved that electric power in the California oil fields has a great future.

Some years ago the electrical contracting business was anything but a holiday affair. There was very little standardization of methods, no co-operative effort and most of the contractors went around with chips on their shoulders—and there was chaos. Finally some of the more far-sighted ones saw that if the business was to prosper, singleness of interest would have to be the rule instead of the cut-throat methods then frequent. So a small group of them, not over 30, assembled and formed the National Electrical Contractors' Association. This was some twelve years ago. Its force began to be felt immediately. Out of it came such co-operative benefits as the

the electrical contractor. The electrical contractor as a rule is a poor business man and his accounts are recorded usually in a loose leaf book carried in his hip pocket. When a job is finished he has no accurate way of checking up to ascertain how much it has cost him and if he has done the work at a loss he has no method of determining where the trouble is.

One of the things Mr. Freeman desires most to accomplish during his presidency is that of placing in the hands of every association contractor a system of bookkeeping applicable to this industry and so simple that the contractor will have no difficulty in checking up.

# Electrical Men of the Times

ERNEST FREEMAN



1212

POPULAR ELECTRICITY MAGAZINE

One of the stories he delights to tell illustrating the co-operative and friendly spirit engendered among the members has to do with a contractor in a large city in Texas. This contractor was new at the business. At best his resources were small and he had bought a large bill of goods on consignment, returnable in six months if not sold. The six months rolled around and most of the goods were still in his store. He had done very little business, creditors were insistent, and he was very down in the mouth. Finally came the sheriff and closed him up and took away his fixtures which were to have been returned.

His extremity became known to the other electrical contractors in the city—fellow members with him in the Contractors' Association. Immediately they formed a pool and staked him, so to speak. They got his fixtures back and opened his store and furnished him some ready money to tide him over. All these brother contractors turned over to him one job of work each, which they had secured for themselves—enough in all to keep him busy for a considerable time—and even lent him men to do the work. He is now one of the most prosperous contractors in that city.

Before the formation of the Association his fate would have been a different one. And it is this very spirit of live and let live, of co-operation instead of elimination, that Mr. Freeman loves in his association, and which he has been so instrumental in bringing about.

On entering Mr. Freeman's offices one is impressed with the quiet, systematic handling of business and this quiet, systematic way is characteristic of the man himself. If he is making a speech he talks slowly and seems to measure each word; but every single word he "gets over;" to use the venacular of the stage. While made to feel perfectly at home, the interviewer's "Tell me something about yourself" is met by a smile and a suggestion that friends and other

sources must be appealed to if one is to find out how this brown eyed man of medium height and quiet personality has won success.

## Telephones in the Vatican

The Vatican has had a telephone system since some time after the present Pope came into power. He is a most progressive man and believes in the adoption of facilities to expe-



TELEPHONE SWITCHBOARD IN THE VATICAN, IN CHARGE OF A UNIFORMED ATTENDANT

dite the enormous business of the Vatican. This telephone system is not only an interior system, but has connection with the outer world by a trunk line or two.

While the Pope does not often use

the system himself, since his secretaries attend to details of Vatican business for him, it is used many times a day on his official business, to transmit his instructions to the various church dignitaries, some of whom reside at the Vatican and many others outside. It can be connected with the long distance lines of Rome and thus with those of the other European cities having telephonic communication with Rome. The picture herewith shows the private exchange telephone switchboard in the Vatican in charge of a uniformed operator.

### Missoula's Lane of Light

"There are cities with a greater number of similar lights in use; there are cities which have spent thousands for a more artistic arrangement of ornamental posts and clusters, but there is no city that has a district of equal size so well lighted." So says *The Missoulian* of Missoula, Montana.

There are no confusing shadows, no dark corners, and the beauty of the win-

dow displays is greatly enhanced by the light from the new lamps. The illumination from without has made it possible for many merchants to reduce the number of lamps within and has been the means of effecting considerable saving to them in this manner.

The accompanying picture of the city's main thoroughfare at night speaks forcefully of the street illumination. Luminous arc (magnetite) lamps set upon brackets eighteen feet above the street are used. The brackets are attached to steel poles set opposite each other on the street, and spaced 100 feet apart along the curb.

Small expense was incurred by the city in connection with the installation owing to the liberal manner with which the matter was handled by Mr. W. A. Clark of the Missoula Light and Water Company. Missoula is the first city west of the Mississippi to adopt these lamps. The first town in which they were used was New Haven, Conn. At present there are ten installations in different parts of the United States, and a large number of towns are considering their use.



NIGHT SCENE IN MISSOULA, MONTANA



# Electrical Interests of Women



EDITED BY GRACE T. HADLEY

## A Lesson in Values

Mrs. Fitzgerald, radiant and successful, awaited her husband in their well furnished dining room; when he appeared, she rang for the maid to serve the bouillon. Then facing him across the spotless table, she proceeded eagerly to demand:

"Have you heard the news?"

"What news?" inquired her husband leisurely.

"I was elected president of the Suffrage Society at the meeting today," was the proud announcement.

"Then I presume you are going in for votes for women and that sort of thing."

"Exactly!" exclaimed Mrs. Fitzgerald.

"Is suffrage taking precedence over bridge and teas and becoming fashionable?"

"Indeed it is among thoughtful women. It is in the very air and even frivolous women are beginning to wake up."

"I don't see why women want to vote," began Mr. Fitzgerald, helping his wife to a choice bit of rare beef. "Don't I provide well for you? Don't I give you the best of everything?"

"Yes, you are a dear, but we women want to be real citizens. We have had a great deal of experience in practical housekeeping within the four walls of our homes and now we want to have a hand in municipal housekeeping."

"Well, we business men are so busy tending to our own affairs we have been in the habit of letting the politicians run things."

"That's just the point. Property own-

ers and business men do not take sufficient interest in municipal affairs. You are all too busy making money. You say things about the grafters, pay the graft and keep right on making money."

"But I don't see how it's going to help if women mix up in such matters."

"To illustrate," began Mrs. Fitzgerald judiciously. "there is the initiative, the referendum and the recall which should be in operation now in practical politics. I have practiced the recall for some time in the administration of my home affairs."

"I don't think I quite understand."

"When you voters put a man in office he is elected for a certain length of time and no matter how crude or how inefficient he may prove to be, or how much positive damage he may do in municipal affairs, there he stays until his term expires. Could anything be more foolish or more wasteful?"

"I admit your point. What is your plan?"

"Well, when I employ a maid who proves to be inefficient, I put into effect the recall. If she begins to break up the dishes, I do not let her continue to break up my best china for two whole years, I recall her at once and dismiss her."

"And do the dishes yourself?" inquired Mr. Fitzgerald quizzically.

"No," returned his wife calmly and serenely. "I get an electric dishwasher and save my chinaware."

Mr. Fitzgerald laughed in his hearty, wholesome way.



"Would you suggest an electric dishwasher for municipal management?"

"No," returned Mrs. Fitzgerald brightly, "but I would apply electrical efficiency to practical politics. Instead of doing the municipal housekeeping in the clumsy, cumbersome way it has been done, we up-to-date women would introduce the principle of efficiency in civic affairs. The slogan of the modern housewife is, 'efficiency, economy of operation and values.'"

"Values!" repeated Mr. Fitzgerald vaguely.

am just a plain everyday banker, and not accustomed to sounding the subtleties of psychology or chemistry."

Br-r-r-r-r! buzzed the front door bell. The maid entered promptly with a folded paper in hand which she gave to Mr. Fitzgerald.

"Great Scott!" exclaimed that gentleman in startled tones.



"GREAT SCOTT! BUT I'VE HAD A GREAT LESSON IN VALUES"

"Yes, women have always been the great conservers of social values. All men do is combine and recombine the elements they find and sometimes the combinations they make are bad, while women have always been accustomed to give things time, place and form values."

"You have a habit, Marian, of sometimes getting beyond my depth," observed Mr. Fitzgerald. "You know I

"What is it dear?" enquired his wife sweetly.

"It's the bill for the electric dishwasher," remarked the head of the house weakly. "You've saved your china, Marian, but—"

"But what?" said his brilliant wife.

"Oh, nothing, it's all right, but I've had a great lesson in values and of course that's worth something."

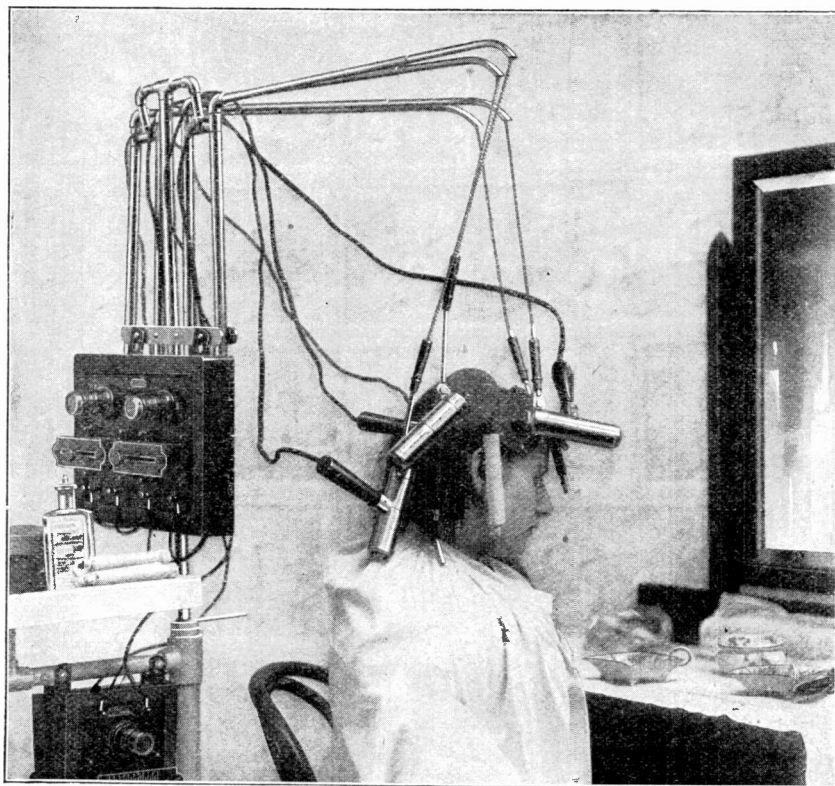

FOUR HEATER OUTFIT FOR HAIRDRESSING ESTABLISHMENTS

## The Permanent Hair Waver

"What would you do with hair like this?" The question was asked by a comely young woman, who possessed a clear complexion, hazel eyes, good features and a tendency to make the most of her talents and her natural charms, but her hair was her despair. It was irregular in length and hung down in lanky locks about her eyes. Every morning with a hot curling iron she gave these locks a few twists on the curler and pinned them up out of her eyes, but by nightfall they hung disconsolately downward without a vestige of curl in them, hence her despairing inquiry.

"What would you do with hair like this?"

"Well," remarked the friendly visitor, "I would have such hair put into a permanent wave."

"A permanent wave," said the young woman, "why what is that?"

"The permanent wave is a new patent process of changing straight hair into natural wavy hair by electrical and chemical process of recent discovery. It is the invention of an eminent specialist formerly of Paris and Germany. It is well known in Europe where it has delighted many women, but women on this

side are quite mystified as to its action.

"To explain simply, just picture a strand of hair as a horn tube. Children's hair and naturally curly hair have tiny pores leading from the surface into the interior of the tube or central channel of the strand of hair. These tiny pores become clogged by a fungus growth as the years pass and with the closing of the pores opening into the central channel, the hair becomes lank and straight, losing its charm and becoming difficult to dress becomingly. The permanent hair waver produces the wave or curls of any style by opening these tiny pores, by removing the fungus growth from the affected straight hair, cleansing it and giving to it the beautiful texture as well as other advantages of natural wavy hair. When once waved, the hair remains so until it grows out from the roots."

Exorbitant prices are obtained by doing this work and the demand has been greatly in excess of the supply of skilled operators who have learned to do it. It is possible for a skilled operator and assistant to wave two heads of hair a day, which would mean an income of something like sixty dollars a day. This can be done at the lady's own home providing there is electricity available, so that it is not really necessary to have an establishment to do the work.

The hair must first be shampooed and it is advisable to have this done the day before the waving is done. After arranging the outfit so that everything is convenient for use, the work is begun by dividing off a portion of the hair beginning in front and tying close to the roots with the tying cord. A strand of hair is wound very tightly around the curler beginning at the end that is tied and the winding must be perfectly flat and smooth. Tie the thread after the entire curl is wound and it is ready for the application of the chemical. The strand of hair is then covered with a



A SMALL OUTFIT IS MADE FOR HOME USE

strip of gauze that protects the hair from the powder after the chemical has dried. A flannel strip moistened with the chemical is wound over the strand above the gauze. It is now ready for the asbestos tube which is slipped over the strand. A shield protects the scalp from the heater. The electric current is then turned on until steam appears from the ends of the heater. This heat creates a vacuum and the suction combined with chemical action draws from the hair the particles that close the cells. By this process the hair is transformed from straight hair into a naturally wavy condition. Hair that is naturally wavy is free from cell clogging fungus growth and if hair that has been subjected to this treatment should become straight, all that is necessary to restore the wave is a good shampoo. Such hair is not affected or straightened by rain, moisture, or shampoo. It is claimed that the process is a benefit to the hair.

A complete outfit for giving this wave at home consists of two electric controllers, heaters, curlers, tubes, chemical and other accessories.



### Captured Coffee

Here is a new coffee pot in which the coffee grounds are scientifically brewed. With prevailing methods the coffee is apt to be overdrawn or else the desirable essences escape before the coffee reaches the cup. Here the coffee grounds are placed in a perforated receptacle at the top of the pot. The electric heating unit is so constructed that only a small portion of water is heated at one time. Steam generated in the pump in the water reservoir forces the water up through the pump tube and sprays it over the coffee grounds. The water percolates through the coffee and



back into the reservoir, the process being continuous. The little pump inside this pot is constructed on the same scientific principle as a city pumping station.

The aromatic, volatile essences do not escape but are captured, producing a delicious beverage.

### Recipe Box Aid to Housewife

The recipe box is a quick and convenient system to take care of cooking recipes. Each recipe is on a separate card filed behind appropriate guides. New recipes may be added at any time. Every woman who has used the ordinary cook book has realized its limitations. It is

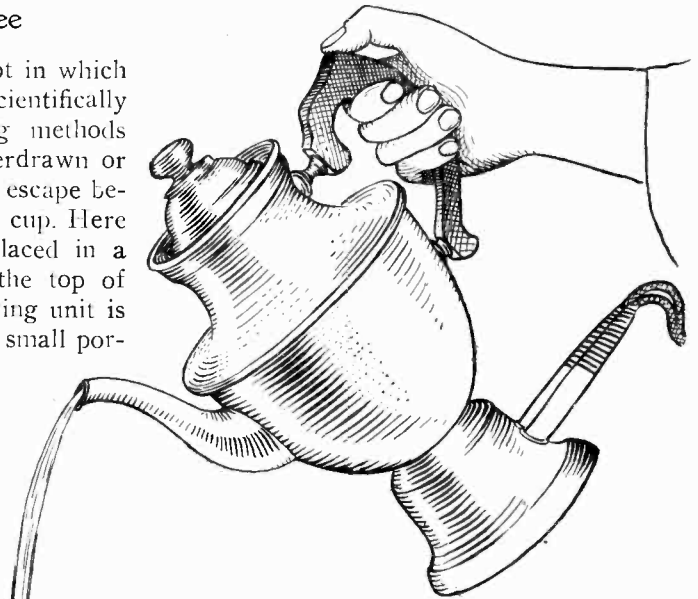

often cumbersome to handle, it does not provide for new recipes and it becomes soiled quickly. Every woman has said at one time or another, as she ran across an appetizing recipe in a magazine, "I'll try this some time, it looks good." But generally she doesn't, because the magazine when wanted is not to be found. Now with the recipe box, you simply take out

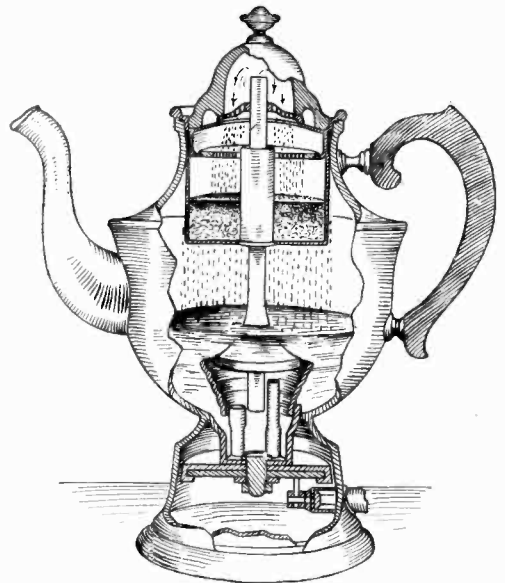

COFFEE BREWED ON SCIENTIFIC PRINCIPLES

a blank card, paste the recipe on one side, make any notations you wish on the other side and file in the box.

There are the hundred-and-one household helps which are encountered in the day's reading. Some are valuable and should be preserved. With the recipe box at hand it is only necessary to clip the article, paste it on a card and file it behind the proper guide in the box. The recipe cards are unique in that they give the ingredients in one column, the quantity in the next column and remarks occupy the third space. In the ordinary cook book the ingredients, quantities and directions are all run together and it is often difficult to differentiate one from the other.

### Clock That Needs No Winding

For years many inventors have tried to produce a practical and ornamental electric clock for the home: one which would not need to be wound and would yet be so simple in its mechanism that it could be produced at a price within the reach of all.

A new clock said to fulfill these requirements is sold under the trade name of the "Never-Wind." The case is of polished brass, heavily gilded and lacquered, 9½ inches high, 6 inches wide and 5½ inches deep. The clock operates without springs, weights or wires or any outside connections, the motive power being an ordinary flashlight, dry battery concealed in the base. The cost of the battery is 25 cents and as the battery runs the clock six months or more, a cent a week for battery power saves the trouble of winding the clock.

From the battery in the base, two small wires run in one of the hollow posts at side of clock, one from the carbon and one from the zinc contacts of the battery, these wires connecting, one with an electro-magnet and one with the pendulum wire at very top of clock movement. The pendulum weights do not swing to and fro as in an ordinary clock but revolve first about one and a

half turns to the right and then to the left. On the pendulum wire is a platinum contact pin, which by the action of the pendulum is brought into contact with a platinum plate, thus completing the electric circuit, pulling up the armature at bottom of the magnets which in turn works a pawl on the ratchet wheel

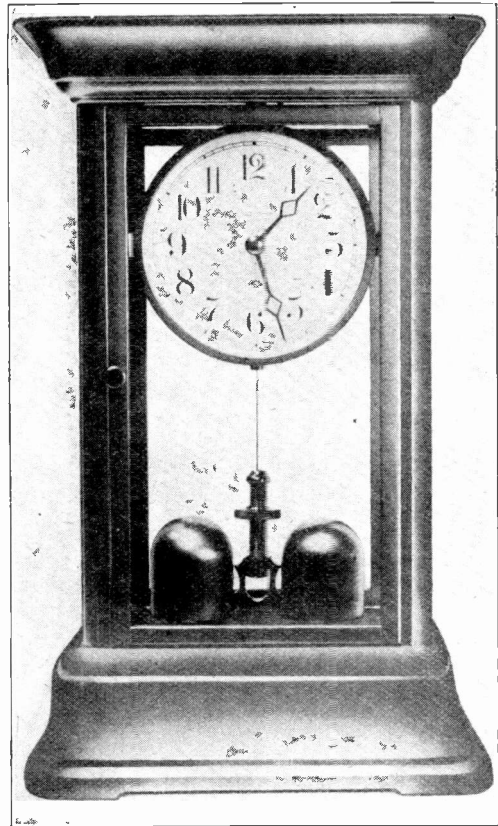

CLOCK OPERATED BY DRY BATTERIES

and thus the minute and hour hands are operated.

A regulating nut just above the pendulum weights can be turned to the right for "fast" or to the left for "slow," in this way shortening or lengthening the twist of the pendulum wire, which in turn regulates the time of the clock.

It is amazingly simple and needs only to be seen to be appreciated, especially by all women who forget to wind their clocks or watches.

### A Versatile Small Motor

Mrs. Deemer, a Pennsylvania woman, has solved the servant problem in a very unique and efficient way by letting a small motor do her hard work. It is true, of course, that many women have a motor driven washing machine, or a motor driven vacuum cleaner, but usually the motor does just one thing and no other. Mrs. Deemer's, however, has seven distinct duties. It runs a vacuum cleaner, a washing machine, a grinding wheel, a polishing wheel, a ventilating fan, a sewing machine and an ice cream freezer. Current is taken from the nearest lamp socket and the motor is started by simply turning the switch.

To operate the vacuum cleaner, the motor, which by the way doesn't weigh much more than a flat iron, is clamped to a small platform and belted to the vacuum cleaner pump, which with the dust receptacle is also mounted on the platform. The platform has casters and rolls around very easily. With this outfit it is easy work to get the dust out of the rugs, tufted furniture, portieres, mattresses and corners hard to get at with a broom.

In a similar way the motor is attached to the washing machine. On wash day the motor is started, and while the family is at breakfast the first tubful is being washed; the second is put through while the dishes are being washed. No attention is needed except to put in and take out the clothes.

For polishing silver a chuck is screwed on the extended shaft of the motor, a cloth wheel is slipped on and it takes just a few minutes to polish all the silverware. By substituting an emery wheel the kitchen knives, choppers and the like are kept in good usable condition.

A fan wheel can also be attached to the shaft and used to circulate the air in the summer and to distribute the furnace heat throughout a room in the winter.

By transferring the motor to the sew-

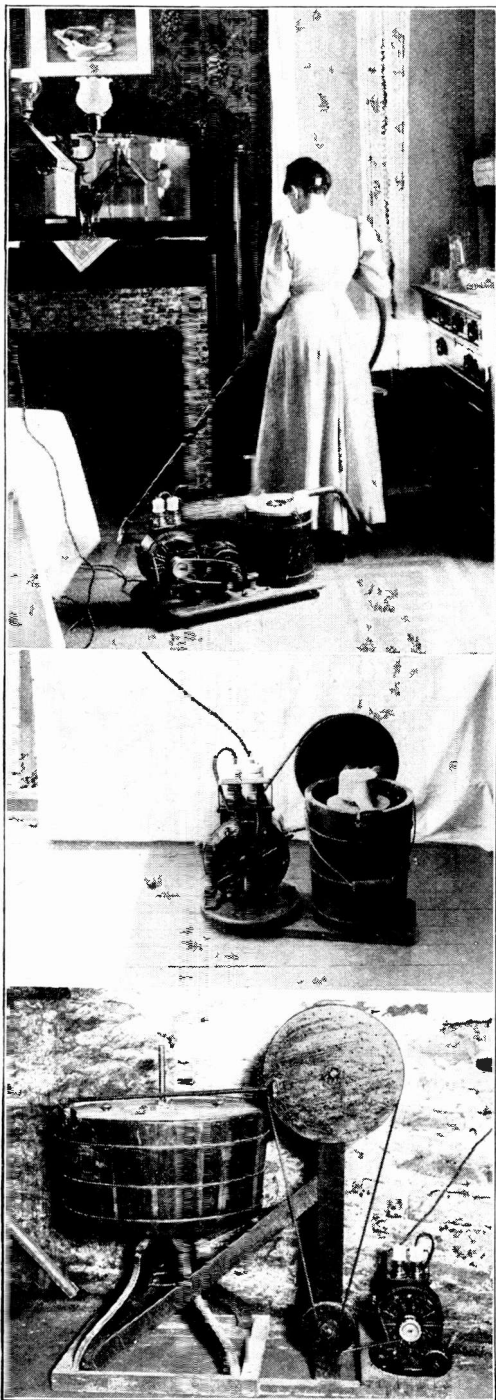

SOME OF THE USES OF A SMALL MOTOR IN THE HOME

ing machine all the hard part of sewing, the treadling, is eliminated. A small idler pulley permanently attached to the motor (shown in the illustrations) is connected by a small chain to the treadle. The belt is run from the motor pulley, over the idler pulley and around the machine hand wheel. By pressing on the treadle the belt is tightened and the machine starts. The speed of the machine is controlled by the pressure on the treadle from a stitch at a time to as fast as desired.

Lastly, the motor turns the ice cream freezer. This was originally hand operated but the crank was replaced by a homemade wooden wheel grooved for a belt. To make ice cream electrically takes about five minutes against two or three times as long by the tiresome hand method; consequently homemade ice cream is almost an everyday occurrence.

It was very easy to apply this motor to so many useful duties and it seems strange that there are so few instances of this kind. It is rated at  $1/6$  horsepower and costs about two cents an hour to run.

### Electricity as an Invigorator

A certain person was ill and on the verge of collapse. She was sure that she could not live through the day, and it was to be a busy day. It was impossible for her to get away to the Springs, but there was hope in an electric bath treatment. There were some very fine baths in the city where she lived, and she resolved to try them when she was about ready to drop from exhaustion.

First she was placed in an electric light cabinet for fifteen minutes, then she was hustled into a tub of warm water with electric currents vibrating through it. "Now, you are going to feel this in your shoulders," said the attendant, and she felt it. "Now you are going to feel this up and down your spine." She felt it. There was a merry little sizzling song on the switchboard and the life-giving currents pulsed through the warm water.

Then came an excellent salt rub and an exhilarating pine needle shower, and the healing process was complete. The sick one was well. "How do you feel?" inquired the attendant, poking her head into the rest room an hour later. "Fine," exclaimed the patient; "I think I'm about well and I'm as hungry as a bear."

Mechanical and electrical therapy are coming into more and more use in treating ailments, and the results obtained are such as to cause the greatest hopes for the future of this kind of treatment. In this field electricity has no competitor, for the science itself is built on electricity.

### Thoughts for Housewives

When women are free from the barbarities of present methods of house-keeping—the market basket, the kitchen utensils, the scrubbing brush gone from every house; electricity everywhere spreading warmth and life, they will still be forced to do a certain amount of work. This cannot be avoided even by the help of the most perfect apparatus or by co-operative methods, provided the house is not to be replaced by the barracks.—*Ellen Key.*

Wherever a true wife comes, home is always around her. The stars may be over her head—the glow worm in the night-cold grass may be the fire at her foot, but home is where she is; and for a noble woman it stretches far around her, better than houses ceiled with cedar or painted with vermilion, shedding its quiet light for those who else are homeless.—*Ruskin.*

You talk of the fire of genius. Many a blessed woman who dies unsung and unremembered has given out more of the real vital heat that keeps the life in human souls, without a spark flitting through her humble chimney to tell the world about it, than would set a dozen theories smoking or a hundred odes simmering in the brains of so many men of genius.—*Oliver Wendell Holmes.*

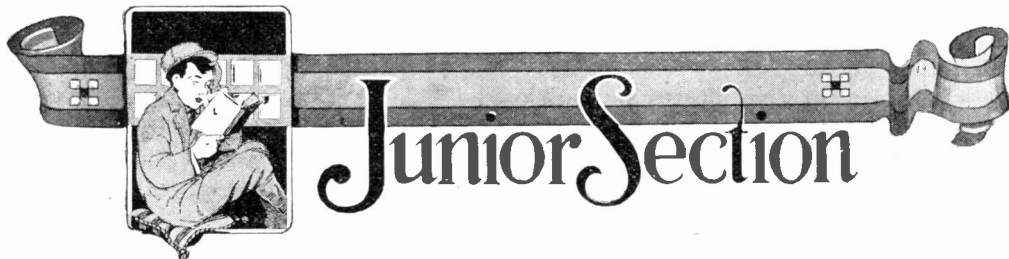

# Junior Section

## To Take Your Photograph.

With an ordinary camera and the apparatus described, one may take his own picture in a darkened room and obtain fairly artistic results. The flash part of the equipment requires a  $3\frac{1}{2}$  volt battery, a  $3\frac{1}{2}$  volt tungsten lamp, fourteen feet of flexible wire to make connections, two battery binding posts, a strip of copper or brass  $\frac{1}{2}$  by 4 inches and a block of wood. Drill a hole in the strip the same size as the binding post screw and about  $\frac{1}{2}$  inch from the end, then connect up the wooden block as shown with the switch in series with one of the wires running to the lamp.

To take your own picture, place the camera on a table and focus it upon some object that is about the same height as your shoulders and the right distance away. Leave the camera setting in this position and turn out the lights as the room should be dark. Now open the shutter of the camera, place the lamp in your hands, using them as a reflector and when you have about the right position press your foot against the spring switch. This will light the lamp and in turn light up your face. The exposure may be about 30 or 40 seconds at the end of which the foot releases the spring contact. Before turning on the light close the camera shutter. A few trials will settle the time question. Photographs taken in this manner do not have the startled expression characteristic of flashlight pictures.



METHOD OF TAKING ONE'S OWN PHOTOGRAPH, AND THE RESULT

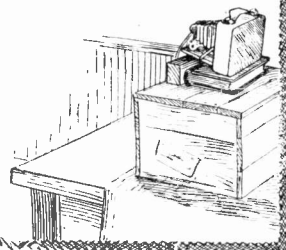

## The Power of a Meteor

A most curious observation of the effects produced by a meteor at sea was once made a part of a government report.

Some years ago, the captain of the British steamship "Nerano," when a little more than 200 miles southeast of Cape Clear, during a voyage from Baltimore to Havre, saw a meteor that appeared to pass close to his ship.

An observation of the North Star taken soon after the appearance of the meteor showed a surprising result. The



direction of the ship's compass needle had been changed no less than eleven degrees. Before the meteor passed, the needle had pointed about five degrees 30 minutes west of true north, but now it pointed five degrees 30 minutes east of north.

That the meteor had caused the change was indicated by the fact that within 24 hours the needle returned to its former position, moving slowly back about eleven degrees toward the west.

## Aiming and Firing a Heavy Gun

Comparatively heavy ordnance, that is, guns as large as four and six inch bore, are aimed and fired in much the same manner as the lighter guns, by aiming directly through the telescopic sights from a position at the breach of the gun. But of course the piece is much too heavy to swing and depress readily by hand, so

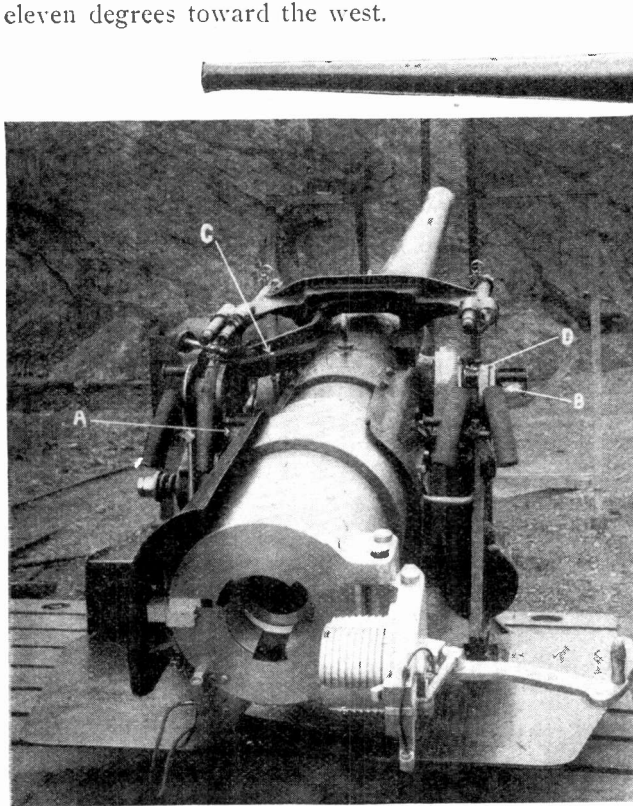

HEAVY ORDNANCE WHICH IS MANIPULATED AND FIRED BY ELECTRICITY

Equally great effects have been produced upon ships' compasses by lightning, but in such cases the bolts have actually struck the ship. The meteor seen by the "Nerano" did not touch that vessel and while no estimate of its actual distance was made, it was probably considerable, since the report contains no record of its having been observed to fall into the sea.

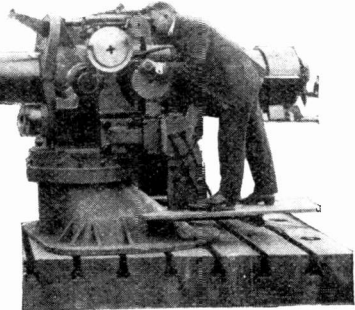

the work is done by motors and electricity also is used for the actual firing. In the four inch pedestal rifle shown the operator is in position at the variable speed gear mechanism. His left hand rests on the lever (A) controlling the electrically operated pointing mechanism. At (B) is the trigger for electric firing. At (C) is a handle used for percussion firing, which may be used if necessity demands. At (D) is the circuit closer putting the electric firing parts in readiness for action upon pulling lever (B).

## Strange Electric Storm

One night in February, in south latitude 33 degrees, west longitude 38 degrees, the sailing vessel *Ville-du-Havre* encountered a most remarkable electric storm. The rain fell in torrents, and the ship appeared to be electrified, the masts heads flaming like giant candles. Strange

lights traveled over the rigging, and after every flash of lightning a part of the vessel which had been newly painted remained for several seconds glowing with phosphorescence. The lightning, which was very frequent, instead of displaying itself in zigzag lines, took the form of flying bombs, which exploded with outbursts of light that illuminated the whole sky. Before and after the more violent explosions of thunder fierce gusts of wind swept the ship. This terrifying experience lasted for five hours with no respite.

### An Archimedes Tower

John B. Daleo, a young Italian sculptor, residing at 228 Degraw street, Brooklyn, N. Y., has constructed a remarkable electric tower, which he has named after the gifted Sicilian, Archimedes. He has so designated it because it is built on the plan of what is known as the Archimedes screw.

The tower measures six feet six inches from base to tip of flagpole and is at once artistic and ingenious. Electricity is employed for propelling the cars, for lighting and for running the water wheels.

In the upper part of the tower is a restaurant, at the entrance to which the car stops. All the electric wires are hidden in the construction, making accidents therefrom impossible. The cars and lighting require 190 volts. Thirty-six tungsten lamps, corresponding to the light of 216 candles, are used for illumination.

The base of the tower, constructed of wood, is 40 inches in diameter. There are four entrances to the building, which are led up to by a flight of steps. The fountains at the side of the doors spout water into a pool, where small fish might be kept. The candelabra in front of each door give the proper light. Eight decorative vases are placed around the base. The bottom of the tower is made of plaster composition, the inside of which contains the electrical apparatus.

The railway structure is of wood and casting metal. At the bottom is the plat-

form station for the loading and unloading of the cars. The electric car starts from the station and runs on the outside track to the restaurant at the top, remaining here but a second or so, and then starting on the return journey, taking the inside track, which connects with the outside one at the bottom. (This railway is an ingenious piece of work.) When a car stops at the upper station, another is at the lower platform. Both cars are in

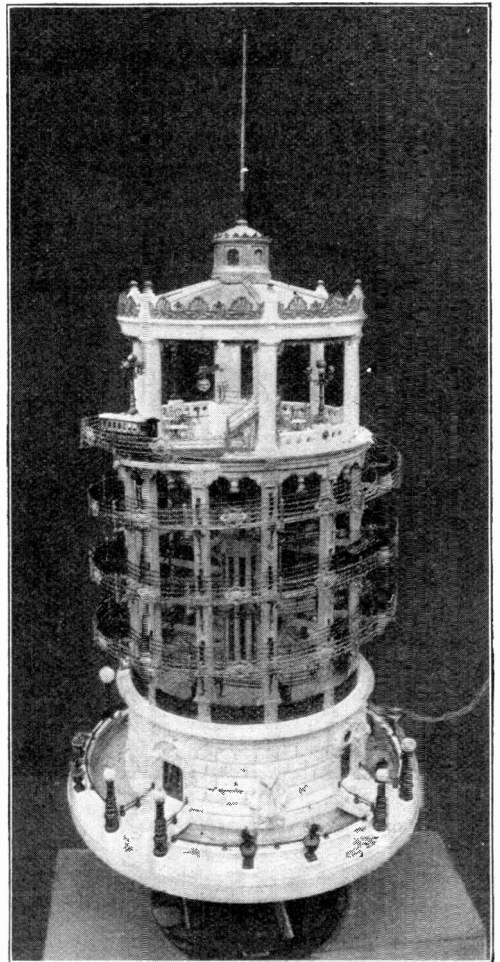

ARCHIMEDES TOWER.

motion at one time, controlled by a separate motor. A fence is built for the safety of the passengers, with a broad walk on the inner side of the railway. The third-rail system is used.

Certainly Mr. Daleo has shown considerable genius in constructing the tower, but the question naturally arises—of what practical use is it? In his opinion, it might serve as a model for a large building at some seaside resort, utilizing the base as a theater and the upper part as a restaurant. One can easily imagine that a building constructed after this model, brilliantly lighted by electricity, with the cars ascending and descending on the winding tracks, with the music floating out on the upper air and with the chance of dining in the cool breezes hundreds of feet from the ground, would attract great throngs and could be made to be a paying investment.

### Odd Static Generator

The outfit here illustrated I accidentally discovered will generate static electricity.

Upon a shelf or the edge of a table fasten a small motor that will run at a

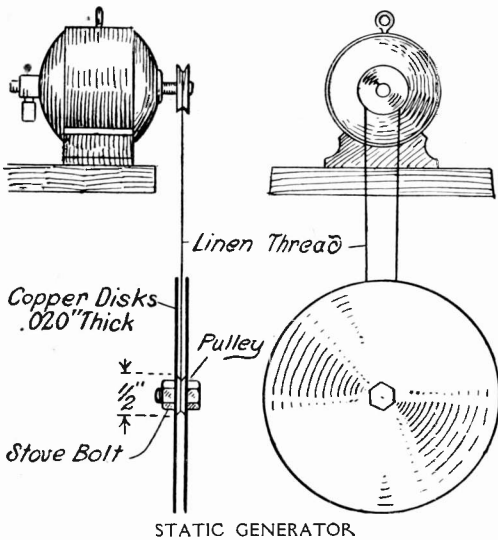

speed of about 3,000 revolutions per minute. On the shaft of the motor there should be a small grooved brass pulley. Provide a second pulley about  $\frac{3}{4}$  inch in diameter and a small stove bolt that just fits the hole in it. From thin sheet copper cut two disks exactly alike, and six

inches in diameter. Drill a hole in each disk of the same size as the hole in the pulley, and fasten the disks, one on each side of the pulley with the stove bolt as shown. Now make a belt of heavy linen thread. Place the thread over the pulley on the motor and set the disks' pulley upon the loop, thus leaving the disks suspended in the air. Start the motor, give the disks a turn and as soon as they come up to speed, they will act as a gyroscope and keep balanced. Take a piece of copper conductor in the hand and bring the metal near the disks. A  $\frac{3}{4}$  inch spark can be taken off. An incandescent lamp held near the disks will glow with a weird blue light.—E. H. SAMEN.

### Short Circuits Produced by Birds

Birds perched on or flying between the wires of a high tension system often cause a short circuit which may result in considerable damage at the central station and also in the electrocution of the bird. This occurs, however, only with birds having a considerable spread of wing; but with these it happens so often that in certain regions the total destruction of birds of large wing area is likely to result.

A case of this kind occurred recently in Germany, caused by a panic in a flock of starlings on the appearance of a hawk. Several of the birds and the hawk were caught between the high tension coils and the insulators in such a way that the high tension cable was grounded; but as the ground wire of the tower carrying the insulators and the transformer had become a bad conductor as the result of dry weather, the high tension current passed by the low tension circuit line to the earth at the same point, occasioning damage and fires in the homes of the consumers, as well as interrupting the light service. The intensity of the current arising from the short circuit formed by the birds was not at any time great enough to put into action the automatic apparatus at the station.

## And Their Friend's Were Led to It

A dingy little confectionery and tobacco-store has stood for years in the center of the ghetto district, Pittsburgh. Nobody remembers just how long it has endured. Many grown-ups have been youthful patrons. From time to time it has changed hands, and with the last change it came



THE STREET WAS HALF FULL OF SHOUTING YOUNGSTERS

into possession of a young man, who introduced some innovations, among them a modern penny-in-the-slot scale.

From the first the scale seemed to become the center of attraction for the youthful population, who tried to work it without the assistance of pennies. The storekeeper soon realized that unless something was done the destruction of the scale was imminent.

An old high tension magneto in the back cellar offered an inspiration. Forthwith it was installed behind the counter. One terminal was grounded. A concealed wire was run from the other terminal to the metal body of the scale. The

scale was propped up from the damp bricks on some dry blocks of wood dipped in melted paraffin.

Very shortly, some youngsters approached and commenced playing with the scale as usual. The storekeeper hied himself back of the counter and gave the magneto a vigorous turn. The kids got the surprise of their lives. Undaunted, however, they touched the scales a second time, receiving another shock. The storekeeper saw them make off up the street at a run and inwardly exulted but he was a poor student of kid nature. In a few minutes the original kids returned with three more. The newcomers were led up to the scales, experienced a shock, wondered a moment, and then "beat it" up the street to find some new victims. In a short time the street was literally half full of shouting youngsters fighting for a chance at the scales. About this time, the storekeeper decided that electricity might be very efficacious for some purposes but here was a case where it was a signal failure.

### Controlling Finger

Electrify a rubber comb by rubbing it briskly with dry flannel. Suspend it as shown by a silk thread previously at-

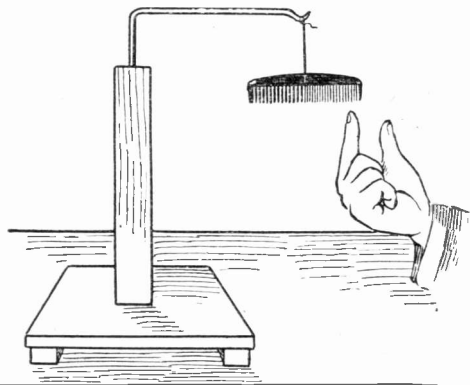

COMB THAT TURNS UNDER THE INFLUENCE OF AN ELECTRICAL CHARGE

tached to it. When a finger is held under it the comb will follow the finger, turning round and round as the hand moves.

### Fishing Up a Cable

A copper wire, coated with gutta-percha, was, in the year 1850, laid under the channel between England and France. Messages were sent from coast to coast, and men of science and capitalists in both countries were congratulating one another upon this triumph, when one morning, soon after the completion of the great work, communication suddenly ceased.

That morning, it appears, a French fisherman of Boulogne was going out in his boat. A British seaman, who at the moment had nothing to do, was seated on a coil of rope on the dock, looking out over the sea and meditating as he smoked his pipe. The Frenchman invited the Britisher to join him in his little expedition for fish.

Away went the two, bearing to the northward along the coast before a light breeze, until they finally brought up off Cape Grisnez.

Here the Frenchman let down his trawl and fished up among other curiosities of the deep the submarine cable before mentioned. Both he and his British friend were, to say the least, surprised. To the fisherman it seemed a species of seaweed; to the Britisher a form of petrified marine monster. The latter, handing his friend a heavy knife, the Frenchman forthwith cut off a small portion of the cable and let the end go.

The two bore their prize to Boulogne, where it was exhibited by them as a specimen of rare seaweed with its center filled with gold! Meanwhile the telegraphers at each end of the cable sat gazing in dismay at their useless instruments.

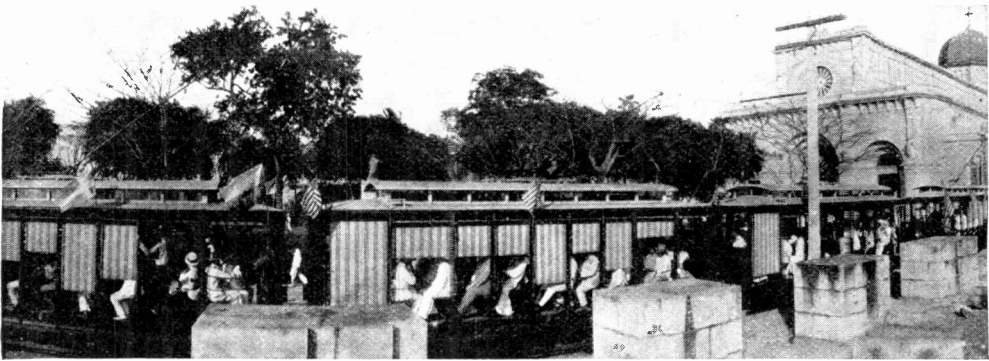

### HANDLING A CARNIVAL CROWD IN MANILA

Handling the annual carnival crowd in Manila requires a lot of forethought on the part of the schedule expert of the street railway system. In the Walled City the streets are so narrow that they accommodate but a single track and the operation of cars to avoid congestion becomes a fine art when traffic is unusually heavy. Often a dozen cars get so close together in creeping through the narrow thoroughfares that they resemble a train of trolleys. All the rolling stock is bedecked in flags during fiesta days and from the large variety displayed one knows that the holiday is an international one, rather than a celebration purely for Americans. For instance, the British don't care to fly the Union Jack along side the Stars and Stripes on the Fourth of July and Spaniards keep the Red and Yellow of Spain in the dark on Occupation Day.



Popular Electricity  
Wireless Club

# Experimental 200 Meter Wave Sets

By PHILIP E. EDELMAN

## PART I

The wireless law practically limits all amateur experimenters to 200 meter wave sets. Although this limitation means that the design and size of the apparatus must conform to certain requirements, it will not be a difficult matter to establish a good 200 meter experimental station.

The purpose of the present article is to give specific data for experimental 200 meter sets which comply with the law and it aims to present the matter so that the readers can establish the stations without calculating the circuits and dimensions. The construction and use of the series condenser will be taken up first because there are many readers who already have outfits, and who do not wish to go to great expense to comply with the law. The series condenser will enable them to make their old outfits comply with the law in most cases at very little expense. The remainder of the chapter will consider sets which use a short aerial. The object is to give definite data for particular sets rather than general data for any desired case.

### THE SERIES CONDENSER.

It is a well known fact that the wave length depends upon the capacity and the

inductance in a given circuit. Now in most of the old outfits the value of the capacity and the inductance is too large to comply with the law because the aerial is too large. At the same time, the large aerial is an advantage for long distance receiving, and as there is no restriction on the receiving wave length, it is very desirable to keep the old aerial as it is.

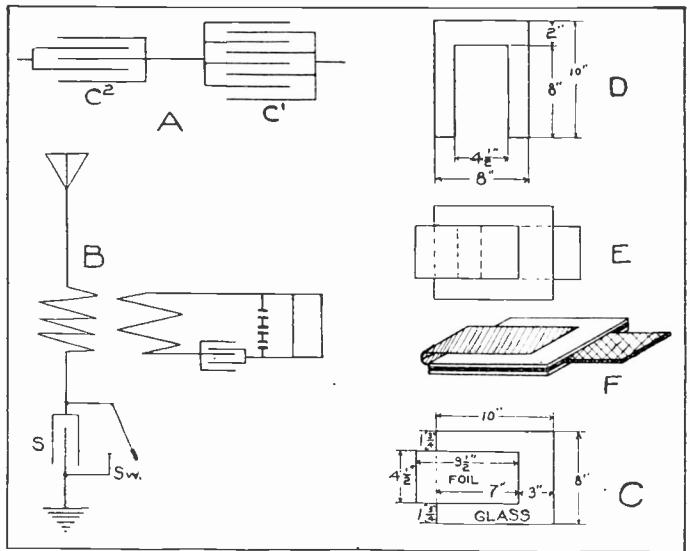

FIG. 1

When the large aerial is the main item which keeps the value of the circuit too high to comply with the law, a small condenser can be inserted in the aerial circuit to keep the wave length within the limit. In this case, the large aerial may be used as it is, for receiving purposes.

The series condenser arrangement

operates on the principle that the combined capacity of two condensers which are connected in series (A, Fig. 1) is less than the capacity of the smaller condenser. Thus if the capacity of the condenser ( $C^1$ ) may be represented by ten units and the capacity of ( $C^2$ ) by two units, the combined capacity of ( $C^1$ ) and ( $C^2$ ) in series is less than two units. The antenna itself may be considered as the larger condenser because it consists essentially of conductors forming a capacity with the earth, the air serving as the dielectric.

The arrangement is shown at (B) Fig. 1. The aerial proper corresponds to ( $C^1$ ) in (A) and the series condenser (S) corresponds to ( $C^2$ ). The switch (Sw) is useful when automatic or break arrangements are used, as the series condenser is not desired for the receiving circuit. It may be omitted, and in any case the switch is always left open when transmitting. It will be understood that the series condenser makes the capacity of the secondary circuit less and consequently lowers the wave length. The aerial system can thus be operated at less than the natural wave length and this new wave length can be limited to 200 meters by the use of the proper size of condenser. The size for this condenser is best determined by trial, using either of two methods, as follows:

1. *Hot Wire Ammeter.* The primary circuit having been fixed at 200 meters, (See "How to Comply with the New Wireless Law," November and December issues), connect the series condenser in the antenna circuit. Pressing the key, and having a hot wire meter in circuit, adjust the inductance in the secondary circuit until a maximum reading is obtained. Now vary the capacity of the series condenser and repeat, continuing until the maximum reading is obtained. Note the connections and the capacity used for future reference.

2. *Wave Meter.* If you have a wave meter, it will only be necessary to measure the wave length of the secondary

circuit with the series condenser connected in. Vary the capacity of the series condenser until a 200 meter wave length is obtained with a desired amount of inductance in the circuit. This may be checked with the hot wire meter to insure the maximum radiation.

*Construction of the Series Condenser.* The condenser for use with the average aerial will not need a very large capacity. The conditions vary so much in each case that a variable condenser is the most desirable form. The condenser which is described is of such dimensions that it will work well with a large percentage of the average old outfits, and if found too small or large it can readily be altered.

Obtain two identical pieces of ordinary window glass 8 by 10 inches. Coat one side only of each piece, with heavy tin foil or copper sheet as shown at (C), Fig. 1, taking care to make the foil smooth and space as shown. The  $2\frac{1}{2}$ -inch extension of the foil is for connection. Give each plate a coat of shellac on all surfaces. Now cut out a piece of  $\frac{1}{32}$  inch fiber sheeting to the dimension and shape shown at (D), Fig. 1. Obtain also a piece of brass or copper sheet cut to the dimensions of  $4\frac{1}{2}$  by  $8\frac{1}{2}$  inches and smooth off the edges with a file. Now shellac the fiber piece to the two glass plates so that the blank faces are next to the fiber and the foil surfaces are on the outside. The two plates will then be fastened together with the fiber between them, so that the extensions of the tin foil are at the back and the open part of the U shaped fiber is at the opposite end. This will be clear by referring to (E) and (F), Fig. 1, which are the plan and isometric views of the assembled condenser. The brass sheet is then placed in the recess thus formed so that it can be moved back and forth, thus varying the capacity. The condenser should be mounted so that it is well insulated and heavy flexible conductors should be soldered to both the foil coatings and the brass sheet. The assembled

condenser should be mounted in a vertical position if possible.

Condensers for larger sets can be constructed in the same manner, using thicker glass, larger dimensions and having the fiber cut larger than the glass plates, to form a flange. The capacity for use with medium sizes of aerials may be larger than for larger aerials. There is a practical limit which will soon be found by experiment. It is well to start with all of the capacity and then to reduce the capacity by pulling out the brass plate until the desired position is found.

#### SHORT AERIALS.

In the remainder of this chapter, we will be concerned particularly with 200 meter sets operating with short aerials. As has already been pointed out in this chapter, the total length of the aerial should not exceed 120 feet. Inasmuch as lead-ins

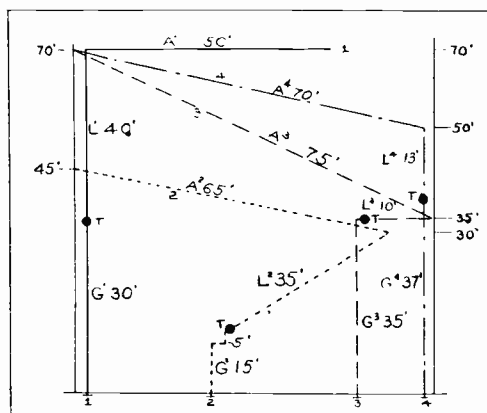

FIG. 2

and ground wires must be counted in the length of the aerial, the aerial proper can not very well exceed 75 feet in length. This will be clear from Fig. 2, in which four cases are shown. The aerials in this illustration are indicated by the numerals (1), (2), (3) and (4) and are shown as simple distinct lines to indicate the length and arrangement of the parts. Thus, ( $A^1$ ) 50 feet means that the aerial (1) proper is 50 feet long. ( $L^2$ ) 35 feet means that the lead-in of aerial (2) is 35 feet. And ( $G^3$ ) 35 feet means that

the distance from the instruments to the ground is 35 feet for aerial (3). The black circles (T) indicate the positions of the sending instruments.

Aerial (1) indicates a horizontal aerial 50 feet long and suspended 70 feet high. In order to use such a high aerial, it is necessary to make it this length, and to have the ground lead and lead-in substantially in a straight line, if the total length is to be kept within the limit.

The aerial (2) is 45 feet high at one end, 30 feet at the other, and is 65 feet long. The lead-in is 35 feet and the instruments are about seventeen feet up from the ground. It will be noted that a bend is indicated in the ground lead, which amounts to about five feet extra. This is a typical case and usually occurs when the water pipes are used for grounding.

Coming now to aerial (3) we see how a 75 foot aerial can be used with a short lead taken from the lower end, to keep within the limit. In this case, the instruments are 35 feet from the ground so that the ground wire must be substantially straight. Aerial (4) needs no special comment, and shows how an aerial 70 feet long may be used if the leads are made substantially straight.

Whatever modification a particular case may require, the total length should be kept within the 120 foot limit. To take a special case, suppose that it is possible to have two aerial supports, one of which is 61 feet high and the other 39 feet. Suppose it is found that the instruments can be located in a room 27 feet up from the ground and situated near the 39 foot aerial support. This case might readily occur in the average city.

A suitable arrangement complying with these limitations is shown in Fig. 3. Here the aerial proper comprises four conductors 75 feet long of No. 12 copper, or seven strand phosphor bronze wire, spaced two feet apart on the spreaders. The supports can be poles as indicated or extensions on buildings, trees, or other arrangements, it being understood that



the aerial is well insulated. The lead-in consists of four wires of the same capacity as the aerial wires, eighteen feet long and in the form of a rat tail. Each wire is fastened and soldered to one of the antenna wires. The instruments are again indicated by (T) and the ground lead is run straight to a good ground. In this illustration the antenna conductors are shown, turned out of their plane, in order to make

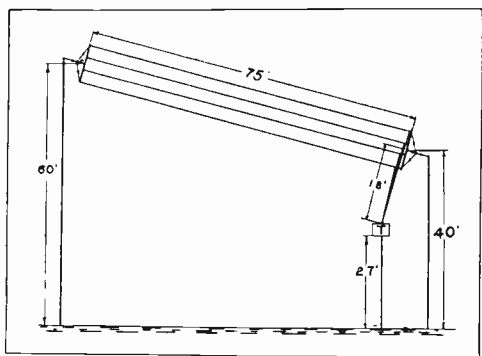

FIG. 3

their appearance clear. It will be noted that the height of the antenna from center to center is 60 feet at one end and 40 feet at the other on account of the slant of the supporting ropes. The fact that a pole is 60 feet high does not always mean that the antenna will be 60 feet high, as is shown in this case.

It should not be difficult to arrange a short aerial to meet the particular conditions for any case. When a larger aerial is already in use, a short aerial can be erected as described, for use with the transmitter only. In such a case it is preferably located at a right angle to the larger aerial. The use of the series condenser, as described, makes the erection of such a short aerial unnecessary. Simple aeri-als with direct leads are to be preferred for short wave lengths because they aid efficient radiation and sharp tuning at the low wave length. An aerial which takes all sorts of twists and bends should be avoided.

#### GROUND CONNECTIONS.

With a low wave length, a good ground becomes even more important than heretofore. It is not considered necessary to go into the details of the various forms of grounds other than to point out the need for good connections. Make the ground lead as short and direct as possible. Remember that every foot saved in this part of the aerial can be put to use in the antenna and that every foot wasted means another limitation to the wave length, which can be allotted to the remainder of the circuit. Every twist and turn should be avoided if possible. If connection is made to the water pipes, be sure that it is a connection, and solder it well. Remember too that it will not aid your effort to secure a short wave length to have your ground circuit run through all of the house pipes before it reaches the ground. The use of wire smaller than No. 8 B. & S. is not desirable. It is not good policy to choke off the energy by the use of small ground leads.

(To be continued.)

#### Receiving Stations on the Ground

At the little town of Neuchateau in the Vosges, France, the signals from the Eiffel Tower at Paris, 250 miles away, have been heard by means of horizontal wires placed close to the ground. One of these arrangements consists of a grill formed of nine wires of galvanized iron, five millimeters in diameter and about 65 feet in length, stretched horizontally four inches apart at a distance of three feet above the earth. The extremities of the wires are soldered to two transverse wires and the collector connects with the instruments on the ground floor of the house. When this arrangement is replaced by a metallic grill, the signals are still heard, but not so well. Another receiving station has for antennæ a strip of wire netting of large mesh, 160 feet long and three feet wide, supported at about 20 inches above the earth.

## Nine New Wireless Stations for Canada

An announcement has just been received to the effect that the Marconi Wireless Telegraph Company, of Canada, has entered into an agreement with the Canadian Government for nine additional stations in the Great Lakes regions.

The Canadian Marconi Company is to receive an annual subsidy of \$31,500 for their operation and maintenance over a period of nineteen years.

### Washington Greets Honolulu

The long distance record is broken and wireless telegraphy has achieved another advance. On Sunday evening, December 8th, the new station at Arlington succeeded in getting in communication with Honolulu, nearly 6000 miles away!

C. F. Elwell, chief engineer of the Federal Telegraph Company, was operating at Arlington Station, near Washington, D. C., which has recently been erected by the Government. He had just succeeded in exchanging messages with San Francisco, and was carrying on this 3500 mile aerial conversation, when suddenly he was astounded to hear signals coming from the station at Honolulu.

Completely surprised and hardly believing his senses, Elwell immediately grasped the sending key and flashed the following message to the San Francisco operator:

"Call Honolulu and tell him to listen, for we get him fine. ELWELL."

The operator at San Francisco did so at once; and as soon as he advised Elwell that Honolulu was ready, the latter flung these words into space:

"This is C. F. Elwell at Arlington near Washington. How do you get us. We get you!"

Immediately on dispatching this message Elwell pressed the receivers to his

ears, and breathlessly awaited a response. Very soon he caught the faint tick of an incoming signal, and while rather inclined toward the feeling that what he hoped for was impossible, he commenced to tune his instruments until finally the sounds came in quite steady and clear; and he experienced the amazement and delight to hear the following from far off Hawaii:

"If this is surely Arlington I hear you O. K., but I can't believe it. This is S. B. Maddams. Give C. F. Elwell my regards and tell him that we launched a yacht here today, named the C. F. Elwell. You come pretty good. Go ahead and give O. K."

For a moment Elwell stood still, full of wonder at the remarkable thing that had just taken place; then he again seized the sending key and flashed these words in reply:

"S. B. Maddams, Honolulu: Thanks Maddams. Will be at 2, our time, tomorrow with Chicago and Kansas City. Good night. C. F. ELWELL."

Thus was achieved a success for the Government's new wireless station at Arlington that was hardly anticipated when this immense structure was projected.

The news of this great accomplishment was immediately sent to all the stations of the Federal Telegraph Company in various parts of the United States. When H. P. Veeder of San Francisco, who is secretary and treasurer of the company, heard of this he immediately communicated direct with Honolulu to verify the announcement from the East. Operator Maddams at Honolulu at once forwarded him an answer, in which he recited the details of this memorable event and added that the messages from Washington "came clear and fairly loud."

This notable feat marks another great record in the wireless transmission of messages, and more firmly establishes this wonderful art as a necessary adjunct of our civilization.—W. ZACHERT.

## THE UNIVERSAL HOUR

The International Time Conference which was held in Paris in October last has agreed to the acceptance of Greenwich time as the basis upon which the proposed international time signals are to be sent out. Since March, 1911, French legal time has been that of the meridian of Greenwich; previous to that it had been the mean astronomical time at the meridian of Paris. The difference is 9 minutes and 21 seconds. Consequently, Greenwich time will be given from the following wireless stations, if the recommendations of the conference are carried out, at the hours indicated, on and after July 1, when they are expected to be ready for this service:

Paris—10 a. m. and midnight; Mogadiscio (Italian Somali)—4 a. m.; San Fernando (Brazil)—2 a. m. and 4 p. m.; Arlington (U. S.)—3 a. m. and 5 p. m.; Norddeich (Germany)—12 m. and 10 p. m.; Massua (Red Sea)—6 p. m.; San Francisco—8 p. m.

The signals will be given according to the code shown by the diagram, beginning two minutes before the hour:

From 57 minutes to 57 minutes 50 seconds—warning signals; from 57 minutes 55 seconds to 60 minutes—time signals.

The advantage of this system to all ships carrying wireless apparatus will be apparent. Now a ship's officer must depend upon the accuracy of his chronometer in determining his location; the chronometer may not have been com-

pared with standard time for days or even weeks, and an error of a fraction of a minute will falsify this reckoning by miles. With the new system he will never be out of range of some time signal for more than a few days at a time. It is thought that these signals may also

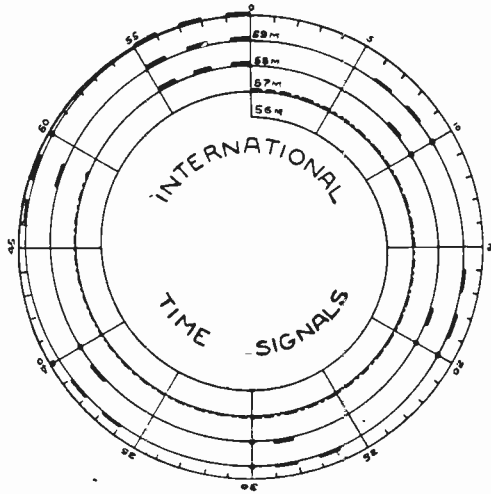

TIME SIGNAL CODE

be used to give warning of the location of icebergs, and it is proposed to extend our present knowledge of meteorology by the exchange of weather reports between the different stations. The conference also appointed a commission to arrange for an organization for the scientific study of the Hertzian waves in their relation to the surrounding media.

### The Increased Cost of Living in France

*La Revue Electrique* gives in a recent number a calculation by which it comes to the conclusion that the law passed in March last year, making Greenwich time the legal time for the whole country, has increased the lighting expenses of every household in France by about 1%. With-

out considering the accuracy of this figure, it is very evident that the cost of electric light, kerosene and candles will be increased somewhat when people stay up o' nights ten minutes longer than they have been doing, as will undoubtedly be the result of putting back the clock ten minutes, seeing that all household and business affairs are regulated, consciously or unconsciously, by the clock.

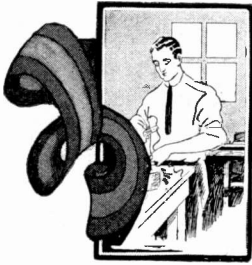

# For Practical Electrical Workers

## Telephone Wiring

By GEO. MADISON

Telephone wires run in pairs, the wires of which are designated as "tip and ring," "odd and even" or "line and test." The tip wire is usually the darker insulated of the two. The idea of having differently colored insulation on the two wires of a pair is to simplify the location of a case of trouble, inasmuch as the wires if cut must be spliced back exactly as they were. In outside wires and in inside wires outside of cables, the wires are designated by the use of a silk thread which runs through the insulation on one wire and not on the other.

The ring wire should always be fastened to the right hand binding post in all telephone terminals, except instrument terminals, and the tip wire should be fastened to the left hand post. If, however, a single row of posts is mounted vertically, then the even numbered posts counting from the top down should be the ring side while the odd numbered posts become the tip side. If the connecting blocks are mounted horizontally and numbered from left to right the lower posts become the tip side, but if the blocks are numbered from right to left the upper binding posts become the tip. Like wires should always be spliced or bridged to like wires and reversals of the circuit thereby avoided.

All wires should pass through the entering rings and through the proper hole in the terminal box before being connected to the terminal. The insulation should be removed and the wires scraped clean, care being exercised that

the wire be not nicked. Wires should be made fast with one complete turn around the binding post in the direction in which the nut tightens and the ends should not lap. The distance from the binding post to the insulation on the wire should not be less than 1-16 nor more than  $\frac{1}{8}$  of an inch. The binding post nuts should be tightened with a regular binding post wrench and not with pliers, shears, etc.

When connecting a wire to a binding post having only one washer between the nuts, the first wire should be placed under the washer, the second over the washer and a third wire may be attached by placing it under the washer and alongside of the first wire, but the wires must lie flat and not lap each other. When the binding post has two washers between the nuts, the first wire should be placed between the washers, the second under the lower washer, while the third wire is placed above the upper washer.

When splicing outside insulated wire, the splice should be made by the use of a copper sleeve. The insulation should be removed for about four inches from the ends of the wire, the wire scraped nice and clean and inserted into the sleeve so that the insulation is tight against it, as in Fig. 1.

Table 1 compiled for the use of the New York Telephone Company, gives the proper size of sleeve to be used, the number of half turns to be given and whether or not the splice is to be taped. All splices in twisted pairs should be

staggered so that the ends of the joints will miss each other by at least six inches.

The splices in inside wires may be made by either twisting the wires into

wire then given eight half turns around the insulation, after which the ends should be trimmed close and pressed into the insulation. The wire should not be exposed for over an inch, after the splice

TABLE I.—SPLICING.

Sleeve, B. & S. Gauge	Length	Size and Kind of Wire Spliced	No. of 1/2 Turns	Taped
6	6 3/4	Connecting No. 8 B. W. G. bare wire	7	No.
6	6 3/8	Dead ending No. 8 B. W. G. bare wire (1/2 sleeve)	3	No.
10	4 3/4	Connecting No. 12 & 14 N. B. S. bare wire	8	No.
14	3	Connecting No. 12 N. B. S. bare to No. 14 B. & S. two pair wire	5	No.
18	3	Connecting No. 12 N. B. S. bare to No. 18 B. & S. two pair wire	5	No.
18	3	Connecting single No. 12 B. & S. covered to No. 18 B. & S. two pair wire	5	Yes.
12	4 1/2	Connecting No. 14 N. B. S. bare wire	8	No.
12	2 1/4	Dead ending No. 14 N. B. S. bare (1/2 sleeve)	3	No.
14	3	Connecting No. 14 N. B. S. bare to No. 14 B. & S. two pair wire	5	No.
18	3	Connecting No. 14 N. B. S. bare to No. 18 B. & S. two pair wire	5	No.
14	3	Connecting No. 14 B. & S. two pair to No. 14 B. & S. two pair wire	5	Yes.
14	3	Connecting No. 14 B. & S. two pair to No. 16 B. & S. leading in	5	Yes.
18	3	Connecting No. 14 B. & S. two pair to No. 18 B. & S. two pair wire	5	Yes.
18	1 1/2	Connecting No. 18 B. & S. two pair to No. 19 B. & S. two pair inside	2	Yes.
18	1 1/2	Connecting No. 19 B. & S. inside to No. 19 B. & S. inside	2	Yes.
10	4 3/4	Connecting No. 12 N. B. S. bare wire (1/2 sleeve)	8	No.
10	2 3/8	Dead ending No. 12 N. B. S. bare wire	3	No.

a Western Union joint and soldering or by means of a copper sleeve. In places where a flame might be dangerous the twisted joint may be tightly wrapped with tinfoil instead of soldering. In splicing a twisted pair, care should be taken to have the strain equally divided between the wires and this is accomplished by keeping both wires exactly the same length. Inside wires should not be spliced between the instrument and picture molding or baseboard in new work, and should never be spliced under floors, in damp places, or in terminal boxes. When the wires are spliced in a shop or storeroom, the wires should be twisted and soldered together.

When making a twisted joint on inside wires the insulation should be removed for about four inches from the ends of the wires without nicking them, and the wire scraped clean. A joint of eight half turns should be made and the

is made, and the joint should be soldered and covered with two layers of pure rubber tape and two layers of friction tape. Fig. 2.

Fig. 3 shows the correct method of splicing a twisted pair to bare line wires on a terminal pole.

When one pair of wires is to be bridged to another, as in Fig. 4, the slot in the base of the connector is slipped over the main line wire and the bridging wire connected in the manner described for fastening a wire to a binding post. If a second No. 18 B. & S. twisted pair wire is to be bridged at the same point it should be placed above the top washer. Additional connections may be made by using two washers, Fig. 4.

A general method of running inside wires is as follows: The inside wire should be run as inconspicuously as possible and should never come in contact with finely finished walls and woodwork,

pipes or electric conduit. It is quite common, however, to have provisions made for the telephone wires at the time the building or house is constructed. These

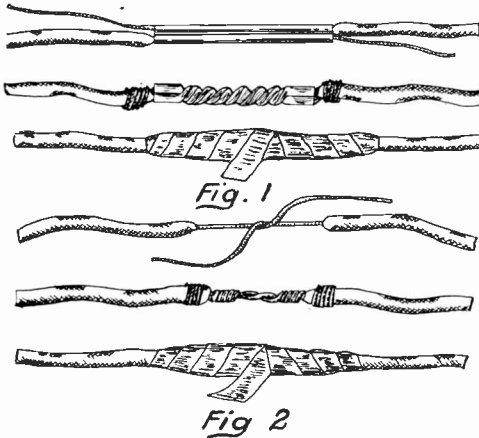

provisions usually take the form of some sort of conduit, often similar to regular electric conduit, or a molding, or a combination of both conduit and molding. The former method is best and as there are often no special wiring facilities provided, we will consider that the building has none, in which event the wires should preferably follow the picture molding, or, if no molding is available, the wires could be fastened to the baseboard but the woodwork should not be damaged. Wires should never be run along chair rails as there they would be directly exposed to mechanical injury.

The greatest damage done in inside wiring is in boring holes through walls or ceilings and extreme care should be used when doing this class of work in order to avoid interference with sliding doors, windows, etc., as well as to avoid damage to the opposite side of the partition or wall.

When the instrument is located on a desk which stands out from the wall, the wires should be brought out under the floor if possible, but if the wire must be laid on top of the floor it should be covered with a molding so as to avoid not only damage to the wire but also the possibility of accidents from tripping

over it. A small coil of slack wire should be left behind the desk or table, so that it may be moved without breaking the wires. It is often required that the wires be run under rugs, carpets, etc., and special treatment is necessary in nearly every case, but one thing holds good for all jobs in which carpets play a part, and that is never to cut holes in rugs or carpets in order to bring the wires through, but bring them through by separating the threads at the seam by means of a sharp pointed lead pencil or a sharp piece of wood.

Inside wires may be fastened with furniture nails, cleats, double pointed tacks, tie wires, clamps, or rings. Furniture nails may be used for fastening wires to woodwork and plaster walls using the shorter  $\frac{1}{2}$  inch for hardwood and the longer one inch for softwood and plaster. Nails and tacks should never be used for outside wiring on metal walls, around window sills or in other damp places and when used on interior work should not be spaced more than twelve

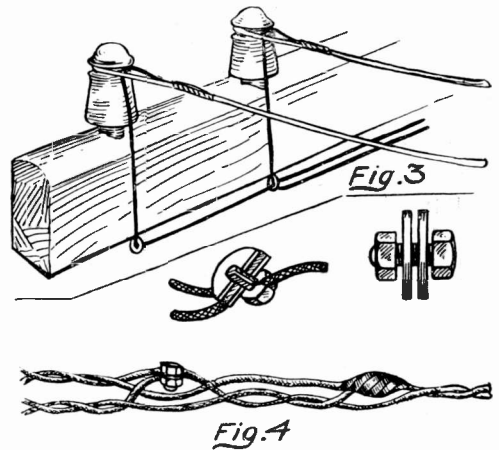

inches apart except when the wires are run in molding, when the nails may be spaced eighteen inches apart. When rounding inside corners the nails should be placed  $\frac{1}{2}$  inch on either side and the wire bent back into place in the corner. Two pairs of wires may be fastened by one nail, as shown in Fig. 5.

When fastening wires around window

sills, to metal or to damp walls, a two or three wire cleat should always be used. A cleat should always be used to fasten wires near the binding posts, as shown in Fig. 6.

Double pointed tacks may be used for

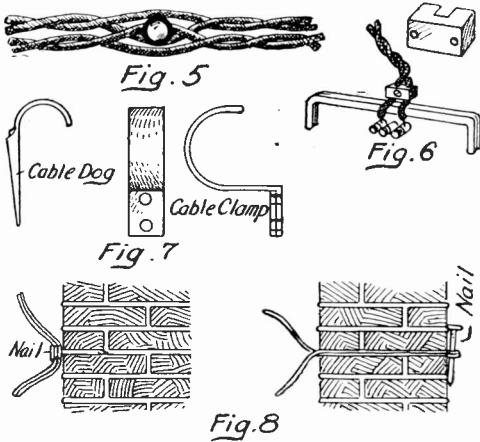

fastening a single wire and sometimes for a twisted pair, but when used in connection with the latter both wires should never be placed under one tack.

When lead covered switchboard cable or inside wire taped in the form of a cable is used, it should be fastened with clamps as shown in Fig. 7, or by annealed iron wire and cut nails, Fig. 8. If cable clamps are used Table II will be of assistance in determining the size of the clamp, screw and anchor to be used.

TABLE II.—FOR 22 GAUGE SWITCHBOARD LEAD COVERED CABLE.

Prs.	Diam. in Ins.	Size Clamp	Size Anchor	Size Screw
5	3/8	00000	No. 10, 3/4 in.	No. 10, 1 in.
10	1/2	0000	" 10, 3/4 "	" 10, 1 "
15	5/8	000	" 10, 3/4 "	" 10, 1 "
20	7/8	00	" 10, 3/4 "	" 10, 1 "
25	1	0	" 14, 1 "	" 14, 1 1/2 "
30	1 1/8	1	" 14, 1 "	" 14, 1 1/2 "
40	1 1/4	1	" 14, 1 "	" 14, 1 1/2 "
50	1 3/8	1	" 14, 1 "	" 14, 1 1/2 "
60	1 1/2	2A	" 14, 1 "	" 14, 1 1/2 "
75	1 3/4	2	" 14, 1 "	" 14, 1 1/2 "
100	2	2	" 14, 1 "	" 14, 1 1/2 "
150	2 1/4	3	" 14, 1 1/2 "	" 14, 2 "
200	2 3/4	3	" 14, 1 1/2 "	" 14, 2 "

When running several pairs of wires in light or air shafts, loft buildings, cellars, factories, stables, etc., where their

appearance is not objectionable, rings may be used.

When inside wiring comes in contact with pipes or passes through floors or plaster walls, and whenever necessary to protect against mechanical injury, the wires should be well taped. Tape may also be used to change the color of the insulation on the wires and make it harmonize with the color scheme of the walls and molding with which it comes in contact. Cloth tape in various colors may be used for this class of work.

When entering a building with No. 18 wire a 3/8 inch hole should be bored for one pair of wires, a 1/2 inch hole for two pairs of wires and a 5/8 inch hole for three pairs of wires. These holes should be well reamed out and slant downward from the inside. In brick buildings the wires are generally led in through the frames of windows or doors and it is preferable to locate them at the top of the frame rather than below. In frame buildings, the holes should be bored through the wood apron under the window sill or through the outside base immediately above the foundation walls. The wires should pass through the hole without untwisting, binding or kinking

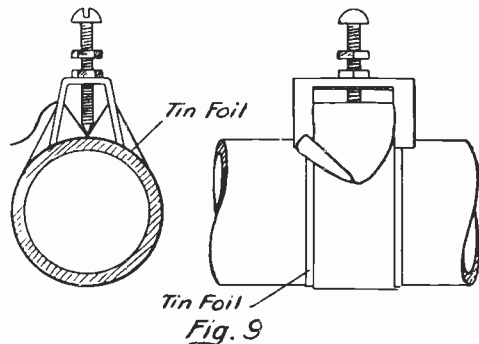

and at the point of entrance they should be wrapped with friction tape for a distance of about two inches and in such a manner as to form a conical wrapping about the wire and having a diameter about the wire and tapering each way. The wire should be drawn into the hole until this wrapping

enters and completely plugs up the opening. The wires should then be fastened below the hole and as close as possible to it.

Ground connections for party line bells, battery feeders, etc., may be made to water pipes, cable sheaths, gas pipes or to a buried ground, the preference

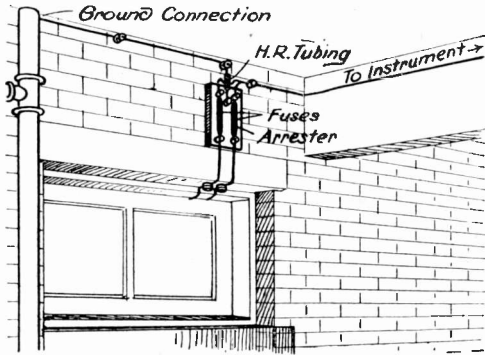

*Fig. 10*

being given in the order named. Steam, hot water or sprinkler pipes should never be used for grounds. All grounds should be made as near to the point of entrance to the building as possible and all attachments should be made in an accessible place and so located that the wires will not be disturbed. When attaching to a gas pipe the connection should be made on the street side of the meter. The best practice for attaching wires to pipes, cables, etc., is to file up the surface if an iron pipe, scrape a cable sheath and sandpaper a galvanized pipe, then wrap the pipe or cable with tinfoil. A ground clamp, Fig. 9, is then attached and, if the connection is exposed to the weather, the entire device is taped.

Wires must not come nearer than two inches to any light or power wires in a building unless separated by some continuous non-conductor such as porcelain tubing or approved flexible tubing.

When the telephone wires run in proximity to high voltage electrical circuits the separation should not be less than one foot. If absolutely impossible

to obtain this separation between the two circuits, the telephone wires should be enclosed in an approved insulating tubing and the greatest clearance possible secured between the two circuits, but under no circumstances should the covering of the high voltage circuit and the insulating tubing on the telephone wires touch each other. The insulating tubing should project six inches on each side of the high voltage conductor and should be securely taped at each end.

When protectors are used they should be placed within the building and as near the entrance of the line wires as possible, allowance being made for an easily accessible ground and for convenience in inspecting and repairing. The protector should be at least six inches from probable contact with curtains, shades or other inflammable material and should be securely fastened to the support with its fuses vertical and so that the line

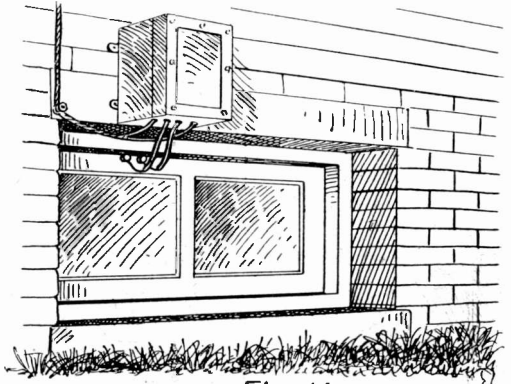

*Fig. 11*

wires may connect directly to the binding posts. The protector should be mounted so that the binding posts are either at the top or at the bottom but the micas should always be placed with the notched side down. The protector should never be placed in a show window, on vibrating partitions, or on damp walls. Fig. 10 shows the usual installation of a protector on the inside of the cellar wall over a window. It is sometimes impracticable to place the protector within the building, in which case it should be



mounted in a cast iron waterproof box as shown in Fig. 11. Fig. 12 shows the position of the protector in the box. This box should be located on the outside of the building in a position accessible for inspection and repairs and as near as possible to the point of entrance. When protected lines enter a building they should enter in the same manner as given in the early part of this article for unprotected lines, but the holes should be bored  $2\frac{1}{2}$  inches apart and bushed with insulating bushings, usually made of porcelain.

The ground wire should be No. 16 B. & S. insulated wire, which should be attached to the post on the protector marked "G" and should be run as straight as possible from the protector to the ground, using a two piece porcelain knob as shown in Fig. 13. In places where these knobs would be unsightly the ground wire may be run on "peanut" cleats as shown in Fig. 14. The knobs and cleats should be placed not more than four feet apart and when passing through walls or floors the ground wire should be run through cir-

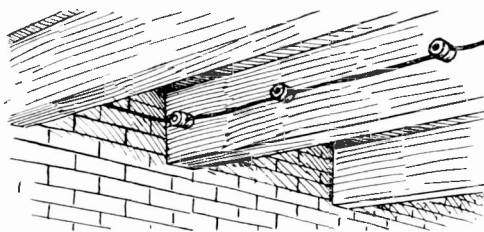

Fig. 13

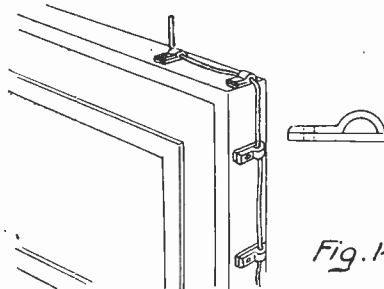

Fig. 14

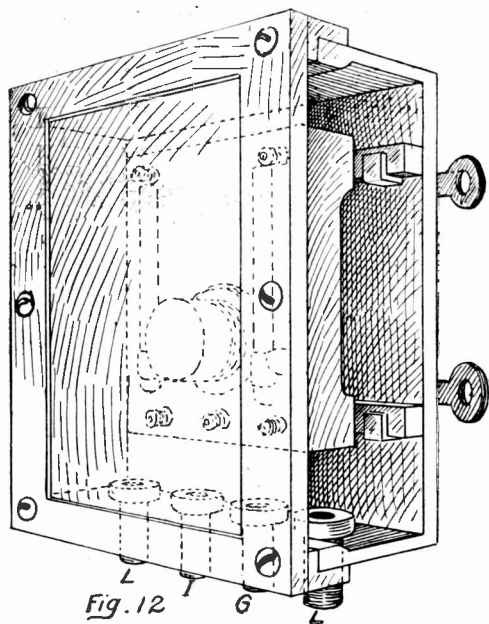

Fig. 12

cular loom or insulating tubing. When installing party line instruments a triple conductor wire should be run between the protector and instrument so as to provide a ground wire for the bell.

The outer covering of the switchboard cable should be carefully removed only as far as necessary to permit of properly forming the cable without damaging the insulation or conductors. The strippers of unfilled cable and one inch of the outer covering should be immersed in hot standard beeswax compound for three minutes and the surplus wax allowed to drip off before cooling. Standard beeswax is a composition composed of half beeswax and half paraffine.

For cotton covered cable the butt should be wrapped with waxed twine for  $\frac{1}{2}$  inch over the strippers, starting at the end of the outer covering. The twine should be wrapped back on itself and extended a distance of  $\frac{1}{2}$  inch back of the starting point. One end of the twine should be pulled in under the wrapping and the other or long end should be used for sewing the form. After cables have been formed up and sewed they should be shellacked and baked until all moisture is expelled.

### Fault Finder

The fault finder here described will give good service in testing knob and tube work, conduit systems and fixtures, for grounds, short circuits, etc.

Make a hardwood box 10 by 8 by 3½ inches having a hinged cover with latch

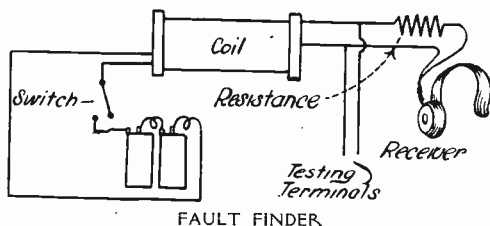

or lock. Purchase a small induction coil (one giving a 1-32 inch spark is large enough), four binding posts, eleven ounces of No. 36 enameled copper magnet wire, a small battery switch, a head receiver and cord and two testing terminal wires.

The next step is to mount the articles in and on the box. The two batteries should be securely fastened in the box by wrapping them with strong wire, then securing the wire to the back of the box with wood screws. The coil should be placed where adjustment will not be difficult. The No. 36 magnet wire wound on a piece of fiber should provide resistance for the receiver and be connected to the apparatus as shown in the diagram. The four binding posts are installed on the box to serve as testing and receiver cord terminals.

In testing for a short circuit a humming sound will be detected in the telephone receiver. Should the coil or wire being tested be of higher resistance than the resistance in series with the receiver the apparatus will prove useless. If the test is being made for an open, the rule should be reversed; that is, the noise in the receivers will be detected upon locating the defective coil. In testing for a ground, apply the rule for detecting a short.

By placing a leather handle on the in-

strument it may be easily carried from place to place. Take care that it receives no jars as this will make necessary the adjusting of the vibrator on the coil, but if a lock nut is placed on the stationary portion of the vibrator this trouble will be eliminated.—P. M. EAMES.

### Why Shunt Motors Speed Up

Most repair men are familiar with the fact that a weakened field or a decreased number of armature coils will result in increased armature speed but the reason of this phenomenon may not be so generally known. First let us state certain facts that are more or less self-evident, or that follow directly from Ohm's law. The current through any circuit is equal to the effective voltage divided by the resistance, the effective voltage being the applied voltage less any opposing voltage that may be present. Also the torque or twisting force of a motor is proportional to the armature current, which in the case of a motor will be the difference between the line voltage and the motor voltage divided by the armature resistance. This last point will become clear if we consider the fact that the motor is essentially the same as a generator and will generate a voltage proportional to its speed and field strength. Therefore the effective voltage is not the line voltage but the difference between it and this counter electro-motive force, as it is called.

Bearing these facts in mind let us consider the probable effect of a weakened field. Since the motor voltage or counter e. m. f. depends on the field strength the former will be reduced and the difference between it and the line voltage will become greater. As this difference is the effective voltage tending to send a current through the armature the current will be increased and the torque will also be increased. Thus we see that weakening the field indirectly tends to increase the torque and speed also, since increased torque will naturally cause increased speed.

The increased speed will partly compensate the weakened field and raise the motor voltage almost to its original value, so that the motor will strike a balance at a slightly higher speed than the original one. Since the motor voltage depends on the number of coils this same phenomenon attends the cutting out of armature coils.—T. G. SEIDELL.

### Office Bell

In offices of doctors and dentists where there is no attendant and in other rooms where the noise of machinery prevents the opening of the door from being heard, a bell connection as in the following description may be used.

Two pieces of tin (A) and (C) are

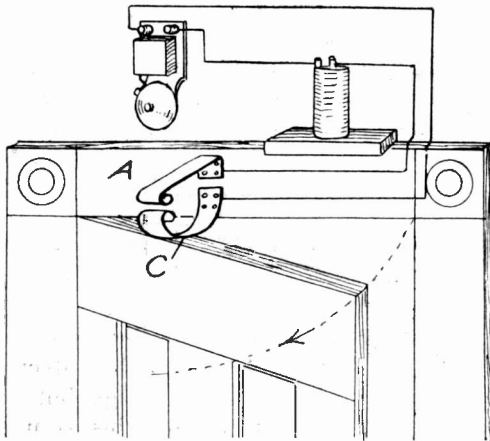

DOOR CONTACT FOR OFFICE BELL

fastened by nails or screws to the door frame and under each is secured the bare end of a bell wire, which connects as shown to a bell and battery. The tin strips may be an inch wide and five or six inches long. Brass may be used in place of tin if desired.

By shaping the strips as indicated, the top of the door strikes the lower tin closing the circuit for only a moment. As the door opens farther, the strips spring apart breaking the circuit automatically.—W. H. ALBRIGHT.

### Drying Telephone Cables

During a recent fire in a telephone exchange the water thrown saturated the cables at the back of the switchboard. To dry these out electric car heaters

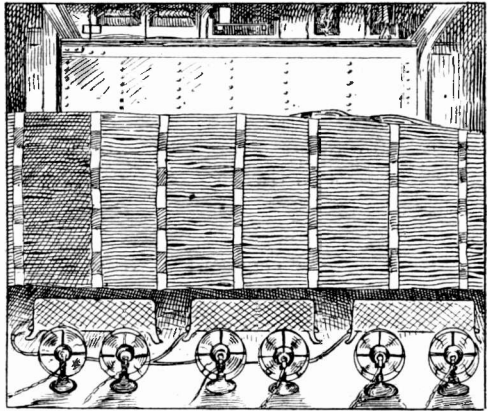

ONE WAY OF DRYING TELEPHONE CABLES

were borrowed from the car company and the heat generated by them blown upon the cables by electric fans as shown. This was considered to be the only feasible means, as great care had to be exercised to prevent the melting of the paraffin used in the cable insulation.

### Dining Table Outlets

In these days of numerous electrical cooking devices, such as percolators, toasters, etc., designed for use on the dining table, it is often a question of where to obtain the necessary circuit

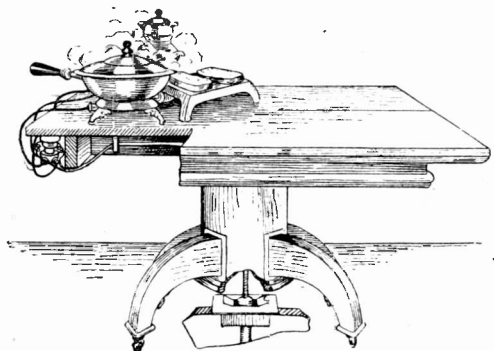

ARRANGEMENT OF TABLE OUTLETS

connection, when several devices are used at the same time. Unsightly cord runs are objectionable.

In one case convenience was found in the following manner: In the center of the dining room floor under the table a flush wall plug receptacle was fitted and connected to a circuit run on the basement ceiling from the service. From this receptacle a No. 14 reinforced portable cord equipped with a plug and long enough to allow for the extension of the table was passed through the hollow center leg and then to a 600 watt, wall socket located under the table edge. Into the wall socket was screwed a three outlet fixture for the reception of the heater circuit plugs. When cleaning is done or the table moved the floor cord and plug are pulled out through a slit in the carpet.

### Hotel Clerk's Private Exchange Board

In a hotel having a private branch exchange using direct current telephones, i. e., transmitter and receiver in series,

ascertain the wants of any guest who may call him after that time. He can see the switchboard from his location and if it is the trunk line from the city exchange which is flashing he throws the double pole, double throw switch shown and places himself directly on the trunk.

Of course if one guest desires to talk to another or to a party in the exchange the clerk must go and put up the connection, but as a majority of the calls are for ice water or of that nature he saves many unnecessary steps.—MAURICE E. YOUNG.

### How Brass for Fixtures is Made

A young man, newly employed as clerk in the office of a brass mill, remarked to a fellow clerk, "I see invoices for the copper, zinc and other stuff, but where do they buy the brass?"

While this may be an exceptional case, yet the general idea of brass, outside of manufacturers and dealers in it, is rather vague. The two most important prod-

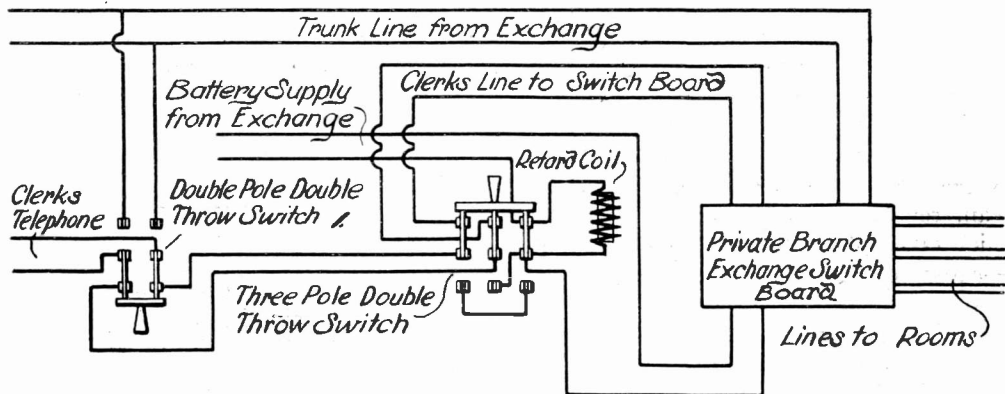

CIRCUITS OF THE TELEPHONE CLERK'S PRIVATE EXCHANGE BOARD

the switchboard is located behind the cigar counter entirely across the lobby from the clerk's desk.

When the operator leaves at night she turns on the night alarm and throws the three pole, double throw switch shown in the accompanying diagram, which allows sufficient current to flow through the clerk's instrument to enable him to

ucts of this industry are sheet brass and tubing.

The brass industry had its inception about a century ago in and around Waterbury, Conn. Dame Fashion gave rise to the need of button shops, for the gentlemen of that day were adorned with bright metal buttons on coats and buckles on shoes, and Yankee shrewdness and

energy answered the demand with little mills along the streams that abounded in this section, for manufacturing them. And from that beginning the value of the brass industry's output has reached a total of \$200,000,000 annually.

Brass is an alloy of copper and zinc in certain proportions, about two parts copper to one of zinc being the alloy most used for sheet brass. The metal is melted in crucibles carrying about 200 pounds. First, the copper is placed in the crucibles; when this has reached a fluid state a flux is added, which in casting shop vernacular "cleans the metal." The melted copper is then covered with a layer of charcoal, to prevent oxidation, by keeping the air from contact with the molten metal—the carbon in the charcoal also acting as a reducing agent. The zinc is next added. After the alloy has been well puddled it is poured into a mould to solidify. If the solid mass shows no imperfections it is sent to the rolling mill, annealed in a furnace in 5,000 pound lots and is then ready for the break-down rolls, two chilled iron rolls 20 inches in diameter and weighing twelve tons. Here, to use a crude illustration it is rolled out as the pie maker rolls crust.

After each annealing the metal is placed in a bath of oil of vitriol (about six per cent) and water and "pickled" clean, removing the surface oxidization which takes place during annealing. By repeated rollings the sheet is reduced to whatever gauge is desired, and after being cleaned in sawdust is inspected and slit to the necessary width, and shipped in coils of about 80 pounds each to be manufactured into the many forms for which brass is used, such as lamp bodies, electrical and gas fixtures, etc.

The tubes used in chandelier work are usually brazed tubes, and are made from sheet brass cut in strips and formed up into tubes, the edges being brazed together in a specially constructed furnace. They are then drawn in a steel die and triblet until the desired diameter and gauge is reached.—*The Fixtureman.*

### Combined Direct and Indirect Fixture

A British company has placed upon the market a combined fixture for converting a pendant lamp with a shade into an indirect lighting unit when desired. A tube for the flexible current conducting cord, a grip for holding the lamp by its shade ring and a swivel permitting the lamp and shade to be turned to any position between an upward reflection of the light and a direct downward illumination make up the fixture.

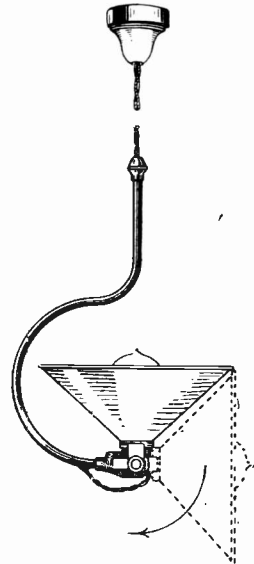

COMBINATION FIXTURE

### Tobacco Jar Humidor

A one pound glass tobacco jar may be converted into a practical humidor.

Drill six or eight  $\frac{3}{8}$  inch holes in the metal top of the jar away from the cen-

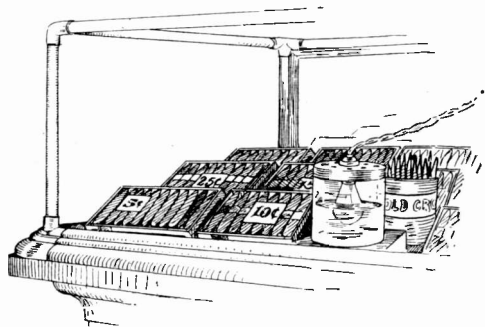

HUMIDOR MADE FROM AN INCANDESCENT LAMP

ter and in a circle preferably. At the center cut out a hole large enough to allow a lamp socket to be passed part way through as shown. With the jar two-thirds full of water when the cover and lamp are put in place the heat from the lamp will cause evaporation.

# ELECTRICITY THE SILENT SALESMAN

Some Helpful Hints on the use of Electric Current in getting up Show Window Displays. The following schemes have all been used with remarkable success

## The "Winking Willies"

An attention attractor that is as unique as it is ingenious is that which has been installed in one of the show windows of the Manchester, N. H., Traction, Light and Power company. It is distinguished by five "winking willies," who succeed in drawing attention of a great many every day to the merits of the various

that every twelve seconds a different article is connected with the meter.

The articles are varied from time to time, but at the time the photograph was taken they were electric toasters, electric flatirons, twin glowler, luminous radiator, percolators, etc. As the apparatus connects each article with the cent-hour meter the young man who has it in charge winks in a very pronounced manner in the



THE "WINKING WILLIES"

articles which the commercial department of the company has to offer for sale.

The picture accompanying this shows the window in question and its winkers. The sign, "When Willy Winks," the diminutive messenger boys and their flirting oculars, are the distinctive features. The Willies are labeled "M. T. L. & P." and each presides over some article of electric usefulness. These latter are connected with a Donkin cent-hour meter, so called, and with a simple rotary flasher designed and built by the company's electricians and operated in such a manner

general direction of the article and simultaneously, on the broad dial of the meter, appears the price in cents per hour at both high and low rates, the charges the traction company makes for furnishing the current to operate it. The connections are so arranged that the current required to operate the winkers does not pass through the meter.

On the face of the meter the low rates, six cents per kilowatt hour, are indicated in red figures, while the high rate, twelve cents, is shown in black. Attention is called to the fact, by means of signs,

that the greater number of Manchester residences are drawing current at the low rate.

### Barber Pole as a Lamp Post

A Springfield (Ill.) barber utilizes his barber pole as a pillar to support a light to illuminate the sidewalk in front of his shop. The pole is set on the outer edge

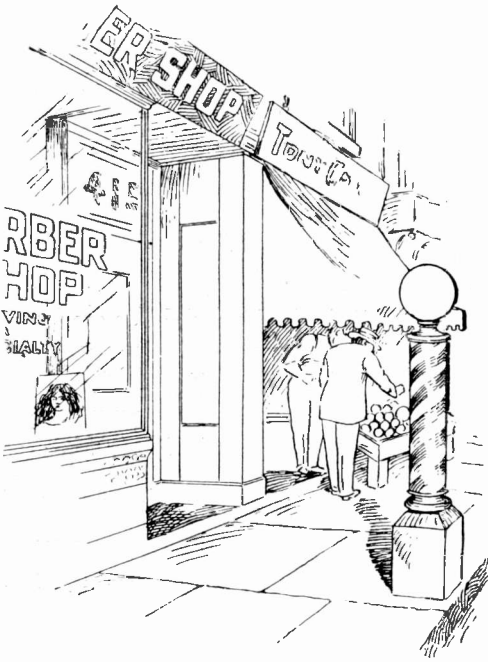

COMBINED BARBER POLE AND LAMP POST

of the walk and is surmounted by a large globe covering an ordinary incandescent lamp. Wires are run up the center of the post from the basement lighting circuit.

### Double Appeal for Customers

An Enid, Okla., restaurant man whose place of business is close to the railroad station uses electricity in two ways upon the outside to call the attention of travelers. Even a blind man can find the place unassisted.

Directly underneath and on the same pole that supports the illuminated sign "EAT," is installed a bell of gong like proportions. Upon the arrival of a train the bell circuit is closed with the

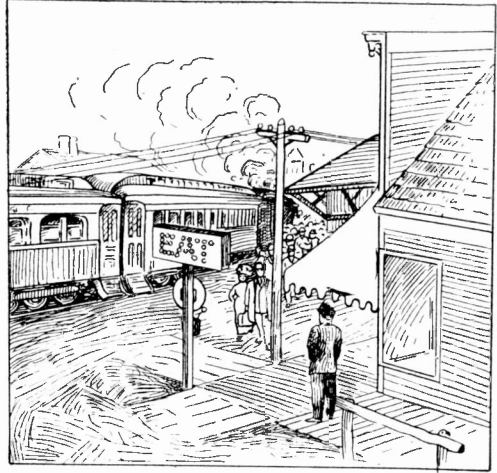

RESTAURANT ADVERTISING

result that there are few who do not know that the restaurateur is ready to supply internal needs.

### Advertising in Waste Space

In the majority of cases there is an unused space of eighteen to 24 inches beneath the usual store window. A Springfield merchant made advertising space out of this by substituting a translucent glass panel for the wooden one. With his name and wares printed thereon and three incandescent lamps tapped off the basement circuit placed behind, he had a cheap but very effective sign well within the range of vision of pedestrians.



A GOOD PLACE FOR AN ELECTIC SIGN

# Electrical Securities

By "CONTANGO"

It is the intention in this article to give additional illustrations of companies, the stock and bonds of which, one or the other, are well worth your consideration and whose statements bring out particular points mentioned in former articles.

## AMERICAN PUBLIC UTILITIES COMPANY.

This company is under the active management of Kelsey, Brewer and Company, engineers and operators of public utility properties, Grand Rapids, Michigan. It controls through stock ownership the

public utility situation in the ever growing demands of an ever increasing population.

CAPITALIZATION		
	Issued	Authorized
Bonds, Thirty-year 5% Collateral Trust.....	\$ 839,000	\$20,000,000
Preferred Stock, 6% Cumulative.....	3,914,000	20,000,000
Common Stock.....	2,995,000	20,000,000

A conservative estimate, based on previous earnings and a thorough knowledge of the communities served and the operating conditions under which the service is rendered, indicates

EARNINGS		
Gross earnings of all Properties.....		\$2,192,453.31
Operating Expenses, including Taxes and Insurance.....	\$1,140,075.72	
Interest on Underlying Securities.....	528,475.00	1,668,550.72
Earnings accruing to American Public Utilities Co.....		523,902.59
Earnings Derived from Working Capital.....		48,000.00
Gross Earnings American Public Utilities Co.....		571,902.59
Deduct Interest on \$839,000 Collateral Trust Bonds.....		41,950.00
		529,952.59
Deduct 6% Dividend on Preferred Stock.....		234,840.00
Earnings on Common Stock less \$75,000 thereof held by Trustee for future Corporate purposes.....		295,112.59
Per cent Earnings on Common Stock.....		10.1%

following subsidiary companies: Merchants Public Utilities Co., Indianapolis, Ind.; Peoples Light & Heat Co., Indianapolis, Ind.; Elkhart Gas & Fuel Co., Elkhart, Ind.; Valparaiso Lighting Co., Valparaiso, Ind.; Utah Gas & Coke Co., Salt Lake City, Utah; Boise Gas Light & Coke Co., Boise, Idaho; Winona Gas Light & Coke Co., Winona, Minn.; Minnesota-Wisconsin Power Corporation; LaCrosse Gas & Electric Co., LaCrosse, Wis.; Albion Gas Light Co., Albion, Mich.; Holland City Gas Co., Holland, Mich.; Jackson Light & Traction Co., Jackson, Miss. The total population, 1910, of the cities served by this company is given as 471,451 compared with 332,920 for the year 1900. This is an increase of 41 per cent and very aptly brings out the inherent strength of the

the following earnings for the present year.

The earnings accruing to the American Public Utilities Company are two and one-quarter times the amount required to pay six per cent upon the company's preferred stock. In a recent offer of \$2,200,000 six per cent cumulative preferred stock and \$770,000 common stock, \$1,000 par value preferred and \$350 value common stock were allotted to the \$1,000 subscription. At the beginning of the year American Public Utilities common was quoted 64 to 67½ and the preferred at 78 to 80.

## REPUBLIC RAILWAY AND LIGHT COMPANY.

The Republic Railway and Light Company was incorporated in June of last



year in New Jersey and has acquired over 90 per cent of the outstanding stocks of 27 minor companies. The company operates (under satisfactory franchises) about 150 miles of electric railway lines and three electric light and power plants, also three gas plants. In all a population of over 200,000 is served, the increase in this population since 1900 being 64 per cent.

## CAPITALIZATION

	Authorized	Issued
Preferred Stock, 6% Cumulative.....	10,000,000	\$5,200,000
Common Stock.....	7,500,000	6,360,000

The Republic Railway and Light Company has no bonded indebtedness. But the subsidiaries have outstanding bonds amounting to \$10,148,000.

The subjoined shows the consolidated statement of earnings for the subsidiary companies for the nine months of the fiscal year ended September 30, 1911, with comparative earnings of the same companies in 1910:

	EARNINGS		
	1911.	1910.	Increase
Gross.....	\$1,705,105	\$1,623,172	5.05%
Operating Ex- penses.....	975,839	945,118	3.25%
Net.....	729,266	678,054	7.55%

The surplus earnings over operating expenses and interest requirements for the three years ended December 31, 1910, and conservatively estimated figures for the following three years have been as follows:

Year	Surplus	Year	Estimated Surplus
1908.....	\$163,156	1911.....	\$488,128
1909.....	375,916	1912.....	562,633
1910.....	445,688	1913.....	641,883

Regular six per cent dividends are being paid on the preferred stock, the present earnings averaging one and one-half times the amount required for the preferred dividend. The preferred has been quoted at 81 to 82¼, which gives a yield on the purchase at that price of 7.29 per cent. The common is quoted at 25 to 27.

As is the case with other consolidated holding and operating companies, savings

and economies are expected by reason of the saving in the cost of power production, better distribution of the power load, double tracking of congested lines, improvement in buildings, standardization of equipment, greater efficiency of employes and the like.

## COMMONWEALTH POWER, RAILWAY AND LIGHT COMPANY.

This company was incorporated in February, 1910, with no bonded indebtedness except such as remains upon the individual properties. Through its constituent companies it owns and operates, in the State of Michigan, street railway properties in Grand Rapids, Saginaw and Bay City, together with an interurban line connecting the two last named points and having a total trackage of 121 miles; the gas properties in Jackson, Kalamazoo, Pontiac, Flint, Saginaw and Bay City; the electric light and power companies in Grand Rapids, Muskegon, Lansing, Kalamazoo, Battle Creek, Jackson, Pontiac, Flint, Saginaw, Bay City, Charlotte, Owosso, Corunna, Big Rapids, Albion, Cadillac and many smaller towns; the water business in Cadillac.

The company also controls valuable hydro-electric plants upon the Muskegon, Kalamazoo and Grand rivers; undeveloped waterpowers capable of an installation capacity of 65,000 horsepower on the Au Sable River, and large undeveloped waterpowers on the Muskegon River. The total population served is about 500,000.

## CAPITAL

Preferred Stock (6% Cumulative) authorized and issued.....	\$ 6,000,000
Common Stock.....	12,000,000
Shares \$100 par. Preferred dividends payable February 1, May 1, August 1, and November 1.	

Figures available showing the combined earnings of the Commonwealth Power, Railway and Light Company and its constituent companies for the eleven months ended November 30, 1912, and the final estimates for 1912 are as follows:

## EARNINGS STATEMENT

For eleven months ended November 30, 1912, and estimated for twelve months ended December 31, 1912, with the percent increase over corresponding eleven and twelve months of preceding year, respectively:

	11 Months	Per Cent	12 Months (est.)	Per Cent
		Increase		Increase
Gross Earnings.....	\$5,739,477.26	15.50	\$6,289,998.35	15.18
Operating Expenses.....	3,024,405.78	16.33	3,311,916.02	15.61
Net Earnings.....	2,715,071.48	14.60	2,978,082.33	14.72
Fixed Charges (see note).....	1,688,232.60	19.67	1,827,409.30	19.44
Net Profits.....	1,026,838.88	7.13	1,150,673.03	7.94
Dividend Preferred Stock.....	330,000.00	...	360,000.00	...
Balance: Available for replacements and dividends on Common Stock.....	696,838.88	10.88	790,673.03	12.00

NOTE.—Fixed charges include dividends on outstanding preferred stocks of constituent companies in addition to taxes and interest.

The final estimated figures for 1912 are well within the results shown the year previous. The preferred stock was quoted at 89 to 90 at the close of 1912 which shows a yield of 6.59 per cent. The common stock is quoted at 67 to 68.

It may be mentioned here that the president of this company is Anton G. Hodenpyl of Hodenpyl, Walbridge and Company, the New York bankers. Mr. Hodenpyl was formerly secretary of the Michigan Trust Company of Grand Rapids, Michigan and is decidedly familiar with conditions in the territory served.

## EASTERN PENNSYLVANIA POWER COMPANY

The Eastern Pennsylvania Power Company does all the commercial electric light and power business in and

about Easton and Bangor, Pa., and Philipsburg and Dover, N. J., serving a population of about 92,000. Through ownership of all the capital stock, the Eastern Pennsylvania Power Company controls the Easton Gas Works which does all the gas business of Easton and Philipsburg.

## CAPITAL

Capital Stock: (Shares \$100 par)	Au- thorized	Out- standing
Preferred, 7% cumulative.....	\$1,000,000	\$ 550,000
Common.....	3,500,000	2,900,000
Funded Debt:		
First and Refunding Mortgage 5's, due 1939.....	4,000,000	1,880,000
Easton Power Company 5's, due 1940..	120,000	120,000
Bernards Electric Company 5's, due 1971..	125,000	125,000
Five Year 6% Notes due 1917, secured by Mortgage.....	1,500,000	1,000,000

The issue of five year six per cent notes is a direct obligation of the Eastern Pennsylvania Power Company and is secured by a joint mortgage of the Eastern Pennsylvania Power Company and the Easton Gas Works upon all the electric lighting and power and gas properties of these companies in the State of Pennsylvania and further secured by \$140,000 mortgage bonds on the gas properties in New Jersey.

H. M. Byllesby and Company, consulting engineers, estimated that on December 31, 1912, the company would be on an annual net earning basis of over \$320,000.

## EARNINGS

	1910	1911
Gross Earnings, from all sources.....	\$472,394.65	\$519,726.61
Operating Expenses, including taxes, maintenance, rentals, and interest on Bernard's Electric 5's.....	287,366.24	314,066.64
Net Earnings.....	\$185,028.41	\$205,659.97
Add saving that will be effected in operating expenses through consolidation (report of H. M. Byllesby & Co.).....		44,000.00
Total Net Earnings.....		\$249,659.97
Interest Deductions:		
Bonds, \$2,000,000 at 5%.....		100,000.00
Surplus.....		\$149,000.00
5-Year 6% Construction and Purchase Money Notes \$1,000,000 at 6%.....		60,000.00
Surplus.....		\$ 89,000.00

## List of Selected Bonds showing Income Yield

Under the above heading, from month to month, a list of carefully selected securities will be given showing the approximate income yield. In this connection it is to be remembered that the income yield depends upon the price that is paid for the bond, and, as in the case of commodities, bond prices fluctuate according to the laws of supply and demand and to the quality or worth of the security in the opinion of the buying public. For instance, if a bond of a face value of \$1,000 and paying six per cent interest can be bought in the market at 98, or, in other words, for \$980, the income yield to the purchaser will not be six per cent but a little over 6.1 per cent.

That is, a year's interest on the bond is \$60. If it is bought for \$980, the income will be  $\$60 \div 980 = 6.1$  per cent. Correspondingly, if the bond is bought above par, say 102, the income yield in that case will be  $\$60 \div 1020 = 5.88$  per cent.

In compiling the list below, the income yields given are perforce those determined by the market prices of the bonds at the time of writing, which is somewhat earlier than the date at which the magazine reaches its readers. But as the market price on stable securities such as these fluctuates very little the table is sufficiently accurate to enable the prospective purchaser to make his selection intelligently.

## BONDS TO YIELD 4.50% TO 5%

California Gas and Electric Company, San Francisco, Cal. General mortgage and collateral trust 5% bonds. Mature 1933. (\$1,000.)	Yield about	4.78
Cleveland Electric Illuminating Co., Cleveland, Ohio. First and refunding 5% bonds. Mature 1939. (\$500.)	Yield about	4.85
Commonwealth Edison Company, Chicago, Ill. First mortgage 5% bonds. Mature 1943. (\$1,000.)	Yield about	4.90
Edison Electric Illuminating Co., Brooklyn, N. Y. Consolidated 5% bonds. Mature 1995. (\$1,000.)	Yield about	4.50
Edison Electric Co., Los Angeles, Cal. First and refunding gold 5% bonds. Mature 1922.	Yield about	4.75
Milwaukee Light, Heat & Traction Co., Milwaukee, Wis. First mortgage 5% gold bonds. Mature 1929. (\$1,000.)	Yield about	4.80
Milwaukee Electric Railway & Light Co., Milwaukee, Wis. Refunding and extension gold 4½% bonds. Mature 1931. (\$1,000.)	Yield about	4.95
Minneapolis General Electric Co., Minneapolis, Minn. First 5% bonds. Mature 1934. (\$1,000.)	Yield about	4.85
Muskogee Gas & Electric Co., Muskogee, Okla. First and refunding gold 5% bonds. Mature 1926. (\$1,000.)	Yield about	4.90
New York Gas & Electric Light, Heat & Power Co., New York City. First mortgage 5% bonds. Mature 1948. (\$1,000.)	Yield about	4.90
Pacific Elec. Ry. Co., Los Angeles, Cal. First gold 5% bonds. Mature 1942. (\$1,000.)	Yield about	4.75
Portland General Electric Co., Portland, Ore. First gold 5% bonds. Mature 1935. (\$1,000.)	Yield about	4.85
Rochester Railway & Light Co., Rochester, N. Y. Consolidated mortgage gold 5% bonds. Mature 1954. (\$500.)	Yield about	4.90
Scranton Electric Co., Scranton, Pa. First and refunding gold 5% bonds. Mature 1937. (\$1,000.)	Yield about	4.78
Washington Water Power Co., Spokane, Wash. First and refunding gold 5% bonds. Mature 1959. (\$1,000.)	Yield about	4.90
Union Electric Light & Power Co., St. Louis, Mo. First mortgage gold 5% bonds. Mature 1932. (\$1,000.)	Yield about	4.85

## BONDS TO YIELD 5% TO 5.50%

Asheville Power and Light Co., Asheville, N. C. Gold 5% bonds. Mature 1942. (\$1,000.)	Yield about	5.20
Buffalo General Electric Co., Buffalo, N. Y. First mortgage 5% bonds. Mature 1939. (\$100.)	Yield about	5.00
Buffalo & Niagara Falls Elec. Light & Power Co., Buffalo, N. Y. First 5% bonds. Mature 1942. (\$500.)	Yield about	5.00

Burlington Railway & Light Co., Burlington, Vt. First 5% bonds. Mature 1932. (\$1,000.)	Yield about	5.30
California Gas & Electric Corporation, San Francisco, Cal. Unifying and refunding gold 5% bonds. Mature 1937. (\$1,000.)	Yield about	5.25
Colorado Springs Light, Heat & Power Co., Colorado Springs, Colo. First and refunding gold 5% bonds. Mature 1919. (\$100.)	Yield about	5.10
Danville Street Railway & Light Co., Danville, Ill. Refunding mortgage gold 5 bonds%. Mature 1925. (\$1,000.)	Yield about	5.00
Denver City Tramway Co., Denver, Colo. First consolidated gold 5% bonds. Mature 1933.	Yield about	5.00
Denver Gas & Electric Co., Denver, Colo. General (now first) mortgage 5% sinking fund gold bonds. Mature 1949. (\$100.)	Yield about	5.00
Eastern Pennsylvania Power Co., Easton, Pa. First and refunding gold 5% bonds. Mature 1939. (\$500.)	Yield about	5.25
Illinois Northern Utilities Co., Chicago, Ill. First and refunding 5% gold bonds. Mature 1957. (\$1,000.)	Yield about	5.30
Indiana Railways & Light Co., Indianapolis, Ind. First and refunding 5% bonds. Mature 1943. (\$500.)	Yield about	5.40
Kankakee Gas & Elec. Co., Kankakee, Ill. First and refunding mortgage 5% sinking fund gold bonds. Mature 1930. (\$100.)	Yield about	5.10
Los Angeles Gas & Electric Corp., Los Angeles, Cal. First and refunding gold 5% bonds. Mature 1939. (\$1,000.)	Yield about	5.07
Niagara Falls Power Co., Niagara Falls, N. Y. First Mortgage 5% bonds. Mature 1932. (\$500.)	Yield about	5.00
Northern California Power Co., San Francisco, Cal. Refunding and consolidated gold 5% bonds. Mature 1948. (\$1,000.)	Yield about	5.34
Oklahoma Railway Co., Oklahoma City, Okla. First and refunding gold 5% bonds. Mature 1941. (\$1,000.)	Yield about	5.37
Oklahoma Gas & Electric Co., Oklahoma City, Okla. First gold 5% bonds. Mature 1929. (\$1,000.)	Yield about	5.07
Pacific Light & Power Corp., Los Angeles, Cal. Collateral trust 6% bonds. Mature 1915. (\$1,000.)	Yield about	5.25
Pacific Light & Power Corp., Los Angeles, Cal. First and refunding mortgage 5% sinking fund gold bonds. Mature 1951. (\$1,000.)	Yield about	5.45
Pacific Light & Power Corp., Los Angeles, Cal. First gold 5% bonds. Mature 1942. (\$1,000.)	Yield about	5.00
Pacific Power & Light Co., New York City. First and refunding (now first) 5% bonds. Mature 1930. (\$1,000.)	Yield about	5.44
Port Huron Light & Power Co., Port Huron, Mich. First mortgage gold 5% bonds. Mature 1921. (\$1,000.)	Yield about	5.00
Portland Electric Co., Portland Me., First mortgage 5% bonds. Mature 1926. (\$1,000.)	Yield about	5.00
Portland Gas & Coke Co., Portland, Ore. First and refunding 5% bonds. Mature 1940. (\$1,000.)	Yield about	5.05
Portland Ry., Light & Power Co., Portland, Ore. First and refunding mortgage 5% sinking fund gold bonds. Mature 1942. (\$100.)	Yield about	5.25
Portsmouth (N. H.) Gas Company. Portsmouth, N. H. Refunding (now first) 5% gold bonds. Mature 1931. (\$500.)	Yield about	5.05
Public Service Company of Northern Illinois, Chicago, Ill. First and refunding gold 5% bonds. Mature 1956. (\$1,000.)	Yield about	5.13

### Buying Stocks and Bonds on the Installment Plan

Most of the Stock Exchange brokers or investment bankers who have adopted the partial payment plan for the purchase of securities for customers using the installment plan, follow much the same system. When the intending buyer wishes to buy on the installment or part payment method he is required to pay as follows:

On a \$1,000 high grade bond, \$100.

On a \$1,000 bond that is considered speculative, \$200.

On stocks selling at \$150 or upwards, one-third to one-half the full amount of the purchase price.

On stocks selling at \$50 to \$100, \$20 per \$100 share.

On stocks selling below \$50 per share, \$15 per share.

If a would-be purchaser of ten shares

of say Union Pacific wished to buy stock on the partial payment plan, an initial cash payment of \$500 would be required. The balance on all stock bought this way would have to be paid for in regular monthly payments, usually \$3 to \$5 per month for each share of the stock so purchased.

The buyer of the ten Union Pacific shares would pay \$30 to \$50 per month and if he bought at \$175 per share, for 10 shares, and paid \$500 down, the balance due would be \$1,250. This if paid off at the rate of \$50 monthly would be all paid for in two years and one month. The dividends on the stock would meet the interest payments, and perhaps a little more so that the stock would be free and clear at the end of the period named.

Altogether the buying of stocks and bonds by paying part of the purchase price down and the balance in one, two or three years or longer, is much the same as paying for a house in installments.

When considering the price of bonds it must not be forgotten that if the owner of bonds has reason to think that they, having advanced in price from the figure he originally gave for them, have reached as high as they are likely to go it will be the part of wisdom on his part to dispose of them at the profit and then reinvest his money in lower priced bonds, perhaps of later issue and on newer propositions, that are equally well secured and just as safe.

By following this plan he will be getting a better income or yield from them with, at the same time, the prospect of enhancement in the value of his property through an advance in their price.

## Unique Lamp Exhibit

One of the interesting exhibits at the recent Electrical Exposition in New York, was that of the General Electric Company showing a collection of the various substances used by Edison in his search for a satisfactory filament. Another collection shown in the illustration, showed the development of the lamp itself, from those of 1880 to the high

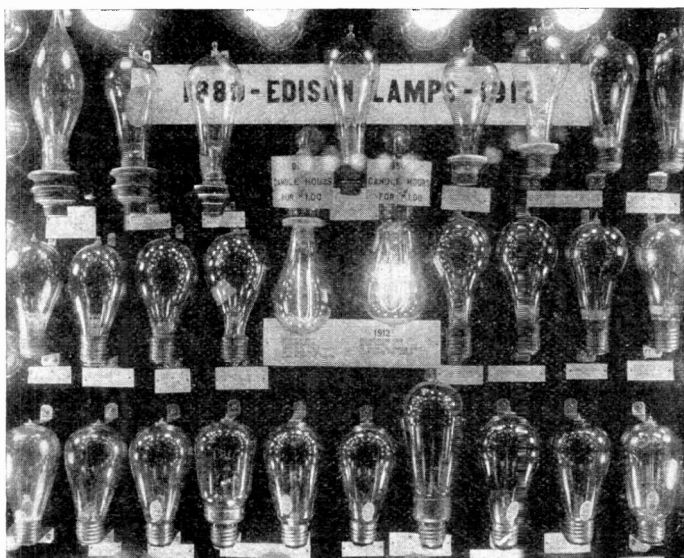

UNIQUE LAMP EXHIBIT

efficiency lamp in use at the present day. Among the lamps there was the old hand made bulb, with the bamboo filament, in which the vacuum was produced with a hand pump, and others of the early '80's with their wooden or plaster bases. Then were shown the various lamps that had been manufactured during the past 30 years; among them the gem, the tantalum, the pressed tungsten filament and the latest type of drawn wire Mazda. In 1881 only 30,000 lamps were manufactured while in 1910 the output was 80,000,000. The lamps of 30 years ago consumed 4.66 watts per candlepower as compared with the 1.17 watts consumed by the latest type of tungsten.

# SCIENCE EXTRACTS FROM FOREIGN JOURNALS

**London Railway Electrification.**—The London and Northwestern railway as well as other railroad lines which are so extensively used in the suburbs of London are now to be equipped for running electric trains. This is a very extensive undertaking, and for the lines owned by one company alone the length of railroad to be fitted out for electric operating is about 80 miles. Passengers will now be able to travel between the city and suburbs under much better conditions than before, and it has long been desired to replace the steam trains by electric trains. Direct current on the 600 volt third rail system is to be used here, and the plans call for a power station of large size which will cover a seventeen acre site near the electric line and will be laid out so that it can be readily increased in the future. Steam turbines will be mounted in the station and they will supply high voltage current upon a power line which runs to a number of substations located along the railroad line so as to be able to supply this latter. Each of the electric cars will carry four motors and the trains will be made up of motor cars and trailers.—*The Electrician, London.*

**Palace of Light at Ghent.**—The Palace of Light is to be one of the original features of the Ghent Exposition of 1913. What is desired is to have the electrical exhibits laid out so that they will be displayed with a better effect than has usually been done at exhibitions. In fact the exhibits are rarely open at night, and during the day the lighting effects are not well brought out, seeing that daylight interferes with this. The new plans are quite original, and call for a vast space which is to be entirely closed, so that it is dark even during the day. But night will be turned into day by the brilliant arc lights, also incandescent and mercury

vapor lamps, as well as the new Moore tubes and neon tubes which will be placed all around the hall. A very attractive effect is given by Geissler tubes of many hues which will be set in constant movement by electric motors.—*L'Electricien, Paris.*

**Ordnance Manufacturing in Russia.**—A large part of the ordnance the Russian army and navy is made at the large works of Motovilika, in the Perm district and within a recent date the works is engaged in putting in quite a number of electric motors so as to take the place of steam engines. To run the motors there is erected a good sized electric plant with 300 horsepower steam engines and dynamos and also a 400 horsepower Diesel oil engine set working on crude oil from the Russian wells. Besides, there will soon be installed a 1,200 horsepower Brown-Boveri steam turbine group of Swiss make. Throughout the shops are motors to the number of 2,450 at the present time, also eighteen traveling electric cranes of fifteen to 90 tons lift. The extensive shops are lighted by 6,450 incandescent lamps and 100 arcs. In the foundry is now running an electric furnace of considerable size which is proving very useful for this kind of work. The nickel plating shop is laid out on a large scale, and here are plated 25,000 projectiles a month.—*Revue Electrique, Paris.*

**Low Aerials for Wireless.**—M. E. Rothe finds that he can receive wireless messages from quite a long distance by the use of an aerial wire running along not far from the ground, so that this will be easier to mount than upon a pole. For instance at Nancy in the east of France he picked up signals from the Eiffel Tower and also from several German posts, with an 80 foot wire stretched at less than eight feet from the ground. In

later experiments at St. Dié, he used a copper wire run along on small stakes six inches high, the wire being attached without care as to having it insulated, and it even touched the grass at times. The shortest length he used was 50 feet and the wire was connected to buried water piping, using a self induction coil between. With a detector telephone and battery set, he could easily hear the Eiffel Tower signals. The garden in this case is entirely surrounded by an iron fence more than three feet high, but this did not appear to have a bad effect.—*Journal Academie des Sciences, Paris.*

**Bearded Grain Draws Electricity from the Air.**—Prof. Lemstrom, of the Helsingfors University, shows that bearded grain such as wheat acts in a hitherto unexpected way in order to draw in electricity from the air, and thus it serves as a veritable lightning rod. This produces a pronounced beneficent effect upon the wheat plant, seeing that the grain, at least and no doubt the other parts of the plant, are constantly in a bath of electricity, and it is now well known that this acts to further the growth of plants to quite a considerable extent. Thus the yield of grain or vegetables is found to increase, according to experiments which have been made in various places. In Europe, farmers have hitherto preferred wheat which is not of the bearded variety for various reasons, although the latter is hardier in growth and produces more grain, as is well known. Now Prof. Lemstrom seems to prove that this superiority is due to the electric currents from the atmosphere. This is another point to be added to the knowledge we are now gaining on the subject of "electro-cultivation," as it is called.—*La Nature, Paris.*

**Radium and Plant Growth.**—It has already been observed that radium has the effect of increasing the growth of plants, and the new experiments made by J. Stoklasa throw new light upon this

interesting field of study. Other workers used radium minerals or salts, but he makes use of the radium bearing mineral waters of Joachimsthal, taking the water directly from the springs each day and before it loses its effect. He shows that when grains are placed in this water, they grow at a surprisingly rapid rate; for instance, using barley grains, at eight days' growth the results were quite striking, for the roots were two inches long and the stalk three inches, while in ordinary water the roots showed but a quarter of an inch and the stalk only half an inch. Other plants gave equally good results. Grain also sprouts much quicker, as for instance it took only 24 to 36 hours for it to sprout when in the radium water and as long as 56 to 120 hours otherwise. Other equally surprising results come from the weight of the plants. After 40 days' growth, the weight for ten stalks of the same plant was over four times as much by the radium treatment.—*Journal Academie des Sciences, Paris.*

**New Telegraph Recorder.**—At the recent exhibition of new apparatus held in London by the Physical Society, Mr. S. G. Brown spoke of a new recorder for receiving telegraph messages over long lines and especially ocean cables. The current is very weak in such cases, and the signals are usually received in the siphon recorder, as the current is not strong enough to work another kind of device. Mr. Brown magnifies the current by the use of a new relay of his design. As usual, the current comes into a suspended coil which swings under the action of the current, but instead of using the siphon for ink signal record on the end of the arm attached to the coil, he uses a very ingenious method which consists of a pair of miniature thermo-electric couples mounted on the arm. The two couples lie midway between two small spirit lamps, so that when the coil is not working, the ends of the thermo-couples are equally heated. When the coil moves

one of the couples comes nearer the flame, and these are now unequally heated so as to give rise to a current. What is remarkable is that this current is nearly 30 times as great as the telegraph current, so that it can be used to work other recording devices for the signals.—*The Electrician, London.*

**Sending Colored Photographs Over the Wire.**—A scheme for sending photographs over the wire in their natural colors is devised by an Italian engineer, Q. Marino. As the apparatus is not made as yet, it is too soon to say whether it will work in practice, but the idea appears to be an attractive one, at any rate. Each point on the original color photograph, or even a natural object, is made to pass before an opening so that the light from this point is decomposed by a prism into the seven colors, in the case of white light, or into a less number. Each color falls on a separate selenium cell whose office is to send current over the line so that the cell having, for instance, red light upon it, will produce red at the other end. This is done by having the cells send a vibratory current which is tuned so as to work with tuned Poulsen arc lights at the receiving end. Without going into details, the selenium cell sends current in such way that the corresponding arc light operates and throws light through a red screen on to an autochrome photographic plate. Thus the red color spot at the sending end gives a red light spot at the receiving end and so on for all the different colors of the photograph.—*Genie Civil, Paris.*

### Keeping Tab on an Electric Wagon

A convenient application of recording watt-hour meters is made in the electric wagon service of the Lowell, Mass., Electric Light Corporation, which is one of the most carefully handled services of its kind in New England. The power wagons shown are equipped with a Sangamo watt-hour meter calibrated between 60 and 115 volts, in addition to an

ampere-hour meter, and by these instruments the company keeps a close record of the energy consumption of the machine in various classes of service, as well as the condition of the battery with respect to charge and discharge. The meters are mounted on the dashboard directly in front of the driver's steering wheel.

## NEW BOOKS

**LESSONS IN WIRELESS TELEGRAPHY.** By Cole and Morgan. Newark, N. J.: Cole and Morgan. 1912. 62 pages with 59 illustrations. Price, 25 cents.

There are 30 lessons, arranged as far as possible in logical sequence, giving a systematic elementary course in the principles of wireless telegraph apparatus and the electrical laws upon which it depends.

**WIRELESS TELEGRAPHY AND TELEPHONY SIMPLY EXPLAINED.** By Alfred P. Morgan. New York: Norman W. Henley Publishing Company. 148 pages with 156 illustrations. Price, \$1.00.

The book furnishes a comprehensive explanation in simple language of the theory and practice of wireless telegraphy and telephony and explains as far as possible the importance of its position today and the possibilities of tomorrow.

**SAW FILING AND MANAGEMENT OF SAWS.** By Robert Grimshaw. New York: Norman W. Henley Publishing Co. 1912. 129 pages with 106 illustrations. Price, \$1.00.

This book is designed as a practical aid to those who use saws for any purpose. While, as its title implies, it treats principally of saw filing, it also goes into the questions of gumming, spring setting and swaging.

**GASOLINE ENGINE TROUBLE CHART.** By Victor W. Page. New York: The Norman W. Henley Publishing Company. Price, 25 cents.

A chart 25 by 38 inches showing a sectional view of a typical four cylinder, four cycle, gasoline engine and a tabulation of troubles, causes, symptoms and remedies to aid in clearing up any engine trouble.



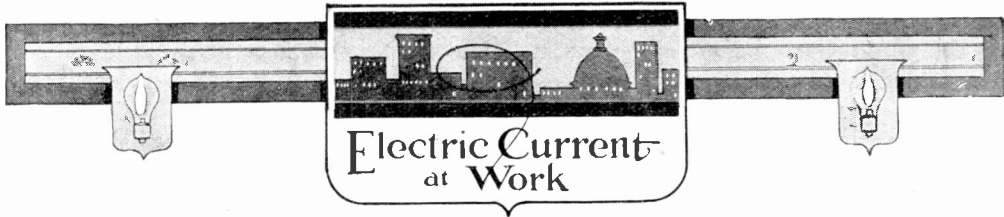

### Photographing Microscopic Objects

Tiny organisms or bits of mineral have been studied up to now by placing them upon a piece of glass called a "slide" and then slipping this glass into a holder under a microscope.

The electric photomicrographic apparatus, as it is called, changes all this

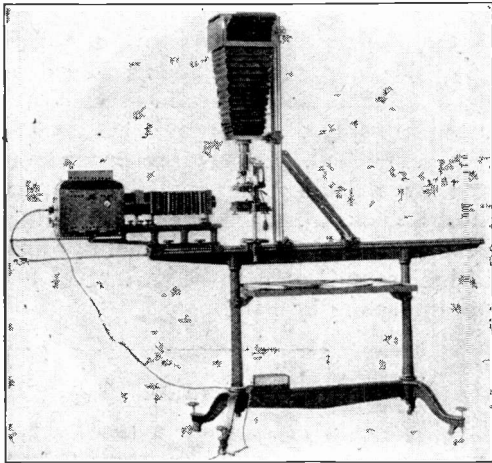

APPARATUS FOR PHOTOGRAPHING MICROSCOPIC OBJECTS

by taking a picture of the slide, using the microscope in doing so and giving us an enlarged picture of what we see if we look into the microscope itself.

The device consists of a camera, an ordinary microscope and either an arc lamp or a Nernst lamp enclosed in a lamp house and fitted with lenses for illuminating the slide during the picture taking. The equipment is fitted to a lathe like table with adjusting devices for accurate work. The camera may be placed in a vertical position and the microscope slide used to hold minerals and opaque objects while they are photographed.

By removing the camera and microscope from the stand the remaining apparatus may be used as a stereopticon.

### A Revolutionary Improvement in Plate Printing

Plate printing, that is, printing from engraved steel plates, is likely to be revolutionized as the result of an experiment now in progress by the United States government. Until recently it was held by all experts in this, the highest branch of the printing art, that impressions of the first quality could be obtained from steel plates only by means of hand work and the use of a hand power press that has shown little modification in design from the original type of printing press devised by the Italian inventors centuries ago. It is this demand for manual labor unaided that Uncle Sam is now challenging by the unique experiment lately undertaken.

The old style plate press has been retained but the old wheel which the plate printer had to revolve in order to bring to bear the pressure needed for each impression has been supplanted. In its place there has been installed an electric motor which supplies energy for the printing operation and brings to bear each successive sheet of paper upon the inked steel surface with all that precision and evenness attained by the hand impression and which are essential for the transfer to the paper of all the exquisite details of lines and shading. The electric manipulation of the roll of the press not only minimizes labor but results in an appreciable saving of time.

The national government has worked out this problem in order to simplify the

task of printing our currency but it is expected that the discovery will be taken advantage of by commercial houses in all parts of the country that are engaged in the production of any of the classes of work to which the new scheme will be applicable. Uncle Sam is disposed to let

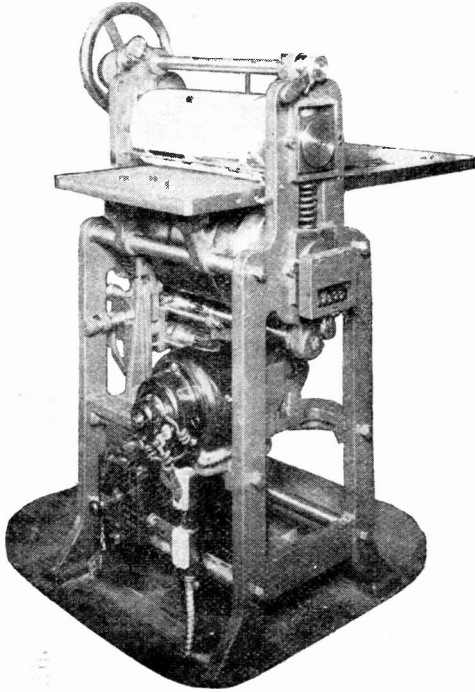

PLATE PRINTING PRESS MOTOR DRIVEN

all such interested persons into the secrets of the special type of motor which the experts designed for this work.

A specially wound armature on the motor, in conjunction with a controller of original design, results in the press starting slowly and gradually increasing speed until the roll reaches and engages the printing plate. Maximum speed is maintained during the passage of the roll across the engraved plate and then there is a gradual decrease in speed to an automatic stop. When it is explained that one second is the total elapsed time required for this operation from the time the current is turned on by means of footpedal control until the roller has mechanically come to rest it will be

appreciated that careful calculation has been made and when it is stated that this operation will be repeated more than 100 times an hour during eight or sixteen hours per day it can be realized that severe exactions are placed upon the motor.

Tests already made show that motor drive will increase the speed of a plate press at least ten per cent. The average skilled operative of a hand press prints about 110 sheets per hour whereas a speed of 121 sheets per hour has been recorded by the electrically operated press under favorable conditions and a record of 100 sheets in 35 minutes has been made in a spurt. The aid of the magic current does not reduce this highly specialized form of printing to the level of the mechanical because now, as formerly, the inking of the plate, which is done by hand, determines in great measure the quality of the product but, as has been explained, it increases production and by relieving the operative of the most arduous manual labor allows him to devote greater care to the exacting duty of inking and rubbing the surface of the printing plate by hand.

### Emergency Extension Plug

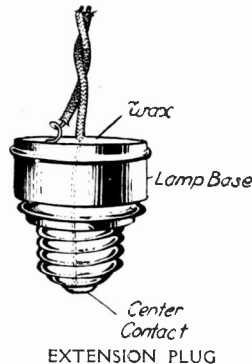

In a case where a plug could not be obtained in time for use on an extension light I made a plug from a tungsten lamp base in the following manner: The two wires of an ordinary drop cord were soldered one to the center contact and the other to the screw shell of a tungsten lamp, the whole interior being then filled with sealing wax. A socket connected to the other end completed the extension which was used until a regular plug could be delivered.—H. G. WILSON.

## Stethoscope to Detect "Valve Slap"

There is no marked similarity between the physician's office of a life insurance company and the engine testing room of a motor car factory, yet they have points in common. Among the tests given in each place is that of the stethoscope.

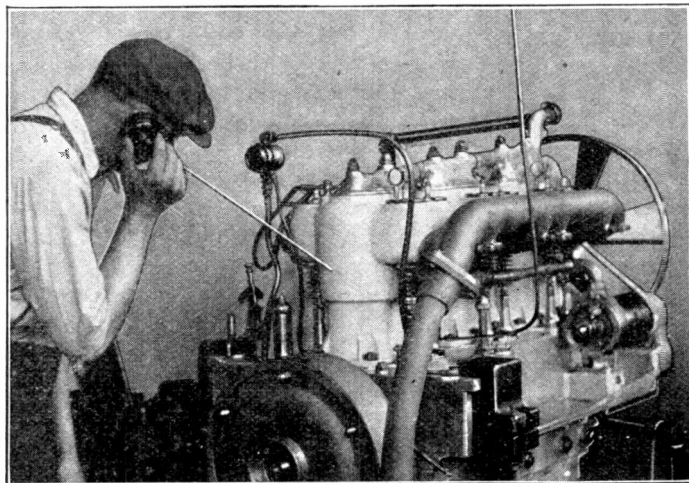

LISTENING FOR VALVE SLAP

The physician uses it to detect irregularities of the heart—the mechanic to discover any unevenness of operation in the motor.

While serving the same purpose as the stethoscope, the instrument used in the high grade motor car factories is slightly different in appearance. It consists of a steel rod made of three separate pieces combined with a regulation telephone receiver. By placing the end of the rod against the side of a motor it is possible to locate the source of the smallest disturbance. The lightest of "valve slaps" or knocks in the engine are thus noted, allowing the correction of any fault before mounting the motor on a chassis. The road testers carry similar instruments as an extra precaution against the possibility of a car being turned over to the sales department with a faulty motor.

The accompanying photograph shows a workman testing a six cylinder motor for interior trouble.

## Automatic Electric Generator for Country Homes

There has lately been put on the market in France an electro-generative outfit which seems to have overcome some of the difficulties of small lighting equipments by means which are both simple and ingenious. When the motor is supplied with its combustible, lubricating oil and cooling water, the apparatus furnishes automatically the current necessary for lighting or other purposes on the turning of a switch.

The arrangement consists of a small gasoline or benzine engine attached by a belt to a dynamo, a tank for the combustible and another for the cooling water, a battery of a small number of elements acting

as an accumulator and a starting rheostat. The whole is mounted on a pair of I beams, and is so light that it can be moved around very easily.

The apparatus being connected with the wiring system of the house, a switch is closed which discharges the current of the accumulators upon the circuit thus opened; this current is sufficient to supply, for a time, three or four lamps without the help of the engine. But if another switch is closed and the current becomes insufficient for doing the work in hand the dynamo, acting as a motor, is connected. This moves with increasing speed, carrying with it the engine, until the latter begins to work of itself. The dynamo is then driven by the engine and produces current to feed the lamps and to re-charge the accumulators.

If at any moment the charge diminishes to a point where it does not exceed the capacity of the accumulators, the dynamo stops and the accumulators are dis-

charged upon the line. Each time that the accumulator charge is lowered below its normal voltage, even if there are no lamps lighted, the apparatus is automatically set in motion to re-charge the accumulators. All these maneuvers are effected by the movements of an electromagnetic relay on the switchboard.

### The Bond Tester

The current which leaves the trolley wire through the trolley pole passes through the car motor and then must return to the power house along the rails of the tracks if no return wire is provided. For this reason each rail is connected to the next by a good heavy wire which is called a "rail bond." This bond

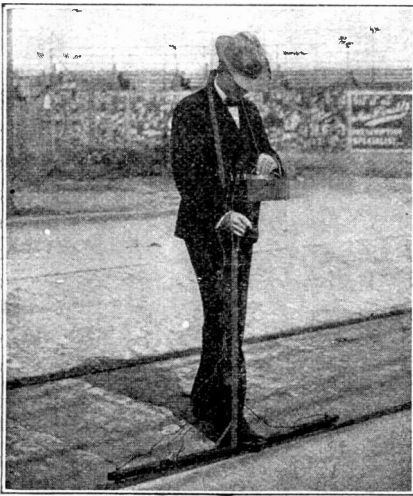

BOND TESTER.

or connecting wire between the rails must be at all times in good condition and to determine this men called "bond testers" travel along the tracks and make tests where the rail ends meet.

Without going into detail the tester shown in the picture equipped with a Roller outfit works about as follows: The inverted T shaped wooden bar is placed on the rails under test. It has three saw blade contacts which are connected by flexible conductors to the port-

able galvanometer swung from his neck. Since current from cars is always flowing along the tracks some of it will flow by way of the contacts through the galvanometer and deflect the needle, but just how much will depend upon the condition of the bond wire.

### Electric Lantern

An electric lantern designed by a locomotive engineer and following the lines of a Pullman conductor's lantern is being placed on the market by a Chicago firm.

The body of the Jenks lantern is made of brass heavily nickel plated and weighs  $2\frac{1}{4}$  pounds. In the base is a three cell dry battery which supplies current to an incandescent lamp. When the lantern is lifted by the bail the lamp lights up. By dropping the bail on one side the light is turned out, while dropping the bail to the other side keeps the light burning.

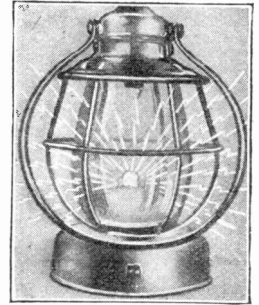

ELECTRIC LANTERN

The lantern does away with the use of oil and the cleaning of smoky chimneys and it cannot be blown out by wind.

### Battery Switch

This switch is designed for service upon battery and magneto circuits. The Fahnestock spring binding posts make it appeal to experimenters on account of the

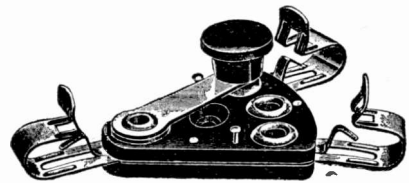

BATTERY SWITCH

ease and quickness with which wires are connected and disconnected.

## Automobile Tire Pump

Considering the amount of hard work this pump can save, its low cost of operation is surprising, since at ordinary rates for electricity it will operate for less than one cent an hour. The cost of filling a tire is therefore insignificant.

The operating parts of the Vaile-Kimes pump, which is operated by a

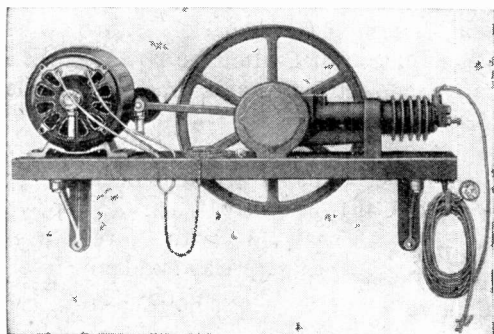

TIRE PUMP

small Westinghouse motor, are enclosed in an oil tight, dust proof casing, so that practically no attention is required.

A pressure gauge registering up to 150 pounds is provided as part of the outfit. The automobile owner is, therefore, able to maintain his tires at the proper pressure, which adds greatly to their life. It is impossible for oil to get into the tire through this pump, so that rotting from this cause is prevented.

## Moving Pictures by Incandescent Lamp

Much enjoyment as well as instruction can be had during winter evenings by the use of the new moving picture machines of small size, and these are coming into service in Paris and other cities for use in the family circle. It may seem strange that the metallic filament electric lamp is responsible for a great deal of this progress in making a simple and inexpensive machine. As soon as it was found that the lamps would flash up and die out much

quicker than the ordinary carbon filament lamp, inventors set to work to make a machine in which the lamp would flash up at one-tenth of a second, that is, making a separate flash just as each picture passed before it. This brilliant flash sends a strong light through the picture film just at the moment it is needed, then the light goes out while the film is passing on.

Before this a revolving shutter was needed to stop off the light while the pictures were being changed.

The new Pathé machine is here illustrated. It uses non-combustible film of smaller size than usual, and at the factory there is a special camera apparatus for reproducing the standard films in this small size. The film will be seen passing in front of the small electric lamp, the light being concentrated by reflector and lens. A magneto supplies the current and an extra brilliant light is given at each impulse by the use of a much higher current than the lamp is made for. This uses up the lamp very quickly, but it costs but little, and one lamp lasts for about ten hours. Even with this small appara-

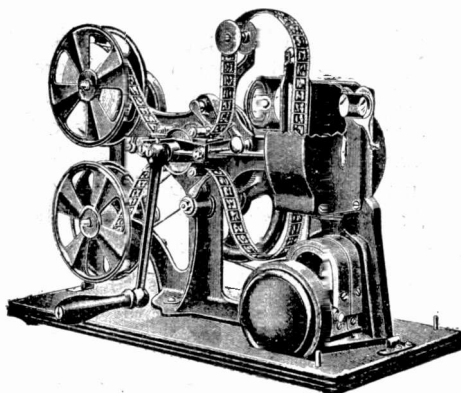

MOVING PICTURE MACHINE OPERATED BY INCANDESCENT LAMP

tus and using an incandescent lamp which would give but two candlepower usually, the picture appears in an excellent light on a screen three feet square, which is very good for use in an ordinary room. For schools the new machine will prove excellent.

# On Polyphase Subjects

The cadmium vapor lamp which has just been invented by a German physician, M. Wolfke, gives a white light. Every one knows the mercury vapor lamp: it has the advantage of being very economical from the point of view of current consumption, but the green coloration of its light limits its usefulness very considerably. M. Wolfke, after having tried a great number of metals and alloys, seems to have solved the problem by an amalgam of cadmium with a small quantity of mercury. Cadmium has the following properties which make it very suitable for this purpose; its temperature of vaporization in a vacuum is low ( $450^{\circ}$  C.); it does not attack glass; its spectrum contains red radiations. Pure cadmium used in a lamp gives a red light; with the addition of from three to ten per cent of mercury it produces a very satisfactory white light. Here seems to be an interesting question for inventors and electricians. If a mercury vapor lamp gives a green light, and a cadmium lamp a red light, and a combination of the two in certain proportions gives a white light, then how shall a blue or yellow light be produced, if such should be desired?

For a time, during the transition from steam to electricity on the Southport Branch of the Lancashire and Yorkshire Railway, it was necessary to run steam trains between the electrical trains, at the same speed.

This afforded an opportunity to compare the coal consumption of the locomotives with that of the power house

supplying the electric trains. It was found that the six wheeled, coupled tank engines consumed 80 pounds of coal per train mile for express trains, and 100 pounds for accommodation trains. The consumption of coal at the power station for the electric trains was 49 pounds per train mile.

A rather unusual accident occurred at Venice, Calif., recently, when the captive balloon with three passengers was suddenly freed and blown out over the ocean.

## Trolley Wire Frees Captive Balloon

The balloon had just risen to the end of its cable when a freakish wind caught the big bag and forced it towards the ground. The steel cable came in contact with a trolley wire and the electric current burned it in two almost instantly. The balloon floated upward and for an hour and a half drifted about in the air sometimes near the land and sometimes far out over the water. About four miles from the San Pedro breakwater the pilot finally noticed some boats beneath him and, descending, they were rescued.

Something over three years ago a new unit of electric illumination, called the "international candle," was

## The International Candle

adopted by France, England and the United States. The American standard candle was thereby reduced one and six-tenths per cent in order to make it uniform with the English candle and the Bougie Decimale of France. The value of the Hefner, the German unit, is nine-tenths that of the international candle.



The French visitor to Gelligaer showed some alarm at the prospect of passing a savage looking dog that stood in the way, barking furiously.

"It's all right," said his host. "Don't you know the proverb, 'Barking dogs don't bite?'"

"Ah, yes," said the Frenchman, "I know ze proverbe, you know ze proverbe, but ze question is, does ze dog know ze proverbe?"

\* \* \*

A traveler in Indiana noticed that a farmer was having trouble with his horse. It would start, go slowly for a short distance and then stop again. Finally the traveler approached and asked, solicitously: "Is your horse sick?"

"Nöt as I knows of."

"Is he balky?"

"No. But he is so danged 'fraid I'll say whoa and he won't hear me, that he stops every once in a while to listen."

\* \* \*

"God bless mama and papa, and God bless Harrigan," said little George, aged four years, as he knelt beside his mother for his evening prayer.

"Why, George," said his mother, "who is Harrigan?"

"That's me," he replied.

\* \* \*

"You are rather a small boy to be earning five dollars a week."

"I suppose I am," he replied. "I know I'm small for my age, but to tell the truth, since I've worked here I've been so busy I haven't had time to grow."

He got the "raise."

\* \* \*

Some years ago a prominent man went into the business of raising hogs. Friends congratulated him on his success, as his breeds were certainly fine. "Hogs!" replied he contemptuously. "Why, these people never knew what a big hog was till I came here!" And he wondered why they laughed.

\* \* \*

Teacher—"Johnny, what is a skeleton?"

Johnny—"Please, ma'am, it's a man with his insides out, and his outsides off."

Subbubs had taken Chumleigh home to dine. Everything went well until they were seated at the dinner table, when Willie Subbubs remarked, "Why, pa, this is roast beef!"

"Well," said his father, "what of it?"

"Why, I heard you tell ma at breakfast that you were going to bring a mutton head home for dinner this evening."

\* \* \*

"Why do you use paint?" asked a violinist of his daughter.

"For the same reason that you use resin, papa."

"How is that?"

"Why, to help me draw my beau."

\* \* \*

Not long ago Bishop Greer recounted some amusing replies to examination questions given by Chinese students. The first of them is evidence how rapidly the sporting instinct is spreading. In answer to the question, "What are the five great races of mankind?" one student replied: "The hundred yards, the hurdles, the quarter mile, the mile and the three miles."

\* \* \*

"It is the duty of everyone to make at least one person happy during the week," said a Sunday school teacher.

"Now, have you done so Johnny?"

"Yes," said Johnny, promptly.

"That's right. What did you do?"

"I went to see my aunt, and she's always happy when I go home!"

\* \* \*

"So you advertised for your lost purse, pretending that the person who found it was recognized?"

"Yes."

"How did the bluff work?"

"Didn't work at all. Next day this ad appeared in the same paper: 'The recognized gentleman who picked up the purse on Boylston street requests the loser to call at his house.'"

\* \* \*

"That lawyer of mine has a nerve."

"Why so?"

"Listen to this item in his bill: 'For waking up in the night and thinking over your case, \$5.'"

# THE ELECTRICAL HOUSE THAT JACK BUILT

THIS IS THE HOUSE THAT JACK BUILT



THESE ARE THE WIRES THAT WIRED THE HOUSE THAT JACK BUILT

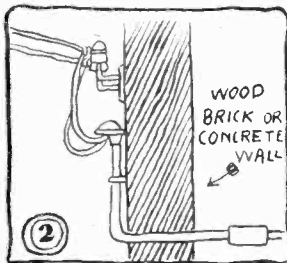

THIS IS THE ELECTRIC RANGE THAT J.'S WIFE BOUGHT AND ATTACHED TO THE ENDS OF TWO OF THE WIRES THAT WIRED THE H. THAT J. BUILT

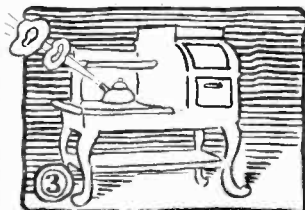

THIS IS THE SINKER ALL FORLORN THAT J.'S WIFE COOKED UPON THE RANGE ATTACHED TO THE ENDS OF TWO OF THE WIRES THAT WIRED THE H. THAT J. BUILT

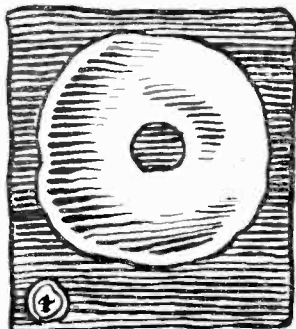

THIS IS THE BITE ALL TATTERED & TORN J. TOOK FROM THE SINKER ALL FORLORN THAT WAS COOKED ON THE RANGE ATTACHED TO THE WIRES THAT WIRED THE H. THAT J. BUILT

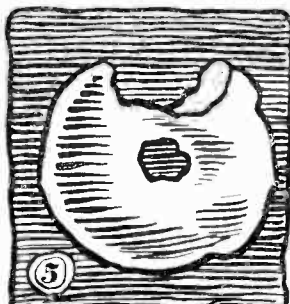

THIS IS THE WINDOW OUT OF WHICH J. HEAVED THE SINKER ALL FORLORN THAT WAS COOKED ON THE RANGE ATTACHED TO THE WIRES THAT WIRED THE H. THAT J. BUILT

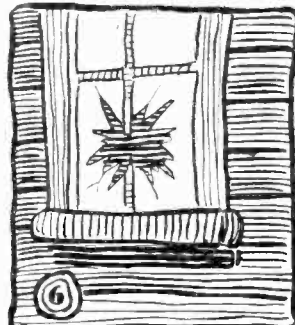

THIS IS THE HOUSE IN RENO WHERE J.'S WIFE WENT WHEN HE CAST AWAY THE BEAUTIFUL SINKER ALL FORLORN THAT WAS COOKED ON THE RANGE ATTACHED TO THE WIRES THAT WIRED THE H. THAT J. BUILT

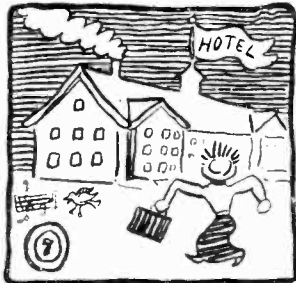

THIS IS THE LETTER J. SENT HIS WIFE

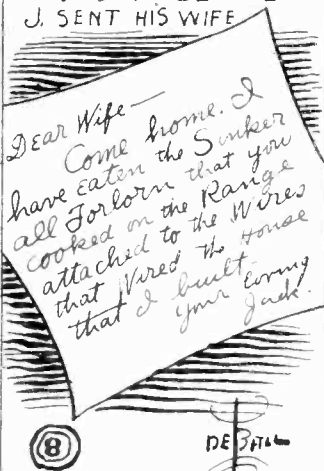

SO SHE CAME BACK AND THEY LIVED HAPPILY AND PROSPERED - AND SHE COOKS NO MORE SINKERS ALL FORLORN UPON THE RANGE ETC.





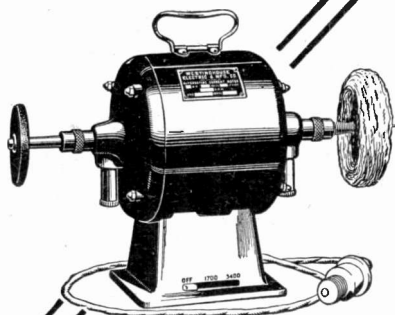

## Westinghouse Buffing and Grinding Motor has plenty of Power to do the Work Required

**T**HIS powerful little motor takes right hold of any buffing, polishing or grinding work you may have to do.

Storekeepers find such a motor a good stock-keeping investment. Tarnished or dingy stock made to look like new in a minute.

If you run a small shop you need an efficient motor of this type. Belt it to a lathe and it will easily care for all your light lathe work *at very little expense for electric current.*

Many householders are buying this motor. They use it to grind knives, polish silver, run a lathe, a circular or jig saw or the family ice cream freezer.

There's no motor like a Westinghouse motor. Write today for full specifications and prices on small motors.

## Westinghouse Electric & Mfg. Co.

Dept. M F, East Pittsburgh, Pa.

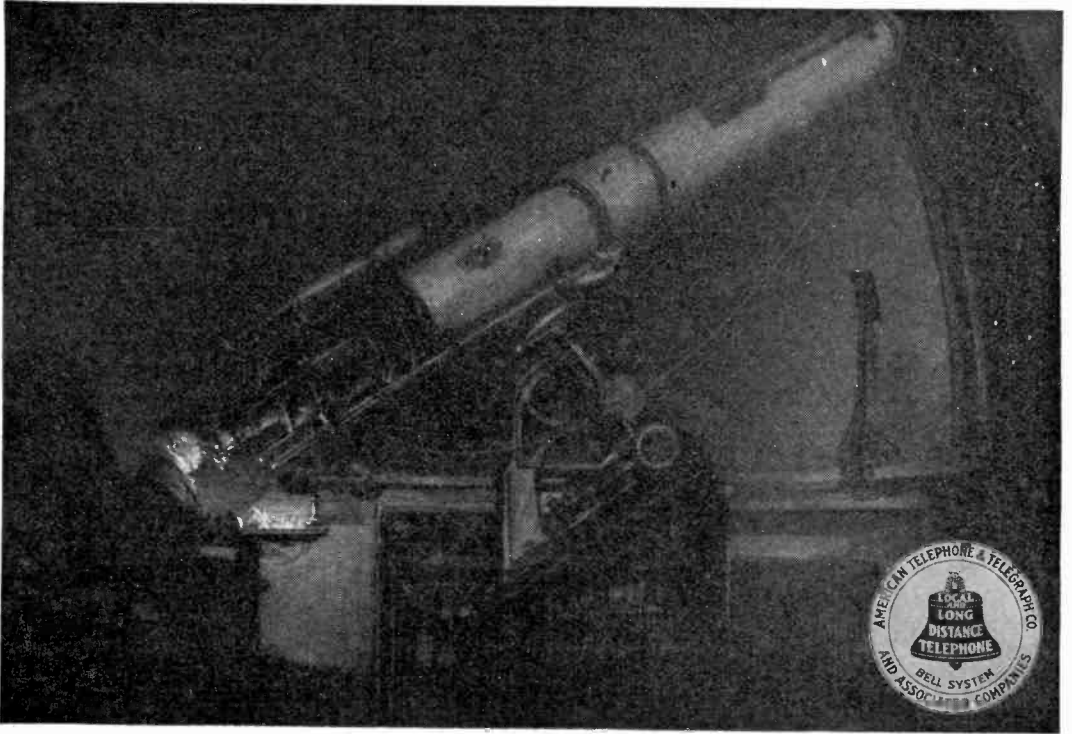

## The Telescope of Speech

The astronomer, by the power of his telescope, becomes a reporter of the movements of a hundred worlds greater than ours, and the student of celestial activities millions of miles away.

He points his instrument at any spot in the heavens, and his sight goes rushing through space to discover and inspect a star hitherto unknown.

Up to the power of his lenses, his vision sweeps the universe.

As the telescope may be focused upon any star, so the telephone may

be focused upon any person within the range of its carrying power.

Your voice may be directed anywhere in the Bell System, and it will be carried across country at lightning speed, to be recognized and answered.

The telescope is for a very limited class, the astronomers. The telephone is for everyone.

At the telescope you may see, but cannot be seen. At the telephone you may speak and be spoken to, you may hear and be heard. By means of the Bell System this responsive service is extended to the whole nation.

**AMERICAN TELEPHONE AND TELEGRAPH COMPANY  
AND ASSOCIATED COMPANIES**

**One Policy**

**One System**

**Universal Service**

For our Mutual Advantage mention Popular Electricity when writing to Advertisers.

Standards  
of



Essential  
to the

## Electrical Fraternity

### SINGLE-PHASE MOTORS

*The Wagner BA Single-Phase Motor* leads in the single-phase field. High starting efficiency—simplicity in control—minimum maintenance cost.

*The Wagner BK Small Users' Unity Power-Factor Type* marks a great advance in the motor art. It improves voltage regulation—increases earning capacity—reduces fixed charges and produces dividends.

### POLYPHASE MOTORS

*The Wagner Polyphase Motor* is the most rugged in construction. Its frames, end plates, bearings, etc., are designed for a continuity of service.

### GENERATORS

*The Wagner Generator* has ample material in all parts and is able to withstand sudden changes or unusual demands with success.

### TRANSFORMERS

*The Wagner Lighting Transformer* maintains the voltage at the end of your lines. It keeps your lights *bright* without increasing your copper.

*The Wagner Power-Transformer* embodies the result of twenty years' research, study and experience and insures the highest degree of efficiency and dependability.

### INSTRUMENTS

*The Wagner Instrument List* includes the most complete line of direct and alternating current instruments the market affords. Wagner instruments are guaranteed.

### CONVERTERS

*The Wagner Converter* is the simplest and most efficient charging outfit yet devised. No complication—no breakage—perfect control. Can be used as a power-motor for operating tire-pumps, machine-tools, etc.

### RECTIFIERS

*The Wagner Rectifier* for automobile electric lighting is unequalled. Connect the rectifier to any ordinary lamp socket and charge your storage battery over night.

# The "BEE" Electric Suction Cleaner

The powerful suction of this machine, together with its numerous superior and exclusive features make it the most efficient sweeper-type Cleaner ever made.

This Cleaner has more good points than any other on the market.

## NOTE THE FOLLOWING:

1. Adjusting Device—by means of which the machine operates on loose carpet, instead of pressing it down and shutting off the air.
2. Can be raised or lowered to suit the thickness of carpet.
3. Weight all borne on three rubber tired wheels, consequently there is no dragging, scraping or wear on carpet.
4. The Nozzle is always level on the floor.
5. Easiest machine to operate.
6. Requires no special care. Oiling once a month.
7. Universal type motor; of great advantage in any household apparatus.
8. Construction mostly aluminum. Best material used throughout. Utmost care in assembling.
9. Each machine carries our absolute guarantee.
10. Equipment for cleaning bedding, drapery, upholstered furniture, etc.

## AGENTS

Some good territory still available. Best season for sale of Cleaners just opening. Exclusive and remunerative agency proposition. *Write today.*

*Manufacturers of full line of Suction Cleaners, Massage Vibrators, Hair Dryers, etc.*

**BIRTMAN ELECTRIC CO., Chicago, Ill.**

## The BEE Cleaner

Model "D"

The Most Highly Developed Sanitary Suction Cleaner

Efficiency Increased 100% by our New Device for raising or lowering the nozzle to suit the thickness of the Rug or Carpet.

**"BEE"**  
Stands for  
**Best**





The Untrained Man



The Trained Man

# Your Future Depends On Yourself

A few years hence, then what? Will you still be an untrained, underpaid laborer, or will you be a specialist in your chosen line of work where you can earn more in one day than the untrained man earns in a week?

Your future depends upon yourself. You must decide now. To hesitate, to put it off, or to be undecided means that you must plod the hard road of disappointment, poverty, and failure. To mark and mail the attached coupon is the first step to promotion and success.

The only way to keep out of the dollar-a-day class is to get the special training that will command the attention and a better salary from the man higher up. The International Correspondence Schools have shown to thousands the way to positions of power and increased salaries. They can do the same for you.

Your future is before you. Are you interested enough in it to learn how the I. C. S. can fit you for a real big job? No matter where you live, how little you earn, or what your previous education has been, the I. C. S. have a way of helping you. For over 21 years the I. C. S. have been helping young men to increase their earnings and to rise to positions that insure a better income.

The 400 or more letters that are sent to us every month reporting increased salaries, prove our ability to help you.

Choose a high-salaried future and

**Mark and Mail the Coupon NOW.**

**International Correspondence Schools**  
Box 1102, Scranton, Pa.

Please explain, without further obligation on my part, how I can qualify for a larger salary and advancement to the position, trade, or profession before which I have marked X.

Electrical Engineering Electric Lighting Electric Railways Electrician Electric Car Running Dynamo Foreman Wireman Mining Engineer Telephone Expert Surveyor Civil Engineer Automobile Running Agriculture	Mechanical Engineer Mechanical Draftsman R. R. Construction Concrete Construction Architect Contracting and Build'g Architectural Draftsman Plumbing and Heating Chemist Bookkeeper Advertising Man Civil Service Exams. Salesmanship
--	---

Name \_\_\_\_\_

St. and No. \_\_\_\_\_

City \_\_\_\_\_ State \_\_\_\_\_

Present Occupation \_\_\_\_\_

For our Mutual Advantage mention Popular Electricity when writing to Advertisers.

# Intelligent Industry Insures Independence

By FRANKLIN O. KING

The Man Who tries to Kill an Elephant with a Pop-Gun is on a Par with the Person who would plan to Pulverize a Peanut with a Pile-Driver. Both may be Terribly in Earnest, but Neither has a Correct Idea of the Eternal Fitness of Things. Fools Spoil their Tools when they try to Reap Results without Rules. Like the Horse on the Treadmill—They are Walking Fast, but not Getting Anywhere, in Particular. The Untrained Man, with only Brute-Strength to commend Him, is up against a Hard Proposition in this Day and Age of *Specialized Supremacy*.

In other Words, the Man who Knows How to do one or two things *well*, has most Everybody else "*On the hummer*," when it comes to Competition. Emerson said:—"The Man who Makes the best Mouse-trap will find a Beaten Path to his Door, even though he Live in the Midst of a Forest." I am not so Sure about the quotation, but it simply bristles with Truth, like Quills on the Ridge-pole of a Fretful Porcupine. The Man with the Hoe would make more "dough" if he used *Modern Methods* to Sow and to Reap.

The Business Man makes the Best Farmer, because he Applies Business Principles to Buying and Selling, as well as to Growing his Crops. His Creed is Simply to make a Two-Dollar Bill grow where only a "One-Spot" grew before, and with all Due Respect to the Yokel who is Merely Multiplying Blades of Grass, I think the Business Farmer has the Bulge.

The Mechanic, the School-teacher, the Doctor, the Lawyer and the Day-laborer are all "Business Men," when it comes Right Down to it—"Even as You and I." Most of Them have had Training in the "School of Hard Knocks," and Know How to Listen when "Money Talks." It only requires the Application of Brains in Order to make the Earth most Anywhere Bloom with Life.

Ben Franklin said:—"He who by the Plow would Thrive, Himself must either Hold or Drive." The Man who is Really in Earnest will *absolutely make good* on a Small Farm, if he will only Put his Shoulder to the Wheel, and stay "Put." **Work Wins**—It Always Wins, but **Industry and Intelligence** are **Irresistible and Invincible**.

Since Investigating Conditions in the Rain Belt of Gulf Coast Texas, I have no Fear of Old Age or Poverty, because I Know I can Take Up a Few Acres

down there and be *Absolutely Independent*. I am Firmly Convinced that with *Average Intelligence* and *Average Industry*, any Man who is now Working His Head off in the North to make a *Bare Living*, where they Snatch one Crop between Snow-Storms and Blizzards, can soon Lay up a Nice Bank Account in the **Winter Garden of America**. Come to the *Land of Least Resistance*, where You can Grow Three Big Money-Making Crops a Year on the Same Soil and Without a Dollar's Worth of Expense for Irrigation or Fertilization.

I believe you could save Twenty-Five Cents a Day if You Tried. I know you would Try if you Realized that our Growers of Figs, Strawberries and Early Vegetables clear a net profit of \$300 to \$500 an Acre. Men have Realized more than \$1,000 an Acre growing Oranges in our Country. Remember that our Early Vegetables get to Northern Markets in Mid-Winter and Early Spring, when they command Top Prices.

One German Truck Grower on adjoining lands last spring realized nearly \$500 from three-fourths of an acre of Strawberries. You could do as well if you only Tried, and on a Ten-Acre Tract **Find Financial Freedom**.

The Biggest Price paid for a car of watermelons on the Houston Market last year was \$140. The car was shipped by the Danbury Fruit and Truck Growers' Association.

We are situated within convenient shipping distance of Three Good Railroads and in addition to this have the inestimable Advantages of Water Transportation through the Splendid Harbors of Galveston and Velasco, so that our Freight Rates are Cut Practically in Half. The Climate is Extremely Healthful and Superior to that of California or Florida—Winter or Summer—owing to the Constant Gulf Breeze.

Our Contract Embodies Life and Accident Insurance, and should You Die or become totally disabled, Your family, or any

one else You name, will get the Farm without the Payment of Another Penny. If you should be Dissatisfied, we will Absolutely Refund your Money, as per the Terms of our Guarantee.

Write for our Free Book, which contains nearly 100 Photographs of Growing Crops, etc. Fill Out the Blank Space below with your Name and Address, plainly written, and mail it to the Texas-Gulf Realty Company, 1383 Peoples Gas Bldg., Chicago, Ill. Read it Carefully, then use your own Good Judgment.

Please send me your book, "Independence With Ten Acres."



Two Texas Gulf Coast Products

# ALMOST FREE!

## Practical Books With The Magazine That Makes Facts More Fascinating Than Fiction

We offer your choice of these practical books. Each one of them was written by an acknowledged authority in his special line. **No technical education is necessary for their complete understanding.** They are just the thing for the beginner, the practical man, or for that studious boy who is continually asking questions. They are not only for the worker or student in each special field, but for the intelligent reader who wants to know in a general way, how things are done in the trades and professions, or in business.

### Just Read These Titles

We want new readers to **TECHNICAL WORLD MAGAZINE**—the most fascinatingly interesting, illustrated monthly published. We want practical men to realize the immense good that they can do for themselves by seeing **TECHNICAL WORLD** every month, and on that account we make the following

### EXTRAORDINARY OFFER

**Technical World Magazine** } All Only  
**For One Full Year (12 Wonderful Numbers)** } **\$1.65**  
**And Any Book Listed Opposite** }  
 (Sent Prepaid)

After one book and the magazine have been ordered at \$1.65, additional books may be added to your order at only 75 cents each, just half price. This is a splendid opportunity to get a full set of practical books. Read the titles over again and see how many there are that you ought to have.

### Now Read Why You Should Be a Subscriber to Technical World Magazine

**TECHNICAL WORLD MAGAZINE** believes that real achievements, real events, when properly presented, are far more interesting than mere fiction; that the most thrilling story in the world is the story of man's ceaseless fight to conquer and overcome, and bend to his service the tremendous forces of nature. Its heroes are men of action, the ones who, the World over, are really doing things, really encountering dangers, really coming out triumphant at the end of the story with a new achievement to be written large in the annals of our progress. These are the stories that are more fascinating than fiction; the stories that you want to read—that everyone in your family wants to read; the things that you must know about in order to keep up-to-date: the things that you can only read about entertainingly in the pages of **TECHNICAL WORLD MAGAZINE**.

**TECHNICAL WORLD MAGAZINE** is not "technical," just wonderfully, informing and fascinatingly interesting. You don't need a college education to like **TECHNICAL WORLD MAGAZINE**; just brains.

### Order at Once

Of course you know that this offer is going to produce a perfect avalanche of orders. Of some of the books listed above, we have only a few hundred copies. It will be best in ordering, to name one or two additional books as alternatives, in case our stock of the one you particularly want is exhausted. But better still, to insure getting what you want, sit right down this minute, cut out the coupon, and mail to us, with currency, stamps, silver or money order.

**Technical World Magazine**  
 5760 Drexel Avenue, Chicago, Ill., U. S. A.

Money Back  
 Coupon 



**TECH. WORLD MAGAZINE**  
 5760 Drexel Ave.  
 Chicago, Ill.

Enclosed herewith is \$..... for which send me **TECHNICAL WORLD MAGAZINE** for one year and the following handbooks, prepaid:

#### THE BOOKS

- Automobiles
- Carpentry
- Gas Engines and Pumps
- Masonry Construction
- Reinforced Concrete
- Steam Engines
- Electric Railways
- Estimating
- Contracts and Specifications
- Valve Gears
- Strength of Materials
- Electric Telegraph
- Mechanical Drawing
- Power Stations
- Pattern Making
- Plane Surveying
- Steel Construction
- Building Superintendence
- Architectural Drawing
- Machine Shop Work
- Machine Design
- Tool Making

#### BUSINESS BOOKS

- Bank Bookkeeping
- Business Management, Part I
- Business Management, Part II
- Corporation Accounts and the Toucher System
- Department Store Accounts
- Factory Accounts
- Insurance and Real Estate Accounts
- Practical Bookkeeping

New, up-to-date material, prepared especially for us. Size of books is 6 1/2-in. x 9 3/4-in.; printed on a fine grade of super-calendered book paper, profusely illustrated with fine drawings and half tones, durably and artistically bound in handsome red cloth. They are \$1.50 books judged from every standard of value in the publishing business. They sell regularly for \$1.50 in first class book stores. Some of them sell for \$2.00.

Five days after receiving books and first copy of the magazine, if I am not satisfied, I may return the books, and you are to return my money.

NAME.....

ADDRESS.....

# CLASSIFIED ADVERTISEMENTS

THE COST OF ADVERTISING IN THIS SECTION IS 5 CENTS PER WORD

Remittance must accompany order, or advertisement will not be inserted.

Forms for the April issue close March 1st.

## AERONAUTICS

MAKE AN AEROPLANE OUT OF YOUR bicycle for \$6.00. Drawings 30c. Thomas Hofmeister, Overlea, Md.

ARE YOU LOOKING FOR ROTATING planes on a flyer? Get the model plans and explanations of my "Circle Aeroplane" for 25c. It's a sure winner. C. R. Zickler, Route No. 29, Yonkers, N. Y.

TWO FOOT MODEL AEROPLANES, Bleriot, Antoinette, Demoiselle, \$1.00 each. Curtiss, Farman, Wright, \$2.00 each, in knock-down form with blueprint and instructions for building, postpaid. Yale Mfg. Co., D5, Newark, N. J.

COMPLETE PLAN, DRAWN TO SCALE, with concise Instructions for building a 3-foot Nieuport Monoplane, 25c. Other Plans: Bleriot, 15c, Wright, 25c, Curtiss, 35c, "Cecil Peoli" Champion Racer, 25c. Set of five, \$1.00. 40 pp. Model Supply Catalog, 5c. IDEAL AEROPLANE CO., 86B West Broadway, New York.

## AGENTS WANTED

AGENTS, RENEW OLD DRY BATTERIES; complete instructions, 25c, guaranteed. Clark, 1613 North 13th, Philadelphia.

NEW \$\$\$, BIG BARGAIN FOUNTAIN PEN. Sample 25c; five for \$1.00 postpaid. Johnson Co., 112 Viola St., St. Paul, Minn.

DON'T ACCEPT AN AGENCY UNTIL YOU get my samples and particulars. Money makers. Address SAYMAN, 706 Sayman Bldg., St. Louis, Mo.

SHOW CARD AGENTS ARE MAKING MONEY in bunches. Catalog free. Popular Show Card Co., Dept. C. H., 1235 Michigan Ave., Chicago.

GET POSTED WHERE TO BUY EVERYTHING the Mail Dealer or Agent needs. Our new Directory is just off the press. Tells you where to buy from first hands about two thousand different articles. It will save you many dollars. Price \$1.00 postpaid. Hardware Electric Supply Co., 56 Charlotte St., Buffalo, N. Y.

SEE WHAT I SAY UNDER "TYPE-writers." ATCHISON.

SEE DISPLAY AD, PAGE 63. DOUD LIGHTING Co., Chicago.

AGENTS—YOU CAN SELL ADDING MACHINES at \$1.00 and \$3.50. Big Profits. B. Bassett, 5921 Indiana Ave., Chicago.

## AGENTS WANTED

PERFECTION POCKET ADDING MACHINE—Lightning seller; agents wanted. Cincinnati Specialty Co., Dept. E, Cincinnati, Ohio.

AGENTS:—MY TWELVE MONEYMAKERS bring repeat orders. Easy selling plans. Big profits. G. Rolfe, 923 N. Alder, Philadelphia, Pa.

AGENTS WANTED TO SELL ARTICLE which can be used in every home and schoolhouse. Non-Draft Ventilator Co., Frankfort, Ind.

190% PROFIT. HOUSEHOLD NECESSITY "IS" New "Will" Sell itself, 20c. package—proposition 10c. John Hellwig, 49½ Clinton St., Albany, N. Y.

DISTRICT MANAGERS—PEERLESS Polisher—an ingenious, indispensable article; wonderful seller, producing \$200 to \$500 monthly. Forslund Sales Agency, Superior, Wisconsin.

A DOZEN NEWLY PATENTED ELECTRICAL devices, all quick sellers; 32-page catalogue; exclusive territory. PRESTO ELECTRIC COMPANY, 325 Geary, San Francisco.

\$100.00 TO \$300.00 INVESTED IN OUR NEW Ball gum vending machines will turn your spare time into big money. May make you independent. Universal Mfg. Co., Box 18, Columbus, Ohio.

AGENTS SELL PALS CHANGEABLE SCARF Pin; make \$30 weekly, send stamp for FREE sample. Pals Manufacturing Company, 25 East 14th Street, N. Y. City.

WONDERFUL INVENTION JUST OUT, makes what was drudgery, "just fun." Sells for \$3.00. Agent pockets half. Big demand. Illustrated circular. Tarbox Coy, Haverhill, Mass.

AGENTS—OUR "HOME LAUNDRY TRIO" are winners. Greatest time and labor savers. Money Makers. Write for attractive proposition—To-day. Leibman, Lefferts Ave., Richmond Hill, N. Y.

SELL AND INSTALL OUR NO-BATTERY Electric Bells at big profit. \$5 to \$10 a day. Expert knowledge not necessary. We can help you start a big profitable business. Write for terms. Searles Electric Co., 1155C Monadnock Block, Chicago.

AGENTS—TO SELL THE NEWEST ELECTRIC appliance on the market; sold everywhere there is electricity, in the home and office; liberal profits; sales-driving sample, weighs a pound, no experience or knowledge of electricity required; it shows how to use one light instead of two and get the same results; sells for \$3.50 and saves the purchaser an investment of \$25. Write for particulars. THE HANDY LIGHT CO., 25 Handy Light Block, Cincinnati, Ohio.

500 PER CENT PROFIT—YOUR OPPORTUNITY. Act now. Buyers everywhere for our U. S. Fire Extinguisher. Low Cost; fast seller; sure profits; exclusive territory. District managers wanted. United Mfg. Co., 1027 Jefferson, Toledo, O.

AGENTS—WOULD YOU TAKE A STEADY job where you can clear \$20 to \$30 weekly and work up to yearly profits of \$3,000 or more? My line is snappy household goods. Quick sellers! Get busy with postal asking particulars. E. M. Davis, B16 Davis Blk., Chicago.



## AGENTS WANTED

MANUFACTURER OF GUARANTEED hosiery with linen heels and toes wants agent in every town and city. Re-orders insure permanent, increasing income. Exclusive territory. Credit. Parker Mills, 707 Chestnut St., Philadelphia, Pa.

AGENTS AND SALESMEN WILL SECURE FREE, complete information of numerous money-making selling propositions and newest specialties in hands of responsible concerns by addressing DISTRIBUTOR, R. 15, 26 Cedar St., N. Y.

AGENTS — SOMETHING NEW — FASTEST sellers and quickest repeater on earth. Permanent, profitable business. Good for \$50 to \$75 a week. Write for particulars. AMERICAN PRODUCTS CO., 6157 Sycamore St., Cincinnati, O.

AGENTS — OUR NIGHT WATCH BURGLAR alarm. Explodes a blank cartridge if window or door is tampered with; never fail; big seller. Sample 35 cents. Wedge Mfg. Company, H. Binghamton, N. Y.

AGENTS MAKE BIG MONEY SELLING our new gold letters for office windows, store fronts and glass signs. Anyone can put them on. Write today for a free sample and full particulars. Metallic Sign Letter Co., 400 N. Clark St., Chicago, Ill.

AGENTS—PORTRAITS 35c, FRAMES 15c, Sheet Pictures 1c. Stereoscopes 25c. Views 1c. 30 days' credit. Samples and catalog free. Consolidated Portrait Co., Dept. 8403, 1027 W. Adams St., Chicago.

MAKE AND SELL YOUR OWN GOODS. Formulas by Expert Chemists. We obtain your Government Serial Number. Catalogue for stamp. E. MYSTIC COMPANY, Washington, D. C.

WE MANUFACTURE GLASS PAPER. Plain glass windows made to look like real stained glass. Easily applied and beautifies the home. Something new for agents. Two sheets of this glass paper sent as a sample with catalogue in colors and complete instructions on receipt of 10c. S. H. Parrish & Co., 202 S. Clark St., Chicago.

AGENTS — SALESMEN. SEASONABLE seller, latest \$3.50 electric invention fills demand never before supplied; home, office, store, everywhere eagerly sought. Repeat orders outnumber first sales; you control territory, no competition, unlimited possibilities. Write Frank W. Alden, Agency Manager, 241 Station F., Cincinnati, Ohio.

GENERAL AGENTS — CAPABLE OF CALLING on the big trade themselves and handling canvassers for the house to house and office to office business to sell the newest electric specialty on the market; sold everywhere there is electricity; in the home, office, factory, store, hotel; liberal profits; sales-driving sample, weighs a pound, no experience or knowledge of electricity required; shows how to use one light instead of two and get the same results; sells for \$2.50, \$3.50, \$5.00 and saves the purchaser an investment of \$25.00. Write for particulars. THE HANDY LIGHT CO., 253 Handy Light Block, Cincinnati, Ohio.

WANTED—DISTRIBUTORS OF ADVERTISING matter everywhere. American Distributor, Blairsville, Pa.

AGENTS—COST 2c, SELL 25c. SIGN LETTERS put on with roller. Samples free. Embossed Letter Co., 232 West Illinois, Chicago.

## AGENTS WANTED

DIME SAFETY RAZOR. BIG SELLER. Agents. Sample 10c. McGuinness, 612 East Fourth St., Brooklyn, N. Y.

AGENTS WANTED FOR ORIENTAL novelties, never before seen in America. Quick sellers. Repeaters. Immense profits. Joseph Kanematz, Box 529, Portland, Oregon.

GREAT NEW AGENTS' ARTICLE! "FAMILY knife and fork cleaner" made of cork, felt and steel. Sells like wildfire. Dozen postpaid 75c. Sample 10c. Bauer, 135 East 34th St., New York.

MANUFACTURER OF FAMOUS BRAND Packages. "Forkola" wants Men and Women to sell direct to the consumer. Protected territory. Send for particulars. Bacon Co., Elmira, N. Y.

AGENTS CAN MAKE BIG MONEY SELLING our line of newly patented household articles. Write to-day. Main Specialty Company, Dept. 9, Williamsport, Pa.

INVISIBLE PEN-PENCIL HOLDER. Holds several. Unique. Agents over hundred per cent. Sample 10 cents. Nouveau Sales Co., Raleigh, N. C.

AGENTS — JUST OUT — BIG PROFITS. Parcel Post Hand Book with map, regulations, rules for finding rates by zones. It's worth 50c. Free circulars. Sample and full particulars 15c. J. Julian & Co., Dept. 5, 110 Mott St., New York.

GUILFORD KEROSENE MANTLE LAMPS — America's largest variety. Burners fit ordinary lamps. The agents' sure money makers. Guilford Co., Seville, Ohio.

HOME BUSINESS — COLLECT NAMES, INFORMATION, etc., for business concerns. Steady income. Instructive booklet for stamp. Information System, 412, Marietta, Ohio.

SELL DEALERS, MAKE 50 PER CENT. ON sales; good article, attractively displayed; retails 10c; send 5c for sample. Rawlings, Box 1053, Central Station, St. Louis, Mo.

SIGN AGENTS, PAINTERS 500% PROFIT with our splendid line guaranteed non-tarnishable gold sign letters, trade emblems, make-up-yourself aluminum door-plates. Catalogue, samples, free. Eastern Specialty Co., Dept. 3, 63 Barclay St., N. Y.

ANY INTELLIGENT CANVASSER CAN earn \$150.00 monthly selling our patented Household Specialties. Every housekeeper a customer. Investigate to-day. Main Specialty Co., Dept. 27, Williamsport, Pa.

CHI-LAQ — NEW IDEA. REPEATER. Sells year round. Agents double money. 25c package makes full quart superior polish, cleanser and renewer. Cleans and polishes everything — automobiles, pianos, furniture, etc. General agents wanted to organize and manage sub-agents. Outfit 25c. Rebated first order. Proposition free. CHI CHEMICAL COMPANY, 5185 Euclid Avenue, Cleveland, Ohio.

BE INDEPENDENT! START A MAIL ORDER business in your own home. We tell you how, and furnish everything needed wholesale. An honorable and profitable business for man or woman. Particulars free. Many make \$3000 a year. Murphy Mfg. Co., South Norwalk, Conn.

**AGENTS WANTED**

**\$2.50 PER DAY PAID ONE MAN OR WOMAN** in each town to distribute free circulars and take orders for concentrated flavoring in tubes. Permanent position. J. S. Ziegler Co., 445-B, Dearborn St., Chicago.

**AGENTS SELL RICH LOOKING IMPORTED** 36x68 Rug, \$1. Carter, Tenn., sold 115 in four days. Profit \$57. You can do as well. Write for selling plan. Sample offer. Exclusive territory. Sample rug sent by prepaid parcel post 98c. R. Condon, Importer, Stonington, Me.

**ATTENTION! WONDERFUL MACHINE** merges one pint of milk into one pound of butter in two minutes. Write for names and addresses of 500 home users, sworn testimonials, illustrated circulars, and agents' credit terms. Family Butter Merger Co., Washington, D. C.

**MILK TESTER "INSPECTOR" SHOWS** immediately if milk is pure or watered. Utmost practical household article at present. Protects every family against fraud. Just out. Sells at sight. Retail 50c. 100% profit. Specialty Co., Dept. H, 672 Eagle Ave., New York, N. Y.

**AGENTS WANTED QUICK. CLEAN LEGITIMATE** money-making proposition. No space for explanations. Write for full particulars and exclusive territory. Krueger Mfg. Co., Dept. 8A, 167 W. Washington, Chicago.

**SAMPLE FREE — BOYERS' AUTOMATIC** Re-Finisher for Furniture, Store, Bank and Office Fixtures — Finest thing in the World. One application lasts a year. Applied with cheese cloth. Boyer Chemical Laboratory Co., State and Michigan Sts., Chicago.

**AGENTS WANTED EVERYWHERE** to sell our wonderful substitute for the back collar button. Agents make good all over. Vest pocket sample. Will convince any merchant. Sample 10c. Laskin Collar Clip Co., 333 S. Market St., Chicago.

**KEROSENE FOR AUTOMOBILES. AIR-FRICTION** Carburetor, new "Model B" uses successfully half and half mixture lowest grades kerosene and gasoline. Starts easy at Zero. One third more power. One third more economy. Satisfaction guaranteed or money refunded. Suits all automobile and marine motors. Special agents' prices. Department "A," Air-Friction Carburetor Co., Dayton, Ohio.

**AGENTS — DROP DEAD ONES. AWAKE!** Grab this new invention. Low-priced waterpower home massage machine. Magical, marvelous, mysterious. New field. Big profits. Sold on money back guarantee. "Margwarth sold 5 in 10 minutes; 31 in 2 days." "Parker sells 8 first day." "Vaughn, your machine has merit. Express 6 dozen." Free information. Blackstone Co., 656 Meredith, Toledo, Ohio.

**WE WANT A FEW LIVE, TOP-NOTCH** salesmen, with experience selling books, subscription or specialty lines, who are looking for a high-class proposition that offers a permanent future with a chance to make good money right from the start, to call on business firms only, with a subscription proposition which is a necessity, and on which there is no competition. Men now with us are making from \$25.00 to \$60.00 weekly. Address W. A. Clink, 1705 Kesner Bldg., Chicago.

**AGENTS WANTED**

**GET VALUABLE AGENCY EXCLUSIVELY,** in your locality — \$50 to \$100 a week commission easily made by reliable, energetic men and women selling low-priced Ind-Electric Beauty and Health machine. Sells on sight. Write immediately or lose big opportunity. Ind-Electric Mfg. Co., Desk 13, 432 Peoples Gas Building, Chicago.

**AGENTS — \$200 MONTHLY DISTRIBUTING** Newell's needle cases. Sell 115 needles in book for 10c and make 200% profit. Approval Plan envelopes make talking unnecessary. Crew Managers write. Send 10c for sample book and particulars. Newell Company, 509 N. Grand, St. Louis, Mo.

**AUTOMOBILES**

**WHITE STEAM AUTOMOBILE, EXCELLENT** condition, \$75. Geo. Wills, Canal Dover, Ohio.

**AUTOMOBILE BARGAINS. LOWEST** prices and largest list in the world. All guaranteed, shipped freight prepaid; get my prices before purchasing. Runabouts, Oldsmobile, Reo, Cadillac, \$50; Fords, Buicks, \$150; Touring cars, Cadillac \$90; Reo \$150; Buick \$175; Winton \$275; Pope Toledo \$300; Ford \$300; Maxwell \$275; I have all makes on hand. I desire agents to sell my cars; write for Special Agents' proposition at once. P. E. King, 217 West 125th St., New York City.

**AUTO ACCESSORIES**

**ELECTRIC LIGHT FOR MOTORCYCLES.** Storage Battery, built right, \$5.00. American Battery Co., 1121 Fulton St., Chicago.

**CHARGE THE BATTERY YOURSELF.** "American" rectifiers—all sizes. Storage batteries—all sizes. American Battery Company, 1123 Fulton St., Chicago.

**TIRES—ALL MAKES, ALL GUARANTEED.** 28x2½ \$4.50; 30x3 \$6; 30x3½ \$13. Write for our complete list of tires and tubes before purchasing. We ship C. O. D. Guarantee Tire Company, Dept. E, 213-219 West 125th St., N. Y. City.

**GUARANTEED 5,000 MILES WITHOUT** puncture. If your tires are old, don't throw them away, or you'll throw away \$50 to \$200. With Durable Treads we give you a written guarantee for 5,000 miles without puncture. This is binding whether your tires are new or old-tread-worn, rim-cut or rut-worn. Durable Treads cost only half as much as tires. Write for booklet and special discount at once to Colorado Tire & Leather Co., 1234 Majestic Bldg., Chicago, Ill., 528 N. W. 34th St., New York City. 435-N Golden Gate Ave. San Francisco Cal. 1348-N Acoua St., Denver Colo.

**BOOKS AND PERIODICALS**

**NEW 32 PAGE BOOK FOR GENTLEMEN.** Send 12c. Curtis Co., E5 Englewood, Chicago.

**HOW TO MAKE STORAGE BATTERY —** Book tells how, and Digest, one year, 25c. Digest, Grand Rapids, Mich.

**"TELEPHONE TROUBLES AND HOW TO** Find them," 15th edition (56 pages), 25c. Hyde Pub. Co., 183 5th St., Milwaukee, Wis.

## BOOKS AND PERIODICALS

**CLASSY BOOKS — STAMP BRINGS CATALOGUE.** Paul Duff, 2713 N. Mozart St., Chicago.

**"RHYMES OF DAVID."** RACY, RARE, true to nature. One dollar. Fetter Book Co., Robinson, Md.

**THREE LITTLE BOOKS FOR LADIES,** postpaid, in plain cover, for 25c. (Tell what you want to know.) O. K. Pub. Co., Decatur, Ill.

**HOW TO MAKE DYNAMO—BOOK TELLS** how, and Digest, one year, 25c. Digest, Grand Rapids, Mich.

**SECOND-HAND BOOKS, HALF-PRICES ON** every subject. New 25 per cent discount. Books bought. Catalogue 544 post free. Foyle, 121 Charing Cross Rd., London, England.

**NO MORE DEAD ENGINES, OR WALKS** back to town. New discovery guaranteed. Instruction booklet 25c. Thomas Mfg. Co. Star Theater Building, Des Moines, Iowa.

**WONDERFUL BOOK ON HYPNOTISM,** personal magnetism, magnetic healing and occult science sent free to anyone. Send your address today. M. D. Betts, Sta. 129, Jackson, Mich.

**THE MARRIAGE GUIDE, TELLS RARE** things you should know before and after marriage. 276 pages of valuable information. Price \$1.00. J. F. Sheridan, 417 E. 151st St., New York.

**SEND 12c FOR "SEXUAL PHILOSOPHY,"** clearest, best, most instructive sex manual published. Actually teaches, not merely argues. Write today. "Health-Wealth" Publishing House, 85 Bennington St., Lawrence, Mass.

**"THE GUARDIANS OF THE COLUMBIA,"** Just published, describes the beautiful Pacific Coast scenery, with maps and 210 illustrations (eight in colors) size 7x10½ inches. Cloth binding. \$1.66 postpaid. Circular for 2c. N. B. Pearson, 340 East 45th St., S. Portland, Ore.

**ELECTRICITY. JUST WHAT YOU HAVE** been looking for. Our Modern Blue Print Chart Method of Electrical Wiring Diagrams. Thoroughly explained so that you can easily understand them. All kinds of Bell Wiring, Annunciators, Telephones, House Wiring, Conduit, Theatre, Isolated Plants, Dynamos, Transformers, Arc Lights, Special Treatise on Motor Wiring. Write now for information. **ELECTRICAL WIRING DIAGRAM CO.,** Box B 173, Altoona, Pa.

**"WIRING A HOUSE," BY H. PRATT,** shows a house already built; tells you just how to start about wiring it; where to begin; what wire to use; how to run it according to insurance rules; in fact, all the information necessary for wiring a house and shop. Postpaid, 25c. Popular Electricity Book Department.

## BUSINESS OPPORTUNITIES

**SEE WHAT I SAY UNDER "TYPE-** writers." ATCHISON.

**MAIL ORDER BUSINESS. ONE DIME FOR** four plans and you're started. E. Dunne, 7631 Sangamon St., Chicago.

**JUST OFF THE PRESS! TWENTY SUCCESS-** ful money-making plans. All sure money-getters by mail, 50 cents. No stamps. B. W. Nettlebeck Falls City, Nebraska.

## BUSINESS OPPORTUNITIES

**WE HAVE ONE OF THE GREATEST PROP-** ositions on the market to-day for the live agent. Catalogue free. Main Specialty Co., Desk 218, Williamsport, Pa.

**FREE! MONEY-MAKING PLAN. JUST** send a self-addressed envelope with a 1c stamp attached for postage. Frank Cote, Box 1, Saco, Maine.

**EARN MONEY WRITING MOTION PIC-** ture Plays; Big Demand. Complete legitimate instructions 10c. Hester, 651 Northampton, Easton, Pa.

**BE A MANUFACTURER! BIG PROFITS.** Easily done. Your kitchen will serve as a factory. Sample formula, lists and plans 10c. The Anjo Company, A497, Galesburg, Ill.

**CONDUCT PAYING MAIL ORDER BUS-** iness from your home: \$5.00 Starts business, complete course \$1, particulars FREE. Box 115, Brooklyn, N. Y.

**START A GOOD PAYING BUSINESS OF** your own during your spare time. The "KEY" will tell you how. Price 10c. L. J. Mathewson, Waubay, S. Dak.

**PATENTS BRING WEALTH. WRITE FOR** proof and book which tells the kind that pay. Your idea may make your fortune. Alexander Wedderburn, Atty., Dept. M, Washington, D. C.

**MAIL ORDER BUSINESS IN ITS TRUE** light, 100 testimonial letters, and particulars how you may obtain on loan, advertised mail order "instructions" and plans, sent on request. Library Division 46, "MAIL ORDER NEWS," FISH-KILL, N. Y.

**WE FURNISH YOU CAPITAL TO RUN** profitable business of your own. Become our local representative and sell high-grade custom-made shirts, also guaranteed sweaters, underwear, hosiery and neckties, direct to homes. Write, Steadfast Mills, Department 21, Cohoes, N. Y.

**IF I START YOU MAKING \$50 to \$200** monthly utilizing spare time evenings will you pay me \$50 in six months time for my services? Remember I GUARANTEE success under forfeiture of my fee. If interested enclose ten cents (to keep out triflers) for full instructions. Address V. K. Leinmiller, 1013 Olive St., Philadelphia, Pennsylvania.

**EARN GOOD PAY SENDING US NAMES** and addresses. Particulars 8 stamps. Princess Perfume Co., 506 East Utica St., Buffalo, N. Y.

**EARN \$10 TO \$15 A WEEK AND HOLD** your position besides. No canvassing. We, as manufacturers of patented just-in-season specialties, have new easy Mail Order Plans to keep factories busy. We furnish everything. Large profits. Small capital. Experience unnecessary. If you are one of the want-to-go-ahead kind, write for our most modern (copyrighted) plans. Sworn statement. J. M. Pease Mfg. Co., 550 Pease Bldg., Main St., Buffalo, N. Y.

**WE START YOU IN BUSINESS, FURNISH-** ing everything; men and women. \$30.00 to \$200.00 weekly operating our ORIGINAL "New System Specialty Candy Factories;" home or small room anywhere. Opportunity lifetime; booklet free. H. RAGSDALE CO., East Orange, N. J.

**BUSINESS OPPORTUNITIES**

**BE YOUR OWN BOSS—WE SHOW YOU** how. One hundred profitable business chances to select from, particulars free. Peoples Supply House, Connellsville, Pa. Dept. A.

**OPEN AUTOMOBILE & MOTORCYCLE** business of your own; capital and experience unnecessary. We show you how to get all the machines you can sell. Full instructions for \$1.00. No stamps. John Routier, Rochester, N. Y.

**ACTIVE STOCK, WHEAT AND COTTON** markets make extraordinary profits possible from ventures of \$10 up; buying option-contracts; best speculative plan; particulars furnished. GEO. B. REIMEL & CO., 6 Wall St., New York.

**ADVERTISERS! MAIL DEALERS. OUR** Advertisers' Guide gives rates, circulation of 2,000 Different Publications. Includes 30 Mail Order Plans. Sent complete 10c. Dearborn Advertising Agency, 527 Franklin Bldg., Chicago.

**WE HELP YOU RAISE CAPITAL AT ONCE** to start you in retail, manufacturing, patent, real estate, mail order or any legitimate business by means of "Our Practical Method." Particulars free. The Business Aid Co., K 508, Detroit, Mich.

**DANDY HOME BUSINESS—COLLECT** names, information, etc., for business concerns. Steady income. Fascinating work. Instructive booklet for stamp. Information System, 410, Marietta, Ohio.

**FOR 10c. TO COVER ADVERTISING, MAIL-**ing, etc., I'll send sample circular and full instructions for operating legitimate scheme that brought me \$2 an hour. If satisfactory remit \$1; if not, return. Fink, Y.M.C.A., Kane, Pa.

**TRY THIS—YOUR NAME IN OUR SYNDI-**cate magazine directory three issues 25c. Big mail for you and the latest propositions from dealers and manufacturers. Results guaranteed. Copy of our magazine 10c. The "LEVER" MAIL TRADER, 449M, Elizabeth, New Jersey.

**LET ME START YOU IN THE MAIL ORDER** business anywhere. I started with an idea and \$100.00 and made six hundred and fifty thousand dollars in 18 months. I tell you **WHAT TO DO AND HOW TO DO IT.** Don't be a wage slave; get out of the rut; get grit; get backbone; wake up and start **NOW.** Write and learn of my money-making mail order plans. My great **FREE** book, "How to Achieve Mail Order Success," tells all about my own achievements and how I equip, teach and get you started. This book tells how to quickly start in your home, while otherwise employed. It is a B line to a large income. Send for my new free book and start making money now. Address President, Mail Order School, Suite 2292 Brecht Bldg., Denver, Colo.

**RESIDENT MANAGER WANTED IN** every city and town to open and manage branch office; brand new proposition; Wonder Cloth finds a steady sale in every home, office, store, factory, garage, etc; three big sources of profit—a local, a mail sales and a jobbing business; cash sales; duplicate orders; samples, printed matter and new selling method furnished free; no experience needed; can make up to \$5,000 yearly. If you have a few dollars and good reference, write—Bethlehem Utilities Co., Dept. 25, 65 Pine Street, New York.

**BUSINESS OPPORTUNITIES**

**BIG MONEY IN THE MAIL ORDER BUSI-**ness. Experience unnecessary. Small capital. Instructions free. Keith, 722 Central Building, Rochester, N. Y.

**\$1.00 A WEEK WILL START YOU IN A BIG** money-making mail order business with the best line—in spare time. Particulars Free. Nadico Co., 1671 Belmont Ave., Chicago.

**COINS AND STAMPS**

**STAMPS—100 ALL DIFFERENT, FREE.** Postage 2c. Mention paper. Quaker Stamp Co., Toledo, Ohio.

**STAMPS—ALL KINDS OF \* STAMPS** bought and sold. If an active collector write for free copy of "Philatelic Opinion." Poole, Box 2, Altadena, Calif.

**OLD COINS BOUGHT AND SOLD—MY** new 50 page fall coin selling catalogue just out. Free to collectors only. Buying coin catalogue sent on receipt of 10c. William Hesslein, Malley Bldg., New Haven, Conn.

**CAMERAS AND OPTICAL GOODS**

**WE BUY, SELL AND EXCHANGE. BAR-**gains in microscopes, telescopes, binoculars, cameras, etc. Bargain list sent. Kahn & Son, Opticians, No. 54 John St., New York. Established 63 years.

**DOGS**

**TRAINED HOUNDS—PEDIGREED COON,** cat, bear, deer, wolf, fox and rabbit hounds, pups that make good with little training. Sharon Center Kennels, W. J. Little, Prop., Sharon Center, Ohio.

**BLOODHOUNDS—FOXHOUNDS, REGIS-**tered; trained bear, deer, wolf, coon, and cat dogs; illustrated catalogue 5-cent stamp. Rookwood Kennels, Lexington, Ky.

**ELECTRICAL**

**RENEW DRY BATTERIES. FORMULA** 20c. Johnson, 4333 N. Sawyer Ave., Chicago.

**WITHOUT CHARGE, WE WILL PLAN THE** wiring of home or business place, showing cost and location of each material, enabling you to do it at half cost. Hadwal Eng. Co., ARECO Building, Bronx, N. Y.

**EXPERIMENTERS, INVENTORS AND** Professional Builders. We can supply anything in in special and regular raw material and articles for experimental and model work. Lowest prices. Free advice for Amateurs, Catalog. 6 cents may be deducted with first order of \$1.00. Experimenters Supply Co., 125 S. Fifth Ave., Chicago, Ill.

**FOR SALE OR EXCHANGE**

**FOR SALE, PEDIGREED AIREDALES.** W. F. Goodin, Columbus, Mont.

**ONE DOLLAR MONTHLY WILL PROVIDE** you with latest policy paying cash benefits for sickness, injury, accident, death. It's great. Write to-day. Edw. Pauley Insurance, Buffalo, New York.

**SEE WHAT I SAY UNDER "TYPE-**writers." ATCHISON.

## FOR SALE OR EXCHANGE

FELT PENNANTS, ALL COLLEGES, 40c. each. Larger sizes 50c. Harold Hartzman, Moline, Ill.

FENCEPOSTS AND POLES OF RED MOUNTAIN cedar—all sizes. Write for price list. Mott & Berg, Cedar Hill Farm, Cocolalla, Idaho.

FOR SALE—ELECTRIC STREET CAR tracks, bridge and switch; any reasonable offer accepted. Fred Loos, 249 Lehigh St., Pittsburgh, Pa.

40,000 POUNDS LEAF TOBACCO FOR SALE. Mail stamps for samples to Anton Wavrin, Franklin, Ky.

HOUSE ROBBED? PROTECT YOURS. Burglar alarm, best on market, 35c. "Juron," J-1400 Noble St., Chicago, Ill.

FOR SALE OR EXCHANGE—ELECTRIC Vibrator slightly used. Cost \$35.00. E. M. Rider, Central Village, Conn.

200 BONA FIDE NAMES OF GOOD BUYERS secured by campaign advertising in Popular Electricity, \$2.00., T. J. Newlin, Denver, Colo.

EXTRA LARGE BULL ELK HEAD, 13 points; one 20 point Moose head. Fine specimens. Reuben Saylor, 497 So. Broadway, Dayton, Ohio.

TATTOOING SUPPLIES, MACHINES \$2.50. To advertise, 6 colored designs 15c price list free. F. Barber, 1019 Vine St., Cincinnati, Ohio.

SALE—COMPLETE I. C. S. STEAM ELECTRIC course (cost \$106.00). Cheap if taken at once. Lawrence Gates, Winnebago, Minn.

TATTOO MACHINE, INK, AND DIRECTIONS, 50c silver. Electric Machines, Supplies. Rebec Mfg. Co., Cedar Rapids, Iowa.

GUARANTEED RAZOR AND SELF-HONING Strop. Two Dollars. Money returned if unsatisfactory. J. Regan, Twenty-second St., East Orange, N. J.

REMOVE THAT STAIN! INK, FRUIT, coffee, rust, grease, etc., quickly removed. Will not injure fabric. Sample prepaid, 30c. Otto, Box 83, Elizabeth, N. J.

INK PILLS THE BEST FOR LOADING fountain pens. No soiled fingers. Put contents of pill in pen, add cold water and write on. 10 cents a box. Schuck, 133 Meserole St., Brooklyn, N. Y.

MAKE YOUR AUTO PUMP WATER, SAW wood, etc., by using QUICK DETACHABLE PULLEY. Clamps on rear wheel. Postal brings illustrated circular with prices. SIMPLEX CO., 5002 Victor Building, Washington, D. C.

ELECTRIC COOKING STOVES WITH CORD AND plug ready to use \$1. Big money attaching these to percolators, chafing dishes, etc. Neville, Broadway 256th Street, N. Y.

BOYS—WE HAVE WHAT YOU NEED, small Power Plants for Shop or House. Enclose stamp for circular. Modern Supply Co., Dept. B., Connellsville, Pa.

300 PER CENT PROFIT ON GLIDING casters, noiseless, won't scratch floors; save carpets, rugs and furniture; child can attach; sell many sets, homes, hotels, restaurants, everybody buys; from 15c to 25c a set, cost 4c. Samples etc., 10c. Gliding Caster Co., Willows, Calif.

## FOR SALE OR EXCHANGE

FOR SALE—ADVANCE 1911 MINNEAPOLIS two-speed Motorcycle, with Thor four-motor, Purdy Exhaust Whistle. In perfect condition, \$125.00. Gus. A. Anderson, Sauk Centre, Minn.

FOR SALE OR EXCHANGE—VALUABLE coin collection. Lewis Pendleton, Dodge City, Kansas.

QUICK SHAVE WITHOUT A RAZOR WITH Razorine the new shaving powder, just rub on, wash off and you have a smooth face. Once used, always used. Box of five shaves 25c postpaid. Clyde Fahrney, Lock Box 157, Waynesboro, Pa.

FOR SALE. ONE 12" SCHEIDEL WESTERN induction coil, with single point interrupter, rectifier, etc. Suitable for wireless or X-ray work. First money order for \$50 gets outfit. The Pope Sanatorium, 115 W. Chestnut, Louisville, Ky.

FOR SALE—PATENT ON NURSING BOTTLE holders; something entirely new. Recommended by all physicians who have seen it in use. Francis H. Escherich, 1917 K St., N. W., Washington, D. C.

## FORMULAS

THERE ARE ONLY THREE GOOD FORMULAS for recharging dry batteries. All three for 10c (silver). Box 126. Winfield, Kans.

TESTED FORMULAS. HAIR REMOVER, Hair Restorer and Hair Grower, all for 25c. Ellis, 18 John St., Newark, N. J.

START A FORMULA BUSINESS, MAKE \$50.00 weekly. 50c. brings complete instructions and 25 best formulas. Parker, Dept. F., Box 28, Columbia, Tenn.

DRY CELL BATTERIES RENEWED FOR one cent each. Two guaranteed formulas 15 cents each or both for 25 cents. Both formulas are entirely different. L. M. Kachel & Co., Whitewater, Wisconsin.

## GAMES AND AMUSEMENTS

MAGIC POCKET TRICK, 10c. ISRAEL, 440E, East 146th St., New York.

105 TRICKS, 25c WITH THREE CATALOGS. Klein, 1193 Broadway, N. Y.

PLAYS, VAUDEVILLE SKETCHES, MONOLOGUES, Dialogues, Speakers, Minstrel Material, Jokes, Recitations, Tableaux, Drills, Entertainments, Make-up Goods. Large Catalog Free. T. S. Denison & Co., Dept. 26, Chicago.

EVERYBODY'S TALKING ABOUT PRESIDENT, the new card game. The most interesting game of Science and Humor ever published. Printed so they may be used as ordinary playing cards. You'll enjoy it immensely. 50c per deck prepaid. Dealers write President Card Co., Detroit, Mich.

## INSTRUCTION

LEARN AUCTIONEERING BY CORRESPONDENCE. P. O. Box 72 A, Attica, Indiana.

THE MASTERY OF WORDS. HOW TO command the right word. Invaluable. Write E. D. Snow, 8 Main, Hornell, N. Y.

OLD DRY BATTERIES MADE NEW AT A cost of 1c each. Instructions 15c. Lotton, Waverly St., Buffalo, N. Y.

## INSTRUCTION

**BE A DETECTIVE. EARN FROM \$150 TO \$300 per month;** travel over the world. Write to C. T. Ludwig, 201 Scarritt Bldg., Kansas City, Mo.

**CANDY MAKING — \$15 COURSE 50c;** CIRCULAR free. Eagle Co., "D," Quincy, Mass.

**HYPNOTIZE (PRACTICALLY) WITHOUT** hypnotic sleep! 16 Lessons—\$1.00 Course, 20c. Publisher, 49½ Clinton St., Albany, N. Y.

**PLAY PIANO OR ORGAN — WALTZES,** songs, harmonies, instantly without teacher. Humanist's blessing—world sensation. Address Musician Selfmaker, 2806 Lake St., Chicago.

**HOME MADE CHEWING GUM. SELLS** like hot cakes with enormous profits. Art of Gum Making teaches how from A to Z. Address with stamp, H. B. Elliott & Sons, Harbor Springs, Mich.

**SECURE CASH FOR YOUR PROPERTY** No matter where located. To buy or sell write for particulars giving full description. National Property Salesman Co., Dept. 9, Omaha, Nebr.

**"LEARN SOMETHING" — "BE SOMETHING."** Complete course in Modern Bookkeeping, Penmanship, Banking, Letter-writing, etc. All sent postpaid \$1. Williams Co., 721 Dearborn Ave., Dept. 20, Chicago.

**MYSTIFY YOUR FRIENDS. BECOME AN** Escape King. Packing case, cloth bag and milk-can escape. These three secrets besides 3 methods of handcuff release, all for 25c in coin. L. J. Knittel, Lyons, N. Y.

**NOTES FOR OPERATORS. PRACTICAL** Information of Real value to motion picture operators and beginners. How to produce clear, steady pictures, avoid trouble, and how to take care of the Projecting apparatus. 20c. in coin. J. W. Buickerood, Bound Brook, N. J.

**UNCLE SAM IS A LIBERAL EMPLOYER.** Qualify for a Government position. We prepare you by mail for any Civil Service Examination. Many vacancies now exist. Write to-day for free Booklet 49. Capital Civil Service School, Washington, D. C.

**LET US TELL YOU ABOUT OUR COURSES** of instruction in Electricity.—One is to make you proficient as an electric wirer; the other, a complete course in Electrical Engineering—as good as the courses given in ANY school of Electric Engineering. Maryland Correspondence School, Union Bridge, Md.

**SPECIAL INTRODUCTORY OFFER FOR** a limited time only. My latest; just off the Press. Book of Individual Instructions on HYPNOTISM, MESMERISM; VERY INTERESTING; VERY ENTERTAINING. Written so that anyone can understand it. You can become a successful Hypnotist by carefully following my very simple instructions in a very short time. For limited time only. Postpaid 50c. D'MARC, 1820 Wash St., St. Louis, Mo.

## MAGIC

**250 MAGIC TRICKS AND CATALOGUE, 10c.** Curtis Co., E-Englewood, Chicago.

**LEARN TO HYPNOTIZE AND MAKE FUN** and money. Send for free book to M. D. Betts, Sta. 129, Jackson, Mich.

## MAGIC

**FREE, 250 TRICKS TO INTRODUCE MAGIC** Catalogue. Send 10c to pay packing and postage. Trick Co., 305 East 51st Street, Chicago.

## MISCELLANEOUS

**ANYTHING IN RAW OR SPECIAL MATE-**rials for experimenters, inventors, manufacturers. W. Brunier, 2249 N. 6th Street, Phila.

**GO INTO BUSINESS FOR YOURSELF.** W. H. Smith Co.; Columbus, Ind., will tell you particulars free.

**FREE! SECRETS OF THE COLLECTION** Business. Mercantile Letter Co., 141 W. Forest, Detroit, Mich.

**13 FUNNY LOVE LETTERS (READ TWO** ways), all new, 10 cents; J. Hardway Co., 207 S. Lee St., Bloomington, Ill.

**ANYONE CAN MAKE GOOD MIRRORS** with my complete instructions; price \$1.00. Formula for preserving eggs; price \$1.00; both for \$1.00. Parker, Dept. G, Box 28, Columbia, Tenn.

**ANYBODY CAN MAKE GOOD CUTS WITH** my simple zinc etching process; price, \$1.00; specimens and particulars for stamp. T. M. Day, Box E., Windfall, Ind.

**IDEAS DEVELOPED, SPECIAL AND EX-**perimental machines designed. Dowler Manufacturing Co., 5155 Wakefield St., Germantown, Pa.

**BROTHER — ACCIDENTALLY DISCOV-**ered Root will cure both tobacco habit and indigestion. Gladly send particulars. F. F. STOKES, Mohawk, Fla.

**I WILL START YOU EARNING \$4.00 DAILY** at home in spare time, silvering mirrors; no capital; send for free instructive booklet, giving plans of operation. G. F. Redmond, Dept. H., Boston, Mass.

**THEATRICAL MANAGERS WILL REQUIRE** hundreds of young men and women this year. Particulars Free telling you how to go on the stage. Ross, 310½ E. 15th St., Kansas City, Mo.

**DO YOU EXPECT TO ATTEND THE PAN-**ama-Pacific Exposition in 1915, at San Francisco? Organizers wanted in every city and town, for the California Travel Club. Two-cent stamp for information, to California Travel Club, 1547 Devisadero St., San Francisco, Cal.

**FREE—INVESTING FOR PROFIT MAGA-**zine. Send me your name and I will mail you this magazine absolutely free. Before you invest a dollar anywhere—get this magazine—it is worth \$10 a copy to any man who intends to invest \$5 or more per month. Tells you how \$1,000 can grow to \$22,000—how to judge different classes of investments, the Real Earning Power of your money. This magazine six months free if you write today. H. L. Barber, Publisher, 423, 20 W. Jackson Blvd., Chicago.

## MOTION PICTURE MACHINES

**\$5.00 TO \$40.00 AND UP TO \$275.00 MOVING** Picture Machines and all other Apparatus. Catalogue. Ralph J. Golsen, 65 East 46th St., Chicago.

**MOTION PICTURE AND STEREOPTICON** outfits, film, song and lecture sets bought and sold. Bargain list free. National Employment Company, Duluth, Minn.

**MOTORCYCLES**

**STOP! ACT QUICK — REBUILT MOTORCYCLES**, Indians, Excelsiors, Harley-Davidsons, Kullures, Standard, Reading, singles and twin, \$25.00 up. Every motorcycle guaranteed. Buy direct, save dealer profits. Denniger Mfg. Co., Rochester, N. Y.

**MOTORCYCLES, I HAVE ALL MAKES**; I can save you dollars, my illustrated catalogue is the largest published, mailed free. Marshes \$20 up; Indians \$25 up; shipped freight prepaid and guaranteed for six years, send for my lists before purchasing. P. E. King, 213 West 125th St., New York City.

**MUSIC**

**ONE SHEET POPULAR MUSIC AND LIST** of reliable publishers. Fifteen cents silver. Melody Music, Box 402, Bridgeport, Connecticut.

**POEMS WANTED. CASH FOR GOOD TALENT.** Send MS. to **INLAND MUSIC HOUSE**, Chicago.

**FREE—BIG SONG HIT. WE WANT YOUR name.** Send 2 two-cent stamps to cover wrapping and mailing. Bostonia Co., Central Exchange, Worcester, Mass.

**SONG POEMS WANTED—SEND US YOUR song poems or melodies.** They may become big hits and bring thousands of dollars. Past experience unnecessary. Available work accepted for publication. Instructive booklet and information free. **MARKS-GOLDSMITH CO.**, Dept. 21, Washington, D. C.

**PATENTS**

**PATENTS SECURED. WRITE FOR terms.** Harry Patton, 340 McGill Bldg., Washington, D. C.

**SEND FOR FREE BOOKLET, ALL ABOUT patents and their cost.** Shepherd & Campbell, Patent Attorneys, 500B, Victor Bldg., Washington, D. C.

**PATENT YOUR INVENTION. FIRST GET free "Inventor's Primer"** with statistical data. Milo B. Stevens & Co., Estab. 1864, 640 F St., Wash.; 351 Monadnock Blk., Chicago.

**WE SELL PATENTS. IF YOU WISH TO add a new product to your line write us.** Established 1900. **CHARLES A. SCOTT CO.**, 1086 Granite Bldg., Rochester, N. Y.

**PATENT—ADVICE AND BOOKS FREE** Highest references. Best results. I procure patents that protect. Watson E. Coleman, Patent Lawyer, 622 F St., N. W., Washington, D. C.

**MODELS MADE OF ANY DESCRIPTION.** Inventions protected and simplified. Electrical work a specialty. Our long experience will be your benefit. Moderate prices. Atlas Model Works, 125 S. Fifth Ave., Chicago, Ill.

**THE PATENTOME IS INTERESTING AND instructive.** A liberal education in patents and how to get them. Free on request. Established 1865. Anderson and Son, Patent Solicitors, 729 G. St., Washington, D. C.

**PATENTS SOLD. I DO THE BUSINESS — not merely collecting advance fees.** If you own a valuable patent send for a free booklet, "How I can get cash for Your Invention." No charges made for listing. Patent Advertising & Sales Co., Frankford, Phila.

**PATENTS**

**SEE WHAT I SAY UNDER "TYPE-writers." ATCHISON.**

**SEND FOR NEW HELPFUL PLAN FOR inventors and booklet free.** Mason, Fenwick & Lawrence, 618 F. Street, Washington, D. C., and New York. Established 52 years. Submit sketch of your invention.

**PATENTS OF VALUE. PROMPT AND efficient service.** No misleading inducements. Expert in Mechanics. Book of Advice and Patent Office Rules free. Clements & Clements, Patent Attorneys, 705 Colorado Bldg., Washington, D. C.

**PATENTS BRING FORTUNES—OUR FREE Book tells how.** Send sketch for Free opinion as to patentability. Best references from inventors of many years' experience. Wm. N. Moore & Co., 508 Loan & Trust Bldg., Washington, D. C.

**PATENT SECURED OR FEE RETURNED.** Send sketch for **FREE EXPERT SEARCH** and Report as to patentability. Books on inventions and patents, and reference book, sent free. John S. Duffie & Co., Dept. 2, Washington, D. C.

**PATENT BOOKS MAILED FREE—SHOWING 100 mechanical movements** invaluable to inventors and mechanics—and telling what is patentable, how to obtain patent or partner, etc. Free on request. Chas. E. Brock, 703 Eighth St., Washington, D. C.

**PATENTS SECURED AND TRADE-MARKS registered.** You get honest personal work backed by 10 years experience. Write to-day! George A. Hutchinson, 729 Loan & Trust Building, Washington, D. C.

**"PATENTS AND PATENT POSSIBILITIES"** is a 72-page treatise which tells all about patents, what to invent and where to sell it. It gives honest advice to inventors, and is full of valuable and interesting information. Write for it today! It is **FREE** H. S. HILL, 929 McLachlen Bldg., Washington, D. C.

**PATENTS EXPLAINED IN MY FREE books** telling what you should know — what to invent — what **NOT** to invent — how to sell your patent, etc. Write to-day. H. L. Woodward, 901 G Street, Washington, D. C.

**BUSINESS GOES WHERE IT IS INVITED** and stays where it is well treated. For 27 years I have given my personal attention to procuring patents for successful inventors and manufacturers. The opportunity is open to you to get the benefit of the same attention and method of procedure. Write or send sketch. Vernon E. Hodges, 631 Barrister Bldg., Washington, D. C.

**FIND OUT FOR YOURSELF WHAT TO invent and how to procure and sell a patent for the same.** My book, "Inventor's Universal Educator," covers the matter from A to Z. 140 pages, elegantly bound. Also contains 600 mechanical movements and 50 perpetual motions. Price \$1.00, postage free. Money returned if not more than satisfactory. F. G. Dieterich, 654 Ouray Bldg., Washington, D. C.

**PATENT ATTORNEYS**

**C. L. PARKER, PATENT ATTORNEY**, 915 G St., Washington, D. C. Inventors' handbook, "Protecting, Exploiting and Selling Inventions," sent free upon request.

**PATENT ATTORNEYS**

GET YOUR PATENT SPECIFICATIONS written up and handled for you absolutely free by joining the Inventors Cut-rate Association, 36 Florida Avenue, N. W., Washington, D. C.

I WRITE PATENT SPECIFICATIONS for \$15. Soliciting agents wanted. Address Edward H. Young, 36 Florida Avenue, N.E., Washington, D. C.

PATENTS THAT PAY BEST. FACTS about Prizes, Rewards, Inventions Wanted, etc. Send 10 cents postage for valuable books. R. S. & A. B. LACEY, Dept. 52, Washington, D. C. Established 1869.

**PERSONAL**

"FOOT TROUBLES—CAUSE AND PREVENTION." Address, Dr. Tracy, South Boston, Mass.

GET MARRIED—MATRIMONIAL PAPER containing advertisements marriageable people from all sections, rich, poor, young, old, Protestants, Catholics, mailed sealed free. THE CORRESPONDENT, Toledo, Ohio.

**PHOTOGRAPHY**

COLOR PHOTOGRAPHY: PRINT YOUR landscape views in colors. Send 2 stamps for circular. Isenmann, 385 Bergen St., Newark, N. J.

MONEY IN PHOTOGRAPHY. I START amateurs making money at home taking portraits; become professionals. Studio secrets, retouching, etc., fully explained. Wells' Studio, East Liverpool, Ohio.

**PICTURES AND POST CARDS**

50 DIFFERENT. 10 CENTS. BURT McCann, 321 Newton, Minneapolis, Minn.

12 REAL PHOTO POSTALS, COTTON scenes, salt industry, etc., 50c. Salt City Studios, Grand Saline, Tex.

10 PERFUMED POSTCARDS. YOUR NAME in gold, 10c. W. Bloomington Co., Bloomington, Ill.

JUST GIRLS. 25 POST CARDS OF GIRLS, 25c. postpaid. No landscapes. Harold Hartzman, Moline, Ill.

PHOTOS "PRETTY GIRLS FROM LIFE," 12 for 25c, 4 for 10c. Harold Hartzman, Moline, Ill.

5 PHILADELPHIA VIEWS AND TRIAL membership 10c. International Postcard Club, 130 Wishart St., Philadelphia, Pa.

POSTALS—JUST GIRLS; 10 FIFTY POSES 10c. 30 for 25c. Bailey, 111 Maple, Napanoch, N. Y.

POSTCARDS OF EGYPT, MOROCCO, India, Soudan, Wales and many others 12c, 17c, 25c pkg. Imperial Art Co., Box 45, Stockport, Ohio.

RECEIVE POST CARDS AND LETTERS from everywhere. Membership 10c. Thomas Howard, 2420 South Elm Street, Spokane, Wash.

TWELVE HIGH GRADE POSTALS, EASTER or St. Patrick's, and one Illustrated Song, Words and Music, 10c—3 sets 25c. Bailey, 111 Maple, Napanoch, N. Y.

PHOTOS—"PRETTY GIRLS"—36 BEAUTY poses 10c. Curtis Co., E4 Englewood, Chicago.

**PICTURES AND POST CARDS**

LADIES AND GENTLEMEN. JOIN THE Florida Correspondence Exchange, and Boost your State. Trial membership 10c. Box 1342, Jacksonville, Fla.

COLLECT POSTCARDS: NAME IN, EXCHANGE list and our 20 page magazine 4 months for 10c. Elite Exchange, Dept. E4, 3827 N. 44th Ct., Chicago.

ART STUDIES—PHOTOGRAPHS FROM life models. Finest collection for artists and art lovers. Illustrated catalogues sent free on demand. C. Klary, 103 Avenue de Villiers, Paris, France.

JOIN EUREKA POSTCARD EXCHANGE. Membership 10c. 451 Oakwood Boulevard, Chicago.

JUST GIRLS—25 POST CARDS OF GIRLS, 25c, postpaid; no landscapes. O. K. Pub. Co., Decatur, Ill.

**POULTRY**

POULTRY PAPER—ALL ABOUT POULTRY, small fruit, garden. Best combination for pleasure and profit. 18 months, 25c. Kiger, Publisher, Donnellson, Iowa.

**PRINTING AND ENGRAVING**

BEN FRANKLIN PRINTING OFFICE, COMPLETE, \$1.50. Juron & Co., 1400 Noble, Chicago.

PRINTING. BUSINESS CARDS, ENVELOPES, Letterheads—100 of each \$1.00; 100 of either 35c. List, write Rex Printery, Trenton, Mo.

ENVELOPES, LETTERHEADS, CARDS, statements printed \$1.20 per 1000. Sample 100 of either above printed and sent prepaid 32c. Andrew Brems, Corona, N. Y.

125 BOND LETTERHEADS AND 125 ENVELOPES, white, pink, blue or green, printed, \$1 prepaid. Samples. W. Kinnier, Box 206, Brooklyn, N. Y.

ALL FOR \$1.10; 100 LETTERHEADS, 100 envelopes, and 100 business cards printed to your order on bond paper. Prepaid. Samples free. Carter Company, State St., Rochester, N. Y.

GOOD PRINTING AT LOW PRICES. 1000 Good Letterheads, Envelopes, Cards, Billheads, Labels, Circulars, \$2.50. Samples Free. Catalogues, Booklets and Circulars our specialty. Ernest L. Fantus Co., 523 S. Dearborn St., Chicago.

PRINTED ENVELOPES. BUY YOUR ENVELOPES from us and save money. Prices including printing, per 1000 envelopes, 3000 \$1.50, 5000 \$1.25, 10,000, \$1.00. Fine white stock. Larger quantities lower prices. Write for samples and prices on any kind, style or quantity. Satisfaction guaranteed. NEW ENGLAND PAPER GOODS COMPANY, Springfield, Mass.

**RUBBER STAMPS**

RUBBER STAMPS AND SPECIALTIES—Most complete line. Send today for my big catalog. Free. Theo. Helbling, 607 Marquette Bldg., Chicago.

**SALESMEN WANTED**

WANTED SALESMEN—EARN \$250 PER month, sell advertised goods. Samples unnecessary. Best contract on earth. Elato Co., Station L, New York, N. Y.



**SALESMEN WANTED**

**SALESMEN WANTED TO HANDLE THE Chase Shock Absorbers for Typewriters.** Exclusive territory. Fine opportunity for the right men. The Chase-Dunipace Co., Toledo, Ohio.

**REAL ESTATE**

**BALANCE EASY MONTHLY PAYMENTS** — at Dalworth Park, Texas, suburb on Interurban midway between Dallas and Ft. Worth, the fastest growing cities in the Great Southwest, only 32 miles apart. Millions going into new skyscrapers, hotels, factories in the two cities and population has trebled in ten years. Fortunes will be made here in suburban property. Early buyers will make enormous profits. Dalworth Park offers best opportunities, being on Interurban, which is to be double tracked, and on railroad and automobile pike. \$100,000.00 already spent on waterworks, natural gas, street improvements, etc.; 43 trains daily. Beautiful, large homesites, only \$50 and up in this special sale; \$1 makes first payment. Write to-day, before prices advance, for FREE booklet, showing views, maps and all particulars. The Dalworth Company, 73 Stewart Title Bldg., Dallas, Texas.

**SCHOOLS**

**SEE WHAT I SAY UNDER "TYPEWRITERS. ATCHISON.**

**DETECTIVES EARN FROM \$100.00 TO \$500.00 per month.** How much are you earning? Write for particulars. Interstate Detective School, Suite No. 15, McDougal Bldg., Peoria, Ill.

**WE TRAIN DETECTIVES. YOU CAN BE one.** Splendid Opportunities. Travel. Earn \$100 to \$300 monthly. This fascinating profession taught practically and scientifically by mail at a nominal cost. American School of Criminology, Dept. G, Detroit, Mich.

**\$35 PAYS FOR COMPLETE, PRACTICAL** unlimited course in automobile driving and repairing. We have the best, most up-to-date and complete school and shop in the city. Actual experience on various makes of cars. State license guaranteed. Day and evening classes. Call or write. Academy of Automobile Engineering, Dept. C, 1452 Michigan Avenue, Chicago.

**TELEGRAPHY**

**TELEGRAPHY—MORSE AND WIRELESS—** Railway Accounting (Station Agency) taught quickly. Railroad Dispatchers' and Western Union wires and complete Wireless Station in school. Splendid opportunities. Graduates assisted. Living expenses low—may be earned. Largest and oldest school—established 38 years. Investment \$25,000. Correspondence courses also. Catalog free. Dodge's Telegraph, Railway and Wireless Institute, 16th St., Valparaiso, Ind.

**TRADE SCHOOLS**

**MAKE \$5 TO \$8 A DAY AS SKILLED ELEC-** trician, plumber, draftsman, painter, decorator, moving picture operator. We teach you in short time at small expense profitable trade. Free employment bureau places graduates in good jobs. Special limited offer now. Write at once for catalogue and full particulars—no obligations. Dept. 8403, Coyne National Trade School, 51 E. Illinois St., Chicago, Ill.

**TYPEWRITERS**

**STENOGRAPHER MUST SELL HER REM-** ington typewriter, \$9.00. Miss King, 2230 Seventh Ave., New York City.

**LARGEST STOCK OF TYPEWRITERS IN** America. All makes: Underwoods, L. C. Smiths, Remingtons, etc., one-quarter to one-half manufacturers' prices (many less). Rented anywhere, applying rent on price. Write for catalogue 102. Typewriter Emporium (Est. 1892), 32-34 Lake St., Chicago.

**I WANT TO CORRESPOND WITH PERSONS** who are about to buy a high-grade typewriter, and object to paying the high prices generally asked by manufacturers and dealers. Any make on approval. Catalogue, bargain list and valuable information sent free. A. E. Atchison, 4125 West 21st St., Chicago.

**SAVE 65% TO 85% OF MANUFACTURERS'** Prices on Typewriters. All Makes, Underwoods, Oliver's, Remingtons, etc. Guaranteed 2 years. 500 typewriters \$10.00 to \$15.00. Send for catalogue. Dept. 103. Dearborn Typewriter Exchange, Chicago, Illinois.

**TYPEWRITER BARGAINS, LOWEST** prices and largest list in the world, all guaranteed five years and shipped on 15 days trial. Remington \$10.00, Smith Premier \$10.00, Underwood \$20.00, send for our large illustrated catalogue, and special agents offer. Harlem Typewriter Exchange, 213 West 125th St., New York.

**TYPEWRITERS—OFFICE SUPPLIES.** Typewriters—All Makes, Lowest Prices. Big volume of business and cash terms enable us to undersell. Smiths, Remingtons, Underwoods, Oliver's, etc., at \$10 up. Fully guaranteed. Write Young Typewriter Company, 64 W. Madison St., Chicago.

**WIRELESS**

**90 MILE WIRELESS TELEPHONE BLUE-** print, 25c. H. SECOR, 162 West 123 St., New York City.

**WIRELESS INSTRUMENTS FOR SALE.** Young experimenter wishes to sell out instruments, for particulars, write George Ives, Statesville, N. C.

**BRANDES 2, 800 RECEIVERS, SPARK GAP,** Coil, Detector, Tuning Coil, Key, Condenser, and Switch. Cost \$23.70. Sell for \$15.00. Frank A. Webb, Bridgton, Maine.

**AIR-COOLED GAPS, GOOD FOR ANY SET** up to  $\frac{1}{2}$  K.W., \$1.50.  $\frac{1}{4}$  K.W. gap, 50c. Vest pocket flash lights, nickel plated case, Tungsten battery, 69c. All prepaid. Catalogues for stamp. A. W. Bowman, 55 $\frac{1}{2}$  Sudbury St., Boston.

**MOLYBDEIUM—PLUMBI DIOXID** MOST recently discovered and positively the most sensitive mineral detector known. Guaranteed to increase your receiving radius and magnify signals fully fifty per cent. Sample Crystal fifteen cents. Full ounce fifty cents. Detector Stand, especially adapted for this crystal, special price fifty cents. UNITED SPECIALTY COMPANY, St. Louis, Mo.

**HELP WANTED**

**PLEASANT SPARE TIME WORK—MAIL-** ing circulars. No scheme. Good pay. Instructions free. Home Pub. Society, 1217 Market St., Philadelphia, Pa.

## HELP WANTED

**BIG PROFITS—OPEN A DYEING AND** cleaning establishment, little capital needed. We teach by mail. Write for booklet. Ben-Vonde System, Dept. AD, Charlotte, N. C.

**WANTED, PEDDLERS TO SELL DOCTOR** Blair's Medicine. We pay big commission distributing circulars. Address Niantic Company, 204 Grape St., Buffalo, N. Y.

**START HOME BUSINESS. SELL YOUR** ideas, plans, formulas and knowledge by mail. Some make \$1,000 monthly. Instructive booklet for stamp. Information System, 411, Marietta, Ohio.

**\$\$\$ REPORT LOCAL INFORMATION,** names, addresses, etc., to us. Big Pay. Confidential. Enclose stamp. National Information Sales Co.—AJM—Cincinnati.

**SONG POEMS WANTED—NEW PLAN, BIG** money. Free book tells all. Hayworth Music Co., 661 G, Washington, D. C.

**WANTED—TEN THOUSAND GENTLEMEN** of good taste to try our "FIGOLA" Havana cigar, 25 box \$1 prepaid. Beaver Cigar Co., Canton, Ill.

**WANTED: COLLEGE GRADUATES IN** Electrical Engineering for work in our Testing Departments. Good opportunities for experience and advancement. Apply, Employment P. O. Box 911, Pittsburgh, Pa.

**RAILWAY MAIL CLERKS WANTED. \$900** first year, promotion to \$1800. Examinations May 3 in every state. Common education sufficient with my coaching. Full information free. Write for booklet V 50. Earl Hopkins, Washington, D. C.

**GET PREPARED FOR MAY 3d RAILWAY** Mail Clerk and other Government "exams" by former U. S. Civil Service Secretary-Examiner. Free booklet 94. PATTERSON CIVIL SERVICE SCHOOL, ROCHESTER, N. Y.

**HOW MUCH ARE YOU WORTH? WHEN** sick, or injured, and at death? Who pays your loss, or your family's then? That's our business! Let us tell you all about it. Write quick for Cash-Bonus offer. The I-L-U 1025, Covington, Ky.

**AGENTS MAKE BIG MONEY AND BE-** come sales managers for our goods. Fast office sellers. Fine profits. Particulars and samples free. One Dip Pen Company, Dept. 4, Baltimore, Md.

**DRAW BIG SALARY DRAWING CARTOONS** Demand for cartoonists way ahead of supply. I teach rapidly and thoroughly in your home by proven methods. Low cost, easy terms, big returns. Particulars for stamp. Ted Hamilton, 209 E. Ontario St., Chicago, Illinois.

**CIVIL SERVICE EXAMINATION—I PRE-** pare you for any branch of Mail Service. Pay me after appointment. Write for free entrance test. Dan Tuhey (Retired R. R. Clerk), 18 Tuhey Bldg., Denver, Colo.

**BIG MONEY WRITING SONGS—WE PAY** hundreds of dollars a year to successful writers. Experience unnecessary. Song poems wanted with or without music—will pay one-half of profits if successful. Send us your work today. ACCEPTANCE GUARANTEED IF AVAILABLE. Largest concern in the country. Free particulars. Dugdale Co., Dept. 13, Washington, D. C.

## HELP WANTED

**DON'T PAY ANYTHING TO LEARN A** trade. Investigate our system of teaching on actual contract jobs. Plumbing, bricklaying, electricity, automobiles; 200 workmen; six years experience. Catalog free. United Trade School Contracting Co., Los Angeles.

**FREE ILLUSTRATED BOOK TELLS ABOUT** over 360,000 protected positions in U. S. service. More than 40,000 vacancies every year. There is a big chance here for you, sure and generous pay, lifetime employment. Easy to get. Just ask for booklet A-50. No obligation. Earl Hopkins, Washington, D. C.

**WANTED: A MAN OR WOMAN ALL OR** spare time to secure information for us. Work at home or travel. Experience not necessary. Nothing to sell. **GOOD PAY.** Send stamp for particulars. Address M. S. I. A., 533 L Bldg., Indianapolis, Indiana.

**MEN AND WOMEN WANTED FOR GOV-** ernment Positions. \$90.00 month. Annual vacations. Short hours. **PARCELS POST** means thousands of Railway Mail Clerks needed. "Pull" unnecessary. Farmers eligible. Write immediately for free list of positions open. Franklin Institute, Dept. L, 53 Rochester, N. Y.

**LOCAL REPRESENTATIVE WANTED.** Splendid income assured right man to act as our representative after learning our business thoroughly by mail. Former experience unnecessary. All we require is honesty, ability, ambition and willingness to learn a lucrative business. No soliciting or traveling. This is an exceptional opportunity for a man in your section to get into a big paying business without capital and become independent for life. Write at once for full particulars. National Co-Operative Realty Company, H-604 Marden Building, Washington, D. C.

**Pull Up Your Socks**

—JUST ONCE, and slip on the "New Idea" Supporters. If they do not STAY in place—if you're even conscious that you WEAR supporters—if they do not give you more COMFORT and SECURITY than \$5.00 worth of the creeping, binding, elastic kind, we will return your money and let you keep them. The PRICE—1/2 for a nickel plated pair, good for five years. For \$5.00 worth of Comfort and service, enclose 1/2c today for a pair postpaid. Circulars Free.

MODERN SPECIALTY CO., 82 St., Racine, Wis.

**Grease Your Pants**

**in 5 Minutes for 1/4 Cent**

—with the "Nu-Pantz" Greaser. Not an iron but a practical low-priced machine which works by automatic pressure. Aluminum self-heating outfit, wgt. 2 lbs. Always ready. No trouble. Wonderful results. Save \$30 per year and add \$100 to appearance by writing today for complete description and approval offer. Address Modern Specialty Co., 81 St., Racine, Wis.

MODERN SPECIALTY CO., 81 St., Racine, Wis.

**A NOSE FOR NEWS**

Have you a "nose for news" as the newspaper editors say? Can you write a simple, interesting description of some unusual application of electricity? Have you a camera to illustrate the article? Send for our little pamphlet "What to Write and How to Write It." It will put you on the track of some easy and profitable work for spare moments.

**POPULAR ELECTRICITY MAGAZINE**  
54 W. Lake Street, Chicago, Ill. Editorial Dept.

FOR  
INGENIOUS  
BOYS

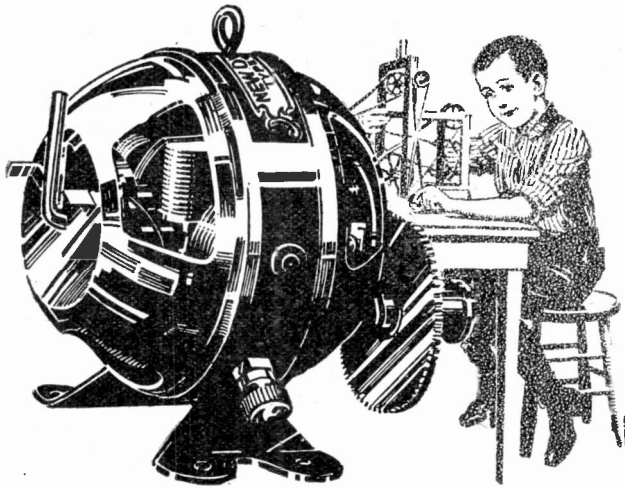

FOR  
MECHANICAL  
TOYS

## SPECIAL SALE of BATTERY MOTORS

THESE miniature battery motors will give any boy or girl a whole lot of pleasure and instruction. They are sturdy little affairs and on one or two dry cells will develop a speed of 3500 revolutions per minute. There is a type for every purpose; will operate all sorts of mechanical toys—lathes, planes, jigsaws, windmills, etc. These miniature motors are substantially constructed and will give good service. We have only a few of each type of motor, as noted below:

	Were	Now
23 Type C (Semi-Enclosed, snap switch) . . . . .	\$1.50	\$ .90
23 Type D " " reversible . . . . .	2.00	1.20
6 Type E " " snap switch, 2 speed . . . . .	2.00	1.20
15 Type F " " 2 speed, reversible . . . . .	2.50	1.50
14 Type G (Fan Motor, semi-enclosed, snap switch) . . . . .	2.50	1.50

The above prices are NET, that is, purchases will be sent express charges collect

### Act Quickly to Secure These Bargains

Select the motor you want and send us your money order for the amount of your purchases. But you should send in the coupon *at once* as there are only a few of these left at these bargain prices. Be sure to write plainly, telling which type wanted, how many and the price.

## ELECTRIC SHOP

### CHICAGO

Michigan and Jackson Boulevards

Send me following described motors per your special sale offer in Popular Electricity.

\_\_\_\_\_ type \_\_\_\_\_ price \$ \_\_\_\_\_

\_\_\_\_\_ type \_\_\_\_\_ price \$ \_\_\_\_\_

Name \_\_\_\_\_

Address \_\_\_\_\_

# Do Your Laundry Work

## the Easy and Economical Way

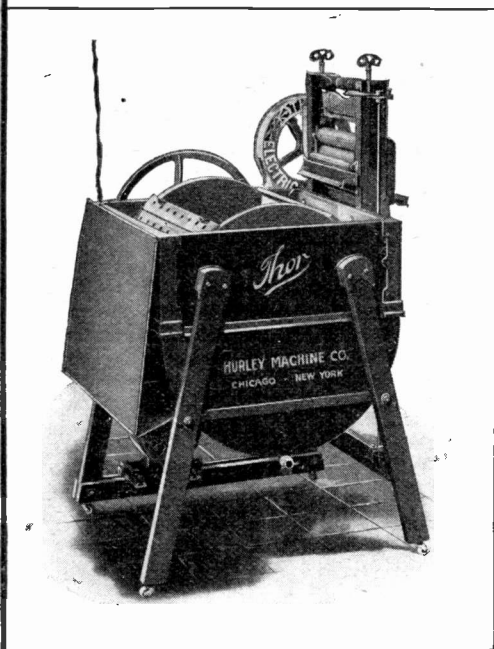

By Using Your  
Electric Light  
Current and a

# Thor Electric Home Laundry Machine

**The Thor does all the hard work of Washday  
Washes and Wrings the Clothes by Electricity**

Furnished complete with specially designed two-roll reversible Wringer and  
guaranteed Westinghouse electric motor

The Thor washes the clothes

**BETTER**—it gets them spotlessly clean—does the work better than any woman can—and without the washboard wear.

**QUICKER**—does the average family washing in 90 minutes, work that would take a woman all day.

**EASIER**—relieves the housewife or household help of all the washday drudgery.

**CHEAPER**—it costs less to buy a Thor than to hire wash-day help or send the clothes to the laundry. The one essential is that you have electric light in your home.

**\$1.50 A WEEK**

quickly pays for the Thor. 3 cents worth of electric current does the average family washing.

**Free Test for 15  
Days**

Let us give you the name of our dealer in your city who will deliver a machine to your home for a 15 days' Free Test.

Write today for Catalog F describing Electric Washing Machines from \$30.00 up

**HURLEY MACHINE COMPANY**

**New York, 1011 Flatiron Bldg. Chicago, 27 S. Clinton St.**

# Danger Lurks in Hidden Dust —Safeguard Your Family!

A clean-looking house may still be *insanitary*. That's the danger of sweeping with a broom. Shoes collect dried sputum from sidewalks and deposit its dust on rugs and carpets. You can't see it, perhaps. But it's *there*. Then comes sweeping day. Your broom fills the air with invisible, germ-laden dust. It finds its way into your lungs—into your food—settles on the floor where playing children stir it up again and become infected. The *broom* is even more dangerous than the *fly*.

## Federal Vacuum Cleaner

### Sucks Up All the Germ-Laden Dust

No dirt too heavy—no dust too light and invisible to escape the FEDERAL Vacuum Cleaner. Its powerful suction searches every thread and fibre of rugs and carpets—clothing and drapery. Yet it can't injure the most delicate fabric. From the innermost depths of thick, heavy padding, the powerful FEDERAL sucks out the dust and germ-laden air—making upholstery, pillows and mattresses as sweet and clean as new.

### The FEDERAL is the Guaranteed Cleaner

But don't think that just any vacuum cleaner will do this. Some really do no more than a carpet sweeper. They pick up the *surface* dust—the *visible* dirt—but not the hidden, germ-laden dust. The Federal, which has no parts to wear out, like a *fan* device, a *bellows* or a *diaphragm*, creates a tremendously powerful suction. Constant use increases, not decreases, its power. The Federal is the machine that has stood the test of time.

### The Powerful Rotary Pump

The Rotary Pump in the FEDERAL revolves steadily in one direction—like a powerful turbine engine on an ocean liner. It creates a suction impossible with a fan or bellows type of cleaner. Its working parts are few—simple—easy of access. No valves to work loose—no gears to rattle—no piston to pound up and down—no bellows to wear out—just a powerful, substantial pump and a motor—both revolving in one direction—steadily, silently, without jar or jerk.

### SEND FOR ILLUSTRATED BOOKLET "Purity in the Home"

The Federal is not a cheap machine—price, \$125—but it is the *most economical* cleaner to buy. We will gladly tell you why in our illustrated booklet, "Purity in the Home," No. 1453. Use the coupon *now*.

Vacuum Cleaner Department

**Federal Sign System (Electric)**  
Lake & Desplaines Sts., Chicago



Federal  
Sign System  
(Electric)  
Lake & Desplaines  
Streets, Chicago, Ill.  
Kindly send me your  
illustrated booklet, No.  
1453, entitled, "Purity in  
the Home." It is under-  
stood that this places me under  
no obligations.

NAME .....  
ADDRESS .....  
CITY .....

SIGN, TEAR OFF AND MAIL

## It will pay to Read These Advertisements

Because they are small you should not pass them over. The good things in life are worth looking for and many of the smaller advertisers have special products which they can sell you although many of them are not in a position to buy large space to tell their story. We bespeak your patronage for these advertisers.

**POPULAR ELECTRICITY MAGAZINE**  
Small Ad Department



**TYPEWRITERS FACTORY REBUILT**  
Remington No. 6—\$27. Smith Premier No. 2—\$23.  
Only two of our special bargains. Have trademark and guarantee like new machines. Are thoroughly rebuilt, and perfect in appearance. Satisfaction guaranteed. We can save you \$25 to \$75 on any machine. Branch stores in leading cities.  
Write for "The Typewriter's Confession" and catalog. AMERICAN WRITING MACHINE CO., Inc., 345 Broadway, N. Y.



**AUTOMATIC TELEPHONE**  
—The one logical phone. 10-second secret connections—no delays, no wrong numbers—low in cost—local and long distance. Automatic service is blanketing Chicago. For details phone or write  
**ILLINOIS TELEPHONE & TELEGRAPH CO.**  
163 WEST MONROE ST., CHICAGO, Coml. Dept. 23-111



**KAFOR GEMS**  
Blue-white Gems of Wonderful Brilliancy, Look, Wear, and stand the test like genuine Diamonds, at the cost. No Imitations, Brilliancy guaranteed for life, set in 14 K. solid Gold diamond mountings. See them before buying, sent free for examination. Send for booklet, special prices, Etc.  
**The Jodean Gem Co. Dept. 4**  
1043 Greenwood Terrace Chicago, Ill.

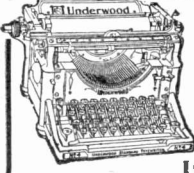

**TYPEWRITERS ALL MAKES**  
\$100.00 Underwoods, Smiths, Oliviers, Remington, etc., from \$10.00 up. Every machine in perfect condition, guaranteed two years, with privilege to exchange at any time. 300 typewriters at \$15.00 each, while they last. Write for our cut rate prices and Free Trial Offer.  
**All Makes Typewriter Exchange Co.**  
166 N. Dearborn St., Chicago, Ill.

# GAS ENERGY

A newsy, reliable monthly for all interested in any kind of gas or gasoline engine. One valuable feature, a comprehensive review, monthly, of all new patents, described and illustrated. 50c a year.

## GAS ENERGY COMPANY

26 Murray Street - - New York City

**FREE**—If you send in your order right away, mentioning this magazine, we will mail you gratis a copy of "How to Run and Install Gasoline Engines."

For our Mutual Advantage mention Popular Electricity when writing to Advertisers.



**Square Deal Miller**  
DIAMONDS WATCHES JEWELRY  
On Easy Monthly Payments  
**SMASH THE TERMS**  
Fine, White, Perfect Diamonds in Solid Gold, 14 Karat, Latest Style Mountings. No matter where you live or what your income is **YOUR CREDIT IS GOOD**  
Lower prices than all cash houses. Send name and address for Guarantee and Easy Payment Plan.  
**SQUARE DEAL MILLER, Pres.**  
Miller-Hoeder Co., 129 Miller Bldg., Detroit, Mich.  
Canadian Branch, Windsor, Ont.



**Be Your OWN BOSS**  
**AGENTS EARN BIG MONEY**  
selling Golden Rule genuine hand forged English Razor steel Knives. We will put any photo or lodge emblem on one side of the transparent handle, and name and address on the other. We have a complete, fully guaranteed line of knives, razors, strops, and cutlery specialties. Quick sales. Big profits. Experience unnecessary. Write today for catalog and terms.  
**GOLDEN RULE CUTLERY CO., 553 W. Lake St., Dept. 47, Chicago**



**To Entertain** 311 Jokes and Riddles, 73 Toasts, 31 Parlor Amusements, 21 Puzzles, 15 Tricks with Cards, 7 Comic Recitations, 3 Monologues, 12 Funny Readings, 8 Fortune Secrets, 52 Money Making Secrets. All 10c postpaid.  
**J. C. DORN, 709 So. Dearborn St., Dept. 50, Chicago, Ill.**

**LET ME READ YOUR CHARACTER**  
from your hand writing. Mind you get a really **GOOD** reading that will help you in love, health, business and domestic affairs. Price 10c. Sure to please you. **Money back** if dissatisfied. N. G. BEAUCHAMP 2583 8th Ave. New York City

Write for **INVENTORS' SUPPLIES** Booklet of **UNION MODEL WORKS** (Established 1882) 119 S. Clark St., Chicago The oldest, most reliable, most efficient model making and experimental house in the West.



**Boy Electrician** with 75 illustrations for making Batteries, Dynamos, Motors, Telegraph apparatus, Telephone, Lights, Bells, Alarms, Coils, "Wireless" Current Reverser, Electric Engine, Etc. By Electrical Experts so that anyone can understand it. With Cat. All 10c Post.  
**J. C. DORN, 709 So. Dearborn St., Dept. 49, Chicago, Ill.**

**INVENTORS** We manufacture METAL SPECIALTIES of all kinds, to order; largest equipment; lowest prices. Send perfect sample **FREE** for low estimate and best expert advice  
**THE EAGLE MFG. COMPANY, DEPT. C, CINCINNATI, O.**

**Agents \$5.00 a Day!**  
Many earn more. Get next to this big money maker. Write today for beautiful free outfit showing all the latest materials for Men's Made-to-Measure Clothes.  
**Suits \$9.00 up — Pants \$2.50 up** Express Paid  
Fit, workmanship and wear guaranteed. Fashions shown in beautiful color—handsomest line on the market. Write at once for free outfit.  
**The Progress Tailoring Co., Dept. 813, Chicago.**

# It will pay to Read These Advertisements

Because they are small you should not pass them over. The good things in life are worth looking for and many of the smaller advertisers have worthy products which they can sell you although many of them are not in a position to buy large space to tell their story. We bespeak your patronage for these advertisers.

## POPULAR ELECTRICITY MAGAZINE

Small Ad Department

### ONE DOLLAR A MONTH Buys a Standard Typewriter



Your choice, Remington, Oliver, Smith Premier, L. C. Smith or Underwood. Prices lower than other cash prices. Perfect machines only. Guaranteed.

#### Typewriter Installment Co.

Dept. 9., 180 N. Dearborn St. Chicago



I will send as long as they last my 25c. Book

### STRONG ARMS

For 10c in stamps or Coin.

Illustrated with 20 full page halftone cuts, showing exercises that will quickly develop, beautify, and gain great strength, in your shoulders, arms, and hands, without any apparatus.

#### PROF. ANTHONY BARKER

1298 Barker Bldg. 110 West 42d Street, New York



### Guaranteed Non-Magnetic

This watch, a handsome stem wind and set, thin model, dust proof time piece, will positively withstand all magnetic attractions. Tested to 2000 Volts. Guaranteed accurate. Money back if not as represented. Approved by all electrical engineers. Price only \$5.00. Delivery FREE

Great Bargains in Diamonds and Jewelry of all kinds

E. KIRCHBERG, 134 NORTH STATE ST., CHICAGO

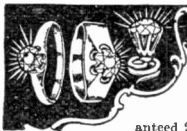

### WHITE VALLEY GEMS IMPORTED from FRANCE SEE THEM BEFORE PAYING!

These gems are chemical white sapphires—LOOK like Diamonds. Stand acid and fire diamond tests. So hard they easily scratch a file and will cut glass. Brilliance guaranteed 25 years. All mounted in 14k solid gold diamond mountings. Will send you any style ring, pin or stud for examination—all charges prepaid—no money in advance. Write today for free illustrated booklet, special prices and ring measure.

WHITE VALLEY GEM CO., 742 Saks Bldg., Indianapolis, Ind.

\$18 in U.S.A.

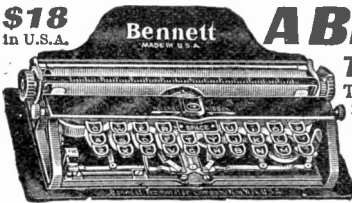

Bennett MADE IN U.S.A.

## A Brand New Typewriter for \$18

That does work equal to any \$100 machine

That's what you get in this unique, wonderful little typewriter, so small it can be carried in pocket or grip, with every modern improvement. Standard keyboard 84 characters.

Get out letters, orders, records, etc., on train, in office, at home, everywhere—see the neat, rapid work the Bennett does—we know you'll decide to keep the machine. Write for catalog and free trial offer.

Splendid chance for agents A V B Bennett Typewriter Co., 366 Broadway, New York

Our Smart Cards in Cases

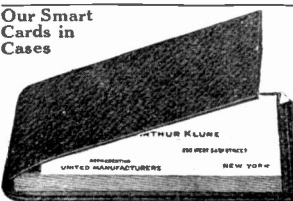

## TO THE END OF TIME

You will be judged by your acts. If you prefer not to be misjudged send in a PEERLESS Patent Book Form Card. Its smooth edges; its genuine elegance will tell the character of man you are. Nothing else like it. Used by the men who care for appearances and who command big pay. It ought to be used by you.

Send today for sample tab of engraved cards, and get get right, in the card line.

The JOHN B. WIGGINS COMPANY, Sole Manufacturers

Engravers, Die Embossers, Plate Printers.

85-88 East Adams Street, Chicago

## BILLIARDS AT HOME

Have your own Burrowes Billiard and Pool Table. A few cents per day will buy it. No special billiard room needed. Write for particulars.

THE E. T. BURROWES CO. 126 Free St., Portland, Me.

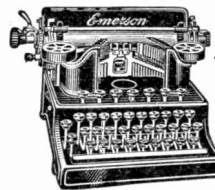

### WOULD YOU

Show this wholly visible Typewriter to your friends and let them see wherein it exceeds any \$100 Typewriter made, if we would send one to you Free of One Cent of Cost for you to keep forever as your own? Then on a postal card, or in a letter to us, simply say: Mail particulars.

EMERSON TYPEWRITER CO. Box 512, Woodstock, Illinois.



### Money in This

Print your own cards, circulars, book newspaper. PRESS \$5, larger \$18. Rotars \$60. All easy, rules sent. Print for others, big profit. Write factory for press catalog, TYPE, cards, paper, etc.

THE PRESS CO.-Meriden, Conn.



### ADDING MACHINE

MULTIPLIES—SUBTRACTS For General Office or Personal Desk Use

Over 60,000 in use

Mostly sold through recommendation

Purchase through your Stationer

If he will not supply you, send remittance to us. We guarantee every machine—money refunded if not satisfactory within 10 days.

P. GANCHER A. A. M. CO. 819 Broadway N.Y.

LIVE AGENTS WANTED

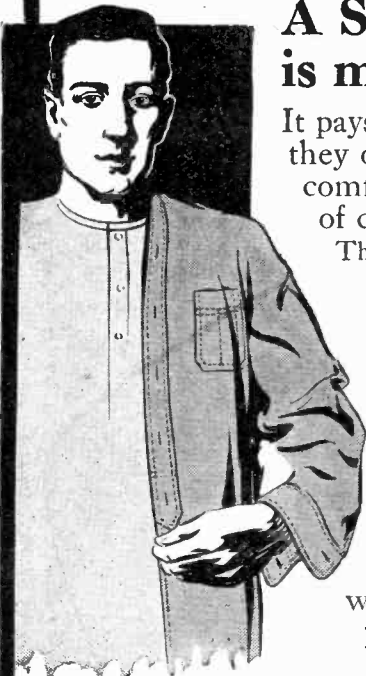

Two detachable collars  
always furnished.

## A Signal on your back is money in your pocket

It pays to wear Signal Coat Shirts because they outlast any shirt of equal price, and comfort is guaranteed by the greatest combination of comfort features in any shirt at *any* price.

These extra improvements of

### SIGNAL \$1 COAT SHIRTS

include: Extra button at bottom of breast plait for smooth fit; rip-proof, gap-proof, sleeve slit; specially cut skirts overlapping three inches in front; two detached or an attached collar as desired; button-holes for white cuffs; double needle machine stitching; two pockets, one a triple combination for pencil, watch and handkerchief. Made by expert union labor from fast, shrinkless percales in big variety of neat patterns.

Send for a couple if your dealer hasn't Signal Coat Shirts; tell us your name and your size and we will express you a couple C.O.D. I'm not delighted with them on examination, *return at our expense.*

Write for folder showing big variety of other styles and sample swatches.

#### Hilker-Wiechers Manufacturing Company

Manufacturers of SIGNAL Work Clothes

1248 Mound Ave.

Racine, Wisconsin.



## The Recognized Authority on Wiring and Construction

# Standard Wiring for Electric Light and Power

*As adopted by the Fire Underwriters of the United States*

The only book on Wiring and Construction  
kept strictly up-to-date

### What the 1913 Edition Contains

The latest rulings of The National Board of Fire Underwriters, explained and illustrated with line cuts and half-tones of the most modern and approved methods.

Directions for installing and operating Dynamos, Motors, Arc Lamps, Switchboards, etc.

Full details on outside wiring and construction for both telephone and power lines.

The simplest and most approved methods of inside wiring for light, heat and power, with examples worked out for both direct and alternating current for all systems—especially prepared for "Standard Wiring" by the greatest electrical engineering company in the world.

The latest data on Carbon, Geni, Tantalum, Tungsten and Mazda incandescent lamps.

All the necessary tables for every requirement of the Constructing Engineer, Contractor, Central Station and Wireman.

The Standard Symbols for wiring plans.

A special chapter on the treatment of electrical injuries, by Chas. A. Lauffer, M.D., of the Westinghouse Co.

Definitions of electrical units.

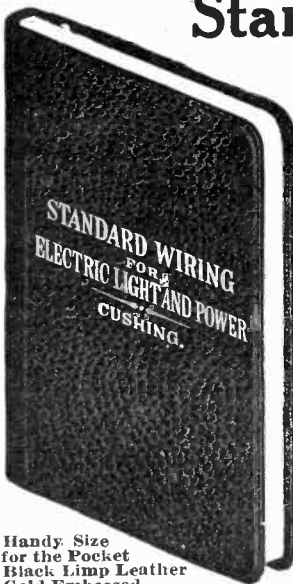

Handy Size  
for the Pocket  
Black Limp Leather  
Gold Embossed

Price \$1.00 Postpaid

POPULAR ELECTRICITY BOOK DEPT., 54 W. Lake St., Chicago, Ill.

For our Mutual Advantage mention Popular Electricity when writing to Advertisers.



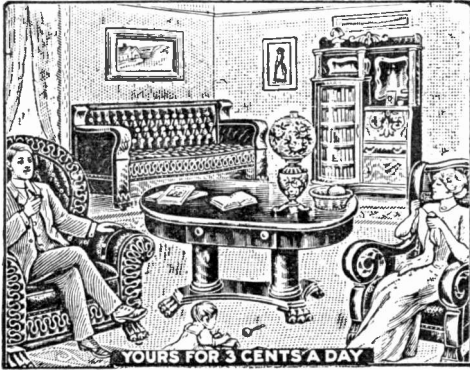

## Best Things in Life Yours for 3 Cents a Day

A million homes with modest incomes have every home-like comfort. They buy these comforts all from us, on open charge account.

They pay, if convenient, a little each month. We have no rigid rules. Nor do we have collectors. All goods are sent on 30 days' trial, subject to return.

And by selling direct, and buying whole factory outputs, we save them from 30 to 50 per cent. That we guarantee.

### New-Style Credit

Our plan is not like others. We ask no contract or mortgage, no red tape or publicity, no interest, no extra price.

We take your word. Then you pay us by saving 2 or 3 cents a day. Pay as you can. We won't hurry or press you.

Think what comforts you can have at these low prices and these easy terms.

### 4,782 Bargains We Give 1 Year to Pay

- |               |                  |
|---------------|------------------|
| Furniture     | Silverware       |
| Carpets—Rugs  | Chinaware        |
| Linoleums     | Sewing Machines  |
| Stoves—Ranges | Kitchen Cabinets |
| Baby Cabs     | Cameras—Guns     |
| Refrigerators | Trunks, etc.     |

### Dollar Book Free

Our mammoth Spring Bargain Book is ready. It pictures 4,782 home things, and many of the pictures are in actual colors. You never saw such an exhibit.

It quotes our prices, tells our plan, shows our order blank. We send it free, though each book mailed costs us just \$1.

Write us for it. Let us prove these things to you. Write us now for fear you may forget it. (372)

# Spiegel, May, Stern & Co.

858 W. 35th Street, Chicago

## Special Offer

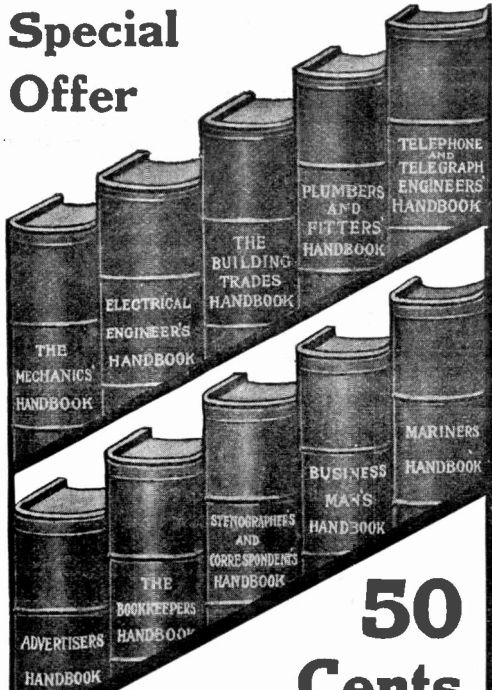

# 50 Cents

No books in existence contain in the same space so much knowledge about the different trades and professions as do the I. C. S. Handbooks. They are compiled from the Courses of the International Correspondence Schools, of Scranton, Pa., which have been written by the best experts in the country. These little books are, therefore, consulting experts of the highest rank—pocket memorandas of inestimable value to the executive, foremen, and managers. They are invaluable as promotion gainers for ambitious men in subordinate positions, because they can be easily understood without a knowledge of higher mathematics, and contain just the information needed by men to secure promotion.

**SPECIAL OFFER:**—For a limited time we are selling these Handbooks, durably bound in cloth, with gilt titles, containing on an average of 375 pages and 175 illustrations, regularly sold for \$1.25, at a price for each Handbook of 50c.

### Send the Coupon NOW!

**International Textbook Company**  
Box 1102, SCRANTON, PA.

I enclose \$\_\_\_\_\_ for which please send me the Handbooks BEFORE which I have marked X.

- |  |  |
|--|--|
| <input type="checkbox"/> Mechanics'            | <input type="checkbox"/> Advertiser's        |
| <input type="checkbox"/> Electrical Engineer's | <input type="checkbox"/> Bookkeeper's        |
| <input type="checkbox"/> Building Trades       | <input type="checkbox"/> Steno. and Corr.    |
| <input type="checkbox"/> Plumbers and Fitters' | <input type="checkbox"/> Business Man's      |
| <input type="checkbox"/> Tel. and Telegraph    | <input type="checkbox"/> Mariners'           |
|  | <input type="checkbox"/> Concrete Engineer's |

Name \_\_\_\_\_

St. & No. \_\_\_\_\_

City \_\_\_\_\_ State \_\_\_\_\_

# Wayne Bell Transformers



Take the place of unreliable, troublesome batteries and use practically no current. Can be connected to any alternating current lamp socket and will

**Operate Door Bells, Buzzers, Toys, Burglar Alarm Systems, Gongs, Annunciators, Etc.**

Made in three types and sizes for different classes of work and so neat in appearance that they can be installed anywhere in homes, hotels, offices, schools, hospitals, etc.

Built to run for hours on dead short circuit without danger of burning out.

If your dealer does not have them write us and we will send our illustrated leaflet 4511.

**Fort Wayne Electric Works**

of General Electric Company  
"Wood" Systems

1603 Broadway FORT WAYNE, IND.  
Branch Offices: Most Large Cities

## TESTED APPARATUS MEANS THE ELIMINATION OF FAULTS IN YOUR PRODUCT

Electrical and photometrical tests of every description. Checking electrical instruments of all kinds and classes. Inspecting and testing new electrical machinery, apparatus and material at factories and after installation. Tests on any electrical machinery and apparatus made anywhere. Arc and incandescent lamp tests, either electric, gas, acetylene or oil. Illumination tests made anywhere. Secondary standards of candle-power furnished. Facilities furnished to experimenters and investigators.

*We have recently added to the above, Coal Testing, and are now prepared to make proximate analyses and calorific determinations on samples of coal, promptly and accurately.*

### ELECTRICAL TESTING LABORATORIES

BOTH STREET AND EAST END AVENUE NEW YORK, N. Y.

## Electric Lights Turned Down "Like Gas"

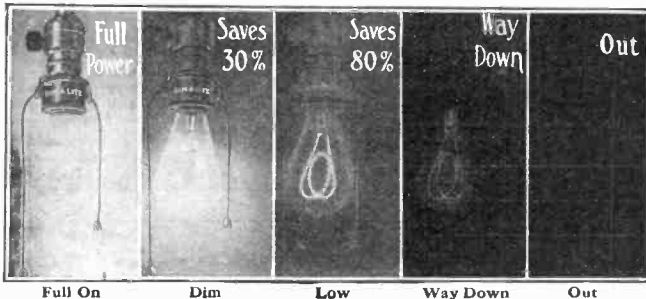

Not a lamp—A small portable attachment for a single incandescent lamp.

Pull the chain—Get five changes of light. That's what the Dim-a-lite will do on any lamp. Fireproof, foolproof, unbreakable and easily attached.

Will last a lifetime. A boon for travelers.

At your dealer's or by mail \$1.00

**Wirt Electric Co.**

Germantown - Pa.



For our Mutual Advantage mention Popular Electricity when writing to Advertisers.

**EARN \$2500.00 TO \$3000.00 YEAR**



**GO IN BUSINESS FOR YOURSELF**

Realize your ambitious Grip success. Be a business man! Earn \$2,500.00 to \$3,000.00 per year net—even more is possible. Here's a wonderful opportunity to make an easy start. Send for one of our money making B. B. Vacuum Cleaners on

**30 Days' Trial**

Tryout the proposition 30 days—see how much there is in it. It's a great chance to start business for yourself—just what you've been wanting to do—the very opening you've been looking for. One of the most wonderful money making propositions ever invented.

**Tremendous Profits**

The headline is conservative. \$15 to \$30 a day should be easily made. Some work three machines—operate one themselves—hire men to work the others. They make big profits from others labor. Maybe that's what someone is doing to you. You're doing the work for small pay. He's getting the profits. Change that. **Work for yourself.** Get all the profits. Be independent.

**Big Demand for Professional Vacuum Cleaners**

You should get lots of business. Every home has to be repeatedly cleaned. Everybody now wants vacuum cleaning. It's the new, easier, better way of cleaning. Nobody wants to tear up carpets and rugs and pound them to pieces. There's a big demand for the man who can clean the whole house—rugs, matting, carpets, mattresses, pillows, portieres, curtains, upholstered furniture, etc.—do the whole job in a few hours without turning the house upside down. One man can clean ordinary home in four hours. One woman engages you—then next door neighbor wants you. So it goes. Think of the homes that need cleaning—think of churches, halls, lodge rooms, hotels, etc., that need cleaning—extra big jobs and extra big money. You should be busy as a bee. Work is easy and fascinating. Always a crowd around your machine. They advertise

you. You get phone calls—business—business—business—all the time. When money is earned—it's yours—all of it.

**Let Your Profits Pay for Machine**

We sell for cash or on installments. You should earn money from first day. **When payment comes due, pay it out of your profits.**

The B. B. Vacuum Cleaner is a wonder—simple—reliable—complete. We are glad to send it on 30 days' trial. We know it will make good.

Our 1913 B. B. Machine consists of a powerful gasoline two-cycle, valveless engine, perfectly adjusted and inspected. It has all the latest attachments and improvements of best quality—made to last and complete in every way. **Protected by Kenney basic patents.**

The whole is erected upon a substantial four-wheeled wagon—steel or rubber tires—full elliptic springs—staggered steel spokes—strong and substantial, yet so compact and light it can be moved from place to place with little effort. Equipped with vacuum condenser, water tank, vacuum gauge—high pressure suction hose—observation glass and cleaning tools all properly connected and adjusted ready for work. All fittings best on the market. Simplest and easiest working Vacuum Cleaner proposition ever set up. All our users praise it. Say it is the best ever.

Send today for free book and full particulars regarding our 30 days' trial. A 2-cent stamp brings it. We tell you how to start—how to get business and make a success. Vacuum cleaning is new—something everybody wants and can afford. It's a tremendous money maker. Now is the time to start. Answer this announcement now. Be ready for the spring rush. Remember you might just as well make \$2500 to \$3000 or more this year.

**Powerful Proof**

Must say that the B. B. machine has given perfect satisfaction. The second day after it arrived we cleaned \$22.00. Montgomery & Porter, Mo. Your favor of the 3rd inst. received. The B. B. does all you claim. It will knock out from \$20 to \$25 in six hours easy. A. O. Rainlow, Mexico. I started out with my machine on March 12, and up to the present time, June 6, have made \$550.00. I will need another machine next season. C. H. Otting, Ky. It is the greatest dirt puller I ever saw. I can make \$20 a day with it which I think is good for the investment. My customers are well pleased with my work. I have three or four regular customers by the month. A. W. Staley, Ill.

**FREE BOOK SEND FOR IT**

**McCreery Mfg. Co.**  
964 Dorr Street  
Toledo - - - Ohio

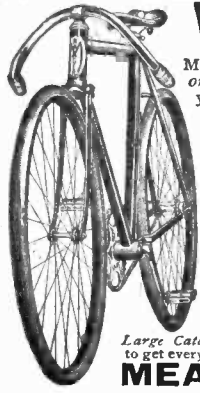

**WANTED—RIDER AGENTS IN EACH TOWN**

and district to ride and exhibit a sample 1913 Model "Ranger" bicycle furnished by us. Our agents everywhere are making money fast. **Write at once for full particulars and special offer.** NO MONEY REQUIRED until you receive and approve of your bicycle. We ship to anyone, anywhere in the U. S. without a cent deposit in advance, **prepay freight,** and allow **TEN DAYS' FREE TRIAL** during which time you may ride the bicycle and put it to any test you wish. If you are then not perfectly satisfied or do not wish to keep the bicycle you may ship it back to us at our expense and **you will not be out one cent.**

**LOW FACTORY PRICES** We furnish the highest grade bicycles it is possible to make at one small profit above the actual factory cost. You save \$10 to \$25 middlemen's profits by buying direct of us and have the manufacturer's guarantee behind your bicycle. **DO NOT BUY a bicycle or a pair of tires from anyone at any price until you receive our catalogues and learn our unheard of factory prices and remarkable special offer.**

**YOU WILL BE ASTONISHED** when you receive our beautiful catalogue and study our superb models at lower prices than any other factory. We are satisfied with \$1.00 profit above factory cost. **BICYCLE DEALERS,** you can sell our bicycles under your own name plate at double our prices. Orders filled the day received. **SECOND HAND BICYCLES**—a limited number taken in trade by our Chicago retail stores will be closed out at once, \$4 to \$8 each. Descriptive bargain list mailed free.

**TIRES, COASTER BRAKE** rear wheels, inner tubes, lamps, cyclometers, parts, repairs and everything in a bicycle line at half usual prices. **DO NOT WAIT**—but write today for our Large Catalogue beautifully illustrated and containing a great fund of interesting matter and useful information. It only costs a postal to get everything. **Write it now.**

**MEAD CYCLE CO. Dept. S-109 CHICAGO, ILL.**

For our Mutual Advantage mention Popular Electricity when writing to Advertisers.

# THERE ARE MANY REASONS WHY

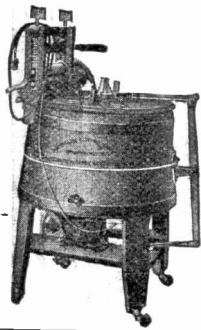

The Automatic Electric Washer pleases the people. No woman who uses it will stop at the old reason "Because." She will tell you more than that. It does the work quickly and does it right. It is easy to understand. It is easy to control. There is nothing hard. It makes little noise. It runs smooth. It wrings dry. It will wash and wring at the same time. It gets no water on the floor. SHE LIKES IT.

There are reasons for all these things. They did not just happen. Listen! Cut gears; careful machine work; control right at hand without reaching; splendid wringer with five year rolls; extra length coil springs that will wring lightest or heaviest articles without changing the tension; reversible water board and extra drip snout; bottom outlet made of galvanized brass, with faucet; mounted on ball bearing casters; guaranteed—wringer and all—for five years for family use.

Send for Bulletin 88.

**Automatic Electric Washer Co.**  
Newton, Iowa

**AutoMatic**  
Washer  
MADE IN NEWTON IOWA

## ELECTRICAL SUPPLY & SALVAGE CO.

527-529 W. VAN BUREN ST., CHICAGO

We Buy, Sell, Exchange, Rent and Repair Everything Electrical  
**Motors, Dynamos and Supplies**

We offer new high grade motors as follows: 1-4 H.P., A. C. Induction Type 60-cycle Single Phase, \$19.00; 1-6 H.P., D. C. 110-volt, \$9.00; 1-12 H.P., D. C. 110 or 220-volt, \$6.50; Bunnell Relays, 150 Ohms, \$2.00; Bunnell Telegraph Leg Key, \$1.00; 3-Bar Magneto-Generator, 50c.

Write us your wants. Prompt shipments. Every article guaranteed  
WALTER L. HODGMAN, Pres.

## An Electric Bell Without a Battery

**30 DAYS' FREE TRIAL**

Our No-Battery Electric Bell is positively the greatest invention of the age. This new inexhaustible and indestructible bell carries its own generator. When you

turn the button, it generates its own electricity and rings loud and as long as the button is turned.

### Anybody Can Install It

No expert electrician needed to install this bell. Any man who knows how to use a screw-driver and hammer can place it without any additional cost.

**30 Days' Trial** Send \$3.50 and we will send you the complete outfit. You risk absolutely nothing. If after a thirty-days' trial you do not find the bell as represented, return it to us and we will refund your money.

**Searles Electric Co.,** 1155 B Monadnock Block, CHICAGO

## The Sanitary Dishwasher

HAND AND ELECTRIC POWER

FOR FAMILY USE



Washes, rinses, dries and polishes the most delicate China—Glassware—Silverware in 3 to 5 minutes. Cleans and sterilizes dishes with scalding soap-suds and rinses them, completely removing all traces of food, grease, etc. Hands do not touch water. Saves labor, time, towels, breakage. All metal—compact—strong—lasts a lifetime. Escape the drudgery of dishwashing.

Write today for catalogue and testimonials

C. FREDERICK RICHARDS, President, DETROIT, MICH.

## "HUMAN INTEREST STUFF"

Big guns out on the coast are trained on a distant target at night by a searchlight; someone sent us a photograph and short description and we bought it at once. Near Los Angeles there is an old, old tree, a government land mark, and a new trolley line was made to take a curve to get around it—we bought another photograph and a couple of hundred words readily. Someone conceived the idea of treating chickens with high frequency current to make them grow faster, and when photographs and description were sent us we were only too glad to accept them. These are examples of what is known in journalism as "human interest stuff." We want more and more of it for the magazine. We want every subscriber to be a human interest scout. Good rates are paid for acceptable material—which must be hinged in some way on electricity. Send for our little pamphlet "What to Write and How to Write It."

POPULAR ELECTRICITY MAGAZINE

54 W. LAKE ST., CHICAGO, ILL.

Editorial Department

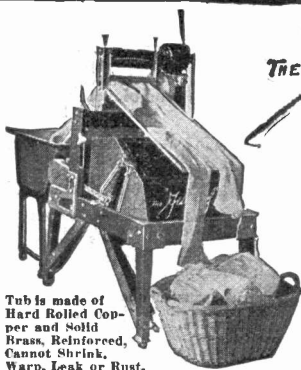

THE *Judd*

## Won't Wear Out the Clothes

The Reason Why? It's Perfectly Smooth Inside

Blankets and finest fabrics are all the same to THE JUDD, for the water is forced through the clothes a hundred times per minute. Ten or fifteen minutes will thoroughly cleanse a tub full.

Two hours to do a family washing! The electricity from any light socket will do the work at a cost of about four cents.

The special motor operates the reversible wringer and washer at the same time.

Let us show you how THE JUDD works. Descriptive literature for the asking.

**JUDD LAUNDRY MACHINE COMPANY**

Room 335 People's Gas Building,

CHICAGO

For our Mutual Advantage mention Popular Electricity when writing to Advertisers.

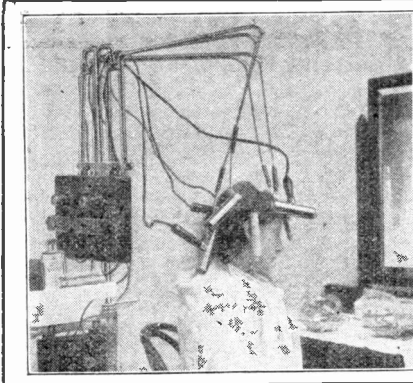

## Do You Know That You Can Make \$90.00 a Day?

### HERMANN'S PERMANENT HAIR WAVER

Offers opportunity to make **BIG PROFITS QUICKLY!** Four Types of Machines. Outfit more than pays for itself the first day. Best Paying Line of Work is the Hermann Permanent Hair Waver. It presents the opportunity you have been looking for. There is a Great Demand for this Work. *Write Today for Complete Catalogue.*

**MOLER SUPPLY HOUSE, 742 S. Wabash Ave., Chicago, Ill.**

# SAVE

**YOUR HEALTH  
YOUR GOOD LOOKS  
YOUR TIME  
YOUR CLOTHES  
YOUR MONEY**

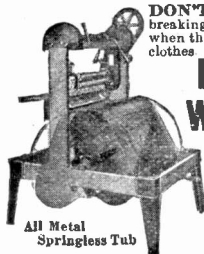

**DON'T** grow prematurely old and haggard over a back-breaking washboard and a side-ache producing wringer, when there is a better and far cheaper way to wash your clothes

## DOMESTIC ELECTRIC WASHER and WRINGER

5 cents worth of electricity and 2 hours time will wash your clothes clean—make them look better and wear longer.

Enclosed Working Parts Easily Cleaned 15 Days' Free Trial in Your Own Laundry. Send for Catalogue and Easy Payment Plan.

**DOMESTIC EQUIPMENT CO.**  
Dept. P. 30 W. Lake St., Chicago

All Metal Springless Tub

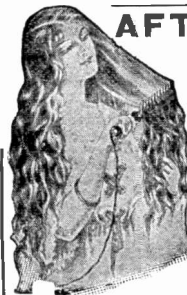

## AFTER A SHAMPOO

Dry the Hair Quickly with a **PELUCZE ELECTRIC COMB AND CURLING IRON**

Acts as a tonic for the hair and scalp—makes the hair luxuriant—saves time and labor—works perfectly. To use Curling Iron—simply remove the comb—makes beautiful lasting waves or curls. The heater and cord revolve together, so that the cord does not kink while in use. The temperature is so regulated in the heater that it can't burn the hair.



No. 442 Electric Comb complete	Price \$8.75	<i>If your dealer hasn't it we prepay expressage on receipt of price.</i>
532 Electric Curling Iron only	8.50	
552 Curling Iron and Comb complete	4.50	

**PELUCZE MFG. CO.**  
232-242 E. Ohio St., CHICAGO

The **PIONEER** and **PEER** of them ALL

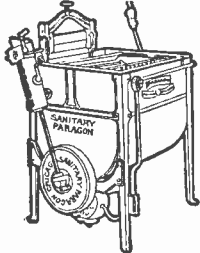

**NO WOOD  
SANITARY METAL ONLY**

## Why Pay Exorbitant Prices

for complicated, insanitary wooden washing machines, if you can buy a practical and everlasting All-Metal **Sanitary Paragon Power Washer** for operation by electric or gas motor

**AT A TREMENDOUS SAVING IN PRICE**

PRICES range from \$23.75 to \$150.00. Three sizes.

**OVER 100,000 PARAGONS USED IN THE U. S.,**

the most convincing proof of unequalled superiority. Before wasting your money in buying inferior makes send for our interesting catalog No. 2 and further details of the most liberal proposition ever made by any manufacturer. *Established 1902.*

**PARAGON MFG. CO., 2403-05 W. 14th St., CHICAGO**

## Let Electricity Make Pure Air for You

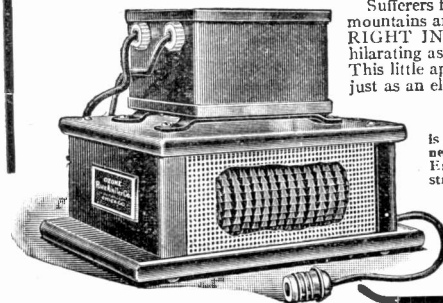

Sufferers from many ailments travel thousands of miles to breathe the **OZONE** of the mountains and pine forests. Yet a recent scientific invention enables everyone to have—**RIGHT IN THEIR OWN BEDROOM**—air constantly as pure, refreshing and exhilarating as the purest oxygen-filled atmosphere of the piny woods and mountain peaks. This little apparatus is operated by electricity and "ozoneizes" the air of the closest room just as an electric stern purifies the out-door air. **The**

### OZONE PURE AIRIFIER

is of greatest benefit in the treatment of Asthma, Hay Fever, Catarrh, Insomnia, Nervousness, Pneumonia, Typhoid and Scarlet Fevers, Diphtheria, Bronchitis, Tuberculosis, etc. Endorsed by highest medical and scientific authorities a thoroughly tested and demonstrated success.

Control Station, Electric Jobber and Dealer, this is the latest Electrical Appliance on the market. Write now for illustrated catalogue, price list and descriptive matter and plan of plating for liberal trial.

We want distribution throughout the United States in Every Place Where Electrical Appliances are Sold.

**OZONE PURE AIRIFIER COMPANY**

906-908 Rand McNally Bldg.

CHICAGO, ILL.

For our Mutual Advantage mention Popular Electricity when writing to Advertisers.

# 2c a Week Pays Wash Bill!

Write for  
**FREE Book**

Electricity or Water-Power Does the Work

## Just a "Twist of the Wrist" Starts or Stops the Machine!

The 1900 Motor Washers are now at work in thousands of homes. They are doing the work formerly done by women, at a cost of 2c a week for power! Saving thousands upon thousands of dollars in wash bills. Saving worlds of wash-day troubles. Leaving the women free to do other work while the machines are doing the washing.

# The 1900 Motor Washer

Washes a Tubful in Six Minutes!

1900 Water Motor Washer  
Can be connected with  
any water tap instantly

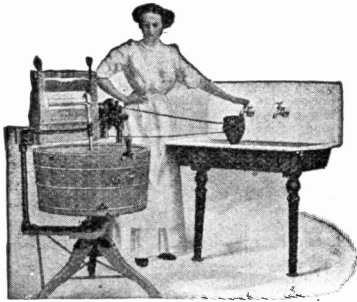

Handles Heavy Blankets or Dainty Laces

The outfit consists of the famous 1900 Washer with either Electric Motor or Water Motor. You turn on the power as easily as you turn on the light, and back and forth goes the tub, washing the clothes for dear life. Then, turn a lever, and the washer does the wringing. All so simple and easy that it is mere child's play.

## A Self-Working Wringer Free With Every Washer!

The motor runs the washer and wringer. We guarantee the perfect working of both. No extra charge for wringer, which is one of the finest made. Write for **FREE BOOK** and **30 Days' FREE TRIAL OFFER!** Don't doubt! Don't say it can't be done. The free book proves that it can. But we do not ask you to take our word for it. We offer to send a 1900 Motor Washer on absolute Free Trial for an entire month to any responsible person. Not a cent of security—nor a promise to buy. Just your word that you will give it a test. We even agree to pay the freight, and will take it back if it fails to do all we claim for it. A postal card with your name and address sent to us today will bring you the book free by return mail. All correspondence should be addressed to 1900 WASHER CO., 6009 Court St., Binghamton, N. Y., or, if you live in Canada, write to the Canadian Washer Co., 455-Yonge St., Toronto, Canada. (23)



Doing the wringing with  
1900 Electric Motor Washer

## WHETHER

At Home or Traveling you can with Simplex heating appliances secure comfort without bother.

The Nursery Milk Warmer, the Indispensable Water Heater, the Heating Pad and the Toaster are a few of the many useful heating appliances of Simplex Quality sold by good dealers and described in detail in our catalog F 17.

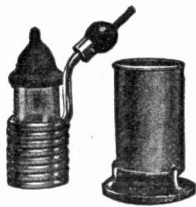

### SIMPLEX ELECTRIC HEATING CO.

Cambridge, Mass. 15 So. Desplaines St., Chicago  
612 Howard St., San Francisco Belleville, Ontario



## A 30 Day Free Trial



in your home will demonstrate to your satisfaction how necessary the

### SIMPLEX IRONER

is for economical management.

It saves your strength, health, beauty, time and money. It irons five times as fast, better and makes it easier. Servants are better contented, more efficient. Heats by gas or electricity. Operates by hand or small motor at small expense. It really costs nothing because it saves its cost every six months. Write for booklet and "Ironing Hints." Both free.

AMERICAN IRONING MACHINE COMPANY  
55 East Lake Street Chicago, Ill.

## Entertain Your Friends and Recall the Summer

by  
using  
a

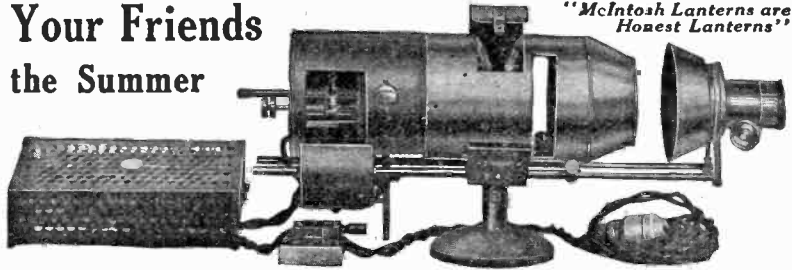

"McIntosh Lanterns are  
Hoaxest Lanterns"

## Miopticon The Newest, Neatest, Niftiest of Stereopticons

You can attach it to an ordinary incandescent socket using 5 amperes, 110 to 115 volts, and project pictures for a whole evening at a cost of about twelve cents for current.

You can show pictures of people, countries, scenes you have traveled through. You can show pictures of any modern science or industry. You can also show your summer vacation.

You can show pictures of Europe, Asia, Africa or any other country or continent. You can even show pictures of the solar system and its different members, using this wonderful little machine.

You can set it down wherever there is a space 5½ inches in diameter. You can operate it without the least difficulty. It is simple: the arc lamp is always centered.

You can use it in any size room or even in a small hall up to fifty feet or more from the screen.

We will send a little booklet telling about the Miopticon if you want it. It is free. A post-card will bring it to you. Write for it now.

McIntosh Stereopticon Company, 411-420 Atlas Block, Chicago, Illinois



This book is brimful of information on  
**ELECTRICITY** Motors, Dynamos, Wireless, Induction Coils, Rheostats, Miniature Electric Railways and Parts, etc.

It's a valuable, up-to-date catalog of one of the largest, most reliable electrical manufacturers in the country. Send for it—6c in stamps or coin, which will be refunded on your first order of 50c or over.

NO POSTALS ANSWERED

Voltamp Electric Mfg. Co., Park Bldg., Baltimore, Md.

### SEWING MACHINE ELECTRIC MOTOR

Anyone can attach it to machine. Simple and durable. \$14.00 alternating or direct.

FIDELITY ELECTRIC COMPANY  
Lancaster, Pa.

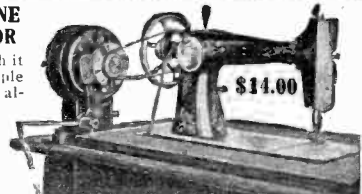

# AGENTS NEWEST ELECTRIC APPLIANCE

## THE Handy Light

REFLECTOR REVOLVES  
HOOKS HERE  
THIS PART FITS OVER DRESSER, CHAIR, BED  
TURN SO LEFT SIDE OF ADVERTISEMENT BECOMES THE BOTTOM.

carry it anywhere in the house. Use it in every room. Hang on wall—lights the room. Over dresser—you stand in flood of light. On table or sewing machine throws light on the work—not in eyes. In kitchen, throws light on stove and sink. On bed for night reading or sickness—snap it on or off without getting up. **One light instead of two—better results. ZIP!** It's attached to electric socket ready to use. Puts light where you want it—everywhere—"the light of a thousand uses" for home, office, store, factory, warehouse, garage, hotel,—tremendous field, liberal profits. Sales-Driving Sample. Weighs a pound. No knowledge of electricity required. Sells for \$3.50 complete with ten feet of cord and plug, and saves the purchaser an investment of \$25.00. Write for particulars.

**The HANDY LIGHT Co.**  
265 Handy Light Block  
Cincinnati, - - - Ohio

**REDUCES ELECTRIC BILLS.  
NO EXPERIENCE NECESSARY.  
DOUBLES ILLUMINATION.  
NO WORK TO INSTALL.**

## Big Price Reduction

### Thordarson's New Junior Bell Ringing Transformer

The New Junior represents Electrical, Magnetic and Mechanical Perfection.

Takes the place of unreliable, troublesome batteries. Operates door bells, buzzers, burglar alarm systems, annunciators, etc.

When properly installed will last a lifetime. Consumes no current.

*New List Price, \$2.50*

Write today for full particulars  
For sale by all Leading Electrical Jobbers

**THORDARSON ELECTRIC MFG. CO.**  
505 S. Jefferson St. Chicago, Ill.

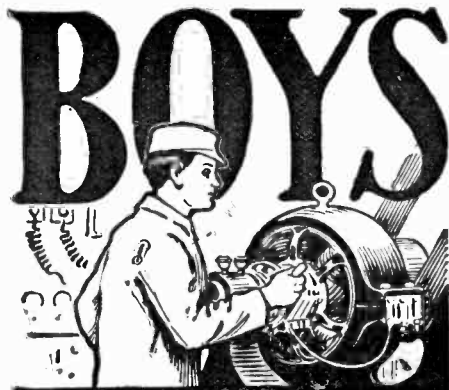

# Big Money in Electricity

The electrical field affords a wonderful opportunity to boys with a liking for electrical work. The salaries paid are large—promotion rapid, and, best of all, the profession is not overcrowded.

The International Correspondence Schools of Scranton can make you an expert in the line of electrical work you like best. Hundreds of boys have already won success through I. C. S. help. You can do the same. Everything is made so clear that you can learn in your spare time, regardless of where you live or what you do. No books to buy. See your parents about it—they want you to succeed.

There's big money in electricity. Get after it by marking and mailing the attached coupon to-day. Finding out costs you nothing.

**INTERNATIONAL CORRESPONDENCE SCHOOLS**  
Box 1102 SCRANTON, PA.

Explain, without further obligation on my part, how I can qualify for the position before which I mark X.

Automobile Running  
Mine Superintendent  
Mine Foreman  
Plumbing, Steam Fitting  
Concrete Construction  
Civil Engineer  
Textile Manufacturing  
Stationary Engineer  
Telephone Expert  
Mechan. Engineer  
Mechanical Draftsman  
Architectural Draftsman  
Electrical Engineer  
Elec. Lighting Supt.

Civil Service  
Architect  
Chemist  
Languages  
Commercial English  
Building Contractor  
Industrial Designing  
Commercial Illustrating  
Window Trimming  
Show Card Writing  
Advertising Man  
Stenographer  
Bookkeeper  
Poultry Farming

Name \_\_\_\_\_  
Present Occupation \_\_\_\_\_  
Street and No. \_\_\_\_\_  
City \_\_\_\_\_ State \_\_\_\_\_

# Wireless Amateurs

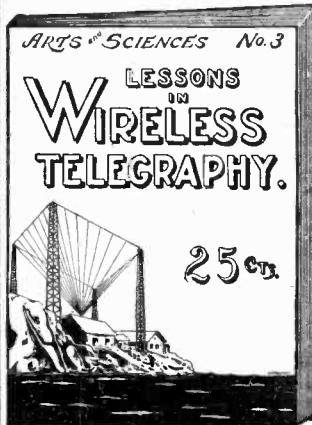

Thirty  
Lessons  
in  
Wireless  
Telegraphy

By  
A. P. Morgan  
25 Cents  
Postpaid

Contains just the information that every amateur should have. Covers the fundamental principles of electricity and wireless telegraphy, with a concise description of each part of the apparatus, showing their purpose and action in connection with the complete outfit.

## Amateur's Wireless Handy Book.

The handiest and most useful book for the wireless operator, amateur or professional, ever published.

### What It Will Do for You.

Contains a complete list of wireless call letters, 1,500 in all, enabling you to locate the origin of any certain call immediately; also the owner of the station or ship and power rating. The Morse and Continental Codes are shown on two large full page charts so that they can be read from a distance, also, a Beginner's Speed Chart so arranged to assist in learning the Codes quickly.

All the abbreviations used by operators to save time and labor. And last but not least over 100 Hook-ups and Diagrams. No matter what instruments you have you will find a perfect hook-up that works in this book. Blank pages are provided for keeping a record of your own hook-ups.

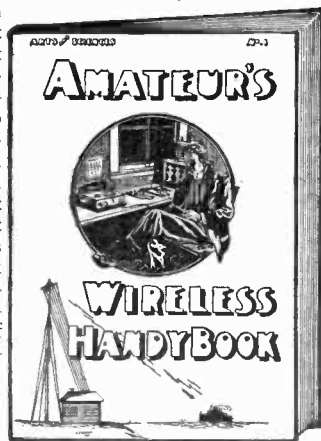

25 Cents  
Postpaid.

Popular Electricity Book Dept.  
54 W. Lake St., Chicago, Ill.



# Complete Wireless Receiving Set Regular \$2.50 Value SPECIAL PRICE **\$1.95**

Read the messages that are flying all around you in the air. Receives messages up to 500 miles.

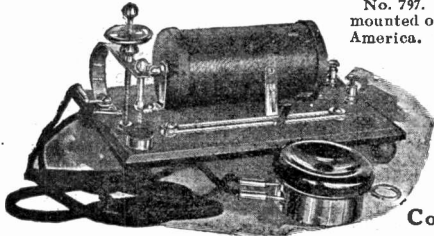

No. 797. Here is another of our great amateur offers; a complete receiving set mounted on a base at a price that cannot be approached by any other firm in America. The base of this set is of solid oak 7½ inches long by 4½ inches wide by ¾ inch thick. It is finished in shellac, rubbed down to a dead finish. The set consists of a combination universal detector, one 75 ohm, nicked case telephone receiver and telephone cord. One tuner, 4½ inches long, wound with bare copper wire by our special method that allows the turns to touch each other and yet are thoroughly insulated from each other, thereby having a wire length nearly equal to the tuners now on the market selling for \$1.95. 1 inch of Wollaston wire, 2 insulators, and 65 feet of aluminum aerial wire. Instructions and codes. Price - \$1.95 (Sent by express.) By mail, 32c extra

Complete Sending and Receiving Sets, \$3.90, \$5.00, \$8.95

Send at once for Circular P, also Morse, Navy, Continental and International codes—it's FREE

**Hunt & McCree, 92-94 Murray St., New York**

**This book makes it easy for anyone to do good lettering**  
12,000 copies sold

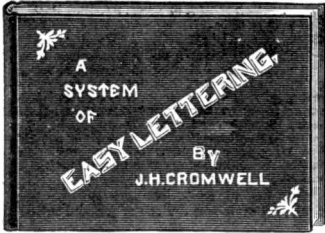

**Contents:**  
**Block Letters:** Heavy, Outline, Condensed, Expanded, Fancy, Shaded and Italics.  
**Gothic:** Condensed, Expanded, Italics.  
**Roman:** Fancy, Italics.  
**Script: Modern, Architectural.**

12th Edition—JUST OUT

Contains 40 alphabets—four of which are new  
55c postpaid

Well printed on fine paper and handsomely bound in cloth

**Spon & Chamberlain, 125 P. E. Liberty St., New York, U. S. A.**

## Any Electrical Book on the Market

Can be obtained through our Book Department. Tell us your wants

**POPULAR ELECTRICITY PUBLISHING CO.**  
54 West Lake Street, Chicago, Illinois

### 10 Amp.-Hour Storage Cell

**Price \$1.00** A set of these wonderful batteries will almost double the transmitting range of your wireless coil. They will also run toy motors, lamps, advertising devices, etc. The most reliable and durable cells made. No renewals, simply recharge from direct current supply. We also manufacture a complete line of Dynamos, Motors, Rectifiers, Transformers, Water Motors, Gasoline Engines, Model Aeroplanes, etc. We sell complete sets of materials for building Loose Couplers, Induction Coils, Motors, Dynamos, Variable Condensers, etc.

We manufacture the largest line of reliable amateur Wireless apparatus in the world. With every Wireless Catalogue we give a complete list of all the Wireless Telegraph Stations, Battleships, Steamships, etc., together with their **ZALL LETTERS**. Over 1,400 in all. It is FREE for 4¢ cents in stamps to cover the cost of mailing. Same may be deducted from the first order. A new edition has just been issued. Send now.

**ADAMS-MORGAN CO.**  
"THE EXPERIMENTER'S SUPPLY HOUSE"  
Box 72a Upper Montclair, N. J.

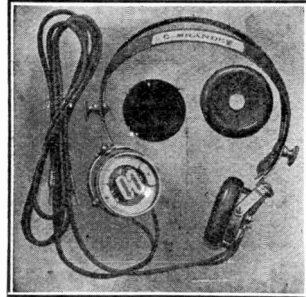
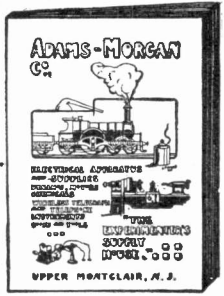

## BRANDES WIRELESS RECEIVERS

Guaranteed Wound With Copper Wire  
Money Refunded If Not Satisfied

- 2000 ohm set - \$5.00 (as illustrated)
- 3000 ohm leather covered double headband set - 4.50
- 1000 ohm receiver 1.60

Send stamp for descriptive matter on receivers from \$1.60 to \$13.00.

**C. BRANDES, Inc., 111-115 Broadway, New York**  
Agents for { SAN FRANCISCO, Ford King, 610 Balboa Building  
CHICAGO, Dawson & Winger Electric Co., 727 S. Dearborn St.

## ELECTRO-PLATING OUTFIT

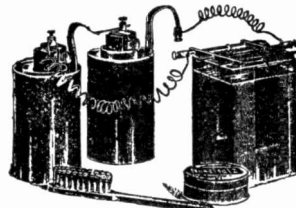

Our complete electroplating outfit as above will be sent to any address express collect for \$8.45. Wireless Novelties and Electrical Supplies of every description. Send stamp for our catalogue. The following is our "special." An electrical massage vibrator to operate on 110-125 A. C. or D. C. for \$14.00.

the same vibrator to operate on dry cells \$13.00. Receivers 2000 ohms complete with headband for \$3.65. Minerals of every description also Electro-Surgical Instruments.

**DETROIT ELECTRICAL SPECIALTY CO.**  
Department Erskine DRETTOIT, MICH.  
SEND STAMP FOR CATALOGUE

## Wireless Course Free

20 Lessons. From 1 to 20.  
With each purchase of \$1.00 worth of our wireless material we give you a lesson free.

Western Agents For  
THE ELECTRO IMPORTING CO.  
Same Catalog. Same Prices.

Send in stamps for catalog  
**ANDERSON LIGHT & SPECIALTY CO.**  
134 N. La Salle St., Chicago, Ill.  
Opposite City Hall.

# DUCK'S BIG 325 PAGE ELECTRICAL & WIRELESS CATALOG

## CELEBRATED FERRON DETECTOR

It yet remains the peer of all Detectors licensed for private use. Price only \$5. The Ferron Detector contains the same high grade crystal and an adjustment equally as admirable as the Pyron Detector licensed for commercial use which sells for \$65.00. License for private use permit of low price. A patron of Greenville, Michigan, voluntarily writes—With your Ferron Detector I received the larger Atlantic Coast stations (700 to 800 miles) and have heard Key West very clearly (1500 miles) all over land.

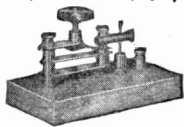

Mailed for 6c. stamps or coin, which you may deduct on first order of \$1.00. Great cost of catalog and low prices prohibit distribution except to those really interested. Save 25% to 33% on Standard Electrical Goods by getting this big Catalog. There is no catalog to take its place; neither will you find elsewhere as large a variety of standard electrical goods at such attractive prices.

### WHAT OUR BIG CATALOG CONTAINS:

100 pp. Wireless Instruments for Experimental and Commercial use. (Wireless section four times as large as the majority of wireless catalogues. It contains over thirty diagrams showing how to connect all combinations of instruments.) 15 pp. Telegraph Instruments of same quality as used by Western Union and Postal Companies. 40 pp. Toy and Commercial Motors. 20 pp. Flash Lights and Miniature Lamps, and 145 pp. of Home Lighting Plants, Mechanical Tools, Guns, Pocket Knives, Miniature Railways, and Electrical Supplies.

THE J. J. DUCK COMPANY, 428 St. Clair St., TOLEDO, OHIO

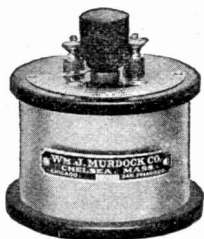

## Variable Condenser No. 364

The sales of this little condenser during 1912 marked it as the most popular wireless instrument ever offered for the use of experimenters. Some time during 1913 let THREE of your dollars bring it to YOU. Your verdict will be that of the army of amateurs who say, "Just right for secondary circuits."

Your money order now, will bring it to you immediately, post paid.

**Wm. J. Murdock Co.**  
50 Carter Street  
**CHELSEA, MASS.**

480 Folsom Street, San Francisco

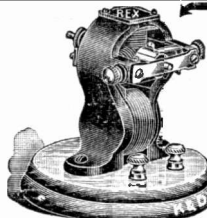

## REX MOTOR

Neat in design and well made—a great favorite with the boys. Runs efficiently on one cell, dry or other battery. Finished in black enamels screws and other trimmings nickel plated. Polished wood base, packed in a neat box, size 3 x 3 1/2 x 3 1/2 inches, properly labeled. Weight about 12 ounces. Sent on receipt of price, \$1.00. Postage 11 cents extra.

**Special Offer** For a limited time only we will send this motor prepaid absolutely free with a trial subscription to Modern Electrics, An Authority

on Wireless. Every live boy should take at least one semi-technical electrical magazine and keep up-to-date on the new wonders and advances in electricity; Modern Electrics illustrates and describes these subjects in a style that can be read and understood by you. It is nearly five years old and contains from 112 to 144 pages monthly. 15 cents per copy; \$1.50 per year. Tells you how to make things at home; contains an experimental department and answers your questions free.

Send \$1.50 today in cash, stamps or M. O. and get Modern Electrics for one year and we will send you the Motor prepaid Absolutely Free.

Modern Electrics  
262 Fulton Street  
New York, N. Y.

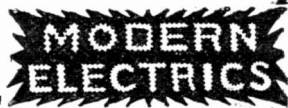

## DROP US A POST CARD

For our book, catalog and pamphlet, "18 Ways to Make Money." They are free.

POPULAR ELECTRICITY MAGAZINE, Book Dept.

**B** SURE and send for our No. 10 Catalog of Wireless and Electrical Supplies containing Hi Grade Instruments of every type. The prices are right and the shipments will be prompt. Write your name and address plainly.

JOHN Y. PARKE & CO.  
Dept. A. 127 N. 7th Street, Philadelphia

## Send for Copy of Our New Wireless Manual E1



It contains 96 pages and tells how to erect and maintain wireless telegraph stations. Shows a number of diagrams. Has the Morse and Continental Telegraph Codes. Illustrates the best instruments to use; tells what they are for and how to use them. Do not wait until some other time, but sit down now and send your name and address, and get one. It costs you nothing

## Send for Our Pocket Catalog E26

It contains 212 pages, with over 1,000 illustrations, and describes in plain, clear language all about Bells, Push Buttons, Batteries, Telephone and Telegraph Material, Electric Toys, Burglar and Fire Alarm Contrivances, Electric Call Bells, Electric Alarm Clocks, Medical Batteries, Motor Boat Horns, Electrically Heated Apparatus, Battery Connectors, Switches, Battery Gauges, Wireless Telegraph Instruments, Ignition Supplies, Etc.

It Means Money Saved to You to Have Our Manual and Our Catalog When You Want to Buy

**MANHATTAN ELECTRICAL SUPPLY COMPANY**

NEW YORK, 17 Park Place

CHICAGO, 114 So. 5th Ave.

ST. LOUIS, 1106 Pine St.

For our Mutual Advantage mention Popular Electricity when writing to Advertisers.



**Double Slide Bare Wire Air Dielectric Tuning Coil \$4.00**

Again we come to the front with something radically new in WIRELESS. The above Tuning Coil is unique in many ways, and we guarantee that with all other things being equal, it will bring in signals louder and clearer than any other Double Slide Tuner manufactured, regardless of price. We have gotten away from the supposedly necessary cylindrical form of core, and in so doing are enabled to air space the turns of wire from each other. The only points of actual contact of the turns with a common support are the four edges of the quadrilateral winding and these supports are of vulcanized Hard Rubber, so practically 95 per cent. of the total length of the wire is air spaced, thus reducing the chance of leakage to a minimum. Price \$4.00, express charges to be paid by consignee at destination.

The above Tuner equipped with an extra slide, thus making a Triple Slide Tuner, price \$4.50. The size of the bare copper wire is either No. 22 or 24 as you may select, prices being the same in either instance.

We are agents for the "BRANDES" Long Distance Receivers now so well and favorably known that detailed description is unnecessary.

"BRANDES" SUPERIOR TYPE, 2000 Ohms total, per pair postpaid, **\$5.20**

"BRANDES" TRANS-ATLANTIC TYPE, 2800 Ohms total, per pair postpaid, **\$9.20**

"BRANDES" IMPROVED NAVY TYPE, 3200 Ohms total, per pair postpaid, **\$13.20**

The above receivers are fully guaranteed, each and every phone having the name "BRANDES" plainly stamped on the aluminum case. Head bands are Hard Rubber covered in the instance of the T. A. T. and Navy and solid German Silver for the "SUPERIOR" type. Cords are green silk 6 ft. in length.

Single "BRANDES" SUPERIOR Phone, 1000 Ohms, postpaid, **\$1.60**

Single "BRANDES" SUPERIOR Phone, 1000 Ohms, with leather covered head band and single cord, postpaid **\$2.65**

Promptness in delivery is our specialty: a large stock of phones always on hand. Send stamp for descriptive circular of Tuners together with some of our other specialties.

**DAWSON & WINGER ELECTRIC COMPANY**  
727 South Dearborn Street Chicago, Illinois

**The Blitzen Rotary Variable Condenser**

Don't chase away the small amount of energy in an incoming signal with condensers which slide in grooves and provide a large leakage path on every edge of every plate. Capacity is large (.0008) and by filling with castor oil may be increased five times to .004. Has 15 rotary and 16 stationary aluminum plates, nickel plated brass case and hard rubber top and handle (not composition).

Better send 4c stamps for our complete catalog—today.

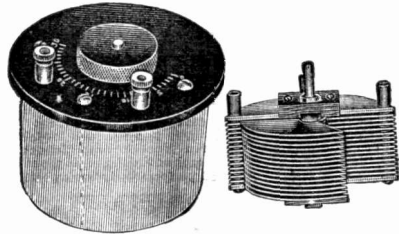

Price \$5.00

**CLAPP-EASTHAM COMPANY**  
141 Main St., Cambridge, Mass.

Aylsworth Agencies Co. J. J. Duck  
143 Second Street 430 St. Clair Street  
San Francisco, Cal. Toledo, Ohio  
Western Sales Agents Central Sales Agent

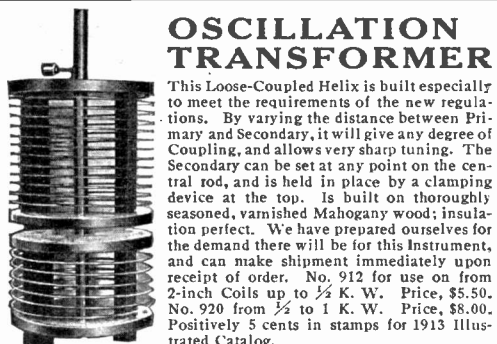

**OSCILLATION TRANSFORMER**

This Loose-Coupled Helix is built especially to meet the requirements of the new regulations. By varying the distance between Primary and Secondary, it will give any degree of Coupling, and allows very sharp tuning. The Secondary can be set at any point on the central rod, and is held in place by a clamping device at the top. Is built on thoroughly seasoned, varnished Mahogany wood; insulation perfect. We have prepared ourselves for the demand there will be for this Instrument, and can make shipment immediately upon receipt of order. No. 912 for use on from 2-inch Coils up to 1/2 K. W. Price, \$5.50. No. 920 from 1/2 to 1 K. W. Price, \$8.00. Positively 5 cents in stamps for 1913 Illustrated Catalog.

F. B. CHAMBERS & CO., 217 N. Ninth St., Philadelphia, Pa.

**THIS SMALL 110 VOLT POWER MOTOR**

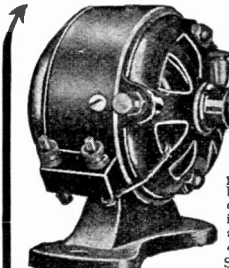

Runs on either 110 volts A.C. or D.C., can be connected to any lamp socket, and is powerful enough to operate an eight inch fan, sign flashers, small window displays, small buffing wheels and is especially recommended for rotary spark gaps. Has laminated field and armature, 3-1/2 inch shaft, mica insulate commutator, phosphor bronze bearings, brass grease cups, pulley and terminals. Absolutely will not run hot. Built for commercial purposes and is no toy. Shipment weight 4 pounds. Send for descriptive circular today.

**PRICE \$6.00**

TYPE "A" 1-15 H. P.  
**Wheeler Electric Co. Inc. 7102 Central St. CHICAGO**

Can you imagine anything more excitingly interesting than sitting in your attic and listening to Wireless messages "coming in" over your E. I. Co. set? We sell sets from \$2.85 up that receive clear messages 100 miles distant; our best set, receiving messages 2000 miles off, costs only \$24.00. Can you afford not to afford one of these modern marvelous instruments? We have made thousands of people happy with "Wireless" since 1905. We don't make toys; our goods satisfy, OR MONEY BACK. We a book let: FREE TO postage elec- with

**WIRELESS**

just issued "Treatise on raphy." IT IS ALL Send today 4c for our great 200 page trical cyclopedia No. 11 400 illustrations and 1600 electrical articles, valuable information and loads of experiments on wireless and electrical subjects. No postals answered. ASK FOR OUR FREE 160 PAGE "WIRELESS COURSE" IN 26 LESSONS.

**THE ELECTRO IMPORTING CO.**  
233 B FULTON STREET NEW YORK  
"EVERYTHING FOR THE EXPERIMENTER"

**HOW TO READ WIRELESS**

messages sent in the continental code. A wonderfully simple method every amateur should know about and practice. With it you can become expert in a very short time. Read all the news flying through the air. Don't miss this opportunity.



Send 10c (special price) for Book P. I.  
**HUNT & McCREE** 92 MURRAY STREET NEW YORK

For our Mutual Advantage mention Popular Electricity when writing to Advertisers.



No. 501

## "OHIO" CHISELS

are made from high grade and specially selected tool steel, and the care, skill and experience of our 89 years in the Edge Tool business is put into every tool bearing our "Ohio" Trade Mark shown here. The result is a high grade and very satisfying tool, with a keen, tough and lasting cutting edge.

## "OHIO" PLANES

are fitted with our special Extra Heavy Cutter, which prevents Chattering or Trembling when used in hard or knotty timber. High grade cutters, accurate adjustments and true faces are only a few of the points in which our planes excel and make it well worth your while to insist on having them from your dealer.

*Write for our free Catalogue of High Grade Tools and Benches.*

**OHIO TOOL CO., (Dept. 12)**  
COLUMBUS, OHIO





## 10 Tools in One

This combination consists of a hollow handle of cocobola, highly polished and finely finished, and containing ten separate and distinct tools, each of which fit into the steel jaws of the chuck and perform their work perfectly.

## TOOL HOLDER No. 5

The handle and chuck is 7 1/2 inches long over all. The tools are high grade, tempered steel, honed to a fine cutting edge and highly finished. The jaws of the handle close over the shoulders of the tools securely and they will not pull out when in use.

For sale by dealers at **\$1.25**  
Send for "TOOL PRACTICE"—An Instructive Book—It's FREE.

## MILLERS FALLS CO.

28 Warren St., New York



**NO PUMP NO VALVE } AUTOMATIC**



"THE TORCH WITH THE WRINKLED NECK"

## GENUINE "IMP" TORCH

**2000° FAHRENHEIT**

**50,000 IN USE**

Heats or Solders Anything  
Thaws Frozen Water Pipes

\$1.50 delivered. If dealer's name is given \$1.25. Money back if wanted.

The Carleton Company 178 Summer Street, BOSTON

For over 45 years

# KEEN KUTTER

Tools and Cutlery

have been famous for quality

**SIMMONS HARDWARE CO., Inc.**

## Building Contractor Agents

Wanted to use and help sell the

## Rapid Floor SCRAPER

One man scrapes more floor than three by hand. Get our Free Catalog.



FREE TRIAL

MONARCH MFG. CO.  
159 Shepard Bldg.  
Grand Rapids, Michigan

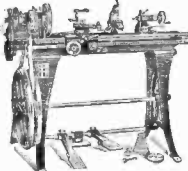

## SOUTH BEND LATHES

\$75

Screw Cutting Foot Power, Steam Power or Electric Motor Drive 9 to 13 In.

South Bend Machine Tool Co.  
427 Madison St., South Bend, Ind

CATALOG FREE

## FOOT AND POWER LATHES, PLANERS

Drill Presses, Shapers and Gear Cutters, First Class Tools at Low Prices Especially for Garages. Write for catalog



SHEPARD LATHE CO.

209 E. Sixth St. Cincinnati, O.



No. 1025

That Thin Nosed "RED DEVIL" still leads all slip joint pliers in popularity, practicability and durability. It's "RED DEVIL," No. 1025, 6 1/2 inches long, has a very thin nose and is a plier you will appreciate.

Ask your local dealer for it or any other "RED DEVIL" tool. We make over 3000 different tools for mechanics.

If you want to see a sample send us 50 cents and one pair only will be sent you postpaid.

SMITH & HEMENWAY CO.

105 Chambers St. New York, U.S.A.

## THE ORIGINAL AND GENUINE



KLEIN TOOLS just keep in order as a matter of course. It's in the nature of them, and, there is a tool for any of your needs shown in the Klein catalogue.

If you are a tool user send for it. Since 1857 Klein Tools have practically wired the earth. Pretty good proof of their worth, isn't it?

Mathias Klein & Sons

Canal Station 3, Chicago, Ill.

**YANKEE TOOLS**  
*Make Better Mechanics*

**"YANKEE" Ratchet Hand Drill**  
No. 1530. Price, \$2.80  
Length, 10½ in.  
Weight, 1¼ lbs.

**5 Adjustments:**

- Plain Drill
- Left-hand
- Right-hand
- Double Ratchet
- Locked

Three-jaw chuck; capacity, 3-16 in.  
Magazine for drills in handle of tool.

These five adjustments are controlled by the Shifter on cylinder, as indicated, and changes are made at a finger-touch.

The "YANKEE" Double Ratchet permits of speedy work in tight places—any motion of the crank, forward or back, no matter how slight, causes the drill to cut continuously.

*Free Tool Books—Mechanics and householders, write for "Yankee" Tool Book. AUTOMOBILISTS, write for "Yankee" Tools in the Garage.*

**NORTH BROS. MFG. CO., Philadelphia**

Your dealer can supply you



**P. S. & W.**  
TRADE MARK  
GUARANTEED

REG. U. S. PAT. OFF.      REG. U. S. PAT. OFF.

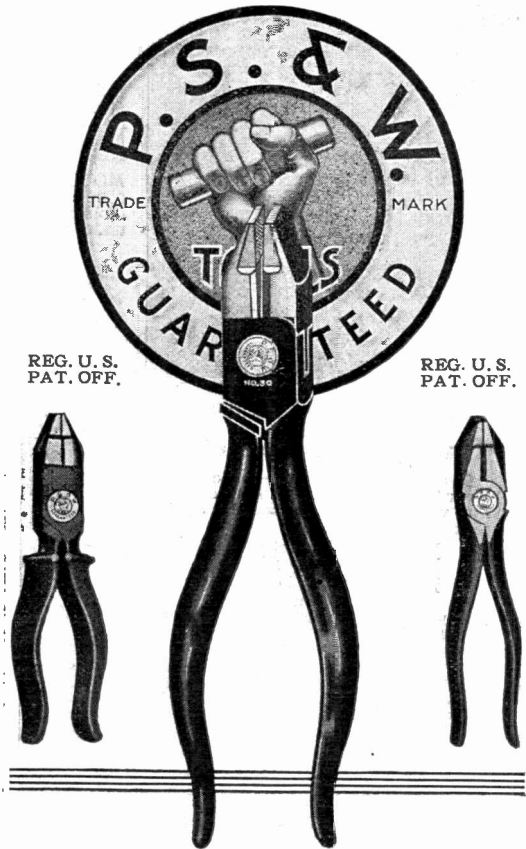

**Perfect Steel and Workmanship  
Guaranteed by The MARK  
of the MAKER**

**T**HERE'S the clue to long wearing, sharp-cutting jaws that always meet accurately—to the service qualities of the most complete line of Box-Joint and Lap-Joint Pliers made.

It's taken years of "know how" to temper that steel just right, and develop that skilled workmanship—94 years of manufacturing ability, experience and progress.

Learn all about P. S. & W. Pliers as well as scores of other highest-grade hand-tools for Electricians, Carpenters, Machinists and Tinsmiths by writing for our free "Mechanics' Handy List." Many pages of reference tables and valuable information.

**The Peck, Stow & Wilcox Co.**

MFRS. of the Largest Line of Mechanics' Hand Tools Offered by Any Maker  
SOUTHINGTON, CONN.      NEW YORK CITY, N. Y.  
CLEVELAND, OHIO  
Address correspondence, 30 Murray Street, New York City

**BUY YOUR FURNACE  
\$10 DOWN \$10 A MONTH**

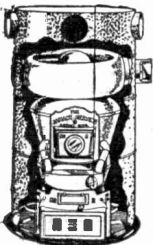

Our monthly payment plan of selling direct saves you the dealer's profits and excessive charges for installation. The

**JAHANT FURNACE**

with the patented "Down Draft System" is best for residences, schools, hotels, churches, etc., because it delivers plenty of heat wherever and whenever desired, at a saving of 1-3 to 1-2 in fuel bills. Install the Jahant yourself. We send complete outfit, freight prepaid with special plans, detailed instructions and all necessary tools for installation. Satisfaction guaranteed or money refunded.

Write for free illustrated book.

**THE JAHANT HEATING CO.**

132 Mill Street      Akron, Ohio

**Save 1/3 to 1/2 on Fuel Bills**

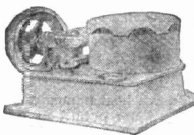

**Awake the "Edison"**

in your boy by giving him a plaything that is as instructive and useful as it is entertaining

Our small engines or power plants are unusually interesting for the mechanically or electrically inclined boy. And they may be profitable too, in the hands of any bright boy. One young man is helping pay his college expenses by charging ignition storage batteries with our baby motor.

Our engines will furnish power to grind skates, run a home lighting dynamo; drive a motor ice boat, canoe, boy's auto, or help mother run the washing machine, cream separator, sewing machine or pump. Start the boy right by getting one of our engines. Ask for catalogue E to-day.

**ELGIN WHEEL & ENGINE CO.**  
Elgin, Ill.

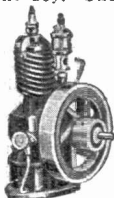

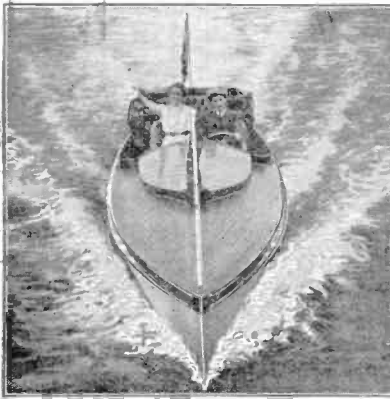

## MULLINS STEEL BOATS CAN'T SINK

Built like Government Torpedo Boats of tough, puncture-proof, galvanized steel plates, pressed to rigid form and so securely joined together that a leak is impossible. The Mullins Steel Boats are GUARANTEED against puncture, leaking, waterlogging, warping, drying-out, opening seams, and NEVER REQUIRE CALKING. Air-tight compartments like a lifeboat.

MOTORS—The Loew-Victor 4-cycle and Ferro 2-cycle—light—powerful—simple—can be operated by the amateur—the beginner—start like automobile motors—one man control—never stall at any speed—exhaust silently under water.

*Our beautiful book, illustrated in colors, is free.*

**THE W. H. MULLINS COMPANY**

*The World's Largest Boat Builders*

193 Franklin St., Salem, Ohio, U.S.A.



Famous Yale and Harvard Model Canoes

**STEEL ROW BOATS AND CEDAR CANOES**

SEND FOR MOTOR CYCLE CATALOGUE

### Three great Pope features

Overhead-valve motor—more power. Rear Spring Suspension insures comfort without retarding speed. Spring fork absorbs vibration.

- Model H "Lightweight" \$165
- Model K "The Big 4" \$200
- Model M "5 h.p." \$215
- Model L "Twin" \$250

Get the details. Write today.

**THE POPE MANUFACTURING COMPANY**  
524 Capitol Ave., Hartford, Conn.  
*Makers of Pope Bicycles. Catalog Free*

Pope quality has never been questioned



# POPE

MOTOR CYCLES



### THIS

is a cut of our latest experimental jump spark coil. It gives a spark 3/16 in. long with two dry cells, can be used for ignition and many other purposes, and experimental work; it is very neat and compact, well worth \$5.00. We will send it to any address in the U. S. A. for a short time only for \$1.50 cash with order. Send for our electric lighting plant literature.

**SCHUG ELECTRIC MFG. CO., 331 East Jeff St., Detroit, Mich.**

## GRAY MOTORS FOR BOATS



Largest Builders of 2-cycle Motors in the World. Over 1000 responsible dealers.

**3 H.P. with Complete Outfit ready to install \$55**  
ALSO 4.2 TO 36 HP

Guaranteed by a big responsible concern. Write for big catalog—tells and shows you all about these high grade motors and how they are made.

**GRAY MOTOR CO., 394 Gray Motor Bldg., Detroit, Mich.**

GET THIS CATALOG FULL OF VALUABLE INFORMATION TO EVERY BOAT OWNER ON

**RACING PROPELLER WHEELS, REVERSE GEARS AND MARINE ACCESSORIES**

LARGE CATALOG FREE. SEND TODAY

**MICHIGAN WHEEL CO.**

1151 MONROE AVE., GRAND RAPIDS, MICH.



## BUILD YOURSELF A BOAT

A RACING CAT OR SPEED LAUNCH

Send for Catalogue

Yacht and Boat Building Books

**RUDDER PUBLISHING CO., 3 Hudson St., New York, N. Y.**

### DROP US A POST CARD

for our book, catalog and pamphlet, "18 Ways to Make Money." They are Free.

**POPULAR ELECTRICITY MAGAZINE, Book Dept.**

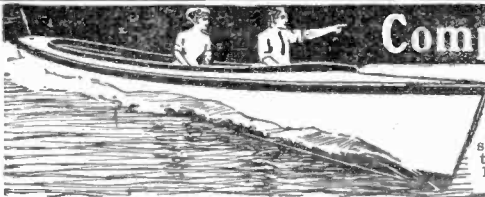

## Complete Launch With Engine \$94.50

Ready to Run

16, 18, 20, 23, 27, 28 and 35 footers at proportionate prices, including Family Launches, Speed Boats, Auto Boats and Hunting Cabin Cruisers. We are the world's largest Power Boat Manufacturers.

**A NEW PROPOSITION TO DEMONSTRATING AGENTS**  
Sixty-four different models in all sizes ready to ship, equipped with the simplest motors made: start without cranking; only three moving parts; ten-year-old child can run them. Boats and engines fully guaranteed. 12,500 satisfied owners. Write today for large Free Illustrated Catalog.

**DETROIT BOAT CO., 1165 Jefferson Ave., DETROIT, MICH.**

# BUILD YOUR OWN BOAT

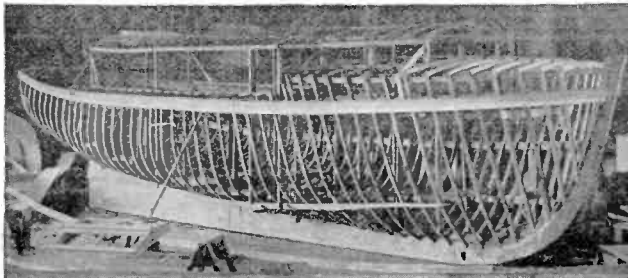

Get Our Catalogue

Do you know about knock-down boat frames and boat patterns? Lack of space will not permit us to describe them here. Send for our free catalogue which tells the whole story. You can build your own boat and save 3/4 the cost. Experience in boat building unnecessary. We build frames and patterns for boats of all sizes from the row-boat to the large cruising yacht.

This picture shows one of our large yacht frames ready to take apart and crate for shipment. People of limited means buy these frames, finish the boat themselves and save 3/4 the cost. People of wealth buy them and have them finished by local hands. They can then watch every piece of timber that enters the construction, plan all details as the work progresses and yet save 3/4 the cost.

**DE FOE BOAT & MOTOR WK'S**

Bay City, Mich. 3215 State Street

**The DEWSBERRY  
ELECTRIC  
ICE CREAM  
FREEZER**

Our power freezer is an ice-cream factory complete in itself, having the crusher, freezer tub and motor all mounted on one base plate that occupies but a small amount of floor space. Nothing but the very best of material and workmanship enter into these machines, and are built unusually substantial; for this reason we guarantee that they will give satisfaction. Made in 4, 6, 8, 20 and 40 quart sizes and are equipped with alternating current, variable speed motors. Write today for circular.

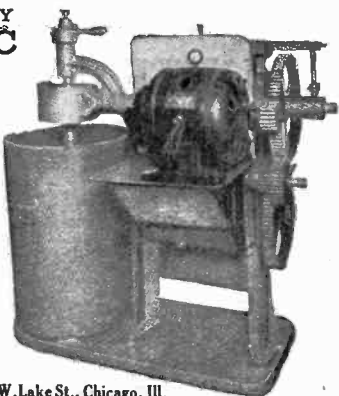

R.A. DEWSBERRY, 1014 W. Lake St., Chicago, Ill.

**Will Not Burn Out**

An important feature of these motors is that they will not heat under any circumstances 1/12 and 1/8 H. P. for A.C. and D.C. Finished in Black Enamel.



**THE  
BARNES**

Variable Speed and Reversible

Are especially adapted for Washing Machines, Printing Presses, Coffee Mills, Dental Apparatus, Vacuum Cleaners, Wireless Apparatus, etc.

Let us figure on your requirements

**BARNES MFG. CO.** 107 Belmont Street  
Susquehanna, Pa.



**STOP! LOOK! LISTEN!**

Our lamps produce a brilliant, steady, white light at one fifth the expense of any other medium; suitable for all places and all purposes, easily installed, generator instantly interchangeable. Exclusive territory to responsible parties. Free Illustrated Catalogue mailed on request. **DOUD LIGHTING CO., 132 N. Sangamon St., CHICAGO, ILL., U.S.A.**

**ELECTRIC LIGHTING PLANTS**

Novelties, Specialties, Motion Picture Equipment, Home, Theatre, Farm, Factory, School and Town Lighting and Power Plants. Hunting, Fishing, Bicycle, Carriage, Automobile, Musicians, Necktie, Flash and Decorative Lights, Mazda and Fluorescent Arc Lamps, Massage, Ozone and Motion Picture Machines, Railways, Transformers, Telephones, Sewing Machine and Power Motors, Heating Pads, Laundry Irons, Lanterns, Hydro Electric Dynamos, Meters, Generators, Engines, Storage and Primary Batteries, Belts, Bells, Books. Fortune for Agents. Catalogue 3 cents. **OHIO ELECTRIC WORKS, Cleveland, Ohio**

**ELECTRIC MOTORS**

SHOULD BE

**"ROTHMOTORS"**

Polishers, Grinders, Blowers

Write for Literature

**ROTH BROS. & CO.**

1385 W. ADAMS STREET, CHICAGO

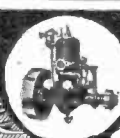

**TOLEDO MARINE MOTORS**

Make boating a pleasure. You know there's no engine troubles to mar the trip. A marvel of smooth working simplicity that the mechanical can easily understand and operate. Complete, gear'd 2 cycle, 2 port, 3 1/2-2x3 1/2-2, 4 1/2-2x4 1/2. Standard fittings. Anywhere. Write today for cat'g P

THE UNIVERSAL MACHINE CO., 417 Bank St., ROWLING GREEN, O.

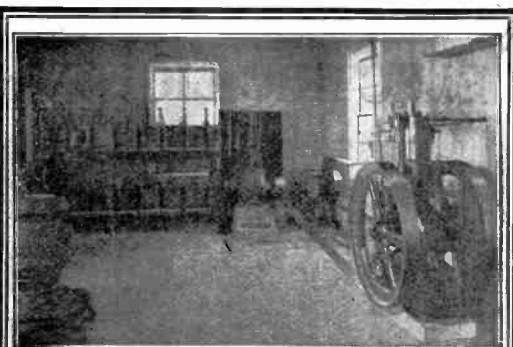

**Electric Light and Power**

with a Fairbanks-Morse Electric Light Plant can be obtained at a very reasonable cost:

**Electric Light** any where, anytime.

**Electric Power** to operate—

Electric Fans for summer comfort

Electric Flat Irons and Washers to save labor

Cooking devices and many other conveniences

**Pumping** by motor or direct from engine.

Engine is our Special Electric. It gives perfect lighting service and runs on Kerosene or Gasoline. These outfits are complete, ready to run (except wiring) and absolutely reliable. Write for Catalog No. #163E8. State your particular requirements.

**Fairbanks, Morse & Co.**

900 S. Wabash Ave., Chicago, Ill.

Oil and Gasoline Engines, Electric Motors, Pumps, Water Systems

**VACUUM PUMPS**

For Powerful Portable and Stationary Vacuum Cleaning Plants. They take up their own wear. Powerful, Noiseless; can't get out of order.

GET CATALOG NO. 85

**LEIMAN BROS., 62AD John St., NEW YORK**

**ELECTRIC LIGHT AND POWER**

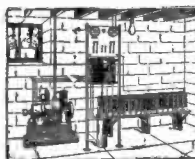

**DAY AND NIGHT SERVICE**

The Junior No. 1 Equipment

Direct Connected Dynamo, Gasoline Engine Set. Complete Switchboard, 16-Cell "American" Storage Battery } \$265

The most complete, reliable equipment ever offered at this price. We want a representative in every county.

**AMERICAN BATTERY COMPANY**  
Est. 1889 1143 Fulton St., CHICAGO

**SMALL ENGINES**

1/2 H. P. Up

Steam, Gas and Gasoline. For Amateurs and Mechanics. Circulars for stamp. Big Catalogue Engines, Small Power Machinery and Electric Light Plants, 2 Lights Up. Sent for 10 cents (coin preferred.) Refunded first order.

**AMATEUR MECHANICS SUPPLY CO.**

860A Monadnock Block, Chicago, Illinois, U. S. A.

## ELECTRIC LIGHT for COUNTRY HOUSES

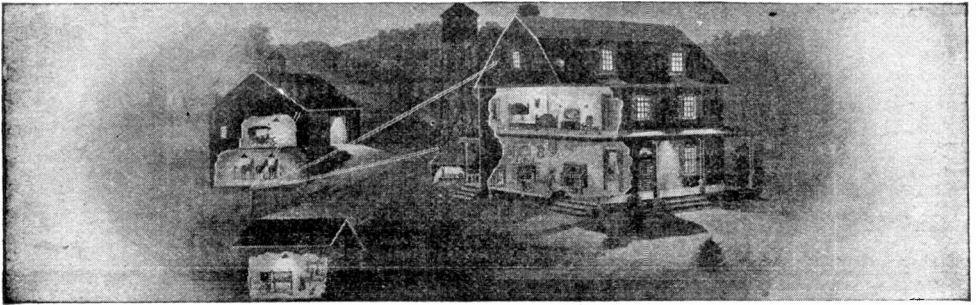

The convenience and safety of electricity both as an illuminant and as a domestic labor-saver appeal as strongly to the isolated farmer or country resident as to the city dweller. Heretofore, there has always been the obstacle of remoteness from an electric power line; this has now been overcome by the advent of inexpensive and easily installed private electric plants.

### Electric Light for the Farm, by N. H. Schneider

Contains practical information on small low voltage electric plants operated by storage batteries and gasoline engines, giving full details for wiring a house according to the Underwriters' Rules, tells you just how to start about the wiring, what wire to use, how to estimate the materials required and complete the installation. Tables and rules are given for estimating the number and size of lights required and the outfit necessary to supply the current.

No technical knowledge is necessary to install or operate these outfits except what may be learned from this book.

172 Pages

PRICE \$1.00 POSTPAID

66 Illustrations

POPULAR ELECTRICITY BOOK DEPT., 54 W. Lake Street, Chicago, Ill.

## Eighteen Ways to Make Money and Advance Yourself in the Electrical Field

WHEN seeking any line of work you should get in touch with men in the field who are doing successfully the thing you want to do. "Eighteen Ways to Make Money and Advance Yourself in the Electrical Field" is the result of personal talks with winners who are engaged in doing the things they give "pointers" about. Advice from a building electrician on how to become one, how one man became an electrical contractor, etc. You can't get anything more direct than that.

### This Book May Be Your Opportunity

It may suggest a line of action that had not occurred to you and which you are in a position to act upon and make yourself financially independent. Moreover it is full of suggestions to the wide-awake fellow who is anxious to "make good."

WRITE FOR A COPY NOW      SEND STAMP FOR POSTAGE

POPULAR ELECTRICITY PUBLISHING COMPANY  
54 West Lake Street - Chicago, Ill.



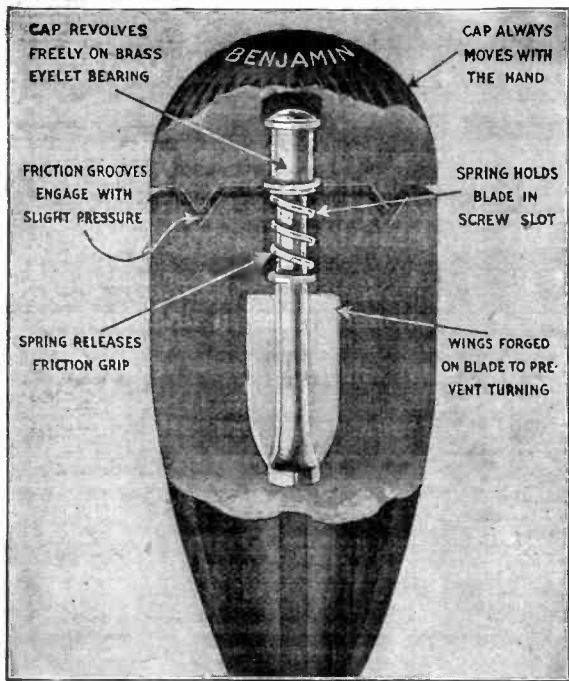

# Electricians, Electrical Workers, Mechanics

Here is what you have  
been waiting for

## An Interchangeable Insulated Screw Driver Set

with a friction-saving cap

### Absolutely prevents blistered or sore hands

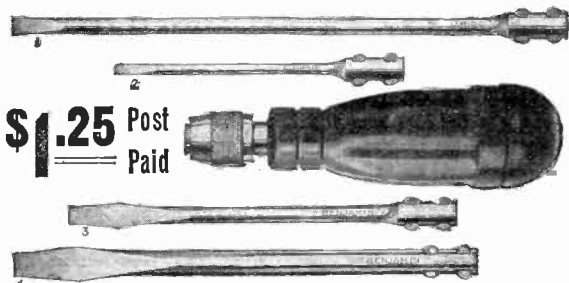

**\$1.25** Post  
Paid

Just think of it—an absolute protection from shock. Insulation has resisted break-down test of over 100,000 volts at weakest point.

**Four Blades in All.** A blade to fit the smallest lamp socket as well as blades to do your heaviest work. The blades range in length from 3" to 6", and from  $\frac{3}{8}$ " to  $\frac{1}{4}$ " in width. The blades can be changed in an instant. All blades are made from a hardened and tempered tool steel and tested with sufficient pressure to split a screw head.

Screw chuck is of the latest improved type, simple and indestructible. Revolving friction cap works freely in either direction, moving with either hand without rubbing or blistering. Ordinary pressure on screw locks friction cap and handle like a ratchet. The fluted handle gives a firm grip and prevents rolling.

This frictionless screw driver is the most useful improvement made in screw drivers in many years and is far superior to the ratchet as it needs no adjustment and never gets out of order. Ideal for quick hand work as spring helps to hold blade in screw slot.



3 inch Blade 60c.  
6 inch Blade 80c.

An opportunity for you to get this very handsome screw driver set for **\$1.25** Post Paid

Send your money today. Money back if you are not satisfied.

We also sell an insulated blade, frictionless screw driver (see illustration). This screw driver has the same handle as on screw driver set. The insulation on this blade is  $\frac{3}{8}$ " in diameter throughout its entire length, allowing it to be used in openings but slightly larger. We offer these in two lengths of blade—3" blade, 60 cents; 6" blade, 80 cents, postpaid to you.

Send stamps, postal or express money order today, mentioning size desired, to

**Williams Electric Co. 50 W. Lake St. Chicago, Ill.**

# Books That Will Advance the Electrical Worker in Position and Pay



**T**HE most practical collection of Books for the Electrical Worker ever published, having the highest endorsement of the INTERNATIONAL BROTHERHOOD OF ELECTRICAL WORKERS.

Don't overlook any opportunity of advancement through not being prepared for the job ahead. Help yourself now to books that will enable you to tackle anything in your line of work.

## Modern Electrical Construction

By H. C. HORSTMAN and V. H. TOUSLEY.

This book treats almost entirely on practical electrical work. It uses the "Rules and Requirements of the National Board of Fire Underwriters" as a text, and explains by numerous illustrations and detailed explanation just how the best class of electrical work is installed.

It is a perfect guide for the beginning electrician and gives him all the theory needed in practical work in addition to full practical instructions.

340 Pages **PRICE \$1.50 POSTPAID**  
173 Illustrations

## Practical Armature and Magnet Winding

By H. C. HORSTMAN and V. H. TOUSLEY.

All practical armature windings are explained with special attention paid to details. All questions which are apt to arise in the minds of the electrician have been completely answered.

Numerous illustrations are shown, and these, taken in conjunction with the text, afford a ready means for either the study of the armature or as a book of reference. Various tables have been prepared especially for the work, and these will not only reduce to a minimum the number of calculations required, but lessen the possibility of errors.

The book is a most valuable aid to the electrician, either in the constructing or operating department.

231 Pages **PRICE \$1.50 POSTPAID**  
Illustrated

## Modern Wiring Diagrams and Descriptions

By H. C. HORSTMAN and V. H. TOUSLEY.

All elementary considerations have been omitted in this book to make room for "diagrams and descriptions" of just such character as workers require. Shows you how to wire for electric light and power, for call and alarm bells, for annunciators, burglar and fire alarms, telephone circuits, install and manage batteries, test circuits, locate "Trouble" and "Ring Out" circuits.

Gives all that ordinary electrical workers need and nothing that they do not need.

250 Pages **PRICE \$1.50 POSTPAID**  
200 Illustrations

## Electricians' Operating and Testing Manual

By H. C. HORSTMAN and V. H. TOUSLEY.

This book was written to instruct the practical electrical worker in the management, operation and testing of the more important electrical devices now in use. It is of particular value to a man in charge of a plant, as it will tell him how to install and operate all electrical devices, and what is more important, instruct how to readily locate and remedy any trouble that may occur.

The subject is covered thoroughly and it is all entirely practical.

360 Pages **PRICE \$1.50 POSTPAID**  
Illustrated

## Modern Illumination

By H. C. HORSTMAN and V. H. TOUSLEY.

Covers Electric Lighting from A to Z and is a practical guide for the electrical worker or contractor, containing all the information needed to the successful installation of good illumination.

It is the last word in illuminating science and construction—check full of the information you want—written in a way you'll understand.

275 Pages **PRICE \$2.00 POSTPAID**  
Illustrated

*Money refunded on any of these books if you are not satisfied.*

**POPULAR ELECTRICITY BOOK DEPARTMENT**  
54 West Lake Street **CHICAGO, ILLINOIS**



Anyone sending a sketch and description may quickly ascertain our opinion free, whether an invention is probably patentable. Communications strictly confidential. Handbook on Patents sent free. Patents taken through Munn & Co. receive special notice, without charge, in the

# SCIENTIFIC AMERICAN

A handsomely illustrated weekly. Largest circulation of any scientific journal. Terms, \$3 a year; four months, \$1. Sold by all newsdealers

**MUNN & CO.** 367 Broadway, New York, and 627 F St., Washington, D. C.

**PATENTS BRING WEALTH;** PROOF BOOKS, ADVICE FREE. LOW RATES, EASY TERMS  
A. Dept. 99, Wederburn, Pat. Atty., Washington, D. C.

**PATENTS** C. L. PARKER  
Formerly Member Examining Corps, U. S. Patent Office.  
**PATENT LAWYERS**  
12 McGill Bldg., WASHINGTON, D. C.

Patents, Trade Marks, Copyrights, Patent Litigation  
Handbook for Inventors, "Protecting, Exploiting and Selling Inventions" sent free upon request.

## Central Station Managers

The current used by the average consumer on the books of one of our clients is more than twice that of five years ago. This class of business—increased consumption of current by present users—is particularly profitable as it can be secured without the expense of installing new lines.

☐ Scores of lighting companies, including those operating in

- |              |           |
|--------------|-----------|
| Denver       | Omaha     |
| Detroit      | Buffalo   |
| Philadelphia | Cleveland |

and including towns of 4,000 to 1,600,000 are benefiting by the use of the Co-operative Advertising Service. The drawings are by the best commercial artists in the country, copy by experts on Central Station advertising, type-set by ad specialists.

A request on your business stationery will bring a book containing specimens of the advertisements supplied and full detail.

**WM. D. McJUNKIN ADVERTISING AGENCY**  
35 South Dearborn Street CHICAGO

**Be an ELECTRICAL ENGINEER**

**EARN \$150 to \$250 PER MONTH**

WRITE TODAY! NO EXPERIENCE NECESSARY to enter this wonderfully fascinating, high salaried work. You should earn **BIG MONEY IMMEDIATELY**—on completing our Electrical Courses. The great engineering companies of the country are **ALWAYS** searching for **PRACTICAL, TRAINED ELECTRICAL ENGINEERS**. Excellent positions open all the time. We teach you to be an expert electrical engineer in a short time **AT SMALL EXPENSE**.

**Edison says:**—There is no limit to the field of Electricity—men who take up this work now will discover uses for this great force now unheard of. Besides the high salaries paid to electrical engineers, great fortunes are to be made through electrical inventions in the future.

**Learn and Earn**—No need to give up your present occupation. Just devote your spare time to this interesting work. As you read through the pages of our courses, you will find yourself simply "wrapped up" in the work. The only expense will be the nominal charge for our complete tuition.

**GUARANTEE:**

The world-wide reputation of the American School of Correspondence for integrity and efficiency, together with its thousands of successful graduates, gives you an unqualified guarantee of Success.

**Pay as You Wish!**

Don't hold back on account of lack of money. We will arrange for you to pay as best suits your needs. You will find our contract most liberal. We do not force our students to pay for instructions they do not receive, nor do we employ agents or collectors.

**Mail this "Success" Coupon**

—No obligations, so mail at once. Your name and address on this coupon brings to you our School bulletin (catalogue) and complete information. Decide now to take this great step toward Success. Don't be a drudge all your life. Be one of the men "higher up"—the man who is paid for what he KNOWS, not for the hard work he actually does.

American School of Correspondence, Chicago, U. S. A.

**SUCCESS COUPON**

American School of Correspondence Chicago, U. S. A.

Without any obligations on me whatever, please send me your school catalogue and complete information regarding course marked "X." Pop. Elec. 3-13

- |                                 |                           |
|---------------------------------|---------------------------|
| ... Electrical Wireman          | ... Telephone Expert      |
| ... Electrical Engineer         | ... Wireless Telephony    |
| ... Elec. Light and Power Supt. | ... Wireless Telegraphy   |
| ... Alternating Current Work    | ... Hydro-Electrical Eng. |

NAME .....  
ADDRESS .....

# Practical 25c Handbooks

*No other books contain in such compact form as much reliable and up-to-date information on Electrical subjects, and at a price within reach of all*

**SMALL DYNAMOS AND MOTORS HOW TO MAKE AND USE THEM.** A practical handbook. By F. E. POWELL. Contents of Chapters: 1. General Considerations. 2. Field Magnets. 3. Armatures. 4. Commutators and Other Details. 5. Tables of Windings. 6. How to Start a Small Machine. 7. Useful Data. 8. Testing and Repairing. 76 pages, fully illustrated with detail drawings.

**WIRING HOUSES FOR ELECTRIC LIGHT** By N. H. SCHNEIDER. Contains house according to Insurance Rules, tells you just how to start about the wiring, what wire to use, how to estimate the materials required and completing the installation. Directions apply equally well to a shop. 86 pages; 42 illustrations.

**LOW VOLTAGE ELECTRIC LIGHTING WITH THE STORAGE BATTERY** By N. H. SCHNEIDER. Gives practical information on small low voltage electric light plants suitable for farms, stores and country homes in general. Full details are given showing how to estimate the number and size of lights required, their best location and most convenient means of control, and the plant necessary to supply the current. 58 pages; 23 illustrations.

**ELECTRICAL CIRCUITS AND DIAGRAMS** Being a selection of original up-to-date and practical diagrams for installing annunciators, alarms, bells, electric gas lighting, telephones, electric power light and wiring circuits, induction coils, gas engine igniters, dynamos and motors, armature windings. By N. H. SCHNEIDER.

**ELECTRICAL BELLS AND ALARMS** How to install them. By N. H. SCHNEIDER. Including batteries, wire and wiring circuits, pushes, bells, burglar alarms, high and low water alarms, fire alarms, thermostats, annunciators, and the locating and remedying of faults. With 56 original diagrams.

**MODERN PRIMARY BATTERIES** Their construction, use and maintenance, including batteries for telephones, telegraphs, motors, electric lights, induction coils and for all experimental work. By N. H. SCHNEIDER. 94 pages; 55 illustrations. The best and latest American book on the subject.

**EXPERIMENTING WITH INDUCTION COILS** By H. S. NORRIE, author of "Making." A most instructive little book, full of practical and interesting experiments fully explained in plain language with numerous hints and suggestions for evening entertainments. Arranged under the following headings: Introduction; The Handling of Ruhmkorff Coil; Experiments with Sparks; Effects in the Vacuum; Induction and Wireless Telegraphy. With 36 original illustrations.

**SIMPLE SOLDERING BOTH HARD AND SOFT.** Together with descriptions of inexpensive home-made apparatus necessary for this art. By EDWARD THATCHER. Contents of Chapters: 1. Soldering. 2. Soft Soldering. 3. Methods of holding work. 4. Hard Soldering and brazing. 5. Cleaning up work, polishing. 6. Standard apparatus. 7. Home-made apparatus. 84 pages; 52 illustrations.

**ELECTRICITY** The study of, and its laws for beginners, comprising the laws of electric current generation and flow. Ohm's law, galvanism, magnetism, induction, principles of dynamos and motors, wiring, with explanations of simple mathematics as applied to electrical calculations. By N. H. SCHNEIDER. With 55 original illustrations and 6 tables.

**WIRELESS TELEPHONE CONSTRUCTION** By NEWTON HARRISON. A comprehensive explanation of the making of a Wireless Telephone Equipment. Both the transmitting and receiving stations fully explained with details of construction sufficient to give an intelligent reader a good start in building a Wireless Telephone system and in operating it. 74 pages and 43 illustrations.

**ALTERNATING CURRENTS SIMPLY EXPLAINED** An Elementary Handbook on Alternating Current Generators, Transformers and Motors. By ALFRED W. MARSHALL. This book is written for those who desire elementary information about Alternating electric currents, simply written and yet intensely interesting. Contents of Chapters: 1. What an Alternating Current is. 2. How Alternating Currents are Produced. 3. How Alternating Currents are Measured. 4. Transformers and Choking Coils. 5. Alternating Current Motors. 6. Rotary Converters. 7. Rectifiers. 82 pages, 32 illustrations.

**INDUCTION COILS** How to Make and Use Them. By P. MARSHALL. New edition revised and enlarged by K. STOYE. A practical handbook on the construction and use of medical and sparking coils for wireless telegraphy, gas engines, automobiles, gas lighting, X-rays, and all other purposes. With complete tables of windings for coils, giving 1/4-inch up to 12-inch sparks. With full directions for the construction of mercury interrupters. 76 pages, 35 illustrations.

**SMALL ELECTRICAL MEASURING INSTRUMENTS** How to Make and Use Them. By PERCIVAL MARSHALL. Contents of Chapters: 1. Instruments for testing the presence of an electric current, detectors, galvanometers. 2. Instruments for measuring the pressure or quantity of an electric current, amperemeters; voltmeters. 3. Instruments for measuring electrical resistance, wheatstone bridge. 4. Instruments for measuring static electricity. 5. Practical details for construction. 6. The principles upon which electrical measuring instruments work. 7. How to use electrical measuring instruments. 8. How to choose electrical measuring instruments. 90 pages; 59 illustrations.

**Special Offer:** FOR A LIMITED TIME WE WILL SEND ANY TEN OF THESE BOOKS TO ONE ADDRESS FOR \$2.00. TO SECURE THIS PRICE SEND US YOUR ORDER AT ONCE.

POPULAR ELECTRICITY BOOK DEPARTMENT  
54 W. Lake St., Chicago, Ill.

# WANTED-IDEAS

Manufacturers are  
constantly writing me for new ideas

## PROTECTED BY OWEN PATENTS

### FREE!

Send for the three finest patent books published and read their letters—see what they want! "SUCCESSFUL PATENTS"—tells how to proceed; "STEPPING STONES"—contains list of over 200 inventions wanted, the truth about prizes, etc.; "PATENT PROMOTION"—tells how to promote and sell your rights, chief causes of failure, etc. A simple request will bring you all three books absolutely free.

*Personal Services. I help my clients sell their patents or dispose of their applications. Advice Free. No obligation incurred by writing me. Manufacturing facilities. I get you strong protection or receive no compensation.*

### VERY HIGHEST REFERENCES

Columbia National Bank, Washington, D. C.	Whitehead Hosiery Mills, Burlington, N. C.
American Loktile Co., Alexandria, Va.	Dickinson Mfg. Co., Des Moines, Iowa.
National Metal Tile Co., Washington, D. C.	The Fancher Drug Co., Bridgeport, Ill.
National Supply Co. Berlin, N. H.	The Starrett Mfg. Co., Shelbina, Mo.
Louden Machinery Co. Fairfield, Iowa.	The C. J. Loftus Co. Youngstown, O.
Antholene Mfg. Co. Hutchinson, Kans.	Lightening Gun and Cycle Works, Okla. City, Okla.

### SPECIAL!

Send me a sketch or model of your invention and I will make a search of the U. S. Patent Office Records **FREE OF CHARGE** and report to you concerning patentability, practicability, etc.

And an immense number of others whose letters are printed in my booklets.

**RICHARD B. OWEN, 6 OWEN BUILDING, WASHINGTON, D. C.**

Inventors submitting their invention to me are protected in a tangible manner until their applications are filed.

# PATENTS

# TRADEMARKS AND COPYRIGHTS SECURED OR FEE RETURNED

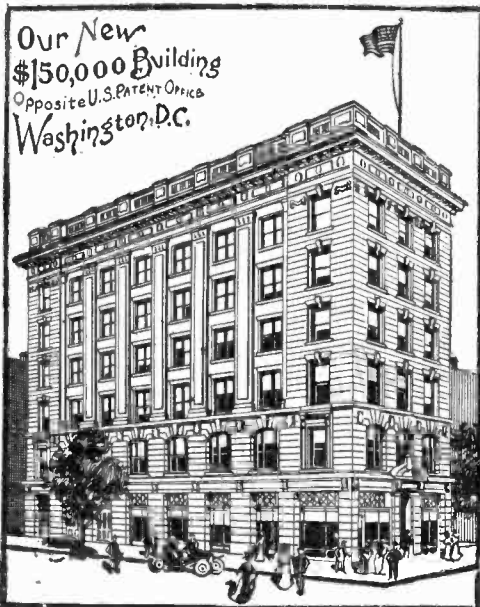

Send model or sketch and description of your invention for free search of the U. S. Patent Office Record.

Our **FOUR BOOKS** mailed free to any address. Send for these books; the finest publications ever issued for free distribution.

**HOW TO OBTAIN A PATENT.** Our Illustrated 80 page Guide Book is an invaluable book of reference for inventors and 100 mechanical movements illustrated and described.

**FORTUNES IN PATENTS.** Tells how to invent for profit and gives history of successful inventions.

**WHAT TO INVENT.** Contains a valuable list of inventions wanted and suggestions concerning profitable fields of invention. Also information regarding prizes offered for inventions, among which is a **Prize of One Million Dollars** offered for one invention and \$10,000 for others.

**PATENTS THAT PAY.** Contains letters from our clients who have built up profitable enterprises founded upon patents procured by us.

**LIST OF PATENT BUYERS.** Personal requests and letters from manufacturers and promoters for patents secured by us and suggestions of new ideas they wish to purchase.

We advertise our clients' inventions free in a list of Sunday newspapers with two million circulation and in the *World's Progress*. Sample copy free.

**Electrical Cases a Specialty.** We have secured many important electrical patents.

**VICTOR J. EVANS & CO.**

Victor Bldg., 724 9th St. N. W., WASHINGTON, D. C.

For our Mutual Advantage mention Popular Electricity when writing to Advertisers.

# Build Your Own Wireless Outfit

## Wireless Telegraph Construction for Amateurs

By Alfred P. Morgan

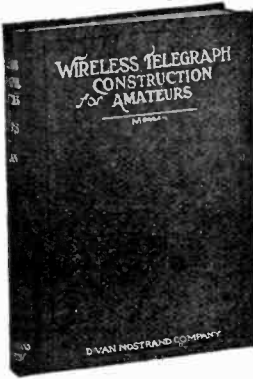

**S**HOWS you how to construct various outfits capable of receiving from 100 to 1,500 miles and of transmitting 3 to 100 miles, giving in minute detail full directions for the construction of each part. Also clearly explains the purpose and action of each instrument with directions for operating and testing, etc.

History and all obsolete forms of apparatus have been omitted, so the information contained is thoroughly up-to-date.

Its thoroughness is a feature not often shown in such books, this together with its splendid treatise of wireless along constructive lines make it the ideal book for an amateur.

Endorsed by Wireless Clubs throughout the country as being the most practical book published on wireless.

### Contents of Chapters

I—Introduction. II—The Apparatus. III—Aerials and Earth Connections. IV—Induction Coils. V—Interrupters. VI—Transformers. VII—Oscillation Condensers and Leyden Jars. VIII—Spark Gaps or Oscillators. IX—Transmitting Helixes. X—Keys. XI—Aerial Switches and Anchor Gaps. XII—Hot Wire Ammeter. XIII—Oscillation Detectors. XIV—Tuning Coils and Transformers. XV—Receiving Condensers. XVI—Telephone Receivers and Head Bands. XVII—Operation.

200 Pages

Price \$1.50 Postage 10c additional

153 Illustrations

*Money refunded if you are not satisfied.*

## Free Book Offer

As a special inducement to our readers we will include a copy of the "Amateur's Wireless Handy Book" free with every order for the above book received in response to this advertisement.

This is the handiest and most useful book for the amateur or professional wireless operator ever published, and is the only book of its kind in existence. Contains among other things a complete list of Wireless Call Letters, 1,500 in all, arranged alphabetically. The Morse and Continental Codes on two full page charts. Beginners Speed Chart so arranged to assist in learning the codes quickly. All the abbreviations used by operators to save time and labor. And last but not least, over 100 different Hook-Ups and Diagrams. Blank pages are provided for keeping a record of your own Hook-ups. Don't overlook this opportunity to secure this valuable book free. Send in your order to-day.

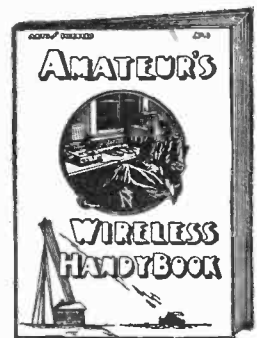

Popular Electricity Book Department, 54 W. Lake Street, Chicago, Illinois



**Y**OU can make better tube repairs at home than those you've been paying 50c apiece for. For the price of a very few vulcanized repairs you can get this complete vulcanizer that will eliminate forever the delay and expense of tire repairing. Carry it with your car and be ready for a quick emergency repair.

### Only \$2.00 for This Shaler Vulcanizer

Isn't it worth this small sum to know that you are prepared to make a permanent tire repair at any time—on the road or at home?

The Vul-Kit is the only inexpensive vulcanizer that vulcanizes tube repairs perfectly, because the patent Shaler method of generating the fuel, gasoline, into gas, maintains the temperature long enough to cure the rubber clear through.

Fill the puncture with raw rubber, the generator with gasoline, clamp vulcanizer on tire and light it—and the Vul-Kit does the job exactly right.

Note the handle for moving vulcanizer while hot—the clamp that adapts heater to tire, insuring smooth repairs—asbestos pad inlaid in tube plate to prevent pinching tube—all exclusive Shaler features.

Furnished complete with repair material and instructions. Nickel plated, will last a lifetime.

**VULCANIZER  
REPAIR KIT  
\$2.00**

#### **Free—A Valuable Book About Tires**

Send coupon today for complete description and receive a complimentary copy of the famous book "Care and Repair of Tires. It's full of valuable repair kinks and descriptions of tire-saving appliances.

## **C. A. SHALER CO.**

**452 Tenth St. WAUPUN, WIS.**

*Makers of the Famous Shaler Electric Vulcanizers*

Name \_\_\_\_\_

Address \_\_\_\_\_

C. A. SHALER CO,  
452 10th Street  
WAUPUN,  
WIS.

# Three Valuable Helpers For The Electrical Worker Or Contractor

## Motor Troubles

By E. B. Raymond



## Alternating and Direct Current

For many years Mr. Raymond was the General Electric Co.'s expert in the tracing of motor troubles, so there can be no one better equipped than he to fortify you against the many difficulties that arise in this field. This book contains the right solution of every problem and is so arranged and indexed that you can instantly put your finger on the remedy.

**CONTENTS**—Starting Up, Sparking, Brush Troubles, Characteristics of the Induction Motor, Locating Faults in Induction Motors, Winding Faults, Balking of Induction Motors, Mechanical Troubles, Troubles with Synchronous Motors, Testing Generators, Motors, Alternating Current Generators, Testing Induction Motors.

Testing Direct-Current Generators. Testing Induction Motors.

197 Pages Illustrated Price \$1.50 Postpaid

## Electrical Contracting

By Louis J. Auerbacher

## How to Get the Work and do It

This book starts at the beginning of the average contractor's troubles—his shop systems and his estimates.

Mr. Auerbacher covers these fully with plenty of good ideas on the short cuts, suggestions and economics which make for a better business and better profit.

Most electrical contractors do not realize that their money is lost because they lack the right shop organization and methods of keeping track of stock, and the contractor who familiarizes himself with this book will not only do better work, but he will do it at a greater profit and his customer will be better satisfied. A large part of this book is devoted to wiring systems of all kinds, forming the most useful wiring handbook on the market. It shows the latest and best methods, and, however experienced you may be, you will find plenty of new ideas in this book, as well as all of the everyday data to which you want to refer.



160 Pages Illustrated Price \$2.00 Postpaid

# Questions and Answers on The National Electrical Code

## A Key and Index to the Official Code

### Contents of Sections—

Generators,  
Transformers,  
Outside Work, Lighting  
Signalling Systems,  
Inside Work,  
Electric Railway  
Systems,  
Marine Work, Tables,  
Rules and Instructions  
for Resuscitation from  
Electric Shock.

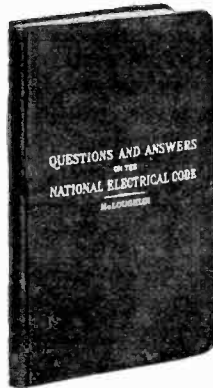

## What Does The Code Require?

That is a question that confronts the practical man every day—You have to be right with the Code. By having this book right on your desk or in your pocket you can find out exactly what the Code prescribes for every job. The questions, carefully indexed, are in plain, simple English, and the answers straight to the point. References are given to the Code, so that you can show the inspector and make sure of approval.

Every contractor, isolated plant manager, progressive electrician and well-informed salesman will find this book of daily use. It prevents mistakes, insures approval of the job, and saves wrangling, time and money.

232 Pages, Illustrated. Price \$1.00 Postpaid. Pocket Size, Flexible Binding.

**MONEY REFUNDED ON ANY OF THESE BOOKS IF NOT SATISFACTORY.**

**POPULAR ELECTRICITY BOOK DEPARTMENT**  
54 W. Lake Street, CHICAGO, ILL.



**How to Select the Right Lamp for Any Part of Your Home**

Using this table, find the approximate size of the room at the head of the column. The first figure on the line for the proper room indicates the number of lamps required; the second figure shows the size of National Mazda lamps, in watts, necessary for correct illumination. The letter "C" indicates wall-bracket. When top of that column is the average or average conditions as for as hangings are very dark, from 10 be provided.

**The National Index**

Room	Size	40-Watt	60-Watt
Bed Room	10-12	1-20-C	1-25-C
Bathroom	5-8	1-15-C	1-20-C
Breakfast Room	8-10	1-15-C	1-20-C
Living Room	12-14	1-25-C	2-20-C
Dining Room	10-12	1-20-C	1-25-C
Kitchen	8-10	1-15-C	1-20-C
Parlor	12-14	1-25-C	2-20-C
Library	10-12	1-20-C	1-25-C
Study	8-10	1-15-C	1-20-C
Hall	4-6	1-10-C	1-15-C
Staircase	4-6	1-10-C	1-15-C
Attic	4-6	1-10-C	1-15-C
Garage	8-10	1-15-C	1-20-C

*Garage, or double 40-Watt or 60-Watt as required. Ceiling and 10-Watt or 15-Watt. Portable or mobile, lamps, 25 or 40-Watt in each room.*

More light without more expense, and the right light in every socket. This is what you want; send for this free book.

## How to Select the Right Lamp for Any Part of Your Home

Buy electric lamps to fit your rooms. Don't guess, when this book will show you at a glance the right size and kind of lamp for every socket from cellar to attic, from closet to garage. Correct Lighting is as important in your home as in your office, factory or store. Every user of incandescent lamps should send for a copy of this book—free.

# NATIONAL MAZDA

THE QUALITY LAMP

This new lamp is as rugged as a carbon lamp and gives three times as much light at the same cost. It burns in any position, uses any current, fits any socket, and is made in all sizes for the home. It is used in trains and automobiles because it is strong. It has given electric lighting to the smallest homes and improved the illumination of the finest residences, stores,



offices, factories. It is the most efficient incandescent lamp for homes, because it turns all the available current into light. Carbon lamps waste two-thirds of the current in heat.

National Mazda lamps are sold by Lighting Companies and thousands of electrical dealers in this blue carton containing five lamps. If you buy single lamps, see that they come from this blue National Carton,—your guaranty of the highest quality and greater efficiency.

Buy lamps in this blue carton

**NATIONAL QUALITY LAMP DIVISION**

of General Electric Co.

For booklet or further information address  
National Mazda Sales Dept., 4411 Hough Avenue, Cleveland

Every National Mazda lamp bears one of the labels shown in this border—a guaranty of National Quality.

For our Mutual Advantage mention Popular Electricity when writing to Advertisers.

## A Complete Course in Applied Electricity

# Practical Applied Electricity

By DAVID PENN MORETON, B. S. E. E.

Covering every line of electrical work as taught in the Armour Institute of Technology, an institution of world wide fame.

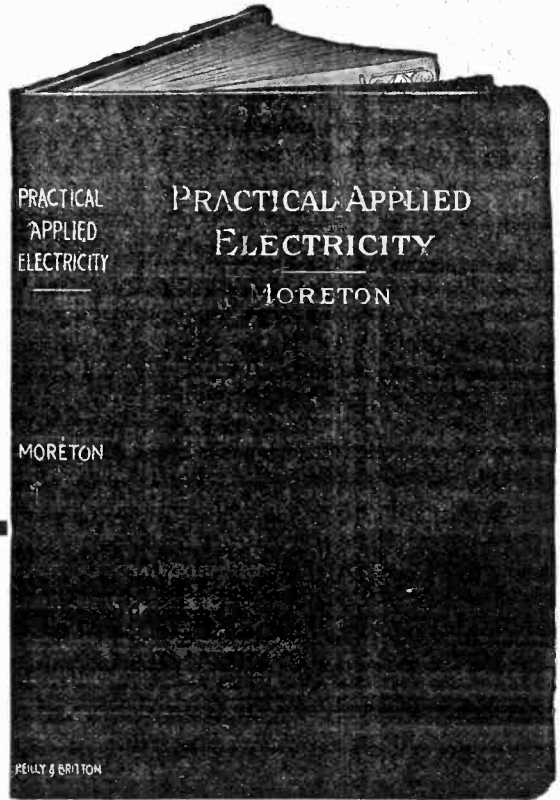

**Practical Applied Electricity** is the outgrowth of actual work combined with classroom experience. The author is Associate Professor of Electrical Engineering at the Armour Institute of Technology. Most of the students taking the electrical course attend the evening classes, being employed at electrical work through the day. The problems which confront these students are embodied in this book—one reason for its being so practical and up-to-date. To illustrate this valuable information, careful detailed drawings have been made under the personal supervision of the author. In plain words, this book contains the experience of a large number of ambitious electrical workers, gathered together by a recognized authority on the subject.

The problems which confront these students are embodied in this book—one reason for its being so practical and up-to-date. To illustrate this valuable information, careful detailed drawings have been made under the personal supervision of the author. In plain words, this book contains the experience of a large number of ambitious electrical workers, gathered together by a recognized authority on the subject.

### CONTENTS:

The Electrical Circuit and Electrical Terms Explained by Means of the Water Analogy; Ohm's Law; Series and Divided Circuits; Calculation of the Resistance of Various Circuits and Conductors; Primary Batteries; Dry and Wet Cells; Voltage; Internal Resistance and Polarization; How to Renew; Series and Parallel Connections; Tables of Data of Commercial Types of Cells; Magnetism; Permanent Magnets; Electromagnets; The Magnetic Circuit and Quantities Involved; Magnetic Properties of Various Materials; Magnetic Calculations; Instruments; Construction of Various Types of Ammeters, Voltmeters, Wattmeters, Galvanometers, etc.; Calibration of Instruments; The Dynamo; Fundamental Principle; The Magnetic Field; Commutation; Armature Reaction; Characteristics of the Series, Shunt and Compound Types of Generators; Motors, Fundamental Principle; Various Types and Their Application to Different Kinds of Work; Motor Speed Control; Variable Speed Motors; Railway Motors, Elevator Motors, etc.; Storage Bat-

tery; Fundamental Principle; Commercial Types; Application; Care of; Systems of Power Distribution; Two and Three Wires; Balancers; Motor Generator Sets, etc.; Practical Operation of Electrical Machinery; Connections in Series and Parallel; Motor and Generator Troubles. How to Locate and Remedy Them; Electrical Lighting; Various Types of Incandescent and Arc Lamps. Application of Various Types; Photometry of Lamps; The Nernst Lamp; Moore Tube; Mercury Vapor Lamp; Electrical Wiring; Calculation of Conductors; How to do Exposed Moulding and Conduit Work; How to Install and Connect Heaters, Motors, Generators, Fixtures, Arc Lamps, etc.; Wiring Tables for Different Classes of Work; Alternating Current Circuit; Comparison of the Direct and Alternating Current Circuits; Quantities Involved; Series and Divided Circuits; Measurements of Power; Alternating Current Generators and Motors; Resuscitation; Numerous Miscellaneous Reference Tables.

*The language is so plain, and the mathematics so simple that no one can fail to understand. Questions and answers given at the end of each chapter, impress upon the mind of the reader the more important points to be remembered.*

450 PAGES 323 ILLUSTRATIONS  
BLACK FLEXIBLE LEATHER BINDING

**Price \$2.00 Postpaid**

*All interested in electricity, old or young--artisan or amateur--expert or experimenter--should own this absolute authority. Money refunded if you are not satisfied.*

**POPULAR ELECTRICITY BOOK DEPT., 54 W. Lake St., Chicago, Ill.**

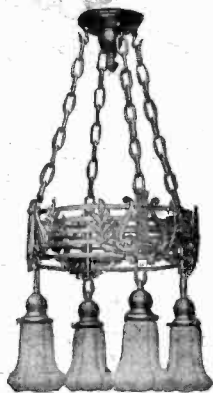

## Beardslee Lighting Fixtures

In beauty of design and finish, Beardslee trade-marked lighting fixtures can not be surpassed. No detail is too small to have the careful attention of expert workmen. Designs are worked out with minute fidelity. All parts are carefully fitted.

The wide variety of Beardslee designs includes patterns suitable for every building, whatever its use and style of architecture. These designs are derived from authentic sources and are true to the school or period to which they belong.

When you build or remodel, give your personal attention to selection of fixtures. Specify the use of "B" trade-marked lighting fixtures throughout—they will add to the beauty and selling value, and are an insurance against dissatisfaction.

Write for our new booklet, "Light and Art in the Home." We shall be glad to mail you a complimentary copy. Illustrates and describes many designs suitable for residences.

**Beardslee Chandelier Mfg. Co.**  
227 South Clinton Street, CHICAGO

# Literary Digest Subscribers Pay \$245,000,000 for Automobiles

Nothing could be more indicative of the enormous purchasing power of Literary Digest subscribers than the above figures show. Think of it! Two hundred forty-five million dollars! This vast sum would build a fleet of forty-one first-class battle-ships! It would wipe out the entire national debts of the Central American Republics of Costa Rica, Guatemala, Honduras, Nicaragua, Panama, Salvador, and still leave enough to clean the slate for Cuba and Santo Domingo—with a matter of more than a million left over.

These figures are not imaginary. They are the result of a census which the publishers have taken among their subscribers. A direct personal letter was mailed in which these questions were asked:

"Do you own an automobile?"

"What is its make?"

"What is your vocation?"

Answers were received from seventy per cent. of those address, location nation-wide. The largest city

was represented as well as the smallest village. It was proved that 102,695 motor-cars had been bought from 181 different makers at an average cost of \$2,391.00 per car.

Thirty-five per cent.—92,450—of the total circulation consists of men of purely commercial activities—the class that is potentially automobile buyers. They need cars in their business—they buy them for their pleasure.

More manufacturers and merchants subscribe for The Literary Digest in proportion to its total circulation than for any other publication of general character in the United States.

In fact, no other magazine can show so large a percentage of yearly subscribers who are possible automobile buyers and who are responsive to automobile advertising. Digest subscribers have a taste for the good things of life—and, what is more, they have the inclination and the means to gratify their tastes. They represent the most progressive citizens, the most successful men and women in the country to-day.

# The Literary Digest

New York City



COST OF MAINTAINING 2000-LB. ELECTRIC WAGON.

Expenditure	Cost per Mile.
General expenses: Supervision, garage rent, wheel tax and state license.....	\$0.018
Operating expenses: Fixed charges (interest, depreciation, taxes and insurance).....	0.040
Tires.....	0.025
Washing and minor repairs.....	0.024
Battery renewals.....	0.019
General repairs.....	0.011
Electricity ( ).....	0.0106
Total cost per mile, exclusive of driver.....	\$0.1476

## 65 Miles in a Single Day

In 33 days a 1-ton Electric made 1490 miles and 950 stops for the Patterson Transfer Company of Memphis, Tenn. At times the mileage stood as high as 65 miles for a *single day's run*, all of which was accomplished *without a single mishap*.

## A Year of Real Service

In one year a 1-ton Electric in the service of L. L. Gilbert Baking Company of New Haven, Conn., covered over 11,000 miles—an average of 35 miles a day—and *never missed a trip*.

# The Electric Invites Investigation

The Electric is the car of swift, silent and economical service for you. Don't put off investigation any longer. Write us now for interesting literature, sent gratis gladly.



## ELECTRIC VEHICLE ASSOCIATION OF AMERICA

BOSTON

NEW YORK: 124 W. 42nd ST.

CHICAGO

(58)

For our Mutual Advantage mention Popular Electricity when writing to Advertisers.

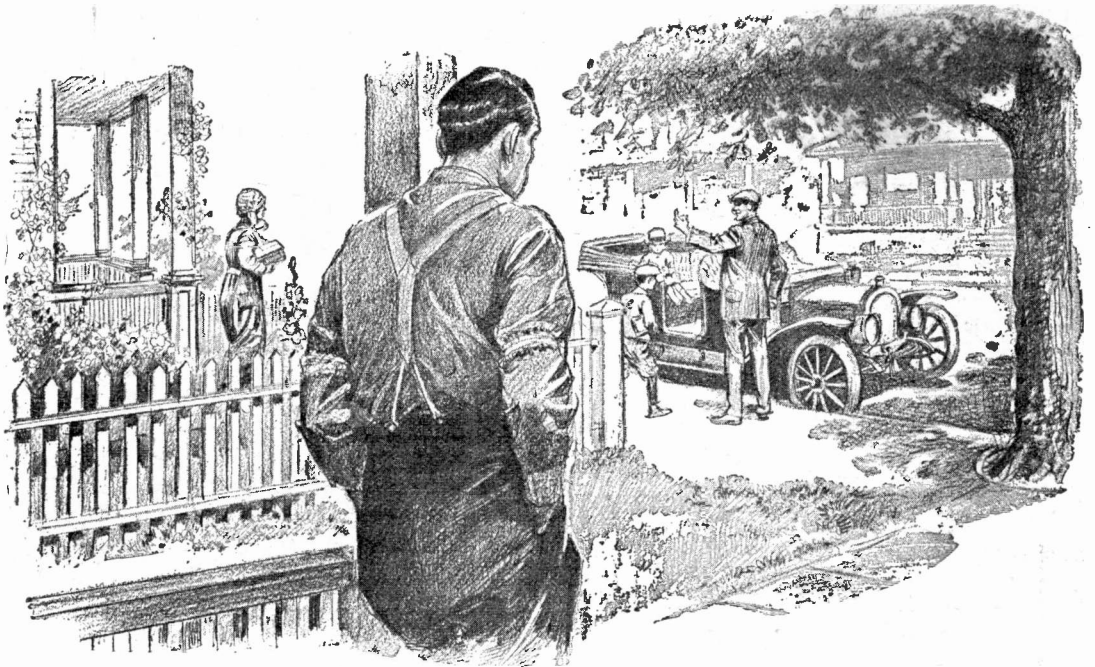

## Don't envy the trained man—be one

No use envying the man who has made good. Don't think he got where he is because he had a "pull." A "pull" doesn't amount to much unless you can deliver the goods, and the best "pull" in the world is **training.**

Just make up your mind today—**right now**—that you are going to be a **trained man**—that you are going to get the money and hold a good job. **You can do it.** The **American School of Correspondence** will show you how. This great school, with its sixty-five complete courses in **Engineering, Business and Law**, can soon give you the training necessary to become a successful man—a man who will be envied as you, perhaps, now envy the men above you.

### Your Opportunity Coupon

Check the course you want and mail the coupon now

American School of Correspondence, Chicago, U. S. A.

Please send me your Bulletin and advise me how I can qualify for the position marked "X." Pop. Elec. 3-13.

- |                                |                          |
|--------------------------------|--------------------------|
| .... Electrical Engineering    | .... Lawyer              |
| .... Elec. Light & Power Supt. | .... Bookkeeper          |
| .... Electrical Wireman        | .... Stenographer        |
| .... Telephone Expert          | .... Private Secretary   |
| .... Architect                 | .... Accountant          |
| .... Building Contractor       | .... Cost Accountant     |
| .... Architectural Draftsman   | .... Cert'd Public Acc't |
| .... Structural Engineer       | .... Auditor             |
| .... Concrete Engineer         | .... Business Manager    |
| .... Civil Engineer            | .... Fire Ins. Inspector |
| .... Surveyor                  | .... Fire Ins. Adjuster  |
| .... Mechanical Engineer       | .... Fire Ins. Expert    |
| .... Mechanical Draftsman      | .... Moving Picture Op'r |
| .... Steam Engineer            | .... Sanitary Engineer   |
| .... Stationary Engineer       | .... Reclamation Eng'r   |
| .... Gas Engine Engineer       | .... Textile Boss        |
| .... Automobile Mechanic       | .... College Preparatory |

NAME .....

ADDRESS .....

### How the American School Will Give You the Training You Need

The American School of Correspondence was established fifteen years ago for the benefit of ambitious men and women everywhere. This school makes it possible for you to obtain the education and training you need without leaving home or giving up your work. It will bring a practical college course to you right in your own home.

No matter where you live, the American School will train you in any branch of **Engineering, Business and Law**, or prepare you for entrance into any resident college. Remember: no need of your leaving home or giving up your present job.

Write the American School now, while the subject of making more money is on your mind. State how far you went in the public schools, what you are doing now, and what you would like to be. Your case will receive special attention.

The American School will tell you the best and quickest way to better your condition and get more money. Check the coupon and mail it now. Don't let this matter drag another day. Another year might slip by and find you at the same old job and prospects for a raise very slim.

### American School of Correspondence

CHICAGO, U. S. A.

**BENJAMIN PLUG  
CLUSTER #92**

MADE WITH TWO  
THREE OR FOUR  
OUTLETS.  
MULTIPLE  
OR SERIES

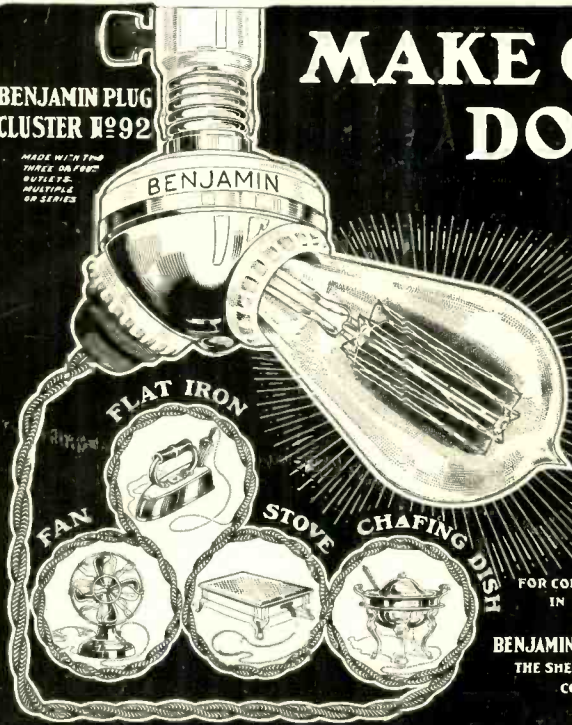

# MAKE ONE SOCKET DO THE WORK OF TWO

*No Extra Wiring-No Labor  
Simple-Durable  
Just Screws into the  
Present Socket*

FOR CONVENIENCE AND SATISFACTION  
IN ATTACHING ELECTRICAL  
DEVICES USE THE  
**BENJAMIN 9-0-3 ATTACHMENT PLUG**  
THE SHELL TURNS INDEPENDENT OF THE  
CORD. NO KINKED WIRE.



**No 9-0-3  
BENJAMIN SWIVEL  
ATTACHMENT PLUG**

We have an acquired reputation for supplying the electric lighting industry useful and meritorious specialties.

Each is the outgrowth of some specific need, is distinctive in character, and by common consent singularly adapted for the purpose intended. It would be difficult to conceive of a plant or community where any extensive use is made of electrical appliances, in which they do not play a prominent part.

Housewives, storekeepers, office managers, are friends of the "Benjamin Trouble-Savers", as they are generally known. Engineers and Contractors are frequently heard saying: "When I am up against it for special fitting on a job, I pull out my 'Benjamin' catalog."

**ASK YOUR DEALER TO SHOW  
YOU SAMPLES**

## **BENJAMIN ELECTRIC MFG. CO.**

New York  
27 Thames St.

Chicago  
120-128 S. Sangamon St.

San Francisco  
151 New Montgomery St.

FOREIGN BRANCHES:

The Benjamin Electric, Ltd.  
1-a Rosebery Ave., London, E. C., England

Benjamin Electric Mfg. Co.  
64 York Street, Toronto, Canada

# WORLD'S WONDROUS WASHERS

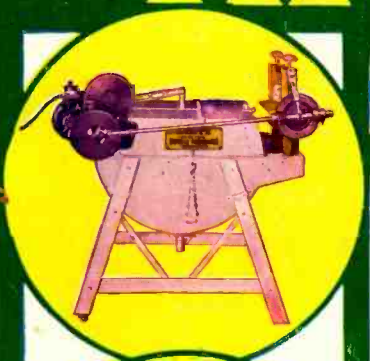

## DIETZ ELECTRIC

Double Rub-board Home Laundry Machine. World's finest machine—mechanically, in design, finish and all around washing and wringing ability. With hot water and good soap, washes a very dirty lot of clothes in 8 minutes. Capacity, 16 shirts

RETAIL PRICE **\$95 00** F. O. B. FACTORY



## QUEEN CITY ELECTRIC

A Particular Washer For Particular People. Neat, compact, simple, convenient, unquestioned washing ability, reversible wringer, cypress tub, all gears fully enclosed. Castings white (baked) enameled, to prevent rust. The washer for medium sized families. Capacity, 10 shirts.

RETAIL PRICE **\$55 00** F. O. B. FACTORY



## QUEEN CITY SPRINGLESS - GEARLESS

An Excellent Example of Present Day Tendency to build machines so well designed that they will run indefinitely without repairs. 90% of trouble with water power washers is caused by the springs, operating valves. Twenty pounds pressure is sufficient. Capacity 10 shirts

RETAIL PRICE **\$16 50** F. O. B. FACTORY

DEALERS—IT WILL PAY YOU TO HANDLE  
OUR COMPLETE LINE · CATALOG FREE ·

**THE JOHN DIETZ MFG. CO.**  
**CINCINNATI**