

Installation Guide

Ply Gem[®]
SIDING

PERFORMANCE
COLLECTION



Known for its outstanding performance qualities, vinyl siding is increasingly the material of choice for homeowners, remodeling contractors, architects, and builders. Compared to other siding products, vinyl is attractive, durable, easy to maintain, and cost-effective. Siding is available in a variety of textures, ranging from matte surfaces to deeply embossed wood grain surfaces, which simulate wood clapboard siding.

For best results, it is recommended that vinyl siding meet the requirements of the Vinyl Siding Institute Sponsored Certification Program. See www.vinyl-siding.org for a current list of certified products.



This manual sets forth the basic guidelines for vinyl siding installation. The instructions herein are based, in part, on ASTM Specification D4756, the standard method for installation of vinyl siding and soffit. Updated information has been added as necessary. Additionally, it is recommended that installers review applicable building codes for variations that may apply to specific products or geographic areas.

The method of applying vinyl siding and soffit is essentially the same for new construction and residing. However, where required, special instructions for new construction and residing are included, as well as recommendations for historic restoration. In all applications, care should be exercised to properly prepare the structure. See the Basic Installation Rules and additional details throughout this document for proper installation techniques.

This publication is not intended to provide specific advice, legal or otherwise, on particular products or

processes. Readers should consult with their own legal and technical advisors, building material suppliers, and other appropriate sources (including but not limited to product or package labels, technical bulletins or sales literature) that contain information about known and reasonably foreseeable health and safety risks of their proprietary products and processes. As the manufacturer of the vinyl siding we do not assume any responsibility for the users' compliance with applicable laws and regulations, nor for any persons relying on the information contained in this guide.

Foreword/Inside cover	1	Horizontal Siding Installation	
Important Notes		Installing Panels	43
Helpful Suggestions	3	Fitting Siding around Fixtures	44
Fire Safety Information	3	Fitting Under Windows	45
Storage and Transportation	3	Finishing at the Top	46
Basic Installation Rules	4	Eave Treatment	47
Cleanup		Transition from Horizontal to Vertical	48
Helpful hints	5	Vertical Siding Installation	
Stains & Cleaners.....	6	(including Board & Batten)	
Terms to Know	7-8	Preparation	49
Basic Installation Tools & Equipment		Siding Accessories	50
Accessories	9	Soffit Installation	
Tools	10	Preparation	51
How to Measure		Over Open Eaves	51-52
Estimating Required Materials	11	Enclosed Eaves	53
Estimating Worksheet	12	Fascia Installation	
Fastener Choices		Aluminum Fascia	54
Nails, Screw Fasteners and Staples.....	13	Porch Ceilings	
Fastening Procedures	14	New Construction Projects	55
Cutting the Siding	15	Residing Projects	55
Preparing the Walls		Replacing Damaged Panels	56-58
New Construction	16	Shutter Installation	59
Residing Existing Structures.....	17	Cedar Dimensions - Shingle & Round Cut ..	60-70
Over Masonry Sub-Surface	18	Historic Restoration	71
Accessories Installation		Leaf Relief	72-84
Starter Strip	19	Notes	85-87
Alternative Methods of Starting			
a Siding Panel	20		
Outside and Inside Corner Post	21-22		
Decorative 3-piece Corner System	23		
Windows and Door Trim	24-34		
Frieze, Rake, and Band Boards.....	35-39		
Gable Treatment	40		
Gable Vents.....	41		
J-Channel	42		

The manufacturer has provided these suggested instructions as installation guidelines. The manufacturer, however, neither installs the panels nor has any control over the installation. It is the responsibility of the contractor and/or the installer to ensure panels are installed in accordance with these instructions and any applicable building codes. The manufacturer assumes no liability for either improper installation or personal injury resulting from improper use or installation.

Fire Safety Information

Vinyl building materials require little maintenance for many years. Nevertheless, common sense dictates that builders and suppliers of vinyl products store, handle, and install vinyl materials in a manner that avoids damage to the product and/or the structure. Owners and installers should take a few simple steps to protect vinyl building materials from fire.

To Home and Building Owners:

Vinyl siding is made from organic materials and will melt or burn when exposed to a significant source of flame or heat. Building owners, occupants, and outside maintenance personnel should always take normal precautions to keep sources of fire, such as grills, and combustible materials, such as dry leaves, mulch and trash, away from vinyl siding.

To the Building Trades, Specifiers, Professionals, and to Do-It Yourself Installers:

When vinyl siding is exposed to significant heat or flame, the vinyl will soften, sag, melt, or burn, and may thereby expose materials underneath. Care must be exercised when selecting underlayment materials because many underlayment materials are made from organic materials that are combustible.

It is important to ascertain the fire properties of underlayment materials prior to installation. All building materials should be installed in accordance with local, state, and federal building code and fire regulations.

Storage and Transportation

When transporting vinyl siding and accessories to the job site, make certain to keep the cartons flat and supported along their entire length. At the job site, take the following precautions when storing panels:

- Store the cartons on a flat surface and support the entire length of the cartons.
- Keep the cartons dry.
- Store the cartons away from areas where falling objects or other construction activity may cause damage.
- Do not store the cartons in stacks more than 6 boxes high.
- Do not store the cartons in any locations where temperatures may exceed 130° F (e.g., on blacktop pavement or under tarps or plastic wraps without air circulation).

Residing over Asbestos Siding

Asbestos siding is a regulated material and the appropriate environmental agency should be contacted before residing over this product begins.

The manufacturer has provided these suggested instructions as installation guidelines. The manufacturer, however, neither installs the panels nor has any control over the installation. It is the responsibility of the contractor and/or the installer to ensure panels are installed in accordance with these instructions and any applicable building codes. The manufacturer assumes no liability for either improper installation or personal injury resulting from improper use or installation.

1. Installed panels must move freely from side to side.
2. Do not stretch horizontal siding panels upward when applying: instead, push upward on the bottom of the panel you are installing, until the locks fully engage. Nail in place. Panels should hang without strain after nailing. Stretching the panel upward pulls the natural radius out of the panel and increases the friction of the locks.
3. Always nail in the center of the slot. **WARNING: Do not nail at the end of a slot!** Doing so will cause the siding panel to be permanently damaged. If you must nail near the end of a slot to hit a stud, etc., extend the length of the slot with a nail slot punch tool.
4. Do not nail tightly. Allow a minimum of $1/32$ " between the back of the nail head, screw or staple crown and the nailing strip. Nails or staples should be placed approximately 12" to 16" apart. Drive fasteners straight and level to prevent distortion and buckling of the panel. For fastening specs, see page 13.
5. Leave a minimum of $1/4$ " clearance at all openings and stops to allow for normal expansion and contraction. When installing in temperatures below 40° F, increase minimum clearance to $3/8$ ".
6. Do not caulk the panels where they meet the receiver of inside corners, outside corners, or J-Channel Trim. Do not caulk the overlap joints.
7. Do not face-nail or staple through siding. Vinyl siding expands and contracts with outside temperature changes. Face-nailing can result in permanent ripples in the siding.
8. Panels should be overlapped approximately 1". Fasten panels approximately 8" or more from the overlap seam for best lap appearance.
9. Avoid the use of unstable or uneven underlayment. Keep in mind that siding can only be as straight and stable as what lies under it. See Section "Preparing the Walls" for more information.
10. When installing shutters, cable mounts, etc., make sure screw hole in the siding is $1/4$ " larger than the attachment screw diameter. (Example: an $1/8$ " screw requires a $3/8$ " hole in the siding.) This will allow the panel to still expand and/or contract.
11. Never attach fixtures directly to panels. When attaching fixtures, first drill a hole in the siding $1/4$ " larger than the diameter of the fasteners, allowing for expansion and contraction. Note: Fasteners for fixtures must penetrate the solid substrate.



The beauty of vinyl siding is maintained with little effort. Although vinyl siding will get dirty, like anything exposed to the atmosphere, a heavy rain will do wonders in cleaning it. Or, it's possible to wash it down with a garden hose. If neither rain nor hosing does a satisfactory job, follow these simple instructions:



1. Use an ordinary, long-handled car washing brush. This brush has soft bristles, and the handle fastens onto the end of the hose. It allows the siding to be washed just like a car. Avoid using stiff bristle brushes or abrasive cleaners, which may change the gloss of the cleaned area and cause the siding to look splotchy.

2. When washing down your entire house, start at the bottom and work up to the top in order to prevent streaking. Rinse Cleaning Solution with water before it dries. If your house has brick facing, cover the brick so that it is not affected by the runoff.

3. Follow the precautionary labeling instructions on the cleaning agent container. Protect shrubs from direct contact with cleaning agents.

4. To remove soot and grime found in industrial areas, wipe down the siding with a solution made up of the following:

1/3 cup powdered detergent [(e.g. Fab®, Tide®, or equivalent powder detergent)]*

2/3 cup powdered household cleaner [(e.g., Soilax®, Spic & Span®, or equivalent)]*

1 gallon water

5. If mold and mildew are a problem, add one quart of liquid laundry bleach to the cleaning solution mentioned above.

6. For stubborn stains, use the chart on the right. (page 6)

• Cleaning materials are listed in alphabetical order. The manufacturer does not endorse proprietary products or processes and makes no warranties for the products referenced herein. Reference to proprietary names is for illustrative purposes only and is not intended to imply that there are not equally effective alternatives.

STAIN*Bubble Gum**Crayon**DAP [Oil-based caulk]**Felt-Tip Pen**Grass**Lipstick**Lithium Grease**Motor Oil**Paint**Pencil**Rust**Tar**Topsoil***CLEANERS***Fantastik[®], Murphy's Oil Soap[®],
or solution of vinegar [30 percent] and
water [70 percent]Lestoil[®]Fantastik[®]Fantastik[®] or water-based cleanersFantastik[®], Lysol[®],
Murphy's Oil Soap[®], or Windex[®]Fantastik[®], or Murphy's Oil Soap[®]Fantastik[®], Lysol[®],
Murphy's Oil Soap[®], or Windex[®]Fantastik[®], Lysol[®],
Murphy's Oil Soap[®], or Windex[®]Brillo[®] Pad or Soft Scrub[®]Soft Scrub[®]Fantastik[®], Murphy's Oil Soap[®],
or Windex[®]Soft Scrub[®]Fantastik[®], Lysol[®],
or Murphy's Oil Soap[®]**CAUTION:** Do not use or mix sodium hypochlorite with other household chemicals or products containing ammonia. To do so will release hazardous gasses.

*Cleaning materials are listed in alphabetical order. The manufacturer does not endorse proprietary products or processes and makes no warranties for the products referenced herein. Reference to proprietary names is for illustrative purposes only and is not intended to imply that there are not equally effective alternatives.

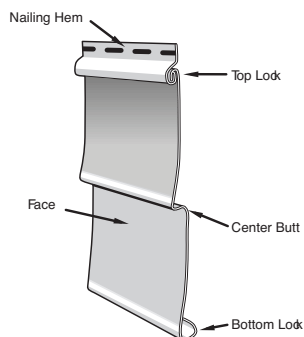

Backerboard/Underlayment—a flat material used on the face of the house, between the studs and the siding, to provide a flat surface for the siding.

Bottom Lock—the bottom edge of a siding or a soffit panel, or accessory piece, opposite the nailing slots, which locks onto the preceding panel.

Channel—the area of the accessory trim or corner post where siding or soffit panel is inserted. Channel also refers to the trim itself, and are named for the letters of the alphabet they resemble (e.g., J-Channel, F-Channel, etc.).

Course—a row of panels, one panel wide, running the length of the house. Or, in the case of vertical siding, from top to bottom.

Drip Cap / Head Flashing—an accessory installed to channel water away from siding panels and sub-wall. Drip cap is often used on the tops of windows/doors and when transitioning from horizontal to vertical siding.

Face—refers to the side of a siding or soffit panel that is exposed once the panel has been installed.

Fascia Board—(sometimes referenced as a sub fascia) board attached to the ends of the rafters between the roofing material and the soffit overhang.

Fascia Cap—the covering installed on the fascia board.

Flashing—a thin, flat material, usually aluminum, positioned under or behind J-Channels, Corner Posts, Windows, etc., to keep draining water from penetrating the home.

Furring/Furring Strip—a wooden framing material, usually 1" x 3", used to provide an even nailing base. To “fur” a surface means to apply these strips.

H-Mold (Double Channel Lineal)—a siding accessory that joins the ends of vertical siding and soffit panels.

Housewrap—weather-resistant, breathable film used to cover wood underlayment prior to the installation of siding.

Lap—to overlap the ends of two siding panels or accessory pieces to join the panels/pieces and allow for expansion and contraction of the vinyl product.

Lug/Crimp—the raised “ears” or tabs on a siding panel, created by a snaplock punch, which can be used to lock a siding panel into undersill trim when the nailing hem has been removed.

Miter—to make a diagonal cut, beveled to a specific angle (usually 45°).

Nailing Hem (or Flange)—the section of siding or accessories where the nailing slots are located.

Plumb—a position or measurement that is truly and exactly vertical, 90° from a level surface.

Scoring—running a utility knife blade across a soffit or siding panel face without cutting all the way through the panel. This weakens the vinyl surface in a specific area and allows the panel to be bent and broken off cleanly.

Soffit—material used to enclose the horizontal underside of an eave, cornice or overhang.

Starter Strip—an accessory applied directly to the surface of the building and used to secure the first course of siding to the home.

Weep Holes—openings cut into the siding panel or accessories during the manufacturing process to allow for water runoff.

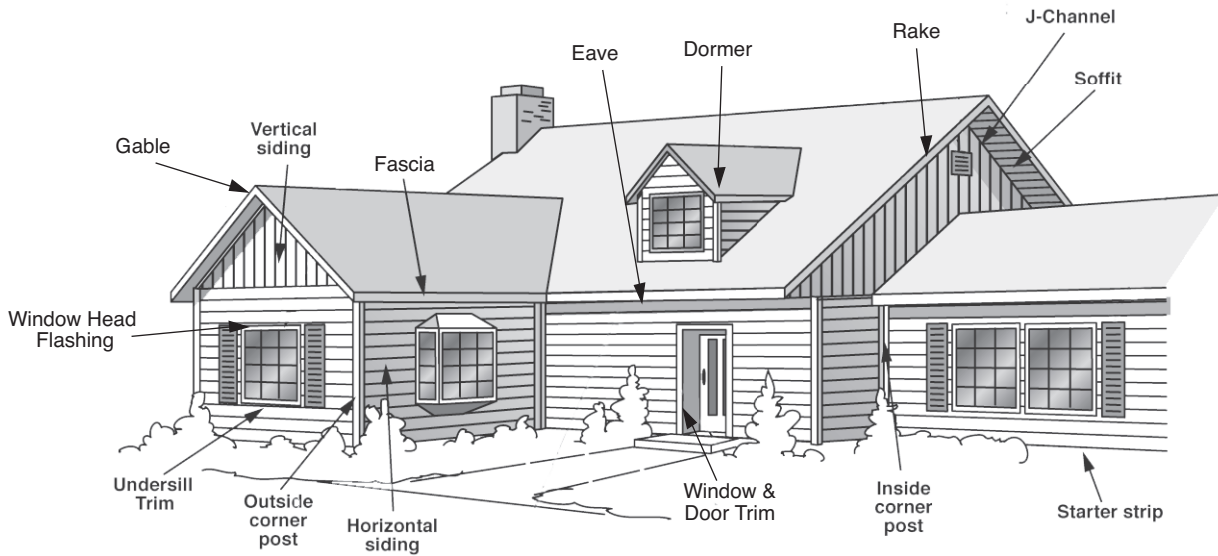

Outside and Inside Corner Post

Corner posts are used to provide a finished edge at an inside or outside corner. The siding from adjoining walls fits neatly into the inside or outside corner post channels.

NOTE: We produce various sizes of J-Channels and Corner Posts. Remember to order accessories of the proper size to accommodate the siding panels.

Trim and Molding

A complete line of accessories is used to give every installation a professional, weather-resistant appearance. Common accessories include Corner Posts, Starter Strips, F-Channels, Undersill Trim, and J-Channels (left). Each of these accessories will be addressed in more detail throughout this manual.

Inside Corner Post



Outside Corner Post

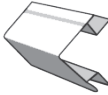

Undersill Trim



J-channel

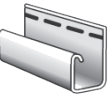

Starter Strip



F-channel



Fig. 1

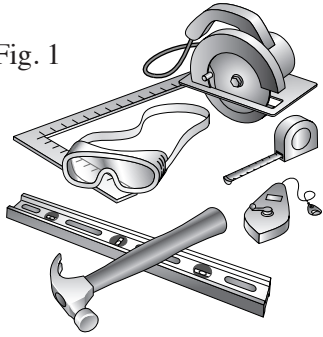

Hand Tools

Common hand tools, such as a hammer, saw, square, chalkline, level, and tape measure are needed for proper installation (Fig. 1). Safety glasses are recommended for eye protection. Other basic tools include:

Power Saw

A bench or radial-arm power saw can speed the cutting of the siding. A finetooth blade (12 to 16 teeth per inch) should be used with the blade installed in the reverse direction. Some applicators prefer a hand-held power saw and a field-built cutting table. In extremely cold weather, move the saw through the material slowly to prevent chipping or cracking (Fig. 2).

Fig. 2

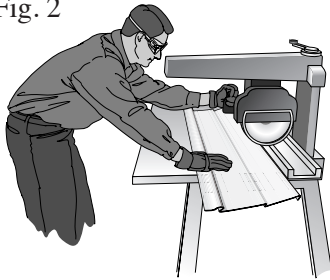

NOTE: A saw blade set up in reverse direction should be used only for cutting vinyl. DO NOT attempt to use it on other materials such as wood, plywood, etc.

Fig. 3

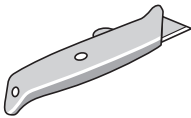

Utility Knife

Vinyl is easy to cut, trim and score with a utility knife or scoring tool (Fig. 3).

Tin Snips

Good quality tin snips and compound aviation-type snips will speed the cutting and shaping of the vinyl (Fig. 4).

Snaplock Punch

A snaplock punch is used to punch lugs in the cut edges of siding to be used for the top or finishing course at the top of a wall, or underneath a window (Fig. 5).

Nail Hole Punch

Occasionally, it may be necessary to elongate a nail slot. The hole is elongated to allow for expansion and contraction (Fig. 6).

Unlocking Tool (Zip-Lock Tool)

Remove or replace a siding panel with the unlocking tool. Insert the curved end of the tool under the end of the panel and hook onto the back lip of the buttlock. To disengage the lock, pull down and slide the tool along the length of the panel. Use the same procedure to relock a panel (Fig. 7).



Fig. 4

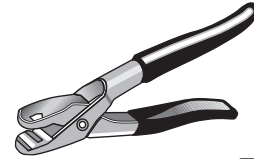

Fig. 5

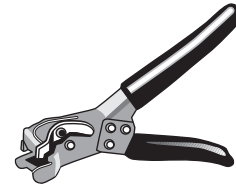

Fig. 6

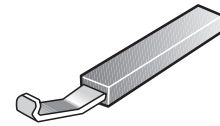
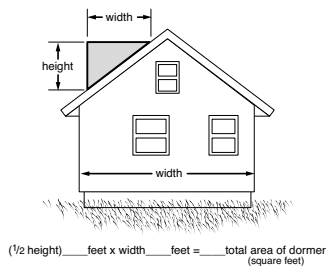
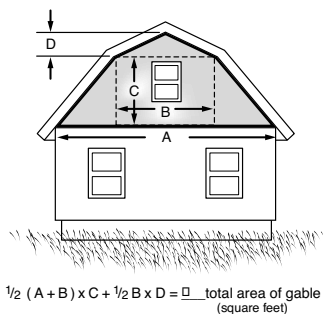
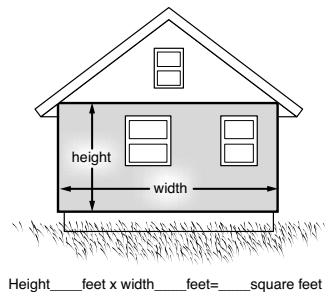
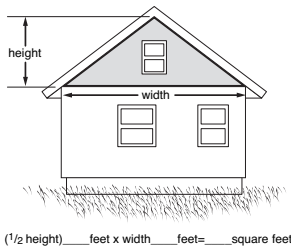

Fig. 7



1. All houses can be broken down into shapes of rectangles, triangles or a combination of both.

2. The area to be sided can be determined by measuring the height and width of the house, including windows (below).

3. Total all of the measurements for the areas to be sided. Windows and doors are not usually deducted. Including them will provide an allowance factor for waste. If the windows and doors are extremely large (such as garage or sliding glass doors), some deductions can be made. Dormers and gables are prone to material waste due to cutting and fitting.

4. To estimate the amount of starter strip required, measure the linear feet around the entire base of the house. When measuring linear footage, add a factor of 10 percent to allow for waste.

Use the following worksheet to estimate the required materials:

Siding Walls		___ square feet
Gable ends		___ square feet
Upper gambrel walls		___ square feet
Total wall surface area		___ square feet
Large areas not covered [garage doors/sliding doors]	<u>x0.50=</u>	___ square feet [A]
Uncovered area		___ square feet [B]
<u>Subtract B from A for</u> Total net surface area		___ square feet
Soffit		___ square feet
Porch Ceiling		___ square feet
Accessories	Starter Strip	___ linear feet
	Utility trim	___ linear feet
Receiving channel	J-Channel	___ linear feet
	Flexible J-Channel	___ linear feet
	F-trim	___ linear feet
	3 1/2" and 5" Window & Door Surround	___ linear feet
Outside corners	Outside corner post	___ linear feet
	Fluted corner trim	___ linear feet
Inside corners	Inside corner post	___ linear feet
	J-Channel	___ linear feet
Other	Soffit cove trim	___ linear feet
	H-molding	___ linear feet
	Light blocks	___ linear feet
	Width of accessory recess opening: [please circle one] 1/2" 5/8" 3/4" 1 1/8"	
Nails	Pounds required	
	Length [1 1/2" minimum]	___ pounds
Tools needed	___ hammer	___ tin snips
	___ utility knife	___ square
	___ nail hole punch	___ tape measure
	___ power saw	___ unlocking tool
	___ snaplock punch	___ finetooth saw blade
		___ chalkline
		___ hacksaw
		___ level

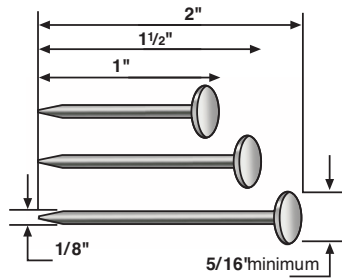
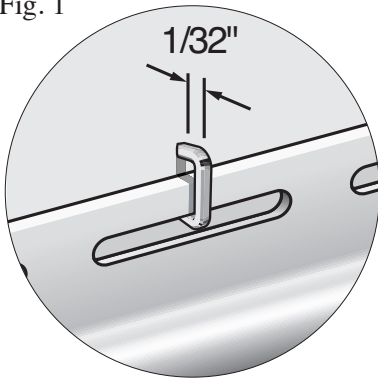

Fig. 1



Use aluminum, galvanized steel or other corrosion-resistant nails, staples or screws when installing vinyl siding. Aluminum trim pieces require aluminum or stainless steel fasteners.

Nails

Nail heads should be 5/16" minimum in diameter. Shank should be 1/8" in diameter.

Minimum nail lengths are as follows:

- 1 1/2" for general use
- 2" for residing
- 1" to 1 1/2" for trim

Screw Fasteners

Screw fasteners can be used if the screws do not restrict the normal expansion and contraction movement of the vinyl siding panel on the wall. Screws must be centered in the slot with a minimum 1/32" space between the screw head and the vinyl.

Screws should be:

- Size #8, truss head or pan head.
- Corrosion-resistant, self-tapping sheet metal type.

*** All fasteners must be long enough to penetrate into the framing 3/4 of an inch.**

Staples

If staples are being used instead of nails or screws, they must be:

- Not less than 16-gauge semi-flattened to an elliptical cross-section (Fig. 1).
- Wide enough in the crown to allow free movement of the siding.
- 1/32" clearance between staple crown and nailing hem of the siding panel. Make sure to adjust staple gap to allow for 1/32" clearance.

Vinyl siding can expand and contract 1/2" or more over a 12' 6" length with changes in temperature. Whether using a nail, screw or staple to fasten the siding, the following basic rules must be followed:

Step 1

Make sure the bottom lock of the panels are fully engaged along the entire length of the panel.
WARNING: Push the panel up fully but do not stretch the panel by pulling it from the top.

Step 2

Do not drive the head of the fastener tightly against the siding nail hem. Leave a minimum of 1/32" (the thickness of a nickel) between the fastener head and the vinyl. Tight nailing, screwing, or stapling will cause the vinyl siding to buckle with changes in temperature (Fig.1). If the head or crown contacts the vinyl panel it may "pimple" or distort due to heat build-up.

Step 3

After locking the panel, fasten the panel in the center, work in, to both ends. This method helps keep panels running straight.

Step 4

Nail 8" or more away from the end of a panel that will be overlapped with another panel. This will help the overlap appearance.

Center the fasteners in the slots to permit expansion and contraction of the siding (Fig. 2).

Step 5

Drive fasteners straight and level to prevent distortion and buckling of the panel (Fig. 3).

Step 6

Space the fasteners a maximum of 16" apart for horizontal siding panels, 12" apart for vertical siding panels, and 8" to 10" apart for the accessories.

Step 7

Start fastening vertical siding and corner posts in the top of the upper-most slots to hold them in position. Place all other fasteners in the center of the slots (Fig. 4).

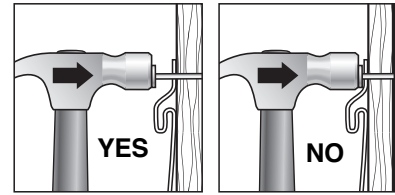

Fig. 1

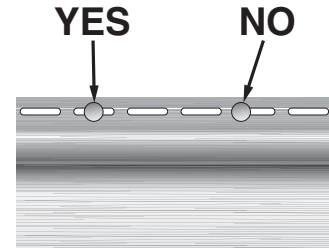

Fig. 2

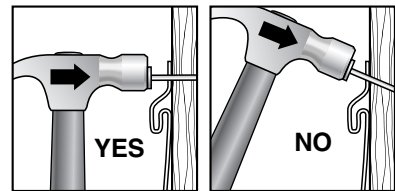

Fig. 3

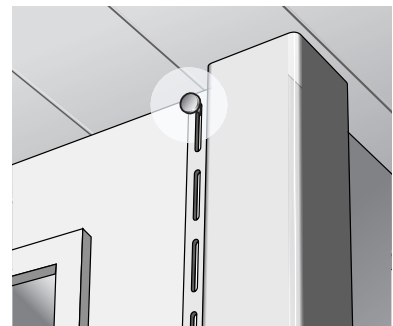

Fig. 4

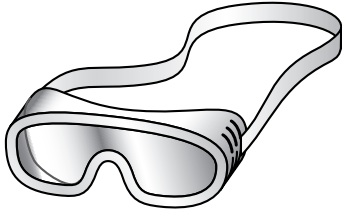

Fig. 1

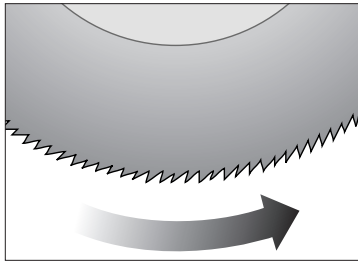

Fig. 2

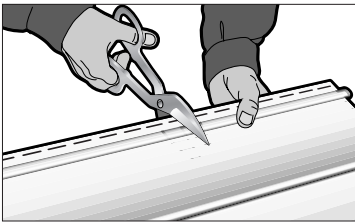

Fig. 3

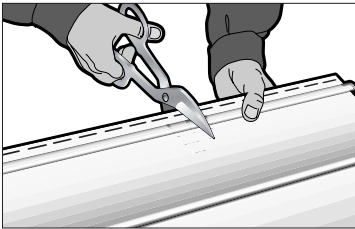

Fig. 4

When cutting vinyl siding, follow these guidelines:

Step 1

Safety goggles are always recommended for all cutting and nailing operations. As on any construction job, use proper safety equipment and follow safe construction practices (Fig. 1).

Step 2

With a circular saw, install the fine-toothed (plywood) blade backward on the saw for a smoother, cleaner cut. Cut slowly. Do not attempt to cut materials other than vinyl with a reversed direction saw blade (Fig. 2).

Step 3

With a utility knife or scoring tool, score the vinyl face up with medium pressure and snap it in half. It is not necessary to cut all the way through the vinyl (Fig. 3).

Step 4

With tin snips, avoid closing the blades completely at the end of a stroke for a neater, cleaner cut (Fig. 4).

Sheathing/Backerboard

Our vinyl siding should be applied over a sheathing that provides a smooth, flat, stable surface. Consult local building codes for sheathing requirements. Vinyl siding should never be applied directly to studs without sheathing. **We recommend that wood-based sheathings be protected utilizing moisture-resistant housewrap or building paper prior to the installation of the siding and accessories. Some building codes now require this protection.**

Flashing

Flashing, such as aluminum coil, roofing felt or house wrap, should be applied around windows, doors, other openings, inside and outside corners, and the intersection of walls and roofing to prevent water infiltration.

New Construction

Step 1

Make sure all studs are straight and true to avoid bulges or dips in the finished wall. Correct any bowed studs at this time.

Step 2

Make sure all sheathing is properly fastened to the framing according to building code requirements and/or the sheathing manufacturer's

recommendations.

NOTE: Sheathing behind vinyl siding must be smooth, flat, stable and appropriate for use on the type of construction being erected. Increasing requirements in building codes, especially in the areas of fire and wind resistance, make the appropriate choice and fastening of wall sheathing an important area of consideration. Check local building codes for the allowable type and thickness of sheathing that can be utilized on the type of structure being sided.

Step 3

Make sure subwall assembly is weathertight before applying siding. Vinyl siding and vinyl siding accessories alone do not constitute a waterproof installation. The combination of proper subwall preparation and siding installation result in the desired protection of the structure.

Wall sheathing should be weather-resistant, or covered with a weather-resistant barrier such as fanfold insulation, housewrap, or building paper. **Independent VSI studies indicate that the combination of a weather resistant barrier plus a housewrap result in improved weather performance of the vinyl siding.** Some building code jurisdictions are

currently requiring this protection.

A weather-resistant covering should be properly fastened according to the manufacturer's instructions, and be smooth and even. Flashing and caulking should be added as needed in areas such as windows, doors, and other openings to control moisture and to protect the subwall assembly.

WARNING: A smooth, flat, stable wall surface is necessary for the proper installation of vinyl siding. Waviness in the finished siding resulting from uneven or inadequate backerboard sheathing constitutes misapplication under the terms of the warranty.

TIP: Place the drywall in the house, on the floor of the room where it is going to be applied, prior to the installation of the siding when possible. This will help load the floor system and the floor band prior to applying siding. This can help reduce panel bulging in the floor band areas where compression and shrinkage typically occur.

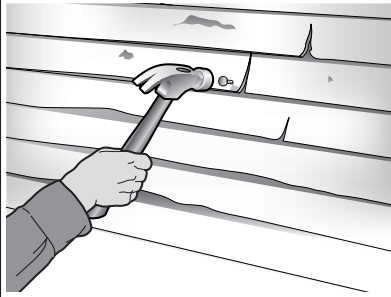

Fig. 1

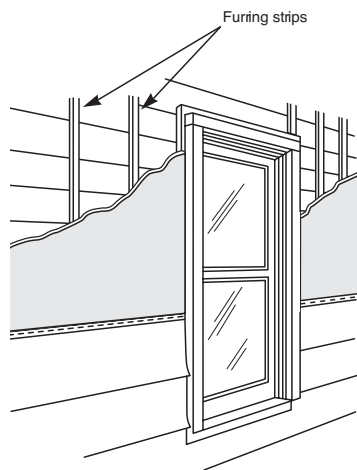

Fig. 2

Residing Existing Structures

Step 1

Nail down any loose boards on existing siding, and replace any rotten wood as needed. **DO NOT INSTALL VINYL SIDING OVER ROTTEN WOOD.** (See Fig. 1)

Step 2

Scrape off loose caulk and any other buildup that may interfere with the siding installation. Remove all items such as gutters, downspouts, and light fixtures as needed.

Step 3

Install suitable sheathing, as needed, to provide a smooth, flat, and stable surface for the installation of the vinyl siding. See information previously given in this segment for additional instructions on subwall protection and flashing.

Step 4

Install furring in areas needing straightening and leveling. Apply rigid sheathing to cover and level the furring strips. Do not apply vinyl siding directly to furring strips without sheathing, because the siding may conform around the furred areas causing an uneven appearance. (See Fig 2)

Step 5

Window and door casings may need additional attention or preparation. Depending on vinyl siding moldings being used, a window/door casing generally needs to extend out from the finished subwall sufficiently, to allow a J-Channel or similar molding to butt to it. In some situations, building out the casings, or using special purpose moldings such as Window and Door Surround may be necessary.

Over Masonry Sub-surface

A minimum 1" x 3" wood strips are installed with masonry nails over the masonry area to be sided (Fig. 1). For increased decay resistance, use pressure treated furring strips.

Step 1

For horizontal siding, strips should be installed vertically 16" on center. They should be installed completely around doors, windows and other openings, at all corners, and at the top and bottom of the area to be sided.

Step 2

For vertical siding, furring is essentially the same as for horizontal siding. Strips should be nailed horizontally 12" centers.

NOTE: Furring strips should be covered with insulated sheathing or the spaces between the furring strips should be filled in with insulated sheathing equal in thickness to the furring strips. This will provide an even wall surface for the siding and help avoid any waviness.

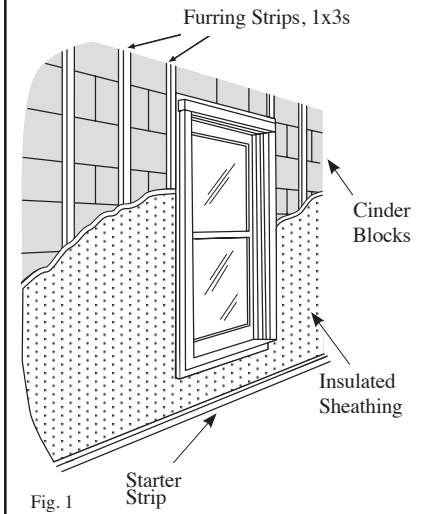

Fig. 1

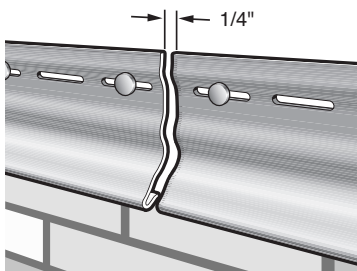

Fig. 1

Before the vinyl siding itself can be installed, a number of accessories must be installed first, including starter strips, corner posts, window flashing, trim and J-Channels.

Step 1

In order for the vinyl siding to be installed properly in a level fashion, the starter strip at the bottom of the wall must be level.

Step 2

The starting chalk line should be located so that it represents the top, not the bottom, of the starter strip.

Chalk lines are normally established from the lowest corner of the house. In situations where the ground at the corner of the house is not level, chalk lines must be measured from the soffit location to assure a uniform panel at the top of the walls.

Step 3

Attach a chalkline: go to the next corner and pull the line taut.

Step 4

Snap the chalkline and repeat the procedure around the entire house.

Step 5

Using the chalkline as a guide, install the top edge of the starter strip along the bottom of the chalkline, nailing at 10" intervals. Allow space for accessories (corner posts, J-Channels, etc.)

Step 6

Keep the ends of starter strips at least 1/4" apart to allow for expansion (Fig. 1).

Step 7

Nail in the center of the starter strip nailing slots.

Step 8

Starter strip fasteners should be driven just flush in the center of the slots to take out starter looseness, but should not be overdriven to where it indents the starter.

In most situations a typical starter strip is used to start the first course of siding. Special circumstances (panel application around decking, special roof lines and other unique applications) may require other techniques to secure the first panel locking leg. This can be accomplished in several manners (as illustrated in Figures 1 & 2).

Anytime a J-Channel is used as a starter strip it must have a 3/16" diameter hole drilled no greater than 24" on center to allow for water drainage.

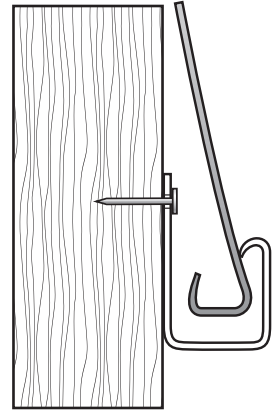

Fig. 1
Inside J-Channel

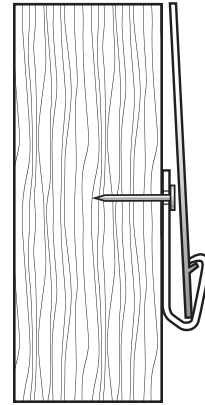

Fig. 2
Undersill with Snaplock

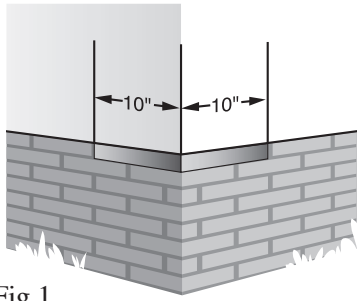

Fig. 1

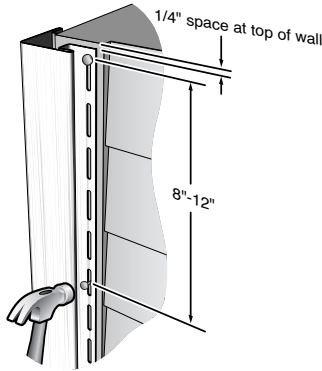

Fig. 2

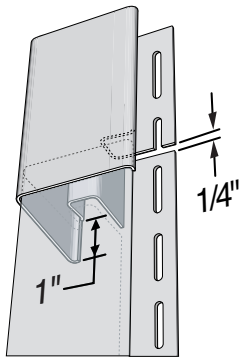

Fig. 3

Step 1

A water-resistant material should be used to flash the inside and outside wall corners a minimum of 10" on each side before installation of the corner posts. A housewrap would be an adequate flashing (Fig. 1).

Step 2

Place the corner post in position, allowing a 1/4" gap between the top of the post and the eave or soffit (Fig. 2).

NOTE: If vinyl or aluminum soffit will be installed, either install prior to corner post installation or allow for soffit and accessory thickness when positioning the height of the corner.

Position a nail at the top of the upper slot on both sides of the corner post, leaving a 1/32" gap between the nail heads and the corner post nailing hem. The corner post hangs from these nails. The balance of the nailing should be in the center of the slot, 8" to 12" apart, again leaving 1/32" between the nail head and the corner post. This allows for the expansion and contraction to occur at the bottom. The corner post should extend 3/4" below the starter strip. Make sure the posts are vertically straight and square.

Do not nail corner post tight.

Step 3

If more than one length of corner post is required, overlap the upper corner post over the lower corner post.

Splicing Outside Corner Post

Remove 1" from the nail hem and receiving channel of the bottom end of the top piece. Position uncut top end of lower post under bottom edge of upper post allowing a 1/4" gap at the nail for expansion and contraction. (Fig. 3).

Splicing Inside Corner Post

Cut 1" off all but the outer face of the upper portion of the bottom corner post. (Fig 4) Lap 3/4" of the upper post over the lower post, allowing 1/4" for expansion.

This method will produce a visible joint between the two posts, but will allow water to flow over the joint, reducing the chance of water infiltration.

Capping a Corner Post

Step 1

Corner posts on homes with a second-story overhang need to be capped by making the cuts shown. Allow approximately 2" extra length on the corner post. Trim away everything except the 2 faces. Fold the flaps created over each other as indicated (Fig. 5).

Step 2

Drill a 1/8" hole in the center through both layers of vinyl, and install a pop rivet to hold them in place. Cut a notch in both layers to allow clearance for the corner (Fig. 5).

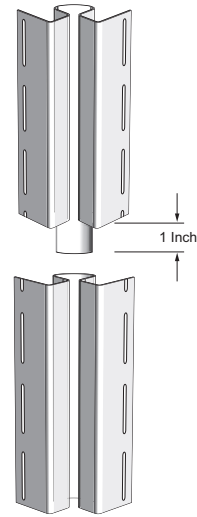

Fig. 4

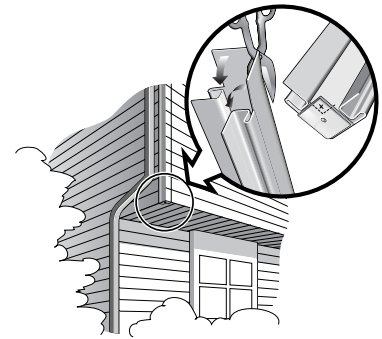

Fig. 5

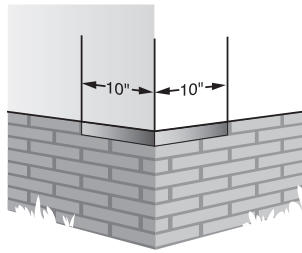

Fig. 1

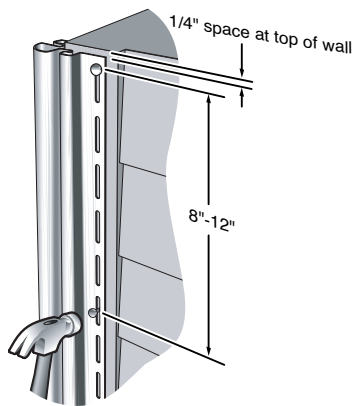

Fig. 2

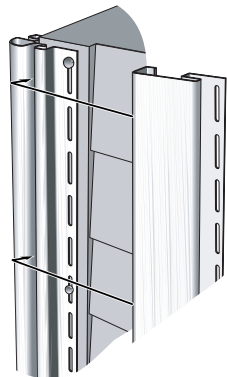

Fig. 3

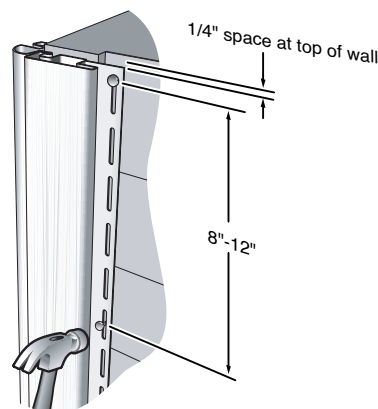

Fig. 4

Step 1

A water-resistant material should be used to flash the inside and outside wall corners a minimum of 10" on each side before installation of the 3-piece corner system (Fig. 1).

Step 2

Place the Decorative Corner Starter on the outside wall corner, allowing a 1/4" gap between the top of the post and the eave or soffit, and extending 3/4" below the siding starter strip. Cut to length (Fig. 2).

Position a nail at the top of the upper full slot on both sides of the Decorative Corner Starter, leaving a 1/32" gap between the nail heads and the corner post nailing hem. The Decorative Corner Starter hangs from these nails. The balance of the nailing should be in the center of the slot, 8" to 12" apart, again leaving 1/32" between the nail head and the Decorative Corner Starter. This allows for proper expansion and contraction clearance. Make sure the Decorative Corner Starter is installed vertically straight and true.

Do not nail corner post tight.

Step 3

For typical installations, cut two 3-1/2" or 5" Window & Door Surround lineals to the same length as the Decorative Corner Starter. Snap the locking side of a Window & Door Surround into one side of the receiving lock section of the Decorative Corner Starter (Fig. 3). Repeat the procedure for installing the other Window and Door Surround.

Step 4

Make sure that all 3 parts are fully locked and line up evenly at the top and bottom. Fasten the Window & Door Surround lineals to the wall following the same nailing procedures outlined in Step 2 (Fig. 4).

Lineals

Step 1

Create a watertight seal:

Apply a 1/8" bead of caulk around the perimeter of the window or door frame before installation.

Apply caulk around the corner of the nail fin and where the window or door meets the sheathing.

Measure the width of the top of the frame and cut a piece of starter strip 1/8" less than the frame. (Fig.1)

Step 2

Butt the starter strip against the opening, center it and nail every 8" to 12" being sure to nail in the center of the nailing slots.

(Starter strips are available for both new construction and remodeling applications.)

Continue to measure and cut starter strips for the other sides of the frame. Be sure to cut starter strips 1/16" less than each measurement. (Fig.2)

Step 3

Install the starters. For vertical starter strips, nail the first nail in the upper most edge of the first slot. All other nails should be centered in the slots every 8" to 12". (Fig.3)

Step 4

Measure and cut the lineals. For 3-1/2" lineals add 7" to your measurement in order to accommodate their widths at corners. For 5" lineals, add 10".

Lineals should be installed in the following order: top, sides, bottom. (Fig. 4)

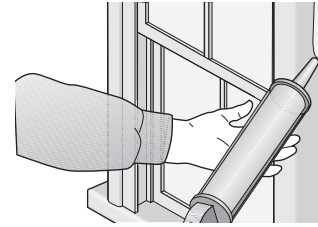

Fig.1

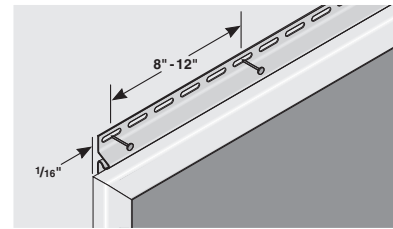

Fig. 2

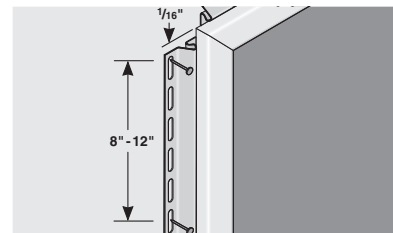

Fig. 3

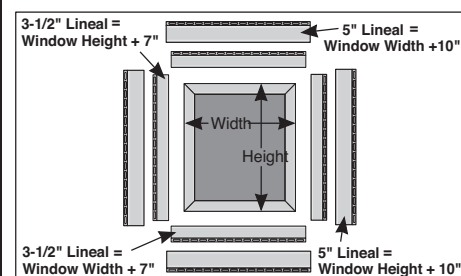

Fig. 4

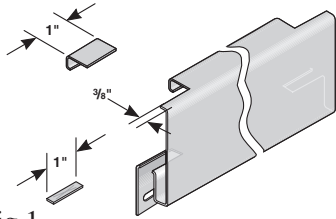

Fig. 1

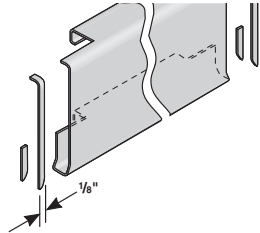

Fig. 2

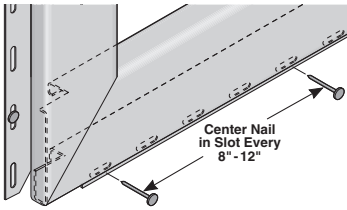

Fig. 3

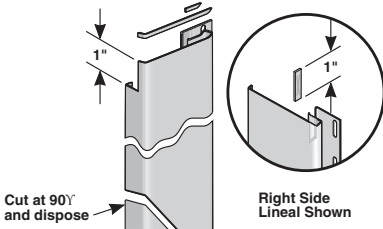

Fig. 4

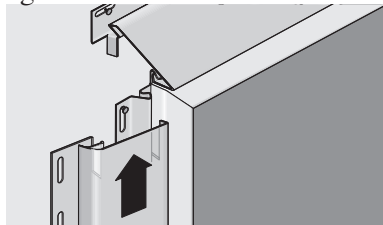

Fig. 5

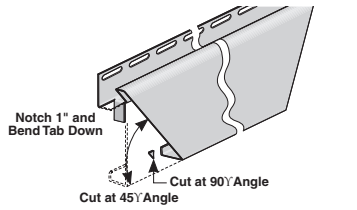

Fig. 6

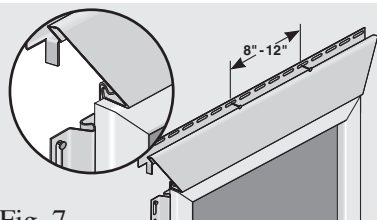

Fig. 7

To install the bottom lineal

Cut a notch on each side of the back of the lineal as shown. Cut a 1" notch out of the nailing hem side. (Fig. 1)

Make a 1/8" curved sliver cut on the bottom front of the lineal. Push the locking leg of the lineal into the channel of the starter.

Nail the bottom lineal into place only after the side lineals are installed.

Work the bottom lineal into place by flexing the material to fit it together with the side lineals, lapping the side lineals over the bottom lineal.

Complete by nailing the bottom lineal every 8" to 12" with nails centered in slots. (Fig. 2 & Fig. 3)

To install side lineals

Cut a 1" notch off the legs for the top of the lineal and a 45° miter cut for the bottom. Cut a 1" notch out of the nailing hem side. Make curved sliver cuts on the top of the lineal. *NOTE: Right and left lineals should have opposite cuts.* (Fig. 4)

Push side lineals into the channel of the Starter about 2" down from the header and slide the lineal into place.

Fit tabs of the header lineal down into the side lineals.

Nail top nail of the side vertical lineal into the top of the slot, then nail lineals into place every 8" to 12" with nails centered in slots. (Fig. 5)

To install the top lineal...

Miter each end of the lineal at a 45° angle. Notch the channel 1" to form a flap and bend it down (do this on both ends) (Fig. 6)

Push the locking leg of the lineal into the channel of the starter and center it above the frame. Nail every 8" to 12" with nails centered in slots of lineal. (Fig. 7)

Window Mantels

Standard Length Mantels

Locate the centerline of where the mantel will be installed. Measure to each side of the centerline as specified for each length mantel (see chart below).

<u>Mantel Length</u>	<u>Measurement</u>
36"	16-5/8"
40"	18-5/8"
44"	20-5/8"

Scribe a vertical line approximately 6". These lines will correspond to the locking legs on the back of the mantels. Install 2 mounting clips to each line with the bottom of each clip at least 2" above the bottom of the mantel, and the top of the other clip no higher than 4-3/4" above the bottom of the mantel. (Fig.1)

Position the mantel over the clips and snap into place. (Fig.2)

NOTE: When applying clips over beveled siding, you will have to shim and/or bend the top of the clips to keep the clip throats the same distance from the wall.

To Install End Caps

(For non-standard window sizes.)

Cut the window mantel to the required length minus 3/8". **NOTE:** The cut on a mantel with dentil blocks must be 1/8" to the right (facing the mantel) of a full dentil block. Clean any shavings or grit from the cut end(s). Insert the end cap into the mantel and mark the mantel on the inside. Remove the end cap and spread adhesive on both the

lip of the end cap and the end of the mantel where marked.

Insert the end cap into the mantel and clamp each side. Allow 10 minutes for drying and then install the mantel into place as described above. (Fig.3)

To Shorten a Mantel

Determine length and make two cuts to remove excess material from the center of the mantel. Be sure to cut through the center of the dentil blocks.

Turn the mantel sections face down. Drill a 3/16" hole in the second indented hole marker 2-3/4" from the cut edge of both mantel sections. Place mantel overlay face down under the cut and drilled mantel sections. The mantel overlay screw bosses will align with the 3/16" drilled clearance holes. A paper pattern is included to locate screw location. Fasten together with #8x1/2" self-tapping screws.

NOTE: Mantels must be installed directly over brick or stucco siding. If vinyl siding is to then be applied, panels will have to be cut to fit around the end caps. Mantels can also be installed in remodeling applications over vinyl siding.

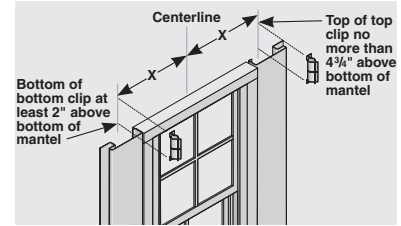

Fig.1

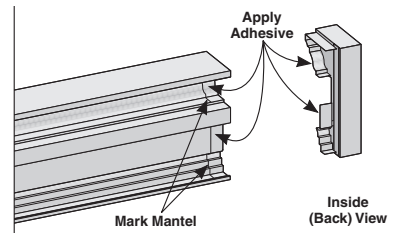
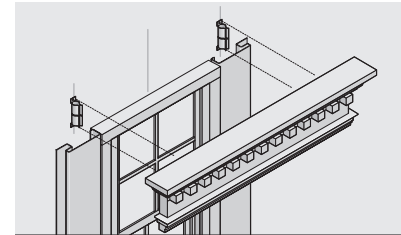

Fig.3

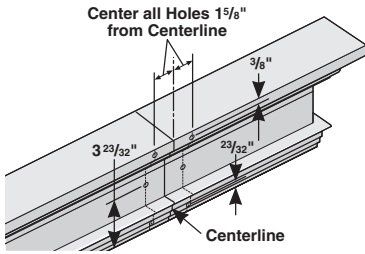

Fig. 1

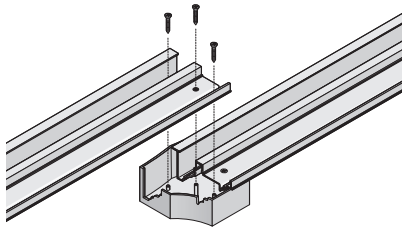

Fig. 2

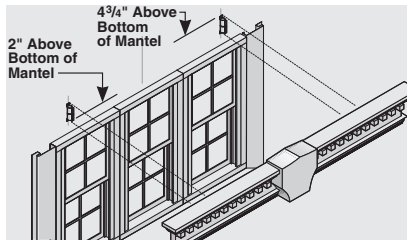

Fig. 3

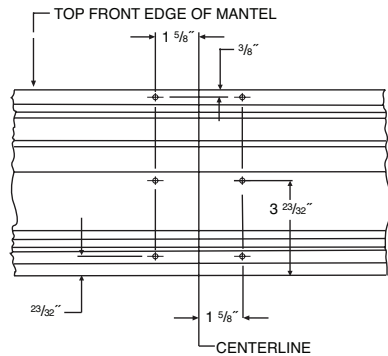

Fig. 4

To Install a Keystone
(to shorten or lengthen a mantel)

NOTE: Mantel keystones can be purely decorative, or can be used to modify mantels.

Determine the length of mantel necessary. Using this measurement, cut two equal pieces of the mantel (each will be one-half the length of the required total length). (Fig. 1)

Clean the cut ends.

Drill three holes 3/16" in diameter into each mantel piece spacing holes 1-5/8" from the centerline (along the cut ends of the mantels). (Fig. 4)

If placing mantel keystone over dentil blocks, you may need to cut away a thin section on both sides of mantel to accommodate keystone over dentil blocks.

Place keystone face down on clean work area. Insert one mantel section into keystone and align drilled holes with molded screw bosses in keystone and fasten with three screws. Insert and fasten second mantel section with three screws. (Fig. 2)

To set clip locations when mantel has modified or cut, measure from new mantel cut centerline to the locking legs. Install clips as described.

Install clips to wall. You must determine the distance to place clips from the center of modified mantel. (Fig. 3)

To stabilize the mantel system, it is recommended that a piece of fitted plywood be screwed into the back of the mantel system behind the keystone.

Install mantel as described in Standard Mantel installation.

Long Length Mantel System

NOTE: If installing mantel over existing siding or masonry surfaces, use brick end caps. If installing new siding, the mantel system should be installed using siding end caps with integrated J-Channels before the siding is applied.

Determine the type of siding accessory to be used around opening. When using a standard J-Channel, cut the mantel to the width of the opening. (Fig.1)

When using a 3-1/2" window and door casing lineal, determine the width of the opening and add 5", then cut the mantel.

When using a 5" corner lineal, determine the width of the opening and add 8", then cut the mantel.

Clean the cut ends of the mantel. (Fig.2)

Insert the end cap into the mantel and mark the end cap with a pencil. Remove the end cap.

Spread a thin coat of styrene adhesive (included with caps) onto the end cap. **CAUTION: Contact with styrene adhesive will cause painted surfaces to smear.** (Fig. 3)

Install mantel end caps to both sides of the mantel. Allow adhesive to set 10 minutes using clamps to hold end caps in place.

Before installing the mantel, apply a 1/4" caulking bead along the back edge of the window/door framing, and on the backside perimeter of the mantel and end caps.

Center the mantel with attached end caps over the frame and fasten through the pre-drilled holes, using screws/washers provided. (Fig.4)

Install cover strip onto the mantel. (Plain & dentil cover strips are available.) (Fig.5)

NOTE: When installing dentil cover strip, it may be necessary to trim cut from both ends to center the dentil blocks on the mantel.

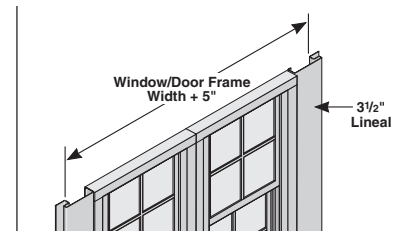

Fig.1

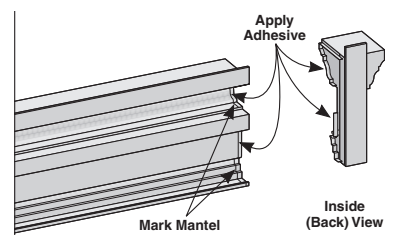
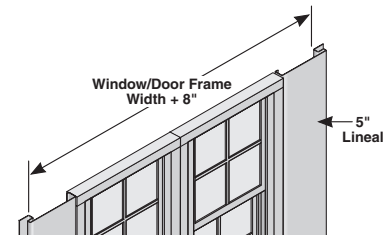

Fig. 3

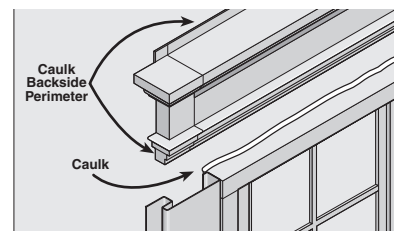
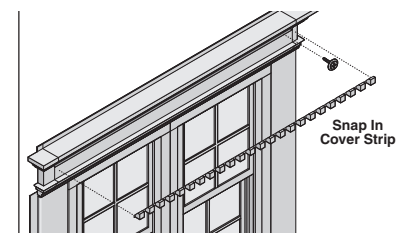

Fig. 4



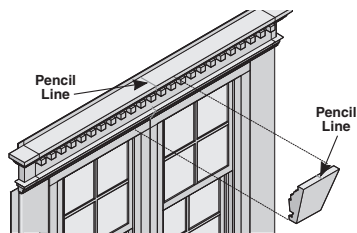

Fig. 1

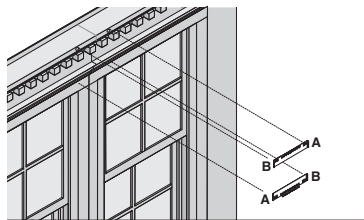

Fig. 2

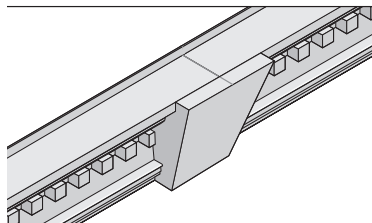

Fig. 3

Installing Long Length Mantel System Keystone

With the mantel already mounted to the wall, pencil a centerline on the top and bottom of both the mantel and keystone.

Using the drill jig provided with the keystone, place on the mantel's top edge and align slotted holes over the penciled centerline on the mantel.

Drill 1/4" holes through hole pattern of drill jig. Repeat second set of holes on bottom edge of mantel. (Fig.1)

Install the keystone clips making sure end "A" is inserted first, then snap in end "B".

Slide clip back 1/16" to ensure clamping legs are fully locked into place. (Fig.2)

Position the keystone using the centerline as the guide and snap it into place starting at one end of the top of the keystone. You may need to trim the sides of the keystone when using dentil cover strips. (Fig.3)

NOTE: When installing keystone over two-piece mantel, make sure mantel pieces are cut to equal lengths. Use the cut ends to form the centerline for clips and keystone. Caulk bottom ends then install.

Installing Over Brick or Existing Siding

To apply on brick or over other existing siding materials, cut mantel to desired length, allowing for brick end caps.

Clean cut ends, insert with adhesive and allow to dry as described in “Long Length Mantel System.”

Score the groove on back of mantel 3-5 times with utility knife and snap off mantel’s top flange.

Secure mantel to wall with anchors, screws and washers provided.

Install cover strip or dentil cover strip as described in “Long Length Mantel System.”

For keystone installation, see Installing Long Length Mantel System Keystones. (Fig.1)

Siding Applications

Installing Accessories Over Top of Mantel

1. Use J-Channel for vertical siding or horizontal panel applications.
2. Use dual utility trim for a Dutch lap applications.
3. Use finish trim for regular panels. (Fig. 2)

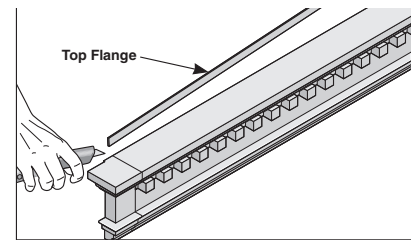

Fig.1

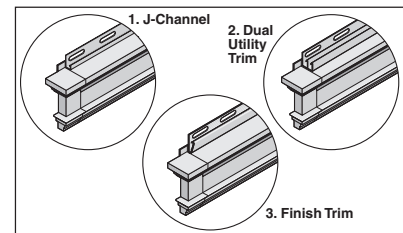

Fig. 2

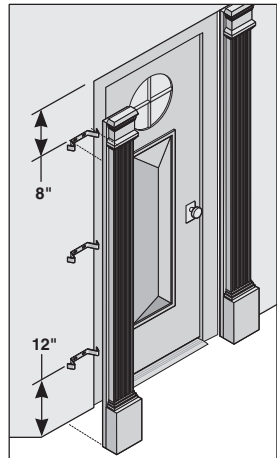
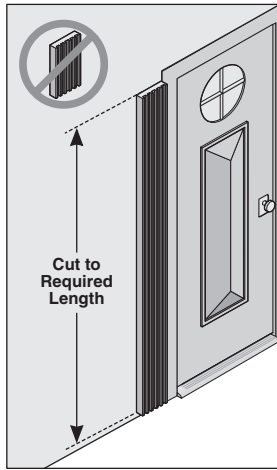

Fig. 2

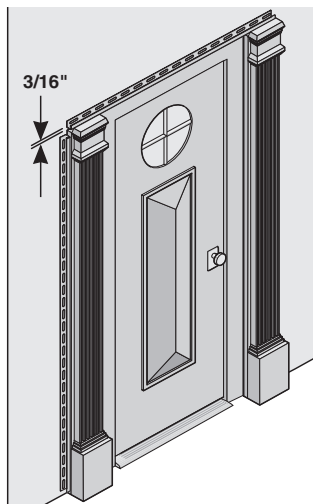

Fig. 3

Door Surrounds

Installation of Pilasters on Brick, Stucco or before vinyl siding.

Measure and cut pilasters to the required length. (Fig. 1)

To attach pilaster caps, use template enclosed in the carton. Mark and drill holes into back of pilasters (use 3/16" drill bit). **IMPORTANT:** When installing during new construction before vinyl siding, use lower set of holes on the template. This will ensure that the caps will sit 3/4" above the top of the pilasters. Attach caps to pilaster using 4 screws (enclosed).

To attach pilaster bases, use template enclosed in the carton. Mark and drill holes into back of pilasters (use 3/16" drill bit). Attach caps to pilaster using 4 screws (enclosed). (Fig.1)

Attach mounting clips and pilasters (three sets for 96" and four sets for 144") by locating top clips 8" from top and bottom clips 12" from the ground. Space third set at mid-point for 96" pilasters. Evenly space the other two sets for 144" pilasters. If

the clips are being applied to beveled wood or vinyl siding, bend the two tabs on the clips so that the clips are installed in a vertical position.

Locate clips 1/8" from door trim. Attach the clips onto the substrate with two screws (enclosed).

Place pilasters over clips and snap into place. (Fig. 2)

Installation With Vinyl Siding

Follow Installation of Pilasters and then install J-Channels around the pilasters.

Make sure to allow a small gap (3/16") between the top of the pilasters and the top J-Channel to allow the pilaster to expand.

Install vinyl siding, completing the wall before installing the top mantel. (Fig.3)

Installation of Mantel Full Length-Mantel

Develop a chalk line that represents the bottom of the mantel. Mark the center of the mantel on the chalk line.

Mark 17-11/16" from both sides of centerline. Draw an 8" vertical line at both marks.

Attach two clips on both lines. Make sure that both clip throats fall in the area that is 3-1/8" to 7-3/8" from the chalk line. When applying on beveled siding you will have to shim and or bend the top of the clips to keep the clip throats the same distance from the wall. (Fig.1)

Place locking legs over the four clips and snap into place. *NOTE: In new construction applications using vinyl siding, the mantel will sit on top of the cap. In all other situations the mantel will sit on the pilaster behind the cap.* (Fig.2)

Modified Length-Mantel

To lengthen a mantel, cut the ends off two mantels. The mantels should be equal in length and must span the required distance. (Fig. 3)

To shorten a mantel, cut out a center piece to make two equal size mantels totaling the required length.

Place the two cut mantels face down and locate hole for mantel overlay. From centerline (cut edge) of mantels measure over 2-3/4", and from top of mantels measure down 4-1/8". At these locations, drill one 3/16" hole into each mantel piece. Place mantel overlay face down located under the two mantel sections. Make sure to tightly butt the two mantel parts and then fasten the two mantels to the overlay with two #8x1/2" screws (provided). (Fig. 4)

To stabilize the system (especially longer lengths) it is recommended that you screw a 6" by 7-3/4" piece of plywood centered into the back of the two mantels. This will eliminate sagging.

To install clips and mount the mantel system to one of the locking legs to determine the location of your clips. *NOTE: Seal gaps at top of mantel if Pediment / Urn system is not used.* (Fig. 5)

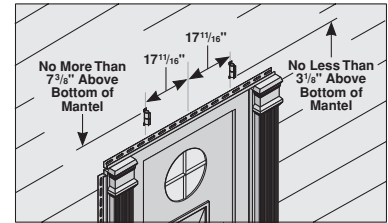

Fig. 1

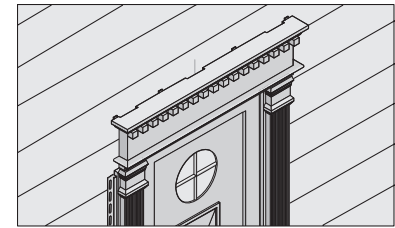

Fig. 2

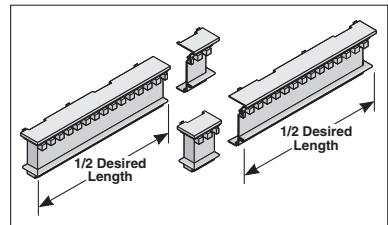

Fig. 3

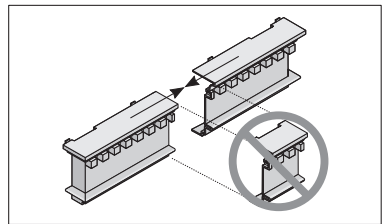

Fig. 4

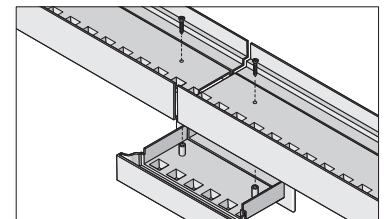

Fig. 5

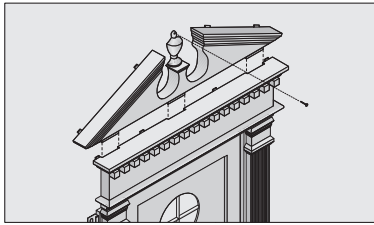
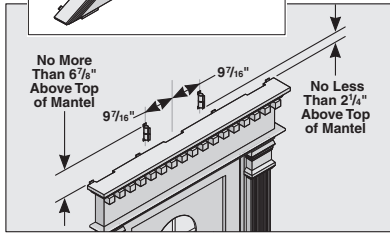
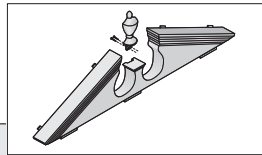

Fig. 2

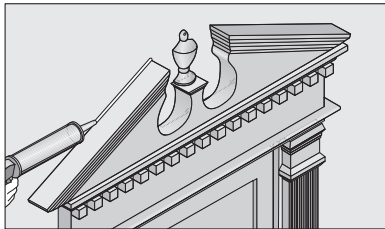

Fig. 3

*Pediment and Urn Installation
(Fits Standard Size
Mantel Only)*

Attach urn to pediment by sliding urn into place from back. Fasten with #8x1/2" self-tapping screws.

Measure 9-7/16" to each side of the mantel center line and scribe a vertical line approximately 8" long.

On each side of the lines, install two clips. Be sure the bottom of the bottom clip throats are located at least 2-1/4" above the top of the mantel and the top of the top clip throat is no higher than 6-7/8" above the top of the mantel. (Fig.1)

Position the pediment over the mantel by inserting the three male lugs on the bottom of the pediment into the matching slots in the top of the mantel.

Align the ribs over the clips and snap into place.

Secure the top of the urn to the wall by nailing through nail hole in urn. (Fig. 2)

With brick or stucco walls, caulk space between top of pediment and wall and other places where water seepage is possible. (Fig. 3)

Window Trim Capping

Measure the required dimensions to cover window trim. Also, determine the required lengths of trims.

Cut trim sheet to the measurements and form each sheet on a bending break. (Fig.1)

Trim sheet should be installed in the following order: bottom, sides, top.

Place the trim sheet on the window frame and mark it for cutting.

Create tabs into the trim sheet (both ends of bottom piece and tops of both side pieces) so that it covers the edge areas.

Miter the bottom of the side pieces and both ends of the top piece. (Fig. 2)

Nail into place using painted aluminum or stainless steel trim nails. Pre drill nail holes and do not nail tight. The top piece should be the last section to be nailed into place. (Fig. 3)

NOTE: Dissimilar Materials: Direct contact of aluminum products with certain dissimilar materials, or contact with water run-off from dissimilar materials, is likely to result in corrosion. Accordingly, care should be taken during installation to avoid such contact of aluminum with dissimilar materials including dissimilar metals (e.g. copper, zinc, steel, etc.), concrete, stucco, asbestos siding, pressure treated/pretreated lumber, masonry, roofing materials or roofing systems containing metallic granules or strips, or corrosive non-metallic materials.

A barrier must be used to separate trim from any pre-treated lumber. Optional barriers include: plastic, house wrap, roofing felt, foam, or a high quality primer or paint.

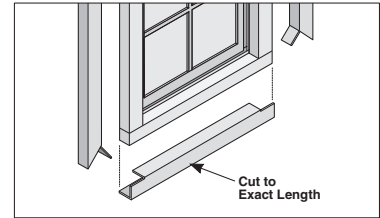

Fig.1

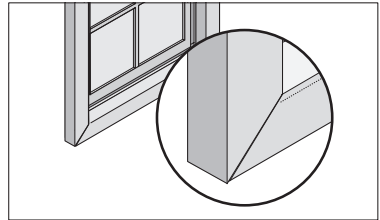

Fig. 2

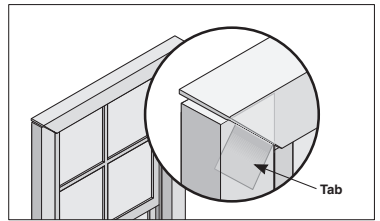

Fig. 3

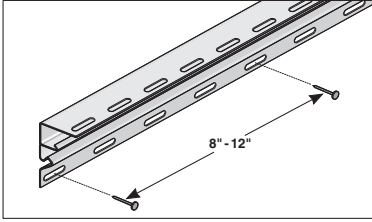

Fig. 1

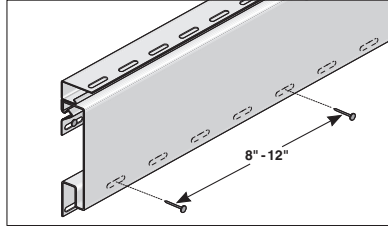

Fig. 2

Lineals

Choose either a 3.5" or 5" lineal, depending on the look you want to achieve.

At Eave or Gable, butt the small leg of the starter against, but not under the J-Channel that was installed to receive the soffit.

Nail the starter in place every 8" to 12" with nails centered in nailing slots. (Fig.1)

Push the locking leg of the lineal into the starter channel.

Nail the Lineal in place every 8" to 12" with nails centered in nailing slots.

Install utility trim into the lineal receiving channel, making sure to align nail slots with lineal nail slots.

Install last course of siding. (Fig. 2)

In some situations you may have to shim the utility trim or you can use a Double utility trim.

Band Board Installation

Option 1: Choose either a 3.5" or 5" lineal, depending on the look you want to achieve.

For easy installation (when possible), lock the lineal onto the last full course of siding.

Nail every 8" to 12" with nail centered in the nailing slots.

A drip cap must be installed along with a starter strip or J-Channel to receive the 1st course of siding above the lineal. (Fig. 4, 5 & 6)

The drip cap should be formed so that it extends up the wall 4" and extends over the face of the lineal by 3/4". (Fig. 4)

Proceed with standard panel application by installing the siding into the lineal J-Channel.

Option 2: (Fig. 2) & (Fig. 3)

Determine the location of the band board in relation to the siding making certain it does not interfere with the butt of the siding panel.

Strike a chalk line and install utility trim along the line nailing every 8" to 12" with nails centered in the nailing slots.

Lock the band board into the utility trim and nail every 36". (Fig. 2)

Once the band board is in place, install another piece of utility trim by aligning the nails slots of the finish trim with the band board lineal. You may have to shim the utility trim. Nail every 8" to 12".

To install siding panels, use a snap-lock tool to create tabs in each panel and install them into the utility trim. (Fig. 3)

Once the siding is in place, install a drip cap (field or factory formed) on top of the band board lineal to prevent water intrusion. (Fig. 4)

Finally, for horizontal siding applications, install a universal starter strip over the drip cap nailing every 8" to 12" centered in slots. Make sure to attach starter strip 1/4" above drip cap to allow siding to lock. (Fig. 5)

For vertical siding applications, install a J-Channel over the drip cap and proceed with standard panel application.

Drill 1/8" holes in base of J-Channel every 24" to allow for water to run off. (Fig. 6)

continued on next page

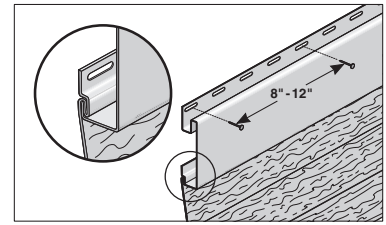

Fig. 1

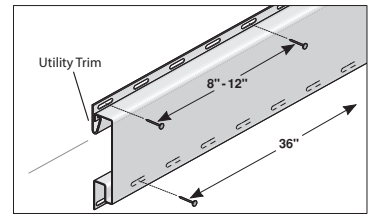

Fig. 2

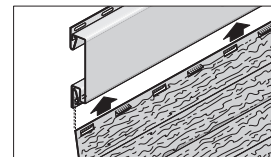
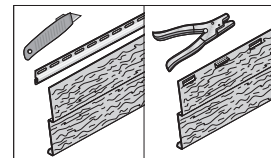
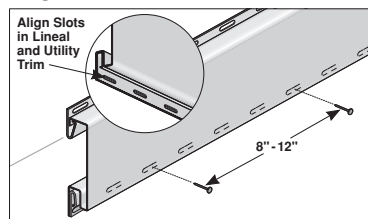

Fig. 3

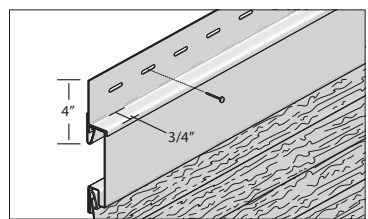

Fig. 4

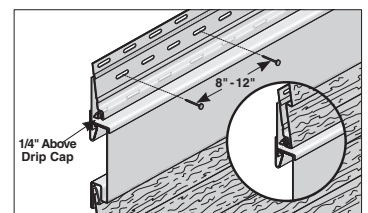

Fig. 5

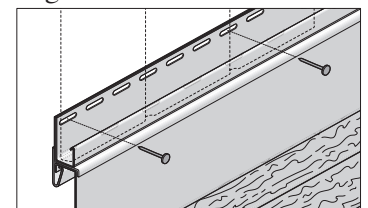

Fig. 6

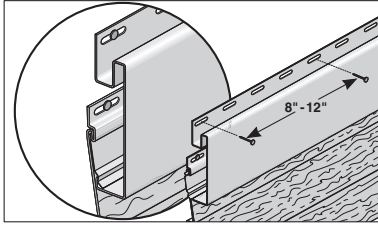

Fig. 1

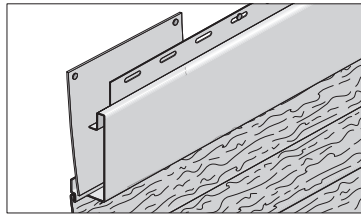
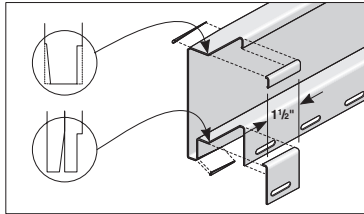

Fig. 2



Option 3:

Determine the band board location.

Install siding to that location and then install the band board. Nail every 8" to 12" with nails centered in slots.

Utilize field form aluminum to adjust the location of the lineal at the desired height.

Proceed with standard panel application for vertical or horizontal siding. (Fig. 1)

Overlapping Lineals

Notch the back legs of the lineal to be overlapped by making a series of cuts as indicated in the diagram.

Cut a tapered notch into the radius at the top and bottom of the lineal on the end to be overlapped.

Slip the un-notched lineal 1" over the notched lineal, leaving 1/2" for expansion. (Fig. 3)

NOTE: For best appearance, be sure the overlaps are away from the direction that the house is most commonly viewed.

Dentil Molding

Vinyl Siding

Snap a chalk line 6-1/2" down from the soffit panel location (chalkline.) (Fig.1)

Prepare the dentil molding either by cutting the soffit flange to create a tab, or by removing a portion of the upper soffit flange and slotting. Center of slots should be spaced 16" apart. (Fig. 2)

Butt the dentil molding to the chalk line and nail into place every 16".

If siding panels are to be terminated with finish trim to complete sidewall application, dentil mold should be slotted and nailed prior to final course of siding. Cover slots with utility trim. (Fig. 3)

Brick, Stucco or Masonry Installation

If a nailable, flat surface is not available, dentil mold can be applied as a decorative element by placing bottom edge of dentil mold into utility trim and nailing tabs to a 1"x6" or 1"x8" board. (Fig. 4)

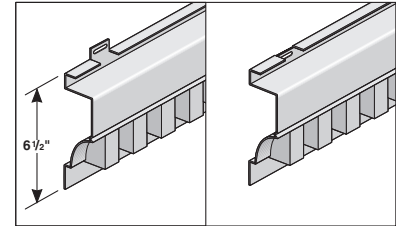
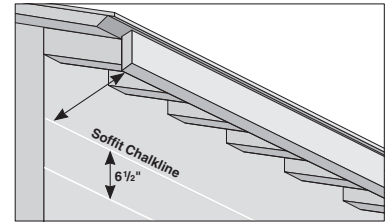

Fig. 2

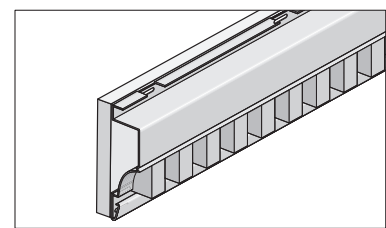
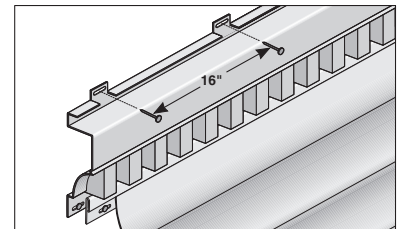

Fig. 4

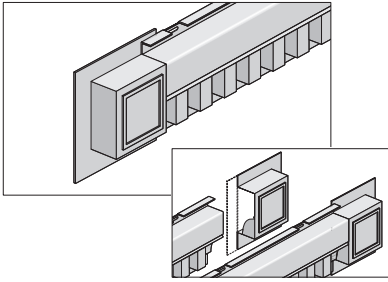

Fig. 1

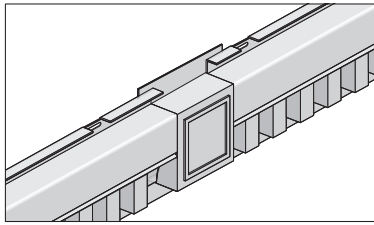

Fig. 2

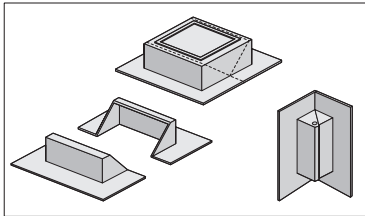

Fig. 3

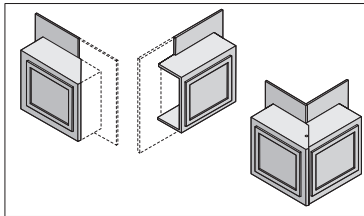

Fig. 4

Dentil Blocks

Dentil blocks finish dentil molding and can be installed at the ends, center, corners or the outside.

To install at ends, position the dentil-molding flange and trim as indicated in the illustration. (An option to installing at the end position is to scribe a line onto the dentil block, remove that portion and then position the dentil block at the end of the dentil molding.) (Fig. 1)

To install at the center, position the end block at the center of the opening and then butt the dentil molding ends into the end of the block. (Fig. 2)

To install inside corners, cut and remove sections as shown in the illustration. Once removed, pop rivet the two pieces together and then fasten it to the wall. (Fig. 3)

To install outside corners, cut and remove sections as shown. Once removed, pop rivet the two pieces together and then fasten it to the wall. (Fig. 4)

Gable Vents

For Vinyl and Aluminum Siding

Using the inward edges of the vent base as a guide, mark the area to be cut in the exterior wall surface, then cut the hole.

Center the base of the vent over the opening and level the base.

Note the word "TOP" on the base when positioning it.

Nail the base onto the wall surface through the slotted nailing flange. A water diverter should be installed at the base. (Fig.1)

Siding can now be installed around the vent base. Be sure to leave a 1/4" clearance between the cut siding and the base to allow for expansion and contraction. (Fig. 2)

Snap the face into the base by pressing firmly.

Should it be necessary to remove the face, firmly pull the face from the base. (Fig. 3)

Gable vents can be installed without cutting a hole if you want it to be decorative only.

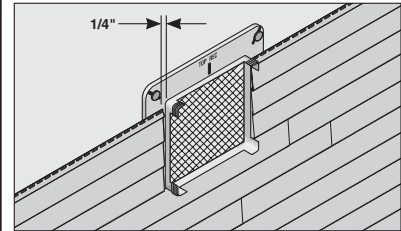
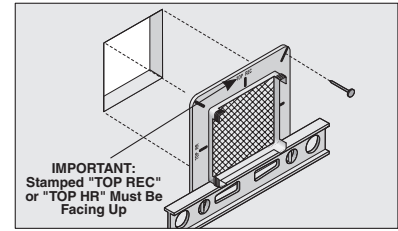
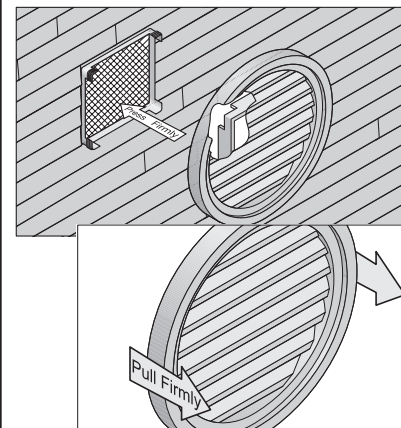

Fig. 2



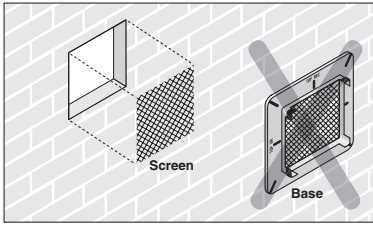

Fig.1

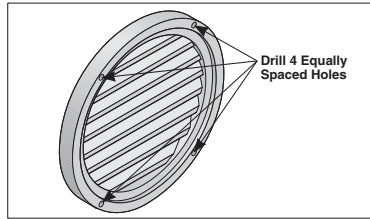

Fig. 2

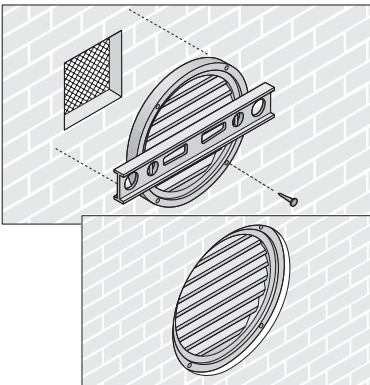

Fig. 3

For Installation onto Masonry Surfaces

Fasten the screen to the inside or outside of the wall opening. Discard the base. (Fig.1)

Drill four equally spaced holes around the outer front surface of the vent face. (Fig. 2)

Place the vent face over the exterior wall opening, level it and fasten it to the wall using masonry fasteners. (Fig. 3)

NOTE: On new homes, the vent face may be recessed into the brick.

J-Channel at roof line

Install the flashing before the J-Channel to prevent water infiltration along the intersection of a roof and wall.

Keep the J-Channel at least 1/2" from the roofline. Chalk a straight line up the roof flashing to guide J-Channel installation.

NOTE: Vinyl J-Channels should not be in direct contact with roofing shingles, since the shingles may transfer enough heat to the vinyl J-Channel to cause distortion. With dark shingles, or a south or west exposure, it is recommended to either use a metal J-Channel or raise the vinyl J-Channel approximately 2" off the shingles

J Channel

J-Channels are designed to receive the siding panels and must be installed around all windows, doors, other large openings and in the gables where built-in J-channels are not present. J-Channels can be installed over old wood casing or placed next to the casing leaving the old window casing exposed.

Water runoff can also be accomplished by making a series of notches and tabs in the J-Channel. (Fig. 2)

Install J-Channel in this order:
Bottom, Sides then top.

and install, having first ensured that there is sufficient flashing behind the J-Channel to prevent water infiltration.

Overlap the J-Channel (lapping the upper piece over the lower piece) if it is necessary to use more than one piece.

Extend the J-Channel past the edge of the roof, channeling water into the gutter, in order to ensure proper runoff.

Miter J-Channels at corners to prevent gaps and allow for proper water drainage. (Fig. 3)

Flex-J

Flexible J-Channels are designed for curved surfaces such as arched windows.

Begin nailing at one end of the arch one-half inch of the end of the channel. Never begin at the crown or middle of the arch.

Nail every six inches. (Fig. 4)

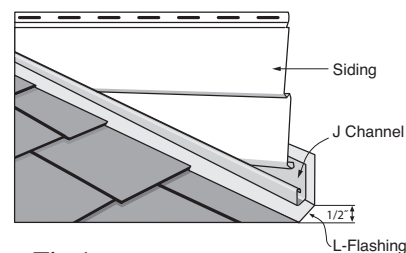

Fig. 1

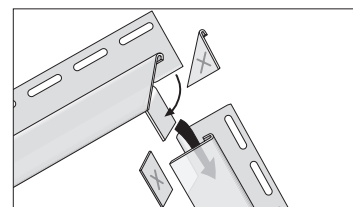

Fig. 2

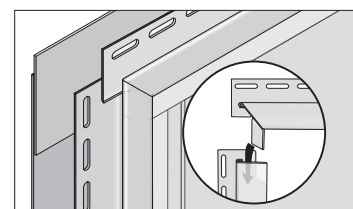

Fig. 3

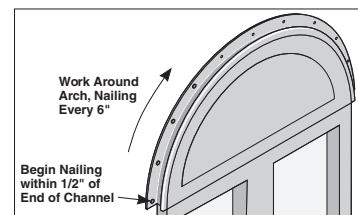

Fig. 4

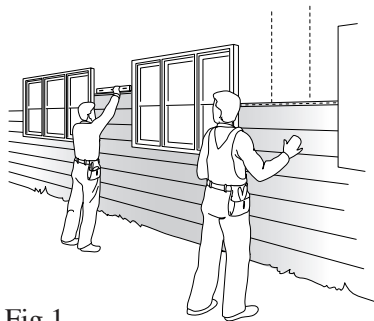

Fig. 1

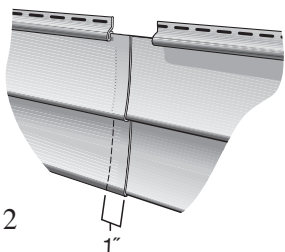

Fig. 2

Step 1

The first panel (or course) should be placed in the starter strip and securely locked along the entire length of the siding panel.

NOTE: Always overlap joints away from entrances and away from the point of greatest traffic. This will improve the overall appearance of the installation.

Step 2

Be sure to fasten the panels according to the instructions on page 14. Allowance should be made for expansion and contraction by leaving a 1/4" gap between the siding and all corner posts and channels (increase to 3/8" when installing in temperatures below 40°F).

Step 3

Do not drive the head of the fastener tightly against the nail slot. Leave 1/32" between the fastener head and the panel nailing strip.

Step 4

Do not stretch the panels up when fastening. Panel locks should be fully engaged; however, the panels should not be under vertical tension

or compression when they are fastened.

Step 5

Since vinyl siding moves as the temperature changes, make certain that the vinyl panels can move freely in a side-to-side direction once fastened.

Step 6

Check every fifth or sixth course for horizontal alignment (Fig. 1).
[Check siding alignment with adjoining walls]

Step 7

When panels overlap, make sure they overlap approximately 1" (Fig. 2).

NOTE: Overlap with factory ends whenever possible. If you must use cut ends, duplicate the factory notches before installing. Avoid stair-step lapping.

Step 8

Stagger the siding end laps so that no two courses are aligned vertically, unless separated by three courses.

Beaded Horizontal Siding

Beaded panels are factory notched in three places (Fig. 1). For best results, overlap panels using factory notched ends only. **This panel should be overlapped 1" due to the unique design of the locking and lapping system.** Overlapping more than 1" will result in less than optimal laps and increase the chances of panel restriction (Fig. 2). For easiest panel installation, start locking the panel at one end and tap the lock into place toward the other end. This panel will not lock by pushing straight up as in standard panel installation.

TIP Always overlap joints away from entrances and away from the point of greatest traffic. This will improve the overall appearance of the installation.

Fitting Siding around Fixtures

For handling protrusions around the wall, refer to the figure (Fig. 3) for hand fabricating, or use manufacturers' accessories specifically designed for this purpose. In addition, the following tips are suggested:

- Always begin a new course of siding at the fixture to avoid excess lap joints.
- Cut a slot 1/4" bigger than the fixture. (Fig. 3)
- When cutting, match the shape and contour of the obstruction. (Fig. 4)

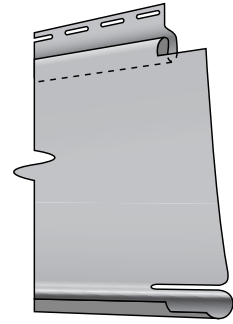

Fig. 1

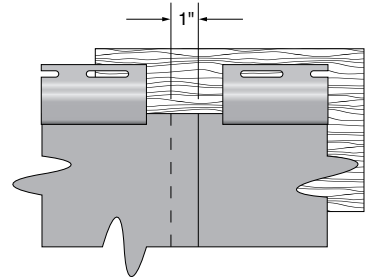

Fig. 2

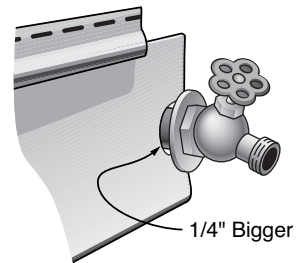

Fig. 3

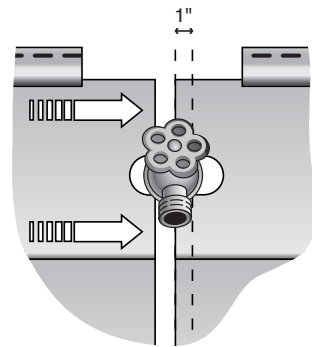

Fig. 4

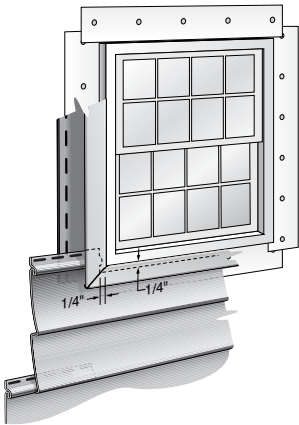
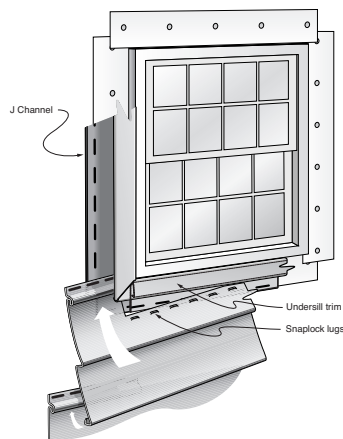

Fig. 1



Fitting under Windows

To mark the section to be cut, perform the following:

Step 1

Hold the panel under the window and mark the width of the window opening on the panel. Add 1/4" to both sides to allow for expansion and contraction of the siding. These marks represent the vertical cuts (Fig. 1).

Step 2

Lock a small piece of scrap siding into the lower panel next to the window. This will be used as a template for the horizontal cuts. Mark it 1/4" below the sill height (Fig. 1).

Step 3

Transfer the horizontal measurement to the panel, which will be installed under the window (Fig. 1).

Step 4

Cut the panel with tin snips and/or a utility knife.

The cut panel is now ready for installation under the window.

Perform the following:

Step 5

Install undersill trim under the window, inside previously installed J-channel as a receiver for the cut siding. Undersill trim is used any time the nail hem has been removed from the siding. Furring may be needed to maintain the face of the panel at the desired angle.

Step 6

Use a snaplock punch to place lugs facing out in the cut edge of the panel every 6"-10".

Step 7

Install the siding panel, making sure the lugs (from the snaplock punch) lock into the undersill trim (Fig. 2).

Finishing at the Top

Before the final course of siding is installed on the wall, any soffit accessories that will be used on the eaves must be installed.

Gable Ends

To install into gable ends, make a pattern that duplicates the slope of the gable (Fig. 1).

Step 1

Lock a short piece of siding into the gable starter course (i.e., the last course before the gable starts).

Step 2

Hold a second piece of siding against the J-Channel at the slope of the gable. Mark the slope with a pencil on the short piece of siding.

Step 3

Remove the short piece and cut along the pencil line as a pattern for the gable angle cuts. Repeat the procedure on the opposite side of the gable.

Step 4

It may be necessary to fasten the last panel at the gable peak with a trim nail. Use a 1 1/4" to 1 1/2" nail. **[This is the only time a nail should be placed in the face of the vinyl siding (Fig. 2).]**

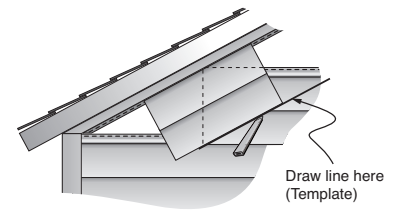

Fig.1

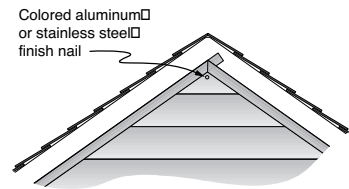

Fig. 2

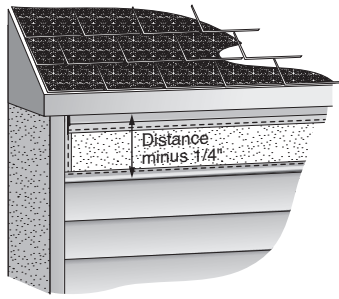

Fig.1

Eave Treatment

The last course of siding will generally need to be cut to fit the eave opening (Fig.1).

Step 1

Install undersill trim under the eave or overhang as a receiver for the cut siding. Undersill trim is used anytime the top or bottom lock has been removed from the siding. Furring may be needed to maintain face of the panel at the desired angle.

Step 2

Measure from the top of the undersill trim to the bottom of the upper lock on the previous course of panels. Subtract 1/4". Mark this dimension on the panel to be cut, measuring from the bottom edge of the panel.

Step 3

Using a snaplock punch, punch the vinyl siding along the cut edge every 6" to 10", so the raised lug is on the outside face.

Step 4

Install the siding panel, making sure the lugs (from snaplock punch) lock into the undersill trim.

Transition from Horizontal to Vertical (Fig. 1)

Finish the last course of horizontal siding with the J-channel and finish trim. Install a drip cap and a J-channel. The top piece of J-channel must have minimum 3/16" (4.8mm) diameter weep holes drilled no more than 24" (610mm) apart to allow for water runoff.

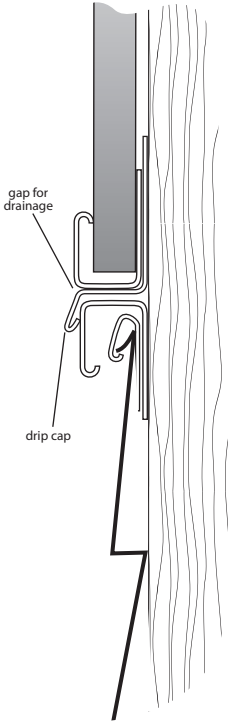

Fig.1

VERTICAL SIDING INSTALLATION

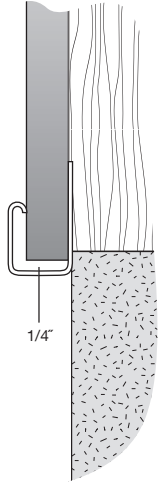

Fig. 1

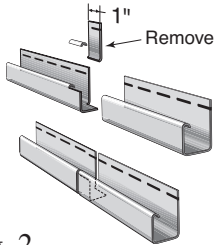

Fig. 2

When installing vertical siding, follow these steps:

Preparation

Step 1

Install a solid, nailable sheathing prior to applying vertical siding, if needed, to level the surface or provide sufficient material for proper fastener penetration. Use minimum 7/16" plywood, OSB or equivalent.

Step 2

Snap a level chalkline around the base of the sidewalls. Typically, the chalkline is positioned so that the bottom of the J-Channel is 1/4" below the lowest point on the wall that will be sided. (See the "Installing Accessories" section for tips on snapping a chalkline.) Install a J-Channel along the chalkline as a receiver for the vertical siding.

Installation

Step 1

Install vinyl outside corner posts, inside corner posts, and door/window trim, and/or J-Channel as needed. See previous sections for corner post installation techniques.

Step 2

Install top and bottom J-Channel: Apply J-Channel along the top and bottom of the walls to receive the siding panels (Fig. 1).

A Install the bottom J-Channel. Overlap J-Channels 3/4". To do this, cut out a 1" section of the nailing flange and face return (see Fig. 2).

B Install inverted J-Channel along the top of the wall, under the eave and the gable. Overlap J-Channels 3/4" to allow for expansion.

NOTE: If you're going to install soffit, you may want to install the receiving channels for the soffit prior to this point.

If a wall requires more than one course of vertical siding, use two lengths of J-Channel, back-to-back and flashing, at the joint between the two courses (Fig. 1).

If a wider wall is being covered, then you can start with a full width vertical panel. In this case you can install that first piece by utilizing a starter strip on the cut nailing hem of a vertical panel. (Fig. 1)

If a smaller wall is being covered, you should try to create a balanced appearance.

- To create a balanced appearance (Fig. 2) divide the length of the wall by the exposure of the vertical panel to be used. For example, if the wall requires 20 full panels plus an additional 8" (203mm), then the first and last pieces installed would be cut to a new width of 4" (102mm). Make sure to allow for proper depth in the receiving channels of the accessories at both ends when measuring.
- To install the siding, if partial panels are required, mark the line to cut by measuring from the edge of the lock of the panel and cut the panel to the proper width. This will leave a panel with an intact nail hem and proper exposure.

The top J-Channel must have a minimum of 3/16" (4-8mm) diameter weep holes drilled no more than 24" (610mm) apart to allow for water runoff.

Step 1

Panel installation should begin at the end of a wall section at a corner post or J-Channel. An undersill trim piece should be installed and fastened inside the opening of the corner post or J-Channel to secure the edge of the first and last course of siding. Snaplock punch the cut edge every 6" to 10", and snap the edge into the secured undersill trim. Cut and install last course in similar fashion. (Fig. 3)

Step 2

TIP: A furring strip may be needed behind the undersill trim before fastening to shim it out and maintain the lines of the vertical panel.

Maintain a 1/4" gap at each end of panels where they butt to trim pieces such as J-Channel. Failure to maintain this gap may result in permanent panel warpage. Maintain a 3/8" gap if installing at temperatures 40° F or below.

Step 3

Fasten panels every 12" through the middle of the nailing slots. Maintain 1/32" minimum clearance between the fastener crown and nail hem of panel.

Special note for vertical panel installation: Vertical panels should be cut to allow clearance as specified. Panels should be positioned on wall allowing equal clearance top and bottom. One fastener should be placed at the top of a nail slot within the upper 12" of the panel when installed. The panel will hang on this fastener and will expand in both directions rather than only upward. Balance of fastening should take place in the center of the nailing slots (Fig. 4).

Step 4

Undersill trim should be installed inside J-Channel, or built-in window receiver on the sides of windows and/or doors to secure cut edge of vertical panels. Vertical panels should be snap-locked before insertion into the undersill trim (Fig. 3). A furring strip may be needed behind the undersill trim to maintain the lines of the vertical panel.

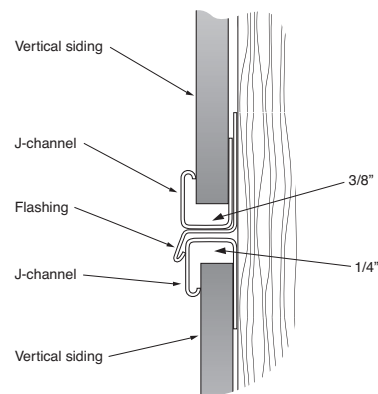

Fig.1

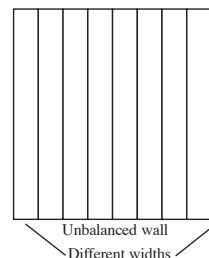
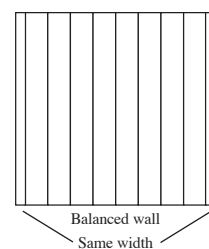

Fig. 2

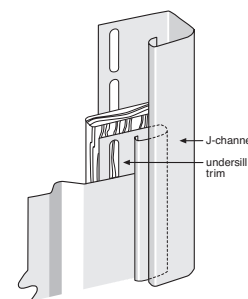

Fig. 3 Start and or finish

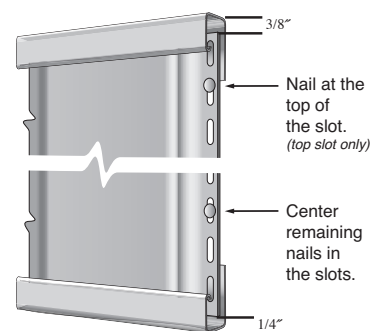

Fig.4

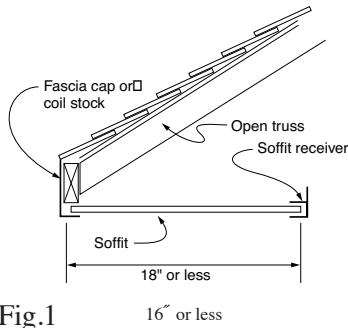

Fig. 1

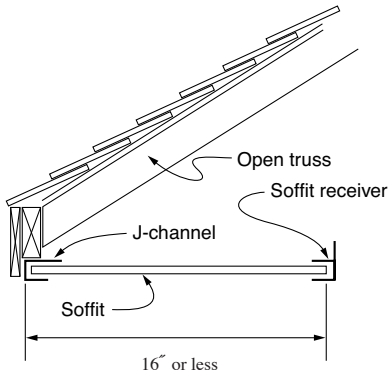

Fig. 2

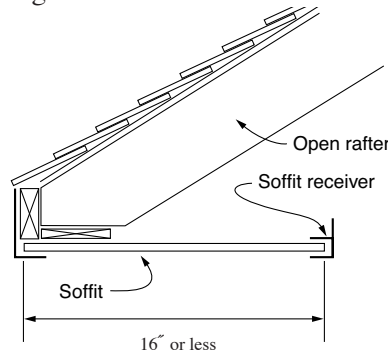

Fig. 3

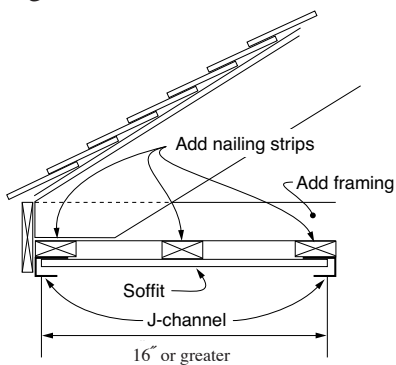

Fig. 4

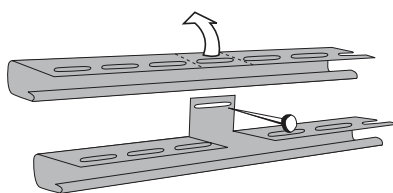

Fig. 5

Soffit is the name given to materials used to enclose the underside of eaves and porch ceilings. The installation of soffit will determine the positioning of the inside and outside corner posts.

Vinyl soffit is designed to be easily installed in residing or new construction. Soffit panels are similar to vertical siding. Soffits are available in aluminum or vinyl. Can be solid, fully perforated or lanced, or combination soffits. Also available in vinyl is a hidden vent system.

NOTE: Proper attic ventilation is important for any home. Consult a local building official for the appropriate requirements for a specific geographical area, and use vented soffit or other vented products as necessary.

Preparation

Inspect and plan the job in advance. For residing applications, nail down any loose panels, boards or shingles. Check surfaces for straightness and fur when necessary. Surfaces should be uniform and straight from various viewing angles.

The procedure used to install soffit depends on the construction of the eaves. There are two different types of eaves:

TYPE ONE

Open eaves with exposed rafters or trusses are typical of new construction. Open eave installation procedures are also used when removing damaged soffit during a residing project.

TYPE TWO

Enclosed eaves (eaves with a wood or plywood soffit already in place) are typical of residing projects.

Installation Over Open Eaves:

Step 1

Install receiving channels (F-Channel or J-Channel).

There are several ways to install receiving channels for soffit. You can use accessories such as J-Channel or F-Channel. The best approach is to select a method that works most effectively with the construction techniques used to create the eave.

Examine the illustrations at left and find one that most closely resembles the construction methods used for your particular project (Figs. 1-4). Another option is to cut tabs into J-Channel and to nail into those tabs.

Install the receiving channels following the details shown in the illustrations. Nail channels every 12", positioning the nail in the center of the slot. Fasten channels, just snug to take out excessive play. Do not over-drive fasteners.

NOTE: If the eave span is over 16", nailing strips must be installed (Fig. 4).

5-step procedure continued:

Step 2

Measure soffit panels 1/2" shorter than opening. Mark this dimension on a soffit panel and cut using a power saw with a reversed finetooth blade or snips.

Step 3

Insert one end of the panel into the channel on the wall, nail the other end to the wood fascia. (Fig. 1)

- Make certain the panel is perpendicular to the wall, and then nail. Depending on the installation method being used, nails will be hammered either into a nailing strip or fascia board.
- Do not nail soffit panels tightly.
- Continue the installation by locking and nailing the panels. Make certain the panels are fully locked along their entire length.

Step 4

To turn a corner, measure from the channel at the wall corner to the channel at the corner of the fascia board (Fig. 1). Subtract 1/4" for expansion. Cut and install H-Molding lineal or back-to-back J-Channel. If necessary, install nailing strips to provide backing for the lineal. Miter cut the corner soffit panels and install as described in Step 3.

Step 5

Install aluminum fascia as needed to finish installation. (see section on fascia installation)

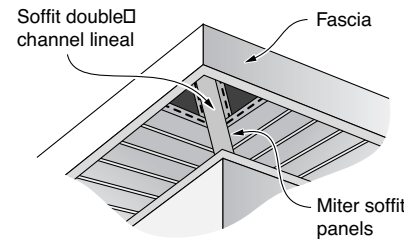

Fig. 1

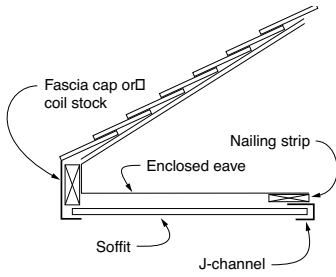

Fig.1

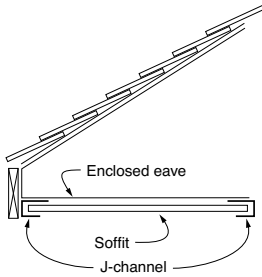

Fig. 2

Type 2

Installation Over Enclosed Eaves

The procedure used to install soffit over enclosed eaves is almost identical to that used for open eaves. A J-Channel or F-Channel can be used to receive soffit panels. (Fig. 1& 2)

Determine the preferred method of installing soffit at the fascia board.

NOTE: If the existing soffit is rotted or damaged, remove it completely before installing vinyl soffit, then use the instructions for open eaves.

Step 1

Install soffit per instructions stated previously. Choose the soffit installation method that applies to your specific needs.

Step 2

Install metal drip edge, gutter trim, undersill trim, etc. along the top of the fascia board to receive and secure the top edge of the aluminum fascia.

Step 3

Measure from the lower side of the soffit panels to the top of the trim installed on the upper side of the fascia board. Deduct approximately 1/8" from this dimension and cut fascia panel using snips, or score and break with a utility knife and straight edge.

Step 4

For the best appearance, we suggest that you do not face nail aluminum fascia. The recommended procedure

is to slip the top edge of the fascia into the drip edge (or utility trim) and secure the fascia in place with trim nails installed through the bottom side (Fig.1). Nail no greater than 2' on center.

Step 5

Outside corners: bend a 1" flange at a 90-degree angle so it turns the corner. Then cut the overlapping fascia and position as shown (Fig. 2).

Inside corners: Use same technique as outside corners.



Fig. 1

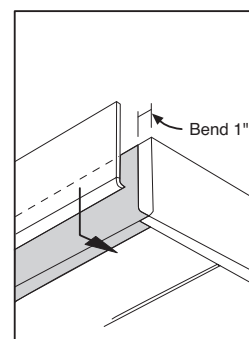

Fig. 2

NOTE: Nails or fasteners installed through the bottom of the aluminum fascia panel may penetrate the ends of the soffit panels in some installations. The following procedures are recommended if this situation occurs.

- * Line up the aluminum fascia fasteners with the V-grooves in the soffit panels to avoid cupping the soffit panel faces.
- * If vinyl soffit panels are over 24" in length, enlarge the fastener hole in the soffit panel 1/4" larger than the fascia fastener diameter. This will allow the soffit panels to expand normally and avoid potential buckling.
- * When fastening aluminum trim, you can only use aluminum or stainless steel painted trim nails. You should always pre-drill (1/8") diameter hole in the aluminum and do not drive the nail tight.

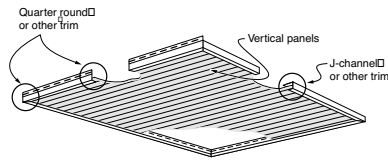

Fig. 1

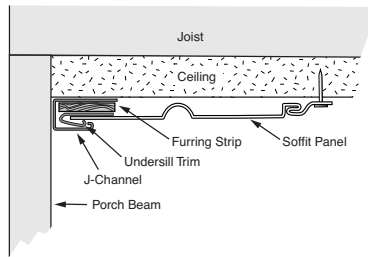

Fig. 2

Porch Ceilings

The procedures to install a porch ceiling are in many ways similar to those used to install soffit. These procedures vary slightly, depending on whether the installation is a new construction or a residing project.

INSTALLATION TIP: In hot climates or in attics with limited ventilation, it is advisable to install solid sheathing to the underside of the porch ceiling joists. This will protect vinyl soffit panels from excessive heat.

New Construction

Step 1

Begin by installing receiving F- or J-Channels on all four sides of the porch (Fig. 1). If F-Channels are being used, nail them to the existing walls or porch beams. If J-Channels are being used, a nailing base will have to be installed.

Step 2

When planning to use light blocks to attach external light fixtures, install them to adequate backing.

Step 3

Plan the layout of the ceiling panels to achieve an even balance or to align with adjacent work. If the ceiling joists run parallel to the direction of the soffit panels, additional 1" x 3" wood furring nailing strips will have to be installed. Install these nailing strips perpendicular to the ceiling joists, placing a strip every 12".

Step 4

Install an undersill trim shimmed down by a furring strip into the J-Channel or F-Channel on the starting end (Fig. 2). Cut the hook side (opposite the nailing hem) off the panel and install snap locks every 6" to 10". Install the soffit panel locking the cut edge into the undersill trim and nailing the other side through the nailing slots. **DO NOT NAIL TIGHTLY.** Install remaining panels.

Step 5

For large areas where more than one panel length is needed, use a H or T mold or back-to-back J-Channel to separate the sections.

Step 6

To install last soffit panel, use same technique as outlined in step 4 and Figure 2, except that the nailing hem sidewall be trimmed and snap lock punched every 6" to 10". Install the final panel by locking the hook side of the panel on the previous panel and inserting the cut edge into the undersill trim for a secure fit.

Residing

Step 1

Check to be sure the existing ceiling can serve as a solid nailing base.

Step 2

If the existing ceiling is solid, remove all existing moldings and fixtures from the ceiling and begin by nailing inverted J-Channels along the perimeter of the ceiling area. Then follow Steps 2 through 6 in the instructions under "New Construction". With a solid ceiling, however, additional nailing strips are not necessary. Use the existing ceiling as the nailing base for the panels.

If the existing ceiling is not solid, install nailing strips to provide a secure nailing base, then install the J-Channels. Additional nailing strips should be installed if the ceiling panels are to run parallel to the ceiling joists. Follow the instructions in Steps 2 through 6 for "New Construction".

Vinyl Siding Panel

To repair or replace a siding panel, insert the zip-lock tool under the butt of the course above the damaged panel.

Pull downward and slide the tool along the length of the panel.

Remove the nails of the damaged panel.

Install the replacement panel making sure the lock is re-engaged. (Use the ziplock tool to re-engage the panel by forcing the bottom lock over the newly replaced panel.) (Fig.1)

When re-nailing, be sure panel can move freely in a horizontal direction to allow for expansion and contraction. (Fig. 2)

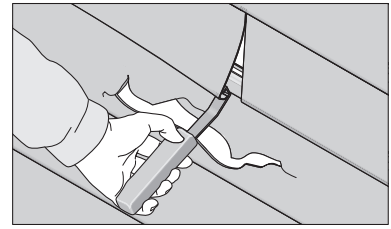

Fig. 1

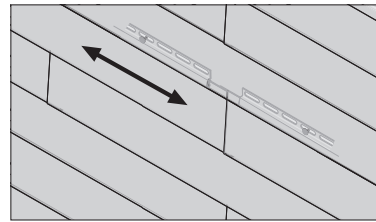

Fig. 2

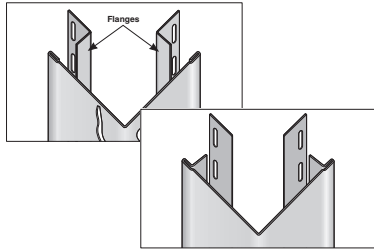

Fig. 1

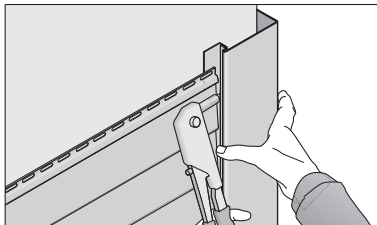
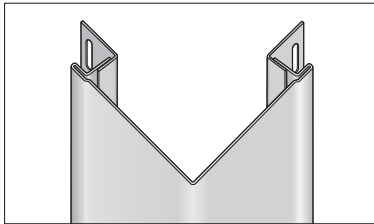

Fig. 3

Corner Posts

Using a utility knife cut away the nailing hem of the damaged corner. Be sure to leave the flange.

Trim the new corner post to fit (leaving the same flange). (Fig.1)

Position the new corner in place with flanges overlapping. (Fig. 2)

Attach the new corner posts to the existing flange with pop rivets. (Fig. 3)

J-Channel

Cut away the face of the channel.

Cut the new J-Channel away from the nailing hem. (Fig.1)

Position the new J-Channel over the old. (Fig.2)

Pop rivet the new piece into place. (Fig.3)

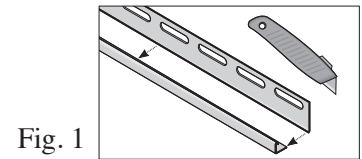
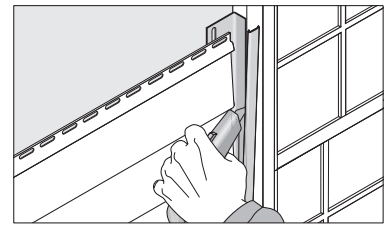

Fig. 1

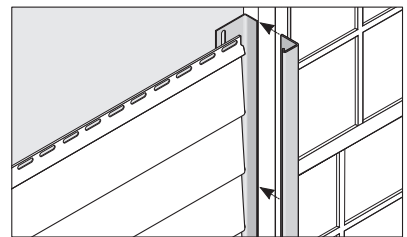

Fig. 2

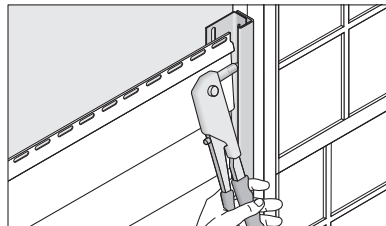

Fig. 3

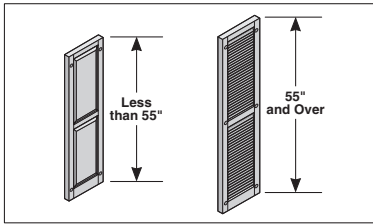

Fig. 1



Fig. 2

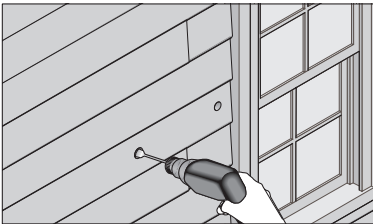

Fig. 3

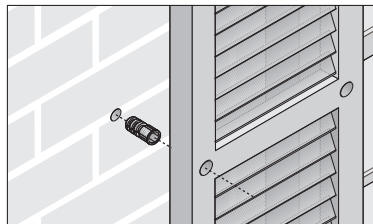

Fig. 4

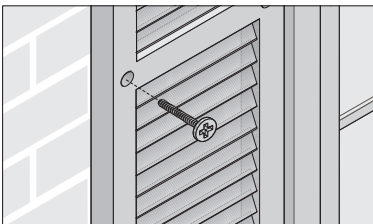

Fig. 5

Shutters

Two types of fasteners are included within the packaging of the shutter product; **metal screws** and **polymer shutterplugs**.

Use four fasteners for shutters less than 55" in length. Position top screw/plug approximately 6" down from the top of the shutter, and bottom screw/plug approximately 6" up from the bottom of the shutter. (Fig.1)

Use six fasteners for shutters 55" and longer in length. Attach the two additional screws at the midpoint along the length of the shutter. (Fig.2)

Following are the instructions when using the two types of fasteners:

Polymer Shutterplugs

Suggested for permanent, non-removable installations; works well on brick or block; solid-base construction material required; not for vinyl over foam insulation without sheathing.

Locate shutter beside window.

Drill a 1/4" diameter hole in shutter and into solid base material a minimum of 2" deep (into mortar joint locations for masonry).

Insert plug by tapping lightly with a hammer. **DO NOT FORCE SHUTTERPLUG SO TIGHTLY AS TO CAUSE DEPRESSION OF SHUTTER SURFACE.**

Metal Screws

Can be used for all solid wall surfaces.

Wood Substrates

Locate shutter beside window

Drill 7/32" diameter hole in shutter and in wood surface.

For vinyl siding applications, redrill a 3/4" hole in the vinyl siding only to allow for expansion and contraction.

Screw shutter in place with 3" long metal screws (included). **DO NOT FORCE SCREW TIGHT ONTO SHUTTER SURFACE.** (Fig.5)

Masonry Construction

Locate shutter beside window.

Drill 7/32" hole into shutter making sure to position at mortar locations.

Drill hole in mortar joint of masonry as instructed by insert manufacturer. (Fig.4)

It is necessary to incorporate inserts (not supplied in shutter packaging) to provide holding power for the screw.

Place insert in hole with hammer.

Position shutter and screw in place with 3" long screws. **DO NOT FORCE SCREW TIGHT ONTO SHUTTER SURFACE.** (Fig.5)

NOTE: Allow 1/4" gap between shutter and window and all other stops to allow for expansion and contraction.

Optional hidden fasteners for standard shutters are available from your distributor.

Tools Required

- Hammer
- Pencil
- Snips
- Nail Slot Punch
- Circular Saw with 18-24 Tooth Carbide Tipped Blade (not reversed)
- Chalk Line
- Utility Knife
- Tape Measure
- Level
- Corrosion-Resistant Siding Nails or Screws

ACCESSORIES

- Corner post:
- Shingle
- Standard
- Inside Coner Post (*j-channel can be used as inside corner*)
- Starter strip
- 3/4" minimum J-channel
- Utility trim

Note: Use universal cedar starter strip and accessories with at least 3/4" pocket depth.

Important

A SOLID NAILABLE SHEATHING, SUCH AS PLY-WOOD OR OSB IS NECESSARY FOR A PROPER AND SECURE INSTALLATION.

- This product is for exterior use only and should be installed on flat, vertical walls to maintain an even appearance.

- Panels should be acclimated to air temperature by placing them in the general work area at least one hour prior to installation. Air temperature should be checked when installing the first course of each new wall to determine the amount of panel overlap. As air temperature changes, it is NOT necessary to go back and adjust the spacing of previously installed panels.
- Allow 1/4" clearance for all stops, such as corner posts and J-channels. When installing product in very cold temperatures (<40°F), allow 3/8" clearance for expansion and contraction.
- In order to finish the wall without a short course at the top, measure down from the soffit and adjust as needed.
- For Maximum wind load nail through center of Nail Slots every 8".
- When nailing though slots, always nail in CENTER of the slot. DO NOT NAIL TIGHT. Panels must be able to move to allow for expansion and contraction caused by temperature change.
- See nailing instructions for specific panels.

Maintenance

- To clean, use mild soap with warm water to remove dirt, dust or surface stains that may collect from time to time.
- Product should NOT be painted.

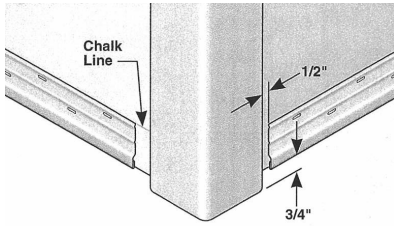

Fig.1 Standard Corner Post

STARTER

- Snap a chalk line on all walls to align the top edge of the starter strip (or J-channel).
- Installation of starter strip (or J-channel) and panels should begin on the lowest wall.
- Install starter strip (or J-channel) along the chalk line, nailing in nail slots to allow for penetration into solid wood. Wood stripping may be required to accomplish this. Nail every 6-8".

DO NOT NAIL TIGHT.

- To allow for movement, install starter strip (or J-channel) $\frac{1}{2}$ " from corner post (see Figure 1).

ACCESSORIES

- If using conventional corner post, nail at least every 12" and **DO NOT NAIL TIGHT**
- Install all accessories including J-channel, corners, etc.
Note: accessories must have 3/4" receiver.

Reference lowest area of panel and install starter strip by nailing every 12" as low as possible, starting with lowest wall and working around the house.

NOTE: Starter strip MUST be installed before corner post. Make sure Starter Strip does not overlap or butt Corner Post.

1. Align the bottom of the nail hem flange with the bottom of the starter strip (see Figure 1).

2. Nail through center hole on both sides of Corner Post.

3. Continue nailing Corner Post every 8" through center of Nail Slots.

NOTE: Do not nail tight.

4. To install additional Corner Post sections, align "V" mark on both corner sections. This will result in an "X" mark for proper installation. Nail adjoining corner through center hole.

5. Repeat Steps 3 and 4 as needed.

6. If top of Corner Post is exposed, field form a cap.

NOTE: To allow for the unevenness of the structure, before nailing center nail holes, adjust the Corner Post so that it aligns with the panel.

Installing Modified Corner Post

When necessary to remove a portion of a Corner Post to complete a wall, the remainder of the Corner Post may be used to start a different corner location.

1. Cut and remove section below butt (Figure 2).

2. Align the bottom of the nail hem flange of the cut post to the bottom of the starter strip. Nail Corner Post.

NOTE: Do not nail tight.

3. To install additional Corner Post sections, align "V" mark on both corner sections. This will result in an "X" mark for proper installation. Nail adjoining corner through center hole, and continue nailing every 8".

4. Repeat step 3 as needed.

NOTE: Panels can also be used with corner posts with foam inserts, Window Casing Trim, and 3/4" J-Channel.

SHINGLE PRODUCT INSTALLATION NOTES

Set panels at job site to allow them to reach the air temperature. Starter strip and/or J-channel and corner post must be installed before panels are installed.

Starter strip/J-channel – Use chalk line to mark level for starter. Nail starter every 12" in lowest set of nail slots.

Corner post – If using conventional corner post, nail at least every 12" and do not nail tight. If using Shingle corner post, see corner post carton for installation instructions. Panels can be cut with a circular saw or tin snips.

Panels must be installed from left to right over a nail able surface that is covered with house wrap, as siding alone is not intended to be a water or moisture barrier. Start with the lowest wall on the house. To allow for panel movement with temperature change, allow 1/4" gap in all corner posts and J-channels.

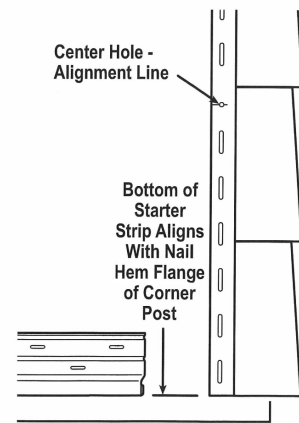

Fig.1

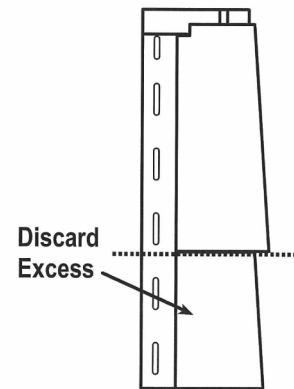

Fig.2

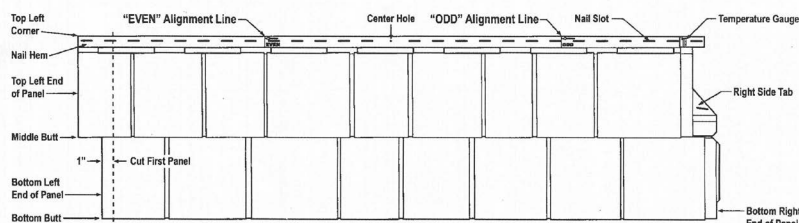

Fig. 1

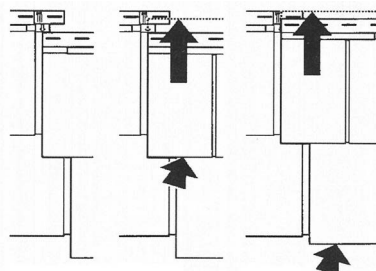

Fig. 2

Fig. 3

Fig. 4

Air Temperature	100°F	70°F	30°F
Panel Overlap			

Fig. 5

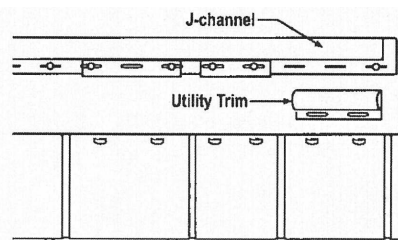

Fig. 6

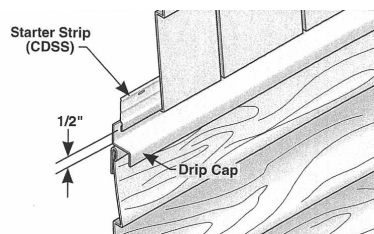

Fig. 7

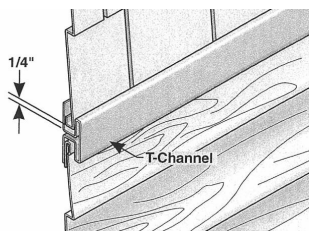

Fig. 8

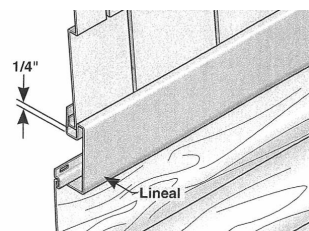

Fig. 9

INSTALLING PANELS

Align the top left side below the arrow on the previously installed panel (See Figure 2).

Apply pressure to middle butt and slide panel up until the top of the panel aligns with the bottom of the nail slot (See Figure 3).

Apply pressure to bottom butt and slide panel up to fully engage (See Figure 4). Slide panel left or right to align with the proper temperature mark (See Figure 5).

NAILING PROCEDURE

Do NOT nail tight.

First, nail through center nail hole – not nail slot. If using partial panel, find center of nail hem and drive nail through center of nail hem (*not in nail slot*).

Next, nail every 8" through center of four nail slots.

Last, nail through slot in right side tab.
NOTE: When nailing through slots, always nail in center of slot, and DO NOT NAIL TIGHT. Panels must be able to move to allow for expansion and contraction caused by temperature change.

1st Course, 1st Panel

Measure and cut 1" from bottom left end of panel (See Figure 1). Leaving 1/4" gap at end of panel, insert left end of panel in to corner post and lock onto starter. Nail panel according to "NAILING PROCEDURE".

1st Course, 2nd Panel

Use full panel and install according to "INSTALLING PANELS". Nail panel according to "NAILING PROCEDURE".

Repeat for remaining full panels in 1st course.

Last Panel of Each Course

Measure from the appropriate temperature mark on the previous panel into the corner post, allowing 1/4" gap for movement. Mark and cut this distance from top left corner of panel.

NOTE: To reduce waste, pieces cut from last panel on each course can be used as starter pieces on adjacent walls; or,

if larger than 14" can be cut to length as starter piece for next course on the same wall.

Install panel according to "INSTALLING PANELS" and nail according to "NAILING PROCEDURE".

2nd Course (and all remaining even courses), 1st Panel

Measure from inside of corner post to EVEN line on nail hem of 1st panel of course below. Cut piece by measuring this distance from bottom right end of new panel.

Install panel by aligning the bottom right end with the EVEN line on nail hem below. Install according to "INSTALLING PANELS" and nail according to "NAILING PROCEDURE".

Install remaining panels in course.

3rd Course (and all remaining odd courses), 1st Panel

Measure from inside of corner post to ODD line on nail hem of 1st panel of course below. Cut piece by measuring this distance from bottom right of new panel. Install panel by aligning the bottom right side with the ODD line on nail hem below. Install according to "INSTALLING PANELS" and nail according to "NAILING PROCEDURE". Install remaining panels in course.

INSTALLING AROUND WINDOWS

Keep the panel pattern across all openings. When installing under windows, cut panels to required width. Use snap lock tool to punch tabs in top edge of panel. Cut small pieces of utility trim, install and nail into J-channel. Install cut panels into trim, avoiding grooves on panels (See Figure 6).

Last Course on Wall

Cut panels to required width. Use snap lock tool to punch tabs in top edge of panel. Cut small pieces of utility trim, install and nail into J-channel. Install cut panels into trim, avoiding grooves on panels (See Figure 6).

INSTALLING ABOVE HORIZONTAL SIDING

Options for transition include:

- Starter Strip with Drip Cap (see Figure 7).
- Field-formed T-Channel (see Figure 8).
- Lineals (see Figure 9).

NOTE: When starting with any channel or lineal, a base flashing should be used.

NAILING PROCEDURES

- DO NOT NAIL TIGHT
- First, nail through center nail hole - not nail slot.
- If using partial panel, find center of nail hem and drive nail through center of nail hem (not in nail slot).
- Next, nail every 8" through center of four nail slots.
- Last, nail through slot in left tab.

NOTE: When nailing through slots, always nail center of slot, and DO NOT NAIL TIGHT. Panels must be able to move to allow for expansion and contraction caused by temperature changes.

FIRST COURSE

NOTE: Panels must be installed from right to left.

- Cut the first Panel at "A" (See Figure 10).

NOTE: To Provide for panel movement, allow 1/4" gap at all corner posts, J-Channels, or other stops.

- Engage bottom lock firmly into starter strip. Nail according to "nailing procedures."

- Slide the next panel into position. The top half of the panel, except the nail hem, slides under, and the bottom half slides over the previous panel. (See Figure 11)

NOTE: The amount of panel overlap is important and varies depending on air temperature. Check and monitor air temperature when starting to install the first course on each wall. See Chart for amount of overlap. (See Figure 12).

- Nail according to "Nailing Procedures."

- Install additional full panels, repeating steps B-D

INSTALLATION

Last Panel on Each Course

- Measure the distance from the correct line on the temperature gauge into the corner post, less 1/4".
- Cut off left end of panel.
- Engage lock into starter strip or continuous lock of previous course, pull up tight and nail according to "NAILING PROCEDURES."

Installation Tip: Panels will flex to allow installation. To minimize waste, cut pieces can be used as starter pieces on adjacent wall.

Using Alignment lines

NOTE: Temperature gauge is used only for installation of the first course on each wall. Do NOT adjust temperature gauge on panels after 1st course is complete "except when adjusting panels for windows or last panel of each course".

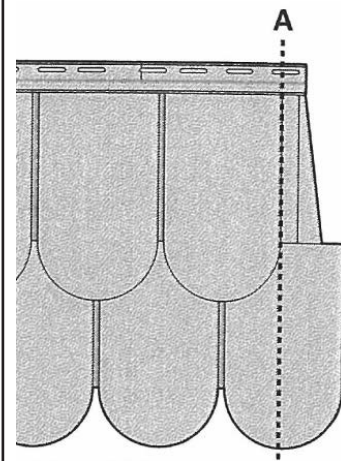

Fig.10

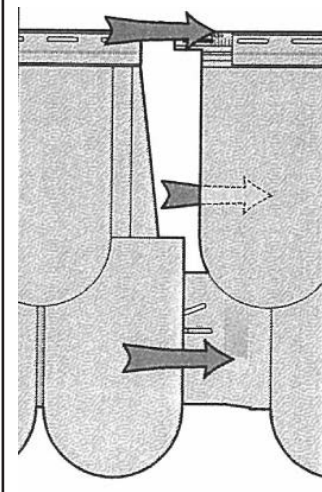

Fig.11

Air Temperature (°F)	10	30	50	70	90
Temperature Mark	1/4		1/8		0
Panel Overlap					

Fig.12

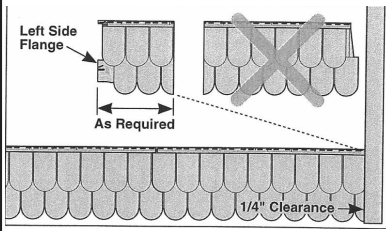

Fig.13

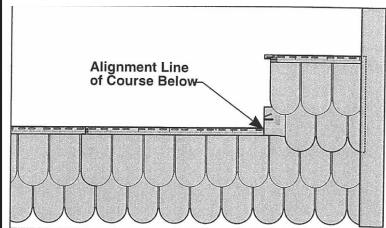

Fig.14

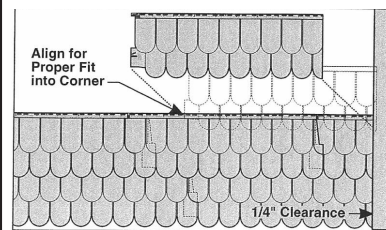

Fig.15

Fig.6

For 2nd and subsequent courses, align Left Side Flange with nearest Alignment Line that allows proper fit and overlap of shingles. Be sure to cut panel to stagger vertical laps.

Second Course (and all even courses)

a. Round Cuts – Measure appropriate distance from the Left Side Flange of panel (allowing for staggered vertical laps) and cut (see Figure 13)

b. Round Cuts –Align Left Side Flange with nearest Alignment Line of course below that allows for proper fit into corner post or J-channel (see Figure 14).

c. Engage lock securely into continuous top lock of course below

d. Pull up tight and nail according to “NAILING PROCEDURES”.

e. Continue installing full panels in the course, following Steps c-d.

f. To finish course, refer to the previous section titled “Last Panel on Each Course”.

Third Course (and all odd courses)

a. Measure the distance from the first RIGHT Alignment Line “0” of the course below to the edge of the corner post or J channel plus 1/4” (see “A” on Figure 14).

b. Engage lock securely into continuous top lock of course below

c. Round Cuts – Align Left Side Flange with nearest Alignment Line of course below that allows for proper fit into corner post or J-channel (see Figure 15).

d. Pull up tight and nail according to “NAILING PROCEDURES.”

e. Continue installing full panels in the course, following Steps c-e above.

f. To finish course, refer to the previous section titled “ Last Panel on Each Course” on page 49.

Securing Panels Around Windows

- Measure and cut panels around windows, allowing $\frac{1}{4}$ " into all window channels for movement. (see Figure 16).
- Make sure to install water diverters at the bottom corners of the window (refer to Basic Accessory Installation Section "Installing J-Channel, Flex-J and Flashing").
- Use a nail slot punch to create nail slots every 8" on the cut edge of the panel.
- Furr as needed.
- Slide panel into window channel.
- Pull up tight and nail according to "NAILING PROCEDURES" (window channel must conceal nail-heads).

Installation Tip: A nail set can be used to ease installation.

Installing Final Course

NOTE: A crown molding, J-channel or wide window casing can be used in eaves and gables to receive the final course (see Figure 17).

- Measure the required width for last course less $\frac{1}{4}$ " to allow for panel movement.
- Cut panel height as required.
- Punch nail slots every 8".
- Nail through center of slots.

NOTE: Furring may also be required.

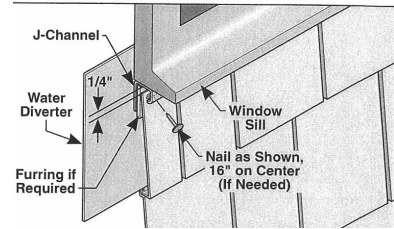

Fig.16

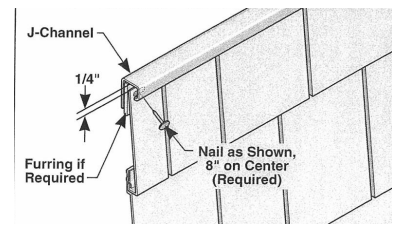

Fig.17

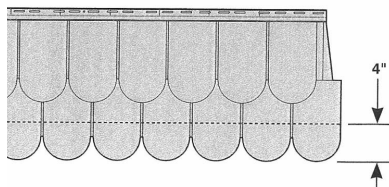

Fig.18

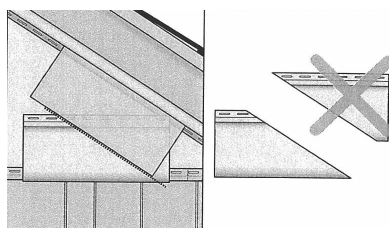

Fig.19

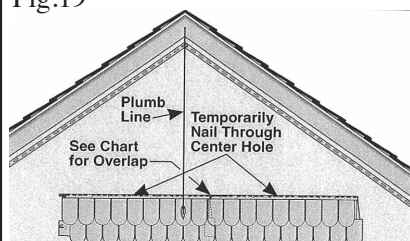

Fig.20

Air Temperature (°F)	10	30	50	70	90
Temperature Mark	1/4		1/8		0
Panel Overlap					

Fig.21

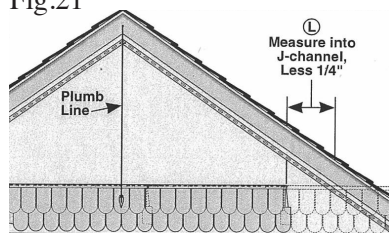

Fig.22

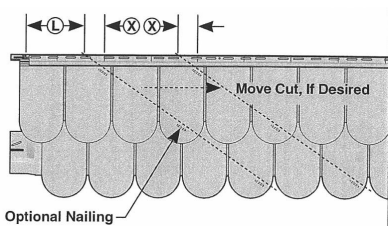

Fig.23

INSTALLATION

Installing Round Cuts on Gable Ends

Round cuts can be installed directly onto Cedar Dimensions Shingle panels. If desired for transitions, panels can be installed using Starter strip over Drip Cap, or into T-Channel or Lineals. When installing into any channel or lineal, cut 4" from the bottom of the Round Cuts (see Figure 18). Allow 1/4" gap for panel movement.

NOTE: PANELS MUST BE INSTALLED FROM RIGHT TO LEFT. Do not nail tight. Allow 1/4" into all channels, posts and stops. Make a template for gable angle by locking a short piece of siding into the gable starter course. Hold a second piece against the gable finish trim. Mark angle on first piece and cut (see Figure 19). Make templates as needed.

Centering Round Cuts on Gable Ends

When installing Round Cuts in gables, the last piece should be centered at the peak of the gable for proper appearance.

a. For symmetrical appearance at peak, position and lock full panel in the first course with Round Cuts at center of the gable (see Figure 20).

Temporarily fasten through center hole. Continue temporarily installing full panels toward right side of the gable (see chart, Figure 21, for overlap).

b. When less than full panel is needed, measure top of Nail Hem into gable end trim, less 1/4" (see Figure 22). Use this dimension (L) to cut first piece for installation.

c. To locate the cut mark on 1st panel, measure from the appropriate temperature mark to the right and mark top of Nail Hem (see "L" on Figure 23).

d. Use template and cut at mark. If needed for secure installation, move the mark an equal distance (X on Figure 20) from any Alignment Line.

e. Remove temporarily nailed panels.

Installing 1st Course on Gable End

- a. Use panel cut in step “d” above. If installing into Siding or Starter Strip, lock firmly, pull up tight and nail according to “NAILING PROCEDURES.”
- b. Slide the next panel into position. The top half of the panel, except the Nail Hem, slides under, and the bottom half slides over the previous panel. The Nail Hem will be on top of the previous panel (Figure 24).
Nail slots can be placed at angle cut for additional nailing.
- c. If this is your first course of Round Cuts refer to chart for over lap amount (Figure 25).
- d. If this is not your first course of Round Cuts, align Left Side Flange with nearest Alignment Line of course below that allows for proper fit into right end finish trim.
- e. Engage bottom lock firmly into Siding or Starter Strip, pull up tight and nail according to “NAILING PROCEDURES”.
- f. Install additional full panels, repeating Steps c-e.

Last Panel on Each Course

- a. Make template for angle if needed.
- b. Measure distance from correct line on temperature gauge into the gable end trim, less 1/4” (see “L” on Figure 26).
- c. Measure panel from right end of Nail Hem and cut at correct angle (see “L” on Figure 27).
- d. Engage lock into starter strip or continuous lock of previous course, pull up tight and nail according to “NAILING PROCEDURES.”

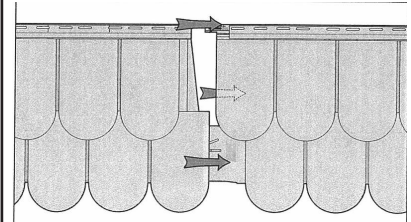

Fig.24

Air Temperature (°F)	10	30	50	70	90
Temperature Mark	1/4		1/8		0
Panel Overlap					

Fig.25

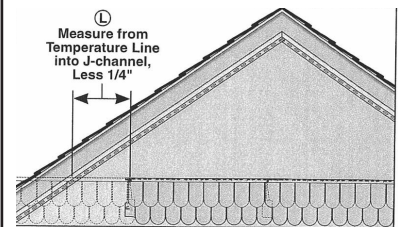

Fig.26

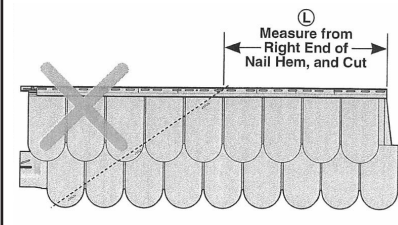

Fig.27

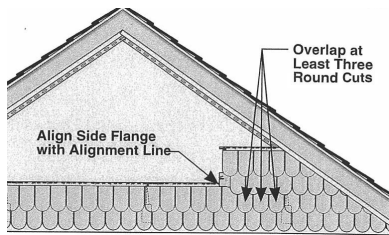

Fig.28

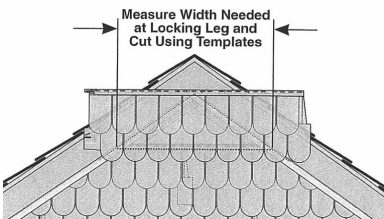

Fig.29

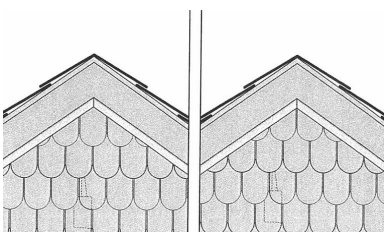

Fig.30

2ND and Subsequent Courses on Gable End

a. Make new template for angle if needed.

b. Measure from the Left Side Flange making sure to stagger the laps by at least 3 half-rounds (Figure 28).

c. Align Left Side Flange with nearest Alignment Line of course below (Figure 28).

d. Insert Bottom Lock into Top Lock of course below. Pull up tight and nail according to "NAILING PROCEDURES".

e. For second and subsequent panels, align Left Side Flange with nearest Alignment Line of course below that allows for proper fit.

Insert Bottom Lock into Top Lock of course below. Pull up tight and nail according to "NAILING PROCEDURES".

Final Course on Gable end

a. Measure width needed at bottom lock (see Figure 29).

b. Carefully check alignment of Round Cuts to center full or partial rounds as needed and cut (see Figure 30).

c. Insert Bottom Lock of final course into Top Lock of course below, pull panel up tight, and nail at peak using a color matching trim nail.

Mansard Roof Installation Instructions

Cedar Dimensions™ can only be installed on mansard roofs with a slope of 45/12 or greater (15-degree angle or less). It must be attached with standard siding nails into a solid wood substrate.

The sheathing must be covered with either:

1 layer 30 lb. roofing felt with a 6" minimum horizontal and vertical laps.

2 layer 15 lb. roofing felt (see Figure 1).

A field formed flashing must be installed at the bottom of the mansard. This can also be the cap for the soffit. The flashing should go up the roof a minimum of at least 4". (see Figure 2).

The Cedar Dimensions™ starter strip should be installed onto the flashing. Follow the standard installation guidelines. (see Figure 3).

Install any 3/4" corner post system at all transitions. The bottom of these corner posts should be closed off by bending flaps as shown (see Figure 4).

Install all Cedar Dimensions™ courses cutting the last course as required. Slot nail holes and nail into top of mansard following standard installation guidelines for last panel installation (see Figure 5).

Form a cap from trim sheet that will cover the top of the mansard and come down to cover the nails that are holding the last course of Cedar Dimensions™. It is recommended that this flashing be installed under the top roofing or behind the sidewall system (see Figure 6).

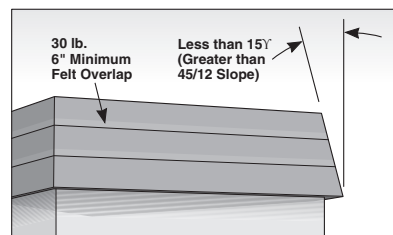

Fig. 1

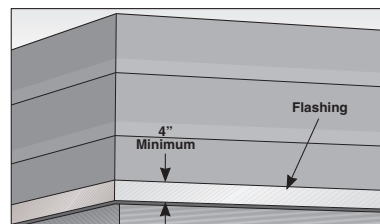

Fig. 2

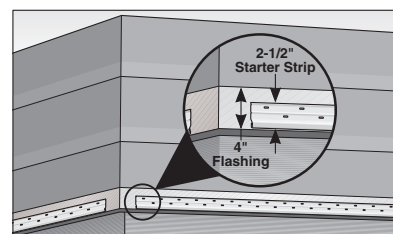

Fig. 3

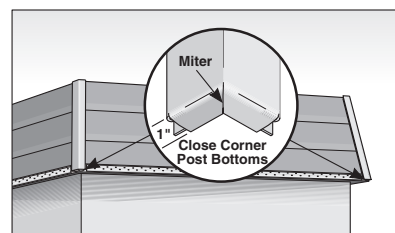

Fig. 4

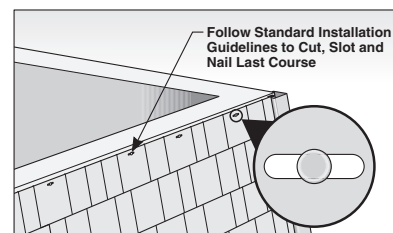

Fig. 5

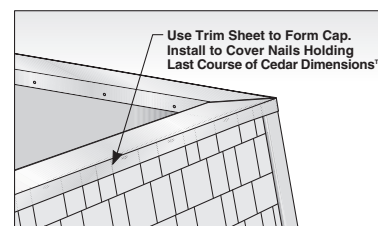

Fig. 6

When historic restoration projects arise, the manufacturer recommends the following:

Step 1

If a building is in a historic area, local Historic District or has been designated as a historic building, make sure that approval for the use of vinyl siding has been obtained from the local historic society or local Historic District Commission. This applies to building additions as well.

Step 2

Before a historic building is resided, it should be examined for moisture, insect infestation, structural defects, and other problems that may be present. These problems should be addressed and the building pronounced “sound” before residing with any material.

Step 3

Do not damage or remove the original siding. If at all possible, do not alter the original structure, so that the application of vinyl siding is reversible (i.e., the original siding would remain intact in the future, so that if desired, the vinyl siding could be removed). Exception: “In cases where a non-historic artificial siding has been applied to the building, the removal of such a siding before application of vinyl siding would, in most cases, be acceptable”.

1Preservation Briefs, Number 8, U.S. Department of Interior, 1984.1

Step 4

Exercise every care to retain architectural details wherever possible. Do not remove, cover, or add details until the building owner’s written approval has been obtained. Determine that the owner has consulted the local historic society for approval.

Step 5

Use siding that closely approximates the appearance of the original siding in color, size and style. In historic districts, the goal is to match the product as closely as possible and retain the original trim.







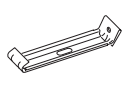
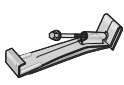

*For further information, contact:
Historic Preservation at www2.cr.nps.gov*

Leaf Relief® Chart

Seamless Gutters

	Spike/ Ferrule	Hidden Hanger Systems	Zip Hanger Systems	No Hanger/ New Gutter
				
TP5300/ TP6300	✓	✓		
TP5100/ TP6100	✓	✓		
SN5200S SN6200S				✓
TP53ZIP TP63ZIP			✓	

Foldover Style Gutter

	Snap In (Free Float) (OG13LR5)	Combin- -ation (OG101)	No Hanger	Snug Fit (OG91)	Bar 5" (OG12R1)	Bar 6" (OG12R61)	Strap 5" (OG111)	Combin- -ation Strap 5" (OG141)	Roof Hanger 5" (OG131)	Roof Hanger 6" (OG1361)
										
TP5300/ TP6300	✓								■ ✓	■ ✓
TP5100/ TP6100	✓								■ ✓	■ ✓
SN5200S SN6200S			✓							
TP53ZIP		✓		✓	✓			✓		
TP63ZIP						✓				
OG13LR5							★ ✓			

- Field notch Leaf Relief® at rod.
- ★ Cut or remove existing hanger.

NOTE: See product guide for ordering code.

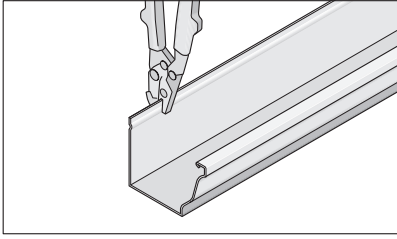

Fig. 1

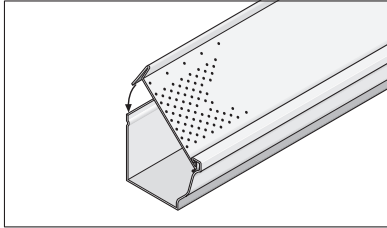

Fig. 2

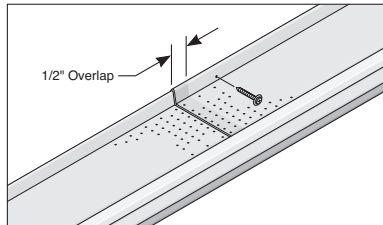

Fig. 3

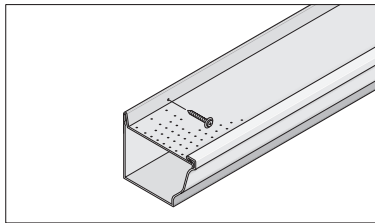

Fig. 4

5~/6" Leaf Relief[®] New Gutter Installation

Prepare the Gutter

Prepare the gutter for downspouts and end caps (including sealant) according to job requirements.

NOTE: Shingles shall extend past drip edge no more than 1/2".

Install Leaf Relief[®] System

Option One (Preferred)

Use snap-lock punch (Malco SL5) or end-cap crimping tool (Malco SL2 – adjustment required) to create lugs every three feet on the back of the gutter (open lug toward fascia). (Figure 1)

Clip the Leaf Relief[®] into the front of the gutter and snap it over the lugs on the back. (Figure 2)

Clip subsequent Leaf Relief[®] sections with 1/2" overlap. (Figure 3)

Lift the gutter and system into place against the fascia and align for proper drainage to outlet.

Fasten into the fascia every 24" using #9x1-1/2" gasketed screws. (Figure 4)

NOTE: Required to use a 6" extension on drill for inserting screws.

Option Two

(when no drip edge is present)

Clip the Leaf Relief[®] system on the gutter (overlap sections 1/2") and secure every two feet by screwing #9x1-1/2" gasketed screws.

Install Leaf Relief® Corners

At inside/outside corners, install Leaf Relief® sections towards the corner with a minimum 1/2" overlap with adjacent Leaf Relief® sections.

Attach Leaf Relief® 5" corners (IC5220/ OC5220) or 6" corners (IC6220/OC6220) using 6 screws as shown in the drawing. (Figure 1)

NOTE: Prefabricated corners must be at the same level as the Leaf Relief® sections.

Important

Downspouts 3" x 4" or larger are recommended for proper function in a coniferous tree zone.

To prevent overflow, all inside corners and valleys must have a water diverter/deflector. Diverter/deflector must be installed on the top surface of the Leaf Relief® (behind front lip). (Figure 2)

The flow from high-level gutters must be transferred within downspouts directly into lower-level gutters and sealed. An alternative to this would be to install water diverters.

In applications where the Leaf Relief® is level with the endcap.

At the end of the run, make a 4" cut on the back of the Leaf Relief® up to the lip on the front. (Figure 3)

Cut parallel to the front about 1/2" from the lip.

Make another cut in the opposite direction to the lip.

Turn and fold under the excess material. (Figure 4)

NOTE: If Leaf Relief® is lower than the endcap, stop the Leaf Relief® 1/16" short of the endcap.

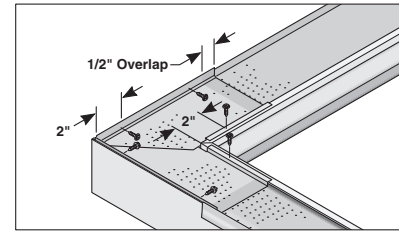

Fig. 1

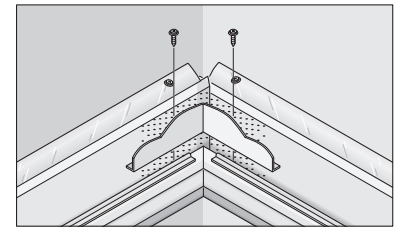

Fig. 2

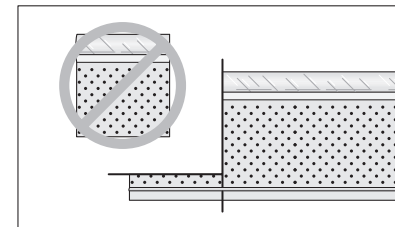

Fig. 3

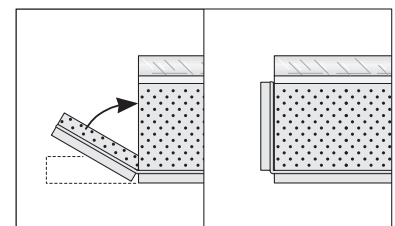

Fig. 4

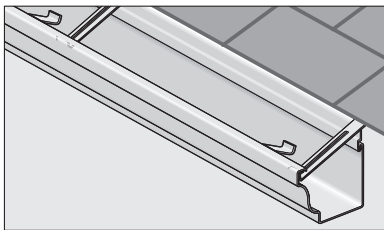

Fig. 1

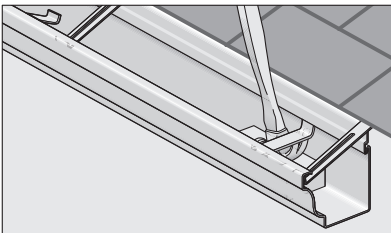

Fig. 2

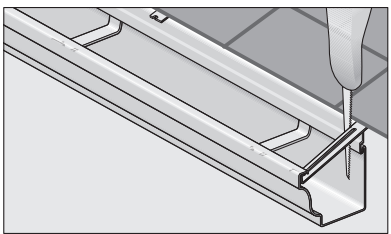

Fig. 3

Preparing Existing Foldover Gutters for Leaf Relief® Application

Replacing Strap Hangers or Bar Hangers on Existing Gutters

Hook front of snap-in (free float gutter hangers (OG13LR5) into front lip of gutter every 24" along length of gutter. (Figure 1)

NOTE: See product guide for ordering code.

Position block of wood inside gutter at hanger locations. Using claw hammer, apply pressure to bottom of each hanger until hanger engages into existing roof apron or fascia apron. Remove wooden block. (Figure 2)

For strap hangers use a metal cutting tool, such as a reciprocating saw, to cut old strap hangers at drip edge and remove from gutter system. (Figure 3)

For bar hangers remove nail or screw and remove bar hanger from gutter system.

Begin installing TP5300 Leaf Relief® product. Refer to Leaf Relief® instructions for proper installation.

5" / 6" Leaf Relief® Retro-Fit Installation on Flat Hangers or Spike/Ferrule

Prepare the Gutter

Clean and flush existing gutters and downspouts thoroughly with water.

Install Leaf Relief® Corners

Attach Leaf Relief® 5" corners (IC5220/ OC5220) or 6" corners (IC6220/OC6220) using 6 screws as shown in the drawing. (Figure 1)

NOTE: Pre-fabricated corners must be at the same level as the Leaf Relief® sections.

Important

Downspouts 3" x 4" or larger are recommended for proper function in a coniferous tree zone.

To prevent overflow, all inside corners and valleys must have a water diverter/deflector (ASDIV). Diverter/deflector must be installed on the top surface of the Leaf Relief® (behind front lip). (Figure 2)

The flow from high-level gutters must be transferred within downspouts directly into lower-level gutters and sealed. An alternative to this would be to install water

diverters.

Install Leaf Relief® System

NOTE: For TP5100P and TP6100P; slide "J" receiver onto the Leaf Relief® sections.

Place the Leaf Relief® sections on top of the gutter with the vinyl strip against the fascia or drip edge. For proper function, the Leaf Relief® surface (front-to-back) must be level or have a slight slope toward the fascia. Do not install Leaf Relief® over hangers that will result in a forward slope.

For best support, place Leaf Relief® so that the piece nearest the hanger is beneath the adjoining Leaf Relief® section (overlap 1/2" with adjacent Leaf Relief® section – do not butt). Add or replace hangers as needed for proper support (maximum support spacing is 30"). (Figure 3)

Starting at one end, fasten front of Leaf Relief® to gutter every 24" using #6-3/8" screws. (Figure 4)

NOTE: For TP5100P and TP6100P; adjust the "J" receiver to fit the width of the gutter. Using same screws as noted above, attach every 2' as shown.

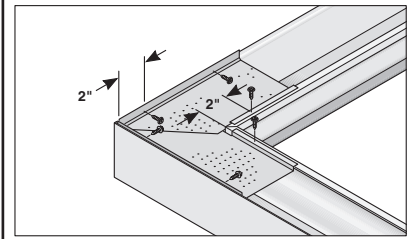

Fig. 1

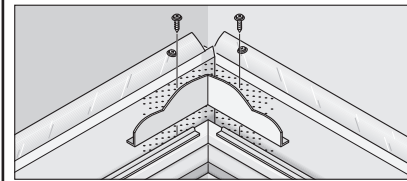

Fig. 2

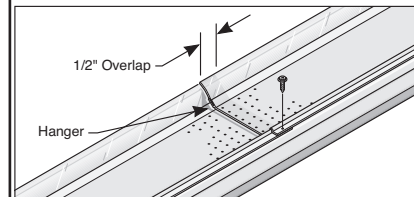

Fig. 3

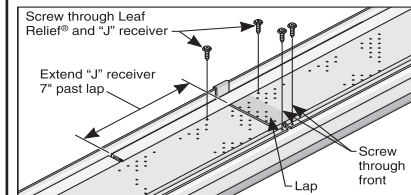
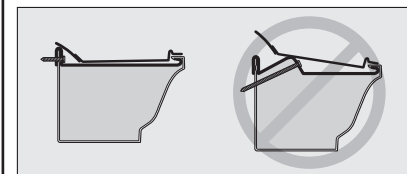

Fig. 4



For application using zip hangers, see section.

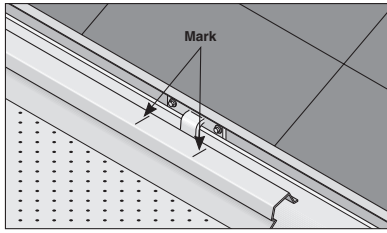

Fig. 1

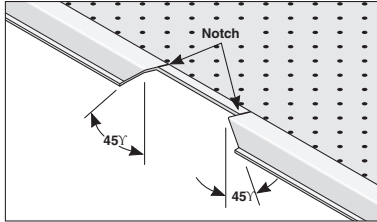

Fig. 2

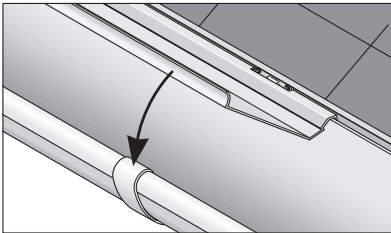

Fig. 4

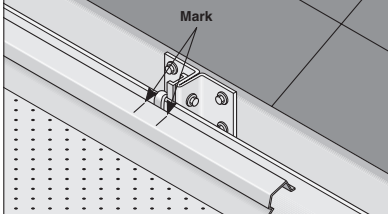
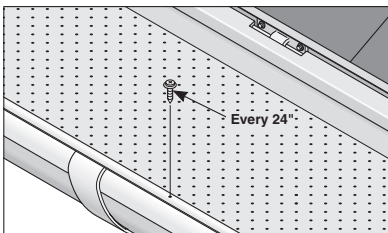

Fig. 5

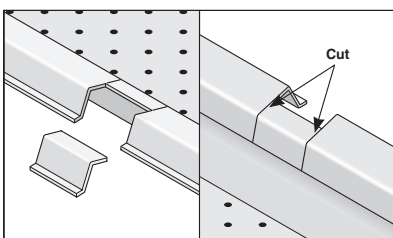

Fig. 6

Installing Leaf Relief[®] on Half-Round Gutters

Wrap-Around Fascia Hangers

Lay Leaf Relief[®] on gutter in front of hanger and mark location of bracket (see Figure 1).

Notch back of Leaf Relief[®] as shown in Figure 2.

Firmly press back of Leaf Relief[®] behind gutter, and pivot down to rest on front lip of gutter (see Figure 3).

Attach with screws through Leaf Relief[®] and front lip of gutter every 24" (Figure 4).

Continue installing Leaf Relief[®] panels, overlapping 1/2". As required, a screw can be inserted through overlapping panels to reduce sagging.

Spring Clip Bar Hangers

Lay Leaf Relief[®] on gutter in front of hanger and mark location of bracket (see Figure 5).

Cut and notch Leaf Relief[®] as shown in Figure 6.

Installing Leaf Relief® on Half-Round Gutters continued

Spring Clip Bar Hangers continued

Bend tab on Leaf Relief® as shown in Figure 1.

Release spring clip on front of gutter and bend up back tab holding gutter. (Figure 2).

Place Leaf Relief® on gutter, bend hanger back tab over the back of the Leaf Relief®. Fasten hanger spring clip over Leaf Relief® (Figure 3).

Continue installing Leaf Relief® panels, overlapping 1/2", attaching with screws through Leaf Relief® and front lip of gutter every 24". As required, a screw can be inserted through overlapping panels to reduce sagging.

Wrap-Around Strap Hangers (Existing Gutters)

Place first Leaf Relief® panel on gutter in front of hanger and mark location of strap (see Figure 4).

Cut and notch Leaf Relief® as shown in Figure 5 and lay in position on gutter.

Place next section of Leaf Relief® on gutter, mark location of strap, then cut and notch as shown in Figure 6.

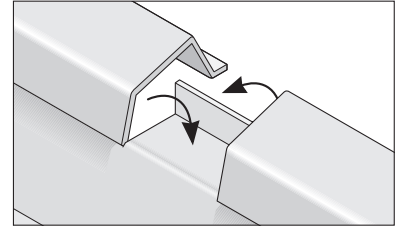

Fig. 1

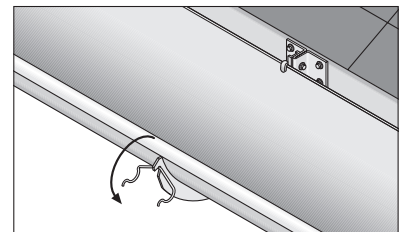

Fig. 2

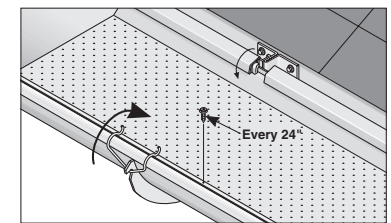

Fig. 3

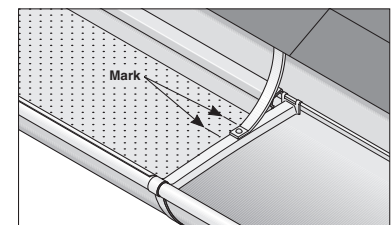

Fig. 4

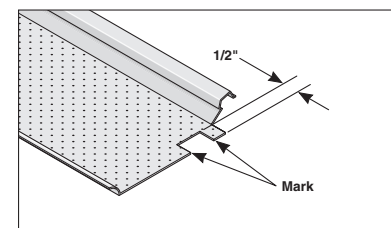

Fig. 5

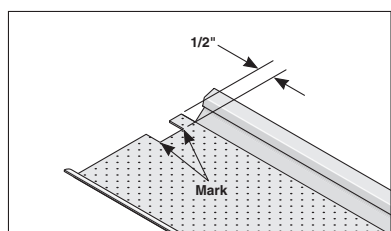

Fig. 6

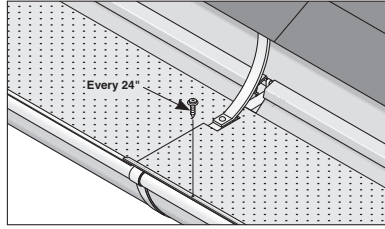

Fig. 1

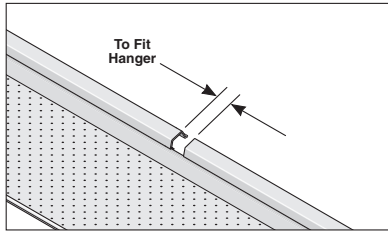

Fig. 2

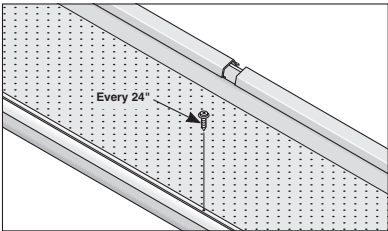

Fig. 3

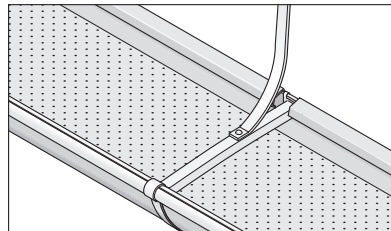

Fig. 4

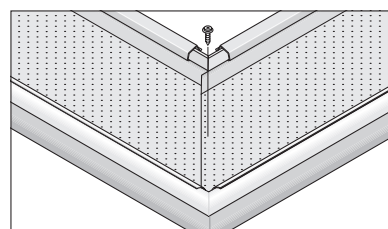
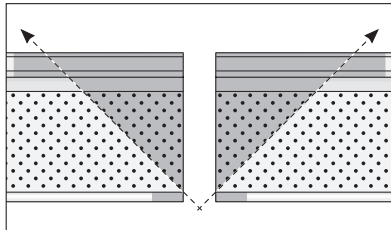

Fig. 6

Installing Leaf Relief[®] on Half-Round Gutters continued

Wrap-Around Strap Hangers (Existing Gutters) continued

Install on gutter in position so that it overlaps previous section by 1/2".

Attach with screws through Leaf Relief[®] at every hanger overlap. Also, attach the Leaf Relief[®] every 24" through the front lip of the gutter (Figure 1). As required, a screw can be inserted through overlapping panels to reduce sagging.

Wrap-Around Strap Hangers (New Gutter Installation)

Plan location of strap hangers and Leaf Relief[®] panels. Remember that Leaf Relief[®] must overlap 1/2". Notch Leaf Relief[®] at each hanger as shown in Figure 2.

Install Leaf Relief[®], overlapping panels by 1/2". Screw through front edge of Leaf Relief[®] into front lip of gutter every 24" (see Figure 3). As required, a screw can be inserted through overlapping panels to reduce sagging.

Attach hangers, over Leaf Relief[®], to gutters (Figure 4).

Install gutters to structure per manufacturer's instructions.

Mitering Corners

For Outside Corners:

Use perforation pattern as a guide to create corners. Using tin snips, cut diagonally along the perforation to create a 45° angle, starting at the outside edge and cutting as shown. Notch and remove one inch of the front edge from the newly formed angle (Figure 5).

When mounted, the pieces will overlap one inch and form a 90° outside corner. Place one screw through the overlapping pieces (Figure 6).

*Installing Leaf Relief®
on Half-Round Gutters
continued*

Mitering Corners continued

For Inside Corners:

Use perforation pattern as a guide to create corners. Using tin snips, cut diagonally along the perforation to create a 45° angle, starting at the rear edge and cutting as shown. Notch and remove one inch of the front edge from the newly formed angle (Figure 1).

When mounted, the pieces will overlap one inch and form a 90° inside corner. Place one screw through the overlapping pieces (Figure 2).

NOTE: To prevent overflow, all inside corners and valleys must have a water diverter/deflector. Diverter/deflector must be installed on the top surface of Leaf Relief®.

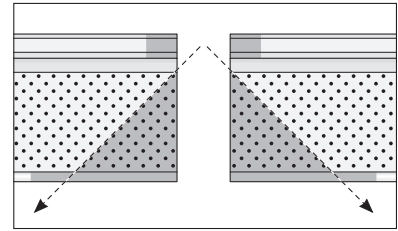

Fig. 1

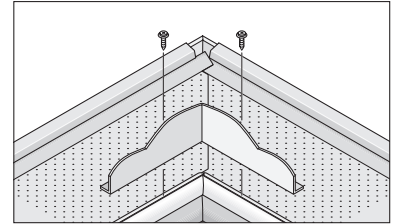

Fig. 2

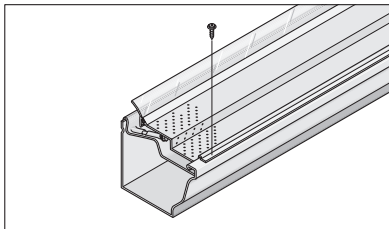

Fig. 1

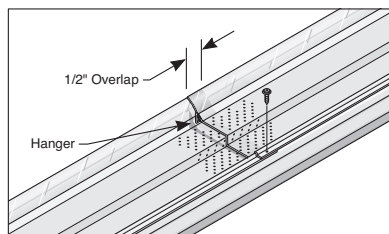

Fig. 2

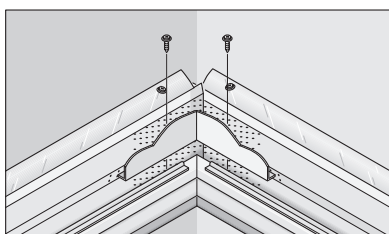

Fig. 3

Leaf Relief[®] Installation (Zip Hangers)

Prepare the Gutter

Clean and flush existing gutters and downspouts thoroughly with water.

Important

Downspouts 3" x 4" or larger are recommended for proper function in a coniferous tree zone.

To prevent overflow, all inside corners and valleys must have a water diverter/deflector. Diverter/deflector must be installed on the top surface of the Leaf Relief[®] (behind front lip).

The flow from high-level gutters must be transferred within downspouts directly into lower-level gutters and sealed. An alternative to this would be to install water diverters.

Install Leaf Relief[®] System

Place the Leaf Relief[®] sections on top of the gutter with the vinyl strip against the fascia or drip edge. For proper function, the Leaf Relief[®] surfaces (front-to-back) must be level or have a slight slope toward the fascia. (Figure 1)

For best support, place Leaf Relief[®] so that the piece nearest the hanger is beneath the adjoining Leaf Relief[®] section (overlap 1/2" with adjacent Leaf Relief[®] section – do not butt). Add or replace hangers as needed for proper support (maximum support spacing is 30"). (Figure 2)

Starting at one end, fasten front of Leaf Relief[®] to gutter every 24" using #6-3/8" screws (SQ6X038).

NOTE: To prevent overflow, all inside corners and valleys must have a water diverter/deflector. Diverter/deflector must be installed on the top surface of Leaf Relief[®].

Leaf Relief® EZ5340-DIY Installation

Prepare the Gutter

Clean and flush existing gutters and downspouts thoroughly with water.

Install Leaf Relief® System

For proper function, the Leaf Relief® surface (front to back) must be level or have a slight slope toward the fascia. (Figure 1)

NOTE: Call 1-800-962-6973 for assistance with hangers that cause a forward slope.

Mounting to Gutter

Using the existing spikes or hidden hangers for support, place Leaf Relief® section flat on the gutter (see sticker denoting “This Side Down”).

Using screws provided, attach Leaf Relief® with three (3) screws on front and two (2) screws through the plastic strip on back as shown. (Figure 2)

Attach remaining pieces, making sure to overlap 1/2" with adjacent Leaf Relief® sections. Place one screw through metal overlap. (Figure 3)

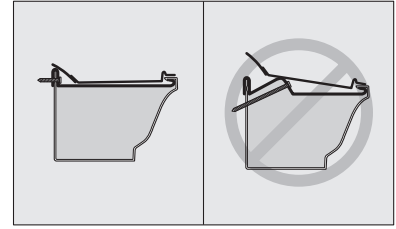

Fig. 1

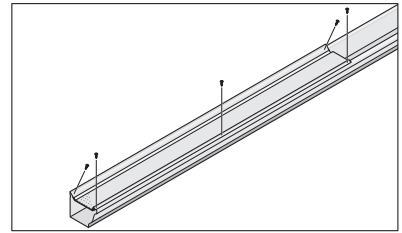

Fig. 2

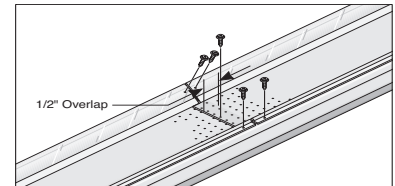

Fig. 3

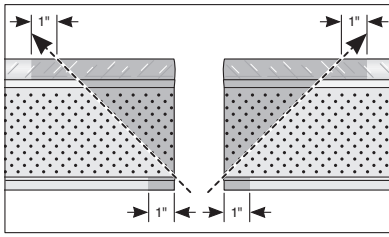

Fig. 1

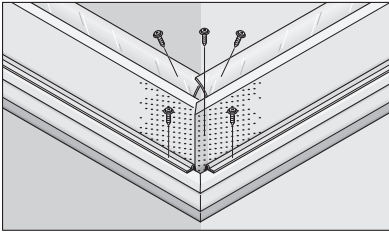

Fig. 2

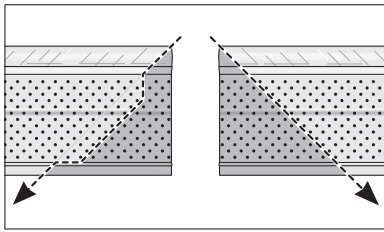

Fig. 3

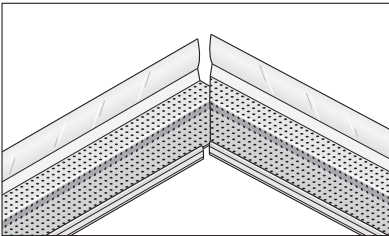

Fig. 4

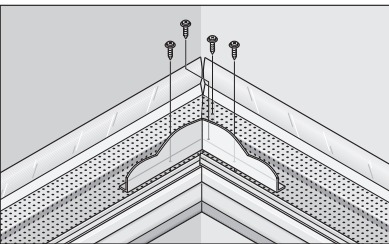

Fig. 5

Leaf Relief® Installation (Mitered Corners)

Outside Corners

Use perforation pattern as a guide to create corners. Using tin snips, cut diagonally along the perforation to create a 45° angle, starting at the outside edge and cutting as shown, through the plastic strip. Notch and remove one inch of the front edge and plastic strip from the newly formed angle. When mounted, the pieces will overlap one inch and form a 90° outside corner. Place one screw through the overlapping pieces. Attach to back through plastic strip, with screws, two inches from the point of the corner.

TP53ZIP/TP63ZIP – Inside Corner

NOTE: Because TP product has profile, pre-fabricated corners can not be used.

Use the perforated pattern to cut a 45° angle at the ends of the Leaf Relief sections. Then cut away 1" from the front and back of one section as shown.

The sections will overlap by 1" and be attached with a #6x3/8" stainless steel screw.

*Leaf Relief® Installation
(Mitered Corners) continued*

Inside Corners

Use perforation pattern as a guide to create corners. Using tin snips, cut diagonally along the perforation to create a 45° angle, starting at the rear edge (plastic strip) and cutting as shown, until complete. Notch and remove one inch of the front edge and plastic strip from the newly formed angle. When mounted, the pieces will overlap one inch and form a 90° inside corner. Place one screw through the overlapping pieces. Attach to back through plastic strip, with screws, two inches from the point of the corner.

Important

To prevent overflow, all inside corners and valleys must have a water diverter/deflector, sold separately. Diverter/deflector must be installed on the top surface of the Leaf Relief® (behind front lip).

*TP53ZIP/TP63ZIP –
Outside Corner*

Use the perforated pattern to cut a 45° angle at the ends of the Leaf Relief sections. Then cut away 1" from the front, first step and back of one section as shown.

Overlap sections by 1" and attach with a #6x3/8" stainless steel screw.

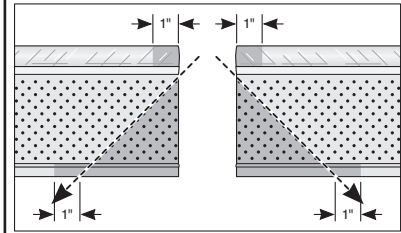

Fig. 1

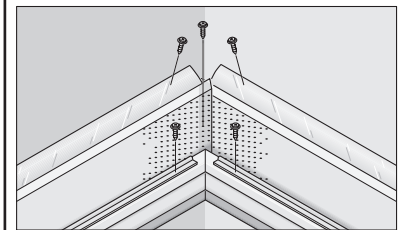

Fig. 2

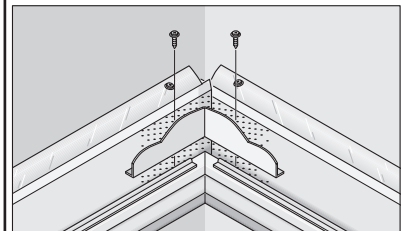

Fig. 3

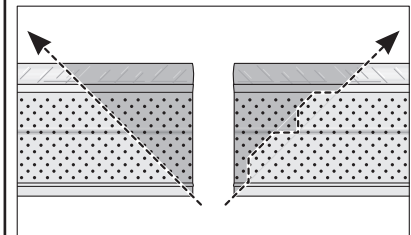

Fig. 4

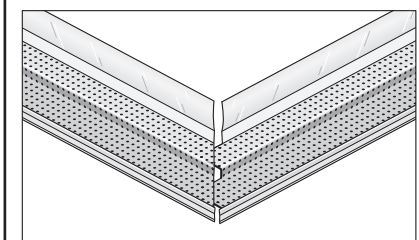

Fig. 5

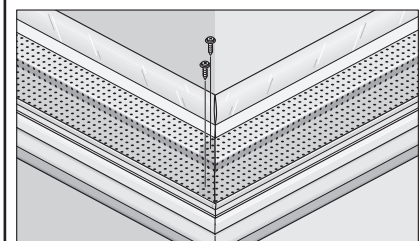

Fig. 6

Lined area for notes, consisting of multiple horizontal lines.



PERFORMANCE
COLLECTION

**MADE IN
THE U.S.A.**

plygem.com

2600 Grand Blvd., Suite 900 • Kansas City, MO 64108 • (800) 335-6701