

GA21-9337-6

File No. S5250/S34/S36/S38-15

**IBM 5250 Information Display System
Planning and Site Preparation Guide**

IBM 5294 Control Unit

IBM 5251 Display Station

IBM 5291 Display Station

IBM 5292 Color Display Station

IBM 5219 Printer

IBM 5224 Printer

IBM 5225 Printer

IBM 5256 Printer

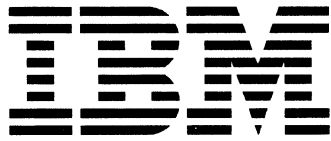

GA21-9337-6

File No. S5250/S34/S36/S38-15

IBM 5250 Information Display System Planning and Site Preparation Guide

IBM 5294 Control Unit

IBM 5251 Display Station

IBM 5291 Display Station

IBM 5292 Color Display Station

IBM 5219 Printer

IBM 5224 Printer

IBM 5225 Printer

IBM 5256 Printer

IBM 4214 Printer

IBM 4224 Printer

IBM 3179 Model 2 Color Display Station

IBM 3812 Printer

Federal Communications Commission (FCC) Statement

WARNING: *This equipment generates, uses, and can radiate radio frequency energy and if not installed and used in accordance with the instructions manual, may cause interference to radio communications. It has been tested and found to comply with the limits for a Class A computing device pursuant to Subpart J of Part 15 of FCC Rules, which are designed to provide reasonable protection against such interference when operated in a commercial environment. Operation of this equipment in a residential area is likely to cause interference in which case the user, at his own expense will be required to take whatever measures may be required to correct the interference.*

Seventh Edition (October 1984)

This major revision makes obsolete GA21-9337-5 and Technical Newsletters, GN21-3014, GN21-0390, and GN21-0400. See *About This Manual* for a summary of major changes to this edition. Changes or additions to the text and illustrations are indicated by a vertical line to the left of the change or addition.

Changes are periodically made to the information herein; any such changes will be reported in subsequent revisions or Technical Newsletters.

This publication is for planning purposes only. Also, this publication contains examples of completed setup forms and communications network worksheets. To illustrate the forms as completely as possible, the examples include the names of individuals and places. The names and places are fictitious and any similarity to actual names and places is entirely coincidental.

References in this publication to IBM products, programs, or services do not imply that IBM intends to make these available in all countries in which IBM operates.

Publications are not stocked at the address given below. Requests for IBM publications should be made to your IBM representative or to the IBM branch office servicing your locality.

This publication could contain technical inaccuracies or typographical errors. A form for readers' comments is provided at the back of this publication. If the form has been removed, comments may be addressed to IBM Corporation, Information Development, Department 245, Rochester, Minnesota, USA 55901. IBM may use or distribute whatever information you supply in any way it believes appropriate without incurring any obligation to you.

Contents

ABOUT THIS MANUAL	v		
Customer Setup Units	v		
If You Need More Information	vi		
CHAPTER 1. GETTING STARTED	1-1		
Starting Your Planning	1-1		
Planning for Direct (Local) Attachment	1-2		
Planning for Remote Attachment Using a 5294 Control Unit	1-3		
Planning for Remote Attachment Using a 5251 Model 12	1-4		
Planning for Replacing a 5251 Model 12 with a 5294 Control Unit	1-5		
Device Descriptions	1-7		
Display Stations	1-7		
Printers	1-8		
Remote Work Station Controllers	1-9		
Plannint Checklist	1-10		
CHAPTER 2. SITE CONSIDERATIONS	2-1		
Using Cable Thru	2-1		
Determining When to Use Cable Thru	2-2		
Determining When Not to Use Cable Thru	2-3		
Attaching Work Stations to Your Remote Work Station Controller	2-4		
Work Stations Attaching to a 5294 Control Unit	2-4		
Work Stations Attaching to a 5251 Model 12	2-6		
Furniture, Space, and Lighting Considerations	2-8		
Environmental Considerations and Requirements	2-10		
Electrical Requirements	2-12		
Cabling Considerations	2-13		
Cabling System	2-14		
CHAPTER 3. SYSTEM SPECIFICATIONS	3-1		
Standard Symbols and Specifications	3-1		
Plugs, Receptacles, and Power Cords	3-1		
World Trade Countries (Except Canada) Power Plug Requirements	3-2		
World Trade Power Cord Information (for Machines Shipped without Plugs)	3-3		
Installation of a Power Plug	3-3		
5294 Control Unit	3-4		
Plan View	3-4		
Specifications	3-4		
5251 Display Station Model 11	3-5		
Plan View	3-5		
Specifications	3-5		
5251 Display Station Model 12	3-6		
Plan View	3-6		
Specifications	3-6		
3180 Display Station Model 2	3-7		
Plan View	3-7		
Specifications	3-7		
5291 Display Station	3-8		
Plan View	3-8		
Specifications	3-8		
5291 Model 2 Display Station	3-9		
Plan View	3-9		
Specifications	3-9		
5292 Color Display Station Models 1 and 2	3-10		
Plan View	3-10		
Specifications	3-10		
5219 Printer	3-11		
Plan View	3-11		
Specifications	3-11		
5224 Printer	3-12		
Plan View	3-12		
Specifications	3-12		
5225 Printer	3-13		
Plan View	3-13		
Specifications	3-13		
5256 Printer	3-14		
Plan View	3-14		
Specifications	3-14		
4214 Model 2 Printer	3-15		
Plan View	3-15		
Specifications	3-15		
4224 Printer	3-16		
Specifications	3-16		
5262 Model 1 Printer	3-16.1		
Plan View	3-16.1		
Specifications	3-16.1		
IBM Modem Information	3-17		
CHAPTER 4. REMOTE WORK STATION CONFIGURATION USING THE 5294 CONTROL UNIT	4-1		
Completing the Setup Form for Configuration of the Remote Work Stations	4-3		
5294 Control Unit Information	4-5		
Identifying the Work Stations	4-9		
Drawing Your Configuration	4-10		
Work Station Address Settings	4-13		
Unit Address	4-14		
Keyboard Codes	4-15		
Completing the Setup Form for Configuration of the 5294 Control Unit	4-18		
Configuration Screen Layout	4-20		
Operator Input Fields	4-21		
CHAPTER 5. ORDERING COMMUNICATIONS EQUIPMENT AND FACILITIES FOR THE 5294 CONTROL UNIT	5-1		
Using an IBM Modem with the 5294 Control Unit	5-1		
Communications Components Order Information for the 5294 Control Unit	5-4		
Analog Nonswitched Lines (Using IBM Modems) Communications Network Worksheet for the 5294 Control Unit	5-7		
Analog Switched Lines (Using IBM Modems) Communications Network Worksheet for the 5294 Control Unit	5-9		
Analog Nonswitched Lines (Using Non-IBM Modems) Communications Network Worksheet for the 5294 Control Unit	5-11		
Analog Switched Lines (Using Non-IBM Modems) Communications Network Worksheet for the 5294 Control Unit	5-15		
AT&T DDS Public Data Communications Network Worksheet for the 5294 Control Unit	5-19		
X.21 Nonswitched Public Data Communications Network Worksheet for the 5294 Control Unit	5-21		
X.21 Switched Public Data Communications Network Worksheet for the 5294 Control Unit	5-23		
X.25 Packet Switched Communications Network Worksheet for the 5294 Control Unit	5-25		
Modem/DCE Information for the 5294 Control Unit	5-31		
CHAPTER 6. COMMUNICATIONS PLANNING FOR THE 5251 MODEL 12	6-1		
Guidelines for Planning and Ordering Communications Components for the 5251 Model 12	6-2		
Communications Components Order Information for the 5251 Model 12	6-2		
Digital Data Service Adapter Feature Worksheet for the 5251 Model 12	6-4		

EIA/CCITT Interface Feature Worksheet for the 5251 Model 12	6-5
EIA/CCITT Interface Feature Order Information for the 5251 Model 12	6-7
1200 bps Integrated Modem Feature Worksheet for the 5251 Model 12	6-10
2400 or 4800 bps Integrated Modem Feature Worksheet for the 5251 Model 12	6-13
FCC Rules Compliance	6-15

CHAPTER 7. REMOTE WORK STATION

CONFIGURATION USING THE 5251 MODEL 12	7-1
Completing the Setup Form for Configuration of the 5251 Model 12	7-3
5251 Model 12 Information	7-5
Switch Settings	7-8
Completing the Setup Form for Configuration of the Remote Work Stations	7-19
Identifying the Work Stations	7-21
Drawing Your Configuration	7-22
Cluster Feature Port Switches and Address Settings ..	7-25

CHAPTER 8. PLANNING FOR CABLES

Ordering Considerations	8-1
Outdoor Cable Installation	8-4
Station Protectors	8-6
Grounding Recommendations	8-8
Installation Requirements	8-9
Station Protector Check	8-10
Communications Cables	8-12

Appendix A. LABELING AND ASSEMBLING CABLES

Labeling Cables	A-1
Completing the Labels	A-2
Attaching the Labels	A-5
Twinaxial Cable	A-6
Assembling Cables	A-9
Cable-to-Cable Adapters	A-13
Line Continuity and Polarity Tests	A-14

Appendix B. 5294 CONTROL UNIT SETUP FORMS

IBM 5294 Control Unit Setup Form (Part 1)	B-3
IBM 5294 Control Unit Setup Form (Part 2)	B-4
IBM 5294 Control Unit Setup Form (Part 1)	B-5
IBM 5294 Control Unit Setup Form (Part 2)	B-6
IBM 5294 Control Unit Setup Form (Part 1)	B-7
IBM 5294 Control Unit Setup Form (Part 2)	B-8

Appendix C. INTRODUCTORY COMMUNICATIONS

INFORMATION FOR USE WITH THE 5294 CONTROL UNIT	C-1
Information Needed to Plan Your Communications Facilities ..	C-1
Types of Communications Lines	C-2
Types of Networks	C-2
Kinds of Networks	C-4
Types of Communications	C-5
Transmission Speeds for the DCE	C-6

Appendix D. COMPLETED SETUP FORM AND COMMUNICATIONS NETWORK WORKSHEET FOR THE 5294 CONTROL UNIT

5294 Control Unit Setup Form Examples	D-1
First Example	D-1
Second Example	D-6
5294 Control Unit Communications Network Worksheet	
Examples	D-10
First Example	D-10
Second Example	D-13

Appendix E. 5294 CONTROL UNIT

COMMUNICATIONS NETWORK WORKSHEETS ..	E-1
Analog Nonswitched Lines (Using IBM Modems)	
Communications Network Worksheet for the 5294 Control Unit	E-2
Analog Switched Lines (Using IBM Modems)	
Communications Network Worksheet for the 5294 Control Unit	E-4
Analog Nonswitched Lines (Using Non-IBM Modems)	
Communications Network Worksheet for the 5294 Control Unit	E-6
Analog Switched Lines (Using Non-IBM Modems)	
Communications Network Worksheet for the 5294 Control Unit	E-10
AT&T DDS Public Data Communications Network Worksheet for the 5294 Control Unit	E-14
X.21 Nonswitched Public Data Communications Network Worksheet for the 5294 Control Unit	E-16
X.21 Switched Public Data Communications Network Worksheet for the 5294 Control Unit	E-18
X.25 Packet Switched Communications Network Worksheet for the 5294 Control Unit	E-20

Appendix F. 5251 MODEL 12 COMMUNICATIONS

FEATURE WORKSHEETS	F-1
Digital Data Service Adapter Feature Worksheet for the 5251 Model 12	F-2
EIA/CCITT Interface Feature Worksheet for the 5251 Model 12	F-3
1200 bps Integrated Modem Feature Worksheet for the 5251 Model 12	F-5
2400 or 4800 bps Integrated Modem Feature Worksheet for the 5251 Model 12	F-7

Appendix G. 5251 MODEL 12 COMMUNICATIONS NETWORK SETUP FORMS

IBM 5251 Model 12 Communications Network Setup Form (Part 1)	G-3
IBM 5251 Model 12 Communications Network Setup Form (Part 2)	G-4
IBM 5251 Model 12 Communications Network Setup Form (Part 1)	G-5
IBM 5251 Model 12 Communications Network Setup Form (Part 2)	G-6
IBM 5251 Model 12 Communications Network Setup Form (Part 1)	G-7
IBM 5251 Model 12 Communications Network Setup Form (Part 2)	G-8

Appendix H. APPLICATIONS SETUP INFORMATION

SDLC Communications Mode	H-2
Nonswitched Analog and Nonswitched Digital Networks (X.21 or DDS)	H-2
Switched Analog (Normal Dial Up Telephone Line) ..	H-2
X.25 Communications Mode	H-3
PVC	H-3
SVC Answer at the 5294 (SVC Call by the Host System) ..	H-5
SVC Call at the 5294 (SVC Call from the 5294)	H-7
X.21 Circuit Switched Communications Mode	H-9
X.21 Direct Call	H-9
X.21 Address Call	H-9
X.21 Answer	H-9
Changing Subscription Parameters	H-9

Glossary

Index	X-1
-------------	-----

About This Manual

This manual will help you with the planning and setup of an IBM 5250 Information Display System. The information and specifications in this manual will help you decide where to set up the work stations and what you must have ready when they arrive. This manual also contains information to help your system programmer configure the system and prepare instructions for your setup personnel at remote sites.

This manual provides environmental, electrical, communications, space, furniture, and cable information.

Additions to this edition were made to include the 5294 X.21 Switched Network Feature. Miscellaneous technical changes and additions were also made throughout the manual. The 5251 Model 1 Display Station, 5251 Model 2 Display Station, and 5252 Dual Display Station are no longer available. Therefore, information about these products has been removed from the publication.

Appendix B of this manual contains copies of the 5294 Control Unit Setup Form. Appendix G of this manual contains copies of the IBM 5251 Model 12 Communications Network Setup Form. Copy the appropriate form and give completed copies to the setup personnel before the work stations are delivered.

Customer Setup Units

Your responsibilities for customer setup units are to:

- Prepare an adequate site and provide the required furniture to support the units.
- Configure your 5250 network.
- Get assembled cables (or bulk cable and connectors) and any necessary adapters for your 5250 units.
- Get communications facilities, equipment, and accessories not provided with the 5250.
- Prepare to receive the 5250 units at your receiving dock.
- Unpack and set up the 5250 units, allowing for IBM service access. (Each unit contains a setup manual that explains how to set up and check out the machine.)
- If you move your 5250, notify IBM of your new location and address.
- If discontinuing and disconnecting the 5250, pack it, and move it to your shipping dock.

Getting Started

Site Considerations

System Specifications

5294 Configuration and Communications

5251 Model 12 Communications and Configuration

Cables

Appendixes

If You Need More Information

You may need to refer to the following manuals:

- *IBM 5250 Information Display Station System Introduction*, GA21-9246, describes the work stations that make up the 5250 and their available functions and features.
- *IBM 5250 Physical Planning Template*, GX21-9278, provides plan views of each of the 5250 devices on a transparent plastic form.
- *IBM 5250 Information Display System Functions Reference Manual*, SA21-9247, describes the programming requirements for communicating with the 5250 Information Display System. This manual also contains information to help a system programmer determine problem-causing areas within the remote link to the host system.
- *IBM 5294 Control Unit Setup Procedure*, GA21-9369, provides step-by-step instructions for the setup of the IBM 5294 Control Unit. This manual is used after the 5294 Control Unit has been unpacked and placed in position.
- *IBM 5251 Display Station Models 1 and 11 Setup Procedure*, GA21-9286, gives step-by-step instructions for setup of the 5251 Models 1 and 11 Display Station.
- *IBM 5251 Display Station Models 2 and 12 Setup Procedure*, GA21-9289, gives step-by-step instructions for setup of the 5251 Models 2 and 12 Display Station.
- *IBM 5291 Display Station Setup Procedure*, GA21-9408, gives step-by-step instructions for the setup and checkout of the 5291 Display Station.
- *IBM 5292 Color Display Station Setup Procedure*, GA21-9415, gives step-by-step instructions for the setup and checkout of the 5292 Color Display Station. This manual is used after the display station has been unpacked and placed in position.
- *IBM 5219 Printer D01/D02 Setup Procedures/Operating Guide*, GA23-1019, describes how to set up, check out, operate, and correct situations when the 5219 Printer does not operate as expected. It also contains instructions on how to attach or remove paper handling features on the printer.
- *IBM 5224 Printer Setup Procedure*, GA34-0093, provides step-by-step instructions for the setup, checkout, relocation, or removal of the 5224 Printer.
- *IBM 5225 Printer Setup Procedure*, GA34-0085, gives step-by-step instructions for setup of the 5225 Printer.
- *IBM 5256 Printer Setup Procedure*, GA21-9290, gives step-by-step instructions for setup of the 5256 Printer.
- *IBM 4224 Printer Setup Instructions*, GC31-3607, provides step-by-step instructions for the setup and checkout of the 4224 Printer.
- *IBM 4224 Printer Operating Instructions*, GC31-2546, describes how to operate the 4224 Printer, and how to correct situations when the printer does not operate as expected.
- *IBM 4224 Printer Product and Programming Descriptions*, GC31-2551, describes the Intelligent Printer Data Stream (IPDS) codes for the 4224 Printer.

- *IBM 3179 Model 2 Color Display Station Introduction and Preinstallation Planning Manual*, GA18-2404, gives planning information for using the 3179 Model 2.
- *IBM 3180 Model 2 Display Station Introduction and Preinstallation Planning Manual*, GA21-9466, describes the 3180 Model 2 and contains planning information about what needs to be done before the display station is set up.
- *IBM 3812 Pageprinter Introduction and Planning Guide*, G544-3265, describes the 3812, and contains planning information about what needs to be done before the printer is set up.
- *IBM System/34 Installation and Modification Reference Manual: Program Products and Physical Setup*, SC21-7689, gives setup and configuration information for persons who plan to use the System/34 as a host system.
- *IBM System/36 What to Do before Your Computer Arrives*, SB0F-4773, gives setup and configuration information for persons who plan to use the System/36 as their host system.
- *IBM System/38 Guide to Program Product Installation and Device Configuration*, GC21-7775, gives setup and configuration information for persons who plan to use the System/38 as a host system.
- *IBM Series/1 System Summary*, GA34-0035, gives an overview of hardware and licensed programs for the Series/1.
- *IBM Series/1 Customer Site Preparation Manual*, GA34-0050, gives setup and configuration information for persons who plan to use the Series/1 as a host system.
- *IBM Data Communications Concepts*, GC21-5169, gives an introduction to teleprocessing.
- *IBM 5250 Information Display System (Including Ideographic Devices) Planning and Site Preparation Guide*, GA09-1622, gives planning information for using the 5251 Model 12 in Japan.
- *IBM 5250 Information Display System (Including Ideographic Devices) Planning and Site Preparation Guide*, GA09-1628, gives planning information for using the 5251 Model 12 in Taiwan and Hong Kong.
- *An Introduction to Local Area Networks*, SC20-8203, gives an introduction to local area networks.
- *IBM Implementation of X.21 Interface General Information Manual*, GA27-3287, gives a general overview of the X.21 interface as implemented by IBM.
- *IBM Cabling System Planning and Installation Guide*, GA27-3361, gives information on how to install and maintain the IBM Cabling System.

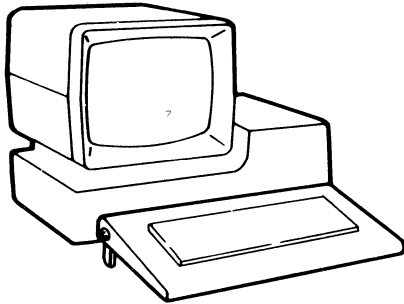

5291 Display Station

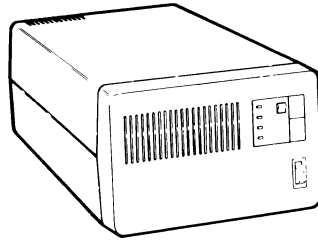

5294 Control Unit

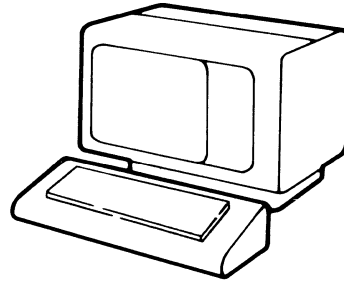

5251 Model 12
Display Station/Work
Station Controller

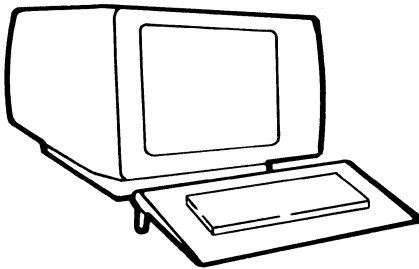

5292 Color Display Station

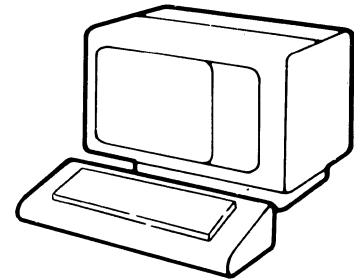
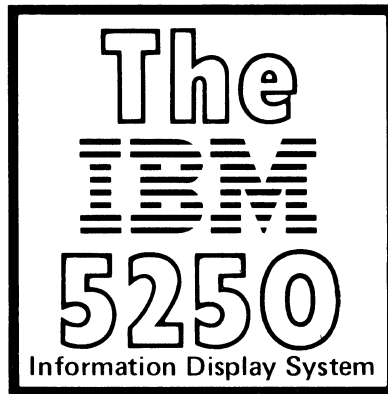

5251 Model 11
Display Station

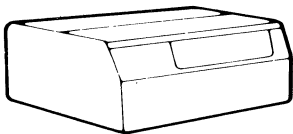

5224 Printer

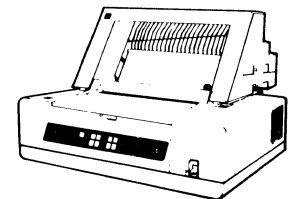

5219 Printer

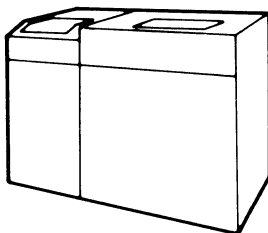

5225 Printer

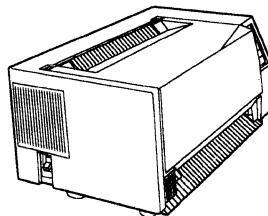

4224 Printer

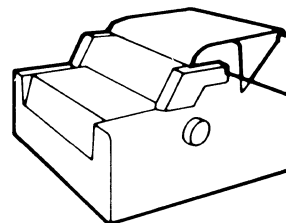

5256 Printer

- *IBM 3180 Model 2 Display Station Introduction and Preinstallation Planning Manual*, GA21-9466, describes the 3180 Model 2 and contains planning information about what needs to be done before the display station is set up.
- *IBM System/34 Installation and Modification Reference Manual: Program Products and Physical Setup*, SC21-7689, gives setup and configuration information for persons who plan to use the System/34 as a host system.
- *IBM System/36 What to Do before Your Computer Arrives*, SBOF-4773, gives setup and configuration information for persons who plan to use the System/36 as their host system.
- *IBM System/38 Guide to Program Product Installation and Device Configuration*, GC21-7775, gives setup and configuration information for persons who plan to use the System/38 as a host system.
- *IBM Series/1 System Summary*, GA34-0035, gives an overview of hardware and licensed programs for the Series/1.
- *IBM Series/1 Customer Site Preparation Manual*, GA34-0050, gives setup and configuration information for persons who plan to use the Series/1 as a host system.
- *IBM Data Communications Concepts*, GC21-5169, gives an introduction to teleprocessing.
- *IBM 5250 Information Display System (Including Ideographic Devices) Planning and Site Preparation Guide*, GA09-1622, gives planning information for using the 5251 Model 12 in Japan.
- *IBM 5250 Information Display System (Including Ideographic Devices) Planning and Site Preparation Guide*, GA09-1628, gives planning information for using the 5251 Model 12 in Taiwan and Hong Kong.
- *An Introduction to Local Area Networks*, SC20-8203, gives an introduction to local area networks.
- *IBM Implementation of X.21 Interface General Information Manual*, GA27-3287, gives a general overview of the X.21 interface as implemented by IBM.
- *IBM Cabling System Planning and Installation Guide*, GA27-3361, gives information on how to install and maintain the IBM Cabling System.

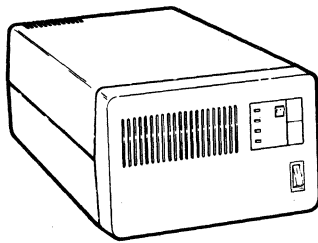

5294 Control Unit

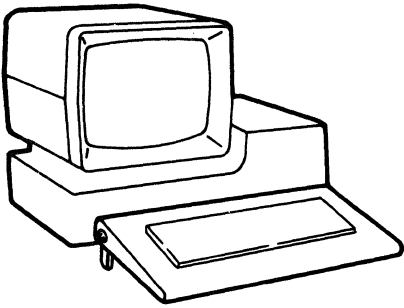

5291 Display Station

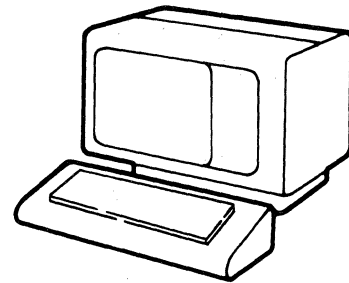

5251 Model 12
Display Station/Work
Station Controller

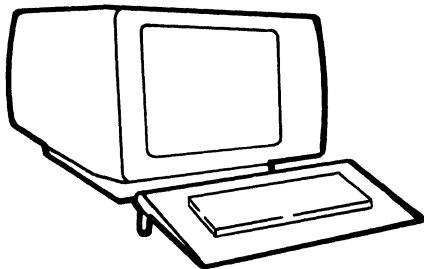

5292 Color Display Station

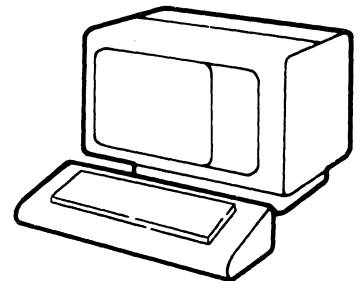
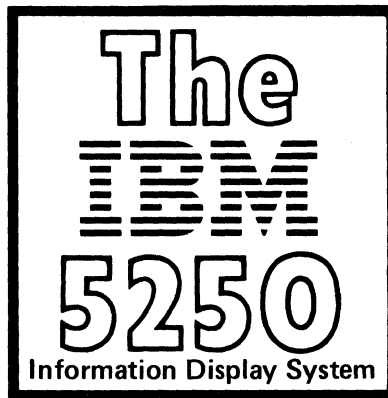

5251 Model 11
Display Station

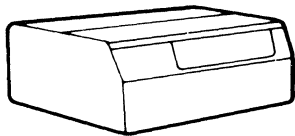

5224 Printer

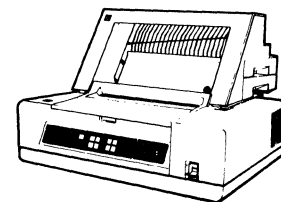

5219 Printer

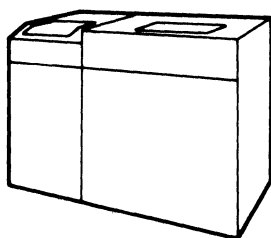

5225 Printer

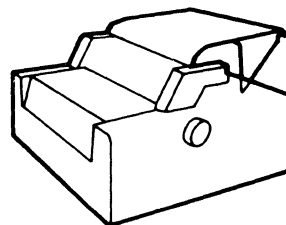

5256 Printer

Chapter 1. Getting Started

This chapter explains what you will need to do in order to plan for the installation of your equipment. It also describes the work stations (display stations and printers) and remote work station controllers.

Note: Before you begin, you might want to read the *IBM 5250 Information Display System Introduction*, GA21-9246.

STARTING YOUR PLANNING

If you are:

- Attaching work stations directly to a host system (such as a System/36 or System/38), go to *Planning for Direct (Local) Attachment* on page 1-2
- Attaching work stations to a 5294 Control Unit, go to *Planning for Remote Attachment Using a 5294 Control Unit* on page 1-3
- Attaching work stations to a 5251 Model 12, go to *Planning for Remote Attachment Using a 5251 Model 12* on page 1-4
- Replacing a 5251 Model 12 with a 5294 Control Unit, go to *Planning for Replacing a 5251 Model 12 with a 5294 Control Unit* on page 1-5

Getting Started

Site Considerations

System Specifications

5294 Configuration and Communications

5251 Model 12 Communications and Configuration

Cables

Appendixes

Planning for Direct (Local) Attachment

A direct attachment is when work stations are attached right to a host system. The number of work stations that can be attached to a system varies.

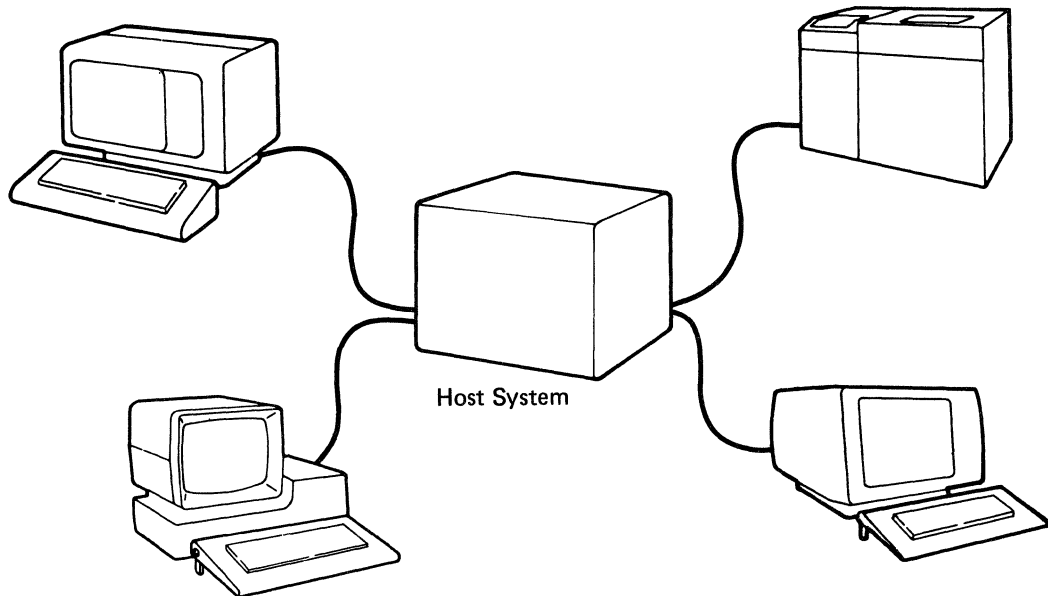

If your work stations will be attached directly to a host system, do the

following tasks to plan your installation. Check off the items as you complete them.

- Review the *Planning Checklist* and *Device Descriptions* later in this chapter.
- Refer to your host system planning manual for further information needed to plan your setup.

Note: The following information in this manual may be needed in addition to your host manual:

- Chapter 2, *Site Considerations*
- Chapter 3, *System Specifications*
- Chapter 8, *Planning for Cables*
- Appendix A, *Labeling and Assembling Cables*

Planning for Remote Attachment Using a 5294 Control Unit

A remote attachment using a 5294 Control Unit is when work stations are attached to a 5294 instead of directly to the host system. The 5294 controls the attached work stations and coordinates communications between the host system and the work stations. The number of work stations that can be attached to a 5294 varies. More information about this is contained later in the manual.

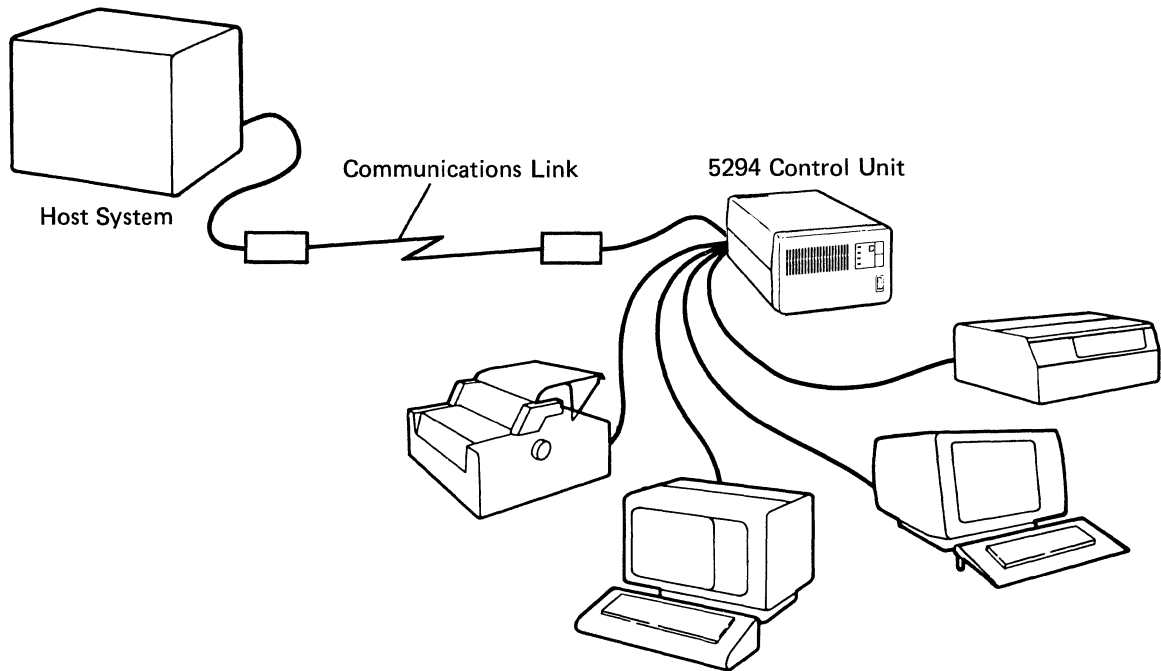

If your work stations will be attaching to a 5294 Control Unit, do the following tasks to plan your installation. Check off the items as you complete them.

- Review the *Device Descriptions* and *Planning Checklist* later in this chapter.
- Review Chapter 2, *Site Considerations*.
- Complete a floor plan as described in Chapter 2.
- Complete the *IBM 5294 Control Unit Setup Form*. Copies of this form are in Appendix B. Instructions for completing this form are in Chapter 4.
- If not already done, order the communications equipment as soon as possible after completing Chapter 4.
- Order cables and make your cable labels. See Chapter 8, *Planning for Cables* and Appendix A, *Labeling and Assembling Cables*.

Planning for Remote Attachment Using a 5251 Model 12

A remote attachment using a 5251 Model 12 is when work stations are attached to a 5251 Model 12 instead of the host system. The 5251 Model 12 controls the attached work stations and coordinates communications between the host system and the work stations. The number of work stations that can be attached to a 5251 Model 12 varies. More information about this is contained later in the manual.

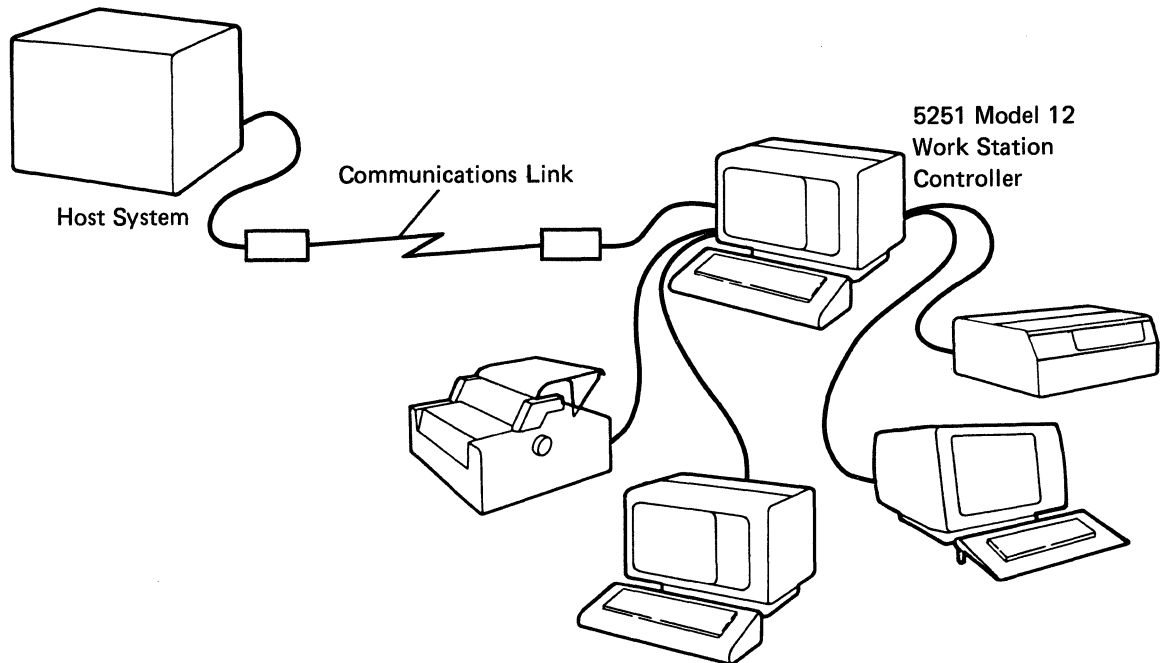

If your work stations will be attaching to a 5251 Model 12, do the following tasks to plan your installation. Check off the items as you complete them.

- Review *Device Descriptions* and the *Planning Checklist* later in this chapter.
- Review Chapter 2, *Site Considerations*.
- Complete a floor plan as described in Chapter 2.
- Complete Chapter 6, *Communications Planning for the 5251 Model 12*.
- If not already done, order the communications equipment as soon as possible after completing Chapter 6.
- Complete the *IBM 5251 Model 12 Communications Network Setup Form*. Copies of this form are in Appendix G. Instructions for completing the form are in Chapter 7.
- Order cables and make your cable labels. See Chapter 8, *Planning for Cables* and Appendix A, *Labeling and Assembling Cables*.

Planning for Replacing a 5251 Model 12 with a 5294 Control Unit

You cannot just remove the 5251 Model 12 and exchange it with a 5294 Control Unit. The following items must be done or at least considered:

- Review the *Planning Checklist* later in this chapter.
- Check if there are more than four ports on the rear of the 5251 Model 12 that have cables attached to them. If there are, some of your work stations will need Cable Thru in order to attach to the 5294 Control Unit since it has a maximum of four ports. Also, you will have to reroute some of the work station cables.

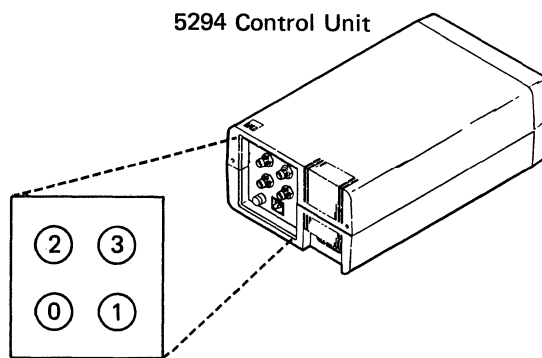
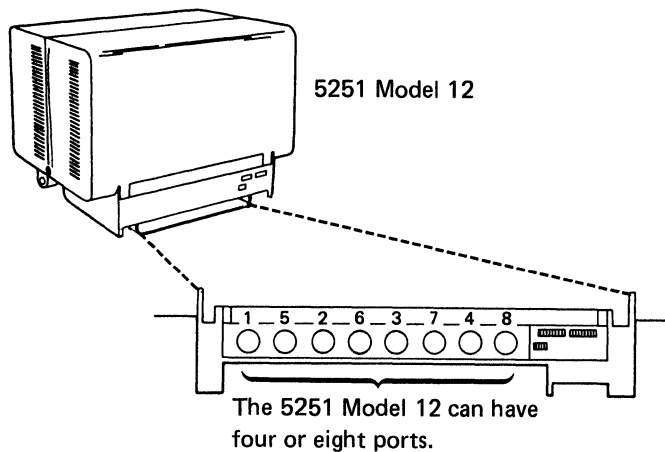

The 5294 can have two or four ports.

- Since the 5294 Control Unit does not have a display screen, you will need a display station for the person that uses the 5251 Model 12 as a display station. (The display station should be ordered when the 5294 is ordered.)

- The 5294 Control Unit can use the same power outlet as the 5251 Model 12. However, you may need an additional outlet to plug in a display station for the person that has been using the 5251 Model 12 as a display station.
- The 5294 Control Unit can use most of the same external modems that the 5251 Model 12 does. However, the communications cable for the 5251 Model 12 is either 6 meters (20 feet) or 12 meters (40 feet) long. The communications cable for the 5294 is only 6 meters (20 feet) long.
- The host system must change the definition of the remote controller and the associated work stations to reflect the new controller. This is needed for configuration and error recovery. The controller communications line address can remain the same as it was for the 5251 Model 12.
- Some of the work stations may have to have a new work station address and a new unit address. Refer to Chapter 4, *Remote Work Station Configuration Using the 5294 Control Unit*, for information about determining work station and unit addresses.
- The 5294 Control Unit, but not the 5251 Model 12:
 - Can operate at speeds above 9600 bps depending on the communications feature installed
 - Can support the X.21 adapter
 - Does not support integrated modems
 - Needs adapter cable, part 2452096, if attaching to a modem eliminator or to some X.21 bis attachments
 - Can attach to an X.25 network with specified features
 - Can attach to an X.21 switched network with specified features
- For a 5294 configuration, you need to know if the attaching modem supports:
 - Local loopback on pin 18
 - Remote loopback on pin 21
 - Test mode indication on pin 25

Note: For more information about modems, see Chapter 5, *Ordering Communications Equipment and Facilities for the 5294 Control Unit*.

DEVICE DESCRIPTIONS

The 5250 Information Display System consists of display stations, printers, and remote work station controllers.

Display Stations

The following display stations are part of the 5250 system:

- The 5251 Display Station, which is available in three models:
 - Model 11, which has a 1920-character display.
 - Model 12, which has a 1920-character display and can also be used as a remote controller.
 - Model 999, which has a 1920-character display. It is the same as the Model 11, except standard functions include Cable Thru and the typewriter-like keyboard.
- Note:** This is the only reference to the 5251 Model 999 in this publication. Throughout the remainder of the manual, it is assumed that a 5251 Model 999 could also be a 5251 Model 11 that has the Cable Thru feature.
- The 5291 Display Station, which has a 1920-character display that can be tilted and an adjustable keyboard.
 - The 5292 Display Station, which has a display that can be tilted and an adjustable keyboard. It is also available in two models:
 - Model 1, which has a 1920-character display and can display characters in seven colors.
 - Model 2, which has a 1920-character display and can display characters in seven colors and graphic images in eight colors (including black) out of 512 possible colors or shades.

There are also some additional display stations that can be attached to the 5294 Control Unit and some host systems. They include:

- The 3179 Model 2 Color Display Station. This display station has a 1920-character display, and an adjustable keyboard, and can display characters in seven colors. In addition, the display can be tilted forward or backward, and turned to the right or left for viewing comfort.
- The 3180 Model 2 Display Station. This display station has a 1920-character display and an adjustable keyboard. In addition, the display can be raised or lowered, tilted forward or backward, and turned to the right or left for viewing comfort.
- The Personal Computer with the 5250 Emulation feature installed.

Printers

The following printers are part of the 5250 system:

- The 5219 Printer, which is a tabletop printer available in two models:
 - Model D01, which has a maximum-rated printed output of 40 characters per second.
 - Model D02, which has a maximum-rated printed output of 60 characters per second.
- The 5224 Printer, which is a tabletop printer available in two models:
 - Model 1, which has a maximum-rated printed output of 140 lines per minute.
 - Model 2, which has a maximum-rated printed output of 240 lines per minute.
- The 5225 Printer, which is a printer available in four models:
 - Model 1, which has a maximum-rated printed output of 280 lines per minute.
 - Model 2, which has a maximum-rated printed output of 400 lines per minute.
 - Model 3, which has a maximum-rated printed output of 490 lines per minute.
 - Model 4, which has a maximum-rated printed output of 560 lines per minute.
- The 5256 Printer, which is a tabletop printer available in three models:
 - Model 1, which has a maximum-rated printed output of 40 characters per second.
 - Model 2, which has a maximum-rated printed output of 80 characters per second.
 - Model 3, which has a maximum-rated printed output of 120 characters per second.

Note: The ability of a printer to reach the rated printed output when it is attached to a 5251 Model 12 or a 5294 Control Unit, depends on the communications line speed and the number of attached work stations that are being used at the same time.

There are also some additional printers that can be attached remotely to a 5294 Control Unit and some host systems. They include:

- The 4214 Model 2 Printer, which can print up to 132 characters per line at either 10 characters per inch or 15 characters per inch.
- The 5262 Model 1 Printer, which can print up to 132 characters per line at 10 characters per inch.
- The 3812 Printer, which is a multifunction, nonimpact page printer of tabletop design, provides cut-sheet, letter-quality text at a maximum of 12 pages per minute.

The following printers can be attached to a 5294 Control Unit if Feature Code 3601 is installed in the control unit:

- The 4224 Printer, which is a tabletop printer available in four models:
 - Model 101, which has a maximum-rated output of 200 characters per second.
 - Model 102, which has a maximum-rated output of 400 characters per second.
 - Model 1E2, which has a maximum-rated output of 400 characters per second, with the Memory Expansion feature.
 - Model 1C2, which has a maximum-rated output of 400 characters per second, with the Memory Expansion feature and Color feature.

Remote Work Station Controllers

A remote work station controller is used to control the operation of work stations located away from the system and allows the work stations attached to it to communicate with the system. The term *work station controller* refers to either the 5294 Control Unit or the 5251 Model 12 Display Station.

- The 5251 Model 12, which uses SNA (Systems Network Architecture) together with the SDLC (Synchronous Data Link Control) line protocol to communicate with the system. It also serves as a display station.
- The 5294 Control Unit, which uses SNA together with the SDLC or X.25 line protocol to communicate with the system.

Following is an inclusive list of devices supported by the 5294:

- Displays
 - IBM 5251 Display Station (Models 11 and 999)
 - IBM 5291 Display Station
 - IBM 3180 Display Station (Model 2)
 - IBM 5292 Color Display Station (Models 1 and 2)
 - IBM 3179 Color Display Station (Model 2)
 - IBM Personal Computer with the 5250 Emulation feature
- Printers
 - SCS Printers
 - IBM 5219 Printer (Models D01 and D02)
 - IBM 5224 Printer
 - IBM 5225 Printer
 - IBM 5256 Printer
 - IBM 5262 Printer (Model 001)
 - IBM 4214 Printer (Model 2)
 - IBM 3812 Printer
 - IPDS Printers
 - IBM 4224 Printer

Note: Any abbreviated list following this list is an example only, and is not intended to be a complete list of devices supported by the 5294 Control Unit.

PLANNING CHECKLIST

The following planning checklist should help you with your planning activities. This checklist may be modified to accommodate your needs, but you should review the checklist closely. Missing any of the items on the checklist could result in serious setup problems. Your IBM sales representative can help you schedule dates for the tasks on the checklist.

Task	Reference	Responsibility		✓	When Task Is to Be Done	Scheduled Date	Completed Date
		Customer	IBM				
Determine the work stations, work station controller(s), and accompanying features needed for your planned layout.	<i>5250 Introduction manual</i>	X	X		Before the time of order		
Order work stations, work station controller(s), features, and other IBM-supplied items.		X	X		At the time of order		
Review the installation plan with your IBM sales representative to define any schedule exposures.		X	X		Before the equipment arrives		
Determine whether changes are needed to existing furniture to accommodate work stations. If so, modify or order furniture. Then draw a floor plan.	Chapter 2	X			Before the equipment arrives		
Prepare a network diagram (local work station configuration worksheet) for all work stations attached directly to the host system. This diagram must contain all station locations and addresses.	Host system's installation and modification reference manual and/or host system's installation and device configuration manual	X			Before the equipment arrives		
Determine whether changes are needed to the existing programs (system control program, program products, and application programs). If so, schedule the required changes.		X			Before the equipment arrives		
If your work stations will communicate with a host system through a 5294 Control Unit, determine the configuration and complete a setup form for each remote site.	Chapters 4 and 5	X			Before the equipment arrives		
If your work station will communicate with a host system through a 5251 Model 12, determine the configuration and complete a setup form for each remote site.	Chapters 6 and 7	X			Before the equipment arrives		

Task	Reference	Responsibility		✓	When Task Is to Be Done	Scheduled Date	Completed Date
		Customer	IBM				
Provide a copy of the completed setup form to the host site so that they can begin system configuration.		X	X		Before the equipment arrives		
Provide a copy of the completed setup form to the setup personnel at the remote site.	Chapter 4 or 7	X			Before the equipment arrives		
Review the progress of data communications. Identify and resolve any schedule conflicts.		X	X		Before the equipment arrives		
Order your communications equipment.		X	X		At the time of order		
Have communications facilities installed (telephone jacks and modems).		X			Before the equipment arrives		
Decide who will install the work station cables, power receptacles, and wiring (your maintenance personnel or a contractor) and supply that person with a copy of the floor plan, Chapter 8, and Appendix A.	Chapter 3, Chapter 8, and Appendix A	X			Before the equipment arrives		
Order cables, accessories and supplies as required.	Chapter 8	X			Before the equipment arrives		
Confirm the arrival of the work station cables you ordered and begin installation of cables and power receptacles.		X			Before the equipment arrives		
Complete the installation of cables and power receptacles. Label the cables.	Appendix A	X			Before the equipment arrives		
Complete the checkout of the system cables by doing the line continuity and polarity tests.	Appendix A	X			Before the equipment arrives		
Complete the required changes to the existing host system programs.		X			Before the equipment arrives		
Receive the work stations and complete setup. (Setup instructions are contained in the shipping carton.)		X			When the equipment arrives		
Receive the work station controller(s) and complete setup. (Setup instructions are contained in the shipping carton.)		X			When the equipment arrives		

- Notes:**
1. Tasks in dark, heavy type pertain only to those users who will set up a remote work station controller and attach work stations to it.
 2. Some of these tasks may have already been completed by someone at the host system site.
 3. All phases of your installation should comply with applicable local and national codes.

Chapter 2. Site Considerations

In planning your configuration, your site requirements must be considered. This chapter contains information on site considerations that include:

- Using Cable Thru
- Attaching work stations to your remote work station controller
- Furniture, space, and lighting considerations
- Environmental considerations and requirements
- Electrical Requirements
- Cabling considerations

USING CABLE THRU

When attaching multiple work stations to a host system or to a remote work station controller, consider using Cable Thru. Cable Thru allows the attachment of multiple work stations to the same cable line and port on the host system or on a controller, thus saving cable cost. All work stations on a cable line, except for the last work station, must have Cable Thru. Cable Thru is indicated by the presence of two sockets on a work station.

Note: The last work station on a Cable Thru line can be no more than 1525 meters (5000 feet) in cable distance from the host system or remote work station controller.

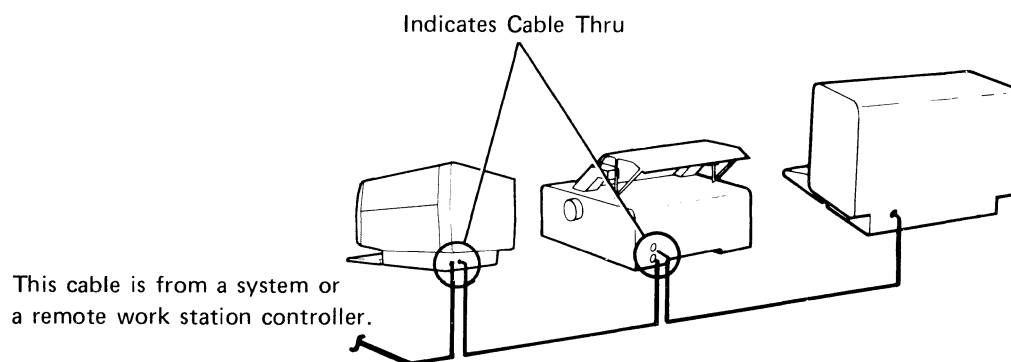

Ordering Cable Thru on all work stations initially will make future additions to your configuration easier. Cable Thru is standard on the 3180 Model 2, 5291, 5292, 5219, and 5224. It is a feature on the 5251 Model 11, 5225, and 5256.

Each 4224 is shipped with a line termination connector, P/N 6342823. This is a T-connector that allows one or two cables to be connected to the printer, without a need for the Cable Thru feature.

Getting Started

Site Considerations

System Specifications

5294 Configuration and Communications

5251 Model 12 Communications and Configuration

Cables

Appendixes

Determining When to Use Cable Thru

Use Cable Thru when the group of work stations to be attached are a relatively long distance from the host system or remote work station controller, but conveniently situated near each other. The following illustration shows an example of when to use Cable Thru.

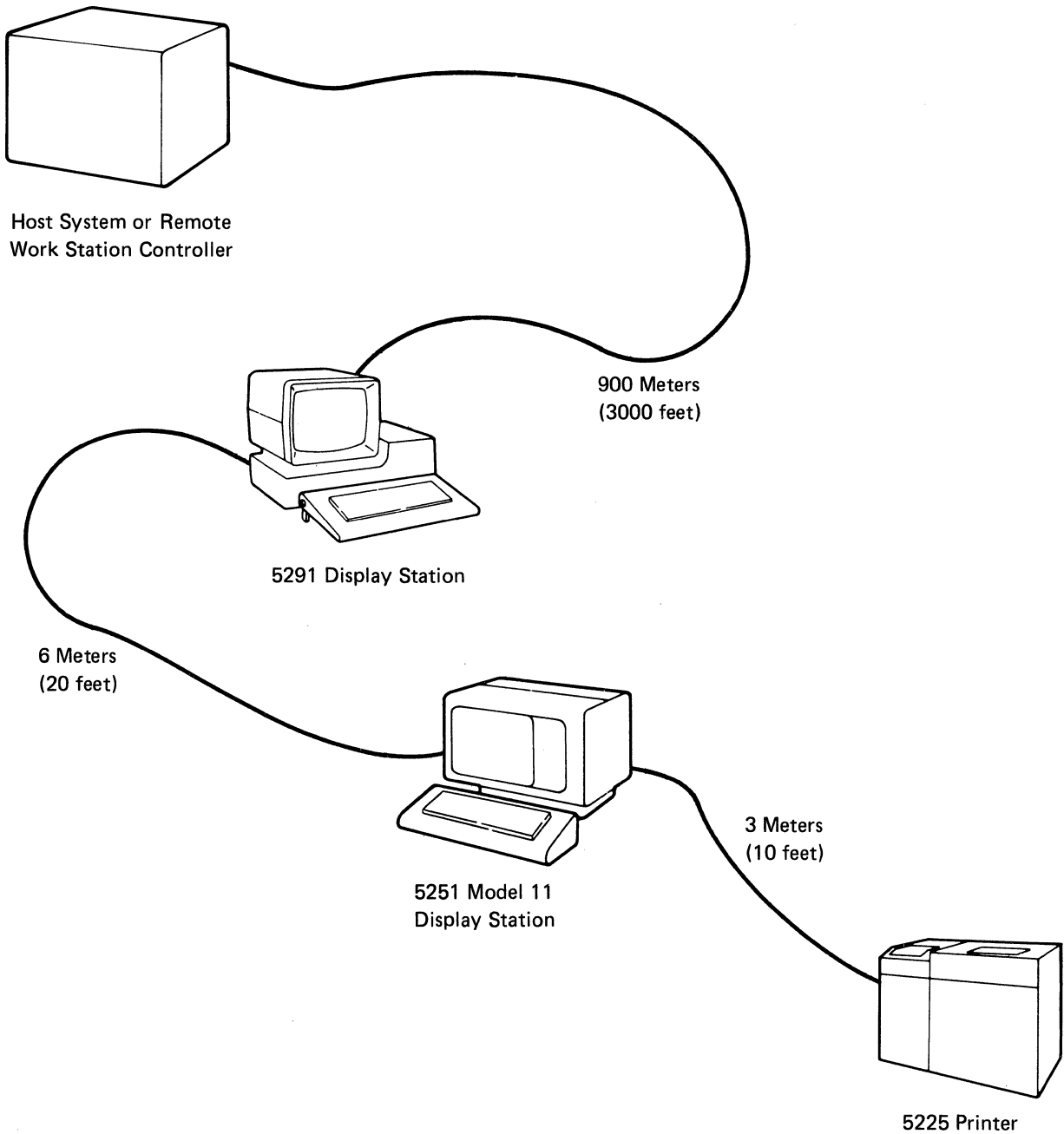

Determining When Not to Use Cable Thru

When the attaching work stations are located at relatively short distances from the host system or the remote work station controller, or when the attaching work stations are in different directions (as shown in the following illustration), attach work stations to separate ports on separate cables.

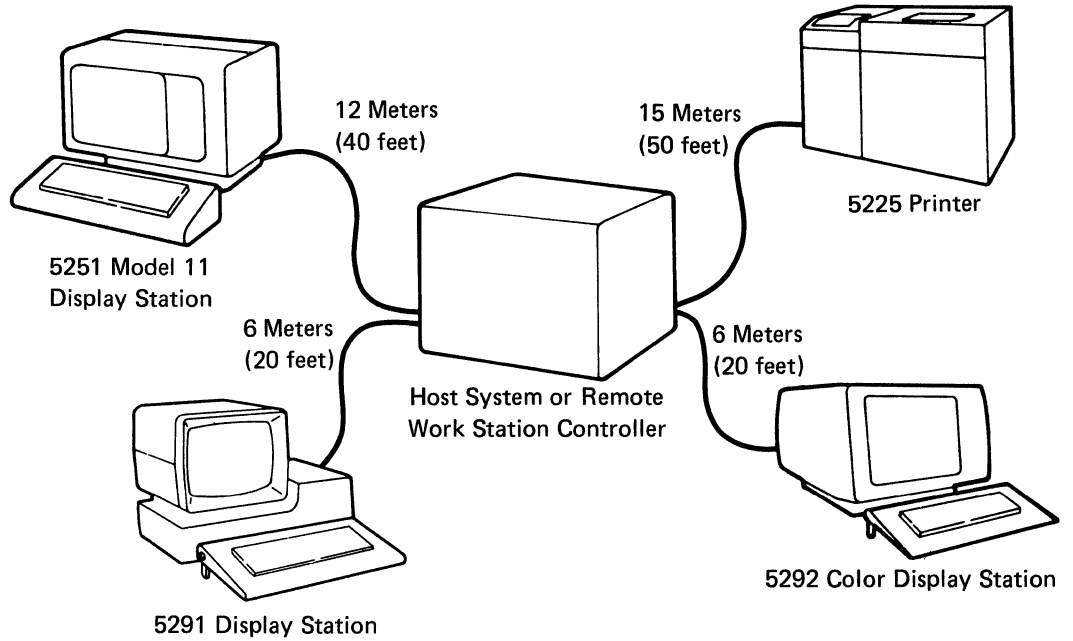

Even when work stations will not be on a Cable Thru line, ordering Cable Thru on work stations initially makes future additions of work stations easier.

ATTACHING WORK STATIONS TO YOUR REMOTE WORK STATION CONTROLLER

Remote work stations can be attached to either a 5294 Control Unit or a 5251 Model 12.

Work Stations Attaching to a 5294 Control Unit

Work stations can be attached to a 5294 Control Unit that has the standard Cluster function or the Extended Cluster feature.

The Cluster function consists of two ports and allows a maximum of four work stations to be attached to a 5294 Control Unit. Of these four, all can be attached to port 0 (using Cable Thru) or they can be attached to both ports in any combination.

Note: For problem determination and servicing of the 5294 Control Unit, at least one display station is required to be attached within 6 meters (20 feet) of the 5294.

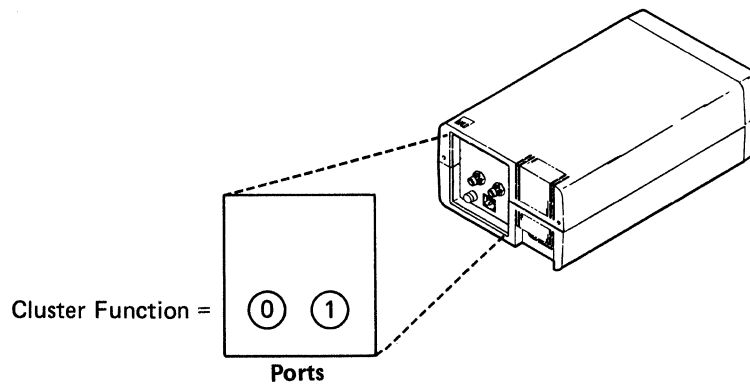

The Extended Cluster feature consists of two additional ports for a total of four ports, and allows an additional four work stations for a maximum of eight work stations that can be attached to a 5294 Control Unit. Of these eight, up to seven can be attached to a single port (using Cable Thru). Any combination of work stations is permitted on a port.

Note: If the 5294 Control Unit will be attached to an X.25 packet switched network and have four ports, the maximum number of work stations that can be attached to it is six. Of these six, all can be attached to one port (using Cable Thru). Any combination of work stations (up to six) is permitted on a port.

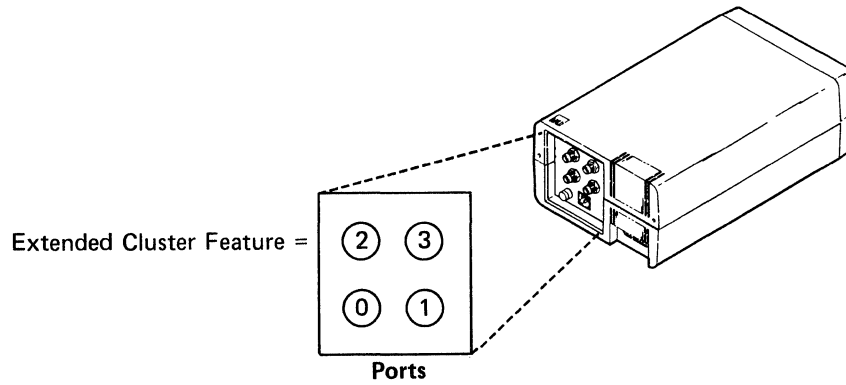

Work Stations Attaching to a 5251 Model 12

Work stations can be attached to a 5251 Model 12 that has the Cluster or Dual Cluster feature.

The Cluster feature provides a set of four ports, numbered 1 through 4, attached to the rear access panel of the 5251 Model 12. The Cluster feature ports are referred to as CF1 ports.

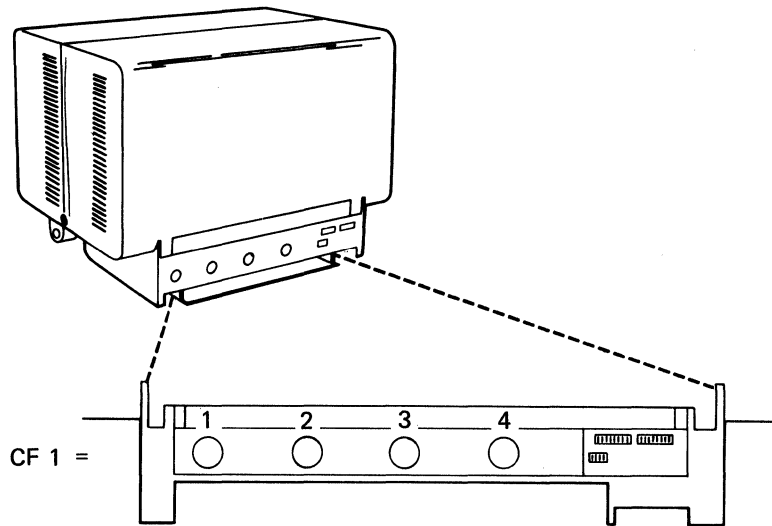

With the Cluster feature, you can attach a maximum of four work stations to a 5251 Model 12. These work stations may be distributed in several ways over the four ports. Your choices range from one work station on each port to a maximum of four work stations on one port.

Note: When using more than one port of the Cluster feature, the first attachment should be made to port 1 and any other attachments to numerically successive ports.

The Dual Cluster feature is a set of eight ports, numbered 1 through 8, attached to the rear access panel of the 5251 Model 12. The Dual Cluster feature has four CF1 ports like the Cluster feature, and also has four CF2 ports (5 through 8) for attachment of a maximum of eight work stations.

Note: The guidelines for using the Cluster feature also apply for the Dual Cluster feature.

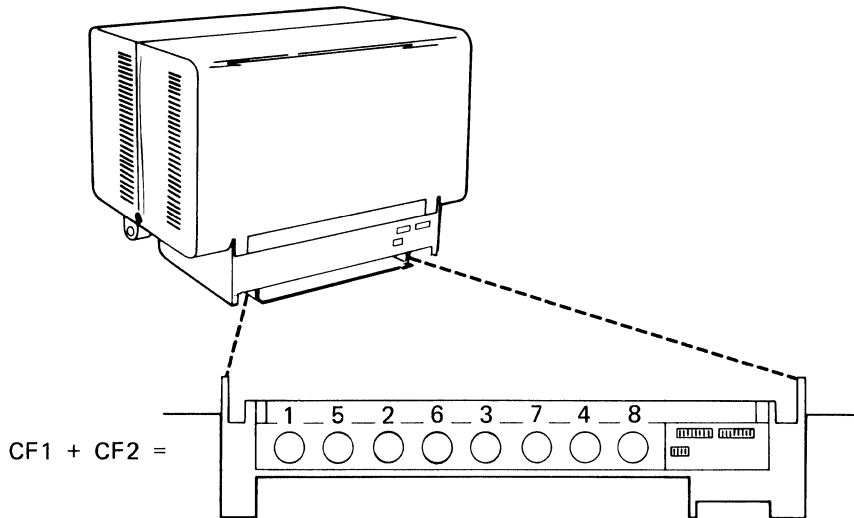
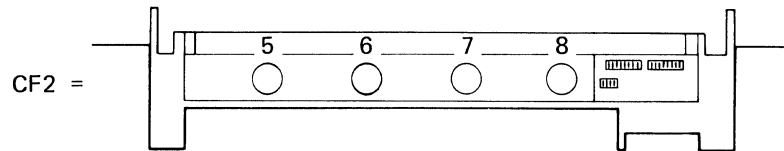
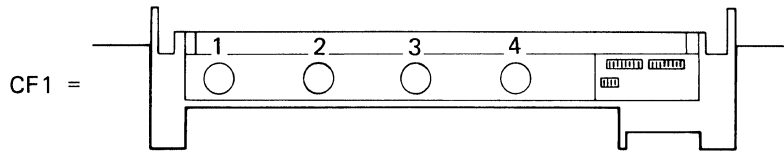

FURNITURE, SPACE, AND LIGHTING CONSIDERATIONS

Furniture: Display stations, any devices attached to display stations, and printers should be placed to handle work flow efficiently, to provide operator comfort and safety, and to allow for adequate service clearances. Consider the following:

- The table for a display station should provide adequate space for the display station and working materials and enough clearance for operator comfort. The recommended table size is:
 - Height: 660 to 685 millimeters (26 to 27 inches)
 - Depth: A minimum of 760 millimeters (30 inches)
 - Width: A minimum of 1120 millimeters (44 inches)

Notes:

1. Do not place anything on top of any display station.
 2. If you plan to attach the Magnetic Stripe Reader feature to your 5251 Display Station, allow an additional 75 millimeters (3 inches) for table width.
 3. If you plan to attach the Selector Light Pen feature to your 5251 Display Station, allow an additional 150 millimeters (6 inches) for table width.
 4. If you plan to attach video equipment, a color printer, and/or a plotter to your 5292 Model 2 Display Station, allow for additional space.
- The 5225 Printer sits on the floor. Forms are placed inside the front door of the printer and are removed from the rear door.
 - The table for a 4224, 5219, 5224, or 5256 Printer should allow for paper movement. The recommended table size is:
 - Height: 685 to 760 millimeters (27 to 30 inches).
 - Depth: 510 to 915 millimeters (20 to 36 inches) depending on the type of printer. (The 5224 Printer must extend 178 millimeters (7 inches) over the table to allow for forms movement.)
 - Width: 760 millimeters (30 inches).

If your 4224, 5219, 5224, or 5256 Printer will have a forms stand, place it behind the printer to catch the printed paper. Allow for space above the printer for forms loading. If you do not have a forms stand, a larger table can be used to hold both the printer and the paper.

- Chairs should be adjustable in height. Operators using a particular chair should be able to rest their feet flat on the floor with a slight allowance to relieve pressure on the lower thigh. Chairs should also have adjustable rests that support the lower back.

Space: You should determine a device arrangement (floor plan) keeping in mind the dimensions of the furniture you will place your devices on and the need for traffic and service clearances. To help you, assemble the following items:

- A list of devices ordered
- The *5250 Physical Planning Template, GX21-9278*
- The Plan Views in Chapter 3
- Grid paper

Complete the floor plan now and then return to here.

Lighting: The following lighting factors should be considered when you prepare a display station environment:

- Offices should be painted in light colors with white ceilings to reflect light.
- To lessen glare, windows should not be in the operator's field of vision or directly facing the display screen.
- Have a low level of general lightning (300 to 500 lux) with adjustable local lighting at each display station.
- Avoid direct sunlight on the display screen.
- To avoid eye fatigue, sources of light should be compatible. White and warm white fluorescent lamps are compatible with both incandescent lamps and daylight.
- If possible, align the display stations so that they are parallel (front to back) to fluorescent lights.

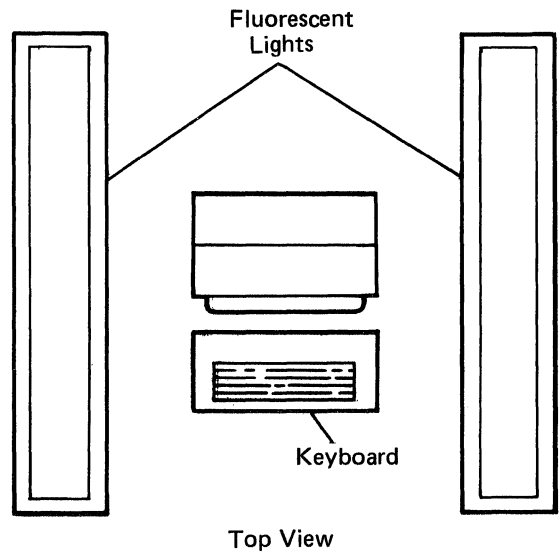

Miscellaneous Equipment: Consider other items that will be or should be in the same area as your system, such as office equipment and furniture.

Storage: Consider storage space for manuals, printouts, and printer forms.

Future Expansion: Consider the possible expansion of your data processing operations in the foreseeable future.

ENVIRONMENTAL CONSIDERATIONS AND REQUIREMENTS

Temperature, Relative Humidity, and Wet Bulb: The following shows the temperature and humidity limits for all the display system devices except for the operating and nonoperating environments of the 5219 Printer. For this information, see *Specifications* under *5219 Printer* in Chapter 3.

Operating Environment:

Temperature	10°C to 40°C (50°F to 105°F)
Relative Humidity	8% to 80%
Maximum Wet Bulb	26°C (80°F)

Nonoperating Environment:

Temperature	10°C to 51°C (50°F to 125°F)
Relative Humidity	8% to 80%
Maximum Wet Bulb	26°C (80°F)

Storage Environment:

Temperature	0°C to 60°C (32°F to 140°F)
Relative Humidity	5% to 80%
Wet Bulb	0°C to 30°C (32°F to 86°F)

Shipping Environment:

Temperature	-40°C to 60°C (-40°F to 140°F)
Relative Humidity	5% to 100% (including condensation, excluding rain)
Wet Bulb	0°C to 30°C (32°F to 86°F)

You should know the temperature and humidity limits of your supplies. Temperature and humidity limits may differ for various supplies such as forms for the printer. If working and storage areas cannot be kept at the same relative humidity, allow enough time for the supplies to acquire the same humidity level as that in the working area before you use the supplies.

Electrostatic Discharge: With low humidity levels, static charges generated by such things as movement of people, carts, furniture, and paper are more readily stored in certain types of floor construction, floor coverings, and furniture. These charges may be high enough that, if discharged by contact with another person or object, they will create a static shock. If discharged to or near data processing or other electronic equipment, *these charges can cause intermittent interference*. To minimize electrostatic discharge:

- Avoid high-resistance floor surface material. Floor surface resistance measured between the floor surface and the building (or other applicable ground reference) should be greater than 1.5×10^5 ohms and less than 2×10^{10} ohms. The measuring method is specified in National Fire Protection Association, Inc., 56A, Chapter 462.
- Avoid carpeting that does not have antistatic properties.
- Avoid plastic seat coverings.
- Avoid low humidity levels.

Electromagnetic Compatibility: Avoid placing a system in an area of high electromagnetic interference that can be radiated or conducted. Such areas may exist within 500 meters (1650 feet) of radio frequency sources, such as radio-transmitting antennas (AM, FM, TV, and two-way radio), radar (FAA and military), and within 50 meters (165 feet) of certain industrial machines (induction heaters, arc welders, and insulation testers), industrial time clocks, and high energy power lines. Other sources of electromagnetic interference may include transformers (including those installed in other units), power distribution panels (three-phase power distribution lines), rotating machinery, and certain electrical heating systems.

Power supplies in printers and other data processing equipment can also cause display screen interference. To avoid this type of interference, maintain a minimum of 1 meter (3.3 feet) between display stations and printers or other data processing equipment.

If any of the above electromagnetic interferences are present, assess your plans to see whether special installation or product considerations are advisable to ensure normal system operation and maintenance. Your IBM sales representative can help you.

Atmospheric Contaminants: Avoid environments where particulate, liquid, and gaseous atmospheric contaminants exist (as found in some process industries). Such environments can cause corrosion of copper and other metals used in computer systems. Extended corrosive growth in any computer system can produce electrical short circuits or contact failures that result in system malfunctions. Corrosion can become so extensive that an entire system or machine may need to be replaced. If you suspect a problem, contact your IBM sales representative.

ELECTRICAL REQUIREMENTS

Voltage: The United States/Canada voltage requirements for the 5294, 5251 Model 12, 3180 Model 2, 5251 Model 11, 5291, 5292, 5219, 5224, 5225, and 5256 are listed on the specification pages in Chapter 3.

Minimum and maximum voltages for each nominal voltage and frequency are listed in the table below.

Nominal Voltage	60 Hertz		50 Hertz	
	Minimum	Maximum	Minimum	Maximum
100	90	110	90	110
110	96.5	119	99	119
120 (115)	104	127	–	–
127 (123.5)	111	137	111	136
200, 208	180	220	180	220
220	198	238	198	238
230	–	–	202	249
235	–	–	212	258
240	208	254	210	259

Power Cords and Receptacles: Each machine has a three-wire power cord that includes an equipment ground wire. See Chapter 3 for more information on power cord lengths (with each *Plan View*), plug styles, and power cord styles. Be sure that the correct receptacles are located within reach of the power cord and out of a traffic area.

CAUTION

For the user's safety, the plug must be connected to a properly wired and grounded receptacle. An improperly wired receptacle could place a hazardous voltage on accessible metal parts of the 5250 units. The customer is responsible for receptacle wiring.

Branch Circuits and Grounding:

CAUTION

All branch-circuit ground wires should be tied to a common ground at the distribution panel, and a single ground wire should be run from the distribution panel to a service ground or a suitable building ground. The conduit must not be used as the only means of grounding because it may not be continuous.

The equipment must be grounded. The power cords have a green, or a green and yellow equipment ground wire.

For purposes of avoiding electrical noise, the grounding conductor should be electrically isolated from the system neutral, except at the building ground station.

The system units will operate satisfactorily using the normal power supplied by most power companies. There are, however, many outside sources that can cause transient electrical noise signals or voltage level variations that may affect system operation.

Typical sources of such electrical noise are:

- Air conditioning devices
- Electric welders
- Electric furnaces
- Elevators
- Electrostatic copying machines
- Large brush-type motors

CABLING CONSIDERATIONS

Work stations connect directly to a host system, a remote work station controller, or to each other using twinaxial cable. This cable is a shielded, two-conductor cable that can be used indoors or outdoors. More information about cabling is discussed later in the manual.

CABLING SYSTEM

It is sometimes costly to add wiring in some areas of existing buildings because older buildings were not wired to accommodate the use of voice and data communications. The solution to this problem is to install a cabling system such as the IBM Cabling System (hereafter called the cabling system) that serves a variety of voice and data communications uses. The cabling system includes the cables and cable accessories for wiring a wide range of work stations. With the cabling system, you can install or remove an IBM work station or system without rewiring the building each time a change is made.

The wiring design for the cabling system uses the wiring-closet distribution concept. That is, most of the wiring is placed in small rooms (closets), and work areas (such as offices and factory locations) are wired to one or more wiring closets. After the cabling system is installed, it can be changed in the work areas and wiring closets to meet the needs of the users without costly rewiring of the building.

Note: The cables of the cabling system and twinaxial cables must not be connected together.

The following figure shows an example of data communications equipment using the cabling system. In this example, only one host system port is shown; however, multiple ports can be connected in a similar manner. Actual wiring would vary from one building to another. For information about installing and maintaining the cabling system, see the *IBM Cabling System Planning and Installation Guide, GA27-3361*.

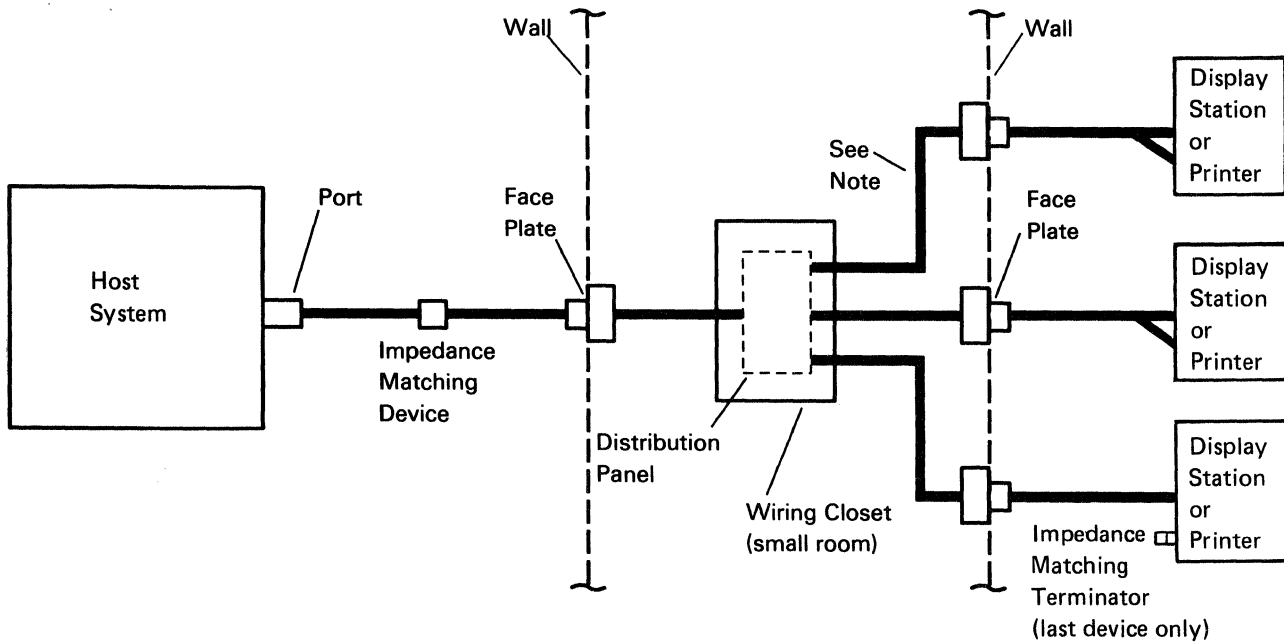





Note: Cables are hidden in walls and ceilings.

Chapter 3. System Specifications

This chapter summarizes the measurements and specifications for your 5250 Information Display System. IBM provides transparent templates for the 5250. In the United States and Canada, order template GX21-9278; in other countries, obtain templates from your IBM marketing representative.

STANDARD SYMBOLS AND SPECIFICATIONS





Standard symbols used on the specifications page and physical planning template are:

	Nonraised floor power cord exit
	Service area boundary
	Signal cable entry or exit
	Leveling pads
	Optional equipment

Note: Plan view dimensions are shown in millimeters. Inch equivalents are shown in parentheses.

PLUGS, RECEPTACLES, AND POWER CORDS

The following are the specifications for plugs and receptacles used in the United States and Canada.

Plug Type	Volts	Rating			Description	Plug Number ¹	Receptacle Number ¹	Receptacle Configuration
		Amperes	Phase	Wires				
H	115/120	15	1	3	Nonlocking	5-15P	5-15R	
J	115/120	15	1	3	Locking	L5-15P	L5-15R	
K	208/230	15	1	3	Nonlocking	6-15P	6-15R	
L	208/230	15	1	3	Locking	L6-15P	L6-15R	









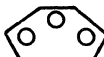

¹The plug and receptacle numbers shown are National Electrical Manufacturers' Association (NEMA) configuration numbers.

World Trade Countries (Except Canada) Power Plug Requirements

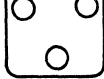
One of the following plugs designated by country, will be installed on your machine unless you specify feature code 2710, which will provide an attachment cord without a plug. Check with your IBM sales representative for further information.

Note: The 2710 specify option is not available for the 3180 Model 2 Display Station and the 5224 Printer.

Country	Plug Number	Country	Plug Number
Algeria	4	Jamaica	3
Argentina	6	Japan	3, 12
Australia	6		
Austria	1	Korea	3
Bahamas	3	Malaysia	5
Barbados	3	Mexico	3
Belgium	4		
Bermuda	3	Netherlands	1
Bolivia	3	Netherlands Antilles	3
Brazil	3	New Zealand	6
Bulgaria	1	Nicaragua	3
		Norway	1
Chile	10		
Colombia	6	Panama	3
Costa Rica	3	Paraguay	6
		Peru	3
Denmark	8	Philippines	3
Dominican Republic	3	Poland	1
		Portugal	1
Ecuador	3		
El Salvador	3	Rumania	1
Finland	1	Singapore	5
France	4	South Africa	7
		Spain	1
Germany	1	Sri Lanka	7
Greece	4	Sweden	1
Guatemala			1
		Switzerland	2
Honduras	3	Taiwan	3, 12
Hong Kong	5	Thailand	3, 12
Hungary	4	Trinidad	3, 6
		Turkey	1
Iceland	1		
Indonesia	1	United Kingdom	5
Iran	1	Uruguay	6
Ireland	5		
Israel	11	Venezuela	6
Italy	10		
		Yugoslavia	4

Plug/Number	Amperage/Voltage
1 	16 A Max, 250 V
2 	10 A Max, 250 V
3 	15 A Max, 125 V
4 	16 A Max, 250 V
5 	13 A Max, 250 V
6 	10 A Max, 250 V
7 	13 A Max, 250 V
8 	10 A Max, 250 V
9 	15 A Max, 125 V
10 	16 A Max, 250 V
11 	10 A Max, 250 V
12 	15 A Max, 200 V

World Trade Power Cord Information (for Machines Shipped without Plugs)

Style	Cable Outside Diameter (OD) (Nominal)	Number of Shields	Conductors		
			Quantity	OD (Nominal)	AWG Number
B	10.2 millimeters (0.40 inch)	0	3	1.3 millimeters (0.051 inch)	16
A8	8.9 millimeters (0.35 inch)	0	3	1.6 millimeters (0.064 inch)	14
A9	9.9 millimeters (0.39 inch)	0	3	1.0 millimeters (0.040 inch)	18

Installation of a Power Plug

Because different plugs are used in different countries, it is difficult to cover all plug installations in one procedure.

If you have ordered a power cord without a plug, the following things must be considered:

- The shield (if any) of the power cord must always have a good electrical connection to the ground pin of the plug.
- The grounding wire and/or the shield cannot come in contact with (touch) the other (hot) wires.
- The grounding wire (green-green/yellow) must be properly attached to the grounding terminal in the plug.

Note: The grounding wire is intended to be longer than the others; do not shorten it.

- The power cord must be well secured to the plug in order to prevent strain on the plug/wire contacts.

5294 CONTROL UNIT

Plan View

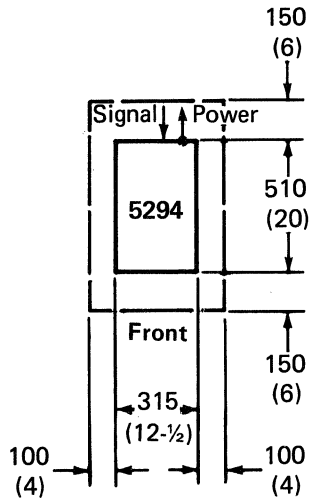

Notes:

1. The 5294 Control Unit can have two or four ports.
2. For problem determination and servicing of the 5294, at least one display station is required to be attached to port 0 and be within 6 meters (20 feet) of the 5294.
3. Data Communications Equipment (DCE) must be within 6 meters (20 feet) of the 5294.

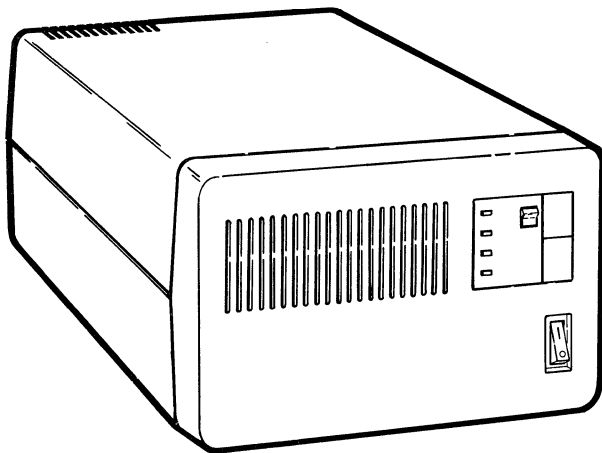

Specifications

Dimensions:

	Width	Depth	Height
Millimeters	315	510	200
Inches	12-1/2	20	8

Service Clearances:

	Front	Rear	Right	Left
Millimeters	150	150	100	100
Inches	6	6	4	4

Weight: 10 kg (22 lb)

Heat Output: 70 watts (240 BTU/hr)

Airflow: 2.1 m³/min (70 cfm)

Power Requirements:

Voltage	115
kVA	0.2
Phase	1
Plug type ¹	H
Power cord style ¹	A9

Operating and Nonoperating Environment:

See *Environmental Considerations and Requirements* in Chapter 2.

¹The power cord is 2.4 meters (8 feet) long. For more information, see *Plugs, Receptacles, and Power Cords* in this chapter.

5251 DISPLAY STATION MODEL 11

Plan View

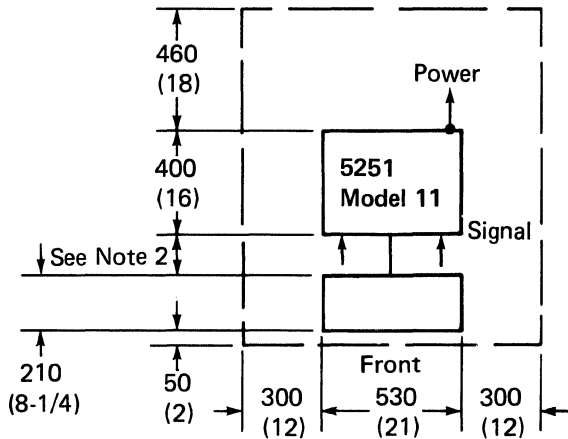

Notes:

1. Signal cables connect into the front of the display unit, but are then routed under the unit to the back.
2. The length of the keyboard cable permits the keyboard to be moved up to 330 millimeters (13 inches) away from the display screen.
3. The cable for the Magnetic Stripe Reader feature is 1.2 meters (4 feet) long.
4. The cable for the Selector Light Pen feature is 0.9 meters (3 feet) long.

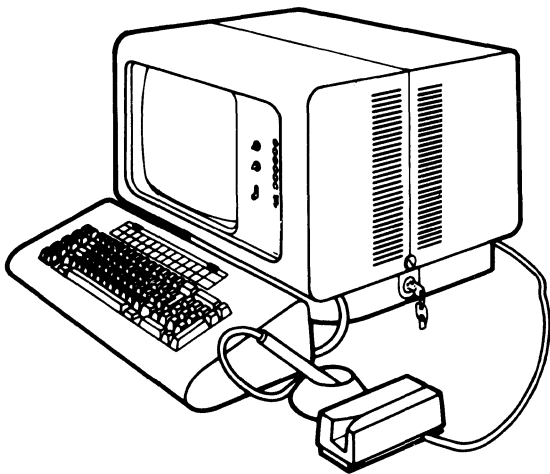

Specifications

Dimensions:¹

	Width	Depth	Height
Millimeters	530	400	400
Inches	21	16	16

Service Clearances:

	Front ¹	Rear	Right	Left
Millimeters		460	300	300
Inches		18	12	12

Weight (without keyboard): 34 kg (75 lb)¹

Heat Output: 125 watts (425 BTU/hr)

Airflow: 3 m³/min (100 cfm)

Power Requirements:

Voltage	115
kVA	0.2
Phase	1
Plug type ²	H or J
Power cord style ²	B

Operating and Nonoperating Environment:

See *Environmental Considerations and Requirements* in Chapter 2.

¹The keyboard is 530 millimeters (21 inches) by 210 millimeters (8-1/4 inches) by 100 millimeters (4 inches) and weighs 6 kilograms (13 pounds). The keyboard may be moved to service the machine. See *Plan View*.

²The power cord is 2.4 meters (8 feet) long. For more information, see *Plugs, Receptacles, and Power Cords* in this chapter.

5251 DISPLAY STATION MODEL 12

Plan View

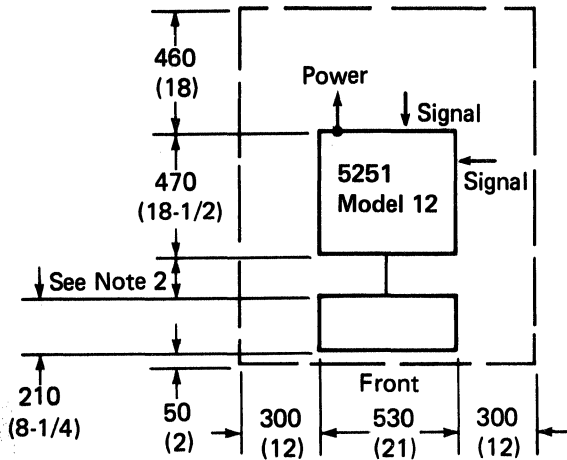

Notes:

1. Signal cables connect into the back of the display unit.
2. The length of the keyboard cable permits the keyboard to be moved up to 330 millimeters (13 inches) away from the display screen.
3. The cable for the Magnetic Stripe Reader feature is 1.2 meters (4 feet) long.
4. The cable for the Selector Light Pen feature is 0.9 meters (3 feet) long.
5. Communications cable lengths are described in Chapter 4.
6. Depending on the cable length, DCE must be within 6 meters (20 feet) or 12 meters (40 feet) of the 5251 Model 12.

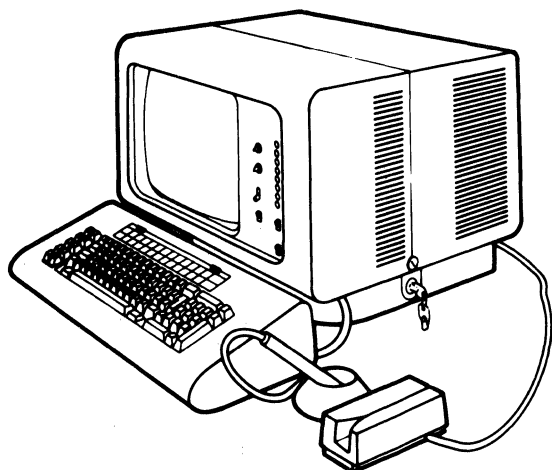

Specifications

Dimensions:¹

	Width	Depth	Height
Millimeters	530	470	400
Inches	21	18-1/2	16

Service Clearances:

	Front ¹	Rear	Right	Left
Millimeters		460	300	300
Inches		18	12	12

Weight (without keyboard): 45 kg (99 lb)¹

Heat Output: 136 watts (465 BTU/hr)

Airflow: 3 m³/min (100 cfm)

Power Requirements:

Voltage	115
kVA	0.2
Phase	1
Plug type ²	H or J
Power cord style ²	B

Operating and Nonoperating Environment:

See *Environmental Considerations and Requirements* in Chapter 2.

¹The keyboard is 530 millimeters (21 inches) by 210 millimeters (8-1/4 inches) by 100 millimeters (4 inches) and weighs 6 kilograms (13 pounds). The keyboard may be moved to service the machine. See *Plan View*.

²The power cord is 2.4 meters (8 feet) long. For more information, see *Plugs, Receptacles, and Power Cords* in this chapter.

3180 DISPLAY STATION MODEL 2

Plan View

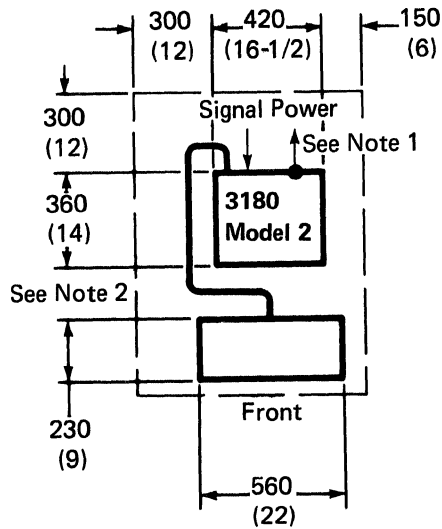

Notes:

1. Signal cables connect into the back of the display.
2. The length of the keyboard cable permits the keyboard to be moved up to 1220 millimeters (48 inches) away from the display screen.

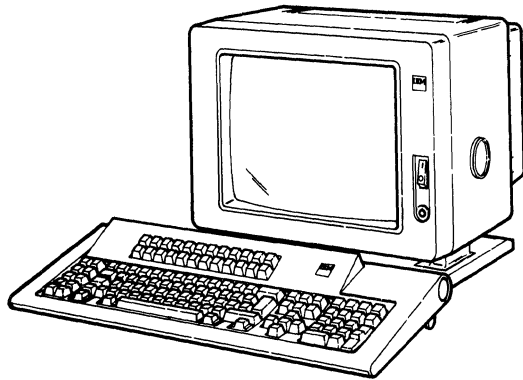

Specifications

Dimensions:¹

	Width	Depth	Height
Millimeters	420	360	370 (unelevated) 495 (elevated)
Inches	16-1/2	14	14-1/2 (unelevated) 19-1/2 (elevated)

Service Clearances:

	Front ¹	Rear	Right	Left
Millimeters	N/A	300	150	300
Inches	N/A	12	6	12

Weight without the keyboard:¹ 18 kg (39 lb)

Heat Output: 126 watts (430 BTU/hr)

Airflow: Machine is convection cooled.

Power Requirements:

Voltage	100-127 200-240 (not in the United States and Canada)
kVA	0.2
Phase	1
Plug type ²	H

¹The keyboard is 560 millimeters (22 inches) by 230 millimeters (9 inches) and weighs 4-1/4 kilograms (9-1/2 pounds). The slope of the keyboard can be adjusted changing the height from 63 millimeters (2-1/2 inches) to 101 millimeters (4 inches).

²The power cord can be either 3 meters (10 feet) or 4.2 meters (14 feet) long. For more information, See *Plugs, Receptacles, and Power Cords* in this chapter.

5291 DISPLAY STATION

Plan View

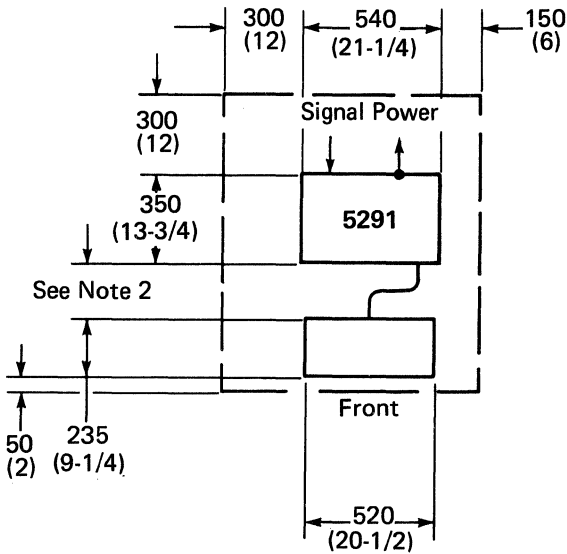

Notes:

1. Signal cables connect into the back of display unit.
2. The length of the keyboard cable permits the keyboard to be moved up to 610 millimeters (24 inches) away from the display screen.

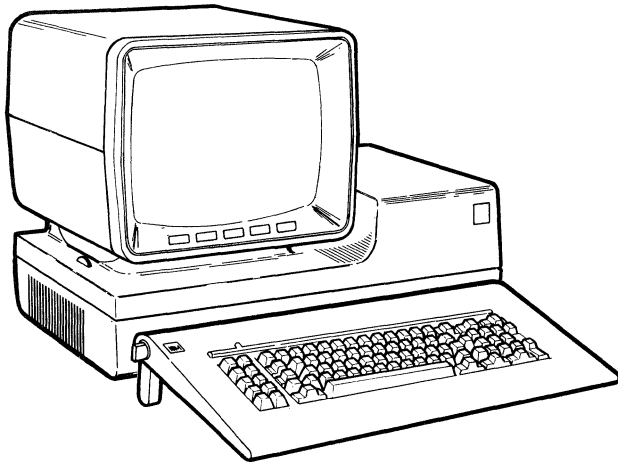

Specifications

Dimensions:¹

	Width	Depth	Height
Millimeters	540	350	460
Inches	21-1/4	13-3/4	18

Service Clearances:

	Front ¹	Rear ¹	Right	Left
Millimeters	50	300	150	300
Inches	2	12	6	12

Weight (without keyboard): 19.8 kg (43 lb)¹

Heat Output: 85 watts (300 BTU/hr)

Airflow: Machine is convection cooled.

Power Requirements:

Voltage	115
kVA	0.2
Phase	1
Plug type ²	H
Power cord style ²	A9

Operating and Nonoperating Environment:

See *Environmental Considerations and Requirements* in Chapter 2.

¹The keyboard is 520 millimeters (20-1/2 inches) by 235 millimeters (9-1/4 inches), adjusts in height from 35 millimeters (1-1/2 inches) to 90 millimeters (3-1/2 inches), and weighs 3.2 kg (7 lbs). The keyboard may be moved to service the machine. See *Plan View*.

²The power cord is 2.4 meters (8 feet) long. For more information, see *Plugs, Receptacles, and Power Cords* in this chapter.

5291 MODEL 2 DISPLAY STATION

Plan View

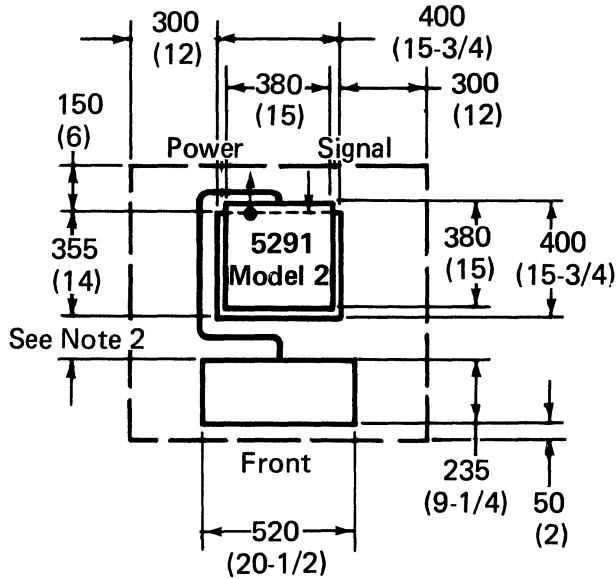

Notes:

1. Signal cables connect into the back of the display unit.
2. The length of the keyboard cable permits the keyboard to be moved up to 510 millimeters (20 inches) away from the display screen.

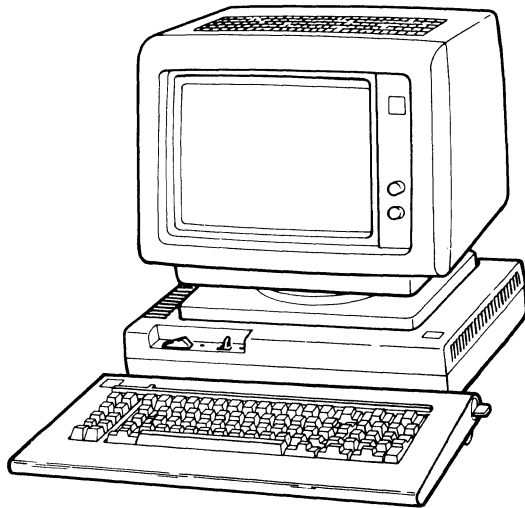

Specifications

Dimensions:¹

	Width	Depth ²	Height ²
Millimeters	400	400	432
Inches	15-3/4	15-3/4	17

Service Clearances:

	Front ¹	Rear ¹	Right	Left	Top
Millimeters	50	150	300	300	100
Inches	2	6	12	12	4

Weight (without keyboard): 12 kg (27 lb)¹

Heat Output: 50 Watts (170 BTU/hr)

Airflow: Machine is convection cooled.

Power Requirements:

Voltage	120
kVA	0.1
Phase	1
Plug type ³	H
Power cord style ³	A9

Operating and Nonoperating Environment:

See *Environmental Considerations and Requirements* in Chapter 2.

¹The keyboard is 520 millimeters (20-1/2 inches) by 235 millimeters (9-1/4 inches), adjusts in height from 35 millimeters (1-1/2 inches) to 90 millimeters (3-1/2 inches), and weighs 3.2 kg (7 lbs). The keyboard can be moved to service the machine. See *Plan View*.

²This measurement is when the display unit is tilted up.

³The power cord is 1.8 meters (6 feet) long. For more information, see *Plugs, Receptacle, and Power Cords* in this chapter.

5292 COLOR DISPLAY STATION MODELS 1 AND 2

Plan View

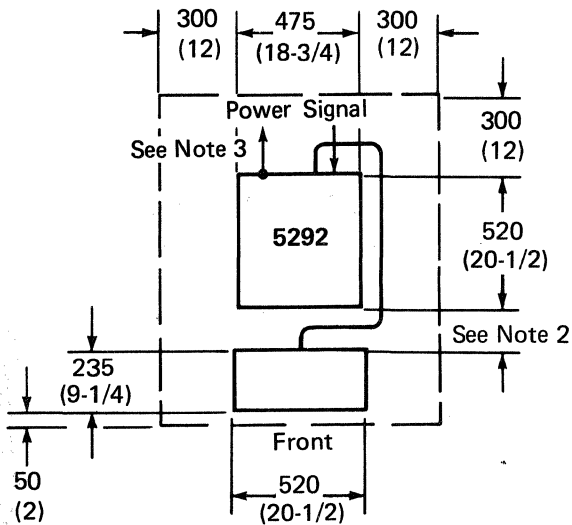

Notes:

1. Signal cables connect into the back of the display unit.
2. The length of the keyboard cable allows the keyboard to be moved up to 510 millimeters (20 inches) away from the display screen.
3. The 5292 Model 2 has an IEEE-488 connector, a printer connector, and video connectors on the back of the display station.

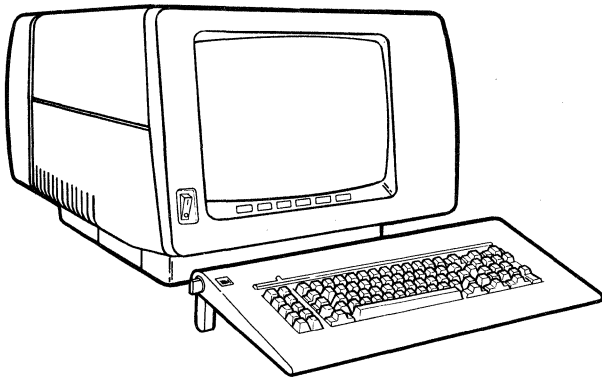

Specifications

Dimensions:¹

	Width	Depth	Height
Millimeters	475	520	430
Inches	18-3/4	20-1/2	17

Service Clearances:

	Front ¹	Rear ¹	Right	Left
Millimeters		300	300	300
Inches		12	12	12

Weight (without keyboard)

Model 1	27.0 kg (59 lb) ¹
Model 2	27.5 kg (60.5 lb) ¹

Heat Output:

Model 1	180 watts (615 BTU/hr)
Model 2	170 watts (580 BTU/hr)

Airflow:

1.6 m³/min (50 ft³/min)

Power Requirements:

Voltage	115
kVA	
Model 1	0.25
Model 2	0.2
Phase	1
Plug type ²	H
Power cord style ²	B

Operating and Nonoperating Environment:

See *Environmental Considerations and Requirements* in Chapter 2.

¹The keyboard is 520 millimeters (20-1/2 inches) by 235 millimeters (9-1/4 inches), adjusts in height from 35 millimeters (1-1/2 inches) to 90 millimeters (3-1/2 inches), and weighs 3.2 kilograms (7 lbs). The keyboard may be moved to service the machine. See *Plan View*.

²The power cord is 1.8 meters (6 feet) or 2.4 meters (8 feet) long. For more information, see *Plugs, Receptacles, and Power Cords* in this chapter.

5219 PRINTER

Plan View

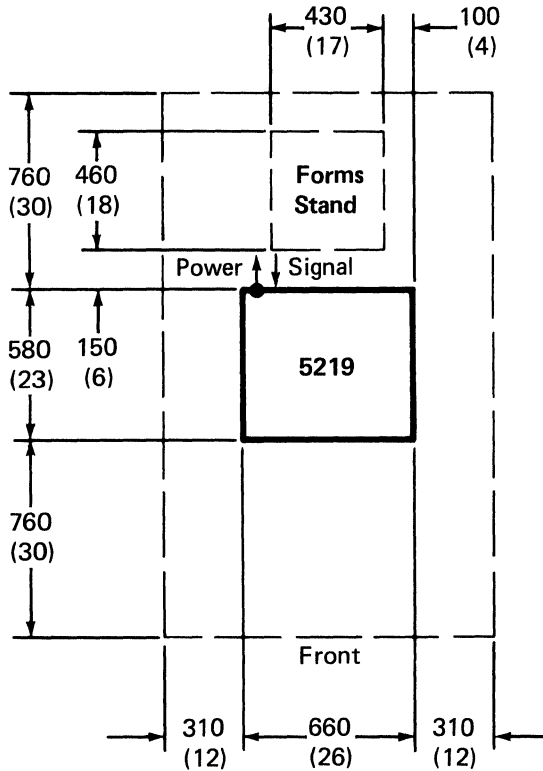

Note: Signal cables connect into the back of the printer.

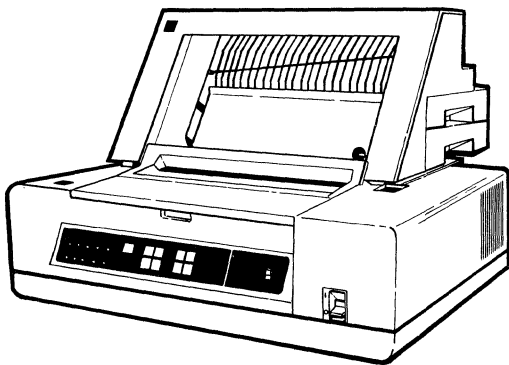

Specifications

Dimensions:

	Width	Depth	Height
Millimeters	660	580	200
Inches	26	23	8
With Automatic Cut Sheet Feed:			
Millimeters	660	730	480
Inches	26	29	19
With Form Tractor:			
Millimeters	660	730	320
Inches	26	29	12-3/4

Service Clearances:

	Front	Rear	Right	Left
Millimeters	760	150	310	310
Inches	30	6	12	12
With Automatic Cut Sheet Feed:				
Millimeters	760	310	760	310
Inches	30	12	30	12
With Form Tractor:				
Millimeters	760	410	310	310
Inches	30	16	12	12

Weight:	31 kg (68 lb)
With Automatic Cut Sheet Feed:	43 kg (95 lb)
With Form Tractor:	35 kg (77 lb)

Heat Output: 265 watts (900 BTU/hr)

Airflow: 1.4 m³/min (50 cfm)

Power Requirements:

Voltage	115
kVA	0.6
Phase	1
Plug type ¹	H
Power cord style ¹	B

Operating and Nonoperating Environment:

Operating Environment:

Temperature	16°C to 32°C (60°F to 90°F)
Relative Humidity	8% to 80%
Maximum Wet Bulb	23°C (73°F)

Nonoperating Environment:

Temperature	10°C to 43°C (50°F to 110°F)
Relative Humidity	8% to 80%
Maximum Wet Bulb	26°C (80°F)

For other environmental considerations, see *Environmental Considerations and Requirements* in Chapter 2.

¹The power cord is 3 meters (10 feet) long. For more information, see *Plugs, Receptacles, and Power Cords* in this chapter.

5224 PRINTER

Plan View

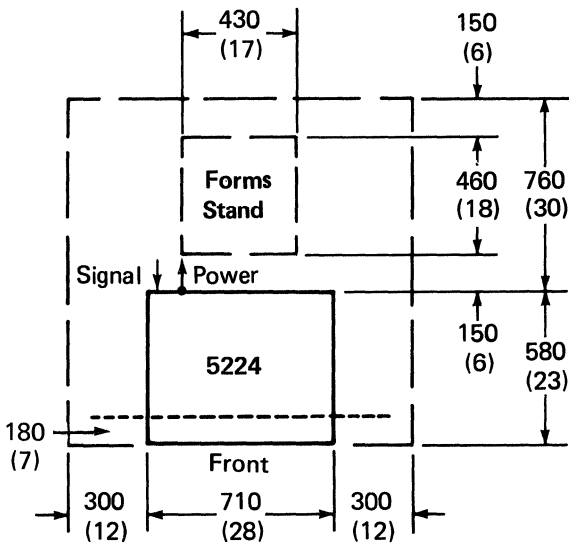

Notes:

1. Signal cables connect into the back of the machine.
2. A 180 millimeter (7 inch) paper clearance entry is allowed at the front of the printer.

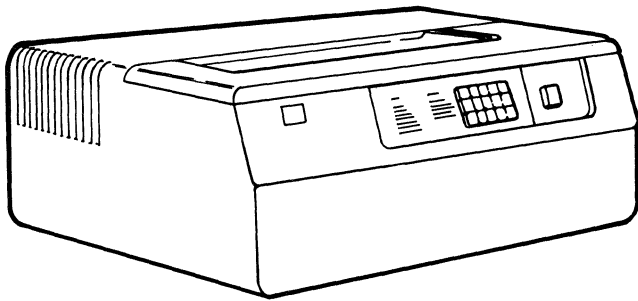

Specifications

Dimensions:

	Width	Depth	Height
Millimeters	710	580	280
Inches	28	23	11

Service Clearances:

	Front ¹	Rear	Right	Left
Millimeters	N/A	760	300	300
Inches	N/A	30	12	12

Weight: 68 kg (149 lb)

Heat Output: 470 watts (1600 BTU/hr)

Airflow: 4.5 m³/min (150 cfm)

Power Requirements:

Voltage	120
kVA	0.6
Phase	1
Plug type ²	H
Power cord style ²	B

Operating and Nonoperating Environment:

See *Environmental Considerations and Requirements* in Chapter 2.

¹A 180 millimeter (7 inch) clearance for paper entry must be provided under the front of the printer; see *Plan View*.

²The power cord is 2.4 meters (8 feet) long. For more information, see *Plugs, Receptacles, and Power Cords* in this chapter.

5225 PRINTER

Plan View

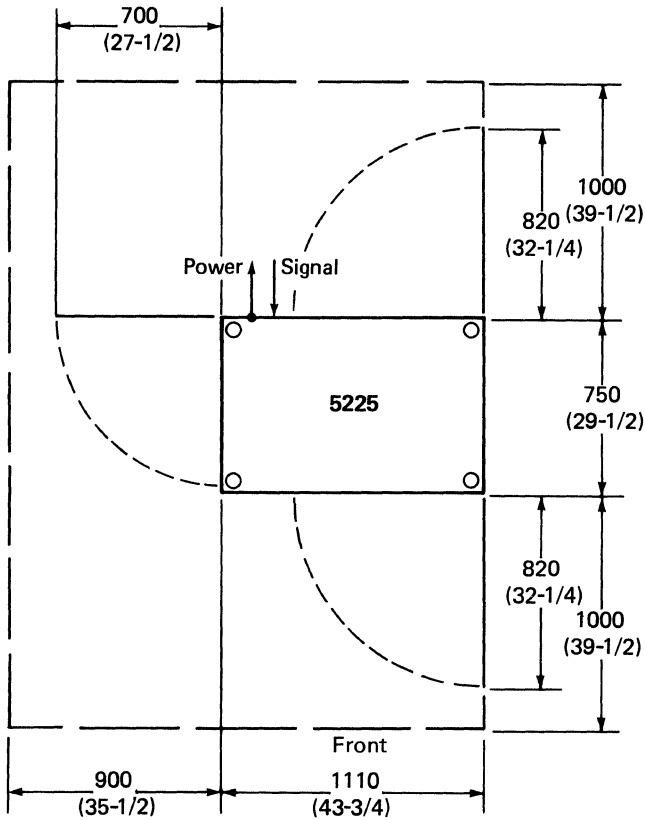

Note: Signal cables connect into the back of the machine.

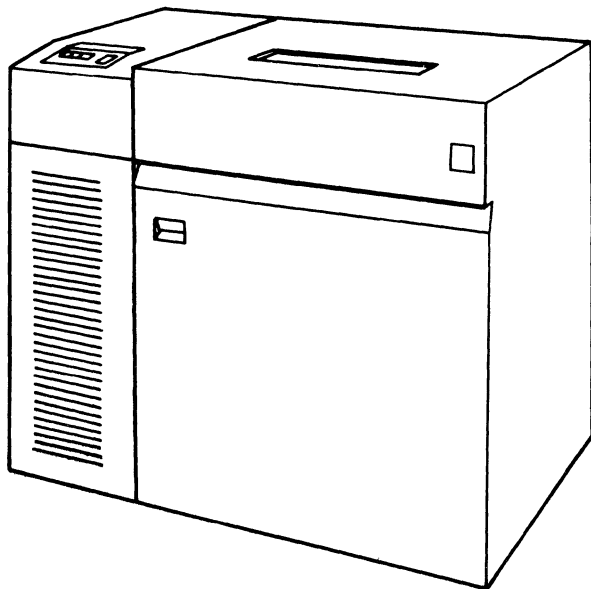

Specifications

Dimensions:

	Width	Depth	Height
Millimeters	1110	750	1000
Inches	43-3/4	29-1/2	39-1/2

Service Clearances:

	Front	Rear	Right	Left
Millimeters	1000	1000	N/A	900
Inches	39-1/2	39-1/2	N/A	35-1/2

Weight:

250 kg (550 lb)

Heat Output:

Model	1	2	3	4
BTU/hr	1900	2400	2400	2900
Watts	550	700	700	850

Airflow:

4.5 m³/min (150 cfm)

Power Requirements:

Model	1	2	3	4
Voltage	120, 208, 240	120, 208, 240	120, 208, 240	120, 208, 240
kVA	0.6	0.72	0.75	0.90
Phase	1	1	1	1
Plug type ¹	H, J, K, L	H, J, K, L	H, J, K, L	H, J, K, L
Power cord style ¹	A8	A8	A8	A8

Operating and Nonoperating Environment:

See *Environmental Considerations and Requirements* in Chapter 2.

¹The power cord is 2.4 meters (8 feet) long. For more information, see *Plugs, Receptacles, and Power Cords* in this chapter.

5256 PRINTER

Plan View

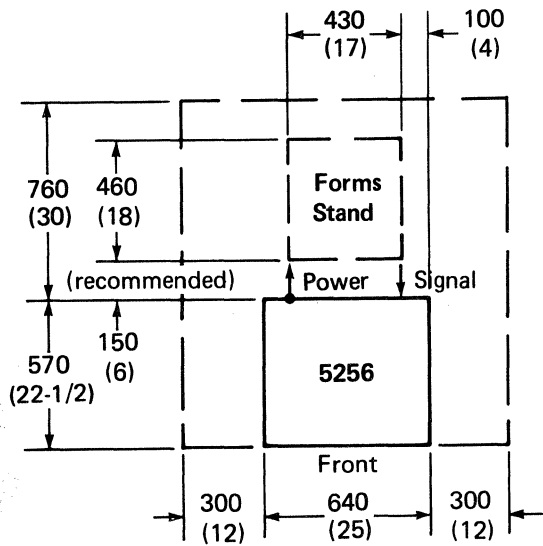

Note: Signal cables connect into the back of the machine.

Specifications

Dimensions:

	Width	Depth	Height ¹
Millimeters	640	570	345
Inches	25	22-1/2	13-1/2

Service Clearances:

	Front	Rear	Right	Left
Millimeters	N/A	760	300	300
Inches	N/A	30	12	12

Weight: 36 kg (78 lb)

Heat Output: 185 watts (630 BTU/hr)

Airflow: 1.3 m³/min (45 cfm)

Power Requirements:

Voltage	115
kVA	0.2
Phase	1
Plug type ²	H or J
Power cord style ²	B

Operating and Nonoperating Environment:

See *Environmental Considerations and Requirements* in Chapter 2.

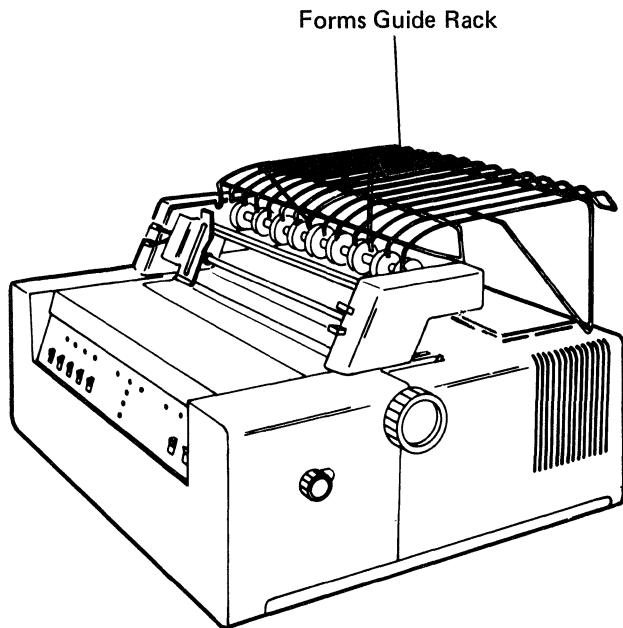

¹When the forms guide rack is tilted up, this measurement is 585 millimeters (23 inches).

²The power cord is 2.4 meters (8 feet) long. For more information, see *Plugs, Receptacles, and Power Cords* in this chapter.

4214 MODEL 2 PRINTER

Plan View

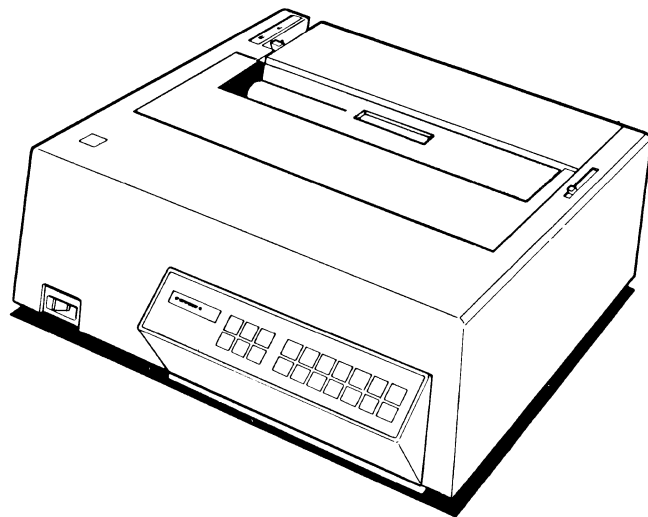
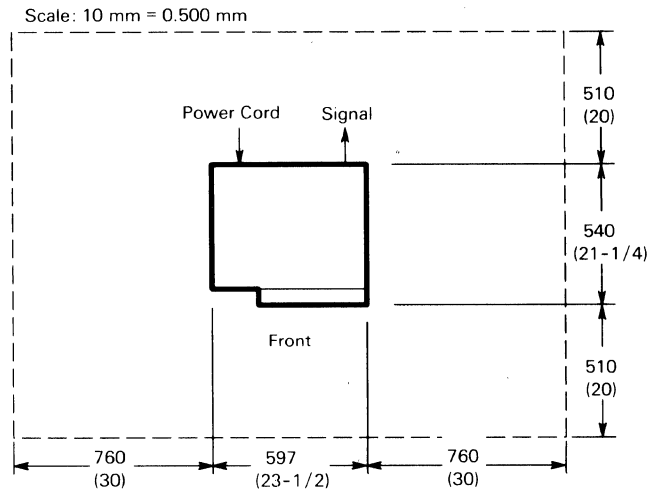

Specifications

Dimensions:

	Width	Depth	Height
Millimeters	597	481	236.5
Inches	23-1/2	19	9-1/2

Service Clearances:¹

	Front	Rear	Right	Left	Above
Millimeters	508	508	762	762	1061
Inches	20	20	30	30	40

Weight: 25 kg (55 lb)

Heat Output: 440 watts (1500 BTU/hr)

Airflow: 2 m³/min (70 cfm)

Power Requirements:

Voltage	100 to 110 or 200 to 240
kVA	100 to 127
Phase	0.5
	1
	1
Plug type ²	H or J
Power cord style ²	A9

Operating and Nonoperating Environment:

See *Environmental Considerations and Requirements* in Chapter 2.

¹Service clearances for the 4214 Model 2 Printer with or without an *Automatic Cut Sheet Feed Feature* are the same.

²The power cord is 1.8 meters (6 feet) long. For more information, see *Plugs, Receptacles, and Power Cords* in this chapter.

4224 PRINTER

Specifications

Dimensions:

	Width	Depth	Height
Millimeters	654	368	290
Inches	25-3/4	14-1/2	11-1/2

Service Clearances:

	Front	Rear	Right	Left
Millimeters	460	688	152	152
Inches	18-1/4	27-1/4	6	6

Weight: 20.5 kg (45 lb)

Heat Output: 90 watts (307 BTU/hr)

Airflow: forced air cooling

Power Requirements:

Voltage	
U.S. and Canada	100 to 127V, 50 to 60 Hz
AFE	100 to 127V, 50 to 60 Hz 200 to 240V, 50 to 60 Hz
EMEA	200 to 240V, 50 to 60 Hz
Saudi Arabia	same as U.S. and EMEA
kVA	0.6
Phase	1
Power cord length	
U.S.	1.83 m (6 ft)
Others	2.44 m (8 ft)

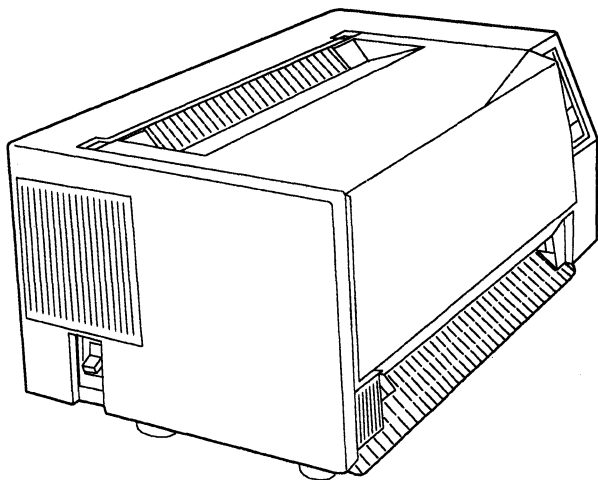

5262 MODEL 1 PRINTER

Plan View

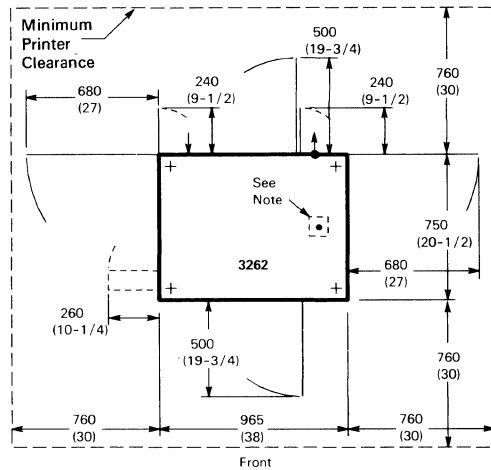

Note: Both the signal cable and power cable can be routed through a single 64-mm (2-1/2 inch) hole in raised floor. Recommended location for the hole is centered between the front and back of the machine, and 100 mm (4 inches) in from the right side.

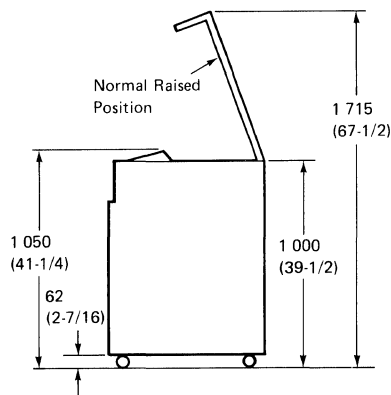

Clearance with Cover Raised

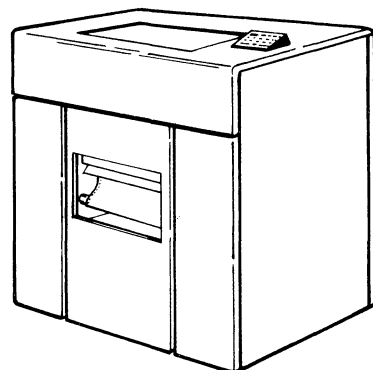

Specifications

Dimensions:

	Width	Depth	Height¹
Millimeters	965	750	1000
Inches	38	29-1/2	39-1/2

Service Clearances:

	Front	Rear	Right	Left
Millimeters	760	760	760	760
Inches	30	30	30	30

Weight: 245 kg (540 lb)

Heat Output: 1100 watts (3750 BTU/hr)

Power Requirements:

Voltage	100 to 110 or 200 to 240
	100 to 127
kVA	1.4
	1.2
Phase	1
Plug type ²	H or J

Note: Branch circuit requires a delayed-action fuse or circuit breaker with a high-surge tolerance for transformer (high-magnetic) applications.

Operating and Nonoperating Environment:

See *Environmental Considerations and Requirements* in Chapter 2.

Note: When the 5262 Model 1 Printer is used in Optical Character Recognition applications, use the following temperature and humidity limits:

Operating Environment:

Temperature, dry bulb	16°C to 29°C (60°F to 85°F)
Relative humidity	20% to 52%
Maximum wet bulb	22°C (72°F)

Nonoperating Environment:

Temperature, dry bulb	10°C to 51°C (50°F to 125°F)
Relative humidity	8% to 80%
Maximum wet bulb	26°C (80°F)

¹With the cover raised, the height is 1715 millimeters (67-1/2 inches).

²For more information, see *Plugs, Receptacles, and Power Cords* in this chapter.

System Specifications



IBM MODEM INFORMATION

IBM modems that can be attached to the remote work station controllers include the 3863, 3864, 3865, 3872, 3874, and 3875.

The dimensions and weight of the modems are:

Modem	Width	Depth	Height	Weight
3863	457 millimeters (18 inches)	222 millimeters (8-3/4 inches)	156 millimeters (6-1/8 inches)	12.8 kg (28 lb)
3864	457 millimeters (18 inches)	222 millimeters (8-3/4 inches)	156 millimeters (6-1/8 inches)	13.2 kg (29 lb)
3865	546 millimeters (21-1/2 inches)	222 millimeters (8-3/4 inches)	156 millimeters (6-1/8 inches)	14.1 kg (31 lb)
3872	432 millimeters (17 inches)	559 millimeters (22 inches)	156 millimeters (6-1/8 inches)	26 kg (57 lb)
3874	432 millimeters (17 inches)	559 millimeters (22 inches)	156 millimeters (6-1/8 inches)	24 kg (53 lb)
3875	432 millimeters (17 inches)	559 millimeters (22 inches)	156 millimeters (6-1/8 inches)	32 kg (71 lb)

More information about the modems is contained in the following publications:

- *IBM 3863, 3864, and 3865 Introduction and Site Preparation Guide, GA27-3200*
- *IBM 3872 Modem User's Guide, GA27-3058*
- *IBM 3874 Modem User's Guide, GA33-0002*
- *IBM 3875 Modem User's Guide, GA33-0001*



Chapter 4. Remote Work Station Configuration Using the 5294 Control Unit

This chapter explains how to plan for the arrangement of the 5294 Control Unit and work stations that attach to it. This is known as configuration. For configuration information about the 5251 Model 12 and any work stations that attach to it, refer to Chapter 7, *Remote Work Station Configuration Using the 5251 Model 12*.

The *IBM 5294 Setup Form* in Appendix B is used for planning the configuration and for installing the 5294 Control Unit and the work stations that attach to it. This form is completed by the person who plans a remote work station configuration using a 5294. (If you would like to see an example of a completed 5294 Control Unit Setup Form and the configuration for it, including the equipment needed at the host system, refer to Appendix D. Then return here.)

In addition to completing the setup form, cable labels need to be completed for each work station attaching to the 5294. Do this after completing the IBM 5294 Setup Form and prior to the arrival of your devices. The completed labels will be required during the actual setup of each work station. Do not be concerned about the labels at this time. Information on how to complete the labels is discussed later.

Connect this end to:	Other end connects to:
Device type/name <u>5291</u>	Device type/name <u>5294</u>
Location <u>Accounting</u>	Location <u>Accounting</u>
Work station address <u>1</u>	
Socket port <u>1</u>	Socket port <u>0</u>
	GX21-9345

This chapter next contains a configuration example using a 5294 Control Unit. It then shows how the *IBM 5294 Setup Form* for the configuration was completed.

At this time, remove a copy of the *IBM 5294 Setup Form* from Appendix B, *5294 Setup Forms*. Then, complete the setup form for your configuration by following the instructions in this chapter under *Completing the Setup Form for Configuration of the Remote Work Stations* and *Completing the Setup Form for Configuration of the 5294 Control Unit*.

After you have completed the setup form for your configuration, you should provide the operator at the 5294 with instructions on how to establish communications with the host system. *Appendix H. Applications Setup Information* contains an Applications Setup Form and instructions on how to fill it out with your specific application procedures.

Getting Started

Site Considerations

System Specifications

5294 Configuration and Communications

5251 Model 12 Communications and Configuration

Cables

Appendixes

The following illustration of a remote work station configuration will be used as a sample configuration throughout this chapter.

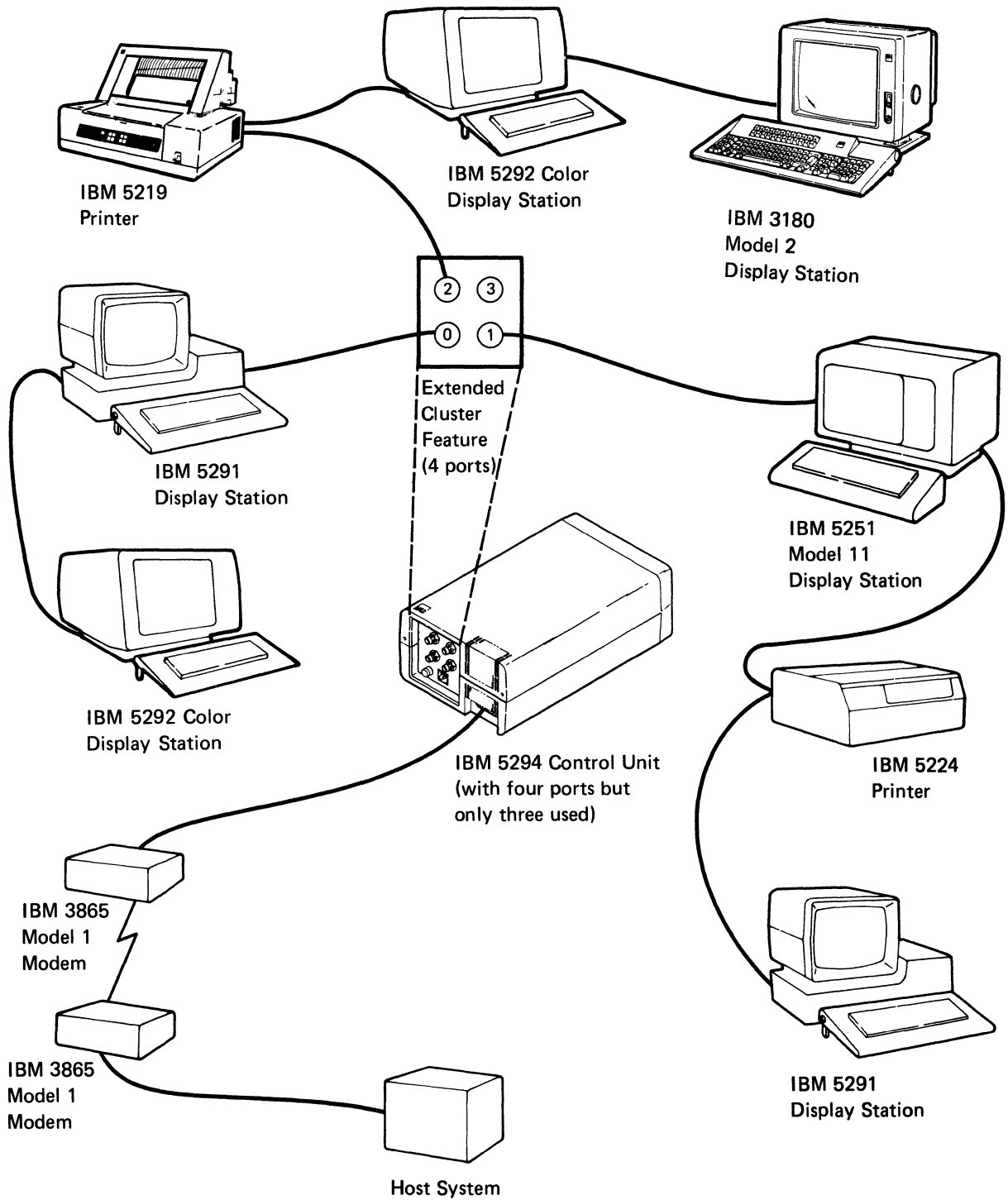

COMPLETING THE SETUP FORM FOR CONFIGURATION OF THE REMOTE WORK STATIONS

The persons, who are responsible for the setup of the IBM 5294 Control Unit and the work stations attaching to it, get the information they need from the setup instructions shipped with each device and from the *IBM 5294 Setup Form*. This form, in Appendix B, is completed by the person who plans the configuration.

As the person responsible for configuration, you must:

- Complete the following items on Part 1 of the *IBM 5294 Control Unit Setup Form* (see the following page):
 - 5294 Control Unit information
 - Identification for each work station
 - Configuration of the work stations
 - Work station address setting for each display station and printer
 - Keyboard language code for each work station

Guidelines for completing these tasks are on the following pages.

- Complete Part 2 of the *IBM 5294 Control Unit Setup Form*. Guidelines on how to do this follow the instructions for completing Part 1 of the form and are under *Completing the Setup Form for Configuration of the 5294*.
- Provide a completed copy of your *IBM 5294 Control Unit Setup Form* to the system site and to each person who will be setting up the 5294 Control Unit or a work station.
- Prepare cable labels for the work stations attaching to the 5294 Control Unit.

The following illustrates Part 1 of the IBM 5294 Control Unit Setup Form.

IBM 5294 CONTROL UNIT SETUP FORM (PART 1)

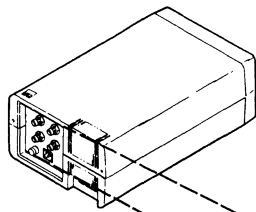

Ports

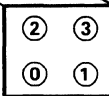

5294 Control Unit Information

Name _____
 Location _____
 City, State _____
 Telephone _____
 System Line/Port Number _____
 Location _____
 Telephone _____

Communications Type _____

Communications Mode SDLC X.25 X.21 sw

CSR assistance required for communications line connection? Yes No

Name		Socket 1
Device Type		
Location		
Work Station Address		
Unit Address		
Keyboard Code		
Telephone		Socket 2

Name		Socket 1
Device Type		
Location		
Work Station Address		
Unit Address		
Keyboard Code		
Telephone		Socket 2

Name		Socket 1
Device Type		
Location		
Work Station Address		
Unit Address		
Keyboard Code		
Telephone		Socket 2

Name		Socket 1
Device Type		
Location		
Work Station Address		
Unit Address		
Keyboard Code		
Telephone		Socket 2

Socket 1	Name	
	Device Type	
	Location	
	Work Station Address	
	Unit Address	
	Keyboard Code	
Socket 2	Telephone	

Socket 1	Name	
	Device Type	
	Location	
	Work Station Address	
	Unit Address	
	Keyboard Code	
Socket 2	Telephone	

Socket 1	Name	
	Device Type	
	Location	
	Work Station Address	
	Unit Address	
	Keyboard Code	
Socket 2	Telephone	

Socket 1	Name	
	Device Type	
	Location	
	Work Station Address	
	Unit Address	
	Keyboard Code	
Socket 2	Telephone	

Note: Each cable connected to a 5294 port should have a tag with a number from 0 through 3. There should be a cable for each port used. Connect each cable to the port indicated on its tag.

5294 Control Unit Information

Complete the 5294 Control Unit information on Part 1 of the Communications Network Setup Form as follows:

1. Fill in an identifying name (a person or place), location (a building, address, or part of town), city, state, and a telephone number where the operator of the 5294 can be reached.

5294 Control Unit Information

Name Ed

Location Accounting Office

City, State New York, New York

Telephone 212-555-6742

System Line/Port Number _____

Location _____

Telephone _____

Communications Type _____

Communications Mode

<input type="checkbox"/> SDLC	<input type="checkbox"/> X.25	<input type="checkbox"/> X.21 sw
-------------------------------	-------------------------------	----------------------------------

CSR assistance required for communications line connection?

<input type="checkbox"/> Yes	<input type="checkbox"/> No
------------------------------	-----------------------------

2. Fill in the system line/port number. This refers to the communications line from the system that the 5294 Control Unit is connected to. Check with the system site to make sure that you have the correct line number. Also, fill in the location and telephone number for the system.

5294 Control Unit Information

Name Ed

Location Accounting Office

City, State New York, New York

Telephone 212-555-6742

System Line/Port Number 3

Location Computer Center

Telephone 212-555-5112

Communications Type _____

Communications Mode

<input type="checkbox"/> SDLC	<input type="checkbox"/> X.25	<input type="checkbox"/> X.21 sw
-------------------------------	-------------------------------	----------------------------------

CSR assistance required for communications line connection?

<input type="checkbox"/> Yes	<input type="checkbox"/> No
------------------------------	-----------------------------

3. Fill in the 5294 Control Unit communications type. The choices for communications type are:
- a. EIA/CCITT
 - b. Digital Data Service Adapter (DDSA)
 - c. X.21 Signal Converter

The communications type is the communications option listed on your 5294 Control Unit sales order.

If you have not ordered your communications equipment, read Chapter 5, *Ordering Communications Equipment and Facilities for the 5294 Control Unit*. Then order your communications equipment and facilities.

5294 Control Unit Information

Name Ed

Location Accounting Office

City, State New York, New York

Telephone 212-555-6742

System Line/Port Number 3

Location Computer Center

Telephone 212-555-5112

← Communications Type EIA/CCITT

Communications Mode

SDLC	X.25	X.21 sw
------	------	---------

CSR assistance required for communications line connection?

Yes	No
-----	----

4. Check the appropriate box to indicate whether the communications mode is SDLC, X.25, or X.21 switched.

The communications mode is SDLC if your 5294 will be attached to an analog network, AT&T Data-Phone Digital Service¹ (DDS) public data network, or an X.21 public data network (nonswitched).

The communications mode is X.25 if your 5294 will be attached to an X.25 network. If your 5294 is being attached to an X.25 network, the X.25 feature must be listed on your sales order.

The communications mode is X.21 (switched) if your 5294 will be attached to an X.21 public data network (switched). If your 5294 is being attached to an X.21 switched network, the X.21 switched feature must be listed on your sales order.

5294 Control Unit Information

Name Ed
 Location Accounting Office
 City, State New York, New York
 Telephone 212-555-6742
 System Line/Port Number 3
 Location Computer Center
 Telephone 212-555-5112
 Communications Type EIA/CCITT



Communications Mode SDLC X.25 X.21 sw

CSR assistance required for communications line connection? Yes No

5294
 Configuration and
 Communications

¹Trademark of American Telephone and Telegraph Company

5. Check the appropriate box to indicate whether the person doing the setup of the 5294 Control Unit will require CSR (customer service representative) assistance to connect the 5294 to the communications line. (In some countries, other than the United States and Canada, a CSR must be present and/or make the connection to the communications line.)

Note: The Yes block should be checked only if your country or PTT regulations require that the connection be made by an IBM CSR.

5294 Control Unit Information

Name Ed

Location Accounting Office

City, State New York, New York

Telephone 212-555-6742

System Line/Port Number 3

Location Computer Center

Telephone 212-555-5112

Communications Type EIA/CCITT

Communications Mode

SDLC ✓	X.25	X.21 sw
-----------	------	---------



CSR assistance required for communications line connection?

Yes	No ✓
-----	---------

Identifying the Work Stations

To identify the work stations, complete the following information for each work station on Part 1 of the IBM 5294 Control Unit Setup Form:

1. Fill in a name for each work station. This may be any unique name that identifies this particular work station. (Names of operators are used in this example.)



Name	Glen	Socket 1
Device Type		
Location		
Work Station Address		
Unit Address		
Keyboard Code		
Telephone		

2. Write in the type of work station (3180 Model 2, 5251 Model 11, 5291, 5292 Model 1, 5292 Model 2, 5219, 5224, 5225, or 5256) or a D for display or a P for printer.



Name	Glen	Socket 1
Device Type	5291	
Location		
Work Station Address		
Unit Address		
Keyboard Code		
Telephone		

3. Fill in the location of the work station.



Name	Glen	Socket 1
Device Type	5291	
Location	Accounting	
Work Station Address		
Unit Address		
Keyboard Code		
Telephone		

Drawing Your Configuration

Draw your configuration of the work stations by doing the following:

1. Look at your floor plan (drawing for the work station[s]).
2. Review the following considerations:
 - a. For problem determination and servicing of the 5294 Control Unit, at least one display station is required to be attached within 6 meters (20 feet) of the 5294.
 - b. If your 5294 Control Unit will have two ports (cluster function), the maximum number of work stations that can be attached to it is four. Of these four, all can be attached to port 0 using Cable Thru, or they can be attached to both ports in any combination.

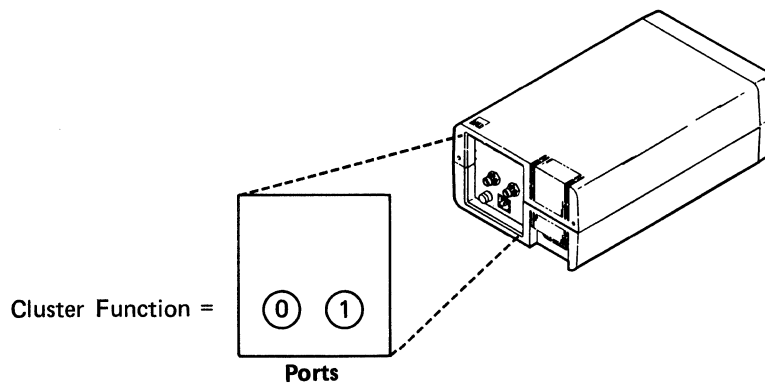

- c. If your 5294 Control Unit will have four ports (Extended Cluster feature), the maximum number of work stations that can be attached to it is eight. Of these eight, up to seven can be attached to a single port using Cable Thru. Any combination of work stations (up to seven) is permitted on a port.

Note: If your 5294 Control Unit will be attached to an X.25 packet switched network and have four ports, the maximum number of work stations that can be attached to it is six. Of these six, all can be attached to one port using Cable Thru. Any combination of work stations (up to six) is permitted on a port.

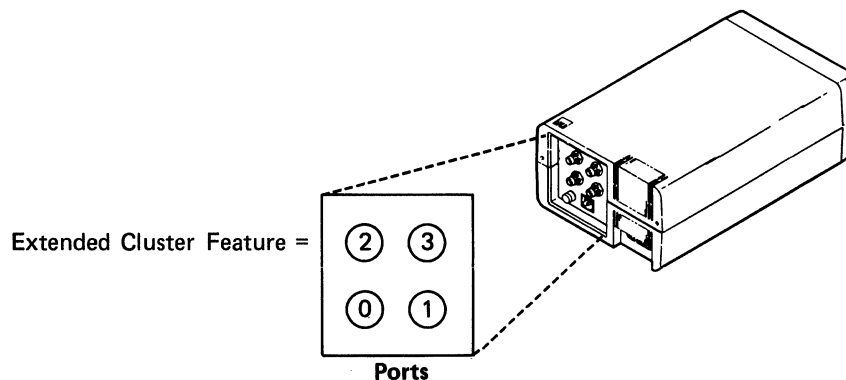

3. Determine the number of ports you will use. Then draw a line between the port(s) and work station(s) that make up your configuration. In the following example, three ports are used.

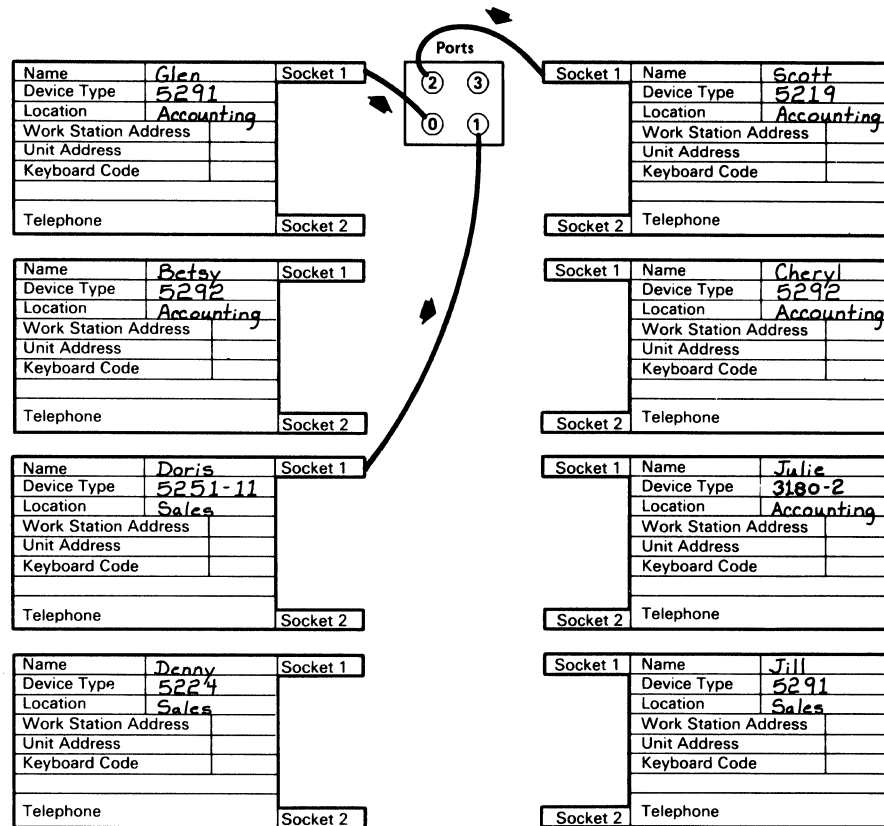

4. If you have Cable Thru on any of your work stations, review the following considerations; if not proceed to *Work Station Address Settings* in this chapter.
- All but the last work station or the only work station on a line must have Cable Thru.
 - The last work station on a Cable Thru line can be no more than 1525 meters (5000 feet) in cable distance away from the 5294 Control Unit.

5. If you have Cable Thru on any of your work station, draw a line between each work station to be connected to the same port, as shown.

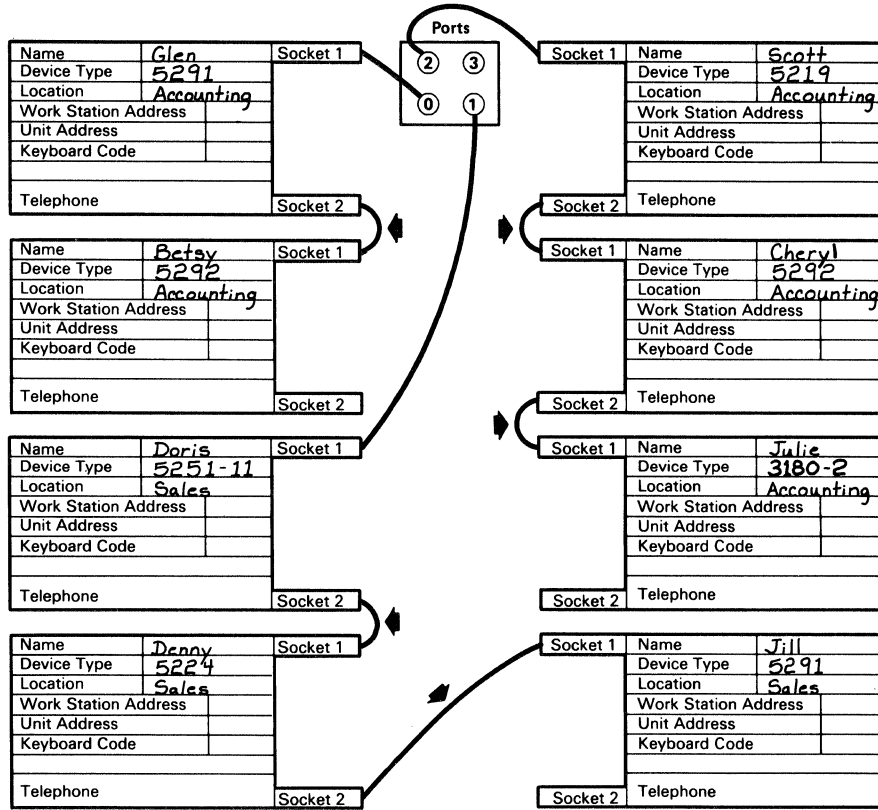

Work Station Address Settings

To determine the work station address for each work station, do the following:

1. Review the following considerations:
 - a. Each work station that attaches to the same port on a 5294 Control Unit using Cable Thru must have a different work station address.
 - b. Any address from 0 through 6 can be used.

Note: If a work station does not have Cable Thru, its work station address is already internally set to 0.

2. From the considerations in the preceding step, fill in the work station address for each work station on part 1 of the setup form.

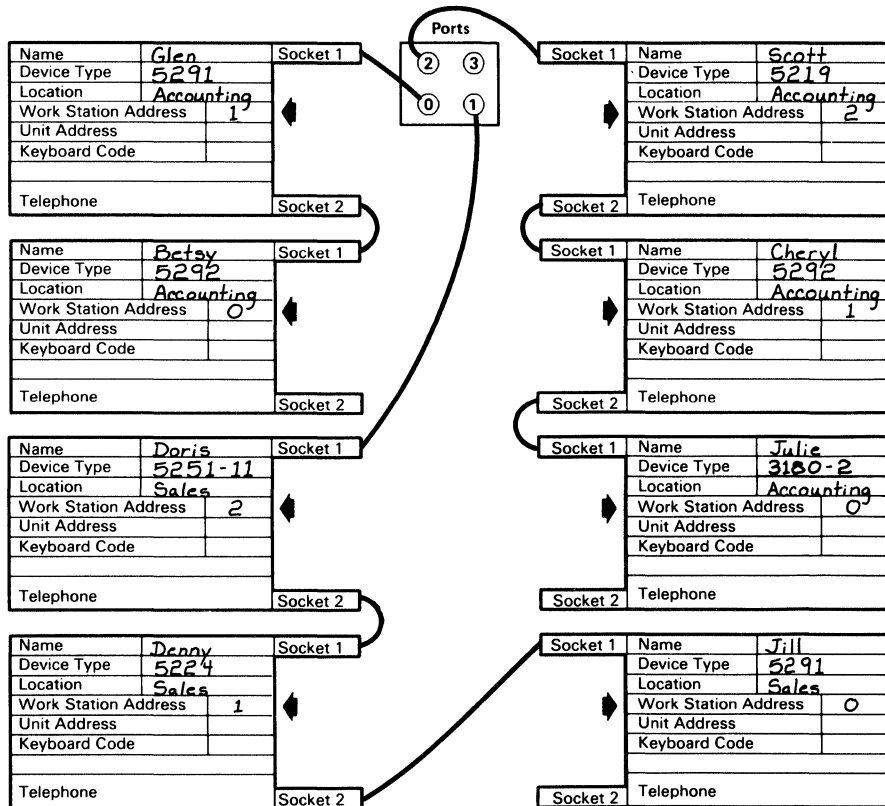

Unit Address

The unit address may be required for use by the host system. To determine the unit address for each work station, do the following:

- In the chart below, find where the address of the work station and the port that the work station is connected to (either directly or by Cable Thru) on the 5294 Control Unit cross. This is the unit address for that work station.

Port	0	1	2	3	4	5	6	Work Station Address
0	00	01	02	03	04	05	06	
1	07	08	09	0A	0B	0C	0D	
2	0E	0F	10	11	12	13	14	
3	15	16	17	18	19	1A	1B	

- Fill in the unit address for each work station on Part 1 of the setup form.

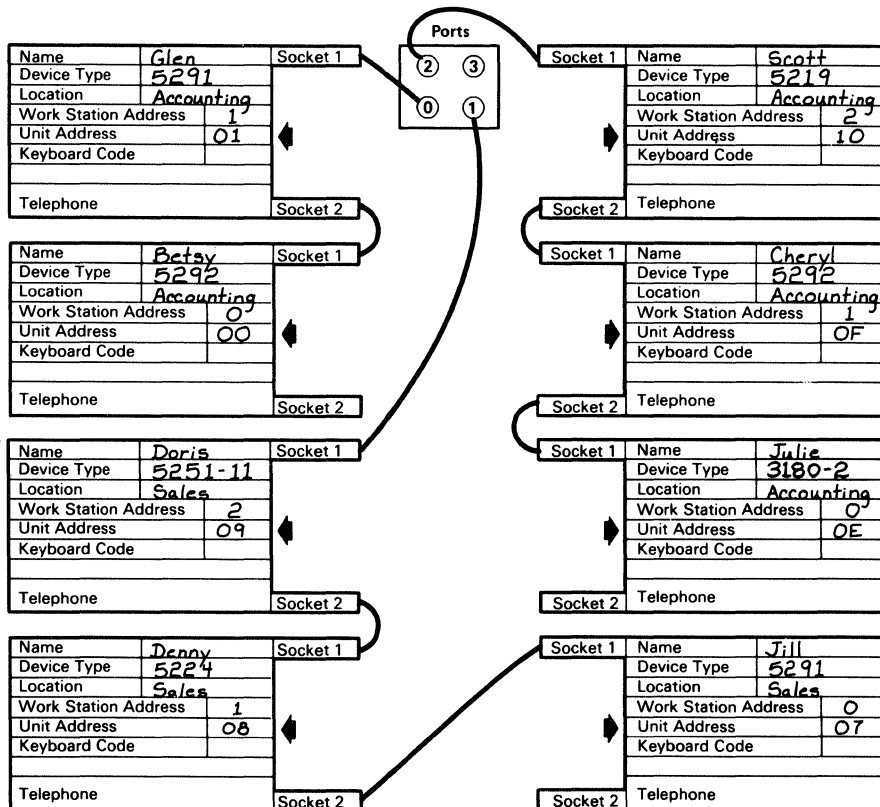

Keyboard Codes

To determine the keyboard code for each work station, do the following:

- In each block on the setup form that identifies a printer, enter *None* for the keyboard code.

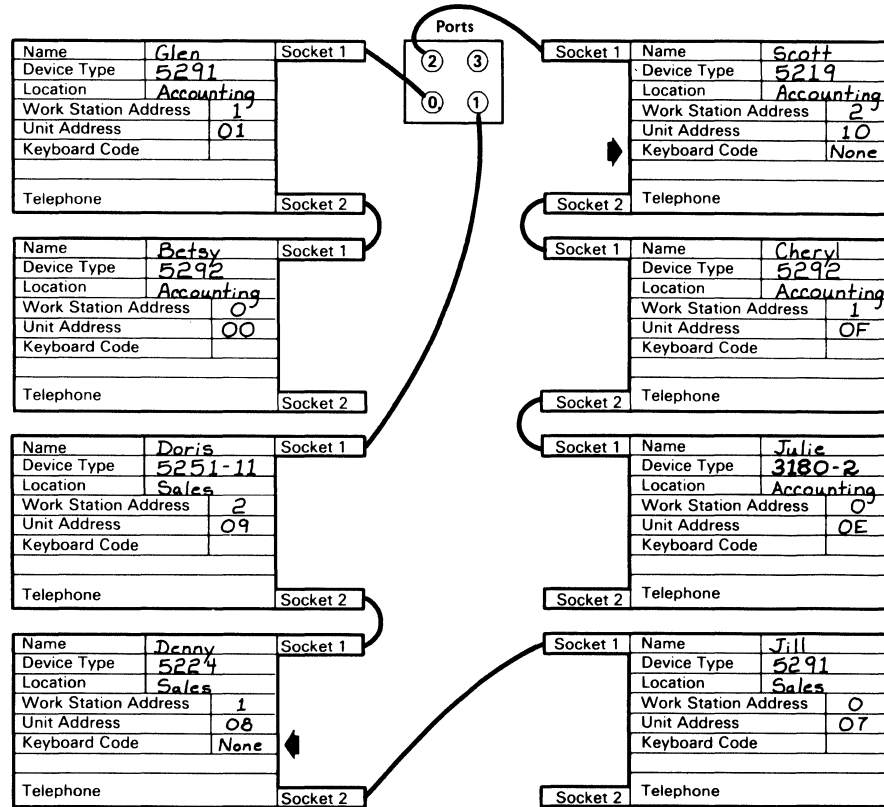

2. For each display station, find the country character set that will be used on it and the corresponding keyboard code in the following chart.

Notes:

- a. All keyboard codes used in your configuration must be supported by your host system.
- b. If all display stations in your configuration will not have the same character set, each character set selected must be a multinational character set.
- c. Keyboard codes 29, 2A, 2B, and 2C are not supported by the 5251 Model 11.
- d. Some 5294s *do* support keyboard codes 01 (Japanese/Katakana), 02 (Japanese/English), and 03 (Japanese/multinational), but *do not* support keyboard codes 2D (ASCII) and 2E (ASCII multinational). These same machines also *do not* support keyboard codes 04 (France [Azerty]) and 05 (France [Azerty] multinational) if used for the 3180 Model 2.
- e. Some 5294s *do not* support keyboard codes 01 (Japanese/Katakana), 02 (Japanese/English), and 03 (Japanese/multinational), but *do* support keyboard codes 2D (ASCII) and 2E (ASCII multinational). These same machines also *do* support keyboard codes 04 (France [Azerty]) and 05 (France [Azerty] multinational) if used for the 3180 Model 2.

Country Character Set	Keyboard Code	Country Character Set	Keyboard Code
ASCII	2D	Japanese/English	02
ASCII multinational	2E	Japanese/Katakana	01
Austria/Germany	22	Japanese/multinational	03
Austria/Germany multinational	23	Mixed Swiss French/French	25
Belgium	06	Mixed Swiss French/French multinational	26
Belgium multinational	07	Mixed Swiss German/German	27
Brazil	20	Mixed Swiss German/German multinational	28
Brazil multinational	21	Norway	16
Canada	00	Norway multinational	17
Canada multinational	24	Portugal	18
Canadian French	08	Portugal multinational	19
Canadian French multinational	09	Spain	1C
Denmark	0A	Spain multinational	1D
Denmark multinational	0B	Spanish-speaking	0E
Finland	0C	Spanish-speaking multinational	0F
Finland multinational	0D	Sweden	1E
France (Azerty)	04	Sweden multinational	1F
France (Azerty) multinational	05	Swiss French	29
France (Qwerty) multinational	1A	Swiss French multinational	2A
France (Qwerty)	1B	Swiss German	2B
International	14	Swiss German multinational	2C
International multinational	15	United Kingdom	12
Italy	10	United Kingdom multinational	13
Italy multinational	11	United States	00
		United States multinational	24

Keyboard Codes

To determine the keyboard code for each work station, do the following:

1. In each block on the setup form that identifies a printer, enter *None* for the keyboard code.

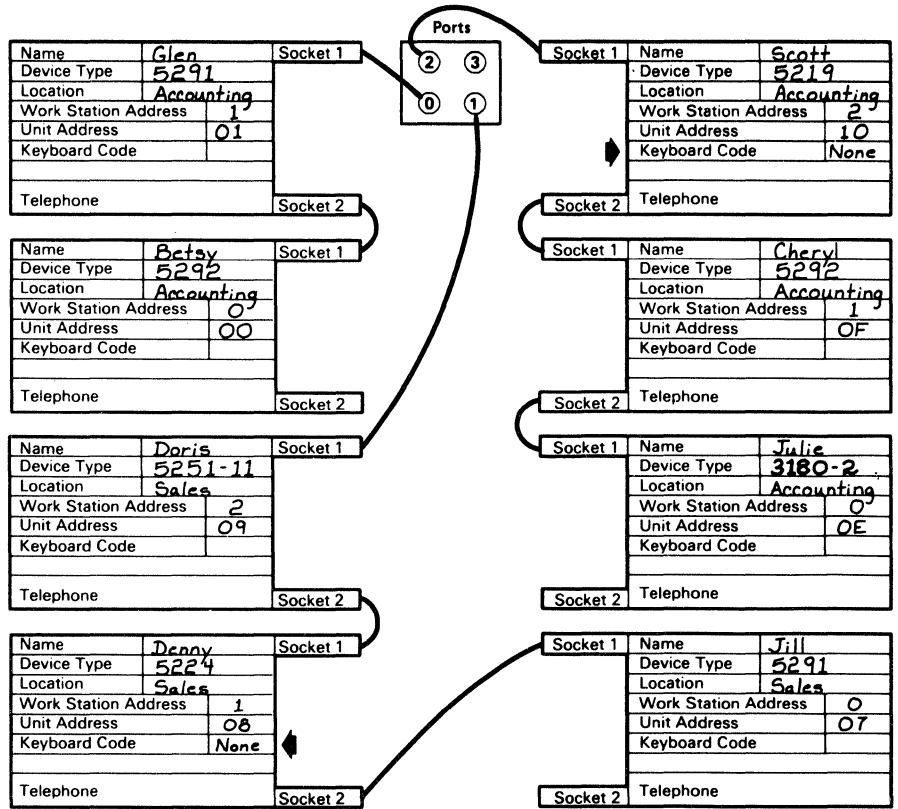

2. For each display station, find the country character set that will be used on it and the corresponding keyboard code in the following chart.

Notes:

- a. All keyboard codes used in your configuration must be supported by your host system.
- b. If all display stations in your configuration will not have the same character set, each character set selected must be a multinational character set.
- c. Keyboard codes 29, 2A, 2B, and 2C are not supported by the 5251 Model 11.
- d. Some 5294s *do* support keyboard codes 01 (Japanese/Katakana), 02 (Japanese/English), and 03 (Japanese/multinational), but *do not* support keyboard codes 2D (ASCII) and 2E (ASCII multinational). These same machines also *do not* support keyboard codes 04 (France [Azerty]) and 05 (France [Azerty] multinational) if used for the 3180 Model 2.
- e. Some 5294s *do not* support keyboard codes 01 (Japanese/Katakana), 02 (Japanese/English), and 03 (Japanese/multinational), but *do* support keyboard codes 2D (ASCII) and 2E (ASCII multinational). These same machines also *do* support keyboard codes 04 (France [Azerty]) and 05 (France [Azerty] multinational) if used for the 3180 Model 2.
- f. The keyboard code selection is 00 for all displays attached to the 5294 Model S01.

Country Character Set	Keyboard Code	Country Character Set	Keyboard Code
ASCII	2D	Japanese/English	02
ASCII multinational	2E	Japanese/Katakana	01
Austria/Germany	22	Japanese/multinational	03
Austria/Germany multinational	23	Mixed Swiss French/French	25
Belgium	06	Mixed Swiss French/French multinational	26
Belgium multinational	07	Mixed Swiss German/German	27
Brazil	20	Mixed Swiss German/German multinational	28
Brazil multinational	21	Norway	16
Canada	00	Norway multinational	17
Canada multinational	24	Portugal	18
Canadian French	08	Portugal multinational	19
Canadian French multinational	09	Spain	1C
Denmark	0A	Spain multinational	1D
Denmark multinational	0B	Spanish-speaking	0E
Finland	0C	Spanish-speaking multinational	0F
Finland multinational	0D	Sweden	1E
France (Azerty)	04	Sweden multinational	1F
France (Azerty) multinational	05	Swiss French	29
France (Qwerty) multinational	1A	Swiss French multinational	2A
France (Qwerty)	1B	Swiss German	2B
International	14	Swiss German multinational	2C
International multinational	15	United Kingdom	12
Italy	10	United Kingdom multinational	13
Italy multinational	11	United States	00
		United States multinational	24

3. Fill in the keyboard code for each display station on the setup form.

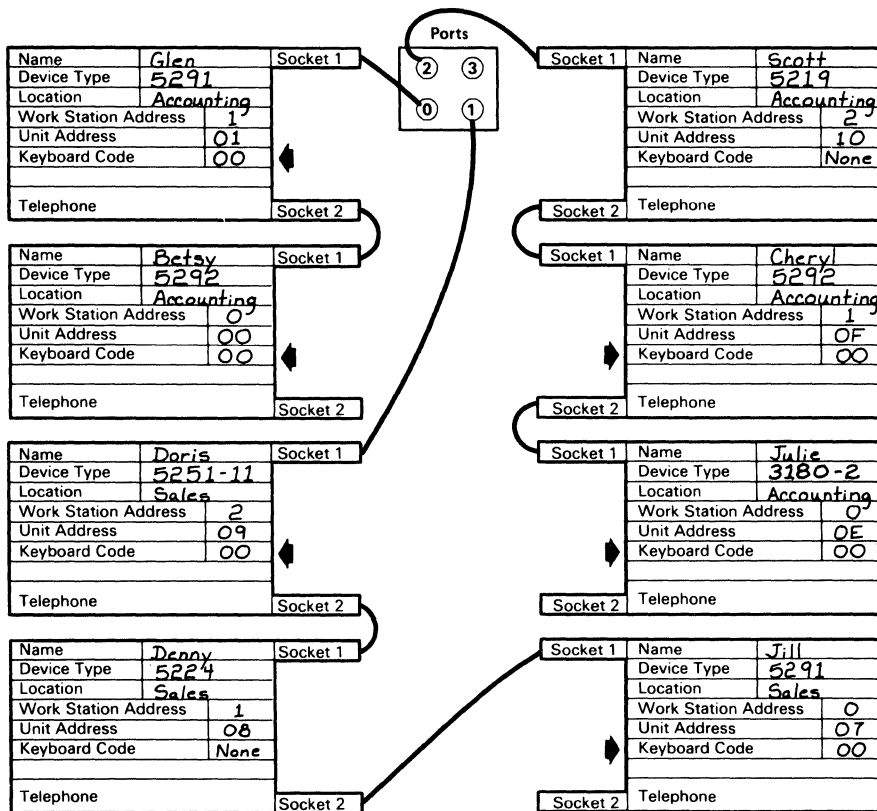

4. If you used keyboard code 25, 26, 27, or 28 in step 3 and have other display stations than the 3180 Model 2 in your configuration, proceed with this step. If not, go to the next section, *Completing the Setup Form for Configuration of the 5294 Control Unit*.

Keyboard codes 25, 26, 27, and 28 are intended only for the 3180 Model 2. If you included any of these codes in step 3 for a 5251 Model 11, 5291, or 5292, they will automatically change to what is shown in the following chart.

Keyboard Code Selected	3180 Model 2	5291 and 5292 (All Models)	5251 Model 11
25	25	1A	1A
26	26	1B	1B
27	27	22	22
28	28	23	23

COMPLETING THE SETUP FORM FOR CONFIGURATION OF THE 5294 CONTROL UNIT

This section describes completing Part 2 of the IBM 5294 Control Unit Setup Form for the 5294 Control Unit configuration.

When the 5294 Control Unit arrives, the person responsible for its setup must attach a display station to it. Then using this display station, enter the necessary information that was completed on Part 2 of the 5294 Control Unit Setup Form in Appendix B. The instructions for setting up the 5294 and entering the required information is in the *IBM 5294 Control Unit Setup Procedure*, GA21-9369. This publication is shipped with the 5294.

As the person responsible for configuration, you must complete the screen on Part 2 of the 5294 Control Unit Setup Form (see the following page).

Guidelines for completing the screen are on the following pages.

The following illustrates Part 2 of the IBM 5294 Control Unit Setup Form.

IBM 5294 CONTROL UNIT SETUP FORM (PART 2)

During 5294 setup, you need to enter the information on this form in the entry fields on the appropriate line at the bottom of your display. Also, if a number is beside a D or P on the top part of the form it must be entered.

Note: On the top of each display are the possible work station addresses (0, 1, 2, 3, 4, 5, or 6). On the left side of each display are the port numbers (0/, 1/, 2/, or 3/). Port numbers 2/ and 3/ appear only when the 5294 has four ports.

Work Station Addresses

	0	1	2	3	4	5	6
Port Numbers	0/						
	1/						
	2/						
	3/						
	1->	2->	3->				

If your 5294 communications mode is SDLC, fill in this line.

If your 5294 communications mode is X.25, fill in this line.

1->	2->	4->	5->	6->
-----	-----	-----	-----	-----

If your 5294 communications mode is X.21 switched, fill in this line.

1->	2->	9->	A->	B->
-----	-----	-----	-----	-----

----- Cut Along Line -----

5294
Configuration and
Communications

Configuration Screen Layout

To determine the configuration screen layout, use Part 1 of the completed setup form for reference. Then do the following:

1. Enter a D (for display station) or a P (for printer) where the work station address and the port number cross for each work station.

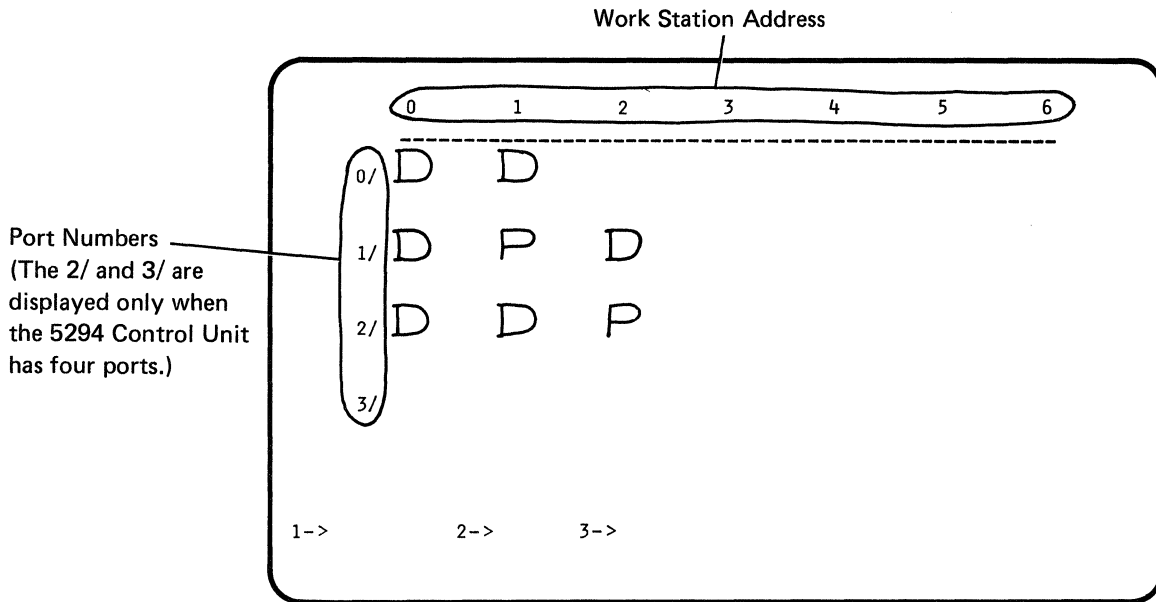

2. Enter a period (.) where the numbers cross that do not have either a D or P. The period indicates that no work station is at this location.

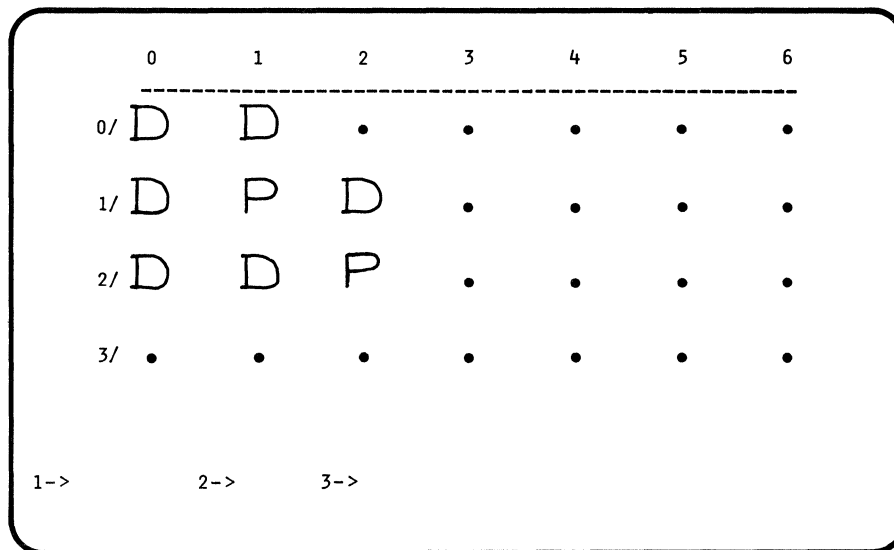

Operator Input Fields

If your 5294 communications mode is SDLC, fields 1, 2, and 3 at the bottom of the screen must be completed.

If your 5294 communications mode is X.25, fields 1, 2, 4, 5, and 6 at the bottom of the screen must be completed.

If your 5294 communications mode is X.21 switched, fields 1, 2, and 9 at the bottom of the screen must be completed. Fields A and B are reserved and should be left as they are.

Field 1 (Keyboard Code Field)

Do one of the following:

- If all the display stations have the same keyboard code shown on Part 1 of the setup form, enter that keyboard code in field 1.

	0	1	2	3	4	5	6
0/	D	D
1/	D	P	D
2/	D	D	P
3/

1-> 00 2-> 3->

Field 1

- If all of the display stations do not have the same keyboard code shown on Part 1 of the setup form, do the following:

Note: The following two screens do not represent the example used throughout this chapter.

1. In field 1, enter the keyboard code that is used on most display stations in your configuration.

Notes:

- a. The keyboard code must be a multinational keyboard code. (See *Keyboard Codes* in this chapter for more information.)
- b. If no one keyboard code represents a majority of the keyboard codes used on your display stations, use any multinational keyboard code in your configuration.

	0	1	2	3	4	5	6
0/	D	D
1/	D	P	D
2/	D	D	P
3/

1-> 24 2-> 3->

Field 1

2. To the right of each D shown on the screen, enter the keyboard code for that display station if it is different from the keyboard code in field 1.

Keyboard Code

	0	1	2	3	4	5	6
0/	D1C	D
1/	D	P	D
2/	D	D	P
3/

1-> 24 2-> 3->

Field 2 (Controller Address Field)

Contact the person at the system site who is responsible for system configuration for the number that needs to be entered in this field. This number is:

1. A hexadecimal number from 01 through FE.
2. Usually different for each 5294 Control Unit attached to the same system.

	0	1	2	3	4	5	6
0/	D	D
1/	D	P	D
2/	D	D	P
3/

1-> 00 2-> 01 3->

Field 2

Field 3 (Communications Field)

The setting for this field must be determined if your 5294 communications mode is SDLC. If your 5294 communications mode is X.25, go to *Fields 4, 5, and 6 (X.25 Fields)* later in this chapter. If your 5294 communications mode is X.21 switched, go to *Fields 9, A, and B (X.21 Switched Fields)* later in this chapter.

Field 3 has ten positions. Each position has a different meaning and must have its own setting (either 0 or 1). The meaning and possible settings for each position is explained under step 2 for completing this field.

To determine the setting for each position, do the following:

1. If your 5294 Control Unit will be connected to the communications line by one of the following methods, the chart below can be used to determine the setting for field 3:
 - a. A network using IBM modems
 - b. DDS network
 - c. X.21 network using the X.21 Signal Converter feature

If your 5294 will not be connected to the communications line by any of the above methods, go to step 2.

- a. In the following chart, find your IBM modem or feature. To the right of this is your setting for field 3.

		Your IBM Modem or Feature	Settings for Field 3									
			1	2	3	4	5	6	7	8	9	10
Nonswitched Point-to-Point	2400 bps	3863-1	0	1	1	0	0	0	1	1	0	1
	2400 bps	3872	0	1	1	0	0	0	0	1	0	0
	4800 bps	3864-1	0	1	1	0	0	0	1	1	0	1
	4800 bps	3874	0	1	1	0	0	0	0	1	0	0
	7200 bps	3875	0	1	1	0	0	0	0	1	0	0
	9600 bps	3865-1	0	1	1	0	0	0	1	1	0	1
	2400, 4800, 9600, or 56,000 bps	DDSA	0	1	1	1	0	0	0	0	0	0
		X.21 ¹	0	1	1	1	0	0	0	0	0	0
Nonswitched Multipoint	2400 bps	3863-1	0	1	0	0	0	0	1	1	0	1
	2400 bps	3872	0	1	0	0	0	0	0	1	0	0
	4800 bps	3864-1	0	1	0	0	0	0	1	1	0	1
	4800 bps	3874	0	1	0	0	0	0	0	1	0	0
	7200 bps	3875	0	1	0	0	0	0	0	1	0	0
	9600 bps	3865-2	0	1	0	0	0	0	1	1	0	1
	2400, 4800, 9600, or 56,000 bps	DDSA	0	1	0	1	0	0	0	0	0	0
		X.21 ¹	0	1	0	1	0	0	0	0	0	0
Switched²	2400 bps	3863-2	1	0	1	0	0	0	1	1	0	1
	2400 bps	3872	1	0	1	0	0	0	0	1	0	0
	4800 bps	3864-2	1	0	1	0	0	0	1	1	0	1
	4800 bps	3874	1	0	1	0	0	0	0	1	0	0

¹For a nonswitched X.21 network using the X.21 Signal Converter feature, use the setting in this chart for your setting for field 3.

²For switched operation using the X.21 bis interface, go to step 2 in this section to determine your setting for field 3.

- b. Copy your 10-position setting for field 3 to field 3 on the screen.

	0	1	2	3	4	5	6
0/	D	D
1/	D	P	D
2/	D	D	P
3/

1-> 00 2-> 01 3-> 0110001101

Field 3

(This example shows the setting for a 3865 Model 1 modem on a nonswitched point-to-point network.)

- c. This completes the planning requirements.

Make sure you give a copy of the completed *IBM 5294 Control Unit Setup Form* to the system location and to the person who will be doing the 5294 Control Unit setup. Also make sure cable labels are completed for each work station attaching to the 5294. For information about the labels, see *Labeling Cables* in Appendix A.

2. If your 5294 Control Unit will not be connected to the communications line by any method listed under step 1, do the following:
- a. If you have not already completed an IBM 5294 Communications Network Worksheet, go to Chapter 5 and complete a worksheet for the kind of network you select.

Note: Contained within the worksheet is a block for entering a setting for each position in field 3. As you complete the worksheet, references are made to these positions. By completing the worksheet, you will also be able to determine what the setting is for each position and can enter it into the box.

- b. From the 10-position box you completed on the IBM 5294 Communications Worksheet in Chapter 5, transfer the setting to the blanks under *Your Setting* in the following chart.

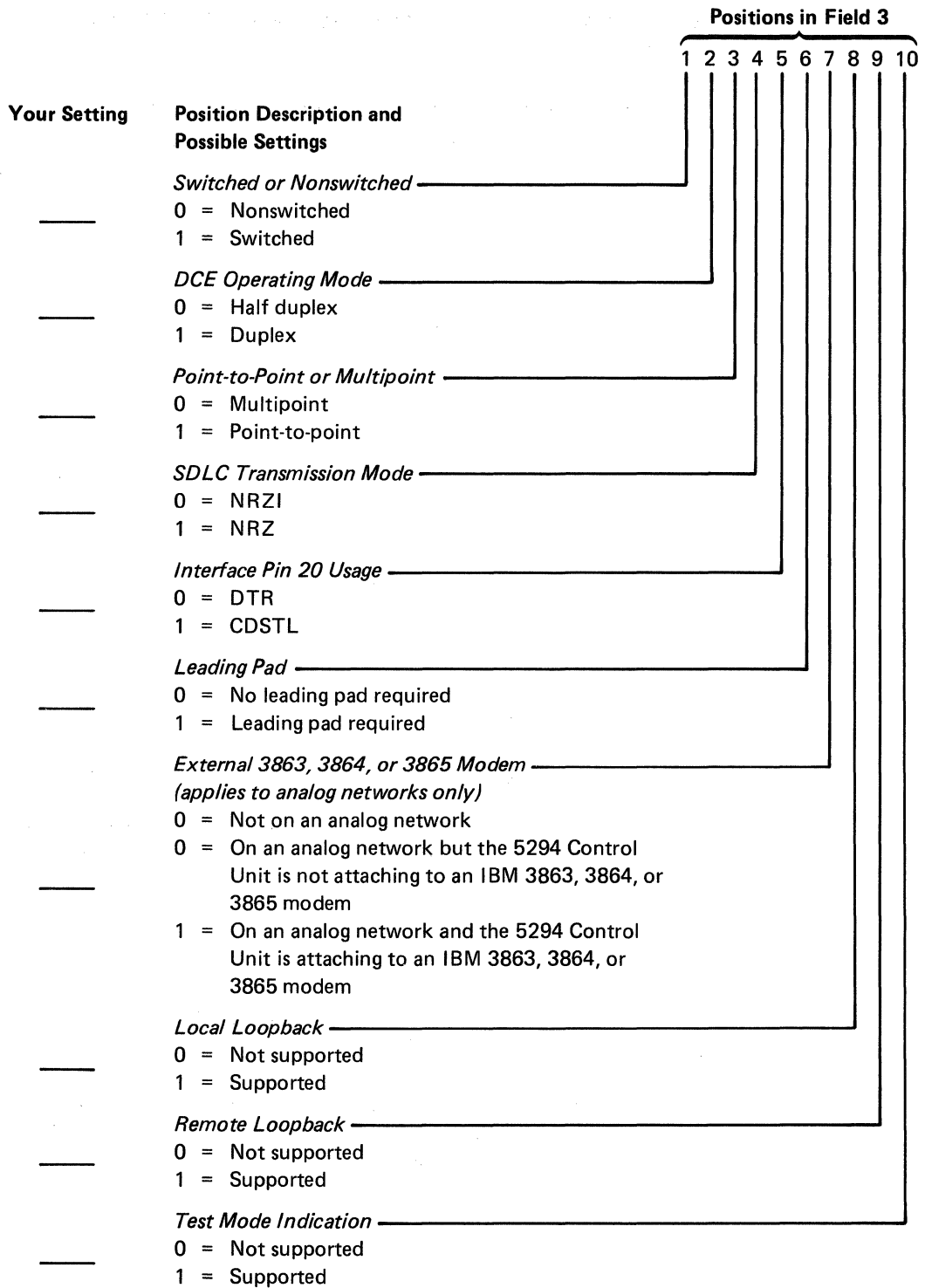

c. Copy the setting for field 3 you just determined to field 3 on the screen.

	0	1	2	3	4	5	6
0/	D	D
1/	D	P	D
2/	D	D	P
3/

1-> 00 2-> 01 3-> 000000000000

Field 3
(This setting is an example only.)

d. This completes the planning requirements.

Make sure you give a copy of the completed *IBM 5294 Setup Form* to the system location and to the person who will be doing the 5294 Control Unit setup. Also make sure cable labels are completed for each work station attaching to the 5294. For information about the labels, see *Labeling Cables* in Appendix A.

Fields 4, 5, and 6 (X.25 Fields)

The settings for fields 4, 5, and 6 must be determined if your 5294 Control Unit communications mode is X.25.

Note: If you have not already completed an IBM 5294 Communications Network Worksheet for an X.25 packet switched network, go to Chapter 5 and fill out the worksheet. Then return here.

Field 4: This field has three positions. Each position has a different meaning and must have its own setting. To determine what the setting for each position should be, do the following:

1. Review the information under *Position Description and Possible Settings*, for field 4.
2. From block 4 you completed on the 5294 Communications Network Worksheet in Chapter 5, transfer the setting to the blanks under *Your Setting* in the chart below.

Your Setting	Position Description and Possible Settings	Positions in Field 4
_____	<i>Modulo Number</i> 0 = Modulo 8 1 = Reserved	1 2 3
_____	<i>Packet Window Size</i> A number 2 through 7	
_____	<i>Link Window Size</i> A number 1 through 7	

3. Copy the setting for field 4 you just determined to field 4 on the screen.

	0	1	2	3	4	5	6
0/	D	D	•	•	•	•	•
1/	D	P	•	•	•	•	•
2/	D	D	•	•	•	•	•
3/	•	•	•	•	•	•	•
1->	00	2-> 01	4-> 027	5->	6->		

Field 4 (This setting is an example only.)

Field 5: This field has seven positions. Each position has a different meaning and must have its own setting. To determine what the setting for each position should be, do the following:

1. Review the information under *Position Description and Possible Settings* for field 5.
2. From block 5 you completed on the 5294 Control Unit Communications Network Worksheet in Chapter 5, transfer the setting to the blanks under *Your Setting* in the chart below.

Note: In block 5 in Chapter 5, all positions should have been completed except for position 4. Complete that setting now based on the information on this page for position 4. If you need information about LLC selection, see the description for field 6 later in this chapter.

		Positions in Field 5						
		1	2	3	4	5	6	7
Your Setting	Position Description and Possible Settings							
_____	<i>Packet Size</i>							
	0 = 64 bytes							
	1 = 128 bytes							
	2 = 256 bytes							
_____	<i>Circuit Type</i>							
	0 = Switched virtual circuit or Multiple circuit connection							
	1 = Single circuit (permanent virtual circuit)							
_____	<i>Flow Control Negotiation</i>							
	0 = Not allowed							
	1 = Allowed							
_____	<i>Manual Options</i>							
	0 = The operator will not select any of the manual options.							
	1 = The operator will select any of the following manual options:							
	• Closed user group facility							
	• Flow control negotiation facility							
	• Reverse charging facility							
	• LLC selection							
	• Packet size							
	• Packet window size							
_____	<i>Local Loopback</i>							
	0 = Not supported							
	1 = Supported							
_____	<i>Remote Loopback</i>							
	0 = Not supported							
	1 = Supported							
_____	<i>Test Mode Indication</i>							
	0 = Not supported							
	1 = Supported							

3. Copy the setting for field 5 you just determined to field 5 on the screen.

	0	1	2	3	4	5	6
0/	D	D	•	•	•	•	•
1/	D	P	•	•	•	•	•
2/	D	D	•	•	•	•	•
3/	•	•	•	•	•	•	•

1->00 2->01 4->027 5->1100000 6->

Field 5
(This is an example only.)

Field 6: This field has eight positions. Each position has a different meaning and must have its own setting. To determine what the setting for each position should be, do the following:

1. Review the information under *Position Description and Possible Settings* for field 6.
2. From block 6 you completed on the 5294 Control Unit Communications Network Worksheet in Chapter 5, transfer the setting to the blanks under *Your Setting* in the chart below.

Note: In block 6 in Chapter 5, all positions should have been completed except for positions 2 and 3. Complete the settings now for that field based on the information on this page for positions 2 and 3.

		Positions in Field 6							
		1	2	3	4	5	6	7	8
Your Setting	Position Description and Possible Settings								
_____	<i>Reverse Charging (Incoming SVC)</i> 0 = Will not accept. 1 = Will accept.								
_____	<i>LLC (Logical Link Control) Selection</i> 00 = Used to communicate with a system using PSH (physical services header). 01 = Used to communicate with a system using QLLC (qualified logical link control). 10 = Used to communicate with a system using ELLC (enhanced logical link control). 11 = Reserved.								
	Notes:								
	<ul style="list-style-type: none"> • When communicating with a system using a 5973-L02, this setting is 00. • If you are not sure what this setting should be, contact the person at the system site who is responsible for system configuration. 								
_____	<i>Special Network Attachment</i> 0 = Attaching to a network other than a Telenet ¹ type network. 1 = Attaching to a Telenet type network (for example, the United Kingdom Switchstream 1 Network).								
_____	<i>Link Initialization</i> 0 = Either the 5294 or the network can initialize the link. 1 = Only the network can initialize the link. ²								
<u> 0 </u>	<i>Reserved</i> 0 is the setting.								
<u> 0 </u>	<i>Reserved</i> 0 is the setting.								
<u> 0 </u>	<i>Reserved</i> 0 is the setting.								

¹Telenet, a trademark of the Telenet Communications Corporation

²Network example: ITAPAC, the Italian network

- Copy the setting for field 6 you just determined to field 6 on the screen.

	0	1	2	3	4	5	6
0/	D	D
1/	D	P
2/	D	D
3/

1->00 2->01 4->027 5->1000000 6->00000000

Field 6
(This setting is an example only.)

- This completes the planning requirements.

Make sure you give a copy of the completed *IBM 5294 Setup Form* to the system location and to the person who will be doing the 5294 setup. Also make sure cable labels are completed for each work station attaching to the 5294 Control Unit. For information about the labels, see *Labeling Cables* in Appendix A.

Fields 9, A, and B (X.21 Switched Fields)

The setting for field 9 must be determined if your 5294 Control Unit communications mode is X.21 switched. Fields A and B are reserved and should be left as they are.

Note: If you have not already completed an IBM Communications Network Worksheet for an X.21 switched network, go to Chapter 5 and fill out the worksheet. Then return here.

Field 9: This field has one position. To determine the setting for field 9, do the following:

1. Review the information under *Position Description and Possible Settings*, for field 9.
2. From block 9 you completed on the 5294 Control Unit Communications Network Worksheet in Chapter 5, transfer the setting to the blank under *Your Setting* in the chart below.

Positions in Field 9

Your Setting	Position Description and Possible Settings	1
	<p><i>Network Selection</i> _____</p> <p>0 = 5294 will not be attached to the Japanese DDX network.</p> <p>1 = 5294 will be attached to the Japanese DDX network.</p>	

A0653085-0

3. Copy the setting for field 9 you just determined to field 9 on the screen.

	0	1	2	3	4	5	6
0/	D	D	•	•	•	•	•
1/	D	P	D	•	•	•	•
2/	D	D	P	•	•	•	•
3/	•	•	•	•	•	•	•

1-> 00 2-> 01 9-> 0 A-> AAAAAAAAAAAAAAAAAA B-> 00 00

Field 9 (This setting is an example only.)

A0653086-0

Fields A and B: These fields are reserved.

5294 Configuration and Communications

Chapter 5. Ordering Communications Equipment and Facilities for the 5294 Control Unit

If your remote work station controller is a 5251 Model 12, go to Chapter 6 for communications equipment ordering information.

If your remote work station controller is a 5294 Control Unit, this chapter will help you to order the necessary communications equipment and facilities (for example the communications line and the kind of network) for use with the 5294. If you have already ordered your communications line and will be using IBM modems, you can skip this chapter; otherwise you must complete it.

Note: If you need general information about communications, see Appendix C, *Introductory Communications Information for Use with the 5294 Control Unit*. This appendix includes information about:

- Types of communications lines
- Types of networks
- Kinds of networks
- Types of communications
- Transmission speeds for the DCE

USING AN IBM MODEM WITH THE 5294 CONTROL UNIT

Figure 5-1 contains information about IBM modems that can be used with the 5294. If you are planning to use an IBM modem with your 5294 and have not already ordered your communications line, you will need to supply the information for your modem (as shown on the next page in Figure 5-1) to the telephone company (common carrier). You can then skip the rest of this chapter.

Getting Started

Site Considerations

System Specifications

5294 Configuration and Communications

5251 Model 12 Communications and Configuration

Cables

Appendixes

IBM Modem (See Note 1)	Speed	Communications Line Connection	United States Line Type	Canada Line Type	United Kingdom Line Type	Other World Trade Line Type
3863 Model 1 (nonswitched)	2400 bps	See Note 6	3002 basic	Schedule 4 Type 4	Schedule B	Normal quality for data transmission
3863 Model 2 (switched) (See Note 2)	2400 bps	See Note 7	Switched			
3864 Model 1 (nonswitched)	4800 bps	See Note 6	3002 basic	Schedule 4 Type 4	Schedule B	Normal quality for data transmission
3864 Model 2 (switched) (See Note 2)	4800 bps	See Note 7	Switched			
3865 Model 1 (point-to-point nonswitched)	9600 bps	See Note 6	3002 basic (See Note 3)	Schedule 4 Type 4 (See Note 4)	Schedule B (See Note 5)	Special quality equivalent to CCITT M102/M1020
3865 Model 2 (multipoint nonswitched)	9600 bps	See Note 6	3002 basic (See Note 3)	Schedule 4 Type 4 (See Note 4)	Schedule B (See Note 5)	Special quality equivalent to CCITT M102/M1020
3872 (nonswitched)	2400 bps	See Note 8	3002 basic	Schedule 4 Type 4	Schedule B	Normal quality for data transmission
3872 (switched)	2400 bps	See Note 9	Switched			
3874 (nonswitched)	4800 bps	See Note 8	3002 with C1 conditioning	Schedule 4 Type 4A	Schedule B	Normal quality for data transmission
3874 (switched)	4800 bps	See Note 9	Switched			
3875 (nonswitched)	7200 bps	See Note 8	3002 with C2 conditioning	Schedule 4 Type 4B	Schedule D	Special quality equivalent to CCITT M102/M1020

Figure 5-1 (Part 1 of 2). IBM Modem Information for Use with the 5294 Control Unit

Notes:

1. All the preceding modems use DTR for pin 20 usage.
2. For the United States only, this modem also requires a telephone set with an exclusion key connected for data with the following options:
 - a. A2-Data set controls line
 - b. B4-Aural monitoring
 - c. C5-Push button dial or C6 rotary dial
 - d. D8-Voice mode indication
3. Model 1 may require D1 line conditioning in some cases and Model 2 may require D2 line conditioning in some cases.
4. The Model 1 may require a Schedule 4 Type 4 D1 line in some cases and Model 2 may require a Schedule 4 Type 4D C1 line in some cases.
5. RFS delay of 1753 millisecond is required for Model 1. RFS delay of 60 millisecond is required for Model 2. In some cases, Schedule D lines may be required. If Schedule D lines are used, the Model 1 can use an RFS (CTS) delay of 253 millisecond and the Model 2 can use an RFS (CTS) delay of 24 millisecond.
6. On all nonswitched 3863, 3864, and 3865 modems, a cable with a 283B plug (connects to a WE-404B or equivalent jack) will be provided for the United States, Canada, and Japan. A cable with a plug meeting national requirements (connects to the PTT provided jack) is provided for Austria, Belgium, France, Germany, Israel, Italy, Netherlands, and Switzerland. A cable with 4-spade lugs is provided for all other countries to allow connection to a terminal block or plug as appropriate.
7. On all switched 3863 and 3864 modems, a cable with an 8-pin modular plug will be provided for the United States. This plug connects to an RJ45 or RJ41 jack provided by the telephone company. A cable with 8-spade lugs will be provided for Canada. A cable with a plug meeting national requirements to connect to the PTT provided jack will be provided for France, Italy, Japan, Netherlands, and the United Kingdom. A cable with 4-space lugs will be provided for all other countries to allow connection to a plug or terminal block as appropriate.
8. On all nonswitched 3872, 3874, and 3875 modems, a cable with a WE-283B plug will be provided for the United States, Canada, and Japan. A cable with 4-spade lugs will be provided for all other countries.
9. On all switched 3872 and 3874 modems, a cable with 8-spade lugs will be provided for the United States and Canada (to allow connection to a data coupler). Refer to the modem users guide for other countries.

Figure 5-1 (Part 2 of 2). IBM Modem Information for Use with the 5294 Control Unit

COMMUNICATIONS COMPONENTS ORDER INFORMATION FOR THE 5294 CONTROL UNIT

Figure 5-2 shows possible communications facilities (features) and networks for attaching a 5294 Control Unit to the host system. Choose the appropriate communications feature and network for your configuration. Modems and equipment options for the host system may differ, but you should make sure that the components used at the host system and at the 5294 are compatible. If you are uncertain about which feature and network you should order or have ordered, contact your IBM sales representative.

Before you proceed, do the following:

- Review the floor plan for each remote location and decide on the positioning for modem and communications line connections. If a floor plan has not been prepared for the remote site, do that now.

Note: The modem should be placed as close as possible to the 5294.

- Schedule the installation of the communications facilities that will connect the 5294 and the system. Refer to the *Planning Checklist* in Chapter 1 for assistance. Establish schedules that ensure that the communications facilities and system communications features are installed and tested before delivery of the 5294 and the work stations.

After you select the 5294 communications feature and network you want from Figure 5-2, go to Figure 5-3. Now find the kind of network you selected on the left side of the page (indicated by a circled A, B, C, or D). To the right of this is stated what IBM 5294 *Communications Network Worksheet* you should complete based on the kind of network selected. The worksheets follow Figure 5-3. The completed worksheet will be used when completing Chapter 4.

Notes:

1. Some of the worksheets are more than one page; the large lettered arrows

(for example, ) direct you to where you should continue on the next page.

2. If you need extra worksheets, go to Appendix E.
3. For an example of a completed IBM 5294 *Communications Network Worksheet*, go to Appendix D.

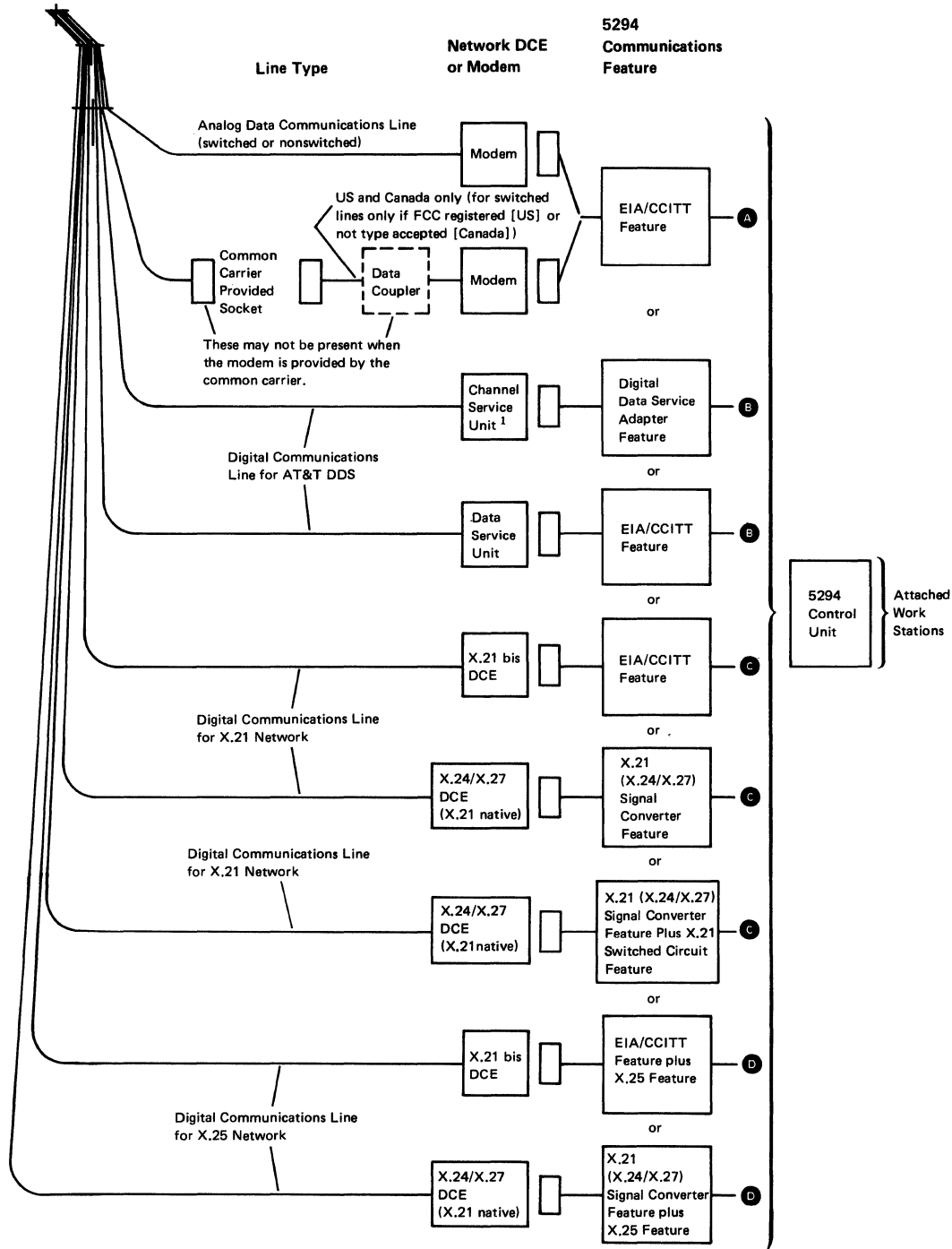

- A** = Analog (normal switched or nonswitched lines) network
- B** = AT&T DDS Public Data Network
- C** = X.21 Public Data Network
- D** = X.25 Packet Switched Network

¹In the figure, Channel Service Unit is a trademark of Western Electric.

Figure 5-2. Possible Communications Features and Networks for the 5294 Control Unit

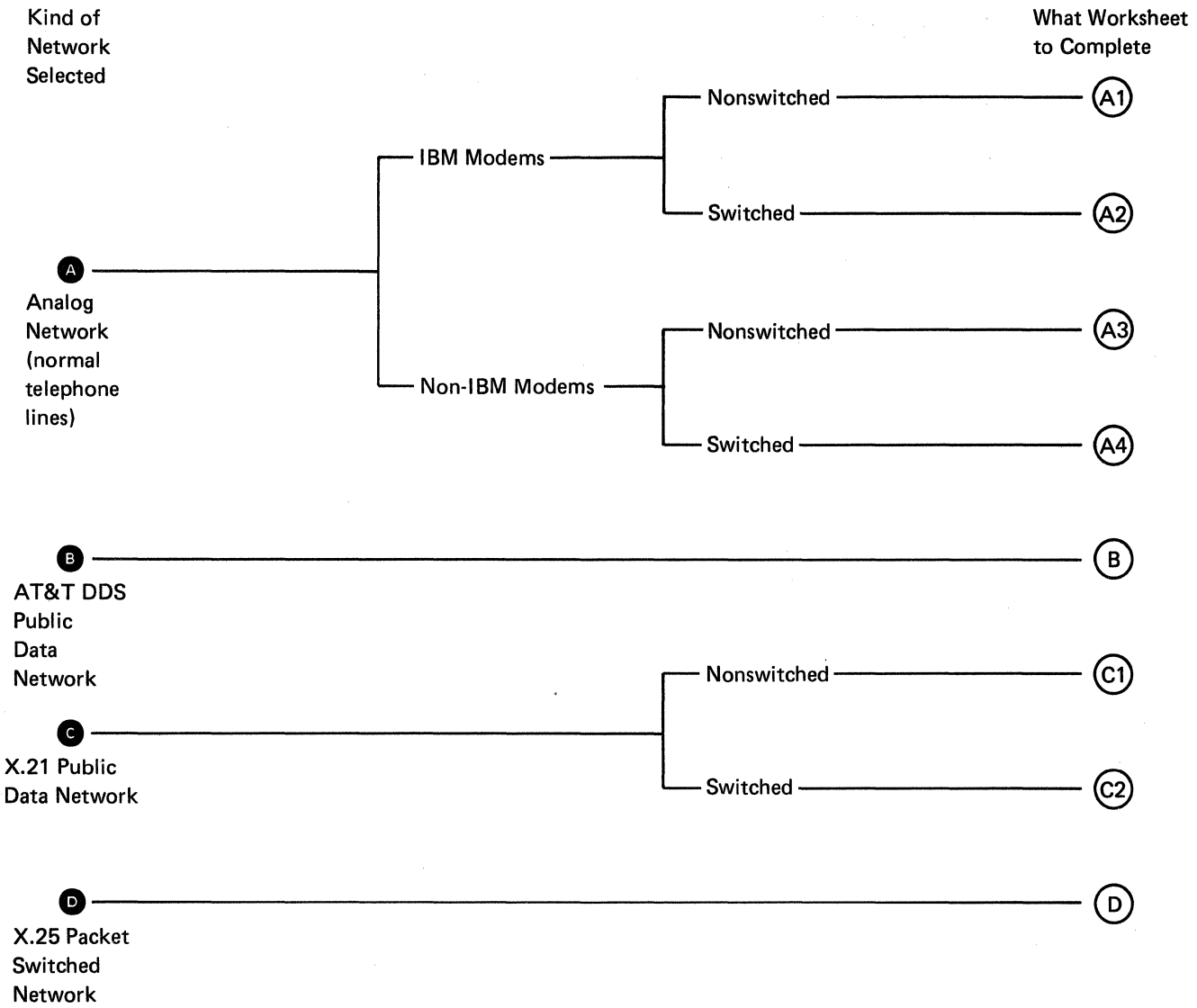

Figure 5-3. Kind of Network and What 5294 Control Unit Communications Worksheet to Complete

A1

Analog Nonswitched Lines (Using IBM Modems) Communications Network Worksheet for the 5294 Control Unit

If you will not use this type of network, proceed to the worksheet for the network selected.

Complete this information before you call the telephone company (common carrier). Some of this information may be on your 5294 Control Unit order.

- Network type (choose one of the following):
 - Point-to-point nonswitched
 - Multipoint nonswitched
- Identify the *line type* required for your country and the *modem* that you will be using (this information is in Figure 5-1).
Line type _____ Modem _____
- Identify the host system (control) modem location. _____
- Identify the location of all modems attached to the remote workstation controller(s).
 1. _____
 2. _____
 3. _____
 4. _____
 5. _____
 6. _____
 7. _____
 8. _____
- Enter the transmission speed of the modem that you will be using (see Figure 5-1). _____ bps
- If in a country other than the US or Canada, enter the PTT homologation approval numbers. (These can be obtained from your IBM sales representative.)

System type _____	Homologation number _____
5294 Control Unit _____	Homologation number _____
Modem type _____	Homologation number _____



A

Call the common carrier/PTT and do the following:

- Order communications lines as required for the network type shown on the previous page.
- Provide the following information as shown on the previous page:
 - Line type
 - Host system (control) modem location
 - Location of all other modems
 - Transmission speed of the modem (if requested)
 - If in a country other than the US or Canada, the PTT homologation approval numbers

Go to Chapter 4.

(A2)

Analog Switched Lines (Using IBM Modems) Communications Network Worksheet for the 5294 Control Unit

If you will not use this type of network, proceed to the worksheet for the network selected.

Complete this information before you call the telephone company (common carrier). Some of this information may be on your 5294 Control Unit order.

- Identify the host system (control) modem location. _____
- Identify the location of all modems attached to the remote workstation controller(s).
 1. _____
 2. _____
 3. _____
 4. _____
 5. _____
 6. _____
 7. _____
 8. _____
- Enter the transmission speed of the modem that you will be using (see Figure 5-1). _____ bps
- If in a country other than the US or Canada, enter the PTT homologation approval numbers. (These can be obtained from your IBM sales representative.)

System type _____	Homologation number _____
5294 Control Unit _____	Homologation number _____
Modem type _____	Homologation number _____
- Identify your country and modem type in one of the two groups below and go to the appropriate chart.

– IBM 3863, 3864, or 3865 in all countries	– IBM 3872, 3874, or 3875 in the US
– IBM 3872, 3874, or 3875 in countries other than the US	

Call a data coupler supplier and do the following.

- Order a CBS type data coupler for each modem you will use.
- Ask for the following:
 - Coupler make/model _____
 - FCC registration number _____
 - Ringer equivalence number _____
 - Telephone set options to specify _____

B

C

5294
Configuration and
Communications

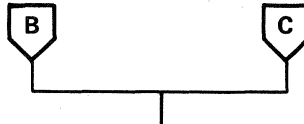

Call the common carrier/PTT and do the following:

- Order switched communications lines for data transmission at the transmission speed shown for the modem on the previous page.
- Tell where all the modems are located (see the previous page).
- Do one of the following:
 - For the IBM 3863, 3864, or 3865 modem, provide the FCC registration and ringer equivalence information listed below for your modem.

Modem	FCC Registration Number	Ringer Equivalence
IBM 3863 Model 2	AN09SA-67992-DP-N	0.8B
IBM 3864 Model 2	AN09SA-67992-DP-N	0.8B
IBM 3863 Model 1 (with 4-wire switched network backup)	AN09SA-67935-DP-N	0.8B
IBM 3864 Model 1 (with 4-wire switched network backup)	AN09SA-67935-DP-N	0.8B
IBM 3865 Model 1 or 2 (with 4-wire switched network backup)	AN09SA-67935-DP-N	0.8B

Note: The IBM 3863 Model 1, 3864 Model 1, 3865 Model 1, and 3865 Model 2, require ordering two switched communications lines for each modem in addition to the nonswitched line.

- For the IBM 3872, 3874, or 3875 modem, provide the data coupler information you completed on the previous page.
- If in Canada, order a CBS type data coupler.
- If in a country other than the US or Canada, specify the PTT homologation approval numbers (see the previous page).

Go to Chapter 4.

A3

Analog Nonswitched Lines (Using Non-IBM Modems) Communications Network Worksheet for the 5294 Control Unit

If you will not use this type of network, proceed to the worksheet for the network selected.

Complete this information before you call the telephone company (common carrier) or the modem supplier. Some of this information may be on your 5294 Control Unit order.

- Network type (choose one of the following):
 - Point-to-point nonswitched
 - Multipoint nonswitched
- Identify the host system (control) modem location. _____
- Identify the location of all modems attached to the remote workstation controller(s).
 1. _____
 2. _____
 3. _____
 4. _____
 5. _____
 6. _____
 7. _____
 8. _____
- Enter the transmission speed required. _____ bps
- If in a country other than the US or Canada, enter the PTT homologation approval numbers. (These can be obtained from your IBM sales representative.)

System type _____	Homologation number _____
5294 Control Unit _____	Homologation number _____

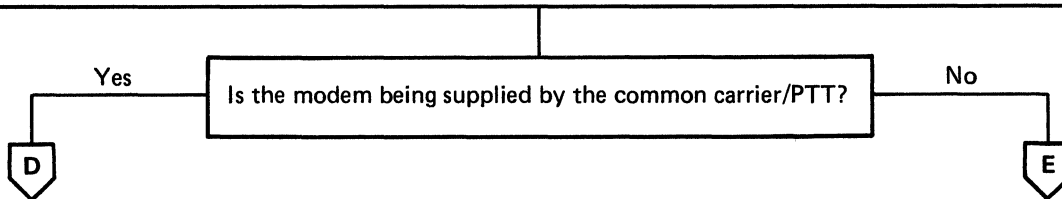

5294 Configuration and Communications

Call the common carrier/PTT and do the following:

- Order modems and communications lines as required for the network type shown on the previous page.
- Provide the following information (see the previous page):
 - Host system (control) modem location
 - Location of all other modems
 - Transmission speed required
 - For countries other than the US and Canada, the PTT homologation approval numbers (if applicable)
- Specify the following options for the modems (for a description of modem options, see *Modem/DCE Information for the 5294 Control Unit* in Chapter 5):
 - *Clear to Send* (CTS) (also referred to as *Ready for Sending* [RFS]) controlled by *Request to Send* (RTS)
 - Carrier controlled by *Request to Send* (switched carrier)
 - Signal ground not connected to frame ground in the modem because signal ground is connected to the frame ground in the 5294 Control Unit
- Ask if the following options are available and if they are, request them:
 - Local loopback controlled by interface pin 18 with *Data Set Ready* on during local loopback
Note: In position 8 of the block below, enter a 1 if the option is available or a 0 if not available.
 - Remote loopback controlled by interface pin 21
Note: In position 9 of the block below, enter a 1 if the option is available or a 0 if not available.
 - Test mode indication on pin 25
Note: In position 10 of the block below, enter a 1 if the option is available or a 0 if not available.
- Ask for the following information:
 - Modem operating mode:
 - a. If *Duplex*, enter a 1 in position 2 of the block below
 - b. If *Half duplex*, enter a 0 in position 2 of the block below
 - Recommended SDLC transmission mode:
 - a. If *NRZI*, enter a 0 in position 4 of the block below
 - b. If *NRZ*, enter a 1 in position 4 of the block below
 - c. If *no recommendation*, enter a 0 in position 4 of the block below
 - For countries other than the US and Canada, also ask for the interface pin 20 usage:
 - a. If *DTR (108.2)*, enter a 0 in position 5 of the block below
 - b. If *CDSTL (108.1)*, enter a 1 in position 5 of the block below
 - Does the modem require a leading pad to be transmitted prior to the SDLC flag?
 - a. If *Yes*, enter a 1 in position 6 of the block below
 - b. If *No*, enter a 0 in position 6 of the block below

Go to Chapter 4.

1	2	3	4	5	6	7	8	9	10
0						0			

In the US and Canada, enter a 0 in position 5.
In position 3, enter a 0 if multipoint or a 1 if point-to-point (see the previous page).

Note: The setting in this block will be used to complete Chapter 4.

E

Call the modem supplier and do the following:

- Order modems.
- Specify the network type and transmission speed for the modem required (see the first chart in this section).
- Specify the following options for the modems (for a description of modem options, see *Modem/DCE Information for the 5294 Control Unit* in Chapter 5):
 - *Clear to Send* (CTS) (also referred to as *Ready for Sending* [RFS]) controlled by *Request to Send* (RTS)
 - Carrier controlled by *Request to Send* (switched carrier)
 - Signal ground not connected to frame ground in the modem because signal ground is connected to the frame ground in the 5294 Control Unit
- Ask if the following options are available and if they are, request them:
 - Local loopback controlled by interface pin 18 with *Data Set Ready* on during local loopback
Note: In position 8 of the block below, enter a 1 if the option is available or a 0 if not available.
 - Remote loopback controlled by interface pin 21
Note: In position 9 of the block below, enter a 1 if the option is available or a 0 if not available.
 - Test mode indication on pin 25
Note: In position 10 of the block below, enter a 1 if the option is available or a 0 if not available.
- Ask for the following:
 - Line type required _____
 - Line conditioning required _____
 - Modem operating mode:
 - a. If *Duplex*, enter a 1 in position 2 of the block below
 - b. If *Half duplex*, enter a 0 in position 2 of the block below
 - Recommended SDLC transmission mode:
 - a. If *NRZI*, enter a 0 in position 4 of the block below
 - b. If *NRZ*, enter a 1 in position 4 of the block below
 - c. If *no recommendation*, enter a 0 in position 4 of the block below
 - For countries other than the US and Canada, also ask for the interface pin 20 usage:
 - a. If *DTR (108.2)*, enter a 0 in position 5 of the block below
 - b. If *CDSTL (108.1)*, enter a 1 in position 5 of the block below
 - Does the modem require a leading pad to be transmitted prior to the SDLC flag?
 - a. If *Yes*, enter a 1 in position 6 of the block below
 - b. If *No*, enter a 0 in position 6 of the block below

F

1	2	3	4	5	6	7	8	9	10
0							0		

In the US and Canada, enter a 0 in position 5.

In position 3, enter a 0 if multipoint or a 1 if point-to-point (see the first chart in this section).

Note: The setting in this block will be used to complete Chapter 4.

F

Call the common carrier/PTT and do the following:

- Order communications lines as required.
- Tell where all the modems are located (see the first chart in this section). For multipoint nonswitched operation, specify which location is the host system (control) location.
- If in a country other than the US or Canada, specify the PTT homologation approval numbers (see the first chart in this section).

Go to Chapter 4.

A4

Analog Switched Lines (Using Non-IBM Modems) Communications Network Worksheet for the 5294 Control Unit

If you will not use this type of network, proceed to the worksheet for the network selected.

Complete this information before you call the telephone company (common carrier) or the modem supplier.
Some of this information may be on your 5294 order.

- Identify the host system (control) modem location. _____
- Identify the location of all modems attached to the remote workstation controller(s).
 1. _____
 2. _____
 3. _____
 4. _____
 5. _____
 6. _____
 7. _____
 8. _____
- Enter the transmission speed required. _____ bps
- If in a country other than the US or Canada, enter the PTT homologation approval numbers.
(These can be obtained from your IBM sales representative.)
System type _____ Homologation number _____
5294 Control Unit Homologation number _____

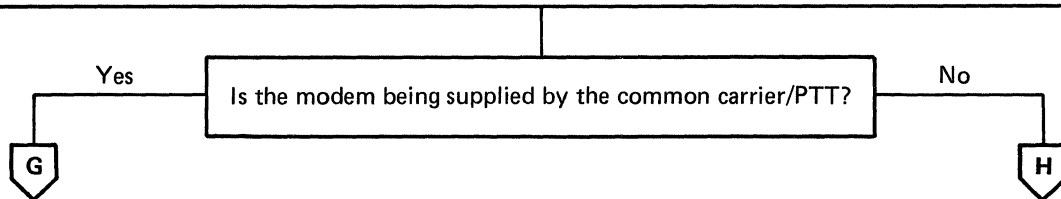

5294
Configuration and
Communications

Call the common carrier/PTT and do the following:

- Order modems and switched communications lines as required.
- Provide the following information (see previous page):
 - Location of all modems
 - Transmission speed required
 - For countries other than the US and Canada, the PTT homologation approval numbers (if applicable)
- Specify the following options for the modems (for a description of modem options, see *Modem/DCE Information for the 5294 Control Unit* in Chapter 5):
 - *Clear to Send* (CTS) (also referred to as *Ready for Sending* [RFS]) controlled by *Request to Send* (RTS)
 - Carrier controlled by *Request to Send* (switched carrier)
 - Signal ground not connected to frame ground in the modem because signal ground is connected to the frame ground in the 5294 Control Unit
 - EIA/CCITT signal level required on interface pin 22
 - Autoanswer controlled by DTR (or CDSTL) only
- Ask if the following options are available and if they are, request them:
 - Local loopback controlled by interface pin 18 with *Data Set Ready* on during local loopback
Note: In position 8 of the block below, enter a 1 if the option is available or a 0 if not available.
 - Remote loopback controlled by interface pin 21
Note: In position 9 of the block below, enter a 1 if the option is available or a 0 if not available.
 - Test mode indication on pin 25
Note: In position 10 of the block below, enter a 1 if the option is available, or a 0 if not available.
- Ask for the following information:
 - Modem operating mode:
 - a. If *Duplex*, enter a 1 in position 2 of the block below
 - b. If *Half duplex*, enter a 0 in position 2 of the block below
 - Recommended SDLC transmission mode:
 - a. If *NRZI*, enter a 0 in position 4 of the block below
 - b. If *NRZ*, enter a 1 in position 4 of the block below
 - c. If *no recommendation*, enter a 0 in position 4 of the block below
 - For countries other than the US and Canada, also ask for the interface pin 20 usage:
 - a. If *DTR (108.2)*, enter a 0 in position 5 of the block below
 - b. If *CDSTL (108.1)*, enter a 1 in position 5 of the block below
 - Does the modem require a leading pad to be transmitted prior to the SDLC flag?
 - a. If *Yes*, enter a 1 in position 6 of the block below
 - b. If *No*, enter a 0 in position 6 of the block below

Go to Chapter 4.

1	2	3	4	5	6	7	8	9	10
1		1				0			

_____ In the US and Canada, enter a 0 in position 5.

Note: The setting in this block will be used to complete Chapter 4.



Call the modem supplier and do the following:

- Order modems for use on switched communications lines.
- Provide the following information (see the first chart in this section):
 - Location of all modems
 - Transmission speed required
- Specify the following options for the modems (for a description of modem options, see *Modem/DCE Information for the 5294 Control Unit* in Chapter 5):
 - *Clear to Send* (CTS) (also referred to as *Ready for Sending* [RFS]) controlled by *Request to Send* (RTS)
 - Carrier controlled by *Request to Send* (switched carrier)
 - Signal ground not connected to frame ground in the modem because signal ground is connected to the frame ground in the 5294 Control Unit
 - EIA/CCITT signal level required on interface pin 22
 - Autoanswer controlled by DTR (or CDSTL) only
- Ask if the following options are available and if they are, request them:
 - Local loopback controlled by interface pin 18 with *Data Set Ready* on during local loopback
Note: In position 8 of the block below, enter a 1 if the option is available or a 0 if not available.
 - Remote loopback controlled by interface pin 21
Note: In position 9 of the block below, enter a 1 if the option is available or a 0 if not available.
 - Test mode indication on pin 25
Note: In position 10 of the block below, enter a 1 if the option is available or a 0 if not available.
- Ask for the following information:
 - Modem operating mode:
 - a. If *Duplex*, enter a 1 in position 2 of the block below
 - b. If *Half duplex*, enter a 0 in position 2 of the block below
 - Recommended SDLC transmission mode:
 - a. If *NRZI*, enter a 0 in position 4 of the block below
 - b. If *NRZ*, enter a 1 in position 4 of the block below
 - c. If *no recommendation*, enter a 0 in position 4 of the block below
 - For countries other than the US and Canada, also ask for the interface pin 20 usage:
 - a. If *DTR (108.2)*, enter a 0 in position 5 of the block below
 - b. If *CDSTL (108.1)*, enter a 1 in position 5 of the block below
 - Does the modem require a leading pad to be transmitted prior to the SDLC flag?
 - a. If *Yes*, enter a 1 in position 6 of the block below
 - b. If *No*, enter a 0 in position 6 of the block below

Continued on the next page



1	2	3	4	5	6	7	8	9	10
1		1				0			

In the US and Canada, enter a 0 in position 5.

Note: The setting in this block will be used to complete Chapter 4.



- Ask for the following information (continued)
 - In the US and Canada, the type of external data coupler required (if any) _____
 - In the US only, if no external data coupler is required, then:
 - a. Make of modem _____
 - b. FCC registration number of the modem _____
 - c. Ringer equivalence number of the modem _____
 - d. Telephone set options to specify for the modem _____
 - In countries other than the US and Canada, the PTT homologation approval number for the modem _____

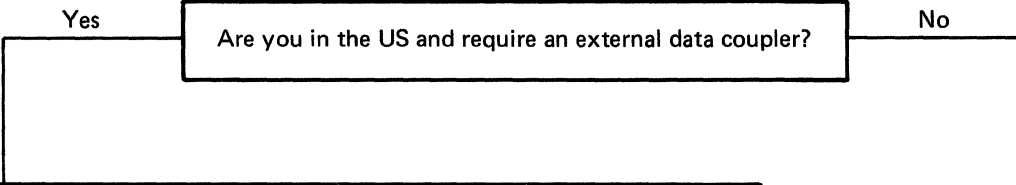

Call a data coupler supplier and do the following.

- Order a data coupler as required for the modem you will use.
- Ask for the following information about the data coupler:
 - Make and model _____
 - FCC registration number _____
 - Ringer equivalence number _____
 - Telephone set options to specify _____

Call the common carrier/PTT and do the following:

- Order switched communications lines as required
- Specify the transmission speed that will be required (see the first chart in this section)
- Tell where all the modems are located (see the first chart in this section)
- In the US only, provide FCC registration information as obtained from the modem or data coupler supplier
- In Canada, order a data coupler, if required (see the first chart in this section)
- If in a country other than the US or Canada, specify the PTT homologation approval numbers (see the first chart in this section and the first chart on this page)

Go to Chapter 4.

B AT&T DDS Public Data Communications Network Worksheet for the 5294 Control Unit

If you will not use this type of network, proceed to the worksheet for the network selected.

Complete this information before you call the telephone company (common carrier). Some of this information may be on your 5294 order.

- Network type (choose one of the following):
 - Point-to-point nonswitched
 - Multipoint nonswitched
- Speed of transmission required for the DCE:
 2400 bps 4800 bps 9600 bps 56,000 bps
- Identify the host system (control) location. _____
- Identify the location of all 5294 Control Units attached to the host system.
 1. _____
 2. _____
 3. _____
 4. _____
 5. _____
 6. _____

What type of communications (also known as interface or communications feature) was ordered for your 5294?

DDSA
(sales feature code
5650 or 5651)

EIA/CCITT
(sales feature code 3701)
For 2400, 4800, or 9600 bps only



5294
Configuration and
Communications

J

K

Call the common carrier and do the following:

- Order DDS for the network type shown on the previous page.
- Specify the following:
 - Connection to the DDS is to be made using a data service unit
 - Signal ground is not to be connected to the frame ground in the DDS because signal ground is connected to the frame ground in the 5294 Control Unit
 - Provide the following information as shown on the previous page:
 - a. Transmission speed for the DCE
 - b. Host system (control) location
 - c. The location of all 5294s attached to the host system

Go to Chapter 4.

Call the common carrier and do the following:

- Order DDS for the network type shown on the previous page.
- Specify the following:
 - Connection to the DDS is to be made using a channel service unit
 - Signal ground is not to be connected to the frame ground in the channel service unit because signal ground is connected to the frame ground in the 5294 Control Unit
 - Provide the following information as shown on the previous page:
 - a. Transmission speed for the DCE
 - b. Host system (control) location
 - c. The location of all 5294s attached to the host system

Go to Chapter 4.

C1

X.21 Nonswitched Public Data Communications Network Worksheet for the 5294 Control Unit

If you will not use this type of network, proceed to the worksheet for the network selected.

Complete this information before you call the PTT/network supplier. Some of this information may be on your 5294 order.

- Network type (choose one of the following):
 - Point-to-point nonswitched
 - Multipoint nonswitched
- Determine the type of communications (also known as communications feature or interface) ordered:
 - EIA/CCITT (sales feature 3701) X.21 bis interface
 - X.21 Signal Converter (sales feature 5655) X.21 switched network feature
- Identify the host system (control) location. _____
- Identify the location of all DCEs attached to the remote work station controller(s):
 1. _____
 2. _____
 3. _____
 4. _____
 5. _____
 6. _____
 7. _____
 8. _____
- Enter the transmission speed of the DCE required: _____ bps
- If in a country other than the US or Canada, enter the PTT homologation approval numbers. (These can be obtained from your IBM sales representative.)

System type _____	Homologation number _____
5294 Control Unit _____	Homologation number _____
DCE type _____	Homologation number _____

5294 Configuration and Communications

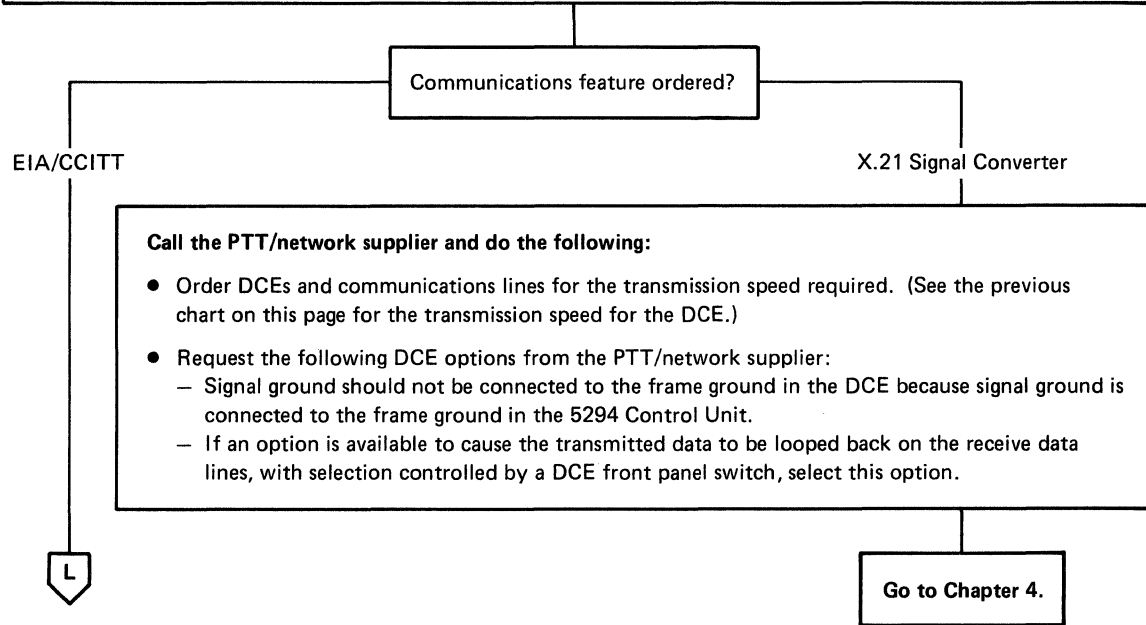



Call the PTT/network supplier and do the following:

- Order DCEs and communications lines for the transmission speed required. (See the first chart on the previous page for the transmission speed for the DCE.)
- Specify the following DCE options (for a description of DCE options, see *Modem/DCE Information for the 5294 Control Unit* in Chapter 5):
 - *Clear to Send* (CTS) (also referred to as *Ready for Sending* [RFS]) controlled by *Request to Send* (RTS)
 - Carrier controlled by *Request to Send* (switched carrier)
 - Signal ground not connected to frame ground in the DCE because signal ground is connected to the frame ground in the 5294 Control Unit.
- Ask if the following options are available and if they are, request them:
 - Local loopback controlled by interface pin 18 with *Data Set Ready* on during local loopback
Note: In position 8 of the block below, enter a 1 if the option is available or a 0 if not available.
 - Remote loopback controlled by interface pin 21
Note: In position 9 of the block below, enter a 1 if the option is available or a 0 if not available.
 - Test mode indication on pin 25
Note: In position 10 of the block below, enter a 1 if the option is available or a 0 if not available.
- Ask for the following information:
 - DCE operating mode:
 - a. If *Duplex*, enter a 1 in position 2 of the block below
 - b. If *Half duplex*, enter a 0 in position 2 of the block below
 - For countries other than the US and Canada, also ask for the interface pin 20 usage:
 - a. If *DTR (108.2)*, enter a 0 in position 5 of the block below
 - b. If *CDSTL (108.1)*, enter a 1 in position 5 of the block below

Go to Chapter 4.

1	2	3	4	5	6	7	8	9	10
0			1		0	0			

In the US and Canada, enter a 0 in position 5.

In position 3, enter a 0 if multipoint or a 1 if point-to-point (see the previous page).

Note: The setting in this block is for an X.21 network with X.21 bis interface only and will be used to complete Chapter 4.

C2

X.21 Switched Public Data Communications Network Worksheet for the 5294 Control Unit

If you will not use this type of network, proceed to the worksheet for the network selected.

Complete this information before you call the PTT/network supplier. Some of this information may be on your 5294 order. The other information is determined by the type of network you select.

● Determine the type of communications (also known as communications feature or interface) ordered:

- X.21 bis (EIA/CCITT) (sales Feature 3701)
- X.21 (X.24/X.27) Signal Converter (sales feature 5655)

● Identify the location of the 5294. _____

Note: If the 5294 will be communicating with more than one host system, identify each host system location.

1. Host system location _____
2. Host system location _____

● Enter the transmission speed required. _____ bps

● Identify the network facilities that you want.

Note: The following list of facilities may include some not available from your PTT/network supplier and may not include others that are available. Contact your IBM sales representative and/or your PTT/network supplier if you need information on the use and/or availability of network facilities.

- | | |
|-------------------------------------------------------------------------------------|-----------------------------------------------------------------------|
| <input type="checkbox"/> Abbreviated address calling | <input type="checkbox"/> Incoming calls barred |
| <input type="checkbox"/> Charge transfer | <input type="checkbox"/> Outgoing calls barred |
| <input type="checkbox"/> Closed user group | <input type="checkbox"/> Registration/cancellation of user facilities |
| <input type="checkbox"/> Closed user group with outgoing access | <input type="checkbox"/> Redirection of call |
| <input type="checkbox"/> Direct call | <input type="checkbox"/> RPOA selection |
| <input type="checkbox"/> Other facilities that the PTT/network supplier may provide | |

● If in a country other than the United States or Canada, enter the PTT homologation approval numbers. (These can be obtained from your IBM sales representative.)

System Type _____	Homologation number _____
5294 Control Unit _____	Homologation number _____
DCE type _____	Homologation number _____

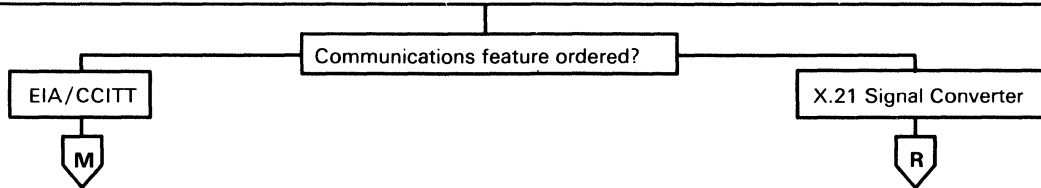

A0653083-0

5294 Configuration and Communications



Call the PTT/network supplier and do the following:

- Order DCEs and communications lines for the transmission speed required. (See the first chart in this section.)
- Specify the following DCE options (for a description of DCE options, see *Modem/DCE Information for the 5294 Control Unit* in Chapter 5):
 - *Clear to Send* (CTS) (also referred to as *Ready for Sending* [RFS]) controlled by *Request to Send* (RTS)
 - Carrier controlled by *Request to Send* (switched carrier)
 - Signal ground not connected to frame ground in the DCE because signal ground is connected to the frame ground in the 5294 Control Unit
 - EIA/CCITT signal level required on interface pin 22
 - Autoanswer controlled by DTR (or CDSTL) only
- Ask if the following options are available and if they are, request them:
 - Local loopback controlled by interface pin 18 with *Data Set Ready* on during local loopback
Note: In position 8 of the block below, enter a 1 if the option is available or a 0 if not available.
 - Remote loopback controlled by interface pin 21
Note: In position 9 of the block below, enter a 1 if the option is available or a 0 if not available.
 - Test mode indication on pin 25
Note: In position 10 of the block below, enter a 1 if the option is available or a 0 if not available.
- Ask for the following information:
 - DCE operating mode:
 - a. If *Duplex*, enter a 1 in position 2 of the block below
 - b. If *Half duplex*, enter a 0 in position 2 of the block below
 - For countries other than the US and Canada, also ask for the interface pin 20 usage:
 - a. If *DTR (108.2)*, enter a 0 in position 5 of the block below
 - b. If *CDSTL (108.1)*, enter a 1 in position 5 of the block below

Go to Chapter 4.

1	2	3	4	5	6	7	8	9	10
1		0	1		0	0			

_____ In the US and Canada, enter a 0 in position 5.

Note: The setting in this block will be used to complete Chapter 4.

D X.25 Packet Switched Communications Network Worksheet for the 5294 Control Unit

If you will not use this type of network, go back to Figure 5-2 and review the networks available.

Complete this information before you call the PTT/network supplier. Some of this information may be on your 5294 order. The other information is determined by the type of network you select.

- Determine the type of communications (also known as communications feature or interface) ordered:
 - X.21 bis (EIA/CCITT) (sales feature 3701)
 - X.21 (X.24/X.27) Signal Converter (sales feature 5655)
- Identify the location of the 5294 and the virtual circuit(s) it will have. The virtual circuit type is either permanent virtual circuit (PVC) or switched virtual circuit (SVC). The type of virtual circuit the 5294 will use must be the same as the one used for the host system.

Location _____	Circuit type(s):	
	PVC _____	Quantity _____
	SVC _____	Quantity _____

Note: If the 5294 will be communicating with more than one host system, identify the type of virtual circuit used to communicate with each host system location.

1. Virtual circuit type _____ Host system location _____
2. Virtual circuit type _____ Host system location _____

- Enter the transmission speed required. _____ bps
- Identify the network facilities that you want.

Note: The following list of facilities may include some not available from your PTT/network supplier and may not include others that are available. Contact your IBM sales representative and/or your PTT/network supplier if you need information on the use and/or availability of network facilities.

- Closed user group
- Flow control negotiation (available with SVC only)
- Reverse charging accepted by the host system
- Reverse charging accepted by the 5294
- Other facilities that the PTT/network supplier may provide _____

- If in a country other than the US or Canada, enter the PTT homologation approval numbers. (These can be obtained from your IBM sales representative.)

System type _____	Homologation number _____
5294 Control Unit	Homologation number _____

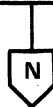

N

Call the PTT/network supplier and do the following:

- Order the network facilities and communications lines for the transmission speed required. (See the preceding chart.)
- Ask for the following information:
 - Packet window size
Note: In position 2 of block 4 below, enter the number for the packet window size as specified by your network supplier. Valid numbers are 2 through 7.
 - Link window size
Note: In position 3 of block 4 below, enter the number for the link window size as specified by your network supplier. Valid numbers are 1 through 7.

O

Block 4

1	2	3
0		

Note: The setting in this block will be used to complete Chapter 4.



• Also ask for the following information from the PTT/network supplier and discuss the advantages of each packet size, subscribing to flow control negotiation, and other optional facilities for your configuration on this network.

- Packet size 64 _____ 128 _____ 256 _____
- Is flow control negotiation provided (SVC only)? Yes _____ No _____

Do one of the following:

- a. If your 5294 will be using only one virtual circuit, enter the number for the packet size as specified below into position 1 of block 5.
- b. If your 5294 will be using more than one PVC, but no SVC, and the PVCs have different packet sizes, enter the number for the most often used packet size as specified below into position 1 of block 5.
- c. If your 5294 will be using both PVC and SVC and flow control negotiation is not provided, enter the number for the packet size of the SVC as specified below into position 1 of block 5.
- d. If your 5294 will be using both PVC and SVC and flow control negotiation is provided, enter the number for the most often used packet size as specified below into position 1 of block 5.

Packet Size	Enter in Position 1 of Block 5
64	0
128	1
256	2

• Answer the following questions only if you will have an SVC subscription. If you will not have an SVC subscription, enter a 0 in position 3 of block 5.

- Will your subscription include flow control negotiation? Yes _____ No _____

Note: In position 3 of block 5, enter a 1 if your subscription will include flow control negotiation or a 0 if it will not.

- Will your subscription include reverse charging accepted by the host system? (This information will be needed later for operating the 5294.) Yes _____ No _____
- Will your subscription include closed user group? (This information will be needed later for operating the 5294.) Yes _____ No _____

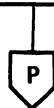

Block 5

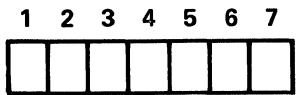

Note: The setting in this block will be used to complete Chapter 4.

If positions 5, 6, and 7 are still blank after completing the next page, enter a 0 in all three positions.

The possible settings for this position are discussed in Chapter 4.

In position 2, enter a 1 if your network subscription is for a single circuit and it is a PVC. Enter a 0 for multiple circuits or SVC.

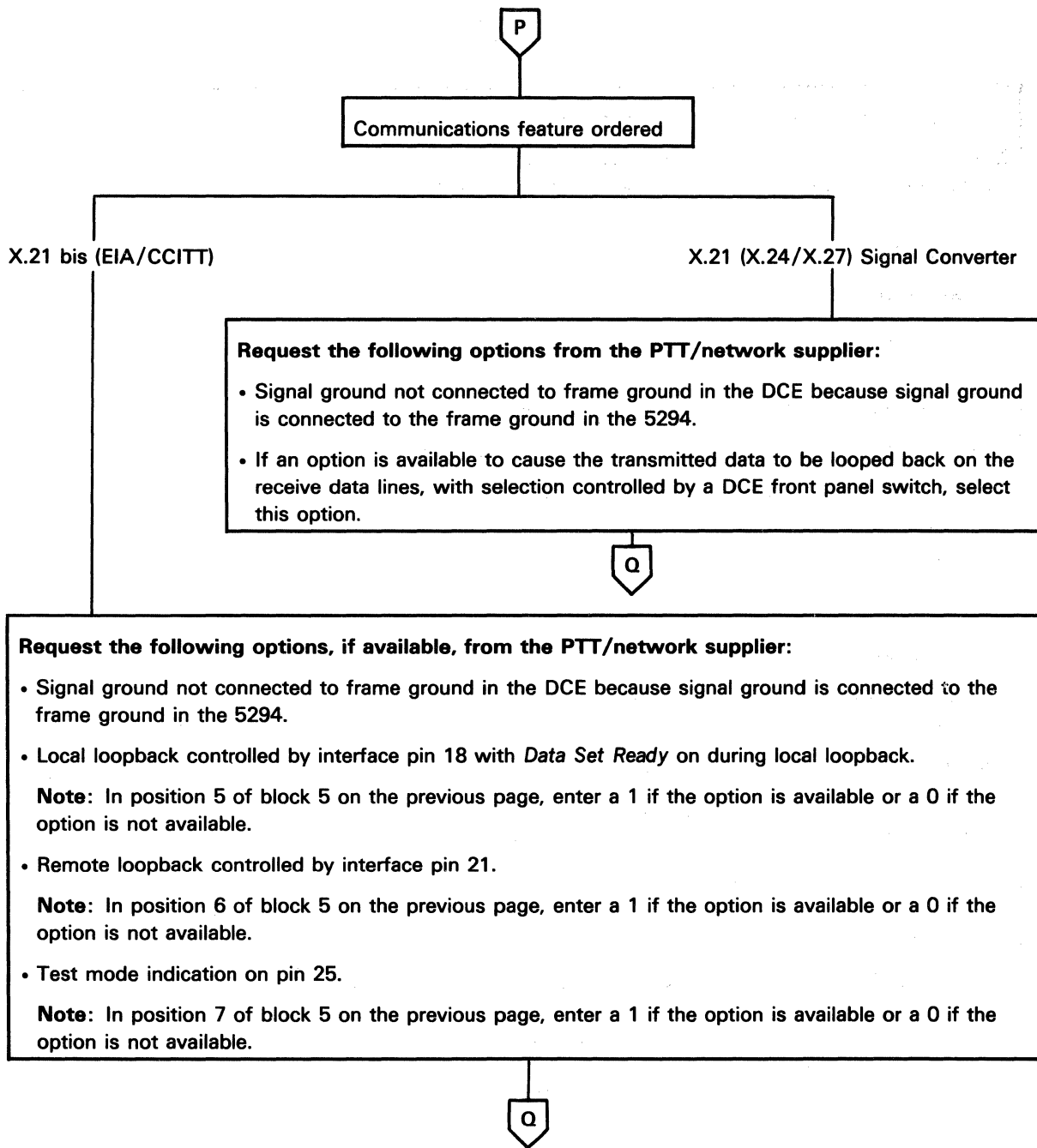



Ask the PTT/network supplier for the following information:

Note: This information will be required by the 5294 and/or the host system operator when using the communications network. If some of this information is not available now, fill it in later when it becomes available.

- For each PVC:

Logical Circuit ID	System Location
1. _____	_____
2. _____	_____

- For SVC, the systems that the 5294 will be communicating with:

System Location	Network Address
1. _____	_____
2. _____	_____
3. _____	_____
4. _____	_____
5. _____	_____

- If reverse charging will be accepted by the 5294

Note: In position 1 of block 6 below, enter a 1 if reverse charging will be accepted by the 5294 or a 0 if reverse charging will not be accepted by the 5294.

- If the network is a Telenet type network (for example, the United Kingdom Switchstream 1 Network)

Note: In position 4 of block 6 below, enter a 1 if the network will be a Telenet type network or a 0 if the network will be other than a Telenet type network.

- How the link will be initialized

- a. If *either the 5294 or the network* will be able to initialize the link, enter a 0 in position 5 of block 6 below.
- b. If *only the network* will be able to initialize the link, enter a 1 in position 5 of block 6 below.

Go to Chapter 4.

Block 6

1	2	3	4	5	6	7	8
<input type="text"/>	<input type="text"/>	<input type="text"/>	<input type="text"/>	<input type="text"/>	0	0	0

Note: The setting in this block will be used to complete Chapter 4.

_____ The possible settings for these positions are discussed in Chapter 4.

R

Call the PTT/network supplier and do the following:

- Order DCEs and communications lines for the transmission speed required. (Refer to the chart you just came from for the transmission speed for the DCE.)

- Request the following DCE options from the PTT/network supplier:
 - Signal ground should not be connected to the frame ground in the DCE because signal ground is connected to the frame ground in the 5294 Control Unit.
 - If an option is available to cause the transmitted data to be looped back on the receive data lines, with selection controlled by a DCE front panel switch, select this option.

- Determine if the 5294 Control Unit will be attached to a Japanese DDX network. If so, enter a 1 in the field 9 block; otherwise, enter a 0 in the field 9 block.

Go to Chapter 4

A0653084-0

Modem/DCE Information for the 5294 Control Unit

When ordering DCE equipment for 5294, you should use the following specifications and options as applicable.

Specifications

- **Interface:** EIA RS232C (CCITT V.24/V.28 or X.21 bis for countries other than the United States and Canada).
- **Speed:** 2400 bps to 9600 bps (1200 bps operation is allowed but is recommended for half speed backup operation only). The DCE must provide clocking.

Options

All options listed may not apply to certain modems. For options not listed, follow the recommendation from the modem supplier.

- **Autoanswer Control:** (Applies to switched line modems only.) Specify the controlled by Data Terminal Ready (DTR) only option.
- **Carrier:** Carrier controlled by 'request to send' signal (switched carrier) is recommended. Continuous carrier can only be used if the 5294 is attached to a point-to-point duplex communications line. (For point-to-point duplex lines, the 5294 has the 'request to send' signal on continuously and continuous carrier is not normally required.)
- **Clocking (Transmit Timing):** Clocking must be provided by the DCE.
- **Data Set Ready:** If the modem you are going to use has the capability to loop data back to the 5294 for testing, select the option that causes the 'data set ready' signal to be on while the local loopback test is running.
- **Grounding:** The signal ground is connected to the 5294 ground; the signal ground should not be connected to the frame ground in the modem.
- **Interface Pin 18:** If available, select the option that provides local loopback initiated by pin 18.
- **New Sync:** This is not used.
- **Request to Send (RTS)/Clear to Send (CTS):** For modems that will be operated in half duplex mode, the modem or Data Service Unit (DSU) must be set for RTS controlled by the 5294; a constant CTS from the modem or DSU is not allowed.

For modems that will be operated in duplex mode, the modem or DSU should be set for RTS controlled by the 5294.

- **Ring Indicate:** (Applies to switched line modems only.) EIA/CCITT level signal is required on EIA/CCITT interface pin 22.



Chapter 6. Communications Planning for the 5251 Model 12

If your remote work station controller is a 5294 Control Unit, go to Chapter 5 for communications information.

If your remote work station controller is a 5251 Model 12, this chapter will help you to gather information about the particular form of communications you select. You will need this information to configure your system.

The chapter guides you in a step-by-step manner in ordering data communications equipment. The *Communications Components Order Information* section of this chapter contains an illustration showing the communications features that are available. The illustration is keyed to lead you to a worksheet for your particular communications feature. The worksheets are for recording information about the communications equipment you order.

Note: If you need general information about communications, see the *IBM Data Communications Concepts* manual, GC21-5169.

Getting Started

Site Considerations

System Specifications

5294 Configuration and Communications

5251 Model 12 Communications and Configuration

Cables

Appendixes

GUIDELINES FOR PLANNING AND ORDERING COMMUNICATIONS COMPONENTS FOR THE 5251 MODEL 12

Use the following guidelines when planning and ordering the components for your configuration:

- Select the type of communications lines and facilities you will use and refer to the *Communications Components Order Information* section that follows this section for order information.
- Review the floor plan for each remote location and decide on the positioning for modem and communications line connections (see Chapter 2). If a floor plan has not been prepared for the remote site, do that now.
- When you are ready to order (or if your order has already been placed), verify that the network design is valid for all devices and systems attached to the communications line.
- Enter the options you select on the appropriate communications feature worksheet in this chapter; this information will be used for configuration of your 5251 Model 12 and remote work stations. Prepare to give your supplier the necessary information for the features you have selected. Also, ask your supplier for any information you need listed with each of the communications features.
- Schedule the installation of the communications facilities that will connect the 5251 Model 12 and the host system. Refer to the *Planning Checklist* in Chapter 1 for assistance. Establish schedules that ensure that the communications facilities and system communications features are installed and tested before delivery of the 5251 Model 12 and the work stations.

COMMUNICATIONS COMPONENTS ORDER INFORMATION FOR THE 5251 MODEL 12

The following illustration shows possible communications facilities (features) for attaching a 5251 Model 12 to a system. Choose the appropriate communications feature for your configuration. Modems and equipment options for the system may differ, but you should ensure that the components used at the system and at the 5251 Model 12 are compatible.

In the illustration, keyed letters (for example, **B**) reference worksheets that follow the illustration. Fill in the appropriate worksheet for the communications feature that your 5251 Model 12 will have. For example, if your 5251 Model 12 will have the EIA/CCITT feature, the keyed letter **B** directs you to the EIA/CCITT worksheet. The completed worksheet will be used later in Chapter 7 when determining the communications line configuration switch settings for your 5251 Model 12.

Notes:

1. Some of the worksheets are more than one page; the large lettered arrows

(for example, ) direct you to where you should continue on the next page.

2. If you need extra worksheets, go to Appendix F.

The following illustration shows the communications features available for the 5251 Model 12. If you are uncertain about which of these features you have ordered or should order, contact your IBM sales representative.

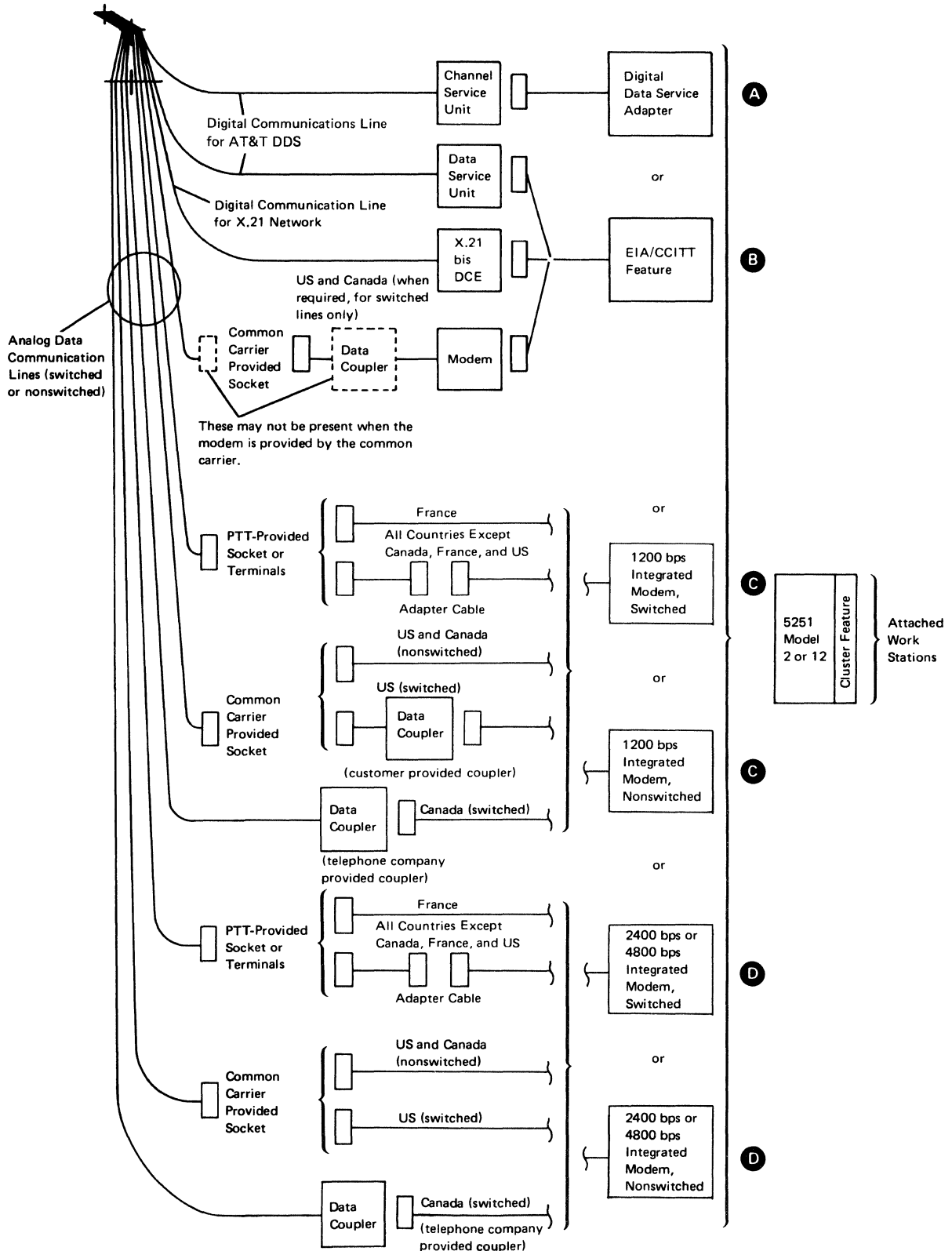

A Digital Data Service Adapter Feature Worksheet for the 5251 Model 12

If you will not use this feature, proceed to the worksheet for your communications feature.

Use this diagram to help you order options for use with the Digital Data Service Adapter feature (SF5650, point-to-point or SF5651, multipoint).

Note: This worksheet is to be used only when attaching to the DDS network using the DDS Adapter feature and a channel service unit. If attaching to the DDS network through a data service unit, the EIA interface must be used. (See the *EIA/CCITT Interface Feature Worksheet* in this chapter for more information.)

Call the common carrier.

Specify:

- Digital Data Service at speed ordered for your 5251 Model 12 (2400 bps, 4800 bps, or 9600 bps).
- Identify all modem/DCE locations. (For multipoint nonswitched, identify the control modem/DCE location.)
- Connection to DDS is to be made using a Channel Service Unit.

Note: The Channel Service Unit is not a modem.

- The signal ground is connected to the frame ground in the 5251 Model 12 (signal ground should not be connected to the frame ground in the channel service unit).

B EIA/CCITT Interface Feature Worksheet for the 5251 Model 12

If you will not use this feature, proceed to the worksheet for your communications feature.

Use this diagram to help you order communication lines and modem or data service unit options for use with the EIA/CCITT interface feature (SF3701).

Complete this information before you call the modem supplier. (This information is available from your 5251 Model 12 order.)

- Network type:
 - Point-to-point switched (dial up)
 - Point-to-point nonswitched
 - Multipoint nonswitched
- Speed of transmission: _____ bps
- Clocking to be provided:
 - Modem
 - 5251 Model 12 Internal Clock feature

Note: Modems must provide clocking for all speeds except 1200 bps. For 1200 bps, if the modem does not provide clocking, the Internal Clock feature is required on the 5251 Model 12.

- For countries other than the US/Canada, specify the PTT homologation approval numbers. (These can be obtained from your IBM sales representative.) _____

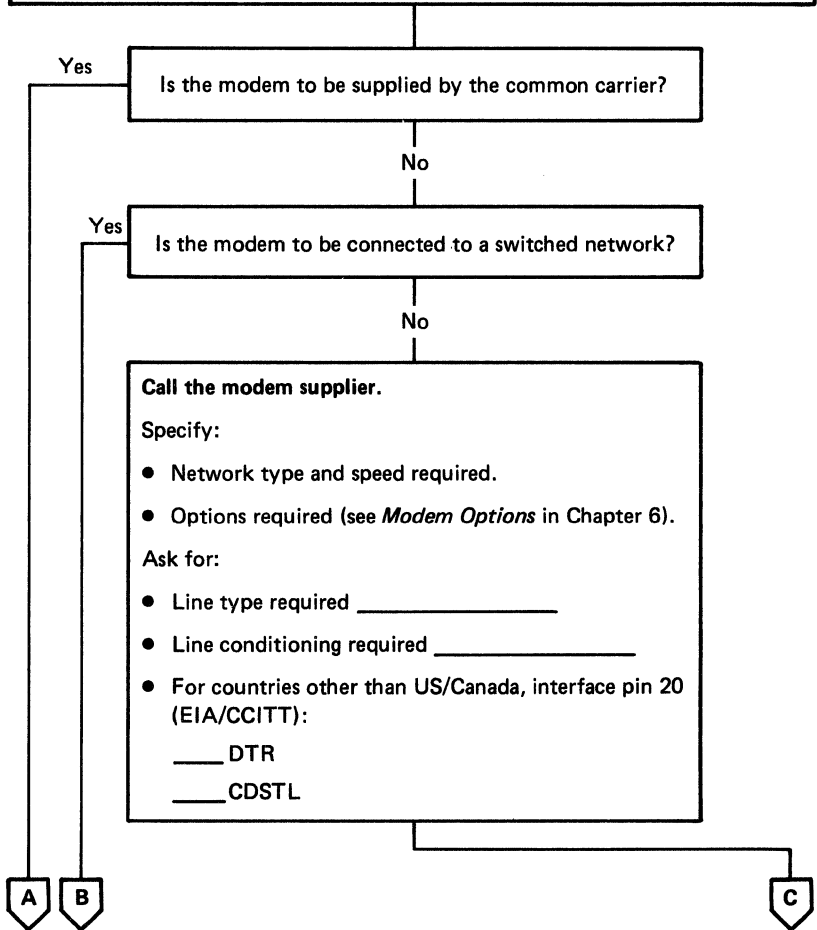

5251 Model 12
Communications
and Configuration

B

Call the modem supplier.

Specify:

- Network type and speed required
- Options required (see *Modem Options* following this chart)

Ask for:

- Line type required _____
- Line conditioning required _____
- Autoanswer capability Yes _____ No _____
- For the US/Canada only, the type of external coupler required (if any) _____
- For the US only, if no external coupler is required, then:
 - Modem make _____
 - FCC registration number _____
 - Ringer equivalence number _____
 - Telephone set options to specify _____
- For countries other than the US/Canada:
 - Does the modem send an answer tone? Yes _____ No _____
 - Interface pin 20 (EIA/CCITT): DTR _____ CDSTL _____
 - Specify the PTT homologation approval numbers.
(These can be obtained from your IBM sales representative.)

Yes

Is an external coupler required in the US?

No

Call the coupler supplier. (See *Recommendations for Data Couplers* in Chapter 6.)

- Order the coupler required for the modem you will use
- Ask for:
 - Coupler make/model _____
 - FCC registration number _____
 - Ringer equivalence number _____
 - Telephone set options to specify _____

A

C

Call the common carrier.

- Order communications lines as required
- Order modems as required or:
 - Provide information from the modem supplier on line type and conditioning
 - Provide information for all modem locations (for nonswitched multipoint operation, specify which location is for the control [host system] modem)
- For US (switched only), provide FCC registration information as obtained from the modem or coupler supplier
- For Canada, order a coupler, if required
- For countries other than the US/Canada, specify the PTT homologation approval numbers (these can be obtained from your IBM sales representative).

STOP

EIA/CCITT Interface Feature Order Information for the 5251 Model 12

When ordering modems to be used with this feature, you should use the following specifications as applicable (see the items below and *Modem Options*).

- Interface: EIA RS232C (CCITT V.24/V.28 for countries other than the United States and Canada)
- Speed: 1200 bps if the 5251 Model 12 provides the clocking; 1200 bps to 9600 bps if a modem provides the clocking

Modem Options

Specify the following options to the modem supplier. (All of the options may not apply to certain modems.) For options not listed, follow the modem supplier's recommendation.

- *Autoanswer Control:* (Applies to switched line modems only.) Specify the controlled by Data Terminal Ready (DTR) only option.
- *Carrier:* Carrier controlled by 'request to send' signal (switched carrier) is recommended. Continuous carrier can only be used if the 5251 Model 12 is attached to a point-to-point duplex (4-wire) communications line. If the option causes a continuous 'clear to send' signal from the modem, the 5251 must be set for a constant RTS (see *Functions of the Communications Line Configuration Switches* in Chapter 7). (For point-to-point nonswitched lines, the 5251 Model 12 has the 'request to send' signal on continuously and continuous carrier is not normally required.)
- *Clocking (Transmit Timing:)* Clocking must be provided by the modem for data rates above 1200 bps. At data rates of 1200 bps, the clocking can be provided by the modem or by the 5251 Model 12.

If the modem you are going to use with the EIA/CCITT Interface feature does not provide clocking, you must order the Internal Clock feature for the 5251 Model 12 (SF4703). The Internal Clock feature provides clocking for operation at 1200 bps in the United States and 1200 or 600 bps in countries other than the United States and Canada.

- **Data Set Ready:** If the modem you are going to use has the capability to loop data back to the 5251 Model 12 for testing, select the option that causes the 'data set ready' signal to be on while the local loopback test is running.
- **Grounding:** The signal ground is connected to the 5251 frame ground; the signal ground should not be connected to the frame ground in the modem.
- **Interface Pin 18:** If available, select the option that provides local loopback initiated by pin 18.
- **New Sync:** This is not used.
- **Request to Send (RTS)/Clear to Send (CTS):** For modems that will be operated in half duplex mode, the modem or Data Service Unit (DSU) must be set for RTS controlled by the 5251 Model 12; a constant CTS from the modem or DSU is not allowed.

For modems that will be operated in duplex mode, the modem or DSU should be set for RTS controlled by the 5251 Model 12. If the modem provides a constant CTS signal then the 5251 Model 12 must be set for a constant RTS signal (see *Switch 1* under *Functions of the Communications Line Configuration Switches* in Chapter 7).

Duplex switched line modems which provide a constant CTS signal can be used with the 5251 Model 12, but only in manual answer mode.

- **Ring Indicate:** (Applies to switched line modems only.) EIA/CCITT level signal is required on EIA/CCITT interface pin 22.

Ask your modem supplier for the following information:

- *Communications Line Facilities:* You must know the line type, and what line conditioning, if any, is needed. Also, for countries other than the United States and Canada:
 - Whether the modem sends an answer tone
 - Whether the modem requires the DTR or CDSTL options on EIA/CCITT interface pin 20

If the equipment is to be used in Canada, no further information is needed.

If the equipment is to be used on the switched network in the United States, and is not supplied by a telephone company, but is FCC registered, you must also know:

- The manufacturer's name
- The equipment type and model number
- The FCC registration number
- The ringer equivalence number
- What telephone set options to specify

If the equipment is to be used on the switched network in the United States, is not supplied by a telephone company, and is not FCC registered, you must know what type of data coupler is needed.

- *Communications Line SDLC Transmission Mode*
 - NRZ
 - NRZI

Ask your data coupler supplier for the following information:

- The manufacturer's name
- The equipment type and model number
- The FCC registration number
- The ringer equivalence number
- What telephone set options to specify

Provide this information to the telephone company when ordering communications line facilities.

C 1200 bps Integrated Modem Feature Worksheet for the 5251 Model 12

If you will not use this feature, proceed to the worksheet for your communications feature.

Use this diagram to help you order options for use with the 1200 bps Integrated Modem feature (SF5502, switched or SF5500, nonswitched).

Complete the following information before calling the telephone company.
(This information can be obtained from your 5251 Model 12 order.)

- Line type:
 - Switched
 - Nonswitched point-to-point
 - Nonswitched multipoint
- For countries other than the US/Canada, specify the PTT homologation approval numbers (these can be obtained from your IBM sales representative).

Yes

Is the modem to be connected to a switched line?

No

Call the common carrier.

Order:

- A voiceband private line for data transmission at 1200 bps
 - Four-wire line for point-to-point
 - Four-wire duplex line for multipoint (if planning multipoint operation, identify the control [host system] location)
- An outlet receptacle:
 - 404B (surface mounted)
 - 493B (flush mounted)

Specify:

- For the US, a nonswitched channel, type 3002 basic or equivalent
- For Canada, a schedule four, type four channel
- For countries other than US/Canada, a normal quality data communications line

STOP

D

D

Yes

Is the modem to be connected to a switched line in the US?

No

Call the PTT or telephone company.

Order:

- A switched telephone line for data transmission at 1200 bps
- For Canada, also order a CDT type data coupler and specify the following options:
 - Telephone set controls line
 - Ringer on the line side of the exclusion key

Provide:

- For countries other than the US/Canada, the PTT homologation approval numbers (these can be obtained from your IBM sales representative).

STOP

Call the coupler supplier.

Order:

- A CDT type data coupler (including any transformer or cables required for power)

Notes:

1. The data coupler must be a CDT type regardless of the type used at the host system.
2. See *Data Coupler Recommendations for 5251 Model 12 1200 bps Integrated Modems* in Chapter 6.

Ask for:

- FCC registration information:
 - Manufacturer's name _____
 - Ringer equivalence number _____
- Line connection _____
- Telephone set options to specify _____

Call the telephone company.

Order:

- A switched telephone line for data transmission at 1200 bps to be connected to an FCC registered coupler
- A telephone set with the options suggested by the coupler supplier

Provide:

- Information from the coupler supplier

STOP

Data Coupler Recommendations for 5251 Model 12 1200 bps Integrated Modems

Programmable Data Couplers: In the United States, IBM recommends a *programmable* CDT type data coupler (order with a transformer and a DC power cable) with the following characteristics:

- Adjusts automatically to the maximum allowable transmit power level *without* operator intervention
- Accepts 0 decibel power level from a 5251 Model 12 (data terminal equipment)
- Has a receive-data path delivering maximum power levels to the integrated modem (that is, a path not degraded by transmit power level attenuation circuitry)
- Complies with Part 68 of the FCC Rules and Regulations

Any data coupler meeting the above specifications can be used. One such known data coupler is manufactured by Pulsecom, Falls Church, Virginia 22041 (Model 1692-18L1).

Nonprogrammable Data Couplers: For a nonprogrammable data coupler, specify the telephone set as recommended by the data coupler supplier. (The telephone-set-controls-line option should be specified.) For a programmable type data coupler, you will need a telephone set with the following options:

- A1: Telephone set controls line
- B3: Aural monitoring not provided
- C5: Touch Tone¹ dial or C6-rotary type
- D7: Switch hook indication

Note: Telephone set suppliers, other than the common carrier, may not use the option identifiers shown above. If you order a telephone set from other than the common carrier, make sure you specify the same options for the telephone set as stated above.

¹Trademark of the American Telephone & Telegraph Company

D 2400 or 4800 bps Integrated Modem Feature Worksheet for the 5251 Model 12

If you will not use this feature, proceed to the worksheet for your communications feature.

Use this diagram to help you order options for use with the 2400 bps (SF5641, switched or SF5640, nonswitched) or 4800 bps (SF5741, switched or SF5740, nonswitched) Integrated Modem feature.

Complete the following information before calling the common carrier.
(This information can be obtained from your 5251 Model 12 order.)

- Speed of transmission _____ bps
- Line type:
 - Switched
 - Nonswitched point-to-point
 - Nonswitched multipoint
- For countries other than the US/Canada, specify the PTT homologation approval numbers (these can be obtained from your IBM sales representative).

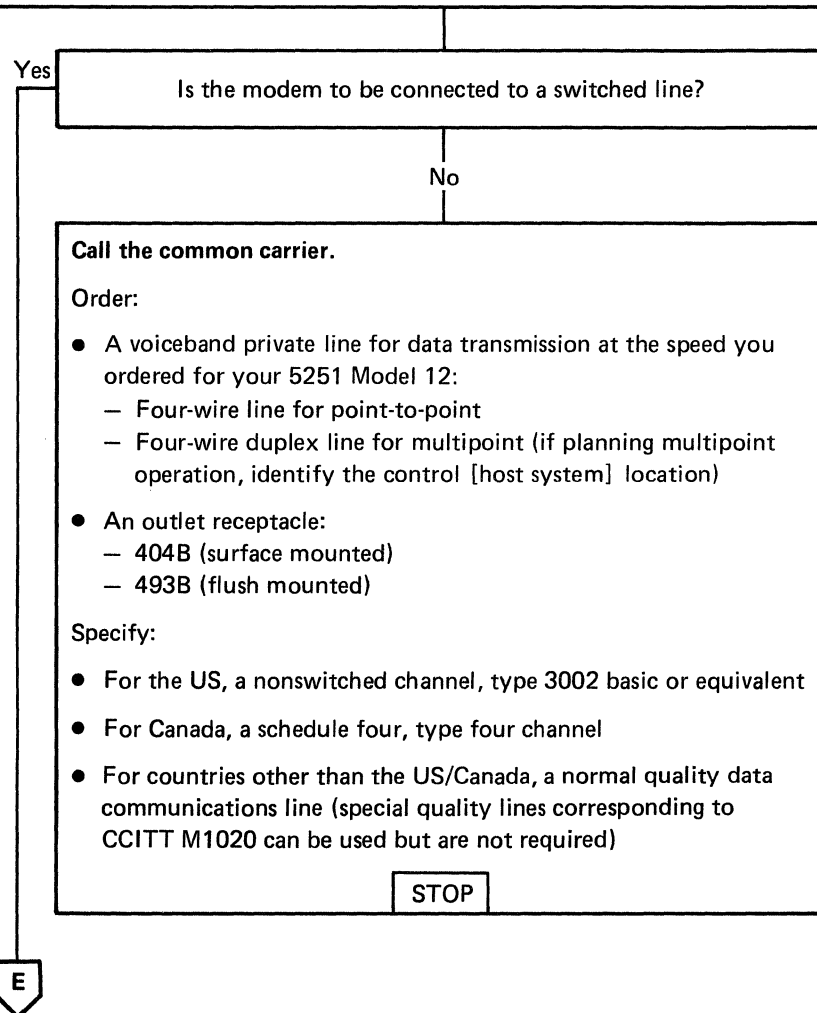

5251 Model 12
Communications
and Configuration

E

Yes

Is the modem to be connected to a switched line in the US?

No

Call the PTT or telephone company.

Order:

- A switched telephone line for data transmission at the same speed ordered for the 5251 Model 12
- For Canada, also order a CBS type data coupler and specify the following options:
 - Modem controls line
 - Ringer on the line side of the exclusion key

Provide:

- For countries other than the US/Canada, the PTT homologation approval numbers (these can be obtained from your IBM sales representative).

STOP

Call the telephone company.

Order:

- A switched telephone line for data transmission at the same speed you ordered for the 5251 Model 12 to be connected to an FCC registered device. Provide the following FCC registration information to the telephone company:
 - Manufacturer: IBM
 - FCC registration number: AN09SA67992-DP-N
 - Ringer equivalence number: .8B
 - Line connection: USOC RJ45S
- A telephone set (USOC-RTC) with the following options:
 - A2: Data equipment controls line
 - B4: Aural (audio) monitoring provided
 - C5: Touch Tone or C6: rotary dial
 - D8: Voice mode indication

Notes:

1. If you wish to use an existing line, provide the telephone company with the line number and the data rate to be used. The telephone set, USOC-RTC, will be needed even when using an existing line.
2. Telephone set suppliers, other than the common carrier, may not use the designation USOC-RTC and option identifiers shown above to identify a telephone set that has an exclusion key. If you order a telephone set from other than the common carrier, make sure you specify the same options for the telephone set as stated above. If aural monitoring is not available, order *switch hook indication* instead of *voice mode indication*.

STOP

FCC RULES COMPLIANCE

If the 5251 Model 12 causes technical problems on the network, the telephone company will notify you, if possible, that service may be temporarily discontinued. When prior notice is not feasible, the telephone company may discontinue service immediately, if such action is reasonable. In the case of a temporary discontinuance of service, the telephone company will:

- Promptly notify you of the temporary discontinuance
- Allow you to correct, or have corrected, the problem that caused the discontinuance
- Inform you of your right to file a complaint with the Federal Communications Commission using the procedures defined in the FCC Rules and Regulations, Part 68, subsection E

All repairs to the FCC registered communications equipment of a 5251 Model 12 attached to the public switched network must be made in accordance with the procedures specified in the maintenance documentation (supplied with the 5251 Model 12). Failure to do so will invalidate the FCC registration.

The telephone company may make changes in its communications facilities, equipment, operations, or procedures where such action is reasonably required in the operation of its business and is not inconsistent with the rules and regulations of the FCC. If these changes are expected to cause your equipment to be incompatible with the telephone company's communication facilities, or require modification or alteration of your equipment, you will be given adequate notice in writing to allow you an opportunity to maintain uninterrupted service.

Chapter 7. Remote Work Station Configuration Using the 5251 Model 12

This chapter will explain how to configure and determine appropriate attachments and switch settings for a 5251 Model 12 controller/work station and any work stations attached to it. For configuration information about the 5294 Control Unit and any work stations that attach to it, refer to Chapter 4, *Remote Work Station Configuration Using the 5294 Control Unit*.

The 5251 Model 12 is a communications attached display station and is also a work station controller for other 5250 devices when the Cluster feature or Dual Cluster feature is installed. *Configuration* is identifying the communications line facilities, the remote work station controller, and the work stations (if any) that are attached to it. This involves documenting your proposed 5251 Model 12 setup information and assigning settings and cable connections. You will also provide this information to the host system (for use in system configuration) and to the person(s) who will do the setup at the remote location.

Getting
Started

Site
Considerations

System
Specifications

5294
Configuration and
Communications

5251 Model 12
Communications
and Configuration

Cables

Appendixes

The following illustration of a remote work station configuration will be used as a sample configuration throughout this chapter.

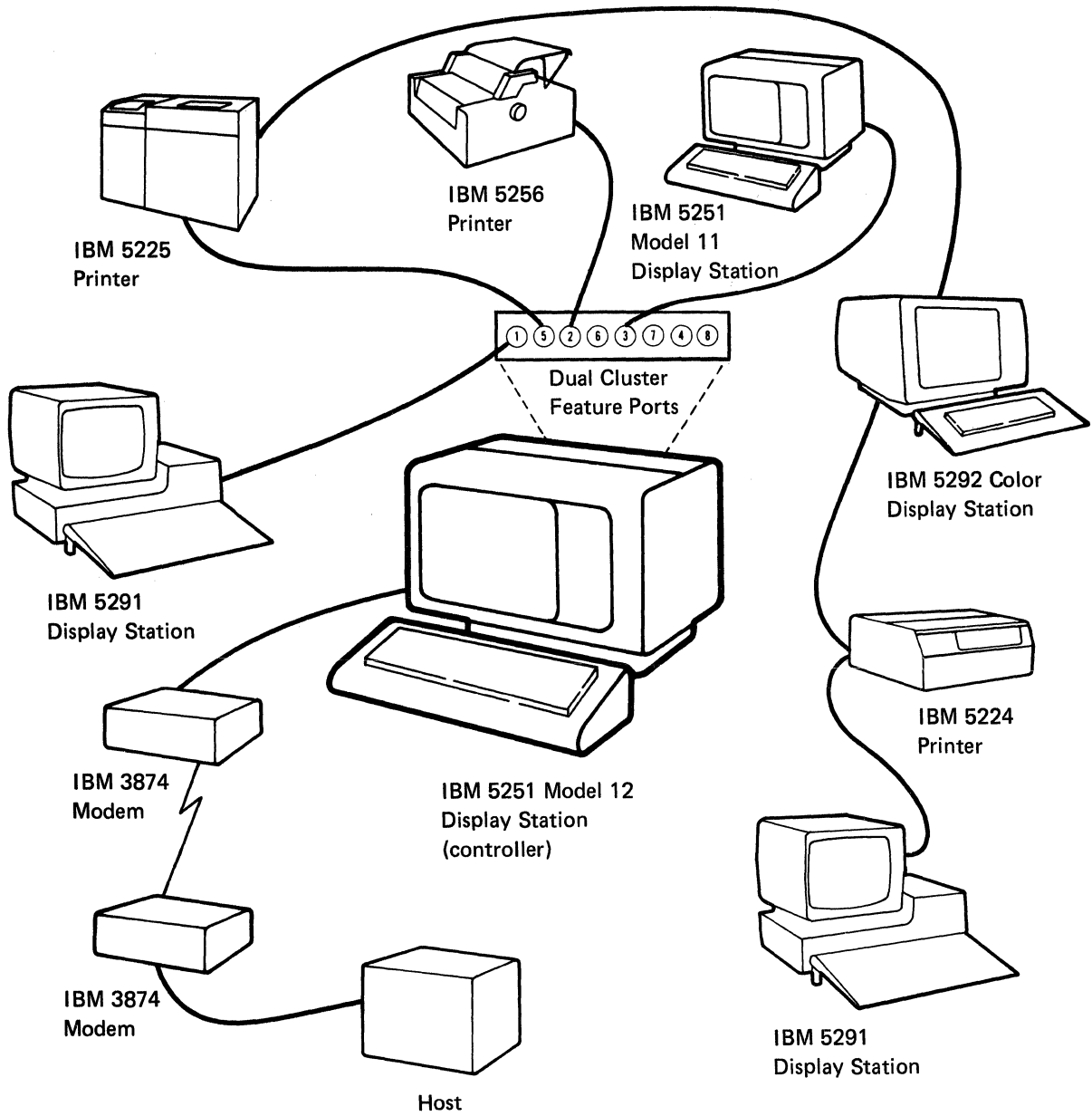

COMPLETING THE SETUP FORM FOR CONFIGURATION OF THE 5251 MODEL 12

When your 5251 Model 12 Display Station arrives, the person responsible for its setup must:

- Set the controller station address switches
- Set the communications line configuration switches
- Set the Cluster Feature port switches (only if work stations are being attached to the 5251 Model 12)

In order to complete setup, the person who sets up the 5251 Model 12 uses information entered on the 5251 Model 12 Communications Network Setup Form (Appendix G). This form is completed by the person who plans the configuration.

As the person responsible for configuration, you must:

- Complete the following items on Part 1 of the 5251 Model 12 Communications Network Setup Form (see the following page):
 - 5251 Model 12 information
 - Controller Station Address switch settings
 - Communications Line Configuration switch settings
 - Cluster Feature Port switch settings (only if work stations are being attached to the 5251 Model 12)

Guidelines for completing these tasks are on the following pages under *5251 Model 12 Information and Switch Settings*.

- Complete Part 2 of the 5251 Model 12 Communications Network Setup Form only if you are attaching work stations to your 5251 Model 12. Guidelines on how to do this follow the instructions for completing Part 1 of the form and are under *Completing the Setup Form for Configuration of the Remote Work Stations*.
- Provide a completed copy of your 5251 Model 12 Communications Network Setup Form to the person responsible for doing the 5251 Model 12 setup.

The following illustrates Part 1 of the 5251 Model 12 Communications Network Setup Form.

IBM 5251 MODEL 12 COMMUNICATIONS NETWORK SETUP FORM (Part 1)

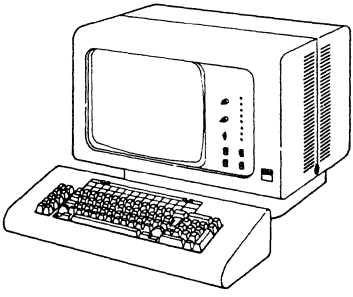

5251 MODEL 12 DISPLAY STATION

5251 Model 12 Information

Name _____

Location _____

City, State _____

Telephone _____

Host System Line/Port Number _____

Location _____

Telephone _____

Device Type _____

Controller Station Address _____

Unit Address ____00 _____

Work Station Address ____0 _____

Communications Type _____

CSR assistance required for communications line connection? Yes No

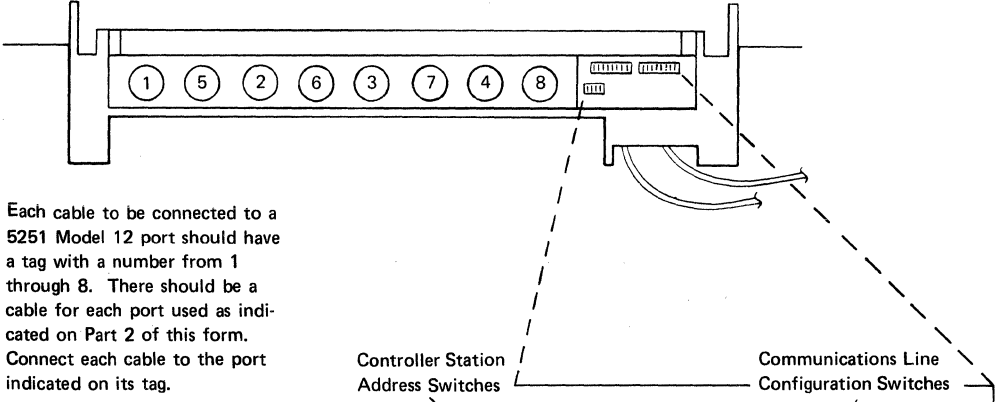

Each cable to be connected to a 5251 Model 12 port should have a tag with a number from 1 through 8. There should be a cable for each port used as indicated on Part 2 of this form. Connect each cable to the port indicated on its tag.

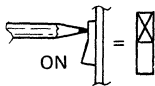

ON

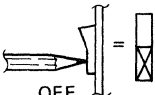

OFF

Controller Station Address Switches

1	2	3	4	5	6	7	8
OFF	ON	OFF	OFF	OFF	OFF	OFF	OFF

Communications Line Configuration Switches

1	2	3	4	5	6	7	8
OFF	OFF	OFF	OFF	OFF	OFF	OFF	OFF

Cluster Feature Port Switches

1	2	3	4
OFF	OFF	OFF	OFF
CF1	CF2		

Set all of the switches to their indicated settings. (Switch settings should be indicated on the diagram by an X in the on or off position.) Use the tip of a pencil to push in the upper half (on position) or lower half (off position) of the switches as indicated.

Note: If your 5251 Model 12 does not have ports, the Cluster Feature Port switches have no function and can be disregarded.

5251 Model 12 Information

Complete the 5251 Model 12 information on Part 1 of the Communications Network Setup Form as follows:

1. Fill in an identifying name (a person or place), location (a building, address, or part of town), city, state, and a telephone number where the operator at the 5251 Model 12 can be reached.

IBM 5251 MODEL 12 COMMUNICATIONS NETWORK SETUP FORM (Part 1)

5251 Model 12 Information

Name MONTRQUEBC

Location Headquarters

City, State Montreal, Quebec

Telephone 514-492-3542

Host System Line/Port Number _____

Location _____

Telephone _____

Device Type _____

Controller Station Address _____

Unit Address 00 _____

Work Station Address 0 _____

Communications Type _____

CSR assistance required for communications line connection?

Yes

No

2. Fill in the host system line/port number. This refers to the communications line from the host system that the 5251 Model 12 is connected to. Check with the host site to make sure that you have the correct line number. Also, fill in the location and telephone number for the host system.

IBM 5251 MODEL 12 COMMUNICATIONS NETWORK SETUP FORM (Part 1)

5251 Model 12 Information

Name MONTRQUEBC

Location Headquarters

City, State Montreal, Quebec

Telephone 514-492-3542

Host System Line/Port Number 2

Location Computer Center

Telephone 212-466-7434

Device Type _____

Controller Station Address _____

Unit Address 00 _____

Work Station Address 0 _____

Communications Type _____

CSR assistance required for Communications line connections?

Yes

No

3. Fill in the device type. This is the machine number; that is, the 5251 Model 12.

Note: The Controller Station Address will be filled in later in this chapter when you have determined the switch settings for the Controller Station Address switches.

IBM 5251 MODEL 12 COMMUNICATIONS NETWORK SETUP FORM (Part 1)

5251 Model 12 Information

Name MONTRQUEBC

Location Headquarters

City, State Montreal, Quebec

Telephone 514-492-3542

Host System Line/Port Number 2

Location Computer Center

Telephone 212-466-7434

Device Type 5251 Model 12

Controller Station Address _____

Unit Address 00

Work Station Address 0

Communications Type _____

CSR assistance required for communications line connection?

 Yes No

4. The unit and work station addresses of the 5251 Model 12 are internally preset and always 00 and 0 respectively (these have been preprinted on the form).

IBM 5251 MODEL 12 COMMUNICATIONS NETWORK SETUP FORM (Part 1)

5251 Model 12 Information

Name MONTRQUEBC

Location Headquarters

City, State Montreal, Quebec

Telephone 514-492-3542

Host System Line/Port Number 2

Location Computer Center

Telephone 212-466-7434

Device Type 5251 Model 12

Controller Station Address _____

Unit Address 00

Work Station Address 0

Communications Type _____

CSR assistance required for Communications line connections?

 Yes No

5. Fill in the communications type. This information can be found on the completed communications type worksheet in Chapter 6. The person responsible for setting up the 5251 Model 12 will use this information to find the correct communications procedure in the *5251 Model 12 Setup Procedure* manual.

IBM 5251 MODEL 12 COMMUNICATIONS NETWORK SETUP FORM (Part 1)

5251 Model 12 Information

Name MONTRQUEBC
 Location Headquarters
 City, State Montreal, Quebec
 Telephone 514-492-3542
 Host System Line/Port Number 2
 Location Computer Center
 Telephone 212-466-7434
 Device Type 5251 Model 12
 Controller Station Address _____
 Unit Address 00
 Work Station Address 0
 Communications Type EIA/CCITT
 CSR assistance required for communications line connection? Yes No

6. Check the appropriate box to indicate whether the person doing the setup of the 5251 Model 12 will require (CSR) Customer Service Representative assistance to connect the Model 12 to the communications line. CSR assistance is required in the following cases:
- When a 5251 Model 12 with a 1200 bps switched integrated modem is to be installed in the United States and the data coupler is not the type recommended in Chapter 6.
 - When a 5251 Model 12 with a switched integrated modem (1200, 2400, or 4800 bps) is to be installed in Canada.
 - Whenever regulations require that a CSR be present and/or make the connection to the communications line.

IBM 5251 MODEL 12 COMMUNICATIONS NETWORK SETUP FORM (Part 1)

5251 Model 12 Information

Name MONTRQUEBC
 Location Headquarters
 City, State Montreal, Quebec
 Telephone 514-492-3542
 Host System Line/Port Number 2
 Location Computer Center
 Telephone 212-466-7434
 Device Type 5251 Model 12
 Controller Station Address _____
 Unit Address 00
 Work Station Address 0
 Communications Type EIA/CCITT
 CSR assistance required for Communications line connections? Yes No

5251 Model 12
 Communications
 and Configuration

Switch Settings

After completing the 5251 Model 12 information on Part 1 of the 5251 Model 12 Communications Network Setup Form, the settings for the controller station address switches and communications line configuration switches need to be determined. Settings for the Cluster Feature port switches need to be determined only if work stations are being attached to the 5251 Model 12 and are described later in this chapter.

Controller Station Address

The controller station address switches are eight switches set to represent the controller station address of the 5251 Model 12. This address is used by the host system to select a specific Model 12 on a communications line.

Controller Station
Address Switches

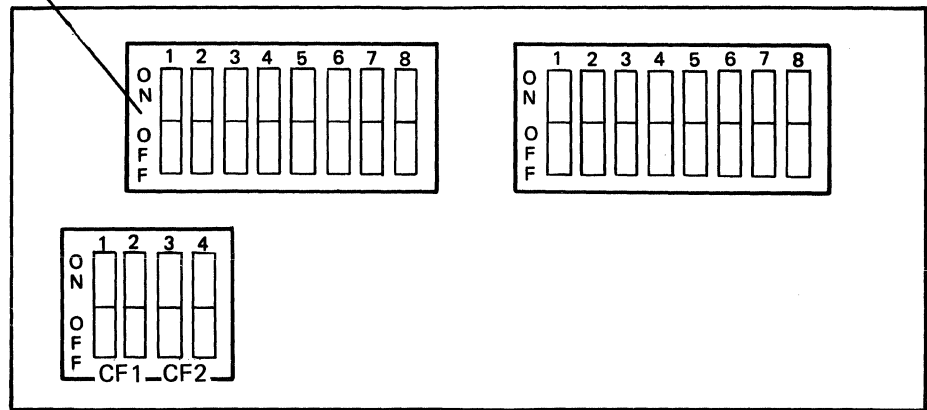

1. Choose any controller station address (from the following chart) so long as:
 - a. A unique address is chosen for each 5251 Model 12 attached to the same communications line.
 - b. A unique address is chosen for each 5251 Model 12 attached to the same system (some systems may not have this restriction).
 - c. You observe the note for asterisked addresses on the chart if your configuration uses the IBM 2400 or 4800 bps Integrated Modem feature.

The following chart shows all possible controller station addresses with their corresponding switch settings. The controller station address chosen for the sample configuration is also shown.

Controller Station
Address Switches

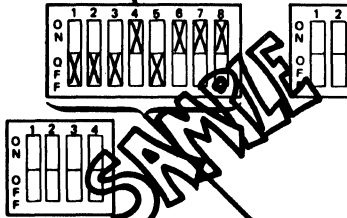

Address	Switch Setting	Address	Switch Setting	Address	Switch Setting	Address	Switch Setting
01*	0000 0001	40*	0100 0000	80*	1000 0000	C0*	1100 0000
02*	0000 0010	41*	0100 0001	81*	1000 0001	C1*	1100 0001
03*	0000 0011	42*	0100 0010	82*	1000 0010	C2*	1100 0010
04	0000 0100	43*	0100 0011	83*	1000 0011	C3*	1100 0011
05	0000 0101	44	0100 0100	84	1000 0100	C4	1100 0100
06	0000 0110	45	0100 0101	85	1000 0101	C5	1100 0101
07	0000 0111	46	0100 0110	86	1000 0110	C6	1100 0110
08	0000 1000	47	0100 0111	87	1000 0111	C7	1100 0111
09	0000 1001	48	0100 1000	88	1000 1000	C8	1100 1000
0A	0000 1010	49	0100 1001	89	1000 1001	C9	1100 1001
0B	0000 1011	4A	0100 1010	8A	1000 1010	CA	1100 1010
0C	0000 1100	4B	0100 1011	8B	1000 1011	CB	1100 1011
0D	0000 1101	4C	0100 1100	8C	1000 1100	CC	1100 1100
0E	0000 1110	4D	0100 1101	8D	1000 1101	CD	1100 1101
0F	0000 1111	4E	0100 1110	8E	1000 1110	CE	1100 1110
10*	0001 0000	4F	0100 1111	8F	1000 1111	CF	1100 1111
11*	0001 0001	50*	0101 0000	90*	1001 0000	D0*	1101 0000
12*	0001 0010	51*	0101 0001	91*	1001 0001	D1*	1101 0001
13*	0001 0011	52*	0101 0010	92*	1001 0010	D2*	1101 0010
14	0001 0100	53*	0101 0011	93*	1001 0011	D3*	1101 0011
15	0001 0101	54	0101 0100	94	1001 0100	D4	1101 0100
16	0001 0110	55	0101 0101	95	1001 0101	D5	1101 0101
17	0001 0111	56	0101 0110	96	1001 0110	D6	1101 0110
18	0001 1000	57	0101 0111	97	1001 0111	D7	1101 0111
19	0001 1001	58	0101 1000	98	1001 1000	D8	1101 1000
1A	0001 1010	59	0101 1001	99	1001 1001	D9	1101 1001
1B	0001 1011	5A	0101 1010	9A	1001 1010	DA	1101 1010
1C	0001 1100	5B	0101 1011	9B	1001 1011	DB	1101 1011
1D	0001 1101	5C	0101 1100	9C	1001 1100	DC	1101 1100
1E	0001 1110	5D	0101 1101	9D	1001 1101	DD	1101 1101
1F	0001 1111	5E	0101 1110	9E	1001 1110	DE	1101 1110
20*	0010 0000	5F	0101 1111	9F	1001 1111	DF	1101 1111
21*	0010 0001	60*	0110 0000	A0*	1010 0000	E0*	1110 0000
22*	0010 0010	61*	0110 0001	A1*	1010 0001	E1*	1110 0001
23*	0010 0011	62*	0110 0010	A2*	1010 0010	E2*	1110 0010
24	0010 0100	63*	0110 0011	A3*	1010 0011	E3*	1110 0011
25	0010 0101	64	0110 0100	A4	1010 0100	E4	1110 0100
26	0010 0110	65	0110 0101	A5	1010 0101	E5	1110 0101
27	0010 0111	66	0110 0110	A6	1010 0110	E6	1110 0110
28	0010 1000	67	0110 0111	A7	1010 0111	E7	1110 0111
29	0010 1001	68	0110 1000	A8	1010 1000	E8	1110 1000
2A	0010 1010	69	0110 1001	A9	1010 1001	E9	1110 1001
2B	0010 1011	6A	0110 1010	AA	1010 1010	EA	1110 1010
2C	0010 1100	6B	0110 1011	AB	1010 1011	EB	1110 1011
2D	0010 1101	6C	0110 1100	AC	1010 1100	EC	1110 1100
2E	0010 1110	6D	0110 1101	AD	1010 1101	ED	1110 1101
2F	0010 1111	6E	0110 1110	AE	1010 1110	EE	1110 1110
30*	0011 0000	6F	0110 1111	AF	1010 1111	EF	1110 1111
31*	0011 0001	70*	0111 0000	B0*	1011 0000	F0*	1111 0000
32*	0011 0010	71*	0111 0001	B1*	1011 0001	F1*	1111 0001
33*	0011 0011	72*	0111 0010	B2*	1011 0010	F2*	1111 0010
34	0011 0100	73*	0111 0011	B3*	1011 0011	F3*	1111 0011
35	0011 0101	74	0111 0100	B4	1011 0100	F4	1111 0100
36	0011 0110	75	0111 0101	B5	1011 0101	F5	1111 0101
37	0011 0111	76	0111 0110	B6	1011 0110	F6	1111 0110
38	0011 1000	77	0111 0111	B7	1011 0111	F7	1111 0111
39	0011 1001	78	0111 1000	B8	1011 1000	F8	1111 1000
3A	0011 1010	79	0111 1001	B9	1011 1001	F9	1111 1001
3B	0011 1011	7A	0111 1010	BA	1011 1010	FA	1111 1010
3C	0011 1100	7B	0111 1011	BB	1011 1011	FB	1111 1011
3D	0011 1101	7C	0111 1100	BC	1011 1100	FC	1111 1100
3E	0011 1110	7D	0111 1101	BD	1011 1101	FD	1111 1101
3F	0011 1111	7E	0111 1110	BE	1011 1110	FE	1111 1110
		7F	0111 1111	BF	1011 1111		

Use to set the switches. 0 = OFF, 1 = ON

*Do not use this address if the IBM 2400 or 4800 bps Integrated Modem feature is installed.

- After selecting your controller station address, transfer the address to the diagram on Part 1 of the Communications Network Setup Form.

IBM 5251 MODEL 12 COMMUNICATIONS NETWORK SETUP FORM (Part 1)

5251 Model 12 Information

Name MONTRQUEBC

Location Headquarters

City, State Montreal, Quebec

Telephone 514-492-3542

Host System Line/Port Number 2

Location Computer Center

Telephone 212-466-7434

Device Type 5251 Model 12

Controller Station Address 17

Unit Address 00

Work Station Address 0

Communications Type EIA/CCITT

CSR assistance required for communications line connection?

Yes

No



Communications Line Configuration

The communications line configuration switches are eight switches that must be set to represent the type of communications configuration used. To determine the setting of the switches, refer to steps 1 and 2 which follow the illustration below. Then enter the setting for the communication line configuration switches on Part 1 of the Communications Network Setup Form.

Communications Line Configuration Switches

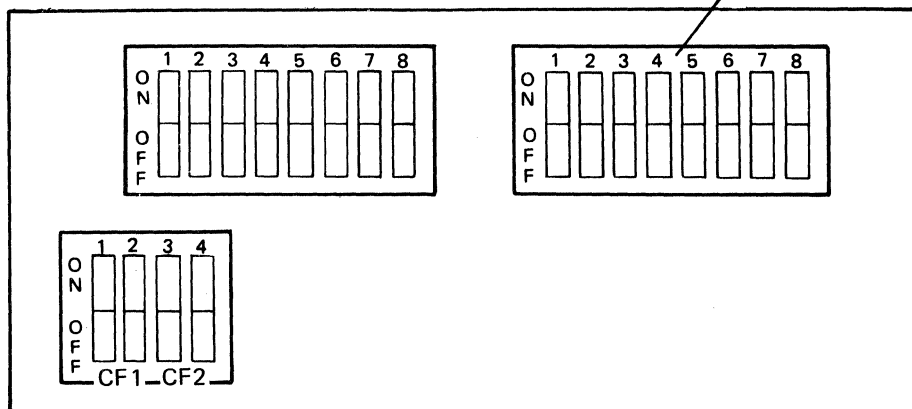

These steps should be followed to successfully determine your communications line configuration switch settings.

1. Using the circled letter identifying your communications feature (for example, **B** identifies EIA/CCITT) and the number in a black box below, determine which combination matches your configuration. To do this, refer to the information block on the communications feature worksheet you filled out in Chapter 6. The letter on that communications feature worksheet shows you which leg of the key to start with. Now, depending on your options, choose the appropriate branch of the key until you reach a number. This number will lead you to the appropriate communications line configuration switch setting on the following pages.

A DDS Adapter **1**

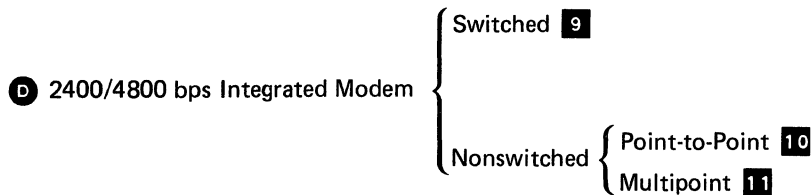
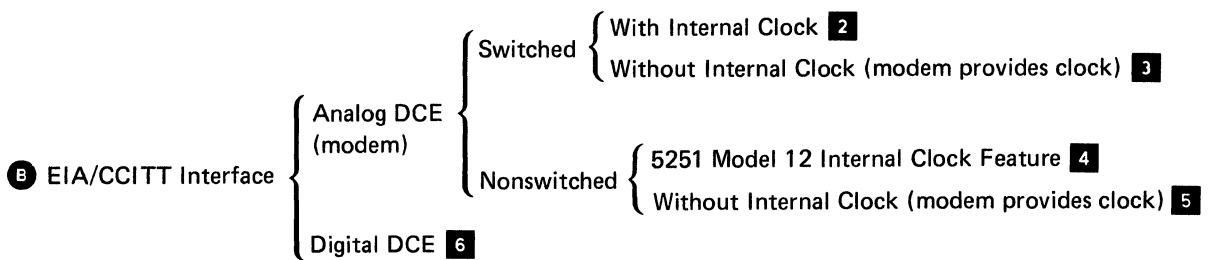

2. Refer to the chart that applies to your country (Figure 7-1 is for the United States and Canada and Figure 7-2 is for all other countries) and locate the numeric key you identified for your configuration.
 - a. Examine the switch settings and read any pertinent notes (these follow the series of options for your country). If necessary, read the description of any of the eight switches that follow the charts.
 - b. Enter the indicated switch settings on your Communications Network Setup Form. If you plan to attach work stations to your 5251 Model 12 proceed to the topic *Completing the Setup Form for Configuration of the Remote Work Stations* in this chapter. If no work stations are to be attached to your 5251 Model 12, this is your last step.

Key Reference to Communications Feature Worksheets	Switch Function	RTS	Network Type	CTS Delay	Answer Tone	Comm Type	Line Type	DTR/CDSTL	NRZI/NRZ	Switch Setting
	Number	1	2	3	4	5	6	7	8	
DDS Adapter										
1	All Configurations	OFF	OFF	OFF	OFF	ON	ON	ON	OFF	
EIA Interface – Switched Line with External Modem										
2	With Internal Clock	Note 5	OFF	OFF	OFF	ON	Note 5	ON	ON	
3	Without Internal Clock	Note 5	OFF	OFF	OFF	ON	Note 5	ON	Note 2	
EIA Interface – Nonswitched Line with External Modem										
4	With Internal Clock	Notes 1 and 5	OFF	OFF	OFF	ON	ON	ON	ON	
5	Without Internal Clock	Notes 1 and 5	OFF	OFF	OFF	ON	ON	ON	Note 2	
EIA Interface with a Digital DCE (See Note 6)										
6	All Configurations	Note 5	OFF	OFF	OFF	ON	ON	ON	OFF	
1200 bps Integrated Modem										
7	Switched	OFF	OFF	OFF	OFF	ON	ON Note 3	ON	ON	
8	Non-switched	Note 1	OFF	OFF	OFF	ON	ON	ON	ON	

Figure 7-1 (Part 1 of 2). Communications Line Configuration Switch Settings for the United States and Canada

Key Reference to Communications Feature Worksheets	Switch Function	RTS	Network Type	CTS Delay	Answer Tone	Comm Type	Line Type	DTR/CDSTL	NRZI/NRZ	Switch Setting
	Number	1	2	3	4	5	6	7	8	
2400 or 4800 bps Integrated Modem										
9	Switched	OFF	OFF	Note 4	OFF	ON	OFF	ON	ON	
10	Non-switched Point-to-Point	OFF	OFF	Note 4	OFF	ON	ON	ON	ON	
11	Non-switched Multi-point	OFF	ON	Note 4	OFF	ON	ON	ON	ON	
<p>Notes:</p> <ol style="list-style-type: none"> 1. This switch may be set to on to minimize turnaround time when operating on a point-to-point duplex communications line. When operating on a multipoint communications line, this switch must be set to off. Refer to the description of switch 1 that follows these charts. 2. This switch should be set to on for most IBM modems. Refer to the description of switch 8 that follows these charts. 3. The nonswitched position is also used for switched manual answer operation (US and Canada only). 4. This switch is normally set to off. Refer to the description of switch 3 that follows these charts. 5. Switches 1 and 6 should be set to on for modems or other DCE that provide a continuous CTS signal. Refer to the descriptions of switches 1 and 6 that follow these charts. 6. Digital DCE includes an AT&T Data Service Unit or an X.21 or X.25 DCE. The internal Clock feature cannot be installed when the EIA interface is used with a digital DCE. 										

Figure 7-1 (Part 2 of 2). Communications Line Configuration Switch Settings for the United States and Canada

Key Reference to Communications Feature Worksheets	Switch Function	RTS	Network Type	CTS Delay	Answer Tone	Comm Type	Line Type	DTR/CDSTL	NRZI/NRZ	Switch Setting
	Number	1	2	3	4	5	6	7	8	
DDS Adapter										
1	All Configurations	OFF	OFF	OFF	OFF	ON	ON	ON	OFF	
EIA Interface – Switched Line with External Modem										
2	With Internal Clock	OFF	OFF	OFF	Note 2	ON	OFF	Note 3	ON	
3	Without Internal Clock	OFF	OFF	OFF	Note 2	ON	OFF	Note 3	Note 4	
EIA Interface – Nonswitched Line with External Modem										
4	With Internal Clock	Notes 1 and 6	OFF	OFF	Note 2	ON	ON	Note 3	ON	
5	Without Internal Clock	Notes 1 and 6	OFF	OFF	Note 2	ON	ON	Note 3	Note 4	
EIA Interface with a Digital DCE (See Note 7)										
6	All Configurations	Note 6	OFF	OFF	OFF	ON	ON	ON	OFF	
1200 bps Integrated Modem										
7	Switched	OFF	OFF	OFF	OFF	ON	OFF	ON	ON	
8	Non-switched	Note 1	OFF	OFF	OFF	ON	ON	ON	ON	

Figure 7-2 (Part 1 of 2). Communications Line Configuration Switch Settings for Countries Other than the United States and Canada

Key Reference to Communications Feature Worksheets	Switch Function	RTS	Network Type	CTS Delay	Answer Tone	Comm Type	Line Type	DTR/CDSTL	NRZI/NRZ	Switch Setting
	Number	1	2	3	4	5	6	7	8	
2400 or 4800 bps Integrated Modem										
9	Switched	OFF	OFF	Note 5	OFF	ON	OFF	ON	ON	
10	Non-switched Point-to-Point	OFF	OFF	Note 5	OFF	ON	ON	ON	ON	
11	Non-switched Multi-point	OFF	ON	Note 5	OFF	ON	ON	ON	ON	
<p>Notes:</p> <ol style="list-style-type: none"> 1. This switch may be set to on to minimize turnaround time when operating on a point-to-point duplex communications line. When operating on a multipoint communications line, this switch must be set to off. Refer to the description of switch 1 that follows these charts. 2. This switch should be set to off except in Sweden when using a GH2002L13 modem or in the United Kingdom when using a Datel 1F Model 5 or a Datel 1D Model 5 modem. 3. This switch should be set to on for all IBM modems and all PTT mandatory modems except in the United Kingdom where this switch should be set to off when using a Datel 1D Model 5 modem. Some other modems might also require that this switch be set to off (CDSTL). 4. This switch should be set to on for most IBM modems. For other modems, refer to the description of switch 8 that follows these charts. 5. This switch is normally set to off. Refer to the description of switch 3 that follows these charts. 6. Switch 1 should be set to on for modems or other DCE that provides a continuous CTS signal. Refer to the description for switch 1 that follows these charts. 7. Digital DCE includes an X.21 or X.25 DCE. The Internal Clock feature cannot be installed when the EIA interface is used with a digital DCE. 										

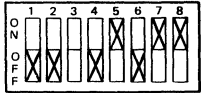
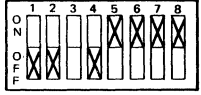
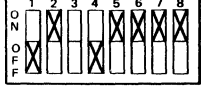
Figure 7-2 (Part 2 of 2). Communications Line Configuration Switch Settings for Countries Other than the United States and Canada

Switch 1 – Request to Send

- On: Constant RTS (request to send)
- Off: Normal RTS

Switch 1 controls the RTS signal line from the 5251 Model 12 to the modem. When this switch is set to on, a constant RTS signal is sent to the modem. (Some modems need a constant RTS to operate; others use it to improve communications line turnaround time.) Switch 1 is set to Constant RTS only when the 5251 Model 12 is operating on a duplex (4-wire) point-to-point communications line. Switch 1 must be set to on when the modem provides a constant CTS signal. When operating on a multipoint communications line, this switch must be set to off. Also refer to the description of switch 6.

Switch 2 – Network Type (Used Only with a Nonswitched 2400 bps or 4800 bps Integrated Modem)

Set Switch 2 to off unless used with a nonswitched 2400 or 4800 bps Integrated Modem

- On: Attached to a multipoint communications line
- Off: Attached to a point-to-point communications line

Switch 3 – Clear To Send Delay (Used Only with a 2400 bps or 4800 bps Integrated Modem)

Set Switch 3 to off unless used with a 2400 or 4800 bps Integrated Modem. For switched lines:

- On: Selects the short CTS (clear to send) delay; can be used only on local lines to decrease line turnaround time
- Off: Selects the normal CTS delay; is recommended for normal use

For multipoint nonswitched lines:

- On: Selects CTS delay to allow increased initialization time; is for use on degraded or poor quality lines
- Off: Selects short CTS delay for normal operation

Switch 3 is used to select the delay between RTS (request to send) and CTS (clear to send) also known as RFS (ready for sending). Switch 3 is not used for nonswitched point-to-point lines.

Switch 4—Answer Tone (Used Only for Switched Line Operation)

Set Switch 4 to off unless used for switched line operation.

- On: The 5251 Model 12 sends answer tone
- Off: The modem sends answer tone

Switch 4 controls the sending of the answer tone by the 5251 Model 12. Switch 4 in the On position causes the Model 12 to generate the answer tone, whereas the Off position causes the Model 12 to expect a modem generated answer tone. (Most modems automatically generate the answer tone, but some World Trade modems do not.) Switch 4 is set to off for United States modems and most World Trade modems.

Switch 5—Communications Type

- On: Standard Communications features installed
- Off: R-loop RPQ feature installed

Switch 6—Line Type

- On: Nonswitched line or switched (manual answer) line
- Off: Switched line (with autoanswer capability even if autoanswer is not used)

Switch 6 indicates to the 5251 Model 12 what type of communications line is being used. Switch 6 in the On position indicates that the communications line is nonswitched (all countries) or switched manual answer (United States and Canada only). In the Off position, switch 6 indicates switched line (autoanswer); the DTR (data terminal ready) signal line will drop in order to disconnect a call and is not turned on again until the DSR (data set ready) signal line goes off.

Note: If a constant RTS signal is required for a switched line modem (switch 1 is on), switch 6 must be set to on; autoanswer operation cannot be used and the 5251 Model 12 cannot automatically disconnect the line.

Switch 7—DTR/CDSTL

- On: DTR (data terminal ready)
- Off: CDSTL (connect data set to line)

Switch 7 controls the protocol used between the Model 12 and the modem to prepare for or answer a call.

The On position of switch 7 indicates DTR protocol; most modems permit the DTR (data terminal ready) signal line to be on if the DSR (data set ready) signal line is off.

The Off position of switch 7 indicates CDSTL protocol; the modem requires that CDSTL be turned on when:

- The 5251 Model 12 takes control of the line to make a call.
- The 5251 Model 12 responds to the RI (Ring Indicate) signal being on and answers a call.

Switch 8—NRZI/NRZ

- On: NRZI (nonreturn to zero inverted) option
- Off: NRZ (nonreturn to zero) option

Switch 8 selects the SDLC transmission coding option, which is used to keep the loss of synchronization between modems to a minimum. All stations communicating with each other on a network must use the same coding option.

The NRZI option must be used if the Internal Clock feature is installed on the 5251 Model 12.

Switch 8 selects the SDLC transmission coding option used to minimize the possibility of losing modem synchronization. Due to the variety of modems available and the differences in the data transmitted, the best setting for this switch cannot always be determined in advance. However, all stations connected to the same line must use the same option.

For operating with external modems on analog networks, the recommended initial setting of switch 8 is on (NRZI). If this setting proves to be unsatisfactory, all stations attached to the line (including the system) must have their option changed to NRZ. For operating on digital networks, the recommended setting is off (NRZ).

COMPLETING THE SETUP FORM FOR CONFIGURATION OF THE REMOTE WORK STATIONS

The following objectives outline what must be done to successfully configure any work stations attached to the 5251 Model 12 and to fill out Part 2 of the 5251 Model 12 Communications Network Setup Form¹.

When the 5251 Model 12 and the work stations that are to be attached to it are delivered, the persons responsible for setup must:

- Set the Cluster Feature port switches on the 5251 Model 12(s)
- Set the work station address and terminator switches on each of the work stations attached to the 5251 Model 12

The persons responsible for setup get the information they need from the setup procedure manual that is shipped with each work station and from the Communications Network Setup Form, which must be filled out with the configuration information for your particular configuration.

As the person responsible for configuration, you must:

- Identify each work station by filling in the required information on Part 2 of the Communications Network Setup Form.
- Draw the connections of all work stations to the 5251 Model 12 and to each other on your floor plan and verify that they are valid.
- Determine the Cluster Feature port switch settings for the 5251 Model 12, the work station address, and the unit address for each work station.
- Enter the work station address and unit address for each work station from the cluster configuration charts (later in this chapter) to Part 2 of the Communications Network Setup Form and provide copies to the host site and the setup personnel.

Guidelines for completing these tasks are on the following pages.

¹If your 5251 Model 12 does not have ports, or if you have no work stations to attach at this time, you can disregard the remainder of this chapter.

The following illustrates Part 2 of the 5251 Model 12 Communications Network Setup Form.

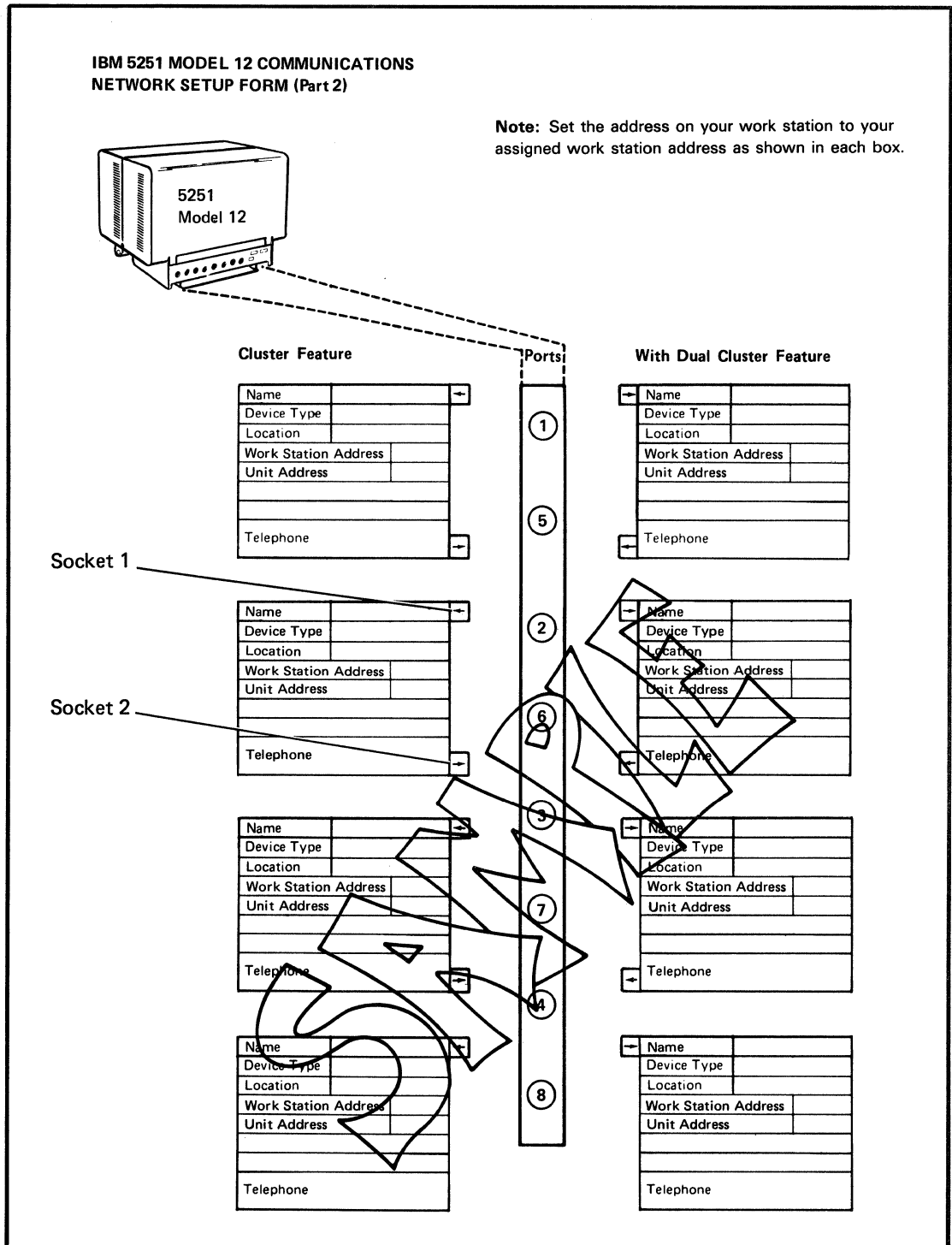

Note: The arrows entering and leaving each box represent socket 1 (in) and socket 2 (out) of an actual work station. Only work stations with Cable Thru will have a second socket; this socket will be used to attach the Cable Thru line.

Identifying the Work Stations

To identify the work stations, complete the following information for each work station on Part 2 of the 5251 Model 12 Communications Network Setup Form:

1. Fill in a name for each work station. This may be any unique name that identifies this particular work station. (Names of operators were used in this example.)

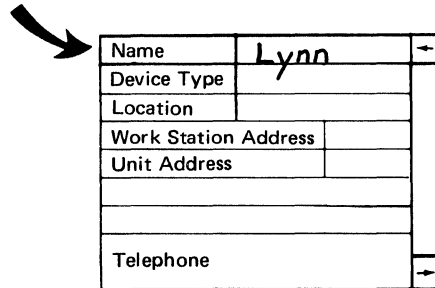

A form with a grid structure. The first row has a label 'Name' and a text box containing 'Lynn'. The second row has a label 'Device Type' and an empty text box. The third row has a label 'Location' and an empty text box. The fourth row has a label 'Work Station Address' and an empty text box. The fifth row has a label 'Unit Address' and an empty text box. The sixth row is empty. The seventh row has a label 'Telephone' and an empty text box. A curved arrow points to the 'Name' field.

Name	Lynn
Device Type	
Location	
Work Station Address	
Unit Address	
Telephone	

2. Write in the device type. This is the machine number of the work station (5251 Model 11, 5291, 5292, 5219, 5224, 5225, or 5256) or a designation of what kind of device this is (D for display; P for printer).

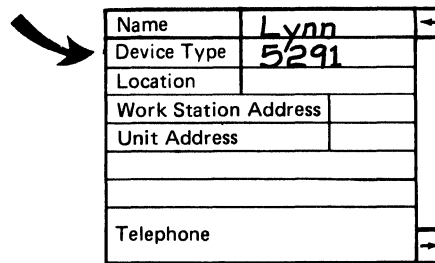

A form with a grid structure. The first row has a label 'Name' and a text box containing 'Lynn'. The second row has a label 'Device Type' and a text box containing '5291'. The third row has a label 'Location' and an empty text box. The fourth row has a label 'Work Station Address' and an empty text box. The fifth row has a label 'Unit Address' and an empty text box. The sixth row is empty. The seventh row has a label 'Telephone' and an empty text box. A curved arrow points to the 'Device Type' field.

Name	Lynn
Device Type	5291
Location	
Work Station Address	
Unit Address	
Telephone	

3. Fill in the location of the work station.

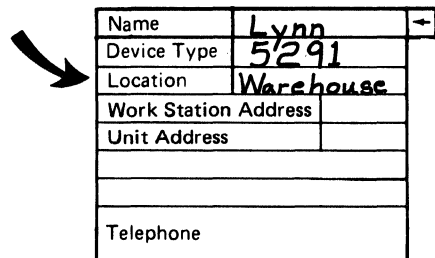

A form with a grid structure. The first row has a label 'Name' and a text box containing 'Lynn'. The second row has a label 'Device Type' and a text box containing '5291'. The third row has a label 'Location' and a text box containing 'Warehouse'. The fourth row has a label 'Work Station Address' and an empty text box. The fifth row has a label 'Unit Address' and an empty text box. The sixth row is empty. The seventh row has a label 'Telephone' and an empty text box. A curved arrow points to the 'Location' field.

Name	Lynn
Device Type	5291
Location	Warehouse
Work Station Address	
Unit Address	
Telephone	

Drawing Your Configuration

Draw your configuration of the work stations by doing the following:

1. Look at your floor plan (drawing) for the work station(s).
2. Review the following considerations:
 - a. The maximum number of work stations that can be attached to each port is four (using Cable Thru).
 - b. The maximum number of work stations that can be attached to the Cluster feature (4 ports per Cluster feature) is four.
 - c. The maximum number of work stations that can be attached to the Dual Cluster feature (8 ports) is eight.
 - d. The Cluster feature configuration that you select must match one of the configurations shown in the cluster configuration charts in this chapter.
3. Determine the number of ports you will use for CF1 and/or CF2. In the following example, three ports are used for CF1 and one port is used for CF2.

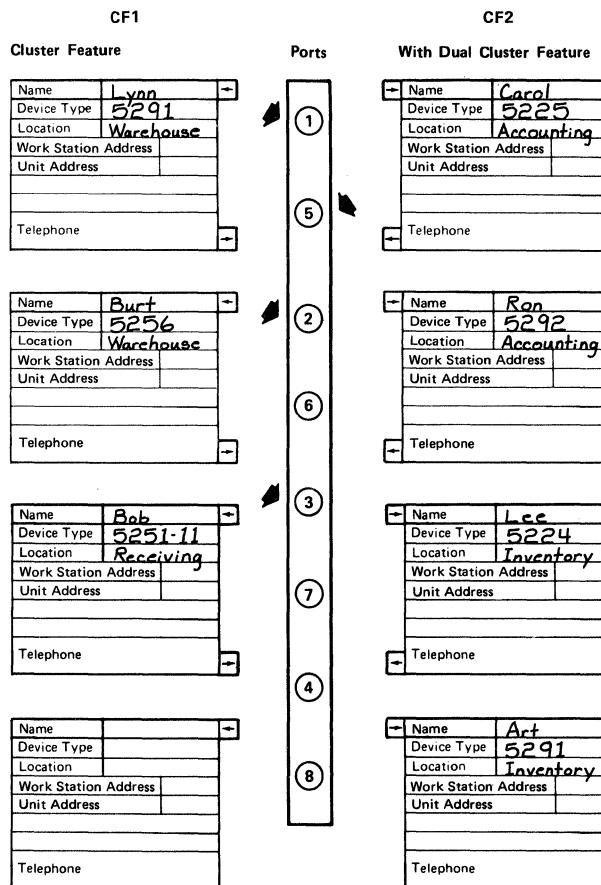

4. Draw a line between the port(s) and work station(s) that make up your configuration.

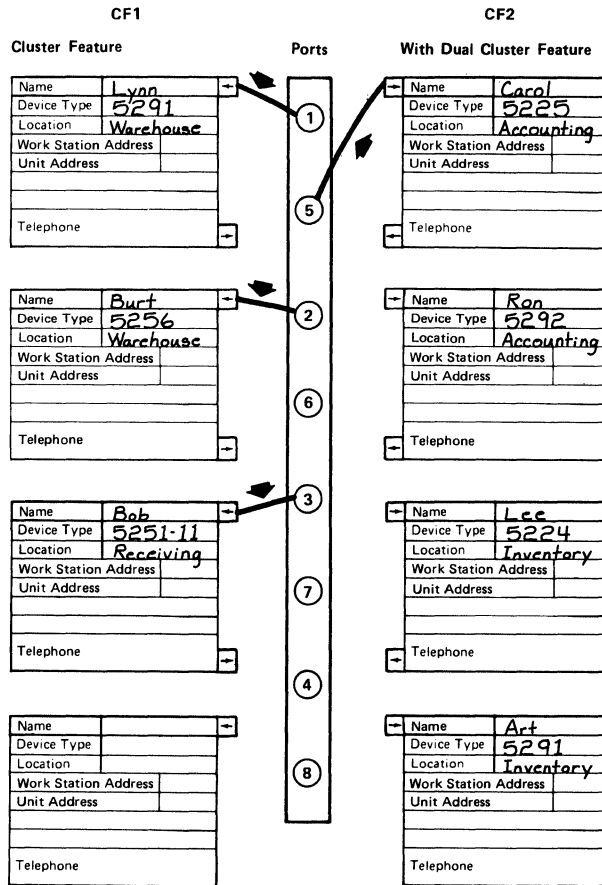

5. If you have Cable Thru on any of your work stations, review the following considerations; if not, proceed to *Cluster Feature Port Switches and Address Settings*.
- If four work stations are on a Cable Thru line, no more attachments can be made on that cluster.
 - All but the last work station on a line must have Cable Thru. If the last work station does have Cable Thru, its work station address must be 0.
 - The last work station on a Cable Thru line can be no more than 1525 meters (5000 feet) in cable distance away from the 5251 Model 12.

6. If you have Cable Thru on any of your work stations, draw a line between each work station to be connected to the same port, as shown.

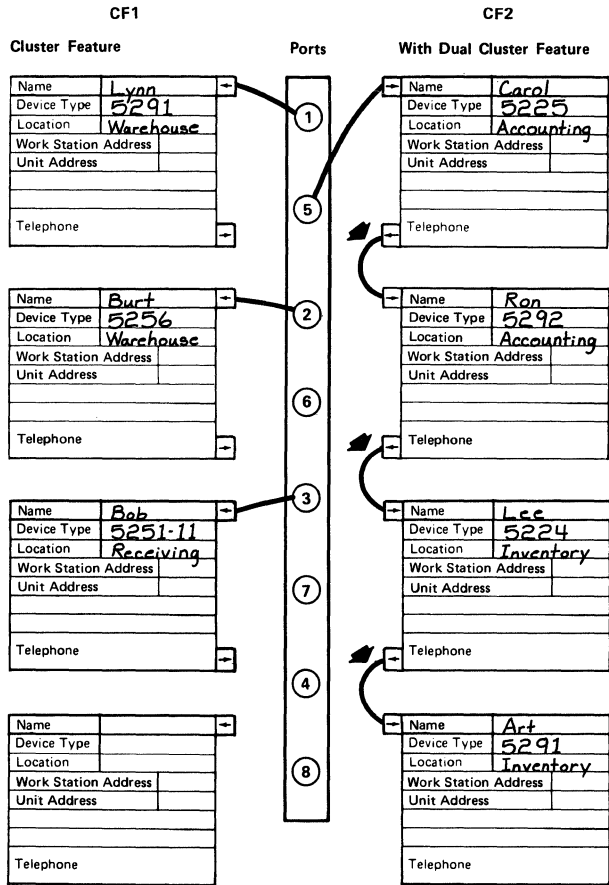

Cluster Feature Port Switches and Address Settings

To determine the Cluster Feature port switch setting for the 5251 Model 12 and also the work station address and the unit address for each work station, do the following:

1. Familiarize yourself with the following symbols and representations from the cluster configuration charts at the end of this chapter.

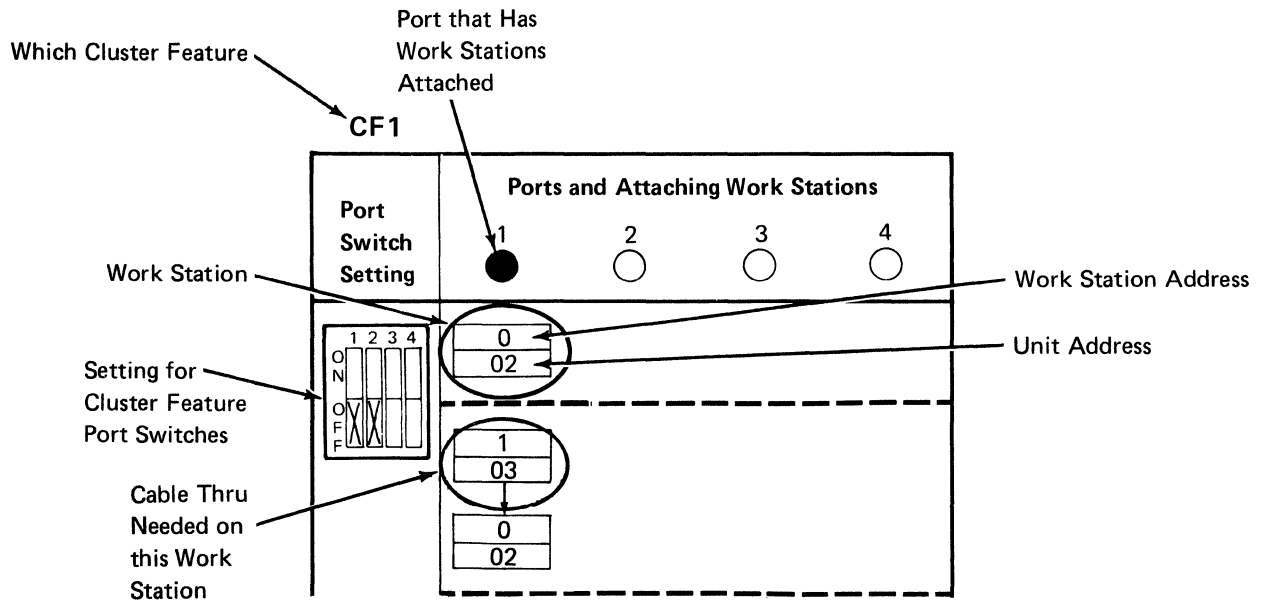

2. Refer to the cluster configuration charts following step 4 in this chapter. Find the chart for the number of ports you will use. (Be sure that you refer to the correct chart for your cluster feature; that is, the chart for CF1 (ports 1 through 4) or the chart for CF2 (ports 5 through 8). If your configuration uses ports on both CF1 and CF2, you must refer to both sets of charts. Be sure that your configuration is represented on the cluster configuration chart for the number of ports you will use; if it is not, it is invalid and should be changed to match one of the configurations shown.)

- Transfer the Cluster Feature port switch settings for CF1 and CF2 to Part 1 of the Communications Network Setup Form. (Switches 1 and 2 are set to indicate the last port used on CF1 ports 1 through 4; switches 3 and 4 are set to indicate the last port used on CF2 ports 5 through 8.)

For Switches 1 and 2:

For Switches 3 and 4:

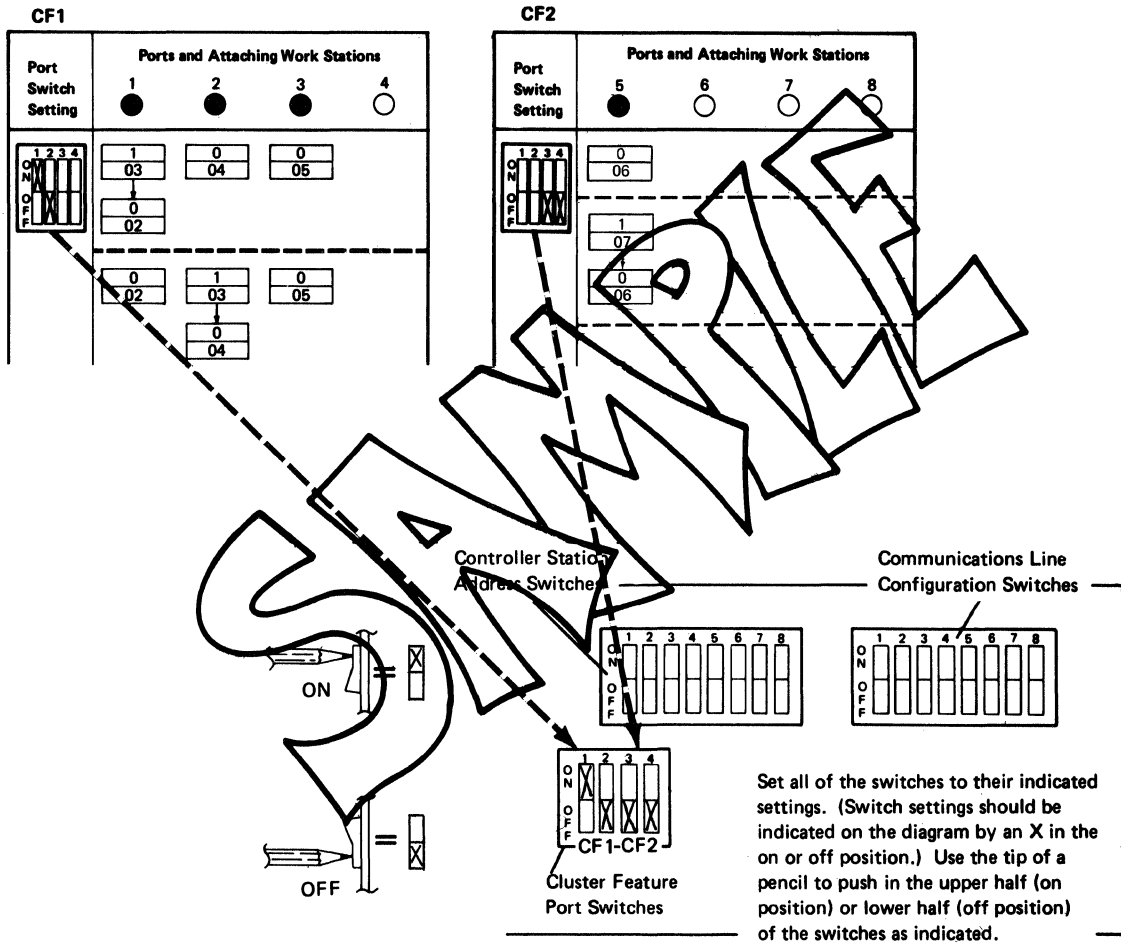

Notes:

- The Cluster Feature port switches determine through which port the 5251 Model 12 searches for work stations. If these switches are set differently from what is indicated on the cluster configuration charts, one or more of the attached work stations may not be found and will not be able to communicate with the system.
- If a work station is being added to an existing configuration or if an existing configuration is being changed, the setting for the Cluster Feature port switches may have to be changed. If the setting is changed, the Power switch on the 5251 Model 12 must be set to Off and then set to On again before the 5251 Model 12 will recognize the new setting.

- Transfer the work station address(es) and unit address(es) from the appropriate cluster configuration chart to Part 2 of your Communications Network Setup Form. Provide copies of the completed form to the host site and the setup personnel.

Notes:

- All possible valid configurations are shown on the cluster configuration charts that follow. You must use the unit address (lower half of box) that is paired with each work station address (upper half of box) to ensure that the system identifies and can communicate with each of the work stations.
- If the last work station or the only work station on a line has Cable Thru, its work station address must be 0.

This completes the planning requirements for the 5251 Model 12.

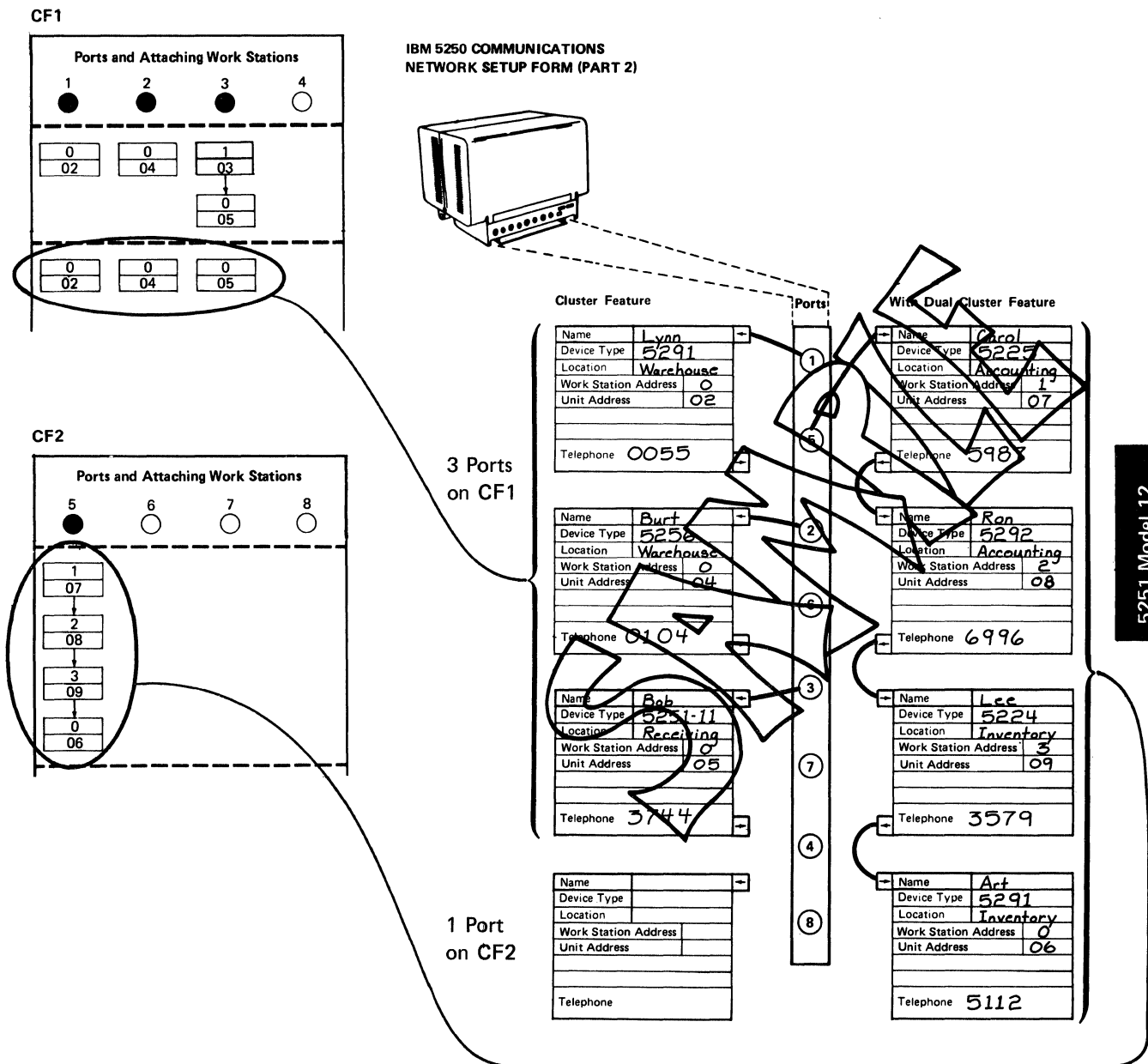

5251 Model 12
Communications
and Configuration

Cluster Configuration Chart (1 Port)

CF1		CF1								
Port Switch Setting	Ports and Attaching Work Stations				Port Switch Setting	Ports and Attaching Work Stations				
	1	2	3	4		1	2	3	4	
	<div style="display: flex; justify-content: space-around;"> <div style="text-align: center;">1 ●</div> <div style="text-align: center;">2 ○</div> <div style="text-align: center;">3 ○</div> <div style="text-align: center;">4 ○</div> </div>	<div style="display: flex; justify-content: space-between;"> <div style="border: 1px solid black; padding: 2px;">0</div> <div>Work Station Address</div> </div> <div style="display: flex; justify-content: space-between;"> <div style="border: 1px solid black; padding: 2px;">02</div> <div>Unit Address</div> </div>								
			<div style="border: 1px solid black; padding: 2px; text-align: center;">1 03</div> <div style="text-align: center;">↓</div> <div style="border: 1px solid black; padding: 2px; text-align: center;">0 02</div>							
			<div style="border: 1px solid black; padding: 2px; text-align: center;">1 03</div> <div style="text-align: center;">↓</div> <div style="border: 1px solid black; padding: 2px; text-align: center;">2 04</div> <div style="text-align: center;">↓</div> <div style="border: 1px solid black; padding: 2px; text-align: center;">0 02</div>							
			<div style="border: 1px solid black; padding: 2px; text-align: center;">1 03</div> <div style="text-align: center;">↓</div> <div style="border: 1px solid black; padding: 2px; text-align: center;">2 04</div> <div style="text-align: center;">↓</div> <div style="border: 1px solid black; padding: 2px; text-align: center;">3 05</div> <div style="text-align: center;">↓</div> <div style="border: 1px solid black; padding: 2px; text-align: center;">0 02</div>							

Cluster Configuration Chart (1 Port)

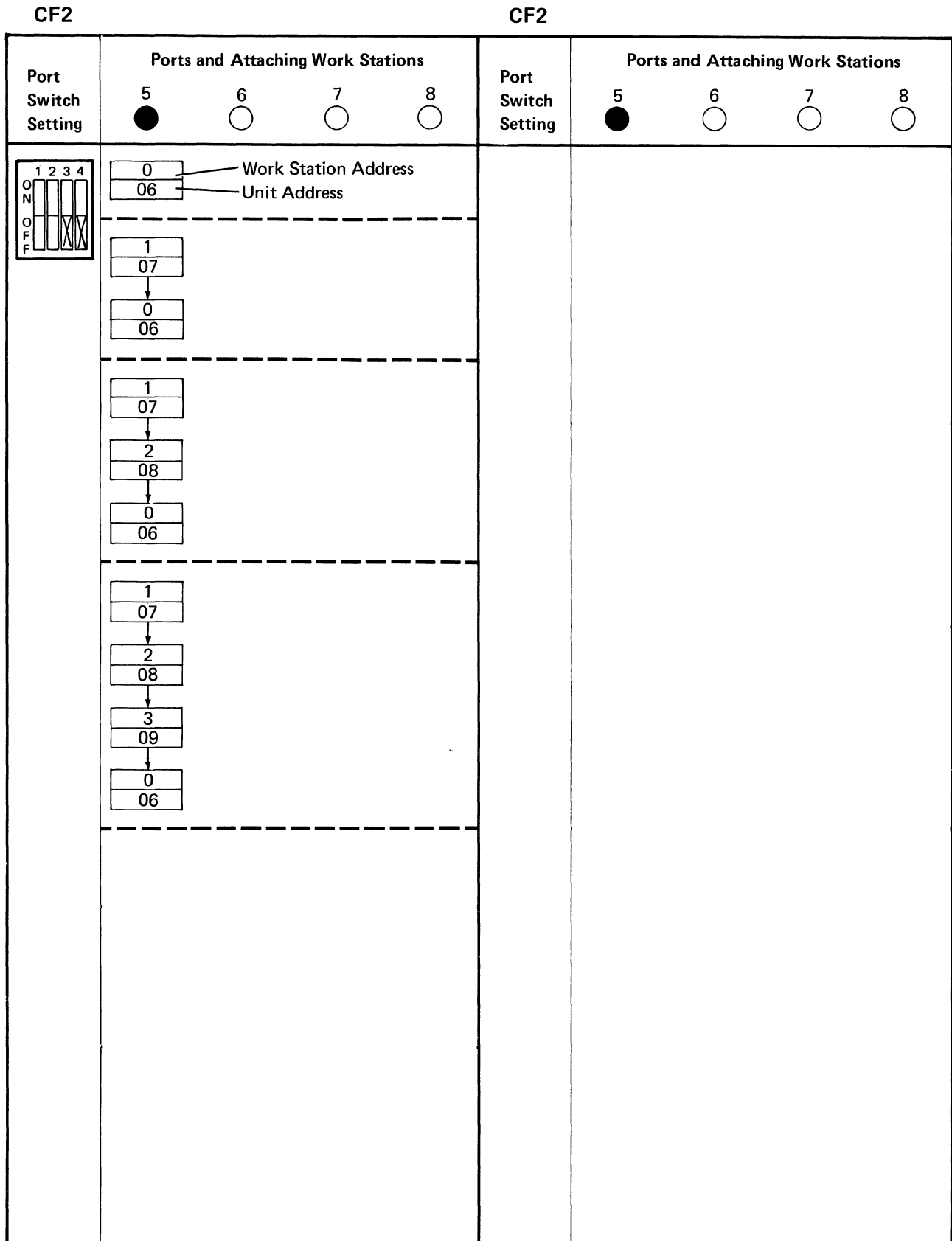

5251 Model 12
Communications
and Configuration

Cluster Configuration Chart (2 Ports)

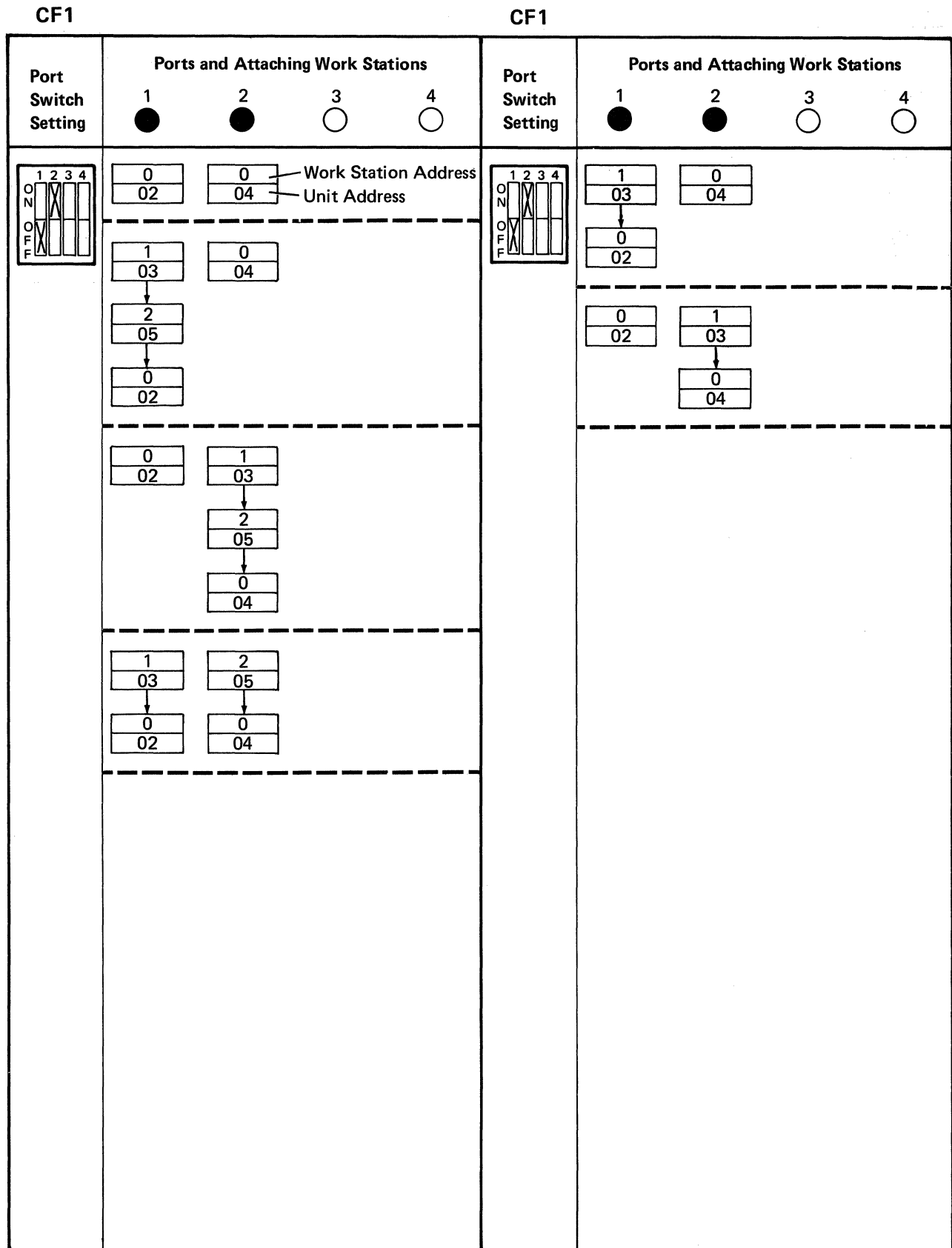

Cluster Configuration Chart (2 Ports)

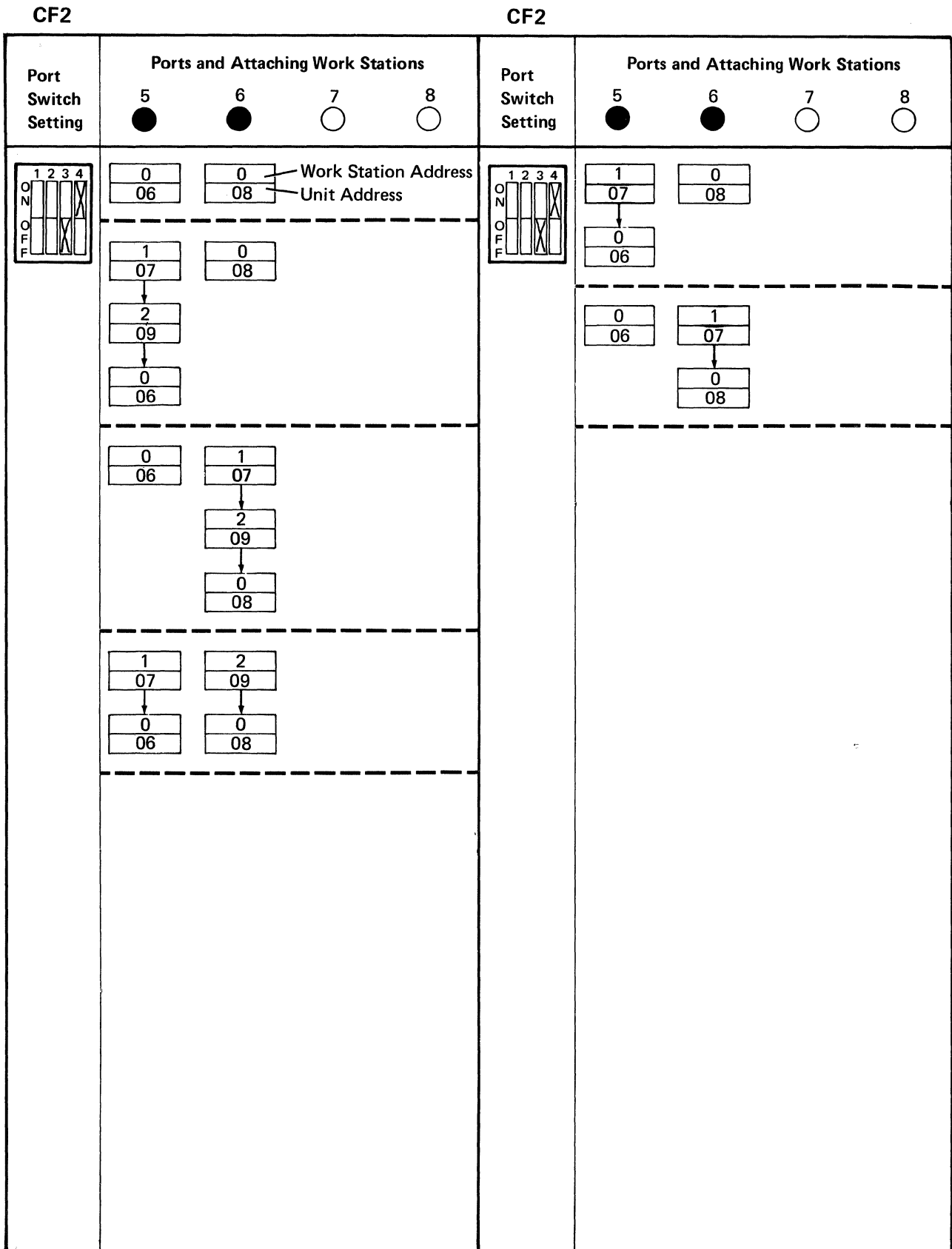

5251 Model 12
Communications
and Configuration

Cluster Configuration Chart (3 Ports)

CF1

CF2

Port Switch Setting	Ports and Attaching Work Stations				Port Switch Setting	Ports and Attaching Work Stations																
	1	2	3	4		5	6	7	8													
	<table border="1"> <tr><td>1</td></tr><tr><td>03</td></tr></table>	1	03	<table border="1"> <tr><td>0</td></tr><tr><td>04</td></tr></table>	0	04	<table border="1"> <tr><td>0</td></tr><tr><td>05</td></tr></table>	0	05			<table border="1"> <tr><td>1</td></tr><tr><td>07</td></tr></table>	1	07	<table border="1"> <tr><td>0</td></tr><tr><td>08</td></tr></table>	0	08	<table border="1"> <tr><td>0</td></tr><tr><td>09</td></tr></table>	0	09		
	1																					
	03																					
	0																					
04																						
0																						
05																						
1																						
07																						
0																						
08																						
0																						
09																						
<table border="1"> <tr><td>0</td></tr><tr><td>02</td></tr></table>	0	02	<p>Work Station Address</p> <p>Unit Address</p>			<table border="1"> <tr><td>0</td></tr><tr><td>06</td></tr></table>	0	06														
0																						
02																						
0																						
06																						
<table border="1"> <tr><td>0</td></tr><tr><td>02</td></tr></table>	0	02	<table border="1"> <tr><td>1</td></tr><tr><td>03</td></tr></table>	1	03	<table border="1"> <tr><td>0</td></tr><tr><td>05</td></tr></table>	0	05		<table border="1"> <tr><td>0</td></tr><tr><td>06</td></tr></table>	0	06	<table border="1"> <tr><td>1</td></tr><tr><td>07</td></tr></table>	1	07	<table border="1"> <tr><td>0</td></tr><tr><td>08</td></tr></table>	0	08	<table border="1"> <tr><td>0</td></tr><tr><td>09</td></tr></table>	0	09	
0																						
02																						
1																						
03																						
0																						
05																						
0																						
06																						
1																						
07																						
0																						
08																						
0																						
09																						
<table border="1"> <tr><td>0</td></tr><tr><td>02</td></tr></table>	0	02	<table border="1"> <tr><td>0</td></tr><tr><td>04</td></tr></table>	0	04	<table border="1"> <tr><td>1</td></tr><tr><td>03</td></tr></table>	1	03		<table border="1"> <tr><td>0</td></tr><tr><td>06</td></tr></table>	0	06	<table border="1"> <tr><td>0</td></tr><tr><td>08</td></tr></table>	0	08	<table border="1"> <tr><td>1</td></tr><tr><td>07</td></tr></table>	1	07	<table border="1"> <tr><td>0</td></tr><tr><td>09</td></tr></table>	0	09	
0																						
02																						
0																						
04																						
1																						
03																						
0																						
06																						
0																						
08																						
1																						
07																						
0																						
09																						
<table border="1"> <tr><td>0</td></tr><tr><td>02</td></tr></table>	0	02	<table border="1"> <tr><td>0</td></tr><tr><td>04</td></tr></table>	0	04	<table border="1"> <tr><td>0</td></tr><tr><td>05</td></tr></table>	0	05		<table border="1"> <tr><td>0</td></tr><tr><td>06</td></tr></table>	0	06	<table border="1"> <tr><td>0</td></tr><tr><td>08</td></tr></table>	0	08	<table border="1"> <tr><td>0</td></tr><tr><td>09</td></tr></table>	0	09				
0																						
02																						
0																						
04																						
0																						
05																						
0																						
06																						
0																						
08																						
0																						
09																						

Cluster Configuration Chart (4 Ports)

CF1					CF2																				
Port Switch Setting	Ports and Attaching Work Stations				Port Switch Setting	Ports and Attaching Work Stations																			
	1	2	3	4		5	6	7	8																
	<table border="1"> <tr><td>0</td></tr> <tr><td>02</td></tr> </table>	0	02	<table border="1"> <tr><td>0</td></tr> <tr><td>03</td></tr> </table>	0	03	<table border="1"> <tr><td>0</td></tr> <tr><td>04</td></tr> </table>	0	04	<table border="1"> <tr><td>0</td></tr> <tr><td>05</td></tr> </table>	0	05		<table border="1"> <tr><td>0</td></tr> <tr><td>06</td></tr> </table>	0	06	<table border="1"> <tr><td>0</td></tr> <tr><td>07</td></tr> </table>	0	07	<table border="1"> <tr><td>0</td></tr> <tr><td>08</td></tr> </table>	0	08	<table border="1"> <tr><td>0</td></tr> <tr><td>09</td></tr> </table>	0	09
0																									
02																									
0																									
03																									
0																									
04																									
0																									
05																									
0																									
06																									
0																									
07																									
0																									
08																									
0																									
09																									
	<p>Work Station Address Unit Address</p>																								

5251 Model 12
Communications
and Configuration

Chapter 8. Planning for Cables

This chapter explains how to order and install cables for your work stations. (Appendix A provides assembly instructions for cables.)

ORDERING CONSIDERATIONS

It is your responsibility to purchase, install, label, and test work station cables. Because of the effort and expertise required to assemble cables, we recommend that you purchase assembled cables.

Notes:

1. It is not necessary to order a cable for the work station controller to the modem.
2. It is not necessary to order a cable for the modem to the phone jack (connection) on the wall.

Twinaxial cable is required for attaching work stations to each other, a remote work station controller, or a host system. When twinaxial cable is used with Cable Thru:

- On a host system, up to seven work stations can be attached to a Cable Thru line.
- On a 5294 Control Unit with two ports, up to four work stations can be attached to a Cable Thru line. On a 5294 with four ports, up to seven work stations can be attached to a Cable Thru line. (If the 5294 will be attached to an X.25 packet switched network and will have four ports, up to six work stations can be attached to a Cable Thru line.)
- On a 5251 Model 12 with either four or eight ports, up to four work stations can be attached to a Cable Thru line.

Note: The last work station on a Cable Thru line can be no more than 1525 meters (5000 feet) in cable distance away from the host system or the remote work station controller.

If you plan to connect two or more lengths of cable, you must order cable-to-cable adapters for the type of cable you are using (see Appendix A).

The total number of cable junctions on a line must not exceed 11. A cable junction occurs whenever the cable is cut to attach a work station, station protector, or to join two cables with an adapter. Each pair of connections to a device is considered one junction.

Getting Started

Site Considerations

System Specifications

5294 Configuration and Communications

5251 Model 12 Communications and Configuration

Cables

Appendixes

The following table provides order information for twinaxial cable.

Note: Some host systems may include the cable to attach certain display system units (for example, system console). See the appropriate system *Installation Manual—Physical Planning*.

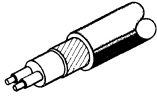
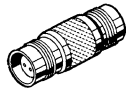
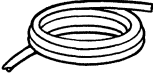
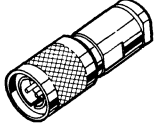
Part Name	Twinaxial Cable Indoor or Outdoor
Cable Assembly ¹ (cable in specified length with connectors at both ends)	IBM part 7362267 (with vinyl covering) IBM part 7362062 (with Teflon ² covering) 
Adapter (cable-to-cable)	IBM part 7362230 Amphenol 82-5588 
Bulk Cable (cable in specified length, without connectors)	IBM part 7362211 (with vinyl covering) IBM part 7362061 (with Teflon covering) IBM part 483619 ³ (tubing used with Teflon covered cables) See Appendix A for instructions on how to assemble cables. 
Connector (single male connector)	IBM part 7362229 Amphenol 82-5589 AMP 22724-1
Connector Kit (two male connectors)	IBM part 7362268 (for vinyl-covered cable) IBM part 7362063 (for Teflon-covered cable) 
<p>¹Specify the total length of each cable when ordering. (This includes the distance from the work station to what it is attached to [host system, remote work station controller, or another work station] plus a sufficient length of cable to reach the cable connection on the units on both ends of the cable, which is approximately 1.8 meters [6 feet]). See <i>Station Protectors</i> in this chapter for sample station protector installation information.</p> <p>²Trademark of E.I. du Pont de Nemours & Co., Inc.</p> <p>³Two pieces of this tubing is included with a connector kit for Teflon-covered cables (IBM part 7362063).</p>	

Work station signal cables should not be installed near electrical equipment or power lines that carry more than 440 volts¹. In areas where a voltage source of less than 440 volts is present, consider the following:

- The minimum distance allowed between signal cable and fluorescent, neon, or incandescent lighting fixtures is 127 millimeters (5 inches).
- The minimum distance allowed between signal cable and unshielded power lines or electrical equipment depends upon the power consumption of the equipment:
 - 2 kVA or below: 127 millimeters (5 inches)
 - 2-5 kVA: 305 millimeters (12 inches)
 - Over 5 kVA: 610 millimeters (24 inches)
- The minimum distance allowed between signal cable and unshielded power lines or electrical equipment with the signal cable enclosed in grounded metallic conduit:
 - 2 kVA or below: 63.5 millimeters (2.5 inches)
 - 2-5 kVA: 152 millimeters (6 inches)
 - Over 5 kVA: 305 millimeters (12 inches)
- The minimum distance allowed between signal cable and power lines in grounded metallic conduit:
 - 2 kVA or below: 63.5 millimeters (2.5 inches)
 - 2-5 kVA: 152 millimeters (6 inches)
 - Over 5 kVA: 305 millimeters (12 inches)
- The minimum distance allowed between signal cable enclosed in grounded metallic conduit and power lines enclosed in grounded metallic conduit:
 - 2 kVA or below: 30.5 millimeters (1.2 inches)
 - 2-5 kVA: 76 millimeters (3 inches)
 - Over 5 kVA: 152 millimeters (6 inches)

¹If you need assistance in determining how best to route your cables, call your IBM sales representative.

OUTDOOR CABLE INSTALLATION

You can use twinaxial cable indoors or outdoors, although twinaxial cable is not recommended for direct burial without conduit. You will need some type of carrier to provide support every 3 meters (10 feet) for overhead installation.

Outdoor connections are permitted only if the connections are potted in a weatherproof compound. Twinaxial cable should not be installed under water. Also, for protection from lightning, you must attach a station protector (see *Station Protectors* in this chapter) at each end of the cable that is run outdoors (for buried and overhead cables).

Cable can be run in the same conduit as telephone lines.

To determine your chances of lightning damage, see Figure 8-1.

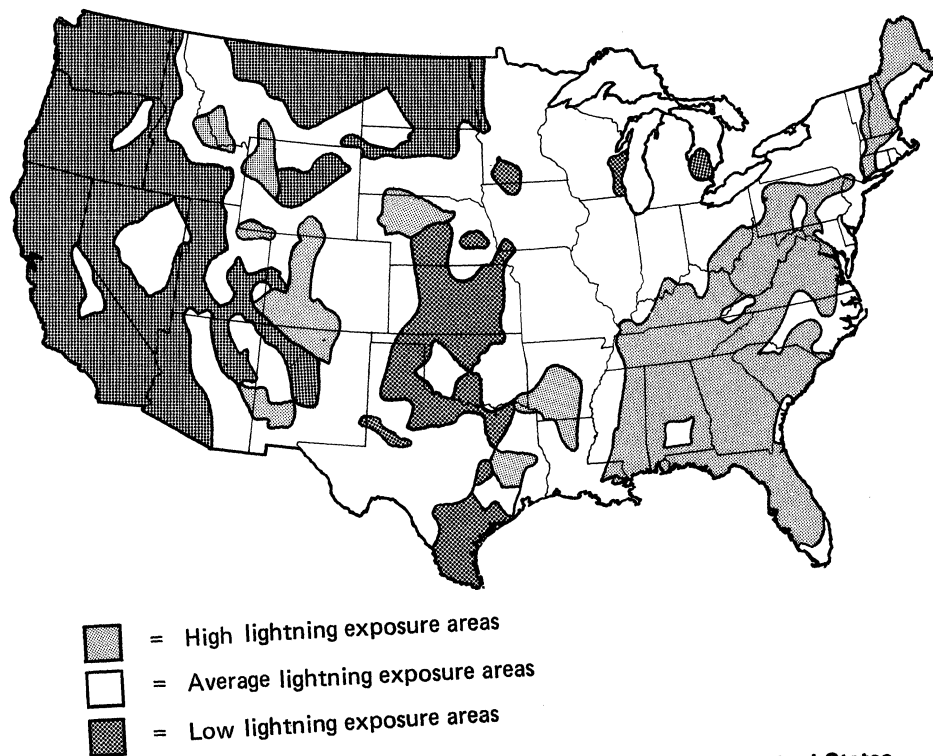
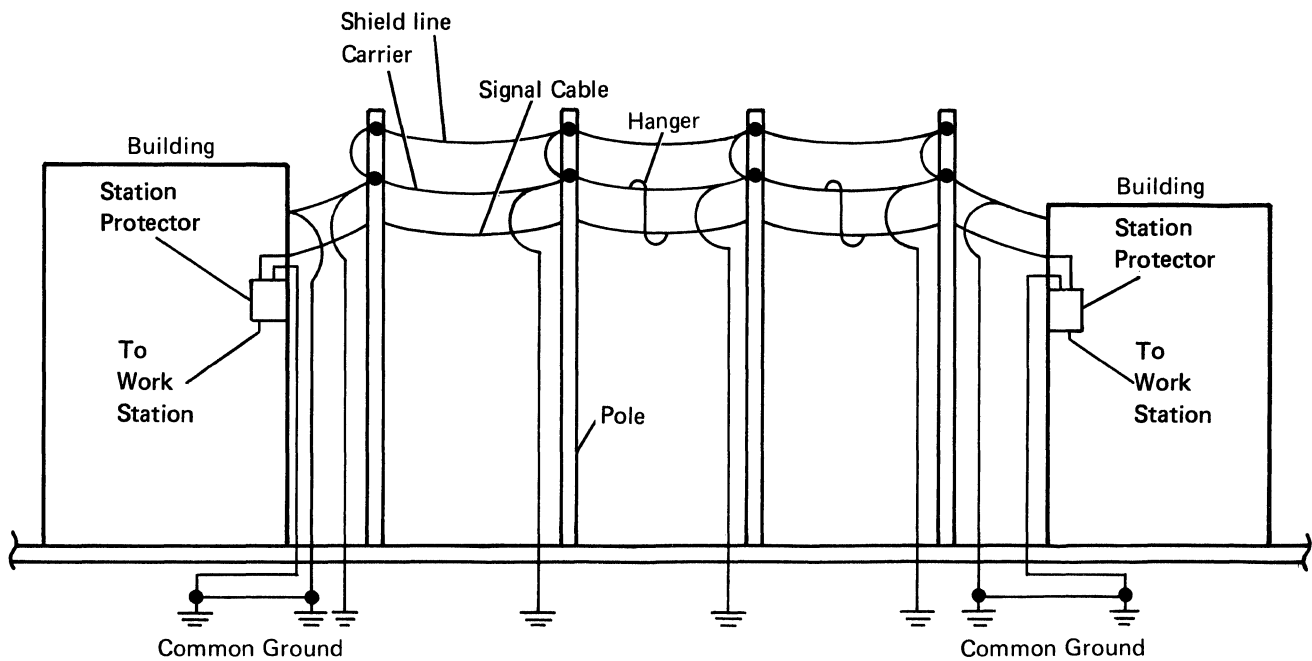

Figure 8-1. Lightning Damage Probability Map for the Continental United States

The following is a list of suggested outdoor installation methods for twinaxial cables. Your site's exposure to lightning should determine which method you use:

- In high lightning exposure areas, bury cables in grounded metal conduit.
- In average lightning exposure areas, do one of the following:
 - Bury cables in metal conduit or bury cables in nonmetallic conduit with two AWG 6 bare copper shield wires installed two feet above the conduit.
 - Put overhead cables under a shield line. The shield line is a metal cable run on the same poles. (Power lines can also have a shielding effect on cables.) The signal cables must hang at least 1 meter (3 feet) below the shield line. See Figure 8-2.



Note: When the cable is run jointly with the power line, the carrier wire should be bonded to the multiground neutral (MGN). The MGN can be used instead of an earth-driven grounding rod. Bond all ground points to the power company multiground neutral.

Figure 8-2. Outdoor Cable Installation for Overhead Cable under a Shield Line

- In low lightning exposure areas, do one of the following:
 - Bury cables in nonmetallic conduit.
 - Put overhead cables on a carrier with the carrier grounded at each end.
 See Figure 8-3.

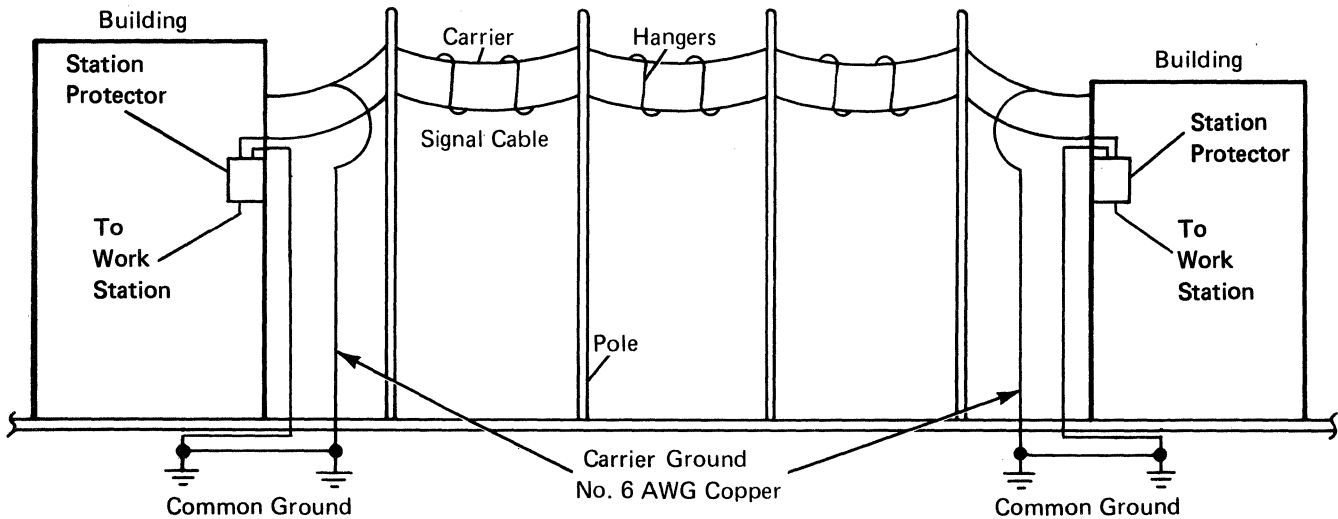

Note: For overhead cables, avoid having the twinaxial cables as the highest point in the area.

Figure 8-3. Outdoor Cable Installation for Overhead Cable on a Grounded Carrier

STATION PROTECTORS

Station protectors are required for each outdoor or underground circuit run. A station protector provides for grounding of the cable shield for personnel safety, and contains solid state components for unit protection. Station protectors *must be installed indoors* where the cable enters or exits the building and as close as possible to a suitable ground. Station protectors must not be installed near combustible materials or in hazardous locations, as defined in Article 500 of the National Electric Code (NEC). Also, the station protector must be grounded at the building entrance or exit point (reference Article 800-31 in NEC).

Station protectors are used in pairs. One station protector is located at each cable exit in the originating building and another station protector is located at each cable entrance to adjoining buildings. Only one station protector kit (two station protectors) can be installed per port; therefore, only one outdoor (or underground) cable run is allowed for each port used. An example of station protector installation is shown in Figure 8-4.

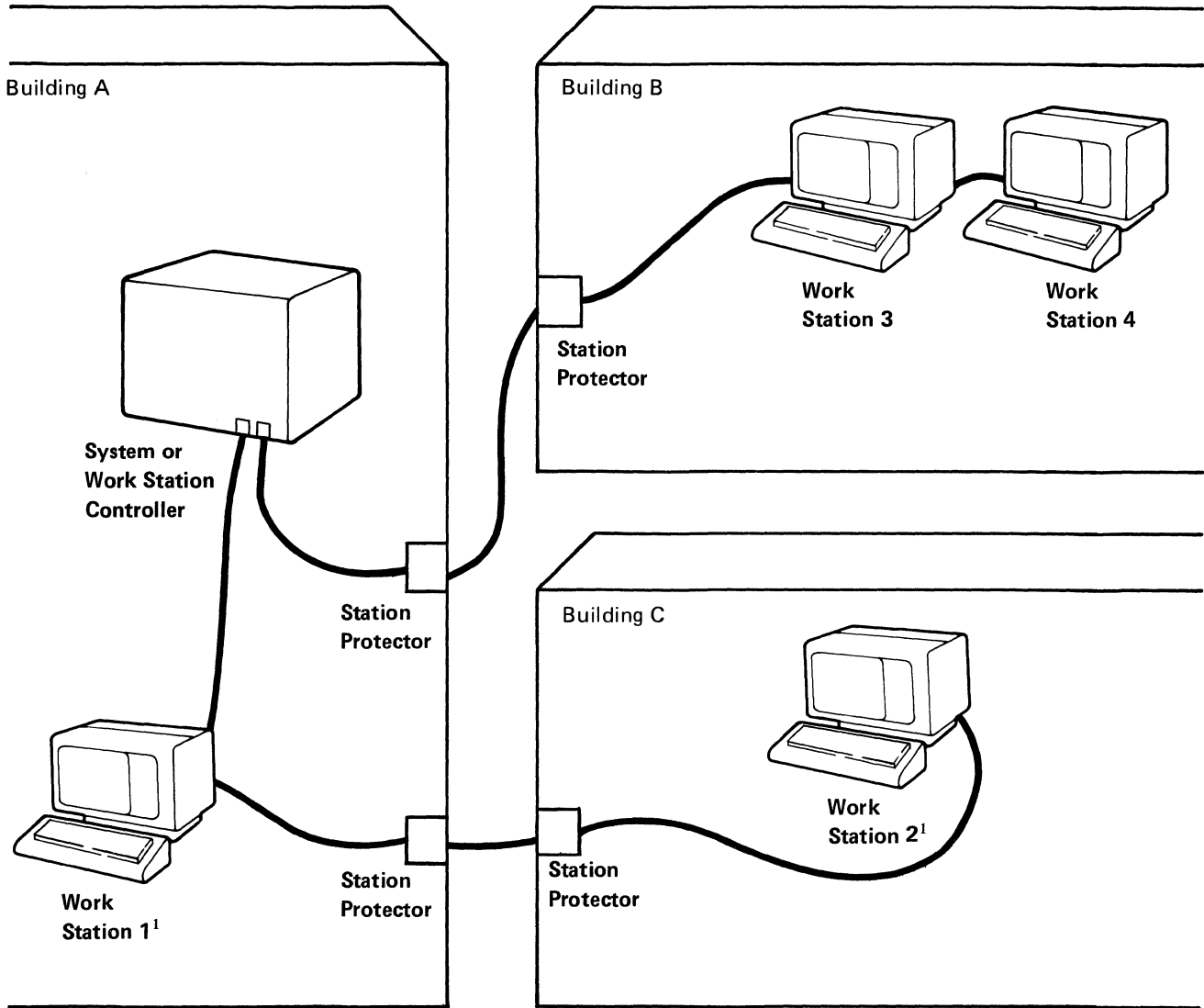

¹Cabling between work stations 1 and 2, for example, consists of three cables as follows: between the two station protectors and between each work station and its adjacent station protector. Each cable must have a connector at each end.

Figure 8-4. Sample Station Protector Installation

You are responsible for supplying, installing, and maintaining station protectors. You can order the Twinaxial Station Protector Kit, IBM part 7361807. (A kit consists of two station protectors and is sufficient to install one outdoor cable with a station protector at each end.) You can order single station protectors for twinaxial cable IBM part 7362426. See order information in this section.

If you want to connect the station protectors to your lines before the work stations arrive, you should order the station protectors separately from your IBM sales representative, specifying an earlier ship date.

To facilitate system recovery in the event of electrical damage, order extra station protectors when your initial order is placed.

You should install the station protectors so that the components in them can be easily inspected, but not in areas where unauthorized persons might come in contact with them. During lightning storms, you should not handle the station protectors or any of the system or work station cables.

Note: Cables are attached to the station protectors with the same connectors that attach to the system. Therefore, cable lengths and number of connectors ordered must allow for two additional connectors for each station protector in your configuration.

Grounding Recommendations

It is important to provide good grounding (grounding conductor and grounding electrode) for the station protector. The following is a list of the minimum recommended requirements for station protector grounding. The grounding conductor:

- Should be AWG 6 wire or larger
- Should be less than 3 meters (10 feet) long
- Should run in a straight line to a grounding electrode that has a ground resistance of less than 10 ohms

You should also provide common grounding between the station protector, the utility ground, and all extensive metal components in the vicinity of the system. (This prevents side flashes caused by lightning.) The conductor used for interconnecting grounds should be at least AWG 6 wire.

Installation Requirements

The station protectors should be installed in line with the cable as it enters or exits a building and should be permanently mounted in the building. (See Figure 8-5.)

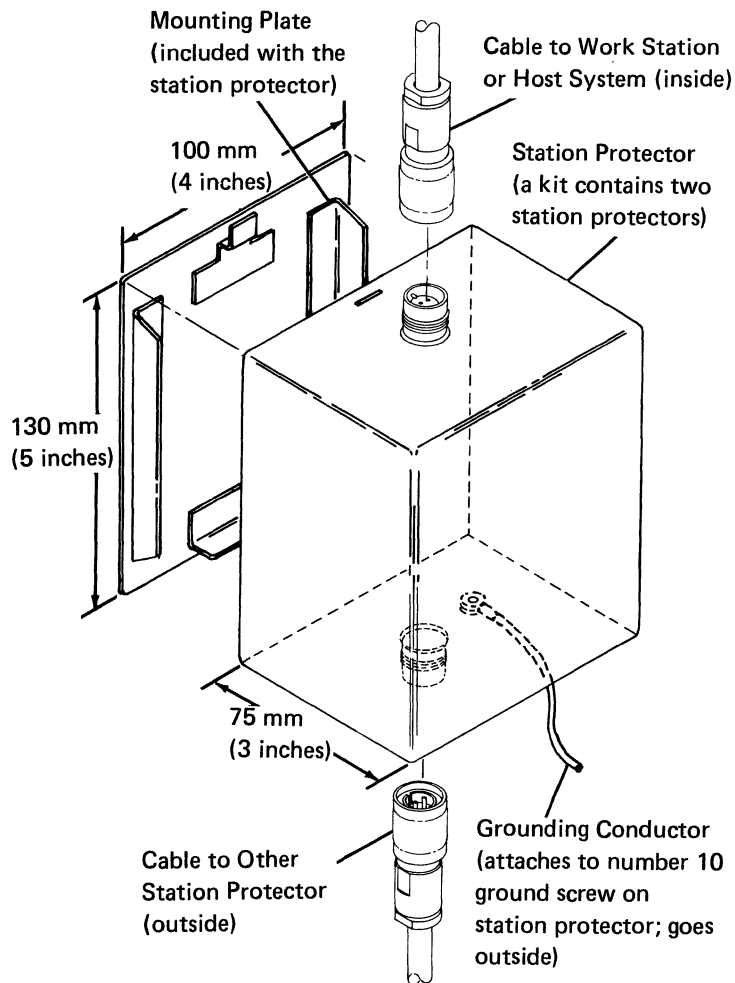

Note: It is important that the grounding conductor is on the same side of the station protector as the cable leading to the outside of the building.

Figure 8-5. Station Protector with Entering/Exiting Cables

Station Protector Check

CAUTION

Never handle cables, connectors, or station protectors during an electrical storm.

The station protector is owned and maintained by the customer. The following procedures can be used to check an IBM supplied station protector.

The cables to the station protector must be disconnected before the checks can be made. This will disconnect the work stations from the system.

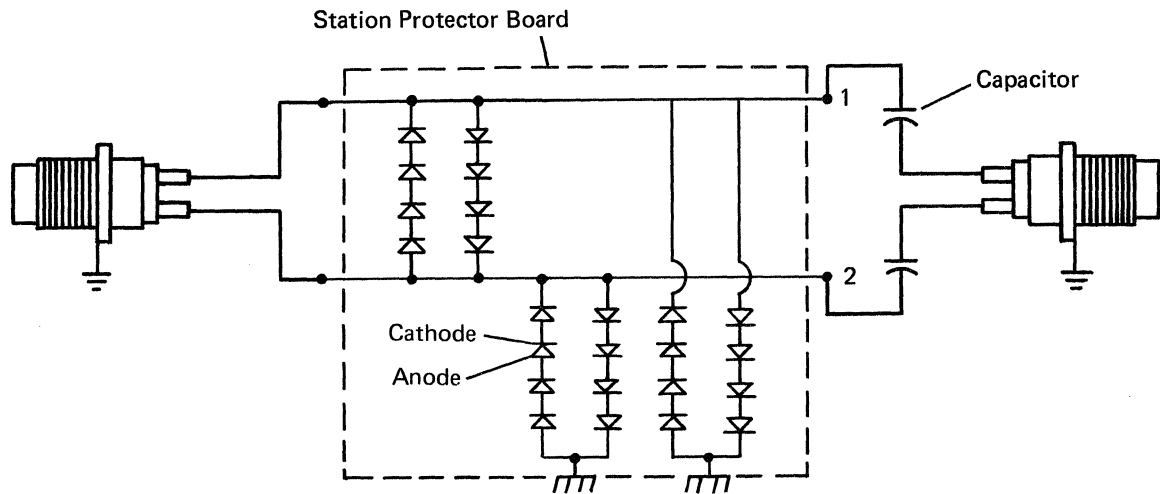

Use a VOM (volt ohm meter) with 50,000 to 100,000 ohms per volt. Set on the *ohms x 100* or *ohms x 200* scale.

To check the diodes, do the following:

1. Check each diode with the - (negative) lead connected to the anode and the + (positive) lead connected to the cathode. The resistance should exceed 10,000 ohms.
2. Check each diode with the - (negative) lead connected to the cathode and the + (positive) lead connected to the anode. The resistance should be less than 2000 ohms.
3. Check for burned or damaged components.

To check the capacitors, do the following:

1. Before each reading, short the capacitors using a screw driver or metal bar across the leads of the capacitors.
2. Set the VOM to RX 100K.
3. Touch the meter leads across the leads of a capacitor. There should be a noticeable instantaneous meter deflection (toward the 0 end of the scale) as the capacitor is charging up. Then, the needle on the VOM will drop back to the high end of the scale.

If the deflection is present, the capacitor is good. No deflection indicates a defective capacitor. No deflection could also be a result of using a VOM set at too low of a range.

COMMUNICATIONS CABLES

IBM provides a communications cable with each communications feature. This cable is for connecting the controller to the common carrier facility. For each communications feature, Figure 8-6 states the length of the cable. It also indicates what figure shows the termination (pin connector, plug, or spade termination) and adapter for that cable.

Communications Feature	Cable Lengths	Available On		Country	Termination	Adapter
		5251 Model 12	5294 Control Unit			
EIA/CCITT (SF3701)	6 meter (20 feet) Standard 12 meter (40 feet) (SF9461)	Yes Yes	Yes No	All	See Figure 8-7	See Notes 1 and 2
DDS Adapter (SF5650, SF5651)	6 meter (20 feet) Standard 12 meter (40 feet) (SF9461)	Yes Yes	Yes No	All	See Figure 8-8	None
X.21 Native	6 meter (20 feet) standard	No	Yes	All	See Figure 8-8	None
1200 bps Integrated Modem, switched (SF5502)	6 meter (20 feet) Standard 12 meter (40 feet) (SF9461)	Yes Yes	No No	US/Canada	See Figure 8-4	None
				France	See Figure 8-13	None
				WT except Canada and France	See Figure 8-9	See Figures 8-10, 8-11, 8-12, and 8-16
1200 bps Integrated Modem, nonswitched (SF5500)	6 meter (20 feet) standard	Yes	No	US/Canada	See Figure 8-9	None
				France	See Figure 8-13	None
				WT except Canada and France	See Figure 8-9	See Figures 8-10, 8-12, and 8-15
2400 (SF5641) or 4800 (SF5741) bps Integrated Modem, switched	6 meter (20 feet) Standard 12 meter (40 feet) (SF9461) (For US see Note 3)	Yes Yes	No No	US (See Note 3)	See Figure 8-17	None
				Canada	See Figure 8-18	None
				France	See Figure 8-13	None
				WT except Canada and France	See Figure 8-9	See Figures 8-10, 8-11, 8-12, and 8-16
2400 (SF5640) or 4800 (SF5740) bps Integrated Modem, nonswitched	6 meter (20 feet) Standard 12 meter (40 feet) Standard	Yes Yes	No No	US/Canada	See Figure 8-9	None
				France	See Figure 8-13	None
				WT except Canada and France	See Figure 8-9	See Figures 8-10, 8-12, and 8-16

Notes:

1. An adapter cable is supplied with Datel 600 (for only the 5251 Model 12) or Datel 2412 (for only the 5251 Model 12) switched service in the United Kingdom; 0.3 meter (12 inches), SF2835; 0.2 meter (8 inches), SF2898; and non-IBM modem attachment in Japan, 0.3 meter (12 inches) SF2946.
2. For the 5294 Control Unit, in all countries if a modem eliminator is to be used, an adapter cable (part number 2452096) must also be used. This adapter cable is an accessory and is available from your IBM sales representative. In Brazil, this adapter cable must always be used to attach any modem to the 5294 Control Unit.
3. For the United States, a 6.7 meter (22 foot) cable is supplied.
4. The code included in parentheses with each feature is a sales feature order number.

Figure 8-6. Cables/Termination for Communications Features

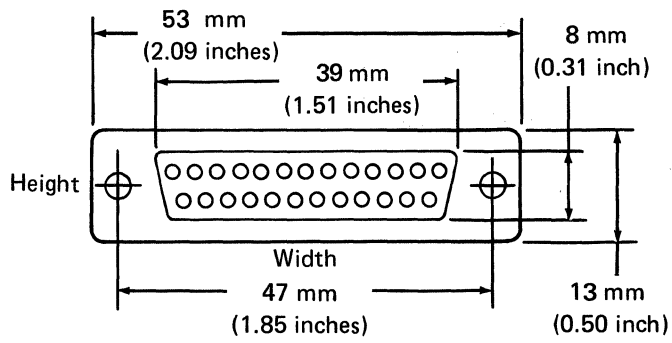

Figure 8-7. 25-Pin Connector

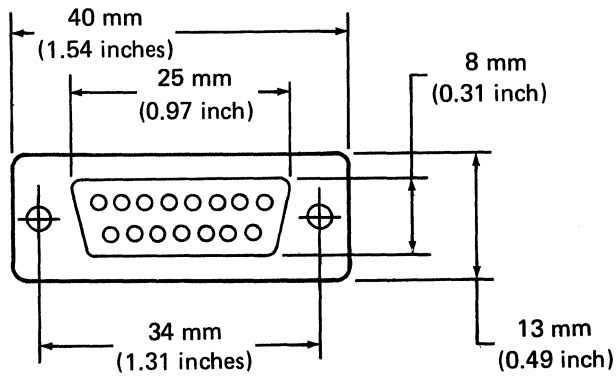

Figure 8-8. 15-Pin Connector

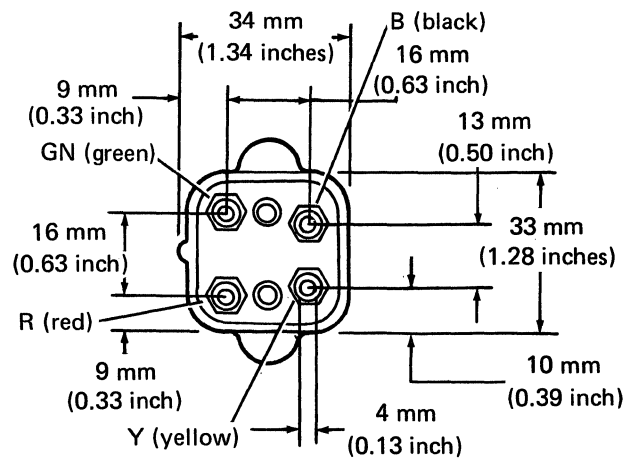

Figure 8-9. WE-283 B Plug

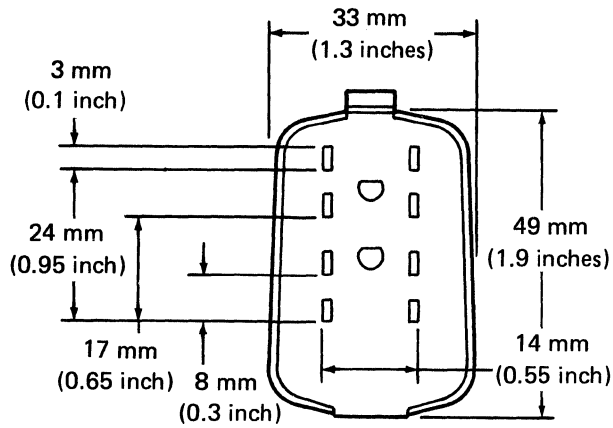

Figure 8-10. World Trade Communications Plug for Israel (Switched) and Austria, Belgium, Israel, the Netherlands, and Switzerland (Nonswitched)

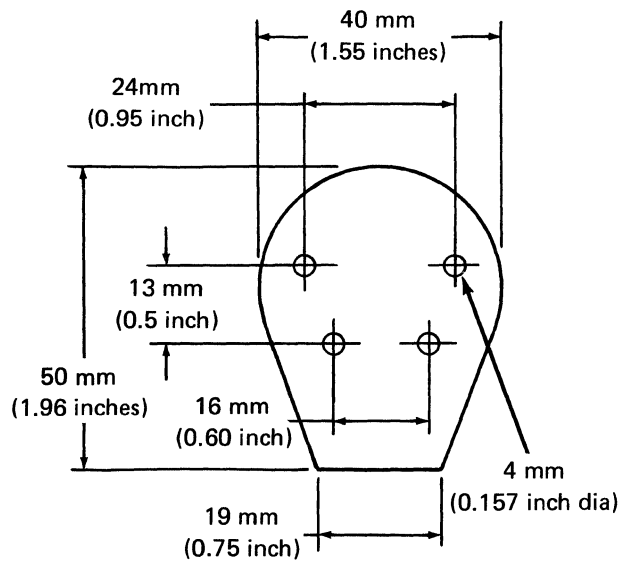

Figure 8-11. World Trade Communications Plug for the Netherlands (Switched)

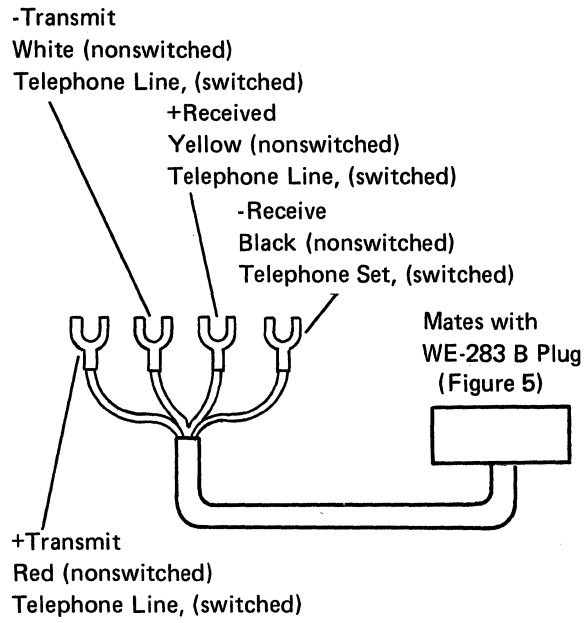

Figure 8-12. 4-Spade Termination

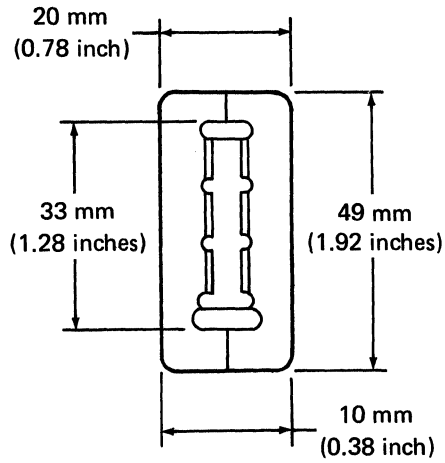

Figure 8-13. World Trade Communications Plug for France (Switched and Nonswitched)

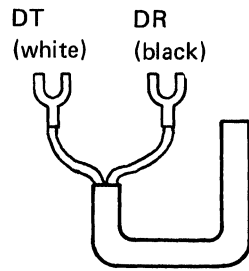

Figure 8-14. 2-Spade Termination

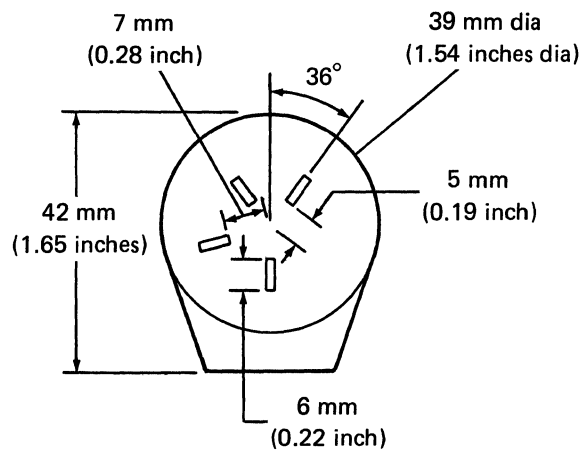

Figure 8-15. World Trade Communications Plug for Finland (Nonswitched)

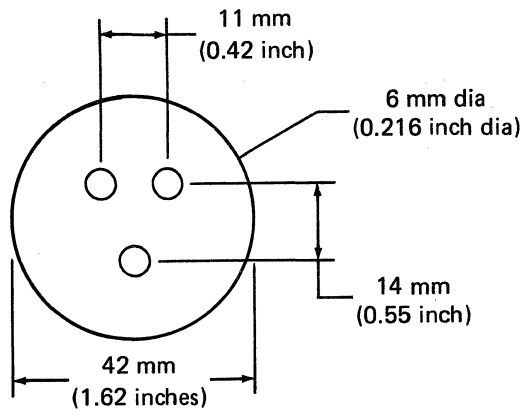

Figure 8-16. World Trade Communications Plug for Finland (Switched)

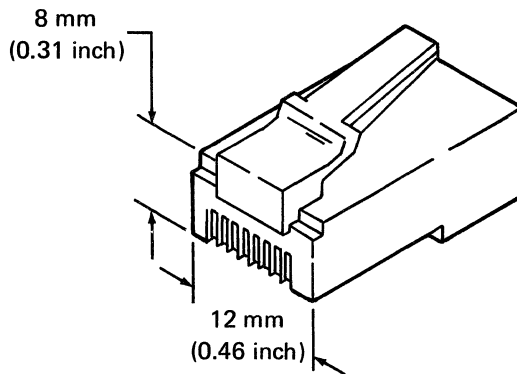

Figure 8-17. 8-Position Modular Plug

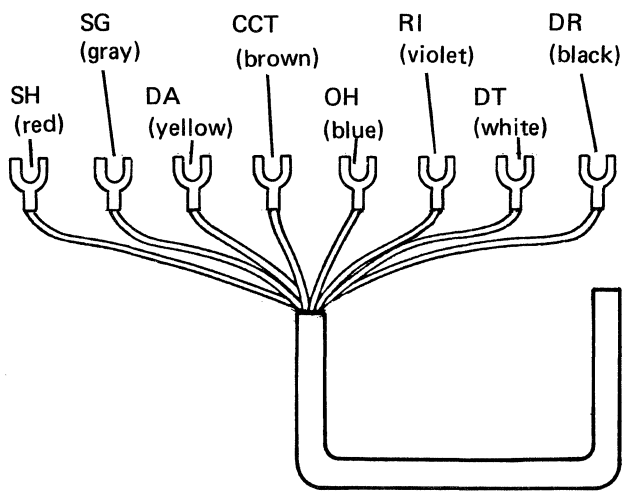

Figure 8-18. 8-Position Termination

If you order a controller, consider the following:

- Communications equipment should be located close to the controller. For the 5251 Model 12, cables can be ordered in 6- or 12-meter (20- or 40-foot) lengths for the 1200 bps Integrated Modem feature and in a 6.7-meter (22-foot) length for the 2400/4800 bps integrated switched line modems for the United States.
- Availability of a telephone with an outside line (not the same one used for data transmission) near the controller to aid in problem determination and communication with the host system.
- Space and power for external modems or digital communications equipment.
- Lightning protection on nonswitched communications lines. Protective devices can be installed by the telephone company. Ask for this protection when you order your communications lines.
- If you plan to install cable outdoors, see *Outdoor Cable Installation* in this chapter.
- Ensure that completion tests of the cables are performed and that the cable is labeled at each end. (See *Completion Tests of Cabling and Cable Labeling* in Appendix A.)





Appendix A. Labeling and Assembling Cables

This appendix contains instructions on how to complete information on labels and how to attach labels to a cable. It also provides specifications for bulk cable, connectors, and adapters as well as information on how to assemble and test your own cables.

LABELING CABLES

You should have received a set of *IBM Labels for Signal Cables, GX21-9345*, with your initial document order. If you do not have the labels yet, ask your IBM sales representative to order some for you or use the example below to produce your own.

Connect this end to:	Other end connects to:
Device type/name	Device type/name
Location	Location
Work station address	
Socket/port	Socket/port
	
	GX21-9345

Getting Started

Site Considerations

System Specifications

5294 Configuration and Communications

5251 Model 12 Communications and Configuration

Cables

Appendixes

Completing the Labels

Two labels should be completed for each twinaxial cable that will be connected to a work station, work station controller, or to a host system. After the labels are completed, attach one label to each end of the cable. These labels are used to assist the people who set up your work stations and work station controller(s). They are also used to aid in problem determination.

To complete each label, do the following:

1. Gather your floor plan, completed network diagram (for a local installation), and/or the network setup form (for a remote installation).
2. Copy the information (a ball-point pen works the best) from the form to the label as shown in the example below.

Note: You may also want to include the telephone number for a telephone located at each end of the cable.

For this example, this is the work station address of the 5291. (If this end of the cable would be connecting to a 5294 or a 5251 Model 12, the box should be left blank.)

This is the socket and socket number on the 5291 where the cable will be connected.

Connect this end to:	Other end connects to:
Device type/name	Device type/name
5291	5294
Location	Location
Accounting	Accounting
Work station address	
Socket port	Socket port
1	0
	GX21-9345

This is the port and port number on the 5294 where the other end of the cable is connected.

3. For each label completed, complete another label for the other end of the cable as shown below.

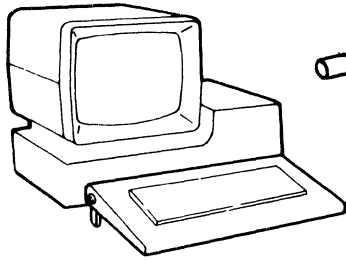

5291 Display Station

Connect this end to:	Other end connects to:
Device type/name	Device type/name
<u>5291</u>	<u>5294</u>
Location	Location
<u>Accounting</u>	<u>Accounting</u>
Work station address	
<u>1</u>	
Socket port <u>1</u>	Socket port <u>0</u>
	GX21-9345

Connect this end to:	Other end connects to:
Device type/name	Device type/name
<u>5294</u>	<u>5291</u>
Location	Location
<u>Accounting</u>	<u>Accounting</u>
Work station address	
Socket port <u>0</u>	Socket port <u>1</u>
	GX21-9345

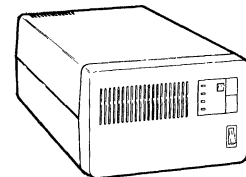

5294 Control Unit

4. If an end of a cable will be connected to a station protector, each end of the cable should have a label attached to it as shown below. Instead of indicating on the label that the cable connects to a certain station protector, indicate what is connected to the station protector.

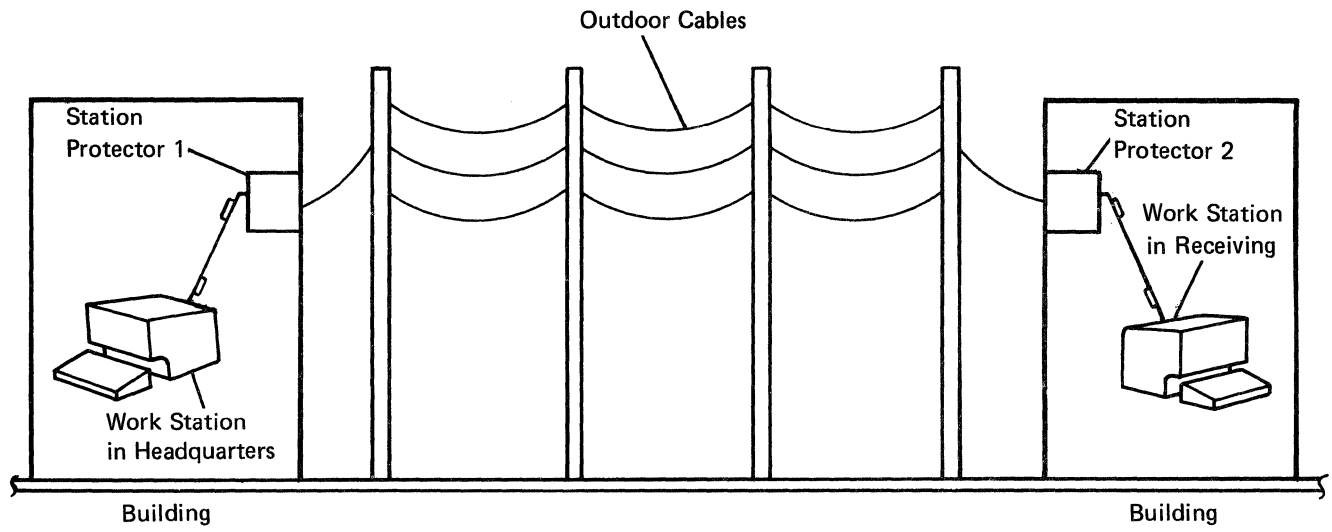

Attaching the Labels

After the labels are completed, attach each label to a cable by doing the following:

1. Remove the backing from the label.

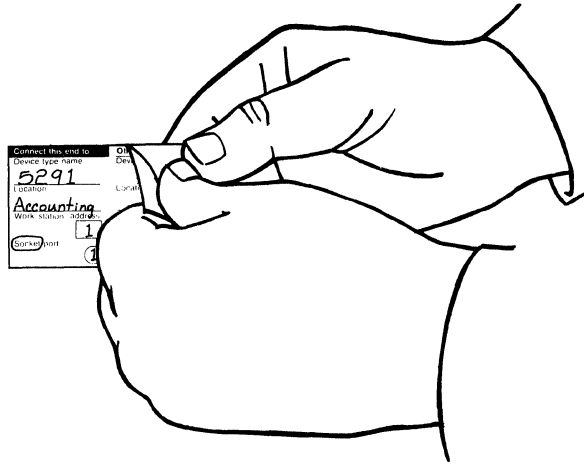

2. Place the label on the cable.

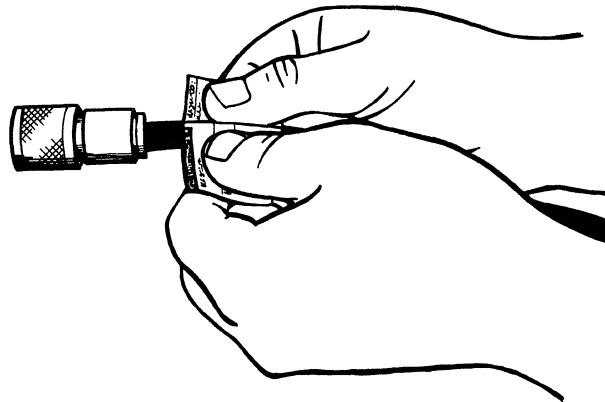

3. Wrap the ends of the label around the cable.

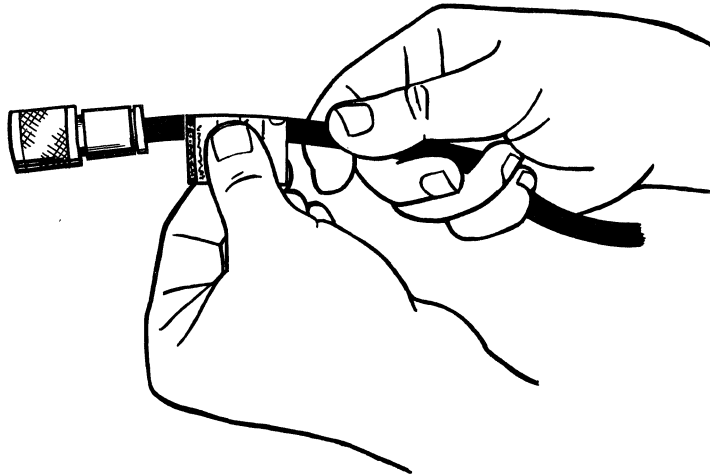

After the labels are attached to the cables, route the cables or place the cables near the areas where the work stations will be located. If possible, be present when the work stations are set up.

TWINAXIAL CABLE

Twinaxial cable is required for use in attaching display stations and printers to the work station controller, host system, or to each other. Twinaxial cable with either a vinyl-covering or a Teflon-covering is available. Teflon-covered cables do not have to be run through conduit.

The following are bulk cable specifications for twinaxial cable with vinyl-covering:

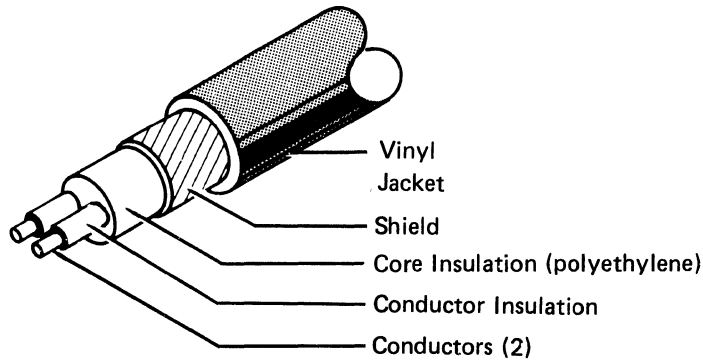

Conductor	AWG wire size	20
	Stranding	7 x 28
	Material	Copper
	Coating	Tin (1 conductor only)
	Resistance	11 ohms maximum per 305 meters (1000 feet)
Insulation	Material	Polyethylene
	Outside diameter	6.1 millimeters (0.24 inch) nominal
Shield	Material	Tinned copper
	Type	Braid, 34 AWG, 7 ends/24 carriers, 9.7 ± 10% picks/inch
	Coverage	95% minimum
	Resistance	3 ohms maximum per 305 meters (1000 feet)
Jacket	Material	Vinyl
	Color	Black
	Average single wall thickness	0.76 millimeter (0.029 inch)
	Outside diameter	8.25 millimeters (0.325 inch) nominal
Rating	Dielectric strength	4500 Vdc for 3 seconds at 28°C (82°F)
Capacitance		53.1 pF/meter (16.2 pF/foot) maximum
Impedance, characteristic		111 ± 5% ohms at 0.5 MHz 107 ± 5% ohms at 1 MHz 105 ± 5% ohms at 2 MHz and above
Attenuation @ 100 MHz		4.5 dB/30.5 meters (100 feet) maximum at 25°C (77°F) 4.7 dB/30.5 meters (100 feet) maximum at 80°C (176°F)
Velocity of propagation		66% ± 5%
Operating environment		-40°C to 80°C (-40°F to 176°F) 10% to 90% relative humidity

The following are bulk cable specifications for twinaxial cable with Teflon-covering:

Notes:

1. Both vinyl- and Teflon-covered cables can be used in the same configuration.
2. Teflon-covered cables comply with the requirements of the National Electrical Code (NEC) for low smoke producing cables when installed in an air plenum.

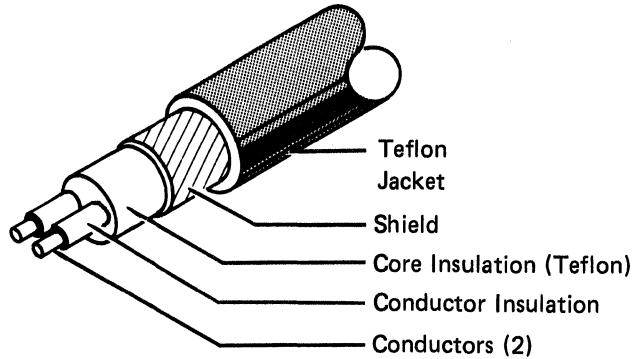

Conductor	AWG wire size	20
	Stranding	7 x 28
	Material	Copper
	Coating	Tin (1 conductor only)
	Resistance	11 ohms maximum per 305 meters (1000 feet)
Core Insulation	Material	Teflon
	Outside diameter	6.1 millimeters (0.24 inch) nominal
Shield	Material	Tinned copper
	Type	Braid, 34 AWG, 8 ends/16 carriers, 10.1 ± 10% picks/25.4 millimeters (inch)
	Coverage	95% minimum
	Resistance	3 ohms maximum per 305 meters (1000 feet)
Jacket	Material	Teflon
	Color	Translucent (white, natural, or light gray)
	Average single wall thickness	0.63 millimeter (0.025 inch)
	Outside diameter	7.00 millimeters (0.275 inch) nominal
Rating	Dielectric strength	4500 Vdc for 3 seconds at 28°C (82°F)
Capacitance		53.1 pF/meter (16.2 pF/foot) maximum
Impedance, characteristic		111 ± 5% ohms at 0.5 MHz 107 ± 5% ohms at 1 MHz 105 ± 5% ohms at 2 MHz and above
Attenuation @ 100 MHz		4.5 dB/30.5 meters (100 feet) maximum at 25°C (77°F) 4.7 dB/30.5 meters (100 feet) maximum at 80°C (176°F)
Velocity of propagation		65% - 75%
Operating environment		-40°C to 105°C (-40°F to 221°F) 10% to 90% relative humidity

Assembling Cables

If you purchase bulk twinaxial cables, assemble them as follows. Refer to the illustrations following these instructions for dimensions and assistance in doing these procedures. If you use connectors provided by a company other than IBM, use the instructions provided by the manufacturer.

1. Be certain that the connector kit has all of the required parts. Check the cross-sectional diagram for location of the cable layers.

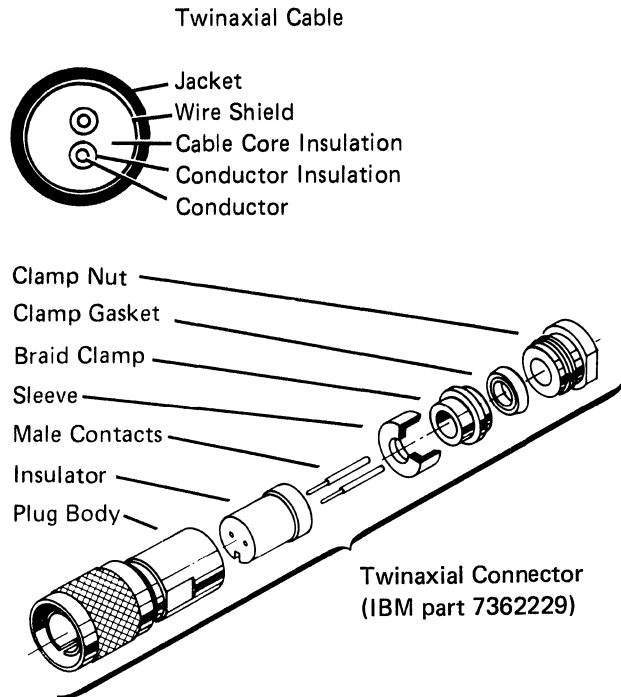

2. Cut the end of the cable sharp and square. Then slide a clamp nut and clamp gasket over the cable jacket and trim the jacket to the dimension given. Push the wire shield back to expose the inner insulation core, and cut the core and conductors to the dimension shown (16 millimeters [0.63 inch]). Slide the wire shield back over the core, and taper it to a point for ease of braid clamp assembly in step 3.

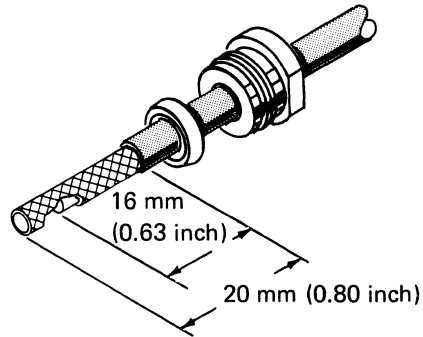

Note: If you are assembling a Teflon cable, install the heat shrink tubing before you continue with step 3.

Heat Shrink Tubing
(IBM part 483619)

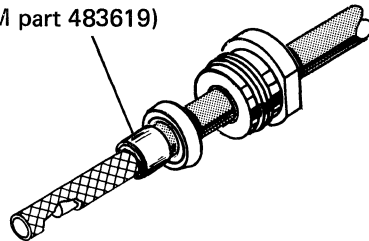

3. Slide a braid clamp over the braid so that its inner shoulder butts against the cable jacket. Then, fold the shield back over the braid clamp and trim below the shoulder.

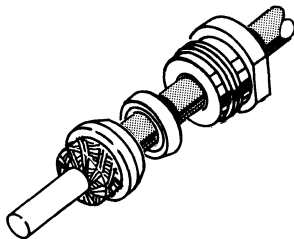

Note: Placement of braid wires over the braid clamp must be uniform to provide good rf (radio frequency) connection of the shield, and to prevent breaking the shield strands.

4. Cut the cable core and the conductor insulation to the dimensions shown. Do not nick the conductors or the insulation. If the braid is frayed, retrim the braid as in step 2.

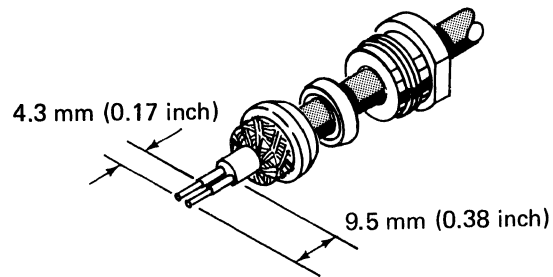

5. Slide the sleeve over the cable core and press the sleeve against the braid wires.

Using a noncorrosive solder and minimum heat, solder the male contacts to the conductors. Clean off any excess solder.

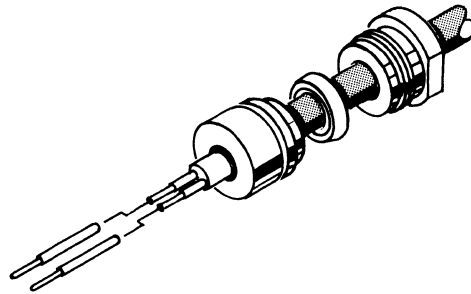

6. Bend the conductors and the contacts out at right angles to the cable axis (approximately 6.4 millimeters [0.25 inch]). Then bend the conductors and contacts back parallel to each other.

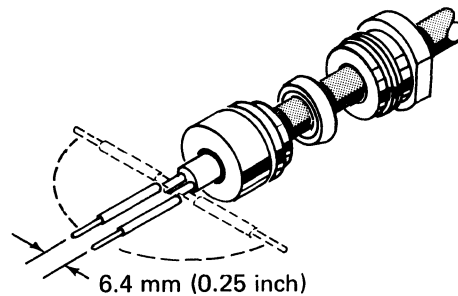

7. Slide the insulator over the contacts and the cable so that the insulator butts against the sleeve. Press all parts together. The contact on the bare copper lead of the cable goes into the insulator hole that has a dot next to it.

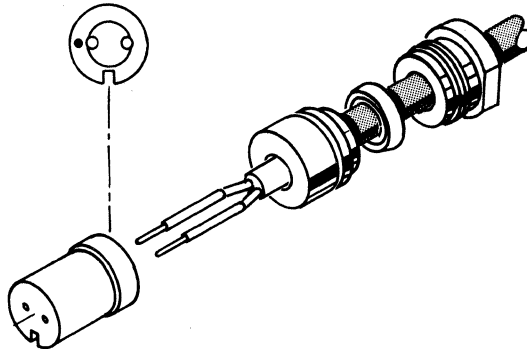

8. Insert the assembly into the connector body, aligning the polarizing slot in the insulator with the polarizing pin inside the plug body. Tighten the clamp nut with 5.7 to 6.8 N.m (Newton meters) (50 to 60 inch lbs) torque. (The cable and plug body should not be allowed to twist as the clamp nut is tightened.)

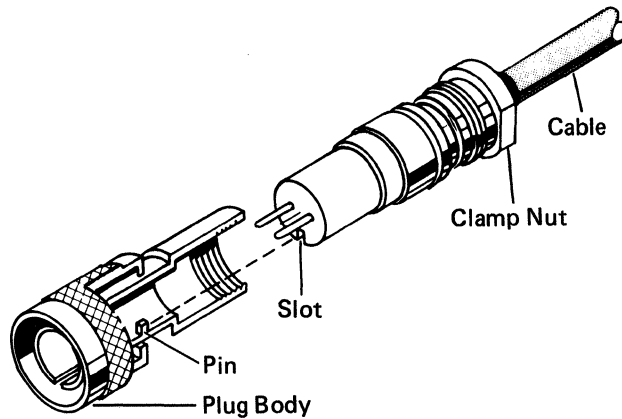

9. Check for shorts between the conductors and between each conductor and connector body.

Cable-to-Cable Adapters

Do not splice cables; instead, use an adapter. You may use IBM part 7362230, Amphenol part 82-5588, or an equivalent for twinaxial cable.

This adapter and the attached cable connectors should be covered with shrink or insulated tubing to prevent accidental grounding of the connection.

The following illustrates the cable adapter for joining twinaxial cables.

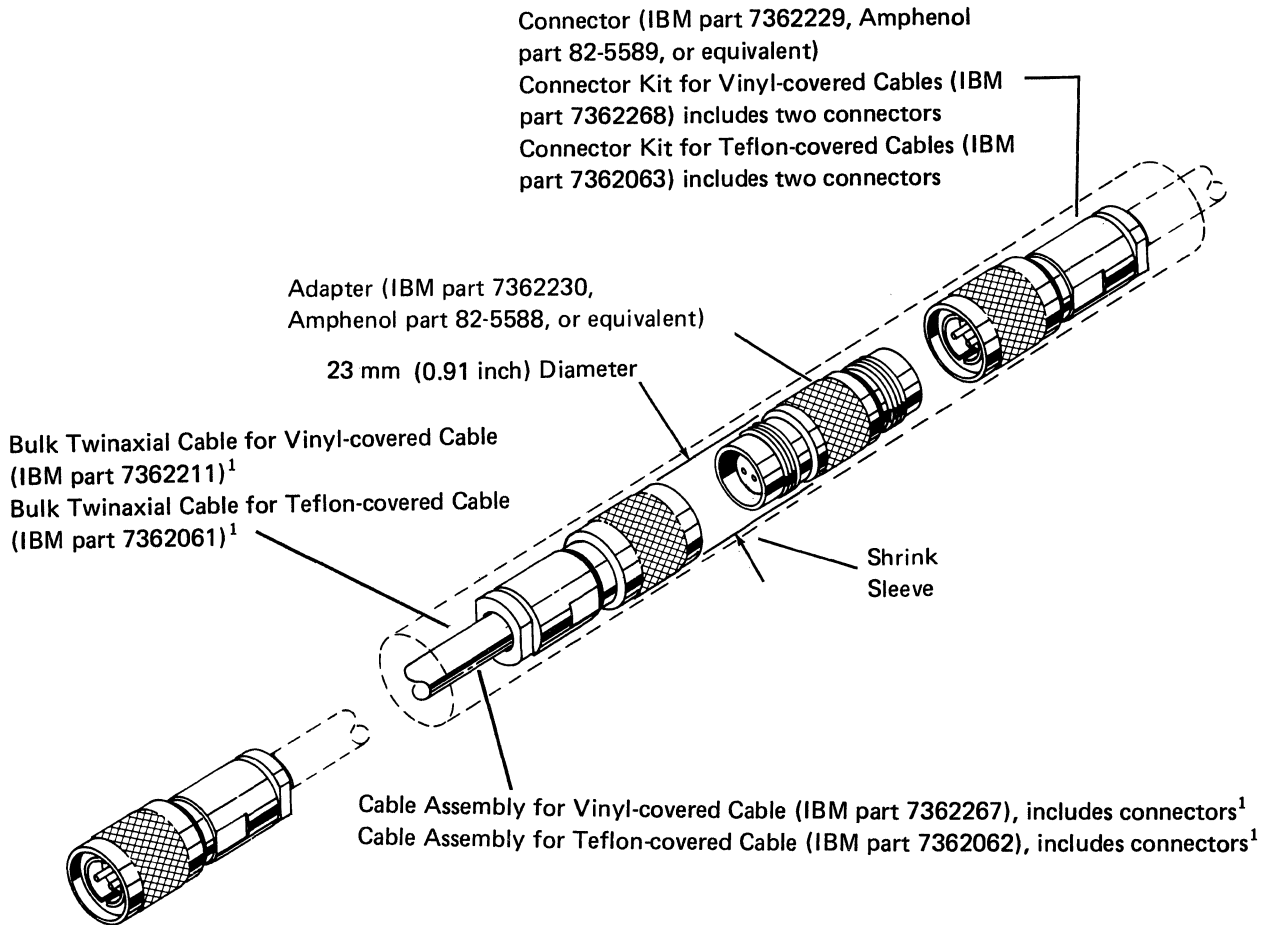

¹Specify the total length of each cable ordered.

Line Continuity and Polarity Tests

Installation of cabling should include completion tests to ensure that there are no faults, no high-resistance connections, and no circuit imbalances. The tests for faults should ensure there are no:

1. Open circuits in individual conductors or shields
2. Short circuits between conductors of the same pair
3. Grounds on individual conductors, either between a conductor and a shield or between a conductor and a grounded object
4. Reversed polarities

The following guidelines can be used for testing line continuity and polarity. The tests should be made for individual cable segments; however, they may be used for a complete cable if the station junctions are connected via an adapter or a work station having Cable Thru (if the power is off).¹

Line Continuity

The only tools required for line continuity checks are an ohmmeter and jumpers to connect between the connector pins (signal lines) and the connector body (cable shield). When the following checks are made, the resistance values measured should fall within the indicated ranges for the maximum 1525 meters (5000 feet).

With both ends of the cable open and the cable not plugged into a machine, measure (at either end):

- Conductor-to-conductor: greater than 1,000,000 ohms
- Each conductor to shield: greater than 1,000,000 ohms

A reading less than 1,000,000 ohms means there is a short.

With both lines tied to the shield at the far end, measure (at the nearest end):

- Conductor-to-conductor: less than 110 ohms²
- Each conductor to shield: less than 70 ohms²

A reading greater than 110 or 70 ohms, respectively, means there is an open.

¹Measurements are not valid with station protectors connected to the line.

²Values for shorter length are proportional because this is a linear function. For example, a cable with half the maximum length would have half the resistance.

Line Polarity

After testing the line continuity and making any necessary corrections, check the polarity as follows:

With conductor A of the cable plug tied to the shield at the far end, measure (at the nearest end): Conductor A to shield: less than 70 ohms. (If over 70 ohms, lines are crossed.)

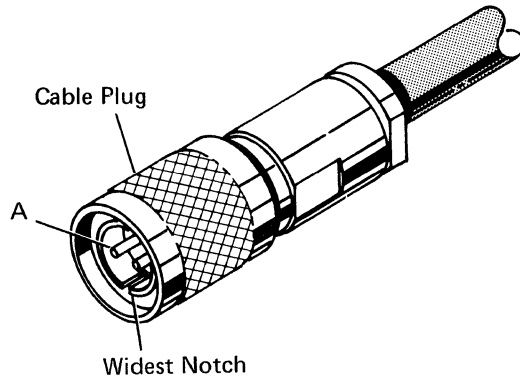

The polarity of the line must be maintained for each cable segment and for the entire cable run to ensure proper machine operation.

Appendix B. 5294 Control Unit Setup Forms

The 5294 Control Unit Setup Form allows you to record the information needed by your setup personnel when they set up your 5294 and any attaching work stations. A completed copy of the setup form should be retained at the 5294 and each work station attaching to it. It may be necessary to use it as a guide for service personnel and as a reference in the event of expansion or relocation.

Instructions for completing this form are in Chapter 4. Remove a copy of the setup form from this appendix and refer to Chapter 4 when filling it out.

Getting
Started

Site
Considerations

System
Specifications

5294
Configuration and
Communications

5251 Model 12
Communications
and Configuration

Cables

Appendixes

This page is intentionally left blank.

IBM 5294 CONTROL UNIT SETUP FORM (PART 1)

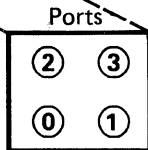
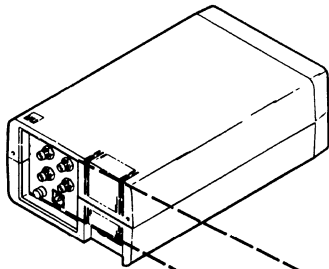

5294 Control Unit Information

Name _____
 Location _____
 City, State _____
 Telephone _____
 System Line/Port Number _____
 Location _____
 Telephone _____

Communications Type _____
 Communications Mode SDLC X.25 X.21 sw

CSR assistance required for communications line connection? Yes No

Name		Socket 1
Device Type		
Location		
Work Station Address		
Unit Address		
Keyboard Code		
Telephone		Socket 2

Name		Socket 1
Device Type		
Location		
Work Station Address		
Unit Address		
Keyboard Code		
Telephone		Socket 2

Name		Socket 1
Device Type		
Location		
Work Station Address		
Unit Address		
Keyboard Code		
Telephone		Socket 2

Name		Socket 1
Device Type		
Location		
Work Station Address		
Unit Address		
Keyboard Code		
Telephone		Socket 2

Socket 1	Name	
	Device Type	
	Location	
	Work Station Address	
	Unit Address	
	Keyboard Code	
Socket 2	Telephone	

Socket 1	Name	
	Device Type	
	Location	
	Work Station Address	
	Unit Address	
	Keyboard Code	
Socket 2	Telephone	

Socket 1	Name	
	Device Type	
	Location	
	Work Station Address	
	Unit Address	
	Keyboard Code	
Socket 2	Telephone	

Socket 1	Name	
	Device Type	
	Location	
	Work Station Address	
	Unit Address	
	Keyboard Code	
Socket 2	Telephone	

Note: Each cable connected to a 5294 port should have a tag with a number from 0 through 3. There should be a cable for each port used. Connect each cable to the port indicated on its tag.

IBM 5294 CONTROL UNIT SETUP FORM (PART 2)

During 5294 setup, you need to enter the information on this form in the entry fields on the appropriate line at the bottom of your display. Also, if a number is beside a D or P on the top part of the form it must be entered.

Note: On the top of each display are the possible work station addresses (0, 1, 2, 3, 4, 5, or 6). On the left side of each display are the port numbers (0/, 1/, 2/, or 3/). Port numbers 2/ and 3/ appear only when the 5294 has four ports.

Cut Along Line

Work Station Addresses

	0	1	2	3	4	5	6
0/							
1/							
2/							
3/							
1->							
2->							
3->							

If your 5294 communications mode is SDLC, fill in this line.

If your 5294 communications mode is X.25, fill in this line.

1->	2->	4->	5->	6->
-----	-----	-----	-----	-----

If your 5294 communications mode is X.21 switched, fill in this line.

1->	2->	9->	A->	B->
-----	-----	-----	-----	-----

IBM 5294 CONTROL UNIT SETUP FORM (PART 1)

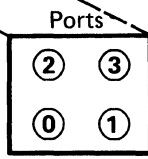
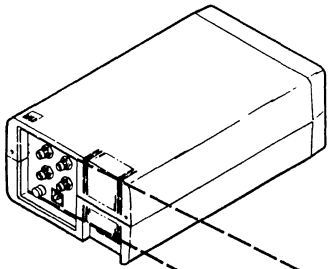

5294 Control Unit Information

Name _____
 Location _____
 City, State _____
 Telephone _____
 System Line/Port Number _____
 Location _____
 Telephone _____
 Communications Type _____
 Communications Mode SDLC X.25 X.21 sw
 CSR assistance required for communications line connection? Yes No

Name		Socket 1
Device Type		
Location		
Work Station Address		
Unit Address		
Keyboard Code		
Telephone		Socket 2

Socket 1	Name	
	Device Type	
	Location	
	Work Station Address	
	Unit Address	
	Keyboard Code	
Socket 2	Telephone	

Name		Socket 1
Device Type		
Location		
Work Station Address		
Unit Address		
Keyboard Code		
Telephone		Socket 2

Socket 1	Name	
	Device Type	
	Location	
	Work Station Address	
	Unit Address	
	Keyboard Code	
Socket 2	Telephone	

Name		Socket 1
Device Type		
Location		
Work Station Address		
Unit Address		
Keyboard Code		
Telephone		Socket 2

Socket 1	Name	
	Device Type	
	Location	
	Work Station Address	
	Unit Address	
	Keyboard Code	
Socket 2	Telephone	

Name		Socket 1
Device Type		
Location		
Work Station Address		
Unit Address		
Keyboard Code		
Telephone		Socket 2

Socket 1	Name	
	Device Type	
	Location	
	Work Station Address	
	Unit Address	
	Keyboard Code	
Socket 2	Telephone	

Note: Each cable connected to a 5294 port should have a tag with a number from 0 through 3. There should be a cable for each port used. Connect each cable to the port indicated on its tag.

IBM 5294 CONTROL UNIT SETUP FORM (PART 2)

During 5294 setup, you need to enter the information on this form in the entry fields on the appropriate line at the bottom of your display. Also, if a number is beside a D or P on the top part of the form it must be entered.

Note: On the top of each display are the possible work station addresses (0, 1, 2, 3, 4, 5, or 6). On the left side of each display are the port numbers (0/, 1/, 2/, or 3/). Port numbers 2/ and 3/ appear only when the 5294 has four ports.

Cut Along Line

Work Station Addresses

	0	1	2	3	4	5	6
0/							
1/							
2/							
3/							
1->							
2->							
3->							

If your 5294 communications mode is SDLC, fill in this line.

If your 5294 communications mode is X.25, fill in this line.

1->	2->	4->	5->	6->
-----	-----	-----	-----	-----

If your 5294 communications mode is X.21 switched, fill in this line.

1->	2->	9->	A->	B->
-----	-----	-----	-----	-----

IBM 5294 CONTROL UNIT SETUP FORM (PART 1)

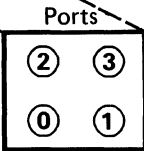
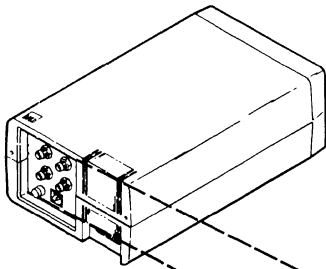

5294 Control Unit Information

Name _____
 Location _____
 City, State _____
 Telephone _____
 System Line/Port Number _____
 Location _____
 Telephone _____
 Communications Type _____
 Communications Mode SDLC X.25 X.21 sw
 CSR assistance required for communications line connection? Yes No

Name		Socket 1
Device Type		
Location		
Work Station Address		
Unit Address		
Keyboard Code		
Telephone		Socket 2

Socket 1	Name	
	Device Type	
	Location	
	Work Station Address	
	Unit Address	
	Keyboard Code	
Socket 2	Telephone	

Name		Socket 1
Device Type		
Location		
Work Station Address		
Unit Address		
Keyboard Code		
Telephone		Socket 2

Socket 1	Name	
	Device Type	
	Location	
	Work Station Address	
	Unit Address	
	Keyboard Code	
Socket 2	Telephone	

Name		Socket 1
Device Type		
Location		
Work Station Address		
Unit Address		
Keyboard Code		
Telephone		Socket 2

Socket 1	Name	
	Device Type	
	Location	
	Work Station Address	
	Unit Address	
	Keyboard Code	
Socket 2	Telephone	

Name		Socket 1
Device Type		
Location		
Work Station Address		
Unit Address		
Keyboard Code		
Telephone		Socket 2

Socket 1	Name	
	Device Type	
	Location	
	Work Station Address	
	Unit Address	
	Keyboard Code	
Socket 2	Telephone	

Note: Each cable connected to a 5294 port should have a tag with a number from 0 through 3. There should be a cable for each port used. Connect each cable to the port indicated on its tag.

IBM 5294 CONTROL UNIT SETUP FORM (PART 2)

During 5294 setup, you need to enter the information on this form in the entry fields on the appropriate line at the bottom of your display. Also, if a number is beside a D or P on the top part of the form it must be entered.

Note: On the top of each display are the possible work station addresses (0, 1, 2, 3, 4, 5, or 6). On the left side of each display are the port numbers (0/, 1/, 2/, or 3/). Port numbers 2/ and 3/ appear only when the 5294 has four ports.

Cut Along Line

Work Station Addresses

	0	1	2	3	4	5	6
0/							
1/							
2/							
3/							
1->							
2->							
3->							

If your 5294 communications mode is SDLC, fill in this line.

If your 5294 communications mode is X.25, fill in this line.

1->	2->	4->	5->	6->
-----	-----	-----	-----	-----

If your 5294 communications mode is X.21 switched, fill in this line.

1->	2->	9->	A->	B->
-----	-----	-----	-----	-----

Appendix C. Introductory Communications Information for Use with the 5294 Control Unit

This appendix contains general information about communications for use with the 5294 Control Unit. You may want to read the appendix before completing a *Communications Network Worksheet for the 5294 Control Unit* as described in Chapter 5.

INFORMATION NEEDED TO PLAN YOUR COMMUNICATIONS FACILITIES

To plan your communications facilities, you will need to decide on the following:

- Type of communications line
- Type of network
- Kind of network
- Type of communications (also known as the interface or communications feature)
- Transmission speed for the DCE

This information is on the following pages. However, if you need additional information, the following may be helpful:

- *IBM Data Communications Concepts*, GC21-5169, which contains general information about communications.
- *IBM Communications Systems Bulletin, X.25 Primer*, GG22-9103, which is a general overview of X.25 packet switching.
- *IBM X.25 Interface for Attaching IBM SNA Nodes to Packet-Switched Data Networks General Information Manual*, GA27-3345, which describes the elements of CCITT recommendation X.25, protocols, and formats of the X.25 DTE/DEC interface as implemented by IBM SNA nodes.
- *IBM Implementation of X.21 Interface General Information Manual*, GA27-3287, which gives a general overview of the X.21 interface as implemented by IBM.

Also available are two *Guided Learning Courses*. For information about these courses, contact your nearest IBM Customer Center or IBM sales representative. The courses are:

- *IBM Data Communications Concepts and Planning*, S2548, which is a course on data communications concepts and planning.
- *IBM Data Communications Installation Planning*, ZR30-0856, which is a course on installation planning for data communications.

Getting Started

Site Considerations

System Specifications

5294 Configuration and Communications

5251 Model 12 Communications and Configuration

Cables

Appendixes

Types of Communications Lines

The types of communications lines for the 5294 Control Unit are analog and digital. The type of communications line you should select depends on the network you select. An illustration that shows the types of communications lines and the networks they are used on, is in Chapter 5 under *Communications Components Order Information for the 5294 Control Unit*. What type of communications line you should select is discussed in this appendix.

Types of Networks

The types of networks for the 5294 include:

- Point-to-point switched
- Point-to-point nonswitched
- Multipoint nonswitched

Note: The network types for an X.25 packet switched network are switched virtual circuit, permanent virtual circuit, and dual connected. Switched virtual circuit is similar to point-to-point switched. Permanent virtual circuit is similar to point-to-point nonswitched. Dual connection is both switched virtual circuit and permanent virtual circuit.

Point-to-Point Switched

Point-to-point switched is a connection between two points using the normal (dial up) telephone system or the X.21 switched network.

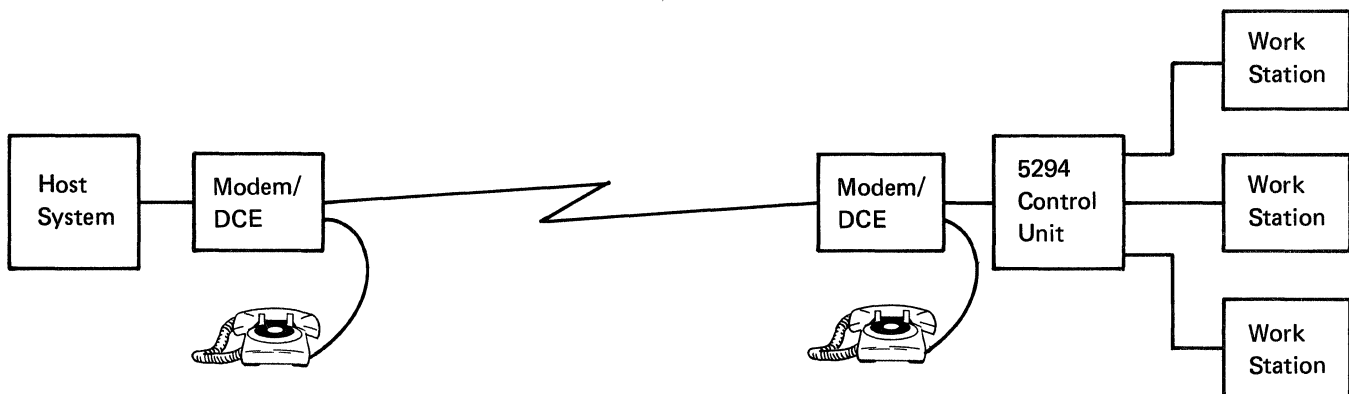

Point-to-Point Nonswitched

Point-to-point nonswitched is a permanently wired communications line between two points. The communications line is either leased from a common carrier (such as the telephone company) or owned by the company using it.

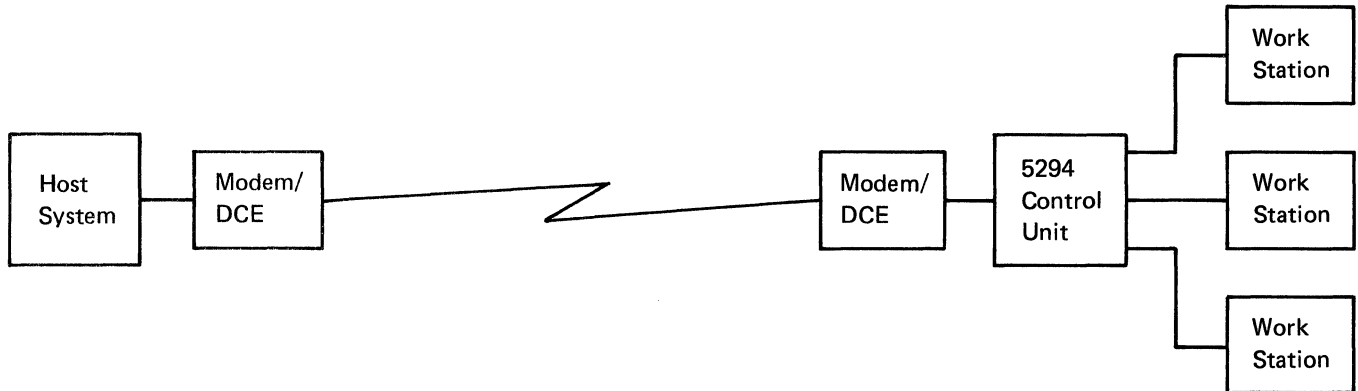

Multipoint Nonswitched

Multipoint nonswitched is a permanently wired communications line between a host system and two or more remote work station controllers.

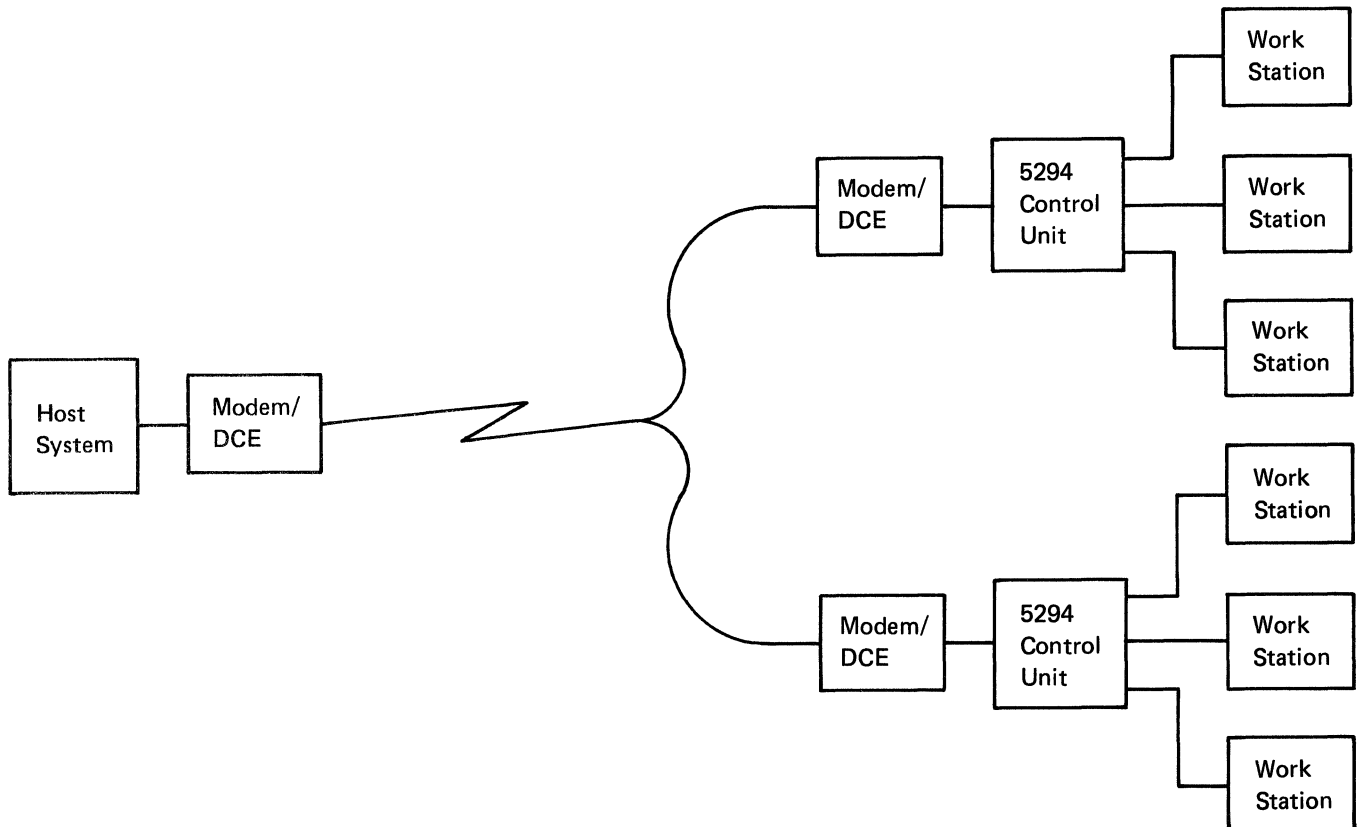

Kinds of Networks

Four kinds of networks are available for the 5294 Control Unit:

- Analog Network
- AT&T DDS Public Data Network
- X.21 Public Data Network
- X.25 Packet Switched Network

All network types (point-to-point switched, point-to-point nonswitched, and multipoint nonswitched) are available with each kind of network. The kind of network you select depends mainly on what networks are available in your area or country. The most common network at this time is an analog network. However, due to availability and pricing policies, a packet switched network (X.25) or a public data network may be more cost effective in some countries. It may be advisable to compare the cost of different networks available in your country or area for the type of service and transmission you require. (Transmission speed is discussed later in this appendix.)

Analog Network

An analog network uses voice grade lines (similar to the kind of line used for voice). This requires that the digital signals from the work station controller or host system be converted to a form that can be sent over this type of line. This is done by a MODulator-DEMulator (modem). Another modem at the other end converts the signal back to digital form for the receiving equipment.

An analog network is the most common kind of network used today. However, this kind of network is being replaced by digital networks, especially in some World Trade countries.

AT&T DDS Public Data Network

An AT&T DDS public data network is used in the United States to transfer data from end-to-end in digital form. This kind of network may either provide nonswitched and/or switched service.

X.21 Public Data Network

An X.21 public data network is used in World Trade countries to transfer data from end-to-end in digital form. This kind of network may provide either nonswitched and/or switched service.

X.25 Packet Switched Network

An X.25 packet switched network transfers data in digital form but does so in groups of data (referred to as packets) instead of maintaining a continuous line connection for the length of time two DCEs are communicating.

Types of Communications

The communications type, also known as the interface or communications feature, is the type of equipment used to connect the work station controller and system to the modem/DCE. You will need to select one. For the 5294, this includes:

- DDSA (Digital Data Service Adapter) feature
- EIA/CCITT feature
- X.21 Signal Converter feature

DDSA Feature

The DDSA feature allows the 5294 to be connected to an AT&T digital communications line. With DDSA, the 5294 can communicate at 2400, 4800, 9600, or 56,000 bits per second (bps).

EIA/CCITT Feature

The EIA/CCITT feature allows the 5294 to be attached to an external modem or other DCE (such as X.21 or X.25 DCE, or a data service unit) and an analog or digital communications line. With EIA/CCITT, the 5294 can communicate at 2400 through 9600 bits per second (bps).

X.21 Signal Converter

The X.21 Signal Converter feature allows the 5294 to be attached to an X.21 nonswitched communications line for use with an X.25 packet switched network or for use as an X.21 circuit switched or nonswitched line to the host system in SDLC mode. With this feature, the 5294 can communicate at 2400 through 48,000 bits per second (bps).

Transmission Speeds for the DCE

In planning your communications facilities, the transmission speed you need will help determine the kind and type of network you can select. Networks are discussed earlier in this appendix. The network type, interface, and transmission speed needed must be made for the total network including the host system and all remote work station controllers.

Note: Your IBM sales representative may be able to assist you in determining your requirements.

The transmission speed you will need depends on:

- The number of remote work station controllers attached to each system communications port.
- The number of display stations and printers that will be attached to the 5294 Control Unit.
- Display station usage. Will the display stations have light usage, such as an occasional inquiry (request for information), or medium to heavy usage, such as interactive data entry and/or updating information?
- Printer usage. Will there be a lot of printing to be done at the same time most display stations are in use, or will most printing be done during off hours?

To determine the transmission speed, you will need to do the following:

1. Review the following three figures:
 - a. Figure C-1 shows different numbers of display stations on a communications line and the approximate transmission speed they need.
 - b. Figure C-2 shows the approximate transmission speed needed for the different types of printers.
 - c. Figure C-3 shows different transmission speeds and what networks and DCE supports each speed.
2. Add the transmission speed needed for the total number of display stations and each printer you will have using Figures C-1 and C-2 for reference.

Note: The transmission speed you determined may not produce the indicated throughput.

3. After you determine the total transmission speed you need, use Figure C-3 to determine the facilities you need.

Number of Display Stations Per Communications Line	Transmission Speed Required		
	Light Usage	Medium Usage	Heavy Usage
1 to 5	2400 bps	2400 or 4800 bps	2400 or 4800 bps
6 to 10	2400 or 4800 bps	4800 or 9600 bps	9600 bps or higher
11 to 15	4800 or 9600 bps	9600 bps or higher	9600 bps or higher
16 or greater	9600 bps	9600 bps or higher	48,000 or 56,000 bps

Notes:

1. Depending on your particular applications and usage, the network type and speed shown may or may not offer satisfactory performance.
2. Instead of using a higher speed to achieve satisfactory performance, it may be more cost effective to use two or more smaller multipoint networks at lower speeds.
3. If the number of display stations shown are attached by three or more work station controllers, the next higher transmission speed may be required.
4. If you plan to attach and use printers on the same network at the same time that the display stations are in maximum usage, the transmission speed may need to be increased to achieve the rated throughput for the printers. This is shown in the next figure.

Figure C-1. Transmission Speeds for Display Stations

Printer Throughput Rate (Characters Per Second or Lines Per Minute)	Type of Printer	Transmission Speed Required
40 Characters per second	5219 Model D01 5256 Model 1	400 bps
60 Characters per second	5219 Model D02	600 bps
80 Characters per second	5256 Model 2	800 bps
120 Characters per second	5256 Model 3	1200 bps
140 Lines per minute	5224 Model 1	1680 bps
240 Lines per minute	5224 Model 2	2880 bps
280 Lines per minute	5225 Model 1	3360 bps
400 Lines per minute	5225 Model 2	4800 bps
490 Lines per minute	5225 Model 3	5880 bps
560 Lines per minute	5225 Model 4	6720 bps
<p>Notes:</p> <ol style="list-style-type: none"> 1. This chart assumes an average of 85 data characters and 5 control characters per line for printers rated in lines per minute. Printing speeds may vary depending on print density and the number of characters per line. 2. This chart does not take into consideration modem and system turnaround time. 3. For additional information, review the notes in Figure C-1. 		

Figure C-2. Transmission Speeds for Printers

Total Transmission Speed Needed	Network Type Available	DCE's Available
2400 bps	Point-to-point nonswitched or multipoint nonswitched (analog)	EIA/CCITT with an IBM 3863 Model 1 Modem or other 2400 bps nonswitched modem
	Point-to-point switched (analog)	EIA/CCITT with an IBM 3863 Model 2 Modem or other 2400 bps switched modem
	Point-to-point switched or nonswitched (X.21)	EIA/CCITT for X.21 DCE with X.21 bis interface or XLCA for X.21 DCE with X.21 native (X.24/X.27) interface
	Packet switched	EIA/CCITT for X.25 DCE with X.21 bis interface or XLCA for X.25 DCE with X.21 native (X.24/X.27) interface
	Point-to-point or multipoint nonswitched DDS	DDSA with a channel service unit or EIA/CCITT with a data service unit
4800 bps	Point-to-point nonswitched or multipoint nonswitched (analog)	EIA/CCITT with an IBM 3864 Model 1 Modem or other 4800 bps nonswitched modem
	Point-to-point switched (analog)	EIA/CCITT with an IBM 3864 Model 2 Modem or other 4800 bps switched modem
	Point-to-point switched or nonswitched (X.21)	EIA/CCITT for X.21 DCE with X.21 bis interface or XLCA for X.21 DCE with X.21 native (X.24/X.27) interface
	Packet switched	EIA/CCITT with X.25 DCE with X.21 bis interface or XLCA for X.25 DCE with X.21 native (X.24/X.27) interface
	Point-to-point or multipoint nonswitched DDS	DDSA with a channel service unit or EIA/CCITT with a data service unit

Figure C-3 (Part 1 of 2). Transmission Speeds Available with Networks and DCEs

Total Transmission Speed Needed	Network Type Available	DCE's Available
9600 bps	Point-to-point nonswitched or multipoint nonswitched (analog)	EIA/CCITT with an IBM 3865 Model 1 Modem or other 9600 bps nonswitched modem
	Point-to-point switched (analog)	EIA/CCITT with an IBM 3865 Model 2 Modem or other 9600 bps switched modem
	Point-to-point switched or nonswitched (X.21)	EIA/CCITT for X.21 DCE with X.21 bis interface or XLCA for X.21 DCE with X.21 native (X.24/X.27) interface
	Packet switched	EIA/CCITT for X.25 DCE with X.21 bis interface or XLCA for X.25 DCE with X.21 native (X.24/X.27) interface
	Point-to-point or multipoint nonswitched DDS	DDSA with a channel service unit or EIA/CCITT with a data service unit
40,000 to 48,000 bps	Point-to-point switched or nonswitched (X.21)	XLCA for X.21 DCE with X.21 native (X.24/X.27) interface
	Packet switched	XLCA for X.25 DCE with X.21 native (X.24/X.27) interface
56,000 bps	Point-to-point or multipoint nonswitched DDS	DDSA with a channel service unit
<p>Note: When doing your planning, you should allow for future expansion. Any changes which will be required within 12 to 18 months should be installed at the start, especially if purchasing the equipment. One thing to keep in mind for multipoint networks is that one large one can be split into two or more smaller ones using the same modems and adding an additional modem per line at the host system.</p>		

Figure C-3 (Part 2 of 2). Transmission Speeds Available with Networks and DCEs

Appendix D. Completed Setup Form and Communications Network Worksheet for the 5294 Control Unit

This appendix contains two examples of a completed 5294 Control Unit Setup Form and two examples of a completed 5294 Communications Network Worksheet.

5294 CONTROL UNIT SETUP FORM EXAMPLES

The next eight pages show two configurations using the 5294 and a completed 5294 Control Unit Setup Form for each configuration. For information on how to complete the form, see Chapter 4, *Remote Work Station Configuration Using the 5294 Control Unit*.

First Example

Figure D-1, on the next page, is a point-to-point nonswitched network example. It shows the communications from a host system to a remote location and what is needed for operating the equipment in the United States. Figure D-2 shows the completed 5294 Setup Form for the remote end of this example.

Getting Started

Site Considerations

System Specifications

5294 Configuration and Communications

5251 Model 12 Communications and Configuration

Cables

Appendixes

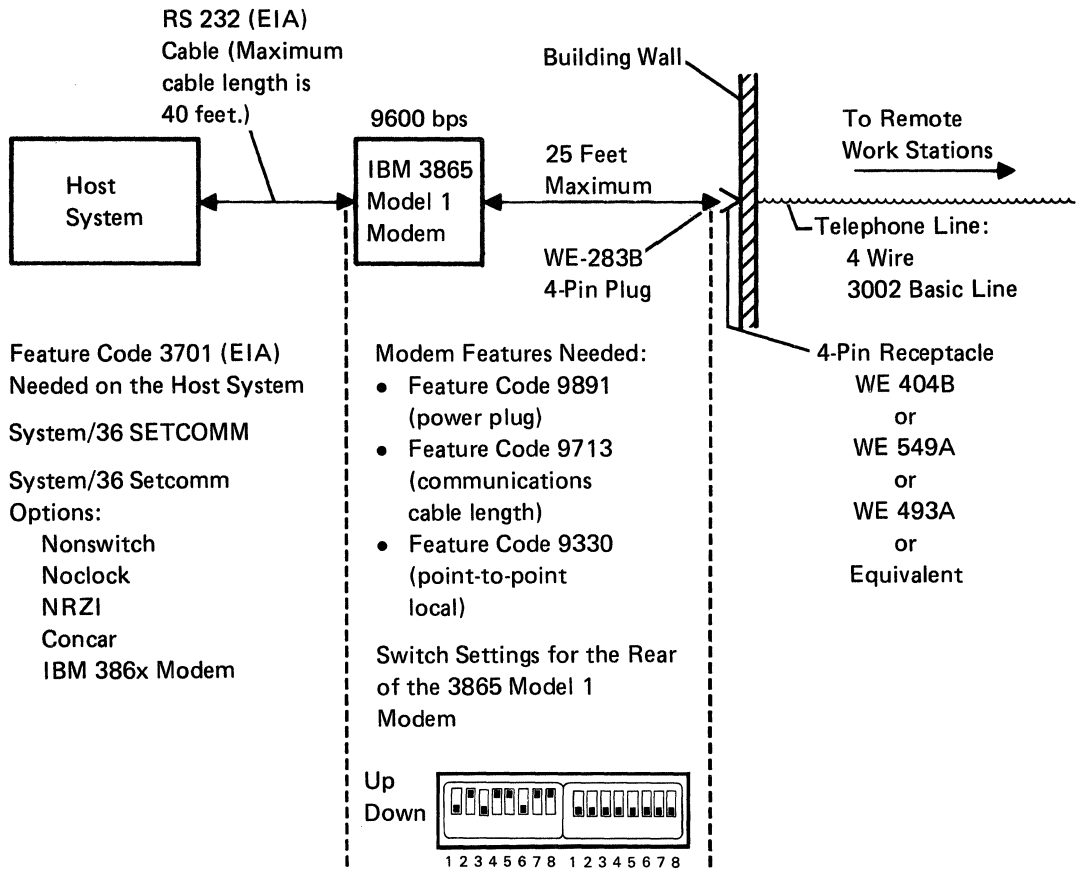

Figure D-1 (Part 1 of 2). Host End Point-to-Point Nonswitched Network Example

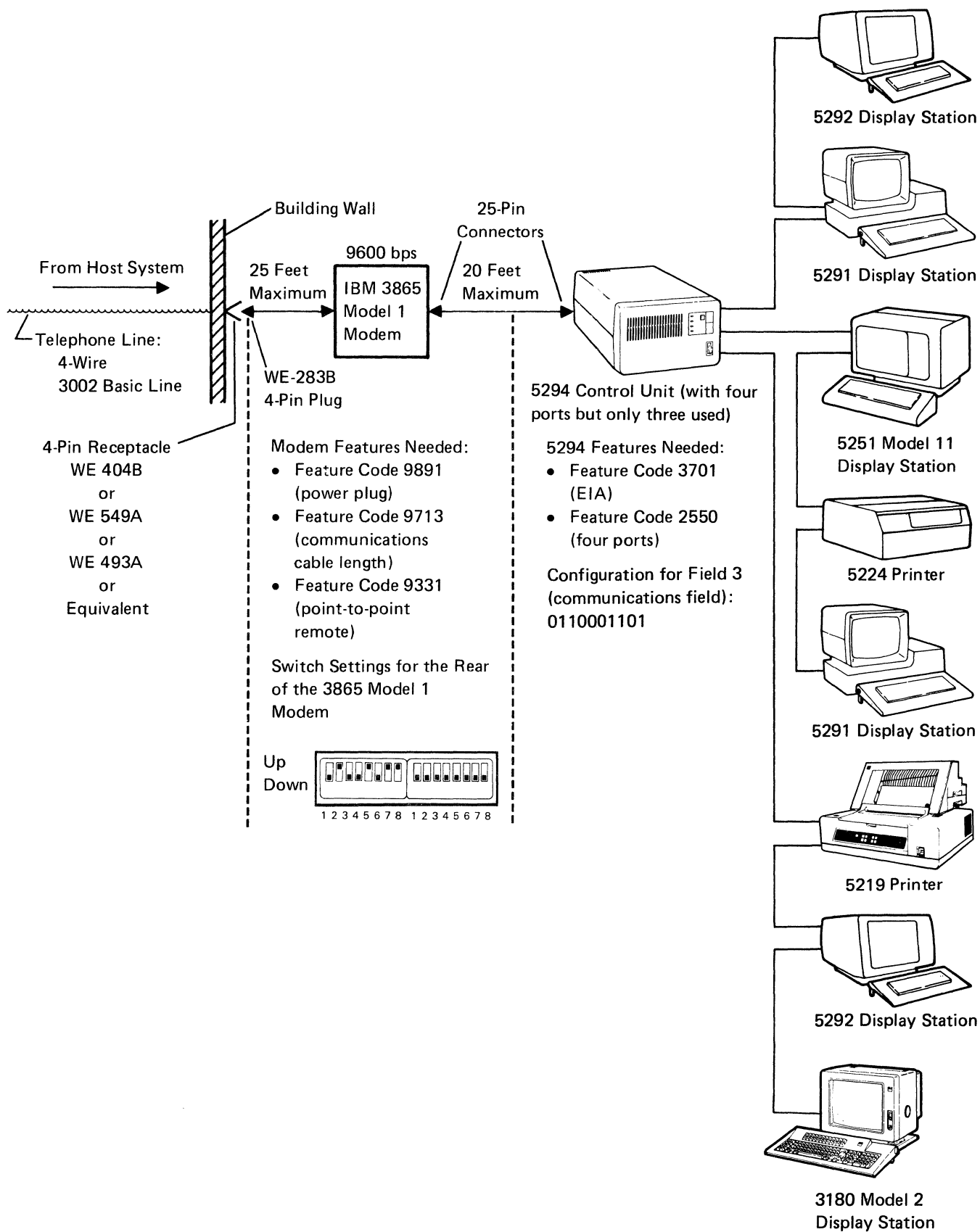
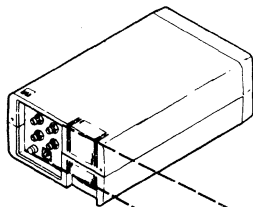

Figure D-1 (Part 2 of 2). Remote End Point-to-Point Nonswitched Network Example

IBM 5294 CONTROL UNIT SETUP FORM (PART 1)



5294 Control Unit Information

Name Ed
 Location Accounting Office
 City, State New York, New York
 Telephone 212-555-6742
 System Line/Port Number 3
 Location Computer Center
 Telephone 212-555-5112
 Communications Type EIA/CCITT
 Communications Mode SDLC X.25 X.21 sw
 CSR assistance required for communications line connection? Yes No

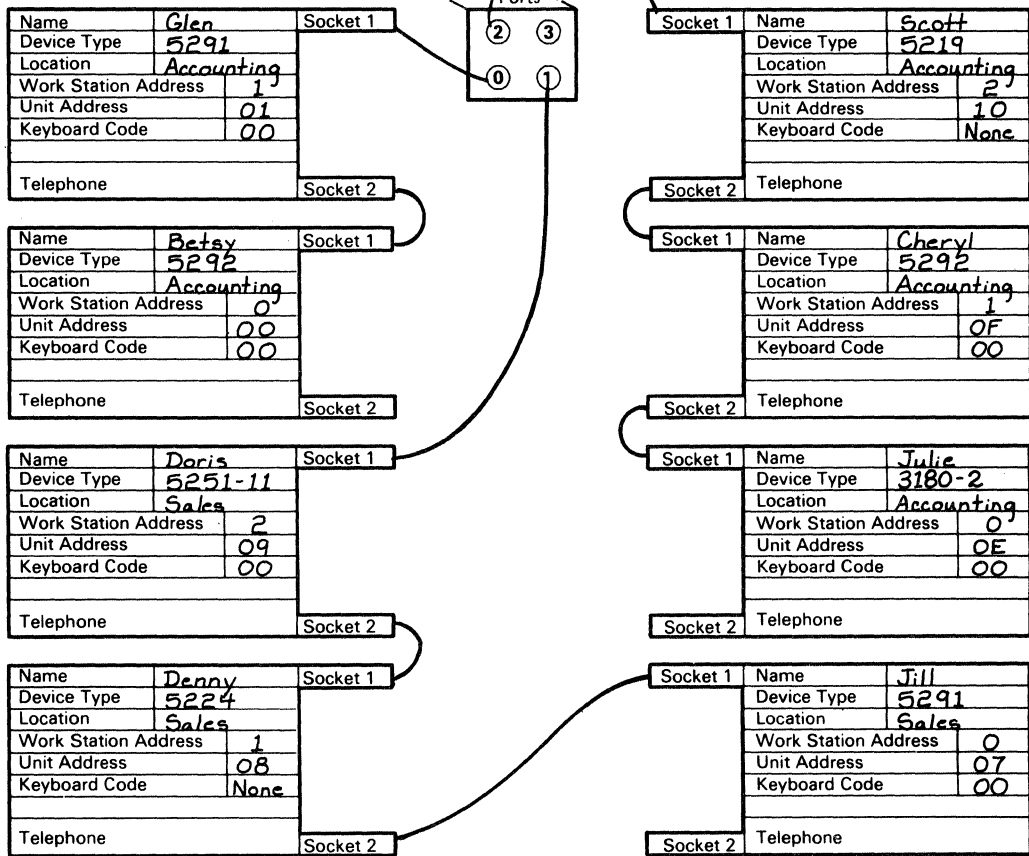

Note: Each cable connected to a 5294 port should have a tag with a number from 0 through 3. There should be a cable for each port used. Connect each cable to the port indicated on its tag.

Figure D-2 (Part 1 of 2). Completed 5294 Setup Form for the First Example

IBM 5294 CONTROL UNIT SETUP FORM (PART 2)

During 5294 setup, you need to enter the information on this form in the entry fields on the appropriate line at the bottom of your display. Also, if a number is beside a D or P on the top part of the form it must be entered.

Note: On the top of each display are the possible work station addresses (0, 1, 2, 3, 4, 5, or 6). On the left side of each display are the port numbers (0/, 1/, 2/, or 3/). Port numbers 2/ and 3/ appear only when the 5294 has four ports.

		Work Station Addresses						
		0	1	2	3	4	5	6
Port Numbers	0/	D	D	•	•	•	•	•
	1/	D	P	D	•	•	•	•
	2/	D	D	P	•	•	•	•
	3/	•	•	•	•	•	•	•

If your 5294 communications mode is SDLC, fill in this line.
 1-> 00 2-> 01 3-> 0110001101

If your 5294 communications mode is X.25, fill in this line.

1->	2->	4->	5->	6->
-----	-----	-----	-----	-----

If your 5294 communications mode is X.21 switched, fill in this line.

1->	2->	9->	A->	B->
-----	-----	-----	-----	-----

Cut Along Line

Figure D-2 (Part 2 of 2). Completed 5294 Setup Form for the First Example

Second Example

The following figure, Figure D-3, is a switched network example. It shows the communications from a host system to a remote location and what is needed for operating the equipment in the United States. Figure D-4 shows the completed 5294 Control Unit Setup Form for the remote end of this example.

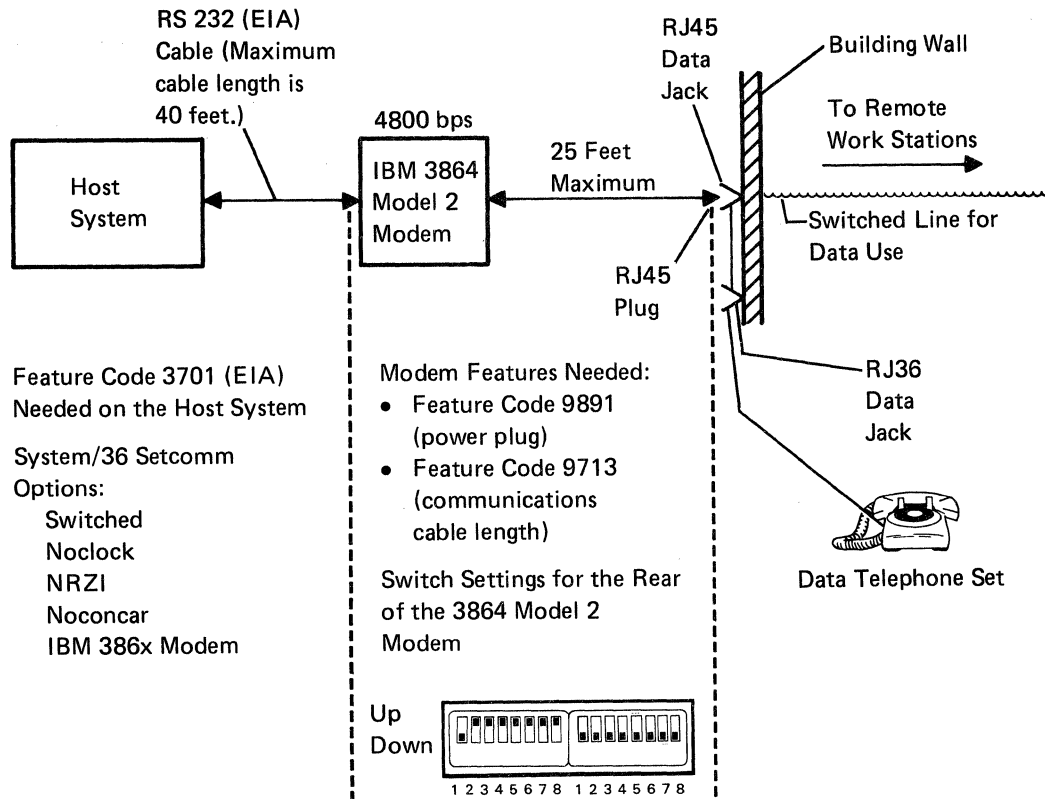

Figure D-3 (Part 1 of 2). Host End Switched Network Example

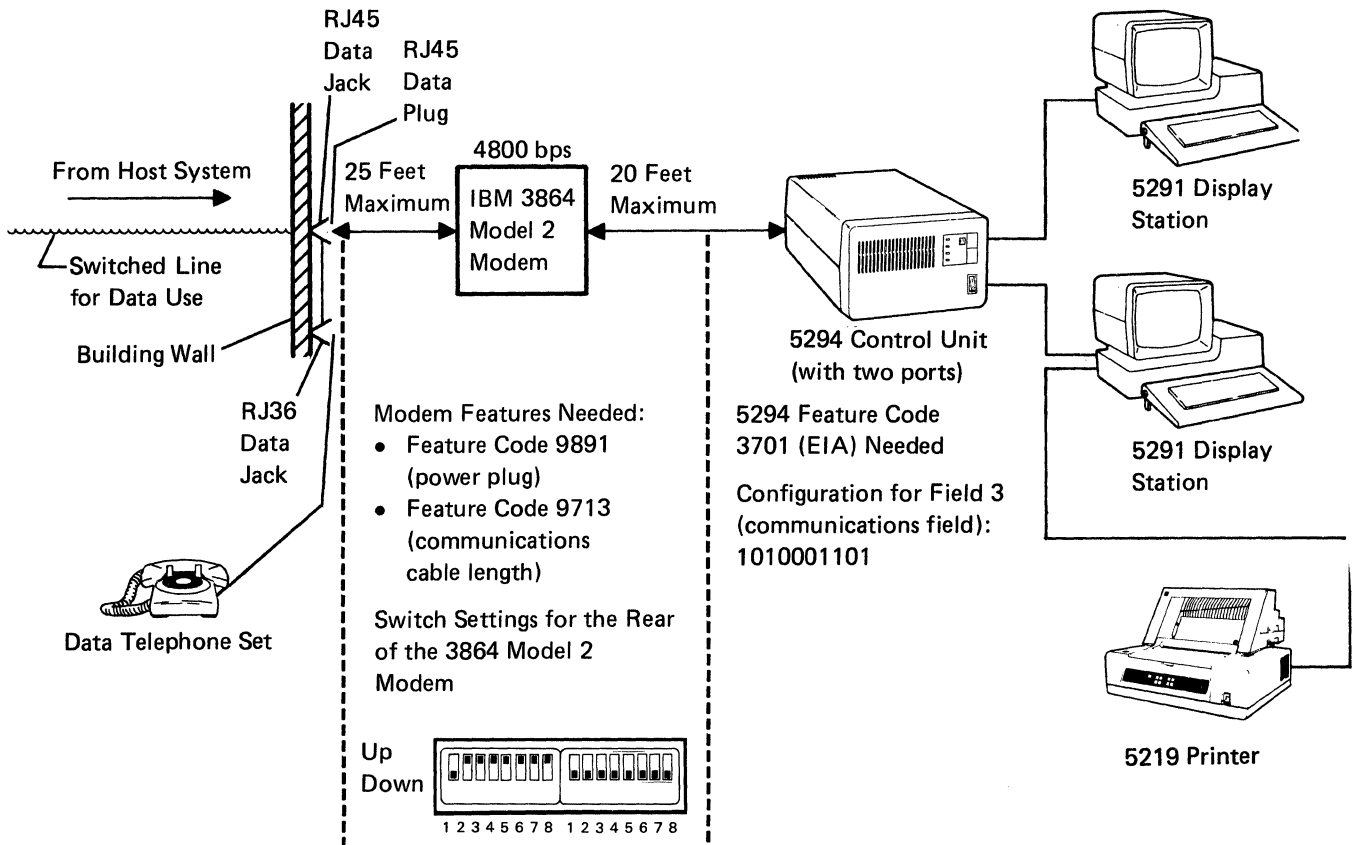
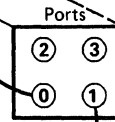
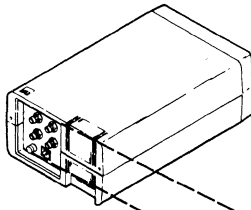

Figure D-3 (Part 2 of 2). Remote End Switched Network Example

IBM 5294 CONTROL UNIT SETUP FORM (PART 1)



5294 Control Unit Information

Name Art
 Location Accounting Office
 City, State New York, New York
 Telephone 212-555-6743
 System Line/Port Number 4
 Location Computer Center
 Telephone 212-555-5112
 Communications Type EIA/CCITT
 Communications Mode SDLC X.25 X.21 sw
 CSR assistance required for communications line connection? Yes No

Name	<u>Jose</u>	Socket 1
Device Type	<u>5291</u>	
Location	<u>Sales</u>	
Work Station Address	<u>0</u>	
Unit Address	<u>00</u>	
Keyboard Code	<u>00</u>	
Telephone		Socket 2

Name	<u>John</u>	Socket 1
Device Type	<u>5291</u>	
Location	<u>Accounting</u>	
Work Station Address	<u>1</u>	
Unit Address	<u>08</u>	
Keyboard Code	<u>00</u>	
Telephone		Socket 2

Name	<u>Greg</u>	Socket 1
Device Type	<u>5291</u>	
Location	<u>Accounting</u>	
Work Station Address	<u>0</u>	
Unit Address	<u>07</u>	
Keyboard Code	<u>None</u>	
Telephone		Socket 2

Name		Socket 1
Device Type		
Location		
Work Station Address		
Unit Address		
Keyboard Code		
Telephone		Socket 2

Socket 1	Name	
	Device Type	
	Location	
	Work Station Address	
	Unit Address	
	Keyboard Code	
Socket 2	Telephone	

Socket 1	Name	
	Device Type	
	Location	
	Work Station Address	
	Unit Address	
	Keyboard Code	
Socket 2	Telephone	

Socket 1	Name	
	Device Type	
	Location	
	Work Station Address	
	Unit Address	
	Keyboard Code	
Socket 2	Telephone	

Socket 1	Name	
	Device Type	
	Location	
	Work Station Address	
	Unit Address	
	Keyboard Code	
Socket 2	Telephone	

Note: Each cable connected to a 5294 port should have a tag with a number from 0 through 3. There should be a cable for each port used. Connect each cable to the port indicated on its tag.

Figure D-4 (Part 1 of 2). Completed 5294 Setup Form for the Second Example

IBM 5294 CONTROL UNIT SETUP FORM (PART 2)

During 5294 setup, you need to enter the information on this form in the entry fields on the appropriate line at the bottom of your display. Also, if a number is beside a D or P on the top part of the form it must be entered.

Note: On the top of each display are the possible work station addresses (0, 1, 2, 3, 4, 5, or 6). On the left side of each display are the port numbers (0/, 1/, 2/, or 3/). Port numbers 2/ and 3/ appear only when the 5294 has four ports.

		Work Station Addresses						
		0	1	2	3	4	5	6
Port Numbers	0/ D	•	•	•	•	•	•	•
	1/ P	D	•	•	•	•	•	•
	2/							
	3/							
If your 5294 communications mode is SDLC, fill in this line.		1-> 00	2-> 02	3-> 1010001101				

If your 5294 communications mode is X.25, fill in this line.

1->	2->	4->	5->	6->
-----	-----	-----	-----	-----

If your 5294 communications mode is X.21 switched, fill in this line.

1->	2->	9->	A->	B->
-----	-----	-----	-----	-----

Cut Along Line

Figure D-4 (Part 2 of 2). Completed 5294 Setup Form for the Second Example

5294 CONTROL UNIT COMMUNICATIONS NETWORK WORKSHEET EXAMPLES

The remainder of this appendix contains two examples of completed communications network worksheets for the 5294 Control Unit. For information on how to complete these forms, see Chapter 5, *Ordering Communications Equipment and Facilities for the 5294 Control Unit*.

First Example

This example shows an analog nonswitched lines communications network worksheet for the 5294 Control Unit. In this example, a company that has two manufacturing plants in different cities with headquarters in a third city is used.

Each plant will have two display stations and one 240 lines per minute printer (5224 Model 2). The display stations will be used for such things as entering production and inventory at different phases in the manufacturing operation, employee time cards, items shipped, and materials received. The printer at each plant will be used for such things as printing shipping orders, payroll, and a daily status report. Most of the printing can be done on second or third shift when the display stations are not being used.

In this example, one multipoint nonswitched network should be adequate. If techniques to minimize the amount of data actually transmitted are used, a speed of 2400 bps might be adequate but 4800 bps would provide better response time.

If due to turnaround time requirements for orders, the printing must be done at the same time the display stations are being used, then at least a 4800 bps transmission line speed would be required. If the volume of printing would require a 400 lines per minute printer (5225 Model 2) at each plant, then a line speed of 9600 bps or higher would be needed.

If line speeds higher than 9600 bps are needed but are not available, then a point-to-point line from the headquarters location to each plant location could be used. Each line would operate at 9600 bps.

(A1) Analog Nonswitched Lines (using IBM modems) Communications Network Worksheet for the 5294 Control Unit

If you will not use this type of network, proceed to the worksheet for the network selected.

Complete this information before you call the telephone company (common carrier). Some of this information may be on your 5294 Control Unit order.

- Network type (choose one of the following):
 - Point-to-point nonswitched
 - Multipoint nonswitched
- Identify the *line type* required for your country and the *modem* that you will be using (this information is in Figure 5-3). Line type 3002 with C1 Modem 3874 (nonswitched)
Conditioning
- Identify the host system (control) modem location. Chicago
- Identify the location of all modems attached to the remote workstation controller(s).
 1. Minneapolis (Plant 1)
 2. New York (Plant 2)
 3. _____
 4. _____
 5. _____
 6. _____
 7. _____
 8. _____
- Enter the transmission speed of the modem that you will be using (see Figure 5-3). 4800 bps
- If in a country other than the US or Canada, enter the PTT homologation approval numbers. (These can be obtained from your IBM sales representative.)

System type _____ Homologation number _____
5294 _____ Homologation number DOES NOT APPLY
Modem type _____ Homologation number _____



A

Call the common carrier/PTT and do the following:

- Order communications lines as required for the network type shown on the previous page.
- Provide the following information as shown on the previous page:
 - Line type
 - Host system (control) modem location
 - Location of all other modems
 - Transmission speed of the modem (if requested)
 - If in a country other than the US or Canada, the PTT homologation approval numbers

Go to Chapter 4.

Second Example

This example is similar to the first example, but is for an X.25 packet switched network.

(D)

X.25 Packet Switched Communications Network Worksheet for the 5294 Control Unit

If you will not use this type of network, go back to Figure 5-2 and review the networks available.

Complete this information before you call the PTT/network supplier. Some of this information may be on your 5294 order. The other information is determined by the type of network you select.

- Determine the type of communications (also known as communications feature or interface) ordered:

- X.21 bis (EIA/CCITT) (sales feature 3701)
- X.21 (X.24/X.27) Signal Converter (sales feature 5655)

- Identify the location of the 5294 and the virtual circuit(s) it will have. The virtual circuit type is either permanent virtual circuit (PVC) or switched virtual circuit (SVC). The type of virtual circuit the 5294 will use must be the same as the one used for the host system.

Location Paris (Sales Office)

Circuit type(s):

PVC

Quantity 1

SVC

Quantity

Note: If the 5294 will be communicating with more than one host system, identify the type of virtual circuit used to communicate with each host system location.

1. Virtual circuit type PVC Host system location Paris (Headquarters)
2. Virtual circuit type Host system location

- Enter the transmission speed required. 4800 bps
- Identify the network facilities that you want.

Note: The following list of facilities may include some not available from your PTT/network supplier and may not include others that are available. Contact your IBM sales representative and/or your PTT/network supplier if you need information on the use and/or availability of network facilities.

- Closed user group No
- Flow control negotiation (available with SVC only)
- Reverse charging accepted by the host system No
- Reverse charging accepted by the 5294 No
- Other facilities that the PTT/network supplier may provide None

- If in a country other than the US or Canada, enter the PTT homologation approval numbers. (These can be obtained from your IBM sales representative.)

System type Homologation number

5294 Homologation number

N

N

Call the PTT/network supplier and do the following:

- Order the network facilities and communications lines for the transmission speed required. (See the preceding chart.)
- Ask for the following information:
 - Packet window size
Note: In position 2 of block 4 below, enter the number for the packet window size as specified by your network supplier. Valid numbers are 2 through 7.
 - Link window size
Note: In position 3 of block 4 below, enter the number for the link window size as specified by your network supplier. Valid numbers are 1 through 7.

O

Block 4

1	2	3
0	2	7

Note: The setting in this block will be used to complete Chapter 4.



• Also ask for the following information from the PTT/network supplier and discuss the advantages of each packet size, subscribing to flow control negotiation, and other optional facilities for your configuration on this network.

- Packet size 64 128 256
- Is flow control negotiation provided (SVC only)? Yes No

Do one of the following:

- a. If your 5294 will be using only one virtual circuit, enter the number for the packet size as specified below into position 1 of block 5.
- b. If your 5294 will be using more than one PVC, but no SVC, and the PVCs have different packet sizes, enter the number for the most often used packet size as specified below into position 1 of block 5.
- c. If your 5294 will be using both PVC and SVC and flow control negotiation is not provided, enter the number for the packet size of the SVC as specified below into position 1 of block 5.
- d. If your 5294 will be using both PVC and SVC and flow control negotiation is provided, enter the number for the most often used packet size as specified below into position 1 of block 5.

Packet Size	Enter in Position 1 of Block 5
64	0
128	1
256	2

• Answer the following questions only if you will have an SVC subscription. If you will not have an SVC subscription, enter a 0 in position 3 of block 5.

- Will your subscription include flow control negotiation? Yes No

Note: In position 3 of block 5, enter a 1 if your subscription will include flow control negotiation or a 0 if it will not.

- Will your subscription include reverse charging accepted by the host system? (This information will be needed later for operating the 5294.) Yes No
- Will your subscription include closed user group? (This information will be needed later for operating the 5294.) Yes No



Block 5

1	2	3	4	5	6	7
1	1	0		0	0	0

Note: The setting in this block will be used to complete Chapter 4.

- If positions 5, 6, and 7 are still blank after completing the next page, enter a 0 in all three positions.
- The possible settings for this position are discussed in Chapter 4.
- In position 2, enter a 0 if SVC or dual connection (both SVC and PVC) or enter a 1 if PVC. (See the first chart on the previous page for the circuit type.)

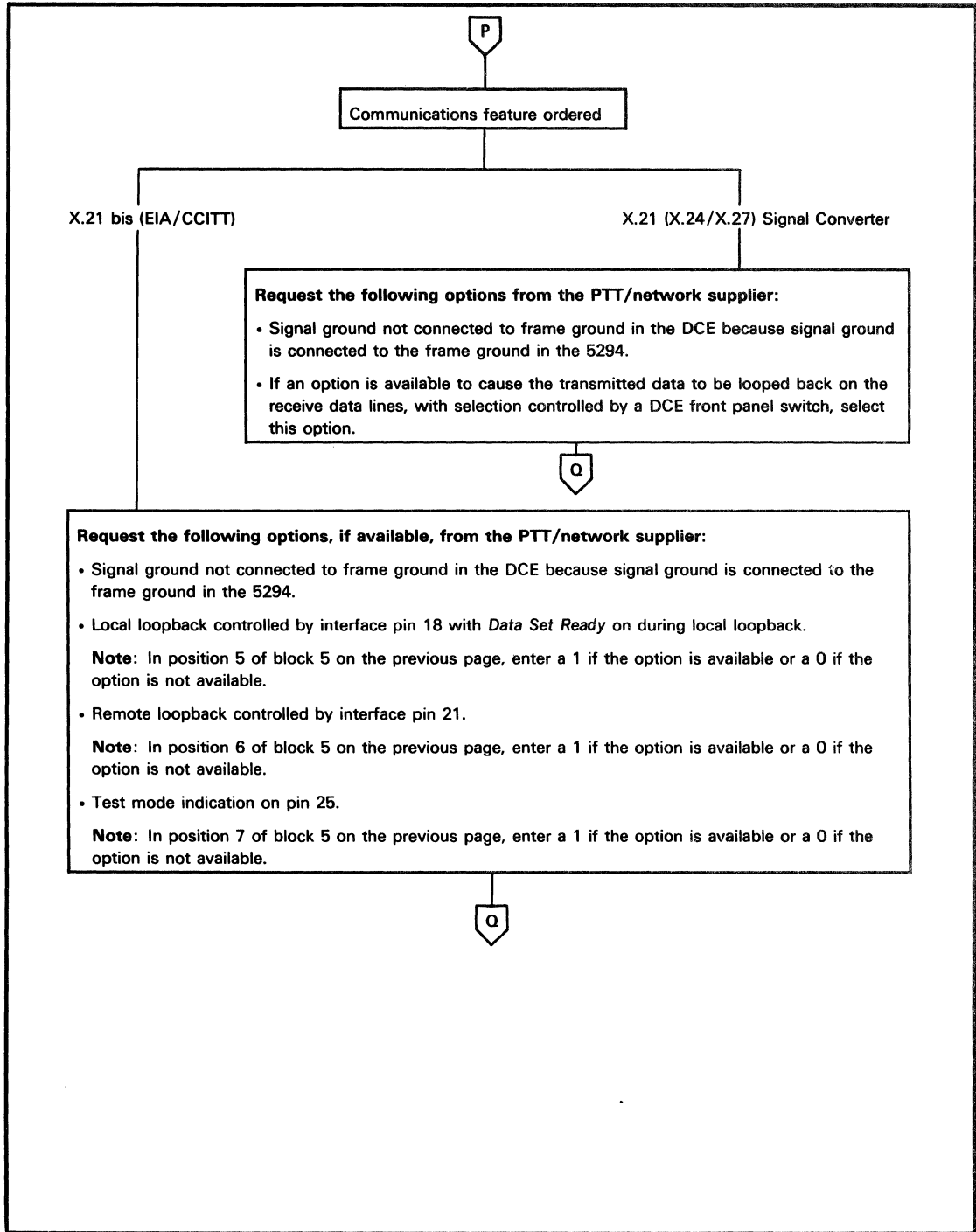

Q

Ask the PTT/network supplier for the following information:

Note: This information will be required by the 5294 and/or the host system operator when using the communications network. If some of this information is not available now, fill it in later when it becomes available.

- For each PVC:

Logical Circuit ID	System Location
1. <u>001</u>	<u>Paris</u>
2. _____	_____

- For SVC, the systems that the 5294 will be communicating with:

System Location	Network Address
1. _____	_____
2. _____	_____
3. <u>DOES NOT APPLY</u>	<u>DOES NOT APPLY</u>
4. _____	_____
5. _____	_____

- If reverse charging will be accepted by the 5294

Note: In position 1 of block 6 below, enter a 1 if reverse charging will be accepted by the 5294 or a 0 if reverse charging will not be accepted by the 5294.

- If the network is a Telenet type network (for example, the United Kingdom Switchstream 1 Network)

Note: In position 4 of block 6 below, enter a 1 if the network will be a Telenet type network or a 0 if the network will be other than a Telenet type network.

- How the link will be initialized

- If *either the 5294 or the network* will be able to initialize the link, enter a 0 in position 5 of block 6 below.
- If *only the network* will be able to initialize the link, enter a 1 in position 5 of block 6 below.

Go to Chapter 4.

Block 6

1	2	3	4	5	6	7	8
0			0	0	0	0	0

Note: The setting in this block will be used to complete Chapter 4.

The possible settings for these positions are discussed in Chapter 4.



Appendix E. 5294 Control Unit Communications Network Worksheets

This appendix contains additional copies of the communications network worksheets from Chapter 5. See Chapter 5 for instructions on completing these worksheets.

Getting Started

Site Considerations

System Specifications

5294 Configuration and Communications

5251 Model 12 Communications and Configuration

Cables

Appendixes

A1

Analog Nonswitched Lines (Using IBM Modems) Communications Network Worksheet for the 5294 Control Unit

If you will not use this type of network, proceed to the worksheet for the network selected.

Complete this information before you call the telephone company (common carrier). Some of this information may be on your 5294 Control Unit order.

- Network type (choose one of the following):
 - Point-to-point nonswitched
 - Multipoint nonswitched
- Identify the *line type* required for your country and the *modem* that you will be using (this information is in Figure 5-1). Line type _____ Modem _____
- Identify the host system (control) modem location. _____
- Identify the location of all modems attached to the remote workstation controller(s).
 1. _____
 2. _____
 3. _____
 4. _____
 5. _____
 6. _____
 7. _____
 8. _____
- Enter the transmission speed of the modem that you will be using (see Figure 5-1). _____ bps
- If in a country other than the US or Canada, enter the PTT homologation approval numbers.
(These can be obtained from your IBM sales representative.)

System type _____	Homologation number _____
5294 Control Unit _____	Homologation number _____
Modem type _____	Homologation number _____



A

Call the common carrier/PTT and do the following:

- Order communications lines as required for the network type shown on the previous page.
- Provide the following information as shown on the previous page:
 - Line type
 - Host system (control) modem location
 - Location of all other modems
 - Transmission speed of the modem (if requested)
 - If in a country other than the US or Canada, the PTT homologation approval numbers

Go to Chapter 4.

A2

Analog Switched Lines (Using IBM Modems) Communications Network Worksheet for the 5294 Control Unit

If you will not use this type of network, proceed to the worksheet for the network selected.

Complete this information before you call the telephone company (common carrier). Some of this information may be on your 5294 Control Unit order.

- Identify the host system (control) modem location. _____
- Identify the location of all modems attached to the remote workstation controller(s).
 1. _____
 2. _____
 3. _____
 4. _____
 5. _____
 6. _____
 7. _____
 8. _____
- Enter the transmission speed of the modem that you will be using (see Figure 5-1). _____ bps
- If in a country other than the US or Canada, enter the PTT homologation approval numbers. (These can be obtained from your IBM sales representative.)

System type _____	Homologation number _____
5294 Control Unit _____	Homologation number _____
Modem type _____	Homologation number _____
- Identify your country and modem type in one of the two groups below and go to the appropriate chart.

– IBM 3863, 3864, or 3865 in all countries	– IBM 3872, 3874, or 3875 in the US
– IBM 3872, 3874, or 3875 in countries other than the US	

Call a data coupler supplier and do the following.

- Order a CBS type data coupler for each modem you will use.
- Ask for the following:
 - Coupler make/model _____
 - FCC registration number _____
 - Ringer equivalence number _____
 - Telephone set options to specify _____

B

C

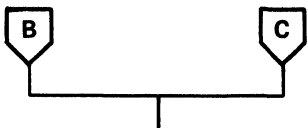

Call the common carrier/PTT and do the following:

- Order switched communications lines for data transmission at the transmission speed shown for the modem on the previous page.
- Tell where all the modems are located (see the previous page).
- Do one of the following:
 - For the IBM 3863, 3864, or 3865 modem, provide the FCC registration and ringer equivalence information listed below for your modem.

Modem	FCC Registration Number	Ringer Equivalence
IBM 3863 Model 2	AN09SA-67992-DP-N	0.8B
IBM 3864 Model 2	AN09SA-67992-DP-N	0.8B
IBM 3863 Model 1 (with 4-wire switched network backup)	AN09SA-67935-DP-N	0.8B
IBM 3864 Model 1 (with 4-wire switched network backup)	AN09SA-67935-DP-N	0.8B
IBM 3865 Model 1 or 2 (with 4-wire switched network backup)	AN09SA-67935-DP-N	0.8B

Note: The IBM 3863 Model 1, 3864 Model 1, 3865 Model 1, and 3865 Model 2, require ordering two switched communications lines for each modem in addition to the nonswitched line.

- For the IBM 3872, 3874, or 3875 modem, provide the data coupler information you completed on the previous page.
- If in Canada, order a CBS type data coupler.
- If in a country other than the US or Canada, specify the PTT homologation approval numbers (see the previous page).

Go to Chapter 4.

A3

Analog Nonswitched Lines (Using Non-IBM Modems) Communications Network Worksheet for the 5294 Control Unit

If you will not use this type of network, proceed to the worksheet for the network selected.

Complete this information before you call the telephone company (common carrier) or the modem supplier. Some of this information may be on your 5294 Control Unit order.

- Network type (choose one of the following):
 - Point-to-point nonswitched
 - Multipoint nonswitched
- Identify the host system (control) modem location. _____
- Identify the location of all modems attached to the remote workstation controller(s).
 1. _____
 2. _____
 3. _____
 4. _____
 5. _____
 6. _____
 7. _____
 8. _____
- Enter the transmission speed required. _____ bps
- If in a country other than the US or Canada, enter the PTT homologation approval numbers. (These can be obtained from your IBM sales representative.)

System type _____	Homologation number _____
5294 Control Unit _____	Homologation number _____

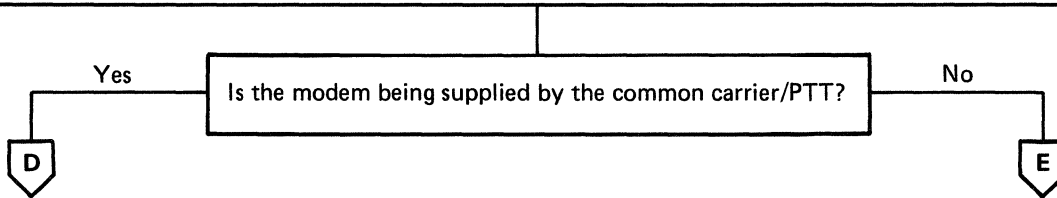

Call the common carrier/PTT and do the following:

- Order modems and communications lines as required for the network type shown on the previous page.
- Provide the following information (see the previous page):
 - Host system (control) modem location
 - Location of all other modems
 - Transmission speed required
 - For countries other than the US and Canada, the PTT homologation approval numbers (if applicable)
- Specify the following options for the modems (for a description of modem options, see *Modem/DCE Information for the 5294 Control Unit* in Chapter 5):
 - *Clear to Send* (CTS) (also referred to as *Ready for Sending* [RFS]) controlled by *Request to Send* (RTS)
 - Carrier controlled by *Request to Send* (switched carrier)
 - Signal ground not connected to frame ground in the modem because signal ground is connected to the frame ground in the 5294 Control Unit
- Ask if the following options are available and if they are, request them:
 - Local loopback controlled by interface pin 18 with *Data Set Ready* on during local loopback
Note: In position 8 of the block below, enter a 1 if the option is available or a 0 if not available.
 - Remote loopback controlled by interface pin 21
Note: In position 9 of the block below, enter a 1 if the option is available or a 0 if not available.
 - Test mode indication on pin 25
Note: In position 10 of the block below, enter a 1 if the option is available or a 0 if not available.
- Ask for the following information:
 - Modem operating mode:
 - a. If *Duplex*, enter a 1 in position 2 of the block below
 - b. If *Half duplex*, enter a 0 in position 2 of the block below
 - Recommended SDLC transmission mode:
 - a. If *NRZI*, enter a 0 in position 4 of the block below
 - b. If *NRZ*, enter a 1 in position 4 of the block below
 - c. If *no recommendation*, enter a 0 in position 4 of the block below
 - For countries other than the US and Canada, also ask for the interface pin 20 usage:
 - a. If *DTR (108.2)*, enter a 0 in position 5 of the block below
 - b. If *CDSTL (108.1)*, enter a 1 in position 5 of the block below
 - Does the modem require a leading pad to be transmitted prior to the SDLC flag?
 - a. If *Yes*, enter a 1 in position 6 of the block below
 - b. If *No*, enter a 0 in position 6 of the block below

Go to Chapter 4.

1	2	3	4	5	6	7	8	9	10
0						0			

In the US and Canada, enter a 0 in position 5.

In position 3, enter a 0 if multipoint or a 1 if point-to-point (see the previous page).

Note: The setting in this block will be used to complete Chapter 4.

E

Call the modem supplier and do the following:

- Order modems.
- Specify the network type and transmission speed for the modem required (see the first chart in this section).
- Specify the following options for the modems (for a description of modem options, see *Modem/DCE Information for the 5294 Control Unit* in Chapter 5):
 - *Clear to Send* (CTS) (also referred to as *Ready for Sending* [RFS]) controlled by *Request to Send* (RTS)
 - Carrier controlled by *Request to Send* (switched carrier)
 - Signal ground not connected to frame ground in the modem because signal ground is connected to the frame ground in the 5294 Control Unit
- Ask if the following options are available and if they are, request them:
 - Local loopback controlled by interface pin 18 with *Data Set Ready* on during local loopback
Note: In position 8 of the block below, enter a 1 if the option is available or a 0 if not available.
 - Remote loopback controlled by interface pin 21
Note: In position 9 of the block below, enter a 1 if the option is available or a 0 if not available.
 - Test mode indication on pin 25
Note: In position 10 of the block below, enter a 1 if the option is available or a 0 if not available.
- Ask for the following:
 - Line type required _____
 - Line conditioning required _____
 - Modem operating mode:
 - a. If *Duplex*, enter a 1 in position 2 of the block below
 - b. If *Half duplex*, enter a 0 in position 2 of the block below
 - Recommended SDLC transmission mode:
 - a. If *NRZI*, enter a 0 in position 4 of the block below
 - b. If *NRZ*, enter a 1 in position 4 of the block below
 - c. If *no recommendation*, enter a 0 in position 4 of the block below
 - For countries other than the US and Canada, also ask for the interface pin 20 usage:
 - a. If *DTR (108.2)*, enter a 0 in position 5 of the block below
 - b. If *CDSTL (108.1)*, enter a 1 in position 5 of the block below
 - Does the modem require a leading pad to be transmitted prior to the SDLC flag?
 - a. If *Yes*, enter a 1 in position 6 of the block below
 - b. If *No*, enter a 0 in position 6 of the block below

F

1	2	3	4	5	6	7	8	9	10
0						0			

In the US and Canada, enter a 0 in position 5.

In position 3, enter a 0 if multipoint or a 1 if point-to-point (see the first chart in this section).

Note: The setting in this block will be used to complete Chapter 4.

F

Call the common carrier/PTT and do the following:

- Order communications lines as required.
- Tell where all the modems are located (see the first chart in this section). For multipoint nonswitched operation, specify which location is the host system (control) location.
- If in a country other than the US or Canada, specify the PTT homologation approval numbers (see the first chart in this section).

Go to Chapter 4.

A4

Analog Switched Lines (Using Non-IBM Modems) Communications Network Worksheet for the 5294 Control Unit

If you will not use this type of network, proceed to the worksheet for the network selected.

Complete this information before you call the telephone company (common carrier) or the modem supplier. Some of this information may be on your 5294 order.

- Identify the host system (control) modem location. _____
- Identify the location of all modems attached to the remote workstation controller(s).
 1. _____
 2. _____
 3. _____
 4. _____
 5. _____
 6. _____
 7. _____
 8. _____
- Enter the transmission speed required. _____ bps
- If in a country other than the US or Canada, enter the PTT homologation approval numbers. (These can be obtained from your IBM sales representative.)
System type _____ Homologation number _____
5294 Control Unit Homologation number _____

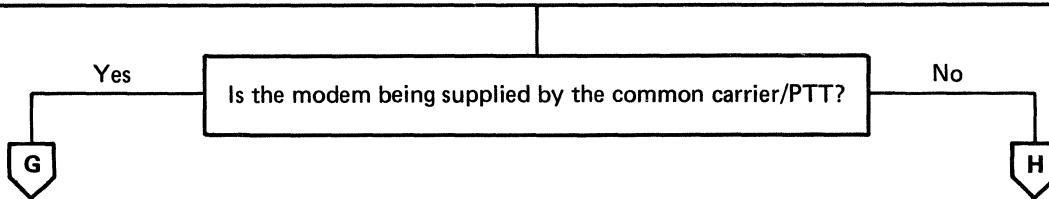

Call the common carrier/PTT and do the following:

- Order modems and switched communications lines as required.
- Provide the following information (see previous page):
 - Location of all modems
 - Transmission speed required
 - For countries other than the US and Canada, the PTT homologation approval numbers (if applicable)
- Specify the following options for the modems (for a description of modem options, see *Modem/DCE Information for the 5294 Control Unit* in Chapter 5):
 - *Clear to Send* (CTS) (also referred to as *Ready for Sending* [RFS]) controlled by *Request to Send* (RTS)
 - Carrier controlled by *Request to Send* (switched carrier)
 - Signal ground not connected to frame ground in the modem because signal ground is connected to the frame ground in the 5294 Control Unit
 - EIA/CCITT signal level required on interface pin 22
 - Autoanswer controlled by DTR (or CDSTL) only
- Ask if the following options are available and if they are, request them:
 - Local loopback controlled by interface pin 18 with *Data Set Ready* on during local loopback
Note: In position 8 of the block below, enter a 1 if the option is available or a 0 if not available.
 - Remote loopback controlled by interface pin 21
Note: In position 9 of the block below, enter a 1 if the option is available or a 0 if not available.
 - Test mode indication on pin 25
Note: In position 10 of the block below, enter a 1 if the option is available or a 0 if not available.
- Ask for the following information:
 - Modem operating mode:
 - a. If *Duplex*, enter a 1 in position 2 of the block below
 - b. If *Half duplex*, enter a 0 in position 2 of the block below
 - Recommended SDLC transmission mode:
 - a. If *NRZI*, enter a 0 in position 4 of the block below
 - b. If *NRZ*, enter a 1 in position 4 of the block below
 - c. If *no recommendation*, enter a 0 in position 4 of the block below
 - For countries other than the US and Canada, also ask for the interface pin 20 usage:
 - a. If *DTR (108.2)*, enter a 0 in position 5 of the block below
 - b. If *CDSTL (108.1)*, enter a 1 in position 5 of the block below
 - Does the modem require a leading pad to be transmitted prior to the SDLC flag?
 - a. If *Yes*, enter a 1 in position 6 of the block below
 - b. If *No*, enter a 0 in position 6 of the block below

Go to Chapter 4.

1	2	3	4	5	6	7	8	9	10
1		1				0			

In the US and Canada, enter a 0 in position 5.

Note: The setting in this block will be used to complete Chapter 4.



Call the modem supplier and do the following:

- Order modems for use on switched communications lines.
- Provide the following information (see the first chart in this section):
 - Location of all modems
 - Transmission speed required
- Specify the following options for the modems (for a description of modem options, see *Modem/DCE Information for the 5294 Control Unit* in Chapter 5):
 - *Clear to Send* (CTS) (also referred to as *Ready for Sending* [RFS]) controlled by *Request to Send* (RTS)
 - Carrier controlled by *Request to Send* (switched carrier)
 - Signal ground not connected to frame ground in the modem because signal ground is connected to the frame ground in the 5294 Control Unit
 - EIA/CCITT signal level required on interface pin 22
 - Autoanswer controlled by DTR (or CDSTL) only
- Ask if the following options are available and if they are, request them:
 - Local loopback controlled by interface pin 18 with *Data Set Ready* on during local loopback
Note: In position 8 of the block below, enter a 1 if the option is available or a 0 if not available.
 - Remote loopback controlled by interface pin 21
Note: In position 9 of the block below, enter a 1 if the option is available or a 0 if not available.
 - Test mode indication on pin 25
Note: In position 10 of the block below, enter a 1 if the option is available or a 0 if not available.
- Ask for the following information:
 - Modem operating mode:
 - a. If *Duplex*, enter a 1 in position 2 of the block below
 - b. If *Half duplex*, enter a 0 in position 2 of the block below
 - Recommended SDLC transmission mode:
 - a. If *NRZI*, enter a 0 in position 4 of the block below
 - b. If *NRZ*, enter a 1 in position 4 of the block below
 - c. If *no recommendation*, enter a 0 in position 4 of the block below
 - For countries other than the US and Canada, also ask for the interface pin 20 usage:
 - a. If *DTR (108.2)*, enter a 0 in position 5 of the block below
 - b. If *CDSTL (108.1)*, enter a 1 in position 5 of the block below
 - Does the modem require a leading pad to be transmitted prior to the SDLC flag?
 - a. If *Yes*, enter a 1 in position 6 of the block below
 - b. If *No*, enter a 0 in position 6 of the block below

Continued on the next page



1	2	3	4	5	6	7	8	9	10
1		1				0			

In the US and Canada, enter a 0 in position 5.

Note: The setting in this block will be used to complete Chapter 4.



- Ask for the following information (continued)
 - In the US and Canada, the type of external data coupler required (if any) _____
 - In the US only, if no external data coupler is required, then:
 - a. Make of modem _____
 - b. FCC registration number of the modem _____
 - c. Ringer equivalence number of the modem _____
 - d. Telephone set options to specify for the modem _____
 - In countries other than the US and Canada, the PTT homologation approval number for the modem _____

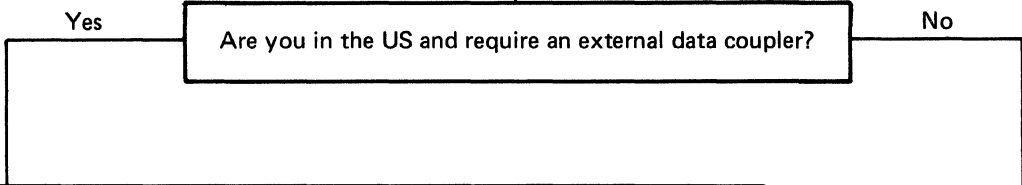

Call a data coupler supplier and do the following.

- Order a data coupler as required for the modem you will use.
- Ask for the following information about the data coupler:
 - Make and model _____
 - FCC registration number _____
 - Ringer equivalence number _____
 - Telephone set options to specify _____

Call the common carrier/PTT and do the following:

- Order switched communications lines as required
- Specify the transmission speed that will be required (see the first chart in this section)
- Tell where all the modems are located (see the first chart in this section)
- In the US only, provide FCC registration information as obtained from the modem or data coupler supplier
- In Canada, order a data coupler, if required (see the first chart in this section)
- If in a country other than the US or Canada, specify the PTT homologation approval numbers (see the first chart in this section and the first chart on this page)

Go to Chapter 4.

B

AT & T DDS Public Data Communications Network Worksheet for the 5294 Control Unit

If you will not use this type of network, proceed to the worksheet for the network selected.

Complete this information before you call the telephone company (common carrier). Some of this information may be on your 5294 order.

- Network type (choose one of the following):
 - Point-to-point nonswitched
 - Multipoint nonswitched
- Speed of transmission required for the DCE:
 2400 bps 4800 bps 9600 bps 56,000 bps
- Identify the host system (control) location. _____
- Identify the location of all 5294 Control Units attached to the host system.
 1. _____
 2. _____
 3. _____
 4. _____
 5. _____
 6. _____

What type of communications (also known as interface or communications feature) was ordered for your 5294?

DDSA
(sales feature code
5650 or 5651)

EIA/CCITT
(sales feature code 3701)
For 2400, 4800, or 9600 bps only



J

K

Call the common carrier and do the following:

- Order DDS for the network type shown on the previous page.
- Specify the following:
 - Connection to the DDS is to be made using a data service unit
 - Signal ground is not to be connected to the frame ground in the DDS because signal ground is connected to the frame ground in the 5294 Control Unit
 - Provide the following information as shown on the previous page:
 - a. Transmission speed for the DCE
 - b. Host system (control) location
 - c. The location of all 5294s attached to the host system

Go to Chapter 4.

Call the common carrier and do the following:

- Order DDS for the network type shown on the previous page.
- Specify the following:
 - Connection to the DDS is to be made using a channel service unit
 - Signal ground is not to be connected to the frame ground in the channel service unit because signal ground is connected to the frame ground in the 5294 Control Unit
 - Provide the following information as shown on the previous page:
 - a. Transmission speed for the DCE
 - b. Host system (control) location
 - c. The location of all 5294s attached to the host system

Go to Chapter 4.



Call the PTT/network supplier and do the following:

- Order DCEs and communications lines for the transmission speed required. (See the first chart on the previous page for the transmission speed for the DCE.)
- Specify the following DCE options (for a description of DCE options, see *Modem/DCE Information for the 5294 Control Unit* in Chapter 5):
 - *Clear to Send* (CTS) (also referred to as *Ready for Sending* [RFS]) controlled by *Request to Send* (RTS)
 - Carrier controlled by *Request to Send* (switched carrier)
 - Signal ground not connected to frame ground in the DCE because signal ground is connected to the frame ground in the 5294 Control Unit.
- Ask if the following options are available and if they are, request them:
 - Local loopback controlled by interface pin 18 with *Data Set Ready* on during local loopback
Note: In position 8 of the block below, enter a 1 if the option is available or a 0 if not available.
 - Remote loopback controlled by interface pin 21
Note: In position 9 of the block below, enter a 1 if the option is available or a 0 if not available.
 - Test mode indication on pin 25
Note: In position 10 of the block below, enter a 1 if the option is available or a 0 if not available.
- Ask for the following information:
 - DCE operating mode:
 - a. If *Duplex*, enter a 1 in position 2 of the block below
 - b. If *Half duplex*, enter a 0 in position 2 of the block below
 - For countries other than the US and Canada, also ask for the interface pin 20 usage:
 - a. If *DTR (108.2)*, enter a 0 in position 5 of the block below
 - b. If *CDSTL (108.1)*, enter a 1 in position 5 of the block below

Go to Chapter 4.

1	2	3	4	5	6	7	8	9	10
0			1		0	0			

In the US and Canada, enter a 0 in position 5.

In position 3, enter a 0 if multipoint or a 1 if point-to-point (see the previous page).

Note: The setting in this block is for an X.21 network with X.21 bis interface only and will be used to complete Chapter 4.

C2

X.21 Switched Public Data Communications Network Worksheet for the 5294 Control Unit

If you will not use this type of network, proceed to the worksheet for the network selected.

Complete this information before you call the PTT/network supplier. Some of this information may be on your 5294 order. The other information is determined by the type of network you select.

● Determine the type of communications (also known as communications feature or interface) ordered:

- X.21 bis (EIA/CCITT) (sales Feature 3701)
- X.21 (X.24/X.27) Signal Converter (sales feature 5655)

● Identify the location of the 5294. _____

Note: If the 5294 will be communicating with more than one host system, identify each host system location.

1. Host system location _____
2. Host system location _____

● Enter the transmission speed required. _____ bps

● Identify the network facilities that you want.

Note: The following list of facilities may include some not available from your PTT/network supplier and may not include others that are available. Contact your IBM sales representative and/or your PTT/network supplier if you need information on the use and/or availability of network facilities.

- | | |
|-------------------------------------------------------------------------------------|-----------------------------------------------------------------------|
| <input type="checkbox"/> Abbreviated address calling | <input type="checkbox"/> Incoming calls barred |
| <input type="checkbox"/> Charge transfer | <input type="checkbox"/> Outgoing calls barred |
| <input type="checkbox"/> Closed user group | <input type="checkbox"/> Registration/cancellation of user facilities |
| <input type="checkbox"/> Closed user group with outgoing access | <input type="checkbox"/> Redirection of call |
| <input type="checkbox"/> Direct call | <input type="checkbox"/> RPOA selection |
| <input type="checkbox"/> Other facilities that the PTT/network supplier may provide | |

● If in a country other than the United States or Canada, enter the PTT homologation approval numbers. (These can be obtained from your IBM sales representative.)

System Type _____	Homologation number _____
5294 Control Unit _____	Homologation number _____
DCE type _____	Homologation number _____

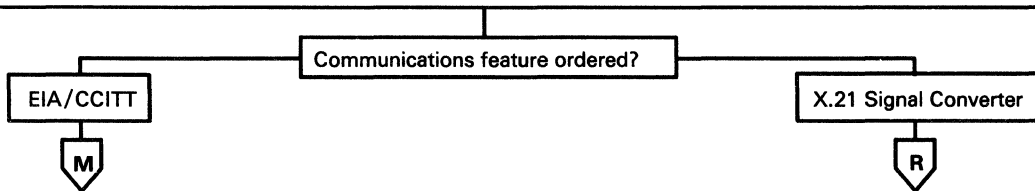

A0653083-0



Call the PTT/network supplier and do the following:

- Order DCEs and communications lines for the transmission speed required. (See the first chart in this section.)
- Specify the following DCE options (for a description of DCE options, see *Modem/DCE Information for the 5294 Control Unit* in Chapter 5):
 - *Clear to Send* (CTS) (also referred to as *Ready for Sending* [RFS]) controlled by *Request to Send* (RTS)
 - Carrier controlled by *Request to Send* (switched carrier)
 - Signal ground not connected to frame ground in the DCE because signal ground is connected to the frame ground in the 5294 Control Unit
 - EIA/CCITT signal level required on interface pin 22
 - Autoanswer controlled by DTR (or CDSTL) only
- Ask if the following options are available and if they are, request them:
 - Local loopback controlled by interface pin 18 with *Data Set Ready* on during local loopback
Note: In position 8 of the block below, enter a 1 if the option is available or a 0 if not available.
 - Remote loopback controlled by interface pin 21
Note: In position 9 of the block below, enter a 1 if the option is available or a 0 if not available.
 - Test mode indication on pin 25
Note: In position 10 of the block below, enter a 1 if the option is available or a 0 if not available.
- Ask for the following information:
 - DCE operating mode:
 - a. If *Duplex*, enter a 1 in position 2 of the block below
 - b. If *Half duplex*, enter a 0 in position 2 of the block below
 - For countries other than the US and Canada, also ask for the interface pin 20 usage:
 - a. If *DTR (108.2)*, enter a 0 in position 5 of the block below
 - b. If *CDSTL (108.1)*, enter a 1 in position 5 of the block below

Go to Chapter 4.

1	2	3	4	5	6	7	8	9	10
1		0	1		0	0			

In the US and Canada, enter a 0 in position 5.

Note: The setting in this block will be used to complete Chapter 4.

D

X.25 Packet Switched Communications Network Worksheet for the 5294 Control Unit

If you will not use this type of network, go back to Figure 5-2 and review the networks available.

Complete this information before you call the PTT/network supplier. Some of this information may be on your 5294 order. The other information is determined by the type of network you select.

- Determine the type of communications (also known as communications feature or interface) ordered:
 - X.21 bis (EIA/CCITT) (sales feature 3701)
 - X.21 (X.24/X.27) Signal Converter (sales feature 5655)
- Identify the location of the 5294 and the virtual circuit(s) it will have. The virtual circuit type is either permanent virtual circuit (PVC) or switched virtual circuit (SVC). The type of virtual circuit the 5294 will use must be the same as the one used for the host system.

Location _____ Circuit type(s):
PVC _____ Quantity _____
SVC _____ Quantity _____

Note: If the 5294 will be communicating with more than one host system, identify the type of virtual circuit used to communicate with each host system location.

1. Virtual circuit type _____ Host system location _____
2. Virtual circuit type _____ Host system location _____

- Enter the transmission speed required. _____ bps
- Identify the network facilities that you want.

Note: The following list of facilities may include some not available from your PTT/network supplier and may not include others that are available. Contact your IBM sales representative and/or your PTT/network supplier if you need information on the use and/or availability of network facilities.

- Closed user group
- Flow control negotiation (available with SVC only)
- Reverse charging accepted by the host system
- Reverse charging accepted by the 5294
- Other facilities that the PTT/network supplier may provide _____

- If in a country other than the US or Canada, enter the PTT homologation approval numbers. (These can be obtained from your IBM sales representative.)

System type _____ Homologation number _____
5294 Control Unit Homologation number _____





Call the PTT/network supplier and do the following:

- Order the network facilities and communications lines for the transmission speed required. (See the preceding chart.)
- Ask for the following information:
 - Packet window size
Note: In position 2 of block 4 below, enter the number for the packet window size as specified by your network supplier. Valid numbers are 2 through 7.
 - Link window size
Note: In position 3 of block 4 below, enter the number for the link window size as specified by your network supplier. Valid numbers are 1 through 7.



Block 4

1 2 3

0		
---	--	--

Note: The setting in this block will be used to complete Chapter 4.



• Also ask for the following information from the PTT/network supplier and discuss the advantages of each packet size, subscribing to flow control negotiation, and other optional facilities for your configuration on this network.

- Packet size 64 _____ 128 _____ 256 _____
- Is flow control negotiation provided (SVC only)? Yes _____ No _____

Do one of the following:

- a. If your 5294 will be using only one virtual circuit, enter the number for the packet size as specified below into position 1 of block 5.
- b. If your 5294 will be using more than one PVC, but no SVC, and the PVCs have different packet sizes, enter the number for the most often used packet size as specified below into position 1 of block 5.
- c. If your 5294 will be using both PVC and SVC and flow control negotiation is not provided, enter the number for the packet size of the SVC as specified below into position 1 of block 5.
- d. If your 5294 will be using both PVC and SVC and flow control negotiation is provided, enter the number for the most often used packet size as specified below into position 1 of block 5.

Packet Size	Enter in Position 1 of Block 5
64	0
128	1
256	2

• Answer the following questions only if you will have an SVC subscription. If you will not have an SVC subscription, enter a 0 in position 3 of block 5.

- Will your subscription include flow control negotiation? Yes _____ No _____

Note: In position 3 of block 5, enter a 1 if your subscription will include flow control negotiation or a 0 if it will not.

- Will your subscription include reverse charging accepted by the host system? (This information will be needed later for operating the 5294.) Yes _____ No _____
- Will your subscription include closed user group? (This information will be needed later for operating the 5294.) Yes _____ No _____

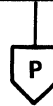

Block 5

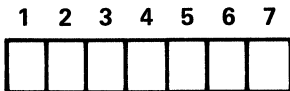

If positions 5, 6, and 7 are still blank after completing the next page, enter a 0 in all three positions.

The possible settings for this position are discussed in Chapter 4.

In position 2, enter a 0 if SVC or dual connection (both SVC and PVC) or enter a 1 if PVC. (See the first chart on the previous page for the circuit type.)

Note: The setting in this block will be used to complete Chapter 4.

P

Communications feature ordered

X.21 bis (EIA/CCITT)

X.21 (X.24/X.27) Signal Converter

Request the following options from the PTT/network supplier:

- Signal ground not connected to frame ground in the DCE because signal ground is connected to the frame ground in the 5294.
- If an option is available to cause the transmitted data to be looped back on the receive data lines, with selection controlled by a DCE front panel switch, select this option.

Q

Request the following options, if available, from the PTT/network supplier:

- Signal ground not connected to frame ground in the DCE because signal ground is connected to the frame ground in the 5294.
- Local loopback controlled by interface pin 18 with *Data Set Ready* on during local loopback.
Note: In position 5 of block 5 on the previous page, enter a 1 if the option is available or a 0 if the option is not available.
- Remote loopback controlled by interface pin 21.
Note: In position 6 of block 5 on the previous page, enter a 1 if the option is available or a 0 if the option is not available.
- Test mode indication on pin 25.
Note: In position 7 of block 5 on the previous page, enter a 1 if the option is available or a 0 if the option is not available.

Q



Ask the PTT/network supplier for the following information:

Note: This information will be required by the 5294 and/or the host system operator when using the communications network. If some of this information is not available now, fill it in later when it becomes available.

- For each PVC:

Logical Circuit ID	System Location
1. _____	_____
2. _____	_____

- For SVC, the systems that the 5294 will be communicating with:

System Location	Network Address
1. _____	_____
2. _____	_____
3. _____	_____
4. _____	_____
5. _____	_____

- If reverse charging will be accepted by the 5294

Note: In position 1 of block 6 below, enter a 1 if reverse charging will be accepted by the 5294 or a 0 if reverse charging will not be accepted by the 5294.

- If the network is a Telenet type network (for example, the United Kingdom Switchstream 1 Network)

Note: In position 4 of block 6 below, enter a 1 if the network will be a Telenet type network or a 0 if the network will be other than a Telenet type network.

- How the link will be initialized

- If *either the 5294 or the network* will be able to initialize the link, enter a 0 in position 5 of block 6 below.
- If *only the network* will be able to initialize the link, enter a 1 in position 5 of block 6 below.

Go to Chapter 4.

Block 6

1	2	3	4	5	6	7	8
<input type="text"/>	<input type="text"/>	<input type="text"/>	<input type="text"/>	<input type="text"/>	0	0	0

The possible settings for these positions are discussed in Chapter 4.

Note: The setting in this block will be used to complete Chapter 4.

R

Call the PTT/network supplier and do the following:

- Order DCEs and communications lines for the transmission speed required. (Refer to the chart you just came from for the transmission speed for the DCE.)

- Request the following DCE options from the PTT/network supplier:
 - Signal ground should not be connected to the frame ground in the DCE because signal ground is connected to the frame ground in the 5294 Control Unit.
 - If an option is available to cause the transmitted data to be looped back on the receive data lines, with selection controlled by a DCE front panel switch, select this option.

- Determine if the 5294 Control Unit will be attached to a Japanese DDX network. If so, enter a 1 in the field 9 block; otherwise, enter a 0 in the field 9 block.

Go to Chapter 4

A0653084-0

Appendix F. 5251 Model 12 Communications Feature Worksheets

This appendix contains additional copies of the communications feature worksheets from Chapter 6. See Chapter 6 for instructions on completing these worksheets.

Getting Started

Site Considerations

System Specifications

5294 Configuration and Communications

5251 Model 12 Communications and Configuration

Cables

Appendixes

A Digital Data Service Adapter Feature Worksheet for the 5251 Model 12

If you will not use this feature, proceed to the worksheet for your communications feature.

Use this diagram to help you order options for use with the Digital Data Service Adapter feature (SF5650, point-to-point or SF5651, multipoint).

Note: This worksheet is to be used only when attaching to the DDS network using the Digital Data Service Adapter feature and a channel service unit. If attaching to the DDS network through a data service unit, the EIA interface must be used. (See the *EIA/CCITT Interface Feature Worksheet* for the 5251 Model 12 in this chapter for more information.)

Call the common carrier.

Specify:

- Digital Data Service at speed ordered for your 5251 Model 12 (2400 bps, 4800 bps, or 9600 bps).
- Identify all modem/DCE locations. (For multipoint nonswitched, identify the control modem/DCE location.)
- Connection to DDS is to be made using a Channel Service Unit .

Note: The Channel Service Unit is not a modem.

- The signal ground is connected to the frame ground in the 5251 Model 12 (signal ground should not be connected to the frame ground in the channel service unit).

B EIA/CCITT Interface Feature Worksheet for the 5251 Model 12

If you will not use this feature, proceed to the worksheet for your communications feature.

Use this diagram to help you order communication lines and modem or data service unit options for use with the EIA/CCITT interface feature (SF3701).

Complete this information before you call the modem supplier. (This information is available from your 5251 Model 12 order.)

- Network type:
 - Point-to-point switched (dial up)
 - Point-to-point nonswitched
 - Multipoint nonswitched
- Speed of transmission: _____ bps
- Clocking to be provided:
 - Modem
 - 5251 Model 12 Internal Clock feature

Note: Modems must provide clocking for all speeds except 1200 bps. For 1200 bps, if the modem does not provide clocking, the Internal Clock feature is required on the 5251 Model 12.

- For countries other than the US/Canada, specify the PTT homologation approval numbers. (These can be obtained from your IBM sales representative.) _____

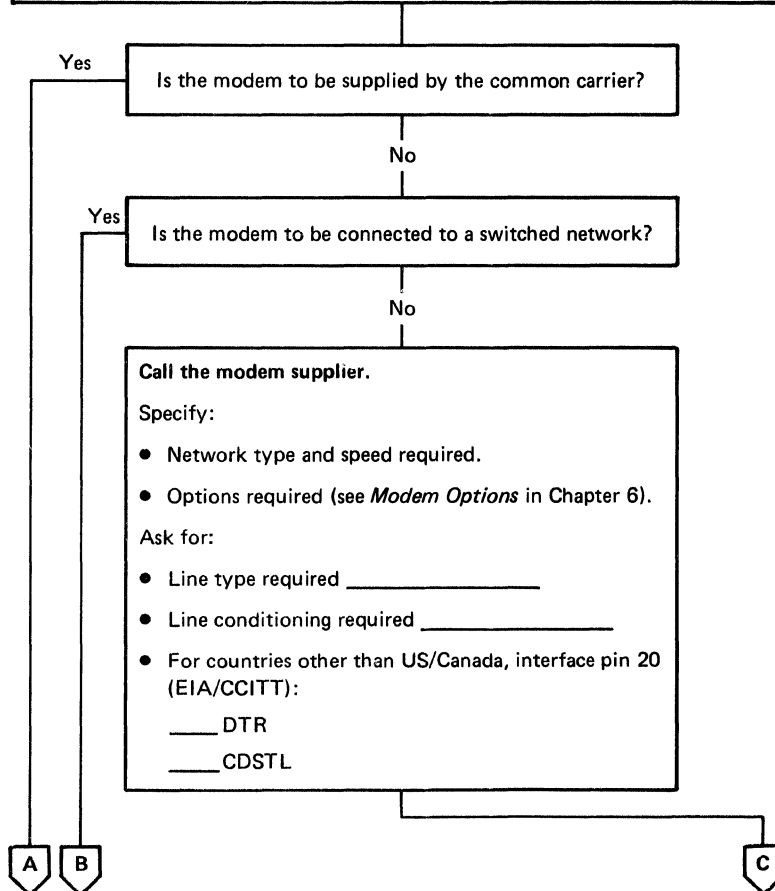

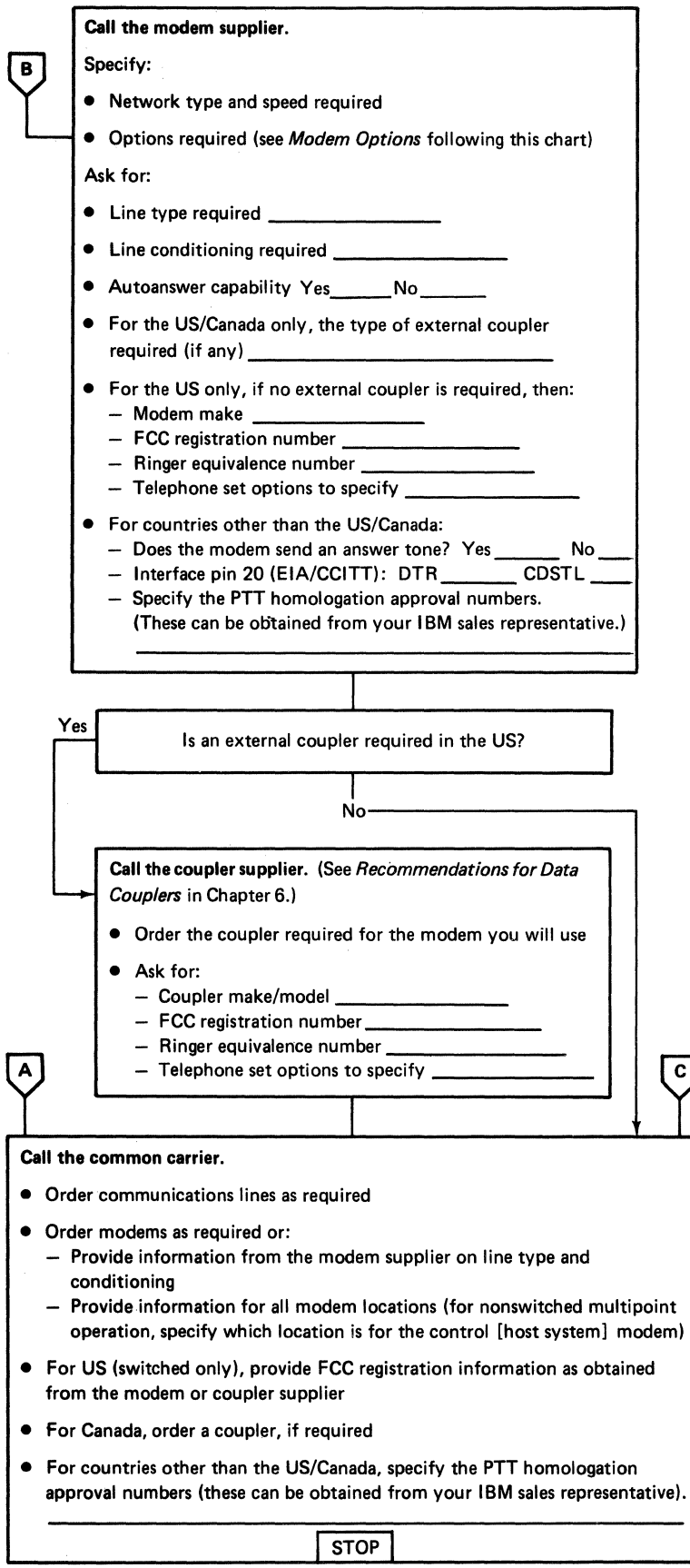

C 1200 bps Integrated Modem Feature Worksheet for the 5251 Model 12

If you will not use this feature, proceed to the worksheet for your communications feature.

Use this diagram to help you order options for use with the 1200 bps Integrated Modem feature (SF5502, switched or SF5500, nonswitched).

Complete the following information before calling the telephone company.
(This information can be obtained from your 5251 Model 12 order.)

- Line type:
 - Switched
 - Nonswitched point-to-point
 - Nonswitched multipoint
 - For countries other than the US/Canada, specify the PTT homologation approval numbers (these can be obtained from your IBM sales representative).
-

Yes

Is the modem to be connected to a switched line?

No

Call the common carrier.

Order:

- A voiceband private line for data transmission at 1200 bps
 - Four-wire line for point-to-point
 - Four-wire duplex line for multipoint (if planning multipoint operation, identify the control [host system] location)
- An outlet receptacle:
 - 404B (surface mounted)
 - 493B (flush mounted)

Specify:

- For the US, a nonswitched channel, type 3002 basic or equivalent
- For Canada, a schedule four, type four channel
- For countries other than US/Canada, a normal quality data communications line

STOP

D

D

Yes

Is the modem to be connected to a switched line in the US?

No

Call the PTT or telephone company.

Order:

- A switched telephone line for data transmission at 1200 bps
- For Canada, also order a CDT type data coupler and specify the following options:
 - Telephone set controls line
 - Ringer on the line side of the exclusion key

Provide:

- For countries other than the US/Canada, the PTT homologation approval numbers (these can be obtained from your IBM sales representative).

STOP

Call the coupler supplier.

Order:

- A CDT type data coupler (including any transformer or cables required for power)

Notes:

1. The data coupler must be a CDT type regardless of the type used at the host system.
2. See *Data Coupler Recommendations for 5251 Model 12 1200 bps Integrated Modems* in Chapter 6.

Ask for:

- FCC registration information:
 - Manufacturer's name _____
 - Ringer equivalence number _____
- Line connection _____
- Telephone set options to specify _____

Call the telephone company.

Order:

- A switched telephone line for data transmission at 1200 bps to be connected to an FCC registered coupler
- A telephone set with the options suggested by the coupler supplier

Provide:

- Information from the coupler supplier

STOP

D 2400 or 4800 bps Integrated Modem Feature Worksheet for the 5251 Model 12

If you will not use this feature, proceed to the worksheet for your communications feature.

Use this diagram to help you order options for use with the 2400 bps (SF5641, switched or SF5640, nonswitched) or 4800 bps (SF5741, switched or SF5740, nonswitched) Integrated Modem feature.

Complete the following information before calling the common carrier.
(This information can be obtained from your 5251 Model 12 order.)

- Speed of transmission _____ bps
- Line type:
 - Switched
 - Nonswitched point-to-point
 - Nonswitched multipoint
- For countries other than the US/Canada, specify the PTT homologation approval numbers (these can be obtained from your IBM sales representative).

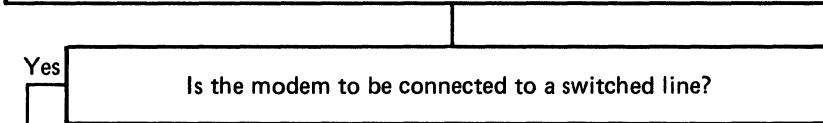

Call the common carrier.

Order:

- A voiceband private line for data transmission at the speed you ordered for your 5251 Model 12:
 - Four-wire line for point-to-point
 - Four-wire duplex line for multipoint (if planning multipoint operation, identify the control [host system] location)
- An outlet receptacle:
 - 404B (surface mounted)
 - 493B (flush mounted)

Specify:

- For the US, a nonswitched channel, type 3002 basic or equivalent
- For Canada, a schedule four, type four channel
- For countries other than the US/Canada, a normal quality data communications line (special quality lines corresponding to CCITT M1020 can be used but are not required)

STOP



E

Yes

Is the modem to be connected to a switched line in the US?

No

Call the PTT or telephone company.

Order:

- A switched telephone line for data transmission at the same speed ordered for the 5251 Model 12
- For Canada, also order a CBS type data coupler and specify the following options:
 - Modem controls line
 - Ringer on the line side of the exclusion key

Provide:

- For countries other than the US/Canada, the PTT homologation approval numbers (these can be obtained from your IBM sales representative).

STOP

Yes

Call the telephone company.

Order:

- A switched telephone line for data transmission at the same speed you ordered for the 5251 Model 12 to be connected to an FCC registered device. Provide the following FCC registration information to the telephone company:
 - Manufacturer: IBM
 - FCC registration number: AN09SA67992-DP-N
 - Ringer equivalence number: .8B
 - Line connection: USOC RJ45S
- A telephone set (USOC-RTC) with the following options:
 - A2: Data equipment controls line
 - B4: Aural (audio) monitoring provided
 - C5: Touch Tone or C6: rotary dial
 - D8: Voice mode indication

Notes:

1. If you wish to use an existing line, provide the telephone company with the line number and the data rate to be used. The telephone set, USOC-RTC, will be needed even when using an existing line.
2. Telephone set suppliers, other than the common carrier, may not use the designation USOC-RTC and option identifiers shown above to identify a telephone set that has an exclusion key. If you order a telephone set from other than the common carrier, make sure you specify the same options for the telephone set as stated above. If aural monitoring is not available, order *switch hook indication* instead of *voice mode indication*.

STOP

Appendix G. 5251 Model 12 Communications Network Setup Forms

The 5251 Model 12 Communications Network Setup Form allows you to record the information needed by your setup personnel when they set up your 5251 Model 12 and any attached work stations. Copies of this form should be retained at each work station as a guide for service personnel, and as a reference in the event of expansion or relocation.

Instructions for completing this form are in Chapter 7. Remove the form and refer to Chapter 7 when filling it out.

Getting
Started

Site
Considerations

System
Specifications

5294
Configuration and
Communications

5251 Model 12
Communications
and Configuration

Cables

Appendixes

This page is intentionally left blank.

IBM 5251 MODEL 12 COMMUNICATIONS NETWORK SETUP FORM (PART 1)

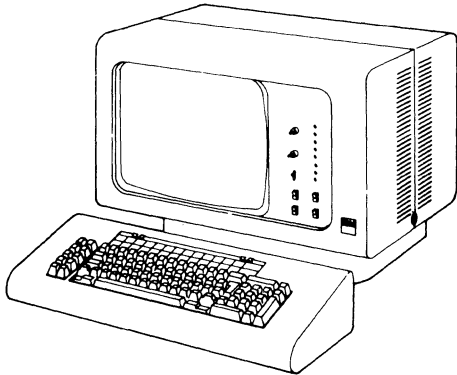

5251 MODEL 12 DISPLAY STATION

5251 Model 12 Information

Name _____
 Location _____
 City, State _____
 Telephone _____
 Host System Line/Port Number _____
 Location _____
 Telephone _____
 Device Type _____
 Controller Station Address _____
 Unit Address ____ 00 _____
 Work Station Address ____ 0 _____
 Communications Type _____
 CSR assistance required for communications line connection? Yes No

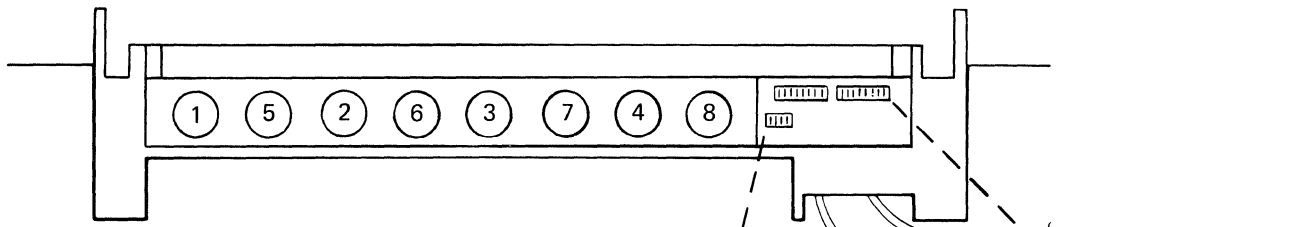

Each cable to be connected to a 5251 Model 12 port should have a tag with a number from 1 through 8. There should be a cable for each port used as indicated on Part 2 of this form. Connect each cable to the port indicated on its tag.

Controller Station Address Switches

Communications Line Configuration Switches

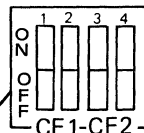
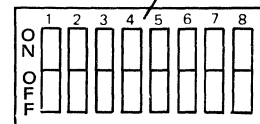
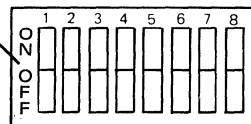
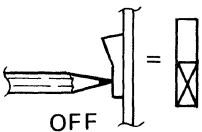
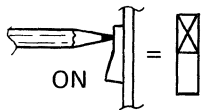

Cluster Feature Port Switches

Set all of the switches to their indicated settings. (Switch settings should be indicated on the diagram by an X in the on or off position.) Use the tip of a pencil to push in the upper half (on position) or lower half (off position) of the switches as indicated.

Note: If your 5251 Model 12 does not have ports, the Cluster Feature Port switches have no function and can be disregarded.

IBM 5251 MODEL 12 COMMUNICATIONS NETWORK SETUP FORM (PART 2)

Note: Set the address on your work station to your assigned work station address as shown in each box.

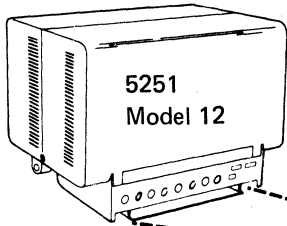

Cluster Feature

Name		→
Device Type		
Location		
Work Station Address		
Unit Address		
Telephone		→

Name		→
Device Type		
Location		
Work Station Address		
Unit Address		
Telephone		→

Name		→
Device Type		
Location		
Work Station Address		
Unit Address		
Telephone		→

Name		→
Device Type		
Location		
Work Station Address		
Unit Address		
Telephone		

Ports

- ①
- ⑤
- ②
- ⑥
- ③
- ⑦
- ④
- ⑧

With Dual Cluster Feature

→ Name	
Device Type	
Location	
Work Station Address	
Unit Address	
← Telephone	

→ Name	
Device Type	
Location	
Work Station Address	
Unit Address	
← Telephone	

→ Name	
Device Type	
Location	
Work Station Address	
Unit Address	
← Telephone	

→ Name	
Device Type	
Location	
Work Station Address	
Unit Address	
Telephone	

Cut Along Line

IBM 5251 MODEL 12 COMMUNICATIONS NETWORK SETUP FORM (PART 1)

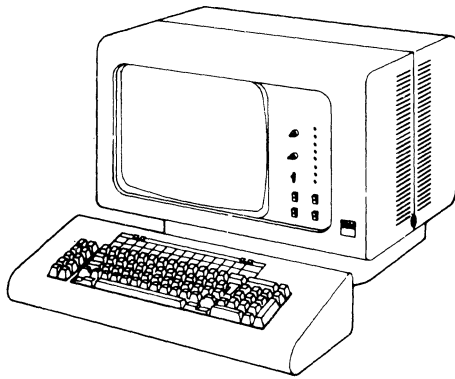

5251 MODEL 12 DISPLAY STATION

5251 Model 12 Information

Name _____
 Location _____
 City, State _____
 Telephone _____
 Host System Line/Port Number _____
 Location _____
 Telephone _____
 Device Type _____
 Controller Station Address _____
 Unit Address ____ 00 _____
 Work Station Address ____ 0 _____
 Communications Type _____
 CSR assistance required for communications line connection? Yes No

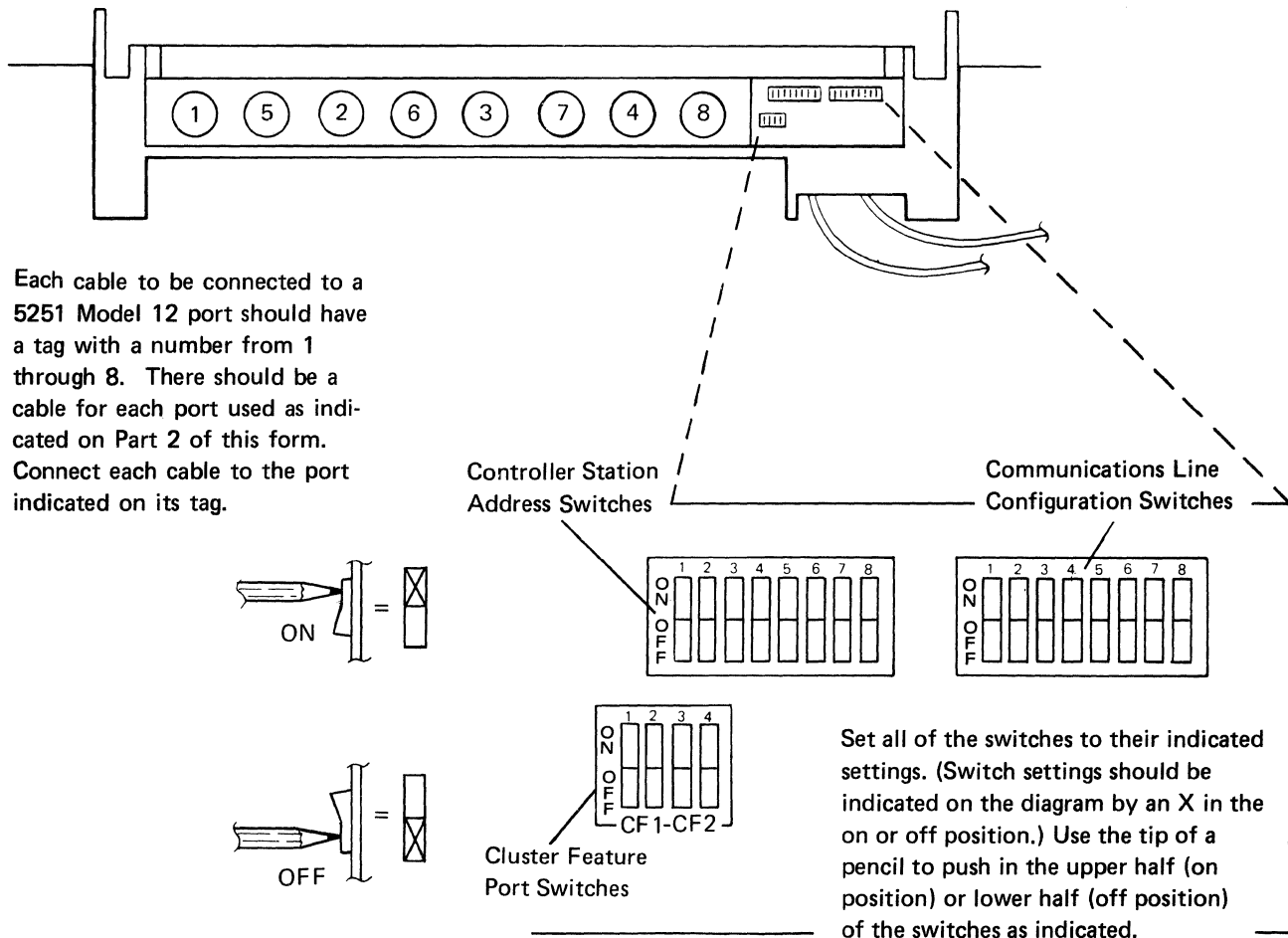

Note: If your 5251 Model 12 does not have ports, the Cluster Feature Port switches have no function and can be disregarded.

IBM 5251 MODEL 12 COMMUNICATIONS NETWORK SETUP FORM (PART 2)

Note: Set the address on your work station to your assigned work station address as shown in each box.

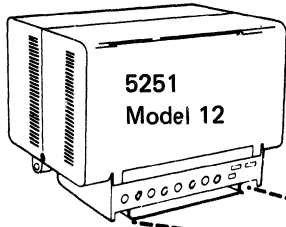

Cluster Feature

Name		↔
Device Type		
Location		
Work Station Address		
Unit Address		
Telephone		↔

Name		↔
Device Type		
Location		
Work Station Address		
Unit Address		
Telephone		↔

Name		↔
Device Type		
Location		
Work Station Address		
Unit Address		
Telephone		↔

Name		↔
Device Type		
Location		
Work Station Address		
Unit Address		
Telephone		

Ports

1
5
2
6
3
7
4
8

With Dual Cluster Feature

↔ Name	
Device Type	
Location	
Work Station Address	
Unit Address	
Telephone	↔

↔ Name	
Device Type	
Location	
Work Station Address	
Unit Address	
Telephone	↔

↔ Name	
Device Type	
Location	
Work Station Address	
Unit Address	
Telephone	↔

↔ Name	
Device Type	
Location	
Work Station Address	
Unit Address	
Telephone	

— Cut Along Line —

IBM 5251 MODEL 12 COMMUNICATIONS NETWORK SETUP FORM (PART 1)

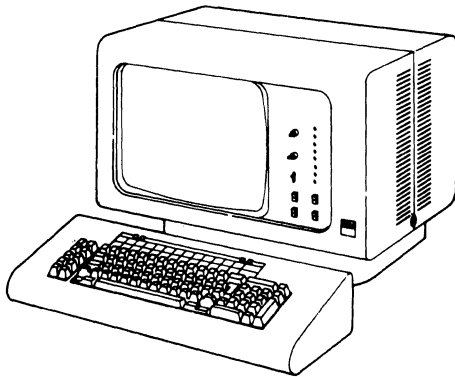

5251 MODEL 12 DISPLAY STATION

5251 Model 12 Information

Name _____
 Location _____
 City, State _____
 Telephone _____
 Host System Line/Port Number _____
 Location _____
 Telephone _____
 Device Type _____
 Controller Station Address _____
 Unit Address ____ 00 _____
 Work Station Address ____ 0 _____
 Communications Type _____
 CSR assistance required for communications line connection? Yes No

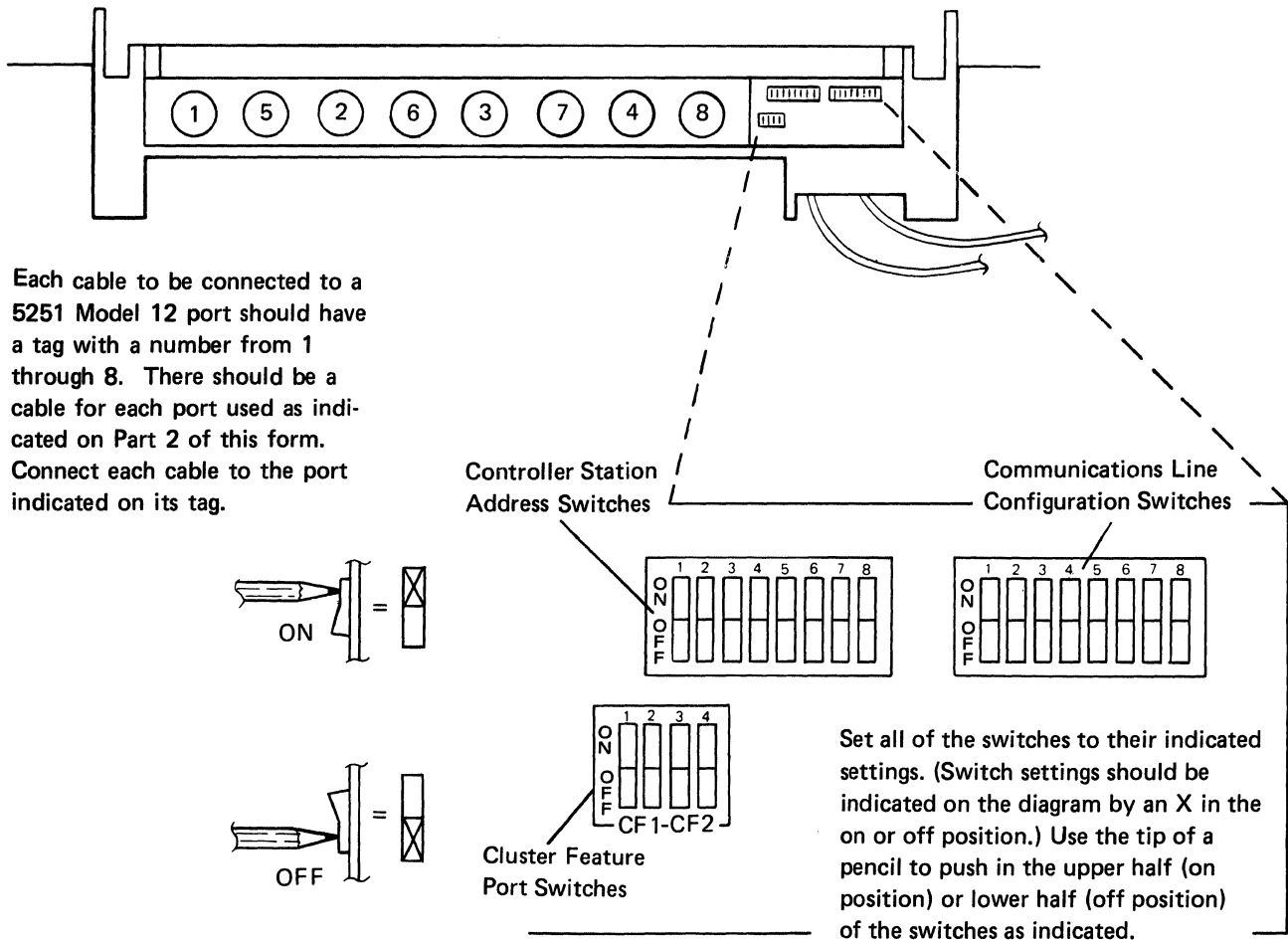

Note: If your 5251 Model 12 does not have ports, the Cluster Feature Port switches have no function and can be disregarded.

IBM 5251 MODEL 12 COMMUNICATIONS NETWORK SETUP FORM (PART 2)

Note: Set the address on your work station to your assigned work station address as shown in each box.

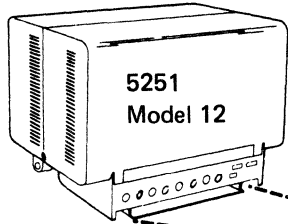

Cluster Feature

Name		→
Device Type		
Location		
Work Station Address		
Unit Address		
Telephone		→

Name		→
Device Type		
Location		
Work Station Address		
Unit Address		
Telephone		→

Name		→
Device Type		
Location		
Work Station Address		
Unit Address		
Telephone		→

Name		→
Device Type		
Location		
Work Station Address		
Unit Address		
Telephone		

Ports

1
5
2
6
3
7
4
8

With Dual Cluster Feature

→ Name		
Device Type		
Location		
Work Station Address		
Unit Address		
← Telephone		

→ Name		
Device Type		
Location		
Work Station Address		
Unit Address		
← Telephone		

→ Name		
Device Type		
Location		
Work Station Address		
Unit Address		
← Telephone		

→ Name		
Device Type		
Location		
Work Station Address		
Unit Address		
Telephone		

Cut Along Line

SDLC COMMUNICATIONS MODE

This section is divided into two types of SDLC communications:

- Nonswitched analog and nonswitched digital networks (X.21 or DDS)
- Switched analog (normal dial up telephone line)

Nonswitched Analog and Nonswitched Digital Networks (X.21 or DDS)

No special action is necessary for this type of communications. Communications will be established as soon as the 5294 is powered on and varied on at the host system. You may want to provide the 5294 operator with an *Applications Setup Form* with the host contact's name and telephone number.

Switched Analog (Normal Dial Up Telephone Line)

The operator at the host system must vary on the 5294. If no communications connection exists (if a call has not been made), the 5294 will be in auto answer mode whenever it is powered on.

To establish a communications connection, a call must be made at either the remote or host site. If communications is to be initiated by the 5294 (remote) site, you must provide the telephone number for the host system data line to the remote operator. Write the telephone number in the boxes provided at the bottom of the *Applications Setup Form*.

If communications is to be initiated by the host system, the host system operator needs the telephone number for the remote site.

X.25 COMMUNICATIONS MODE

This section describes three methods for establishing X.25 communications at the 5294: PVC, SVC answer, and SVC call. Listed under each method are the required parameters followed by the optional ones. You should fill in the boxes provided at the bottom of the *Applications Setup Form* with the required parameters. The optional parameters should only be filled in if that option is already allowed by the setup configuration and you want to override or supplement the setup information.

PVC

If your network subscription provides only a single logical channel and no manual options are to be entered, no action is required for a PVC except when:

1. Reestablishing communications without powering off the 5294.
2. Recovering from an error.

On the *Applications Setup Form*, you should make a note to the operator that this procedure only needs to be done when reestablishing communications without powering off the 5294 or when recovering from an error.

In the first box on the bottom of the form, enter an O (alphabetic O).

If your network subscription provides more than one logical channel or manual options are to be entered, use the following instructions to complete the form:

To select the logical channel, enter , followed by a three-character hexadecimal code to identify the logical channel to be used. Valid hexadecimal values are 0 through 9 and A through F.

The following options can be selected if the 5294 setup configuration specifies that manual options are allowed:

1. To change the logical link protocol (QLLC, ELLC, or PSH), do one of the following:
 - If you want to change the logical link protocol to QLLC, enter Q.
 - If you want to change the logical link protocol to ELLC, enter E, followed by a three-digit number that defines the number of seconds for end-to-end error recovery. Valid values are 100 through 999. This value should be the same value used by the host system.

Note: You cannot change the logical link protocol to PSH.
2. To change the packet size, enter P, followed by the new packet size. Valid values are 064, 128, or 256.
3. To change the packet window size, enter W, followed by a two-digit code. Valid values are 02 through 07.

APPLICATIONS SETUP FORM--OPERATOR'S INFORMATION

Setup instructions for the following applications:

Payroll

Inventory Update

Time Cards

Host Contact E.P. Barton Telephone 287-1956

(a) Press Error Reset on the typewriter-like keyboard or a Reset key on the data entry keyboard.
 (b) Press and hold the Upper Shift key and press Sys to display the single-line format at the top of the screen.
 (c) Enter the following as one line:

0	,	E	1	0	0	,	L	0	0	1	,	P	0	6	4	,	W	0	7

(d) Press Enter.

SVC Answer at the 5294 (SVC Call by the Host System)

For SVC answer, the first parameter listed below is required. The other parameters are optional.

1. Enter an A in the first box. This is required.
2. If you want to enter a network address, enter , followed by the host network address. The address can be from 1 through 15 numeric characters.
3. If you want to enter a password, enter , followed by the password. The password can be from 1 through 8 alphameric characters.
4. You can change the logical link protocol (QLLC, ELLC, or PSH) if the 5294 setup configuration specifies that manual options are allowed. To change the logical link protocol, do one of the following:
 - If you want to change the logical link protocol to QLLC, enter .
 - If you want to change the logical link protocol to ELLC, enter , followed by a three-digit number that defines the number of seconds for end-to-end error recovery. Valid values are 100 through 999. This value should be the same value used by the host system.

Note: You cannot change the logical link protocol to PSH.

5. The following options can be selected if the 5294 setup configuration specifies that manual options and flow control negotiation are allowed:

- To change the packet size, enter , followed by the new packet size. Valid values are 064, 128, or 256.
- To change the packet window size, enter , followed by a two-digit code. Valid values are 02 through 07.

APPLICATIONS SETUP FORM--OPERATOR'S INFORMATION

Setup instructions for the following applications:

Payroll

Inventory Update

Time Cards

Host Contact E.P. Barton Telephone 287-1956

① Press Error Reset on the typewriter-like keyboard or a P. on the data entry keyboard.

② Press and hold the Upper Shift key and press to display the single-line format at the top of the screen.

③ Enter the following as one line:

A , N 2 3 8 4 2 5 8 3 2 9 7 4 2 1 5 , X P A S S W O

R D , E 1 0 0 , P 2 5 6 , W 0 7

④ Press Enter.

EXAMPLE

SVC Call at the 5294 (SVC Call from the 5294)

For SVC call, the first two parameters listed below are required. The other parameters are optional.

1. Enter a C in the first box. This is required.
2. Enter , followed by the host network address. The address can be from 1 through 15 numeric characters. This is required.
3. If you want to enter a password, enter , followed by the password. The password can be from 1 through 8 alphanumeric characters.
4. If a logical channel other than 001 is required, specify , followed by a three-character hexadecimal code. Valid hexadecimal values are 0 through 9 and A through F.

The following options can be selected if the 5294 setup configuration specifies that manual options are allowed:

1. If you want to use the closed user group, enter , followed by the closed user group ID, a two-digit numeric code.
2. If you want to use reverse charging, enter .

Note: If your network does not conform to CCITT recommendation X.25 for the facility selection codes for closed user group and/or reverse charging, then the general facility selection procedure must be used to select these facilities.

3. Other optional facilities can be selected by entering , followed by two characters that identify the facility and two or more characters for the parameter code. Valid characters are 0 through 9 and A through F.

The following examples show facilities defined by CCITT recommendation X.25. For other facilities, the facility code and parameter code must be obtained from your network supplier.

- To select a specific throughput class facility, enter , followed by two hexadecimal values. Valid values are 0 through 9 and A through F.
- To select a recognize private operating agency (RPOA), enter , followed by the four-digit code for the RPOA you want to use.

4. To change the logical link protocol (QLLC, ELLC, or PSH), do one of the following:

- If you want to change the logical link protocol to QLLC, enter , Q .
- If you want to change the logical link protocol to ELLC, enter , E , followed by a three-digit number that defines the number of seconds for end-to-end error recovery. Valid values are 100 through 999. This value should be the same value used by the host system.

Note: You cannot change the logical link protocol to PSH.

5. The following options can be selected if the 5294 setup configuration specifies that manual options and flow control negotiation are allowed:

- To change the packet size, enter , P , followed by the new packet size. Valid values are 064, 128, or 256.
- To change the packet window size, enter , W , followed by a two-digit code. Valid values are 02 through 07.

APPLICATIONS SETUP FORM--OPERATOR'S INFORMATION

Setup instructions for the following applications:

Payroll

Inventory Update

Time Cards

Host Contact E.P. Barton Telephone 287-1956

A Press Error Reset on the typewriter-like keyboard or **A** on the data entry keyboard.

B Press and hold the Upper Shift key and press **A**, Attn to display the single-line format at the top of the screen.

C Enter the following as one line:

C	,	N	2	3	8	4	2	5	B	3	2	9	7	4	2	1	5	,	X	P	A	S	S	W	O
R	D	,	L	0	0	5	,	U	2	3	,	R	,	,	F	0	2	0	A	,	F	4	4	2	9
3	6	,	P	2	5	6	,	W	0	7															

D Press Enter.

EXAMPLE

X.21 CIRCUIT SWITCHED COMMUNICATIONS MODE

This section is divided into four types of communications: X.21 Direct Call, X.21 Address Call, X.21 Answer, and Changing Subscription Parameters. Depending upon the application, more than one of these may be used for a particular procedure. You should indicate on the *Applications Setup Form* exactly what needs to be done for each application.

Communications can be initiated at the host system or at the 5294 (remote) site.

If communications is to be initiated by the host system, the host system operator needs the network address for the remote site.

Communications can be initiated at the 5294 by either direct call or address call, depending upon your network subscription.

X.21 Direct Call

If you planned this installation for direct call from the 5294, nothing has to be entered at the 5294. However, the operator still has to perform the procedure on the *Applications Setup Form*.

X.21 Address Call

If you planned this installation for address call from the 5294, the operator at the 5294 must enter the network address of the host system in order to initiate communications. Enter the network address in the boxes provided on the bottom of the *Applications Setup Form*.

X.21 Answer

No special action is necessary for X.21 answer communications. Communications is established as soon as the 5294 is powered on and varied on at the host system. You may want to provide the 5294 operator with an *Applications Setup Form* with the host contact's name and telephone number.

Changing Subscription Parameters

If you want to change the subscription parameters from those already defined by the network, enter the new facility code in the boxes provided on the bottom of the *Applications Setup Form*.

Glossary

A: Amperes.

A/U: A commercial cable designation.

address switches: See *work station address switches* and *controller station address switches*.

air plenum: The area above a ceiling or under a floor which is used for air circulation.

AM: Amplitude modulation.

analog network: A type of network that uses regular telephone lines.

avg: Average.

AWG: American Wire Gage.

B/M: Bill of material.

bps: Bits per second.

BTU/hr: British thermal units per hour.

C: Celsius.

cable junction: A cable junction occurs whenever the cable is cut to attach a work station, station protector, or to join two cables with an adapter. Each pair of connections to a device is considered one junction.

Cable Thru: A special feature or standard function that allows multiple work stations to be attached to a single cable path.

CCITT: See *International Telegraph and Telephone Consultative Committee*.

CDSTL: Connect data set to line.

cfm: Cubic feet per minute.

CF1: Cluster feature 1. See also *Cluster feature (CF1)*.

CF2: Cluster feature 2. See also *Dual Cluster feature*.

Channel Service Unit: An interface unit, supplied by the common carrier, which provides for the attachment of the controller to the DDS network through the DDS Adapter feature.

circuit type: A connection between two remote locations. X.25 circuit types may be either PVC or SVC. Both PVC and SVC can be used on the same 5294 Control Unit but not at the same time.

closed user group: A closed user group is a group of locations which can communicate among themselves but cannot call to or receive calls from any location outside the group. This facility allows a limited number of users to communicate with either the controller or the host system and thus increases security. It is usually available at a nominal fee or even provided as a basic service with every subscription. On some networks, it is possible to specify different closed user groups for different applications if your subscription includes more than one group and a Closed User Group index is included in the connection setup instructions. Variations which allow calls to or from a DTE outside the group may be available depending on the network.

Cluster feature (CF1): A special feature that allows attachment of as many as four work stations to the 5251 Model 12.

Cluster Feature port switches: Four switches on the rear access panel of a 5251 Model 12 Display Station that identify the last port used on each Cluster feature.

Cluster function: A standard function on the 5294 Control Unit that allows the attachment of up to four work stations.

cm: Centimeter.

common carrier: In the US, a government-regulated private company that furnishes the general public with telecommunication service facilities; for example, a telephone or telegraph company.

communications line configuration switches: Eight switches on the rear access panel of a 5251 Model 12 Display Station that identify the type of communications configuration being used.

Getting
Started

Site
Considerations

System
Specifications

5294
Configuration and
Communications

5251 Model 12
Communications
and Configuration

Cables

Appendixes

control unit: See *controller*.

controller: A device (such as the 5294 or 5251 Model 12) that is used to coordinate and control the operations of one or more attached work stations and to synchronize their operation with that of the host system.

controller function: The 5251 Model 12 or 5294 that is linked to the host system via a communications network and that has work stations attached to it.

controller station address: The SDLC line address of the remote 5251 Model 12 or 5294 that distinguishes it from other controllers on the same line.

controller station address switches: Eight switches on the rear access panel of the 5251 Model 12 that indicate the controller station's address to the host system.

CSR: Customer Service Representative.

CTS: Clear to send (also referred to as RFS).

Data Communications Equipment (DCE): This term is used to refer to the equipment installed at the user's premises which provides:

- All the functions required to establish, maintain, and terminate a connection.
- The signal conversion and coding between the data terminal equipment (DTE) and the common carrier's line; for example, a modem.

The term DCE is also used to refer to functions performed by a carrier's network node.

data coupler: An electrical isolation device usually required by common carriers to attach to their switched telephone lines. Also referred to as a data access arrangement or protective coupler.

data packet: The type of packet used to send information from one DTE to another DTE attached to an X.25 packet switched network.

Data Service Unit: An interface unit, supplied by the common carrier, which provides for the attachment of the 5251 Model 12 or 5294 to the DDS network via the EIA/CCITT Interface feature.

Data Terminating Equipment (DTE): This term is used to refer to any machine, such as the 5294 or 5251 Model 12 or its host computer, that is connected to a network.

dB: Decibel.

DC: Direct current.

DCE: See *data communications equipment*.

DDS: An abbreviation for Digital Data Service.

DDSA: An abbreviation for Digital Data Service Adapter.

dia: Diameter.

direct attachment: Attachment of work stations to the host system with system cable.

display screen: An electronic vacuum tube similar to a TV display tube, used to display entered characters.

display station: An input/output device containing a display screen and an attached keyboard.

display system: A family of display stations and printers that are attached to a system or to a controller.

DSR: Data set ready.

DTE: See *data terminating equipment*.

DTR: Data terminal ready.

Dual Cluster feature: A special feature for the 5251 Model 12 that provides eight cable connections and allows the attachment of up to eight work stations to the 5251 Model 12.

dual connection: An SVC and a PVC operating on the same physical network connection.

duplex: A method of data transmission in which the data can be transmitted in both directions simultaneously.

EIA/CCITT: Electronic Industries Association/Consultative Committee on International Telegraphy and Telephony.

ELLC: Enhanced logical link control.

enhanced logical link control: A type of logical link control that uses the first six bytes of a data packet (first in a series of data packets if more than one data packet is required) to indicate whether data is logical link control information or normal user data.

exclusion key: An optional key on the telephone located under the handset that is used to establish communications.

Extended Cluster feature: A feature on the 5294 that provides two additional ports to the two already there and allows the attachment of up to eight work stations.

external modem: A device that is used to transmit and to receive data for a controller from a position on the communications line.

F: Fahrenheit.

FAA: Federal Aviation Agency.

FCC: Federal Communications Commission.

field: One or more consecutive positions on the display set up for a specific type of data.

flow control negotiation: The ability to alter the packet size and packet window size. They may be changed from call-to-call if the network subscription allows flow control negotiation.

FM: Frequency modulation.

frame: A 32-bit (minimum) format that SDLC uses for sending commands and data to and from the work station/controller and the host system.

ft: Feet.

half duplex: A method of data transmission in which data can be transmitted in both directions, but not at the same time.

hexadecimal: Pertains to a number system with a base of 16. (Valid digits range from 0 through F, where F represents the highest units possible – 15.)

host system: The controlling or highest level system in a data communications configuration.

I/O: Input/output.

in: Inch.

integrated modem: A modem built into the 5251 Model 12.

Internal Clock feature: A special feature for the 5251 Model 12 that provides clocking for data transmission when the Integrated Modem feature is used that does not provide its own clock.

International Telegraph and Telephone Consultative Committee (CCITT): This committee is an organization of common carriers and other interested parties who meet periodically to define standards which they will mutually adopt.

kg: Kilogram.

kVA: Kilovolt-amperes.

lb: Pound.

leased line: See *nonswitched line*.

link window size: The maximum number of I-frames that can be sent from the controller without receiving an acknowledgement from the network. Valid values are 1 through 7.

LLC: Logical link control.

LLC selection: The type of logical link control that will be used by the controller.

local loopback: A test procedure performed to verify the operation of the local modem.

local work station: A work station that is attached directly to the host system with twinaxial cable.

Logical link control: A series of rules used to exchange units of information over an imaginary circuit between two DTEs which are attached to an X.25 packet switched network.

lux: A measurement of light.

m: Meter.

m³/min: Cubic meters per minute.

manual options: Options that allow keyboard changes from call-to-call.

max: Maximum.

MES: Miscellaneous equipment specification.

MHz: Megahertz.

min: Minimum.

mm: Millimeter.

modem (modulator-demodulator): A device that modulates an analog carrier signal with digital signal and transmits the composite signal. A modem also receives the composite signal and demodulates it.

Modulo number: The maximum number of data packets that can be sent without an acknowledgement minus one.

N.m: Newton meters.

N/A: Not applicable.

NEC: National Electric Code.

NEMA: National Electrical Manufacturers' Association.

NFPA: National Fire Protection Association.

nonreturn to zero (NRZ): A data encoding method.

nonreturn to zero inverted (NRZI): A data encoding method.

nonswitched line: A communications line that is permanently connected, always available, and does not require dialing to establish communications.

NRZ: Nonreturn to zero.

NRZI: Nonreturn to zero inverted.

OD: Outside diameter.

P/N: Part number.

packet: Information transmitted through a packet switching network is divided up and inserted into packets. These usually consist of control information fields giving destination, sequence number, optional facilities, and often a user data area. Various kinds of packet are used to transmit error codes and supervise the virtual circuit.

packet size: The maximum number of bytes allowed in the user data area of a data packet. A default value, usually 128 bytes, is assigned at subscription time. On some networks, the packet size can be altered from call to call.

packet switching: The transfer of data by means of addressed packets that occupy the network channel only during actual transmission. The channel is available for the simultaneous transfer of packets belonging to other network users. The network determines the optimum routing of each individual packet during, rather than prior to, the transmission from a DTE.

packet window size: The maximum number of bytes allowed in the user data area of a data packet. A default value, usually 128 bytes, is assigned at subscription time. On some networks, the packet size can be altered from call-to-call.

Permanent Virtual Circuit (PVC): A permanent virtual circuit is the packet switching equivalent of a leased line. The 5294 and its host system appear to the user to be permanently connected.

pF/ft: Picofarads/foot.

physical services header: A type of logical link control that uses the first two bytes of a data packet to indicate whether data is logical link control information or normal user data.

point-to-point line: A data link that connects a single remote controller to the system; it can be either switched or nonswitched.

port: The hardware coupling used to attach work stations to a controller.

Post Telegraph Telephone (PTT): A name used to describe a World Trade operating agency that controls the transportation of information (postal, voice, and/or data).

power cord: A cord that plugs into a wall outlet supplying electrical power.

printer: A device that provides printed output.

PSH: Physical services header.

PSN: Public switched network. See also *public switched network (PSN)*.

PTT: Post Telegraph Telephone Administration.

public switched network (PSN): A communications facility owned by the telephone company through which subscribers can be connected by dialing the unique telephone number of another subscriber.

PVC: Permanent virtual circuit.

QLLC: Qualified logical link control.

Qualified logical link control: A type of logical link control that uses the Q (qualifier) bit in a data packet to indicate logical link control information is present.

REC: Receive.

recommendation X.25: This recommendation for packet switching interfaces is set by the CCITT (International Telegraph and Telephone Consultative Committee) and amended periodically. The X series of recommendations defines standards for data transmission interfaces.

remote attachment: Attachment of work stations to the host system through communications lines.

remote loopback: A test procedure performed to verify the operation of the local modem, remote modem, and the communications lines between them.

remote work station: A work station that is attached to the host system via communications lines.

reverse charging acceptance: This facility allows the network to pass reversed-charge calls to the DTE.

reversed charging: Reversed charging allows virtual calls originating from the 5294 to be billed to the host being called if the host subscribes to reverse charge acceptance.

rf: Radio frequency.

RFS: Ready for sending (also referred to as CTS).

RI: Ring indicate.

RTS: Request to send.

screen: See *display screen*.

SDLC: Synchronous data link control.

SF: Sales feature.

SNA: Systems network architecture.

special network attachment: An attachment that allows the 5294 to operate on a United Kingdom X.25 network using Telenet type operation.

station protector: A device used on the system cable to offer protection against lightning for attachments made in different buildings.

std: Standard.

subscription: An agreement between a user and a PTT/network supplier for the use of certain network services and optional facilities.

SVC: Switched virtual circuit.

switched line: A communications line that uses the same equipment and transmission lines used for telephone communication. (Dialing is required to establish communication.)

switched virtual circuit: A switched virtual circuit is the packet switching service equivalent of a switched line. It allows communication between the 5294 and one of several possible hosts. Switched virtual circuits are also known as *virtual calls*.

system: The main computer and the programming necessary to execute data processing. The system can have numerous work stations attached.

system cable: A cable that carries commands and data between the system and the locally attached work stations or between the controller and attached work stations.

system generation: A procedure used to configure the host system for the particular options and functions chosen.

system operator: A person who uses a display station that is designated as the system console, to activate certain system functions, and to control and monitor system operation.

terminator switch: A switch used to terminate the system cable on the last work station when Cable Thru is used and to provide a feed thru path for other stations on the cable thru line.

test mode indication: A signal generated by the modem/DCE that indicates that the modem/DCE is in a test mode because of performing a self-test, a remotely requested test, or a locally requested test.

twinaxial cable: A shielded cable with two conductors.

U.L.: Underwriters' Laboratories.

unit address: The address used to define each remote work station including the work station portion of the 5251 Model 12. This address is determined for the remote configuration and must be obtained for use by the host system.

US: United States.

USOC: Universal service order code.

V: Volts.

Vdc: Volts direct current.

virtual call: See *switched virtual circuit*.

virtual circuit: A virtual circuit is a logical connection between two DTEs which enables them to exchange information according to a standard communications procedure with the sequence of information preserved. A virtual circuit occupies transmission capacity only when the data is actually being transmitted.

window: The window size is the maximum number of packets that the DTE is authorized to transmit and have outstanding at any given time. It is the basic flow control mechanism in X.25 and protects the network from accepting packets faster than they can be accepted by the remote DTE. The window can also be used by a DTE to prevent transmission of packets from the network if the DTE is unable or unwilling to queue them. A default window size, usually 2, is assigned at subscription time. On some networks, this can be altered for a given virtual call.

work station: An I/O device that allows either the transmission of data or the reception of data (or both) from a host system, as needed to perform a job; for example, a display station or printer.

work station address: The address to which the switches on a work station are set or the internal default address. (The 5292 does not have work station address switches. Instead the address is entered using the keyboard.)

work station address switches: Two or three switches on the access panel of a work station that has Cable Thru. The switches are set to the assigned work station address. (The 5292 does not have work station address switches. Instead the address is entered using the keyboard.)

World Trade (WT): Any of the countries in Europe, Asia, Africa, and South America served by IBM.

WT: World Trade.

X.25: See *Recommendation X.25*.

XMIT: Transmit.

Index

A

adapter
 cable to cable A-13, 8-2
 communications 8-13
adding a work station 7-26
address settings
 unit address
 when attaching to a 5251 Model 12 7-25
 when attaching to a 5294 Control Unit 4-14
 5251 Model 12 7-6
 work station
 when attaching to a 5251 Model 12 7-25
 when attaching to a 5294 Control Unit 4-13
 5251 Model 12 7-6
address switches, controller station 7-8
airflow
 3180 Model 2 Display Station 3-7
 4214 Model 2 Printer 3-15
 4224 Printer 3-16
 5219 Printer 3-11
 5224 Printer 3-12
 5225 Printer 3-13
 5251 Model 11 Display Station 3-5
 5251 Model 12 Display Station 3-6
 5256 Printer 3-14
 5262 Model 1 Printer 3-16.1
 5291 Display Station 3-8
 5291 Model 2 Display Station 3-9
 5292 Color Display Station 3-10
 5294 Control Unit 3-4
analog network C-4
analog nonswitched communications worksheet for the 5294
 using IBM modems E-2, 5-7
 using non-IBM modems E-6, 5-11
analog switched communications worksheet for the 5294
 using IBM modems E-4, 5-9
 using non-IBM modems E-10, 5-15
answer tone switch 7-17
applications setup form H-10
applications setup information H-1
assembling cables A-9, 8-2
AT&T DDS public data communications worksheet for the 5294 E-14, 5-19
AT&T DDS public data network C-4
atmospheric contaminants 2-11
attaching cable labels A-5
attaching work stations to
 a 5251 Model 12 2-6
 a 5294 Control Unit 2-4
 your remote work station controller 2-4

attenuation
 teflon covered cable A-8
 vinyl covered cable A-7
autoanswer control 5-31, 6-7

B

branch circuits 2-13
bulk cable assembly A-9, 8-2
bulk cable specifications
 Teflon covered A-8, 8-2
 vinyl covered A-7, 8-2

C

cable
 adapters A-13, 8-2
 assembly A-9, 8-2
 bulk specifications
 Teflon covered A-8, 8-2
 vinyl covered A-7, 8-2
 communications 8-12
 completion tests A-14
 connector A-9, 8-2
 connector kit 8-2
 considerations 8-1
 distance 2-1
 installation 8-5
 junctions 8-1
 labeling A-1
 light pen, selector 3-5, 3-6
 limitations 8-1
 line continuity test A-14
 line polarity test A-15
 magnetic stripe reader 3-5, 3-6
 male connector 8-2
 ordering considerations A-7, A-8, 8-1
 ordering information 8-2
 part numbers 8-2
 planning 8-1
 polarity test A-15
 selector light pen 3-5, 3-6
 shielding 8-5
 signal 8-3
 Teflon covered A-8, 8-2
 termination, communications 8-13
 testing A-14
 thru 2-1, 4-11, 7-23
 to cable adapter 8-2, 8-13

- cable (continued)
 - tubing A-10, 8-2
 - twinaxial A-6
 - vinyl covered A-7, 8-2
- cabling considerations 2-13, 8-1
- capacitance, twinaxial cable
 - Teflon covered A-8
 - vinyl covered A-7
- capacitors, checking 8-11
- carrier 5-31, 6-7
- CBS type data coupler 6-14
- CDSTL (connect data set to line) 7-18
- CDT type data coupler 6-12
- CF1 ports 2-6
- CF2 ports 2-7
- chair considerations 2-8
- changing a configuration 7-26
- character set, country 4-16
- checking
 - capacitors 8-11
 - diodes 8-11
- checklist, planning 1-10
- circuit type 4-29
- clear to send 5-31, 6-8
- clear to send delay switch 7-16
- clocking 5-31, 6-7
- cluster
 - configuration charts for the 5251 Model 12
 - use of 7-25
 - 1 port 7-28
 - 2 ports 7-30
 - 3 ports 7-32
 - 4 ports 7-33
 - dual 2-7
 - extended 2-5
 - feature 2-6
 - feature port switches 7-25
 - function 2-4
- color display station, 5292 1-7, 3-10
- communications cables 8-12
- communications components order information
 - for the 5251 Model 12 6-2
 - for the 5294 Control Unit 5-4
- communications, establishing H-1
- communications feature, 5294 types of
 - DDSA C-5
 - EIA/CCITT C-5
 - X.21 signal converter C-5
- communications features
 - for the 5251 Model 12 6-3
 - for the 5294 control unit 5-5
- communications field 4-23
- communications line configuration
 - switch settings
 - for countries other than the United States and Canada 7-14
 - for the United States and Canada 7-12
 - switches
 - charts 7-12, 7-14

- communications line configuration (continued)
 - switches (continued)
 - description 7-10, 7-16
 - setting 7-11
- communications line
 - connection 4-7, 5-2, 7-7
- communications line facilities 6-9
- communications mode 4-7
- communications network setup form, 5251 Model 12 G-1, G-3
- communications option 4-6
- communications planning
 - for the 5251 Model 12 6-1
 - for the 5294 Control Unit 5-1
- communications type switch 7-17
- communications worksheets
 - for the 5251 Model 12
 - digital data service adapter F-2, 6-4
 - EIA/CCITT interface F-3, 6-5
 - 1200 bps integrated modem F-5, 6-10
 - 2400 bps integrated modem F-7, 6-13
 - 4800 bps integrated modem F-7, 6-13
 - for the 5294 Control Unit
 - analog nonswitched lines (using IBM modems) E-2, 5-7
 - analog nonswitched lines (using non-IBM modems) E-6, 5-11
 - analog switched lines (using IBM modems) E-4, 5-9
 - analog switched lines (using non-IBM modems) E-10, 5-15
 - AT&T DDS public data E-14, 5-19
 - X.21 nonswitched public data E-16, 5-21
 - X.21 switched public data E-18, 5-23
 - X.25 packet switched E-20, 5-25
- communications, types of C-5
- completed
 - 5294 communications worksheet D-10, D-13
 - 5294 setup form D-4, D-8
- completing the cable labels A-2
- completing the setup form
 - for the 5251 Model 12 7-3
 - for the 5294 Control Unit 4-18
 - for work stations attaching to the 5251 Model 12 7-19
 - for work stations attaching to the 5294 Control Unit 4-3
- completion tests of cabling A-14
- conductor, twinaxial cable
 - Teflon covered A-8
 - vinyl covered A-7
- configuration
 - change 7-26
 - examples
 - using the 5251 Model 12 7-2
 - using the 5394 Control Unit 4-2
 - remote work station
 - using the 5251 Model 12 7-1
 - using the 5294 Control Unit 4-1

configuration (continued)
 screen layout 4-20
connector
 cable A-9, 8-2
 kit 8-2
considerations
 cabling 4-2, 8-1
 chair 2-8
 environmental 2-10
 furniture 2-8
 lighting 2-9
 site 2-1
 space 2-9
 table 2-8
control unit
 setup form B-1, B-3
 5294 1-9, 3-4
controller address field 4-23
controller station address switches 7-8
controller, remote work station
 5251 Model 12 1-7, 1-9, 3-6
 5294 Control Unit 1-9, 3-4
country
 character set 4-16
 keyboard code 4-16
CTS delay switch 7-16
customer setup switches, setting of
 cluster feature port 7-25
 communications line 7-10, 7-16
 controller station 7-8

D

data coupler recommendations for 1200 bps
 integrated modems 6-12
data set ready 5-31, 6-8
DCE
 information for the 5294 Control
 Unit 5-31
 operating mode 4-26
 transmission speed C-6
DDS adapter feature worksheet F-16, 6-4
DDSA communications feature C-5
determining when
 not to use cable thru 2-3
 to use cable thru 2-2
device
 descriptions
 display stations 1-7
 printers 1-8
 remote work station controllers 1-9
 location 4-9, 7-21
 name 4-9, 7-21
 type 4-9, 7-21
dielectric strength
 Teflon covered cable A-8
 vinyl covered cable A-7

digital data service adapter feature
 communications worksheet F-2, 6-4
dimensions
 3180 Model 2 Display Station 3-7
 3863 Modem 3-17
 3864 Modem 3-17
 3865 Modem 3-17
 3872 Modem 3-17
 3874 Modem 3-17
 3875 Modem 3-17
 4214 Model 2 Printer 3-15
 4224 Printer 3-16
 5219 Printer 3-11
 5224 Printer 3-12
 5225 Printer 3-13
 5251 Model 11 Display Station 3-5
 5251 Model 12 Display Station 3-6
 5256 Printer 3-14
 5262 Model 1 Printer 3-16.1
 5291 Display Station 3-8
 5291 Model 2 Display Station 3-9
 5292 Color Display Station 3-10
 5294 Control Unit 3-4
diodes, checking 8-11
direct attachment 1-2
display station
 interference 2-11
 personal computer 1-7
 transmission speeds C-7
 3179 Model 2 1-7
 3180 Model 2 1-7, 3-7
 5251 Model 11 1-7, 3-5
 5251 Model 12 1-7, 1-9, 3-6
 5251 Model 999 1-7
 5291 1-7, 3-8
 5291 Model 2 3-9
 5292 1-7, 3-10
drawing your configuration
 when attaching to the 5251 Model
 12 7-22
 when attaching to the 5294 Control
 Unit 4-10
DSR (data set ready) 5-31, 6-8
DTR (data terminal ready) 7-18
DTR/CDSTL switch 7-18
dual
 cluster feature 2-7
 connected network C-2

E

EIA/CCITT communications feature C-5
EIA/CCITT interface feature
 modem options 5-31, 6-7
 order information 5-31, 6-7
 worksheet for the 5251 Model 12 F-3, 6-5
electrical requirements 2-12
electromagnetic compatibility 2-11
electromagnetic interference 2-11
electrostatic discharge 2-11

environmental considerations and requirements 2-10
establishing communications H-1
examples
 cable thru 2-2
 configuration 4-2, 7-2
 direct attachment 2-3
 local attachment 2-3
 network worksheet D-10, D-13
 nonswitched network D-2
 remote attachment 2-3
 station protector installation 8-7
 switched network D-6
 5294 communications network worksheet, completed D-10, D-13
 5294 setup form, completed D-4, D-8
extended cluster feature 2-5

F

facilities, network 5-25
FCC
 registration numbers for IBM modems 5-10
 rules compliance 6-15
feature port switches, cluster 7-25
fields
 communications 4-23
 controller address 4-23
 field 1 4-21
 field 2 4-23
 field 3 4-23
 field 3 settings 4-24
 field 4 4-28
 field 5 4-29
 field 6 4-31
 field 9 4-33
 fields A and B 4-33
 keyboard code 4-21
 operator input 4-21
 settings for field 3 4-24
 X.25 fields 4-27
floor plan 2-9
flow control negotiation 4-29
frequency 2-12
furniture considerations 2-8
future expansion 2-10

G

getting started 1-1
glare reduction 2-9
glossary 1-1
grounding 2-13
 modem 5-31, 6-8
 outdoor cable 8-5
 recommendations, station protector 8-8

guided learning courses C-1
guidelines for planning and ordering communications
 for the 5251 Model 12 6-2
 for the 5294 Control Unit 5-4

H

heat output
 3180 Model 2 Display Station 3-7
 4214 Model 2 Printer 3-15
 4224 Printer 3-16
 5219 Printer 3-11
 5224 Printer 3-12
 5225 Printer 3-13
 5251 Model 11 Display Station 3-5
 5251 Model 12 Display Station 3-6
 5256 Printer 3-14
 5262 Model 1 Printer 3-16.1
 5291 Display Station 3-8
 5291 Model 2 Display Station 3-9
 5292 Color Display Station 3-10
 5294 Control Unit 3-4
humidity, relative 2-10

I

IBM modem information 3-17, 5-2, 5-10
identifying the work stations
 attaching to the 5251 Model 12 7-21
 attaching to the 5294 Control Unit 4-9
impedance, twinaxial cable
 Teflon covered A-8
 vinyl covered A-7
information needed to plan your communications facilities C-1
input fields, operator 4-21
installation, power plug 3-3
insulation, twinaxial cable
 Teflon covered A-8
 vinyl covered A-7
integrated modem feature worksheet 6-10, 6-13
interface pin 18 5-31, 6-8
interface pin 20 4-26
interface pin 22 5-31, 6-8
interface, modem 5-31, 6-7
interference, display screen 2-11
introductory communications information for use with the 5294 C-1

J

jacket, twinaxial cable
 Teflon covered A-8
 vinyl covered A-7
junction, cable 8-1

K

keyboard
 code field 4-21
 codes 4-15
kinds of networks
 analog C-4
 AT&T DDS public data C-4
 X.21 public data C-4
 X.25 packet switched C-5

L

labeling cables A-1
leading pad 4-26
light pen, selector 2-8, 3-5, 3-6
lighting considerations 2-9
lightning damage probability map 8-4
lightning protection 8-5
line continuity A-14
line polarity A-15
line type switch 7-17
line types
 for the 5251 Model 12 6-3
 for the 5294 Control Unit 5-5
link initialization 4-31
link window size 4-28
LLC selection 4-31
local
 attachment 1-2
 work station configuration 1-2
logical link control selection 4-31

M

magnetic stripe reader 2-8, 3-5, 3-6
manual options 4-29
modems
 autoanswer control 5-31, 6-7
 carrier 5-31, 6-7
 clear to send 5-31, 6-8
 clocking 5-31, 6-7
 data set ready 5-31, 6-8
 FCC registration numbers 5-10
 grounding 5-31, 6-8

modems (continued)

 information for the 5251 Model 12 6-7
 information for the 5294 Control Unit 5-31
 information, IBM 3-17, 5-2
 interface 5-31, 6-7
 interface pin 18 5-31, 6-8
 interface pin 22 5-31, 6-8
 new sync 5-31, 6-8
 options 5-31, 6-7
 request to send 5-31, 6-8
 ring indicate 5-31, 6-8
 ringer equivalences 5-10
 speed 5-31, 6-7
 transmit timing 5-31, 6-7
modulo number 4-28
multipoint nonswitched network C-3

N

network DCE
 for the 5251 Model 12 6-3
 for the 5294 Control Unit 5-5
network example
 nonswitched D-2
 switched D-6
network facilities 5-25
network type switch 7-16
networks, kinds of
 analog C-4
 AT&T DDS public data C-4
 X.21 public data C-4
 X.25 packet switched C-5
networks, types of
 dual connected C-2
 multipoint nonswitched C-3
 permanent virtual circuit C-2
 point-to-point nonswitched C-3
 point-to-point switched C-2
 switched virtual circuit C-2
new sync 5-31, 6-8
nonoperating environment 2-10
nonprogrammable data coupler 6-12
nonswitched network example D-2
NRZI/NRZ switch 7-18

O

operating environment 2-10
operator input fields 4-21
ordering communications equipment and facilities
 for the 5251 Model 12 6-1
 for the 5294 Control Unit 5-1
ordering considerations for cables 8-1

ordering information, twinaxial cable
 Teflon covered A-8, 8-2
 vinyl covered A-7, 8-2
outdoor cable installation 8-4

P

packet size 4-29, 5-27
packet window size 4-28
permanent virtual circuit network C-2
personal computer 1-7
plan view
 3180 Model 2 Display Station 3-7
 4214 Model 2 Printer 3-15
 5219 Printer 3-11
 5224 Printer 3-12
 5225 Printer 3-13
 5251 Model 11 Display Station 3-5
 5251 Model 12 Display Station 3-6
 5256 Printer 3-14
| 5262 Model 1 Printer 3-16.1
 5291 Display Station 3-8
 5291 Model 2 Display Station 3-9
 5292 Color Display Station 3-10
 5294 Control Unit 3-4
planning
 checklist 1-10
 for
 cables 8-1
 direct attachment 1-2
 local attachment 1-2
 remote attachment using a 5251 Model
 12 1-4
 remote attachment using a 5294 Control
 Unit 1-3
 replacing a 5251 Model 12 with a 5294
 Control Unit 1-5
 starting 1-1
plugs 3-1
point-to-point network
 example D-2
 nonswitched C-3
 switched C-2
polarity line test A-15
port assignment
 for the 5251 Model 12 7-22
 for the 5294 Control Unit 4-10
power cords 2-12, 3-1
power plugs 3-1
power receptacles 2-12, 3-1
power requirements
 3180 Model 2 Display Station 3-7
 4214 Model 2 Printer 3-15
| 4224 Printer 3-16
 5219 Printer 3-11
 5224 Printer 3-12
 5225 Printer 3-13
 5251 Model 11 Display Station 3-5
 5251 Model 12 Display Station 3-6

power requirements (continued)
 5256 Printer 3-14
| 5262 Model 1 Printer 3-16.1
 5291 Display Station 3-8
 5291 Model 2 Display Station 3-9
 5292 Color Display Station 3-10
 5294 Control Unit 3-4
printer
 transmission speeds C-8
 3812 1-8
 4214 Model 2 1-8, 3-15
 4224 3-16
 5219 1-8, 3-11
 5224 1-8, 3-12
 5225 1-8, 3-13
 5256 1-8, 3-14
| 5262 Model 1 3-16.1
programmable data coupler 6-12

R

R-loop 7-17
rating, twinaxial cable
 Teflon covered A-8
 vinyl covered A-7
reader, magnetic stripe 2-8, 3-5, 3-6
receptacles, power 3-1
relative humidity 2-10
remote attachment to host system
 using the 5251 Model 12 7-1
 using the 5294 Control Unit 4-1
remote work station configuration
 using the 5251 Model 12 7-1
 using the 5294 Control Unit 4-1
remote work station controllers
 5251 Model 12 1-7, 1-9, 3-6
 5294 Control Unit 1-9, 3-4
replacing a 5251 Model 12 1-5
request to send (RTS) 5-31, 6-8
request to send switch 7-16
ring indicate 5-31, 6-8
ringer equivalences for IBM modems 5-10

S

sample configuration
 using the 5251 Model 12 7-2
 using the 5294 Control Unit 4-2
scheduling 1-10
screen layout, configuration 4-20
SDLC transmission
 coding option 7-18
 mode 4-26
selector light pen 2-8, 3-5, 3-6
service clearance
 3180 Model 2 Display Station 3-7
 4214 Model 2 Printer 3-15
| 4224 Printer 3-16
 5219 Printer 3-11

service clearance (continued)
5224 Printer 3-12
5225 Printer 3-13
5251 Model 11 Display Station 3-5
5251 Model 12 Display Station 3-6
5256 Printer 3-14
5262 Model 1 Printer 3-16.1
5291 Display Station 3-8
5291 Model 2 Display Station 3-9
5292 Color Display Station 3-10
5294 Control Unit 3-4
settings for field 3 4-24
setup form
5251 Model 12 G-1, G-3
5294 Control Unit B-1, B-3
shield line 8-5
shield, twinaxial cable
Teflon covered A-8
vinyl covered A-7
shipping environment 2-10
signal cable, work station 8-3
site considerations 2-1
site requirements 2-1
space considerations 2-9
special network attachment 4-31
specifications
system 3-1
3180 Model 2 Display Station 3-7
3863 Modem 3-17
3864 Modem 3-17
3865 Modem 3-17
3872 Modem 3-17
3874 Modem 3-17
3875 Modem 3-17
4214 Model 2 Printer 3-15
4224 Printer 3-16
5219 Printer 3-11
5224 Printer 3-12
5225 Printer 3-13
5251 Model 11 Display Station 3-5
5251 Model 12 Display Station 3-6
5256 Printer 3-14
5262 Model 1 Printer 3-16.1
5291 Display Station 3-8
5291 Model 2 Display Station 3-9
5292 Color Display Station 3-10
5294 Control Unit 3-4
standard symbols and specifications 3-1
starting your planning 1-1
station protectors 8-6
check 8-10
grounding recommendations 8-8
installation requirements 8-9
kit 8-8
storage environment 2-10
switch setting
cluster feature port 7-25
communications line configuration 7-10
controller station address 7-8
switched network example D-6
switched virtual circuit network C-2
system specifications 3-1

T

table considerations 2-8
Teflon covered cables A-8, 8-2
telephone set options 5-3, 6-12
temperature 2-10
transmission coding
NRZ 7-18
NRZI 7-18
transmission speeds
available C-9
for DCE C-6
for display stations C-7
for printers C-8
transmit timing 5-31, 6-7
tubing, cable A-10, 8-2
twinaxial cable A-6, 8-2
adapter A-13, 8-2
assembly A-9, 8-2
bulk specifications
Teflon covered A-8, 8-2
vinyl covered A-7, 8-2
ordering information 8-2
station protector kit 8-8
tests A-14
types of
communications
DDSA feature C-5
EIA/CCITT feature C-5
X.21 signal converter feature C-5
communications lines
for the 5251 Model 12 6-3
for the 5294 Control Unit C-2, 5-5
for the 5295 Control Unit C-2
networks
dual connected C-2
multipoint nonswitched C-3
permanent virtual circuit C-2
point-to-point nonswitched C-3
point-to-point switched C-2
switched virtual circuit C-2

U

unit address
when attaching to the 5251 Model
12 7-25
when attaching to the 5294 Control
Unit 4-14
5251 Model 12 7-6
using an IBM modem with the 5294 5-1
using cable thru 2-1
using the cluster configuration
charts 7-25

V

velocity of propagation, twinaxial cable
 Teflon covered A-8
 vinyl covered A-7
vinyl covered cables A-7, 8-2
virtual circuit type 5-25
voltage 2-12

W

weight
 3180 Model 2 Display Station 3-7
 3863 Modem 3-17
 3864 Modem 3-17
 3865 Modem 3-17
 3872 Modem 3-17
 3874 Modem 3-17
 3875 Modem 3-17
 4214 Model 2 Printer 3-15
 4224 Printer 3-16
 5219 Printer 3-11
 5224 Printer 3-12
 5225 Printer 3-13
 5251 Model 11 Display Station 3-5
 5251 Model 12 Display Station 3-6
 5256 Printer 3-14
 5262 Model 1 Printer 3-16.1
 5291 Display Station 3-8
 5291 Model 2 Display Station 3-9
 5292 Color Display Station 3-10
 5294 Control Unit 3-4
wet bulb 2-10
work station address settings
 when attaching to the 5251 Model
 12 7-25
 when attaching to the 5294 Control
 Unit 4-13
 5251 Model 12 7-6
work station configuration
 local 1-2
 remote
 when attaching to a 5251 Model 12 7-1
 when attaching to a 5294 Control
 Unit 4-1
work station controller, remote
 5251 Model 12 1-7, 1-9, 3-6
 5294 Control Unit 1-9, 3-4
work stations attaching to a
 5251 Model 12 2-6, 7-1
 5294 Control Unit 2-4, 4-1
World Trade
 power cord information for machines
 shipped without plug 3-3
 power plug requirements 3-2

X

X.21 public data communications worksheet
 for the 5294
 nonswitched E-16, 5-21
 switched E-18, 5-23
X.21 public data network C-4
X.21 signal converter communications
 feature C-5
X.21 switched public data communications
 network worksheet for the 5294 E-18, 5-23

X.25 fields 4-27
X.25 packet switched communications
 worksheet for the 5294 E-20, 5-25
X.25 packet switched network C-5

1200 bps integrated modem worksheet for the
 5251 Model 12 F-5, 6-10
2400 bps integrated modem worksheet for the
 5251 Model 12 F-7, 6-13
3180 Model 2 Display Station
 description 7-1
 plan view 3-7
 specifications 3-7
3863 Modem information 3-17, 5-2
3864 Modem information 3-17, 5-2
3865 Modem information 3-17, 5-2
3872 Modem information 3-17, 5-2
3874 Modem information 3-17, 5-2
3875 Modem information 3-17, 5-2
4214 Model 2 Printer
 description 1-8
 plan view 3-15
 specifications 3-15
4224 Printer 3-16
 description 3-16
 specification 3-16
4800 bps integrated modem worksheet for the
 5251 Model 12 F-7, 6-13
5219 Printer
 description 1-8
 plan view 3-11
 specifications 3-11
5224 Printer
 description 1-8
 plan view 3-12
 specifications 3-12
5225 Printer
 description 1-8
 plan view 3-13
 specifications 3-13
5250
 attachment methods 1-1
 communications 5-1, 6-1
 description 1-7

5251 Model 11 Display Station
description 1-7
plan view 3-5
specifications 3-5

5251 Model 12 Display Station
attaching work stations to 2-6, 7-1
communications feature worksheets
digital data service adapter F-2, 6-4
EIA/CCITT interface F-3, 6-5
1200 bps integrated modem F-5, 6-10
2400 bps integrated modem F-7, 6-13
4800 bps integrated modem F-7, 6-13
communications features 6-3
communications setup form G-1, G-3
configuration 7-3
controller station address 7-8
description 1-7, 1-9
information 7-5
plan view 3-6
specifications 3-6
switches 7-8, 7-10, 7-25
unit address 7-6
work station address 7-6

5251 Model 999 Display Station 1-7

5256 Printer
description 1-8
plan view 3-14
specifications 3-14

5262 Model 1 Printer
description 1-8
plan view 3-16.1
specification 3-16.1

5291 Display Station
description 1-7
plan view 3-8
specifications 3-8

5291 Model 2 display station
description 1-7
plan view 3-9
specifications 3-9

5292 Color Display Station
description 1-7
plan view 3-10
specifications 3-10

5294 Control Unit
attaching work stations to 2-4, 4-1
communications features 5-5
communications network worksheets
analog nonswitched lines (using IBM modems) E-2, 5-7
analog nonswitched lines (using non-IBM modems) E-6, 5-11
analog switched lines (using IBM modems) E-4, 5-9
analog switched lines (using non-IBM modems) E-10, 5-15
AT&T DDS public data E-14, 5-19
X.21 nonswitched public data E-16, 5-21

5294 Control Unit (continued)
communications network worksheets (continued)
X.21 switched public data E-18, 5-23
X.25 packet switched E-20, 5-25
completed network worksheets
first example D-10
second example D-13
completed setup form
first example D-4
second example D-8
configuration 4-18
description 1-9
information 4-5
plan view 3-4

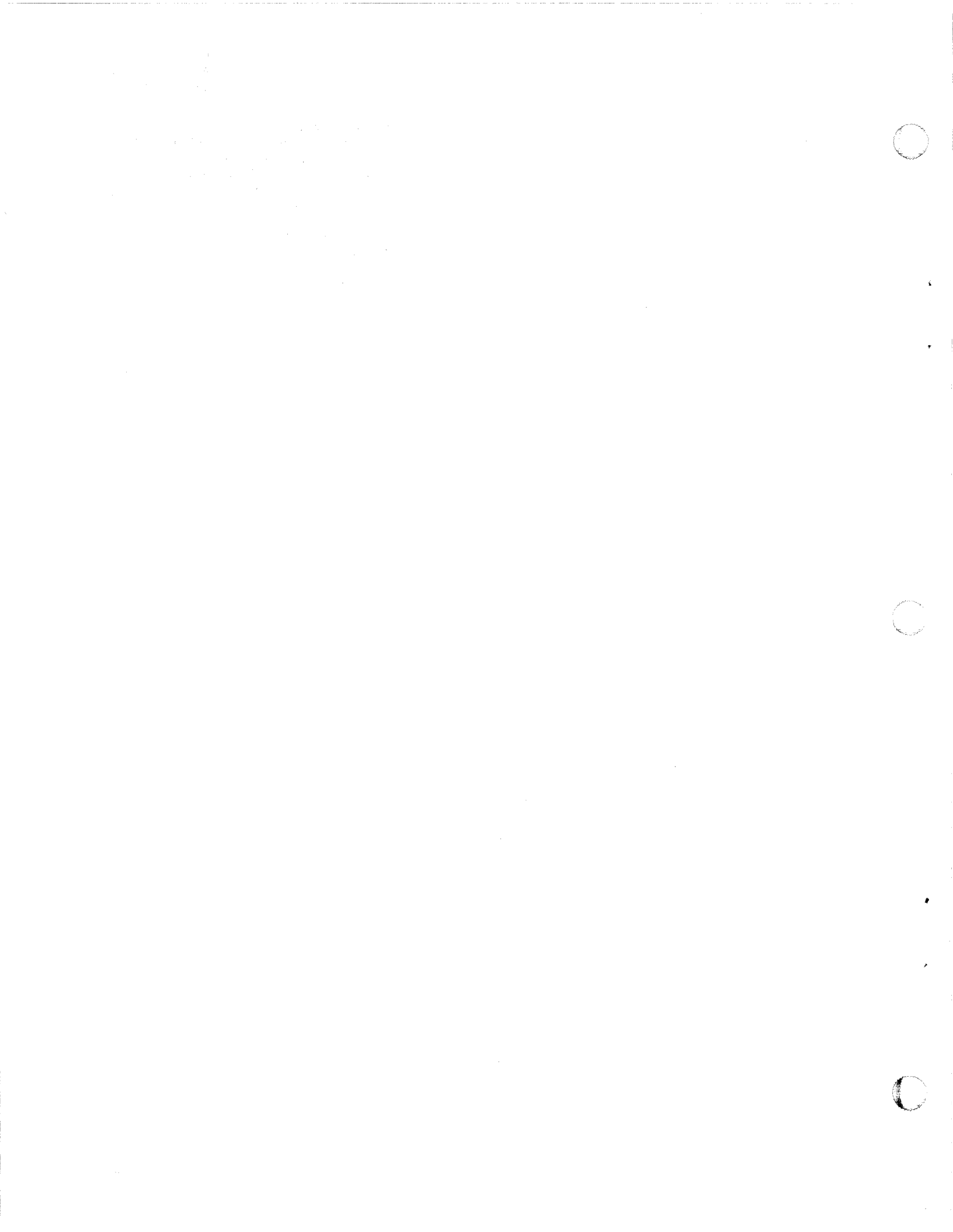

READER'S COMMENT FORM

Please use this form only to identify publication errors or to request changes in publications. Direct any requests for additional publications, technical questions about IBM systems, changes in IBM programming support, and so on, to your IBM representative or to your nearest IBM branch office. You may use this form to communicate your comments about this publication, its organization, or subject matter, with the understanding that IBM may use or distribute whatever information you supply in any way it believes appropriate without incurring any obligation to you.

If your comment does not need a reply (for example, pointing out a typing error) check this box and do not include your name and address below. If your comment is applicable, we will include it in the next revision of the manual.

If you would like a reply, check this box. Be sure to print your name and address below.

Page number(s):

Comment(s):

Please contact your nearest IBM branch office to request additional publications.

Name _____

Company or
Organization _____

Address _____

No postage necessary if mailed in the U.S.A.

City _____ State _____ Zip Code _____

Phone No. () _____

Area Code

Cut Along Line

IBM 5250 Information Display System Planning and Site Preparation Guide (File No. S5250/334/S36/S38-15) Printed in U.S.A. GA21-9337-6

Fold and tape

Please do not staple

Fold and tape



NO POSTAGE
NECESSARY IF
MAILED IN THE
UNITED STATES

BUSINESS REPLY MAIL
FIRST CLASS PERMIT NO. 40 ARMONK, N. Y.

POSTAGE WILL BE PAID BY . . .

International Business Machines Corporation
Information Development
Department 245
Rochester, Minnesota, U.S.A. 55901

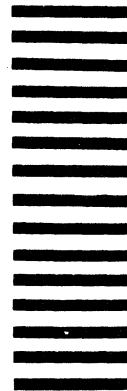

Fold and tape

Please do not staple

Fold and tape



READER'S COMMENT FORM

Please use this form only to identify publication errors or to request changes in publications. Direct any requests for additional publications, technical questions about IBM systems, changes in IBM programming support, and so on, to your IBM representative or to your nearest IBM branch office. You may use this form to communicate your comments about this publication, its organization, or subject matter, with the understanding that IBM may use or distribute whatever information you supply in any way it believes appropriate without incurring any obligation to you.

If your comment does not need a reply (for example, pointing out a typing error) check this box and do not include your name and address below. If your comment is applicable, we will include it in the next revision of the manual.

If you would like a reply, check this box. Be sure to print your name and address below.

Page number(s):

Comment(s):

Please contact your nearest IBM branch office to request additional publications.

Name _____

Company or
Organization _____

Address _____

No postage necessary if mailed in the U.S.A.

City _____ State _____ Zip Code _____

Phone No. (_____) _____

Area Code

IBM 5250 Information Display System Planning and Site Preparation Guide (File No. S5250/S34/S36/S38-15) Printed in U.S.A. GA21-9337-6

Fold and tape

Please do not staple

Fold and tape



NO POSTAGE
NECESSARY IF
MAILED IN THE
UNITED STATES

BUSINESS REPLY MAIL
FIRST CLASS PERMIT NO. 40 ARMONK, N. Y.



POSTAGE WILL BE PAID BY . . .

International Business Machines Corporation
Information Development
Department 245
Rochester, Minnesota, U.S.A. 55901

Fold and tape

Please do not staple

Fold and tape



C

C

C



International Business Machines Corporation