



owner.ford.com



ford.ca

2021 E-SERIES Owner's Manual



December 2019
First Printing
Litho in U.S.A.



MC2J 19A321 AA



The information contained in this publication was correct at the time of going to print. In the interest of continuous development, we reserve the right to change specifications, design or equipment at any time without notice or obligation. No part of this publication may be reproduced, transmitted, stored in a retrieval system or translated into any language in any form by any means without our written permission. Errors and omissions excepted.

© Ford Motor Company 2019

All rights reserved.

Part Number: 201910 20191023173703

California Proposition 65



WARNING: Operating, servicing and maintaining a passenger vehicle or off-highway motor vehicle can expose you to chemicals including engine exhaust, carbon monoxide, phthalates, and lead, which are known to the State of California to cause cancer and birth defects or other reproductive harm. To minimize exposure, avoid breathing exhaust, do not idle the engine except as necessary, service your vehicle in a well-ventilated area and wear gloves or wash your hands frequently when servicing your vehicle. For more information go to www.P65Warnings.ca.gov/passenger-vehicle.



WARNING: Battery posts, terminals and related accessories contain lead and lead compounds, chemicals known to the State of California to cause cancer and reproductive harm.
Wash your hands after handling.

Table of Contents

Introduction

| | |
|--|----|
| About This Manual | 5 |
| Symbols Glossary | 5 |
| Data Recording | 7 |
| Perchlorate | 11 |
| Ford Credit | 12 |
| Replacement Parts Recommendation | 12 |
| Special Notices | 12 |
| Mobile Communications Equipment | 14 |

Environment

| | |
|----------------------------------|----|
| Protecting the Environment | 15 |
|----------------------------------|----|

At a Glance

| | |
|------------------------|----|
| Instrument Panel | 16 |
|------------------------|----|

Child Safety

| | |
|-----------------------------------|----|
| General Information | 17 |
| Installing Child Restraints | 19 |
| Booster Seats | 23 |
| Child Restraint Positioning | 25 |

Seatbelts

| | |
|---|----|
| Principle of Operation | 27 |
| Fastening the Seatbelts | 28 |
| Seatbelt Height Adjustment | 30 |
| Seatbelt Warning Lamp and Indicator Chime | 30 |
| Child Restraint and Seatbelt Maintenance | 31 |
| Seatbelt Extensions | 31 |

Supplementary Restraints System

| | |
|--|----|
| Principle of Operation | 32 |
| Driver and Passenger Airbags | 33 |
| Crash Sensors and Airbag Indicator | 37 |
| Airbag Disposal | 38 |

Keys and Remote Controls

| | |
|--|----|
| General Information on Radio Frequencies | 39 |
| Remote Control | 39 |
| Replacing a Lost Key or Remote Control | 41 |

Doors and Locks

| | |
|-----------------------------|----|
| Locking and Unlocking | 42 |
|-----------------------------|----|

Security

| | |
|---------------------------------|----|
| Passive Anti-Theft System | 45 |
|---------------------------------|----|

Steering Wheel

| | |
|---|----|
| Adjusting the Steering Wheel | 47 |
| Cruise Control - Vehicles With: Adaptive Cruise Control | 47 |
| Cruise Control - Vehicles With: Cruise Control | 48 |
| Information Display Control | 48 |
| Horn | 48 |

Wipers and Washers

| | |
|--------------------------|----|
| Windshield Wipers | 49 |
| Windshield Washers | 49 |

Lighting

| | |
|----------------------------------|----|
| General Information | 50 |
| Lighting Control | 50 |
| Autolamps | 51 |
| Instrument Lighting Dimmer | 51 |
| Daytime Running Lamps | 51 |
| Direction Indicators | 52 |

Automatic High Beam Control

| | |
|--|----|
| What Is Automatic High Beam Control | 53 |
| Switching Automatic High Beam Control On and Off | 53 |

Table of Contents

| | |
|--|----|
| Automatic High Beam Control Indicators | 53 |
| Overriding Automatic High Beam Control | 54 |

Windows and Mirrors

| | |
|------------------------|----|
| Power Windows | 55 |
| Exterior Mirrors | 55 |
| Interior Mirror | 56 |
| Sun Visors | 56 |

Instrument Cluster

| | |
|---------------------------------------|----|
| Gauges | 57 |
| Warning Lamps and Indicators | 60 |
| Audible Warnings and Indicators | 62 |

Information Displays

| | |
|----------------------------|----|
| General Information | 63 |
| Information Messages | 66 |

Climate Control

| | |
|---|----|
| Manual Climate Control | 70 |
| Hints on Controlling the Interior Climate | 71 |
| Rear Passenger Climate Controls | 72 |

Seats

| | |
|---------------------------------------|----|
| Sitting in the Correct Position | 73 |
| Head Restraints | 73 |
| Manual Seats | 74 |
| Power Seats | 75 |

Auxiliary Power Points

| | |
|------------------------------|----|
| Auxiliary Power Points | 76 |
|------------------------------|----|

Starting and Stopping the Engine

| | |
|----------------------------------|----|
| General Information | 78 |
| Ignition Switch | 78 |
| Starting a Gasoline Engine | 78 |

| | |
|---------------------------|----|
| Engine Block Heater | 80 |
|---------------------------|----|

Fuel and Refueling

| | |
|-------------------------------|----|
| Safety Precautions | 82 |
| Fuel Quality - E85 | 82 |
| Fuel Quality - Gasoline | 84 |
| Running Out of Fuel | 84 |
| Refueling | 85 |
| Fuel Consumption | 86 |

Engine Emission Control

| | |
|---------------------------|----|
| Emission Law | 88 |
| Catalytic Converter | 89 |

Transmission

| | |
|------------------------------|----|
| Automatic Transmission | 92 |
|------------------------------|----|

Rear Axle

| | |
|---------------------------------|----|
| Limited Slip Differential | 96 |
|---------------------------------|----|

Brakes

| | |
|--|----|
| General Information | 97 |
| Hints on Driving With Anti-Lock Brakes | 97 |
| Parking Brake | 98 |
| Hill Start Assist | 98 |

Traction Control

| | |
|------------------------------|-----|
| Principle of Operation | 100 |
| Using Traction Control | 100 |

Parking Aids

| | |
|------------------------|-----|
| Rear View Camera | 101 |
|------------------------|-----|

Cruise Control

| | |
|---|-----|
| What Is Cruise Control | 103 |
| Switching Cruise Control On and Off | 103 |
| Setting the Cruise Control Speed | 103 |
| Canceling the Set Speed | 103 |

Table of Contents

| | | | |
|--|-----|--|-----|
| Resuming the Set Speed | 104 | Ordering Additional Owner's Literature | 149 |
| Cruise Control Indicators | 104 | Reporting Safety Defects (U.S. Only) | 149 |
| Using Adaptive Cruise Control | 104 | Reporting Safety Defects (Canada Only) | 150 |
| Driving Aids | | Fuses | |
| Driver Alert | 111 | Fuse Specification Chart | 151 |
| Lane Keeping System | 112 | Changing a Fuse | 159 |
| Steering | 115 | Maintenance | |
| Pre-Collision Assist | 116 | General Information | 161 |
| Load Carrying | | Opening and Closing the Hood | 161 |
| Load Limit | 120 | Under Hood Overview | 162 |
| Towing | | Engine Oil Dipstick | 163 |
| Towing a Trailer | 125 | Engine Oil Check | 163 |
| Recommended Towing Weights | 126 | Oil Change Indicator Reset | 164 |
| Essential Towing Checks | 130 | Engine Coolant Check | 165 |
| Towing the Vehicle on Four Wheels | 136 | Automatic Transmission Fluid Check | 169 |
| Driving Hints | | Brake Fluid Check | 171 |
| Breaking-In | 137 | Power Steering Fluid Check | 172 |
| Reduced Engine Performance | 137 | Washer Fluid Check | 173 |
| Economical Driving | 137 | Fuel Filter | 173 |
| Driving Through Water | 138 | Changing the 12V Battery | 173 |
| Floor Mats | 138 | Checking the Wiper Blades | 174 |
| Roadside Emergencies | | Changing the Wiper Blades | 175 |
| Roadside Assistance | 140 | Adjusting the Headlamps | 175 |
| Hazard Flashers | 141 | Removing a Headlamp | 176 |
| Fuel Shutoff | 141 | Changing a Bulb | 177 |
| Jump Starting the Vehicle | 142 | Changing the Engine Air Filter | 178 |
| Transporting the Vehicle | 143 | Vehicle Care | |
| Customer Assistance | | General Information | 180 |
| Getting the Services You Need | 145 | Cleaning Products | 180 |
| In California (U.S. Only) | 146 | Cleaning the Exterior | 180 |
| The Better Business Bureau (BBB) Auto Line Program (U.S. Only) | 147 | Waxing | 182 |
| Getting Assistance Outside the U.S. and Canada | 148 | Cleaning the Engine | 182 |

Table of Contents

| | |
|---|-----|
| Cleaning the Windows and Wiper Blades | 182 |
| Cleaning the Interior | 183 |
| Cleaning the Instrument Panel and Instrument Cluster Lens | 183 |
| Cleaning Leather Seats | 184 |
| Repairing Minor Paint Damage | 185 |
| Cleaning the Wheels | 185 |
| Vehicle Storage | 185 |

Wheels and Tires

| | |
|---------------------------------------|-----|
| General Information | 188 |
| Tire Care | 189 |
| Using Snow Chains | 207 |
| Tire Pressure Monitoring System | 208 |
| Changing a Road Wheel | 213 |
| Technical Specifications | 217 |

Capacities and Specifications

| | |
|-------------------------------------|-----|
| Engine Specifications | 219 |
| Motorcraft Parts | 219 |
| Vehicle Identification Number | 221 |
| Transmission Code Designation | 222 |
| Capacities and Specifications | 223 |
| Bulb Specification Chart | 232 |

Connected Vehicle

| | |
|--|-----|
| Connected Vehicle Requirements | 234 |
| Connected Vehicle Limitations | 234 |
| Connecting the Vehicle to a Mobile Network | 234 |
| Connected Vehicle – Troubleshooting | 234 |

Audio System

| | |
|-------------------------------------|-----|
| General Information | 235 |
| Audio Unit | 235 |
| Digital Radio | 238 |
| Connecting a Bluetooth Device | 240 |

| | |
|---------------------------------------|-----|
| Satellite Radio | 241 |
| Streaming Bluetooth Audio | 243 |
| Playing Media From a USB Device | 243 |
| USB Port | 244 |
| Using Voice Recognition | 244 |

Accessories

| | |
|--------------------------|-----|
| Accessories | 245 |
| Auxiliary Switches | 246 |

Ford Protect

| | |
|--------------------|-----|
| Ford Protect | 248 |
|--------------------|-----|

Scheduled Maintenance

| | |
|--|-----|
| General Maintenance Information | 250 |
| Normal Scheduled Maintenance | 253 |
| Special Operating Conditions Scheduled Maintenance | 255 |
| Scheduled Maintenance Record | 257 |

Appendices

| | |
|-------------------------------------|-----|
| Electromagnetic Compatibility | 267 |
| End User License Agreement | 269 |

Introduction

ABOUT THIS MANUAL

Thank you for choosing Ford. We recommend that you take some time to get to know your vehicle by reading this manual. The more that you know about your vehicle, the greater the safety and pleasure you will get from driving it.



WARNING: Driving while distracted can result in loss of vehicle control, crash and injury. We strongly recommend that you use extreme caution when using any device that may take your focus off the road. Your primary responsibility is the safe operation of your vehicle. We recommend against the use of any hand-held device while driving and encourage the use of voice-operated systems when possible. Make sure you are aware of all applicable local laws that may affect the use of electronic devices while driving.

Note: This manual describes product features and options available throughout the range of available models, sometimes even before they are generally available. It may describe options not fitted to the vehicle you have purchased.

Note: Some of the illustrations in this manual may show features as used in different models, so may appear different to you on your vehicle.

Note: Always use and operate your vehicle in line with all applicable laws and regulations.

Note: Pass on this manual when selling your vehicle. It is an integral part of your vehicle.

This manual may qualify the location of a component as left-hand side or right-hand side. The side is determined when facing forward in the seat.

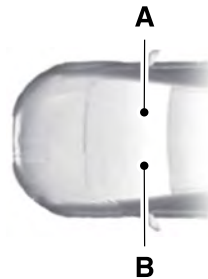

E154903

- A Right-hand side.
- B Left-hand side.

SYMBOLS GLOSSARY

These are some of the symbols you may see on your vehicle.



Air conditioning system



Air conditioning system lubricant type



Anti-lock braking system



Avoid smoking, flames or sparks



Battery



Battery acid



Brake fluid - non petroleum based



Brake system

Introduction



Brake system



Flammable



Cabin air filter



Front airbag



Check fuel cap



Front fog lamps



Child safety door lock or unlock



Fuel pump reset



Child seat lower anchor



Fuse compartment



Child seat tether anchor



Hazard flashers



Cruise control



Heated rear window



Do not open when hot



Windshield defrosting system



Engine air filter



Interior luggage compartment release



Engine coolant



Jack



Engine coolant temperature



Keep out of reach of children



Engine oil



Lighting control



Explosive gas



Low tire pressure warning



Fan warning



Maintain correct fluid level



Fasten seatbelt



Note operating instructions

Introduction



Horn control



Panic alarm



Parking aid



Parking brake



Power steering fluid



Power windows front/rear



Power window lockout



Requires registered technician



Safety alert



See Owner's Manual



See Service Manual



Service engine soon



Passenger airbag activated



Passenger airbag deactivated



Side airbag



Shield the eyes



Stability control



Hill descent control



Trail control



Windshield wiper system



Windshield wash and wipe

DATA RECORDING



WARNING: Do not connect wireless plug-in devices to the data link connector. Unauthorized third parties could gain access to vehicle data and impair the performance of safety related systems. Only allow repair facilities that follow our service and repair instructions to connect their equipment to the data link connector.

We respect your privacy and are committed to protecting it. The information contained in this publication was correct at the time of going to print, but as technology rapidly changes, we recommend that you visit the regional Ford website for the latest information.

Introduction

Your vehicle has electronic control units that have data recording functionality and the ability to permanently or temporarily store data. This data could include information on the condition and status of your vehicle, vehicle maintenance requirements, events and malfunctions. The types of data that can be recorded are described in this section. Some of the data recorded is stored in event logs or error logs.

Note: *Error logs are reset following a service or repair.*

Note: *We may provide information in response to requests from law enforcement, other government authorities and third parties acting with lawful authority or through a legal process. Such information could be used by them in legal proceedings.*

Data recorded includes, for example:

- Operating states of system components, for example, fuel level, tire pressure and battery charge level.
- Vehicle and component status, for example, wheel speed, deceleration, lateral acceleration and seatbelt status.
- Events or errors in essential systems, for example, headlamps and brakes.
- System responses to driving situations, for example, airbag deployment and stability control.
- Environmental conditions, for example, temperature.

Some of this data, when used in combination with other information, for example, an accident report, damage to a vehicle or eyewitness statements, could be associated with a specific person.

Service Data

Service data recorders in your vehicle are capable of collecting and storing diagnostic information about your vehicle. This potentially includes information about the performance or status of various systems and modules in the vehicle, such as engine, throttle, steering or brake systems. In order to properly diagnose and service your vehicle, Ford Motor Company (Ford of Canada in Canada), and service and repair facilities may access or share among them vehicle diagnostic information received through a direct connection to your vehicle when diagnosing or servicing your vehicle. Additionally, Ford Motor Company (Ford of Canada, in Canada) may, where permitted by law, use vehicle diagnostic information for vehicle improvement or with other information we may have about you, for example, your contact information, to offer you products or services that may interest you. Data may be provided to our service providers such as part suppliers that may help diagnose malfunctions, and who are similarly obligated to protect data. We retain this data only as long as necessary to perform these functions or to comply with law. We may provide information where required in response to official requests to law enforcement or other government authorities or third parties acting with lawful authority or court order, and such information may be used in legal proceedings. For U.S. only (if equipped), if you choose to use connected apps and services, you consent that certain diagnostic information may also be accessed electronically by Ford Motor Company and Ford authorized service facilities, and that the diagnostic information may be used to provide services to you, personalizing your experience, troubleshoot, and to improve products and services and offer you products and services that may interest

Introduction

you, where permitted by law. For Canada only, for more information, please review the Ford of Canada privacy policy at www.ford.ca, including our U.S. data storage and use of service providers in other jurisdictions who may be subject to legal requirements in Canada, the United States and other countries applicable to them, for example, lawful requirements to disclose personal information to governmental authorities in those countries.

Event Data

This vehicle is equipped with an event data recorder. The main purpose of an event data recorder is to record, in certain crash or near crash-like situations, such as an airbag deployment or hitting a road obstacle; this data assist in understanding how a vehicle's systems performed. The event data recorder is designed to record data related to vehicle dynamics and safety systems for a short period of time, typically 30 seconds or less.

The event data recorder in this vehicle is designed to record such data as:

- How various systems in your vehicle were operating;
- Whether or not the driver and passenger seatbelts were buckled/fastened;
- How far (if at all) the driver was depressing the accelerator and/or the brake pedal; and
- How fast the vehicle was traveling; and
- Where the driver was positioning the steering wheel.

This data can help provide a better understanding of the circumstances in which crashes and injuries occur.

Note: *Event data recorder data is recorded by your vehicle only if a non-trivial crash situation occurs; no data is recorded by the event data recorder under normal driving conditions and no personal data or information (e.g., name, gender, age, and crash location) is recorded. However, other parties, such as law enforcement, could combine the event data recorder data with the type of personally identifying data routinely acquired during a crash investigation.*

To read data recorded by an event data recorder, special equipment is required, and access to the vehicle or the event data recorder is needed. In addition to the vehicle manufacturer, other parties, such as law enforcement, that have such special equipment, can read the information if they have access to the vehicle or the event data recorder.

Comfort, Convenience and Entertainment Data

Your vehicle has electronic control units that have the ability to store data based on your personalized settings. The data is stored locally in the vehicle or on devices that you connect to it, for example, a USB drive or digital music player. You can delete some of this data and also choose whether to share it through the services to which you subscribe.

Comfort and Convenience Data

Data recorded includes, for example:

- Seat and steering wheel position.
- Climate control settings.
- Radio presets.

Introduction

Entertainment Data

Data recorded includes, for example:

- Music, videos or album art.
- Contacts and corresponding address book entries.
- Navigation destinations.

Services That We Provide

If you use our services, we collect and use data, for example, account information, vehicle location and driving characteristics, that could identify you. We transmit this data through a dedicated, protected connection. We only collect and use data to enable your use of our services to which you have subscribed, with your consent or where permitted by law. For additional information, see the terms and conditions of the services to which you have subscribed.

Services That Third Parties Provide

We recommend that you review the terms and conditions and data privacy information for any services to which you subscribe. We take no responsibility for services that third parties provide.

Vehicles With a Connectivity Device (If Equipped)



The connectivity device has a SIM. The connectivity device was enabled when your vehicle was built and periodically sends messages to stay connected to the cell phone network. These messages could include information that identifies your vehicle, the SIM and the electronic serial number of the connectivity device. Cell phone network service providers could have access to additional information, for example, cell phone network tower identification.

Note: *The connectivity device continues to send this information unless you disable the connectivity device. To find out more about having the connectivity device disabled, contact the Ford Customer Relationship Center. Disabling this connectivity device is permanent. See **Connected Vehicle** (page 234).*

If FordPass is connected to your vehicle, Ford also receives additional information, for example, location and vehicle data. See FordPass Terms and Privacy Policy. For additional information about our privacy policy, visit www.FordConnected.com or refer to your local Ford website.

Note: *To stop the connectivity device from sharing this information, for example, location and vehicle data, see your Connectivity Settings through the FordPass app. You may also remove the vehicle from your FordPass account.*

Note: *The service can be unavailable or interrupted for a number of reasons, for example, environmental or topographical conditions and data plan coverage.*

Note: *To find out if your vehicle has a connectivity technology, visit www.FordConnected.com.*

Note: *If you plan to no longer use your vehicle, for example, by selling or donating it, remember to remove the vehicle from your FordPass account. If you recently purchased the vehicle and want to disable connectivity, please contact the Ford Customer Relationship Center through the FordPass app or by using the e-mail address on the local Ford website.*

Introduction

Vehicles With SYNC

Mobile Device Data

If you connect a mobile device to your vehicle, you can display data from your device on the touchscreen for example, music and album art. You can share your vehicle data with mobile apps on your device through the system.

The mobile apps function operates by your connected device sending data to us in the United States. The data is encrypted and includes the vehicle identification number of your vehicle, the SYNC module serial number, odometer, enabled apps, usage statistics and debugging information. We retain it only as long as necessary to provide the service, to troubleshoot, for continuous improvement and to offer you products and services that may be of interest to you according to your preferences and where allowed by law.

If you connect a cell phone to the system, the system creates a profile that links to that cell phone. The cell phone profile enables more mobile features and efficient operation. The profile contains, for example, data from your phonebook, read and unread text messages and call history, including history of calls when your cell phone was not connected to the system.

If you connect a media device, the system creates and retains a media device index of supported media content. The system also records a short diagnostic log of approximately 10 minutes of all recent system activity.

The cell phone profile, media device index and diagnostic log remain in your vehicle unless you delete them and are generally accessible only in your vehicle when you connect your cell phone or media device. If you no longer plan to use the system or your vehicle, we recommend you use the master reset function to erase the stored information.

System data cannot be accessed without special equipment and access to your vehicle's module.

For additional information about our privacy policy, refer to your local Ford website.

Note: *To find out if your vehicle has a connectivity technology, visit www.FordConnected.com.*

Vehicles With an Emergency Call System

When the emergency call system is active, it may disclose to emergency services that your vehicle has been in a crash involving the deployment of an airbag or activation of the fuel pump shut-off. Certain versions or updates to the emergency call system may also be capable of electronically or verbally disclosing to emergency services operators your vehicle location or other details about your vehicle or crash to assist emergency services operators to provide the most appropriate emergency services. If you do not want to disclose this information, do not activate the emergency call system.

Note: *You cannot deactivate emergency call systems that are required by law.*

PERCHLORATE

Certain components in your vehicle such as airbag modules, seatbelt pretensioners and remote control batteries may contain perchlorate material. Special handling may apply for service or vehicle end of life disposal.

Introduction

For more information visit:

| Web Address |
|--|
| www.dtsc.ca.gov/hazardouswaste/perchlorate |

FORD CREDIT

US Only

Ford Credit offers a full range of financing and lease plans to help you acquire your vehicle. If you have financed or leased your vehicle through Ford Credit, thank you for your business.

For assistance call 1-800-727-7000, or for more information about Ford Credit and access to the online Account Manager tool, visit www.ford.com/finance.

REPLACEMENT PARTS RECOMMENDATION

We have built your vehicle to the highest standards using quality parts. We recommend that you demand the use of genuine Ford and Motorcraft parts whenever your vehicle requires scheduled maintenance or repair. You can clearly identify genuine Ford and Motorcraft parts by looking for the Ford, FoMoCo or Motorcraft branding on the parts or their packaging.

Scheduled Maintenance and Mechanical Repairs

One of the best ways for you to make sure that your vehicle provides years of service is to have it maintained in line with our recommendations using parts that conform to the specifications detailed in this Owner's Manual. Genuine Ford and Motorcraft parts meet or exceed these specifications.

Collision Repairs

We hope that you never experience a collision, but accidents do happen. Genuine Ford replacement collision parts meet our stringent requirements for fit, finish, structural integrity, corrosion protection and dent resistance. During vehicle development we validate that these parts deliver the intended level of protection as a whole system. A great way to know for sure you are getting this level of protection is to use genuine Ford replacement collision parts.

Warranty on Replacement Parts

Genuine Ford and Motorcraft replacement parts are the only replacement parts that benefit from a Ford Warranty. The Ford Warranty may not cover damage caused to your vehicle as a result of failed non-Ford parts. For additional information, refer to the terms and conditions of the Ford Warranty.

SPECIAL NOTICES

New Vehicle Limited Warranty

For a detailed description of what is covered by your New Vehicle Limited Warranty, see your warranty guide that is available online. For more information, refer to our website and download your copy of the warranty guide.

Special Instructions

For your added safety, your vehicle is fitted with sophisticated electronic controls.

Introduction



WARNING: You risk death or serious injury to yourself and others if you do not follow the instruction highlighted by the warning symbol. Failure to follow the specific warnings and instructions could result in personal injury.



WARNING: Never place front seat mounted rear-facing child or infant seats in front of an active passenger airbag.

Fleet Telematics Modem (If Equipped)

The onboard modem provides access to data to support telematics services such as location, speed, idle time, fuel, vehicle diagnostics and maintenance alerts. To explore data, telematics services, third party service provider support and to manage existing telematics accounts, refer to www.commercialsolutions.ford.com or call 833-FCS-FORD.

Note: This is not available with FordPass Connect.

FordPass Connect (If Equipped)

With a FordPass Connect-equipped vehicle, you can use FordPass to track your vehicle's location and remotely access vehicle features such as start, lock and unlock and vehicle status including fuel level and approximate mileage. Message and data rates may apply. Services may be limited by mobile phone network coverage area. For additional information, refer to www.fordpass.com.

On Board Diagnostics Data Link Connector



WARNING: Do not connect wireless plug-in devices to the data link connector. Unauthorized third parties could gain access to vehicle data and impair the performance of safety related systems. Only allow repair facilities that follow our service and repair instructions to connect their equipment to the data link connector.

Your vehicle has an OBD Data Link Connector (DLC) that is used in conjunction with a diagnostic scan tool for vehicle diagnostics, repairs and reprogramming services. Installing an aftermarket device that uses the DLC during normal driving for purposes such as remote insurance company monitoring, transmission of vehicle data to other devices or entities, or altering the performance of the vehicle, may cause interference with or even damage to vehicle systems. We do not recommend or endorse the use of aftermarket plug-in devices unless approved by Ford. The vehicle Warranty will not cover damage caused by an aftermarket plug-in device.

Notice to Owners of Pickup Trucks and Utility Type Vehicles



WARNING: Utility vehicles have a significantly higher rollover rate than other types of vehicles.

Before you drive your vehicle, please read this Owner's Manual carefully. Your vehicle is not a passenger car. As with other vehicles of this type, failure to operate this vehicle correctly may result in loss of vehicle control, vehicle rollover, personal injury or death.

Introduction

Using your Vehicle as an Ambulance

If your light truck has the Ford Ambulance Preparation Package, it may be utilized as an ambulance. Ford urges ambulance manufacturers to follow the recommendations of the Ford Incomplete Vehicle Manual, Ford Truck Body Builder's Layout Book and the Qualified Vehicle Modifiers (QVM) Guidelines as well as pertinent supplements. For additional information, please contact the Truck Body Builders Advisory Service at <http://www.fleet.ford.com/truckbbas/> and then by selecting Contact Us or by phone at 1-877-840-4338.

Use of your Ford light truck as an ambulance, without the Ford Ambulance Preparation Package voids the Ford New Vehicle Limited Warranty and may void the emissions warranties. In addition, ambulance usage without the preparation package could cause high underbody temperatures, over-pressurized fuel and a risk of spraying fuel, which could lead to fires.

If your vehicle has the Ford Ambulance Preparation Package, it will be indicated on the Safety Compliance Certification Label. The label is on the driver side door pillar or on the rear edge of the driver door. You can determine whether the ambulance manufacturer followed Ford's recommendations by directly contacting that manufacturer.

MOBILE COMMUNICATIONS EQUIPMENT



WARNING: Driving while distracted can result in loss of vehicle control, crash and injury. We strongly recommend that you use extreme caution when using any device that may take your focus off the road. Your primary responsibility is the safe operation of your vehicle. We recommend against the use of any hand-held device while driving and encourage the use of voice-operated systems when possible. Make sure you are aware of all applicable local laws that may affect the use of electronic devices while driving.

Using mobile communications equipment is becoming increasingly important in the conduct of business and personal affairs. However, you must not compromise your own or others' safety when using such equipment. Mobile communications can enhance personal safety and security when appropriately used, particularly in emergency situations. Safety must be paramount when using mobile communications equipment to avoid negating these benefits. Mobile communication equipment includes, but is not limited to, cellular phones, pagers, portable email devices, text messaging devices and portable two-way radios.

Environment

PROTECTING THE ENVIRONMENT

You should play your part in protecting the environment. Correct vehicle usage and the authorized disposal of waste, cleaning and lubrication materials are significant steps toward this aim.

For additional information about our sustainability progress and initiatives, visit www.sustainability.ford.com.

At a Glance

INSTRUMENT PANEL

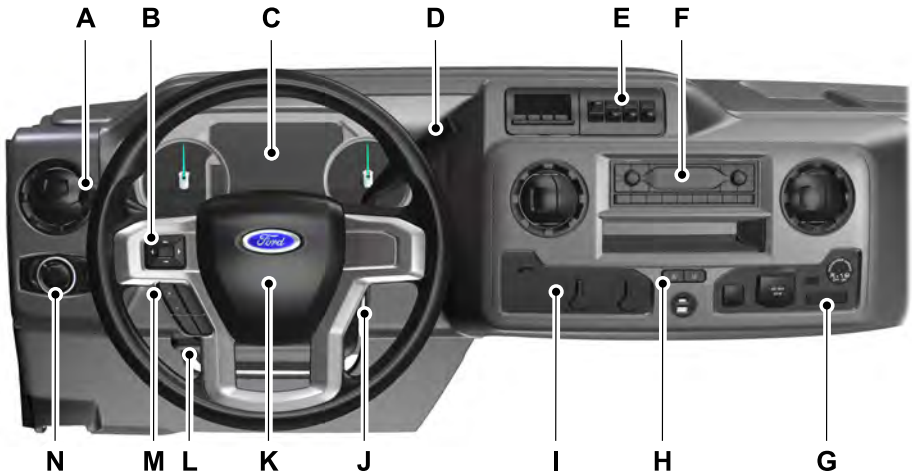

- A Direction indicators. See **Direction Indicators** (page 52). Wiper lever. See **Windshield Wipers** (page 49).
- B Information display control. See **Information Display Control** (page 48).
- C Instrument cluster. See **General Information** (page 63).
- D Gearshift lever. See **Automatic Transmission** (page 92).
- E Auxiliary switches. See **Auxiliary Switches** (page 246).
- F Audio unit. See **Audio Unit** (page 235).
- G Passenger airbag deactivation indicator. See **Driver and Passenger Airbags** (page 33).
- H Hazard flasher switch. See **Hazard Flashers** (page 141).
- I Climate control. See **Manual Climate Control** (page 70).
- J Ignition. See **Ignition Switch** (page 78).
- K Horn.
- L Steering wheel adjustment. See **Adjusting the Steering Wheel** (page 47).
- M Cruise control. See **Cruise Control** (page 103).
- N Lighting control. See **Lighting Control** (page 50).

Child Safety

GENERAL INFORMATION

See the following sections for directions on how to properly use safety restraints for children.



WARNING: Always make sure your child is secured properly in a device that is appropriate for their height, age and weight. Child safety restraints must be bought separately from your vehicle. Failure to follow these instructions and guidelines may result in an increased risk of serious injury or death to your child.



WARNING: All children are shaped differently. The National Highway Traffic Safety Administration and other safety organizations, base their recommendations for child restraints on probable child height, age and weight thresholds, or on the minimum requirements of the law. We recommend that you check with a NHTSA Certified Child Passenger Safety Technician

(CPST) to make sure that you properly install the child restraint in your vehicle and that you consult your pediatrician to make sure you have a child restraint appropriate for your child. To locate a child restraint fitting station and CPST, contact NHTSA toll free at 1-888-327-4236 or go to www.nhtsa.dot.gov. In Canada, contact Transport Canada toll free at 1-800-333-0371 or go to www.tc.gc.ca to find a Child Car Seat Clinic in your area. Failure to properly restrain children in child restraints made especially for their height, age and weight, may result in an increased risk of serious injury or death to your child.



WARNING: On hot days, the temperature inside the vehicle can rise very quickly. Exposure of people or animals to these high temperatures for even a short time can cause death or serious heat related injuries, including brain damage. Small children are particularly at risk.

Child Safety

Recommendations for Safety Restraints for Children

| Child | Child Size, Height, Weight, or Age | Recommended Restraint Type |
|---------------------|---|---|
| Infants or toddlers | Children weighing 40 lb (18 kg) or less (generally age four or younger). | Use a child restraint (sometimes called an infant carrier, convertible seat, or toddler seat). |
| Small children | Children who have outgrown or no longer properly fit in a child restraint (generally children who are less than 57 in (1.45 m) tall, are greater than age four and less than age 12, and between 40 lb (18 kg) and 80 lb (36 kg) and upward to 100 lb (45 kg) if recommended by your child restraint manufacturer). | Use a belt-positioning booster seat. |
| Larger children | Children who have outgrown or no longer properly fit in a belt-positioning booster seat (generally children who are at least 57 in (1.45 m) tall or greater than 80 lb (36 kg) or 100 lb (45 kg) if recommended by child restraint manufacturer). | Use a vehicle seatbelt having the lap belt snug and low across the hips, shoulder belt centered across the shoulder and chest, and seat backrest upright. |

- You are required by law to properly use child restraints for infants and toddlers in the United States and Canada.
- Many states and provinces require that small children use approved booster seats until they reach age eight, a height of 57 in (1.45 m) tall, or 80 lb (36 kg). Check your local and state or provincial laws for specific requirements about the safety of children in your vehicle.
- When possible, always properly restrain children 12 years of age and under in a rear seating position of your vehicle. Accident statistics suggest that children are safer when properly restrained in the rear seating positions than in a front seating position.
- When installing a rear facing child restraint, adjust the vehicle seats to avoid interference between the child restraint and the vehicle seat in front of the child restraint.

Child Safety

INSTALLING CHILD RESTRAINTS

Child Seats



E142594

Use a child restraint (sometimes called an infant carrier, convertible seat, or toddler seat) for infants, toddlers, or children weighing 40 lb (18 kg) or less (generally age four or younger).

Using Lap and Shoulder Belts



WARNING: Do not place a rearward facing child restraint in front of an active airbag. Failure to follow this instruction could result in personal injury or death.



WARNING: Properly secure children 12 years old and under in a rear seating position whenever possible. If you are unable to properly secure all children in a rear seating position, properly secure the largest child on the front seat. If you must use a forward facing child restraint on the front seat, move the seat as far back as possible. Failure to follow these instructions could result in personal injury or death.



WARNING: Depending on where you secure a child restraint, and depending on the child restraint design, you may block access to certain seatbelt buckle assemblies and LATCH lower anchors, rendering those features potentially unusable. To avoid risk of injury, make sure occupants only use seating positions where they are able to be properly restrained.

When installing a child restraint with combination lap and shoulder belts:

- Use the correct seatbelt buckle for that seating position.
- Insert the belt tongue into the proper buckle until you hear a snap and feel it latch. Make sure the tongue is securely fastened in the buckle.
- Keep the buckle release button pointing up and away from the child restraint, with the tongue between the child restraint and the release button, to prevent accidental unbuckling.
- Place the vehicle seat in the upright position before you install the child restraint.
- Put the seatbelt in the automatic locking mode. See Step 5. This vehicle does not require the use of a locking clip.

Perform the following steps when installing the child restraint with combination lap and shoulder belts:

Note: *Although the child restraint illustrated is a forward facing child restraint, the steps are the same for installing a rear facing child restraint.*

Child Safety



E142528

1. Position the child restraint in a seat with a combination lap and shoulder belt.



E142529

2. Pull down on the shoulder belt and then grasp the shoulder belt and lap belt together.



E142530

3. While holding the shoulder and lap belt portions together, route the tongue through the child restraint according to the child restraint manufacturer's instructions. Make sure that you did not twist the belt webbing.

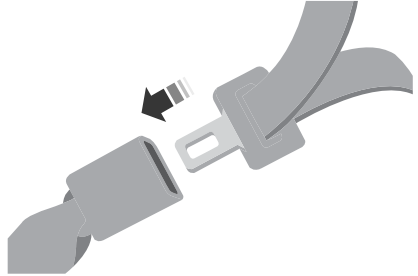

E142531

4. Insert the belt tongue into the proper buckle (the buckle closest to the direction the tongue is coming from) for that seating position until you hear a snap and feel the latch engage. Make sure the tongue is latched securely by pulling on it.



E142875

5. To put the retractor in the automatic locking mode, grasp the shoulder portion of the belt and pull downward until you pull all of the belt out.

Child Safety

6. Allow the belt to retract to remove slack. The belt clicks as it retracts to indicate it is in the automatic locking mode.
7. Try to pull the belt out of the retractor to make sure the retractor is in the automatic locking mode. You should not be able to pull more belt out. If the retractor is not locked, unbuckle the belt and repeat Steps 5 and 6.



E142533

8. Remove remaining slack from the belt. Force the seat down with extra weight, for example, by pressing down or kneeling on the child restraint while pulling up on the shoulder belt in order to force slack from the belt. This is necessary to remove the remaining slack that exists once you add the extra weight of the child to the child restraint. It also helps to achieve the proper snugness of the child restraint to your vehicle. Sometimes, a slight lean toward the buckle will help to remove remaining slack from the belt.
9. If the child restraint has a tether strap, attach it.

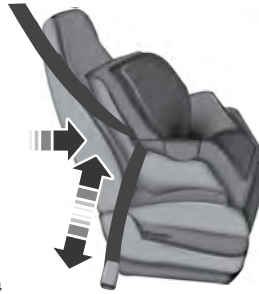

E142534

10. Before placing the child in the seat, forcibly move the seat forward and back to make sure the seat is securely held in place.

To check this, grab the seat at the belt path and attempt to move it side to side and forward and back. There should be no more than 1 in (2.5 cm) of movement for proper installation.

We recommend checking with a NHTSA Certified Child Passenger Safety Technician to make certain the child restraint is properly installed. In Canada, check with Transport Canada for referral to a Child Car Seat Clinic.

Using Tether Straps

Many forward-facing child restraints include a tether strap which extends from the back of the child restraint and hooks to an anchoring point called the top tether anchor. Tether straps are available as an accessory for many older child restraints. Contact the manufacturer of your child restraint for information about ordering a tether strap, or to obtain a longer tether strap if the tether strap on your child restraint does not reach the appropriate top tether anchor in the vehicle.

Attach the tether strap only to the tether anchor as shown. The tether strap may not work properly if attached somewhere other than the correct tether anchor.

Child Safety

Note: Do not tighten the tether strap enough to lift the child restraint off the vehicle seat cushion when the child is seated in it. Keep the tether strap just snug without lifting the front of the child restraint. Keeping the child restraint just touching the vehicle seat gives the best protection in a severe crash.

Perform the following steps to install a child restraint with tether anchors:

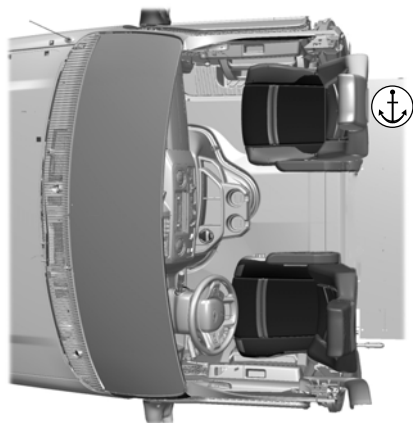

You can attach the tether directly to the rear of the front seat.

1. Adjust the front passenger seat fully forward.



E190810

2. Route the child restraint tether strap over the back of the front passenger seat as shown.



E190811

3. Clip the tether strap hook to the seat pedestal at the location shown. If the tether strap is clipped incorrectly, the child restraint may not be retained properly in the event of a crash.
4. Adjust the front passenger seat to the full rearward position.
5. Tighten the child restraint tether strap according to the manufacturer's instructions.

If you do not properly anchor the child restraint, the risk of a child being injured in a crash greatly increases.

Child Safety

BOOSTER SEATS



WARNING: Do not put the shoulder section of the seatbelt or allow the child to put the shoulder section of the seatbelt under their arm or behind their back. Failure to follow this instruction could reduce the effectiveness of the seatbelt and increase the risk of injury or death in a crash.

Use a belt-positioning booster seat for children who have outgrown or no longer properly fit in a child safety restraint (generally children who are less than 57 in (1.45 m) tall, are greater than age 4 and less than age 12, and between 40 lb (18 kg) and 80 lb (36 kg) and upward to 100 lb (45 kg) if recommended by your child restraint manufacturer). Many state and provincial laws require that children use approved booster seats until they reach age eight, a height of 57 in (1.45 m) tall, or 80 lb (36 kg).

Booster seats should be used until you can answer YES to ALL of these questions when seated without a booster seat:

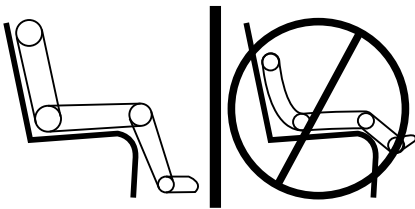

E142595

- Can the child sit all the way back against their vehicle seat backrest with knees bent comfortably at the edge of the seat cushion?
- Can the child sit without slouching?

- Does the lap belt rest low across the hips?
- Is the shoulder belt centered on the shoulder and chest?
- Can the child stay seated like this for the whole trip?

Always use booster seats in conjunction with your vehicle lap and shoulder belt.

Types of Booster Seats



E68924

- Backless booster seats

If your backless booster seat has a removable shield, remove the shield. If a vehicle seating position has a low seat backrest or no head restraint, a backless booster seat may place your child's head (as measured at the tops of the ears) above the top of the seat. In this case, move the backless booster to another seating position with a higher seat backrest or head restraint and lap and shoulder belts, or consider using a high back booster seat.

Child Safety



E70710

- High back booster seats

If, with a backless booster seat, you cannot find a seating position that adequately supports your child's head, a high back booster seat would be a better choice.

Children and booster seats vary in size and shape. Choose a booster that keeps the lap belt low and snug across the hips, never up across the stomach, and lets you adjust the shoulder belt to cross the chest and rest snugly near the center of the shoulder. The following drawings compare the ideal fit (center) to a shoulder belt uncomfortably close to the neck and a shoulder belt that could slip off the shoulder. The drawings also show how the lap belt should be low and snug across the child's hips.



E142596



E142597

Child Safety

If the booster seat slides on the vehicle seat upon which it is being used, placing a rubberized mesh sold as shelf or carpet liner under the booster seat may improve this condition. Do not introduce any item thicker than this under the booster seat. Check with the booster seat manufacturer's instructions.

CHILD RESTRAINT POSITIONING



WARNING: Do not place a rearward facing child restraint in front of an active airbag. Failure to follow this instruction could result in personal injury or death.



WARNING: Properly secure children 12 years old and under in a rear seating position whenever possible. If you are unable to properly secure all children in a rear seating position, properly secure the largest child on the front seat. If you must use a forward facing child restraint on the front seat, move the seat as far back as possible. Failure to follow these instructions could result in personal injury or death.



WARNING: Always carefully follow the instructions and warnings provided by the manufacturer of any child restraint to determine if the restraint device is appropriate for your child's size, height, weight, or age. Follow the child restraint manufacturer's instructions and warnings provided for installation and use in conjunction with the instructions

and warnings provided by your vehicle manufacturer. A safety seat that is improperly installed or utilized, is inappropriate for your child's height, age, or weight or does not properly fit the child may increase the risk of serious injury or death.



WARNING: Do not allow a passenger to hold a child on their lap when your vehicle is moving. Failure to follow this instruction could result in personal injury or death in the event of a sudden stop or crash.



WARNING: Do not use pillows, books or towels to boost your child's height. Failure to follow this instruction could result in personal injury or death.



WARNING: Properly secure child restraints or booster seats when they are not in use. They could become projectiles in a sudden stop or crash. Failure to follow this instruction could result in personal injury or death.



WARNING: Do not put the shoulder section of the seatbelt or allow the child to put the shoulder section of the seatbelt under their arm or behind their back. Failure to follow this instruction could reduce the effectiveness of the seatbelt and increase the risk of injury or death in a crash.



WARNING: Do not leave children or pets unattended in your vehicle. Failure to follow this instruction could result in personal injury or death.

Child Safety

Recommendations for Attaching Child Restraints

| Restraint Type | Use Any Attachment Method as Indicated Below by X. | | |
|--------------------------------|--|--------------------------------|----------------|
| | Combined Weight of Child and Child Restraint | Seatbelt and Top Tether Anchor | Seatbelt Only |
| Rear-facing child restraint | Up to 65 lb (29.5 kg) | | X |
| Rear-facing child restraint | Over 65 lb (29.5 kg) | | X |
| Forward-facing child restraint | Up to 65 lb (29.5 kg) | X | X ¹ |
| Forward-facing child restraint | Over 65 lb (29.5 kg) | X | X ¹ |

¹We recommend using a top tether if the child restraint has one, and the child restraint manufacturer recommends its use.

Note: *The child restraint must rest tightly against the vehicle seat upon which it is installed. It may be necessary to lift or remove the head restraint. See **Head Restraints** (page 73).*

Seatbelts

PRINCIPLE OF OPERATION



WARNING: Always drive and ride with the seat backrest upright and the lap belt snug and low across the hips.



WARNING: To reduce the risk of injury, make sure children sit where they can be properly restrained.



WARNING: Never let a passenger hold a child on his or her lap while your vehicle is moving. The passenger cannot protect the child from injury in a crash which may result in serious injury or death.



WARNING: All occupants of the vehicle, including the driver, should always properly wear their safety belts, even when an airbag supplemental restraint system is provided. Failure to properly wear your safety belt could seriously increase the risk of injury or death.



WARNING: It is extremely dangerous to ride in a cargo area, inside or outside of a vehicle. In a crash, people riding in these areas are more likely to be seriously injured or killed. Do not allow people to ride in any area of your vehicle that is not equipped with seats and safety belts. Be sure everyone in your vehicle is in a seat and using a safety belt properly.



WARNING: In a rollover crash, an unbelted person is significantly more likely to die than a person wearing a safety belt.



WARNING: Each seating position in your vehicle has a specific safety belt assembly which is made up of one buckle and one tongue that are designed to be used as a pair. 1) Use the shoulder belt on the outside shoulder only. Never wear the shoulder belt under the arm. 2) Never swing the safety belt around your neck over the inside shoulder. 3) Never use a single belt for more than one person.



WARNING: When possible, all children 12 years old and under should be properly restrained in a rear seating position. Failure to follow this could seriously increase the risk of injury or death.



WARNING: Safety belts and seats can become hot in a vehicle that has been closed up in sunny weather; they could burn a small child. Check seat covers and buckles before you place a child anywhere near them.



WARNING: Front and rear seat occupants, including pregnant women, should wear safety belts for optimum protection in an accident.

All seating positions in this vehicle have lap and shoulder safety belts. All occupants of the vehicle should always properly wear their safety belts, even when an airbag supplemental restraint system is provided.

The safety belt system consists of:

- Lap and shoulder safety belts.
- Shoulder safety belt with automatic locking mode, (except driver safety belt).

Seatbelts

- Height adjuster at the front outboard seating positions.
- Safety belt pretensioner at the front outboard seating positions.



- Safety belt warning light and chime.



- Crash sensors and monitoring system with readiness indicator.

The safety belt pretensioners at the front seating positions are designed to tighten the safety belts when activated. In frontal and near-frontal crashes, the safety belt pretensioners may be activated alone or, if the crash is of sufficient severity, together with the front airbags.

FASTENING THE SEATBELTS

The front outboard safety restraints in the vehicle are combination lap and shoulder belts.



E142587

1. Insert the belt tongue into the proper buckle (the buckle closest to the direction the tongue is coming from) until you hear a snap and feel it latch. Make sure the tongue is securely fastened in the buckle.

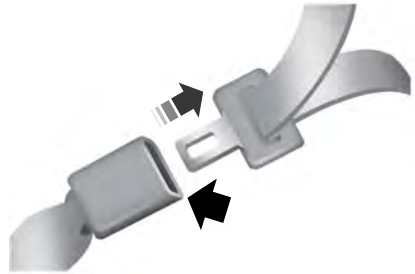

E142588

2. To unfasten, press the release button and remove the tongue from the buckle.

Using Seatbelts During Pregnancy



WARNING: Always ride and drive with your seatback upright and properly fasten your seatbelt. Fit the lap portion of the seatbelt snugly and low across the hips. Position the shoulder portion of the seatbelt across your chest. Pregnant women must follow this practice. See the following figure.

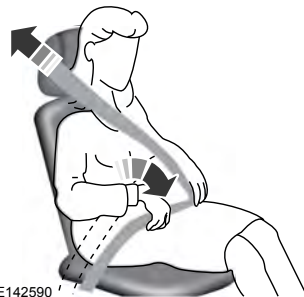

E142590

Seatbelts

Pregnant women should always wear their seatbelt. Position the lap belt portion of a combination lap and shoulder belt low across the hips below the belly and worn as tight as comfort allows. Position the shoulder belt to cross the middle of the shoulder and the center of the chest.

Seatbelt Locking Modes



WARNING: If your vehicle is involved in a crash, have the seatbelts and associated components inspected as soon as possible. Failure to follow this instruction could result in personal injury or death.

All safety restraints in the vehicle are combination lap and shoulder belts. The driver seatbelt has the first type of locking mode. The front outboard passenger seatbelt has both types of locking modes described as follows:

Vehicle Sensitive Mode

This is the normal retractor mode, which allows free shoulder belt length adjustment to your movements and locking in response to vehicle movement. For example, if the driver brakes suddenly or turns a corner sharply, or the vehicle receives an impact of about 5 mph (8 km/h) or more, the combination seatbelts lock to help reduce forward movement of the driver and passengers.

In addition, the retractor is designed to lock if you pull the webbing out too quickly. If the seatbelt retractor locks, slowly lower the height adjuster to allow the seatbelt to retract. If the retractor does not unlock, pull the seatbelt out slowly then feed a

small length of webbing back toward the stowed position. For rear seatbelts, recline the rear seat backrest or push the seat backrest cushion away from the seatbelt. Feed a small length of webbing back toward the stowed position.

Automatic Locking Mode

In this mode, the shoulder belt automatically pre-locks. The belt will still retract to remove any slack in the shoulder belt. The automatic locking mode is not available on the driver seatbelt.

When to Use the Automatic Locking Mode

Use this mode any time a child safety seat, except a booster, is installed in the passenger front seating position. See **Child Safety** (page 17).

How to Use the Automatic Locking Mode



E142591

1. Buckle the combination lap and shoulder belt.
2. Grasp the shoulder portion and pull downward until the entire belt is pulled out.
3. Allow the belt to retract. As the belt retracts, you will hear a clicking sound. This indicates the seatbelt is now in the automatic locking mode.

Seatbelts

How to Disengage the Automatic Locking Mode

Unbuckle the combination lap and shoulder belt and allow it to retract completely to disengage the automatic locking mode and activate the vehicle sensitive (emergency) locking mode.



E190812

SEATBELT HEIGHT ADJUSTMENT



WARNING: Position the safety belt height adjuster so that the belt rests across the middle of your shoulder. Failure to adjust the safety belt properly could reduce the effectiveness of the safety belt and increase the risk of injury in a crash.

Adjust the height of the shoulder belt so the belt rests across the middle of your shoulder.

To adjust the shoulder belt height:

1. Press the button and slide the height adjuster up or down.
2. Release the button and pull down on the height adjuster to make sure it is locked in place.

SEATBELT WARNING LAMP AND INDICATOR CHIME



This lamp illuminates and an indicator chime will sound if the driver seatbelt has not been fastened when the vehicle's ignition is turned on.

Conditions of operation

| If | Then |
|---|---|
| The driver seatbelt is not buckled before the ignition switch is turned to the on position... | The seatbelt warning lamp illuminates and the indicator chime sounds for a few seconds. |
| The driver seatbelt is buckled while the warning lamp is illuminated and the indicator chime is sounding... | The seatbelt warning lamp and indicator chime turn off. |
| The driver seatbelt is buckled before the ignition switch is turned to the on position... | The seatbelt warning lamp and indicator chime remain off. |

Seatbelts

CHILD RESTRAINT AND SEATBELT MAINTENANCE

Inspect the vehicle seatbelts and child restraint systems periodically to make sure they work properly and are not damaged. Inspect the vehicle seatbelts to make sure there are no nicks, tears or cuts. Replace if necessary. All vehicle seatbelt assemblies, including retractors, buckles, front seatbelt buckle assemblies, buckle support assemblies (slide bar-if equipped), shoulder belt height adjusters (if equipped), shoulder belt guide on seatback (if equipped), rear inflatable seatbelts (if equipped), child restraint LATCH and tether anchors, and attaching hardware, should be inspected after a crash. Read the child restraint manufacturer's instructions for additional inspection and maintenance information specific to the child restraint.

We recommend that all seatbelt assemblies in use in vehicles involved in a crash be replaced. However, if the crash was minor and an authorized dealer finds that the belts do not show damage and continue to operate properly, they do not need to be replaced. Seatbelt assemblies not in use during a crash should also be inspected and replaced if either damage or improper operation is noted.

Properly care for seatbelts. See **Cleaning the Interior** (page 183).

SEATBELT EXTENSIONS



WARNING: Persons who fit into the vehicle's seatbelt should not use an extension. Unnecessary use could result in serious personal injury in the event of a crash.



WARNING: Only use extensions provided free of charge by our dealers. The dealer will provide an extension designed specifically for this vehicle, model year and seating position. The use of an extension intended for another vehicle, model year or seating position may not offer you the full protection of your vehicle's seatbelt restraint system.



WARNING: Never use seatbelt extensions to install child restraints.



WARNING: Do not use a seatbelt extension with an inflatable seatbelt.



WARNING: Do not use extensions to change the way the seatbelt fits across the torso, over the lap or to make the seatbelt buckle easier to reach.

If, because of body size or driving position, it is not possible to properly fasten the seatbelt over your lap and shoulder, an extension that is compatible with the seatbelts is available free of charge from our dealers. Only use our seatbelt extensions made by the original equipment seatbelt manufacturer with our seatbelts. Ask your authorized dealer if your extension is compatible with your vehicle restraint system.

Supplementary Restraints System

PRINCIPLE OF OPERATION



WARNING: Airbags do not inflate slowly or gently, and the risk of injury from a deploying airbag is the greatest close to the trim covering the airbag module.



WARNING: All occupants of your vehicle, including the driver, should always properly wear their seatbelts, even when an airbag supplemental restraint system is provided. Failure to properly wear your seatbelt could seriously increase the risk of injury or death.



WARNING: Properly secure children 12 years old and under in a rear seating position whenever possible. If you are unable to properly secure all children in a rear seating position, properly secure the largest child on the front seat. If you must use a forward facing child restraint on the front seat, move the seat as far back as possible. Failure to follow these instructions could result in personal injury or death.



WARNING: Do not place your arms on the airbag cover or through the steering wheel. Failure to follow this instruction could result in personal injury.



WARNING: Do not place a rearward facing child restraint in front of an active airbag. Failure to follow this instruction could result in personal injury or death.



WARNING: Do not attempt to service, repair, or modify the supplementary restraint system or associated components. Failure to follow this instruction could result in personal injury or death.



WARNING: Several airbag system components get hot after inflation. To reduce the risk of injury, do not touch them after inflation.



WARNING: If a supplementary restraint system component has deployed, it will not function again. Have the system and associated components inspected as soon as possible. Failure to follow this instruction could result in personal injury or death.

The airbags are a supplemental restraint system and are designed to work with the seatbelts to help protect the driver and right front passenger from certain upper body injuries. Airbags do not inflate slowly; there is a risk of injury from a deploying airbag.

Note: *You will hear a loud bang and see a cloud of harmless powdery residue if an airbag deploys. This is normal.*

The airbags inflate and deflate rapidly upon activation. After airbag deployment, it is normal to notice a smoke-like, powdery residue or smell the burnt propellant. This may consist of cornstarch, talcum powder (to lubricate the bag) or sodium compounds (for example, baking soda) that result from the combustion process that inflates the airbag. Small amounts of sodium hydroxide may be present which may irritate the skin and eyes, but none of the residue is toxic.

While the system is designed to help reduce serious injuries, contact with a deploying airbag may also cause abrasions or swelling. Temporary hearing loss is also a possibility as a result of the noise associated with a deploying airbag. Because airbags must inflate rapidly and with considerable force, there is the risk of death or serious injuries such as fractures, facial and eye injuries or internal injuries,

Supplementary Restraints System

particularly to occupants who are not properly restrained or are otherwise out of position at the time of airbag deployment. Thus, it is extremely important that occupants be properly restrained as far away from the airbag module as possible while maintaining vehicle control.

Routine maintenance of the airbags is not required.

DRIVER AND PASSENGER AIRBAGS

 **WARNING:** Do not place your arms on the airbag cover or through the steering wheel. Failure to follow this instruction could result in personal injury.

 **WARNING:** Do not place a rearward facing child restraint in front of an active airbag. Failure to follow this instruction could result in personal injury or death.

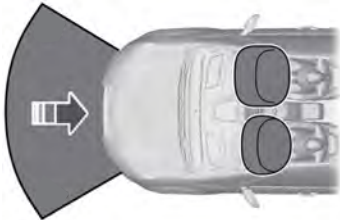

E151127

The driver and front passenger airbags deploy during significant frontal and near frontal crashes.

The driver and passenger front airbag system consists of:

- Driver and passenger airbag modules.



• Crash sensors and monitoring system with readiness indicator. See **Crash Sensors and Airbag Indicator** (page 37).

Passenger Airbag On and Off Switch (If Equipped)

 **WARNING:** Your vehicle may have an airbag deactivation switch. Before driving, always look at the switch to make sure it is in the appropriate position. Failure to put the switch in the proper position can increase the risk of serious injury or death in a crash.

Note: *The passenger airbag on and off switch may be on vehicles with no rear seats.*

Switching the Passenger Airbag Off

 **WARNING:** If the light does not illuminate when the passenger airbag switch is off and you switch the ignition on, have the passenger airbag switch serviced immediately by a qualified technician.

 **WARNING:** To avoid switching on the airbag, always remove the ignition key with the switch in the off position.

 **WARNING:** NEVER use a rearward facing child restraint on a seat protected by an ACTIVE AIRBAG in front of it, DEATH or SERIOUS INJURY to the CHILD can occur.

Supplementary Restraints System



E224283

1. Insert the ignition key into the passenger airbag on and off switch, turn the switch to off and hold it in off while removing the key.
2. When you switch the ignition on and the passenger airbag switch is in the off position, the off light illuminates briefly, momentarily shuts off and then turns back on. This indicates that the passenger airbag is deactivated.

Switching the Passenger Airbag Back On

WARNING: The seatbelts for the driver and right front passenger seating positions are specifically designed to operate together with the airbags in certain types of crashes. When you switch off your airbag, you not only lose the protection of the airbag, you also may reduce the effectiveness of your seatbelt system. If the passenger does not meet the requirements stated in the National Highway Traffic Safety Administration or Transport Canada deactivation criteria, switching off the airbag can increase the risk of serious injury or death in a crash.

WARNING: If your vehicle has rear seats, always transport children who are 12 and younger in the rear seat. Always use seatbelts and child restraints properly. Do not place a child in a rear facing infant seat in the front seat unless your vehicle is equipped with an airbag on and off switch and the passenger airbag is turned off. This is because the back of the infant seat is too close to the inflating airbag and the risk of a fatal injury to the infant when the airbag inflates is substantial.

WARNING: If the passenger airbag off light is illuminated when the passenger airbag switch is on and the ignition is on, have the passenger airbag switch serviced immediately by a qualified technician.

The passenger airbag remains off until you switch it back on.



E190814

1. Insert the ignition key into the passenger airbag on and off switch and turn the switch to on.
2. The off light briefly illuminates when you switch the ignition on. This indicates that the passenger airbag is operational.

Supplementary Restraints System

The passenger side airbag should always be on (the airbag off light should not be illuminated) unless the passenger is a person who meets the requirements stated either in Category 1, 2 or 3 of the National Highway Traffic Safety Administration/Transport Canada deactivation criteria which follows.

The vast majority of drivers and passengers are much safer with an airbag than without. To do their job and reduce the risk of life threatening injuries, airbags must open with great force, and this force can pose a potentially deadly risk in some situations, particularly when a front seat occupant is not properly buckled up. The most effective way to reduce the risk of unnecessary airbag injuries without reducing the overall safety of the vehicle is to make sure all occupants are properly restrained in the vehicle, especially in the front seat. This provides the protection of seatbelts and permits the airbags to provide the additional protection they were designed to provide. If you choose to deactivate your airbag, you are losing the very significant risk reducing benefits of the airbag and you are also reducing the effectiveness of the seatbelts, because seatbelts in modern vehicles are designed to work as a safety system with the airbags.

National Highway Traffic Safety Administration Deactivation Criteria (Excluding Canada)



WARNING: This vehicle has special energy management seatbelts for the driver and right front passenger. These particular seatbelts are specifically designed to work with airbags to help reduce the risk of injury in a crash. The energy management seatbelt gives or releases additional seatbelt webbing in some accidents to reduce the

concentration of force on an occupant's chest and to reduce the risk of certain bone fractures and injuries to underlying organs. In a crash, if the airbag is off, this energy management seatbelt might permit the passenger wearing the seatbelt to move forward enough to have a serious or fatal injury. The more severe the crash, and the heavier the occupant, the greater the risk. Make sure the airbag is on for any passenger who does not qualify under the National Highway Traffic Safety Administration deactivation criteria.

1. **Infant.** An infant (less than 1 year old) must ride in the front seat because:

- The vehicle has no rear seat.
- The vehicle has a rear seat too small to accommodate a rear-facing infant seat.
- The infant has a medical condition which, according to the infant's physician, makes it necessary for the infant to ride in the front so that the driver can constantly monitor the child's condition.

2. **Child age 1 to 12.** A child age 1 to 12 must ride in the front seat because:

- The vehicle has no rear seat.
- Although children ages 1 to 12 ride in the rear seat(s) whenever possible, children ages 1 to 12 sometimes must ride in the front because no space is available in the rear seat(s) of the vehicle.
- The child has a medical condition which, according to the child's physician, makes it necessary for the child to ride in the front seat so that the driver can constantly monitor the child's condition.

Supplementary Restraints System

3. Medical condition. A passenger has a medical condition which, according to his or her physician:

- Causes the passenger airbag to pose a special risk for the passenger.
- Makes the potential harm from the passenger airbag in a crash greater than the potential harm from turning off the airbag and allowing the passenger, even if belted, to hit the dashboard or windshield in a crash.

Transport Canada Deactivation Criteria (Canada Only)



WARNING: This vehicle has special energy management seatbelts for the driver and right front passenger. These particular seatbelts are specifically designed to work with airbags to help reduce the risk of injury in a crash. The energy management seatbelt gives or releases additional seatbelt webbing in some accidents to reduce the concentration of force on an occupant's chest and to reduce the risk of certain bone fractures and injuries to underlying organs. In a crash, if the airbag is off, this energy management seatbelt might permit the passenger wearing the seatbelt to move forward enough to have a serious or fatal injury. The more severe the crash, and the heavier the occupant, the greater the risk. Make sure the airbag is on for any passenger who does not qualify under the Transport Canada deactivation criteria.

1. Infant: An infant (less than 1 year old) must ride in the front seat because:

- My vehicle has no rear seat.
 - The rear seat in my vehicle cannot accommodate a rear-facing infant seat.
 - The infant has a medical condition which, according to the infant's physician, makes it necessary for the infant to ride in the front seat so that the driver can monitor the infant's condition.
- 2. Child age 12 or under:** A child age 12 or under must ride in the front seat because:

- My vehicle has no rear seat.
- Although children age 12 and under ride in the rear seat whenever possible, children age 12 and under have no option but to sometimes ride in the front seat because rear seat space is insufficient.
- The child has a medical condition that, according to the child's physician, makes it necessary for the child to ride in the front seat so that the driver can monitor the child's condition.

3. Medical condition: A passenger has a medical condition that, according to his or her physician:

- Poses a special risk for the passenger if the airbag deploys.
- Makes the potential harm from the passenger airbag deployment greater than the potential harm from turning off the airbag and experiencing a crash without the protection offered by the airbag.

Supplementary Restraints System

Proper Driver and Front Passenger Seating Adjustment

WARNING: National Highway Traffic Safety Administration (NHTSA) recommends a minimum distance of at least 10 in (25 cm) between an occupant's chest and the driver airbag module.

To properly position yourself away from the airbag:

- Move your seat to the rear as far as you can while still reaching the pedals comfortably.
- Recline the seat slightly (one or two degrees) from the upright position.

After all occupants have adjusted their seats and put on seatbelts, it is very important that they continue to sit properly. Properly seated occupants sit upright, lean against the seat back, and center themselves on the seat cushion, with their feet comfortably extended on the floor. Sitting improperly can increase the chance of injury in a crash event. For example, if an occupant slouches, lies down, turns sideways, sits forward, leans forward or sideways, or puts one or both feet up, the chance of injury during a crash is greatly increased.

Children and Airbags

WARNING: Do not place a rearward facing child restraint in front of an active airbag. Failure to follow this instruction could result in personal injury or death.



E142846

Children must always be properly restrained. Accident statistics suggest that children are safer when properly restrained in the rear seating positions than in the front seating position. Failure to follow these instructions may increase the risk of injury in a crash.

CRASH SENSORS AND AIRBAG INDICATOR (IF EQUIPPED)

WARNING: Modifying or adding equipment to the front end of the vehicle (including frame, bumper, front end body structure and tow hooks) may affect the performance of the airbag system, increasing the risk of injury. Do not modify the front end of the vehicle.

Your vehicle has a collection of crash and occupant sensors which provide information to the restraints control module. The restraints control module deploys (activates) the front safety belt pretensioners, driver airbag and passenger airbag. Based on the type of accident, the restraints control module will deploy the appropriate safety devices.

Supplementary Restraints System

The restraints control module also monitors the readiness of the above safety devices plus the crash sensors. The readiness of the safety system is indicated by a warning indicator light in the instrument cluster or by a backup tone if the warning light is not working. See **Instrument Cluster** (page 57). Routine maintenance of the airbag is not required.

A difficulty with the system is indicated by one or more of the following:



The readiness light will not illuminate immediately after the ignition is turned on.

- The readiness light will either flash or stay lit.
- A series of five beeps will be heard. The tone pattern will repeat periodically until the problem, the light or both are repaired.

If any of these things happen, even intermittently, have the supplemental restraint system serviced at an authorized dealer immediately. Unless serviced, the system may not function properly in the event of a crash.

The safety belt pretensioners and the airbag supplemental restraint system are designed to activate when the vehicle sustains frontal deceleration sufficient to cause the restraints control module to deploy a safety device.

The fact that the safety belt pretensioners or airbags did not activate in a crash does not mean that something is wrong with the system. Rather, it means the restraints control module determined the accident conditions (such as crash severity, belt usage) were not appropriate to activate these safety devices.

- The design of the front airbags is to activate only in frontal and near-frontal crashes (not rollovers, side impacts or rear impacts) unless the crash causes sufficient frontal deceleration.
- The design of the safety belt pretensioners is to activate in frontal or near-frontal crashes and may deploy in rollovers if the vehicle is equipped with roll stability control.

AIRBAG DISPOSAL

Contact your authorized dealer as soon as possible. Airbags must be disposed of by qualified personnel.

Keys and Remote Controls

GENERAL INFORMATION ON RADIO FREQUENCIES

This device complies with Part 15 of the FCC Rules and with Licence exempt RSS Standards of Industry Canada. Operation is subject to the following two conditions:

- This device may not cause harmful interference, and
- This device must accept any interference received, including interference that may cause undesired operation.



WARNING: Changes or modifications not expressly approved by the party responsible for compliance could void the user's authority to operate the equipment. The term "IC:" before the radio certification number only signifies that Industry Canada technical specifications were met.

The typical operating range for your transmitter is approximately 33 ft (10 m). Vehicles with the remote start feature will have a greater range. One of the following could cause a decrease in operating range:

- Weather conditions.
- Nearby radio towers.
- Structures around the vehicle.
- Other vehicles parked next to your vehicle.

Other short distance radio transmissions, for example amateur radios, medical equipment, wireless headphones, remote controls and alarm systems can also use the radio frequency used by your remote control. If the frequencies are jammed, you will not be able to use your remote control. You can lock and unlock the doors with the key.

Note: Make sure to lock your vehicle before leaving it unattended.

Note: If you are in range, the remote control will operate if you press any button unintentionally.

Note: The remote control contains sensitive electrical components. Exposure to moisture or impact may cause permanent damage.

REMOTE CONTROL (IF EQUIPPED)



E195660

Note: If there are problems with the remote entry system, make sure to take all remote entry transmitters with you to an authorized dealer in order to aid in troubleshooting the problem.

Note: If your vehicle is fitted with the E-Guard Cargo Protection System™, the remote transmitter unlock command only unlocks the front doors. The side or rear cargo doors can only be unlocked from outside your vehicle using the key.

Keys and Remote Controls

Reprogramming the Remote Control

You must have all remote controls readily accessible before beginning this procedure. Any remote control that is not present during the programming procedure will no longer operate your vehicle.

Note: You can program a maximum of four coded keys to your vehicle.

Note: Do not apply the brake pedal during this procedure.

1. Switch the ignition from off to on 8 times within 10 seconds, finishing in the on position. The doors lock then unlock to confirm that programming has started.
2. Press any button on the remote control that you want to program within 20 seconds. The doors lock then unlock to confirm that programming was successful.
3. Repeat step 2 to program each additional remote control.
4. After you have programmed all remote controls, switch the ignition off.
5. The doors lock then unlock to confirm that programming is complete.

Changing the Remote Control Battery

The remote control uses one coin-type three-volt lithium battery CR2032 or equivalent.



Make sure that you dispose of old batteries in an environmentally friendly way.

Seek advice from your local authority about recycling old batteries.



E195662

1. Twist a thin coin in the slot of the transmitter near the key ring to remove the battery cover.

Note: Do not remove the rubber cover and circuit board from the front housing of the remote entry transmitter.

Note: Do not wipe off any grease on the battery terminals or on the back surface of the circuit board.

2. Remove the old battery.

Keys and Remote Controls



Note: The panic alarm operates regardless of the ignition position.

REPLACING A LOST KEY OR REMOTE CONTROL

Replacement keys or remote controls can be purchased from an authorized dealer. Authorized dealers can program remote controls for your vehicle.

E195661

3. Insert the new battery. Refer to the symbols inside the transmitter for the correct orientation of the battery. Press the battery down to make sure it is fully in the housing.
4. Reinstall the battery housing cover onto the transmitter.

Note: Replacing the battery does not erase the programmed key from your vehicle. The transmitter should operate normally.

Car Finder



Press the button twice within three seconds. The horn sounds and the direction indicators flash. We recommend you use this method to locate your vehicle, rather than using the panic alarm.

Sounding the Panic Alarm



Press the button to sound the panic alarm. Press the button again or switch the ignition on to turn it off.

Doors and Locks

LOCKING AND UNLOCKING

You can use the power door lock control or the remote control to lock and unlock your vehicle.

Power Door Locks (If Equipped)

The power door lock control is on the driver and front passenger door panels.

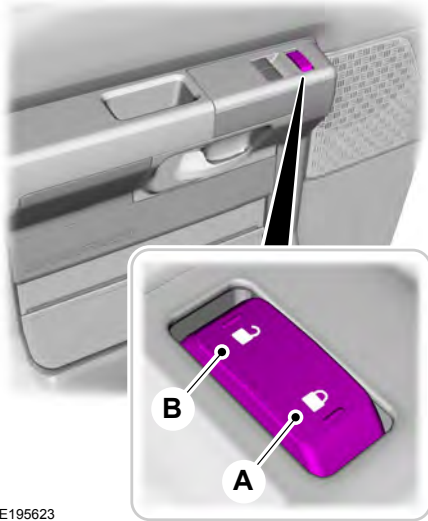

E195623

- A Lock.
- B Unlock.

Remote Control (If Equipped)

You can use the remote control at any time when the ignition is off.

Unlocking the Doors (Two-Stage Unlock)



Press the button to unlock the driver door.

Press the button again within three seconds to unlock all doors. The direction indicators flash.

Note: *The driver door can be unlocked with the key if the remote control is not functioning.*

Note: *When you leave your vehicle unattended for several weeks, the remote control turns off. Your vehicle must be unlocked and started. Unlocking and starting your vehicle once enables the remote control.*

Reprogramming the Unlocking Function

Note: *When you press the unlock button, either all the doors are unlocked or only the driver door is unlocked. Pressing the unlock button again unlocks all the doors.*

You can reprogram the unlocking function so that only the driver door is unlocked.

Press and hold the unlock and lock buttons on the remote control simultaneously for at least four seconds with the ignition off. The direction indicators flash twice to confirm the change.

To return to the original unlocking function, repeat the process.

Locking the Doors



Press the button to lock all doors. The direction indicators flash.

Press the button again within three seconds to confirm that all the doors are closed. The doors lock again, the horn sounds and the direction indicators flash if all the doors are closed.

Note: *If any door is open, the horn sounds twice and the direction indicators do not flash.*

Doors and Locks

Autolock Feature

The autolock feature locks all the doors when:

- All doors are closed.
- The ignition is on.
- You shift into any gear putting your vehicle in motion.
- The ignition is on, all the doors are closed and your vehicle has been in motion at a speed greater than 12 mph (20 km/h).

Autounlock Feature

The autounlock feature unlocks all the doors when:

- Your vehicle comes to a stop and you switch the ignition off or to accessory.
- You open the driver door within 10 minutes of switching the ignition off or to accessory.

Note: *If you electronically lock your vehicle after you switch the ignition off with the driver door closed, the doors do not autounlock.*

Enabling or Disabling Autolock and Autounlock

You can enable or disable the autolock and autounlock features independently of each other.

To enable or disable autolock, do the following:

1. Switch the ignition on.
2. Press the power door unlock control three times.
3. Switch the ignition off.
4. Press the power door unlock control three times.
5. Switch the ignition on. The horn sounds indicating your vehicle is in programming mode.

6. Press the power door unlock control and within five seconds, press the power door lock control. The horn sounds once if disabled or twice if enabled.
7. Switch the ignition off. The horn sounds indicating programming is complete.

Note: *You can also switch this feature on or off using the information display. See **Information Displays** (page 63).*

To enable or disable autounlock, do the following:

1. Switch the ignition on.
2. Press the power door unlock control three times.
3. Switch the ignition off.
4. Press the power door unlock control three times.
5. Switch the ignition on. The horn sounds indicating your vehicle is in programming mode.
6. Press the power door lock control and within five seconds, press the power door unlock control. The horn sounds once if disabled or twice if enabled.
7. Switch the ignition off. The horn sounds indicating programming is complete.

Note: *You can also switch this feature on or off using the information display. See **Information Displays** (page 63).*

Illuminated Entry

The interior lamps and some exterior lamps illuminate when you unlock the doors with the remote control.

The lamps turn off if:

- The ignition is on.
- You press the remote control lock button.
- 25 seconds have elapsed.

Doors and Locks

The lamps do not turn off if:

- You switch them on with the lighting control.
- Any door is open.

Security

PASSIVE ANTI-THEFT SYSTEM

Note: *The system is not compatible with non-Ford aftermarket remote start systems. Use of these systems may result in vehicle starting problems and a loss of security protection.*

Note: *Metallic objects, electronic devices or a second coded key on the same key chain may cause vehicle starting problems if they are too close to the key when starting the engine. Prevent these objects from touching the coded key while starting the engine. Switch the ignition off, move all objects on the key chain away from the coded key and restart the engine if a problem occurs.*

Note: *Do not leave a duplicate coded key in the vehicle. Always take your keys and lock all doors when leaving the vehicle.*

SecuriLock®

The system is an engine immobilization system designed to prevent someone from starting the engine unless they use a correctly coded key for your vehicle. Using an incorrectly coded key may prevent the engine from starting. A message may appear in the information display. If you are unable to start the engine with a correctly coded key, a malfunction has happened and a message may appear in the information display.

Automatic Arming

The engine immobilization system arms immediately after you switch the ignition off.

Automatic Disarming

Switching the ignition on with a correctly coded key disarms the engine immobilization system.

Replacement Keys

If your keys become lost or stolen and you do not have a spare correctly coded key, you need to have your vehicle towed to an authorized dealer. You need to erase the coded keys from your vehicle and program new coded keys.

Store an extra correctly coded key away from the vehicle in a safe place to help prevent any inconveniences. See an authorized dealer to purchase additional spare or replacement keys.

Note: *Your vehicle comes with two integrated keyhead transmitters.*

Programming a Spare Integrated Keyhead Transmitter

You can program your own integrated keyhead transmitter or standard SecuriLock coded keys to your vehicle. This procedure programs both the engine immobilizer keycode and the remote entry portion of the remote control to your vehicle

Only use integrated keyhead transmitters or standard SecuriLock keys.

You must have two previously programmed correctly coded keys and the new unprogrammed key readily accessible. See an authorized dealer to have the spare key programmed if two previously programmed correctly coded keys are not available.

Read and understand the entire procedure before you begin.

1. Insert the first previously programmed correctly coded key into the ignition.
2. Switch the ignition from off to on. Keep the ignition on for at least three seconds, but no more than 10 seconds.
3. Switch the ignition off and remove the first correctly coded key from the ignition.

Security

4. After three seconds but within 10 seconds of switching the ignition off, insert the second previously correctly coded key into the ignition.
5. Switch the ignition from off to on. Keep the ignition on for at least three seconds, but no more than 10 seconds.
6. Switch the ignition off and remove the second previously programmed correctly coded key from the ignition.
7. After three seconds but within 10 seconds of switching the ignition off and removing the previously programmed correctly coded key, insert the new unprogrammed key into the ignition.
8. Switch the ignition from off to on. Keep the ignition on for at least six seconds.
9. Remove the newly programmed correctly coded key from the ignition.

If you successfully program the key, it starts the engine and operates the remote entry system, if the new key is an integrated keyhead transmitter.

If you did not successfully program the key, wait 10 seconds and repeat Steps 1 through 8. If you are still unsuccessful, take your vehicle to an authorized dealer.

Note: *You can program a maximum of eight coded keys to your vehicle. All eight can be integrated keyhead transmitters.*

Steering Wheel

ADJUSTING THE STEERING WHEEL



WARNING: Do not adjust the steering wheel when your vehicle is moving.

Note: Make sure that you are sitting in the correct position. See **Sitting in the Correct Position** (page 73).

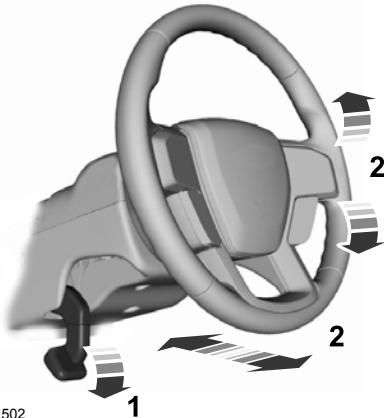

E261502

1. Unlock the steering column.
2. Adjust the steering wheel to the desired position.

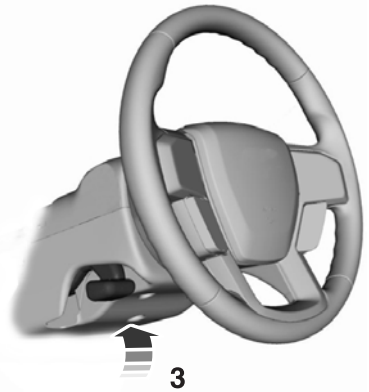

E261503

3. Lock the steering column.

CRUISE CONTROL - VEHICLES WITH: ADAPTIVE CRUISE CONTROL



E191337

See **Using Adaptive Cruise Control** (page 104).

Steering Wheel

CRUISE CONTROL - VEHICLES WITH: CRUISE CONTROL



E191329

See **What Is Cruise Control** (page 103).

INFORMATION DISPLAY CONTROL



E191336

See **Information Displays** (page 63).

HORN



Wipers and Washers

WINDSHIELD WIPERS

Note: Fully defrost the windshield before you switch the windshield wipers on.

Note: Make sure you switch the windshield wipers off before entering a car wash.

Note: If streaks or smears appear on the windshield, clean the windshield and the wiper blades. If that does not resolve the issue, install new wiper blades.

Note: Do not operate the wipers on a dry windshield. This may scratch the glass, damage the wiper blades or cause the wiper motor to burn out. Always use the windshield washers before wiping a dry windshield.

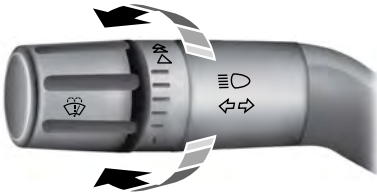

E172816

- Rotate away from you for a long wipe interval.
- Rotate toward you for a short wipe interval.

Speed Dependent Wipers

When your vehicle speed increases, the interval between wipes decreases.

WINDSHIELD WASHERS



E172818

- A brief press causes a single wipe without washer fluid.
- A brief press and hold causes the wipers to swipe three times with washer fluid.
- A long press and hold turns on the wipers and washer fluid for up to 10 seconds.

A wipe occurs a few seconds after washing to clear any remaining washer fluid. You can switch this feature on or off in the information display. See **Information Displays** (page 63).

Note: Do not operate the washers when the washer reservoir is empty. This could cause the washer pump to overheat.

Lighting

GENERAL INFORMATION

Condensation in the Exterior Front Lamps and Rear Lamps

Exterior front lamps and rear lamps have vents to accommodate normal changes in air pressure.

Condensation can be a natural by-product of this design. When moist air enters the lamp assembly through the vents, there is a possibility that condensation can occur when the temperature is cold. When normal condensation occurs, a fine mist can form on the interior of the lens. The fine mist eventually clears and exits through the vents during normal operation.

Clearing time may take as long as 48 hours under dry weather conditions.

Examples of acceptable condensation are:

- The presence of a fine mist (no streaks, drip marks or large droplets).
- A fine mist covers less than 50% of the lens.

Examples of unacceptable condensation are:

- A water puddle inside the lamp.
- Streaks, drip marks or large droplets present on the interior of the lens.

If you see any unacceptable condensation, have your vehicle checked by an authorized dealer.

LIGHTING CONTROL

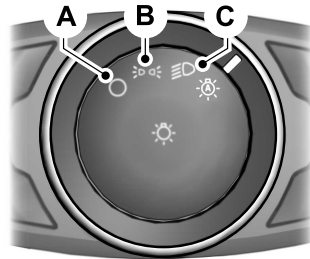

- A Lamps off.
- B Parking lamps, instrument panel lamps, license plate lamps and rear lamps.
- C Headlamps.

Headlamp High Beam

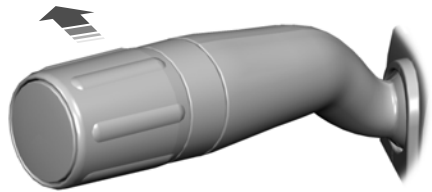

Push the lever away from you to switch the high beam on.

Push the lever forward again or pull the lever toward you to switch the high beams off.

Lighting

Flashing the Headlamp High Beam

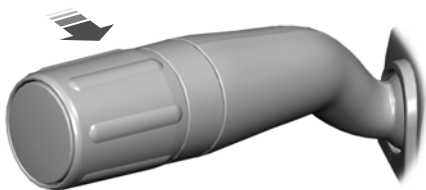

Slightly pull the lever toward you and release it to flash the headlamps.

AUTOLAMPS



WARNING: The system does not relieve you of your responsibility to drive with due care and attention. You may need to override the system if it does not turn the headlamps on in low visibility conditions, for example daytime fog.

Autolamps turn the headlamps on in low light situations or when the wipers operate.



Switch the lighting control to the autolamps position.

The headlamps remain on for a period of time after you switch the ignition off. Use the information display controls to adjust the period of time that the headlamps remain on.

Note: *If you switch the autolamps on, you cannot switch the high beams on until the system turns the low beams on.*

Windshield Wiper Activated Headlamps

When you switch the autolamps on, the headlamps turn on within 10 seconds of switching the wipers on. They turn off approximately 60 seconds after you switch the windshield wipers off.

The headlamps do not turn on with the wipers:

- During a single wipe.
- When using the windshield washers.
- If the wipers are in intermittent mode.

Note: *If you switch the autolamps and the autowipers on, the headlamps turn on when the windshield wipers continuously operate.*

INSTRUMENT LIGHTING DIMMER

The instrument lighting dimmer buttons are on the lighting control.



Repeatedly press one of the buttons to adjust the brightness.



DAYTIME RUNNING LAMPS (IF EQUIPPED)



WARNING: The daytime running lamps system does not activate the rear lamps and may not provide adequate lighting during low visibility driving conditions. Make sure you switch the headlamps on, as appropriate, during all low visibility conditions. Failure to do so may result in a crash.

Lighting

The system turns the lamps on in daylight conditions.

To switch the system on, switch the lighting control to any position except headlamps.

DIRECTION INDICATORS

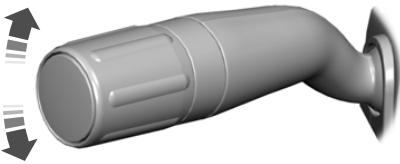

Push the lever up or down to use the direction indicators.

Note: Tap the lever up or down to make the direction indicators flash three times.

Automatic High Beam Control

WHAT IS AUTOMATIC HIGH BEAM CONTROL (IF EQUIPPED)

The system turns on high beams if it is dark enough and no other traffic is present. If it detects an approaching vehicle's headlamps or tail lamps, or street lighting ahead, the system turns the high beams off. Low beams remain on.

A camera sensor, centrally mounted behind the windshield of your vehicle, continuously monitors conditions to turn the high beams on and off.

SWITCHING AUTOMATIC HIGH BEAM CONTROL ON AND OFF

(IF EQUIPPED)

Switch the system on or off using the information display. See **General Information** (page 63).

Activating the Automatic High Beam Control



Switch the lighting control to the autolamps position to activate. See **Autolamps** (page 51).

Note: Automatic high beams are not available when autolamps are not turned on.

When active, the high beams turn on if:

- The ambient light level is low enough.
- There is no traffic in front of your vehicle.
- The vehicle speed is greater than approximately 32 mph (52 km/h).

When active, the high beams turn off if:

- The ambient light level is high enough that high beams are not required.
- The system detects an approaching vehicle's headlamps or tail lamps.

- The system detects severe rain, snow or fog.
- The camera is blocked.
- The vehicle speed falls below approximately 27 mph (44 km/h).

Note: The deactivation speed is lower on curves.

Note: High beam reactivation may be delayed in certain curvy road situations.

Note: The system may not operate properly if the sensor is blocked. Keep the windshield free from obstruction or damage.

Note: The system may not operate properly in cold or inclement conditions. You can switch on the high beams by overriding the system.

Note: If the system detects a blockage, for example bird droppings, bug splatter, snow or ice, the system goes into low beam mode until you clear the blockage. A message may appear in the information display if the camera is blocked.

Note: Using much larger tires or equipping vehicle accessories such as snowplows can modify your vehicle's ride height and degrade automatic high beam control performance.

AUTOMATIC HIGH BEAM CONTROL INDICATORS (IF

EQUIPPED)



The indicator illuminates to confirm when the system is ready to assist.

Automatic High Beam Control

OVERRIDING AUTOMATIC HIGH BEAM CONTROL (IF

EQUIPPED)



WARNING: The system does not relieve you of your responsibility to drive with due care and attention. You may need to override the system if it does not turn the high beams on or off.



WARNING: You may need to override the system when approaching other road users.



WARNING: You may need to override the system during inclement weather.

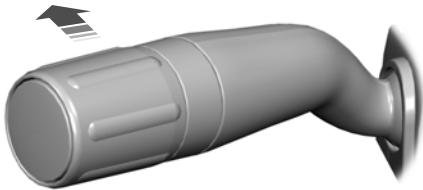

Push the lever away from you to switch between high beam and low beam.

Windows and Mirrors

POWER WINDOWS (IF EQUIPPED)



WARNING: Do not leave children unattended in your vehicle and do not let them play with the power windows. They may seriously injure themselves.



WARNING: When closing the power windows, you should verify they are free of obstructions and make sure that children and pets are not in the proximity of the window openings.



E163056

Note: You may hear a pulsing noise when just one of the windows is open. Lower the opposite window slightly to reduce this noise.

Press the switch to open the window.

Lift the switch to close the window.

One-Touch Down

Press the switch fully and release it. Press again or lift it to stop the window.

Accessory Delay

You can use the window switches for several minutes when you switch the ignition off or until you open either front door.

EXTERIOR MIRRORS (IF EQUIPPED)

Power Exterior Mirrors (If Equipped)



WARNING: Do not adjust the mirrors when your vehicle is moving.

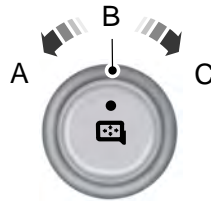

E163059

- A Left mirror.
- B Off.
- C Right mirror.

To adjust your mirrors:

1. Select the mirror you want to adjust.
2. Move the control in the direction you want to tilt the mirror.
3. Return the control to the center position to lock the mirrors in place.

Fold-Away Exterior Mirrors

Push the mirror toward the door window glass. Make sure that you fully engage the mirror in its support when returning it to its original position.

Windows and Mirrors

Telescoping Mirrors (If Equipped)

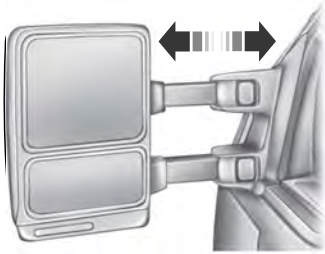

E163061

This feature lets you extend the mirror about 3 in (75 mm). It is useful when towing a trailer. You can manually pull out or push in the mirrors to the desired position.

INTERIOR MIRROR (IF EQUIPPED)



WARNING: Do not adjust the mirrors when your vehicle is moving. This could result in the loss of control of your vehicle, serious personal injury or death.

Note: Do not clean the mirror housing or glass with harsh abrasives, fuel or other petroleum-based cleaning products.

You can adjust the interior mirror to your preference. Some mirrors also have a second pivot point. This lets you move the mirror head up or down and from side to side.

Manual Dimming Mirror

Pull the tab below the mirror toward you to reduce the effect of bright light from behind.

Automatic Dimming Mirror (If Equipped)

Note: Do not block the sensors on the front and back of the mirror. A rear center passenger or raised rear center head restraint may also block light from reaching the sensor.

The mirror dims to reduce the effect of bright light from behind. It returns to normal when the bright light from behind is no longer present or if you shift into reverse (R).

SUN VISORS (IF EQUIPPED)

Illuminated Vanity Mirror (If Equipped)

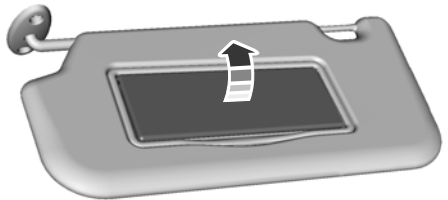

E162197

Lift the cover to switch the lamp on.

Instrument Cluster

GAUGES

2.3 Inch Display

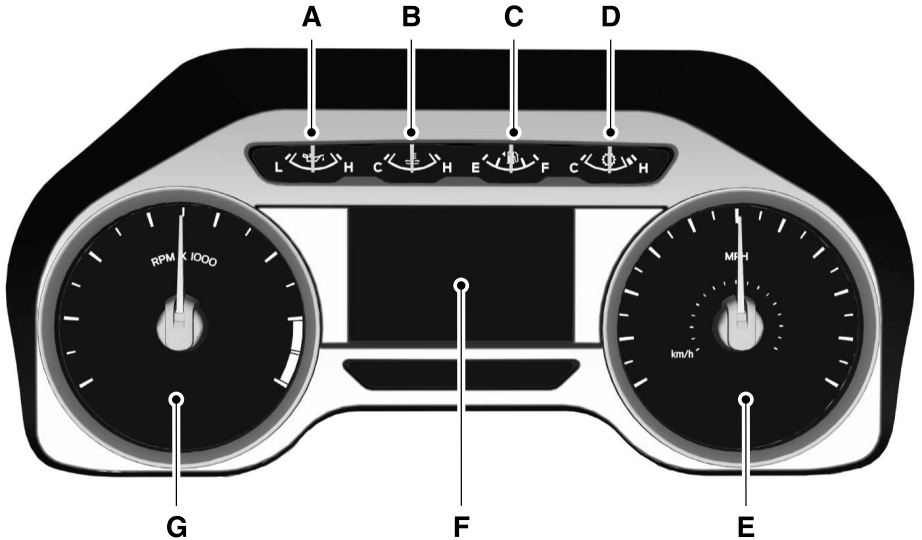

E219638

- A Engine oil pressure gauge.
- B Engine coolant temperature gauge.
- C Fuel gauge.
- D Transmission fluid temperature gauge.
- E Speedometer.
- F Information display.
- G Tachometer.

Instrument Cluster

8 Inch Display

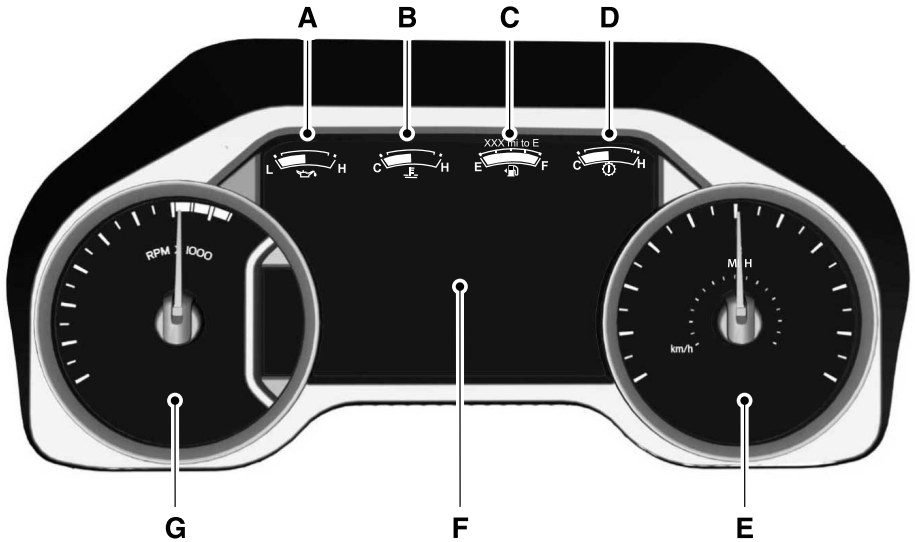

- A Engine oil pressure gauge.
- B Engine coolant temperature gauge.
- C Fuel gauge.
- D Transmission fluid temperature gauge.
- E Speedometer.
- F Information display.
- G Tachometer.

Instrument Cluster

Engine Oil Pressure Gauge

Indicates engine oil pressure. At normal operating temperature, the level indicator is in the normal range. If the pressure gauge falls below the normal range, stop your vehicle, switch off the engine and check the engine oil level. Add oil if needed. If the oil level is correct, have your vehicle checked by an authorized dealer.

Engine Coolant Temperature Gauge



WARNING: Do not remove the coolant reservoir cap when the engine is on or the cooling system is hot. Wait 10 minutes for the cooling system to cool down. Cover the coolant reservoir cap with a thick cloth to prevent the possibility of scalding and slowly remove the cap. Failure to follow this instruction could result in personal injury.

Indicates engine coolant temperature. At normal operating temperature, the level indicator is in the normal range. If the engine coolant temperature exceeds the normal range, stop your vehicle as soon as possible, switch off the engine and let the engine cool.

Fuel Gauge

The fuel gauge indicates about how much fuel is in the fuel tank.

The arrow adjacent to the fuel pump symbol indicates on which side of your vehicle the fuel filler door is located.

Note: *The fuel gauge may vary slightly when your vehicle is moving or on a slope.*

Low Fuel Reminder

A low fuel level reminder displays and sounds when the distance to empty reaches 75 mi (120 km) to empty for MyKey, and at 50 mi (80 km), 25 mi (40 km), 10 mi (20 km) and 0 mi (0 km) for all vehicle keys.

Note: *The low fuel reminder can appear at different fuel gauge positions depending on fuel economy conditions. This variation is normal.*

Distance to Empty

Indicates the approximate distance your vehicle can travel on the fuel remaining in the tank. Changes in driving pattern can cause the value to not only decrease but also increase or stay constant for periods of time.

Transmission Fluid Temperature Gauge

Indicates transmission fluid temperature. At normal operating temperature, the level indicator is in the normal range. If the transmission fluid temperature exceeds the normal range, stop your vehicle as soon as possible and verify the airflow is not restricted by snow or debris blocking airflow through the grille.

Special operating conditions such as snowplowing, towing, or off-road use may cause higher than normal operating temperatures. See **Special Operating Conditions Scheduled Maintenance** (page 255).

To lower the transmission temperature into the normal range, alter the severity of your driving conditions. Operating the transmission for extended periods with the gauge in the higher than normal area may cause internal transmission damage. If the gauge continues to show high temperatures, see an authorized dealer.

Instrument Cluster

WARNING LAMPS AND INDICATORS

The following warning lamps and indicators alert you to a vehicle condition that may become serious. Some lamps illuminate when you start your vehicle to make sure they work. If any lamps remain on after starting your vehicle, refer to the respective system warning lamp for further information.

Note: *Some warning indicators appear in the information display and operate the same as a warning lamp but do not illuminate when you start your vehicle.*

Airbag Warning Lamp



If it does not illuminate when you switch the ignition on, continues to flash or remains on when the engine is running, this indicates a malfunction. Have your vehicle checked as soon as possible.

Anti-Lock Brake System Warning Lamp



If it illuminates when you are driving, this indicates a malfunction. Your vehicle continues to have normal braking without the anti-lock brake system function. Have your vehicle checked as soon as possible.

Battery



If it illuminates while driving, it indicates a malfunction. Switch off all unnecessary electrical equipment and have an authorized dealer check the system immediately.

Brake System Warning Lamp



WARNING: Driving your vehicle with the warning lamp on is dangerous. A significant decrease in braking performance may occur. It may take you longer to stop your vehicle. Have your vehicle checked as soon as possible. Driving extended distances with the parking brake engaged can cause brake failure and the risk of personal injury.

Note: *Indicators vary depending on region.*

This lamp is a dual function lamp and will illuminate when:

- You apply the parking brake with the ignition on.
- Your vehicle has a brake fault or low brake fluid level, regardless of parking brake position.



If the lamp illuminates while you are moving, you may have the parking brake applied. Be sure that the parking brake is off. Have your vehicle checked as soon as possible if the lamp continues to illuminate.



Cruise Control Indicator (If Equipped)



It illuminates when you switch the system on.

See **What Is Cruise Control** (page 103).

Direction Indicator



Illuminates when you switch on the left or right direction indicator or the hazard warning flasher. If the indicators stay on or flash faster, check for a burned out bulb.

Instrument Cluster

Engine Coolant Temperature Warning Lamp



If it illuminates when your vehicle is moving, this indicates that the engine is overheating. Stop your vehicle as soon as it is safe to do so and switch the engine off. Have your vehicle checked as soon as possible.

Engine Oil



It illuminates when you switch the ignition on.

If it illuminates when the engine is running this indicates a malfunction. Stop your vehicle as soon as it is safe to do so and switch the engine off. Check the engine oil level. If the oil level is sufficient, this indicates a system malfunction. Have your vehicle checked as soon as possible.

See **Engine Oil Check** (page 163).

Fasten Seatbelt Warning Lamp



It illuminates and a tone sounds until you fasten the seatbelts.

Headlamp High Beam Indicator



It illuminates when you switch the headlamp high beam on.

Low Fuel Level Warning Lamp



If it illuminates when you are driving, refuel as soon as possible.

Low Tire Pressure Warning Lamp

(If Equipped)



It illuminates if the tire pressure in one or more tires is below the correct tire pressure.

It also illuminates momentarily when you switch the ignition on to confirm the lamp is functional. If it does not illuminate when you switch the ignition on, or begins to flash at any time, have the system checked by your authorized dealer.

Powertrain Malfunction/Electronic Throttle Control



Illuminates when the system detects a powertrain fault, have an authorized dealer check the system as soon as possible.

Service Engine Soon



If it illuminates when the engine is running this indicates a malfunction. The On Board Diagnostics system has detected a malfunction of the vehicle emission control system.

If it flashes, engine misfire may be occurring. Increased exhaust gas temperatures could damage the catalytic converter or other vehicle components. Avoid heavy acceleration and deceleration and have your vehicle serviced immediately.

It illuminates when you switch the ignition on prior to engine start to check the bulb and to indicate whether your vehicle is ready for Inspection and Maintenance (I/M) testing.

Normally, it illuminates until the engine is cranked and automatically turns off if no malfunctions are present. However, if after 15 seconds it flashes eight times, this indicates that your vehicle is not ready for Inspection and Maintenance (I/M) testing. See **Emission Law** (page 88).

Instrument Cluster

Traction Control Indicator



It flashes during a traction control event.

If it does not illuminate when you switch the ignition on, or remains on when the engine is running, this indicates a malfunction. Have your vehicle checked as soon as possible.

Traction Control System Off



It will illuminate when the driver disables traction control.

Tow Haul Indicator



Illuminates when the driver activates the tow/haul feature. If the light flashes steadily, have an authorized dealer check the system immediately, damage to the transmission could occur.

AUDIBLE WARNINGS AND INDICATORS

Headlamps On Warning Chime

Sounds when you remove the key from the ignition and open the driver's door and you have left the headlamps or parking lamps on.

Key in Ignition Warning Chime

Sounds when you open the driver's door and you have left the key in the ignition.

Parking Brake On Warning Chime

Sounds when you have left the parking brake on and drive your vehicle. If the warning chime remains on after you have released the parking brake, have the system checked by your authorized dealer immediately.

Information Displays

GENERAL INFORMATION



WARNING: Driving while distracted can result in loss of vehicle control, crash and injury. We strongly recommend that you use extreme caution when using any device that may take your focus off the road. Your primary responsibility is the safe operation of your vehicle. We recommend against the use of any hand-held device while driving and encourage the use of voice-operated systems when possible. Make sure you are aware of all applicable local laws that may affect the use of electronic devices while driving.

Note: Trailer options are not available if your vehicle speed is greater than 3 mph (5 km/h).

Note: Some MyKey menu options only appear if MyKey is enabled and at least one MyKey is programmed.

Information Display Controls



E184451

- Press the up and down arrow buttons to scroll through and highlight the options within a menu.
- Press the right arrow button to enter a sub-menu.
- Press the left arrow button to exit a menu.
- Press the **OK** button to choose and confirm a setting or messages.



This icon shows the features on or off status. A check in the box indicates the feature is on, and unchecked indicates the feature is off.

2.3 Inch Display Menu

Note: Some options may appear slightly different or not at all if the items are optional.

| Main Menu |
|---------------|
| Trip 1 |
| Trip 2 |
| Fuel Economy |
| Driver Assist |
| Settings |

Information Displays

Trip 1 or 2

Displays the following of an individual journey.

- Digital speed.
- Distance.
- Time.
- Distance to empty.
- Average fuel economy.

Note: Press and hold **OK** to reset values.

Fuel Economy

Displays the following:

Settings

| Settings | | |
|---------------|-------------|---------------------|
| Vehicle | Locks | Select Your Setting |
| Display Setup | Units | Select Your Setting |
| | Temperature | |
| | Language | |

8 Inch Display Menu

Note: Some options may appear slightly different or not at all if the items are optional.

| Main Menu |
|------------|
| MyView |
| Trip/Fuel |
| Truck Info |
| Settings |

- Instant fuel economy.
- Average fuel economy.
- Average speed.
- Distance to empty.

Note: Press and hold **OK** to reset values.

Driver Assist

Displays the following:

- Progressive range select.
- Engine hours.
- Maintenance monitor

Information Displays

MyView

| MyView | |
|------------------|----------------------------------|
| Trip 1 | |
| Fuel Economy | |
| Configure MyView | Press OK for more options |

Trip/Fuel

| Trip/Fuel |
|--------------|
| Trip 1 |
| Trip 2 |
| Fuel Economy |
| Fuel History |

Trip 1 or 2

Displays the following of an individual journey.

- Trip timer.
- Distance to empty.
- Trip odometer.
- Average fuel economy.

Note: Press and hold **OK** to reset values.

Fuel Economy

Displays your instantaneous fuel usage as a bar graph and average mpg.

Fuel History

Displays your fuel usage based on time. The graph is updated each minute with the fuel economy that you achieved during 30 minutes of driving.

Truck Info

| Truck Info |
|---------------------|
| Digital Speedometer |
| Dual Fuel Tanks |
| Engine Information |
| Maintenance Monitor |

- Engine Information - Shows engine hours, engine idle hours and engine oil temp and oil life.

Information Displays

Settings

| Settings | | | |
|-------------------|---------|-----------------|---------------------|
| Advanced Settings | Vehicle | Lighting | Select Your Setting |
| | | Easy Entry/Exit | |
| | | Locks | |
| | | Windows | |
| | | Wiper Controls | |
| Display Setup | Units | Units | Select Your Setting |
| | | Temperature | |
| | | Language | |

INFORMATION MESSAGES

Note: Depending on the vehicle options equipped with your vehicle, not all of the messages will display or be available. Certain messages may be abbreviated or shortened depending upon which cluster type you have.

AdvanceTrac and Traction Control

| Message | Action |
|----------------------|--|
| Service AdvanceTrac | The system detects a condition that requires service. Contact an authorized dealer as soon as possible. |
| AdvanceTrac Off | The status of the AdvanceTrac system after you switched it off. |
| AdvanceTrac On | The status of the AdvanceTrac system after you switched it on. |
| Traction Control Off | The status of the traction control system after you switched it off. See Using Traction Control (page 100). |
| Traction Control On | The status of the traction control system after you switched it on. See Using Traction Control (page 100). |

Information Displays

Battery and Charging System

| Message | Action |
|---|---|
| Check Charging System | The charging system needs servicing. If the warning stays on or continues to come on, contact an authorized dealer as soon as possible. |
| Low Battery Features Temporarily Turned Off | The battery management system detects an extended low-voltage condition. Your vehicle will disable various features to help preserve the battery. Turn off as many of the electrical loads as soon as possible to improve system voltage. If the system voltage has recovered, the disabled features will operate again as normal. |
| Turn Power Off To Save Battery | The battery management system determines that the battery is at a low state of charge. Turn your ignition off as soon as possible to protect the battery. This message will clear once you restart your vehicle and the battery state of charge has recovered. Turning off unnecessary electrical loads will allow faster battery state-of-charge recovery. |

Doors and Locks

| Message | Action |
|----------------------------------|--|
| Driver Door Ajar | The driver door is not completely closed. |
| Passenger Door Ajar | The passenger door is not completely closed. |
| Switches Inhibited Security Mode | The system has disabled the door switches. |

Engine

| Message | Action |
|------------------------------------|--|
| Power Reduced to Lower Engine Temp | The engine has reduced power to help reduce high engine temperature. |

Information Displays

Fuel

| Message | Action |
|-----------------------|---|
| Fuel Level Low | An early reminder of a low fuel condition. |
| Check Fuel Fill Inlet | The fuel fill inlet may not be properly closed. |

Maintenance

| Message | Action |
|---|--|
| Low Engine Oil Pressure | Stop your vehicle as soon as safely possible and turn off the engine. Check the oil level. If the warning stays on or continues to come on with your engine running, contact an authorized dealer as soon as possible. |
| Change Engine Oil Soon | The engine oil life remaining is 10% or less. |
| Oil Change Required | The oil life left is at 0%. |
| Brake Fluid Level Low | The brake fluid level is low, inspect the brake system immediately. See Brake Fluid Check (page 171). |
| Check Brake System | The brake system needs servicing. Stop your vehicle in a safe place. Contact an authorized dealer. |
| Transport / Factory Mode Contact Dealer | Your vehicle is still in Transport or Factory mode. This may not allow some features to operate properly. See an authorized dealer. |
| See Manual | The powertrain needs service due to a powertrain malfunction. |

Information Displays

Power Steering

| Message | Action |
|--|---|
| Steering Fault Service Now | The power steering system detects a condition that requires service. See an authorized dealer. |
| Steering Loss Stop Safely | The power steering system is not working. Stop your vehicle in a safe place. Contact an authorized dealer. |
| Steering Assist Fault Service Required | The power steering system detects a condition within the power steering system or passive entry or passive start system requires service. Contact an authorized dealer. |
| Steering Lock Malfunction Service Now | The steering lock system detects a condition that requires service. See an authorized dealer. |

Transmission

| Message | Action |
|---|---|
| Shift to Park | You switched the engine off and shift select lever is in any position other than park (P). |
| Press Brake Pedal | Displays when the brake pedal needs to be depressed. |
| Transmission Over Temperature Stop Safely | The transmission is overheating and needs to cool. Stop in a safe place as soon as it's possible. |
| Transmission Service Required | See an authorized dealer. |
| Transmission Too Hot Press Brake | The transmission is overheating and needs to cool. Stop in a safe place as soon as it's possible. |
| Transmission Limited Function See Manual | The transmission has limited functionality. See an authorized dealer. |
| Transmission Not in Park | A reminder to shift into park. In addition, this message is typical after reconnecting or recharging the battery until you cycle the ignition to the on mode. See Changing the 12V Battery (page 173). |
| Depress Brake to Shift from Park | Displays when the brake pedal needs to be depressed to enable the transmission to shift from park. |

Climate Control

MANUAL CLIMATE CONTROL

Heater Only System (If Equipped)



Note: Depending on your vehicle option package, the controls may look different from what you see here.

Directing the Air

Turn the control to direct the air.

VENT Direct air to the instrument panel air vents.

FLR Direct air to the footwell air vents.

MIX Direct air to the instrument panel and footwell air vents.

 Direct air to the windshield air vents. You can also use this setting to defog and clear the windshield of a thin covering of ice.

Setting the Blower Motor Speed

 Turn the control to adjust the volume of air circulated in the vehicle.

Setting the Temperature

COOL

WARM

Turn the control to set the temperature.

Switching the Heater On and Off

OFF

Turn the control.

Manual Climate Control (If Equipped)



Note: Depending on your vehicle option package, the controls may look different from what you see here.

Directing the Air

Turn the control to direct the air.

VENT

Direct air to the instrument panel air vents.

FLR

Direct air to the footwell air vents.

MIX

Direct air to the instrument panel and footwell air vents.

Climate Control



Direct air to the windshield air vents. You can also use this setting to defog and clear the windshield of a thin covering of ice.

Switching the Air Conditioning On and Off



Turn to switch the air conditioning on or off.

Switching Maximum Air Conditioning On and Off



Turn the control for maximum cooling.

Recirculated air flows through the instrument panel vents and air conditioning turns on.

Setting the Blower Motor Speed



Turn the control to adjust the volume of air circulated in the vehicle.

Setting the Temperature



Turn the control to set the temperature.

Switching the Climate Control On and Off



Turn the control.

HINTS ON CONTROLLING THE INTERIOR CLIMATE

General Hints

Note: Prolonged use of recirculated air may cause the windows to fog up.

Note: You may feel a small amount of air from the footwell air vents regardless of the air distribution setting.

Note: To reduce humidity build-up inside your vehicle, do not drive with the system switched off or with recirculated air always switched on.

Note: To reduce fogging of the windshield during humid weather, adjust the air distribution control to the windshield air vents position.

Note: Do not place objects under the front seats as this may interfere with the airflow to the rear seats.

Note: Remove any snow, ice or leaves from the air intake area at the base of the windshield.

Note: To improve the time to reach a comfortable temperature in hot weather, drive with the windows open until you feel cold air through the air vents.

Quickly Heating the Interior

1. Adjust the fan speed to the highest speed setting.
2. Adjust the temperature control to the full heat setting.
3. Direct air to the footwell air vents.

Recommended Settings for Heating

1. Adjust the fan speed to the center setting.
2. Adjust the temperature control to the midway point of the hot settings.

Climate Control

3. Direct air to the footwell air vents.

Quickly Cooling the Interior

1. Turn to **MAX A/C**.
2. Drive with the windows open until you feel cold air through the air vents.

Recommended Settings for Cooling

1. Adjust the fan speed to the center setting.
2. Adjust the temperature control to the midway point of the cold settings.
3. Direct air to the instrument panel air vents.

Vehicle Stationary for Extended Periods During Extreme High Ambient Temperatures

1. Apply the parking brake.
2. Place your vehicle in park (P) or neutral.
3. Turn to **MAX A/C**.
4. Adjust the fan speed to the lowest speed setting.

Defogging the Side Windows in Cold Weather

1. Direct air to the instrument panel and windshield vents.
2. Turn to **NORM A/C**.
3. Adjust the temperature control to the desired setting.
4. Adjust the fan speed to the highest setting.
5. Direct air toward the side windows.
6. Close the instrument panel vents.

REAR PASSENGER CLIMATE CONTROLS

Setting the Blower Motor Speed

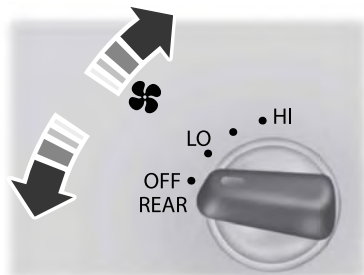

Turn the control to adjust the volume of air circulated in the vehicle.

Note: Depending on your vehicle option package, the controls may look different from what you see here.

Switching the Rear Climate Control On and Off

OFF Turn the control.

Seats

SITTING IN THE CORRECT POSITION



WARNING: Sitting improperly, out of position or with the seatback reclined too far can take weight off the seat cushion and affect the decision of the passenger sensing system, resulting in serious injury or death in the event of a crash. Always sit upright against your seat back, with your feet on the floor.



WARNING: Do not recline the seatback too far as this can cause the occupant to slide under the seatbelt, resulting in serious injury in the event of a collision.



WARNING: Do not place objects higher than the top of the seat backrest. Failure to follow this instruction could result in personal injury or death in the event of a sudden stop or crash.

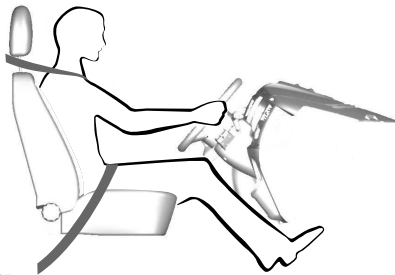

E68595

When you use them properly, the seat, head restraint, seatbelt and airbags will provide optimum protection in the event of a crash.

We recommend that you follow these guidelines:

- Sit in an upright position with the base of your spine as far back as possible.
- Do not recline the seat backrest so that your torso is more than 30° from the upright position.
- Adjust the head restraint so that the top of it is level with the top of your head and as far forward as possible. Make sure that you remain comfortable.
- Keep sufficient distance between yourself and the steering wheel. We recommend a minimum of 10 in (25 cm) between your breastbone and the airbag cover.
- Hold the steering wheel with your arms slightly bent.
- Bend your legs slightly so that you can press the pedals fully.
- Position the shoulder strap of the seatbelt over the center of your shoulder and position the lap strap tightly across your hips.

Make sure that your driving position is comfortable and that you can maintain full control of your vehicle.

HEAD RESTRAINTS



E190815

Seats

The front row outboard non-adjustable head restraints consist of a trimmed foam covering over the upper structure of the seatback. Properly adjust the seatback to an upright driving or riding position, so that the head restraint is positioned as close as possible to the back of your head.

MANUAL SEATS (IF EQUIPPED)

WARNING: Make sure the seat fully locks into place by rocking it backward and forward. Not securing the seat into the locked position can be dangerous in a crash and could cause serious personal injury or death.

Moving the Seat Backward and Forward

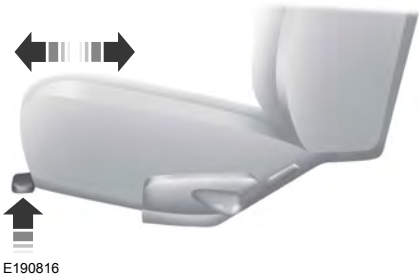

Recline Adjustment (If Equipped)

WARNING: Do not place cargo or any objects behind the seat backrest before returning it to the original position. Pull on the seat backrest to make sure that it has fully latched after returning the seat backrest to its original position. An unlatched seat may become dangerous if you stop suddenly or have a crash.



E190817

Manual Lumbar (If Equipped)



E166702

The lumbar control is on the inboard side of the driver seat. Turn the control to adjust your support.

Seats

POWER SEATS (IF EQUIPPED)



WARNING: Do not adjust the driver seat or seatback while your vehicle is moving. Adjusting your seatback while the vehicle is in motion may cause loss of control of the vehicle.

The control is located on the outboard side of the seat cushion.

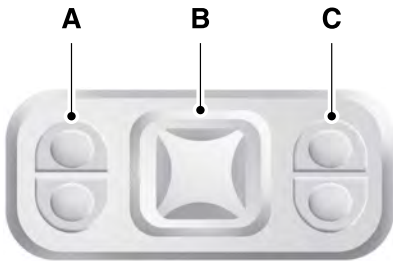

E190818

- Press A to raise or lower the front portion of the seat cushion.
- Press B to move the seat forward, backward, up or down.
- Press C to raise or lower the rear portion of the seat cushion.

Recline Adjustment (If Equipped)

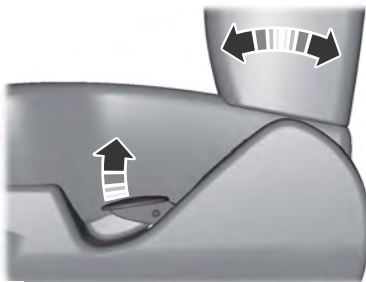

E190819

Auxiliary Power Points

12 Volt DC Power Point



WARNING: Do not plug optional electrical accessories into the cigar lighter socket. Incorrect use of the cigar lighter can cause damage not covered by the vehicle warranty, and can result in fire or serious injury.

Note: When you switch the ignition on, you can use the socket to power 12 volt appliances with a maximum current rating of 15 amps.

If the power supply does not work after you switch the ignition off, switch the ignition on.

Note: Do not hang any accessory from the accessory plug.

Note: Do not use the power point over the vehicle capacity of 12 volt DC 180 watts or a fuse may blow.

Note: Always keep the power point caps closed when not in use.

Do not insert objects other than an accessory plug into the power point. This damages the power point and may blow the fuse.

Run the vehicle for full capacity use of the power point.

To prevent the battery from running out of charge:

- Do not use the power point longer than necessary when the vehicle is not running.
- Do not leave devices plugged in overnight or when you park your vehicle for extended periods.

Locations

Power points may be in the following locations:

- On the instrument panel.
- Inside the glove box.
- Behind the driver's seat, upper trim panel.

110 Volt AC Power Point (If Equipped)



WARNING: Do not keep electrical devices plugged in the power point whenever the device is not in use. Do not use any extension cord with the 110 volt AC power point, since it will defeat the safety protection design. Doing so may cause the power point to overload due to powering multiple devices that can reach beyond the 150 watt load limit and could result in fire or serious injury.

Note: The power point turns off when you switch the ignition off, or when the battery voltage drops below 11 volts.

You can use the power point for electric devices that require up to 150 watts. It is on the rear of the center console.



E194174

To gain access to the outlet contacts, press the plug against the outlet and rotate clockwise.

Auxiliary Power Points

When the indicator light on the power point is:

- On: The power point is working, the ignition is on and a device is plugged in.
- Off: The power point is off, the ignition is off or no device is plugged in.
- Flashing: The power point is in fault mode.

The power outlet temporarily turns off power when in fault mode if the device exceeds the 150 watt limit. Unplug your device and switch the ignition off. Switch the ignition back on, but do not plug your device back in. Let the system cool off and switch the ignition off to reset the fault mode. Switch the ignition back on and make sure the indicator light remains on.

Do not use the power point for certain electric devices, including:

- Cathode-ray, tube-type televisions.
- Motor loads, such as vacuum cleaners, electric saws and other electric power tools or compressor-driven refrigerators.
- Measuring devices, which process precise data, such as medical equipment or measuring equipment.
- Other appliances requiring an extremely stable power supply such as microcomputer-controlled electric blankets or touch-sensor lamps.

Starting and Stopping the Engine

GENERAL INFORMATION



WARNING: Extended idling at high engine speeds can produce very high temperatures in the engine and exhaust system, creating the risk of fire or other damage.



WARNING: Do not park, idle or drive your vehicle on dry grass or other dry ground cover. The emission system heats up the engine compartment and exhaust system, creating the risk of fire.



WARNING: Do not start the engine in a closed garage or in other enclosed areas. Exhaust fumes can be toxic. Always open the garage door before you start the engine.



WARNING: Exhaust leaks may result in entry of harmful and potentially lethal fumes into the passenger compartment. If you smell exhaust fumes inside your vehicle, have your vehicle inspected immediately. Do not drive if you smell exhaust fumes.

If you disconnect the battery, your vehicle may exhibit some unusual driving characteristics for approximately 5 mi (8 km) after you reconnect it. This is because the engine management system must realign itself with the engine. You can disregard any unusual driving characteristics during this period.

The powertrain control system meets all Canadian interference-causing equipment standard requirements regulating the impulse electrical field or radio noise.

When you start the engine, avoid pressing the accelerator pedal before and during operation. Only use the accelerator pedal when you have difficulty starting the engine.

IGNITION SWITCH

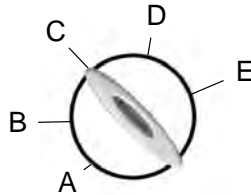

E161572

A (accessory) - Allows the electrical accessories, such as the radio, to operate while the engine is not running.

Note: Do not leave the ignition key in this position for too long. This could cause your vehicle battery to lose charge.

B (lock) - Locks the gearshift lever and allows key removal.

C (off) - The ignition is off.

Note: When you switch the ignition off and leave your vehicle, do not leave your key in the ignition. This could cause your vehicle battery to lose charge.

D (on) - All electrical circuits are operational and the warning lamps and indicators illuminate.

E (start) - Cranks the engine.

STARTING A GASOLINE ENGINE

When you start the engine, the idle speed increases, this helps to warm up the engine. If the engine idle speed does not slow down automatically, have your vehicle checked by an authorized dealer.

Starting and Stopping the Engine

Before starting the engine check the following:

- Make sure all occupants have fastened their safety belts.
- Make sure the headlamps and electrical accessories are off.
- Make sure the parking brake is on.
- Make sure the transmission is in park (P) or neutral (N).
- Turn the ignition key to the on position.

Note: Do not touch the accelerator pedal.

1. Fully press the brake pedal.
2. Turn the key to the start position to start the engine. Release the key when the engine starts.

Note: The engine may continue cranking for up to 15 seconds or until it starts.

Note: If you cannot start the engine on the first try, wait for a short period and try again.

Failure to Start

If you cannot start the engine after three attempts, wait 10 seconds and follow this procedure:

1. Fully press the brake pedal.
2. Fully press the accelerator pedal and hold it there.
3. Start the engine.

Stopping the Engine When Your Vehicle is Stationary

1. Shift into park (P) or neutral (N).
2. Turn the key to the off position.
3. Apply the parking brake.

Stopping the Engine When Your Vehicle is Moving



WARNING: Switching off the engine when the vehicle is still moving will result in a loss of brake and steering assistance. The steering will not lock, but higher effort will be required. When the ignition is switched off, some electrical circuits, including air bags, warning lamps and indicators may also be off. If the ignition was turned off accidentally, you can shift into neutral (N) and re-start the engine.

1. Put the transmission into neutral (N) and use the brakes to bring your vehicle to a safe stop.
2. When your vehicle has stopped, shift into park (P) or neutral (N) and switch the ignition off.
3. Apply the parking brake.

Guarding Against Exhaust Fumes



WARNING: If you smell exhaust fumes inside your vehicle, have your vehicle checked by your authorized dealer immediately. Do not drive your vehicle if you smell exhaust fumes. Carbon monoxide is present in exhaust fumes. Take precautions to avoid its dangerous effects.

Important Ventilating Information

If you stop your vehicle and then leave the engine idling for long periods of time, we recommend that you do one of the following:

- Open the windows at least 1 in (3 cm).
- Set your climate control to outside air.

Starting and Stopping the Engine

ENGINE BLOCK HEATER (IF EQUIPPED)



WARNING: Failure to follow engine block heater instructions could result in property damage or serious personal injury.



WARNING: Do not use your heater with ungrounded electrical systems or two-pronged adapters. There is a risk of electrical shock.



WARNING: Do not fully close the hood, or allow it to drop under its own weight when using the engine block heater. This could damage the power cable and may cause an electrical short resulting in fire, injury and property damage.

Note: *The heater is most effective when outdoor temperatures are below 0°F (-18°C).*

The heater acts as a starting aid by warming the engine coolant. This allows the climate control system to respond quickly. The equipment includes a heater element, installed in the engine block and a wire harness. You can connect the system to a grounded 120-volt AC electrical source.

We recommend that you do the following for a safe and correct operation:

- Use a 16-gauge outdoor extension cord that is product certified by Underwriter's Laboratory (UL) or Canadian Standards Association (CSA). This extension cord must be suitable for use outdoors, in cold

temperatures, and be clearly marked Suitable for Use with Outdoor Appliances. Do not use an indoor extension cord outdoors. This could result in an electric shock or become a fire hazard.

- Use as short an extension cord as possible.
- Do not use multiple extension cords.
- Make sure that when in operation, the extension cord plug and heater cord plug connections are free and clear of water. This could cause an electric shock or fire.
- If the block heater cord is under the hood, Do Not remove the wiring from its original location. Do Not close the hood on the extension wiring.
- Make sure your vehicle is parked in a clean area, clear of combustibles.
- Make sure the heater, heater cord and extension cord are firmly connected.
- Check for heat anywhere in the electrical hookup once the system has been operating for approximately 30 minutes.
- Make sure the system is unplugged and properly stowed before starting and driving your vehicle. Make sure the protective cover seals the prongs of the block heater cord plug when not in use.
- Make sure the heater system is checked for proper operation before winter.

Using the Engine Block Heater

Make sure the receptacle terminals are clean and dry prior to use. Clean them with a dry cloth if necessary.

Starting and Stopping the Engine

The heater uses 0.4 to 1.0 kilowatt-hours of energy per hour of use. The system does not have a thermostat. It achieves maximum temperature after approximately three hours of operation. Using the heater longer than three hours does not improve system performance and unnecessarily uses electricity.

Fuel and Refueling

SAFETY PRECAUTIONS



WARNING: Do not overfill the fuel tank. The pressure in an overfilled tank may cause leakage and lead to fuel spray and fire.



WARNING: The fuel system may be under pressure. If you hear a hissing sound near the fuel filler inlet, do not refuel until the sound stops. Otherwise, fuel may spray out, which could cause serious personal injury.



WARNING: Fuels can cause serious injury or death if misused or mishandled.



WARNING: Fuel may contain benzene, which is a cancer-causing agent.



WARNING: When refueling always shut the engine off and never allow sparks or open flames near the fuel tank filler valve. Never smoke or use a cell phone while refueling. Fuel vapor is extremely hazardous under certain conditions. Avoid inhaling excess fumes.

- Avoid inhaling fuel vapors. Inhaling fuel vapor can lead to eye and respiratory tract irritation. In severe cases, excessive or prolonged breathing of fuel vapor can cause serious illness and permanent injury.
- Avoid getting fuel in your eyes. If you splash fuel in your eyes, immediately remove contact lenses (if worn), flush with water for 15 minutes and seek medical attention. Failure to seek proper medical attention could lead to permanent injury.
- Fuels can be harmful if absorbed through the skin. If you splash fuel on your skin, clothing or both, promptly remove contaminated clothing and thoroughly wash your skin with soap and water. Repeated or prolonged skin contact causes skin irritation.
- Be particularly careful if you are taking Antabuse or other forms of Disulfiram for the treatment of alcoholism. Breathing fuel vapors could cause an adverse reaction, serious personal injury or sickness. Immediately call a physician if you experience any adverse reactions.

Follow these guidelines when refueling:

- Extinguish all smoking materials and any open flames before refueling your vehicle.
- Always switch the engine off before refueling.
- Automotive fuels can be harmful or fatal if swallowed. Fuel is highly toxic and if swallowed can cause death or permanent injury. If fuel is swallowed immediately call a physician, even if no symptoms are immediately apparent. The toxic effects of fuel may not be apparent for hours.

FUEL QUALITY - E85

Choosing the Right Fuel - Flex Fuel Vehicles

Flex fuel vehicles have one of the following identifiers:

- Yellow fuel filler cap.
- Yellow bezel around the fuel filler inlet.
- Yellow fuel filler housing.
- Yellow E85 label on the fuel tank filler door.

Fuel and Refueling

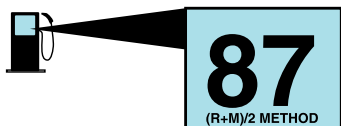

E161513

Your vehicle is designed to operate on regular unleaded gasoline with a minimum pump (R+M)/2 octane rating of 87 or regular unleaded gasoline blended with a maximum of 85% ethanol (E85).

Some fuel stations, particularly those in high altitude areas, offer fuels posted as regular unleaded gasoline with an octane rating below 87. The use of these fuels could result in engine damage that will not be covered by the vehicle warranty.

For best overall vehicle and engine performance, premium fuel with an octane rating of 91 or higher is recommended. The performance gained by using premium fuel is most noticeable in hot weather as well as other conditions, for example when towing a trailer. See **Towing** (page 125).

Do not be concerned if the engine sometimes knocks lightly. However, if the engine knocks heavily while using fuel with the recommended octane rating, contact an authorized dealer to prevent any engine damage.

We recommend Top Tier detergent gasolines, where available to help minimize engine deposits and maintain optimal vehicle and engine performance. For additional information, refer to www.toptiergas.com.

Note: *Use of any fuel for which the vehicle was not designed can impair the emission control system, cause loss of vehicle performance, and cause damage to the engine which may not be covered by the vehicle Warranty.*

Do not use:

- Diesel fuel.
- Fuels containing kerosene or paraffin.
- Fuels containing more than 85% ethanol or E100 fuel.
- Fuels containing methanol.
- Fuels containing metallic-based additives, including manganese-based compounds.
- Fuels containing the octane booster additive, methylcyclopentadienyl manganese tricarbonyl (MMT).
- Leaded fuel, using leaded fuel is prohibited by law.

The use of fuels with metallic compounds such as methylcyclopentadienyl manganese tricarbonyl (commonly known as MMT), which is a manganese-based fuel additive, will impair engine performance and affect the emission control system.

Switching Between E85 and Gasoline

We do not recommend repeatedly alternating between E85 and gasoline. If you switch from using E85 to gasoline, or from gasoline to E85, add as much fuel as possible, at least half a tank. Drive your vehicle immediately for a minimum of 5 mi (8 km) to allow it to adapt to the change in ethanol concentration. If you use E85 exclusively, we recommend that you fill the fuel tank with regular unleaded gasoline at each scheduled oil change.

Fuel and Refueling

FUEL QUALITY - GASOLINE

Choosing the Right Fuel

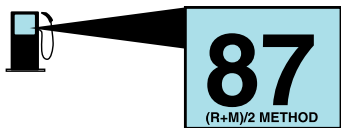

E161513

Your vehicle is designed to operate on regular unleaded gasoline with a minimum pump (R+M)/2 octane rating of 87.

Some fuel stations, particularly those in high altitude areas, offer fuels posted as regular unleaded gasoline with an octane rating below 87. The use of these fuels could result in engine damage that will not be covered by the vehicle warranty.

For best overall vehicle and engine performance, premium fuel with an octane rating of 91 or higher is recommended. The performance gained by using premium fuel is most noticeable in hot weather as well as other conditions, for example when towing a trailer. See **Towing** (page 125).

Do not be concerned if the engine sometimes knocks lightly. However, if the engine knocks heavily while using fuel with the recommended octane rating, contact an authorized dealer to prevent any engine damage.

We recommend Top Tier detergent gasolines, where available to help minimize engine deposits and maintain optimal vehicle and engine performance. For additional information, refer to www.toptiergas.com.

Note: Use of any fuel for which the vehicle was not designed can impair the emission control system, cause loss of vehicle performance, and cause damage to the engine which may not be covered by the vehicle Warranty.

Do not use:

- Diesel fuel.
- Fuels containing kerosene or paraffin.
- Fuel containing more than 15% ethanol or E85 fuel.
- Fuels containing methanol.
- Fuels containing metallic-based additives, including manganese-based compounds.
- Fuels containing the octane booster additive, methylcyclopentadienyl manganese tricarbonyl (MMT).
- Leaded fuel, using leaded fuel is prohibited by law.

The use of fuels with metallic compounds such as methylcyclopentadienyl manganese tricarbonyl (commonly known as MMT), which is a manganese-based fuel additive, will impair engine performance and affect the emission control system.

RUNNING OUT OF FUEL

Avoid running out of fuel. Running out of fuel can cause damage not covered by the vehicle Warranty.

Fuel and Refueling

If your vehicle runs out of fuel:

- Normally, adding 1.3 gal (5 L) of fuel is enough to restart the engine. If your vehicle is on a steep grade, more fuel may be required.
- You may need to cycle the ignition from off to on several times after refueling to allow the fuel system to pump the fuel from the tank to the engine. On restarting, cranking time will take a few seconds longer than normal.

Filling a Portable Fuel Container



WARNING: Flow of fuel through a fuel pump nozzle can produce static electricity. This can cause a fire if you are filling an ungrounded fuel container.

Use the following guidelines to avoid electrostatic charge build-up, which can produce a spark, when filling an ungrounded fuel container:

- Only use an approved fuel container to transfer fuel to your vehicle. Place the container on the ground when filling.
- Do not fill a fuel container while it is inside your vehicle (including the cargo area).
- Keep the fuel pump nozzle in contact with the fuel container while filling.
- Do not use a device that holds the fuel pump nozzle lever in the fill position.

REFUELING



WARNING: Fuel vapor burns violently and a fuel fire can cause severe injuries.



WARNING: Read and follow all the instructions on the pump island.



WARNING: When refueling always shut the engine off and never allow sparks or open flames near the fuel tank filler valve. Never smoke or use a cell phone while refueling. Fuel vapor is extremely hazardous under certain conditions. Avoid inhaling excess fumes.



WARNING: Stay outside your vehicle and do not leave the fuel pump unattended when refueling your vehicle.



WARNING: Keep children away from the fuel pump. Never let children pump fuel.



WARNING: Wait at least five seconds before removing the fuel pump nozzle to allow any residual fuel to drain into the fuel tank.



WARNING: Stop refueling after the fuel pump nozzle automatically shuts off for the second time. Failure to follow this will fill the expansion space in the fuel tank and could lead to fuel overflowing.



WARNING: Do not remove the fuel pump nozzle from its fully inserted position when refueling.

Use the following guidelines to avoid electrostatic charge build-up when filling an ungrounded fuel container:

- Place approved fuel container on the ground.
- Do not fill a fuel container while it is in the vehicle (including the cargo area).
- Keep the fuel pump nozzle in contact with the fuel container while filling.
- Do not use a device that would hold the fuel pump handle in the fill position.

Fuel and Refueling

Fuel Filler Cap



WARNING: The fuel system may be under pressure. If you hear a hissing sound near the fuel filler inlet, do not refuel until the sound stops. Otherwise, fuel may spray out, which could cause serious personal injury.

Note: *If you must replace the fuel filler cap, replace it with a fuel filler cap that is designed for your vehicle. The customer warranty may be void for any damage to the fuel tank or fuel system if the correct genuine Ford, Motorcraft or other certified fuel filler cap is not used.*

Your fuel tank filler cap has an SAE standard thread design. When fueling your vehicle:

1. Put your vehicle in park (P).
2. Switch the engine off.
3. Carefully turn the filler cap counterclockwise until it spins off.
4. Pull to remove the cap from the fuel filler pipe and place on the fuel door hanging hook if equipped.
5. To install the fuel filler cap, hold the cap by the cover handle and place the threaded end of the cap into filler pipe. Turn the cap clockwise until it clicks at least once.

If the Check Fuel Cap light or a Check Fuel Cap message appears in the instrument cluster and stays on after you start the engine, you may not have installed the fuel filler properly.

If the fuel cap light remains on, at the next opportunity, safely pull off of the road, remove the fuel filler cap, align the cap properly and reinstall it. The check fuel cap light or Check fuel cap message may not reset immediately. It may take several driving cycles for the indicators to turn off. A driving cycle consists of an engine start-up (after four or more hours with the engine off) followed by normal city and highway driving.

FUEL CONSUMPTION

Advertised Capacity

The advertised capacity is the maximum amount of fuel that you can add to the fuel tank after running out of fuel. Included in the advertised capacity is an empty reserve. The empty reserve is an unspecified amount of fuel that remains in the fuel tank when the fuel gauge indicates empty.

Note: *The amount of fuel in the empty reserve varies and should not be relied upon to increase driving range.*

Fuel Economy

Your vehicle calculates fuel economy figures through the trip computer average fuel function. See **General Information** (page 63).

The first 1,000 mi (1,500 km) of driving is the break-in period of the engine. A more accurate measurement is obtained after 2,000 mi (3,000 km).

Impacting Fuel Economy

- Incorrect tire inflation pressures.
- Fully loading your vehicle.
- Carrying unnecessary weight.

Fuel and Refueling

- Adding certain accessories to your vehicle such as bug deflectors, rollbars or light bars, running boards and ski racks.
- Using fuel blended with alcohol. See **Fuel Quality** (page 82).
- Fuel economy may decrease with lower temperatures.
- Fuel economy may decrease when driving short distances.
- You may get better fuel economy when driving on flat terrain than when driving on hilly terrain.

Engine Emission Control

EMISSION LAW



WARNING: Do not remove or alter the original equipment floor covering or insulation between it and the metal floor of the vehicle. The floor covering and insulation protect occupants of the vehicle from the engine and exhaust system heat and noise. On vehicles with no original equipment floor covering insulation, do not carry passengers in a manner that permits prolonged skin contact with the metal floor. Failure to follow these instructions may result in fire or personal injury.

U.S. federal laws and certain state laws prohibit removing or rendering inoperative emission control system components. Similar federal or provincial laws may apply in Canada. We do not approve of any vehicle modification without first determining applicable laws.



Tampering with emissions control systems including related sensors or the Diesel Exhaust Fluid system can result in reduced engine power and the illumination of the service engine soon light.

Tampering With a Noise Control System

Federal laws prohibit the following acts:

- Removal or rendering inoperative by any person other than for purposes of maintenance.
- Repair or replacement of any device or element of the design incorporated into a new vehicle for the purpose of noise control prior to its sale or delivery to the ultimate purchaser or while it is in use.
- The use of the vehicle after any person removes or renders inoperative any device or element of the design.

The U.S. Environmental Protection Agency may presume to constitute tampering as follows:

- Removal of hood blanket, fender apron absorbers, fender apron barriers, underbody noise shields or acoustically absorptive material.
- Tampering or rendering inoperative the engine speed governor, to allow engine speed to exceed manufacturer specifications.

If the engine does not start, runs rough, experiences a decrease in engine performance, experiences excess fuel consumption or produces excessive exhaust smoke, check for the following:

- A plugged or disconnected air inlet system hose.
- A plugged engine air filter element.
- Water in the fuel filter and water separator.
- A clogged fuel filter.
- Contaminated fuel.
- Air in the fuel system, due to loose connections.
- An open or pinched sensor hose.
- Incorrect engine oil level.

Engine Emission Control

- Incorrect fuel for climatic conditions.
- Incorrect engine oil viscosity for climactic conditions.

Note: *Some vehicles have a lifetime fuel filter that is integrated with the fuel tank. Regular maintenance or replacement is not needed.*

Note: *If these checks do not help you correct the concern, have your vehicle checked as soon as possible.*

Noise Emissions Warranty, Prohibited Tampering Acts and Maintenance

On January 1, 1978, Federal regulation became effective governing the noise emission on trucks over 10,000 lb (4,536 kg) Gross Vehicle Weight Rating (GVWR). The preceding statements concerning prohibited tampering acts and maintenance, and the noise warranty found in the Warranty Guide, are applicable to complete chassis cabs over 10,000 lb (4,536 kg) GVWR.

CATALYTIC CONVERTER



WARNING: Do not park, idle or drive your vehicle on dry grass or other dry ground cover. The emission system heats up the engine compartment and exhaust system, creating the risk of fire.



WARNING: The normal operating temperature of the exhaust system is very high. Never work around or attempt to repair any part of the exhaust system until it has cooled. Use special care when working around the catalytic converter. The catalytic converter heats up to a very high temperature after only a short period of engine operation and stays hot after the engine is switched off.



WARNING: Exhaust leaks may result in entry of harmful and potentially lethal fumes into the passenger compartment. If you smell exhaust fumes inside your vehicle, have your vehicle inspected immediately. Do not drive if you smell exhaust fumes.

Your vehicle has various emission control components and a catalytic converter that enables it to comply with applicable exhaust emission standards.

To make sure that the catalytic converter and other emission control components continue to work properly:

- Do not crank the engine for more than 10 seconds at a time.
- Do not run the engine with a spark plug lead disconnected.
- Do not push-start or tow-start your vehicle. Use booster cables. See **Jump Starting the Vehicle** (page 142).
- Use only the specified fuel listed.
- Do not switch the ignition off when your vehicle is moving.
- Avoid running out of fuel.
- Have the items listed in scheduled maintenance information performed according to the specified schedule.

Note: *Resulting component damage may not be covered by the vehicle Warranty.*

The scheduled maintenance items listed in scheduled maintenance information are essential to the life and performance of your vehicle and to its emissions system.

If you use anything other than Ford, Motorcraft or Ford-authorized parts for maintenance replacements or for service of components affecting emission control, such non-Ford parts should be equivalent to genuine Ford Motor Company parts in performance and durability.

Engine Emission Control

Illumination of the service engine soon indicator, charging system warning light or the temperature warning light, fluid leaks, strange odors, smoke or loss of engine power could indicate that the emission control system is not working properly.

An improperly operating or damaged exhaust system may allow exhaust to enter the vehicle. Have a damaged or improperly operating exhaust system inspected and repaired immediately.

Do not make any unauthorized changes to your vehicle or engine. By law, vehicle owners and anyone who manufactures, repairs, services, sells, leases, trades vehicles, or supervises a fleet of vehicles are not permitted to intentionally remove an emission control device or prevent it from working. Information about your vehicle's emission system is on the Vehicle Emission Control Information Decal located on or near the engine. This decal also lists engine displacement.

Please consult your warranty information for complete details.

On-Board Diagnostics (OBD-II)

Your vehicle has a computer known as the on-board diagnostics system (OBD-II) that monitors the engine's emission control system. The system protects the environment by making sure that your vehicle continues to meet government emission standards. The OBD-II system also assists a service technician in properly servicing your vehicle.



When the service engine soon indicator illuminates, the OBD-II system has detected a malfunction. Temporary malfunctions may cause the service engine soon indicator to illuminate. Examples are:

1. Your vehicle has run out of fuel—the engine may misfire or run poorly.
2. Poor fuel quality or water in the fuel—the engine may misfire or run poorly.
3. The fuel fill inlet may not have closed properly. See **Refueling** (page 85).
4. Driving through deep water—the electrical system may be wet.

You can correct these temporary malfunctions by filling the fuel tank with good quality fuel, properly closing the fuel fill inlet or letting the electrical system dry out. After three driving cycles without these or any other temporary malfunctions present, the service engine soon indicator should stay off the next time you start the engine. A driving cycle consists of a cold engine startup followed by mixed city and highway driving. No additional vehicle service is required.

If the service engine soon indicator remains on, have your vehicle serviced at the first available opportunity. Although some malfunctions detected by the OBD-II may not have symptoms that are apparent, continued driving with the service engine soon indicator on can result in increased emissions, lower fuel economy, reduced engine and transmission smoothness and lead to more costly repairs.

Readiness for Inspection and Maintenance (I/M) Testing

Some state and provincial and local governments may have Inspection/Maintenance (I/M) programs to inspect the emission control equipment on your vehicle. Failure to pass this inspection could prevent you from getting a vehicle registration.



If the service engine soon indicator is on or the bulb does not work, your vehicle may need service. See On-Board Diagnostics.

Engine Emission Control

Your vehicle may not pass the I/M test if the service engine soon indicator is on or not working properly (bulb is burned out), or if the OBD-II system has determined that some of the emission control systems have not been properly checked. In this case, the vehicle is not ready for I/M testing.

If the vehicle's engine or transmission has just been serviced, or the battery has recently run down or been replaced, the OBD-II system may indicate that the vehicle is not ready for I/M testing. To determine if the vehicle is ready for I/M testing, turn the ignition key to the on position for 15 seconds without cranking the engine. If the service engine soon indicator blinks eight times, it means that the vehicle is not ready for I/M testing; if the service engine soon indicator stays on solid, it means that your vehicle is ready for I/M testing.

The OBD-II system checks the emission control system during normal driving. A complete check may take several days.

If the vehicle is not ready for I/M testing, you can perform the following driving cycle consisting of mixed city and highway driving:

1. 15 minutes of steady driving on an expressway or highway followed by 20 minutes of stop-and-go driving with at least four 30-second idle periods.
2. Allow your vehicle to sit for at least eight hours with the ignition off. Then, start the vehicle and complete the above driving cycle. The vehicle must warm up to its normal operating temperature. Once started, do not turn off the vehicle until the above driving cycle is complete.

If the vehicle is still not ready for I/M testing, you need to repeat the above driving cycle.

Transmission

AUTOMATIC TRANSMISSION



WARNING: Apply the parking brake, shift into park (P), switch the ignition off and remove the key before you leave your vehicle. Failure to follow this instruction could result in personal injury or death.

P R N D M 2 1

Putting your vehicle in or out of gear:

1. Fully press down the brake pedal.
2. Move the gearshift lever into the preferred gear.
3. When you finish driving, come to a complete stop.
4. Move the gearshift lever and securely latch it in park (P).
5. Release the brake pedal and the transmission remains in the selected gear.

Park (P)

This position locks the transmission and prevents the wheels from turning.

Reverse (R)

With the transmission in reverse (R), your vehicle moves backward. Always come to a complete stop before shifting into and out of reverse (R).

Neutral (N)

With the transmission in neutral (N), you can start your vehicle and it is free to roll. Hold the brake pedal down when in this position.

Drive (D)

Drive (D) is the normal driving position for the best fuel economy. The overdrive function allows automatic upshifts and downshifts through gears one through six.

Manual (M)

Moving the gearshift lever to the manual (M) position allows you to manually select the gear you prefer. Only the current gear displays. Use the buttons on the gearshift lever to manually select gears. Press the + button to upshift or the – button to downshift. Return the transmission to a different gearshift position to deactivate manual control.

Second (2)

Transmission operates in second (2) gear only. Use second (2) gear to start-up on slippery roads.

First (1)

- Transmission operates in first (1) gear only.
- Provides maximum engine braking.
- Allows upshifts by moving gearshift lever.
- Does not downshift into first (1) gear at high speeds; allows for first (1) gear when vehicle reaches slower speeds.

Forced downshifts

- Allowed in drive (D) with the tow/haul feature on or off.
- Press the accelerator to the floor.
- Allows transmission to select an appropriate gear.

Transmission

Tow/Haul Mode

TOW HAUL To activate tow/haul, press the button on the gearshift lever. The TOW HAUL indicator light illuminates in the instrument cluster.

The tow/haul feature:

- Delays upshifts to reduce the frequency of transmission shifting.
- Provides engine braking in all forward gears, which slows your vehicle and assists you in controlling your vehicle when descending a slope.
- Depending on driving conditions and load conditions, may downshift the transmission, slow your vehicle and control your vehicle speed when descending a hill, without pressing the accelerator pedal. The amount of downshift braking provided varies based upon the amount you press the brake pedal.

The tow/haul feature improves transmission operation when towing a trailer or a heavy load. All transmission gear ranges are available when using tow/haul.

To deactivate the tow/haul feature and return to normal driving mode, press the button on the gearshift lever again. The TOW HAUL light deactivates. Tow/haul also deactivates when you power down your vehicle.



WARNING: Do not use tow/haul when the road surface is slippery. Failure to follow this instruction could result in the loss of control of your vehicle.

Understanding Your SelectShift Automatic™ Transmission



Note: When pressing the button on the gearshift lever, you can cycle through the available drive modes.

Your vehicle has a SelectShift Automatic™ transmission gearshift lever. The SelectShift Automatic transmission gives you the ability to change gears up or down without a clutch.

To prevent the engine from running at too low an RPM, which may cause it to stall, SelectShift still makes some downshifts if it has determined that you have not downshifted in time. Although SelectShift makes some downshifts for you, it still allows you to downshift at any time if the SelectShift determines that damage to the engine does not occur from over-revving.

SelectShift does not upshift, even if the engine is approaching the RPM limit. Shift manually by pressing the + button.

Note: Engine damage may occur if you maintain excessive engine revving without shifting.

SelectShift does not automatically upshift, even if the engine is approaching the RPM limit. Shift manually by pressing the (+) paddle.

Transmission

Progressive Range Selection - PRS

(If Equipped)

Progressive Range Selection gives you the ability to lockout gears from the automatic shifting range. This may provide you with an improved driving experience. For example, in slippery conditions or when experiencing a steep grade.

With the gearshift lever in drive (D), press the – button to active PRS. The instrument cluster indicates the available and selected gears.

All available gears display with the current gear indicated. Press the – button again to lock out gears beginning with the highest gear. Example: press the – button twice to lock out 6th and 5th gears. Only the available gears display, and the transmission automatically shifts between the available gears. Press the + button to unlock gears to allow the transmission to shift to higher gears. The transmission shifts within the gear range you select.

Automatic Transmission Adaptive Learning

This feature may increase durability and provide consistent shift feel over the life of your vehicle. A new vehicle or transmission may have firm shifts, soft shifts, or both. This is normal and does not affect function or durability of the transmission. Over time, the adaptive learning process fully updates transmission operation.

Brake-Shift Interlock



WARNING: Do not drive your vehicle until you verify that the stoplamps are working.



WARNING: When doing this procedure, you need to take the transmission out of park (P) which means your vehicle can roll freely. To avoid unwanted vehicle movement, always fully apply the parking brake prior to doing this procedure. Use wheels chocks if appropriate.



WARNING: If the parking brake is fully released, but the brake warning lamp remains illuminated, the brakes may not be working properly. Have your vehicle checked as soon as possible.

Your vehicle has a brake-shift interlock feature that prevents the gearshift lever from moving from park (P) when the ignition is in the 3 (on) position and the brake pedal is not pressed.

If you cannot move the gearshift lever out of park (P) position with the ignition in the 3 (on) position and the brake pedal pressed, a malfunction may have occurred. It is possible that a fuse has blown or your vehicle's brake lamps are not operating properly. See **Fuse Specification Chart** (page 151).

If the fuse is not blown and the brake lamps are working properly, the following procedure allows you to move the gearshift lever from park (P):

1. Apply the parking brake. Switch the ignition key to 1 (off), then remove the key.
2. Move the steering column to the full down and full rearward position, toward the driver seat.
3. Remove the gearshift lever boot.

Transmission

- Place your fingers into the hole where you removed the gearshift lever boot and pull the top half of the shroud up and forward to separate it from the lower half of the shroud. There is a hinge at the forward edge of the top of the shroud. Roll the top half of the shroud upward on the hinge point, then pull straight rearward toward the driver seat to remove.
- Remove the top half of the shroud.
- Remove the three fasteners under the column that secure the lower shroud half to the column.



E163185

- Pull the lock lever into the full unlocked position and remove the lower shroud cover by pulling the lever handle through the slot in the cover.
- Apply the brake. Gently lift the override disk and move the gearshift lever into neutral (N).



E163186

- Start your vehicle.

Perform Steps 4 through 8 in reverse order, making sure to engage the hinge pivots between the upper and lower halves of the shroud. Keep slight pressure in the forward direction as you rotate the halves together.

If Your Vehicle Gets Stuck in Mud or Snow

Note: Do not rock your vehicle if the engine is not at normal operating temperature or damage to the transmission may occur.

Note: Do not rock your vehicle for more than a minute or damage to the transmission and tires may occur, or the engine may overheat.

If your vehicle is stuck in mud or snow, you may rock it out by shifting between forward and reverse gears, stopping between shifts in a steady pattern. Press lightly on the accelerator in each gear.

Rear Axle

LIMITED SLIP DIFFERENTIAL

(IF EQUIPPED)

This axle provides added traction on slippery surfaces, particularly when one wheel is on a poor traction surface. Under normal conditions, the limited-slip axle functions like a standard rear axle. The axle may exhibit a slight noise or vibration during tight turns with low vehicle speed. This is normal behavior and indicates the axle is working.

Brakes

GENERAL INFORMATION

Note: Occasional brake noise is normal. If a metal-to-metal, continuous grinding or continuous squeal sound is present, the brake linings may be worn-out and should be inspected by an authorized dealer. If the vehicle has continuous vibration or shudder in the steering wheel while braking, the vehicle should be inspected by an authorized dealer.

Note: Brake dust may accumulate on the wheels, even under normal driving conditions. Some dust is inevitable as the brakes wear and does not contribute to brake noise. See **Cleaning the Wheels** (page 185).

See **Warning Lamps and BRAKE Indicators** (page 60).



Wet brakes result in reduced braking efficiency. Gently press the brake pedal a few times when driving from a car wash or standing water to dry the brakes.

Brake Over Accelerator

In the event the accelerator pedal becomes stuck or entrapped, apply steady and firm pressure to the brake pedal to slow the vehicle and reduce engine power. If you experience this condition, apply the brakes and bring your vehicle to a safe stop. Switch the engine off, shift the transmission into park (P), apply the parking brake, and then inspect the accelerator pedal for any interferences. If none are found and the condition persists, have your vehicle towed to the nearest authorized dealer.

Hydraulic brake booster system (Hydroboost or Hydromax)

The Hydroboost and Hydromax systems receive fluid pressure from the power steering pump to provide power assist during braking.

The Hydromax booster receives backup pressure from the reserve system electric pump whenever the fluid in the power steering system is not flowing. When the engine is off, the pump turns on if you apply the brake pedal, or if you switch the ignition to the on position.

The sound of the pump operating may be heard by the driver. This is a normal characteristic of the system.

The reserve system provides reduced braking power, so the vehicle should be operated under these conditions with caution, and only to seek service repair and removal of the vehicle from the roadway.

Note: For vehicles with the Hydromax system operating under normal conditions, the noise of the fluid flowing through the booster may be heard whenever you apply the brake. This condition is normal. Vehicle service is not required.

If braking performance or pedal response becomes very poor, even when you strongly press the pedal, it may indicate the presence of air in the hydraulic system or leakage of fluid. Stop the vehicle safely as soon as possible and seek service immediately.

HINTS ON DRIVING WITH ANTI-LOCK BRAKES

The anti-lock braking system does not eliminate the risks when:

- You drive too closely to the vehicle in front of you.
- Your vehicle is hydroplaning.

Brakes

- You take corners too fast.
- The road surface is poor.

Note: *If the system activates, the brake pedal may pulse and may travel further. Maintain pressure on the brake pedal. You may also hear a noise from the system. This is normal.*

PARKING BRAKE



WARNING: Always fully apply the parking brake. Make sure you shift into park (P) for vehicles with an automatic transmission. Switch the ignition off and remove the key whenever you leave your vehicle.

Apply the parking brake whenever you park your vehicle.

- For vehicles with a foot operated parking brake, press the pedal down.
- For vehicles with a hand operated parking brake, pull the parking brake lever up.



It illuminates when you switch the ignition on and apply the parking brake. It also illuminates momentarily when you switch the ignition on to confirm the lamp is functional. If it does not illuminate when you switch the ignition on or begins to flash at any time, have the system checked by an authorized dealer.

If it illuminates when your vehicle is moving, make sure you disengage the parking brake.

If the parking brake is disengaged, this indicates a low brake fluid level or a brake system fault. Have your vehicle checked as soon as possible.

To release the parking brake:

- For vehicles with a foot operated parking brake, pull the parking brake release lever.
- For vehicles with a hand operated parking brake, push the parking brake lever down.

HILL START ASSIST



WARNING: The system does not replace the parking brake. When you leave your vehicle, always apply the parking brake.



WARNING: You must remain in your vehicle when the system turns on. At all times, you are responsible for controlling your vehicle, supervising the system and intervening, if required. Failure to take care may result in the loss of control of your vehicle, serious personal injury or death.



WARNING: The system will turn off if a malfunction is apparent or if you rev the engine excessively. Failure to take care may result in the loss of control of your vehicle, serious personal injury or death.

The system makes it easier to pull away when your vehicle is on a slope without the need to use the parking brake.

When the system is active, your vehicle remains stationary on the slope for two to three seconds after you release the brake pedal. This allows time to move your foot from the brake to the accelerator pedal. The system releases the brakes automatically once the engine has

Brakes

developed sufficient torque to prevent your vehicle from rolling down the slope. This is an advantage when pulling away on a slope, for example from a car park ramp, traffic lights or when reversing uphill into a parking space.

The system activates on any slope that causes your vehicle to roll.

Note: *There is no warning light to indicate the system is either on or off.*

Using Hill Start Assist

1. Press the brake pedal to bring your vehicle to a complete standstill. Keep the brake pedal pressed and shift into first gear when facing uphill or reverse (R) when facing downhill.
2. If the sensors detect that your vehicle is on a slope, the system activates automatically.
3. When you remove your foot from the brake pedal, your vehicle remains on the slope without rolling away for about two to three seconds. This hold time automatically extends if you are in the process of driving off.
4. Drive off in the normal manner. The system releases the brakes automatically.

Note: *When you remove your foot from the brake pedal and press the pedal again when the system is active, you will experience significantly reduced brake pedal travel. This is normal.*

Switching the System On and Off

Vehicles with Manual Transmission

You can switch this feature on or off in the information display. The system remembers the last setting when you start your vehicle.

Vehicles with Automatic Transmission

You cannot turn the system on or off. When you switch the ignition on, the system automatically turns on.

Traction Control (If Equipped)

PRINCIPLE OF OPERATION

The traction control system helps avoid drive wheel spin and loss of traction.

If your vehicle begins to slide, the system applies the brakes to individual wheels and, when needed, reduces engine power at the same time. If the wheels spin when accelerating on slippery or loose surfaces, the system reduces engine power in order to increase traction.

USING TRACTION CONTROL



WARNING: The traction control light illuminates steadily if a failure is detected in the system. Verify that the traction control system was not manually disabled using the switch. If the traction control light is still illuminating steadily, have the system serviced by an authorized dealer immediately. Operating your vehicle with traction control disabled could lead to an increased risk of loss of vehicle control, vehicle rollover, personal injury and death.

The system automatically turns on each time you switch the ignition on.

If your vehicle is stuck in mud or snow, switching traction control off may be beneficial as this allows the wheels to spin.

Switching the System Off



The switch for the traction control system is located on the instrument panel.

When you switch the system off, an illuminated icon appears on the instrument cluster.

Use the switch again to return the traction control system to normal operation.

System Indicator Lights and Messages



The traction control light temporarily illuminates on engine start-up and flashes when a driving condition activates the system.



The traction control off light temporarily illuminates on engine start-up and stays on:

- When you switch the traction control system off.
- If a problem occurs in the system.

Parking Aids

REAR VIEW CAMERA (IF EQUIPPED)



WARNING: The rear view camera system is a reverse aid supplement device that still requires the driver to use it in conjunction with the interior and exterior mirrors for maximum coverage.



WARNING: Objects that are close to either corner of the bumper or under the bumper, might not be seen on the screen due to the limited coverage of the camera system.



WARNING: Reverse your vehicle as slow as possible, higher speeds may limit your reaction time to stop your vehicle.



WARNING: Use caution when the rear cargo door is ajar. If the rear cargo door is ajar, the camera will be out of position and the video image may be incorrect. All guidelines disappear when the rear cargo door is ajar. Some vehicles may not come equipped with guidelines.



WARNING: Use caution when turning camera features on or off when the transmission is not in park (P). Make sure your vehicle is not moving.

The rear view camera system provides a video image of the area behind your vehicle.

Example



The camera is located on the rear of your vehicle.

Note: Camera location may vary depending on the configuration of your vehicle.

Using the Rear View Camera System

The rear view camera system displays what is behind your vehicle when you place the transmission in reverse (R).

Note: The image may remain on momentarily when you shift the transmission out of reverse (R). If your vehicle speed reaches 6 mph (10 km/h) or 10 seconds elapse and the image remains on, have your system inspected by an authorized dealer.

Note: When towing, the camera only sees what you are towing behind your vehicle. This might not provide adequate coverage as it usually provides in normal operation and you might not see some objects.

Parking Aids

The camera may not operate correctly under the following conditions:

- Nighttime or dark areas if the reverse lamps are not operating.
- Mud, water or debris obstructs the camera's view. Clean the lens with a soft, lint-free cloth and non-abrasive cleaner.
- The camera is misaligned due to damage to the rear of your vehicle.

Rear Camera Delay

When shifting the transmission out of reverse (R) and into any gear other than park (P), the camera image remains on until your vehicle speed reaches 6 mph (10 km/h) or 10 seconds elapses. This occurs when the rear camera delay feature is ON.

Selectable settings for this feature are ON and OFF. The default setting for the rear camera delay is OFF.

Cruise Control (If Equipped)

WHAT IS CRUISE CONTROL

Cruise control lets you maintain a set speed without keeping your foot on the accelerator pedal. You can use cruise control when your vehicle speed is greater than 20 mph (30 km/h).

SWITCHING CRUISE CONTROL ON AND OFF



WARNING: Do not use cruise control on winding roads, in heavy traffic or when the road surface is slippery. This could result in loss of vehicle control, serious injury or death.

The cruise controls are on the steering wheel. See **Cruise Control** (page 48).

Switching Cruise Control On

ON

Press the button.

Switching Cruise Control Off

OFF

Press the button when the system is in standby mode.

The system also turns off when you switch the ignition off.

Note: *The set speed erases when you switch the system off.*

SETTING THE CRUISE CONTROL SPEED



WARNING: When you are going downhill, your vehicle speed could increase above the set speed. The system does not apply the brakes.

Drive to the speed you prefer.

SET+

Press either button to set the current speed.

SET-

Take your foot off the accelerator pedal.

Note: *The indicator changes color in the information display.*

Changing the Set Speed

SET+

Press and release the button to increase the set speed in small increments.

Press and hold the button to accelerate. Release the button when you reach your preferred speed.

SET-

Press and release the button to decrease the set speed in small increments.

Press and hold the button to decelerate. Release the button when you reach your preferred speed.

Note: *If you accelerate by pressing the accelerator pedal, the set speed does not change. When you release the accelerator pedal, your vehicle returns to the speed that you previously set.*

CANCELING THE SET SPEED

CNCL

Press the button, or tap the brake pedal to cancel the set speed.

Note: *The system remembers the set speed.*

Note: *The system cancels if the vehicle speed drops below 10 mph (16 km/h) under the set speed when driving uphill.*

Cruise Control (If Equipped)

RESUMING THE SET SPEED

 Press the button.

CRUISE CONTROL INDICATORS

 Illuminates when you switch the system on.

USING ADAPTIVE CRUISE CONTROL

 **WARNING:** Always pay close attention to changing road conditions when using the system. It does not replace attentive driving. Failure to follow this instruction could result in personal injury or death.

 **WARNING:** Do not use the system when entering or leaving a highway, on roads with intersections or roundabouts or non-vehicular traffic or roads that are winding, slippery, unpaved, or steep slopes.

 **WARNING:** Do not use the system in poor visibility, for example fog, heavy rain, spray or snow.

 **WARNING:** Do not use the system when towing a trailer that has aftermarket electronic trailer brake controls. Failure to follow this instruction could result in the loss of control of your vehicle, personal injury or death.

 **WARNING:** Do not use tire sizes other than those recommended because this can affect the normal operation of the system. Failure to do so may result in a loss of vehicle control, which could result in serious injury.

 **WARNING:** The system may not detect stationary or slow moving vehicles below 6 mph (10 km/h).

 **WARNING:** The system does not detect pedestrians or objects in the road.

 **WARNING:** The system does not detect oncoming vehicles in the same lane.

 **WARNING:** The system is not a crash warning or avoidance system.

 **WARNING:** Do not use the system with a snow plow blade installed.

The system adjusts your vehicle speed to maintain the set gap between you and the vehicle in front of you in the same lane. You can select four gap settings.

The system uses a radar sensor that projects a beam directly in front of your vehicle.



E262918

Cruise Control (If Equipped)

The adaptive cruise controls are on the steering wheel.

Switching Adaptive Cruise Control On

ON

Press and release the button.



The indicator, current gap setting and set speed appear in the information display.



E233874

Setting the Adaptive Cruise Speed

Drive to your preferred speed.

SET+

SET-

Press and release either button.

Take your foot off the accelerator pedal.

The indicator, current gap setting and set speed appear in the information display.



E233874

A vehicle graphic illuminates if there is a vehicle detected in front of you.

Note: When adaptive cruise control is active, the speedometer may vary slightly from the set speed displayed in the information display.

Following a Vehicle



WARNING: When following a vehicle that is braking, your vehicle does not always decelerate quickly enough to avoid a crash without driver intervention. Apply the brakes when necessary. Failure to follow this instruction could result in personal injury or death.



WARNING: The system only warns of vehicles detected by the radar sensor. In some cases there may be no warning or a delayed warning. Apply the brakes when necessary. Failure to follow this instruction could result in personal injury or death.

Note: When you are following a vehicle and you switch on a direction indicator, adaptive cruise control may provide a small temporary acceleration to help you pass.

Note: The brakes may emit noise when applied by the system.

Cruise Control (If Equipped)

When a vehicle ahead of you enters the same lane or a slower vehicle is ahead in the same lane, the vehicle speed adjusts to maintain a preset gap distance. A vehicle graphic illuminates in the instrument cluster.

Your vehicle maintains a consistent gap from the vehicle ahead until:

- The vehicle in front of you accelerates to a speed above the set speed.
- The vehicle in front of you moves out of the lane you are in.
- Your vehicle speed falls below 12 mph (20 km/h).
- You set a new gap distance.

The system applies the brakes to slow your vehicle to maintain a safe gap distance from the vehicle in front. The system only applies limited braking. You can override the system by applying the brakes.

If the system determines that its maximum braking level is not sufficient, an audible warning sounds, a message appears in the information display and an indicator flashes when the system continues to brake. Take immediate action.

Setting the Gap Distance

You can decrease or increase the distance between your vehicle and the vehicle in front by pressing the gap control.



Press and release to decrease the gap distance.



Press and release to increase the gap distance.



E233874

The selected gap appears in the information display as shown by the bars in the image.

Note: *The gap setting is time dependent and therefore the distance adjusts with your vehicle speed.*

Note: *It is your responsibility to select a gap appropriate to the driving conditions.*

Adaptive Cruise Control Gap Settings

| Graphic Display, Bars Indicated Between Vehicles | Distance Gap | Dynamic Behavior |
|--|--------------|------------------|
| 1 | Closest. | Sport. |
| 2 | Close. | Normal. |
| 3 | Medium. | Normal. |
| 4 | Far. | Comfort. |

Each time you switch the system on, it selects the last chosen gap setting.

Cruise Control (If Equipped)

Overriding the Set Speed



WARNING: If you override the system by pressing the accelerator pedal, it does not automatically apply the brakes to maintain a gap from any vehicle ahead.

When you press the accelerator pedal, you override the set speed and gap distance.



Use the accelerator pedal normally to intentionally exceed the set speed limit.

When you override the system, the green indicator light illuminates and the vehicle image does not appear in the information display.

The system resumes operation when you release the accelerator pedal. The vehicle speed decreases to the set speed, or a lower speed if following a slower vehicle.

Changing the Set Speed



Press and release to increase the set speed in small increments.



Press and release to decrease the set speed in small increments.

Press and hold either button to change the set speed in large increments. Release the button when you reach your preferred speed.

The system may apply the brakes to slow the vehicle to the new set speed. The set speed displays continuously in the information display when the system is active.

Canceling the Set Speed



Press and release the button or tap the brake pedal.

The set speed does not erase.

Resuming the Set Speed



Press and release the button.

Your vehicle speed returns to the previously set speed and gap setting. The set speed displays continuously in the information display when the system is active.

Note: Only use resume if you are aware of the set speed and intend to return to it.

Automatic Cancellation

The system is not functional at vehicle speeds below 12 mph (20 km/h). An audible alarm sounds and the automatic braking releases if the vehicle drops below this speed.

Automatic cancellation can also occur when:

- The tires lose traction.
- You apply the parking brake.

Hilly Condition and Trailer Tow Usage

You should select a lower gear when the system is active in situations such as prolonged downhill driving on steep grades, for example in mountainous areas. The system needs additional engine braking in these situations to reduce the load on the vehicle's regular brake system to prevent it from overheating.

Note: An audible alarm sounds and the system shuts down if it applies brakes for an extended period of time. This allows the brakes to cool. The system functions normally again after the brakes cool.

Note: When towing with adaptive cruise control, switch on Tow/Haul Mode and Diesel Engine Brake.

Cruise Control (If Equipped)

Note: Tow/Haul mode increases the time gaps and allows more distance for braking.

Switching Adaptive Cruise Control Off

OFF

Press and release the button when the system is in standby mode, or switch the ignition off.

Note: You erase the set speed and gap setting when you switch the system off.

Detection Issues



WARNING: On rare occasions, detection issues can occur due to the road infrastructures, for example bridges, tunnels and safety barriers. In these cases, the system may brake late or unexpectedly. At all times, you are responsible for controlling your vehicle, supervising the system and intervening, if required.



WARNING: If the system malfunctions, have your vehicle checked as soon as possible.

The radar sensor has a limited field of view. It may not detect vehicles at all or detect a vehicle later than expected in some situations. The lead vehicle graphic does not illuminate if the system does not detect a vehicle in front of you.

A

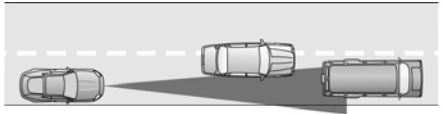

B



C

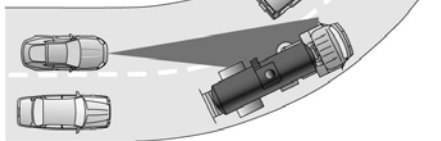

E71621

Detection issues can occur:

- A When driving on a different line than the vehicle in front.
- B With vehicles that edge into your lane. The system can only detect these vehicles once they move fully into your lane.
- C There may be issues with the detection of vehicles in front when driving into and coming out of a bend or curve in the road.

In these cases, the system may brake late or unexpectedly. You should stay alert and take action when necessary.

If something hits the front end of your vehicle or damage occurs, the radar-sensing zone may change. This could cause missed or false vehicle detection.

Cruise Control (If Equipped)

Optimal system performance requires a clear view of the road by the windshield-mounted camera.

Optimal performance may not occur if:

- The camera is blocked.
- There is poor visibility or lighting conditions.
- There are bad weather conditions.

System Not Available

Conditions that can cause the system to deactivate or prevent the system from activating when requested include:

- A blocked sensor.
- High brake temperature.
- A failure in the system or a related system.

Blocked Sensor



E243054

The camera is mounted on the windshield behind the interior mirror.



E183741

A message displays if something obstructs the radar signals from the sensor. The sensor is in the lower grille. The system cannot detect a vehicle ahead and does not function when something blocks the sensor.

Note: *You cannot see the sensor. It is behind a fascia panel.*

Keep the front of your vehicle free of dirt, metal badges or objects. Vehicle front protectors and aftermarket lights may also block the sensor.

Possible Causes and Actions for This Message Displaying:

| Cause | Action |
|---|--|
| The surface of the radar is dirty or obstructed. | Clean the grille surface in front of the radar or remove the object causing the obstruction. |
| The surface of the radar is clean but the message remains in the display. | Wait a short time. It may take several minutes for the radar to detect that it is free from obstruction. |
| Heavy rain or snow is interfering with the radar signals. | Do not use the system in these conditions because it may not detect any vehicles ahead. |

Cruise Control (If Equipped)

| Cause | Action |
|---|---|
| Water, snow or ice on the surface of the road may interfere with the radar signals. | Do not use the system in these conditions because it may not detect any vehicles ahead. |
| You are in a desert or remote area with no other vehicles and no roadside objects. | Wait a short time or switch to normal cruise control. |

Due to the nature of radar technology, it is possible to get a blockage warning with no actual block. A false blocked condition either self clears, or clears after you restart your vehicle.

Switching to Normal Cruise Control



WARNING: Normal cruise control will not brake when your vehicle is approaching slower vehicles. Always be aware of which mode you have selected and apply the brakes when necessary.



The cruise control indicator light replaces the adaptive cruise control indicator light if you select normal cruise control. The gap setting does not display, and the system does not respond to lead vehicles. Automatic braking remains active to maintain set speed.

You can change from adaptive cruise control to normal cruise control through the information display.

Driving Aids

DRIVER ALERT (IF EQUIPPED)

WARNING: The system is designed to aid the driver. It is not intended to replace your attention and judgment. You are still responsible to drive with due care and attention.

WARNING: At all times, you are responsible for controlling your vehicle, supervising the system and intervening, if required. Failure to take care may result in the loss of control of your vehicle, serious personal injury or death.

WARNING: The system may not function if the sensor is blocked.

WARNING: Take regular rest breaks if you feel tired. Do not wait for the system to warn you.

WARNING: Certain driving styles may result in the system warning you even if you are not feeling tired.

WARNING: In cold and severe weather conditions the system may not function. Rain, snow and spray can all limit sensor performance.

WARNING: The system will not operate if the sensor cannot track the road lane markings.

WARNING: If damage occurs in the immediate area surrounding the sensor, have your vehicle checked as soon as possible.

WARNING: The system may not correctly operate if your vehicle is fitted with a suspension kit not approved by us.

Note: Keep the windshield free from obstructions. For example, bird droppings, insects and snow or ice.

Note: If the camera is blocked or if the windshield is damaged, the system may not function.

Note: The system remembers the last setting when you start your vehicle, unless a MyKey™ is detected.

Note: If enabled in the menu, the system activates at speeds above 40 mph (64 km/h).

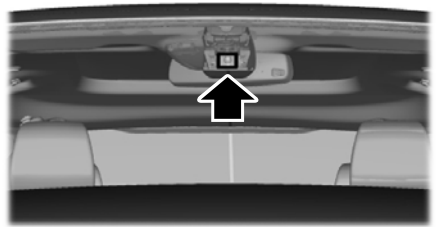

E249505

The system automatically monitors your driving behavior using various inputs including the front camera sensor.

If the system detects that your driving alertness is reduced below a certain threshold, the system will alert you using a chime and a message in the information display.

Using Driver Alert

Switching the system on and off

You may switch the system on or off through the information display by selecting Settings then Driver Assist then Driver Alert in the menu. When activated, the system will monitor your alertness level based upon your driving behavior in relation to the lane markings, and other factors.

Driving Aids

System Warnings

Note: The system will not issue warnings below approximately 40 mph (64 km/h).

The warning system is in two stages. At first the system issues a temporary warning that you need to take a rest. This message will only appear for a short time. If the system detects further reduction in driving alertness, another warning may be issued which will remain in the information display for a longer time. Press OK on the steering wheel control to clear the warning. When active the system will run automatically in the background and only issue a warning if required.

Resetting the System

You can reset the system by either:

- Switching the ignition off and on.
- Stopping the vehicle and then opening and closing the driver's door.

LANE KEEPING SYSTEM (IF EQUIPPED)



WARNING: You are responsible for controlling your vehicle at all times. The system is designed to be an aid and does not relieve you of your responsibility to drive with due care and attention. Failure to follow this instruction could result in the loss of control of your vehicle, personal injury or death.



WARNING: Always drive with due care and attention when using and operating the controls and features on your vehicle.



WARNING: In cold and severe weather conditions the system may not function. Rain, snow and spray can all limit sensor performance.



WARNING: The system will not operate if the sensor cannot track the road lane markings.



WARNING: The sensor may incorrectly track lane markings as other structures or objects. This can result in a false or missed warning.



WARNING: Large contrasts in outside lighting can limit sensor performance.



WARNING: The system may not operate properly if the sensor is blocked. Keep the windshield free from obstruction.



WARNING: If damage occurs in the immediate area surrounding the sensor, have your vehicle checked as soon as possible.



WARNING: The system may not correctly operate if your vehicle is fitted with a suspension kit not approved by US.

Note: The system works as long as the camera can detect one lane marking at a speed above 40 mph (64 km/h).

Note: The system may not function with a blocked camera, or if the windshield is damaged or dirty.

Driving Aids

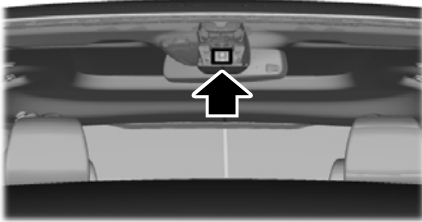

E249505

When you switch the system on and it detects an unintentional drift out of your lane is likely to occur, the system notifies or assists you to stay in your lane through the steering system and information display. The system provides a warning by an audible tone.

Switching the System On and Off

Note: The system on or off setting is stored until it is manually changed, unless a MyKey is detected. If the system detects a MyKey, it defaults to on and the mode is set to alert.

Note: If a MyKey is detected, pressing the button does not affect the on or off status of the system. You can only change the mode and sensitivity settings.



Press the button to switch the system on or off. The button is above the audio unit or on the center console.

System Settings

The system sensitivity and intensity can be adjusted through the display screen. See **General Information** (page 63). The system remembers the last selection. You do not need to readjust the setting each time you turn on your vehicle.

Sensitivity: This setting allows you to select where in the lane a warning is provided. Increasing the sensitivity setting moves the warning zones in closer to your vehicle.



E165517

- A Normal
- B Increased

Note: The alert diagram illustrates general zone coverage. It does not provide exact zone parameters.

System Display



E233874

When you switch on the system, a graphic with lane markings appears in the display screen.

Note: The overhead vehicle graphic may still display if adaptive cruise control is enabled.

Driving Aids

While the system is on, the color of the lane markings change to indicate the system status.

Gray: Indicates that the system is temporarily unable to provide a warning on the indicated side(s). This may be because:

- Your vehicle is below the activation speed.
- The direction indicator is active.
- Your vehicle is in a dynamic maneuver.
- The road has no or poor lane markings in the camera field-of-view.
- The camera is obscured or unable to detect the lane markings due to environmental, traffic or vehicle conditions. For example, significant sun angles, shadows, snow, heavy rain or fog, following a large vehicle that is blocking or shadowing the lane or poor headlamp illumination.

See **Troubleshooting** for additional information.

Green: Indicates that the system is available or ready to provide a warning on the indicated side(s).

Red: Indicates that the system is providing or has just provided a lane keeping alert warning.

You can temporarily disable the system at any time by doing the following:

- Quick braking.
- Fast acceleration.
- Using your direction indicator.
- Evasive steering maneuver.
- Driving too close to the lane markings.

Troubleshooting

| Why is the feature not available (lane markings are gray) when I can see the lane markings on the road? |
|--|
| Your vehicle speed is outside the operational range of the feature. |
| The sun is shining directly into the camera lens. |
| A quick intentional lane change has occurred. |
| Your vehicle stays too close to the lane markings. |
| Driving at high speeds in curves. |
| The last feature activation occurred a short time ago. |
| Ambiguous lane markings, for example in construction zones. |
| Rapid transition from light to dark, or from dark to light. |
| Sudden offset in lane markings. |
| ABS or AdvanceTrac™ is active. |
| There is a camera blockage due to dirt, grime, fog, frost or water on the windshield. |

Driving Aids

| Why is the feature not available (line markings are gray) when I can see the lane markings on the road? |
|--|
| You are driving too close to the vehicle in front of you. |
| Transitioning between no lane markings to lane markings or vice versa. |
| There is standing water on the road. |
| Faint lane markings, for example partial yellow lane markings on concrete roads. |
| Lane width is too narrow or too wide. |
| The camera has not been calibrated after a windshield replacement. |
| Driving on tight roads or on uneven roads. |
| Vehicle accessories are blocking the camera, for example a snow plow. |

STEERING

Hydraulic Power Steering

To help prevent damage to the power steering system:

- Do not hold the steering wheel at its furthest turning points for more than three to five seconds when the engine is running.
- Avoid continuously steering back and forth with elevated engine RPM as this may overheat the system. If trying to free a stuck vehicle, pause between attempts to allow the power steering system to cool or seek assistance. Typical steering and driving maneuvers allow the system to cool.
- Do not operate the vehicle if the power steering pump fluid level is below the MIN mark on the reservoir.
- Some noise is normal during operation. If excessive, check for low power steering pump fluid level before seeking service by your dealer.

- Heavy or uneven efforts may be caused by low power steering fluid. Check for low power steering pump fluid level before seeking service by your dealer.
- Do not fill the power steering pump reservoir above the MAX mark on the reservoir, as this may result in leaks from the reservoir.

If the power steering system breaks down or if you switch the engine off, you can steer the vehicle manually, but it takes more effort.

If you have any steering components serviced or replaced, install new fasteners. Many fasteners have coatings with thread adhesive, or have prevailing torque features you cannot reuse. Do not reuse a bolt or nut. Torque fasteners to specifications.

Steering Tips

If the steering wanders or pulls, check for:

- An improperly inflated tire.
- Uneven tire wear.
- Loose or worn suspension components.

Driving Aids

- Loose or worn steering components.
- Improper vehicle alignment.

Note: A high crown in the road or high crosswinds may also make the steering seem to wander or pull.

PRE-COLLISION ASSIST (IF EQUIPPED)



WARNING: You are responsible for controlling your vehicle at all times. The system is designed to be an aid and does not relieve you of your responsibility to drive with due care and attention. Failure to follow this instruction could result in the loss of control of your vehicle, personal injury or death.



WARNING: The system does not detect vehicles that are driving in a different direction, pedestrians at night, cyclists or animals. Apply the brakes when necessary. Failure to follow this instruction could result in the loss of control of your vehicle, personal injury or death.



WARNING: The system does not operate during hard acceleration or steering. Failure to take care may lead to a crash or personal injury.



WARNING: The system may fail or operate with reduced function during cold and severe weather conditions. Snow, ice, rain, spray and fog can adversely affect the system. Keep the front camera and radar free of snow and ice. Failure to take care may result in the loss of control of your vehicle, serious personal injury or death.



WARNING: Some situations and objects prevent hazard detection. For example low or direct sunlight, inclement weather, unconventional vehicle types, and pedestrians. Apply the brakes when necessary. Failure to follow this instruction could result in the loss of control of your vehicle, personal injury or death.



WARNING: Take additional care if your vehicle is heavily loaded or you are towing a trailer. These conditions could result in reduced performance of this system. Failure to follow this instruction could result in the loss of control of your vehicle, personal injury or death.



WARNING: The system cannot help prevent all crashes. Do not rely on this system to replace driver judgment and the need to maintain a safe distance and speed.

Using the Pre-Collision Assist System

The Pre-Collision Assist system is active at speeds above approximately 3 mph (5 km/h)



E156130

If your vehicle is rapidly approaching another stationary vehicle or a vehicle traveling in the same direction as yours, the system provides three levels of functionality:

1. Alert
2. Brake Support
3. Active Braking

Driving Aids

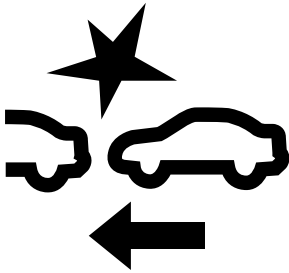

E255268

Alert: When active, a flashing visual warning appears and an audible warning tone sounds.

Brake Support: The system is designed to help reduce the impact speed by preparing the brakes for rapid braking. The system does not automatically apply the brakes. If you press the brake pedal, the system could apply additional braking up to maximum braking force, even if you lightly press the brake pedal.

Active Braking: Active braking may activate if the system determines that a collision is imminent. The system may help the driver reduce impact damage or avoid the crash completely.

Note: *If you perceive Pre-Collision Assist alerts as being too frequent or disturbing, then you can reduce the alert sensitivity, though the manufacturer recommends using the highest sensitivity setting where possible. Setting lower sensitivity would lead to fewer and later system warnings.*

Distance Indication and Alert

Distance Indication and Alert is a function that provides the driver with a graphical indication of the time gap to other preceding vehicles traveling in the same direction. The Distance Indication and Alert screen in the display screen shows one of the graphics that follow.



E254791

If the time gap to a preceding vehicle is small, a red visual indication displays.

Note: *Distance Indication and Alert deactivates and the graphics do not display when Adaptive Cruise Control is active.*

Adjusting the Pre-Collision Assist Settings

You can adjust the following settings by using the information display controls. See **General Information** (page 63).

- You can change Alert and Distance Alert sensitivity to one of three possible settings.
- You can switch Distance Indication and Alert on or off.
- If required, you can switch Active Braking on or off.
- If required, you can switch the entire Pre-Collision Assist feature on or off.

Note: *Active braking automatically turns on every time you switch the ignition on.*

Driving Aids

Note: We recommend that you switch the system off if you install a snow plow or similar object in such a way that it may block the radar sensor. Your vehicle remembers the selected setting across key cycles.

Blocked Sensors

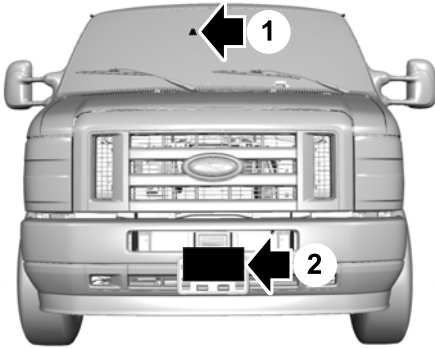

- 1 Camera.
- 2 Radar sensor.

If a message regarding a blocked sensor or camera appears in the information display, the radar signals or camera images are obstructed. With a blocked sensor or camera, the Pre-Collision Assist system may not function, or performance may reduce. The following table lists possible causes and actions for when this message displays.

Camera Troubleshooting

| Cause | Action |
|---|---|
| The windshield in front of the camera is dirty or obstructed in some way. | Clean the outside of the windshield in front of the camera. |
| The windshield in front of the camera is clean but the message remains in the display screen. | Wait a short time. It may take several minutes for the camera to detect that there is no obstruction. |

Driving Aids

Radar Troubleshooting

| Cause | Action |
|--|--|
| The surface of the radar in the grille is dirty or obstructed in some way. | Clean the grille surface in front of the radar or remove the object causing the obstruction. |
| The surface of the radar in the grille is clean but the message remains in the display screen. | Wait a short time. It may take several minutes for the radar to detect that there is no obstruction. |
| Heavy rain, spray, snow or fog is interfering with the radar signals. | The Pre-Collision Assist system is temporarily disabled. Pre-Collision Assist automatically reactivates a short time after the weather conditions improve. |
| Swirling water or snow or ice on the surface of the road may interfere with the radar signals. | The Pre-Collision Assist system is temporarily disabled. Pre-Collision Assist automatically reactivates a short time after the weather conditions improve. |
| Radar is out of alignment due to a front end impact. | Contact an authorized dealer to have the radar checked for proper coverage and operation. |

Note: *Proper system operation requires a clear view of the road by the camera. Have any windshield damage in the area of the camera's field of view repaired.*

Note: *If something hits the front end of your vehicle or damage occurs and your vehicle has a radar sensor, the radar sensing zone may change. This could cause missed or false vehicle detections. Contact an authorized dealer to have the radar checked for proper coverage and operation.*

Note: *If your vehicle detects excessive heat at the camera or a potential misalignment condition, a message may display in the information display indicating temporary sensor unavailability. When operational conditions are correct, the message deactivates. For example, when the ambient temperature around the sensor decreases or the sensor automatically recalibrates successfully.*

Load Carrying

LOAD LIMIT

Vehicle Loading - with and without a Trailer

This section guides you in the proper loading of your vehicle, trailer, or both. Keep your loaded vehicle weight within its design rating capability, with or without a trailer. Properly loading your vehicle provides maximum return of vehicle design performance. Before you load your vehicle, become familiar with the following terms for determining your vehicle's weight rating, with or without a trailer, from the vehicle's Tire and Loading Information label or Safety Compliance Certification label.

Tire and Loading Label Information Example:



TIRE AND LOADING INFORMATION

SEATING CAPACITY TOTAL: 5 FRONT: 2 REAR: 3
 NOMBRE DE PLACES TOTAL 5 AVANT 2 ARRIERE 3

The combined weight of occupants and cargo should never exceed: 385 kg or 850 lbs.
 Le poids total des occupants et du chargement ne doit jamais dépasser 385 kg ou 850 lbs.

| TIRE | SIZE | COLD TIRE PRESSURE |
|-------|---------------|--------------------|
| FRONT | 235/45R18 94V | 235 KPA, 34 PSI |
| REAR | 235/45R18 94V | 235 KPA, 34 PSI |
| SPARE | NONE | NONE |

SEE OWNER'S
 MANUAL FOR
 ADDITIONAL
 INFORMATION



TIRE AND LOADING INFORMATION RENSEIGNEMENTS SUR LES PNEUS ET LE CHARGEMENT

SEATING CAPACITY TOTAL 5 FRONT 2 REAR 3
 NOMBRE DE PLACES TOTAL 5 AVANT 2 ARRIERE 3

The combined weight of occupants and cargo should never exceed 396 kg or 875 lbs.
 Le poids total des occupants et du chargement ne doit jamais dépasser 396 kg ou 875 lbs.

| TIRE PNEU | SIZE DIMENSIONS | COLD TIRE PRESSURE PRESSION DES PNEUS A FROID |
|------------------------|--------------------|---|
| FRONT AVANT | 235/40R19 96V | 255 KPA, 37 PSI |
| REAR ARRIERE | 235/40R19 96V | 255 KPA, 37 PSI |
| SPARE DE SECOURS | T125/80R16 97M | 415 KPA, 60 PSI |

SEE OWNER'S
 MANUAL FOR
 ADDITIONAL
 INFORMATION
 VOIR LE MANUEL
 DE L'USAGER
 POUR PLUS DE
 RENSEIGNEMENTS

E198719

Payload

Payload is the combined weight of cargo and passengers that your vehicle is carrying. The maximum payload for your vehicle appears on the Tire and Loading label. The label is either on the B-pillar or the edge of the driver door. Vehicles exported outside the US and Canada may not have a tire and loading label. Look for "The combined weight of occupants and cargo should never exceed XXX kg OR XXX lb" for maximum payload. The payload listed on the Tire and Loading Information label

Load Carrying

is the maximum payload for your vehicle as built by the assembly plant. If you install any additional equipment on your vehicle, you must determine the new payload. Subtract the weight of the equipment from the payload listed on the Tire and Loading label. When towing, trailer tongue weight or king pin weight is also part of payload.



WARNING: The appropriate loading capacity of your vehicle can be limited either by volume capacity (how much space is available) or by payload capacity (how much weight the vehicle should carry). Once you have reached the maximum payload of your vehicle, do not add more cargo, even if there is space available. Overloading or improperly loading your vehicle can contribute to loss of vehicle control and vehicle rollover.

GAWR (Gross Axle Weight Rating)

GAWR is the maximum allowable weight that a single axle (front or rear) can carry. These numbers are on the Safety Compliance Certification label. The label is located on the door hinge pillar, door-latch post, or the door edge that meets the door-latch post, next to the driver seating position.

The total load on each axle must never exceed its Gross Axle Weight Rating.

GVWR (Gross Vehicle Weight Rating)

GVWR is the maximum allowable weight of the fully loaded vehicle. This includes all options, equipment, passengers and cargo. It appears on the Safety Compliance Certification label. The label is located on the door hinge pillar, door-latch post, or the door edge that meets the door-latch post, next to the driver seating position.

The gross vehicle weight must never exceed the Gross Vehicle Weight Rating.

Safety Compliance Certification Label Example:

MFD. BY FORD MOTOR CO.

DATE: XXXX GVWR: XXXX LB (XXXX LB)

FRONT GAWR: XXXX LB REAR GAWR: XXXX LB WITH XXXX LB (XXXX LB)

XXX XXXX XXXX WITH XXXX LB (XXXX LB) THIS XXXX

XXX XXXX XXXX THIS XXXX

AT XXXX KPa/ XXX PSI (GOLD AT XXXX KPa/ XXX PSI (GOLD)

THIS VEHICLE CONFORMS TO ALL APPLICABLE FEDERAL MOTOR VEHICLE SAFETY AND TIRES PROVISION STANDARDS IN EFFECT ON THE DATE OF MANUFACTURE SHOWN ABOVE.

VIN: XXXXXXXXXXXXXXXXXXXX

TYPE: XXXX



EXP: XX XXXX EC: XX XXXX

BB: (M) (H) (P) (S) (T) (L) (B) (T) (S) (R) (I) (XXX)

XXX XX XXX I XX I XXX XXX

XXXXXXXXXXXX XXX XXX-XXXX-XXXX-XX

MFD. BY FORD MOTOR CO.

DATE: XXXX GVWR: XXXX LB (XXXX LB)

FRONT GAWR: XXXX LB REAR GAWR: XXXX LB WITH XXXX LB (XXXX LB)

XXX XXXX XXXX WITH XXXX LB (XXXX LB) THIS XXXX

XXX XXXX XXXX THIS XXXX

AT XXXX KPa/ XXX PSI (GOLD AT XXXX KPa/ XXX PSI (GOLD)

THIS VEHICLE CONFORMS TO ALL APPLICABLE FEDERAL MOTOR VEHICLE SAFETY AND TIRES PROVISION STANDARDS IN EFFECT ON THE DATE OF MANUFACTURE SHOWN ABOVE.

VIN: XXXXXXXXXXXXXXXXXXXX

TYPE: XXXX



EXP: XX XXXX EC: XX XXXX

BB: (M) (H) (P) (S) (T) (L) (B) (T) (S) (R) (I) (XXX)

XXX XX XXX I XX I XXX XXX

XXXXXXXXXXXX XXX XXX-XXXX-XXXX-XX

E19828

Load Carrying



WARNING: Exceeding the Safety Compliance Certification label vehicle weight limits can adversely affect the performance and handling of your vehicle, cause vehicle damage and can result in the loss of control of your vehicle, serious personal injury or death.

Maximum Loaded Trailer Weight

Maximum loaded trailer weight is the highest possible weight of a fully loaded trailer the vehicle can tow. Consult an authorized dealer (or the RV and Trailer Towing Guide available at an authorized dealer) for more detailed information.

GCWR (Gross Combined Weight Rating)

GCWR is the maximum allowable weight of the vehicle and the loaded trailer, including all cargo and passengers, that the vehicle can handle without risking damage. (Important: The towing vehicle's braking system is rated for operation at Gross Vehicle Weight Rating, not at Gross Combined Weight Rating.) Separate functional brakes should

be used for safe control of towed vehicles and for trailers where the Gross Combined Weight of the towing vehicle plus the trailer exceed the Gross Vehicle Weight Rating of the towing vehicle.

The gross combined weight must never exceed the Gross Combined Weight Rating.

Note: For trailer towing information refer to the *RV and Trailer Towing Guide* available at an authorized dealer.



WARNING: Do not exceed the GVWR or the GAWR specified on the certification label.



WARNING: Do not use replacement tires with lower load carrying capacities than the original tires because they may lower your vehicle's GVWR and GAWR limitations. Replacement tires with a higher limit than the original tires do not increase the GVWR and GAWR limitations.



WARNING: Exceeding any vehicle weight rating can adversely affect the performance and handling of your vehicle, cause vehicle damage and can result in the loss of control of your vehicle, serious personal injury or death.

Load Carrying

Steps for determining the correct load limit:

1. Locate the statement "The combined weight of occupants and cargo should never exceed XXX kg or XXX lb." on your vehicle's placard.
2. Determine the combined weight of the driver and passengers that will be riding in your vehicle.
3. Subtract the combined weight of the driver and passengers from XXX kg or XXX lb.
4. The resulting figure equals the available amount of cargo and luggage load capacity. For example, if the "XXX" amount equals 1,400 lb. and there will be five 150 lb. passengers in your vehicle, the amount of available cargo and luggage load capacity is 650 lb. $(1400 - 750 (5 \times 150) = 650 \text{ lb.})$
5. Determine the combined weight of luggage and cargo being loaded on the vehicle. That weight may not safely exceed the available cargo and luggage load capacity calculated in Step 4.
6. If your vehicle will be towing a trailer, load from your trailer will be transferred to your vehicle. Consult this manual to determine how this reduces the available cargo and luggage load capacity of your vehicle.

Helpful examples for calculating the available amount of cargo and luggage load capacity

Suppose your vehicle has a 1400-pound (635-kilogram) cargo and luggage capacity. You decide to go golfing. Is there enough load capacity to carry you, four of your friends and all the golf bags? You and four friends average 220 pounds (99 kilograms) each and the golf bags weigh approximately 30 pounds (13.5 kilograms) each. The calculation would be: $1400 - (5 \times 220) - (5 \times 30) = 1400 - 1100 - 150 = 150$ pounds. Yes, you have enough load capacity in your vehicle to transport four friends and your golf bags. In metric units, the calculation would be: $635 \text{ kilograms} - (5 \times 99 \text{ kilograms}) - (5 \times 13.5 \text{ kilograms}) = 635 - 495 - 67.5 = 72.5$ kilograms.

Suppose your vehicle has a 1400-pound (635-kilogram) cargo and luggage capacity. You and one of your friends decide to pick up cement from the local home improvement store to finish that patio you have been planning for the past two years. Measuring the inside of the vehicle with the rear seat folded down, you have room for twelve 100-pound (45-kilogram) bags of cement. Do you have enough load capacity to transport the cement to your home? If you and your friend each weigh 220 pounds (99 kilograms), the calculation would be: $1400 - (2 \times 220) - (12 \times 100) = 1400 - 440$

Load Carrying

- 1200 = - 240 pounds. No, you do not have enough cargo capacity to carry that much weight. In metric units, the calculation would be: 635 kilograms - (2 x 99 kilograms) - (12 x 45 kilograms) = 635 - 198 - 540 = -103 kilograms. You will need to reduce the load weight by at least 240 pounds (104 kilograms). If you remove three 100-pound (45-kilogram) cement bags, then the load calculation would be: 1400 - (2 x 220) - (9 x 100) = 1400 - 440 - 900 = 60 pounds. Now you have the load capacity to transport the cement and your friend home. In metric units, the calculation would be: 635 kilograms - (2 x 99 kilograms) - (9 x 45 kilograms) = 635 - 198 - 405 = 32 kilograms.

handle differently than unloaded vehicles. Take extra precautions, such as slower speeds and increased stopping distance, when driving a heavily loaded vehicle.

The above calculations also assume that the loads are positioned in your vehicle in a manner that does not overload the front or the rear gross axle weight rating specified for your vehicle on the Safety Compliance Certification label.

Special Loading Instructions for Owners of Pick-up Trucks and Utility-type Vehicles



WARNING: When loading the roof racks, we recommend you evenly distribute the load, as well as maintain a low center of gravity. Loaded vehicles, with higher centers of gravity, may

Towing

TOWING A TRAILER



WARNING: Do not exceed the GVWR or the GAWR specified on the certification label.



WARNING: Towing trailers beyond the maximum recommended gross trailer weight exceeds the limit of your vehicle and could result in engine damage, transmission damage, structural damage, loss of vehicle control, vehicle rollover and personal injury.

Your vehicle may have electrical items, for example fuses or relays, related to towing. See **Fuses** (page 151).

Your vehicle's load capacity designation is by weight, not by volume, so you cannot necessarily use all available space when loading your vehicle.

Towing a trailer places an extra load on your vehicle's engine, transmission, axle, brakes, tires and suspension. Inspect these components periodically during, and after, any towing operation.

Load Placement

To help minimize how trailer movement affects your vehicle when driving:

- Load the heaviest items closest to the trailer floor.
- Load the heaviest items centered between the left and right side trailer tires.
- Load the heaviest items above the trailer axles or just slightly forward toward the trailer tongue. Do not allow the final trailer tongue weight to go above or below 10-15% of the loaded trailer weight.
- Select a draw bar with the correct rise or drop. When both the loaded vehicle and trailer are connected, the trailer frame should be level, or slightly angled down toward your vehicle, when viewed from the side.

When driving with a trailer or payload, a slight takeoff vibration or shudder may be present due to the increased payload weight. Additional information regarding correct trailer loading and setting your vehicle up for towing is located in another chapter of this Owner's Manual. See **Load Limit** (page 120). You can also find the information in the RV & Trailer Towing Guide. See an authorized dealer.

Towing

RECOMMENDED TOWING WEIGHTS

Note: Make sure to take into consideration the trailer frontal area. Vehicles that have the Trailer Tow Package or the Heavy Duty Payload Package should not exceed a 60 ft² (5.6 m²) trailer frontal area.

Note: Exceeding this limitation may significantly reduce the performance of your towing vehicle. Selecting a trailer with a low aerodynamic drag and rounded front design helps optimize performance and fuel economy.

Note: For high altitude operation, reduce the gross combined weight by 2% per 1,000 ft (300 m) starting at the 1,000 ft (300 m) elevation point.

Note: Certain states require electric trailer brakes for trailers over a specified weight. Be sure to check state regulations for this specified weight. Your vehicle's electrical system may not include the wiring connector needed to activate electric trailer brakes if the trailer exceeds this specified weight.

| E-350 Cutaway | | | | |
|---------------|-------------------|----------------|-----------------|---|
| Engine | Rear Axle Option | Wheelbase | Rear Axle Ratio | Maximum Gross Combination Weight Rating |
| 7.3L DVCT | Single Rear Wheel | 138 in (3.5 m) | 4.10 | 13,000 lb (5,897 kg) |
| | | | 4.56 | |
| 7.3L DEVCT | Single Rear Wheel | 138 in (3.5 m) | 4.10 | 18,500 lb (8,391 kg) |
| | | | 4.56 | |
| 7.3L DVCT | Dual Rear Wheel | 138 in (3.5 m) | 4.10 | 13,000 lb (5,897 kg) |
| | | | 4.56 | 17,000 lb (7,711 kg) |
| 7.3L DEVCT | Dual Rear Wheel | 138 in (3.5 m) | 4.10 | 18,500 lb (8,391 kg) |
| | | | 4.56 | |

Towing

| E-350 Cutaway | | | | |
|----------------------|-------------------------|------------------|------------------------|--|
| Engine | Rear Axle Option | Wheelbase | Rear Axle Ratio | Maximum Gross Combination Weight Rating |
| 7.3L DVCT | Single Rear Wheel | 158 in (4.01 m) | 4.10 | 13,000 lb (5,897 kg) |
| | | | 4.56 | |
| 7.3L DEVCT | Single Rear Wheel | 158 in (4.01 m) | 4.10 | 18,500 lb (8,391 kg) |
| | | | 4.56 | |
| 7.3L DVCT | Dual Rear Wheel | 158 in (4.01 m) | 4.10 | 13,000 lb (5,897 kg) |
| | | | 4.56 | 17,000 lb (7,711 kg) |
| 7.3L DEVCT | Dual Rear Wheel | 158 in (4.01 m) | 4.10 | 18,500 lb (8,391 kg) |
| | | | 4.56 | |
| 7.3LDVCT | Dual Rear Wheel | 176 in (4.47 m) | 4.10 | 13,000 lb (5,897 kg) |
| | | | 4.56 | 17,000 lb (7,711 kg) |
| 7.3L DEVCT | Dual Rear Wheel | 176 in (4.47 m) | 4.10 | 18,500 lb (8,391 kg) |
| | | | 4.56 | |

Towing

| E-350 Stripped Chassis | | | | |
|-------------------------------|-------------------------|-------------------------|------------------------|----------------------|
| Engine | Rear Axle Option | Wheelbase Length | Rear Axle Ratio | Maximum GCWR |
| 7.3L DVCT | Dual Rear Wheel | 138 in (3.5 m) | 4.10 | 13,000 lb (5,897 kg) |
| | | | 4.56 | 17,000 lb (7,711 kg) |
| 7.3L DEVCT | Dual Rear Wheel | 138 in (3.5 m) | 4.10 | 18,500 lb (8,391 kg) |
| | | | 4.56 | |
| 7.3L DVCT | Dual Rear Wheel | 158 in (4.01 m) | 4.10 | 13,000 lb (5,897 kg) |
| | | | 4.56 | 17,000 lb (7,711 kg) |
| 7.3L DEVCT | Dual Rear Wheel | 158 in (4.01 m) | 4.10 | 18,500 lb (8,391 kg) |
| | | | 4.56 | |
| 7.3L DVCT | Dual Rear Wheel | 176 in (4.47 m) | 4.10 | 13,000 lb (5,897 kg) |
| | | | 4.56 | 17,000 lb (7,711 kg) |
| 7.3L DEVCT | Dual Rear Wheel | 176 in (4.47 m) | 4.10 | 18,500 lb (8,391 kg) |
| | | | 4.56 | |

Towing

| E-450 Cutaway | | | | |
|----------------------|-------------------------|-------------------------|------------------------|----------------------|
| Engine | Rear Axle Option | Wheelbase Length | Rear Axle Ratio | Maximum GCWR |
| 7.3L DVCT | Dual Rear Wheel | 158 in (4.01 m) | 4.56 | 18,000 lb (8,165 kg) |
| 7.3L DEVCT | Dual Rear Wheel | 158 in (4.01 m) | 4.56 | 22,000 lb (9,979 kg) |
| 7.3L DVCT | Dual Rear Wheel | 176 in (4.47 m) | 4.56 | 18,000 lb (8,165 kg) |
| 7.3L DEVCT | Dual Rear Wheel | 176 in (4.47 m) | 4.56 | 22,000 lb (9,979 kg) |

| E-450 Stripped Chassis | | | | |
|-------------------------------|-------------------------|-------------------------|------------------------|----------------------|
| Engine | Rear Axle Option | Wheelbase Length | Rear Axle Ratio | Maximum GCWR |
| 7.3L DVCT | Dual Rear Wheel | 158 in (4.01 m) | 4.56 | 18,000 lb (8,165 kg) |
| 7.3L DEVCT | Dual Rear Wheel | 158 in (4.01 m) | 4.56 | 22,000 lb (9,979 kg) |
| 7.3L DVCT | Dual Rear Wheel | 176 in (4.47 m) | 4.56 | 18,000 lb (8,165 kg) |
| 7.3L DEVCT | Dual Rear Wheel | 176 in (4.47 m) | 4.56 | 22,000 lb (9,979 kg) |

Calculating the Maximum Loaded Trailer Weight for Your Vehicle

1. Start with the gross combined weight rating for your vehicle model and axle ratio. See the previous charts.
2. Subtract all the following that apply to your vehicle:
 - Vehicle curb weight.
 - Hitch hardware weight, such as a draw bar, ball, locks or weight distributing hardware.
 - Driver weight.

Towing

- The weight of all passengers.
- Payload, cargo and luggage weight.
- Aftermarket equipment weight.

The maximum loaded trailer weight is this value or 10,000 lb (4,536 kg), whichever is less.

Note: *Your vehicle's payload should include the trailer tongue load. Reduce the total payload by the final trailer tongue weight.*

Note: *Consult an authorized dealer to determine the maximum trailer weight allowed for your vehicle if you are not sure.*

ESSENTIAL TOWING CHECKS

Follow these guidelines for safe towing:

- Do not tow a trailer until you drive your vehicle at least 1,000 mi (1,600 km).
- Consult your local motor vehicle laws for towing a trailer.
- See the instructions included with towing accessories for the proper installation and adjustment specifications.
- Service your vehicle more frequently if you tow a trailer. See your scheduled maintenance information. See **Scheduled Maintenance** (page 250).
- If you use a rental trailer, follow the instructions the rental agency gives you.

See **Load limits** in the Load Carrying chapter for load specification terms found on the tire label and Safety Compliance label and instructions on calculating your vehicle's load.

Remember to account for the trailer tongue weight as part of your vehicle load when calculating the total vehicle weight.

Trailer Towing Connector



E163167

When attaching the trailer wiring connector to your vehicle, only use a proper fitting connector that works with the vehicle and trailer functions. Some seven-position connectors may have the SAE J2863 logo, which confirms that it is the proper wiring connector and works correctly with your vehicle.

| Color | Function |
|--------|---------------------------------|
| Yellow | Left turn signal and stop lamp |
| White | Ground (-) |
| Blue | Electric brakes |
| Green | Right turn signal and stop lamp |
| Orange | Battery (+) |
| Brown | Running lights |
| Grey | Reverse lights |

Towing

Hitches

Do not use a hitch that either clamps onto the bumper or attaches to the axle. You must distribute the load in your trailer so that 10-15% of the total weight of the trailer is on the tongue.

Weight-distributing Hitches



WARNING: Do not adjust the spring bars so that your vehicle's rear bumper is higher than before attaching the trailer. Doing so will defeat the function of the weight-distributing hitch, which may cause unpredictable handling, and could result in serious personal injury.

When hooking-up a trailer using a weight-distributing hitch, always use the following procedure:

1. Park the loaded vehicle, without the trailer, on a level surface.
2. Measure the height to the top of your vehicle's front wheel opening on the fender. This is H1.
3. Attach the loaded trailer to your vehicle without the weight-distributing bars connected.
4. Measure the height to the top of your vehicle's front wheel opening on the fender a second time. This is H2.
5. Install and adjust the tension in the weight-distributing bars so that the height of your vehicle's front wheel opening on the fender is approximately half the way down from H2, toward H1.
6. Check that the trailer is level or slightly nose down toward your vehicle. If not, adjust the ball height accordingly and repeat Steps 2-6.

When the trailer is level or slightly nose down toward the vehicle:

- Lock the bar tension adjuster in place.
- Check that the trailer tongue securely attaches and locks onto the hitch.
- Install safety chains, lighting, and trailer brake controls as required by law or the trailer manufacturer.

Safety Chains

Note: Do not attach safety chains to the bumper.

Always connect the safety chains to the frame or hook retainers of your vehicle hitch.

To connect the safety chains, cross the chains under the trailer tongue and allow enough slack for turning tight corners. Do not allow the chains to drag on the ground.

Trailer Brakes



WARNING: Do not connect a trailer's hydraulic brake system directly to your vehicle's brake system. Your vehicle may not have enough braking power and your chances of having a collision greatly increase.

Electric brakes and manual, automatic or surge-type trailer brakes are safe if you install them properly and adjust them to the manufacturer's specifications. The trailer brakes must meet local and federal regulations.

The rating for the tow vehicle's braking system operation is at the gross vehicle weight rating, not the gross combined weight rating.

Separate functioning brake systems are required for safe control of towed vehicles and trailers weighing more than 1500 lb (680 kg) when loaded.

Towing

Integrated Trailer Brake Controller (If Equipped)



WARNING: Use the integrated trailer brake controller to properly adjust the trailer brakes and check all connections before towing a trailer. Failure to follow this instruction could result in the loss of control of your vehicle, personal injury or death.

Note: *The Ford trailer brake controller has been verified to be compatible with trailers having electric-actuated drum brakes (one to four axles) and electric-over-hydraulic brakes. It will not activate hydraulic surge-style trailer brakes. It is the responsibility of the customer to ensure that the trailer brakes are adjusted appropriately, functioning normally and all electric connections are properly made.*

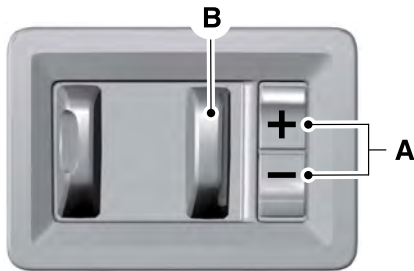

E183395

When used properly, the trailer brake controller assists in smooth and effective trailer braking by powering the trailer's electric or electric-over-hydraulic brakes with a proportional output based on the towing vehicle's brake pressure.

The controller user interface consists of the following:

A: + and - (Gain adjustment buttons): Pressing these buttons adjusts the controller's power output to the trailer brakes in 0.5 increments. You can increase the gain setting to 10.0 (maximum trailer braking) or decrease it to 0 (no trailer braking). The gain setting displays in the message center.

The controller shows gain setting, output bar graph, and trailer connectivity status in the information display. They appear in the information display as follows:

- Trailer Brake Controller Gain (without trailer connected): Shows the current gain setting during a given ignition cycle and when adjusting the gain. This also displays if you use the manual control lever or make gain adjustments with no trailer connected.
- Trailer Brake Controller Gain Output: Displays when you push your vehicle's brake pedal, or upon use of the manual control. Bar indicators illuminate in the information display to indicate the amount of power going to the trailer brakes relative to the brake pedal or manual control input. One bar indicates the least amount of output; six bars indicate maximum output.
- Trailer Connected: Displays when the system senses a correct trailer wiring connection (a trailer with electric trailer brakes) during a given ignition cycle.
- Trailer Disconnected: Displays, accompanied by a single audible time, when the system senses a trailer connection and then a disconnection, either intentional or unintentional, during a given ignition cycle. It also displays if a truck or trailer-wiring fault occurs causing the trailer to appear disconnected. This message can also display if you use the manual control lever without a trailer connected.

Towing

B: Manual control lever: Slide the control lever to the left to switch on the trailer's electric brakes independent of the tow vehicle's. See the following **Procedure for Adjusting Gain** section for instructions on proper use of this feature. If you use the manual control while the brake is also applied, the greater of the two inputs determines the power sent to the trailer brakes.

- **Stop lamps:** Using the manual control lever illuminates both the trailer brake lamps and your vehicle brake lamps except the center high-mount stop lamp, if you make the proper electrical connection to the trailer. Pressing your vehicle brake pedal also illuminates both trailer and vehicle brake lamps.

Procedure for Adjusting Gain

Note: Only perform this procedure in a traffic-free environment at speeds of approximately 20-25 mph (30-40 km/h).

The gain setting sets the trailer brake controller for the specific towing condition. You should change the setting as towing conditions change. Changes to towing conditions include trailer load, vehicle load, road conditions and weather.

The gain should be set to provide the maximum trailer braking assistance while making sure the trailer wheels do not lock when using the brakes. Locked trailer wheels may lead to trailer instability.

1. Make sure the trailer brakes are in good working condition, functioning normally and properly adjusted. See your trailer dealer if necessary.
2. Hook up the trailer and make the electrical connections according to the trailer manufacturer's instructions.
3. When you plug in a trailer with electric or electric-over-hydraulic brakes, a message confirming connection appears in the information display.

4. Use the gain adjustment (+ and -) buttons to increase or decrease the gain setting to the desired starting point. A gain setting of 6.0 is a good starting point for heavier loads.
5. In a traffic-free environment, tow the trailer on a dry, level surface at a speed of 20-25 mph (30-40 km/h) and squeeze the manual control lever completely.
6. If the trailer wheels lock up, indicated by squealing tires, reduce the gain setting. If the trailer wheels turn freely, increase the gain setting. Repeat Steps 5 and 6 until the gain setting is at a point just below trailer wheel lock-up. If towing a heavier trailer, trailer wheel lock-up may not be attainable even with the maximum gain setting of 10.

Explanation of Information Display Warning Messages

Note: An authorized dealer can diagnose the trailer brake controller to determine exactly which trailer fault has occurred. However, your Ford warranty does not cover this diagnosis if the fault is with the trailer.

A message indicating a trailer brake module fault may display in response to faults sensed by the trailer brake controller, accompanied by a single tone. If this message appears, contact an authorized dealer as soon as possible for diagnosis and repair. The controller may still function, but performance may be degraded.

A message indicating a trailer wiring fault may display when there is a short circuit on the electric brake output wire. If this message displays, accompanied by a single tone, with no trailer connected, the problem is with your vehicle wiring between the trailer brake controller and the 7-pin connector at the bumper. If the message only displays with a trailer connected, the problem is with the trailer

Towing

wiring. Consult your trailer dealer for assistance. This can be a short to ground (such as a chafed wire), short to voltage (such as a pulled pin on trailer emergency breakaway battery) or the trailer brakes may be drawing too much current.

Points to Remember

Note: Do not attempt removal of the trailer brake controller without consulting the Workshop Manual. Damage to the unit may result.

- Adjust gain setting before using the trailer brake controller for the first time.
- Adjust gain setting, using the procedure above, whenever road, weather and trailer or vehicle loading conditions change from when the gain was initially set.
- Only use the manual control lever for proper adjustment of the gain during trailer setup. Misuse, such as application during trailer sway, could cause instability of trailer or tow vehicle.
- Avoid towing in adverse weather conditions. The trailer brake controller does not provide anti-lock control of the trailer wheels. Trailer wheels can lock up on slippery surfaces, resulting in reduced stability of trailer and tow vehicle.
- The trailer brake controller is equipped with a feature that reduces output at vehicle speeds below 11 mph (18 km/h) so trailer and vehicle braking is not jerky or harsh. This feature is only available when applying the brakes using your vehicle's brake pedal, not the controller.
- The controller interacts with the brake control system and powertrain control system of your vehicle to provide the best performance on different road conditions.

- Your vehicle's brake system and the trailer brake system work independently of each other. Changing the gain setting on the controller does not affect the operation of your vehicle's brakes whether you attach a trailer or not.
- When you switch the engine off, the controller output is disabled and the display and module shut down. The controller module and display turn on when you switch the ignition on.
- The trailer brake controller is only a factory-installed or dealer-installed item. Ford is not responsible for warranty or performance of the controller due to misuse or customer installation.

Trailer Lamps



WARNING: Never connect any trailer lamp wiring to the vehicle's tail lamp wiring; this may damage the electrical system resulting in fire. Contact your authorized dealer as soon as possible for assistance in proper trailer tow wiring installation. Additional electrical equipment may be required.

Trailer lamps are required on most towed vehicles. Make sure all running lights, brake lights, direction indicators and hazard lights are working.

Before Towing a Trailer

Practice turning, stopping and backing up to get the feel of your vehicle-trailer combination before starting on a trip. When turning, make wider turns so the trailer wheels clear curbs and other obstacles.

Towing

When Towing a Trailer

- Do not drive faster than 70 mph (113 km/h) during the first 500 mi (800 km).
- Do not make full-throttle starts.
- Check your hitch, electrical connections and trailer wheel lug nuts thoroughly after you have traveled 50 mi (80 km).
- When stopped in congested or heavy traffic during hot weather, place the gearshift in position **P** to aid engine and transmission cooling and to help A/C performance.
- Switch off the speed control with heavy loads or in hilly terrain. The speed control may turn off automatically when you are towing on long, steep grades.
- Shift to a lower gear when driving down a long or steep hill. Do not apply the brakes continuously, as they may overheat and become less effective.
- If your transmission is equipped with a Grade Assist or Tow/Haul feature, use this feature when towing. This provides engine braking and helps eliminate excessive transmission shifting for optimum fuel economy and transmission cooling.
- If your vehicle is equipped with AdvanceTrac with RSC, this system may turn on during typical cornering maneuvers with a heavily loaded trailer. This is normal. Turning the corner at a slower speed while towing may reduce this tendency.
- If you are towing a trailer frequently in hot weather, hilly conditions, at the gross combined weight rating (or any combination of these factors), consider refilling your rear axle with synthetic gear lubricant. See **Capacities and Specifications** (page 219).

- Allow more distance for stopping with a trailer attached. Anticipate stops and brake gradually.
- Avoid parking on a grade. However, if you must park on a grade:
 1. Turn the steering wheel to point your vehicle tires away from traffic flow.
 2. Set your vehicle parking brake.
 3. Place the automatic transmission in position **P**.
 4. Place wheel chocks in front and back of the trailer wheels. (Chocks not included with vehicle.)

Your vehicle may be equipped with a temporary or conventional spare tire. A "temporary" spare tire is different in size (diameter or width), tread-type (All-Season or All Terrain) or is from a different manufacturer than the road tires on your vehicle. Consult information on the tire label or Safety Compliance label for limitations when using.

Launching or Retrieving a Boat or Personal Watercraft (PWC)

Note: *Disconnect the wiring to the trailer before backing the trailer into the water.*

Note: *Reconnect the wiring to the trailer after removing the trailer from the water.*

When backing down a ramp during boat launching or retrieval:

- Do not allow the static water level to rise above the bottom edge of the rear bumper.
- Do not allow waves to break higher than 6 in (15 cm) above the bottom edge of the rear bumper.

Towing

Exceeding these limits may allow water to enter vehicle components:

- Causing internal damage to the components.
- Affecting driveability, emissions and reliability.

Replace the rear axle lubricant anytime the rear axle has been submerged in water. Water may have contaminated the rear axle lubricant, which is not normally checked or changed unless a leak is suspected or other axle repair is required.

TOWING THE VEHICLE ON FOUR WHEELS

Emergency Towing



WARNING: If your vehicle has a steering wheel lock make sure the ignition is in the accessory or on position when being towed.

You can flat-tow (all wheels on the ground, regardless of the powertrain or transmission configuration) your disabled vehicle (without access to wheel dollies or vehicle transport trailer) under the following conditions:

- Your vehicle is facing forward so you tow it in a forward direction.
- You shift into Neutral (N). If you cannot shift into Neutral (N), you may need to override the transmission. See **Transmission** (page 92).
- Maximum speed is 35 mph (56 km/h).
- Maximum distance is 50 mi (80 km).

Recreational Towing

Note: Put your climate control system in recirculated air mode to prevent exhaust fumes from entering the vehicle. See **Climate Control** (page 70).

Follow these guidelines if you have a need for recreational (RV) towing. An example of recreational towing would be towing your vehicle behind a motorhome. These guidelines are to make sure you do not damage the transmission during towing.

Do not tow your vehicle with any wheels on the ground, as vehicle or transmission damage may occur. It is recommended to tow your vehicle with all four wheels off the ground, for example when using a vehicle transport trailer. Otherwise, you cannot tow your vehicle.

Driving Hints

BREAKING-IN

You need to break in new tires for approximately 300 mi (480 km). During this time, your vehicle may exhibit some unusual driving characteristics.

Avoid driving too fast during the first 1,000 mi (1,600 km). Vary your speed frequently and change up through the gears early. Do not labor the engine.

Do not tow during the first 1,000 mi (1,600 km).

REDUCED ENGINE PERFORMANCE



WARNING: If you continue to drive your vehicle when the engine is overheating, the engine could stop without warning. Failure to follow this instruction could result in the loss of control of your vehicle.

If the engine coolant temperature gauge needle moves to the upper limit position, the engine is overheating. See **Gauges** (page 57).

You must only drive your vehicle for a short distance if the engine overheats. The distance you can travel depends on ambient temperature, vehicle load and terrain. The engine continues to operate with limited power for a short period of time.

If the engine temperature continues to rise, the fuel supply to the engine reduces. The air conditioning switches off and the engine cooling fan operates continually.

1. Gradually reduce your speed and stop your vehicle as soon as it is safe to do so.
2. Immediately switch the engine off to prevent severe engine damage.

3. Wait for the engine to cool down.
4. Check the coolant level. See **Engine Coolant Check** (page 165).
5. Have your vehicle checked as soon as possible.

ECONOMICAL DRIVING

Fuel economy is affected by several things such as how you drive, the conditions you drive under and how you maintain your vehicle.

There are some things to keep in mind that may improve your fuel economy:

- Accelerate and slow down in a smooth, moderate fashion.
- Drive at steady speeds.
- Anticipate stops; slowing down may eliminate the need to stop.
- Combine errands and minimize stop-and-go driving (When running errands, go to the furthest destination first and then work your way back home).
- Close the windows for high-speed driving.
- Drive at reasonable speeds.
- Keep the tires properly inflated and use only the recommended size.
- Use the recommended engine oil.
- Perform all regularly scheduled maintenance.

There are also some things you may want to avoid doing because they reduce your fuel economy:

- Avoid sudden or hard accelerations.
- Avoid revving the engine before turning off the car.
- Avoid long idle periods.
- Do not warm up your vehicle on cold mornings.

Driving Hints

- Reduce the use of air conditioning and heat.
- Avoid using speed control in hilly terrain.
- Do not rest your foot on the brake pedal while driving.
- Avoid carrying unnecessary weight.
- Avoid adding particular accessories to your vehicle (e.g. bug deflectors, rollbars/light bars, running boards, ski racks).
- Avoid driving with the wheels out of alignment.

DRIVING THROUGH WATER

 **WARNING:** Do not drive through flowing or deep water as you may lose control of your vehicle.

Note: *Driving through standing water can cause vehicle damage.*

Note: *Engine damage can occur if water enters the air filter.*

Before driving through standing water, check the depth. Never drive through water that is higher than the bottom of the wheel hubs.

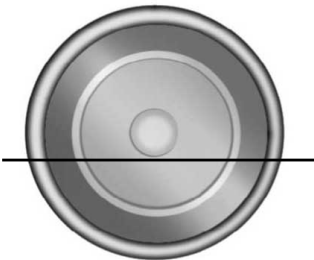



E176913

When driving through standing water, drive very slowly and do not stop your vehicle. Your brake performance and traction may be limited. After driving through water and as soon as it is safe to do so:

- Lightly press the brake pedal to dry the brakes and to check that they work.
- Check that the horn works.
- Check that the exterior lights work.
- Turn the steering wheel to check that the steering power assist works.

FLOOR MATS

 **WARNING:** Use a floor mat designed to fit the footwell of your vehicle that does not obstruct the pedal area. Failure to follow this instruction could result in the loss of control of your vehicle, personal injury or death.

 **WARNING:** Pedals that cannot move freely can cause loss of vehicle control and increase the risk of serious personal injury.

 **WARNING:** Secure the floor mat to both retention devices so that it cannot slip out of position and interfere with the pedals. Failure to follow this instruction could result in the loss of control of your vehicle, personal injury or death.

 **WARNING:** Do not place additional floor mats or any other covering on top of the original floor mats. This could result in the floor mat interfering with the operation of the pedals. Failure to follow this instruction could result in the loss of control of your vehicle, personal injury or death.

Driving Hints



WARNING: Always make sure that objects cannot fall into the driver foot well while your vehicle is moving. Objects that are loose can become trapped under the pedals causing a loss of vehicle control.



E142666

To install the floor mats, position the floor mat eyelet over the retention post and press down to lock in position.

To remove the floor mat, reverse the installation procedure.

Note: *Regularly check the floor mats to make sure they are secure.*

Roadside Emergencies

ROADSIDE ASSISTANCE

Vehicles Sold in the United States: Getting Roadside Assistance

To fully assist you should you have a vehicle concern, Ford Motor Company offers a complimentary roadside assistance program. This program is separate from the New Vehicle Limited Warranty.

The service is available:

- 24 hours a day, seven days a week.
- For the coverage period supplied with your vehicle.

Roadside Assistance covers:

- A flat tire change with a good spare (except vehicles supplied with a tire inflation kit).
- Battery jump start.
- Lock-out assistance (key replacement cost is the customer's responsibility).
- Fuel delivery — independent service contractors, if not prohibited by state, local or municipal law, shall deliver up to 2 gal (8 L) of gasoline or 5 gal (20 L) of diesel fuel to a disabled vehicle. Roadside Assistance limits fuel delivery service to two no-charge occurrences within a 12-month period.
- Winch out — available within 100 ft (30 m) of a paved or county maintained road, no recoveries.

- Towing — independent service contractors, if not prohibited by state, local or municipal law, shall tow Ford eligible vehicles to an authorized dealer within 35 mi (56 km) of the disablement location or to the nearest authorized dealer. If a member requests a tow to an authorized dealer that is more than 35 mi (56 km) from the disablement location, the member shall be responsible for any mileage costs in excess of 35 mi (56 km).
- Roadside Assistance includes up to \$200 for a towed trailer if the disabled eligible vehicle requires service at the nearest authorized dealer. If the towing vehicle is operational but the trailer is not, then the trailer does not qualify for any roadside services.

Vehicles Sold in the United States: Using Roadside Assistance

Complete the roadside assistance identification card and place it in your wallet for quick reference. This card is in the Owner's Manual kit.

United States vehicle customers who require Roadside Assistance, call 1-800-241-3673.

If you need to arrange roadside assistance for yourself, Ford Motor Company reimburses a reasonable amount for towing to the nearest dealership within 35 mi (56 km). To obtain reimbursement information, United States vehicle customers call 1-800-241-3673. Customers need to submit their original receipts.

Roadside Emergencies

Vehicles Sold in Canada: Getting Roadside Assistance

To fully assist you should you have a vehicle concern, Ford Motor Company of Canada, Limited offers a complimentary roadside assistance program. This program is eligible within Canada or the continental United States.

The service is available 24 hours a day, seven days a week.

This program is separate from the New Vehicle Limited Warranty, but the coverage is concurrent with the powertrain coverage period of your vehicle. Canadian roadside coverage and benefits may differ from the U.S. coverage.

If you require more information, please call us in Canada at 1-800-665-2006, or visit our website at www.ford.ca.

HAZARD FLASHERS

Note: *If used when the vehicle is not running, the battery loses charge. As a result, there may be insufficient power to restart your vehicle.*

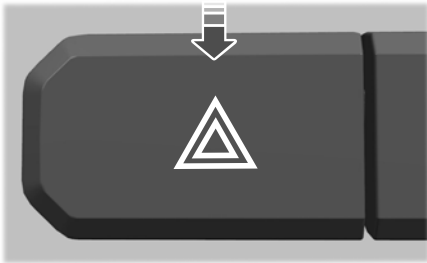

The hazard flasher control is located on the instrument panel. Use it when your vehicle is creating a safety hazard for other motorists.

- Press the flasher control and all front and rear direction indicators flash.
- Press the flasher control again to switch them off.

FUEL SHUTOFF

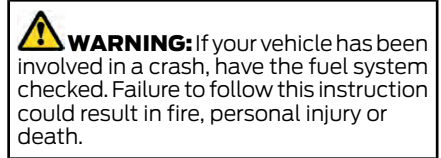

Note: *When you try to restart your vehicle after a fuel shutoff, your vehicle makes sure that various systems are safe to restart. Once your vehicle determines that the systems are safe, your vehicle allows you to restart.*

Note: *In the event that your vehicle does not restart after your third attempt, contact a qualified technician.*

The fuel pump shutoff stops the flow of fuel to the engine in the event of a moderate to severe crash. Not every impact causes a shutoff.

Should your vehicle shut off after a crash, you may restart your vehicle.

If your vehicle has a key system:

1. Turn key to the off position.
2. Turn key to the start position.
3. Turn key to the off position.
4. Turn key to the on position.
5. The fuel pump is now re-enabled.

Roadside Emergencies

JUMP STARTING THE VEHICLE



WARNING: Batteries normally produce explosive gases which can cause personal injury. Therefore, do not allow flames, sparks or lighted substances to come near the battery. When working near the battery, always shield your face and protect your eyes. Always provide correct ventilation.



WARNING: Keep batteries out of reach of children. Batteries contain sulfuric acid. Avoid contact with skin, eyes or clothing. Shield your eyes when working near the battery to protect against possible splashing of acid solution. In case of acid contact with skin or eyes, flush immediately with water for a minimum of 15 minutes and get prompt medical attention. If acid is swallowed, call a physician immediately.



WARNING: Use only adequately sized cables with insulated clamps.

Preparing Your Vehicle

Do not attempt to push-start your automatic transmission vehicle.

Note: Attempting to push-start a vehicle with an automatic transmission may cause transmission damage.

Note: Use only a 12-volt supply to start your vehicle.

Note: Do not disconnect the battery of the disabled vehicle as this could damage the vehicle electrical system.

Park the booster vehicle close to the hood of the disabled vehicle, making sure the two vehicles do not touch.

Connecting the Jumper Cables



WARNING: Do not connect the negative jumper cable to any other part of your vehicle. Use the ground point.



WARNING: Make sure that the cables are clear of any moving parts and fuel delivery system parts.

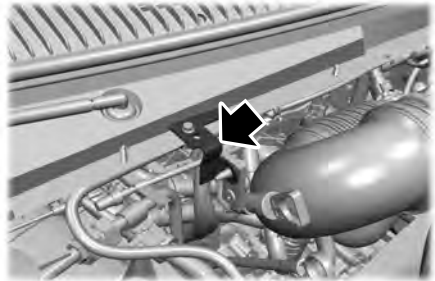

Note: See the above image for your vehicle's assigned ground connection point.

1. Connect the positive (+) jumper cable to the positive (+) terminal of the discharged battery.
2. Connect the other end of the positive (+) cable to the positive (+) terminal of the booster vehicle battery.
3. Connect the negative (-) cable to the negative (-) terminal of the booster vehicle battery.
4. Make the final connection of the negative (-) cable to the ground connection point.

Jump Starting

1. Start the engine of the booster vehicle and rev the engine moderately, or press the accelerator gently to keep your engine speed between 2000 and 3000 RPM, as shown in your tachometer.

Roadside Emergencies

2. Start the engine of the disabled vehicle.
3. Once the disabled vehicle has been started, run both vehicle engines for an additional three minutes before disconnecting the jumper cables.
4. Remove the jumper cable from the positive (+) terminal of the disabled vehicle battery.
5. Allow the engine to idle for at least one minute.

Removing the Jumper Cables

Remove the jumper cables in the reverse order that they were connected.

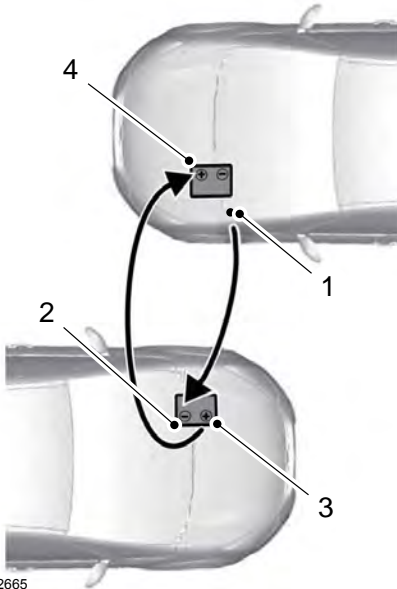

1. Remove the negative (-) jumper cable from the disabled vehicle.
2. Remove the jumper cable on the negative (-) terminal of the booster vehicle battery.
3. Remove the jumper cable from the positive (+) terminal of the booster vehicle battery.

TRANSPORTING THE VEHICLE

⚠ WARNING: Block the wheels to help prevent the vehicle from moving.

⚠ WARNING: Unexpected and possibly sudden vehicle movement may occur if you do not take these precautions.

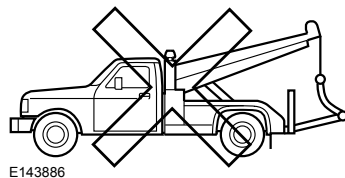
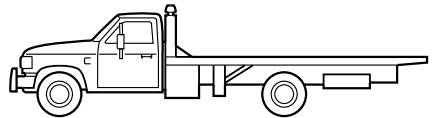
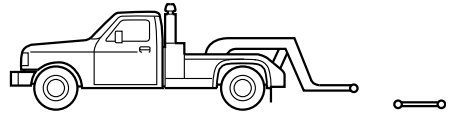

Roadside Emergencies

If you need to have your vehicle towed, contact a professional towing service or, if you are a member of a roadside assistance program, your roadside assistance service provider.

We recommend the use of a wheel lift and dollies or flatbed equipment to tow your vehicle. Do not tow with a slingbelt. Ford Motor Company has not approved a slingbelt towing procedure. Vehicle damage may occur if towed incorrectly, or by any other means.

Ford Motor Company produces a towing manual for all authorized tow truck operators. Have your tow truck operator refer to this manual for proper hook-up and towing procedures for your vehicle.

It is acceptable to have your two-wheel drive vehicle towed with the front wheels on the ground (without dollies) and the rear wheels off the ground.

Customer Assistance

GETTING THE SERVICES YOU NEED

Warranty repairs to your vehicle must be performed by an authorized dealer. While any authorized dealer handling your vehicle line will provide warranty service, we recommend you return to your selling authorized dealer who wants to ensure your continued satisfaction.

Please note that certain warranty repairs require special training and equipment, so not all authorized dealers are authorized to perform all warranty repairs. This means that, depending on the warranty repair needed, you may have to take your vehicle to another authorized dealer.

A reasonable time must be allowed to perform a repair after taking your vehicle to the authorized dealer. Repairs will be made using Ford or Motorcraft® parts, or remanufactured or other parts that are authorized by Ford.

Away From Home

If you are away from home when your vehicle needs service, contact the Ford Customer Relationship Center or use the online resources listed below to find the nearest authorized dealer.

In the United States:

Mailing address

Ford Motor Company
Customer Relationship Center
P.O. Box 6248
Dearborn, MI 48126

Telephone

1-800-392-3673 (FORD)
(TDD for the hearing impaired:
1-800-232-5952)

If your vehicle is configured as a motorhome please call 1-800-444-3311 for support.

Additional information and resources are available online:

| Website |
|--|
| www.owner.ford.com |

These are some of the items that can be found online:

- U.S. dealer locator by Dealer Name, City/State or Zip Code.
- Owner Manuals.
- Maintenance Schedules.
- Recalls.
- Ford Extended Service Plans.
- Ford Genuine Accessories.
- Service specials and promotions.

In Canada:

Mailing address

Customer Relationship Centre
Ford Motor Company of Canada, Limited
P.O. Box 2000
Oakville, Ontario L6K 0C8

Telephone

1-800-565-3673 (FORD)

| Website |
|--|
| www.ford.ca |

Twitter

@FordServiceCA (English Canada)
@FordServiceQC (Quebec)

Additional Assistance

If you have questions or concerns, or are unsatisfied with the service you are receiving, follow these steps:

1. Contact your Sales Representative or Service Advisor at your selling or servicing authorized dealer.

Customer Assistance

2. If your inquiry or concern remains unresolved, contact the Sales Manager, Service Manager or Customer Relations Manager.
3. If you require assistance or clarification on Ford Motor Company policies, please contact the Ford Customer Relationship Center.

In order to help us serve you better, please have the following information available when contacting a Customer Relationship Center:

- Vehicle Identification Number.
- Your telephone number (home and business).
- The name of the authorized dealer and city where located.
- The vehicle's current odometer reading.

In some states within the United States, you must directly notify Ford in writing before pursuing remedies under your state's warranty laws, and Ford is also allowed a final repair attempt.

Additionally, in some states within the United States, a consumer has the option of submitting a warranty dispute to the BBB Auto Line before taking action under the Magnuson-Moss Warranty Act, or to the extent allowed by state law, before pursuing replacement or repurchase remedies provided by certain state laws. This dispute handling procedure is not required prior to enforcing state created rights or other rights which are independent of the Magnuson-Moss Warranty Act or state replacement or repurchase laws.

IN CALIFORNIA (U.S. ONLY)

California Civil Code Section 1793.2(d) requires that, if a manufacturer or its representative is unable to repair a motor vehicle to conform to the vehicle's applicable express warranty after a reasonable number of attempts, the manufacturer shall be required to either replace the vehicle with one substantially identical or repurchase the vehicle and reimburse the buyer in an amount equal to the actual price paid or payable by the consumer (less a reasonable allowance for consumer use). The consumer has the right to choose whether to receive a refund or replacement vehicle.

California Civil Code Section 1793.22(b) presumes that the manufacturer has had a reasonable number of attempts to conform the vehicle to its applicable express warranties if, within the first 18 months of ownership of a new vehicle or the first 18,000 mi (29,000 km), whichever occurs first:

1. Two or more repair attempts are made on the same non-conformity likely to cause death or serious bodily injury OR
2. Four or more repair attempts are made on the same nonconformity (a defect or condition that substantially impairs the use, value or safety of the vehicle) OR
3. The vehicle is out of service for repair of nonconformities for a total of more than 30 calendar days (not necessarily all at one time).

In the case of 1 or 2 above, the consumer must also notify the manufacturer of the need for the repair of the nonconformity at the following address:

Ford Motor Company
16800 Executive Plaza Drive
Mail Drop 3NE-B
Dearborn, MI 48126

Customer Assistance

You are required to submit your warranty dispute to BBB AUTO LINE before asserting in court any rights or remedies conferred by California Civil Code Section 1793.22(b). You are also required to use BBB AUTO LINE before exercising rights or seeking remedies created by the Federal Magnuson-Moss Warranty Act, 15 U.S.C. sec. 2301 et seq. If you choose to seek redress by pursuing rights and remedies not created by California Civil Code Section 1793.22(b) or the Magnuson-Moss Warranty Act, resort to BBB AUTO LINE is not required by those statutes.

THE BETTER BUSINESS BUREAU (BBB) AUTO LINE PROGRAM (U.S. ONLY)

Your satisfaction is important to Ford Motor Company and to your dealer. If a warranty concern has not been resolved using the three-step procedure outlined earlier in this chapter in the Getting the Services you need section, you may be eligible to participate in the BBB AUTO LINE program.

The BBB AUTO LINE program consists of two parts – mediation and arbitration. During mediation, a representative of the BBB will contact both you and Ford Motor Company to explore options for settlement of the claim. If an agreement is not reached during mediation or you do not want to participate in mediation, and if your claim is eligible, you may participate in the arbitration process. An arbitration hearing will be scheduled so that you can present your case in an informal setting before an impartial person. The arbitrator will consider the testimony provided and make a decision after the hearing.

Disputes submitted to the BBB AUTO LINE program are usually decided within forty days after you file your claim with the BBB. You are not bound by the decision, and may reject the decision and proceed to court where all findings of the BBB Auto Line dispute, and decision, are admissible in the court action. Should you choose to accept the BBB AUTO LINE decision, Ford is then bound by the decision, and must comply with the decision within 30 days of receipt of your acceptance letter.

BBB AUTO LINE Application: Using the information provided below, please call or write to request a program application. You will be asked for your name and address, general information about your new vehicle, information about your warranty concerns, and any steps you have already taken to try to resolve them. A Customer Claim Form will be mailed that will need to be completed, signed and returned to the BBB along with proof of ownership. Upon receipt, the BBB will review the claim for eligibility under the Program Summary Guidelines.

You can get more information by calling BBB AUTO LINE at 1-800-955-5100, or writing to:

**BBB AUTO LINE
3033 Wilson Boulevard, Suite 600
Arlington, Virginia 22201**

BBB AUTO LINE applications can also be requested by calling the Ford Motor Company Customer Relationship Center at 1-800-392-3673.

For additional information refer to the Better Business Bureau website.

Note: *Ford Motor Company reserves the right to change eligibility limitations, modify procedures, or to discontinue this process at any time without notice and without obligation.*

Customer Assistance

GETTING ASSISTANCE OUTSIDE THE U.S. AND CANADA

Before exporting your vehicle to a foreign country, contact the appropriate foreign embassy or consulate. These officials can inform you of local vehicle registration regulations and where to find unleaded fuel or petrol/gas engines or the proper sulfur fuel for diesel engines.

If you cannot find the proper fuel recommended for your vehicle, contact our Customer Relationship Center.

The use of improper fuels in your vehicle without proper conversion may damage the effectiveness of your emission control system and may cause engine knocking or serious engine damage. Ford Motor Company or Ford of Canada is not responsible for any damage caused by use of improper fuel. Using improper fuels may also result in difficulty importing your vehicle back into the United States.

If your vehicle must be serviced while you are traveling or living in Asia-Pacific Region, Sub-Saharan Africa, U.S. Virgin Islands and/or Puerto Rico, Central America, the Caribbean, and Israel and the Middle East, contact the nearest authorized dealer. If the authorized dealer cannot help you, contact the corresponding Ford Customer Assistance Center:

FORD MOTOR COMPANY

Customer Relationship Centers in:

| Customer Relationship Center | Phone | Fax | E-mail |
|-------------------------------|--|----------------|------------------|
| Asia Pacific | N/A | N/A | apemcrc@ford.com |
| Caribbean and Central America | +1 313 594 4857 | - | expcac@ford.com |
| Middle East | Ford 80004443673 | 971 4 3327 266 | menacac@ford.com |
| | Lincoln 80004441067 | | |
| | UAE 80004441066 | | |
| | Saudi Arabia 8008443673 | | |
| | Mobily and Zain cell phone users in Saudi 800850078 | | |
| Kuwait 22280384 | | | |

Customer Assistance

| Customer Relationship Center | Phone | Fax | E-mail |
|-------------------------------------|------------------|------------|---|
| North Africa | N/A | N/A | nafcrc@ford.com |
| Puerto Rico and U.S. Virgin Islands | +1-800-841-3673 | N/A | prcac@ford.com |
| Sub-Saharan Africa | N/A | N/A | ssacrc@ford.com |
| South Korea | +82-02-1600-6003 | N/A | infokr1@ford.com or infokr@lincoln.com |

If you buy your vehicle in North America and then relocate to any of the above locations, register your vehicle identification number (VIN) and new address with Ford Global Trade Services by emailing, expcso@ford.com.

If you are in another foreign country, contact the nearest authorized dealer. In the event your inquiry is unresolved, communicate your concern with the dealership's Sales Manager, Service Manager or Customer Relations Manager. If you require additional assistance or clarification, please contact the respective Customer Relationship Center as previously listed.

Customers in the U.S. should call 1-800-392-3673.

ORDERING ADDITIONAL OWNER'S LITERATURE

To order the publications in this portfolio, contact Helm, Incorporated at:

HELM, INCORPORATED
47911 Halyard Drive
Plymouth, Michigan 48170
Attention: Customer Service

Or to order a free publication catalog, call toll free: 1-800-782-4356

Monday-Friday 8:00 a.m. - 6:00 p.m. EST

Helm, Incorporated can also be reached by their website:

www.helminc.com

(Items in this catalog may be purchased by credit card, check or money order.)

Obtaining a French Owner's Manual

French Owner's Manual can be obtained from your authorized dealer or by contacting Helm, Incorporated using the contact information listed previously in this section.

REPORTING SAFETY DEFECTS (U.S. ONLY)

If you believe that your vehicle has a defect which could cause a crash or could cause injury or death, you should immediately inform the National Highway Traffic Safety Administration (NHTSA) in addition to notifying Ford Motor Company.

Customer Assistance

If NHTSA receives similar complaints, it may open an investigation, and if it finds that a safety defect exists in a group of vehicles, it may order a recall and remedy campaign. However, NHTSA cannot become involved in individual problems between you, your dealer, or Ford Motor Company.

To contact NHTSA, you may call the Vehicle Safety Hotline toll-free at 1-888-327-4236 (TTY: 1-800-424-9153); go to www.safercar.gov; or write to:

Administrator

1200 New Jersey Avenue,
Southeast

Washington, D.C. 20590

You can also obtain other information about motor vehicle safety from www.safercar.gov.

REPORTING SAFETY DEFECTS (CANADA ONLY)

If you believe that your vehicle has a defect which could cause a crash or could cause injury or death, you should immediately inform Transport Canada and Ford of Canada.

| Transport Canada Contact Information | |
|---|--|
| Website | http://www.tc.gc.ca/eng/motorvehiclesafety/reporting-defects-motor-vehicles.html (English) |
| Website | http://www.tc.gc.ca/fra/secureautomobile/signaler-defaults-vehicules-automobiles.html (French) |
| Phone | 1-800-333-0510 |

| Ford of Canada Contact Information | |
|---|--|
| Website | www.ford.ca |
| Phone | 1-800-565-3673 |

Fuses

FUSE SPECIFICATION CHART

Engine Compartment Fuse Box



WARNING: Always disconnect the battery before servicing high current fuses.



WARNING: To reduce risk of electrical shock, always replace the cover to the power distribution box before reconnecting the battery or refilling fluid reservoirs.

Note: If your vehicle has dual batteries, disconnecting the primary under hood battery does not remove power from all circuits.

The engine compartment fuse box is in the engine compartment. It has high-current fuses that protect your vehicle's main electrical systems from overloads.

If you disconnect and reconnect the battery, you need to reset some features. See **Changing the 12V Battery** (page 173).

Replace fuses with the same type and rating. See **Changing a Fuse** (page 159).

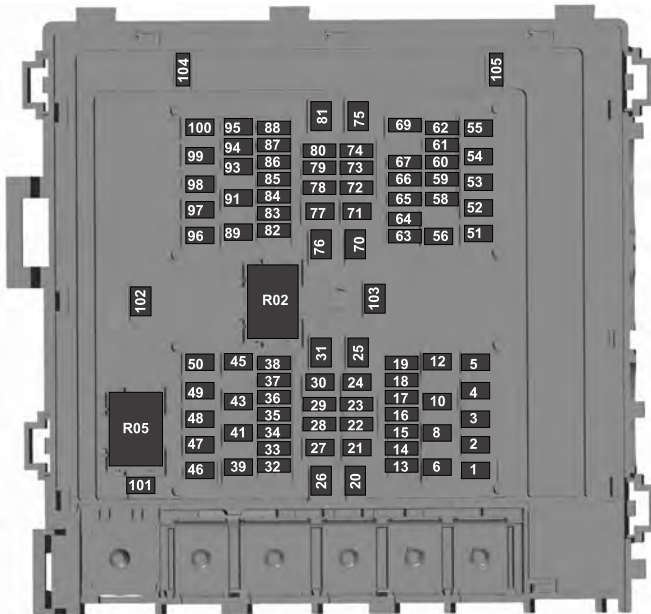

E251921

Fuses

| Fuse Number | Fuse Rating | Protected Component |
|-------------|-------------|--|
| 1 | 20 A | Horn. |
| 2 | 50 A | Blower motor. |
| 3 | — | Not used. |
| 4 | 30 A | Starter relay. |
| 5 | 20 A | Not used (spare). |
| 6 | 20 A | Upfitter relay 4 (cutaway). Not used (spare) (stripped chassis). |
| 8 | — | Not used. |
| 10 | — | Not used. |
| 12 | 20 A | Power point 4. |
| 13 | 10 A | Yaw sensor (stripped chassis). Not used (spare) (cutaway). |
| 14 | 10 A | Forward looking radar (cutaway). Not used (spare) (stripped chassis). |
| 15 | — | Not used. |
| 16 | — | Not used. |
| 17 | 10 A | Powertrain control module run/start feed. |
| 18 | 10 A | Anti-lock brake system run/start feed. |
| 19 | — | Not used. |
| 20 | 30 A | Wiper power. |
| 21 | — | Not used. |
| 22 | 10 A | Wiper module (stripped chassis). Not used (spare) (cutaway). |
| 23 | — | Not used. |
| 24 | 40 A | Body control module - run power in feed 2. |
| 25 | 50 A | Body control module - run power in feed 1. |
| 26 | — | Not used. |

Fuses

| Fuse Number | Fuse Rating | Protected Component |
|-------------|-------------|---|
| 27 | 20 A | Body builder frame connector. |
| 28 | — | Not used. |
| 29 | 10 A | B+ power 12 V(special order vehicle). |
| 30 | 30 A | Power driver seat (cutaway). Not used (spare) (stripped chassis). |
| 31 | — | Not used. |
| 32 | 20 A | Vehicle power 1. |
| 33 | 20 A | Vehicle power 2. |
| 34 | 10 A | Vehicle power 3. |
| 35 | 20 A | Vehicle power 4. |
| 36 | — | Not used. |
| 37 | — | Not used. |
| 38 | 10 A | Washer relay (stripped chassis). Not used (spare) (cutaway). |
| 39 | — | Not used. |
| 41 | 30 A | Trailer brake control connector. |
| 43 | 30 A | Instrument panel connector (stripped chassis). Not used (spare) (cutaway). |
| 45 | — | Not used. |
| 46 | 10 A | A/C clutch. |
| 47 | 40 A | Upfitter relay 1 (cutaway). Not used (spare) (stripped chassis). |
| 48 | — | Not used. |
| 49 | 30 A | Pump electronics module. |
| 50 | 15 A | Injectors. |
| 51 | 20 A | Power point 1. |
| 52 | 50 A | B-pillar vehicle connector (cutaway). Not used (spare) (stripped chassis). |

Fuses

| Fuse Number | Fuse Rating | Protected Component |
|--------------------|--------------------|---|
| 53 | 30 A | Trailer tow park lamps. |
| 54 | 40 A | Upfitter 2 relay (cutaway). Not used (spare) (stripped chassis). |
| 55 | 20 A | Upfitter 3 relay (cutaway). Not used (spare) (stripped chassis). |
| 56 | 20 A | Power point 2 prep B-pillar connector. |
| 58 | 5 A | USB smart charger. |
| 59 | 10 A | Park lamps 1 (special order vehicle). |
| 60 | — | Not used. |
| 61 | — | Not used. |
| 62 | — | Not used. |
| 63 | — | Not used. |
| 64 | — | Not used. |
| 65 | — | Not used. |
| 66 | — | Not used. |
| 67 | — | Not used. |
| 69 | — | Not used. |
| 70 | 40 A | Inverter. |
| 71 | 30 A | Anti-lock brake system valves. |
| 72 | 10 A | Brake on and off switch. |
| 73 | — | Not used. |
| 74 | — | Not used. |
| 75 | — | Not used. |
| 76 | 60 A | Anti-lock brake system pump. |
| 77 | 30 A | Voltage quality module power - body control module. |
| 78 | 10 A | Trailer tow stop lamps. |
| 79 | — | Not used. |

Fuses

| Fuse Number | Fuse Rating | Protected Component |
|--------------------|--------------------|--|
| 80 | 10 A | Trailer tow backup lamps. |
| 81 | — | Not used. |
| 82 | 5 A | Run/start fuse - upfitter relays (cutaway). B+ fuse - upfitter relay. |
| 83 | — | Not used. |
| 84 | — | Not used. |
| 85 | — | Not used. |
| 86 | — | Not used. |
| 87 | — | Not used. |
| 88 | — | Not used. |
| 89 | — | Not used. |
| 91 | 40 A | B-pillar (cutaway). Instrument panel (stripped chassis). |
| 93 | 10 A | Park lamps 3 (special order vehicle). |
| 94 | 10 A | Park lamps 2 (special order vehicle). |
| 95 | 20 A | Stop lamp relay. |
| 96 | — | Not used. |
| 97 | 50 A | Engine. B-pillar vehicle connector. Instrument panel. |
| 98 | 30 A | Trailer tow battery charge. |
| 99 | 40 A | Instrument panel connector. |
| 100 | — | Not used. |
| 101 | — | Not used. |
| 102 | — | Not used. |
| 103 | — | Not used. |

Fuses

| Fuse Number | Fuse Rating | Protected Component |
|-------------|-------------|--|
| 104 | — | Not used. |
| 105 | 15 A | Trailer tow right-hand and left-hand stop and direction indicator relay power. |

Note: Spare fuse amperage may vary.

| Relay Number | Fuse Rating | Protected Component |
|--------------|-------------|--|
| R02 | — | Powertrain control module. Power relay. |
| R05 | — | Not used. |

Passenger Compartment Fuse Box



WARNING: Always disconnect the battery before servicing high current fuses.

Note: If your vehicle has dual batteries, disconnecting the primary under hood battery does not remove power from all circuits.

The fuse panel is to the left-hand side of the brake pedal and mounted onto the lower left-hand cowl panel. Remove the fuse panel cover to access the fuses.

To remove a fuse, use the fuse puller tool provided on the inside of the fuse panel cover.

Replace fuses with the same type and rating. See **Changing a Fuse** (page 159).

Fuses

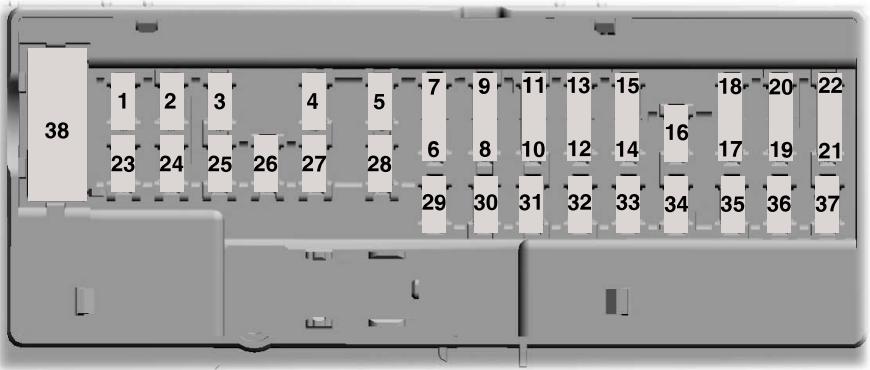

E145984

| Fuse Number | Fuse Rating | Protected Component |
|-------------|-------------|--|
| 1 | — | Not used. |
| 2 | 10 A | Left-hand front and right-hand front door lock switch (cutaway). Inverter (cutaway). Connector (stripped chassis). |
| 3 | 7.5 A | Power mirror switch (cutaway). |
| | — | Not used (stripped chassis). |
| 4 | 20 A | Trailer brake control. |
| 5 | 20 A | Not used (spare). |
| 6 | 10 A | Not used (spare). |
| 7 | 10 A | Not used (spare). |
| 8 | 10 A | Not used (spare). |
| 9 | 10 A | Not used (spare). |
| 10 | — | Not used. |
| 11 | — | Not used. |
| 12 | 7.5 A | Smart datalink connector. |

Fuses

| Fuse Number | Fuse Rating | Protected Component |
|-------------|-------------|---|
| | | Enterprise wired-in-device. |
| 13 | 7.5 A | Cluster. Steering column control module. |
| 14 | 15 A | Not used (spare). |
| 15 | 15 A | Not used (spare). |
| 16 | — | Not used. |
| 17 | 7.5 A | Not used. |
| 18 | 7.5 A | Climate mode switch. |
| 19 | 5 A | Radio transceiver module. |
| 20 | 5 A | Ignition switch. |
| 21 | 5 A | Not used. |
| 22 | 5 A | Body builder B-pillar connector (cutaway). |
| | 5 A | Not used (stripped chassis). |
| 23 | 30 A | Not used (spare). |
| 24 | 30 A | Not used (spare). |
| 25 | 20 A | Not used (spare). |
| 26 | 30 A | Not used (spare). |
| 27 | 30 A | Not used (spare). |
| 28 | 30 A | Not used (spare). |
| 29 | 15 A | Upfitter interface module (cutaway). |
| | — | Not used (stripped chassis). |
| 30 | 5 A | Not used (spare). |
| 31 | 10 A | Smart datalink connector. |
| 32 | 20 A | Radio. |
| 33 | — | Not used. |
| 34 | 30 A | Not used (spare). |
| 35 | 5 A | Tow haul switch. |

Fuses

| Fuse Number | Fuse Rating | Protected Component |
|-------------|-------------|--|
| 36 | 15 A | Rear view mirror (cutaway). Rear view camera (cutaway). |
| | — | Not used (stripped chassis). |
| 37 | 20 A | Not used (spare). |
| 38 | 30 A | Rear window switches and motors (cutaway). |
| | — | Not used (stripped chassis). |

Note: Spare fuse amperage may vary.

CHANGING A FUSE

Fuses



WARNING: Always replace a fuse with one that has the specified amperage rating. Using a fuse with a higher amperage rating can cause severe wire damage and could start a fire.



E217331

If electrical components in the vehicle are not working, a fuse may have blown. Blown fuses are identified by a broken wire within the fuse. Check the appropriate fuses before replacing any electrical components.

Fuses

Fuse Types

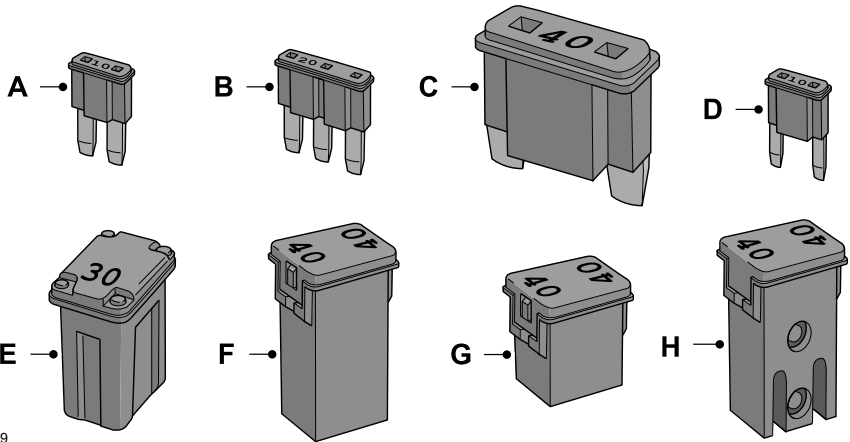

E267379

- A Micro 2.
- B Micro 3.
- C Maxi.
- D Mini.
- E M Case.
- F J Case.
- G J Case Low Profile.
- H Slotted M Case.

Maintenance

GENERAL INFORMATION

Have your vehicle serviced regularly to help maintain its roadworthiness and resale value. There is a large network of authorized dealers that are there to help you with their professional servicing expertise. We believe that their specially trained technicians are best qualified to service your vehicle properly and expertly. They are supported by a wide range of highly specialized tools developed specifically for servicing your vehicle.

If your vehicle requires professional service, an authorized dealer can provide the necessary parts and service. Check your warranty information to find out which parts and services are covered.

Use only recommended fuels, lubricants, fluids and service parts conforming to specifications. Motorcraft® parts are designed and built to provide the best performance in your vehicle.

Precautions

- Do not work on a hot engine.
- Make sure that nothing gets caught in moving parts.
- Do not work on a vehicle with the engine running in an enclosed space, unless you are sure you have enough ventilation.
- Keep all open flames and other burning material (such as cigarettes) away from the battery and all fuel related parts.

Working with the Engine Off

1. Set the parking brake and shift the transmission to park (P).

2. Switch off the engine.
3. Block the wheels.

Working with the Engine On

 **WARNING:** To reduce the risk of vehicle damage and personal burn injuries, do not start your engine with the air cleaner removed and do not remove it while the engine is running.

1. Set the parking brake and shift the transmission to park (P).
2. Block the wheels.

OPENING AND CLOSING THE HOOD



1. Inside the vehicle, pull the hood release handle located under the bottom left corner of the instrument panel.
2. Go to the front of the vehicle and push the auxiliary latch, located in the center of the top grille, to the left in order to release the hood.
3. Lift the hood and secure it with the prop rod.

Maintenance

UNDER HOOD OVERVIEW

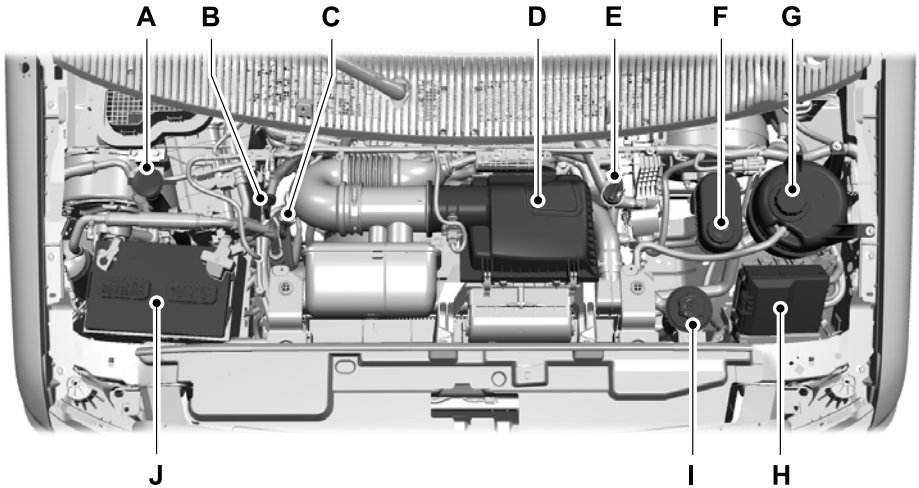

- A Windshield washer fluid reservoir. See **Washer Fluid Check** (page 173).
- B Automatic transmission fluid dipstick. See **Automatic Transmission Fluid Check** (page 169).
- C Engine oil dipstick. See **Engine Oil Dipstick** (page 163).
- D Air cleaner assembly. See **Changing the Engine Air Filter** (page 178).
- E Engine oil filler cap. See **Engine Oil Check** (page 163).
- F Brake fluid reservoir. See **Brake Fluid Check** (page 171).
- G Engine coolant reservoir. See **Engine Coolant Check** (page 165).
- H Engine compartment fuse box. See **Fuses** (page 151).
- I Power steering fluid reservoir. See **Power Steering Fluid Check** (page 172).
- J Battery. See **Changing the 12V Battery** (page 173).

Maintenance

ENGINE OIL DIPSTICK



E161560

- A MIN
- B MAX

ENGINE OIL CHECK

To check the engine oil level consistently and accurately, do the following:

1. Make sure the parking brake is on. Make sure the transmission is in park (P) or neutral (N).
2. Run the engine until it reaches normal operating temperature.
3. Make sure that your vehicle is on level ground.
4. Switch the engine off and wait 15 minutes for the oil to drain into the oil pan. Checking the engine oil level too soon after you switch the engine off may result in an inaccurate reading.
5. Open the hood. See **Opening and Closing the Hood** (page 161).
6. Remove the dipstick and wipe it with a clean, lint-free cloth. See **Under Hood Overview** (page 162).
7. Replace the dipstick and remove it again to check the oil level. See **Engine Oil Dipstick** (page 163).

8. Make sure that the oil level is between the maximum and minimum marks. If the oil level is at the minimum mark, add oil immediately. See **Capacities and Specifications** (page 223).
9. If the oil level is correct, replace the dipstick and make sure it is fully seated.

Note: Do not remove the dipstick when the engine is running.

Note: If the oil level is between the maximum and minimum marks, the oil level is acceptable. Do not add oil.

Note: The oil consumption of new engines reaches its normal level after approximately 3,100 mi (5,000 km).

Adding Engine Oil

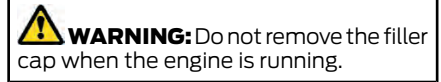

WARNING: Do not remove the filler cap when the engine is running.

Do not use supplemental engine oil additives because they are unnecessary and could lead to engine damage that may not be covered by the vehicle Warranty.



E142732

Maintenance

Only use oils certified for gasoline engines by the American Petroleum Institute (API). An oil with this trademark symbol conforms to the current engine and emission system protection standards and fuel economy requirements of the International Lubricants Specification Advisory Committee (ILSAC).

To top up the engine oil level do the following:

1. Clean the area surrounding the engine oil filler cap before you remove it.
2. Remove the engine oil filler cap. See **Under Hood Overview** (page 162). Turn it counterclockwise and remove it.
3. Add engine oil that meets Ford specifications. See **Capacities and Specifications** (page 223). You may have to use a funnel to pour the engine oil into the opening.
4. Recheck the oil level.
5. If the oil level is correct, replace the dipstick and make sure it is fully seated.
6. Replace the engine oil filler cap. Turn it clockwise until you feel a strong resistance.

Note: Do not add oil further than the maximum mark. Oil levels above the maximum mark may cause engine damage.

Note: Make sure you install the oil filler cap correctly.

Note: Soak up any spillage with an absorbent cloth immediately.

OIL CHANGE INDICATOR RESET

Base Cluster

Use the information display controls on the steering wheel to reset the oil change indicator.

From the main menu scroll to:

| Message | Action and Description |
|----------------------------------|--|
| Settings | Press the right arrow button, then from this menu scroll to the following message. |
| Vehicle | Press the down arrow button, then from this menu scroll to the following message. |
| Oil Life Reset | Press the right arrow button, then from this menu scroll to the following message. |
| Oil Life Hold to Reset | Press and hold the OK button until the instrument cluster displays the following message. |
| Oil Life Hold OK to Reset | Press and hold the OK button until the instrument cluster displays the following message. Reset Complete |
| | If the instrument cluster displays the following message, repeat the process. Reset Cancelled |

High Series Cluster

Use the information display controls on the steering wheel to reset the oil change indicator.

Maintenance

From the main menu scroll to:

| Message | Action and Description |
|----------------------------------|--|
| Truck Info | Press the down arrow button, then from this menu scroll to the following message. |
| Maintenance Monitor | Press the OK button. |
| Oil Life: xxx% | Press the down arrow button, then from this menu scroll to the following message. |
| Oil Life | Press the OK button. |
| Oil Life Hold OK to Reset | Press and hold the OK button until the instrument cluster displays the following message. |
| | Oil Life: 100% |
| | When the oil change indicator resets, the instrument cluster displays 100%. |
| | Repeat the process if the oil change indicator does not reset. |

ENGINE COOLANT CHECK



WARNING: Do not remove the coolant reservoir cap when the engine is on or the cooling system is hot. Wait 10 minutes for the cooling system to cool down. Cover the coolant reservoir cap with a thick cloth to prevent the possibility of scalding and slowly remove the cap. Failure to follow this instruction could result in personal injury.



WARNING: Do not put coolant in the windshield washer reservoir. If sprayed on the windshield, coolant could make it difficult to see through the windshield.



WARNING: To reduce the risk of personal injury, make sure the engine is cool before unscrewing the coolant pressure relief cap. The cooling system is under pressure. Steam and hot liquid can come out forcefully when you loosen the cap slightly.



WARNING: Do not add coolant further than the **MAX** mark.

When the engine is cold, check the concentration and level of the coolant at the intervals listed in the scheduled maintenance information. See **Scheduled Maintenance** (page 250).

Note: Make sure that the coolant level is between the **MIN** and **MAX** marks on the coolant reservoir.

Note: Coolant expands when it is hot. The level may extend beyond the **MAX** mark.

Maintain coolant concentration within 48% to 50%, which equates to a freeze point between -29°F (-34°C) and -35°F (-37°C). Coolant concentration should be checked using a refractometer. We do not recommend the use of hydrometers or coolant test strips for measuring coolant concentration.

Adding Coolant



WARNING: Do not add engine coolant when the engine is on or the cooling system is hot. Failure to follow this instruction could result in personal injury.

Maintenance



WARNING: Do not remove the coolant reservoir cap when the engine is on or the cooling system is hot. Wait 10 minutes for the cooling system to cool down. Cover the coolant reservoir cap with a thick cloth to prevent the possibility of scalding and slowly remove the cap. Failure to follow this instruction could result in personal injury.

Note: Automotive fluids are not interchangeable. Do not use coolant or windshield washer fluid outside of its specified function and vehicle location.

Note: Do not use stop leak pellets, cooling system sealants, or non-specified additives as they can cause damage to the engine cooling or heating systems. Resulting component damage may not be covered by the vehicle Warranty.

It is very important to use prediluted coolant approved to the correct specification in order to avoid plugging the small passageways in the engine cooling system. See **Capacities and Specifications** (page 219). Do not mix different colors or types of coolant in your vehicle. Mixing of engine coolants or using an incorrect coolant may harm the engine or cooling system components and may not be covered by the vehicle Warranty.

Note: If prediluted coolant is not available, use the approved concentrated coolant diluting it to 50/50 with distilled water. See **Capacities and Specifications** (page 219). Using water that has not been deionized may contribute to deposit formation, corrosion and plugging of the small cooling system passageways.

Note: Coolants marketed for all makes and models may not be approved to Ford specifications and may cause damage to the cooling system. Resulting component damage may not be covered by the vehicle Warranty.

If the coolant level is at or below the minimum mark, add prediluted coolant immediately.

To top up the coolant level do the following:

1. Unscrew the cap slowly. Any pressure escapes as you unscrew the cap.
2. Add prediluted coolant approved to the correct specification. See **Capacities and Specifications** (page 219).
3. Add enough prediluted coolant to reach the correct level.
4. Replace the coolant reservoir cap. Turn the cap clockwise until it contacts the hard stop.
5. Check the coolant level in the coolant reservoir the next few times you drive your vehicle. If necessary, add enough prediluted engine coolant to bring the coolant level to the correct level.

If you have to add more than 1.1 qt (1 L) of engine coolant per month, have your vehicle checked as soon as possible. Operating an engine with a low level of coolant can result in engine overheating and possible engine damage.

Note: During normal vehicle operation, the coolant may change color, and slightly darken. As long as the coolant is clear and uncontaminated, this color change does not indicate the coolant has degraded nor does it require the coolant to be drained, the system to be flushed, or the coolant to be replaced.

In case of emergency, you can add a large amount of water without coolant in order to reach a vehicle service location. In this instance, qualified personnel:

1. Must drain the cooling system.
2. Chemically clean the coolant system.

Maintenance

3. Refill with coolant that meets the correct specification. See **Capacities and Specifications** (page 219).

Water alone, without coolant, can cause engine damage from corrosion, overheating or freezing.

Do not use the following as a coolant substitute:

- Alcohol.
- Methanol.
- Brine.
- Any coolant mixed with alcohol or methanol antifreeze.

Alcohol and other liquids can cause engine damage from overheating or freezing.

Do not add extra inhibitors or additives to the coolant. These can be harmful and compromise the corrosion protection of the coolant.

Recycled Coolant

We do not recommend the use of recycled coolant as an approved recycling process is not yet available.

Dispose of used engine coolant in an appropriate manner. Follow your community's regulations and standards for recycling and disposing of automotive fluids.

Severe Climates

If you drive in extremely cold climates:

- It may be necessary to increase the coolant concentration above 50%.
- A coolant concentration of 60% provides improved freeze point protection. Coolant concentrations above 60% decrease the overheat protection characteristics of the coolant and may cause engine damage.

If you drive in extremely hot climates:

- You can decrease the coolant concentration to 40%.
- Coolant concentrations below 40% decrease the freeze and corrosion protection characteristics of the coolant and may cause engine damage.

Vehicles driven year-round in non-extreme climates should use prediluted coolant for optimum cooling system and engine protection.

Coolant Change

At specific mileage intervals, as listed in the scheduled maintenance information, the coolant should be changed. Add prediluted coolant approved to the correct specification. See **Capacities and Specifications** (page 219).

Fail-Safe Cooling

Fail-safe cooling allows you to temporarily drive your vehicle before any incremental component damage occurs. The fail-safe distance depends on ambient temperature, vehicle load and terrain.

How Fail-Safe Cooling Works

If the engine begins to overheat, the coolant temperature gauge moves toward the red zone:



A warning lamp illuminates and a message may appear in the information display.



If the engine reaches a preset over-temperature condition, the engine automatically switches to alternating cylinder operation. Each disabled cylinder acts as an air pump and cools the engine.

Maintenance

When this occurs, your vehicle still operates, however:

- Engine power is limited.
- The air conditioning system turns off.

Continued operation increases the engine temperature, causing the engine to completely shut down. Your steering and braking effort increases in this situation.

When the engine temperature cools, you can re-start the engine. Have your vehicle checked as soon as possible to minimize engine damage.

When Fail-Safe Mode Is Activated



WARNING: Fail-safe mode is for use during emergencies only. Operate your vehicle in fail-safe mode only as long as necessary to bring your vehicle to rest in a safe location and seek immediate repairs. When in fail-safe mode, your vehicle will have limited power, will not be able to maintain high-speed operation, and may completely shut down without warning, potentially losing engine power, power steering assist, and power brake assist, which may increase the possibility of a crash resulting in serious injury.



WARNING: Do not remove the coolant reservoir cap when the engine is on or the cooling system is hot. Wait 10 minutes for the cooling system to cool down. Cover the coolant reservoir cap with a thick cloth to prevent the possibility of scalding and slowly remove the cap. Failure to follow this instruction could result in personal injury.

Your vehicle has limited engine power when in the fail-safe mode, drive your vehicle with caution. Your vehicle does not maintain high-speed operation and the engine may operate poorly.

Remember that the engine is capable of automatically shutting down to prevent engine damage. In this situation:

1. Pull off the road as soon as safely possible and switch the engine off.
2. If you are a member of a roadside assistance program, we recommend that you contact your roadside assistance service provider.
3. If this is not possible, wait a short period for the engine to cool.
4. Check the coolant level. If the coolant level is at or below the minimum mark, add prediluted coolant immediately.
5. When the engine temperature cools, you can re-start the engine. Have your vehicle checked as soon as possible to minimize engine damage.

Note: *Driving your vehicle without repair increases the chance of engine damage.*

Engine Coolant Temperature Management (If Equipped)



WARNING: To reduce the risk of crash and injury, be prepared that the vehicle speed may reduce and the vehicle may not be able to accelerate with full power until the coolant temperature reduces.

If you tow a trailer with your vehicle, the engine may temporarily reach a higher temperature during severe operating conditions, for example ascending a long or steep slope in high ambient temperatures.

At this time, you may notice the coolant temperature gauge moves toward the red zone and a message may appear in the information display.

Maintenance

You may notice a reduction in vehicle speed caused by reduced engine power in order to manage the engine coolant temperature. Your vehicle may enter this mode if certain high-temperature and high-load conditions take place. The amount of speed reduction depends on vehicle loading, grade and ambient temperature. If this occurs, there is no need to pull off the road. You can continue to drive your vehicle.

The air conditioning may automatically turn on and off during severe operating conditions to protect the engine from overheating. When the coolant temperature decreases to the normal operating temperature, the air conditioning turns on.

If the coolant temperature gauge moves fully into the red zone, or if the coolant temperature warning or service engine soon messages appear in your information display, do the following:

1. Pull off the road as soon as safely possible and shift the transmission into park (P).
2. Leave the engine running until the coolant temperature gauge needle returns to the normal position. If the temperature does not drop after several minutes, follow the remaining steps.
3. Switch the engine off and wait for it to cool. Check the coolant level.
4. If the coolant level is at or below the minimum mark, immediately add prediluted coolant.
5. If the coolant level is normal, restart the engine and continue driving.

AUTOMATIC TRANSMISSION FLUID CHECK

Have an authorized dealer check and change the transmission fluid and filter at the correct service interval. See **Scheduled Maintenance** (page 250).

Do not use supplemental transmission fluid additives, treatments or cleaning agents. The use of these materials may affect transmission operation and result in damage to internal transmission components.

Checking Automatic Transmission Fluid

For scheduled intervals of the fluid checks and changes, See **Scheduled Maintenance** (page 250). Your transmission does not consume fluid. However, if the transmission is not working properly, for example, if the transmission slips or shifts slowly, or if you notice some sign of fluid leakage, check the fluid level as soon as possible.

Automatic transmission fluid expands when warmed. To obtain an accurate fluid check, drive the vehicle until it is at normal operating temperature, approximately 19 mi (30 km). Verify that the transmission fluid temperature gauge on the instrument cluster is within normal range.

1. Drive the vehicle 19 mi (30 km) until it reaches normal operating temperature.
2. Park the vehicle on a level surface and engage the parking brake.
3. With the engine running, parking brake engaged and your foot on the brake pedal, move the gearshift lever through all of the gear ranges. Allow sufficient time for each gear to engage.
4. Put the transmission in park (P) and leave the engine running.

Maintenance

5. Remove the dipstick, wiping it clean with a clean, dry, lint free rag.
6. Install the dipstick, fully seating it in the filler tube.
7. Remove the dipstick and inspect the fluid level. The fluid should be in the designated area for normal operating temperature or ambient temperature.

Low Fluid Level



E163740

Do not drive the vehicle if there is no indication of fluid on the dipstick and the ambient temperature is above 50°F (10°C).

Correct Fluid Level



E163742

Drive the vehicle 19 mi (30 km) or until it reaches normal operating temperature. Check the fluid at the normal operating temperature of 196°F (91°C) to 215°F (102°C) on a level surface.

High Fluid Level



E163744

Fluid levels above the safe range may result in transmission failure. An overfill condition of transmission fluid may cause shift and engagement concerns, and possible damage.

An overheating condition can cause high fluid levels.

Adjusting Automatic Transmission Fluid Levels

Note: Use of a non-approved automatic transmission fluid may cause internal transmission component damage.

Make sure to use the correct type of fluid. You can find the type of fluid used on the transmission dipstick, or in your owner's manual. See **Capacities and Specifications** (page 219).

If necessary, add fluid in 8 fl oz (250 ml) increments through the filler tube until the level is correct.

Maintenance

For transmission filter maintenance, see your authorized dealer.

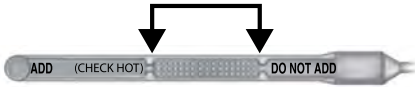

E163746

If an overfill occurs, have a qualified technician remove excess fluid.

Note: *An overfill condition of transmission fluid may cause shift and engagement concerns, and possible damage.*

Do not use supplemental transmission fluid additives, treatments or cleaning agents. The use of these materials may affect transmission operation and result in damage to internal transmission components.

Automatic Transmission Fluid Filter

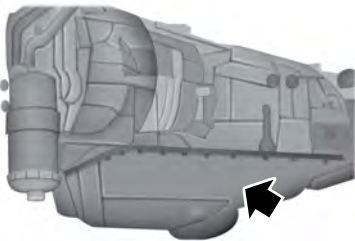



E196355

Your automatic transmission has a serviceable transmission fluid filter inside the transmission bottom pan. For service intervals for the automatic transmission fluid and transmission filter, See **Scheduled Maintenance** (page 250).

BRAKE FLUID CHECK

 **WARNING:** Do not use any fluid other than the recommended brake fluid as this will reduce brake efficiency. Use of incorrect fluid could result in the loss of vehicle control, serious personal injury or death.

 **WARNING:** Only use brake fluid from a sealed container. Contamination with dirt, water, petroleum products or other materials may result in brake system damage or failure. Failure to adhere to this warning could result in the loss of vehicle control, serious personal injury or death.

 **WARNING:** Do not allow the fluid to touch your skin or eyes. If this happens, rinse the affected areas immediately with plenty of water and contact your physician.

 **WARNING:** The brake system could be affected if the brake fluid level is below the **MIN** mark or above the **MAX** mark on the brake fluid reservoir.

Maintenance



E170684

1. Park your vehicle on a level surface.
2. Look at the brake fluid reservoir to see where the brake fluid level is relative to the **MIN** and the **MAX** marks on the reservoir.

Note: If the brake fluid level is between the **MIN** and the **MAX** marks on the reservoir, it is acceptable.

Note: If the brake fluid level is below the **MIN** mark or above the **MAX** mark, have your vehicle checked as soon as possible.

Note: To avoid fluid contamination, the reservoir cap must remain in place and fully tight, unless you are adding fluid.

Only use fluid that meets our specifications. See **Capacities and Specifications** (page 219).

Brake Fluid Service Interval

Brake fluid absorbs water over time which degrades the effectiveness of the brake fluid. Change the brake fluid at the specified intervals to prevent degraded braking performance.

For detailed interval information, see Scheduled Maintenance in your Owner's Manual or your local maintenance guide.

POWER STEERING FLUID CHECK



WARNING: A fluid level between the **MAX** and **MIN** lines is within the normal operating range and there is no need to add fluid. A fluid level not in the normal operating range could compromise the performance of the system.



WARNING: For E-350 and E-450 vehicles with the Hydro-Boost Brake System, do not press the brake pedal after the engine has been turned off. Pressing the brake pedal after the engine has been turned off will give a false power steering fluid level reading.

Only use fluid that meets Ford specifications. See **Capacities and Specifications** (page 223).

To top up the power steering fluid level do the following.

1. Start the engine and let it run until it reaches normal operating temperature.
2. Make sure the fluid is within the **MIN** and **MAX** range.
3. If the fluid level is low, add fluid to be within the **MIN** and **MAX** range. Do not overfill.
4. While the engine idles, turn the steering wheel left and right several times.
5. Recheck the fluid level in the reservoir.

Note: Do not operate the vehicle with a low power steering pump fluid level.

Maintenance

WASHER FLUID CHECK



WARNING: If you operate your vehicle in temperatures below 40°F (5°C), use washer fluid with antifreeze protection. Failure to use washer fluid with antifreeze protection in cold weather could result in impaired windshield vision and increase the risk of injury or accident.

Add fluid to fill the reservoir if the level is low. Only use a washer fluid that meets Ford specifications. See **Capacities and Specifications** (page 219).

State or local regulations on volatile organic compounds may restrict the use of methanol, a common windshield washer antifreeze additive. Washer fluids containing non-methanol antifreeze agents should be used only if they provide cold weather protection without damaging the vehicle's paint finish, wiper blades or washer system.

FUEL FILTER

Your vehicle is equipped with a lifetime fuel filter that is integrated with the fuel tank. Regular maintenance or replacement is not needed.

CHANGING THE 12V BATTERY



WARNING: This vehicle may be fitted with more than one battery, removal of cable from only one battery does not disconnect the vehicle electrical system. Be sure to disconnect cables from all batteries when disconnecting power. Failure to do so may cause serious personal injury or property damage.



WARNING: Batteries normally produce explosive gases which can cause personal injury. Therefore, do not allow flames, sparks or lighted substances to come near the battery. When working near the battery, always shield your face and protect your eyes. Always provide proper ventilation.



WARNING: When lifting a plastic-cased battery, excessive pressure on the end walls could cause acid to flow through the vent caps, resulting in personal injury and/or damage to the vehicle or battery. Lift the battery with a battery carrier or with your hands on opposite corners.



WARNING: Keep batteries out of reach of children. Batteries contain sulfuric acid. Avoid contact with skin, eyes or clothing. Shield your eyes when working near the battery to protect against possible splashing of acid solution. In case of acid contact with skin or eyes, flush immediately with water for a minimum of 15 minutes and get prompt medical attention. If acid is swallowed, call a physician immediately.



WARNING: Battery posts, terminals and related accessories contain lead and lead compounds. Wash hands after handling.

Note: If your vehicle battery has a cover, make sure it is reinstalled after the battery has been cleaned or replaced.

Note: Electrical or electronic accessories or components added to the vehicle by the dealer or the owner may adversely affect battery performance and durability.

Your vehicle is fitted with a Motorcraft® maintenance-free battery which normally does not require additional water during its life of service.

Maintenance

For longer, trouble-free operation, keep the top of the battery clean and dry. Also, make certain the battery cables are always tightly fastened to the battery terminals.

If you see any corrosion on the battery or terminals, remove the cables from the terminals and clean with a wire brush. You can neutralize the acid with a solution of baking soda and water.

Always dispose of automotive batteries in a responsible manner. Follow your local authorized standards for disposal. Call your local authorized recycling center to find out more about recycling automotive batteries.

Reconnecting the Battery

Because your vehicle's engine is electronically controlled by a computer, some control conditions are maintained by power from the battery. When the battery is disconnected or a new battery is installed, the engine must relearn its idle and fuel trim strategy for optimum driveability and performance. Flexible fuel vehicles (FFV) must also relearn the ethanol content of the fuel for optimum driveability and performance.

To begin this process.

1. Switch off all accessories and start the engine.
2. Run the engine until it reaches normal operating temperature.
3. Allow the engine to idle for at least one minute.
4. Turn the A/C on and allow the engine to idle for at least one minute.
5. Fully press the foot brake. Release the parking brake. Shift the gearshift lever to Drive (D) and allow the engine to idle for at least one minute.
6. Drive the vehicle for approximately 10 mi (16 km) to complete the relearning process.

Note: *If you do not carry out the above process, the idle quality of your vehicle may be adversely affected until the idle trim is eventually relearned.*

Flexible fuel vehicles operating on E85 may experience poor starts and driveability problems until the fuel trim and ethanol content have been relearned.

When the battery is disconnected or a new battery installed, the transmission must learn its adaptive strategy. As a result of this, the transmission may shift firmly. This operation is considered normal and fully updates transmission operation to its optimum shift feel. We recommend that the negative battery cable terminal be disconnected from the battery if you plan to store your vehicle for an extended period of time. This minimizes the discharge of your battery during storage.

Dual Batteries (If Equipped)

Your vehicle may be fitted with a frame-mounted battery located on the passenger side frame rail, behind the front passenger door. This battery is connected in parallel with the battery in the engine compartment. Both batteries are used to start the vehicle.

CHECKING THE WIPER BLADES



E142463

Run the tip of your fingers over the edge of the blade to check for roughness.

Maintenance

Clean the wiper blades with washer fluid or water applied with a soft sponge or cloth.

CHANGING THE WIPER BLADES

You can manually move the wiper arms when the ignition is off. This allows for ease of blade replacement and cleaning under the blades.



E165804

1. Pull the wiper blade and arm away from the glass.



E165794

2. Release the wiper blade lock (A) and separate the wiper blade from the wiper arm.
3. Install in the reverse order.

Note: Make sure that the wiper blade locks into place. Lower the wiper arm and blade back on the windshield. The wiper arms will automatically return to their normal position when you turn the ignition on.

- Replace wiper blades at least once per year for optimum performance.
- You can improve poor wiper quality by cleaning the wiper blades and the windshield.

ADJUSTING THE HEADLAMPS

We properly aim the headlamps on your vehicle at the assembly plant. If your vehicle has been in an accident, have an authorized dealer check the alignment of your headlamps.

Vertical Aim Adjustment Procedure

You can only adjust the headlamps vertically. Your vehicle does not require horizontal aim adjustments.

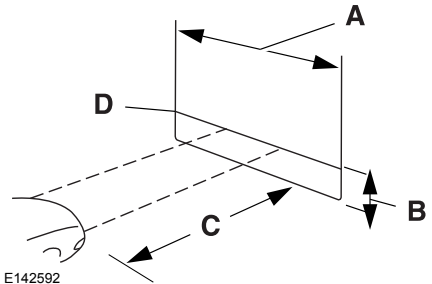

- A 8 feet (2.4 meters).
- B Center height of lamp to ground.
- C 25 feet (7.6 meters).
- D Horizontal reference line.

To adjust the headlamps:

Maintenance

1. Park the vehicle directly in front of a wall or screen on a level surface, approximately 25 ft (7.6 m) away.
2. Measure the height of the headlamp bulb center from the ground and mark an 8 ft (2.4 m) horizontal reference line on the vertical wall or screen at this height.

Note: To see a clearer light pattern for adjusting, you may want to block the light from one headlamp while adjusting the other.

3. Turn on the low beam headlamps to illuminate the wall or screen and open the hood.

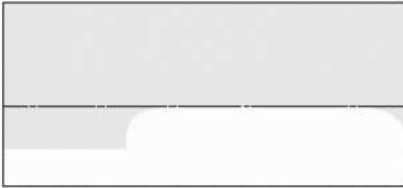

E142465

4. On the wall or screen, you will observe a flat zone of high intensity light located at the top of the right hand portion of the beam pattern. If the top edge of the high intensity light zone is not at the horizontal reference line, you will need to adjust the headlamp.



E163806

5. Locate the vertical adjuster on each headlamp. Using a Phillips #2 screwdriver, turn the adjuster either clockwise or counterclockwise in order to adjust the vertical aim of the headlamp.
6. Repeat steps 3 through 5 to adjust the other headlamp.
7. Close the hood and switch off the lamps.

REMOVING A HEADLAMP

1. Make sure the headlamp switch is in the off position, then open the hood.



E196385

2. Remove the three screws from the headlamp assembly and pull the assembly straight out.

Maintenance

3. Disconnect the electrical connector by squeezing the release tab and pushing the connector forward, then pulling it rearward.
4. Remove the headlamp.

To install the new lamp, follow the removal procedures in reverse order.

CHANGING A BULB

Lamp Assembly Condensation

Exterior lamps are vented to accommodate normal changes in pressure. Condensation can be a natural by-product of this design. When moist air enters the lamp assembly through the vents, there is a possibility that condensation can occur when the temperature is cold. When normal condensation occurs, a thin film of mist can form on the interior of the lens. The thin mist eventually clears and exits through the vents during normal operation. Clearing time may take as long as 48 hours under dry weather conditions.

Examples of acceptable condensation are:

- Presence of thin mist (no streaks, drip marks or droplets).
- Fine mist covers less than 50% of the lens.

Examples of unacceptable moisture (usually caused by a lamp water leak) are:

- Water puddle inside the lamp.
- Large water droplets, drip marks or streaks present on the interior of the lens.

Take your vehicle to a dealer for service if any of the above conditions of unacceptable moisture are present.

Replacing Headlamp Bulbs



WARNING: Make sure the bulbs have cooled down before removing them. Failure to follow this warning could result in serious personal injury.

Note: Grasp the bulb by only its plastic base and do not touch the glass. The oil from your hand could cause the bulb to break the next time the headlamps are operated.

Note: If the bulb is accidentally touched, clean it with rubbing alcohol before use.

1. Make sure the headlamp switch is in the off position, then open the hood.
2. Remove the headlamp. See **Removing a Headlamp** (page 176).
3. Disconnect the electrical connector by squeezing the release tab and pushing the connector forward, then pulling it rearward.



E196386

4. Remove the bulb assembly by turning it counterclockwise and pulling it straight out.

To install the new bulb, follow the removal procedures in reverse order.

Maintenance

Replacing Front Parking Lamp and Direction Indicator Bulbs



E196388

1. Make sure the headlamp switch is in the off position, then open the hood.
2. Remove the headlamp assembly. Refer to **Replacing Headlamp Bulbs** in this section.
3. Rotate the bulb socket counterclockwise and remove.
4. Carefully pry up the bulb straight out of the socket.

To complete installation, follow the removal procedures in reverse order.

Replacing Side Marker Bulbs



E196390

1. Make sure the headlamp switch is in the off position, then open the hood.

2. Remove the headlamp assembly. Refer to **Replacing Headlamp Bulbs** in this section.
3. Rotate the bulb socket counterclockwise and remove.
4. Carefully pry up the bulb straight out of the socket.

To complete installation, follow the removal procedures in reverse order.

Replacing Brake/Tail/Turn/Reverse Lamp Bulbs (Cut-Away Only)

1. Make sure the headlamps are off.



E163828

2. Remove the four screws and the lamp lens from the lamp assembly.
3. Carefully pull the bulb straight out of the socket and push in the new bulb.

CHANGING THE ENGINE AIR FILTER



WARNING: To reduce the risk of vehicle damage and personal burn injuries, do not start your engine with the air cleaner removed and do not remove it while the engine is running.

Maintenance

Note: Failure to use the correct air filter element may result in severe engine damage. The customer warranty may be void for any damage to the engine if the correct air filter element is not used.

When changing the air filter element, use only the air filter element listed. See **Motorcraft Parts** (page 219). The air filter element should be replaced at the appropriate intervals. See **Normal Scheduled Maintenance** (page 253).

Note: Failure to use the correct air filter element may result in severe engine damage. Resulting component damage may not be covered by the vehicle Warranty.

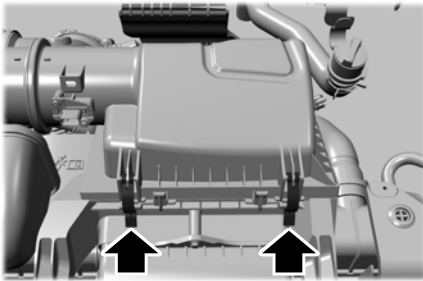

1. Release the clips (x2) that secure the two halves of the air filter housing together.

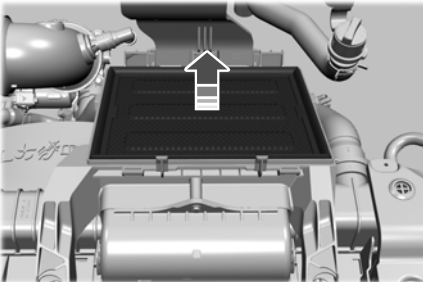

2. Carefully separate the two halves of the air filter housing.

3. Remove the air filter element from the housing.
4. Install a new air filter element. Be careful not to crimp the filter element edges between the air filter housing. This could cause filter damage and allow unfiltered air to enter the engine if not properly seated.
5. Install the air filter housing cover. Use special care to ensure that the air cleaner cover is reinstalled correctly. Verify that the tabs at the rear of the air cleaner housing cover are fully inserted into the slots at the rear of the air cleaner housing tray.
6. Secure the air filter housing clips (x2).

Vehicle Care

GENERAL INFORMATION

Your dealer has many quality products available to clean your vehicle and protect its finishes.

CLEANING PRODUCTS

Materials

For best results, use the following products or products of equivalent quality:

| Name | Specification |
|--|---------------|
| Motorcraft® Bug and Tar Remover, ZC-42 (U.S. & Canada) | |
| Motorcraft® Custom Bright Metal Cleaner, ZC-15 (U.S. & Canada) | ESR-M5B194-B |
| Motorcraft® Detail Wash, ZC-3-A (U.S. & Canada) | ESR-M14P4-A |
| Motorcraft® Engine Shampoo and Degreaser, ZC-20 (U.S.) | ESR-M14P3-A |
| Motorcraft® Engine Shampoo, CXC-66-A (Canada) | |
| Motorcraft® Premium Leather and Vinyl Cleaner, ZC-56 (U.S. & Canada) | |
| Motorcraft® Multi-Purpose Cleaner, CXC-101 (Canada) | |
| Motorcraft® Premium Windshield Wash Concentrate with Bitterant, ZC-32-B2 (U.S.) | WSS-M14P19-A |
| Motorcraft® Premium Quality Windshield Washer Fluid, CXC-37-A/B/D/F (Canada) | WSS-M14P19-A |
| Motorcraft® Professional Strength Carpet & Upholstery Cleaner, ZC-54 (U.S. & Canada) | |
| Motorcraft® Premium Glass Cleaner, CXC-100 (Canada) | ESR-M14P5-A |
| Motorcraft® Spot and Stain Remover, ZC-14 (U.S.) | |
| Motorcraft® Ultra-Clear Spray Glass Cleaner, ZC-23 (U.S.) | ESR-M14P5-A |
| Motorcraft® Wheel and Tire Cleaner, ZC-37-A (U.S. & Canada) | |

CLEANING THE EXTERIOR

Wash your vehicle regularly with cool or lukewarm water and a neutral pH shampoo, we recommend Motorcraft Detail Wash.

- Never use strong household detergents or soap, for example dish washing or laundry liquid. These products can discolor and spot painted surfaces.
- Never wash your vehicle when it is hot to the touch, or during strong or direct sunlight.

Vehicle Care

- Dry your vehicle with a chamois or soft terry cloth towel to eliminate water spotting.
- Immediately remove fuel spillages, bird droppings, insect deposits and road tar. These may cause damage to your vehicle's paintwork or trim over time. We recommend Motorcraft Bug and Tar Remover.
- Remove any exterior accessories, for example antennas, before entering a car wash.
- When filling with AdBlue®, remove any residue on painted surfaces immediately.

Note: *Suntan lotions and insect repellents can damage painted surfaces. If these substances come in contact with your vehicle, wash the affected area as soon as possible.*

Cleaning the Headlamps

Note: *Do not scrape the headlamp lenses or use abrasives, alcoholic solvents or chemical solvents to clean them.*

Note: *Do not wipe the headlamps when they are dry.*

Exterior Chrome Parts

- Apply a high quality-cleaning product to bumpers and other chrome parts. Follow the manufacturer's instructions. We recommend Motorcraft Custom Bright Metal Cleaner.
- Do not apply the cleaning product to hot surfaces. Do not leave the cleaning product on chrome surfaces longer than the time recommended.
- Using non-recommended cleaners can result in severe and permanent cosmetic damage.

Note: *Never use abrasive materials, for example steel wool or plastic pads as they can scratch the chrome surface.*

Note: *Do not use chrome cleaner, metal cleaner or polish on wheels or wheel covers.*

Exterior Plastic Parts

For routine cleaning we recommend Motorcraft Detail Wash. If tar or grease spots are present, we recommend Motorcraft Bug and Tar Remover.

Stripes or Graphics (If Equipped)

Hand washing your vehicle is preferred however, pressure washing may be used under the following conditions:

- Do not use water pressure higher than 2,000 psi (14,000 kPa).
- Do not use water hotter than 179°F (82°C).
- Use a spray with a 40° wide spray angle pattern.
- Keep the nozzle at a 12 in (305 mm) distance and 90° angle to your vehicle's surface.

Note: *Holding the pressure washer nozzle at an angle to the vehicle's surface may damage graphics and cause the edges to peel away from the vehicle's surface.*

Underbody

Regularly clean the underside of your vehicle using water. Keep body and door drain holes free of debris or foreign material.

Under Hood

For removing black rubber marks from under the hood we recommend Motorcraft Wheel and Tire Cleaner or Motorcraft Bug and Tar Remover.

Vehicle Care

WAXING

Regular waxing is necessary to protect your car's paint from the elements. We recommend that you wash and wax the painted surface once or twice a year.

When washing and waxing, park your vehicle in a shaded area out of direct sunlight. Always wash your vehicle before applying wax.

- Use a quality wax that does not contain abrasives.
- Follow the manufacturer's instructions to apply and remove the wax.
- Apply a small amount of wax in a back-and-forth motion, not in circles.
- Do not allow wax to come in contact with any non-body (low-gloss black) colored trim. The wax will discolor or stain the parts over time.
 - Roof racks.
 - Bumpers.
 - Grained door handles.
 - Side moldings.
 - Mirror housings.
 - Windshield cowl area.
- Do not apply wax to glass areas.
- After waxing, your car's paint should feel smooth, and be free of streaks and smudges.

CLEANING THE ENGINE

Engines are more efficient when they are clean because grease and dirt buildup keep the engine warmer than normal.

When washing:

- Take care when using a power washer to clean the engine. The high-pressure fluid could penetrate the sealed parts and cause damage.
- Do not spray a hot engine with cold water to avoid cracking the engine block or other engine components.
- Spray Motorcraft Engine Shampoo and Degreaser on all parts that require cleaning and pressure rinse clean. In Canada, use Motorcraft Engine Shampoo.

Note: *If your vehicle has an engine cover remove the cover before application of Motorcraft Engine Shampoo and Degreaser. Immediately rinse away any over spray.*

- Never wash or rinse the engine while it is hot or running; water in the running engine may cause internal damage.
- Never wash or rinse any ignition coil, spark plug wire or spark plug well, or the area in and around these locations.
- Cover the battery, power distribution box, and air filter assembly to prevent water damage when cleaning the engine.

CLEANING THE WINDOWS AND WIPER BLADES

Car wash chemicals and environmental fallout can result in windshield and wiper blade contamination. Dirty windshield and wipers will result in poor windshield wiper operation. Keep the windshield and wiper blades clean to maintain windshield wiper performance.

Vehicle Care

To clean the windshield and wiper blades:

- Clean the windshield with a non-abrasive glass cleaner. When cleaning the interior of the windshield, avoid getting any glass cleaner on the instrument panel or door panels. Wipe any glass cleaner off these surfaces immediately.
- For windshields contaminated with tree sap, chemicals, wax or bugs, clean the entire windshield using steel wool (no greater than 0000 grade) in a circular motion and rinse with water.
- Clean the wiper blades with isopropyl rubbing alcohol or windshield washer concentrate.

Note: Do not use razor blades or other sharp objects to clean or remove decals from the inside of the heated rear window. The vehicle warranty does not cover damage caused to the heated rear window grid lines.

CLEANING THE INTERIOR



WARNING: Do not use cleaning solvents, bleach or dye on the vehicle's seatbelts, as these actions may weaken the belt webbing.



WARNING: On vehicles equipped with seat-mounted airbags, do not use chemical solvents or strong detergents. Such products could contaminate the side airbag system and affect performance of the side airbag in a crash.

For fabric, carpets, cloth seats and seats equipped with side airbags:

- Remove dust and loose dirt with a vacuum cleaner.
- Remove light stains and soil with Motorcraft Professional Strength Carpet & Upholstery Cleaner.

- If grease or tar is present on the material, spot-clean the area first with Motorcraft Spot and Stain Remover. In Canada, use Motorcraft Multi-Purpose Cleaner.
- If a ring forms on the fabric after spot cleaning, clean the entire area immediately (but do not oversaturate) or the ring will set.
- Do not use household cleaning products or glass cleaners, which can stain and discolor the fabric and affect the flame retardant abilities of the seat materials.

Mirrors

Do not clean the housing or glass of any mirror with harsh abrasives, fuel or other petroleum or ammonia-based cleaning products.

CLEANING THE INSTRUMENT PANEL AND INSTRUMENT CLUSTER LENS



WARNING: Do not use chemical solvents or strong detergents when cleaning the steering wheel or instrument panel to avoid contamination of the airbag system.

Note: Follow the same procedure as cleaning leather seats for cleaning leather instrument panels and leather interior trim surfaces. See **Cleaning Leather Seats** (page 184).

Clean the instrument panel and cluster lens with a clean, damp and soft cloth, then use a clean, dry and soft cloth to dry these areas.

Vehicle Care

- Avoid cleaners or polishes that increase the gloss of the upper portion of the instrument panel. The dull finish in this area helps protect you from undesirable windshield reflection.
- Do not use any household cleaning products or glass cleaners as these may damage the finish of the instrument panel, interior trim and cluster lens.
- Wash or wipe your hands clean if you have been in contact with certain products such as insect repellent and suntan lotion to avoid possible damage to the interior painted surfaces.
- Do not allow air fresheners and hand sanitizers to spill onto interior surfaces. If a spill occurs, wipe off immediately. Your warranty may not cover these damages.

If a staining liquid like coffee or juice has been spilled on the instrument panel or on interior trim surfaces:

1. Wipe up spilled liquid using a clean, soft cloth as quickly as possible.
2. Use Motorcraft Premium Leather and Vinyl Cleaner or a commercially available leather cleaning product for automotive interiors. Test any cleaner or stain remover on an inconspicuous area.
3. Alternatively, wipe the surface with a clean, soft cloth and a mild soap and water solution. Dry the area with a clean, soft cloth.
4. If necessary, apply more soap and water solution or cleaning product to a clean, soft cloth and press it onto the soiled area. Allow this to set at room temperature for 30 minutes.
5. Remove the soaked cloth, then with a clean, damp cloth, use a rubbing motion for 60 seconds on the soiled area.

6. Dry the area with a clean, soft cloth.

CLEANING LEATHER SEATS

Note: *Follow the same procedure as cleaning leather seats for cleaning leather instrument panels and leather interior trim surfaces.*

For routine cleaning, wipe the surface with a soft, damp cloth and a mild soap and water solution. Dry the area with a clean, soft cloth.

For cleaning and removing stains such as dye transfer, use Motorcraft Premium Leather and Vinyl Cleaner or a commercially available leather cleaning product for automotive interiors.

Note: *Test any cleaner or stain remover on an inconspicuous area.*

You should:

- Remove dust and loose dirt with a vacuum cleaner.
- Clean and treat spills and stains as soon as possible.

Do not use the following products as these may damage the leather:

- Oil and petroleum or silicone-based leather conditioners.
- Household cleaners.
- Alcohol solutions.
- Solvents or cleaners intended specifically for rubber, vinyl and plastics.

Vehicle Care

REPAIRING MINOR PAINT DAMAGE

Authorized dealers have touch-up paint to match your vehicle's color. Your vehicle color code is printed on a sticker on the front, left-hand side door jamb. Take your color code to your authorized dealer to make sure you get the correct color.

Before repairing minor paint damage, use a cleaner such as Motorcraft Bug and Tar Remover to remove particles such as bird droppings, tree sap, insect deposits, tar spots, road salt and industrial fallout.

Always read the instructions before using cleaning products.

CLEANING THE WHEELS

1. Regularly clean them with a wheel cleaner. We recommend that you use Ford approved wheel cleaner if available.
2. Remove dirt and brake dust with a sponge.
3. Remove tar and grease with a bug and tar remover. We recommend that you use Ford approved bug and tar remover if available.
4. Thoroughly rinse the wheels with water after cleaning.

If you intend on parking your vehicle for an extended period after cleaning the wheels with a wheel cleaner, drive your vehicle for a few minutes before doing so. This reduces the risk of corrosion of the brake discs, brake pads and linings.

Do not clean the wheels when they are hot.

Note: *Some car washes could damage wheel rims and covers.*

Note: *Using non-recommended cleaners, harsh cleaning products, chrome wheel cleaners or abrasive materials could damage wheel rims and covers.*

VEHICLE STORAGE

If you plan on storing your vehicle for 30 days or more, read the following maintenance recommendations to make sure your vehicle stays in good operating condition.

We engineer and test all motor vehicles and their components for reliable, regular driving. Under various conditions, long-term storage may lead to degraded engine performance or failure unless you use specific precautions to preserve engine components.

General

- Store all vehicles in a dry, ventilated place.
- Protect from sunlight, if possible.
- If vehicles are stored outside, they require regular maintenance to protect against rust and damage.

Body

- Wash your vehicle thoroughly to remove dirt, grease, oil, tar or mud from exterior surfaces, rear-wheel housing and the underside of front fenders.
- Periodically wash your vehicle if it is stored in exposed locations.
- Touch-up exposed or primed metal to prevent rust.
- Cover chrome and stainless steel parts with a thick coat of auto wax to prevent discoloration. Re-wax as necessary when you wash your vehicle.
- Lubricate all hood, door and luggage compartment hinges and latches with a light grade oil.

Vehicle Care

- Cover interior trim to prevent fading.
- Keep all rubber parts free from oil and solvents.

Engine

- Change the engine oil and filter prior to storage because used engine oil contains contaminants which may cause engine damage.
- Start the engine every 15 days for a minimum of 15 minutes. Run at fast idle with the climate controls set to defrost until the engine reaches normal operating temperature.
- With your foot on the brake, shift through all the gears while the engine is running.
- We recommend that you change the engine oil before you use your vehicle again.

Fuel system

- Fill the fuel tank with high-quality fuel until the first automatic shutoff of the fuel pump nozzle.

Cooling system

- Protect against freezing temperatures.
- When removing your vehicle from storage, check coolant fluid level. Confirm that there are no cooling system leaks and that fluid is at the recommended level.

Disconnecting Your 12 Volt Battery

- Check and recharge as necessary. Keep connections clean.
- If storing your vehicle for more than 30 days without recharging the battery, we recommend that you disconnect the battery cables to maintain battery charge for quick starting.

Note: *It is necessary to reset memory features if you disconnect the battery cables.*

Brakes

- Make sure the brakes and parking brake release fully.

Tires

- Maintain recommended air pressure.

Miscellaneous

- Make sure all linkages, cables, levers and pins under your vehicle are covered with grease to prevent rust.
- Move vehicles at least 25 ft (7.5 m) every 15 days to lubricate working parts and prevent corrosion.

Removing Vehicle From Storage

When your vehicle is ready to come out of storage, do the following:

- Wash your vehicle to remove any dirt or grease film build-up on window surfaces.
- Check windshield wipers for any deterioration.
- Check under the hood for any foreign material that may have collected during storage such as mice or squirrel nests.
- Check the exhaust for any foreign material that may have collected during storage.
- Check tire pressures and set tire inflation per the Tire Label.
- Check brake pedal operation. Drive your vehicle 15 ft (4.5 m) back and forth to remove rust build-up.

Vehicle Care

- Check fluid levels (including coolant, oil and gas) to make sure there are no leaks, and fluids are at recommended levels.
- If you remove the battery, clean the battery cable ends and check for damage.

Contact an authorized dealer if you have any concerns or issues.

Wheels and Tires

GENERAL INFORMATION

Notice to Utility Vehicle, Van and Truck Owners



WARNING: Utility vehicles have a significantly higher rollover rate than other types of vehicles. To reduce the risk of serious injury or death from a rollover or other crash you must avoid sharp turns and abrupt maneuvers, drive at safe speeds for the conditions, keep tires properly inflated, never overload or improperly load your vehicle, and make sure every passenger is properly restrained.



WARNING: In a rollover crash, an unbelted person is significantly more likely to die than a person wearing a seat belt. All occupants must wear seat belts. Children and infants must use appropriate restraints to minimize the risk of injury or ejection.



E145298

Utility vehicles and trucks handle differently than passenger cars in the various driving conditions that are encountered on streets, highways and off-road. Utility vehicles and trucks are not designed for cornering at speeds as high as passenger cars any more than low-slung sports cars are designed to perform satisfactorily under off-road conditions.

How Your Vehicle Differs from Other Vehicles

Sport-utility vehicles, vans and trucks can differ from some other vehicles in a few noticeable ways. Your vehicle may be:

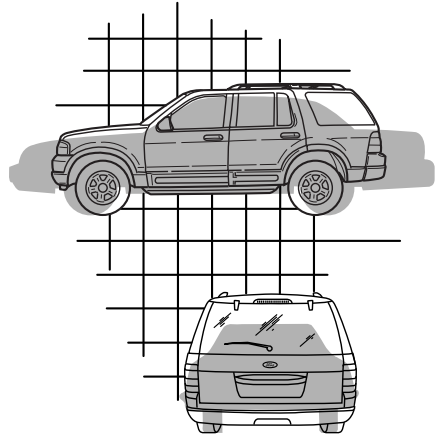

E145299

Wheels and Tires

- Higher - to allow higher load carrying capacity and to allow it to travel over rough terrain without getting hung up or damaging underbody components.
- Shorter - to give it the capability to approach inclines and drive over the crest of a hill without getting hung up or damaging underbody components. All other things held equal, a shorter wheelbase may make your vehicle quicker to respond to steering inputs than a vehicle with a longer wheelbase.
- Narrower - to provide greater maneuverability in tight spaces, particularly in off-road use.

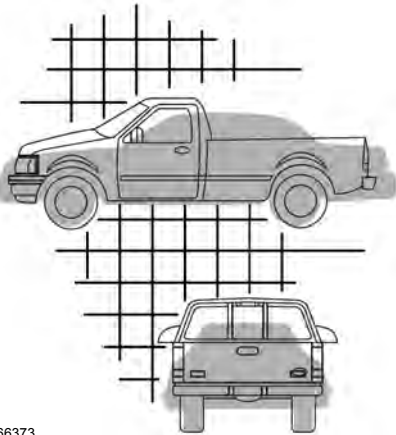

E166373

As a result of the above dimensional differences, sport-utility vehicles, vans and trucks often will have a higher center of gravity and a greater difference in center of gravity between the loaded and unloaded condition.

These differences that make your vehicle so versatile also make it handle differently than an ordinary passenger car.

TIRE CARE

Information About Uniform Tire Quality Grading



E142542

Tire Quality Grades apply to new pneumatic passenger car tires. The Quality grades can be found where applicable on the tire sidewall between tread shoulder and maximum section width. For example: **Treadwear 200 Traction AA Temperature A.**

These Tire Quality Grades are determined by standards that the United States Department of Transportation has set.

Tire Quality Grades apply to new pneumatic passenger car tires. They do not apply to deep tread, winter-type snow tires, space-saver or temporary use spare tires, light truck or LT type tires, tires with nominal rim diameters of 10 to 12 inches or limited production tires as defined in Title 49 Code of Federal Regulations Part 575.104 (c)(2).

Wheels and Tires

U.S. Department of Transportation Tire quality grades:

The U.S. Department of Transportation requires Ford Motor Company to give you the following information about tire grades exactly as the government has written it.

Treadwear

The treadwear grade is a comparative rating based on the wear rate of the tire when tested under controlled conditions on a specified government test course. For example, a tire graded 150 would wear one and one-half (1 ½) times as well on the government course as a tire graded 100. The relative performance of tires depends upon the actual conditions of their use, however, and may depart significantly from the norm due to variations in driving habits, service practices, and differences in road characteristics and climate.

Traction AA A B C



WARNING: The traction grade assigned to this tire is based on straight-ahead braking traction tests, and does not include acceleration, cornering, hydroplaning or peak traction characteristics.

The traction grades, from highest to lowest are AA, A, B, and C. The grades represent the tire's ability to stop on wet pavement as measured under controlled conditions on specified government test surfaces of asphalt and concrete. A tire marked C may have poor traction performance.

Temperature A B C



WARNING: The temperature grade for this tire is established for a tire that is properly inflated and not overloaded. Excessive speed, underinflation, or excessive loading, either separately or in combination, can cause heat buildup and possible tire failure.

The temperature grades are A (the highest), B and C, representing the tire's resistance to the generation of heat and its ability to dissipate heat when tested under controlled conditions on a specified indoor laboratory test wheel. Sustained high temperature can cause the material of the tire to degenerate and reduce tire life, and excessive temperature can lead to sudden tire failure. The grade C corresponds to a level of performance which all passenger car tires must meet under the

Wheels and Tires

Federal Motor Vehicle Safety Standard No. 139. Grades B and A represent higher levels of performance on the laboratory test wheel than the minimum required by law.

Glossary of Tire Terminology

***Tire label:** A label showing the original equipment tire sizes, recommended inflation pressure and the maximum weight the vehicle can carry.

***Tire Identification Number (TIN):** A number on the sidewall of each tire providing information about the tire brand and manufacturing plant, tire size and date of manufacture. Also referred to as DOT code.

***Inflation pressure:** A measure of the amount of air in a tire.

***Standard load:** A class of P-metric or Metric tires designed to carry a maximum load at set pressure. For example: For P-metric tires 35 psi (2.4 bar) and for Metric tires 36 psi (2.5 bar). Increasing the inflation pressure beyond this pressure does not increase the tire's load carrying capability.

***Extra load:** A class of P-metric or Metric tires designed to carry a heavier maximum load at 42 psi (2.9 bar). Increasing the inflation pressure beyond this pressure does not increase the tire's load carrying capability.

***kPa:** Kilopascal, a metric unit of air pressure.

***PSI:** Pounds per square inch, a standard unit of air pressure.

***Cold tire pressure:** The tire pressure when the vehicle has been stationary and out of direct sunlight for an hour or more and prior to the vehicle being driven for 1.0 mi (1.6 km).

***Recommended inflation pressure:** The cold inflation pressure found on the Safety Compliance Certification Label (affixed to either the door hinge pillar, door-latch post, or the door edge that meets the door-latch post, next to the driver's seating position), or Tire Label located on the B-pillar or the edge of the driver's door.

B-pillar: The structural member at the side of the vehicle behind the front door.

***Bead area of the tire:** Area of the tire next to the rim.

* **Sidewall of the tire:** Area between the bead area and the tread.

***Tread area of the tire:** Area of the perimeter of the tire that contacts the road when mounted on the vehicle.

***Rim:** The metal support (wheel) for a tire or a tire and tube assembly upon which the tire beads are seated.

Wheels and Tires

Information Contained on the Tire Sidewall

Both United States and Canada Federal regulations require tire manufacturers to place standardized information on the sidewall of all tires. This information identifies and describes the fundamental characteristics of the tire and also provides a U.S. DOT Tire Identification Number for safety standard certification and in case of a recall.

Information on P Type Tires

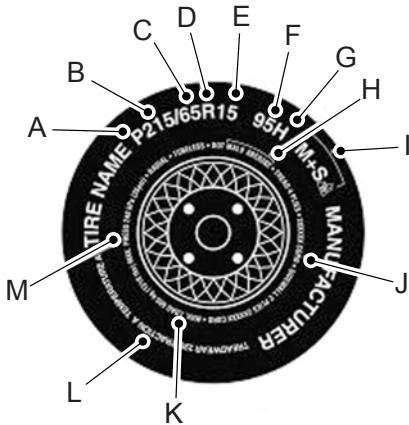

E142543

P215/65R15 95H is an example of a tire size, load index and speed rating. The definitions of these items are listed below. (Note that the tire size, load index and speed rating for your vehicle may be different from this example.)

A. P: Indicates a tire, designated by the Tire and Rim Association, that may be used for service on cars, sport utility vehicles, minivans and light trucks. **Note:** If your tire size does not begin with a letter this may mean it is designated by either the European Tire and Rim Technical Organization or the Japan Tire Manufacturing Association.

B. 215: Indicates the nominal width of the tire in millimeters from sidewall edge to sidewall edge. In general, the larger the number, the wider the tire.

C. 65: Indicates the aspect ratio which gives the tire's ratio of height to width.

D. R: Indicates a radial type tire.

E. 15: Indicates the wheel or rim diameter in inches. If you change your wheel size, you have to purchase new tires to match the new wheel diameter.

F. 95: Indicates the tire's load index. It is an index that relates to how much weight a tire can carry. You may find this information in your owner's manual. If not, contact a local tire dealer.

Note: You may not find this information on all tires because it is not required by federal law.

Wheels and Tires

G. H: Indicates the tire's speed rating. The speed rating denotes the speed at which a tire is designed to be driven for extended periods of time under a standard condition of load and inflation pressure. The tires on your vehicle may operate at different conditions for load and inflation pressure. These speed ratings may need to be adjusted for the difference in conditions. The ratings range from 81–186 mph (130–299 km/h). These ratings are listed in the following chart.

Note: You may not find this information on all tires because it is not required by federal law.

| Letter rating | mph (km/h) |
|---------------|-------------|
| L | 75 (120) |
| M | 81 (130) |
| N | 87 (140) |
| Q | 99 (159) |
| R | 106 (171) |
| S | 112 (180) |
| T | 118 (190) |
| U | 124 (200) |
| H | 130 (210) |
| V | 149 (240) |

| Letter rating | mph (km/h) |
|---------------|-------------|
| W | 168 (270) |
| Y | 186 (299) |

Note: For tires with a maximum speed capability over 149 mph (240 km/h), tire manufacturers sometimes use the letters ZR. For those with a maximum speed capability over 186 mph (299 km/h), tire manufacturers always use the letters ZR.

H. U.S. DOT Tire Identification

Number: This begins with the letters DOT and indicates that the tire meets all federal standards. The next two numbers or letters are the plant code designating where it was manufactured, the next two are the tire size code and the last four numbers represent the week and year the tire was built. For example, the numbers 317 mean the 31st week of 1997. After 2000 the numbers go to four digits. For example, 2501 means the 25th week of 2001. The numbers in between are identification codes used for traceability. This information is used to contact customers if a tire defect requires a recall.

I. M+S or M/S: Mud and Snow, or

AT: All Terrain, or

AS: All Season.

Wheels and Tires

J. Tire Ply Composition and Material Used: Indicates the number of plies or the number of layers of rubber-coated fabric in the tire tread and sidewall. Tire manufacturers also must indicate the ply materials in the tire and the sidewall, which include steel, nylon, polyester, and others.

K. Maximum Load: Indicates the maximum load in kilograms and pounds that can be carried by the tire. (affixed to either the door hinge pillar, door-latch post, or the door edge that meets the door-latch post, next to the driver's seating position), or Tire Label located on the B-pillar or the edge of the driver's door.

L. Treadwear, Traction and Temperature Grades:

***Treadwear:** The treadwear grade is a comparative rating based on the wear rate of the tire when tested under controlled conditions on a specified government test course. For example, a tire graded 150 would wear 1½ times as well on the government course as a tire graded 100.

***Traction:** The traction grades, from highest to lowest are AA, A, B, and C. The grades represent the tire's ability to stop on wet pavement as measured under controlled conditions on specified government test surfaces of asphalt and concrete. A tire marked C may have poor traction performance.

***Temperature:** The temperature grades are A (the highest), B and C, representing the tire's resistance to the generation of heat and its ability to dissipate heat when tested under controlled conditions on a specified indoor laboratory test wheel.

M. Maximum Inflation Pressure: Indicates the tire manufacturers' maximum permissible pressure or the pressure at which the maximum load can be carried by the tire. This pressure is normally higher than the vehicle manufacturer's recommended cold inflation pressure which can be found on the Safety Compliance Certification Label (affixed to either the door hinge pillar, door-latch post, or the door edge that meets the door-latch post, next to the driver's seating position), or Tire Label located on the B-pillar or the edge of the driver's door. The cold inflation pressure should never be set lower than the recommended pressure on the vehicle label.

Wheels and Tires

The tire suppliers may have additional markings, notes or warnings such as standard load or radial tubeless.

Additional Information Contained on the Tire Sidewall for LT Type Tires

Note: *Tire Quality Grades do not apply to this type of tire.*

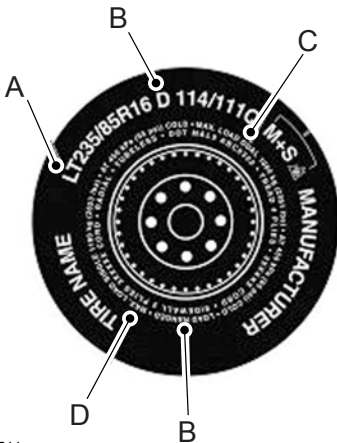

E142544

LT type tires have some additional information beyond those of P type tires. These differences are described below.

A. LT: Indicates a tire, designated by the Tire and Rim Association, that is intended for service on light trucks.

B. Load Range and Load Inflation Limits: Indicates the tire's load-carrying capabilities and its inflation limits.

C. Maximum Load Dual lb (kg) at psi (kPa) cold: Indicates the maximum load and tire pressure when the tire is used as a dual; defined as four tires on the rear axle (a total of six or more tires on the vehicle).

D. Maximum Load Single lb (kg) at psi (kPa) cold: Indicates the maximum load and tire pressure when the tire is used as a single; defined as two tires (total) on the rear axle.

Information on T Type Tires

T145/80D16 is an example of a tire size.

Note: *The temporary tire size for your vehicle may be different from this example. Tire Quality Grades do not apply to this type of tire.*

Wheels and Tires

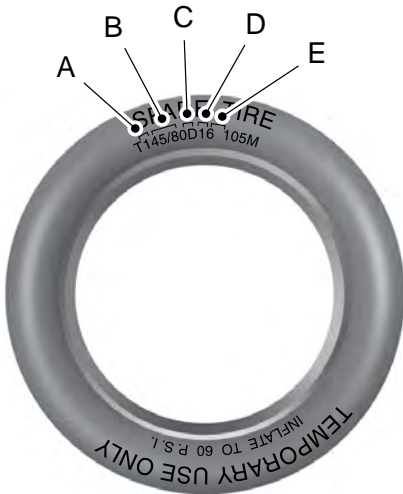

E142545

T type tires have some additional information beyond those of P type tires. These differences are described below:

A. T: Indicates a type of tire, designated by the Tire and Rim Association, that is intended for temporary service on cars, sport utility vehicles, minivans and light trucks.

B. 145: Indicates the nominal width of the tire in millimeters from sidewall edge to sidewall edge. In general, the larger the number, the wider the tire.

C. 80: Indicates the aspect ratio which gives the tire's ratio of height to width. Numbers of 70 or lower indicate a short sidewall.

D. D: Indicates a diagonal type tire.

R: Indicates a radial type tire.

E. 16: Indicates the wheel or rim diameter in inches. If you change your wheel size, you have to purchase new tires to match the new wheel diameter.

Location of the Tire Label

You can find a Tire Label containing tire inflation pressure by tire size and other important information located on the B-Pillar or the edge of the driver's door.

Inflating Your Tires

Safe operation of your vehicle requires that your tires are properly inflated. Remember that a tire can lose up to half of its air pressure without appearing flat.

Every day before you drive, check your tires. If one looks lower than the others, use a tire gauge to check pressure of all tires and adjust if required.

At least once a month and before long trips, inspect each tire and check the tire pressure with a tire gauge (including spare, if equipped). Inflate all tires to the inflation pressure recommended by Ford Motor Company.

Wheels and Tires

You are strongly urged to buy a reliable tire pressure gauge, as automatic service station gauges may be inaccurate. Ford recommends the use of a digital or dial-type tire pressure gauge rather than a stick-type tire pressure gauge.

Use the recommended cold inflation pressure for optimum tire performance and wear. Under-inflation or over-inflation may cause uneven treadwear patterns



WARNING: Under-inflation is the most common cause of tire failures and may result in severe tire cracking, tread separation or blowout, with unexpected loss of vehicle control and increased risk of injury. Under-inflation increases sidewall flexing and rolling resistance, resulting in heat buildup and internal damage to the tire. It also may result in unnecessary tire stress, irregular wear, loss of vehicle control and accidents. A tire can lose up to half of its air pressure and not appear to be flat!

Always inflate your tires to the Ford recommended inflation pressure even if it is less than the maximum inflation pressure information found on the tire. The Ford recommended tire inflation pressure is found on the Safety Compliance Certification Label or

Tire Label (affixed to either the door hinge pillar, door-latch post, or the door edge that meets the door-latch post, next to the driver's seating position), or Tire Label located on the B-pillar or the edge of the driver's door. Failure to follow the tire pressure recommendations can cause uneven treadwear patterns and adversely affect the way your vehicle handles

Note: *Do not reduce tire pressure to change the ride characteristics of the vehicle. If you do not maintain the inflation pressure at the levels specified by Ford, your vehicle may experience a condition known as shimmy. Shimmy is a severe vibration and oscillation in the steering wheel after the vehicle travels over a bump or dip in the road that does not dampen out by itself. Shimmy may result from significant under-inflation of the tires, improper tires (load range, size, or type), or vehicle modifications such as lift-kits. In the event that your vehicle experiences shimmy, you should slowly reduce speed by either lifting off the accelerator pedal or lightly applying the brakes. The shimmy ceases as the vehicle speed decreases.*

Maximum Inflation Pressure is the tire manufacturer's maximum permissible pressure and the pressure at which the maximum load can be carried by the tire. This pressure is normally higher than

Wheels and Tires

the manufacturer's recommended cold inflation pressure which can be found on the Safety Compliance Certification Label (affixed to either the door hinge pillar, door-latch post, or the door edge that meets the door-latch post, next to the driver's seating position), or Tire Label located on the B-pillar or the edge of the driver's door. The cold inflation pressure should never be set lower than the recommended pressure on the Safety Compliance Certification Label or Tire Label.

When weather temperature changes occur, tire inflation pressures also change. A 10°F (6°C) temperature drop can cause a corresponding drop of 1 psi (7 kPa) in inflation pressure. Check your tire pressures frequently and adjust them to the proper pressure which can be found on the Safety Compliance Certification Label or Tire Label.

To check the pressure in your tire(s):

1. Make sure the tires are cool, meaning they are not hot from driving even a mile.

Note: *If you are checking tire pressure when the tire is hot, (for example, driven more than 1.0 mi (1.6 km)), never bleed or reduce air pressure. The tires are hot from driving and it is normal for pressures to increase above recommended cold pressures. A hot tire at or below recommended cold inflation pressure could be significantly under-inflated.*

Note: *If you have to drive a distance to get air for your tire(s), check and record the tire pressure first and add the appropriate air pressure when you get to the pump. It is normal for tires to heat up and the air pressure inside to go up as you drive.*

2. Remove the cap from the valve on one tire, then firmly press the tire gauge onto the valve and measure the pressure.

3. Add enough air to reach the recommended air pressure.

Note: *If you overfill the tire, release air by pressing on the metal stem in the center of the valve. Then recheck the pressure with your tire gauge.*

4. Replace the valve cap.

5. Repeat this procedure for each tire, including the spare.

Wheels and Tires

Note: *Some spare tires operate at a higher inflation pressure than the other tires. For T type mini-spare tires, (see the Dissimilar spare wheel and tire assembly information for a description. Store and maintain at 60 psi (4.15 bar). For full-size and dissimilar spare tires, see the Dissimilar spare wheel and tire assembly information for a description. Store and maintain at the higher of the front and rear inflation pressure as shown on the Safety Compliance Certification Label or Tire Label.*

6. Visually inspect the tires to make sure there are no nails or other objects embedded that could poke a hole in the tire and cause an air leak.

7. Check the sidewalls to make sure there are no gouges, cuts or bulges.

Tire Inflation Information



WARNING: An inflated tire and rim can be very dangerous if improperly used, serviced or maintained. To reduce the risk of serious injury, never attempt to re-inflate a tire which has

been run flat or seriously under-inflated without first removing the tire from the wheel assembly for inspection. Do not attempt to add air to tires or replace tires or wheels without first taking precautions to protect persons and property.

All tires with Steel Carcass Plies (if equipped):

This type of tire utilizes steel cords in the sidewalls. As such, they cannot be treated like normal light truck tires. Tire service, including adjusting tire pressure, must be performed by personnel trained, supervised and equipped according to Federal Occupational Safety and Health Administration regulations. For example, during any procedure involving tire inflation, the technician or individual must utilize a remote inflation device, and ensure that all persons are clear of the trajectory area.

Wheels and Tires

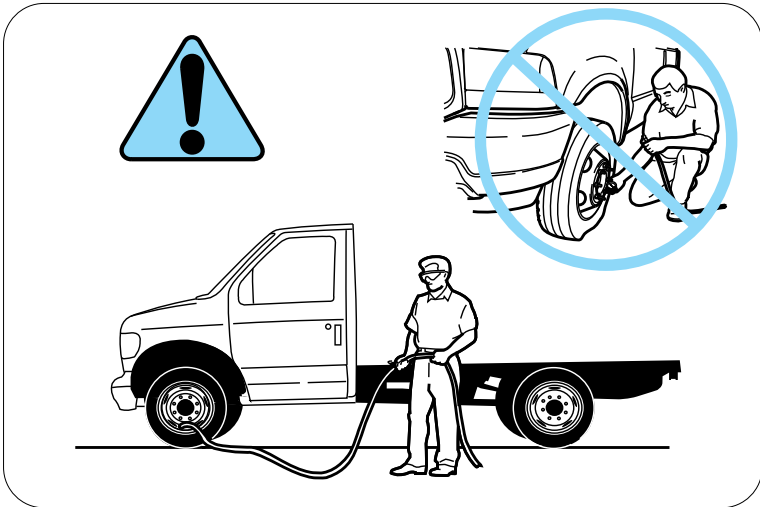

E161437

Wheels and Tires

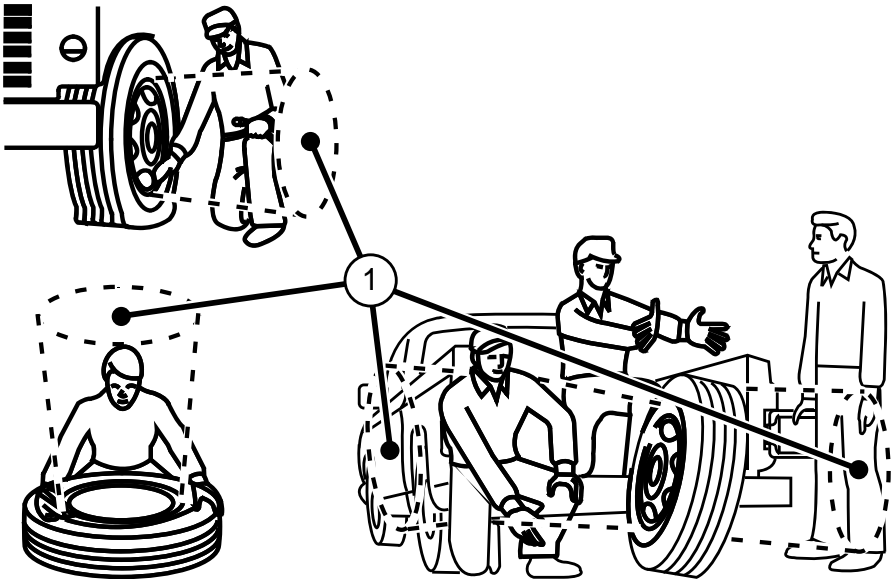

E161438

Note: *Stay out of the trajectory (1) as indicated in the illustration.*

Inspecting Your Tires and Wheel Valve Stems

Periodically inspect the tire treads for uneven or excessive wear and remove objects such as stones, nails or glass that may be wedged in the tread grooves. Check the tire and valve stems for holes, cracks, or cuts that may permit air leakage and repair or replace the tire and replace the valve stem. Inspect the tire sidewalls for cracking, cuts, bruises and other signs of damage or excessive wear. If internal damage to the tire

is suspected, have the tire demounted and inspected in case it needs to be repaired or replaced. For your safety, tires that are damaged or show signs of excessive wear should not be used because they are more likely to blow out or fail.

Improper or inadequate vehicle maintenance can cause tires to wear abnormally. Inspect all your tires, including the spare, frequently, and replace them if one or more of the following conditions exist:

Wheels and Tires

Tire Wear

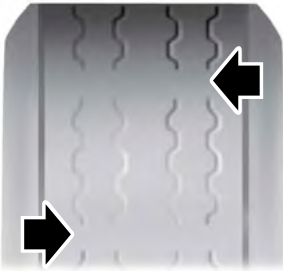

E142546

When the tread is worn down to one sixteenth of an inch (2 millimeters), tires must be replaced to help prevent your vehicle from skidding and hydroplaning. Built-in treadwear indicators, or wear bars, which look like narrow strips of smooth rubber across the tread appears on the tire when the tread is worn down to one sixteenth of an inch (2 millimeters).

When the tire tread wears down to the same height as these wear bars, the tire is worn out and must be replaced.

Damage

Periodically inspect the tire treads and sidewalls for damage (such as bulges in the tread or sidewalls, cracks in the tread groove and separation in the tread or sidewall). If damage is observed

or suspected have the tire inspected by a tire professional. Tires can be damaged during off-road use, so inspection after off-road use is also recommended.

Age



WARNING: Tires degrade over time depending on many factors such as weather, storage conditions, and conditions of use (load, speed, inflation pressure) the tires experience throughout their lives.

In general, tires should be replaced after six years regardless of tread wear. However, heat caused by hot climates or frequent high loading conditions can accelerate the aging process and may require tires to be replaced more frequently.

You should replace your spare tire when you replace the road tires or after six years due to aging even if it has not been used.

U.S. DOT Tire Identification Number

Both United States and Canada Federal regulations require tire manufacturers to place standardized information on the sidewall of all tires. This information identifies and

Wheels and Tires

describes the fundamental characteristics of the tire and also provides a U.S. DOT Tire Identification Number for safety standard certification and in case of a recall.

This begins with the letters DOT and indicates that the tire meets all federal standards. The next two numbers or letters are the plant code designating where it was manufactured, the next two are the tire size code and the last four numbers represent the week and year the tire was built. For example, the numbers 317 mean the 31st week of 1997. After 2000 the numbers go to four digits. For example, 2501 means the 25th week of 2001. The numbers in between are identification codes used for traceability. This information is used to contact customers if a tire defect requires a recall.

Tire Replacement Requirements

Your vehicle is equipped with tires designed to provide a safe ride and handling capability.



WARNING: Only use replacement tires and wheels that are the same size, load index, speed rating and type (such as P-metric versus LT-metric or all-season versus all-terrain) as those originally provided by Ford. The

recommended tire and wheel size may be found on either the Safety Compliance Certification Label (affixed to either the door hinge pillar, door-latch post, or the door edge that meets the door-latch post, next to the driver's seating position), or the Tire Label which is located on the B-Pillar or edge of the driver's door. If this information is not found on these labels, then you should contact your authorized dealer as soon as possible. Use of any tire or wheel not recommended by Ford can affect the safety and performance of your vehicle, which could result in an increased risk of loss of vehicle control, vehicle rollover, personal injury and death.



WARNING: To reduce the risk of serious injury, when mounting replacement tires and wheels, you should not exceed the maximum pressure indicated on the sidewall of the tire to set the beads without additional precautions listed below. If the beads do not seat at the maximum pressure indicated, re-lubricate and try again.

Wheels and Tires



WARNING: For a mounting pressure more than 20 psi (1.38 bar) greater than the maximum pressure, a Ford dealer or other tire service professional should do the mounting.



WARNING: Always inflate steel carcass tires with a remote air fill with the person inflating standing at a minimum of 12 ft (3.66 m) away from the wheel and tire assembly.



WARNING: When inflating the tire for mounting pressures up to 20 psi (1.38 bar) greater than the maximum pressure on the tire sidewall, the following precautions must be taken to protect the person mounting the tire:

- Make sure that you have the correct tire and wheel size.
- Lubricate the tire bead and wheel bead seat area again.
- Stand at a minimum of 12 ft (3.6 m) away from the wheel and tire assembly.
- Use both eye and ear protection.

Important: Remember to replace the wheel valve stems when the road tires are replaced on your vehicle

The two front tires or two rear tires should generally be replaced as a pair.

The tire pressure sensors mounted in the wheels are not designed to be used in aftermarket wheels.

The use of wheels or tires not recommended by Ford Motor Company may affect the operation of your tire pressure monitoring system.

If the tire pressure monitoring system indicator is flashing, the system is malfunctioning. Your replacement tire might be incompatible with your tire pressure monitoring system, or some component of the system may be damaged.

Replacing a Tire That is Greenhouse Gas Certified

The tires installed on this vehicle at the factory as original equipment are certified for Greenhouse Gas and Fuel Efficiency regulations. Replacement tires must be of equal or lower rolling resistance level (TRRL or Crr). Consult with your tire supplier(s) for appropriate replacement tires.

Wheels and Tires

Safety Practices



WARNING: If your vehicle is stuck in snow, mud or sand, do not rapidly spin the tires; spinning the tires can tear the tire and cause an explosion. A tire can explode in as little as three to five seconds.



WARNING: Do not spin the wheels at over 34 mph (55 km/h). The tires may fail and injure a passenger or bystander.

Driving habits have a great deal to do with your tire mileage and safety.

- *Observe posted speed limits
- *Avoid fast starts, stops and turns
- *Avoid potholes and objects on the road
- *Do not run over curbs or hit the tire against a curb when parking

Highway Hazards

No matter how carefully you drive there's always the possibility that you may eventually have a flat tire on the highway. Drive slowly to the closest safe area out of traffic. This may further damage the flat tire, but your safety is more important.

If you feel a sudden vibration or ride disturbance when driving, or you suspect your tire or vehicle has been damaged, immediately reduce your speed. Drive with caution until you can safely pull off the road. Stop and inspect the tires for damage. If a tire is under-inflated or damaged, deflate it, remove wheel and replace it with your spare tire and wheel. If you cannot detect a cause, have the vehicle towed to the nearest repair facility or tire dealer to have the vehicle inspected.

Tire and Wheel Alignment

A bad jolt from hitting a curb or pothole can cause the front end of your vehicle to become misaligned or cause damage to your tires. If your vehicle seems to pull to one side when you're driving, the wheels may be out of alignment. Have an authorized dealer check the wheel alignment periodically.

Wheel misalignment in the front or the rear can cause uneven and rapid treadwear of your tires and should be corrected by an authorized dealer. Front-wheel drive vehicles and those with an independent rear suspension may require alignment of all four wheels.

The tires should also be balanced periodically. An unbalanced tire and wheel assembly may result in irregular tire wear.

Wheels and Tires

Tire Rotation



WARNING: If the tire label shows different tire pressures for the front and rear tires and the vehicle has a tire pressure monitoring system, then you need to update the settings for the system sensors. Always perform the system reset procedure after tire rotation. If you do not reset the system, it may not provide a low tire pressure warning when necessary.

Note: If your tires show uneven wear ask an authorized dealer to check for and correct any wheel misalignment, tire imbalance or mechanical problem involved before tire rotation.

Note: Your vehicle may be equipped with a dissimilar spare wheel and tire assembly. A dissimilar spare wheel and tire assembly is defined as a spare wheel and tire assembly that is different in brand, size or appearance from the road tires and wheels. If you have a dissimilar spare wheel and tire assembly it is intended for temporary use only and should not be used in a tire rotation.

Note: After having your tires rotated, inflation pressure must be checked and adjusted to the vehicle requirements.

Rotating your tires at the recommended interval (as indicated in the Scheduled Maintenance chapter) helps your tires wear more evenly, providing better tire performance and longer tire life. Sometime irregular tire wear can be corrected by rotating the tires.

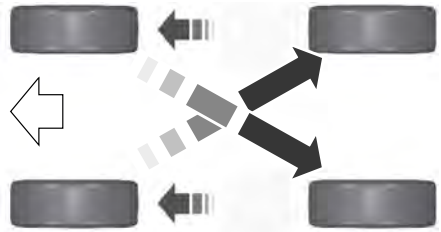

E142548

Rear-wheel drive vehicles and four-wheel drive vehicles (front tires at left of diagram).

Wheels and Tires

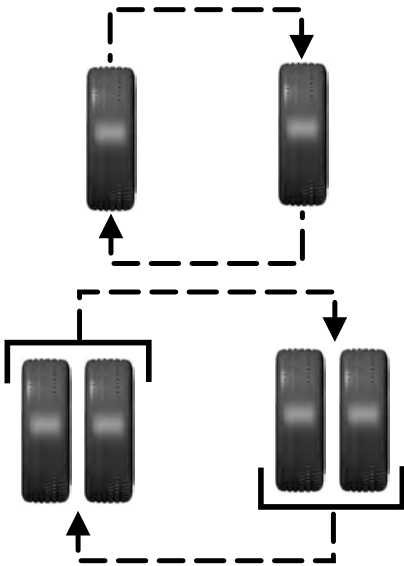

E166988

Dual rear wheel drive vehicle - six tire rotation (front tires at top of diagram).

If your vehicle is equipped with dual rear wheels it is recommended that the front and rear tires (in pairs) be rotated only side to side. We do not recommend splitting up the dual rear wheels. Rotate them side to side as a set. After tire rotation, inflation pressures must be adjusted for the tires new positions in accordance with vehicle requirements.

USING SNOW CHAINS

WARNING: Snow tires must be the same size, load index, and speed rating as those originally provided by Ford. Use of any tire or wheel not recommended by Ford can affect the safety and performance of your vehicle, which could result in an increased risk of loss of vehicle control, vehicle rollover, personal injury, and death. Additionally, the use of non-recommended tires and wheels could cause steering, suspension, axle, transfer case, or power transfer unit failure. It is also strongly advised to follow the Ford recommended tire inflation pressure found on the Safety Compliance Certification Label (affixed to either the door hinge pillar, door-latch post, or the door edge that meets the door-latch post, next to the driver's seating position), or Tire Label which is located on the B-Pillar or the edge of the driver door. Failure to follow the tire pressure recommendations can cause uneven treadwear patterns and adversely affect the way your vehicle handles.

The tires on your vehicle have all-weather treads to provide traction in rain and snow. However, in some climates, you may need to use snow tires and cables. If you need to use cables, it is recommended that steel wheels (of the same size and specifications) be used, as cables may chip aluminum wheels.

Note: *The suspension insulation and bumpers help prevent vehicle damage. Do not remove these components from your vehicle when using snow tires and chains.*

Follow these guidelines when using snow tires and chains:

Wheels and Tires

- If possible, avoid fully loading your vehicle.
- Use only SAE Class S chains.
- Install chains securely, verifying that the chains do not touch any wiring, brake lines or fuel lines.
- Drive cautiously. If you hear the chains rub or bang against your vehicle, stop and retighten the chains. If this does not work, remove the chains to prevent damage to your vehicle.
- Remove the tire chains when they are no longer needed. Do not use tire chains on dry roads.

If you have any questions regarding snow chains or cables, please contact your authorized dealer.

TIRE PRESSURE MONITORING SYSTEM (IF EQUIPPED)



WARNING: The tire pressure monitoring system is not a substitute for manually checking tire pressures. You should periodically check tire pressures using a pressure gauge. Failure to correctly maintain tire pressures could increase the risk of tire failure, loss of control, vehicle rollover and personal injury.

Note: You should only use tire sealants in roadside emergencies as they may cause damage to the tire pressure monitoring system sensor.

Note: If the tire pressure monitoring system sensor becomes damaged, it may not function.



Each tire, including the spare, if provided, should be checked monthly when cold and inflated to the inflation pressure recommended by the vehicle manufacturer on the vehicle placard or tire inflation pressure label. If your vehicle has tires of a different size than the size indicated on the vehicle placard or tire inflation pressure label, you should determine the proper tire inflation pressure for those tires.

As an added safety feature, your vehicle has been equipped with a Tire Pressure Monitoring System (TPMS) that illuminates a low tire pressure telltale when one or more of your tires is significantly under-inflated. Accordingly, when the low tire pressure telltale illuminates, you should stop and check your tires as soon as possible, and inflate them to the proper pressure. Driving on a significantly under-inflated tire causes the tire to overheat and can lead to tire failure. Under-inflation also reduces fuel efficiency and tire tread life, and may affect the vehicle's handling and stopping ability.

Please note that the TPMS is not a substitute for proper tire maintenance, and it is the driver's responsibility to maintain correct tire pressure, even if under-inflation has not reached the level to trigger illumination of the TPMS low tire pressure telltale.

Your vehicle has a TPMS malfunction indicator to indicate when the system is not operating properly. The TPMS malfunction indicator is combined with the low tire pressure telltale. When the system detects a malfunction, the telltale flashes for approximately one minute and then remains continuously illuminated. This sequence continues upon subsequent vehicle start-ups as long as the malfunction exists.

Wheels and Tires

When the malfunction indicator is illuminated, the system may not be able to detect or signal low tire pressure as intended. TPMS malfunctions may occur for a variety of reasons, including the installation of replacement or alternate tires or wheels on the vehicle that prevent the TPMS from functioning properly. Always check the TPMS malfunction telltale after replacing one or more tires or wheels on your vehicle to ensure that the replacement or alternate tires and wheels allow the TPMS to continue to function properly.

This device complies with Part 15 of the FCC Rules and with License exempt RSS Standards of Industry Canada. Operation is subject to the following two conditions:

1. This device may not cause harmful interference.
2. This device must accept any interference received, including interference that may cause undesired operation.

Note: *Changes or modifications not expressly approved by the party responsible for compliance could void the user's authority to operate the equipment. The term "IC:" before the radio certification number only signifies that Industry Canada technical specifications were met.*

Changing Tires With a Tire Pressure Monitoring System



E142549

Note: *Each road tire is equipped with a tire pressure sensor located inside the wheel and tire assembly cavity. The pressure sensor is attached to the valve stem. The pressure sensor is covered by the tire and is not visible unless the tire is removed. Take care when changing the tire to avoid damaging the sensor.*

You should always have your tires serviced by an authorized dealer.

Check the tire pressure periodically, at least monthly, using an accurate tire gauge. See *Inflating Your Tires* in this chapter.

Understanding Your Tire Pressure Monitoring System

The tire pressure monitoring system measures pressure in your four road tires and sends the tire pressure readings to your vehicle. The low tire pressure warning light turns on if the tire pressure is significantly low. Once the light is illuminated, your tires are under-inflated and need to be inflated to the manufacturer's recommended tire pressure. Even if the light turns on and a short time later turns off, your tire pressure still needs to be checked.

Wheels and Tires

When Your Temporary Spare Tire is Installed

When you replace one of the road tires with the temporary spare, the system continues to identify an issue to remind you that you need to repair and put back on the damaged road wheel and tire assembly on your vehicle.

To restore the full function of the tire pressure monitoring system, have the damaged road wheel and tire assembly repaired and remounted on your vehicle.

When You Believe Your System is Not Operating Properly

The main function of the tire pressure monitoring system is to warn you when your tires need air. It can also warn you in the event the system is no longer capable of functioning as intended. See the following chart for information concerning your tire pressure monitoring system:

Wheels and Tires

| Low Tire Pressure Warning Light | Possible Cause | Customer Action Required |
|---------------------------------|------------------------|--|
| Solid warning light | Tire(s) under-inflated | Make sure tires are at the proper pressure. See Inflating your tires in this chapter. After inflating your tires to the manufacturer's recommended pressure as shown on the Tire Label, located on the edge of driver door or the B-Pillar, the vehicle must be driven for at least two minutes over 20 mph (32 km/h) before the light turns off. |
| | Spare tire in use | Repair the damaged road wheel and tire assembly and reinstall it on the vehicle to restore system function. For a description on how the system functions, see When your temporary spare tire is installed in this section. |
| | TPMS malfunction | If the tires are properly inflated and the spare tire is not in use but the light remains on, contact your authorized dealer as soon as possible. |
| Flashing warning light | Spare tire in use | Repair the damaged road wheel and tire assembly and reinstall it on the vehicle to restore system function. For a description on how the system functions, see When your temporary spare tire is installed in this section. |
| | TPMS malfunction | If the tires are properly inflated and the spare tire is not in use but the light remains on, contact your authorized dealer as soon as possible. |

When Inflating Your Tires

When putting air into your tires, such as at a gas station or in your garage, the tire pressure monitoring system may not respond immediately to the air added to your tires.

It may take up to two minutes of driving over 20 mph (32 km/h) for the light to turn off after you have filled your tires to the recommended inflation pressure.

Wheels and Tires

How Temperature Affects Your Tire Pressure

The tire pressure monitoring system monitors tire pressure in each pneumatic tire. When driving in a normal manner, a typical passenger tire inflation pressure may increase about 2–4 psi (14–28 kPa) from a cold start situation. If the vehicle is stationary overnight with the outside temperature significantly lower than the daytime temperature, the tire pressure may decrease about 3 psi (21 kPa) for a drop of 30°F (17°C) in ambient temperature. This lower pressure value may be detected by the tire pressure monitoring system as being significantly lower than the recommended inflation pressure and activate the system warning light for low tire pressure. If the low tire pressure warning light is on, visually check each tire to verify that no tire is flat. If one or more tires are flat, repair as necessary. Check the air pressure in the road tires. If any tire is under-inflated, carefully drive the vehicle to the nearest location where air can be added to the tires. Inflate all the tires to the recommended inflation pressure.

Tire Pressure Monitoring System Reset Procedure



WARNING: To determine the required pressure(s) for your vehicle, see the Safety Compliance Certification Label (on the door hinge pillar, door-latch post or the door edge that meets the door-latch post, next to the driver seat) or the Tire Label on the B-Pillar or the edge of the driver door.

Note: You need to perform the tire pressure monitoring system reset procedure after each tire rotation.

To provide the vehicle's load carrying capability, some vehicles require different recommended tire pressures in the front tires as compared to the rear tires. The tire pressure monitoring system on these vehicles illuminate the low tire pressure warning light at two different pressures: one for the front tires and one for the rear tires.

Since tires need to be rotated to provide consistent performance and maximum tire life, the tire pressure monitoring system needs to know when the tires are rotated to determine which set of tires are on the front and which are on the rear. With this information, the system can detect and properly warn of low tire pressures.

System reset tips:

- To reduce the chances of interference from another vehicle, perform the system reset procedure at least 3 ft (1 m) away from another vehicle undergoing the system reset procedure at the same time.
- Do not wait more than two minutes between resetting each tire sensor or the system can time-out and you have to repeat the entire procedure on all four wheels.
- A double horn sounds indicating the need to repeat the procedure.

Performing the System Reset Procedure - Single Rear Wheel

Read the entire procedure before attempting.

1. Drive the vehicle above 20 mph (32 km/h) for at least two minutes, then park in a safe location where you can easily get to all four tires and have access to an air pump.
2. Place the ignition in the off position and keep the key in the ignition.

Wheels and Tires

3. Cycle the ignition to the on position with the engine off.
 4. Turn the hazard flashers on then off three times. You must accomplish this within 10 seconds. If you successfully enter the reset mode, the horn sounds once, the system indicator flashes and a message shows in the information display. If this does not occur, please try again starting at step 2. If after repeated attempts to enter the reset mode, the horn does not sound, the system indicator does not flash and no message shows in the information display, have the system checked as soon as possible.
 5. Train the tire pressure monitoring system sensors in the tires using the following system reset sequence starting with the left front tire in the following clockwise order: Left front - driver side front tire, Right front - passenger side front tire, Right rear - passenger side rear tire, Left rear - driver side rear tire.
 6. Remove the valve cap from the valve stem on the left front tire. Decrease the air pressure until the horn sounds.
- Note:** *The single horn tone confirms that the sensor identification code has been learned by the module for this position. If you hear a double horn, the reset procedure was unsuccessful, and you must repeat it.*
7. Remove the valve cap from the valve stem on the right front tire. Decrease the air pressure until the horn sounds.
 8. Remove the valve cap from the valve stem on the right rear tire. Decrease the air pressure until the horn sounds.
 9. Remove the valve cap from the valve stem on the left rear tire. Decrease the air pressure until the horn sounds. Training is complete after the horn sounds for the last tire trained, driver side rear tire, the system indicator stops flashing, and a message shows in the information display.
 10. Turn the ignition off. If you hear two short tones, the reset procedure was unsuccessful and you must repeat it. If you hear two short beeps when the ignition is off after repeating the procedure, have the system checked as soon as possible.
 11. Set all four tires to the recommended air pressure as indicated on the Safety Compliance Certification Label, affixed to either the door hinge pillar, door-latch post, or the door edge that meets the door-latch post, next to the driver seating position or Tire Label located on the B-Pillar or the edge of the driver door.

CHANGING A ROAD WHEEL (IF EQUIPPED)



WARNING: To determine the required pressure(s) for your vehicle, see the Safety Compliance Certification Label (on the door hinge pillar, door-latch post or the door edge that meets the door-latch post, next to the driver seat) or the Tire Label on the B-Pillar or the edge of the driver door.

Note: *You should only use tire sealants in roadside emergencies as they may cause damage to the tire pressure monitoring system sensor.*

Wheels and Tires

Note: The tire pressure monitoring system indicator light illuminates when the spare tire is in use. To restore the full function of the monitoring system, all road wheels equipped with tire pressure monitoring sensors must be mounted on the vehicle.

Note: Do not use wheels or lug nuts different than the original equipment, as this may damage the wheel or mounting system.

If you get a flat tire when driving, do not apply the brake heavily. Instead, gradually decrease your speed. Hold the steering wheel firmly and slowly move to a safe place on the side of the road.

Have a flat serviced by an authorized dealer in order to prevent damage to the tire pressure monitoring system sensors. See **Tire Pressure Monitoring System** (page 208). Replace the spare tire with a road tire as soon as possible. During repairing or replacing of the flat tire, have the authorized dealer inspect the tire pressure monitoring system sensor for damage.

Dissimilar Spare Wheel and Tire Assembly Information



WARNING: Failure to follow these guidelines could result in an increased risk of loss of vehicle control, injury or death.

If you have a dissimilar spare wheel and tire, then it is intended for temporary use only. This means that if you need to use it, you should replace it as soon as possible with a road wheel and tire assembly that is the same size and type as the road tires and wheels that were originally provided by Ford. If the dissimilar spare tire or wheel is damaged, it should be replaced rather than repaired.

A dissimilar spare wheel and tire assembly is defined as a spare wheel and tire assembly that is different in brand, size or appearance from the road tires and wheels and can be one of three types:

1. **T-type mini-spare:** This spare tire begins with the letter T for tire size and may have Temporary Use Only molded in the sidewall.

2. **Full-size dissimilar spare with label on wheel:** This spare tire has a label on the wheel that states: THIS WHEEL AND TIRE ASSEMBLY FOR TEMPORARY USE ONLY.

When driving with one of the dissimilar spare tires listed above, do not:

- Exceed 50 mph (80 km/h).
- Load the vehicle beyond maximum vehicle load rating listed on the Safety Compliance Label.
- Tow a trailer.
- Use snow chains on the end of the vehicle with the dissimilar spare tire.
- Use more than one dissimilar spare tire at a time.
- Use commercial car washing equipment.
- Try to repair the dissimilar spare tire.

Use of one of the dissimilar spare tires listed above at any one wheel location can lead to impairment of the following:

- Handling, stability and braking performance.
- Comfort and noise.
- Ground clearance and parking at curbs.
- Winter weather driving capability.
- Wet weather driving capability.
- All-wheel driving capability.

3. **Full-size dissimilar spare without label on wheel**

Wheels and Tires

When driving with the full-size dissimilar spare wheel and tire assembly, do not:

- Exceed 70 mph (113 km/h).
- Use more than one dissimilar spare wheel and tire assembly at a time.
- Use commercial car washing equipment.
- Use snow chains on the end of the vehicle with the dissimilar spare wheel and tire assembly.

The usage of a full-size dissimilar spare wheel and tire assembly can lead to impairment of the following:

- Handling, stability and braking performance.
- Comfort and noise.
- Ground clearance and parking at curbs.
- Winter weather driving capability.
- Wet weather driving capability.
- All-wheel driving capability.

When driving with the full-size dissimilar spare wheel and tire assembly additional caution should be given to:

- Towing a trailer.
- Driving vehicles equipped with a camper body.
- Driving vehicles with a load on the cargo rack.

Drive cautiously when using a full-size dissimilar spare wheel and tire assembly and seek service as soon as possible.

Tire Change Procedure



WARNING: When one of the front wheels is off the ground, the transmission alone will not prevent the vehicle from moving or slipping off the jack, even if the transmission is in park (P).



WARNING: To help prevent your vehicle from moving when changing a wheel, shift the transmission into park (P), set the parking brake and use an appropriate block or wheel chock to secure the wheel diagonally opposite to the wheel being changed. For example, when changing the front left wheel, place an appropriate block or wheel chock on the right rear wheel.



WARNING: Do not get under a vehicle that is only supported by a vehicle jack.



WARNING: Do not attempt to change a tire on the side of the vehicle close to moving traffic. Pull far enough off the road to avoid the danger of being hit when operating the jack or changing the wheel.



WARNING: Always use the jack provided as original equipment with your vehicle. If using a jack other than the one provided, make sure the jack capacity is adequate for the vehicle weight, including any vehicle cargo or modifications. If you are unsure if the jack capacity is adequate, contact the authorized dealer.

Note: *Passengers should not remain in your vehicle when the vehicle is being jacked.*

Removing the flat wheel and tire

1. Park on a level surface, set the parking brake and activate the hazard flashers.
2. Place the transmission in park (P) and turn the engine off.

Wheels and Tires

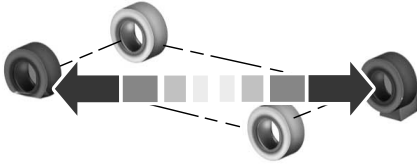

E142551

3. Block both directions of the wheel that is diagonally opposite to the wheel that is being lifted.
4. Remove the spare tire and jack from the storage location.
5. Remove the wheel trim (if equipped) by inserting the tapered end of the lug nut wrench behind the wheel cover or hubcap and twist it off.
6. Loosen each wheel lug nut one-half turn counterclockwise, but do not remove them until the wheel is raised off the ground.

Jacking location



E201348

Front axle jacking point: Place the jack under the pin on the front surface of the front axle.

Note: Do not place the jack under or on the steering linkage.



E201346

Rear axle jacking points: All models except E-350 and E-450 dual rear wheel.

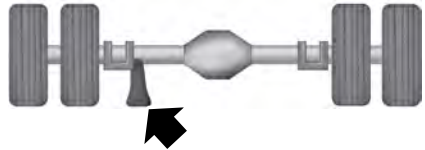

E201347

Rear axle jacking points: E-350 and E-450 dual rear wheel.

Installing the spare wheel and tire

1. Refer to the diagrams above to locate the correct jacking point for your vehicle.
2. Raise the vehicle by using the jack handle to turn the jack nut clockwise. Once the flat tire is raised above the ground, remove the lug nuts with the lug wrench.

Wheels and Tires

3. Replace the flat tire with the spare, making sure the valve stem of the spare is facing outward when replacing a front wheel or the rear wheel position on vehicles with single rear wheel fitments. For vehicles with dual rear wheels, the valve stem of the spare must face outward when replacing an inner wheel, but must face inward when replacing an outboard wheel.
4. Reinstall the lug nuts until the wheel is snug against the hub. Do not fully tighten the lug nuts until the vehicle has been lowered
5. Lower the wheel by turning the jack handle counter-clockwise.



E161441

6. Remove the jack and fully tighten the lug nuts in the order shown. See **Technical Specifications** (page 217).
7. Install any wheel covers or hubcaps. Make sure they snap into place.
8. Stow the jack and lug wrench.
9. Unblock the wheels.

TECHNICAL SPECIFICATIONS

Wheel Lug Nut Torque Specifications



WARNING: When you install a wheel, always remove any corrosion, dirt or foreign materials present on the mounting surfaces of the wheel or the surface of the wheel hub, brake drum or brake disc that contacts the wheel. Make sure to secure any fasteners that attach the rotor to the hub so they do not interfere with the mounting surfaces of the wheel. Installing wheels without correct metal-to-metal contact at the wheel mounting surfaces can cause the wheel nuts to loosen and the wheel to come off while your vehicle is in motion, resulting in loss of vehicle control, personal injury or death.

| Bolt size | lb.ft (Nm) |
|-----------------------------|--------------------|
| 9/16 x 18 two-piece lug nut | 140 lb.ft (190 Nm) |

On vehicles equipped with single rear wheels, retighten the lug nuts to the specified torque at 100 miles (160 kilometers) after any wheel disturbance (such as tire rotation, changing a flat tire, wheel removal).

On vehicles equipped with dual rear wheels, retighten the wheel lug nuts to the specified torque at 100 miles (160 kilometers), and again at 500 miles (800 kilometers) of new vehicle operation and after any wheel disturbance (such as tire rotation, changing a flat tire, wheel removal).

Wheels and Tires



E161443

On all two-piece flat wheel nuts, apply one drop of motor oil between the flat washer and the nut. Do not apply motor oil to the wheel nut threads or the wheel stud threads.



E145950

A Wheel pilot bore

Inspect the wheel pilot hole and mounting surface prior to installation. Remove any visible corrosion or loose particles.

Capacities and Specifications

ENGINE SPECIFICATIONS

| Engine | 7.3L V8 Engine |
|--------------------|--|
| Displacement. | 445 in ³ (7,293 cm ³) |
| Required fuel. | Minimum 87 octane |
| Firing order. | 1-5-4-8-6-3-7-2 |
| Ignition system. | Coil near spark plug with spark plug wire |
| Spark plug gap. | 0.049 in (1.25 mm) - 0.053 in (1.35 mm) |
| Compression ratio. | 10.5:1 |

Drivebelt Routing

Single Alternator

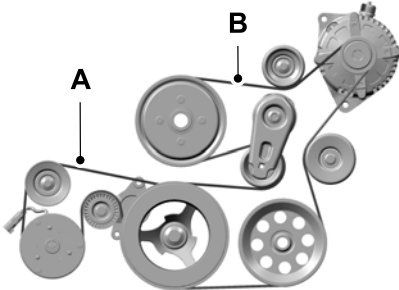

- A Drivebelt closest to the engine.
- B Drivebelt furthest from the engine.

Dual Alternator

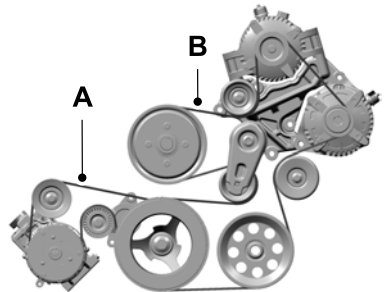

- A Drivebelt closest to the engine.
- B Drivebelt furthest from the engine.

MOTORCRAFT PARTS

| Component | Motorcraft Part number |
|---------------------------|------------------------|
| Air filter element. | FA-1953 |
| One battery. | BXT-65-750 |
| Two batteries (optional). | BXT-65-750 |

Capacities and Specifications

| Component | Motorcraft Part number |
|---------------------------------|------------------------|
| Engine oil filter. ¹ | FL-820-S |
| Spark plug. ² | SP-586 |
| Transmission fluid filter. | FT-187 |
| Windshield wiper blade. | WW-2005 |

¹If a Motorcraft® oil filter is not available, use an oil filter that meets industry performance specification SAE/USCAR-36.

²For spark plug replacement, contact your authorized dealer. Replace the spark plugs at the recommended intervals. See **Normal Scheduled Maintenance** (page 253).

We recommend Motorcraft® parts that are available at your authorized dealer or at www.fordparts.com. These parts are engineered for your vehicle, and meet or exceed our specifications. Use of other parts could impact vehicle performance, emissions and durability. Your warranty could be void for any damage related to use of other parts.

Capacities and Specifications

VEHICLE IDENTIFICATION NUMBER

The vehicle identification number is located on the left-hand side of the instrument panel.



E142476

Please note that in the graphic, XXXX is representative of your vehicle identification number.

The Vehicle Identification Number contains the following information:

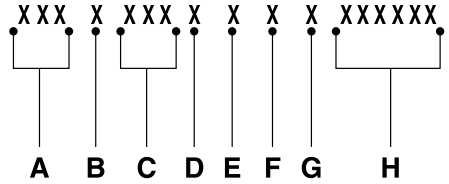

E142477

- A World manufacturer identifier
- B Brake system, Gross Vehicle Weight Rating, Restraint Devices and their locations
- C Make, vehicle line, series, body type
- D Engine type
- E Check digit
- F Model year
- G Assembly plant
- H Production sequence number

Capacities and Specifications

TRANSMISSION CODE DESIGNATION

The transmission code is on the Safety Compliance Certification Label. The following table shows the transmission code along with the transmission description.

MFD. BY FORD MOTOR CO.

DATE: XX/XX GVWR: XXXX KG (XXXX LB)
 FRONT GAWR: REAR GAWR:
 XXXX KG (XXXX LB) WITH XXXX KG (XXXX LB) WITH
 XXXXXXXXXXXXXXXX TIRES XXXXXXXXXXXXXXXX TIRES
 XXXXXXXX RIMS XXXXXXXX RIMS
 AT XXXX kPa/ XXX PSI COLD AT XXXX kPa/ XXX PSI COLD

THIS VEHICLE CONFORMS TO ALL APPLICABLE FEDERAL MOTOR VEHICLE SAFETY AND THEFT PREVENTION STANDARDS IN EFFECT ON THE DATE OF MANUFACTURE SHOWN ABOVE.

VIN: XXXXXXXXXXXXXXXX XXXXX
 TYPE: XXXX XXXXX



EXT PNT: XX XXXXXX RC: XY DSO: XXXX
 WB INT TR TP/PS R AXLE TR SPR XXXX
 XXX XX XXX X XX X XXXX XXXX
 XXXXXXXXXXXXXXXX XX = XXXX-XXXXXX-XX



E167814

| Description | Code |
|--|------|
| Six-speed automatic transmission 6R140 | P |

Capacities and Specifications

CAPACITIES AND SPECIFICATIONS

Use oil and fluid that meets the defined specification and viscosity grade.

If you do not use oil and fluid that meets the defined specification and viscosity grade, it could result in:

- Component damage not covered by the vehicle warranty.
- Longer engine cranking periods.
- Increased emission levels.

- Reduced engine performance.
- Reduced fuel economy.
- Reduced brake performance.

Air Conditioning System



WARNING: The air conditioning refrigerant system contains refrigerant under high pressure. Only qualified personnel should service the air conditioning refrigerant system. Opening the air conditioning refrigerant system can cause personal injury.

Capacities

| Variant | Refrigerant | Refrigerant Oil |
|-----------------|---------------------|----------------------|
| Front only. | 26.98 oz (0.765 kg) | 7.00 fl oz (207 ml) |
| With prep pack. | 33.02 oz (0.936 kg) | 14.00 fl oz (414 ml) |

Materials

| Name | Specification |
|---|---------------|
| Motorcraft® R-134a Refrigerant (U.S.) R-134a Refrigerant / Frigorigène R-134a (Canada) YN-19 (U.S.) CYN-19-R (Canada) | WSH-M17B19-A |
| Motorcraft® PAG Refrigerant Compressor Oil (U.S.) Motorcraft® PAG Refrigerant Compressor Oil / Huile PAG pour compresseur frigorifique Motorcraft® (Canada) YN-12-D (U.S. & Canada) | WSH-MIC231-B |

Automatic Transmission

Note: *Automatic transmissions that require MERCON® LV transmission fluid should only use MERCON® LV transmission fluid. The use of any other fluid could cause transmission damage.*

Capacities and Specifications

Capacities

| Variant | Quantity |
|---------|-------------------------------|
| All. | 17.4 qt (16.5 L) ¹ |

¹ Approximate dry fill capacity. Actual amount could vary during fluid changes.

Materials

| Name | Specification |
|--|-------------------------|
| Motorcraft® MERCON® LV Automatic Transmission Fluid (U.S.) Motorcraft® MERCON® LV Automatic Transmission Fluid / Huile pour boîte automatique MERCON® LV Motorcraft® (Canada) XT-10-QLVC (U.S.) CXT-10-LV6 (Canada) | MERCON® LV WSS-M2C938-A |

Engine Coolant

Capacities

| Variant | Quantity |
|---------|------------------|
| All. | 20.0 qt (18.9 L) |

Materials

| Name | Specification |
|---|---------------|
| Motorcraft® Yellow Prediluted Antifreeze/Coolant (U.S.) Motorcraft® Yellow Prediluted Antifreeze/Coolant / Antigel/liquide de refroidissement prédilué jaune Motorcraft® (Canada) VC-13DL-G (U.S.) CVC-13DL-G (Canada) | WSS-M97B57-A2 |

Capacities and Specifications

Engine Oil



E142732



E276075

An oil that displays this symbol conforms to current engine, emission system and fuel economy performance standards of ILSAC.

We recommend Motorcraft® motor oil for your vehicle. If Motorcraft® oil is not available, use motor oils of the recommended viscosity grade that meet API SN PLUS requirements and display the API Certification Mark for gasoline engines.

Do not use supplemental engine oil additives because they are unnecessary and could lead to engine damage that your vehicle warranty does not cover.

Capacities

| Variant | Including the Oil Filter |
|---------|--------------------------|
| All. | 8.0 qt (7.6 L) |

Materials

| Name | Specification |
|---|---------------|
| Engine Oil - SAE 5W-30 - Synthetic Blend Motor Oil (U.S.) Engine Oil - SAE 5W-30 - Super Premium Motor Oil / Huile moteur de très haute qualité SAE 5W-30 Motorcraft® (Canada) XO-5W30-Q1SP (U.S.) CXO-5W30-LSP6 (Canada) | WSS-M2C946-B1 |

Capacities and Specifications

Alternative Engine Oil for Extremely Cold Climates

To improve engine cold start performance,

we recommend that you use the following alternative engine oil in extremely cold climates, where the ambient temperature reaches -22.0°F (-30°C) or below.

Materials

| Name | Specification |
|------------------------|---------------|
| Engine Oil - SAE 0W-30 | WSS-M2C953-B1 |

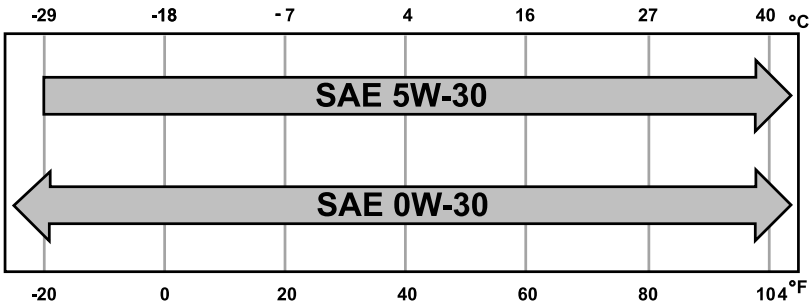

Fuel Tank

Capacities

| Variant | Quantity |
|---------------------------|------------------|
| Standard. | 39.9 gal (151 L) |
| Optional or E-Super Duty. | 54.9 gal (208 L) |

Grease

Capacities and Specifications

Materials

| Name | Specification |
|---|---------------|
| Motorcraft® Multi-Purpose Grease Spray (U.S.) Motorcraft® Multi-Purpose Grease Spray / Graisse tout usage en aérosol Motorcraft® (Canada) XL-5-A (U.S. & Canada) | ESB-MIC93-B |

Vacuum Brake System

Capacities

| Variant | Quantity |
|---------|-------------------|
| All. | Fill as required. |

Materials

| Name | Specification |
|--|---------------|
| Motorcraft® DOT 4 LV High Performance Motor Vehicle Brake Fluid (U.S.) Motorcraft® DOT 4 LV High Performance Motor Vehicle Brake Fluid / Liquide de frein automobile haute performance DOT 4 LV Motorcraft® (Canada) PM-20 (U.S. & Canada) | WSS-M6C65-A2 |
| Motorcraft® High Performance DOT 3 Motor Vehicle Brake Fluid (U.S.) Motorcraft® High Performance DOT 3 Motor Vehicle Brake Fluid / Liquide de frein automobile DOT 3 haute performance Motorcraft® (Canada) PM-1-C (U.S.) CPM-1-C (Canada) | WSS-M6C65-A1 |

Note: We recommend using DOT 4 Low Viscosity (LV) High Performance Brake Fluid for vehicles with vacuum brake booster systems. High Performance DOT 3 brake fluid is also acceptable to use.

Note: Use of any fluid other than the recommended fluid could cause reduced brake performance and not meet our performance standards. Keep brake fluid clean and dry. Contamination with dirt, water, petroleum products or other materials could result in brake system damage and possible failure.

Capacities and Specifications

Hydroboost Brake System

Capacities

| Variant | Quantity |
|---------|-------------------|
| All. | Fill as required. |

Materials

| Name | Specification |
|---|---------------|
| Motorcraft® DOT 4 LV High Performance Motor Vehicle Brake Fluid (U.S.) Motorcraft® DOT 4 LV High Performance Motor Vehicle Brake Fluid / Liquide de frein automobile haute performance DOT 4 LV Motorcraft® (Canada) PM-20 (U.S. & Canada) | WSS-M6C65-A2 |
| Motorcraft® High Performance DOT 3 Motor Vehicle Brake Fluid (U.S.) Motorcraft® High Performance DOT 3 Motor Vehicle Brake Fluid / Liquide de frein automobile DOT 3 haute performance Motorcraft® (Canada) PM-1-C (U.S.) CPM-1-C (Canada) | WSS-M6C65-A1 |

Note: We recommend using DOT 4 Low Viscosity (LV) High Performance Brake Fluid for vehicles with hydroboost brake booster systems. High Performance DOT 3 brake fluid is also acceptable to use.

Note: Use of any fluid other than the recommended fluid could cause reduced brake performance and not meet our performance standards. Keep brake fluid clean and dry. Contamination with dirt, water, petroleum products or other materials could result in brake system damage and possible failure.

Power Steering System

Capacities

| Variant | Quantity |
|---------|--|
| All. | Between MIN/MAX on power steering fluid reservoir. |

Capacities and Specifications

Materials

| Name | Specification |
|--|-------------------------|
| Motorcraft® MERCON® LV Automatic Transmission Fluid (U.S.) Motorcraft® MERCON® LV Automatic Transmission Fluid / Huile pour boîte automatique MERCON® LV Motorcraft® (Canada) XT-10-QLVC (U.S.) CXT-10-LV6 (Canada) | MERCON® LV WSS-M2C938-A |

Door Weatherstrips

Materials

| Name | Specification |
|---|---------------|
| Motorcraft® Silicone Spray Lubricant (U.S.) Motorcraft® Silicone Lubricant / Lubrifiant à la silicone Motorcraft® (Canada) XL-6 (U.S.) CXC-90-B (Canada) | ESR-M13P4-A |

Locks

Materials

| Name | Specification |
|--|---------------|
| Motorcraft® Penetrating and Lock Lubricant (U.S.) Motorcraft® Penetrating Fluid / Liquide dégrissant Motorcraft® (Canada) XL-1 (U.S.) CXC-51-A (Canada) | - |

Dana Limited Slip Axle M70FF (M267FF)

Capacities

| Variant | Quantity |
|---------|------------------------------|
| E-350 | 3.28 qt (3.1 L) ¹ |

¹ Fill Dana rear axles to 0.24–0.55 in (6–14 mm) below the bottom of the fill hole.

Capacities and Specifications

Materials

| Name | Specification |
|--|---------------|
| Motorcraft® SAE 75W-140 Synthetic Rear Axle Lubricant (U.S.) Motorcraft® SAE 75W-140 Synthetic Rear Axle Lubricant / Lubrifiant synthétique pour pont arrière SAE 75W-140 Motorcraft® (Canada) XY-75W140-QL (U.S.) CXY-75W140-1L (Canada) | WSL-M2C192-A |

Dana Limited Slip Axle M70HD (M273HD)

Capacities

| Variant | Quantity |
|---------|------------------------------|
| E-450 | 4.86 qt (4.6 L) ¹ |

¹ Fill Dana rear axles to 0.24–0.55 in (6–14 mm) below the bottom of the fill hole.

Materials

| Name | Specification |
|--|---------------|
| Motorcraft® SAE 75W-140 Synthetic Rear Axle Lubricant (U.S.) Motorcraft® SAE 75W-140 Synthetic Rear Axle Lubricant / Lubrifiant synthétique pour pont arrière SAE 75W-140 Motorcraft® (Canada) XY-75W140-QL (U.S.) CXY-75W140-1L (Canada) | WSL-M2C192-A |

Dana Conventional Axle M70FF (M267FF)

Capacities

| Variant | Quantity |
|---------|------------------------------|
| E-350 | 3.28 qt (3.1 L) ¹ |

¹ Fill Dana rear axles to 0.24–0.55 in (6–14 mm) below the bottom of the fill hole.

Capacities and Specifications

Materials

| Name | Specification |
|---|---------------|
| Motorcraft® SAE 80W-90 Premium Rear Axle Lubricant (U.S.) Motorcraft® SAE 80W-90 Premium Axle Lubricant / Lubrifiant pour essieux de très haute qualité SAE 80W-90 Motorcraft® (Canada) XY-80W90-QL (U.S.) CXY-80W90-1L (Canada) | WSP-M2C197-A |

Dana Conventional Axle M70HD (M273HD)

Capacities

| Variant | Quantity |
|---------|------------------------------|
| E-450 | 4.86 qt (4.6 L) ¹ |

¹ Fill Dana rear axles to 0.24–0.55 in (6–14 mm) below the bottom of the fill hole.

Materials

| Name | Specification |
|---|---------------|
| Motorcraft® SAE 80W-90 Premium Rear Axle Lubricant (U.S.) Motorcraft® SAE 80W-90 Premium Axle Lubricant / Lubrifiant pour essieux de très haute qualité SAE 80W-90 Motorcraft® (Canada) XY-80W90-QL (U.S.) CXY-80W90-1L (Canada) | WSP-M2C197-A |

Washer Reservoir

Capacities

| Variant | Quantity |
|---------|-------------------|
| All. | Fill as required. |

Capacities and Specifications

Materials

| Name | Specification |
|---|---------------|
| Motorcraft® Premium Windshield Wash Concentrate with Bitterant (U.S.) Motorcraft® Premium Quality Windshield Washer Fluid / Liquide lave-glace de haute qualité Motorcraft® (Canada) ZC-32-B2 (U.S.) CXC-37-A/B/D/F (Canada) | WSS-M14P19-A |

BULB SPECIFICATION CHART

Replacement bulbs are specified in the chart below. Headlamp bulbs must be marked with an authorized "D.O.T." for North America and an "E" for Europe to ensure lamp performance, light brightness and pattern and safe visibility. The correct bulbs will not damage the lamp assembly or void the lamp assembly warranty and will provide quality bulb illumination time.

Exterior Lamps

| Lamp | Trade Name |
|---|------------|
| Front side marker lamp. | W5W |
| Park lamp. | 3157AK |
| Front direction indicator. | 3157AK |
| Headlamp low beam. | H13 |
| Headlamp high beam. | H13 |
| Front clearance lamp (exterior mirror). | 2825 |
| Brake, rear and direction indicator lamp. | 3157K |
| Reversing lamps. | 3156 |

Capacities and Specifications

Interior Lamps

| Lamp | Trade Name |
|-----------------|-------------------|
| Underhood Lamp. | 906 |
| Map lamp. | 578 |
| Dome lamp. | 578 |
| Cargo lamp. | 578 |

To replace all instrument panel lights - see your authorized dealer.

Connected Vehicle (If Equipped)

CONNECTED VEHICLE REQUIREMENTS

Connected service and related feature functionality requires a compatible vehicle network and the FordPass app.

Some remote features require a subscription. For additional information, see the FordPass app. Some restrictions, third party terms and message or data rates may apply.

CONNECTED VEHICLE LIMITATIONS

Evolving technology or evolving cellular networks could affect functionality and availability, or continued provision of some features. These changes could even stop some features from functioning.

CONNECTING THE VEHICLE TO A MOBILE NETWORK

What Is the Connectivity Device



The connectivity device enables access to a range of features built into your vehicle.

Disabling the Connectivity Device

To disable the connectivity device, contact the Ford Customer Relationship Center.

Note: *Disabling your connectivity device is permanent.*

Connecting FordPass to the Connectivity Device

1. Open the FordPass app on your device and log in.
2. Add your vehicle or select your vehicle if already added.
3. Select the option for vehicle details.
4. Select the option to activate your vehicle.

CONNECTED VEHICLE – TROUBLESHOOTING

| Symptom | Possible Cause and Resolution |
|--|--|
| I cannot confirm the connection of my FordPass account to the connectivity device. | – Contact the Ford Customer Relationship Center to check that the FordPass account is connected to the device. |
| | – Weak network signal. <ul style="list-style-type: none">• Move your vehicle closer to a place where the network signal is not obstructed. |

Audio System (If Equipped)

GENERAL INFORMATION



WARNING: Driving while distracted can result in loss of vehicle control, crash and injury. We strongly recommend that you use extreme caution when using any device that may take your focus off the road. Your primary responsibility is the safe operation of your vehicle. We recommend against the use of any

hand-held device while driving and encourage the use of voice-operated systems when possible. Make sure you are aware of all applicable local laws that may affect the use of electronic devices while driving.

Radio Frequencies and Reception Factors

Note: *Listening to loud audio for long periods of time could damage your hearing.*

Radio Reception Factors

| | |
|------------------------------|---|
| Distance and strength | The further you travel from an AM or FM station, the weaker the signal and the weaker the reception. |
| Terrain | Hills, mountains, tall buildings, bridges, tunnels, freeway overpasses, parking garages, dense tree foliage and thunderstorms can interfere with the reception. |
| Station overload | When you pass a ground-based broadcast repeating tower, a stronger signal may overtake a weaker one and result in the audio system muting. |

AUDIO UNIT



WARNING: Driving while distracted can result in loss of vehicle control, crash and injury. We strongly recommend that you use extreme caution when using any device that may take your focus off the road. Your primary responsibility is the safe operation of your vehicle. We recommend against the use of any hand-held device while driving and encourage the use of voice-operated systems when possible. Make sure you are aware of all applicable local laws that may affect the use of electronic devices while driving.



Note: *Depending on your vehicle option package, the controls may look different from what you see here.*

Note: *Some features, such as satellite radio, may not be available in your location. Check with an authorized dealer.*

Audio System (If Equipped)

Accessing the Sound Settings



Press the button to adjust the sound settings. You can also activate and set the sensitivity of the adaptive or speed compensated volume.

Accessing the System Settings



Press the button.

Adjusting the Volume

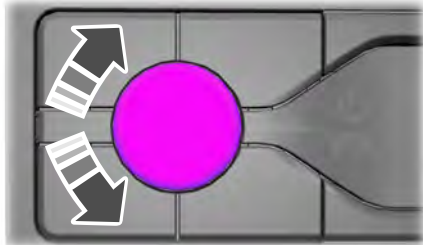

E260697

Turn to adjust the volume.

Changing Radio Stations

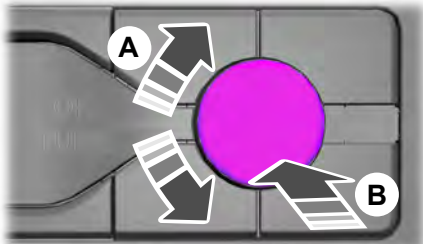

E260687

- A Auto or Manual tuning.
- B Station name tuning.

Note: You can change between auto or manual tuning with the rotary control using the system settings.

Note: You can change radio stations using the seek buttons.

Note: You can recall radio stations using the numeric preset buttons.

Pausing or Playing Media



In media mode, press and release the button to pause playback. Press the button again to resume playback.

In radio mode, press the button to mute the signal. Press the button again to restore the signal.

Returning to the Previous Screen



Press and release the button.

Scrolling Through the Menu Options

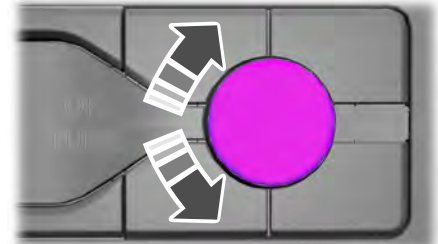

E260782

Selecting Media



Press the button to select media mode.

Repeatedly press the button, or rotate the right-hand rotary control to scroll through the available media sources.

Audio System (If Equipped)

Selecting a Menu Option

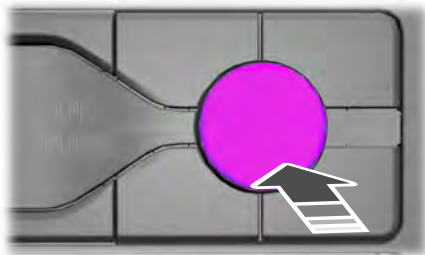

E260781

Switching the Audio Unit On and Off

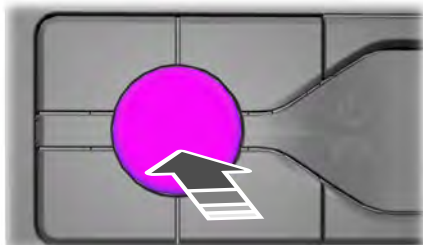

E260686

Selecting the Radio



Press the button to select radio mode.

Press the button again to display the available radio sources. Repeatedly press the button, or rotate the right-hand rotary control to scroll through the available radio sources.

Setting a Memory Preset

Tune to a station then press and hold one of the numbered memory preset buttons. The audio mutes briefly while the system saves the station and returns once the station is stored.

Press and release the button.

Using a Cell Phone



Press the button to either answer an incoming phone call or to make a phone call.



Press and hold the button to end a phone call.

Using Seek, Fast Forward and Reverse



Press and release the button to skip to the next track.

Press and hold the button to fast forward through the track.



Press and release the button to return to the beginning of a track.

Repeatedly press the button to return to previous tracks.

Press and hold the button to rewind.

In radio mode, select a frequency band and press and release either button. The system stops at the first station it finds in that direction.

Audio System (If Equipped)

In satellite radio mode, press and release to select the next or previous satellite radio station. If you select a specific category, such as jazz, rock or news, press to find the next or previous station in the category you select.

DIGITAL RADIO

Note: *HD Radio broadcasts are not available in all markets.*

HD Radio technology is the digital evolution of analog AM/FM radio. Your system has a special receiver that allows it to receive digital broadcasts, where available, in addition to the analog broadcasts, it already receives. Digital broadcasts provide a better sound quality than analog broadcasts with free, crystal-clear audio and no static or distortion. For more information, and a guide to available stations and programming, please visit www.hdradio.com.

When HD Radio is on and you tune to a station broadcasting HD Radio technology, you may notice the HD Radio logo on your screen. When this logo is available, you may also see Title and Artist fields on-screen.

The multicast indicator appears in FM mode, only, if the current station is broadcasting multiple digital broadcasts. The highlighted numbers signify available digital channels where new or different content is available. HD1 signifies the main programming status and is available in analog and digital broadcasts. Other multicast stations, HD2 through HD7, are only available digitally.

When HD Radio broadcasts are active, you can access the following functions:

- **Memory presets** allow you to save an active channel as a memory preset. Touch and hold a memory preset slot until the sound returns. There is a brief mute while the radio saves the station. Sound returns when finished. When switching to an HD2 or HD3 memory preset, the sound mutes before the digital audio plays, because the system has to reacquire the digital signal.

Note: *As with any saved radio station, you cannot access the saved station if your vehicle is outside the station's reception area.*

Audio System (If Equipped)

HD Radio Reception and Station Troubleshooting

| Potential reception issues | |
|-----------------------------------|---|
| Reception area | If you are listening to a multicast station and you are on the fringe of the reception area, the station may mute due to weak signal strength. |
| | If you are listening to HD1, the system switches back to the analog broadcast until the digital broadcast is available again. However, if you are listening to any of the possible HD2-HD7 multicast channels, the station mutes and stays muted unless it is able to connect to the digital signal again. |
| Station blending | When the system first receives a station, aside from HD2-HD7 multicast stations, it first plays the station in the analog version. Once the receiver verifies the station is an HD Radio station, it shifts to the digital version. Depending on the station quality, you may hear a slight sound change when the station changes from analog to digital. Blending is the shift from analog to digital sound or digital back to analog sound. |

In order to provide the best possible experience, use the contact form to report any station issues found while listening to a station broadcasting with HD Radio technology. Independent entities own and operate each station. These stations are responsible for the accuracy of all audio streams and data fields.

Audio System (If Equipped)

| Potential station issues | | |
|--|---|---|
| Issues | Cause | Action |
| Echo, stutter, skip or repeat in audio. Increase or decrease in audio volume. | This is poor time alignment by the radio broadcaster. | No action required. This is a broadcast issue. |
| Sound fading or blending in and out. | The radio is shifting between analog and digital audio. | No action required. The reception issue may clear up as you continue to drive. |
| There is an audio mute delay when selecting HD2 or HD3, multicast preset or Direct Tune . | The digital multicast is not available until the HD Radio broadcast is decoded. Once decoded, the audio is available. | No action required. This is normal behavior. Wait until the audio is available. |
| Cannot access HD2 or HD3 multicast channel when recalling a preset or from a direct tune. | The previously stored multicast preset or direct tune is not available in your current reception area. | No action required. The station is not available in your current location. |
| Text information does not match currently playing audio. | Data service issue by the radio broadcaster. | Fill out the station issue form at website listed below. ¹ |
| There is no text information shown for currently selected frequency. | Data service issue by the radio broadcaster. | Fill out the station issue form at website listed below. ¹ |

¹ <http://hdradio.com/stations/feedback>

HD Radio Technology manufactured under license from iBiquity Digital Corporation and foreign patents. HD Radio and the HD and HD Radio logos are proprietary trademarks of DTS Ford Motor Company and DTS are not responsible for the content sent using HD Radio technology. Content may be changed, added or deleted at any time at the station owner's discretion.

CONNECTING A BLUETOOTH DEVICE

Pairing a Device



Press the button.

Select Bluetooth and follow the instructions on the screen.

Audio System (If Equipped)

Note: When pairing a new device, you can choose to download contacts, set this as the primary device and enable Emergency Assistance.

SATELLITE RADIO

SiriusXM® Satellite Radio broadcasts a variety of music, news, sports, weather, traffic and entertainment satellite radio channels. For more information and a complete list of SiriusXM satellite radio channels, visit www.siriusxm.com in the United States, www.siriusxm.ca in Canada, or call SiriusXM at 1-888-539-7474.

Note: This receiver includes the eCos real-time operating system. eCos is published under the eCos License.

Satellite Radio Reception Factors

| Potential satellite radio reception issues | |
|--|--|
| Antenna obstructions | For optimal reception performance, keep the antenna clear of snow and ice build-up and keep luggage and other material as far away from the antenna as possible. |
| Terrain | Hills, mountains, tall buildings, bridges, tunnels, freeway overpasses, parking garages, dense tree foliage and thunderstorms can interfere with your reception. |
| Station overload | When you pass a ground-based broadcast-repeating tower, a stronger signal may overtake a weaker one and the audio system may mute. |
| Satellite radio signal interference | Your display may show ACQUIRING . . . to indicate the interference and the audio system may mute. |

SiriusXM Satellite Radio Service

Note: SiriusXM reserves the unrestricted right to change, rearrange, add or delete programming including canceling, moving or adding particular channels, and its prices, at any time, with or without notice to you. Ford Motor Company shall not be responsible for any such programming changes.



E208625

Audio System (If Equipped)

SiriusXM satellite radio is a subscription-based satellite radio service that broadcasts a variety of music, sports, news, weather, traffic and entertainment programming. Your factory-installed SiriusXM satellite radio system includes hardware and a limited subscription term, which begins on the date of sale or lease of your vehicle. See an authorized dealer for availability.

For more information on extended subscription terms (a service fee is required), the online media player and a complete list of SiriusXM satellite radio channels, and other features, please visit www.siriusxm.com in the United States, www.siriusxm.ca in Canada, or call SiriusXM at 1-888-539-7474.

Satellite Radio Electronic Serial Number (ESN)

You need your ESN to activate, modify or track your satellite radio account. When in satellite radio mode, tune to channel 0.

Troubleshooting

| Message | Condition | Action |
|--|---|--|
| Acquiring... | Radio requires more than two seconds to produce audio for the selected channel. | No action required. This message should disappear shortly. |
| Satellite antenna fault SIRIUS system failure | There is an internal module or system failure present. | If this message does not clear shortly, or with an ignition key cycle, your receiver may have a fault. See an authorized dealer for service. |
| Invalid Channel | The channel is no longer available. | Tune to another channel or choose another preset. |
| Unsubscribed Channel | Your subscription does not include this channel. | Contact SiriusXM at 1-888-539-7474 to subscribe to the channel, or tune to another channel. |
| No Signal | The signal is lost from the SiriusXM satellite or SiriusXM tower to your vehicle antenna. | The signal is blocked. When you move into an open area, the signal should return. |
| Updating... | Update of channel programming in progress. | No action required. The process may take up to three minutes. |

Audio System (If Equipped)

| Message | Condition | Action |
|-----------------------------------|---|--|
| Questions? Call 1-888-539-7474 | Your satellite service is no longer available. | Contact SiriusXM at 1-888-539-7474 to resolve subscription issues. |
| None found Check Channel Guide | All the channels in the selected category are either skipped or locked. | Use the channel guide to turn off the Lock or Skip function on that station. |
| Subscription Updated | SiriusXM has updated the channels available for your vehicle. | No action required. |

STREAMING BLUETOOTH AUDIO

Selecting a Bluetooth Source



Press the button to display the menu.

Repeatedly press the button to scroll to the Bluetooth device.

Press the **OK** button.



Press the button to play the track. Press the button again to pause the track.



Press the button to skip to the next track.

Press and hold the button to fast forward through the track.



Press the button once to return to the beginning of the track. Repeatedly press the button to return to previous tracks.

Press and hold the button to fast rewind.

Note: *Not all functions are supported by all phones.*

PLAYING MEDIA FROM A USB DEVICE

Supported Audio File Formats

You can play audio file formats including MP3, WMA, WAV, M4A, M4B, AAC, and FLAC.

Note: *The NTFS file system is not supported.*

Selecting the USB Device



Press the button to display the menu.

Repeatedly press the button to scroll to your USB device.

Press the **OK** button.

Playing from the USB Device



Press the button to play a track. Press the button again to pause the track.



Press the button to skip to the next track.

Press and hold the button to fast forward through the track.

Audio System (If Equipped)



Press the button once to return to the beginning of a track.

Repeatedly press the button to return to previous tracks.

Press and hold the button to fast rewind.

Sorting by Categories

You can also sort and play music by specific categories, for example artist or album.

Press the **OK** button to view the available categories.

USB PORT



WARNING: Driving while distracted can result in loss of vehicle control, crash and injury. We strongly recommend that you use extreme caution when using any device that may take your focus off the road. Your primary responsibility is the safe operation of your vehicle. We recommend against the use of any hand-held device while driving and encourage the use of voice-operated systems when possible. Make sure you are aware of all applicable local laws that may affect the use of electronic devices while driving.

The USB port allows you to plug in media playing devices, memory sticks and charge devices.

Note: *Not all USB ports in your vehicle have data transfer capabilities. See **Auxiliary Power Points** (page 76).*

USING VOICE RECOGNITION

Phone Voice Service

This system allows you to use the voice recognition features of your phone and focus on your driving.



Press and hold the voice control button on the audio unit.

Note: *This only works when connected via Bluetooth. See **Connecting a Bluetooth Device** (page 240).*

Note: *When using voice recognition use the language set on the device.*

Note: *We recommend that you check your data plan before using your phone voice service through the system. Using them could result in additional charges.*



Accessories

For a complete listing of the accessories that are available for your vehicle, please contact your authorized dealer or visit the online store web site:

| |
|--|
| Web Address (United States) |
| www.Accessories.Ford.com |

| |
|--|
| Web Address (Canada) |
| www.Accessories.Ford.ca |

We will repair or replace any properly authorized dealer-installed Ford Original Accessory found to be defective in factory-supplied materials or workmanship during the warranty period, as well as any component damaged by the defective accessories.

We will warrant your Ford Original Accessory through the warranty that provides the greatest benefit:

- 24 months, unlimited mileage.
- The remainder of your new vehicle limited warranty.

Contact an authorized dealer for details and a copy of the warranty.

*Ford Licensed Accessories. The accessory manufacturer designs, develops and therefore warrants Ford Licensed Accessories, and does not design or test these accessories to Ford Motor Company engineering requirements. Contact an authorized Ford dealer for the manufacturer's limited warranty details, and request a copy of the Ford Licensed Accessories product limited warranty from the accessory manufacturer.

For maximum vehicle performance, keep the following information in mind when adding accessories or equipment to your vehicle:

- When adding accessories, equipment, passengers and luggage to your vehicle, do not exceed the total weight capacity of the vehicle or of the front or rear axle (GVWR or GAWR as indicated on the Safety Compliance Certification label). Ask an authorized dealer for specific weight information.
- The Federal Communications Commission (FCC) and Canadian Radio Telecommunications Commission (CRTC) regulate the use of mobile communications systems that are equipped with radio transmitters, for example two-way radios, telephones and theft alarms. Any such equipment installed in your vehicle should comply with Federal Communications Commission (FCC) and Canadian Radio Telecommunications Commission (CRTC) regulations and should be installed only by an authorized dealer.
- An authorized dealer needs to install mobile communications systems. Improper installation may harm the operation of your vehicle, particularly if the manufacturer did not design the mobile communication system specifically for automotive use.
- If you or an authorized Ford dealer add any non-Ford electrical or electronic accessories or components to your vehicle, you may adversely affect battery performance and durability. In addition, you may also adversely affect the performance of other electrical systems in the vehicle.

Accessories

AUXILIARY SWITCHES (IF EQUIPPED)

For maximum vehicle performance, keep the following information in mind when adding accessories or equipment to your vehicle:

- When adding accessories, equipment, passengers and luggage to your vehicle, do not exceed the total weight capacity of the vehicle or of the front or rear axle (GVWR or GAWR as indicated on the Safety Compliance Certification label). Ask an authorized dealer for specific weight information.
- The Federal Communications Commission (FCC) and Canadian Radio Telecommunications Commission (CRTC) regulate the use of mobile communications systems equipped with radio transmitters, for example, two-way radios, telephones and theft alarms. Any such equipment installed in your vehicle should comply with Federal Communications Commission (FCC) and Canadian Radio Telecommunications Commission (CRTC) regulations, and should be installed by an authorized dealer.
- An authorized dealer needs to install mobile communications systems. Improper installation may harm the operation of your vehicle, particularly if the manufacturer did not design the mobile communication system specifically for automotive use.
- If you or an authorized Ford dealer add any non-Ford electrical or electronic accessories or components to your vehicle, you may adversely affect battery performance and durability. In addition, you may also adversely affect the performance of other electrical systems in the vehicle.



E163431

The auxiliary switch option package provides four switches, mounted in the center of the instrument panel. These switches operate when the vehicle is running or from battery power, depending on the switchable PDB fuse locations #82 and #83. Ford recommends, however, that the engine remain running to maintain battery charge when using the auxiliary switches for extended periods of time or higher current draws.

When switched on, the auxiliary switches provide 20 amps or 40 amps of electrical battery power for a variety of personal or commercial uses.

The switches include the fuse and relay kit. This kit contains the required fuses and relays that an authorized technician needs to install into the power distribution box, located under the hood. Refer to the instruction sketch included in the kit. Contact an authorized dealer for service.

Each switch includes a power lead (a blunt-cut and sealed wire) located in the underhood cowl shield above the engine block powertrain control module.

The power leads are coded as follows:

Accessories

| Switch | Circuit Number | Wire Color | Fuse Amp Rating |
|--------|----------------|-------------------------|-----------------|
| AUX 1 | CAC05 | Yellow | 40A |
| AUX 2 | CAC06 | Green with Brown Trace | 40A |
| AUX 3 | CAC07 | Violet with Green Trace | 20A |
| AUX 4 | CAC08 | Brown | 20A |

Learn more about auxiliary switches by visiting <https://www.fleet.ford.com/truckbbas/>.

Upfitter Interface Module (If Equipped)

The Upfitter Interface Module (UIM) is an electronic control module that operates equipment (such as lift buckets, cranes, motors, salt spreaders and snow plows) with external relays.

If you replace the module, it will require additional programming by the upfitter. Obtain this data directly from the upfitter company. The upfitter contact information is in the vehicle door opening.

For more information on the Upfitter Interface Module and the auxiliary switches, contact your upfitter.

Ford Protect

PROTECT YOURSELF FROM THE RISING COST OF VEHICLE REPAIRS WITH A FORD PROTECT EXTENDED SERVICE PLAN.

Ford Protect Extended Service Plans (U.S. Only)

Ford Protect extended service plan means peace of mind. It's the extended service plan backed by Ford Motor Company, and provides more protection beyond the New Vehicle Limited Warranty coverage. When you visit your Ford Dealer, Insist on Ford Protect extended service plans!

Ford Protect Can Quickly Pay for Itself

One trip to the Service Center could easily exceed the price of your Ford Protect extended service plan. With Ford Protect extended service plan you minimize your risk for unexpected repair bills and rising repair costs.

Up to 1,000+ Covered Vehicle Components

There are four mechanical Ford Protect extended service plans with different levels of coverage. Ask your authorized dealer for details.

1. PremiumCARE - Our most comprehensive coverage. With over 1,000 covered components, this plan is so complete it's probably easier to list what's not covered.
2. ExtraCARE - Covers 113 components, and includes many high-tech items.
3. BaseCARE - Covers 84 components.
4. PowertrainCARE - Covers 29 critical components.

Ford Protect extended service plans are honored by all authorized Ford dealers in the U.S., Canada and Mexico.

That means you get:

- Reliable, quality service at any Ford or Lincoln dealership.
- Repairs performed by factory trained technicians, using genuine parts.

Rental Car Reimbursement

1st day Rental Benefit

If you bring your car into your dealer for service, we'll give you a loaner to use for the day.

Extended Rental Benefits

If your vehicle is kept overnight for covered repairs, you are eligible for rental car coverage, including warranty repairs, and Field Service Actions.

Roadside Assistance

Exclusive 24/7 roadside assistance, including:

- Towing, flat-tire change and battery jump starts.
- Out of fuel and lock-out assistance.
- Travel expense reimbursement for lodging, meals and rental car.
- Assistance for taxi, shuttle, rental car coverage or other transportation.

Transferable Coverage

If you sell your vehicle before your Ford Protect extended service plan coverage expires, you can transfer any remaining coverage to the new owner. Which should give you and your potential buyer a little more peace of mind.

Ford Protect

Less Cost to Properly Maintain Your Vehicle

Ford Protect extended service plan also offers a Premium Maintenance Plan that covers all scheduled maintenance, and selected wear items. The coverage is prepaid, so you never have to worry about the cost of your vehicle's maintenance.

Covered maintenance includes:

- Windshield wiper blades.
- Spark plugs.
- The clutch disc (if equipped).
- Brake pads and linings.
- Shock absorbers.
- Struts.
- Engine Belts.
- Engine coolant hoses, clamps and o-rings.
- Diesel exhaust fluid replenishment (if equipped).
- Cabin air filter replacement every 20,000 mi (32,000 km) (electric vehicles only).

Interest Free Finance Options

Just a 5% down payment will provide you with an affordable, no interest, no fee payment program allowing you all the security and benefits Ford Protect extended service plan has to offer while paying over time. You are pre-approved with no credit check or hassles. To learn more, call our Ford Protect extended service plan specialists at 800-367-3377.

Ford Protect Extended Service Plan
P.O. Box 321067
Detroit, MI 48232

Ford Protect Extended Service Plan (CANADA ONLY)

You can get more protection for your vehicle by purchasing a Ford Protect extended service plan. Ford Protect extended service plan is the only service contract backed by Ford Motor Company of Canada, Limited. Depending on the plan you purchase, Ford Protect extended service plan provides benefits such as:

- Rental reimbursement.
- Coverage for certain maintenance and wear items.
- Protection against repair costs after your New Vehicle Limited Warranty Coverage expires.
- Roadside Assistance benefits.

There are several Ford Protect extended service plans available in various time, distance and deductible combinations. Each plan is tailored to fit your own driving needs, including reimbursement for towing and rental. When you purchase Ford Protect extended service plan, you receive added peace-of-mind protection throughout Canada, the United States and Mexico, provided by a network of participating authorized Ford Motor Company dealers.

Note: *Repairs performed outside of Canada and the United States are not eligible for Ford Protect extended service plan coverage.*

This information is subject to change. For more information; visit your local Ford of Canada dealer or www.ford.ca to find the Ford Protect extended service plan that is right for you.

Scheduled Maintenance

GENERAL MAINTENANCE INFORMATION

Why Maintain Your Vehicle?

Carefully following the maintenance schedule helps protect against major repair expenses resulting from neglect or inadequate maintenance and may help to increase the value of your vehicle when you sell or trade it. Keep all receipts for completed maintenance with your vehicle.

We have established regular maintenance intervals for your vehicle based upon rigorous testing. It is important that you have your vehicle serviced at the proper times. These intervals serve two purposes; one is to maintain the reliability of your vehicle and the second is to keep your cost of owning your vehicle down.

It is your responsibility to have all scheduled maintenance performed and to make sure that the materials used meet the specifications identified in this owner's manual. See **Capacities and Specifications** (page 219).

Failure to perform scheduled maintenance invalidates warranty coverage on parts affected by the lack of maintenance.

Why Maintain Your Vehicle at Your Dealership?

Factory-trained Technicians

Service technicians participate in extensive factory-sponsored certification training to help them become experts on the operation of your vehicle. Ask your dealership about the training and certification their technicians have received.

Genuine Ford and Motorcraft Replacement Parts

Dealerships stock Ford, Motorcraft and Ford-authorized branded re-manufactured replacement parts. These parts meet or exceed our specifications. Parts installed at your dealership carry a nationwide 24-month or unlimited mile (kilometer) parts and labor limited warranty.

If you do not use Ford authorized parts they may not meet our specifications and depending on the part, it could affect emissions compliance.

Convenience

Many dealerships have extended evening and Saturday hours to make your service visit more convenient and they offer one stop shopping. They can perform any services that are required on your vehicle, from general maintenance to collision repairs.

Note: *Not all dealers have extended hours or body shops. Please contact your dealer for details.*

Protecting Your Investment

Maintenance is an investment that pays dividends in the form of improved reliability, durability and resale value. To maintain the proper performance of your vehicle and its emission control systems, make sure you have scheduled maintenance performed at the designated intervals.

Your vehicle is very sophisticated and built with multiple, complex, performance systems. Every manufacturer develops these systems using different specifications and performance features. That is why it is important to rely upon your dealership to properly diagnose and repair your vehicle.

Scheduled Maintenance

Ford Motor Company has recommended maintenance intervals for various parts and component systems based upon engineering testing. Ford Motor Company relies upon this testing to determine the most appropriate mileage for replacement of oils and fluids to protect your vehicle at the lowest overall cost to you and recommends against maintenance schedules that deviate from the scheduled maintenance information.

We strongly recommend the use of only genuine Ford, Motorcraft or Ford-authorized re-manufactured replacement parts engineered for your vehicle.

Additives and Chemicals

This owner's manual and the Ford Workshop Manual list the recommended additives and chemicals for your vehicle. We do not recommend using chemicals or additives not approved by us as part of your vehicle's normal maintenance. Please consult your warranty information.

Oils, Fluids and Flushing

In many cases, fluid discoloration is a normal operating characteristic and, by itself, does not necessarily indicate a concern or that the fluid needs to be changed. However, a qualified expert, such as the factory-trained technicians at your dealership, should inspect discolored fluids that also show signs of overheating or foreign material contamination immediately.

Make sure to change your vehicle's oils and fluids at the specified intervals or in conjunction with a repair. Flushing is a viable way to change fluid for many vehicle sub-systems during scheduled maintenance. It is critical that systems are flushed only with new fluid that is the same as that required to fill and operate the system or using a Ford-approved flushing chemical.

Owner Checks and Services

Make sure you perform the following basic maintenance checks and inspections every month or at six-month intervals.

| Check every month |
|---|
| Engine oil level. |
| Function of all interior and exterior lights. |
| Tires (including spare) for wear and proper pressure. |
| Windshield washer fluid level. |

| Check every six months |
|---|
| Battery connections. Clean if necessary. |
| Body and door drain holes for obstructions. Clean if necessary. |
| Cooling system fluid level and coolant strength. |
| Door weatherstrips for wear. Lubricate if necessary. |

Scheduled Maintenance

| Check every six months |
|---|
| Hinges, latches and outside locks for proper operation. Lubricate if necessary. |
| Parking brake for proper operation. |
| Safety belts and seat latches for wear and function. |
| Safety warning lamps (brake, ABS, airbag and safety belt) for operation. |
| Washer spray and wiper operation. Clean or replace blades as necessary. |

Multi-point Inspection

In order to keep your vehicle running right, it is important to have the systems on your vehicle checked regularly. This can help identify potential issues and prevent major problems. We recommend having the following multi-point inspection performed at every scheduled maintenance interval to help make sure your vehicle keeps running great.

| Multi-point inspection | |
|--|--|
| Accessory drive belt(s) | Horn operation |
| Battery performance | Radiator, cooler, heater and A/C hoses |
| Engine air filter | Suspension component for leaks or damage |
| Exhaust system | Steering and linkage |
| Exterior lamps and hazard warning system operation | Tires (including spare) for wear and proper pressure** |
| Fluid levels*; fill if necessary | Windshield for cracks, chips or pits |
| For oil and fluid leaks | Washer spray and wiper operation |

* Brake, coolant recovery reservoir, automatic transmission, power steering and window washer.

**If your vehicle is equipped with a temporary mobility kit, check the tire sealant expiration Use By date on the canister. Replace as needed.

Scheduled Maintenance

Be sure to ask your dealership service advisor or technician about the multi-point vehicle inspection. It is a comprehensive way to perform a thorough inspection of

your vehicle. Your checklist gives you immediate feedback on the overall condition of your vehicle.

NORMAL SCHEDULED MAINTENANCE

Note: Do not exceed the mileage or time intervals.

| Maintenance | |
|---|--|
| Every 7,500 mi (12,000 km) | Rotate the tires, inspect tire wear and measure tread depth. ¹ |
| | Inspect the wheels and related components for abnormal noise, wear, looseness or drag. |
| | Perform a multi-point inspection. |
| Every 10,000 mi (16,000 km) /12 months or 450 engine hours, whichever comes first | Change the engine oil and filter. |

¹Rotate the front wheels on vehicles with dual rear wheels when specified. Only rotate the rear wheels if you notice unusual wear.

| Maintenance | |
|-----------------------------------|---|
| Every 15,000 mi (24,000 km) | Inspect the automatic transmission fluid level. Consult dealer for requirements. |
| | Inspect the brake pads, rotors, hoses and parking brake. |
| | Inspect the engine cooling system strength and hoses. |
| | Inspect the exhaust system and heat shields. |
| | Inspect the steering linkage, ball joints, suspension, tie-rod ends, driveshaft and the U-joints. |

Scheduled Maintenance

| Brake Fluid Maintenance¹ | |
|--|--------------------------------------|
| Every 3 Years | Change the brake fluid. ² |

¹ Perform this maintenance item every 3 years. Do not exceed the designated time for the interval.

² Brake fluid servicing requires special equipment available at your authorized dealer.

| Other Maintenance Items | |
|----------------------------------|--|
| Every 30,000 mi (48,000 km) | Replace the engine air filter. Torque the rear axle U-bolts to specification. |
| Every 60,000 mi (96,000 km) | Replace the front wheel bearing grease and grease seal, if you use non-sealed bearings. |
| Every 97,500 mi (157,000 km) | Replace the spark plugs. |
| | Replace the rear axle fluid. See Special Operating Conditions Scheduled Maintenance (page 255). |
| Every 105,000 mi (168,000 km) | Inspect the accessory drive belts. ¹ |
| Every 150,000 mi (240,000 km) | Change the automatic transmission fluid. |
| | Change the automatic transmission filter. |
| | Replace the accessory drive belts if not replaced within the last 100,000 mi (160,000 km). |
| | Replace the front wheel bearings and seals, if you use non-sealed bearings. |
| Every 200,000 mi (320,000 km) | Change the engine coolant. ² |

¹ If not replaced, inspect every 15,000 mi (24,000 km).

² Initial replacement at ten years or 200,000 mi (320,000 km), then every five years or 100,000 mi (160,000 km).

Scheduled Maintenance

SPECIAL OPERATING CONDITIONS SCHEDULED MAINTENANCE

If you operate your vehicle **primarily** in any of the following conditions, you need to

perform extra maintenance as indicated. If you operate your vehicle **occasionally** under any of these conditions, it is not necessary to perform the extra maintenance. For specific recommendations, see your dealership service advisor or technician.

| Towing a Trailer or Using a Car-top Carrier | |
|--|---|
| As required | Change the engine oil and filter as indicated by the information display and perform services listed in the Normal Scheduled Maintenance chart. |
| Inspect frequently, service as required | Inspect the U-joints. |
| Every 22,500 mi (36,000 km) | Replace the rear axle fluid. See axle maintenance items under Exceptions . |
| Every 60,000 mi (96,000 km) | Replace the spark plugs. |

| Extensive Idling or Low-speed Driving for Long Distances, as in Heavy Commercial Use (Such as Delivery, Taxi, Patrol Car or Livery) | |
|--|---|
| As required | Change the engine oil and filter as indicated by the information display and perform services listed in the Normal Scheduled Maintenance chart. |
| Inspect frequently, service as required | Replace the engine air filter. |
| Every 22,500 mi (36,000 km) | Replace the rear axle fluid. See axle maintenance items under Exceptions . |
| Every 60,000 mi (96,000 km) | Replace the spark plugs. |

Scheduled Maintenance

| Operating in Dusty or Sandy Conditions (Such as Unpaved or Dusty Roads) | |
|--|--|
| Inspect frequently, service as required | Replace engine air filter. |
| Every 5,000 mi (8,000 km) | Inspect the wheels and related components for abnormal noise, wear, looseness or drag. |
| | Rotate the tires ¹ , inspect tires for wear and measure the tread depth. |
| Every 5,000 mi (8,000 km) or six months | Change the engine oil and filter. ² |
| | Perform a multi-point inspection. |

¹Vehicles with dual rear wheels should rotate the front wheels when specified; rear wheels only if unusual wear is noted.

²Reset your Intelligent Oil-Life Monitor after each engine oil and filter change. See **Oil Change Indicator Reset** (page 164).

| Exclusive Use of E85 - Flex Fuel Vehicles Only | |
|---|---|
| Every oil change | If ran exclusively on E85, fill the fuel tank with regular unleaded fuel. |

Exceptions

There are several exceptions to the Normal Schedule:

Axle(s) and transfer case, four-wheel drive vehicles, fluid changes or level checks are not required unless a leak is suspected or the assembly has been submerged in water. Contact an authorized dealer for service.

California fuel filter replacement: If you register your vehicle in California, the California Air Resources Board has determined that the failure to perform this maintenance item does not nullify the emission warranty or limit recall liability before the completion of your vehicle's useful life. We however, urge you to have all recommended maintenance services performed at the specified intervals and to record all vehicle service.

Hot climate oil change intervals: Vehicles operating in the Middle East, North Africa, Sub-Saharan Africa or locations with similar climates using an American Petroleum Institute (API) Certified for Gasoline Engines (Certification mark) oil of SM or SN quality, the normal oil change interval is 5,000 mi (8,000 km).

Scheduled Maintenance

If the available API SM or SN oils are not available, then the oil change interval is 3,000 mi (4,800 km).

Engine air filter replacement: The life of the engine air filter is dependent on exposure to dusty and dirty conditions. Vehicles operated in these conditions require frequent inspection and replacement of the engine air filter.

SCHEDULED MAINTENANCE RECORD

After the scheduled maintenance services are performed, record the Repair Order #, Distance and Engine Hours in the boxes provided.

| | |
|--|---------------------|
| <input type="radio"/> Repair Order #: | <p>Dealer stamp</p> |
| <input type="radio"/> Distance: | |
| <input type="radio"/> Engine hours (optional): | |
| <input type="radio"/> Multi-point inspection (recommended): <input type="checkbox"/> | |
| <input type="radio"/> Signature: | |

| | |
|--|---------------------|
| <input type="radio"/> Repair Order #: | <p>Dealer stamp</p> |
| <input type="radio"/> Distance: | |
| <input type="radio"/> Engine hours (optional): | |
| <input type="radio"/> Multi-point inspection (recommended): <input type="checkbox"/> | |
| <input type="radio"/> Signature: | |

Scheduled Maintenance

| | |
|--|--------------|
| <input type="radio"/> Repair Order #: | Dealer stamp |
| <input type="radio"/> Distance: | |
| <input type="radio"/> Engine hours (optional): | |
| <input type="radio"/> Multi-point inspection (recommended): <input type="checkbox"/> | |
| <input type="radio"/> Signature: | |

| | |
|--|--------------|
| <input type="radio"/> Repair Order #: | Dealer stamp |
| <input type="radio"/> Distance: | |
| <input type="radio"/> Engine hours (optional): | |
| <input type="radio"/> Multi-point inspection (recommended): <input type="checkbox"/> | |
| <input type="radio"/> Signature: | |

Scheduled Maintenance

| | |
|--|---------------------|
| <input type="radio"/> Repair Order #: | <p>Dealer stamp</p> |
| <input type="radio"/> Distance: | |
| <input type="radio"/> Engine hours (optional): | |
| <input type="radio"/> Multi-point inspection (recommended): <input type="checkbox"/> | |
| <input type="radio"/> Signature: | |

| | |
|--|---------------------|
| <input type="radio"/> Repair Order #: | <p>Dealer stamp</p> |
| <input type="radio"/> Distance: | |
| <input type="radio"/> Engine hours (optional): | |
| <input type="radio"/> Multi-point inspection (recommended): <input type="checkbox"/> | |
| <input type="radio"/> Signature: | |

Scheduled Maintenance

| | |
|--|--------------|
| <input type="radio"/> Repair Order #: | Dealer stamp |
| <input type="radio"/> Distance: | |
| <input type="radio"/> Engine hours (optional): | |
| <input type="radio"/> Multi-point inspection (recommended): <input type="checkbox"/> | |
| <input type="radio"/> Signature: | |

| | |
|--|--------------|
| <input type="radio"/> Repair Order #: | Dealer stamp |
| <input type="radio"/> Distance: | |
| <input type="radio"/> Engine hours (optional): | |
| <input type="radio"/> Multi-point inspection (recommended): <input type="checkbox"/> | |
| <input type="radio"/> Signature: | |

Scheduled Maintenance

| | |
|--|---------------------|
| <input type="radio"/> Repair Order #: | <p>Dealer stamp</p> |
| <input type="radio"/> Distance: | |
| <input type="radio"/> Engine hours (optional): | |
| <input type="radio"/> Multi-point inspection (recommended): <input type="checkbox"/> | |
| <input type="radio"/> Signature: | |

| | |
|--|---------------------|
| <input type="radio"/> Repair Order #: | <p>Dealer stamp</p> |
| <input type="radio"/> Distance: | |
| <input type="radio"/> Engine hours (optional): | |
| <input type="radio"/> Multi-point inspection (recommended): <input type="checkbox"/> | |
| <input type="radio"/> Signature: | |

Scheduled Maintenance

| | |
|--|--------------|
| <input type="radio"/> Repair Order #: | Dealer stamp |
| <input type="radio"/> Distance: | |
| <input type="radio"/> Engine hours (optional): | |
| <input type="radio"/> Multi-point inspection (recommended): <input type="checkbox"/> | |
| <input type="radio"/> Signature: | |

| | |
|--|--------------|
| <input type="radio"/> Repair Order #: | Dealer stamp |
| <input type="radio"/> Distance: | |
| <input type="radio"/> Engine hours (optional): | |
| <input type="radio"/> Multi-point inspection (recommended): <input type="checkbox"/> | |
| <input type="radio"/> Signature: | |

Scheduled Maintenance

| | |
|--|--------------|
| <input type="radio"/> Repair Order #: | Dealer stamp |
| <input type="radio"/> Distance: | |
| <input type="radio"/> Engine hours (optional): | |
| <input type="radio"/> Multi-point inspection (recommended): <input type="checkbox"/> | |
| <input type="radio"/> Signature: | |

| | |
|--|--------------|
| <input type="radio"/> Repair Order #: | Dealer stamp |
| <input type="radio"/> Distance: | |
| <input type="radio"/> Engine hours (optional): | |
| <input type="radio"/> Multi-point inspection (recommended): <input type="checkbox"/> | |
| <input type="radio"/> Signature: | |

Scheduled Maintenance

| | |
|--|--------------|
| <input type="radio"/> Repair Order #: | Dealer stamp |
| <input type="radio"/> Distance: | |
| <input type="radio"/> Engine hours (optional): | |
| <input type="radio"/> Multi-point inspection (recommended): <input type="checkbox"/> | |
| <input type="radio"/> Signature: | |

| | |
|--|--------------|
| <input type="radio"/> Repair Order #: | Dealer stamp |
| <input type="radio"/> Distance: | |
| <input type="radio"/> Engine hours (optional): | |
| <input type="radio"/> Multi-point inspection (recommended): <input type="checkbox"/> | |
| <input type="radio"/> Signature: | |

Scheduled Maintenance

| | |
|--|---------------------|
| <input type="radio"/> Repair Order #: | <p>Dealer stamp</p> |
| <input type="radio"/> Distance: | |
| <input type="radio"/> Engine hours (optional): | |
| <input type="radio"/> Multi-point inspection (recommended): <input type="checkbox"/> | |
| <input type="radio"/> Signature: | |

| | |
|--|---------------------|
| <input type="radio"/> Repair Order #: | <p>Dealer stamp</p> |
| <input type="radio"/> Distance: | |
| <input type="radio"/> Engine hours (optional): | |
| <input type="radio"/> Multi-point inspection (recommended): <input type="checkbox"/> | |
| <input type="radio"/> Signature: | |

Scheduled Maintenance

| | |
|--|--------------|
| <input type="radio"/> Repair Order #: | Dealer stamp |
| <input type="radio"/> Distance: | |
| <input type="radio"/> Engine hours (optional): | |
| <input type="radio"/> Multi-point inspection (recommended): <input type="checkbox"/> | |
| <input type="radio"/> Signature: | |

| | |
|--|--------------|
| <input type="radio"/> Repair Order #: | Dealer stamp |
| <input type="radio"/> Distance: | |
| <input type="radio"/> Engine hours (optional): | |
| <input type="radio"/> Multi-point inspection (recommended): <input type="checkbox"/> | |
| <input type="radio"/> Signature: | |

Appendices

ELECTROMAGNETIC COMPATIBILITY



WARNING: Do not place objects or mount equipment on or near the airbag cover, on the side of the seatbacks (of the front seats), or in front seat areas that may come into contact with a deploying airbag. Failure to follow these instructions may increase the risk of personal injury in the event of a crash.



WARNING: Do not fasten antenna cables to original vehicle wiring, fuel pipes and brake pipes.



WARNING: Keep antenna and power cables at least 4 in (10 cm) from any electronic modules and airbags.

Note: We test and certify your vehicle to meet electromagnetic compatibility legislation (UNECE Regulation 10 or other applicable local requirements). It is your responsibility to make sure that any equipment an authorized dealer installs on your vehicle complies with applicable local legislation and other requirements.

Note: Any radio frequency transmitter equipment in your vehicle (such as cellular telephones and amateur radio transmitters) must keep to the parameters in the following table. We do not provide special provisions or conditions for installations or use.

Car

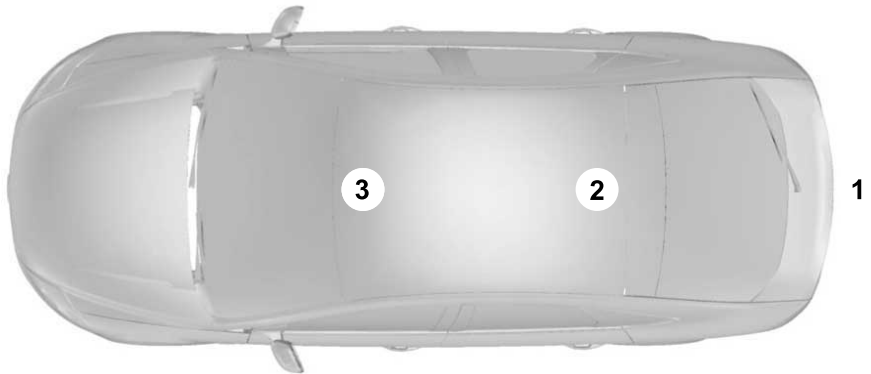

E239120

Appendices

Van



E239122

Truck

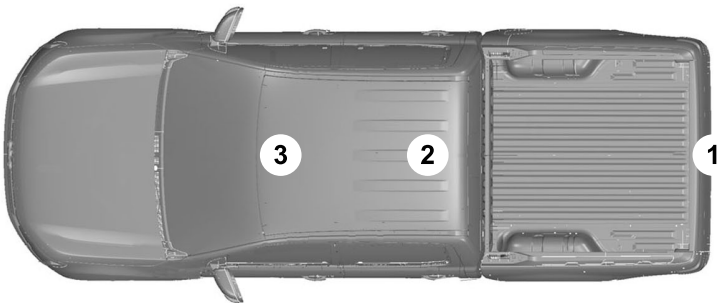

E239121

Appendices

| Frequency Band MHz | Maximum output power Watt (Peak RMS) | Antenna Positions |
|--------------------|--------------------------------------|-------------------|
| 1-30 | 50 | 1 |
| 50-54 | 50 | 2, 3 |
| 68-88 | 50 | 2, 3 |
| 142-176 | 50 | 2, 3 |
| 380-512 | 50 | 2, 3 |
| 806-870 | 10 | 2, 3 |

Note: After the installation of radio frequency transmitters, check for disturbances from and to all electrical equipment in your vehicle, both in the standby and transmit modes.

Check all electrical equipment:

- With the ignition ON.
- With the engine running.
- During a road test at various speeds.

Check that electromagnetic fields generated inside your vehicle cabin by the transmitter installed do not exceed applicable human exposure requirements.

END USER LICENSE AGREEMENT

SYNC End User License Agreement (EULA)

- You have acquired a device ("DEVICE") that includes software licensed by Ford Motor Company and its affiliates ("FORD MOTOR COMPANY") from an affiliate of Microsoft Corporation ("MS"). Those installed software products of MS origin, as well as associated media, printed materials,

and "online" or electronic documentation ("MS SOFTWARE") are protected by international intellectual property laws and treaties. The MS SOFTWARE is licensed, not sold. All rights reserved.

- The MS SOFTWARE may interface with and/or communicate with, or may be later upgraded to interface with and/or communicate with additional software and/or systems provided by FORD MOTOR COMPANY. The additional software and systems of FORD MOTOR COMPANY origin, as well as associated media, printed materials, and "online" or electronic documentation ("FORD SOFTWARE") are protected by international intellectual property laws and treaties. The FORD SOFTWARE is licensed, not sold. All rights reserved.

Appendices

- The MS SOFTWARE and/or FORD SOFTWARE may interface with and/or communicate with, or may be later upgraded to interface with and/or communicate with additional software and/or systems provided by third party software and service suppliers. The additional software and services of third party origin, as well as associated media, printed materials, and "online" or electronic documentation ("THIRD PARTY SOFTWARE") are protected by international intellectual property laws and treaties. The THIRD PARTY SOFTWARE is licensed, not sold. All rights reserved.
- The MS SOFTWARE, FORD SOFTWARE and THIRD PARTY SOFTWARE hereinafter collectively and individually will be referred to as "SOFTWARE".

IF YOU DO NOT AGREE TO THIS END USER LICENSE AGREEMENT ("EULA") DO NOT USE THE DEVICE OR COPY THE SOFTWARE. ANY USE OF THE SOFTWARE, INCLUDING BUT NOT LIMITED TO USE ON THE DEVICE, WILL CONSTITUTE YOUR AGREEMENT TO THIS EULA (OR RATIFICATION OF ANY PREVIOUS CONSENT).

GRANT OF SOFTWARE LICENSE: This EULA grants you the following license:

- You may use the SOFTWARE as installed on the DEVICE and as otherwise interfacing with systems and/or services provide by or through FORD MOTOR COMPANY or its third party software and service providers.

Description of Other Rights and Limitations

- **Speech Recognition:** If the SOFTWARE includes speech recognition component(s), you should understand that speech recognition is an inherently statistical process and that recognition errors are inherent in the process. Neither FORD MOTOR COMPANY nor its suppliers shall be liable for any damages arising out of errors in the speech recognition process.
- **Limitations on Reverse Engineering, Decompilation and Disassembly:** You may not reverse engineer, decompile, or disassemble nor permit others to reverse engineer, decompile or disassemble the SOFTWARE, except and only to the extent that such activity is expressly permitted by applicable law notwithstanding this limitation.
- **Limitations on Distributing, Copying, Modifying and Creating Derivative Works:** You may not distribute, copy, make modifications to or create derivative works based on the SOFTWARE, except and only to the extent that such activity is expressly permitted by applicable law notwithstanding this limitation.
- **Single EULA:** The end user documentation for the DEVICE and related systems and services may contain multiple EULAs, such as multiple translations and/or multiple media versions (e.g., in the user documentation and in the software). Even if you receive multiple EULAs, you are licensed to use only one (1) copy of the SOFTWARE.

Appendices

- **SOFTWARE Transfer:** You may permanently transfer your rights under this EULA only as part of a sale or transfer of the DEVICE, provided you retain no copies, you transfer all of the SOFTWARE (including all component parts, the media and printed materials, any upgrades, and, if applicable, the Certificate(s) of Authenticity), and the recipient agrees to the terms of this EULA. If the SOFTWARE is an upgrade, any transfer must include all prior versions of the SOFTWARE.
- **Termination:** Without prejudice to any other rights, FORD MOTOR COMPANY or MS may terminate this EULA if you fail to comply with the terms and conditions of this EULA.
- **Security Updates/Digital Rights Management:** Content owners use the WMDRM technology included in your DEVICE to protect their intellectual property, included copyrighted content. Portions of the SOFTWARE on your DEVICE use WMDRM software to access WMDRM-protected content. If the WMDRM software fails to protect the content, content owners may ask Microsoft to revoke the SOFTWARE's ability to use WMDRM to play or copy protected content. This action does not affect unprotected content. When your DEVICE downloads licenses for protected content, you agree that Microsoft may include a revocation list with the licenses. Content owners may require you to upgrade the SOFTWARE on your DEVICE to access their content. If you decline an upgrade, you will not be able to access content that requires the upgrade.
- **Consent to Use of Data:** You agree that MS, Microsoft Corporation, FORD MOTOR COMPANY, third party software and systems suppliers, their affiliates and/or their designated agent may collect and use technical information gathered in any manner as part of product support services related to the SOFTWARE or related services. MS, Microsoft Corporation, FORD MOTOR COMPANY, third party software and services suppliers, their affiliates and/or their designated agent may use this information solely to improve their products or to provide customized services or technologies to you. MS, Microsoft Corporation, FORD MOTOR COMPANY, third party software and systems suppliers, their affiliates and/or their designated agent may disclose this information to others, but not in a form that personally identifies you.
- **Internet-Based Services Components:** The SOFTWARE may contain components that enable and facilitate the use of certain Internet-based services. You acknowledge and agree that MS, Microsoft Corporation, FORD MOTOR COMPANY, third party software and service suppliers, their affiliates and/or their designated agent may automatically check the version of the SOFTWARE and/or its components that you are utilizing and may provide upgrades or supplements to the SOFTWARE that may be automatically downloaded to your DEVICE.
- **Additional Software/Services:** The SOFTWARE may permit FORD MOTOR COMPANY, third party software and service suppliers, MS, Microsoft Corporation, their affiliates and/or their designated agent to provide or make available to you SOFTWARE updates,

Appendices

supplements, add-on components, or Internet-based services components of the SOFTWARE after the date you obtain your initial copy of the SOFTWARE ("Supplemental Components").

If FORD MOTOR COMPANY or third party software and services suppliers provide or make available to you Supplemental Components and no other EULA terms are provided along with the Supplemental Components, then the terms of this EULA shall apply.

If MS, Microsoft Corporation, their affiliates and/or their designated agent make available Supplemental Components, and no other EULA terms are provided, then the terms of this EULA shall apply, except that the MS, Microsoft Corporation or affiliate entity providing the Supplemental Component(s) shall be the licensor of the Supplemental Component(s).

FORD MOTOR COMPANY, MS, Microsoft Corporation, their affiliates and/or their designated agent reserve the right to discontinue without liability any Internet-based services provided to you or made available to you through the use of the SOFTWARE.

- **Links to Third Party Sites:** The MS SOFTWARE may provide you with the ability to link to third party sites through the use of the SOFTWARE. The third party sites are not under the control of MS, Microsoft Corporation, their affiliates and/or their designated agent. Neither MS nor Microsoft Corporation nor their affiliates nor their designated agent are responsible for (i) the contents of any third party sites, any links contained in third party sites, or any changes or updates to third party sites, or (ii) webcasting or any other form of transmission received from any third party sites. If the SOFTWARE provides links to third party sites, those links are provided to you only as a convenience, and the inclusion of any link does not imply an endorsement of the third party site by MS, Microsoft Corporation, their affiliates and/or their designated agent.
- **Obligation to Drive Responsibly:** You recognize your obligation to drive responsibly and keep attention on the road. You will read and abide with the DEVICE operating instructions particularly as they pertain to safety and assumes any risk associated with the use of the DEVICE.

UPGRADES AND RECOVERY MEDIA:

If the SOFTWARE is provided by FORD MOTOR COMPANY separate from the DEVICE on media such as a ROM chip, CD ROM disk(s) or via web download or other means, and is labeled "For Upgrade Purposes Only" or "For Recovery Purposes Only" you may install one (1) copy of such SOFTWARE onto the DEVICE as a replacement copy for the existing SOFTWARE, and use it in accordance with this EULA, including any additional EULA terms accompanying the upgrade SOFTWARE.

Appendices

INTELLECTUAL PROPERTY RIGHTS:

All title and intellectual property rights in and to the SOFTWARE (including but not limited to any images, photographs, animations, video, audio, music, text and "applets" incorporated into the SOFTWARE), the accompanying printed materials, and any copies of the SOFTWARE, are owned by MS, Microsoft Corporation, FORD MOTOR COMPANY, or their affiliates or suppliers. The SOFTWARE is licensed, not sold. You may not copy the printed materials accompanying the SOFTWARE. All title and intellectual property rights in and to the content which may be accessed through use of the SOFTWARE is the property of the respective content owner and may be protected by applicable copyright or other intellectual property laws and treaties. This EULA grants you no rights to use such content. All rights not specifically granted under this EULA are reserved by MS, Microsoft Corporation, FORD MOTOR COMPANY, third party software and service providers, their affiliates and suppliers. Use of any on-line services which may be accessed through the SOFTWARE may be governed by the respective terms of use relating to such services. If this SOFTWARE contains documentation that is provided only in electronic form, you may print one copy of such electronic documentation.

EXPORT RESTRICTIONS: You acknowledge that the SOFTWARE is subject to U.S. and European Union export jurisdiction. You agree to comply with all applicable international and national laws that apply to the SOFTWARE, including the U.S. Export Administration Regulations, as well as end-user, end-use and destination restrictions issued by U.S. and other governments. For additional information, see:

| Website |
|---|
| http://www.microsoft.com/exporting/ |

TRADEMARKS: This EULA does not grant you any rights in connection with any trademarks or service marks of FORD MOTOR COMPANY, MS, Microsoft Corporation, third party software or service providers, their affiliates or suppliers.

PRODUCT SUPPORT: Product support for the SOFTWARE is not provided by MS, its parent corporation Microsoft Corporation, or their affiliates or subsidiaries. For product support, please refer to FORD MOTOR COMPANY instructions provided in the documentation for the DEVICE. Should you have any questions concerning this EULA, or if you desire to contact FORD MOTOR COMPANY for any other reason, please refer to the address provided in the documentation for the DEVICE.

No Liability for Certain Damages: EXCEPT AS PROHIBITED BY LAW, FORD MOTOR COMPANY, ANY THIRD PARTY SOFTWARE OR SERVICES SUPPLIERS, MS, MICROSOFT CORPORATION AND THEIR AFFILIATES SHALL HAVE NO LIABILITY FOR ANY INDIRECT, SPECIAL, CONSEQUENTIAL OR INCIDENTAL DAMAGES ARISING FROM OR IN CONNECTION WITH THE USE OR PERFORMANCE OF THE SOFTWARE. THIS LIMITATION SHALL APPLY EVEN IF ANY REMEDY FAILS OF ITS ESSENTIAL PURPOSE. IN NO EVENT SHALL MS, MICROSOFT CORPORATION AND/OR THEIR AFFILIATES BE LIABLE FOR ANY AMOUNT IN EXCESS OF U.S. TWO HUNDRED FIFTY DOLLARS (U.S. \$250.00).

Appendices

- THERE ARE NO WARRANTIES OTHER THAN THOSE THAT MAY EXPRESSLY BE PROVIDED FOR YOUR NEW VEHICLE.

Adobe

Contains Adobe® [Flash® Player] or [AIR®] technology by Adobe Systems Incorporated. This [Licensee Product] contains [Adobe® Flash® Player] [Adobe® AIR®] software under license from Adobe Systems Incorporated, Copyright ©1995-2009 Adobe Macromedia Software LLC. All rights reserved. Adobe, Flash and AIR are trademarks of Adobe Systems Incorporated.

End User Notice

Microsoft® Windows® Mobile for Automotive Important Safety Information

This system Ford SYNC contains software that is licensed to Manufacturer FORD MOTOR COMPANY by an affiliate of Microsoft Corporation pursuant to a license agreement. Any removal, reproduction, reverse engineering or other unauthorized use of the software from this system in violation of the license agreement is strictly prohibited and may subject you to legal action.

Read and follow instructions: Before using your Windows Automotive-based system, read and follow all instructions and safety information provided in this end user manual ("User's Guide"). Not following precautions found in this User's Guide can lead to an accident or other serious consequences.

Keep User's Guide in vehicle: When kept in the vehicle, the User's Guide will be a ready reference for you and other users unfamiliar with the Windows Automotive-based system. Please make certain that before using the system for the first time, all persons have access to the User's Guide and read its instructions and safety information carefully.



WARNING: Operating certain parts of this system while driving can distract your attention away from the road, and possibly cause an accident or other serious consequences. Do not change system settings or enter data non-verbally (using your hands) while driving. Stop the vehicle in a safe and legal manner before attempting these operations. This is important since while setting up or changing some functions you might be required to distract your attention away from the road and remove your hands from the wheel.

General Operation

Voice Command Control: Functions within the Windows Automotive-based system may be accomplished using only voice commands. Using voice commands while driving allows you to operate the system without removing your hands from the wheel.

Prolonged Views of Screen: Do not access any function requiring a prolonged view of the screen while you are driving. Pull over in a safe and legal manner before attempting to access a function of the system requiring prolonged attention. Even occasional short scans to the screen may be hazardous if your attention has been diverted away from your driving task at a critical time.

Appendices

Volume Setting: Do not raise the volume excessively. Keep the volume at a level where you can still hear outside traffic and emergency signals while driving. Driving while unable to hear these sounds could cause an accident.

Use of Speech Recognition Functions: Speech recognition software is inherently a statistical process which is subject to errors. It is your responsibility to monitor any speech recognition functions included in the system and address any errors.

Navigation Features: Any navigation features included in the system are intended to provide turn by turn instructions to get you to a desired destination. Please make certain all persons using this system carefully read and follow instructions and safety information fully.

Distraction Hazard: Any navigation features may require manual (non-verbal) setup. Attempting to perform such set-up or insert data while driving can seriously distract your attention and could cause an accident or other serious consequences. Stop the vehicle in a safe and legal manner before attempting these operations.

Let Your Judgment Prevail: Any navigation features are provided only as an aid. Make your driving decisions based on your observations of local conditions and existing traffic regulations. Any such feature is not a substitute for your personal judgment. Any route suggestions made by this system should never replace any local traffic regulations or your personal judgment or knowledge of safe driving practices.

Route Safety: Do not follow the route suggestions if doing so would result in an unsafe or illegal maneuver, if you would be placed in an unsafe situation, or if you would be directed into an area that you consider unsafe. The driver is ultimately responsible for the safe operation of the vehicle and therefore, must evaluate whether it is safe to follow the suggested directions.

Potential Map Inaccuracy: Maps used by this system may be inaccurate because of changes in roads, traffic controls or driving conditions. Always use good judgment and common sense when following the suggested routes.

Emergency Services: Do not rely on any navigation features included in the system to route you to emergency services. Ask local authorities or an emergency services operator for these locations. Not all emergency services such as police, fire stations, hospitals and clinics are likely to be contained in the map database for such navigation features.

Telenav Software End User License Agreement

Please read these terms and conditions carefully before you use the Telenav Software. Your use of the Telenav Software indicates that you accept these terms and conditions. If you do not accept these terms and conditions, do not break the seal of the package, launch, or otherwise use the Telenav Software.

These terms and conditions represent the agreement (“Agreement”) between you and Telenav, Inc. (“Telenav”) with respect to the Telenav Software (including upgrades, modifications, or additions thereto) (collectively “Telenav Software”). All references herein to “you” and “your” means you, your employees, agents, and contractors, and any other entity on whose behalf you accept these terms and

Appendices

conditions, all of whom shall also be bound by this Agreement. Additionally, all of your account information, as well as other payment and personal information provided by you to Telenav (directly or through the use of the Telenav Software, is subject to Telenav's privacy policy located at <http://www.telenav.com>.

Telenav may revise this Agreement and the privacy policy at any time, with or without notice to you. You agree to visit <http://www.telenav.com> from time to time to review the then current version of this Agreement and of the privacy policy.

1. Safe and Lawful Use

You acknowledge that devoting attention to the Telenav Software may pose a risk of injury or death to you and others in situations that otherwise require your undivided attention, and you therefore agree to comply with the following when using the Telenav Software: (a) observe all traffic laws and otherwise drive safely; (b) use your own personal judgment while driving. If you feel that a route suggested by the Telenav Software instructs you to perform an unsafe or illegal maneuver, places you in an unsafe situation, or directs you into an area that you consider to be unsafe, do not follow such instructions; (c) do not input destinations, or otherwise manipulate the Telenav Software, unless your vehicle is stationary and parked; (d) do not use the Telenav Software for any illegal, unauthorized, unintended, unsafe, hazardous, or unlawful purposes, or in any manner inconsistent with this Agreement; (e) arrange all GPS and wireless devices and cables necessary for use of the Telenav Software in a secure manner in your vehicle so that they will not interfere with your driving and will not prevent the operation of any safety device (such as an airbag).

You agree to indemnify and hold Telenav harmless against all claims resulting from any dangerous or otherwise inappropriate use of the Telenav Software in any moving vehicle, including as a result of your failure to comply with the directions above.

2. Account Information

You agree: (a) when registering the Telenav Software, to provide Telenav with true, accurate, current, and complete information about yourself, and (b) to inform Telenav promptly of any changes to such information, and to keep it true, accurate, current and complete.

3. Software License

Subject to your compliance with the terms of this Agreement, Telenav hereby grants to you a personal, non-exclusive, non-transferable license (except as expressly permitted below in connection with your permanent transfer of the Telenav Software license), without the right to sublicense, to use the Telenav Software (in object code form only) in order to access and use the Telenav Software. This license shall terminate upon any termination or expiration of this Agreement. You agree that you will use the Telenav Software only for your personal business or leisure purposes, and not to provide commercial navigation services to other parties.

3.1 License Limitations

You agree not to do any of the following: (a) reverse engineer, decompile, disassemble, translate, modify, alter or otherwise change the Telenav Software or any part thereof; (b) attempt to derive the source code, audio library or structure of the Telenav Software without the prior express written consent of Telenav; (c) remove from the Telenav Software, or alter, any of Telenav's or its suppliers' trademarks, trade names, logos, patent or

Appendices

copyright notices, or other notices or markings; (d) distribute, sublicense or otherwise transfer the Telenav Software to others, except as part of your permanent transfer of the Telenav Software; or (e) use the Telenav Software in any manner that (i) infringes the intellectual property or proprietary rights, rights of publicity or privacy or other rights of any party, (ii) violates any law, statute, ordinance or regulation, including but not limited to laws and regulations related to spamming, privacy, consumer and child protection, obscenity or defamation, or (iii) is harmful, threatening, abusive, harassing, tortuous, defamatory, vulgar, obscene, libelous, or otherwise objectionable; and (f) lease, rent out, or otherwise permit unauthorized access by third parties to the Telenav Software without advanced written permission of Telenav.

4. Disclaimers

To the fullest extent permissible pursuant to applicable law, in no event will Telenav, its licensors and suppliers, or agents or employees of any of the foregoing, be liable for any decision made or action taken by you or anyone else in reliance on the information provided by the Telenav Software. Telenav also does not warrant the accuracy of the map or other data used for the Telenav Software. Such data may not always reflect reality due to, among other things, road closures, construction, weather, new roads and other changing conditions. You are responsible for the entire risk arising out of your use of the Telenav Software. For example but without limitation, you agree not to rely on the Telenav Software for critical navigation in areas where the well-being or survival of you or others is dependent on the accuracy of navigation, as the maps or functionality of the Telenav Software are not intended to support such high risk applications, especially in more remote geographical areas.

TELENAV EXPRESSLY DISCLAIMS AND EXCLUDES ALL WARRANTIES IN CONNECTION WITH THE TELENAV SOFTWARE, WHETHER STATUTORY, EXPRESS OR IMPLIED, INCLUDING ALL WARRANTIES WHICH MAY ARISE FROM COURSE OF DEALING, CUSTOM OR TRADE AND INCLUDING, BUT NOT LIMITED TO, THE IMPLIED WARRANTIES OF MERCHANTABILITY, FITNESS FOR A PARTICULAR PURPOSE AND NON-INFRINGEMENT OF THIRD PARTY RIGHTS WITH RESPECT TO THE TELENAV SOFTWARE. Certain jurisdictions do not permit the disclaimer of certain warranties, so this limitation may not apply to you.

5. Limitation of Liability

TO THE EXTENT PERMITTED UNDER APPLICABLE LAW, UNDER NO CIRCUMSTANCES SHALL TELENAV OR ITS LICENSORS AND SUPPLIERS BE LIABLE TO YOU OR TO ANY THIRD PARTY FOR ANY INDIRECT, INCIDENTAL, CONSEQUENTIAL, SPECIAL OR EXEMPLARY DAMAGES (INCLUDING IN EACH CASE, BUT NOT LIMITED TO, DAMAGES FOR THE INABILITY TO USE THE EQUIPMENT OR ACCESS DATA, LOSS OF DATA, LOSS OF BUSINESS, LOSS OF PROFITS, BUSINESS INTERRUPTION OR THE LIKE) ARISING OUT OF THE USE OF OR INABILITY TO USE THE TELENAV SOFTWARE, EVEN IF TELENAV HAS BEEN ADVISED OF THE POSSIBILITY OF SUCH DAMAGES.

NOTWITHSTANDING ANY DAMAGES THAT YOU MIGHT INCUR FOR ANY REASON WHATSOEVER (INCLUDING, WITHOUT LIMITATION, ALL DAMAGES REFERENCED HEREIN AND ALL DIRECT OR GENERAL DAMAGES IN CONTRACT, TORT (INCLUDING NEGLIGENCE) OR OTHERWISE), THE ENTIRE LIABILITY OF TELENAV AND OF ALL OF TELENAV'S SUPPLIERS SHALL BE LIMITED TO THE AMOUNT ACTUALLY PAID BY YOU FOR

Appendices

THE TELENNAV SOFTWARE. SOME STATES AND/OR JURISDICTIONS DO NOT ALLOW THE EXCLUSION OR LIMITATION OF INCIDENTAL OR CONSEQUENTIAL DAMAGES, SO THE ABOVE LIMITATIONS OR EXCLUSIONS MAY NOT APPLY TO YOU.

6. Arbitration and Governing Law

You agree that any dispute, claim or controversy arising out of or relating to this Agreement or the Telenav Software shall be settled by independent arbitration involving a neutral arbitrator and administered by the American Arbitration Association in the County of Santa Clara, California. The arbitrator shall apply the Commercial Arbitration Rules of the American Arbitration Association, and the judgment upon the award rendered by the arbitrator may be entered by any court having jurisdiction. Note that there is no judge or jury in an arbitration proceeding and the decision of the arbitrator shall be binding upon both parties. You expressly agree to waive your right to a jury trial.

This Agreement and performance hereunder will be governed by and construed in accordance with the laws of the State of California, without giving effect to its conflict of laws provisions. To the extent judicial action is necessary in connection with the binding arbitration, both Telenav and you agree to submit to the exclusive jurisdiction of the courts of the County of Santa Clara, California. The United Nations Convention on Contracts for the International Sale of Goods shall not apply.

7. Assignment

You may not resell, assign, or transfer this Agreement or any of your rights or obligations, except in totality, in connection with your permanent transfer of the Telenav Software, and expressly conditioned upon the new user of the

Telenav Software agreeing to be bound by the terms and conditions of this Agreement. Any such sale, assignment or transfer that is not expressly permitted under this paragraph will result in immediate termination of this Agreement, without liability to Telenav, in which case you and all other parties shall immediately cease all use of the Telenav Software. Notwithstanding the foregoing, Telenav may assign this Agreement to any other party at any time without notice, provided the assignee remains bound by this Agreement.

8. Miscellaneous

8.1

This Agreement constitutes the entire agreement between Telenav and you with respect to the subject matter hereof.

8.2

Except for the limited licenses expressly granted in this Agreement, Telenav retains all right, title and interest in and to the Telenav Software, including without limitation all related intellectual property rights. No licenses or other rights which are not expressly granted in this Agreement are intended to, or shall be, granted or conferred by implication, statute, inducement, estoppel or otherwise, and Telenav and its suppliers and licensors hereby reserve all of their respective rights other than the licenses explicitly granted in this Agreement.

8.3

By using the Telenav Software, you consent to receive from Telenav all communications, including notices, agreements, legally required disclosures or other information in connection with the Telenav Software (collectively, "Notices") electronically. Telenav may provide such

Appendices

Notices by posting them on Telenav's Website or by downloading such Notices to your wireless device. If you desire to withdraw your consent to receive Notices electronically, you must discontinue your use of the Telenav Software.

8.4

Telenav's or your failure to require performance of any provision shall not affect that party's right to require performance at any time thereafter, nor shall a waiver of any breach or default of this Agreement constitute a waiver of any subsequent breach or default or a waiver of the provision itself.

8.5

If any provision herein is held unenforceable, then such provision will be modified to reflect the intention of the parties, and the remaining provisions of this Agreement will remain in full force and effect.

8.6

The headings in this Agreement are for convenience of reference only, will not be deemed to be a part of this Agreement, and will not be referred to in connection with the construction or interpretation of this Agreement. As used in this Agreement, the words "include" and "including," and variations thereof, will not be deemed to be terms of limitation, but rather will be deemed to be followed by the words "without limitation."

9. Other Vendors Terms and Conditions

The Telenav Software utilizes map and other data licensed to Telenav by third party vendors for the benefit of you and other end users. This Agreement includes end-user terms applicable to these companies (included at the end of this

Agreement), and thus your use of the Telenav Software is also subject to such terms. You agree to comply with the following additional terms and conditions, which are applicable to Telenav's third party vendor licensors:

9.1 End User Terms Required by HERE North America, LLC

The data ("Data") is provided for your personal, internal use only and not for resale. It is protected by copyright, and is subject to the following terms and conditions which are agreed to by you, on the one hand, and Telenav ("Telenav") and its licensors (including their licensors and suppliers) on the other hand.

© 2013 HERE. All rights reserved.

The Data for areas of Canada includes information taken with permission from Canadian authorities, including: © Her Majesty the Queen in Right of Canada, © Queen's Printer for Ontario, © Canada Post Corporation, GeoBase®, © Department of Natural Resources Canada.

HERE holds a non-exclusive license from the United States Postal Service® to publish and sell ZIP+4® information.

©United States Postal Service® 2014. Prices are not established, controlled or approved by the United States Postal Service®. The following trademarks and registrations are owned by the USPS: United States Postal Service, USPS, and ZIP+4.

The Data for Mexico includes certain data from Instituto Nacional de Estadística y Geografía.

TERMS AND CONDITIONS

Appendices

9.2 End User Terms Required by NAV2 (Shanghai) Co., Ltd

The data (“Data”) is provided for your personal, internal use only and not for resale. It is protected by copyright, and is subject to the following terms and conditions which are agreed to by you, on the one hand, and NAV2 (Shanghai) Co., Ltd (“NAV2”) and its licensors (including their licensors and suppliers) on the other hand.

© 20xx. All rights reserved.

Permitted Use.

You agree to use this Data together with the Telenav Software solely for the internal business and personal purposes for which you were licensed, and not for service bureau, time-sharing or other similar purposes. Accordingly, but subject to the restrictions set forth in the following paragraphs, you agree not to otherwise reproduce, copy, modify, decompile, disassemble, create any derivative works of, or reverse engineer any portion of this Data, and may not transfer or distribute it in any form, for any purpose, except to the extent permitted by mandatory laws.

Restrictions.

Except where you have been specifically licensed to do so by Telenav, and without limiting the preceding paragraph, you may not use this Data (a) with any products, systems, or applications installed or otherwise connected to or in communication with vehicles, capable of vehicle navigation, positioning, dispatch, real time route guidance, fleet management or similar applications; or (b) with or in communication with any

positioning devices or any mobile or wireless-connected electronic or computer devices, including without limitation cellular phones, palmtop and handheld computers, pagers, and personal digital assistants or PDAs.

Warning.

The Data may contain inaccurate or incomplete information due to the passage of time, changing circumstances, sources used and the nature of collecting comprehensive geographic data, any of which may lead to incorrect results.

No Warranty.

This Data is provided to you “as is,” and you agree to use it at your own risk. Telenav and its licensors (and their licensors and suppliers) make no guarantees, representations or warranties of any kind, express or implied, arising by law or otherwise, including but not limited to, content, quality, accuracy, completeness, effectiveness, reliability, fitness for a particular purpose, usefulness, use or results to be obtained from this Data, or that the Data or server will be uninterrupted or error-free.

Disclaimer of Warranty:

TELENAV AND ITS LICENSORS (INCLUDING THEIR LICENSORS AND SUPPLIERS) DISCLAIM ANY WARRANTIES, EXPRESS OR IMPLIED, OF QUALITY, PERFORMANCE, MERCHANTABILITY, FITNESS FOR A PARTICULAR PURPOSE OR NON-INFRINGEMENT. Some States, Territories and Countries do not allow certain warranty exclusions, so to that extent the above exclusion may not apply to you.

Appendices

Disclaimer of Liability:

TELENAV AND ITS LICENSORS (INCLUDING THEIR LICENSORS AND SUPPLIERS) SHALL NOT BE LIABLE TO YOU: IN RESPECT OF ANY CLAIM, DEMAND OR ACTION, IRRESPECTIVE OF THE NATURE OF THE CAUSE OF THE CLAIM, DEMAND OR ACTION ALLEGING ANY LOSS, INJURY OR DAMAGES, DIRECT OR INDIRECT, WHICH MAY RESULT FROM THE USE OR POSSESSION OF THE INFORMATION; OR FOR ANY LOSS OF PROFIT, REVENUE, CONTRACTS OR SAVINGS, OR ANY OTHER DIRECT, INDIRECT, INCIDENTAL, SPECIAL OR CONSEQUENTIAL DAMAGES ARISING OUT OF YOUR USE OF OR INABILITY TO USE THIS INFORMATION, OR THE BREACH OF THESE TERMS OR CONDITIONS, WHETHER IN AN ACTION IN CONTRACT OR TORT OR BASED ON A WARRANTY, EVEN IF TELENAV OR ITS LICENSORS HAVE BEEN ADVISED OF THE POSSIBILITY OF SUCH DAMAGES. Some States, Territories and Countries do not allow certain liability exclusions or damages limitations, so to that extent the above may not apply to you.

Export Control.

You shall not export from anywhere any part of the Data or any direct product thereof except in compliance with, and with all licenses and approvals required under, applicable export laws, rules and regulations, including but not limited to the laws, rules and regulations administered by the Office of Foreign Assets Control of the U.S. Department of Commerce and the Bureau of Industry and Security of the U.S. Department of Commerce. To the extent

that any such export laws, rules or regulations prohibit HERE from complying with any of its obligations hereunder to deliver or distribute Data, such failure shall be excused and shall not constitute a breach of this Agreement.

Entire Agreement.

These terms and conditions constitute the entire agreement between Telenav (and its licensors, including their licensors and suppliers) and you pertaining to the subject matter hereof, and supersedes in their entirety any and all written or oral agreements previously existing between us with respect to such subject matter.

Governing Law.

The above terms and conditions shall be governed by the laws of the State of Illinois [insert "Netherlands" where European HERE Data is used], without giving effect to (i) its conflict of laws provisions, or (ii) the United Nations Convention for Contracts for the International Sale of Goods, which is explicitly excluded. You agree to submit to the jurisdiction of the State of Illinois [insert "The Netherlands" where European HERE Data is used] for any and all disputes, claims and actions arising from or in connection with the Data provided to you hereunder.

Government End Users.

If the Data is being acquired by or on behalf of the United States government or any other entity seeking or applying rights similar to those customarily claimed by the United States government, this Data is a "commercial item" as that term is defined at 48 C.F.R. ("FAR") 2.101, is licensed in accordance with these End-User Terms, and each copy of Data delivered or otherwise furnished shall be marked and embedded as appropriate with the following "Notice of Use," and shall be treated in accordance with such Notice:

Appendices

NOTICE OF USE

CONTRACTOR (MANUFACTURER/
SUPPLIER) NAME: HERE

CONTRACTOR (MANUFACTURER/
SUPPLIER) ADDRESS: c/o Nokia, 425
West Randolph Street, Chicago, Illinois
60606

This Data is a commercial item as
defined in FAR 2.101 and is subject to
these End-User Terms under which this
Data was provided.

© 1987 – 2014 HERE – All rights reserved.

If the Contracting Officer, federal government agency, or any federal official refuses to use the legend provided herein, the Contracting Officer, federal government agency, or any federal official must notify HERE prior to seeking additional or alternative rights in the Data.

I. US/Canada Territory

A. United States Data. The End-User Terms for any Application containing Data for the United States shall contain the following notices:

“HERE holds a non-exclusive license from the United States Postal Service® to publish and sell ZIP+4® information.”

“©United States Postal Service® 20XX. Prices are not established, controlled or approved by the United States Postal Service®. The following trademarks and registrations are owned by the USPS: United States Postal Service, USPS, and ZIP+4.”

B. Canada Data. The following provisions apply to the Data for Canada, which may include or reflect data from third party licensors (“Third Party Data”), including Her Majesty the Queen in Right of Canada (“Her Majesty”), Canada Post Corporation (“Canada Post”) and the Department of Natural Resources of Canada (“NRCan”):

1. Disclaimer and Limitation: Client agrees that its use of the Third Party Data is subject to the following provisions:

a. Disclaimer: The Third Party Data is licensed on an “as is” basis. The licensors of such data, including Her Majesty, Canada Post and NRCan, make no guarantees, representations or warranties respecting such data, either express or implied, arising by law or otherwise, including but not limited to, effectiveness, completeness, accuracy or fitness for a particular purpose.

b. Limitation on Liability: The Third Party Data licensors, including Her Majesty, Canada Post and NRCan, shall not be liable: (i) in respect of any claim, demand or action, irrespective of the nature of the cause of the claim, demand or action alleging any loss, injury or damages, direct or indirect, which may result from the use or possession of such Data; or (ii) in any way for loss of revenues or contracts, or any other consequential loss of any kind resulting from any defect in the Data.

Appendices

2. Copyright Notice: In connection with each copy of all or any portion of the Data for the Territory of Canada, Client shall affix in a conspicuous manner the following copyright notice on at least one of: (i) the label for the storage media of the copy; (ii) the packaging for the copy; or (iii) other materials packaged with the copy, such as user manuals or end user license agreements: "This data includes information taken with permission from Canadian authorities, including © Her Majesty the Queen in Right of Canada, © Queen's Printer for Ontario, © Canada Post Corporation, GeoBase®, © The Department of Natural Resources Canada. All rights reserved!"

3. End-User Terms: Except as otherwise agreed by the parties, in connection with the provision of any portion of the Data for the Territory of Canada to End-Users as may be authorized under the Agreement, Client shall provide such End-Users, in a reasonably conspicuous manner, with terms (set forth with other end user terms required to be provided under the Agreement, or as otherwise may be provided, by Client) which shall include the following provisions on behalf of the Third Party Data licensors, including Her Majesty, Canada Post and NRCan:

The Data may include or reflect data of licensors, including Her Majesty the Queen in the Right of Canada ("Her Majesty"), Canada Post Corporation ("Canada Post") and the Department of Natural Resources Canada ("NRCan"). Such data is licensed on an "as is" basis. The licensors, including Her Majesty, Canada Post and NRCan, make no guarantees, representations or warranties respecting such data,

either express or implied, arising by law or otherwise, including but not limited to, effectiveness, completeness, accuracy or fitness for a particular purpose. The licensors, including Her Majesty, Canada Post and NRCan, shall not be liable in respect of any claim, demand or action, irrespective of the nature of the cause of the claim, demand or action alleging any loss, injury or damages, direct or indirect, which may result from the use or possession of the data or the Data. The licensors, including Her Majesty, Canada Post and NRCan, shall not be liable in any way for loss of revenues or contracts, or any other consequential loss of any kind resulting from any defect in the data or the Data.

End User shall indemnify and save harmless the licensors, including Her Majesty, Canada Post and NRCan, and their officers, employees and agents from and against any claim, demand or action, irrespective of the nature of the cause of the claim, demand or action, alleging loss, costs, expenses, damages or injuries (including injuries resulting in death) arising out of the use or possession of the data or the Data.

4. Additional Provisions: The terms contained in this Section are in addition to all of the rights and obligations of the parties under the Agreement. To the extent that any of the provisions of this Section are inconsistent with, or conflict with, any other provisions of the Agreement, the provisions of this Section shall prevail.

Appendices

II. Mexico. The following provision applies to the Data for Mexico, which includes certain data from the Instituto Nacional de Estadística y Geografía (“INEGI”):

A. Any and all copies of the Data and/or packaging containing Data for Mexico shall contain the following notice: “Fuente: INEGI (Instituto Nacional de Estadística y Geografía)”

III. Latin America Territory

A. Third Party Notices. Any and all copies of the Data and/or packaging relating thereto shall include the respective Third Party Notices set forth below and used as described below corresponding to the Territory (or portion thereof) included in such copy:

| Territory | Notice |
|---|--|
| Ecuador | “INSTITUTO GEOGRAFICO MILITAR DEL ECUADOR AUTORIZACION N° IGM-2011-01- PCO-01 DEL 25 DE ENERO DE 2011” “source: © IGN 2009 - BD TOPO ®” |
| Guadeloupe, French Guiana and Martinique Mexico | “Fuente: INEGI (Instituto Nacional de Estadística y Geografía)” |

IV. Middle East Territory

A. Third Party Notices. Any and all copies of the Data and/or packaging relating thereto shall include the respective Third Party Notices set forth below and used as described below corresponding to the Territory (or portion thereof) included in such copy:

| Country | Notice |
|---------|--|
| Jordan | “© Royal Jordanian Geographic Centre”. The foregoing notice requirement for Jordan Data is a material term of the Agreement. If Client or any of its permitted sublicensees (if any) fail to meet such requirement, HERE shall have the right to terminate Client’s license with respect to the Jordan Data. |

B. Jordan Data. Client and its permitted sublicensees (if any) are restricted from licensing and/or otherwise distributing HERE’s database for the country of Jordan (“Jordan Data”) for use in Enterprise Applications to (i) non-Jordanian entities for use of the Jordan Data solely in Jordan or (ii) Jordan-based customers. In addition, Client, its permitted sublicensees (if any) and End-Users are restricted from using the Jordan Data in Enterprise Applications if such party is (i) a non-Jordanian entity using the Jordan Data solely in Jordan or (ii) a Jordan-based customer. For purposes of the foregoing, “Enterprise Applications” shall mean Geomarketing applications, GIS applications, mobile business asset management applications, call center applications, telematics applications, public organization Internet applications or for providing geocoding services.

Appendices

V. Europe Territory

A. Use of Certain Traffic Codes in Europe

1. General Restrictions Applicable to Traffic Codes. Client acknowledges and agrees that in certain countries of the Europe Territory, Client will need to obtain rights directly from third party RDS-TMC code providers to receive and use the Traffic Codes in the Data and to deliver to End-Users Transactions in any way derived from or based on such Traffic Codes. For such countries, HERE shall deliver the Data incorporating Traffic Codes to Client only after receiving certification from Client of its having obtained such rights.

2. Display of Third Party Rights Legends for Belgium. Client shall, for each Transaction that uses Traffic Codes for Belgium, provide the following notice to the End-User: "Traffic Codes for Belgium are provided by the Ministerie van de Vlaamse Gemeenschap and the Ministère de l'Équipement et des Transports."

B. Paper Maps. With respect to any license granted to Client relating to making, selling or distributing paper maps (i.e., a map fixed on a paper or paper-like medium): (a) such license with respect to Data for the Territory of Great Britain is conditioned on Client's entering into and complying with a separate written agreement with the Ordnance Survey ("OS") to create and sell paper maps, Client's paying to the OS any and all applicable paper map royalties, and Client's complying with the OS copyright notice requirements; (b) such license for selling or otherwise distributing for charge with respect to Data for the Territory of Czech Republic

is conditioned on Client's obtaining prior written consent from Kartografie a.s.; (c) such license for selling or distributing with respect to Data for the Territory of Switzerland is conditioned on Client's obtaining a permit from Bundesamt für Landestopografie of Switzerland; (d) Client is restricted from using Data for the Territory of France to create paper maps with a scale between 1:5,000 and 1:250,000; and (e) Client is restricted from using any Data to create, sell or distribute paper maps that are the same or substantially similar, in terms of data content and specific use of color, symbols and scale, to paper maps published by the European national mapping agencies, including without limitation, Landvermessungämter of Germany, Topografische Dienst of the Netherlands, Nationaal Geografisch Instituut of Belgium, Bundesamt für Landestopografie of Switzerland, Bundesamt für Eich-und Vermessungswesen of Austria, and the National Land Survey of Sweden.

C. OS Enforcement. Without limiting Section IV(B) above, with respect to Data for the Territory of Great Britain, Client acknowledges and agrees that the Ordnance Survey ("OS") may bring a direct action against Client to enforce compliance with the OS copyright notice (see Section IV(D) below) and paper map requirements (see Section IV(B) above) contained in this Agreement.

D. Third Party Notices. Any and all copies of the Data and/or packaging relating thereto shall include the respective Third Party Notices set forth below and used as described below corresponding to the Territory (or portion thereof) included in such copy:

Country(ies) Notice

Appendices

| | | | |
|---------------|--|-------------------------|---|
| Austria | “© Bundesamt für Eich- und Vermessungswesen” | Spain | “Información geográfica propiedad del CNIG” |
| Croatia | | Sweden | “Based upon electronic data © National Land Survey Sweden.” |
| Cyprus, | | Switzerland | “Topografische Grundlage: © Bundesamt für Landestopographie. |
| Estonia, | | | E. Respective Country Distribution. Client acknowledges that HERE has not received approvals to distribute map data for the following countries in such respective countries: Albania, Belarus, Kyrgyzstan, Moldova and Uzbekistan. HERE may update such list from time to time. The license rights granted to Client under this TL with respect to the Data for such countries are contingent upon Client’s compliance with all applicable laws and regulations, including, without limitation, any required licenses or approvals to distribute the Application incorporating such Data in such respective countries. |
| Latvia, | “© EuroGeographics” | | |
| Lithuania, | | | |
| Moldova, | | | |
| Poland, | | | |
| Slovenia | | | |
| and/or | | | |
| Ukraine | | | |
| France | “source: © IGN 2009 – BD TOPO ®” | | |
| Germany | “Die Grundlagendaten wurden mit Genehmigung der zuständigen Behörden entnommen” | | |
| Great Britain | “Contains Ordnance Survey data © Crown copyright and database right 2010 Contains Royal Mail data © Royal Mail copyright and database right 2010” | | |
| Greece | “Copyright Geomatics Ltd.” | | |
| Hungary | “Copyright © 2003; Top-Map Ltd.” | VI. Australia Territory | A. Third Party Notices. Any and all copies of the Data and/or packaging relating thereto shall include the respective Third Party Notices set forth below and used as described below corresponding to the Territory (or portion thereof) included in such copy: |
| Italy | “La Banca Dati Italiana è stata prodotta usando quale riferimento anche cartografia numerica ed al tratto prodotta e fornita dalla Regione Toscana.” | | Copyright. Based on data provided under license from PSMA Australia Limited (www.pasma.com.au). |
| Norway | “Copyright © 2000; Norwegian Mapping Authority” | | |
| Portugal | “Source: IgeoE – Portugal” | | |

Appendices

Product incorporates data which is © 20XX Telstra Corporation Limited, GM Holden Limited, Intelomatics Australia Pty Ltd and Continental Pty Ltd.

B. Third Party Notices for Australia. In addition to the foregoing, the End-User Terms for any Application containing RDS-TMC Traffic Codes for Australia shall contain the following notice: “Product incorporates traffic location codes which is © 20XX Telstra Corporation Limited and its licensors.”

VII. China Territory

Personal Use Only

You agree to use this Data together with [insert name of Client Application] for the solely personal, non-commercial purposes for which you were licensed, and not for service bureau, time-sharing or other similar purposes. Accordingly, but subject to the restrictions set forth in the following paragraphs, you may copy this Data only as necessary for your personal use to (i) view it, and (ii) save it, provided that you do not remove any copyright notices that appear and do not modify the Data in any way. You agree not to otherwise reproduce, copy, modify, decompile, disassemble or reverse engineer any portion of this Data, and may not transfer or distribute it in any form, for any purpose, except to the extent permitted by mandatory laws.

Restrictions

Except where you have been specifically licensed to do so by NAV2, and without limiting the preceding paragraph, you may not (a) use this Data with any products, systems, or applications installed or otherwise connected to or in communication with vehicles, capable of vehicle navigation, positioning, dispatch, real time route guidance, fleet management or similar applications; or (b)

with or in communication with any positioning devices or any mobile or wireless-connected electronic or computer devices, including without limitation cellular phones, palmtop and handheld computers, pagers, and personal digital assistants or PDAs. You agree to cease using this Data if you fail to comply with these terms and conditions.

Limited Warranty

NAV2 warrants that (a) the Data will perform substantially in accordance with the accompanying written materials for a period of ninety (90) days from the date of receipt, and (b) any support services provided by NAV2 shall be substantially as described in applicable written materials provided to you by NAV2, and NAV2's support engineers will make commercially reasonable efforts to solve any problem issues.

rigCustomer Remedies

NAV2 and its suppliers' entire liability and your exclusive remedy shall be, at NAV2's sole discretion, either (a) return of the price paid, if any, or (b) repair or replacement of the Data that do not meet NAV2's Limited Warranty and that are returned to NAV2 with a copy of your receipt. This Limited Warranty is void if failure of the Data has resulted from accident, abuse, or misapplication. Any replacement Data will be warranted for the remainder of the original warranty period or thirty (30) days, whichever is longer. Neither these remedies nor any product support services offered by NAV2 are available without proof of purchase from an authorized international source.

Appendices

No Other Warranty:

EXCEPT FOR THE LIMITED WARRANTY SET FORTH ABOVE AND TO THE EXTENT PERMITTED BY APPLICABLE LAW, NAV2 AND ITS LICENSORS (INCLUDING THEIR LICENSORS AND SUPPLIERS) DISCLAIM ANY WARRANTIES, EXPRESS OR IMPLIED, OF QUALITY, PERFORMANCE, MERCHANTABILITY, FITNESS FOR A PARTICULAR PURPOSE, OWNERSHIP OR NON-INFRINGEMENT. Certain warranty exclusions may not be permitted under applicable law, so to that extent the above exclusion may not apply to you.

Limited Liability:

TO THE EXTENT PERMITTED BY APPLICABLE LAW, NAV2 AND ITS LICENSORS (INCLUDING THEIR LICENSORS AND SUPPLIERS) SHALL NOT BE LIABLE TO YOU: IN RESPECT OF ANY CLAIM, DEMAND OR ACTION, IRRESPECTIVE OF THE NATURE OF THE CAUSE OF THE CLAIM, DEMAND OR ACTION ALLEGING ANY LOSS, INJURY OR DAMAGES, DIRECT OR INDIRECT, WHICH MAY RESULT FROM THE USE OR POSSESSION OF THE INFORMATION; OR FOR ANY LOSS OF PROFIT, REVENUE, CONTRACTS OR SAVINGS, OR ANY OTHER DIRECT, INDIRECT, INCIDENTAL, SPECIAL OR CONSEQUENTIAL DAMAGES ARISING OUT OF YOUR USE OF OR INABILITY TO USE THIS INFORMATION, ANY DEFECT IN THE INFORMATION, OR THE BREACH OF THESE TERMS OR CONDITIONS, WHETHER IN AN ACTION IN CONTRACT OR TORT OR BASED ON A WARRANTY, EVEN IF NAV2 OR ITS LICENSORS HAVE BEEN ADVISED OF THE POSSIBILITY OF SUCH DAMAGES. UNDER NO CIRCUMSTANCES SHALL NAV2'S OR ITS SUPPLIERS' LIABILITY HEREUNDER EXCEED THE PRICE PAID. Certain liability exclusions may not be permitted under applicable law, so to that extent the above exclusion may not apply to you.

Export Control

You agree not to export to anywhere any part of the Data provided to you or any direct product thereof except in compliance with, and with all licenses and approvals required under, applicable export laws, rules and regulations.

IP Protection

The Data are owned by NAV2 or its suppliers and are protected by applicable copyright and other intellectual property law and treaties. The Data are provided solely on the basis of a license to use, not sale.

Entire Agreement

These terms and conditions constitute the entire agreement between NAV2 (and its licensors, including their licensors and suppliers) and you pertaining to the subject matter hereof, and supersedes in their entirety any and all written or oral agreements previously existing between us with respect to such subject matter.

Governing Law.

The above terms and conditions shall be governed by the laws of the People's Republic of China, without giving effect to (i) its conflict of laws provisions, or (ii) the United Nations Convention for Contracts for the International Sale of Goods, which is explicitly excluded. Any dispute arising from or in connection with the Data provided to you hereunder shall be submitted to the Shanghai International Economic and Trade Arbitration Commission for arbitration.

Appendices

Gracenote® Copyright

CD and music-related data from Gracenote, Inc., copyright© 2000-2007 Gracenote. Gracenote Software, copyright © 2000-2007 Gracenote. This product and service may practice one or more of the following U.S. Patents #5,987,525, #6,061,680, #6,154,773, #6,161,132, #6,230,192, #6,230,207, #6,240,459, #6,330,593 and other patents issued or pending. Some services supplied under license from Open Globe, Inc. for U.S. Patent: #6,304,523.

Gracenote and CDDB are registered trademarks of Gracenote. The Gracenote logo and logotype, and the "Powered by Gracenote™" logo are trademarks of Gracenote.

Gracenote® End User License Agreement (EULA)

This device contains software from Gracenote, Inc. of 2000 Powell Street Emeryville, California 94608 ("Gracenote").

The software from Gracenote (the "Gracenote Software") enables this device to do disc and music file identification and obtain music-related information, including name, artist, track, and title information ("Gracenote Data") from online servers ("Gracenote Servers"), and to perform other functions. You may use Gracenote Data only by means of the intended End User functions of this device.

This device may contain content belonging to Gracenote's providers. If so, all of the restrictions set forth herein with respect to Gracenote Data shall also apply to such content and such content providers shall be entitled to all of the benefits and protections set forth herein that are available to Gracenote.

You agree that you will use the content from Gracenote ("Gracenote Content"), Gracenote Data, the Gracenote Software, and Gracenote Servers for your own personal, non-commercial use only. You agree not to assign, copy, transfer or transmit the Gracenote Content, Gracenote Software or any Gracenote Data (except in a Tag associated with a music file) to any third party. YOU AGREE NOT TO USE OR EXPLOIT GRACENOTE CONTENT, GRACENOTE DATA, THE GRACENOTE SOFTWARE, OR GRACENOTE SERVERS, EXCEPT AS EXPRESSLY PERMITTED HEREIN.

You agree that your non-exclusive licenses to use the Gracenote Content, Gracenote Data, the Gracenote Software, and Gracenote Servers will terminate if you violate these restrictions. If your licenses terminate, you agree to cease any and all use of the Gracenote Content, Gracenote Data, the Gracenote Software, and Gracenote Servers. Gracenote, respectively, reserve all rights in Gracenote Data, the Gracenote Software, and the Gracenote Servers and Gracenote Content, including all ownership rights. Under no circumstances will either Gracenote become liable for any payment to you for any information that you provide, including any copyrighted material or music file information. You agree that Gracenote may enforce its respective rights, collectively or separately, under this agreement against you, directly in each company's own name.

Gracenote uses a unique identifier to track queries for statistical purposes. The purpose of a randomly assigned numeric identifier is to allow Gracenote to count queries without knowing anything about who you are. For more information, see the web page at www.gracenote.com for the Gracenote Privacy Policy.

Appendices

THE GRACENOTE SOFTWARE, EACH ITEM OF GRACENOTE DATA AND THE GRACENOTE CONTENT ARE LICENSED TO YOU "AS IS". NEITHER GRACENOTE MAKES ANY REPRESENTATIONS OR WARRANTIES, EXPRESS OR IMPLIED, REGARDING THE ACCURACY OF ANY GRACENOTE DATA FROM THE GRACENOTE SERVERS OR GRACENOTE CONTENT. GRACENOTE COLLECTIVELY AND SEPARATELY RESERVE THE RIGHT TO DELETE DATA AND/OR CONTENT FROM THE COMPANIES' RESPECTIVE SERVERS OR, IN THE CASE OF GRACENOTE, CHANGE DATA CATEGORIES FOR ANY CAUSE THAT GRACENOTE DEEMS SUFFICIENT. NO WARRANTY IS MADE THAT EITHER GRACENOTE CONTENT OR THE GRACENOTE SOFTWARE OR GRACENOTE SERVERS ARE ERROR-FREE OR THAT THE FUNCTIONING OF THE GRACENOTE SOFTWARE OR GRACENOTE SERVERS WILL BE UNINTERRUPTED. GRACENOTE IS NOT OBLIGATED TO PROVIDE YOU WITH ANY ENHANCED OR ADDITIONAL DATA TYPES THAT GRACENOTE MAY CHOOSE TO PROVIDE IN THE FUTURE AND IS FREE TO DISCONTINUE ITS ONLINE SERVICES AT ANY TIME. GRACENOTE DISCLAIM ALL WARRANTIES EXPRESS OR IMPLIED, INCLUDING, BUT NOT LIMITED TO, IMPLIED WARRANTIES OF MERCHANTABILITY, FITNESS FOR A PARTICULAR PURPOSE, TITLE, AND NON-INFRINGEMENT. NEITHER GRACENOTE WARRANTS THE RESULTS THAT WILL BE OBTAINED BY YOUR USE OF THE GRACENOTE SOFTWARE OR ANY GRACENOTE SERVER. IN NO CASE WILL GRACENOTE BE LIABLE FOR ANY CONSEQUENTIAL OR INCIDENTAL DAMAGES OR FOR ANY LOST PROFITS OR LOST REVENUES FOR ANY REASON WHATSOEVER.

© Gracenote 2007.

Vehicle with SYNC only United States and Mexico

FCC ID: KMHSG1G1

IC: 1422A-SG1G1

Mexico

Model: KMHSG1P1

NOM-121-SCT1-2009

The operation of this equipment is subject to the following two conditions: (1) This equipment or device may not cause harmful interference, and (2) this equipment or device must accept any interference, including interference that may cause undesired operation.

Vehicle with SYNC with Touchscreen/My Touch

FCC ID: KMHSYNGG2

IC: 1422A-SYNGG2

This device complies with Part 15 of the FCC Rules and with RSS-210 of Industry Canada. Operation is subject to the following two conditions: (1) This device may not cause harmful interference, and (2) this device must accept any interference received, including interference that may cause undesired operation.



WARNING: Changes or modifications not expressly approved by the party responsible for compliance could void the user's authority to operate the equipment. The term "IC" before the radio certification number only signifies that Industry Canada technical specifications were met.

The antenna used for this transmitter must not be co-located or operating in conjunction with any other antenna or transmitter.

Index

A

A/C

See: Climate Control.....70

About This Manual.....5

ABS

See: Brakes.....97

ABS driving hints

See: Hints on Driving With Anti-Lock

Brakes.....97

Accessories.....245

Accessories

See: Replacement Parts

Recommendation.....12

ACC

See: Using Adaptive Cruise Control.....104

Adjusting the Headlamps.....175

Vertical Aim Adjustment Procedure.....175

Adjusting the Steering Wheel.....47

Airbag Disposal.....38

Air Conditioning

See: Climate Control.....70

Air Filter

See: Changing the Engine Air Filter.....178

Appendices.....267

At a Glance.....16

Audible Warnings and Indicators.....62

Headlamps On Warning Chime.....62

Key in Ignition Warning Chime.....62

Parking Brake On Warning Chime.....62

Audio System.....235

General Information.....235

Audio Unit.....235

Accessing the Sound Settings.....236

Accessing the System Settings.....236

Adjusting the Volume.....236

Changing Radio Stations.....236

Pausing or Playing Media.....236

Returning to the Previous Screen.....236

Scrolling Through the Menu Options.....236

Selecting a Menu Option.....237

Selecting Media.....236

Selecting the Radio.....237

Setting a Memory Preset.....237

Switching the Audio Unit On and Off.....237

Using a Cell Phone.....237

Using Seek, Fast Forward and
Reverse.....237

Autolamps.....51

Windshield Wiper Activated

Headlamps.....51

Automatic High Beam Control.....53

Automatic High Beam Control

Indicators.....53

Automatic Transmission.....92

Brake-Shift Interlock.....94

If Your Vehicle Gets Stuck in Mud or

Snow.....95

Progressive Range Selection - PRS.....94

Putting your vehicle in or out of gear.....92

Understanding Your SelectShift

Automatic™ Transmission.....93

Automatic Transmission Fluid

Check.....169

Automatic Transmission Fluid Filter.....171

Checking Automatic Transmission

Fluid.....169

Auxiliary Power Points.....76

110 Volt AC Power Point.....76

12 Volt DC Power Point.....76

Locations.....76

Auxiliary Switches.....246

Upfitter Interface Module.....247

B

Battery

See: Changing the 12V Battery.....173

Bonnet Lock

See: Opening and Closing the Hood.....161

Booster Seats.....23

Types of Booster Seats.....23

Brake Fluid Check.....171

Brake Fluid Service Interval.....172

Brakes.....97

General Information.....97

Breaking-In.....137

Bulb Specification Chart.....232

C

Canceling the Set Speed.....103

Capacities and Specifications.....223

Air Conditioning System.....223

Alternative Engine Oil for Extremely Cold

Climates.....226

Index

| | | | |
|--|-----|---|-----|
| Automatic Transmission..... | 223 | Child Safety..... | 17 |
| Dana Conventional Axle M70FF (M267FF)..... | 230 | General Information..... | 17 |
| Dana Conventional Axle M70HD (M273HD)..... | 231 | Cleaning Leather Seats..... | 184 |
| Dana Limited Slip Axle M70FF (M267FF)..... | 229 | Cleaning Products..... | 180 |
| Dana Limited Slip Axle M70HD (M273HD)..... | 230 | Materials..... | 180 |
| Door Weatherstrips..... | 229 | Cleaning the Engine..... | 182 |
| Engine Coolant..... | 224 | Cleaning the Exterior..... | 180 |
| Engine Oil..... | 225 | Cleaning the Headlamps..... | 181 |
| Fuel Tank..... | 226 | Exterior Chrome Parts..... | 181 |
| Grease..... | 226 | Exterior Plastic Parts..... | 181 |
| Hydroboost Brake System..... | 228 | Stripes or Graphics..... | 181 |
| Locks..... | 229 | Underbody..... | 181 |
| Power Steering System..... | 228 | Under Hood..... | 181 |
| Vacuum Brake System..... | 227 | Cleaning the Instrument Panel and Instrument Cluster Lens..... | 183 |
| Washer Reservoir..... | 231 | Cleaning the Interior..... | 183 |
| Car Wash | | Mirrors..... | 183 |
| See: Cleaning the Exterior..... | 180 | Cleaning the Wheels..... | 185 |
| Catalytic Converter..... | 89 | Cleaning the Windows and Wiper Blades..... | 182 |
| On-Board Diagnostics (OBD-II)..... | 90 | Climate Control..... | 70 |
| Readiness for Inspection and Maintenance (I/M) Testing..... | 90 | Connected Vehicle..... | 234 |
| Changing a Bulb..... | 177 | Connecting the Vehicle to a Mobile Network..... | 234 |
| Lamp Assembly Condensation..... | 177 | Connected Vehicle Limitations..... | 234 |
| Replacing Brake/Tail/Turn/Reverse Lamp Bulbs (Cut-Away Only)..... | 178 | Connected Vehicle Requirements..... | 234 |
| Replacing Front Parking Lamp and Direction Indicator Bulbs..... | 178 | Connected Vehicle – Troubleshooting..... | 234 |
| Replacing Headlamp Bulbs..... | 177 | Connecting a Bluetooth Device..... | 240 |
| Replacing Side Marker Bulbs..... | 178 | Pairing a Device..... | 240 |
| Changing a Fuse..... | 159 | Connecting the Vehicle to a Mobile Network..... | 234 |
| Fuses..... | 159 | Connecting FordPass to the Connectivity Device..... | 234 |
| Changing a Road Wheel..... | 213 | Disabling the Connectivity Device..... | 234 |
| Dissimilar Spare Wheel and Tire Assembly Information..... | 214 | What Is the Connectivity Device..... | 234 |
| Tire Change Procedure..... | 215 | Coolant Check | |
| Changing the 12V Battery..... | 173 | See: Engine Coolant Check..... | 165 |
| Dual Batteries..... | 174 | Crash Sensors and Airbag Indicator..... | 37 |
| Reconnecting the Battery..... | 174 | Cruise Control..... | 103 |
| Changing the Engine Air Filter..... | 178 | Cruise Control Indicators..... | 104 |
| Changing the Wiper Blades..... | 175 | Cruise Control – Vehicles With: Adaptive Cruise Control..... | 47 |
| Checking the Wiper Blades..... | 174 | Cruise Control – Vehicles With: Cruise Control..... | 48 |
| Child Restraint and Seatbelt Maintenance..... | 31 | Customer Assistance..... | 145 |
| Child Restraint Positioning..... | 25 | | |

Index

D

| | |
|---|-----|
| Data Recording..... | 7 |
| Comfort, Convenience and Entertainment | |
| Data..... | 9 |
| Event Data..... | 9 |
| Service Data..... | 8 |
| Services That Third Parties Provide..... | 10 |
| Services That We Provide..... | 10 |
| Vehicles With a Connectivity Device..... | 10 |
| Vehicles With an Emergency Call | |
| System..... | 11 |
| Vehicles With SYNC..... | 11 |
| Daytime Running Lamps..... | 51 |
| Digital Radio..... | 238 |
| HD Radio Reception and Station | |
| Troubleshooting..... | 239 |
| Direction Indicators..... | 52 |
| Doors and Locks..... | 42 |
| Driver Alert..... | 111 |
| Using Driver Alert..... | 111 |
| Driver and Passenger Airbags..... | 33 |
| Children and Airbags..... | 37 |
| Passenger Airbag On and Off Switch | 33 |
| Proper Driver and Front Passenger Seating | |
| Adjustment..... | 37 |
| Driving Aids..... | 111 |
| Driving Hints..... | 137 |
| Driving Through Water..... | 138 |
| DRL | |
| See: Daytime Running Lamps..... | 51 |

E

| | |
|--------------------------------------|-----|
| Economical Driving..... | 137 |
| Electromagnetic Compatibility..... | 267 |
| Emission Law..... | 88 |
| Noise Emissions Warranty, Prohibited | |
| Tampering Acts and Maintenance..... | 89 |
| Tampering With a Noise Control | |
| System..... | 88 |
| End User License Agreement..... | 269 |
| SYNC End User License Agreement | |
| (EULA)..... | 269 |
| Engine Block Heater..... | 80 |
| Using the Engine Block Heater..... | 80 |
| Engine Coolant Check..... | 165 |
| Adding Coolant..... | 165 |

| | |
|--|-----|
| Coolant Change..... | 167 |
| Engine Coolant Temperature | |
| Management..... | 168 |
| Fail-Safe Cooling..... | 167 |
| Recycled Coolant..... | 167 |
| Severe Climates..... | 167 |
| Engine Emission Control..... | 88 |
| Engine Immobilizer | |
| See: Passive Anti-Theft System..... | 45 |
| Engine Oil Check..... | 163 |
| Adding Engine Oil..... | 163 |
| Engine Oil Dipstick..... | 163 |
| Engine Specifications..... | 219 |
| Drivebelt Routing..... | 219 |
| Environment..... | 15 |
| Essential Towing Checks..... | 130 |
| Before Towing a Trailer..... | 134 |
| Hitches..... | 131 |
| Launching or Retrieving a Boat or Personal | |
| Watercraft (PWC)..... | 135 |
| Safety Chains..... | 131 |
| Trailer Brakes..... | 131 |
| Trailer Lamps..... | 134 |
| Trailer Towing Connector..... | 130 |
| When Towing a Trailer..... | 135 |
| Event Data Recording | |
| See: Data Recording..... | 7 |
| Exterior Mirrors..... | 55 |
| Fold-Away Exterior Mirrors..... | 55 |
| Power Exterior Mirrors..... | 55 |
| Telescoping Mirrors | 56 |

F

| | |
|---|-----|
| Fastening the Seatbelts..... | 28 |
| Seatbelt Locking Modes..... | 29 |
| Using Seatbelts During Pregnancy..... | 28 |
| Flat Tire | |
| See: Changing a Road Wheel..... | 213 |
| Floor Mats..... | 138 |
| Ford Credit..... | 12 |
| US Only..... | 12 |
| Ford Protect..... | 248 |
| Ford Protect Extended Service Plan | |
| (CANADA ONLY)..... | 249 |
| Ford Protect Extended Service Plans (U.S. | |
| Only)..... | 248 |
| Fuel and Refueling..... | 82 |

Index

| | | | |
|---|-----|---|-----|
| Fuel Consumption..... | 86 | Headlamp Adjusting | |
| Advertised Capacity..... | 86 | See: Adjusting the Headlamps..... | 175 |
| Fuel Economy..... | 86 | Headlamp Removal | |
| Fuel Filter..... | 173 | See: Removing a Headlamp..... | 176 |
| Fuel Quality - E85..... | 82 | Headrest | |
| Choosing the Right Fuel - Flex Fuel | | See: Head Restraints..... | 73 |
| Vehicles..... | 82 | Head Restraints..... | 73 |
| Switching Between E85 and Gasoline..... | 83 | Heating | |
| Fuel Quality - Gasoline..... | 84 | See: Climate Control..... | 70 |
| Choosing the Right Fuel..... | 84 | Hill Start Assist..... | 98 |
| Fuel Shutoff..... | 141 | Switching the System On and Off..... | 99 |
| Fuses..... | 151 | Using Hill Start Assist..... | 99 |
| Fuse Specification Chart..... | 151 | Hints on Controlling the Interior | |
| Engine Compartment Fuse Box..... | 151 | Climate..... | 71 |
| Passenger Compartment Fuse Box..... | 156 | Defogging the Side Windows in Cold | |
| | | Weather..... | 72 |
| G | | General Hints..... | 71 |
| Gauges..... | 57 | Quickly Cooling the Interior..... | 72 |
| 2.3 Inch Display..... | 57 | Quickly Heating the Interior..... | 71 |
| 8 Inch Display..... | 58 | Recommended Settings for Cooling..... | 72 |
| Engine Coolant Temperature Gauge..... | 59 | Recommended Settings for Heating..... | 71 |
| Engine Oil Pressure Gauge..... | 59 | Vehicle Stationary for Extended Periods | |
| Fuel Gauge..... | 59 | During Extreme High Ambient | |
| Transmission Fluid Temperature | | Temperatures..... | 72 |
| Gauge..... | 59 | Hints on Driving With Anti-Lock | |
| Gearbox | | Brakes..... | 97 |
| See: Transmission..... | 92 | Hood Lock | |
| General Information on Radio | | See: Opening and Closing the Hood..... | 161 |
| Frequencies..... | 39 | Horn..... | 48 |
| General Maintenance Information..... | 250 | | |
| Multi-point Inspection..... | 252 | I | |
| Owner Checks and Services..... | 251 | Ignition Switch..... | 78 |
| Protecting Your Investment..... | 250 | In California (U.S. Only)..... | 146 |
| Why Maintain Your Vehicle?..... | 250 | Information Display Control..... | 48 |
| Why Maintain Your Vehicle at Your | | Information Displays..... | 63 |
| Dealership?..... | 250 | General Information..... | 63 |
| Getting Assistance Outside the U.S. and | | Information Messages..... | 66 |
| Canada..... | 148 | AdvanceTrac and Traction Control..... | 66 |
| Getting the Services You Need..... | 145 | Battery and Charging System..... | 67 |
| Away From Home..... | 145 | Doors and Locks..... | 67 |
| | | Engine..... | 67 |
| H | | Fuel..... | 68 |
| Handbrake | | Maintenance..... | 68 |
| See: Parking Brake..... | 98 | Power Steering..... | 69 |
| Hazard Flashers..... | 141 | Transmission..... | 69 |
| | | Installing Child Restraints..... | 19 |
| | | Child Seats..... | 19 |

Index

| | |
|--|-----|
| Using Lap and Shoulder Belts..... | 19 |
| Using Tether Straps..... | 21 |
| Instrument Cluster..... | 57 |
| Instrument Lighting Dimmer..... | 51 |
| Instrument Panel..... | 16 |
| Interior Mirror..... | 56 |
| Automatic Dimming Mirror..... | 56 |
| Manual Dimming Mirror..... | 56 |
| Introduction..... | 5 |
| J | |
| Jump Starting the Vehicle..... | 142 |
| Connecting the Jumper Cables..... | 142 |
| Jump Starting..... | 142 |
| Preparing Your Vehicle..... | 142 |
| Removing the Jumper Cables..... | 143 |
| K | |
| Keys and Remote Controls..... | 39 |
| L | |
| Lane Keeping System..... | 112 |
| Switching the System On and Off..... | 113 |
| System Display..... | 113 |
| System Settings..... | 113 |
| Troubleshooting..... | 114 |
| Lighting Control..... | 50 |
| Flashing the Headlamp High Beam..... | 51 |
| Headlamp High Beam..... | 50 |
| Lighting..... | 50 |
| General Information..... | 50 |
| Limited Slip Differential..... | 96 |
| Load Carrying..... | 120 |
| Load Limit..... | 120 |
| Special Loading Instructions for Owners of Pick-up Trucks and Utility-type Vehicles..... | 124 |
| Vehicle Loading - with and without a Trailer..... | 120 |
| Locking and Unlocking..... | 42 |
| Autolock Feature..... | 43 |
| Autounlock Feature..... | 43 |
| Enabling or Disabling Autolock and Autounlock..... | 43 |
| Illuminated Entry..... | 43 |
| Power Door Locks..... | 42 |
| Remote Control..... | 42 |
| Lug Nuts See: Changing a Road Wheel..... | 213 |
| M | |
| Maintenance..... | 161 |
| General Information..... | 161 |
| Manual Climate Control..... | 70 |
| Heater Only System..... | 70 |
| Manual Climate Control..... | 70 |
| Manual Seats..... | 74 |
| Manual Lumbar..... | 74 |
| Moving the Seat Backward and Forward..... | 74 |
| Recline Adjustment..... | 74 |
| Message Center See: Information Displays..... | 63 |
| Mirrors See: Windows and Mirrors..... | 55 |
| Mobile Communications Equipment..... | 14 |
| Motorcraft Parts..... | 219 |
| N | |
| Normal Scheduled Maintenance..... | 253 |
| O | |
| Oil Change Indicator Reset..... | 164 |
| Oil Check See: Engine Oil Check..... | 163 |
| Opening and Closing the Hood..... | 161 |
| Ordering Additional Owner's Literature..... | 149 |
| Obtaining a French Owner's Manual..... | 149 |
| Overriding Automatic High Beam Control..... | 54 |
| P | |
| Parking Aids..... | 101 |
| Parking Brake..... | 98 |
| Passive Anti-Theft System..... | 45 |
| SecuriLock®..... | 45 |
| PATS See: Passive Anti-Theft System..... | 45 |

Index

| | |
|---|-----|
| Perchlorate..... | 11 |
| Playing Media From a USB Device..... | 243 |
| Selecting the USB Device..... | 243 |
| Supported Audio File Formats..... | 243 |
| Power Door Locks | |
| See: Locking and Unlocking..... | 42 |
| Power Seats..... | 75 |
| Recline Adjustment..... | 75 |
| Power Steering Fluid Check..... | 172 |
| Power Windows..... | 55 |
| Accessory Delay..... | 55 |
| One-Touch Down..... | 55 |
| Pre-Collision Assist..... | 116 |
| Adjusting the Pre-Collision Assist | |
| Settings..... | 117 |
| Blocked Sensors..... | 118 |
| Distance Indication and Alert..... | 117 |
| Using the Pre-Collision Assist System..... | 116 |
| Protecting the Environment..... | 15 |
| Puncture | |
| See: Changing a Road Wheel..... | 213 |
| R | |
| Rear Axle..... | 96 |
| Rear Passenger Climate Controls..... | 72 |
| Setting the Blower Motor Speed..... | 72 |
| Switching the Rear Climate Control On and | |
| Off..... | 72 |
| Rear View Camera..... | 101 |
| Using the Rear View Camera System..... | 101 |
| Rear View Camera | |
| See: Rear View Camera..... | 101 |
| Recommended Towing Weights..... | 126 |
| Calculating the Maximum Loaded Trailer | |
| Weight for Your Vehicle..... | 129 |
| Reduced Engine Performance..... | 137 |
| Refueling..... | 85 |
| Fuel Filler Cap..... | 86 |
| Remote Control..... | 39 |
| Car Finder..... | 41 |
| Changing the Remote Control Battery..... | 40 |
| Reprogramming the Remote Control..... | 40 |
| Sounding the Panic Alarm..... | 41 |
| Removing a Headlamp..... | 176 |
| Repairing Minor Paint Damage..... | 185 |
| Replacement Parts | |
| Recommendation..... | 12 |
| Collision Repairs..... | 12 |
| Scheduled Maintenance and Mechanical | |
| Repairs..... | 12 |
| Warranty on Replacement Parts..... | 12 |
| Replacing a Lost Key or Remote | |
| Control..... | 41 |
| Reporting Safety Defects (Canada | |
| Only)..... | 150 |
| Reporting Safety Defects (U.S. | |
| Only)..... | 149 |
| Resuming the Set Speed..... | 104 |
| Roadside Assistance..... | 140 |
| Vehicles Sold in Canada: Getting Roadside | |
| Assistance..... | 141 |
| Vehicles Sold in the United States: Getting | |
| Roadside Assistance..... | 140 |
| Vehicles Sold in the United States: Using | |
| Roadside Assistance..... | 140 |
| Roadside Emergencies..... | 140 |
| Running-In | |
| See: Breaking-In..... | 137 |
| Running Out of Fuel..... | 84 |
| Filling a Portable Fuel Container..... | 85 |
| S | |
| Safety Precautions..... | 82 |
| Satellite Radio..... | 241 |
| Satellite Radio Electronic Serial Number | |
| (ESN)..... | 242 |
| Satellite Radio Reception Factors..... | 241 |
| SiriusXM Satellite Radio Service..... | 241 |
| Troubleshooting..... | 242 |
| Scheduled Maintenance Record..... | 257 |
| Scheduled Maintenance..... | 250 |
| Seatbelt Extensions..... | 31 |
| Seatbelt Height Adjustment..... | 30 |
| Seatbelts..... | 27 |
| Principle of Operation..... | 27 |
| Seatbelt Warning Lamp and Indicator | |
| Chime..... | 30 |
| Conditions of operation..... | 30 |
| Seats..... | 73 |
| Security..... | 45 |
| Setting the Cruise Control Speed..... | 103 |
| Changing the Set Speed..... | 103 |

Index

| | |
|--|-----|
| Sitting in the Correct Position..... | 73 |
| Snow Chains | |
| See: Using Snow Chains..... | 207 |
| Spare Wheel | |
| See: Changing a Road Wheel..... | 213 |
| Special Notices..... | 12 |
| Fleet Telematics Modem..... | 13 |
| FordPass Connect..... | 13 |
| New Vehicle Limited Warranty..... | 12 |
| Notice to Owners of Pickup Trucks and Utility Type Vehicles..... | 13 |
| On Board Diagnostics Data Link Connector..... | 13 |
| Special Instructions..... | 12 |
| Using your Vehicle as an Ambulance..... | 14 |
| Special Operating Conditions Scheduled Maintenance..... | 255 |
| Exceptions..... | 256 |
| Speed Control | |
| See: Cruise Control..... | 103 |
| Starter Switch | |
| See: Ignition Switch..... | 78 |
| Starting a Gasoline Engine..... | 78 |
| Failure to Start..... | 79 |
| Guarding Against Exhaust Fumes..... | 79 |
| Important Ventilating Information..... | 79 |
| Stopping the Engine When Your Vehicle is Moving..... | 79 |
| Stopping the Engine When Your Vehicle is Stationary..... | 79 |
| Starting and Stopping the Engine..... | 78 |
| General Information..... | 78 |
| Steering..... | 115 |
| Hydraulic Power Steering..... | 115 |
| Steering Wheel..... | 47 |
| Streaming Bluetooth Audio..... | 243 |
| Selecting a Bluetooth Source..... | 243 |
| Sun Visors..... | 56 |
| Illuminated Vanity Mirror..... | 56 |
| Supplementary Restraints System..... | 32 |
| Principle of Operation..... | 32 |
| Switching Automatic High Beam Control On and Off..... | 53 |
| Activating the Automatic High Beam Control..... | 53 |
| Switching Cruise Control On and Off..... | 103 |
| Switching Cruise Control Off..... | 103 |
| Switching Cruise Control On..... | 103 |
| Symbols Glossary..... | 5 |
| T | |
| Technical Specifications | |
| See: Capacities and Specifications..... | 219 |
| The Better Business Bureau (BBB) Auto Line Program (U.S. Only)..... | 147 |
| Tire Care..... | 189 |
| Glossary of Tire Terminology..... | 191 |
| Information About Uniform Tire Quality Grading..... | 189 |
| Information Contained on the Tire Sidewall..... | 192 |
| Temperature A B C..... | 190 |
| Traction AA A B C..... | 190 |
| Treadwear..... | 190 |
| Tire Pressure Monitoring System..... | 208 |
| Changing Tires With a Tire Pressure Monitoring System..... | 209 |
| Understanding Your Tire Pressure Monitoring System..... | 209 |
| Tires | |
| See: Wheels and Tires..... | 188 |
| Towing a Trailer..... | 125 |
| Load Placement..... | 125 |
| Towing the Vehicle on Four Wheels..... | 136 |
| Emergency Towing..... | 136 |
| Recreational Towing..... | 136 |
| Towing..... | 125 |
| Traction Control..... | 100 |
| Principle of Operation..... | 100 |
| Transmission Code Designation..... | 222 |
| Transmission..... | 92 |
| Transporting the Vehicle..... | 143 |
| U | |
| Under Hood Overview..... | 162 |
| USB Port..... | 244 |
| Using Adaptive Cruise Control..... | 104 |
| Automatic Cancellation..... | 107 |
| Blocked Sensor..... | 109 |
| Canceling the Set Speed..... | 107 |
| Changing the Set Speed..... | 107 |
| Detection Issues..... | 108 |

Index

| | |
|---|-----|
| Following a Vehicle..... | 105 |
| Hilly Condition and Trailer Tow Usage..... | 107 |
| OVERRIDING THE SET SPEED..... | 107 |
| RESUMING THE SET SPEED..... | 107 |
| Setting the Adaptive Cruise Speed..... | 105 |
| Setting the Gap Distance..... | 106 |
| Switching Adaptive Cruise Control Off..... | 108 |
| Switching Adaptive Cruise Control On..... | 105 |
| Switching to Normal Cruise Control..... | 110 |
| System Not Available..... | 109 |
| Using Snow Chains..... | 207 |
| Using Traction Control..... | 100 |
| Switching the System Off | 100 |
| System Indicator Lights and Messages..... | 100 |
| Using Voice Recognition..... | 244 |
| Phone Voice Service..... | 244 |
| V | |
| Vehicle Care..... | 180 |
| General Information..... | 180 |
| Vehicle Identification Number..... | 221 |
| Vehicle Storage..... | 185 |
| Body..... | 185 |
| Brakes..... | 186 |
| Cooling system..... | 186 |
| Disconnecting Your 12 Volt Battery..... | 186 |
| Engine..... | 186 |
| Fuel system..... | 186 |
| General..... | 185 |
| Miscellaneous..... | 186 |
| Removing Vehicle From Storage..... | 186 |
| Tires..... | 186 |
| Ventilation | |
| See: Climate Control..... | 70 |
| VIN | |
| See: Vehicle Identification Number..... | 221 |
| W | |
| Warning Lamps and Indicators..... | 60 |
| Airbag Warning Lamp..... | 60 |
| Anti-Lock Brake System Warning Lamp..... | 60 |
| Battery..... | 60 |
| Brake System Warning Lamp..... | 60 |
| Cruise Control Indicator..... | 60 |
| Direction Indicator..... | 60 |
| Engine Coolant Temperature Warning Lamp..... | 61 |
| Engine Oil..... | 61 |
| Fasten Seatbelt Warning Lamp..... | 61 |
| Headlamp High Beam Indicator..... | 61 |
| Low Fuel Level Warning Lamp..... | 61 |
| Low Tire Pressure Warning Lamp..... | 61 |
| Powertrain Malfunction/Electronic Throttle Control..... | 61 |
| Service Engine Soon..... | 61 |
| Tow Haul Indicator..... | 62 |
| Traction Control Indicator..... | 62 |
| Traction Control System Off..... | 62 |
| Washer Fluid Check..... | 173 |
| Washers | |
| See: Cleaning the Exterior..... | 180 |
| See: Wipers and Washers..... | 49 |
| Waxing..... | 182 |
| What Is Automatic High Beam Control..... | 53 |
| What Is Cruise Control..... | 103 |
| Wheel Nuts | |
| See: Changing a Road Wheel..... | 213 |
| Wheels and Tires..... | 188 |
| General Information..... | 188 |
| Technical Specifications..... | 217 |
| Windows and Mirrors..... | 55 |
| Windshield Washers..... | 49 |
| Windshield Wipers..... | 49 |
| Speed Dependent Wipers..... | 49 |
| Wiper Blades | |
| See: Checking the Wiper Blades..... | 174 |
| Wipers and Washers..... | 49 |