



Level



Pressure



Flow



Temperature



Liquid Analysis



Registration



Systems Components



Services



Solutions

Description of Device Functions

Proline Promag 55 FOUNDATION Fieldbus

Electromagnetic flow measuring system

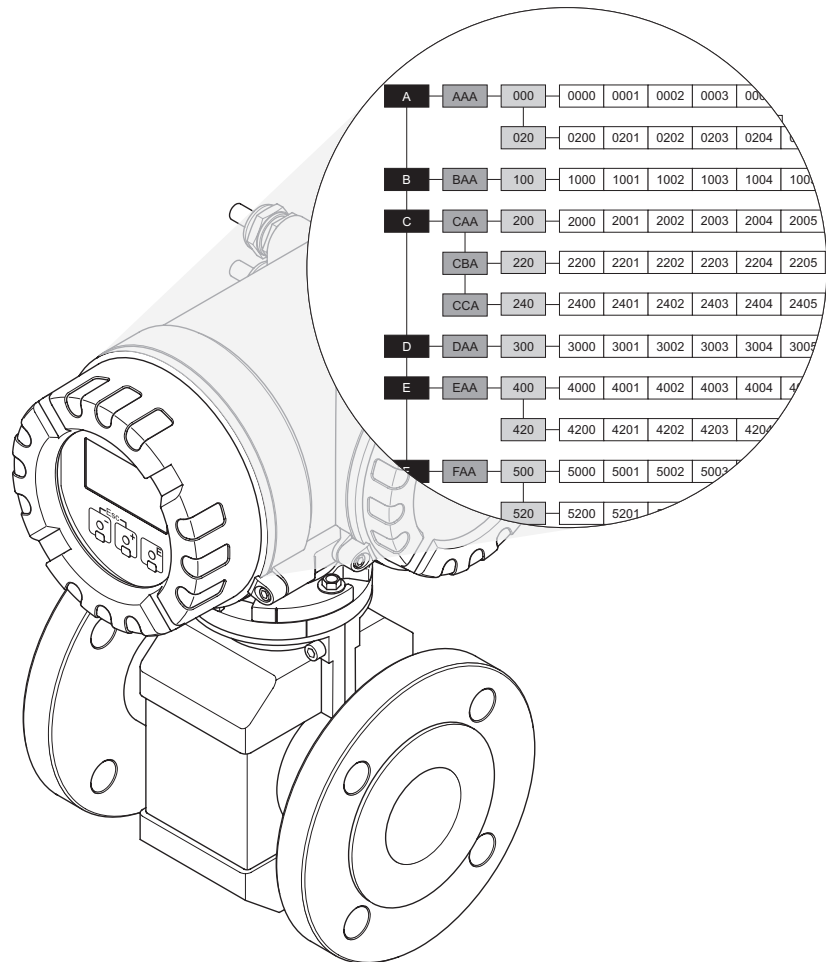

Operating Promag 55 FOUNDATION Fieldbus

with local operation: → **Page 3**

with FOUNDATION Fieldbus: → **Page 93**

Table of contents (local operation)

1	Using the manual	5	7	Block BASIC FUNCTION	47
1.1	Using the table of contents to locate a function description	5	7.1	Group FOUNDATION FIELDBUS	48
1.2	Using the graphic of the function matrix to locate a function description	5	7.1.1	Function group CONFIGURATION	48
1.3	Using the index of the function matrix to locate a function description	5	7.1.2	Function group FUNCTION BLOCKS	49
			7.1.3	Function group INFORMATION	50
2	Function matrix	6	7.2	Group PROCESS PARAMETER	51
2.1	General layout of the function matrix	6	7.2.1	Function group CONFIGURATION	51
2.1.1	Blocks (A, B, C, etc.)	6	7.2.2	Function group EPD PARAMETER	53
2.1.2	Groups (AAA, AEA, CAA, etc.)	6	7.2.3	Function group ECC PARAMETER	55
2.1.3	Function groups (000, 020, 060, etc.)	6	7.2.4	Function group ADJUSTMENT	57
2.1.4	Functions (0000, 0001, 0002, etc.)	6	7.3	Group SYSTEM PARAMETER	58
2.1.5	Codes identifying cells	7	7.3.1	Function group CONFIGURATION	58
2.2	Function matrix	8	7.4	Group SENSOR DATA	60
			7.4.1	Function group CONFIGURATION	60
3	Block MEASURED VARIABLES	9	7.4.2	Function group OPERATION	61
3.1	Group MEASURING VALUES	10	8	Block SPECIAL FUNCTION	63
3.1.1	Function group MAIN VALUES	10	8.1	Group ADVANCED DIAGNOSTICS	64
3.1.2	Function group ADD.VALUES CONC.	11	8.1.1	Function group CONFIGURATION	66
3.2	Group SYSTEM UNITS	13	8.1.2	Function group ACQUISITION	67
3.2.1	Function group CONFIGURATION	13	8.1.3	Function group CONFIG. COATING	68
3.2.2	Function group ADDITIONAL CONFIGURATION	16	8.1.4	Function group COATING E1	69
3.3	Group SPECIAL UNITS	17	8.1.5	Function group COATING E2	70
3.3.1	Function group DENSITY PARAMETER	17	8.1.6	Function group ELECTRODE POT. 1	71
4	Block QUICK SETUP	18	8.1.7	Function group ELECTRODE POT. 2	72
4.1	"Commissioning" Quick Setup menu	19	8.1.8	Function group VOLUME FLOW	73
4.2	Data backup/transmission	20	8.1.9	Function group NOISE VALUE	74
5	Block USER INTERFACE	21	8.2	Group SOLID CONTENT FLOW	76
5.1	Group CONTROL	22	8.2.1	Function group CONFIGURATION	76
5.1.1	Function group BASIC CONFIGURATION	22	9	Block SUPERVISION	77
5.1.2	Function group UNLOCKING/LOCKING	24	9.1	Group SYSTEM	78
5.1.3	Function group OPERATION	25	9.1.1	Function group CONFIGURATION	78
5.2	Group MAIN LINE	26	9.1.2	Function group OPERATION	80
5.2.1	Function group CONFIGURATION	26	9.2	Group VERSION INFO	82
5.2.2	Function group MULTIPLEX	28	9.2.1	Function group DEVICE	82
5.3	Group ADDITIONAL LINE	30	9.2.2	Function group SENSOR	82
5.3.1	Function group CONFIGURATION	30	9.2.3	Function group AMPLIFIER	83
5.3.2	Function group MULTIPLEX	33	9.2.4	Function group F-CHIP	84
5.4	Group INFORMATION LINE	36	9.2.5	Function group I/O MODULE	84
5.4.1	Function group CONFIGURATION	36	10	Index Function matrix	85
5.4.2	Function group MULTIPLEX	39	11	Index (local operation)	89
6	Block TOTALIZER	42			
6.1	Group TOTALIZER (1 to 3)	43			
6.1.1	Function group CONFIGURATION	43			
6.1.2	Function group OPERATION	45			
6.2	Group HANDLING TOTALIZER	46			

1 Using the manual

There are various ways of locating the description of a function of your choice in the manual:

1.1 Using the table of contents to locate a function description

The designations of all the cells in the function matrix are listed in the table of contents. You can use these unambiguous designations (such as USER INTERFACE, INPUTS, OUTPUTS, etc.) to choose whichever functions are applicable to a particular set of conditions. The page references show you exactly where to find the detailed descriptions of the functions in question. The table of contents can be found on Page 3.

1.2 Using the graphic of the function matrix to locate a function description

This step-by-step, top-down approach starts with the blocks, the highest level, and works down through the matrix to the description of the function you need:

1. All available blocks, and their corresponding groups, are illustrated on Page 8. Select the block (or the group within the block) which you need for your application and use the page reference to locate the information corresponding to the next level.
2. The page in question contains a graphic showing of the block with all its subordinate groups, function groups and functions. Select the function which you need for your application and use the page reference to locate the detailed function description.

1.3 Using the index of the function matrix to locate a function description

Each "cell" in the function matrix (blocks, groups, function groups, functions) has a unique identifier in the form of a code consisting of one or three letters or a three- or four-digit number. The code identifying a selected "cell" appears at the top right on the local display.

Example:

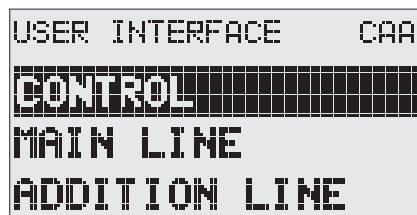

A0004750-EN

The function matrix index lists the codes for all the available "cells" in alphabetic and consecutive order, complete with the page references for the corresponding functions. The index to the function matrix is on Page 85.

2 Function matrix

2.1 General layout of the function matrix

The function matrix consists of four levels:

Blocks -> Groups -> Function groups -> Functions

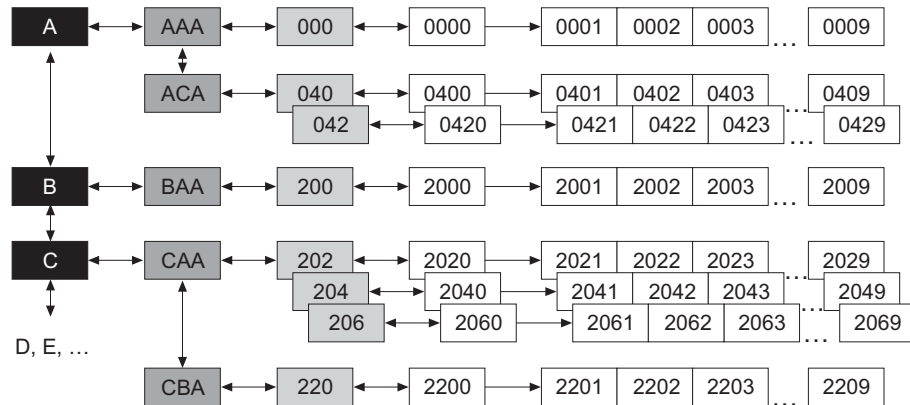

A0000961

2.1.1 Blocks (A, B, C, etc.)

The blocks are the highest-level grouping of the operation options for the device. The blocks include, for example: MEASURED VARIABLES, QUICK SETUP, USER INTERFACE, TOTALIZER, etc.

2.1.2 Groups (AAA, AEA, CAA, etc.)

A block consists of one or more groups. Each group represents a more detailed selection of the operation options in the higher-order block. The groups in the USER INTERFACE block, for example, include: CONTROL, MAIN LINE, ADDITIONAL LINE, etc.

2.1.3 Function groups (000, 020, 060, etc.)

A group consists of one or more function groups. Each function group represents a more detailed selection of the operation options in the higher-order group. The function groups available in the CONTROL group are for example: BASIC CONFIGURATION, UNLOCKING/LOCKING, OPERATION, etc.

2.1.4 Functions (0000, 0001, 0002, etc.)

Each function group consists of one or more functions. The functions are used to operate and parameterize the device. Numerical values can be entered here or parameters selected and saved. The functions in the BASIC CONFIGURATION function group include LANGUAGE, DISPLAY DAMPING, CONTRAST LCD, etc. The procedure for changing the language of the user interface, for example, is as follows:

1. Select the USER INTERFACE block
2. Select the CONTROL group
3. Select the BASIC CONFIGURATION function group
4. Select the LANGUAGE function (here you can set the language required).

2.1.5 Codes identifying cells

Each cell (block, group, function group and function) in the function matrix has an individual, unique code.

Blocks:

The code is a letter (A, B, C, etc.)

Groups:

The code consists of three letters (AAA, ABA, BAA, etc.).

The first letter matches the block code (i.e. each group in block A has a code starting with an A _ _; the codes of the groups in block B start with a B _ _, etc.). The other two letters are for identifying the group within the respective block.

Function groups:

The code consists of three digits (000, 001, 100, etc.).

Functions:

The code consists of four digits (0000, 0001, 0201, etc.).

The first three digits are the same as the code for the function group.

The last digit in the code is a counter for the functions in the function group, incrementing from 0 to 9 (e.g. function 0005 is the sixth function in group 000).

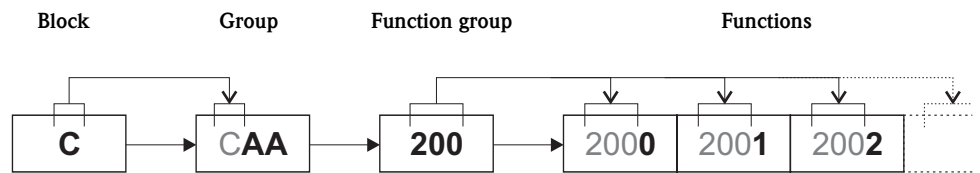

A0001251

2.2 Function matrix

BLOCKS	GROUPS	FUNCTION GROUPS
MEASURED VARIABLES A (→ Page 9)	→ MEASURING VALUES AAA →	Page 10
	→ SYSTEM UNITS ACA →	Page 13
	→ SPECIAL UNITS AEA →	Page 17
↓		
QUICK SETUP B (→ Page 18)	→ Commissioning and application setups →	Page 18
↓		
USER INTERFACE C (→ Page 21)	→ CONTROL CAA →	Page 22
	→ MAIN LINE CCA →	Page 26
	→ ADDITIONAL LINE CEA →	Page 30
	→ INFORMATION LINE CGA →	Page 36
↓		
TOTALIZER D (→ Page 42)	→ TOTALIZER 1 DAA →	Page 43
	→ TOTALIZER 2 DAB →	Page 43
	→ TOTALIZER 3 DAC →	Page 43
	→ HANDLING TOTALIZER DJA →	Page 46
↓		
BASIC FUNCTION G (→ Page 47)	→ FOUNDATION FIELDBUS GAA →	Page 48
	→ PROCESS PARAMETER GIA →	Page 51
	→ SYSTEM PARAMETER GLA →	Page 58
	→ SENSOR DATA GNA →	Page 60
↓		
SUPERVISION J (→ Page 77)	→ SYSTEM JAA →	Page 78
	→ VERSION INFO JCA →	Page 82

3 Block MEASURED VARIABLES

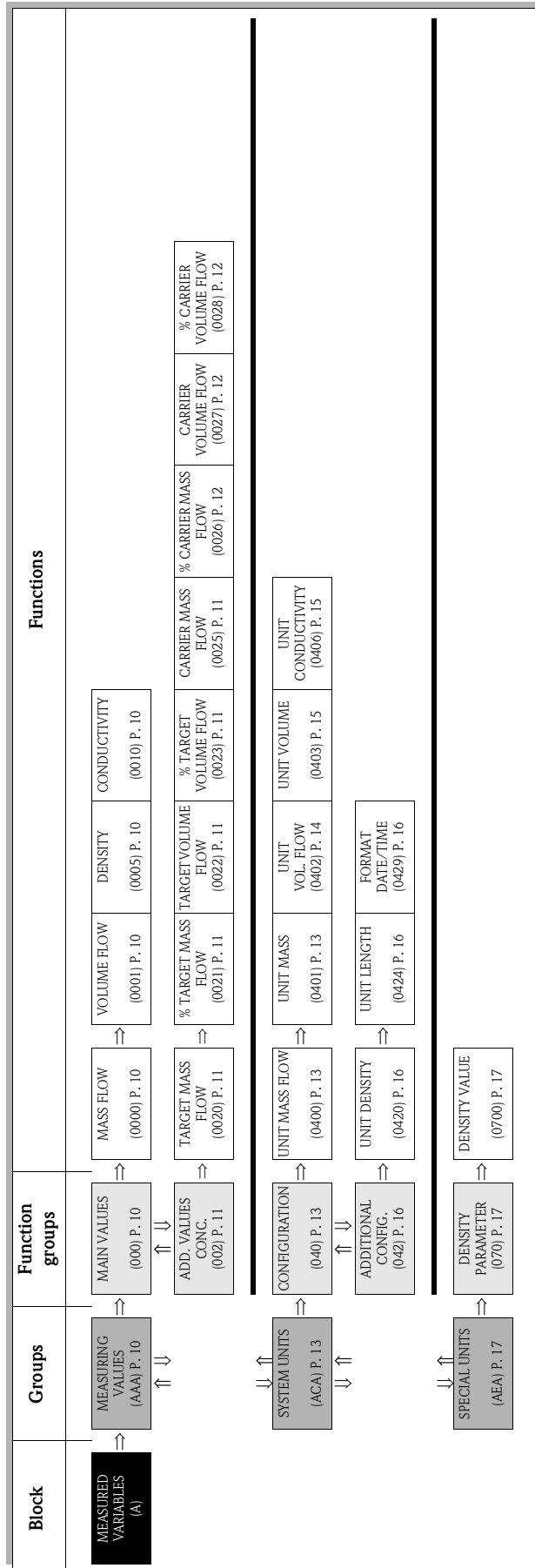

3.1 Group MEASURING VALUES

3.1.1 Function group MAIN VALUES



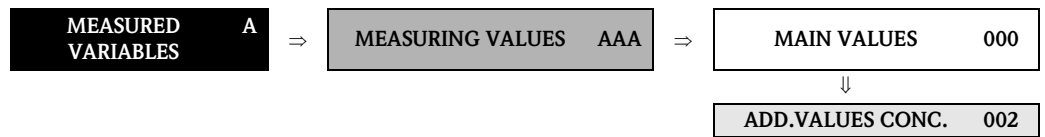

Function description	
MEASURED VARIABLES → MEASURING VALUES → MAIN VALUES	
<p> Note!</p> <ul style="list-style-type: none"> ■ The engineering units of all the measured variables shown here can be set in the SYSTEM UNITS group. ■ If the fluid in the pipe flows backwards, a negative sign prefixes the flow reading on the display. 	
CALCULATED MASS FLOW (0000)	<p>Use this function to view the calculated mass flow. The mass flow is derived from the measured volume flow and the fixed (or temperature-compensated) density.</p> <p>User interface: 5-digit floating-point number, including unit and sign (e.g. 462.87 kg/h; -731.63 lb/min; etc.)</p>
VOLUME FLOW (0001)	<p>Use this function to view the actual measured volume flow.</p> <p>User interface: 5-digit floating-point number, including unit and sign (e.g. 5.5445 dm³/min; 1.4359 m³/h; -731.63 gal/d; etc.)</p>
DENSITY (0005)	<p>Use this function to view the fixed density, temperature-compensated density or density fed in via the current input.</p> <p>User interface: 5-digit floating-point number, including unit (corresponding to 0.10000 to 6.0000 kg/dm³) e.g. 1.2345 kg/dm³; 993.5 kg/m³; 1.0015 SG_20 °C; etc.</p>
CONDUCTIVITY (0010)	<p>Use this function to view the actual conductivity without temperature compensation (only when conductivity is switched on → Page 62).</p> <p>User interface: 5-digit floating-point number, including unit (e.g. 20 µS/cm, 460 µS/m etc.)</p>

3.1.2 Function group ADD.VALUES CONC.



Function description MEASURED VARIABLES → MEASURING VALUES → ADD.VALUES CONC.	
TARGET MASS FLOW (0020)	<p> Note! This function is only available if the measuring device is equipped with an F-CHIP for measuring solid content flows (s. Page 76).</p> <p>The actual measured mass flow of the target medium is displayed in this function. Target medium = solids transported with the fluid (e.g. stone, gravel, sand, etc.).</p> <p>User interface: 5-digit floating-point number, including unit and sign</p>
% TARGET MASS FLOW (0021)	<p> Note! This function is only available if the measuring device is equipped with an F-CHIP for measuring solid content flows (s. Page 76).</p> <p>The actual measured mass flow of the target medium as a percentage (%) of the total mass flow is displayed in this function. Target medium = solids transported with the fluid (e.g. stone, gravel, sand, etc.).</p> <p>User interface: 5-digit floating-point number, including unit and sign</p>
TARGET VOLUME FLOW (0022)	<p> Note! This function is only available if the measuring device is equipped with an F-CHIP for measuring solid content flows (s. Page 76).</p> <p>The actual measured volume flow of the target medium is displayed in this function. Target medium = solids transported with the fluid (e.g. stone, gravel, sand, etc.).</p> <p>User interface: 5-digit floating-point number, including unit and sign</p>
% TARGET VOLUME FLOW (0023)	<p> Note! This function is only available if the measuring device is equipped with an F-CHIP for measuring solid content flows (s. Page 76).</p> <p>The actual measured volume flow of the target medium as a percentage (%) of the total volume flow is displayed in this function. Target medium = solids transported with the fluid (e.g. stone, gravel, sand, etc.).</p> <p>User interface: 5-digit floating-point number, including unit and sign</p>
CARRIER MASS FLOW (0025)	<p> Note! This function is only available if the measuring device is equipped with an F-CHIP for measuring solid content flows (s. Page 76).</p> <p>The actual measured mass flow of the carrier fluid is displayed in this function. Carrier fluid = transporting liquid (e.g. water).</p> <p>User interface: 5-digit floating-point number, including unit and sign</p>

Function description	
MEASURED VARIABLES → MEASURING VALUES → ADD.VALUES CONC.	
% CARRIER MASS FLOW (0026)	<p> Note! This function is only available if the measuring device is equipped with an F-CHIP for measuring solid content flows (s. Page 76).</p> <p>The actual measured mass flow of the carrier fluid as a percentage (%) of the total mass flow is displayed in this function. Carrier fluid = transporting liquid (e.g. water).</p> <p>User interface: 5-digit floating-point number, including unit and sign</p>
CARRIER VOLUME FLOW (0027)	<p> Note! This function is only available if the measuring device is equipped with an F-CHIP for measuring solid content flows (s. Page 76).</p> <p>The actual measured volume flow of the carrier fluid is displayed in this function. Carrier fluid = transporting liquid (e.g. water).</p> <p>User interface: 5-digit floating-point number, including unit and sign</p>
% CARRIER VOLUME FLOW (0028)	<p> Note! This function is only available if the measuring device is equipped with an F-CHIP for measuring solid content flows (s. Page 76).</p> <p>The actual measured volume flow of the carrier fluid as a percentage (%) of the total volume flow is displayed in this function. Carrier fluid = transporting liquid (e.g. water).</p> <p>User interface: 5-digit floating-point number, including unit and sign</p>

3.2 Group SYSTEM UNITS

3.2.1 Function group CONFIGURATION

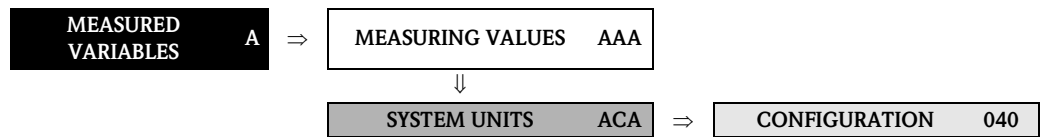

Function description	
MEASURED VARIABLES → SYSTEM UNITS → CONFIGURATION	
<p>You can select the units for measured variables in this function group.</p>	
<p>UNIT MASS FLOW (0400)</p>	<p>Use this function to select the unit for displaying the calculated mass flow (mass/time). The mass flow is derived from the preset (compensated) specific fluid density and the measured volume flow.</p> <p>The unit you select here is also valid for:</p> <ul style="list-style-type: none"> ■ Switch points (limit value for mass flow, flow direction) ■ Low flow cutoff <p>Options: Metric: gram → g/s; g/min; g/h; g/day Kilogram → kg/s; kg/min; kg/h; kg/day Metric ton → t/s; t/min; t/h; t/day</p> <p>US: ounce → oz/s; oz/min; oz/h; oz/day pound → lb/s; lb/min; lb/h; lb/day ton → ton/s; ton/min; ton/h; ton/day</p> <p>Factory setting: Depends on nominal diameter and country (→ Page 167 ff.).</p>
<p>UNIT MASS (0401)</p>	<p>Use this function to select the unit for displaying the calculated mass. The mass is derived from the preset (compensated) specific fluid density and the measured volume.</p> <p>The unit you select here is also valid for:</p> <ul style="list-style-type: none"> ■ Pulse value (e.g. kg/p) <p>Options: Metric → g; kg; t US → oz; lb; ton</p> <p>Factory setting: Depends on nominal diameter and country (→ Page 167 ff.).</p> <p> Note! The unit for the totalizers is independent of your choice here. The unit for each totalizer is selected separately for the totalizer in question.</p>

Function description	
MEASURED VARIABLES → SYSTEM UNITS → CONFIGURATION	
UNIT VOLUME FLOW (0402)	<p>Use this function to select the unit for displaying the volume flow (volume/time).</p> <p>The unit you select here is also valid for:</p> <ul style="list-style-type: none"> ■ Switch points (limit value for volume flow, flow direction) ■ Low flow cutoff <p>Options:</p> <p>Metric:</p> <p>Cubic centimeter → cm³/s; cm³/min; cm³/h; cm³/day Cubic decimeter → dm³/s; dm³/min; dm³/h; dm³/day Cubic meter → m³/s; m³/min; m³/h; m³/day Milliliter → ml/s; ml/min; ml/h; ml/day Liter → l/s; l/min; l/h; l/day Hectoliter → hl/s; hl/min; hl/h; hl/day Megaliter → Ml/s; ml/min; Ml/h; ml/day</p> <p>US:</p> <p>Cubic centimeter → cc/s; cc/min; cc/h; cc/day Acre foot → af/s; af/min; af/h; af/day Cubic foot → ft³/s; ft³/min; ft³/h; ft³/day Fluid ounce → oz f/s; oz f/min; oz f/h; oz f/day Gallon → gal/s; gal/min; gal/h; gal/day Kilo gallon → Kgal/s; Kgal/min; Kgal/h; Kgal/day Million gallon → Mgal/s; Mgal/min; Mgal/h; Mgal/day Barrel (normal fluids: 31.5 gal/bbl) → bbl/s; bbl/min; bbl/h; bbl/day Barrel (beer: 31.0 gal/bbl) → bbl/s; bbl/min; bbl/h; bbl/day Barrel (petrochemicals: 42.0 gal/bbl) → bbl/s; bbl/min; bbl/h; bbl/day Barrel (filling tanks: 55.0 gal/bbl) → bbl/s; bbl/min; bbl/h; bbl/day</p> <p>Imperial:</p> <p>Gallon → gal/s; gal/min; gal/h; gal/day Mega gallon → Mgal/s; Mgal/min; Mgal/h; Mgal/day Barrel (beer: 36.0 gal/bbl) → bbl/s; bbl/min; bbl/h; bbl/day Barrel (petrochemicals: 34.97 gal/bbl) → bbl/s; bbl/min; bbl/h; bbl/day</p> <p>Factory setting: Depends on nominal diameter and country (→ Page 167 ff.).</p>

Function description MEASURED VARIABLES → SYSTEM UNITS → CONFIGURATION	
UNIT VOLUME (0403)	<p>Use this function to select the unit for displaying the volume.</p> <p>The unit you select here is also valid for:</p> <ul style="list-style-type: none"> ■ Pulse weighting (e.g. m³/p) <p>Options: Metric → cm³; dm³; m³; ml; l; hl; Ml Mega</p> <p>US → cc; af; ft³; oz f; gal; Kgal; Mgal; bbl (normal fluids); bbl (beer); bbl (petrochemicals); → bbl (filling tanks)</p> <p>Imperial → gal; Mgal; bbl (beer); bbl (petrochemicals)</p> <p>Factory setting: Depends on nominal diameter and country (→ Page 167 ff.).</p> <p> Note! The unit of the totalizers is independent of your choice here. The unit for each totalizer is selected separately for the totalizer in question.</p>
UNIT CONDUCTIVITY (0406)	<p>Use this function to select the unit for displaying the conductivity (only when conductivity is switched on → Page 62).</p> <p>Options: μS/cm, mS/cm, S/m</p> <p>Factory setting: μS/cm</p>

3.2.2 Function group ADDITIONAL CONFIGURATION

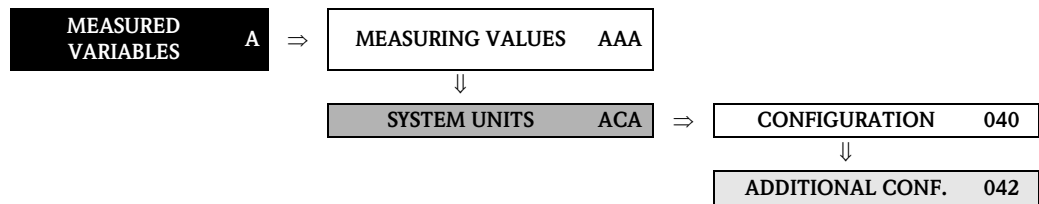

Function description MEASURED VARIABLES → SYSTEM UNITS → ADDITIONAL CONFIGURATION	
UNIT DENSITY (0420)	<p>Use this function to select the unit for displaying the fluid density.</p> <p>The unit you select here is also valid for:</p> <ul style="list-style-type: none"> ■ Fluid density entry <p>Options: Metric → g/cm³; g/cc; kg/dm³; kg/l; kg/m³; SD 4 °C, SD 15 °C, SD 20 °C; SG 4 °C, SG 15 °C, SG 20 °C; g/l</p> <p>US → lb/ft³; lb/gal; lb/bbl (normal fluids); lb/bbl (beer); lb/bbl (petrochemicals); lb/bbl (filling tanks)</p> <p>Imperial → lb/gal; lb/bbl (beer); lb/bbl (petrochemicals)</p> <p>Factory setting: kg/l (SI units: not for USA and Canada) g/cc (US units: only for USA and Canada)</p> <p>SD = Specific Density, SG = Specific Gravity The specific density is the ratio of fluid density to water density (at water temperature = 4, 15, 20 °C).</p>
UNIT LENGTH (0424)	<p>Use this function to select the unit for displaying the length of the nominal diameter.</p> <p>The unit you select here is also valid for:</p> <p>Nominal diameter of sensor (function NOMINAL DIAMETER (6804) on Page 60)</p> <p>Options: MILLIMETER INCH</p> <p>Factory setting: MILLIMETER (SI units: not for USA and Canada) INCH (US units: only for USA and Canada)</p>
FORMAT DATE/TIME (0429)	<p>Use this function to select the format for the date and the time.</p> <p>The unit you select here is also valid for:</p> <p>Displaying the current calibration date (function CALIBRATION DATE (6808) on Page 60)</p> <p>Options: DD.MM.YY 24H MM/DD/YY 12H A/P DD.MM.YY 12H A/P MM/DD/YY 24H</p> <p>Factory setting: DD.MM.YY 24H (SI units) MM/DD/YY 12H A/P (US units)</p>

3.3 Group SPECIAL UNITS

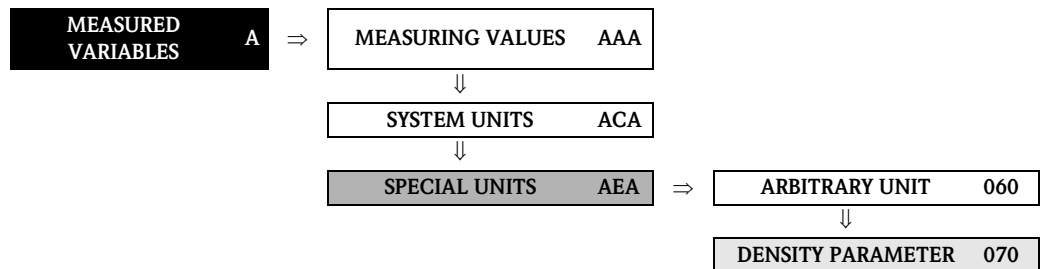

3.3.1 Function group DENSITY PARAMETER

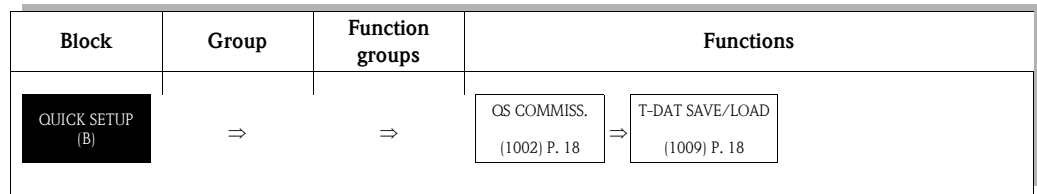

Function description	
MEASURED VARIABLES → SPECIAL UNITS → DENSITY PARAMETER	
<p>Use this function group to calculate a mass flow from a volume flow.</p> <p> Note! It is advisable to enter the density factor at process temperature for calculating the mass flow without compensating for thermal expansion.</p> <p>Example of calculated mass flow without compensation for thermal expansion of the fluid:</p> $\dot{m} = \dot{V} \cdot \rho = 1 \text{ [dm}^3/\text{h]} \times 0.900 \text{ [kg/l]} = 0.900 \text{ [kg/h]} \text{ (mass flow at } 20 \text{ }^\circ\text{C)}$ $\dot{m} = \dot{V} \cdot \rho = 1 \text{ [dm}^3/\text{h]} \times 0.783 \text{ [kg/l]} = 0.783 \text{ [kg/h]} \text{ (mass flow at } 150 \text{ }^\circ\text{C)}$	
DENSITY VALUE (0700)	<p>Use this function to enter a density value preferably at process temperature. This density value is used to convert the volume flow to a mass flow.</p> <p>User input: 5-digit floating-point number</p> <p>Factory setting: 1 [unit]</p> <p> Note! The appropriate unit is taken from the function UNIT DENSITY (0420), (see Page 16).</p>

4 Block QUICK SETUP



Function description QUICK SETUP	
QUICK SETUP COMMISSIONING (1002)	<p>Use this function to start the Setup menu for commissioning.</p> <p>Options: YES NO</p> <p>Factory setting: NO</p> <p> Note! You will find a flowchart of the COMMISSIONING Setup menu on Page 19. For more detailed information on Setup menus, please refer to the Operating Instructions for Proline Promag 55 FOUNDATION FIELDBUS.</p>
T-DAT SAVE/LOAD (1009)	<p>Use this function to save the parameter settings / configuration of the transmitter in a transmitter DAT (T-DAT), or to load the parameter settings from the T-DAT into the EEPROM (manual security function).</p> <p>Application examples:</p> <ul style="list-style-type: none"> ■ After commissioning, the actual measuring point parameters can be saved to the T-DAT as a backup. ■ If the transmitter is replaced for some reason, the data from the T-DAT can be loaded into the new transmitter (EEPROM). <p>Options: CANCEL SAVE (from EEPROM to T-DAT) LOAD (from the T-DAT into EEPROM)</p> <p>Factory setting: CANCEL</p> <p> Note!</p> <ul style="list-style-type: none"> ■ If the target device has an older software version, the message "TRANSM. SW-DAT" is displayed during startup. Then only the SAVE option is available. ■ LOAD This option is only possible if: <ul style="list-style-type: none"> – The target device has the same software version as, or a more recent software version than, the source device or – The T-DAT contains valid data that can be retrieved ■ SAVE This option is always available.

4.1 "Commissioning" Quick Setup menu

The "Commissioning" Quick Setup menu guides you systematically through all the important device functions that have to be configured for standard operation.

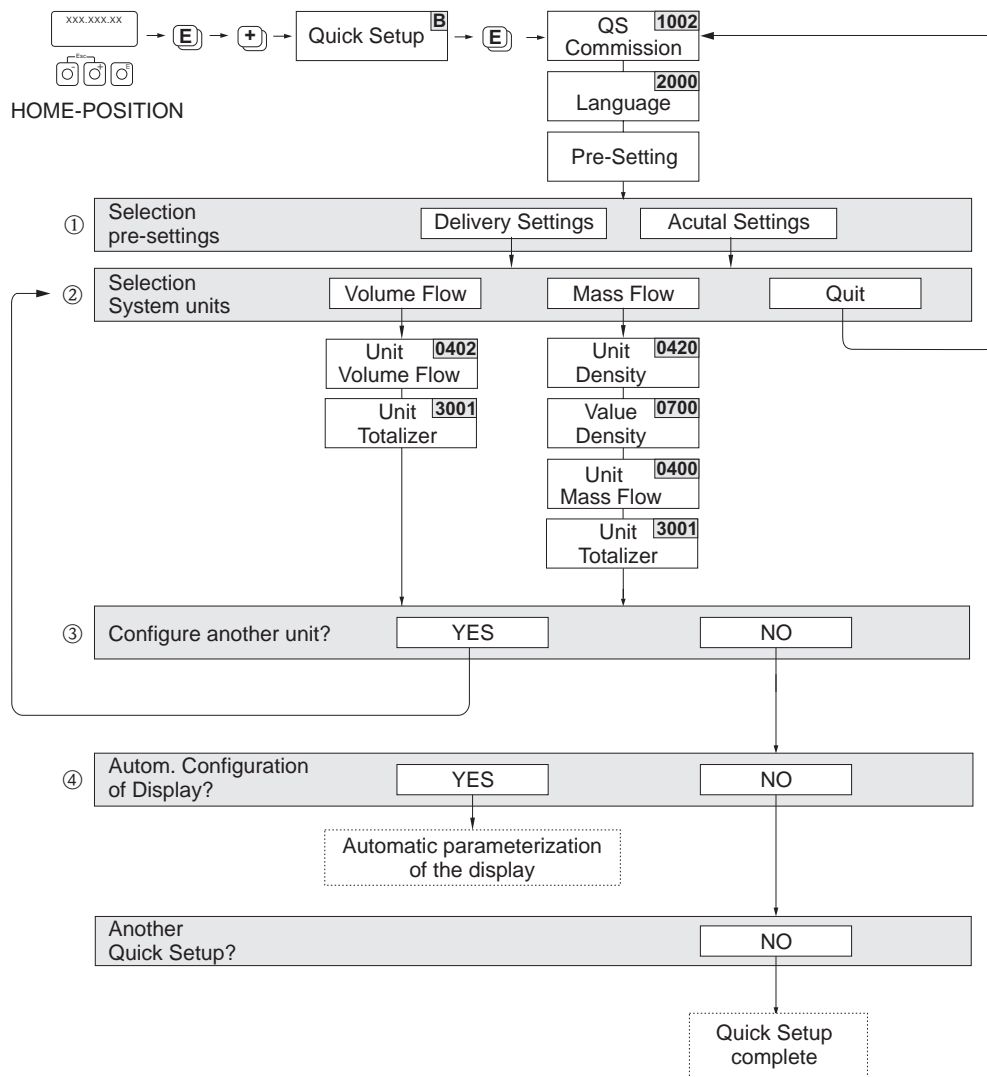

a0006395-en

Note!

- The display returns to the cell SETUP COMMISSIONING (1002) if you press the key combination during parameter interrogation. The stored parameters remain valid.
- The system units selected via the Quick Setup only apply for displaying on the local display and for parameters in the Transducer Blocks. They do not affect the process variables (volume flow, calculated mass flow, totalizer) that are transmitted via FOUNDATION Fieldbus.

- ① The DELIVERY SETTINGS option sets every selected unit to the factory setting. The ACTUAL SETTING option accepts the units you previously configured.
- ② Only units not yet configured in the current Setup are offered for selection in each cycle. The unit for mass and volume is derived from the corresponding flow unit.
- ③ The YES option remains visible until all the units have been configured. NO is the only option displayed when no further units are available.
- ④ The "automatic parameterization of the display" option contains the following basic settings/factory settings:

YES Main line = Volume flow
 Additional line = Totalizer 1
 Information line = Operating/system condition

NO The existing (selected) settings remain.

4.2 Data backup/transmission

Using the T-DAT SAVE/LOAD function, you can transfer data (device parameters and settings) between the T-DAT (exchangeable memory) and the EEPROM (device storage unit).

This is required in the following instances:

- Creating a backup: current data are transferred from an EEPROM to the T-DAT.
- Replacing a transmitter: current data are copied from an EEPROM to the T-DAT and then transferred to the EEPROM of the new transmitter.
- Duplicating data: current data are copied from an EEPROM to the T-DAT and then transferred to EEPROMs of identical measuring points.



Note!

Installing and removing T-DAT → See Operating Instructions for Proline Promag 55 FOUNDATION Fieldbus.

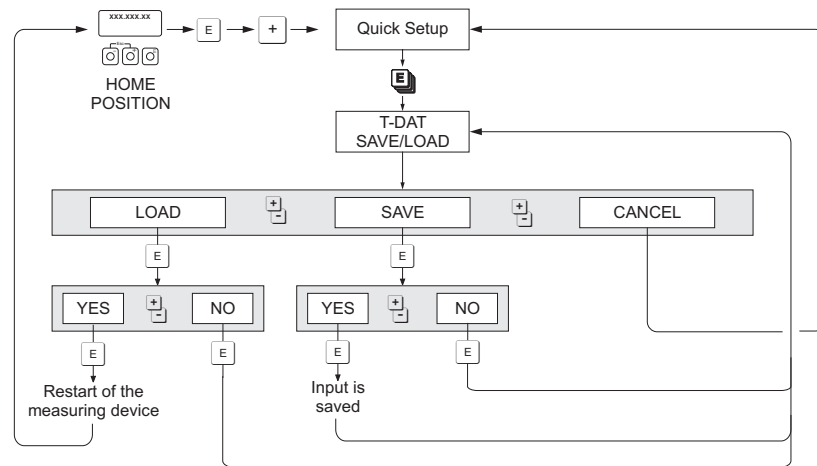

Data backup/transmission with T-DAT SAVE/LOAD function

a0001221-en

Information on the LOAD and SAVE options available:

LOAD: Data are transferred from the T-DAT to the EEPROM.



Note!

- Any settings already saved on the EEPROM are deleted.
- This option is only available if the T-DAT contains valid data.
- This option can only be executed if the software version of the T-DAT is the same or newer than that of the EEPROM. Otherwise, the error message "TRANSM. SW-DAT" appears after restarting and the LOAD function is then no longer available.

SAVE:

Data are transferred from the EEPROM to the T-DAT



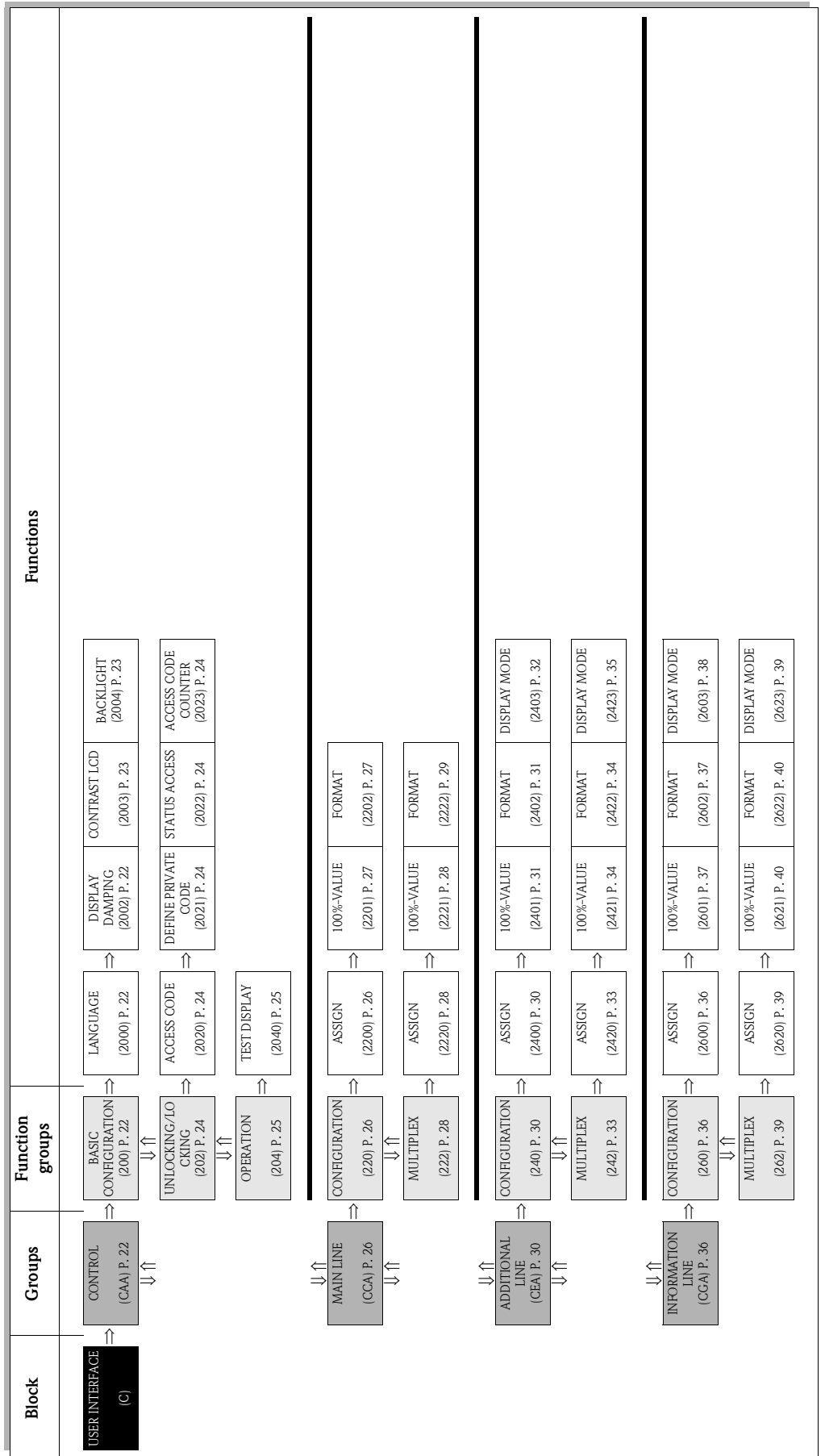

5 Block USER INTERFACE



5.1 Group CONTROL

5.1.1 Function group BASIC CONFIGURATION

USER INTERFACE C ⇒ CONTROL CAA ⇒ BASIC CONFIGURATION 200

Function description	
USER INTERFACE → CONTROL → BASIC CONFIGURATION	
LANGUAGE (2000)	<p>Use this function to select the language for all texts, parameters and messages shown on the local display.</p> <p> Note! The displayed options depend on the available language group shown in the LANGUAGE GROUP (8226) function.</p> <p>OPTIONS: Language group WEST EU / USA: ENGLISH DEUTSCH FRANCAIS ESPANOL ITALIANO NEDERLANDS PORTUGUESE</p> <p>Language group EAST EU / SCAND: ENGLISH NORSK SVENSKA SUOMI POLISH RUSSIAN CZECH</p> <p>Language group ASIA: ENGLISH BAHASA INDONESIA JAPANESE (syllabary)</p> <p>Language group CHINA: ENGLISH CHINESE</p> <p>Factory setting: Country-dependent (→ Page 167)</p> <p> Note!</p> <ul style="list-style-type: none"> ■ If you press the  key combination at startup, the language defaults to ENGLISH. ■ You can change the language group via the configuration program FieldCare. Please do not hesitate to contact your Endress+Hauser sales office if you have any questions.
DISPLAY DAMPING (2002)	<p>Use this function to enter a time constant defining how the display reacts to severely fluctuating flow variables, either very quickly (enter a low time constant) or with damping (enter a high time constant).</p> <p>User input: 0 to 100 seconds</p> <p>Factory setting: 1 s</p> <p> Note! Setting the time constant to zero seconds switches off damping.</p>

Function description	
USER INTERFACE → CONTROL → BASIC CONFIGURATION	
CONTRAST LCD (2003)	<p>Use this function to optimize display contrast to suit local operating conditions.</p> <p>User input: 10 to 100%</p> <p>Factory setting: 50%</p>
BACKLIGHT (2004)	<p>Use this function to optimize the backlight to suit local operating conditions.</p> <p>User input: 0 to 100%</p> <p> Note! Entering the value "0" means that the backlight is "switched off". The display then no longer emits any light, i.e. the display texts can no longer be read in the dark.</p> <p>Factory setting: 50%</p>

5.1.2 Function group UNLOCKING/LOCKING

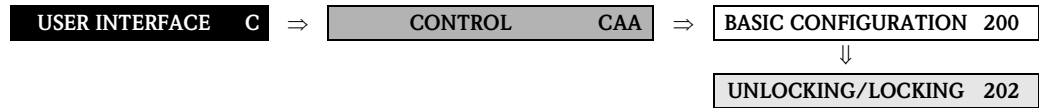

Function description	
USER INTERFACE → CONTROL → UNLOCKING/LOCKING	
<p>ACCESS CODE (2020)</p>	<p> Note!</p> <p>This function is only relevant for local operation. If functions or parameters are to be changed via the fieldbus, programming must be enabled separately via the parameter "Access - Code"/Transducer Blocks.</p> <p>All data of the measuring system are protected against inadvertent change. Programming is disabled and the settings cannot be changed until a code is entered in this function. If you press the key combination in any function, the measuring system automatically goes to this function and the prompt to enter the code appears on the display (when programming is disabled).</p> <p>You can enable programming by entering your personal code (factory setting = 55, see DEFINE PRIVATE CODE function 2021).</p> <p>User input: Max. 4-digit number: 0 to 9999</p> <p> Note!</p> <ul style="list-style-type: none"> ■ The programming levels are disabled if you do not press a key within 60 seconds following automatic return to the HOME position. You can also disable programming in this function by entering any number (other than the defined private code). ■ The Endress+Hauser service organization can be of assistance if you mislay your personal code.
<p>DEFINE PRIVATE CODE (2021)</p>	<p>Use this function to specify a personal code for enabling programming in the function ACCESS CODE (2020).</p> <p>User input: 0 to 9999 (max. 4-digit number)</p> <p>Factory setting: 55</p> <p> Note!</p> <ul style="list-style-type: none"> ■ Programming is always enabled with the code "0". ■ Programming has to be enabled before this code can be changed. When programming is disabled this function is not available, thus preventing others from accessing your personal code.
<p>STATUS ACCESS (2022)</p>	<p>Use this function to check the access status for the function matrix.</p> <p>User interface: ACCESS CUSTOMER (parameterization possible) LOCKED (parameterization disabled)</p>
<p>ACCESS CODE COUNTER (2023)</p>	<p>Displays how often the customer code, service code or the digit "0" (code-free) has been entered to gain access to the function matrix.</p> <p>User interface: Max. 7-digit number: 0 to 9999999</p> <p>Factory setting: 0</p>

5.1.3 Function group OPERATION

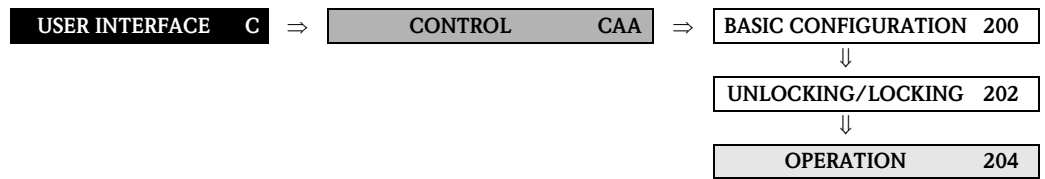



Function description	
USER INTERFACE → CONTROL → OPERATION	
TEST DISPLAY (2040)	<p>Use this function to test the operability of the local display and its pixels.</p> <p>Options: OFF ON</p> <p>Factory setting: OFF</p> <p>Test sequence:</p> <ol style="list-style-type: none"> 1. Start the test by selecting ON. 2. All pixels of the main line, additional line and information line are darkened for minimum 0.75 seconds. 3. Main line, additional line and information line show an "8" in each field for minimum 0.75 seconds. 4. Main line, additional line and information line show a "0" in each field for minimum 0.75 seconds. 5. Main line, additional line and information line show nothing (blank display) for minimum 0.75 seconds. <p>When the test completes the local display returns to its initial state and the setting changes to OFF.</p>

5.2 Group MAIN LINE

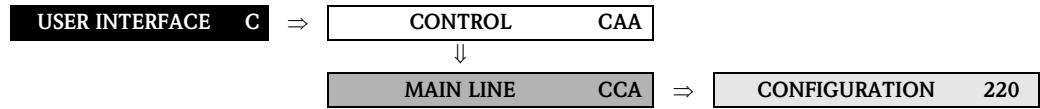
5.2.1 Function group CONFIGURATION



Function description USER INTERFACE → MAIN LINE → CONFIGURATION	
A0001253	
1 = main line, 2 = additional line, 3 = information line	
<p>ASSIGN (2200)</p>	<p>In this function, a value to be displayed is assigned to the main line (top line in the local display). This value is displayed during normal operation.</p> <p>Options: OFF VOLUME FLOW MASS FLOW VOLUME FLOW IN % MASS FLOW IN % TOTALIZER (1 to 3) AI (1...5) - OUT VALUE AO - DISPLAY VALUE PID - IN VALUE (controlled variable) PID - CAS IN VALUE (external set point) PID - OUT VALUE (manipulated variable)</p> <p>* only when conductivity is switched on → Page 62</p> <p>Factory setting: VOLUME FLOW</p> <p>Advanced options with optional software package ADVANCED DIAGNOSTICS: DEVIATION COATING E1 (only when coating detection is switched on → Page 68) DEVIATION COATING E2 (only when coating detection is switched on → Page 68) DEVIATION ELECTRODE POTENTIAL 1 DEVIATION ELECTRODE POTENTIAL 2 DEVIATION VOLUME FLOW DEVIATION NOISE VALUE</p> <p>Advanced options with optional software package SOLID CONTENT FLOW: TARGET MASS FLOW % TARGET MASS FLOW TARGET VOLUME FLOW % TARGET VOLUME FLOW CARRIER MASS FLOW % CARRIER MASS FLOW CARRIER VOLUME FLOW % CARRIER VOLUME FLOW</p>

Function description	
USER INTERFACE → MAIN LINE → CONFIGURATION	
100%-VALUE (2201)	<p> Note! This function is only available if VOLUME FLOW IN % or MASS FLOW IN % was selected in the function ASSIGN (2200).</p> <p>Use this function to define the flow value to be shown on the display as the 100% value.</p> <p>User input: 5-digit floating-point number</p> <p>Factory setting: Depends on nominal diameter and country (→ Page 167 ff.).</p>
FORMAT (2202)	<p>Use this function to define the maximum number of places after the decimal point displayed for the reading in the main line.</p> <p>Options: XXXXX. – XXXX.X – XXX.XX – XX.XXX – X.XXXX</p> <p>Factory setting: X.XXXX</p> <p> Note!</p> <ul style="list-style-type: none"> ■ Note that this setting only affects the reading as it appears on the display, it has no influence on the accuracy of the system's calculations. ■ The places after the decimal point as computed by the measuring device cannot always be displayed, depending on this setting and the engineering unit. In such instances an arrow appears on the display between the measuring value and the engineering unit (e.g. 1.2 → kg/h), indicating that the measuring system is computing with more decimal places than can be shown on the display.

5.2.2 Function group MULTIPLEX

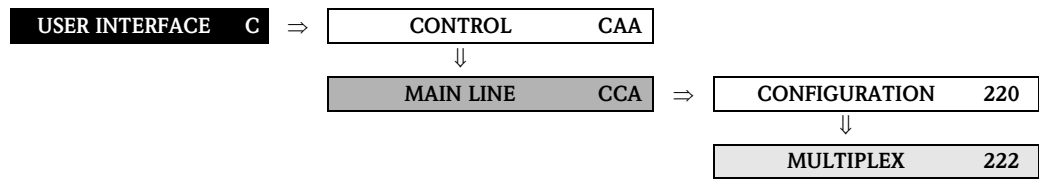

Function description USER INTERFACE → MAIN LINE → MULTIPLEX	
ASSIGN (2220)	<p>Use this function to define the second reading to be displayed in the main line alternately (every 10 seconds) with the value defined in the ASSIGN function (2220).</p> <p>Options: OFF VOLUME FLOW MASS FLOW VOLUME FLOW IN % MASS FLOW IN % TOTALIZER (1 to 3) CONDUCTIVITY * AI (1..5) - OUT VALUE AO - DISPLAY VALUE PID - IN VALUE (controlled variable) PID - CAS IN VALUE (external set point) PID - OUT VALUE (manipulated variable)</p> <p>* only when conductivity is switched on → Page 62</p> <p>Factory setting: OFF</p> <p>Advanced options with optional software package ADVANCED DIAGNOSTICS: DEVIATION COATING E1 (only when coating detection is switched on → Page 68) DEVIATION COATING E2 (only when coating detection is switched on → Page 68) DEVIATION ELECTRODE POTENTIAL 1 DEVIATION ELECTRODE POTENTIAL 2 DEVIATION VOLUME FLOW DEVIATION NOISE VALUE</p> <p>Advanced options with optional software package SOLID CONTENT FLOW: TARGET MASS FLOW % TARGET MASS FLOW TARGET VOLUME FLOW % TARGET VOLUME FLOW CARRIER MASS FLOW % CARRIER MASS FLOW CARRIER VOLUME FLOW % CARRIER VOLUME FLOW</p>
100%-VALUE (2221)	<p> Note! This function is only available if VOLUME FLOW IN % or MASS FLOW IN % was selected in the function ASSIGN (2220).</p> <p>Use this function to define the flow value to be shown on the display as the 100% value.</p> <p>User input: 5-digit floating-point number</p> <p>Factory setting: Depends on nominal diameter and country (→ Page 167 ff.).</p>



Function description	
USER INTERFACE → MAIN LINE → MULTIPLEX	
FORMAT (2222)	<p>Use this function to define the maximum number of places after the decimal point for the second value displayed in the main line.</p> <p>Options: XXXXX. – XXXX.X – XXX.XX – XX.XXX – X.XXXX</p> <p>Factory setting: X.XXXX</p> <p> Note!</p> <ul style="list-style-type: none"> ■ Note that this setting only affects the reading as it appears on the display, it has no influence on the accuracy of the system's calculations. ■ The places after the decimal point as computed by the measuring device cannot always be displayed, depending on this setting and the engineering unit. In such instances an arrow appears on the display between the measuring value and the engineering unit (e.g. 1.2 → kg/h), indicating that the measuring system is computing with more decimal places than can be shown on the display.

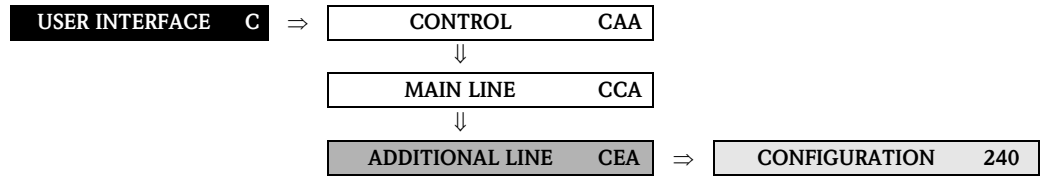

5.3 Group ADDITIONAL LINE

5.3.1 Function group CONFIGURATION



Function description USER INTERFACE → ADDITIONAL LINE → CONFIGURATION	
<p style="text-align: right;">A0001253</p>	
1 = main line, 2 = additional line, 3 = information line	
<p>ASSIGN (2400)</p>	<p>In this function, a value to be displayed is assigned to the additional line (middle line in the local display). This value is displayed during normal operation.</p> <p>Options: OFF VOLUME FLOW MASS FLOW VOLUME FLOW IN % MASS FLOW IN % VOLUME FLOW BARGRAPH IN % MASS FLOW BARGRAPH IN % FLOW VELOCITY TOTALIZER (1 to 3) TAG NAME CONDUCTIVITY * AI (1...5) - OUT VALUE AO - DISPLAY VALUE PID - IN VALUE (controlled variable) PID - CAS IN VALUE (external set point) PID - OUT VALUE (manipulated variable) DEVICE PD-TAG</p> <p>* only when conductivity is switched on → Page 62</p> <p>Factory setting: TOTALIZER 1</p> <p>Advanced options with optional software package ADVANCED DIAGNOSTICS: DEVIATION COATING E1 (only when coating detection is switched on → Page 68) DEVIATION COATING E2 (only when coating detection is switched on → Page 68) DEVIATION ELECTRODE POTENTIAL 1 DEVIATION ELECTRODE POTENTIAL 2 DEVIATION VOLUME FLOW DEVIATION NOISE VALUE</p> <p>(continued on next page)</p>





Function description	
USER INTERFACE → ADDITIONAL LINE → CONFIGURATION	
ASSIGN (continued)	<p>Advanced options with optional software package SOLID CONTENT FLOW: TARGET MASS FLOW % TARGET MASS FLOW TARGET MASS FLOW BARGRAPH % TARGET VOLUME FLOW % TARGET VOLUME FLOW TARGET VOLUME FLOW BARGRAPH % CARRIER MASS FLOW % CARRIER MASS FLOW CARRIER VOLUME FLOW % CARRIER VOLUME FLOW</p>
100%-VALUE (2401)	<p> Note! This function is not available unless one of the following was selected in the function ASSIGN (2400):</p> <ul style="list-style-type: none"> ■ VOLUME FLOW IN % ■ MASS FLOW IN % ■ VOLUME FLOW BARGRAPH IN % ■ MASS FLOW BARGRAPH IN % <p>Use this function to define the flow value to be shown on the display as the 100% value.</p> <p>User input: 5-digit floating-point number</p> <p>Factory setting: Depends on nominal diameter and country (→ Page 167 ff.).</p>
FORMAT (2402)	<p> Note! This function is not available unless a number was selected in the ASSIGN function (2400).</p> <p>Use this function to define the maximum number of places after the decimal point displayed for the reading in the additional line.</p> <p>Options: XXXXX. – XXXX.X – XXX.XX – XX.XXX – X.XXXX</p> <p>Factory setting: X.XXXX</p> <p> Note!</p> <ul style="list-style-type: none"> ■ Note that this setting only affects the reading as it appears on the display, it has no influence on the accuracy of the system's calculations. ■ The places after the decimal point as computed by the measuring device cannot always be displayed, depending on this setting and the engineering unit. In such instances an arrow appears on the display between the measuring value and the engineering unit (e.g. 1.2 → kg/h), indicating that the measuring system is computing with more decimal places than can be shown on the display.

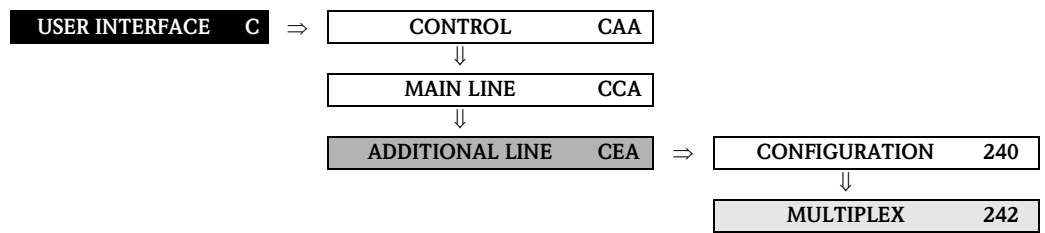

Function description	
USER INTERFACE → ADDITIONAL LINE → CONFIGURATION	
DISPLAY MODE (2403)	<p> Note! This function is only available if VOLUME FLOW BARGRAPH IN % or MASS FLOW BARGRAPH IN % was selected in the function ASSIGN (2400).</p> <p>Use this function to define the format of the bar graph.</p> <p>Options: STANDARD (Simple bar graph with 25 / 50 / 75% gradations and integrated sign).</p> <div style="text-align: center;">  </div> <p style="text-align: right;"><small>A0001258</small></p> <p>SYMMETRY (Symmetrical bar graph for positive and negative directions of flow, with -50 / 0 / +50% gradations and integrated sign).</p> <div style="text-align: center;">  </div> <p style="text-align: right;"><small>A0001259</small></p> <p>Factory setting: STANDARD</p>

5.3.2 Function group MULTIPLEX



Function description	
USER INTERFACE → ADDITIONAL LINE → MULTIPLEX	
ASSIGN (2420)	<p>Use this function to define the second reading to be displayed in the additional line alternately (every 10 seconds) with the value defined in the function ASSIGN (2400).</p> <p>Options: OFF VOLUME FLOW MASS FLOW VOLUME FLOW IN % MASS FLOW IN % VOLUME FLOW BARGRAPH IN % MASS FLOW BARGRAPH IN % FLOW VELOCITY TOTALIZER (1 to 3) TAG NAME CONDUCTIVITY * AI (1...5) - OUT VALUE AO - DISPLAY VALUE PID - IN VALUE (controlled variable) PID - CAS IN VALUE (external set point) PID - OUT VALUE (manipulated variable) DEVICE PD-TAG</p> <p>* only when conductivity is switched on → Page 62</p> <p>Factory setting: OFF</p> <p>Advanced options with optional software package ADVANCED DIAGNOSTICS: DEVIATION COATING E1 (only when coating detection is switched on → Page 68) DEVIATION COATING E2 (only when coating detection is switched on → Page 68) DEVIATION ELECTRODE POTENTIAL 1 DEVIATION ELECTRODE POTENTIAL 2 DEVIATION VOLUME FLOW DEVIATION NOISE VALUE</p> <p>Advanced options with optional software package SOLID CONTENT FLOW: TARGET MASS FLOW % TARGET MASS FLOW TARGET MASS FLOW BARGRAPH % TARGET VOLUME FLOW % TARGET VOLUME FLOW TARGET VOLUME FLOW BARGRAPH % CARRIER MASS FLOW % CARRIER MASS FLOW CARRIER VOLUME FLOW % CARRIER VOLUME FLOW</p> <p>(continued on next page)</p>

Function description	
USER INTERFACE → ADDITIONAL LINE → MULTIPLEX	
ASSIGN (continued)	<p> Note!</p> <p>Multiplex mode is suspended as soon as a fault / notice message is generated. The message in question appears on the display.</p> <ul style="list-style-type: none"> ■ Fault message (identified by a lightning icon): <ul style="list-style-type: none"> – If ON was selected in the function ACKNOWLEDGE FAULTS (8004), multiplex mode is continued as soon as the fault has been acknowledged and is no longer active. – If OFF was selected in the function ACKNOWLEDGE FAULTS (8004), multiplex mode is continued as soon as the fault is no longer active. ■ Notice message (identified by an exclamation mark): <ul style="list-style-type: none"> – Multiplex mode is continued as soon as the notice message is no longer active.
100%-VALUE (2421)	<p> Note!</p> <p>This function is not available unless one of the following was selected in the function ASSIGN (2420):</p> <ul style="list-style-type: none"> ■ VOLUME FLOW IN % ■ MASS FLOW IN % ■ VOLUME FLOW BARGRAPH IN % ■ MASS FLOW BARGRAPH IN % <p>Use this function to define the flow value to be shown on the display as the 100% value.</p> <p>User input: 5-digit floating-point number</p> <p>Factory setting: Depends on nominal diameter and country (→ Page 167 ff.).</p>
FORMAT (2422)	<p> Note!</p> <p>This function is not available unless a number was selected in the ASSIGN function (2420).</p> <p>Use this function to define the maximum number of places after the decimal point for the second value displayed in the additional line.</p> <p>Options: XXXXX. – XXXX.X – XXX.XX – XX.XXX – X.XXXX</p> <p>Factory setting: X.XXXX</p> <p> Note!</p> <ul style="list-style-type: none"> ■ Note that this setting only affects the reading as it appears on the display, it has no influence on the accuracy of the system's calculations. ■ The places after the decimal point as computed by the measuring device cannot always be displayed, depending on this setting and the engineering unit. In such instances an arrow appears on the display between the measuring value and the engineering unit (e.g. 1.2 → kg/h), indicating that the measuring system is computing with more decimal places than can be shown on the display.



Function description	
USER INTERFACE → ADDITIONAL LINE → MULTIPLEX	
DISPLAY MODE (2423)	<p> Note! This function is only available if VOLUME FLOW BARGRAPH IN % or MASS FLOW BARGRAPH IN % was selected in the function ASSIGN (2420).</p> <p>Use this function to define the format of the bar graph.</p> <p>Options: STANDARD (Simple bar graph with 25 / 50 / 75% gradations and integrated sign).</p> <div style="text-align: center;">  </div> <p>SYMMETRY (Symmetrical bar graph for positive and negative directions of flow, with -50 / 0 / +50% gradations and integrated sign). A0001258</p> <div style="text-align: center;">  </div> <p>Factory setting: STANDARD A0001259</p>

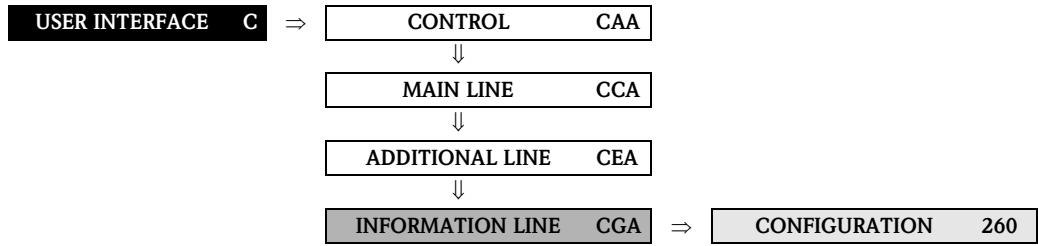

5.4 Group INFORMATION LINE

5.4.1 Function group CONFIGURATION



Function description	
USER INTERFACE → INFORMATION LINE → CONFIGURATION	
<p>1 = main line, 2 = additional line, 3 = information line</p>	
<p>ASSIGN (2600)</p>	<p>In this function, a value to be displayed is assigned to the information line (bottom line in the local display). This value is displayed during normal operation.</p> <p>Options: OFF VOLUME FLOW IN % MASS FLOW IN % VOLUME FLOW BARGRAPH IN % MASS FLOW BARGRAPH IN % FLOW VELOCITY TOTALIZER (1 to 3) TAG NAME OPERATING/SYSTEM CONDITIONS DISPLAY FLOW DIRECTION CONDUCTIVITY * AI (1...5) - OUT VALUE AO - DISPLAY VALUE PID - IN VALUE (controlled variable) PID - CAS IN VALUE (external set point) PID - OUT VALUE (manipulated variable) DEVICE PD-TAG</p> <p>* only when conductivity is switched on → Page 62</p> <p>Factory setting: OPERATING/SYSTEM CONDITIONS</p> <p>Advanced options with optional software package ADVANCED DIAGNOSTICS: DEVIATION COATING E1 (only when coating detection is switched on → Page 68) DEVIATION COATING E2 (only when coating detection is switched on → Page 68) DEVIATION ELECTRODE POTENTIAL 1 DEVIATION ELECTRODE POTENTIAL 2 DEVIATION VOLUME FLOW DEVIATION NOISE VALUE</p> <p>(continued on next page)</p>





Function description USER INTERFACE → INFORMATION LINE → CONFIGURATION	
ASSIGN (continued)	<p>Advanced options with optional software package SOLID CONTENT FLOW:</p> TARGET MASS FLOW % TARGET MASS FLOW TARGET MASS FLOW BARGRAPH % TARGET VOLUME FLOW % TARGET VOLUME FLOW TARGET VOLUME FLOW BARGRAPH % CARRIER MASS FLOW % CARRIER MASS FLOW CARRIER VOLUME FLOW % CARRIER VOLUME FLOW
100%-VALUE (2601)	<p> Note! This function is not available unless one of the following was selected in the function ASSIGN (2600):</p> <ul style="list-style-type: none"> ■ VOLUME FLOW IN % ■ MASS FLOW IN % ■ VOLUME FLOW BARGRAPH IN % ■ MASS FLOW BARGRAPH IN % <p>Use this function to define the flow value to be shown on the display as the 100% value.</p> <p>User input: 5-digit floating-point number</p> <p>Factory setting: Depends on nominal diameter and country (→ Page 167 ff.).</p>
FORMAT (2602)	<p> Note! This function is not available unless a number was selected in the ASSIGN function (2600).</p> <p>Use this function to define the maximum number of places after the decimal point displayed for the reading in the information line.</p> <p>Options: XXXXX. – XXXX.X – XXX.XX – XX.XXX – X.XXXX</p> <p>Factory setting: X.XXXX</p> <p> Note!</p> <ul style="list-style-type: none"> ■ Note that this setting only affects the reading as it appears on the display, it has no influence on the accuracy of the system's calculations. ■ The places after the decimal point as computed by the measuring device cannot always be displayed, depending on this setting and the engineering unit. In such instances an arrow appears on the display between the measuring value and the engineering unit (e.g. 1.2 → kg/h), indicating that the measuring system is computing with more decimal places than can be shown on the display.

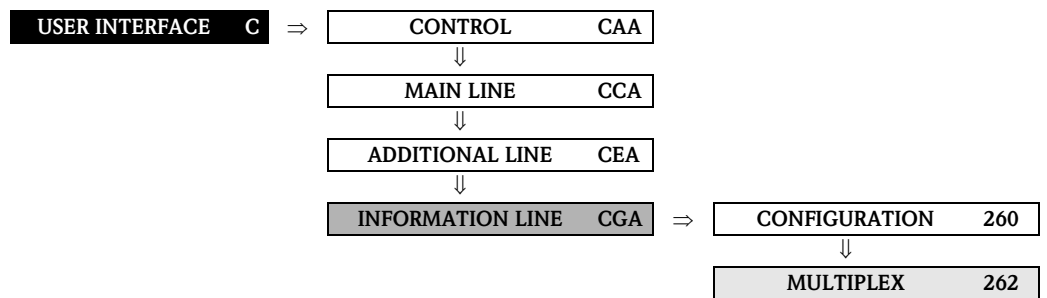

Function description	
USER INTERFACE → INFORMATION LINE → CONFIGURATION	
DISPLAY MODE (2603)	<p> Note! This function is only available if VOLUME FLOW BARGRAPH IN % or MASS FLOW BARGRAPH IN % was selected in the function ASSIGN (2600).</p> <p>Use this function to define the format of the bar graph.</p> <p>Options: STANDARD (Simple bar graph with 25 / 50 / 75% gradations and integrated sign).</p> <div style="text-align: center;">  </div> <p style="text-align: right;"><small>A0001258</small></p> <p>SYMMETRY (Symmetrical bar graph for positive and negative directions of flow, with -50 / 0 / +50% gradations and integrated sign).</p> <div style="text-align: center;">  </div> <p style="text-align: right;"><small>A0001259</small></p> <p>Factory setting: STANDARD</p>

5.4.2 Function group MULTIPLEX



Function description	
USER INTERFACE → INFORMATION LINE → MULTIPLEX	
ASSIGN (2620)	<p>Use this function to define the second reading to be displayed in the information line alternately (every 10 seconds) with the value defined in the function ASSIGN (2600).</p> <p>Options: OFF VOLUME FLOW IN % MASS FLOW IN % VOLUME FLOW BARGRAPH IN % MASS FLOW BARGRAPH IN % FLOW VELOCITY TOTALIZER (1 to 3) TAG NAME OPERATING/SYSTEM CONDITIONS DISPLAY FLOW DIRECTION CONDUCTIVITY * AI (1..5) - OUT VALUE AO - DISPLAY VALUE PID - IN VALUE (controlled variable) PID - CAS IN VALUE (external set point) PID - OUT VALUE (manipulated variable) DEVICE PD-TAG</p> <p>* only when conductivity is switched on → Page 62</p> <p>Factory setting: OFF</p> <p>Advanced options with optional software package ADVANCED DIAGNOSTICS: DEVIATION COATING E1 (only when coating detection is switched on → Page 68) DEVIATION COATING E2 (only when coating detection is switched on → Page 68) DEVIATION ELECTRODE POTENTIAL 1 DEVIATION ELECTRODE POTENTIAL 2 DEVIATION VOLUME FLOW DEVIATION NOISE VALUE</p> <p>Advanced options with optional software package SOLID CONTENT FLOW: TARGET MASS FLOW % TARGET MASS FLOW TARGET MASS FLOW BARGRAPH % TARGET VOLUME FLOW % TARGET VOLUME FLOW TARGET VOLUME FLOW BARGRAPH % CARRIER MASS FLOW % CARRIER MASS FLOW CARRIER VOLUME FLOW % CARRIER VOLUME FLOW</p> <p>(continued on next page)</p>

Function description	
USER INTERFACE → INFORMATION LINE → MULTIPLEX	
ASSIGN (continued)	<p> Note!</p> <p>Multiplex mode is suspended as soon as a fault / notice message is generated. The message in question appears on the display.</p> <ul style="list-style-type: none"> ■ Fault message (identified by a lightning icon): <ul style="list-style-type: none"> – If ON was selected in the function ACKNOWLEDGE FAULTS (8004), multiplex mode is continued as soon as the fault has been acknowledged and is no longer active. – If OFF was selected in the function ACKNOWLEDGE FAULTS (8004), multiplex mode is continued as soon as the fault is no longer active. ■ Notice message (identified by an exclamation mark): <ul style="list-style-type: none"> – Multiplex mode is continued as soon as the notice message is no longer active.
100%-VALUE (2621)	<p> Note!</p> <p>This function is not available unless one of the following was selected in the function ASSIGN (2620):</p> <ul style="list-style-type: none"> ■ VOLUME FLOW IN % ■ MASS FLOW IN % ■ VOLUME FLOW BARGRAPH IN % ■ MASS FLOW BARGRAPH IN % <p>Use this function to define the flow value to be shown on the display as the 100% value.</p> <p>User input: 5-digit floating-point number</p> <p>Factory setting: Depends on nominal diameter and country (→ Page 167 ff.).</p>
FORMAT (2622)	<p> Note!</p> <p>This function is not available unless a number was selected in the ASSIGN function (2600).</p> <p>Use this function to define the maximum number of places after the decimal point for the second value displayed in the information line.</p> <p>Options: XXXXX. – XXXX.X – XXX.XX – XX.XXX – X.XXXX</p> <p>Factory setting: X.XXXX</p> <p> Note!</p> <ul style="list-style-type: none"> ■ Note that this setting only affects the reading as it appears on the display, it has no influence on the accuracy of the system's calculations. ■ The places after the decimal point as computed by the measuring device cannot always be displayed, depending on this setting and the engineering unit. In such instances an arrow appears on the display between the measuring value and the engineering unit (e.g. 1.2 → kg/h), indicating that the measuring system is computing with more decimal places than can be shown on the display.

Function description	
USER INTERFACE → INFORMATION LINE → MULTIPLEX	
DISPLAY MODE (2623)	<p> Note! This function is only available if VOLUME FLOW BARGRAPH IN % or MASS FLOW BARGRAPH IN % was selected in the function ASSIGN (2620).</p> <p>Use this function to define the format of the bar graph.</p> <p>Options: STANDARD (Simple bar graph with 25 / 50 / 75% gradations and integrated sign).</p> <div style="text-align: center;">  </div> <p style="text-align: right;"><small>A0001258</small></p> <p>SYMMETRY (Symmetrical bar graph for positive and negative directions of flow, with -50 / 0 / +50% gradations and integrated sign).</p> <div style="text-align: center;">  </div> <p style="text-align: right;"><small>A0001258</small></p> <p>Factory setting: STANDARD</p>

6 Block TOTALIZER

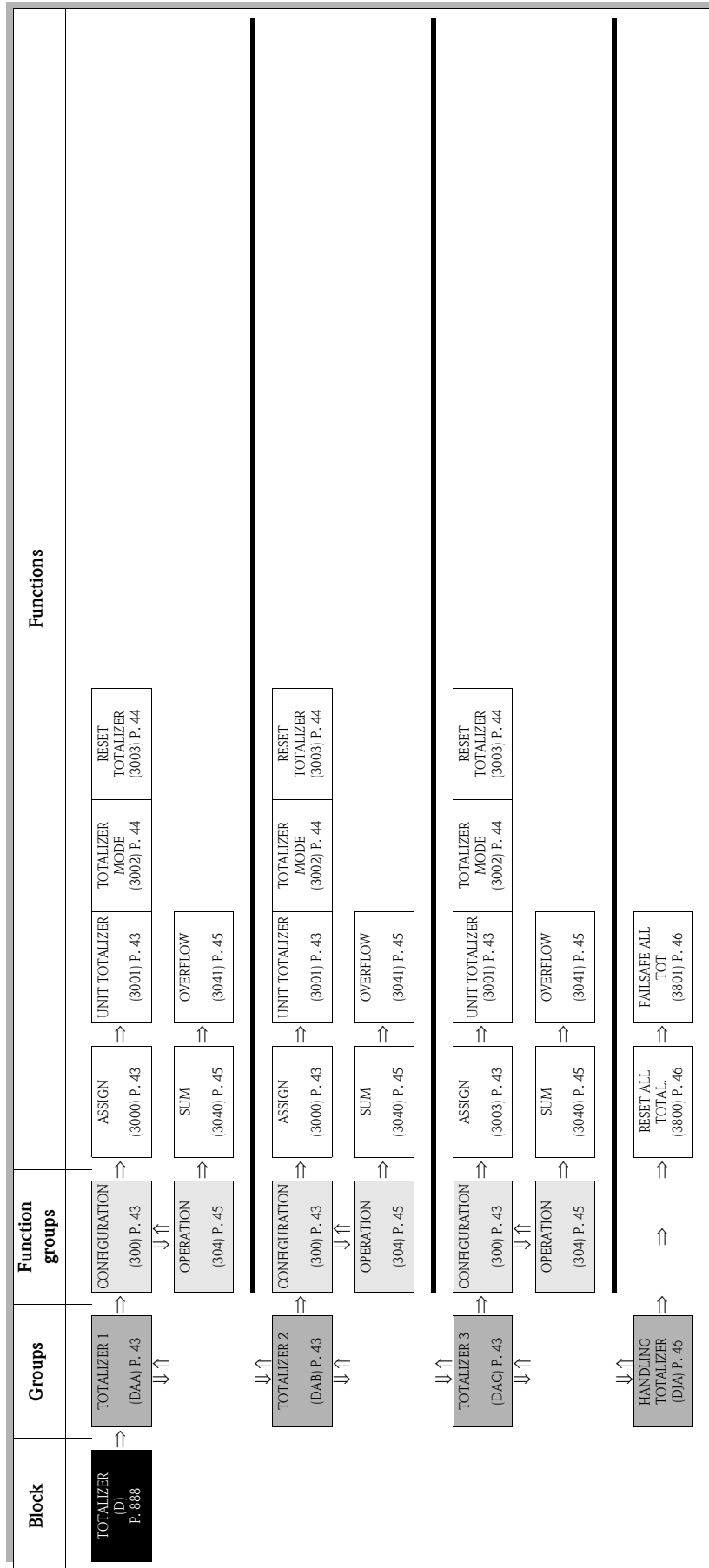

6.1 Group TOTALIZER (1 to 3)

6.1.1 Function group CONFIGURATION

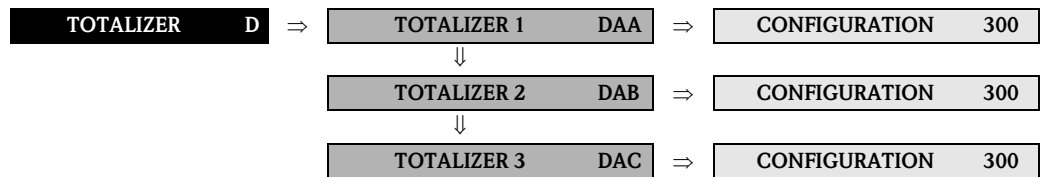

Function description	
TOTALIZER → TOTALIZER (1 to 3) → CONFIGURATION	
The function descriptions below apply to totalizers 1 to 3; the totalizers are independently configurable.	
ASSIGN (3000)	<p>Use this function to assign a measured variable to the totalizer in question.</p> <p>Options: OFF MASS FLOW VOLUME FLOW</p> <p>Factory setting: VOLUME FLOW</p> <p> Note!</p> <ul style="list-style-type: none"> ■ The totalizer is reset to "0" as soon as the selection is changed. ■ If you select OFF, the function group CONFIGURATION (300) of the totalizer in question only displays the ASSIGN (3000) function.
UNIT TOTALIZER (3001)	<p>Use this function to define the unit for the totalizer's measured variable, as selected beforehand.</p> <p>Options: (for MASS FLOW assignment): Metric → g; kg; t</p> <p>US → oz; lb; ton</p> <p>Factory setting: Depends on nominal diameter and country → Page 167 ff.</p> <p>Options (for VOLUME FLOW assignment): Metric → cm³; dm³; m³; ml; l; hl; Ml Mega</p> <p>US → cc; af; ft³; oz f; gal; Kgal; Mgal; bbl (normal fluids); bbl (beer); bbl (petrochemicals); bbl (filling tanks)</p> <p>Imperial → gal; Mgal; bbl (beer); bbl (petrochemicals)</p> <p>Factory setting: Depends on nominal diameter and country → Page 167 ff.</p>

Function description	
TOTALIZER → TOTALIZER (1 to 3) → CONFIGURATION	
TOTALIZER MODE (3002)	<p>Use this function to define how the flow components are to be totalized.</p> <p>Options: BALANCE Positive and negative flow components. The positive and negative flow components are balanced. In other words, net flow in the flow direction is registered.</p> <p>FORWARD Positive flow components only</p> <p>REVERSE Negative flow components only</p> <p>Factory setting: Totalizer 1 = BALANCE Totalizer 2 = FORWARD Totalizer 3 = REVERSE</p>
RESET TOTALIZER (3003)	<p>Use this function to reset the sum and the overflow of the totalizer to zero.</p> <p>Options: NO YES</p> <p>Factory setting: NO</p>

6.1.2 Function group OPERATION

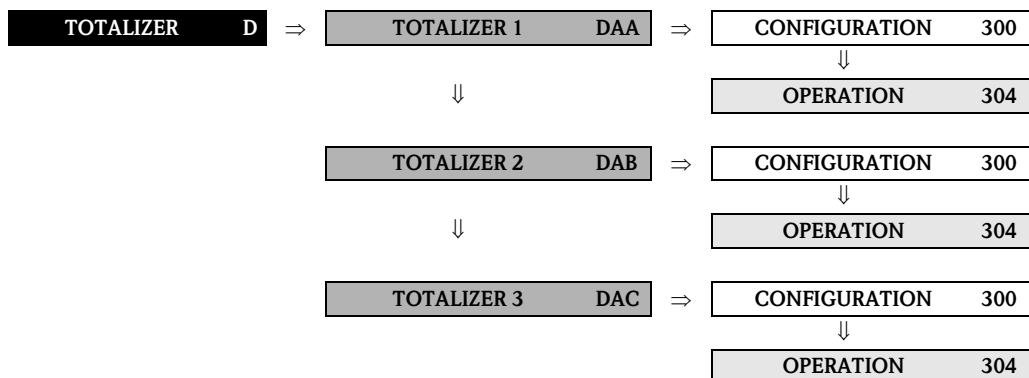

Function description	
TOTALIZER → TOTALIZER (1 to 3) → OPERATION	
The function descriptions below apply to totalizers 1 to 3; the totalizers are independently configurable.	
SUM (3040)	<p>Use this function to view the total for the totalizer's measured variable aggregated since measuring commenced. The value can be positive or negative, depending on the setting selected in the TOTALIZER MODE function (3002), and the direction of flow.</p> <p>User interface: Max. 7-digit floating-point number, including sign and unit (e.g. 15 467.04 m³; -4925.631 kg)</p> <p> Note!</p> <ul style="list-style-type: none"> ■ The effect of the setting in the TOTALIZER MODE function (→ Page 44) is as follows: <ul style="list-style-type: none"> – If the setting is "BALANCE", the totalizer balances flow in the positive and negative directions. – If the setting is "FORWARD", the totalizer registers only flow in the positive direction. – If the setting is "REVERSE", the totalizer registers only flow in the negative direction. ■ The totalizer's response to faults is defined in the FAILSAFE ALL TOT function (3801), (→ Page 46).
OVERFLOW (3041)	<p>Use this function to view the overflow for the totalizer aggregated since measuring commenced.</p> <p>Total flow quantity is represented by a floating-point number consisting of max. 7 digits. You can use this function to view higher numerical values (>9999999) as overflows. The effective quantity is thus the total of OVERFLOW plus the value returned by the SUM function.</p> <p>Example: Reading for 2 overflows: 2 · 10⁷ dm³ (= 20000000 dm³) The value displayed in the function SUM = 196845.7 dm³ Effective total quantity = 20 196 845.7 dm³</p> <p>User interface: Integer with exponent, including sign and unit, e.g. 2 · 10⁷ dm³</p>

6.2 Group HANDLING TOTALIZER

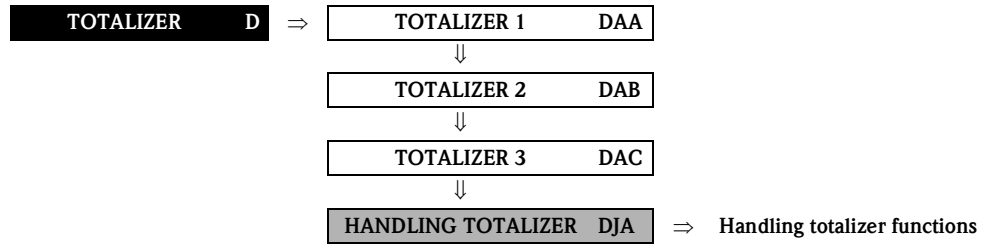

Function description	
TOTALIZER → HANDLING TOTALIZER → Handling totalizer functions	
RESET ALL TOTALIZERS (3800)	<p>Use this function to reset the totals (including all overflows) of the totalizers (1 to 3) to zero (= RESET).</p> <p>Options: NO YES</p> <p>Factory setting: NO</p>
FAILSAFE ALL TOT (3801)	<p>Use this function to define the common response of all totalizers (1 to 3) in case of error.</p> <p>Options: STOP The totalizer is paused until the fault is rectified.</p> <p>ACTUAL VALUE The totalizers continue to count based on the actual flow measured value. The fault is ignored.</p> <p>HOLD VALUE The totalizers continue to count the flow based on the last valid flow value (before the fault occurred).</p> <p>Factory setting: STOP</p>

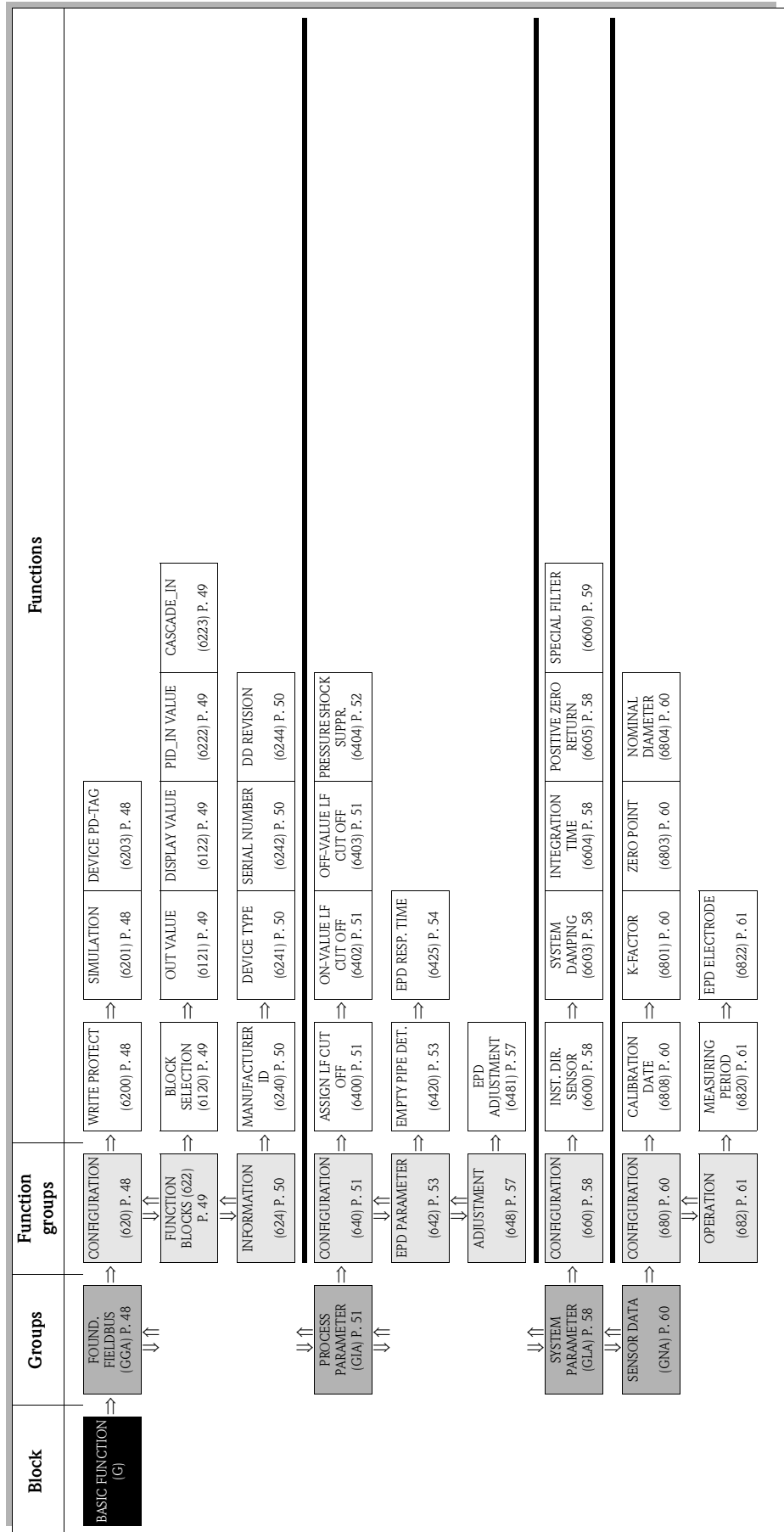

7 Block BASIC FUNCTION



7.1 Group FOUNDATION FIELDBUS

7.1.1 Function group CONFIGURATION

BASIC FUNCTION	G	⇒	FOUNDATION FIELDBUS	GGA	⇒	CONFIGURATION	620
----------------	---	---	---------------------	-----	---	---------------	-----

Function description	
BASIC FUNCTION → FOUNDATION FIELDBUS → CONFIGURATION	
<p>WRITE PROTECT (6200)</p>	<p>Use this function to check whether the measuring device can be write-accessed via the fieldbus.</p> <p>User interface: OFF → Write access via FOUNDATION Fieldbus possible ON → Write access via FOUNDATION Fieldbus not possible</p> <p>Factory setting: OFF</p> <p> Note! Hardware write protection is activated and deactivated by means of a jumper on the I/O board (→ see Operating Instructions for Proline Promag 55 FOUNDATION Fieldbus).</p>
<p>SIMULATION (6201)</p>	<p>Use this function to check whether a simulation in the Analog Input or Discrete Output function block is possible.</p> <p>User interface: OFF → Simulation in the Analog Input and Discrete Output function block is not possible. ON → Simulation in the Analog Input and Discrete Output function block is possible</p> <p>Factory setting: ON</p> <p> Note! ■ The simulation mode is enabled and disabled by means of a jumper on the I/O board (→ see also Operating Instructions for Proline Promag 55 FOUNDATION Fieldbus). ■ The status of the simulation mode is also shown in the parameter BLOCK_ERR of the Resource Block.</p>
<p>DEVICE PD-TAG (6203)</p>	<p>Use this function to enter a tag name for the measuring device.</p> <p>User input: Max. 32-character text, permissible: A-Z, 0-9, +,-, punctuation marks</p> <p>Factory setting: E+H_PROMAG_55_XXXXXXXXXX</p>

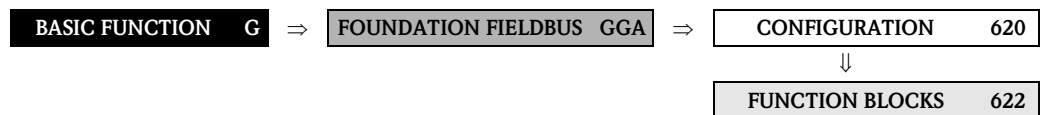

7.1.2 Function group FUNCTION BLOCKS

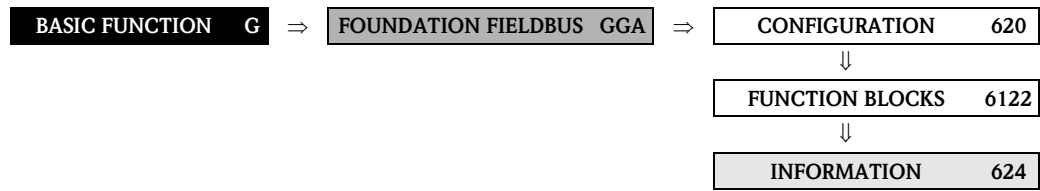

Function description	
BASIC FUNCTION → FOUNDATION FIELDBUS → FUNCTION BLOCKS	
BLOCK SELECTION (6120)	<p>Use this function to select a function block whose value and status is shown in the subsequent functions.</p> <p>Options: ANALOG INPUT 1 to 5 ANALOG OUTPUT 1 PID BLOCK</p> <p>Factory setting: ANALOG INPUT 1</p>
OUT VALUE (6121)	<p>Use this function to display the output value OUT, incl. unit and status, of the function block selected in the BLOCK SELECTION function (6120).</p>
DISPLAY VALUE (6122)	<p> Note! This function is not available unless the ANALOG OUTPUT 1 option was selected in the BLOCK SELECTION function (6120).</p> <p>User interface: The measured variable (DISPLAY_VALUE module) transmitted from the FOUNDATION Fieldbus master to the measuring device, including the unit and status, is displayed. This is the measured variable to be shown on the local display.</p>
PID_IN VALUE (6222)	<p> Note! This function is not available unless the PID BLOCK option was selected in the BLOCK SELECTION (6120) function.</p> <p>User interface: Use this function to display the controlled variable IN, incl. unit and status, of the PID function block.</p>
CASCADE_IN (6223)	<p> Note! This function is not available unless the PID option was selected in the BLOCK SELECTION (6120) function.</p> <p>User interface: Display of an analog set value, incl. units and status, taken over from an external function block.</p>

7.1.3 Function group INFORMATION



Function description	
BASIC FUNCTION → FOUNDATION FIELDBUS → INFORMATION	
MANUFACTURER ID (6240)	Use this function to view the manufacturer ID in decimal numerical format. User interface: 452B48 (hex) for Endress+Hauser
DEVICE TYPE (6241)	Use this function to view the device ID in hexadecimal numerical format. User interface: 1042 (hex) for Promag 55 FOUNDATION Fieldbus
SERIAL NUMBER (6242)	Use this function to view the serial number. User interface: 11-digit number
DEVICE REVISION (6243)	Use this function to view the device revision number.  Note! The information displayed here can be used to ensure that the correct system files (DD = Device Description) are used for integration into the host system. The system files can be downloaded free of charge from the Internet at www.endress.com . Example: Information displayed in the DEVICE REVISION function (6243) → 04 Information displayed in the DD REVISION function (6244) → 01 Required device description files (DD) → 0401.sym / 0401.ffo
DD REVISION (6244)	Use this function to view the revision number of the device description.  Note! The information displayed here can be used to ensure that the correct system files (DD = Device Description) are used for integration into the host system. The system files can be downloaded free of charge from the Internet at www.endress.com . Example: Information displayed in the DEVICE REVISION function (6243) → 04 Information displayed in the DD REVISION function (6244) → 01 Required device description files (DD) → 0401.sym / 0401.ffo

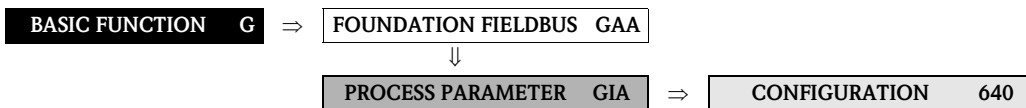

7.2 Group PROCESS PARAMETER

7.2.1 Function group CONFIGURATION

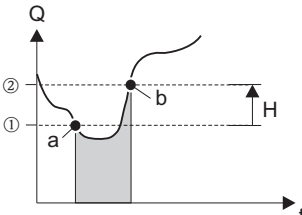

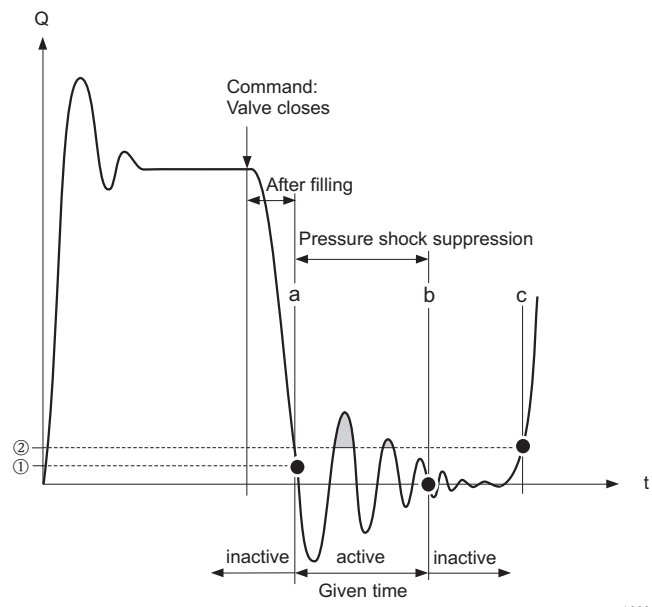

Function description	
BASIC FUNCTION → PROCESS PARAMETER → CONFIGURATION	
ASSIGN LOW FLOW CUT OFF (6400)	Use this function to assign the switch point for the low flow cut off. Options: OFF MASS FLOW VOLUME FLOW Factory setting: VOLUME FLOW
ON-VALUE LOW FLOW CUT OFF (6402)	Use this function to enter the switch-on point for low flow cut off. Low flow cut off is active if the value entered is not equal to 0. The sign of the flow value is highlighted on the display to indicate that low flow cut off is active. User input: 5-digit floating-point number [unit] Factory setting: Depends on nominal diameter and country → Page 167 ff.  Note! The appropriate unit is taken from the function UNIT VOLUME FLOW (0402) or UNIT MASS FLOW (0400) (→ Page 14 or Page 13).
OFF-VALUE LOW FLOW CUT OFF (6403)	Use this function to enter the switch-off (b) point for low flow cut off. Enter the switch-off point as a positive hysteresis (H) from the switch-on point (a). User input: Integer 0 to 100% Factory setting: 50% <div style="text-align: center;">  </div> <p>① = switch-on point , ② = switch-off point</p> <p>a Low flow cut off is switched on</p> <p>b Low flow cut off is switched off (a + a · H)</p> <p>H Hysteresis value: 0 to 100%</p> <p>■ Low flow cut off active</p> <p>Q Flow</p>

A0003882

Function description	
BASIC FUNCTION → PROCESS PARAMETER → CONFIGURATION	
<p>PRESSURE SHOCK SUPPRESSION (6404)</p>	<p>The closure of a valve can cause brief but severe movements of the fluid in the piping system, movements which the measuring system registers. The pulses totaled in this way result in a totalizer reading error, particularly in the case of batching processes. For this reason, the measuring device is equipped with pressure shock suppression (= short-term signal suppression) which can eliminate system-related "disruptions".</p> <p> Note! Note that pressure shock suppression cannot be used unless the low flow cut off is active (see ON-VALUE LOW FLOW CUT OFF function on Page 51).</p> <p>Use this function to define the time span for active pressure shock suppression.</p> <p>Activation of pressure shock suppression Pressure shock suppression is activated once the flow falls below the switch-on point of the low flow cut off (see point a in graphic).</p> <p>While pressure shock suppression is active, the following conditions apply:</p> <ul style="list-style-type: none"> ■ Flow reading on display → 0 ■ Totalizer reading → The totalizers are pegged at the last correct value. <p>Deactivation of pressure shock suppression The pressure shock suppression is deactivated after the time interval, set in this function, has passed (see point b).</p> <p> Note! The actual flow value is displayed and output, when the time interval for the pressure shock suppression has passed and the flow exceeds the switch-off point of the low flow cut off (see point c in graphic).</p> <div style="text-align: center;">  </div> <p style="text-align: right; font-size: small;">A0001285-EN</p> <p><i>m = on value (low flow cut off), n = off value (low flow cut off)</i> <i>a Activated when the on-value for low flow cut off is undershot</i> <i>b Deactivated once the time specified expires</i> <i>c Flow values are taken into account again for calculating the pulses</i> <i>n Suppressed values</i> <i>Q Flow</i></p> <p>User input: Max. 4-digit number, incl. unit: 0.00 to 100.0 s</p> <p>Factory setting: 0.00 s</p>

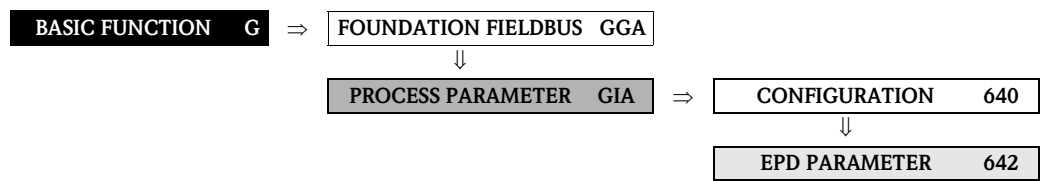
7.2.2 Function group EPD PARAMETER





Function description	
BASIC FUNCTION → PROCESS PARAMETER → EPD PARAMETER	
<p>EMPTY PIPE DET. (6420)</p>	<p>Flow cannot be measured correctly unless the measuring tube is completely full. This status can be monitored at all times with the Empty Pipe Detection function. To do this, the empty pipe detection (EPD, empty pipe detection by means of EPD electrode) can be activated in this function:</p> <p>Options: OFF ON STANDARD</p> <p>Factory setting: OFF</p> <p> Note!</p> <ul style="list-style-type: none"> ■ The option ON STANDARD is not available unless the sensor is equipped with an EPD electrode. ■ The default setting for the EPD function when the device is delivered is OFF. The function must be activated as required. ■ The devices are already calibrated at the factory with water (approx. 500 µS/cm). If the conductivity of certain fluids deviates from this reference, empty pipe/full pipe adjustment must be performed again on site (see function EPD ADJUSTMENT (6481) on Page 57). ■ The adjustment coefficients must be valid before you can switch on the EPD function. If these coefficients are not available, the function EPD ADJUSTMENT (s. Page 57) is displayed. ■ If there are problems with the adjustment, the following error messages appear on the screen: <ul style="list-style-type: none"> – ADJUSTMENT FULL = EMPTY: The adjustment values for empty pipe and full pipe are identical. In such instances, empty pipe adjustment/full pipe adjustment must be carried out again. – ADJUSTMENT NOT OK: Adjustment is not possible as the fluid conductivity values are outside the permitted range. <p>Notes on empty pipe detection (EPD)</p> <ul style="list-style-type: none"> ■ Flow cannot be measured correctly unless the measuring tube is completely full. This status can be monitored at all times with the EPD function. ■ An empty or partially filled pipe is a process error. A default factory setting defines that a fault message is issued and that this process error has an effect on the outputs. ■ A plausibility check of the adjustment values will only be executed by activating the empty pipe detection. If an empty or full pipe adjustment is performed when empty pipe detection is active, the empty pipe detection has to be deactivated and activated again after finishing the adjustment in order to start the plausibility check. <p>Response to partially filled pipes</p> <p>If the EPD is switched on and responds to a partially filled or empty pipe, the notice message "EMPTY PIPE" appears on the display. If the pipe is partially empty and the EPD is not switched on, the response can vary in identically configured systems:</p> <ul style="list-style-type: none"> ■ Flow reading fluctuates ■ Zero flow ■ Excessively high flow values

Function description	
BASIC FUNCTION → PROCESS PARAMETER → EPD PARAMETER	
EPD RESPONSE TIME (6425)	<p> Note! The function is only available if the function EMPTY PIPE DET. (6420) has been switched on.</p> <p>Use this function to enter the time span for which the criteria for an "empty" pipe have to be satisfied without interruption before a notice message or fault message is generated.</p> <p>User input: fixed point number: 1.0 to 100 s</p> <p>Factory setting: 1.0 s</p>

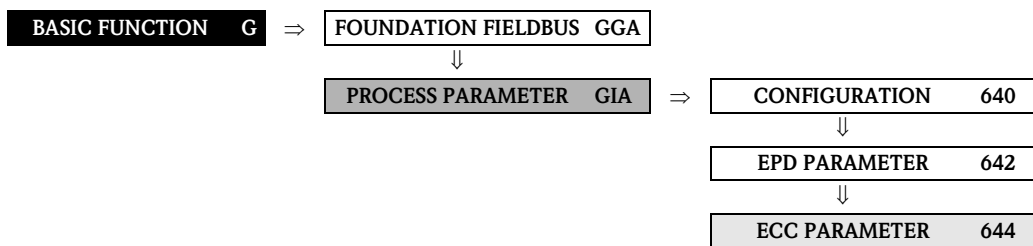
7.2.3 Function group ECC PARAMETER





Function description	
BASIC FUNCTION → PROCESS PARAMETER → ECC PARAMETER	
ECC (6440)	<p> Note! This function is not available unless the measuring device is equipped with an (optional) electrode cleaning function.</p> <p>Use this function to activate cyclical electrode cleaning (ECC).</p> <p>Options: ON (only with the optional electrode cleaning function ECC) OFF</p> <p>Factory setting: ON (only if the optional electrode cleaning function ECC is available)</p> <p>Notes on electrode cleaning (ECC) Conductive deposits on the electrodes and on the walls of the measuring tube (e.g. magnetite) can falsify measurement values. The Electrode Cleaning Circuitry (ECC) was developed to prevent such conductive deposits accreting in the vicinity of the electrodes. ECC functions as described above for all available electrode materials except tantalum. If tantalum is used as the electrode material, the ECC protects the electrode surface only against oxidation.</p> <p> Caution! If the ECC is switched off for a prolonged period in applications with conductive deposits, a layer forms inside the measuring tube and this can falsify measurement values. If the layer is allowed to accrete beyond a certain level, it might no longer be possible to remove it by switching on the ECC. If this happens the measuring tube must be cleaned and the layer removed.</p>
ECC DURATION (6441)	<p> Note! This function is not available unless the measuring device is equipped with the optional electrode cleaning function (ECC).</p> <p>Use this function to specify the electrode cleaning duration.</p> <p>User input: Fixed-point number: 0.01 to 30.0 s</p> <p>Factory setting: 2.0 s</p>

Function description	
BASIC FUNCTION → PROCESS PARAMETER → ECC PARAMETER	
ECC RECOVERY TIME (6442)	<p> Note! This function is not available unless the measuring device is equipped with the optional electrode cleaning function (ECC).</p> <p>Use this function to specify the recovery time for which the last flow value measured prior to cleaning is retained. A recovery time is necessary as the signal outputs can fluctuate after electrode cleaning on account of electrochemical interference voltages.</p> <p>User input: max. 3-digit number: 1 to 600 s</p> <p>Factory setting: 60 s</p> <p> Caution! The last value measured prior to cleaning is output for the duration of the recovery time (max. 600 s). This in turn means that the measuring system does not register changes in flow, e.g. stoppage, during this time span.</p>
ECC CLEANING CYCLE (6443)	<p> Note! This function is not available unless the measuring device is equipped with the optional electrode cleaning function (ECC).</p> <p>Use this function to specify the cleaning cycle for electrode cleaning.</p> <p>User input: Integer: 30 to 10080 min</p> <p>Factory setting: 40 min</p>

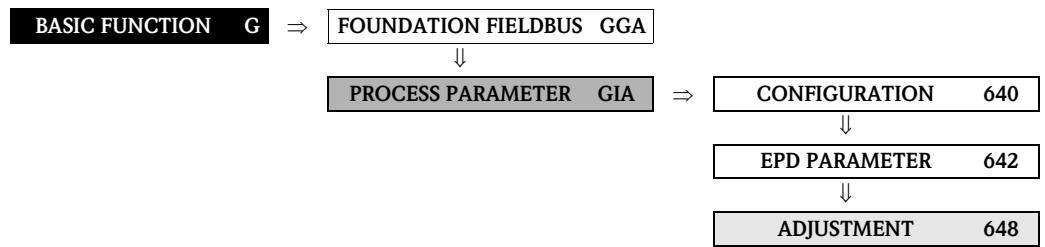
7.2.4 Function group ADJUSTMENT



Function description	
BASIC FUNCTION → PROCESS PARAMETER → ADJUSTMENT	
<p>EPD ADJUSTMENT (6481)</p>	<p>Use this function to activate the EPD adjustment for an empty or full measuring tube.</p> <p> Note! A detailed description of the empty pipe detection function can be found on Page 53.</p> <p>Options: OFF FULL PIPE ADJUST EMPTY PIPE ADJUST</p> <p>Factory setting: OFF</p> <p>Procedure for EPD empty pipe / full pipe adjustment</p> <ol style="list-style-type: none"> 1. Empty the piping. In case of an EPD adjustment, the wall of the measuring tube should be wetted with fluid. 2. Start empty pipe adjustment: Select "EMPTY PIPE ADJUST" and press <input type="checkbox"/> to confirm. 3. After empty pipe adjustment, fill the piping with fluid. 4. Start full pipe adjustment: Select "FULL PIPE ADJUST" and press <input type="checkbox"/> to confirm. 5. Having completed the adjustment, select the setting "OFF" and exit the function by pressing <input type="checkbox"/>. 6. Now select the EMPTY PIPE DET. function (s. Page 53). Switch on the empty pipe detection by selecting ON STANDARD and press <input type="checkbox"/> to confirm. <p> Caution! The adjustment coefficients must be valid before you can activate the EPD function. If adjustment is incorrect the following messages might appear on the display:</p> <ul style="list-style-type: none"> - FULL = EMPTY The adjustment values for empty pipe and full pipe are identical. In such instances, empty pipe adjustment/full pipe adjustment must be carried out again. - ADJUSTMENT NOT OK Adjustment is not possible because the fluid's conductivity is out of range.

7.3 Group SYSTEM PARAMETER

7.3.1 Function group CONFIGURATION

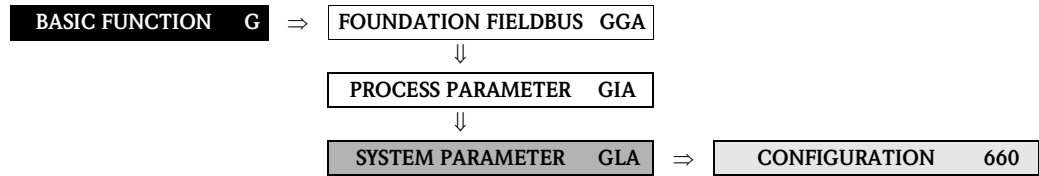

Function description BASIC FUNCTION → SYSTEM PARAMETER → CONFIGURATION	
INSTALLATION DIRECTION SENSOR (6600)	<p>Use this function to reverse the sign of the flow measured variable, if necessary.</p> <p>Options: NORMAL (flow as indicated by the arrow) INVERSE (flow opposite to direction indicated by the arrow)</p> <p>Factory setting: NORMAL</p> <p> Note! Ascertain the actual direction of fluid flow with reference to the direction indicated by the arrow on the sensor (nameplate).</p>
SYSTEM DAMPING (6603)	<p>Use this function to set the filter depth of the digital filter. This reduces the sensitivity of the measuring signal to interference peaks (e.g. high solids content, gas bubbles in the fluid, etc.). The reaction time of the measuring system increases with every increase in the filter setting.</p> <p>User input: 0 to 15</p> <p>Factory setting: 7</p> <p> Note! The system damping acts on all functions and outputs of the measuring device.</p>
INTEGRATION TIME (6604)	<p>Use this function to view the set integration time.</p> <p>The integration time defines the duration of internal totaling of the induced voltage in the fluid (measured by the measuring electrode), i.e. the time in which the measuring device records the true flow (afterwards the magnetic field for the next integration is created from the opposite pole).</p> <p>User interface: Max. 2-digit number: 1 to 65 ms</p> <p>Factory setting: 5 ms</p>
POSITIVE ZERO RETURN (6605)	<p>Use this function to interrupt evaluation of measured variables. This is necessary when a piping system is being cleaned, for example. This setting acts on all function and outputs of the measuring device.</p> <p>Options: OFF ON → Signal output is set to the "ZERO FLOW" value.</p> <p>Factory setting: OFF</p>

Function description	
BASIC FUNCTION → SYSTEM PARAMETER → CONFIGURATION	
SPECIAL FILTER (6606)	<p>There is the option of activating two signal filters in this function. These filters make it possible to either suppress the signal caused by severely fluctuating flows (STANDARD option) or to reproduce it completely – both on the display and at the FOUNDATION Fieldbus output (DYNAMIC FLOW option).</p> <p>Options: STANDARD For signal output with normal, stable flow.</p> <p>DYNAMIC FLOW For signal output with severely fluctuating or pulsating flow.</p> <p>Factory setting: STANDARD</p> <p> Caution!</p> <ul style="list-style-type: none"> ■ The signal behavior at the outputs also depends on the SYSTEM DAMPING (6603) function. ■ Additional filter settings (e.g. STANDARD CIP or DYNAMIC FLOW CIP) can only be selected with the aid of a special service code. Such settings, which are normally made by a service technician, are deleted, however, when the private code is entered again and can then no longer be activated!

7.4 Group SENSOR DATA

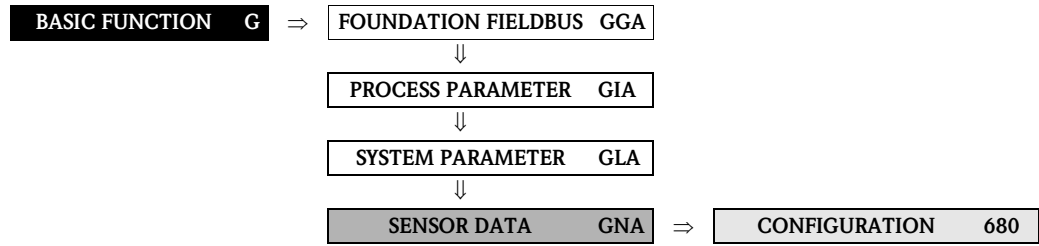

7.4.1 Function group CONFIGURATION

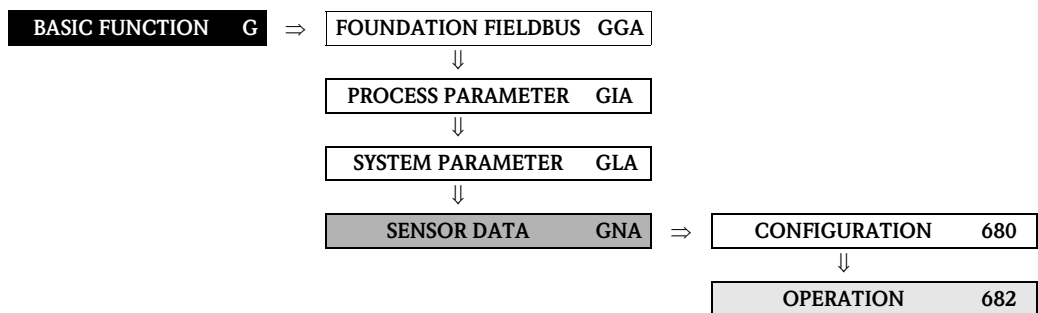

Function description	
BASIC FUNCTION → SENSOR DATA → CONFIGURATION	
<p>All sensor data (calibration factors, zero (point) and nominal diameter) are set at the factory and saved on the S-DAT sensor memory chip.</p> <p> Note! The individual values of the functions are also provided on the sensor nameplate.</p> <p> Caution! Under normal circumstances you should not change the following parameter settings, because changes affect numerous functions of the entire measuring facility in general and the accuracy of the measuring system in particular. For this reason, the functions described below cannot be changed even when you enter your personal code. Contact the Endress+Hauser service organization if you have any questions about these functions.</p>	
<p>CALIBRATION DATE (6808)</p>	<p>Use this function to view the current calibration date and time for the sensor.</p> <p>User interface: Calibration date and time</p> <p>Factory setting: Calibration date and time of the current calibration.</p> <p> Note! The calibration date and time format is defined in the FORMAT DATE TIME (0429) function, → Page 16.</p>
<p>K-FACTOR (6801)</p>	<p>Use this function to display the actual calibration factor (positive and negative flow direction) for the sensor. The calibration factor is determined and set at the factory.</p> <p>User interface: 5-digit fixed point number: 0.5000 to 2.0000</p> <p>Factory setting: Depends on nominal diameter and calibration</p>
<p>ZERO POINT (6803)</p>	<p>Use this function to view the actual zero-point correction value for the sensor. Zero-point correction is determined and set at the factory.</p> <p>User interface: Max. 4-digit number: -1000 to +1000</p> <p>Factory setting: Depends on nominal diameter and calibration</p>
<p>NOMINAL DIAMETER (6804)</p>	<p>Use this function to view the nominal diameter of the sensor. The nominal diameter depends on the size of the sensor and is set at the factory.</p> <p>User interface: 2 to 2000 mm or 1/12 to 78"</p> <p>Factory setting: Depends on the size of the sensor</p>

7.4.2 Function group OPERATION



Function description	
BASIC FUNCTION → SENSOR DATA → OPERATION	
<p>All sensor data (measuring period, overvoltage time, etc.) are set at the factory and saved on the S-DAT sensor memory chip.</p> <p> Caution! Under normal circumstances you should not change the following parameter settings, because changes affect numerous functions of the entire measuring facility in general and the accuracy of the measuring system in particular. For this reason, the functions described below cannot be changed even when you enter your personal code.</p> <p>Contact the Endress+Hauser service organization if you have any questions about these functions.</p>	
MEASURING PERIOD (6820)	<p>Use this function to view the measuring period. The duration of the measuring period is calculated from the rise time of the magnetic field, the brief recovery time, the integration time and the empty pipe detection time.</p> <p>User interface: max. 4-digit number: 10 to 1000 ms</p> <p>Factory setting: Depends on nominal diameter</p>
EPD ELECTRODE (6822)	<p>Use this function to check whether the sensor is equipped with an EPD electrode.</p> <p>User interface: YES NO</p> <p>Factory setting: YES → Electrode fitted as standard</p>
POLARITY ECC (6823)	<p>Use this function to display the actual current polarity for optional electrode cleaning (ECC). Electrode cleaning uses either a positive or negative current, depending on the electrode material.</p> <p>The measuring device automatically selects the correct polarity on the basis of the electrode-material data stored in the S-DAT.</p> <p>User interface: POSITIVE → for electrodes made of: 1.4435/316L, Alloy C-22, platinum, titanium, tungsten carbide coating (for electrodes made of 1.4435), 1.4310/302 NEGATIVE → for electrodes made of: tantalum</p> <p> Caution! If the incorrect current is applied to the electrodes, the electrode material is destroyed.</p>

Function description	
BASIC FUNCTION → SENSOR DATA → OPERATION	
COND.VITY ENABLE (6824)	<p>Use this function to check whether the sensor is capable of conductivity measurement. The availability of this function depends on characteristics of the sensors.</p> <p>User interface:</p> <p>YES → Conductivity enable: – Sensor S (without brush electrodes)</p> <p>NO → Conductivity not enable: – Sensor S (with brush electrodes) – Sensor H</p>

8 Block SPECIAL FUNCTION

Block	Groups	Function groups	Functions						
SPECIAL FUNCTION (H)	ADVANCED DIAGNOSTICS (HEA) P. 64	CONFIGURATION (750) P. 66	SELECT REF. COND. (7502) P. 66	WARNING MODE (7503) P. 66					
			REF. COND. USER (7501) P. 66						
	↓ ↑	ACQUISITION (751) P. 67	ACQUISITION MODE (7510) P. 67	ACQUISITION PERIOD (7511) P. 67	DO ACQUISITION (7512) P. 67	RESET HISTORY (7513) P. 67			
			CONFIG. COATING (752) P. 68	VOLTAGE COATING PULSE (7521) P. 68	PULSE DURATION (7522) P. 68	RECOVERY TIME (7523) P. 68			
	↓ ↑	COATING E1 (753) P. 69	REFERENCE VALUE (7530) P. 69	ACTUAL VALUE (7531) P. 69	MINIMUM VALUE (7532) P. 69	MAXIMUM VALUE (7533) P. 69	HISTORY (7534) P. 69	ACTUAL DEVIATION (7535) P. 69	WARNING (7536) P. 69
			COATING E2 (754) P. 70	REFERENCE VALUE (7540) P. 70	ACTUAL VALUE (7541) P. 70	MINIMUM VALUE (7542) P. 70	MAXIMUM VALUE (7543) P. 70	HISTORY (7544) P. 70	ACTUAL DEVIATION (7545) P. 70
	↓ ↑	ELECTRODE POT. 1 (755) P. 71	REFERENCE VALUE (7550) P. 71	ACTUAL VALUE (7551) P. 71	MINIMUM VALUE (7552) P. 71	MAXIMUM VALUE (7553) P. 71	HISTORY (7554) P. 71	ACTUAL DEVIATION (7555) P. 71	
			ELECTRODE POT. 2 (756) P. 72	REFERENCE VALUE (7560) P. 72	ACTUAL VALUE (7561) P. 72	MINIMUM VALUE (7562) P. 72	MAXIMUM VALUE (7563) P. 72	HISTORY (7564) P. 72	ACTUAL DEVIATION (7565) P. 72
	↓ ↑	VOLUME FLOW (757) P. 73	REFERENCE VALUE (7570) P. 73	ACTUAL VALUE (7571) P. 73	MINIMUM VALUE (7572) P. 73	MAXIMUM VALUE (7573) P. 73	HISTORY (7574) P. 73	ACTUAL DEVIATION (7575) P. 73	
			NOISE VALUE (758) P. 74	REFERENCE VALUE (7580) P. 74	ACTUAL VALUE (7581) P. 74	MINIMUM VALUE (7582) P. 74	MAXIMUM VALUE (7583) P. 74	HISTORY (7584) P. 74	ACTUAL DEVIATION (7585) P. 74
	↓ ↑	SOLID CONT. FLOW (HEA) P. 76	CONFIGURATION (770) P. 76	CARRIER DENSITY (771) P. 76	TARGET MAT. DENSITY (7712) P. 76				

8.1 Group ADVANCED DIAGNOSTICS

Introduction

The optional software package "Advanced Diagnostics" (F-CHIP) can be used to detect changes to the measuring system at an early stage, e.g. as a result of build-up (coating), abrasion and corrosion at the measuring electrodes. Such factors cause a reduction in accuracy in normal cases or lead to system errors in extreme cases.

With the aid of diagnostic functions it is possible to record the following diagnostic parameters during operation:

- Decay times of test pulses at the measuring electrodes
- Electrode potentials at both measuring electrodes
- Volume flow value (before applying the test pulses)

By analysing general trends of these diagnostic parameters, deviations of the measuring system from a "reference condition" can be detected at an early stage, allowing for countermeasures to be taken.

Measurement of the decay time constant of test pulses (Abb. 1):

Monitoring both measuring electrodes makes it possible to detect the formation of build-up at an early stage. To do this, a defined voltage pulse (U_B) with a pulse width (t_p , typically 1 to 20 ms) is applied periodically at an electrode and its decay time constant (τ_R) is measured. The decay time constant is a function of the condition of the measuring electrode in question.

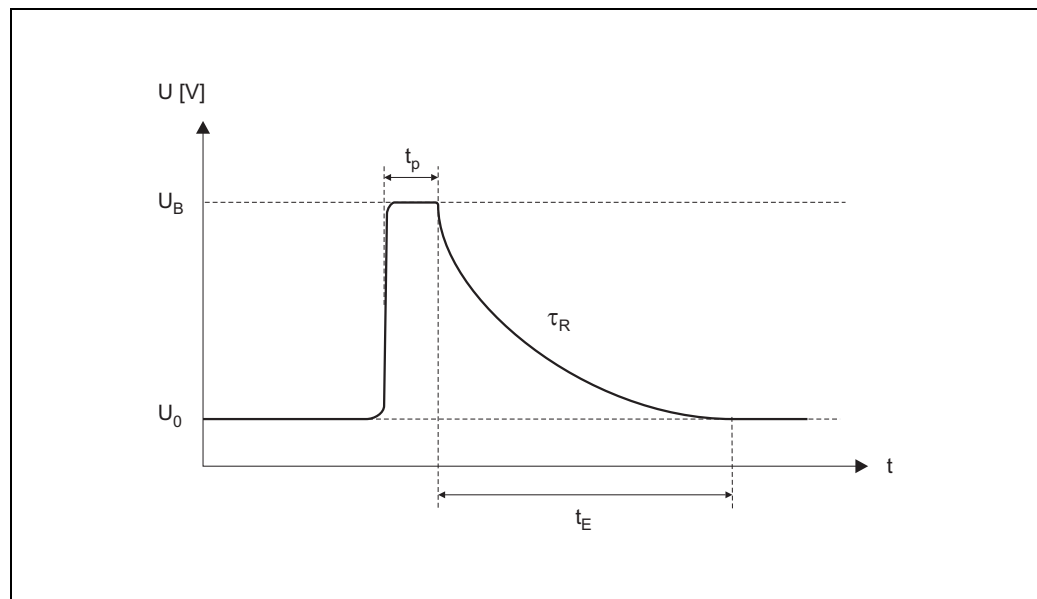

Fig. 1: Schematic curve of the decay time constant of a voltage pulse at a measuring electrode.
 U_0 = zero voltage, U_B = voltage of the test pulse for the coating detection, t_p = pulse duration, τ_R = decay time constant, t_E = recovery time

Measurement of electrode potentials:

The measuring electrode potential is influenced by various factors, for example by solids, air bubbles, inhomogeneities in the fluid, sudden pH changes, mechanical damage or corrosive changes. Therefore, monitoring the electrode potentials provides information about the specified disturbance factors.

Measurement of the volume flow (immediately before applying the test pulses):

What is meant here by "volume flow" is the volume flow value that is acquired immediately before the test pulses are applied to the measuring electrodes. This value serves as another basis for the interpretation of decay time constants or electrode potentials with regard to coating formation, abrasion or corrosion.

Activating coating detection (procedure)

1. Ascertain reference values for the diagnostic parameters → Function REFERENCE CONDITION USER (7501).
2. Select reference condition → Function SELECT REFERENCE CONDITION (7502)
3. Specify when and how the diagnostic parameter values are to be ascertained:
 - Time intervals → Function ACQUISITION PERIOD (7511)
 - Periodical or manual → Function ACQUISITION MODE (7510)
4. Switch on coating detection → Function DETECTION COATING (7520)
5. Activate warning mode (if desired):

 **Note!**

Activating the WARNING MODE (7503) function normally only makes sense if a trend analysis of the diagnostic parameter values in question has been performed beforehand! Only then, can process-specific limit values be entered (= max. permitted deviation from the reference status).

- Switch on warning mode → Function WARNING MODE (7503)
- Enter the maximum permitted deviation of the decay time constant from the reference condition → Function WARNING (7536, 7546)

Trend analysis of diagnostic parameters

By evaluating a sufficiently large number of measuring values, useful trend information can be acquired that provides information about possible coating formations or damage to the measuring electrodes - for example, as a result of corrosion or mechanical influences.

The following values of diagnostic parameters can be called up via the function matrix:

- Reference values
- Actual values of the decay time constant or of the electrode potential
- Minimum/maximum values since the last adjustment
- Data history of the last 10 measuring values (or 100 values when interrogating via the "FieldCare" software)
- Actual deviation between diagnostic parameter value and reference value

To assess possible build-up, the diagnostic parameters of the COATING 1 and COATING 2 function groups should only be interpreted and assessed in combination with those of ELECTRODE POTENTIAL 1/2 and VOLUME FLOW parameters. As build-up typically develops over a period of months, it is useful to present and analyze the relevant measured data and parameters using appropriate software, for example, the Endress+Hauser software packages "FieldCare".

**Caution!**

Since the decay time and the electrode potential are dependent on the process conditions at the electrode and, therefore, on the fluid, a new reference measurement is required as the starting point for a trend analysis for each process and each fluid in a balanced state. The measuring values are then measured periodically and saved in the device storage unit (RAM).

**Note!**

More information about "trend analysis" can be found in the Operating Instructions for this measuring device.

8.1.1 Function group CONFIGURATION

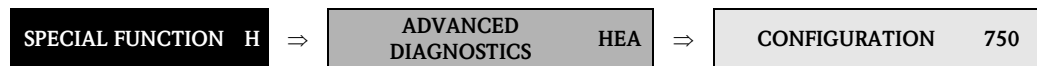

Function description SPECIAL FUNCTION → ADVANCED DIAGNOSTICS → CONFIGURATION	
REFERENCE STATUS USER (7501)	<p>This function enables the user to start an adjustment, in order to ascertain the reference values of various diagnostic parameters valid for his process. These reference values are authoritative as the "starting point" for later trend analyses (regarding abrasion, corrosion or coating formation) and should be ascertained for each process or fluid in a balanced state.</p> <p>When adjustment is performed, the reference values of the following diagnostic parameters are ascertained:</p> <ul style="list-style-type: none"> ■ Decay time constant of test pulses (at measuring electrodes 1 and 2) ■ Electrode potentials (of measuring electrodes 1 and 2) ■ Volume flow (flow value immediately before applying the test pulses) <p>Options: CANCEL START</p> <p>Factory setting: CANCEL</p>
SELECTION REFERENCE STATUS (7502)	<p>In this function, the reference condition is selected (at the factory or by the user), which the affected diagnostic parameters are to be compared to later.</p> <p>Options: FACTORY (reference values determined at the factory) USER (reference values ascertained by the user → Function 7501)</p> <p>Factory setting: FACTORY</p>
WARNING MODE (7503)	<p>In this function, you can determine whether a warning is generated if a deviation occurs between the reference condition (see Function SELECTION REFERENCE STATUS) and the actual measured diagnostic parameters.</p> <p>When doing so, the following diagnostic parameters are compared to the reference condition:</p> <ul style="list-style-type: none"> ■ Decay time constant of test pulses → Function group COATING E1 or E2 ■ Electrode potentials → Function group ELECTRODE POT. 1 or 2 ■ Volume flow → Function group VOLUME FLOW <p>Options: OFF ON</p> <p>Factory setting: OFF</p>

8.1.2 Function group ACQUISITION

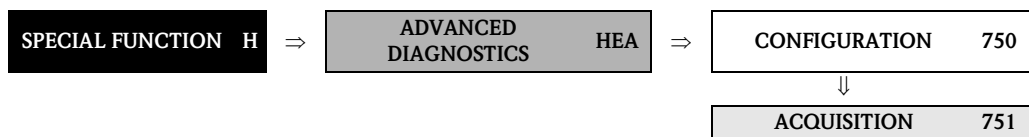

Function description	
SPECIAL FUNCTION → ADVANCED DIAGNOSTICS → ACQUISITION	
ACQUISITION MODE (7510)	<p>In this function, you define whether the diagnostic parameters are acquired periodically by the measuring device or manually by the user.</p> <p>Options: OFF PERIODICAL SINGLE SHOT</p> <p>Factory setting: OFF</p>
ACQUISITION PERIOD (7511)	<p> Note! This function is not available unless the "PERIODICAL" setting was selected in the ACQUISITION MODE function (7510).</p> <p>In this function, a time interval is specified that is used to acquire and record the affected diagnostic parameters periodically. This function is active as soon as the input is confirmed with the key.</p> <p>User input: 10 to 10 080 min</p> <p>Factory setting: 60 min</p> <p> Note! A defined reference condition must be present before the diagnostic parameters are measured → see Function SELECTION REFERENCE STATUS (7502).</p>
DO ACQUISITION (7512)	<p> Note! This function is not available unless the "SINGLE SHOT" setting was selected in the ACQUISITION MODE function (7510).</p> <p>This function can be used to start the test measurements of diagnostic parameters manually, e.g. sporadically depending on the process conditions.</p> <p>Options: CANCEL START</p> <p>Factory setting: CANCEL</p> <p> Note! A defined reference condition must be present before the diagnostic parameters are acquired → see Function SELECTION REFERENCE STATUS (7502).</p>
RESET HISTORY (7513)	<p>All previously saved diagnostic parameter values can be deleted with this function (= parameters of the COATING E1, COATING E2, ELECTRODE POTENTIAL 1, ELECTRODE POTENTIAL 2 and VOLUME FLOW function groups).</p> <p>Options: NO YES</p> <p>Factory setting: NO</p>

8.1.3 Function group CONFIG. COATING

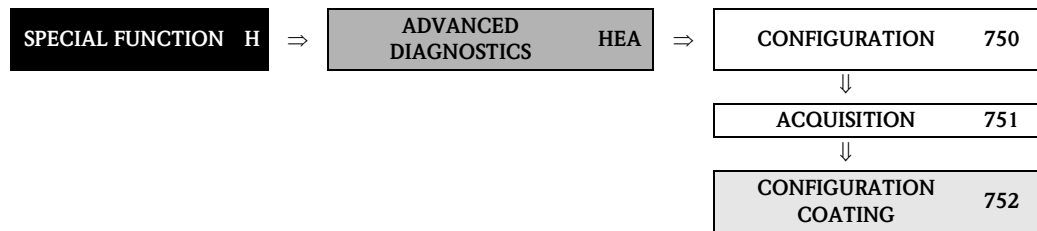

Function description	
SPECIAL FUNCTION → ADVANCED DIAGNOSTICS → CONFIGURATION COATING	
DETECTION COATING (7520)	<p>The coating detection (= detecting build-up on the measuring electrodes) can be switched on in this function.</p> <p>Options: OFF ON</p> <p>Factory setting: OFF</p>
VOLTAGE COATING PULSE (7521)	<p>The extent of the voltage pulse required for the coating detection (U_B, Abb. 1) is entered in this function.</p> <p>User input: 0.1 to 6 V(olt)</p> <p>Factory setting: 3 V</p>
PULSE DURATION (7522)	<p>The pulse width (t_p, Abb. 1) for measuring the decay time constant is entered in this function.</p> <p>User input: 0.1 to 10 ms</p> <p>Factory setting: 1 ms</p>
RECOVERY TIME (7523)	<p>In this function, a recovery time (t_E, Abb. 1) for the decay of the test pulse is specified, while the last – before coating detection – measured flow rate value is retained. It is necessary to enter a recovery time because the pulse (for coating detection) can cause the signal outputs to fluctuate due to electrochemical interference voltages.</p> <p>User input: 0.1 to 100 s</p> <p>Factory setting: 10 s</p> <p> Caution!</p> <ul style="list-style-type: none"> ■ During the recovery time, the measuring device outputs the last flow rate value measured before coating detection. This in turn means that the measuring system does not register changes in flow, e.g. zero flow, during this time span. ■ If the value entered for the recovery time is too small, then the measuring device generates the error message "COATING FAILED" (# 845).

8.1.4 Function group COATING E1

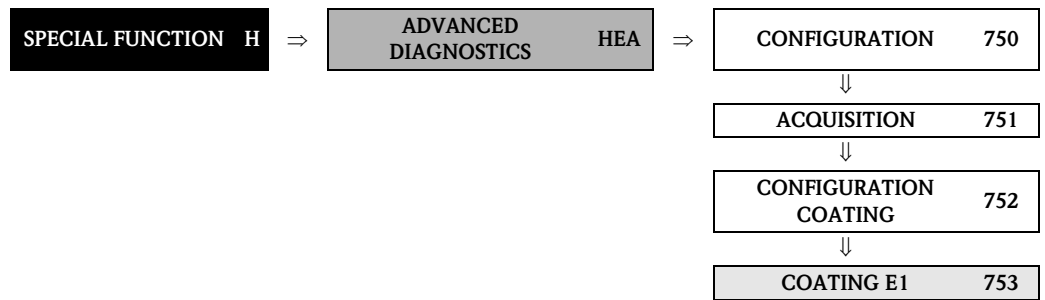

Function description SPECIAL FUNCTION → ADVANCED DIAGNOSTICS → COATING E1	
REFERENCE VALUE (7530)	<p>Use this function to view the reference value for the decay time constant at measuring electrode 1.</p> <p>User interface: 5-digit floating-point number, including unit in milliseconds</p>
ACTUAL VALUE (7531)	<p>Use this function to view the actual measured decay time constant at measuring electrode 1.</p> <p>User interface: 5-digit floating-point number, including unit in milliseconds</p>
MINIMUM VALUE (7532)	<p>Use this function to view the lowest measured value for the decay time constant at measuring electrode 1, since the last reset or deletion of the stored values.</p> <p>User interface: 5-digit floating-point number, including unit in milliseconds</p>
MAXIMUM VALUE (7533)	<p>Use this function to view the highest measured value for the decay time constant at measuring electrode 1, since the last reset or deletion of the stored values.</p> <p>User interface: 5-digit floating-point number, including unit in milliseconds</p>
HISTORY (7534)	<p>Use this function to view the last 10 measuring values for the decay time constant at measuring electrode 1.</p> <p>User interface: 5-digit floating-point number, including unit in milliseconds</p>
ACTUAL DEVIATION (7535)	<p>Use this function to view the deviation between the actual (last measured) value for the decay time constant at measuring electrode 1 and the reference values selected in the SELECTION REFERENCE STATUS function (7502).</p> <p>User interface: 5-digit floating-point number, including unit in milliseconds</p>
WARNING (7536)	<p> Note! This function is not available unless the ON setting was selected in the WARNING MODE function (7503).</p> <p>In this function, the user can specify a maximum permitted deviation (limit value) from the reference status for the decay time constant. If this limit value is overshoot or undershot, a system error message (categorized as a notice message) is output. To do this, the measuring system compares the actual deviation (see Function ACTUAL DEVIATION, 7535) to the value entered here.</p> <p>User input: 1 to 10000 ms</p> <p>Factory setting: 100 ms</p>

8.1.5 Function group COATING E2

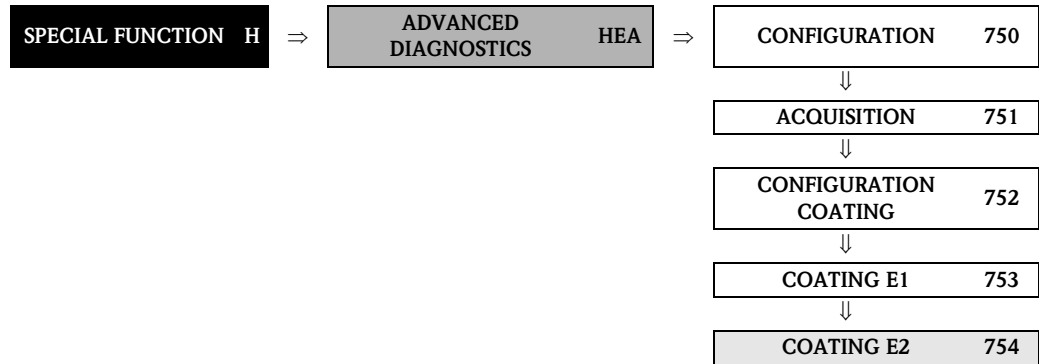

Function description SPECIAL FUNCTION → ADVANCED DIAGNOSTICS → COATING E2	
REFERENCE VALUE (7540)	<p>Use this function to view the reference value for the decay time constant at measuring electrode 2.</p> <p>User interface: 5-digit floating-point number, including unit in milliseconds</p>
ACTUAL VALUE (7541)	<p>Use this function to view the actual measured decay time constant at measuring electrode 2.</p> <p>User interface: 5-digit floating-point number, including unit in milliseconds</p>
MINIMUM VALUE (7542)	<p>Use this function to view the lowest measured value for the decay time constant at measuring electrode 2, since the last reset or deletion of the stored values.</p> <p>User interface: 5-digit floating-point number, including unit in milliseconds</p>
MAXIMUM VALUE (7543)	<p>Use this function to view the highest measured value for the decay time constant at measuring electrode 2, since the last reset or deletion of the stored values.</p> <p>User interface: 5-digit floating-point number, including unit in milliseconds</p>
HISTORY (7544)	<p>Use this function to view the last 10 measured values for the decay time constant at measuring electrode 2.</p> <p>User interface: 5-digit floating-point number, including unit in milliseconds</p>
ACTUAL DEVIATION (7545)	<p>Use this function to view the deviation between the actual (last measured) value for the decay time constant at measuring electrode 2 and the reference values selected in the SELECTION REFERENCE STATUS function (7502).</p> <p>User interface: 5-digit floating-point number, including unit in milliseconds</p>
WARNING (7546)	<p> Note! This function is not available unless the ON setting was selected in the WARNING MODE function (7503).</p> <p>In this function, the user can enter a maximum permitted deviation (limit value) from the reference status for the decay time constant. If this limit value is overshoot or undershot, a system error message (categorized as a notice message) is output. To do this, the measuring system compares the actual deviation (see Function ACTUAL DEVIATION, 7535) to the value entered here.</p> <p>User input: 1 to 10000 ms</p> <p>Factory setting: 100 ms</p>

8.1.6 Function group ELECTRODE POT. 1

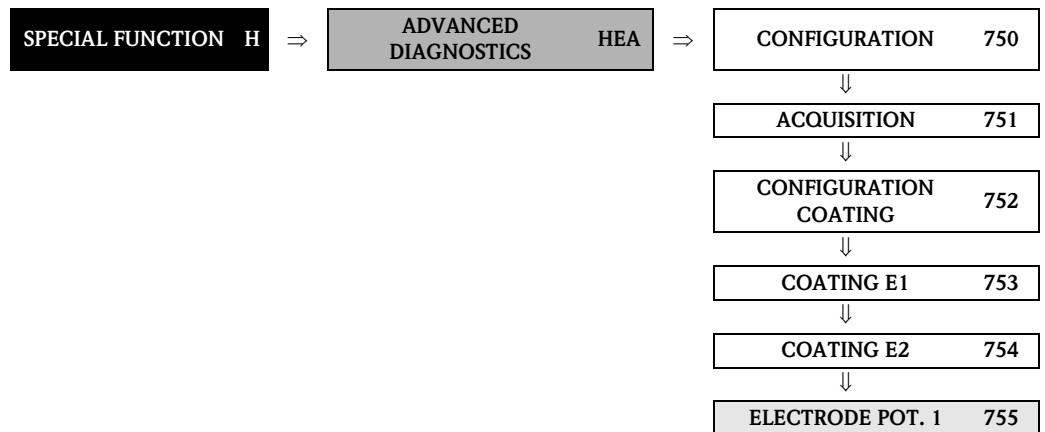

Function description	
SPECIAL FUNCTION → ADVANCED DIAGNOSTICS → ELECTRODE POT. 1	
REFERENCE VALUE (7550)	Use this function to view the reference value for the electrode potential at measuring electrode 1. User interface: 5-digit floating-point number, including unit in millivolts
ACTUAL VALUE (7551)	Use this function to view the actual measured electrode potential at measuring electrode 1. User interface: 5-digit floating-point number, including unit in millivolts
MINIMUM VALUE (7552)	Use this function to view the lowest measured value for the electrode potential at measuring electrode 1, since the last reset or deletion of the stored values. User interface: 5-digit floating-point number, including unit in millivolts
MAXIMUM VALUE (7553)	Use this function to view the highest measured value for the electrode potential at measuring electrode 1, since the last reset or deletion of the stored values. User interface: 5-digit floating-point number, including unit in millivolts
HISTORY (7554)	Use this function to view the last 10 measured values for the electrode potential at measuring electrode 1. User interface: 5-digit floating-point number, including unit in millivolts
ACTUAL DEVIATION (7555)	Use this function to view the deviation between the actual (last measured) value for the electrode potential at measuring electrode 1 and the reference values selected in the SELECTION REFERENCE STATUS function (7502). User interface: 5-digit floating-point number, including unit in millivolts

8.1.7 Function group ELECTRODE POT. 2

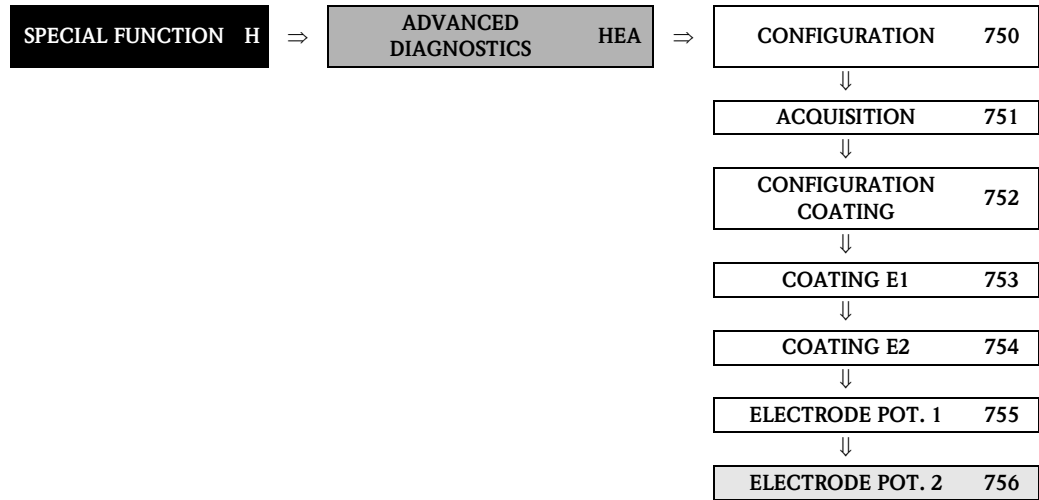

Function description	
SPECIAL FUNCTION → ADVANCED DIAGNOSTICS → ELECTRODE POT. 2	
REFERENCE VALUE (7560)	Use this function to view the reference value for the electrode potential at measuring electrode 2. User interface: 5-digit floating-point number, including unit in millivolts
ACTUAL VALUE (7561)	Use this function to view the actual measured electrode potential at measuring electrode 2. User interface: 5-digit floating-point number, including unit in millivolts
MINIMUM VALUE (7562)	Use this function to view the lowest measured value for the electrode potential at measuring electrode 2, since the last reset or deletion of the stored values. User interface: 5-digit floating-point number, including unit in millivolts
MAXIMUM VALUE (7563)	Use this function to view the highest measured value for the electrode potential at measuring electrode 2, since the last reset or deletion of the stored values. User interface: 5-digit floating-point number, including unit in millivolts
HISTORY (7564)	Use this function to view the last 10 measured values for the electrode potential at measuring electrode 2. User interface: 5-digit floating-point number, including unit in millivolts
ACTUAL DEVIATION (7565)	Use this function to view the deviation between the actual (last measured) value for the electrode potential at measuring electrode 2 and the reference values selected in the SELECTION REFERENCE STATUS function (7502). User interface: 5-digit floating-point number, including unit in millivolts

8.1.8 Function group VOLUME FLOW

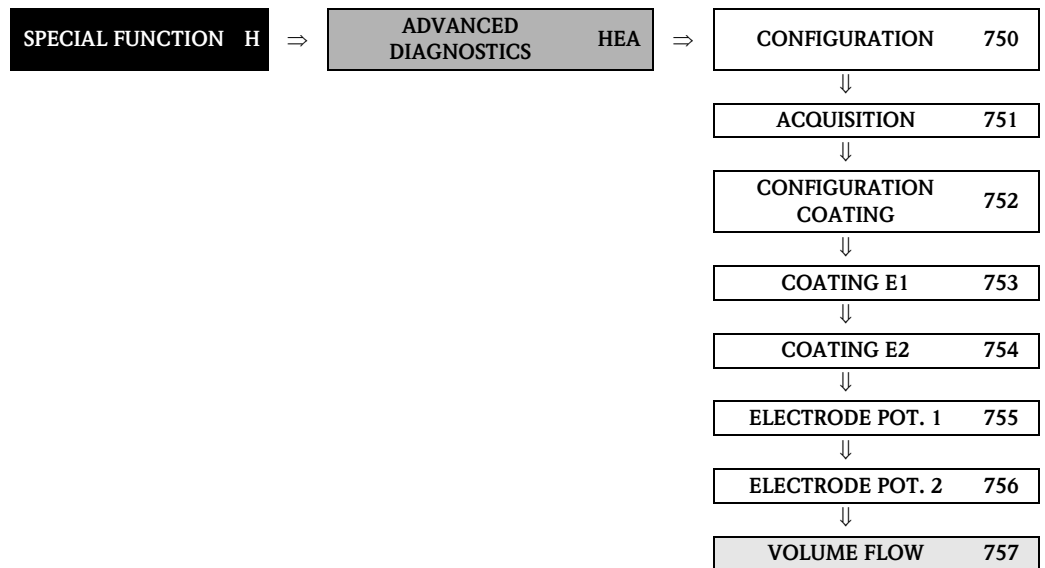

Function description	
SPECIAL FUNCTION → ADVANCED DIAGNOSTICS → VOLUME FLOW	
<p>What is meant here by "volume flow" is the volume flow value that was acquired immediately before the test pulses were applied to the measuring electrodes. This value serves as another basis for the interpretation of decay time constants or electrode potentials with regard to coating formation, abrasion or corrosion.</p>	
REFERENCE VALUE (7570)	<p>Use this function to view the reference value for the volume flow.</p> <p>User interface: 5-digit floating-point number, including unit</p>
ACTUAL VALUE (7571)	<p>Use this function to view the actual measured volume flow.</p> <p>User interface: 5-digit floating-point number, including unit</p>
MINIMUM VALUE (7572)	<p>Use this function to view the lowest measured value for the volume flow, since the last reset or deletion of the stored values.</p> <p>User interface: 5-digit floating-point number, including unit</p>
MAXIMUM VALUE (7573)	<p>Use this function to view the highest measured value for the volume flow, since the last reset or deletion of the stored values.</p> <p>User interface: 5-digit floating-point number, including unit</p>
HISTORY (7574)	<p>Use this function to view the last 10 measured values for the volume flow.</p> <p>User interface: 5-digit floating-point number, including unit</p>
ACTUAL DEVIATION (7575)	<p>Use this function to view the deviation between the actual (last measured) value for the volume flow and the reference values selected in the SELECTION REFERENCE STATUS function (7502).</p> <p>User interface: 5-digit floating-point number, including unit</p>

8.1.9 Function group NOISE VALUE

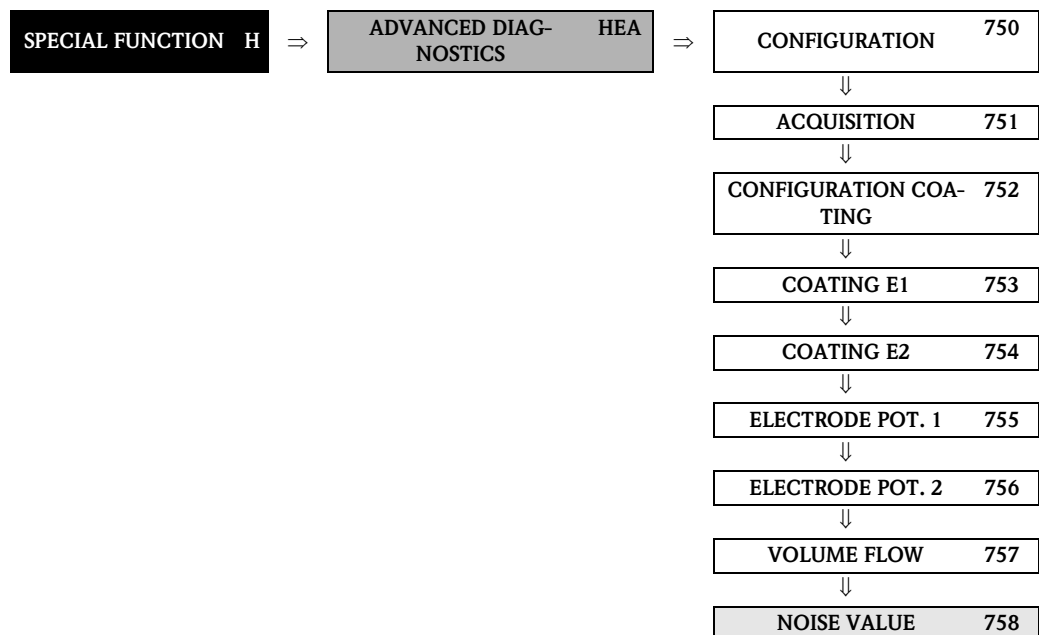

Function description	
SPECIAL FUNCTION → ADVANCED DIAGNOSTICS → NOISE VALUE	
NOISE VALUE ist the standard deviation of differential signal of both measuring electrodes. It is an additional indicator for the quality of the measuring signal.	
REFERENCE VALUE (7580)	Use this function to view the reference value for the noise value. User interface: 5-digit floating-point number, including unit in mV
ACTUAL VALUE (7581)	Use this function to view the actual measured noise value. User interface: 5-digit floating-point number, including unit in mV
MINIMUM VALUE (7582)	Use this function to view the lowest measured value for the noise value, since the last reset or deletion of the stored values. User interface: 5-digit floating-point number, including unit in mV
MAXIMUM VALUE (7583)	Use this function to view the highest measured value for the noise value, since the last reset or deletion of the stored values. User interface: 5-digit floating-point number, including unit in mV
HISTORY (7584)	Use this function to view the last 10 measured values for the noise value. User interface: 5-digit floating-point number, including unit in mV
ACTUAL DEVIATION (7585)	Use this function to view the deviation between the actual (last measured) value for the noise value and the reference values selected in the SELECTION REFERENCE STATUS function (7502). User interface: 5-digit floating-point number, including unit in mV

Function description SPECIAL FUNCTION → ADVANCED DIAGNOSTICS → NOISE VALUE	
WARNING LEVEL (7586)	<p> Note! This function is not available unless the ON setting was selected in the WARNING MODE function (7503).</p> <p>In this function, the user can enter a maximum permitted deviation (limit value) from the reference status for the decay time constant. If this limit value is overshoot or undershot, a system error message (categorized as a notice message) is output. To do this, the measuring system compares the actual deviation (see Function ACTUAL DEVIATION, 7535) to the value entered here.</p> <p>User input: positive value in mV</p> <p>Factory setting: 0.1 mV</p>

8.2 Group SOLID CONTENT FLOW



Note!

A brief introduction to the calculation of solid content flows with Promag 55 and the requirements needed for this can be found in the Operating Instructions (BA119D/06/en).

Observe the following points when commissioning the solid content flow function:

1. Be aware that the settings in the following functions are identical both for the flowmeter and for the external density meter:
 - ASSIGN CURRENT (5200)
 - CURRENT SPAN (5201)
 - VALUE 0_4 mA (5202)
 - VALUE 20 mA (5203)
 - ERROR-VALUE (5204)
 - UNIT DENSITY (0420)
2. Enter the following density values:
SPECIAL FUNCTIONS > SOLID CONTENT FLOW > CONFIGURATION > CARRIER DENSITY (7711) and TARGET MAT. DENSITY (7712)
3. Enter the desired density unit:
MEASURED VARIABLES > SYSTEM UNITS > ADDITIONAL CONFIGURATION > UNIT DENSITY (0420)
4. The "ASSIGN ..." functions can also be used to assign the calculated solid content flow measured variables to a display line or to the outputs (current, frequency, relay).

8.2.1 Function group CONFIGURATION

SPECIAL FUNCTION H ⇒ SOLID CONTENT FLOW HFA ⇒ CONFIGURATION 770

Function description	
SPECIAL FUNCTION → SOLID CONTENT FLOW → CONFIGURATION	
CARRIER DENSITY (7711)	<p> Note! This function is only available if the measuring device has an F-CHIP for calculating solid content flows (order option).</p> <p>In this function, the density of the transporting liquid (e.g. water) can be entered, in order to calculate the flow rate of solids. This density value can, for example, be determined from reference tables or by means of corresponding laboratory tests.</p> <p>User input: 5-digit floating-point number (0 to 99999), including unit</p> <p>Factory setting: 1.0 kg/l</p>
TARGET MAT. DENSITY (7712)	<p> Note! This function is only available if the measuring device has an F-CHIP for calculating solid content flows (order option).</p> <p>In this function, the density of the target medium (e.g. transported solids) can be entered, in order to calculate the flow rate of solids. This density value can, for example, be determined from reference tables or by means of corresponding laboratory tests.</p> <p>User input: 5-digit floating-point number (0 to 99999), including unit</p> <p>Factory setting: 2.5 kg/l</p>

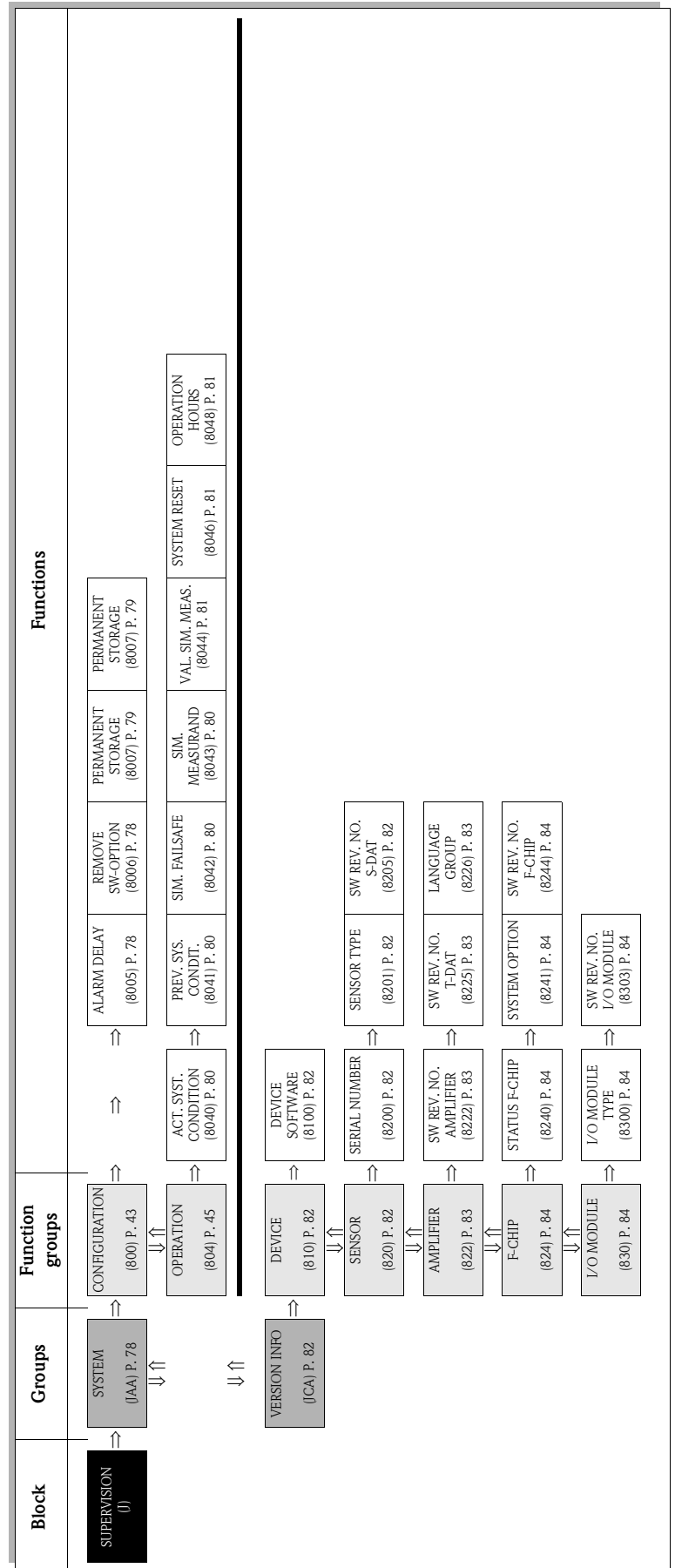

9 Block SUPERVISION



9.1 Group SYSTEM

9.1.1 Function group CONFIGURATION





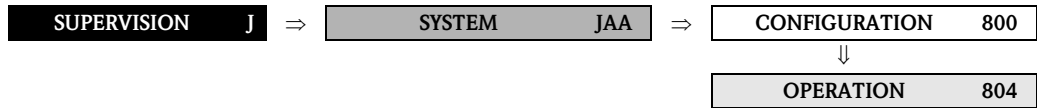

Function description SUPERVISION → SYSTEM → CONFIGURATION	
ALARM DELAY (8005)	<p>Use this function to define a time span in which the criteria for a fault have to be satisfied without interruption before a fault or notice message is generated.</p> <p>Depending on the setting and the type of fault, this suppression acts on:</p> <ul style="list-style-type: none"> ■ Display ■ Output blocks (AI Blocks) FOUNDATION Fieldbus interface <p>User input: 0 to 100 s (in steps of one second)</p> <p>Factory setting: 0 s</p> <p> Caution! If this function is activated, fault and notice messages are delayed by the time corresponding to the setting before being transmitted to the higher-order controller (process controller, etc.). It is therefore imperative to check in advance in order to make sure whether a delay of this nature could affect the safety requirements of the process. If fault and notice messages may not be suppressed, a value of 0 seconds must be entered here.</p>
REMOVE SW-OPTION (8006)	<p> Note! This function is only available if:</p> <ul style="list-style-type: none"> ■ The F-CHIP software options were saved beforehand ■ The F-CHIP is not located on the I/O board of the measuring device <p>Deletes all F-CHIP software options, such as batching, etc.</p> <p>The measuring device is restarted after the software options have been deleted.</p> <p>Options: 0 = NO 1 = YES</p> <p>Factory setting: NO</p> <p> Caution! If process variables which are only available via the F-CHIP software options are assigned to the local display or the outputs, these have to be reconfigured.</p>

Function description	
SUPERVISION → SYSTEM → CONFIGURATION	
PERMANENT STORAGE (8007)	<p>This function displays whether permanent storage of all parameters in the EEPROM is switched on or off.</p> <p>User interface: 0 = OFF 1 = ON</p> <p>Factory setting: ON</p> <p> Caution!</p> <ul style="list-style-type: none"> ■ The options in this function can only be changed by the Endress+Hauser service organization. ■ If the "OFF" option is selected, all the subsequent parameter changes are not stored permanently to the EEPROM. This means, in particular, that these changes are not available after a power failure. The device then starts with the last parameter configuration saved in the EEPROM. <p>The following also for FOUNDATION Fieldbus devices: Transducer Block "Flow"/ Basisindex 1400 Parameter: Sys. - Permanent Storage Write access with operating mode (MODE_BLK) read only</p>

9.1.2 Function group OPERATION



Function description SUPERVISION → SYSTEM → OPERATION	
ACTUAL SYSTEM CONDITION (8040)	<p>Use this function to check the present system condition.</p> <p>User interface: SYSTEM OK or the fault/notice message with the highest priority.</p>
PREVIOUS SYSTEM CONDITIONS (8041)	<p>Use this function to view the fifteen most recent fault and notice messages since measuring last started.</p> <p>User interface: The 15 most recent error or notice messages</p>
SIMULATION FAILSAFE MODE (8042)	<p>Use this function to set the Analog Input and Totalizer function blocks to their defined flow-response modes in order to check whether they respond correctly. During this time, message no. 691 "SIMULATION FAILSAFE MODE" appears on the display.</p> <p>Options: OFF ON</p> <p>Factory setting: OFF</p> <p> Note! With the fieldbus, an active simulation is relayed to downstream function blocks and higher-order control systems by means of the status "UNCERTAIN" of the output value OUT (AI Block).</p>
SIMULATION MEASURAND (8043)	<p>Use this function to set all inputs, outputs and totalizers to their defined flow-response modes in order to check whether they respond correctly. During this time, the words "SIMULATION MEASURAND" appear on the display.</p> <p>Options: OFF MASS FLOW VOLUME FLOW</p> <p>Factory setting: OFF</p> <p> Caution!</p> <ul style="list-style-type: none"> ■ The measuring device cannot be used for measuring while this simulation is in progress. ■ The setting is not saved if the power supply fails.

Function description SUPERVISION → SYSTEM → OPERATION	
VALUE SIMULATION MEASURAND (8044)	<p> Note! This function is only displayed if the SIMULATION MEASURAND (8043) function is active.</p> <p>Use this function to specify a selectable value (e.g. 12 m³/s). This is used to test the associated functions in the device itself and downstream signal loops.</p> <p>User input: 5-digit floating-point number [unit]</p> <p>Factory setting: 0 [unit]</p> <p> Caution!</p> <ul style="list-style-type: none"> ■ The setting is not saved if the power supply fails. ■ The appropriate unit is taken from the function group SYSTEM UNITS (ACA) (see Page 13).
SYSTEM RESET (8046)	<p>Use this function to perform a reset of the measuring system.</p> <p>Options: NO RESTART SYSTEM (restart without interrupting power supply)</p> <p>Factory setting: NO</p>
OPERATION HOURS (8048)	<p>Use this function to view the hours of operation of the device.</p> <p>User interface: Depends on the number of hours of operation elapsed: Hours of operation < 10 hours → display format = 0:00:00 (hr:min:sec) Hours of operation 10 to 10,000 hours → display format = 0000:00 (hr:min) Hours of operation >10,000 hours → display format = 000000 (hr)</p>

9.2 Group VERSION INFO

9.2.1 Function group DEVICE

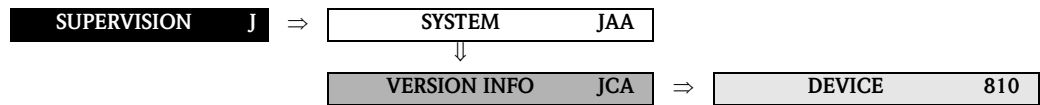

Function description	
SUPERVISION → VERSION INFO → DEVICE	
DEVICE SOFTWARE (8100)	Use this function to view the current device software version.

9.2.2 Function group SENSOR

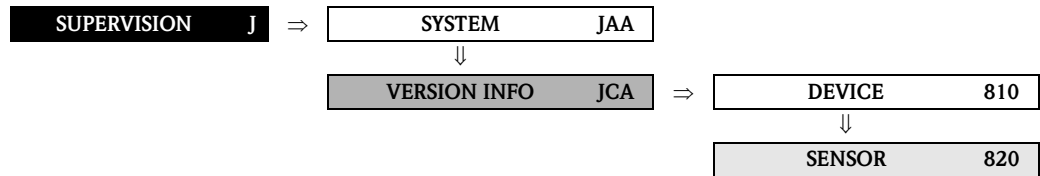

Function description	
SUPERVISION → VERSION INFO → SENSOR	
SERIAL NUMBER (8200)	Use this function to view the serial number of the sensor.
SENSOR TYPE (8201)	Use this function to view the sensor type.
SOFTWARE REVISION NUMBER S-DAT (8205)	Use this function to view the software revision number of the software used to create the content of the S-DAT.

9.2.3 Function group AMPLIFIER

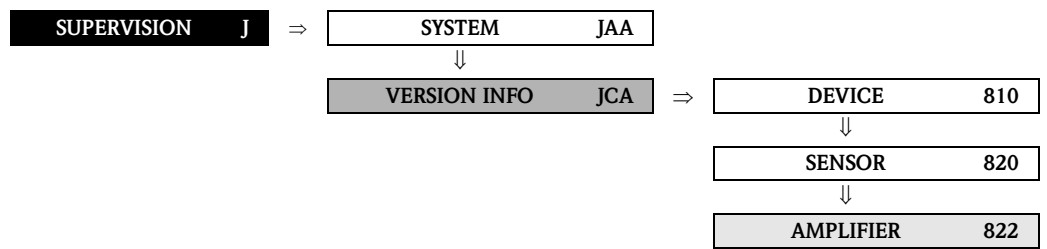

Function description SUPERVISION → VERSION INFO → AMPLIFIER	
SOFTWARE REVISION NUMBER AMPLIFIER (8222)	Use this function to view the software revision number of the amplifier.
SOFTWARE REVISION NUMBER T-DAT (8225)	Use this function to view the software revision number of the software used to create the content of the T-DAT.
LANGUAGE GROUP (8226)	<p>Use this function to view the language group.</p> <p>The following language groups can be ordered: WEST EU / USA, EAST EU / SCAND., ASIA, CHINA.</p> <p>User interface: available language group</p> <p> Note!</p> <ul style="list-style-type: none"> ■ The language options of the available language group are displayed in the LANGUAGE (2000) function. ■ You can change the language group via the configuration program FieldCare. Please do not hesitate to contact your Endress+Hauser sales office if you have any questions.

9.2.4 Function group F-CHIP

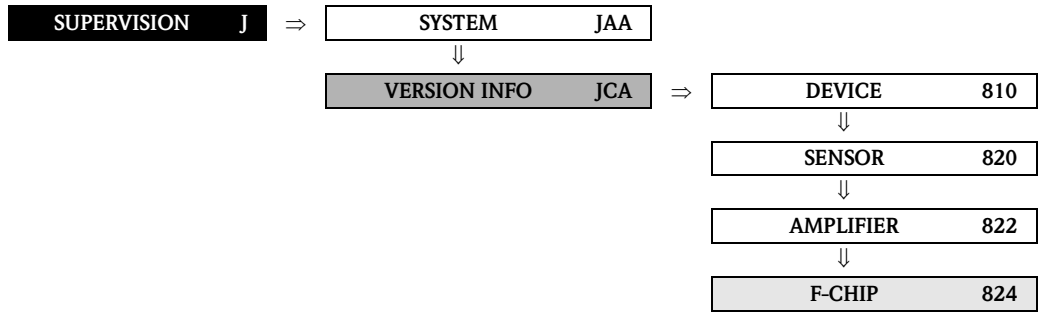

Function description	
SUPERVISION → VERSION INFO → F-CHIP	
STATUS F-CHIP (8240)	Use this function to check whether an F-CHIP is installed and which software options are available.
SYSTEM OPTION (8241)	<p> Note! This function is not available unless the measuring device is equipped an F-CHIP.</p> <p>Use this function to view the software options available in the measuring device (by entering the customer code).</p>
SOFTWARE REVISION NUMBER F-CHIP (8244)	<p> Note! This function is not available unless the measuring device is equipped an F-CHIP.</p> <p>Use this function to view the software revision number of the F-CHIP.</p>

9.2.5 Function group I/O MODULE

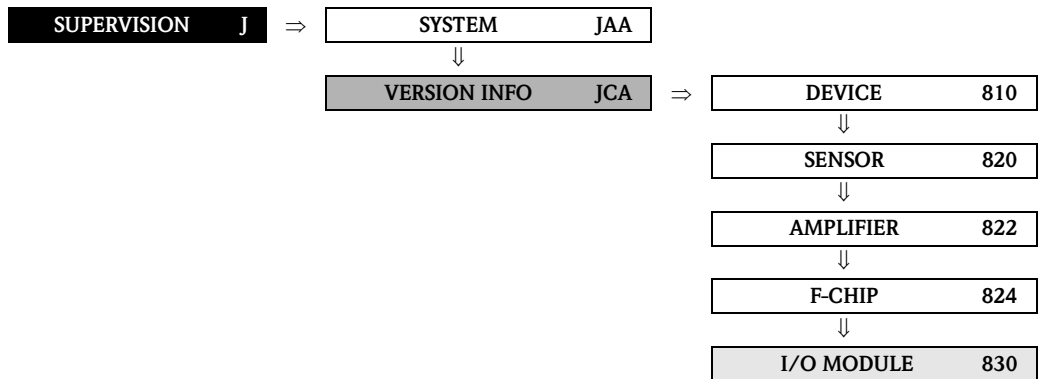

Function description	
SUPERVISION → VERSION INFO → I/O MODULE	
I/O MODULE TYPE (8300)	Use this function to view the configuration of the I/O module complete with terminal numbers.
SOFTWARE REVISION NUMBER I/O MODULE (8303)	Use this function to view the software revision number of the I/O module.

10 Index Function matrix

Blocks

A = MEASURED VARIABLES	9
B = QUICK SETUP	18
C = USER INTERFACE	21
D = TOTALIZER	42
G = BASIC FUNCTION	47
H = SPECIAL FUNCTION	63
J = SUPERVISION	77

Groups

AAA = MEASURING VALUES	10
ACA = SYSTEM UNITS	13
CAA = CONTROL	22
CCA = MAIN LINE	26
CEA = ADDITIONAL LINE	30
CGA = INFORMATION LINE	36
DAA = TOTALIZER 1	43
DAB = TOTALIZER 2	43
DAC = TOTALIZER 3	43
DJA = HANDLING TOTALIZER	46
GAA = FOUNDATION Fieldbus	48
GIA = PROCESS PARAMETER	51
GLA = SYSTEM PARAMETER	58
GNA = SENSOR DATA	60
HEA = ADVANCED DIAGNOSTICS	64
HEA = SOLID CONTENT FLOW	76
JAA = SYSTEM	78
JCA = VERSION INFO	82

Function groups

000 = MAIN VALUES	10
002 = ADDITIONAL CONCENTRATION	11
040 = CONFIGURATION	13
042 = ADDITIONAL CONFIGURATION	16
070 = DENSITY PARAMETER	17
200 = BASIC CONFIGURATION	22
202 = UNLOCKING/LOCKING	24
204 = OPERATION	25
220 = CONFIGURATION	26
222 = MULTIPLEX	28
240 = CONFIGURATION	30
242 = MULTIPLEX	33
260 = CONFIGURATION	36
262 = MULTIPLEX	39
300 = CONFIGURATION	43
304 = OPERATION	45
610 = CONFIGURATION	48
620 = CONFIGURATION	48
622 = FUNCTION BLOCKS	49
624 = INFORMATION	50
640 = CONFIGURATION	51
642 = EPD PARAMETER	53
644 = ECC PARAMETER	55
648 = ADJUSTMENT	57
660 = CONFIGURATION	58
680 = CONFIGURATION	60
682 = OPERATION	61

750 = CONFIGURATION	66
751 = ACQUISITION	67
752 = CONFIGURATION COATING	68
753 = COATING E1	69
754 = COATING E2	70
755 = ELECTRODE POTENTIAL 1	71
756 = ELECTRODE POTENTIAL 2	72
757 = VOLUME FLOW	73
758 = NOISE VALUE	74
770 = CONFIGURATION	76
800 = CONFIGURATION	78
804 = OPERATION	80
810 = DEVICE	82
820 = SENSOR	82
822 = AMPLIFIER	83
824 = F-CHIP	84
830 = I/O MODULE	84

Functions 0...

0000 = CALCULATED MASS FLOW	10
0001 = VOLUME FLOW	10
0005 = DENSITY	10
0010 = CONDUCTIVITY	10
0020 = TARGET MASS FLOW	11
0021 = % TARGET MASS FLOW	11
0022 = TARGET VOLUME FLOW	11
0023 = % TARGET VOLUME FLOW	11
0025 = CARRIER MASS FLOW	11
0026 = % CARRIER MASS FLOW	12
0027 = CARRIER VOLUME FLOW	12
0028 = % CARRIER VOLUME FLOW	12
0400 = UNIT MASS FLOW	13
0401 = UNIT MASS	13
0402 = UNIT VOLUME FLOW	14
0403 = UNIT VOLUME	15
0406 = UNIT CONDUCTIVITY	15
0420 = UNIT DENSITY	16
0424 = UNIT LENGTH	16
0429 = FORMAT DATE/TIME	16
0700 = DENSITY VALUE	17

Functions 1...

1002 = QUICK SETUP COMMISSION	18
1009 = T DAT SAVE/LOAD	18

Functions 2...

2000 = LANGUAGE	22
2002 = DISPLAY DAMPING	22
2003 = CONTRAST LCD	23
2004 = BACKLIGHT	23
2020 = ACCESS CODE	24
2021 = DEFINE PRIVATE CODE	24
2022 = STATUS ACCESS	24
2023 = ACCESS CODE COUNTER	24
2040 = TEST DISPLAY	25
2200 = ASSIGN	26
2201 = 100% VALUE	27

2202 = FORMAT	27
2220 = ASSIGN	28
2221 = 100% VALUE	28
2222 = FORMAT	29
2400 = ASSIGN	30
2401 = 100% VALUE	31
2402 = FORMAT	31
2403 = DISPLAY MODE	32
2420 = ASSIGN	33
2421 = 100% VALUE	34
2422 = FORMAT	34
2423 = DISPLAY MODE	35
2600 = ASSIGN	36
2601 = 100% VALUE	37
2602 = FORMAT	37
2603 = DISPLAY MODE	38
2620 = ASSIGN	39
2621 = 100% VALUE	40
2622 = FORMAT	40
2623 = DISPLAY MODE	41

Functions 3...

3000 = ASSIGN	43
3001 = UNIT TOTALIZER	43
3002 = TOTALIZER MODE	44
3003 = RESET TOTALIZER	44
3040 = SUM	45
3041 = OVERFLOW	45
3800 = RESET ALL TOTALIZERS	46
3801 = FAILSAFE ALL TOT	46

Functions 6...

6120 = BLOCK SELECTION	49
6121 = OUT VALUE	49
6122 = DISPLAY VALUE	49
6200 = WRITE PROTECTION	48
6201 = SIMULATION	48
6203 = DEVICE PD-TAG	48
6222 = PID_IN VALUE	49
6223 = CASCADE_IN	49
6240 = MANUFACTURER ID	50
6241 = DEVICE TYPE	50
6242 = SERIAL NUMBER	50
6243 = DEVICE REVISION	50
6244 = DD REVISION	50
6400 = ASSIGN LOW FLOW CUT OFF	51
6402 = ON-VALUE LOW FLOW CUT OFF	51
6403 = OFF-VALUE LOW FLOW CUT OFF	51
6404 = PRESSURE SHOCK SUPPRESSION	52
6420 = EMPTY PIPE DETECTION (EPD)	53
6425 = EPD RESPONSE TIME	54
6440 = ECC	55
6441 = ECC DURATION	55
6442 = ECC RECOVERY TIME	56
6443 = ECC CLEANING CYCLE	56
6481 = EPD ADJUSTMENT	57
6600 = INSTALLATION DIRECTION SENSOR	58
6603 = SYSTEM DAMPING	58
6604 = INTEGRATION TIME	58
6605 = POSITIVE ZERO RETURN	58

6606 = SPECIAL FILTER	59
6801 = K-FACTOR	60
6803 = ZERO POINT	60
6804 = NOMINAL DIAMETER	60
6808 = CALIBRATION DATE	60
6820 = MEASURING PERIOD	61
6822 = EPD ELECTRODE	61
6823 = POLARITY ECC	61
6824 = COND.VITY ENABLE	62

Functions 7...

7501 = REFERENCE STATUS USER	66
7502 = SELECTION REFERENCE STATUS	66
7503 = WARNING MODE	66
7510 = ACQUISITION MODE	67
7511 = ACQUISITION PERIOD	67
7512 = ACQUISITION MANUAL	67
7513 = RESET HISTORY	67
7520 = DETECTION COATING	68
7521 = VOLTAGE COATING PULSE	68
7522 = PULSE DURATION	68
7523 = RECOVERY TIME	68
7530 = REFERENCE VALUE COATING E1	69
7531 = ACTUAL VALUE COATING E1	69
7532 = MINIMUM VALUE COATING E1	69
7533 = MAXIMUM VALUE COATING E1	69
7534 = MAXIMUM VALUE COATING E1	69
7535 = ACT. DEVIATION COATING E1	69
7536 = WARNING COATING E1	69
7540 = REFERENCE VALUE COATING E2	70
7541 = ACTUAL VALUE COATING E2	70
7542 = MINIMUM VALUE COATING E2	70
7543 = MAXIMUM VALUE COATING E2	70
7544 = HISTORY COATING E2	70
7545 = ACT. DEVIATION COATING E2	70
7546 = WARNING COATING E2	70
7550 = REFERENCE VALUE ELECTR. POT. 1	71
7551 = ACTUAL VALUE ELECTR. POT. 1	71
7552 = MINIMUM VALUE ELECTR. POT. 1	71
7553 = MAXIMUM VALUE ELECTR. POT. 1	71
7554 = HISTORY ELECTR. POT. 1	71
7555 = ACT. DEVIATION ELECTR. POT. 1	71
7560 = REFERENCE VALUE ELECTR. POT. 2	72
7561 = ACTUAL VALUE ELECTR. POT. 2	72
7562 = MINIMUM VALUE ELECTR. POT. 2	72
7563 = MAXIMUM VALUE ELECTR. POT. 2	72
7564 = HISTORY ELECTR. POT. 2	72
7565 = ACT. DEVIATION ELECTR. POT. 2	72
7570 = REFERENCE VALUE VOLUME FLOW	73
7571 = ACTUAL VALUE VOLUME FLOW	73
7572 = MINIMUM VALUE VOLUME FLOW	73
7573 = MAXIMUM VALUE VOLUME FLOW	73
7574 = HISTORY VOLUME FLOW	73
7575 = ACT. DEVIATION VOLUME FLOW	73
7580 = REFERENCE VALUE	74
7581 = ACTUAL VALUE NOISE VALUE	74
7582 = MINIMUM VALUE NOISE VALUE	74
7583 = MAXIMUM VALUE NOISE VALUE	74
7584 = HISTORY NOISE VALUE	74
7585 = ACTUAL DEVIATION NOISE VALUE	74

7586 = WARNING NOISE VALUE	75
7711 = CARRIER DENSITY	76
7712 = TARGET MAT. DENSITY	76

Functions 8...

8005 = ALARM DELAY	78
8006 = REMOVE SW-OPTION	78
8007 = PERMANENT SAVING	79
8040 = ACTUAL SYSTEM CONDITION	80
8041 = PREVIOUS SYSTEM CONDITIONS	80
8042 = SIMULATION FAILSAFE MODE	80
8043 = SIMULATION MEASURAND	80
8044 = VALUE SIMULATION MEASURAND	81
8046 = SYSTEM RESET	81
8048 = OPERATION HOURS	81
8100 = DEVICE SOFTWARE	82
8200 = SERIAL NUMBER	82
8201 = SENSOR TYPE	82
8205 = SOFTWARE REV. NO. S-DAT	82
8222 = SOFTWARE REV. NO. AMPLIFIER	83
8225 = SOFTWARE REV. NO. T-DAT	83
8226 = LANGUAGE GROUP	83
8240 = STATUS F-CHIP	84
8241 = SYSTEM OPTION	84
8244 = SOFTWARE REV. NO. F-CHIP	84
8300 = I/O MODULE TYPE	84
8303 = SOFTWARE REV. NO. I/O MODULE	84

11 Index (local operation)

A

Abrasion (measuring electrodes)	64
Actual system condition	80
Additional configuration (system units)	16
Additional line	
Configuration	30
Multiplex	33
Additional values	11
Adjustment EPD	57
Advanced diagnostics	64
Alarm delay	78
Amplifier (version info)	83
Assign	
Additional line	30
Additional line (Multiplex)	33
Information line	36
Information line (Multiplex)	39
Low flow cut off	51
Main line	26
Main line (Multiplex)	28
Totalizer	43

B

Basic configuration (user interface)	22
Basic function	47
Block	
Basic function	47
Measured variables	9
Quick Setup	18
Special function	63
Supervision	77
Totalizer	42
User interface	21
Block selection	49
Block Supervision	77

C

Carrier fluid (mass flow)	11
Carrier fluid (volume flow)	12
Cascade IN Value	49
Coating detection (detection of build-up)	64
Coating detection, activating (procedure)	65
Code	
Access	24
Define private code	24
Commissioning	18
Communication (Quick Setup)	19
Configuration	
Additional line	30
FOUNDATION Fieldbus	48
Information line	36
Main line	26
Process parameter	51
Sensor data	60
System	78
System parameter	58
System units	13

Totalizer	43
Contrast LCD	23
Control	
Basic configuration	22
Operation	25
Unlocking/locking	24
Corrosion (measuring electrodes)	64

D

Damping	
System, reaction time	58, 108
User interface	22
DD Revision	50
Define private code	24
Density	
Density parameter (introduction)	17
Density value (display)	10
Density value (input)	17
Device PD-Tag	48
Device Revision	50
Device software	82
Device type	50
Device (version info)	82
Diagnostics, advanced	64
Display	
See User interface	
Display mode	
Additional line	32
Additional line (Multiplex)	35
Information line	38
Information line (Multiplex)	41
Display Value	49

E

ECC (Electrode Cleaning Circuitry)	55
Cleaning cycle	56
Duration	55
Parameter	55
Polarity	61
Recovery time	56
Einheit	
Volumen	15
Electrode potentials	64
Empty pipe detection (EPD)	
Empty/Full pipe adjustment	57
EPD electrode	61
General information	53
Response time	54
Switching on/off	53
EMPTY PIPE DET.	
see Empty pipe detection	

F

Failsafe	
All totalizers	46
F-CHIP (version info)	84

Format		Overview	8
Additional line	31	G	
Additional line (Multiplex)	34	Group	
Datum und Uhr	16	Additional line	30
Information line	37	Advanced diagnostics	64
Information line (Multiplex)	40	Control (user interface)	22
Main line	27	FOUNDATION Fieldbus	48
Main line (Multiplex)	29	Handling Totalizer	46
FOUNDATION FIELDBUS	48	Information line	36
Function group		Main line	26
Acquisition (diagnostic parameters)	67	Measuring values	10
Additional configuration (system units)	16	Process parameter	49, 51
Additional values	11	Sensor data	60
Adjustment	57	Solid content flow	76
Amplifier	83	Special units	17
Basic configuration (user interface)	22	System	78
Coating electrode 1	68, 146	System parameter	58
Coating electrode 2	70	System units	13
Configuration		Version info	82
Additional line	30	H	
Advanced diagnostics	66	Handling Totalizer	46
Coating	68	I	
FOUNDATION Fieldbus	48	IN Value, Cascade	49
Information line	36	Information line	
Main line	26	Configuration	36
Operation	61	Multiplex	39
Process parameter	51	Installation direction sensor	58
Sensor data	60	Integration time	58
Solid content flow	76	K	
System	78	K-factor	60
System parameter	58	L	
System units	13	Language	
Totalizer	43	Factory settings (SI units)	167
Density parameter	17	Language group (display)	83
Device	82	Selection	22
ECC parameter	55	LCD contrast	23
Electrode potential 1	71	Leitfähigkeit Freigabe	62
Electrode potential 2	72	Low flow cut off	51
EPD parameter	53	M	
F-CHIP	84	Main line	
Function blocks	49	Configuration	26
Information	50	Multiplex	28
I/O Module	84	Main values	10
Main values	10	Manufacturer ID	50
Multiplex		Mass flow (calculated)	10
Additional line	33	Measured variables (block A)	9
Information line	39	Measuring period, sensor	61
Main line	28	Measuring values	10
Noise value (diagnostics)	74	Additional values	11
Operation		Main values	10
System	80	Multiplex	
Totalizer	45	Additional line	33
User interface	25	Information line	39
Sensor	82	Main line	28
Unlocking/locking (display)	24		
Volume flow (diagnostics)	73		
Function matrix			
Identification code	7		
Layout	6		

N

Nominal diameter 60

O

Off-value

Low flow cut off 51

On-value

Low flow cut off 51

Operation

Sensor data 61

System 80

Totalizer 45

User interface 25

Operation hours 81

OUT Value 49

Overflow 45

P

Permanent storage 79

Polarity ECC 61

Positive zero return 58

Pressure shock suppression 52

Previous system conditions 80

Process parameter

Adjustment 57

Configuration 51

ECC parameter 55

EPD parameter 53

Q

Quick Setup

Commissioning 18

Quick Setup (Block B) 18

R

Reference condition

Deviation - coating electrode 1 69

Deviation - coating electrode 2 70

Deviation (of the diagnostic parameters) 65

Remove SW-option 78

Reset

All totalizers 46

System 81

Totalizer 44

S

Sensor

Configuration 60

Installation direction 58

Measuring period 61

Operating data 61

see Sensor

Version info 82

Zero point 60

Serial number

Measuring device (FF) 50

Serial number sensor 82

Simulation

Failsafe 80

Measurand 80

Simulation, display 48

Software revision number

Amplifier 83

F-CHIP 84

I/O Module 84

S-DAT 82

T-DAT 83

Solid flow measurement 76

Special filter 59

Special units

Arbitrary unit 17

Density parameter 17

Status access 24

Status F-CHIP 84

System

Configuration 78

Damping 58

Operation 80

Operation hours 81

Reset 81

System condition

Actual 80

Previous 80

System option (additional software) 84

System parameters, configuration 58

System units

Additional configuration 16

Configuration 13

T

Target medium mass flow 11

Target medium volume flow 11

T-DAT save/load 18

Test display 25

Test pulses (coating detection) 64

Totalizer 42

Configuration 43

Handling totalizer (Reset, etc.) 46

Operation 45

Reset 44

Sum (display) 45

Totalizer mode 44

Trend analysis (diagnostics) 65

Type I/O Module 84

U

Unit

Density 16

Length 16

Mass 13

Mass flow 13

Totalizer 43

Volume 15

Volume flow 14

Unlocking/locking (display) 24

User interface 21

Contrast LCD 23

Display test 25

Language selection 22

Lighting (back lighting) 23

V

Value simulation	
Measurand	81
Version info	
Amplifier	83
F-CHIP	84
I/O Module	84
Sensor	82
Volume flow (display)	10

W

Write protect	48
---------------------	----

Z

Zero point	60
------------------	----

Numerics

100% value flow	
Additional line	31
Additional line (Multiplex)	34
Information line	37
Information line (Multiplex)	40
Main line	27
Main line (Multiplex)	28

Table of contents (FOUNDATION Fieldbus)

1	Operation via FOUNDATION Fieldbus	95		
1.1	Block model	95		
2	Resource Block	97		
2.1	Selecting the operating mode	97		
2.2	Block status	97		
2.3	Write protection and simulation	98		
2.4	Alarm detection and processing	98		
2.5	Parameters of the Resource Block	99		
3	Transducer Block	100		
3.1	Signal processing	101		
3.2	Important functions and parameters of the Transducer Blocks	102		
3.2.1	Block output values	102		
3.2.2	Selecting the operating mode	103		
3.2.3	Alarm detection and processing	103		
3.2.4	Diagnosis	103		
3.2.5	Accessing the device-specific parameters	104		
3.3	Parameters of the "Flow" Transducer Block	104		
3.4	Parameters of the "Diagnosis" Transducer Block	122		
3.5	Parameters of the "Display" Transducer Block	126		
3.6	Parameters of the "Totalizer" Transducer Block	140		
3.7	Parameter Transducer Block "Advanced Diagnostics"	144		
3.8	Parameter Transducer Block "Solid Content Flow"	152		
4	Function blocks	155		
5	Analog Input function block	156		
5.1	Signal processing	156		
5.2	Important functions and parameters of the Analog Input function blocks	158		
5.2.1	Selecting the operating mode	158		
5.2.2	Assignment of the process variable	158		
5.2.3	Linearization types	158		
5.2.4	Selection of units	159		
5.2.5	Status of the output value OUT	159		
5.2.6	Simulation of input/output	160		
5.2.7	Diagnosis	160		
5.2.8	Rescaling the input value	160		
5.2.9	Limit values	161		
5.2.10	Alarm detection and processing	161		
6	Discrete Output Function block	163		
6.1	Signal processing	163		
6.2	Important functions and parameters of the Discrete Output function block	164		
6.2.1	Selecting the operating mode	164		
6.2.2	Safety behavior	164		
6.2.3	Assignment between the Discrete Output Function block and the Transducer Block	164		
6.2.4	Values for the parameters CAS_IN_D, RCAS_IN_D, OUT_D, and SP_D	165		
7	Additional function blocks	166		
8	Factory settings	167		
8.1	SI units (not for USA and Canada)	167		
8.2	US units (only for USA and Canada)	168		
9	Index (FOUNDATION Fieldbus)	169		

1 Operation via FOUNDATION Fieldbus

1.1 Block model

In the FOUNDATION Fieldbus all the device parameters are categorized according to their functional properties and task and are generally assigned to three different blocks. A block may be regarded as a container in which parameters and the associated functionalities are contained. A FOUNDATION Fieldbus device has the following block types:

- A Resource Block
The Resource Block contains all the device-specific characteristics of the device.
- One or more Transducer Blocks (transmission blocks)
The Transducer Block contains all the measuring technology and device-specific parameters of the device. The measurement principles (e.g. flow, temperature) are depicted in the Transducer Blocks in accordance with the FOUNDATION Fieldbus specification.
- One or more function blocks
Function blocks contain the automation functions of the device. We distinguish between different function blocks, e.g. Analog Input function block, Analog Output function block, PID function block (PID controller), etc. Each of these function blocks is used to process different application functions.

Different automation tasks can be realized depending on the arrangement and connection of the individual blocks. In addition to these blocks, a field device may have any number of other blocks, e.g. several Analog Input function blocks if more than one process variable is available from the field device.

Blocks used by the Promag 55 FOUNDATION Fieldbus:

- One Resource Block
- Four Transducer Blocks
- Eleven function blocks comprising:
 - Five Analog Input function blocks for the process variables volume flow, calculated mass flow and totalizer 1 to 3.
 - One Discrete Output function block
 - One PID function block (PID controller)
 - One Arithmetic function block
 - One Input Selector function block
 - One Signal Characterizer function block
 - One Integrator function block

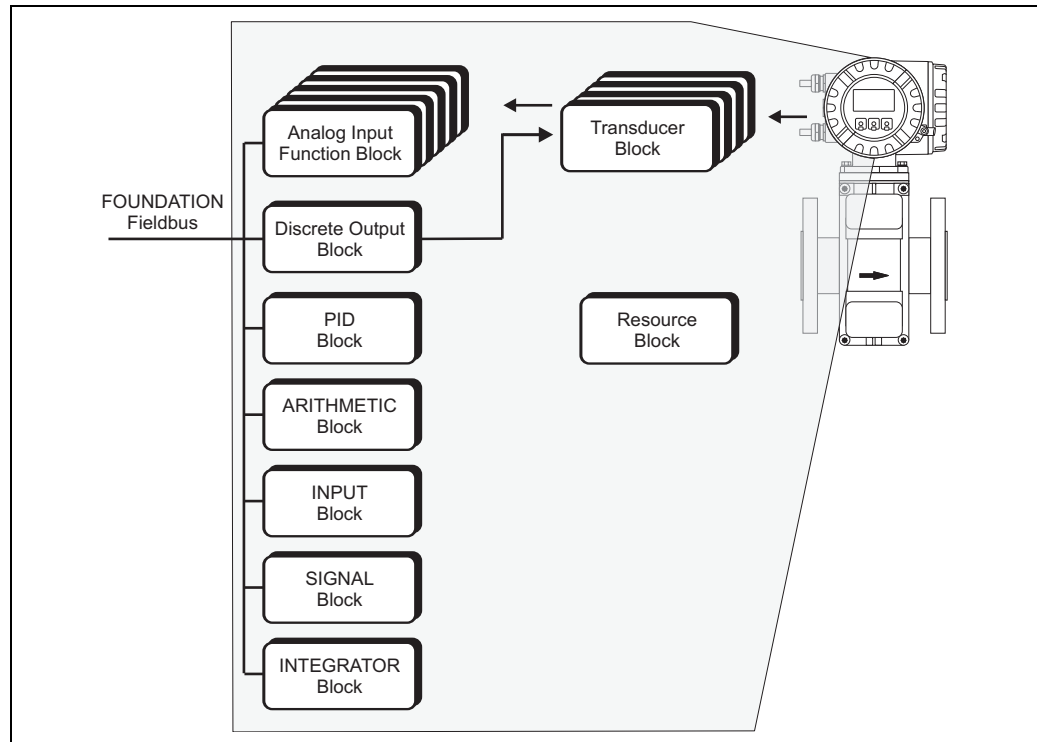

A0006559-EN

Abb. 1: Promag 55 FOUNDATION Fieldbus blocks

The sensor signal is first prepared specifically for the flow in the measuring block (the **Transducer Block**). The process variables are then passed to the Analog Input function blocks for control-related processing (e.g. scaling, limit value processing).

The process variables go through the complete function block algorithm and are available to other function blocks, e.g. the PID block, as a starting variable for connecting the desired application function.

Using the **Discrete Output function block (DO)**, various actions and functions can be initiated and controlled via FOUNDATION Fieldbus in the Device Functions Proline Promag 55 FOUNDATION Fieldbus.



Hinweis!

Other function blocks such as the PID, Arithmetic, Input Selector, Signal Characterizer and Integrator function block are described in the "FOUNDATION Fieldbus Overview" (BA013S) Operating Instructions (acquired at: → www.endress.com → Download).

2 Resource Block

A Resource Block contains all the data that uniquely identifies and characterizes the field device. It is an electronic version of a nameplate on the field device. Parameters of the Resource Block include device type, device name, manufacturer ID, serial number, etc.

A further task of the Resource Blocks is the management of overall parameters and functions that have an influence on the execution of the remaining blocks in the field device. The Resource Block is thus the central unit that also checks the device status and thereby influences or controls the operability of the other blocks and thus also of the device. Since the Resource Block has no block input and block output data, it cannot be linked with other blocks.

The major functions and parameters of the Resource Block are listed below; you will find an overview of all the available parameters starting on Page 99.

2.1 Selecting the operating mode

The operation mode is set by means of the MODE_BLK parameter group. The Resource Block supports the following operating modes:

- AUTO (automatic mode)
- OOS (out of service)



Hinweis!

The block status OOS is also shown via the parameter BLOCK_ERR. In operating mode OOS, if write protection is not enabled, you can access all the write parameters without restriction.

2.2 Block status

The current operating status of the Resource Block is shown in the parameter RS_STATE.

The Resource Block can take on the following states:

- STANDBY The Resource Block is in OOS operating mode. The remaining blocks cannot be executed.
- ONLINE LINKING The connections configured between the function blocks have not yet been linked.
- ONLINE Normal operating status; the Resource Block is in operating mode AUTO. The configured connections between the function blocks have been established.

2.3 Write protection and simulation

Write protection of the device parameters and simulation in the Analog Input and Discrete Output function block can be locked or unlocked via a jumper setting on the FOUNDATION Fieldbus I/O board (→ Operating Instructions for Proline Promag 55 FOUNDATION Fieldbus, BA126D).

The parameter WRITE_LOCK shows the status of the hardware write protection. The following statuses are possible:

- LOCKED = Device data cannot be modified by means of the FOUNDATION Fieldbus interface.
- NOT LOCKED = Device data can be modified by means of the FOUNDATION Fieldbus interface.

The parameter BLOCK_ERR indicates whether a simulation is possible in the Analog Input and Discrete Output function block.

- Simulation Active = Simulation possible in the Analog Input function block via the SIMULATE parameter and in the Discrete Output function block via the SIMULATE_D parameter.

2.4 Alarm detection and processing

Process alarms provide information on particular block statuses and block events. The status of the process alarms is communicated to the fieldbus host system via the parameter BLOCK_ALM. The parameter ACK_OPTION specifies whether an alarm must be acknowledged via the fieldbus host system.

The following process alarms are generated by the Resource Block:

Block process alarms

The following block process alarms of the Resource Block are shown via the parameter BLOCK_ALM:

- OUT OF SERVICE
- SIMULATE ACTIVE

Write protect process alarm

If write protection is disabled on the FOUNDATION Fieldbus I/O board, then prior to communicating the change of status to the fieldbus host system the alarm priority specified in the parameter WRITE_PRI is checked. The alarm priority specifies the action taken when the write protection alarm WRITE_ALM is enabled.



Hinweis!

- If the option of a process alarm has **not** been enabled in the parameter ACK_OPTION, this process alarm only has to be acknowledged in the parameter BLOCK_ALM.
- The parameter ALARM_SUM shows the current status of all the process alarms.

2.5 Parameters of the Resource Block

The following table shows all the Endress+Hauser-specific parameters of the Resource Block.



Hinweis!

FOUNDATION Fieldbus parameters are described in the "FOUNDATION Fieldbus Overview" Operating Instructions (BA013S) (acquired at: → www.endress.com → Download).

Resource Block		
Parameter	Write access with operating mode (MODE_BLK)	Description
Sensor - Serial Number	read only	Use this function to view the sensor serial number.
Amp. - HW Rev.Number	read only	Use this parameter to view the hardware revision number of the amplifier.
Amp. - HW Identification	read only	Use this parameter to view the hardware ID number of the amplifier.
Amp. - SW Rev.Number	read only	Use this function to view the software revision number of the amplifier.
Amp. - SW Identification	read only	Use this parameter to view the software ID number of the amplifier.
Amp. - Prod.-Number	read only	Use this parameter to view the production number of the amplifier.
Amp. - SW-Rev.No. T-DAT	read only	Use this parameter to view the software revision number of the software used to create the content of the T-DAT.
Amp. - Language Group	read only	Use this function to view the language group.
I/O - Type	read only	Use this function to view the I/O module type.
I/O - HW Rev.Number	read only	Use this parameter to view the hardware revision number of the I/O module.
I/O - HW Identification	read only	Use this parameter to view the hardware ID number of the I/O module.
I/O - SW Rev. Number	read only	Use this parameter to view the software revision number of the I/O module.
I/O - SW Identification	read only	Use this parameter to view the software ID number of the I/O module.
I/O - Prod.Number	read only	Use this parameter to view the production number of the I/O module.

3 Transducer Block

The Transducer Blocks contain all the measurement- and device-specific parameters of the flowmeter. All the settings directly connected with the flow measurement/application are made here. They form the interface between the sensor-specific measured value preprocessing and the Analog Input function blocks required for automation.

A Transducer Block allows you to influence the input and output values of a function block. The parameters of a Transducer Block include information on the sensor type, sensor configuration, physical units, calibration, damping, diagnosis, etc. as well as the device-specific parameters. The device-specific parameters and functions are split into several Transducer Blocks that cover different task areas.

"Flow" Transducer Block/base index 1400:

This Block contains all the flow-specific parameters and functions, e.g. calibration functions, sensor data etc. → Page 104

"Diagnosis" Transducer Block/base index 1600:

This Block contains all the parameters for system diagnosis, e.g. current system condition etc. → Page 122

"Display" Transducer Block/base index 1800:

This Block contains all the parameters for the configuration of the local display → Page 126

"Totalizer" Transducer Block/base index 1900:

This Block contains all the parameters for the configuration of the totalizers → Page 140

"Advanced Diagnostics" Transducer Block/base index 2500:

This Block contains all the parameters for the configuration of the totalizers → Page 144

3.1 Signal processing

The following figure shows the internal structure of the individual Transducer Blocks:

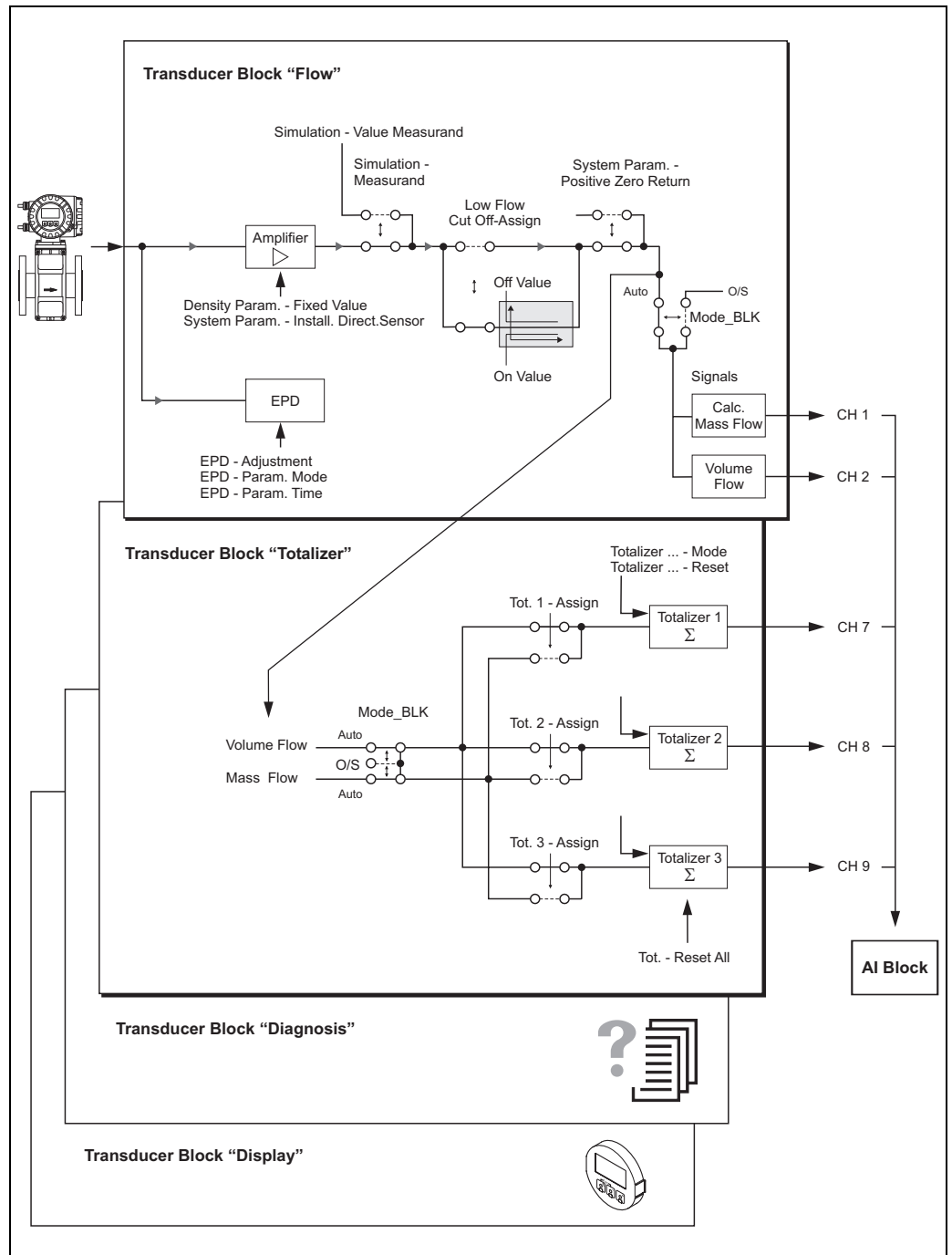

A0006545-EN

Abb. 2: Internal structure of the individual Transducer Blocks

The "Flow" Transducer Block receives a signal variable (volume) from the sensor as the input signal. The amplifier converts this input signal to volume flow. The amplifier calculates the current mass flow via the "Density Param. - Fixed Value" parameter (→ Page 118) by deriving the value from the measured volume flow.

Optionally, the empty pipe detection function can be adjusted and switched on or off by means of the EPD parameter group.

The parameter "Simulate - Value Measurand" (→ Page 120) allows you to specify a simulation value in order to test assigned parameters in the device and downstream function blocks. The process variable (volume or mass flow) to be simulated is selected by means of the "Simulation - Measurand" parameter (→ Page 119).

The parameter "Low Flow Cut Off - On-Value" (see → Page 110) allows you to define a limit value for low flow cut off. If the measured flow value is below this limit value then the output value of 0 is output.

In addition, the parameter "Sys. - Positive Zero Return" (→ Page 108) allows you to switch the measured value to "Zero Flow". This is necessary when a piping system is being cleaned, for example.

The "Flow" Transducer Block makes the process variables volume and mass flow available to the downstream function blocks. Depending on these two process variables, the "Totalizer" Transducer Block derives the integrated measured variables Totalizer 1 to 3 which are then also made available as a process variable at the output for further processing. In addition, the totalizers are also configured in this Block; for example all totalizers can be reset simultaneously by means of the "Tot. - Reset All" parameter (→ Page 143 ff.).

The "Diagnosis" Transducer Block comprises all the parameters and functions necessary for the diagnosis and maintenance of the device. For example, the "Diag. - Act.Sys.Condition" parameter displays the current system condition or, if an error occurs, provides a detailed reason for the error (→ Page 122 ff.).

If the measuring device is equipped with a local display, various display parameters can be configured by means of the "Display" Transducer Block, e.g. display language, contrast etc. (→ Page 126 ff.).

The "Diagnosis" and "Display" Transducer Blocks do not have any output variables, i.e. they only affect the measuring device itself.

The primary functions and parameters of the Transducer Blocks are listed below. You will find an overview of all the available Endress+Hauser-specific parameters starting on → Page 104 ff.

3.2 Important functions and parameters of the Transducer Blocks

3.2.1 Block output values

The Transducer Blocks make the following output variables (process variables) available:

- "Flow" Transducer Block:
 - Calculated mass flow
 - Volume flow
- "Totalizer" Transducer Block
 - Totalizer 1
 - Totalizer 2
 - Totalizer 3
- The "Diagnosis" and "Display" Transducer Blocks do not have any output variables.

The CHANNEL parameter in the Analog Input function block is used to assign which process variable is read in and processed in the downstream Analog Input function block:

- Process variable calculated mass flow → CHANNEL 1 (Analog Input function block)
- Process variable volume flow → CHANNEL = 2 (Analog Input function block)
- Process variable totalizer 1 → CHANNEL = 7 (Analog Input function block)
- Process variable totalizer 2 → CHANNEL = 8 (Analog Input function block)
- Process variable totalizer 3 → CHANNEL 9 (Analog Input function block)

3.2.2 Selecting the operating mode

The operation mode is set by means of the MODE_BLK parameter group. The Transducer Blocks support the following operation modes:

- AUTO (automatic mode)
- OOS (out of service)



Hinweis!

- The block status OOS is also shown via the parameter BLOCK_ERR. In operating mode OOS, if write protection is not enabled and the access code is entered, you can access all the write parameters without restriction.
- The following applies for the "Flow" and "Totalizer" Transducer Blocks: With the "OOS" operating mode, the process variables are updated but the status of the output value OUT (AI Block) changes to "BAD".
- If problems occur during the configuration of the function blocks → see Operating Instructions for Proline Promag 55 FOUNDATION Fieldbus (BA126D), "Troubleshooting" section.

3.2.3 Alarm detection and processing

The Transducer Blocks do not generate any process alarms. The status of the process variables is evaluated in the downstream Analog Input function blocks. If the Analog Input function block does not receive an input value that can be evaluated from the "Flow" or "Totalizer" Transducer Blocks, then a process alarm is generated. This process alarm is displayed in the BLOCK_ERR parameter of the Analog Input function block (BLOCK_ERR = Input Failure).

The parameter BLOCK_ERR of the Transducer Blocks displays the device error that produced the input value that could not be evaluated and thus triggered the process alarm in the Analog Input function block.

In addition, the active device error is displayed via the "Diagnosis" Transducer Block in the "Diagnosis - Act.Sys. Condition" parameter (→ Page 122).

For further information on rectifying errors → see Operating Instructions for Proline Promag 55 FOUNDATION Fieldbus (BA126D), "Troubleshooting" section.

3.2.4 Diagnosis

The status of the device is displayed via the following parameters specified in the FOUNDATION Fieldbus specification:

- BLOCK_ERR
- Transducer Error

More detailed information on the current device status is displayed via the "Diagnosis" Transducer Block in the manufacturer-specific parameter "Diag. - Act.Sys.Condition" (→ Page 122).

For further information on rectifying errors → see Operating Instructions for Proline Promag 55 FOUNDATION Fieldbus (BA126D), "Troubleshooting" section.

3.2.5 Accessing the device-specific parameters

To access the device-specific parameters the following requirements must be met:

1. Hardware write protection must be deactivated → see Operating Instructions for Proline Promag 55 FOUNDATION Fieldbus (BA126D).
2. The correct code must be entered by means of the corresponding Transducer Block in the "Access - Code" parameter.

3.3 Parameters of the "Flow" Transducer Block



The following table shows all the Endress+Hauser-specific parameters of the "Flow" Transducer Block. These can only be changed after entering an enabling code in the "Access - Code" parameter.





Hinweis!



FOUNDATION Fieldbus parameters are described in the "FOUNDATION Fieldbus Overview" Operating Instructions (BA013S) (acquired at: → www.endress.com → Download).

"Flow" Transducer Block/base index 1400		
Parameter	Write access with operating mode (MODE_BLK)	Description
Access - Code	AUTO - OOS	<p>All data of the measuring system are protected against inadvertent change. Only when the code has been entered in this parameter can the manufacturer-specific parameters be programmed and the device configuration modified.</p> <p>You can enable programming by entering:</p> <ul style="list-style-type: none"> ■ Code 55 (factory setting) ■ Personal code (→ Page 127) <p>User input: Max. 4-digit number (0 to 9999)</p> <p> Hinweis!</p> <ul style="list-style-type: none"> ■ If the write protection is enabled then access to the manufacturer-specific parameters is blocked even if the right code is entered. Write protection can be activated and deactivated by means of jumpers on the I/O board (→ see Operating Instructions for Proline Promag 55 FOUNDATION Fieldbus, BA126D). ■ You can disable programming again by entering any number (other than the access code) in this parameter. ■ The Endress+Hauser service organization can be of assistance if you mislay your personal code. ■ Certain parameters are not accessible unless a special service code is entered. This service code is known only to the Endress+Hauser service organization. Please contact your Endress+Hauser service center if you require clarification. ■ The entry made here does not affect the local display. Thus, programming via the function matrix must be enabled separately.
Access - Status	read only	<p>Use this parameter to display the current status of the possibilities for accessing the manufacturer-specific parameters of the device.</p> <p>User interface:</p> <ul style="list-style-type: none"> ■ LOCKED (parameterization disabled) ■ ACCESS CUSTOMER (parameterization enabled) ■ ACCESS SERVICE (parameterization enabled, access to service level)



"Flow" Transducer Block/base index 1400		
Parameter	Write access with operating mode (MODE_BLK)	Description
System Value - Volume Flow	read only	<p>Use this parameter to view the current volume flow. The volume flow is made available as a process variable to the downstream Analog Input function blocks.</p> <p> Hinweis! The unit is displayed in the "System Unit - Volume Flow" parameter (→ Page 105).</p>
System Unit - Volume Flow	AUTO - OOS	<p>Use this parameter to select the unit for the volume flow (volume/time).</p> <p>The unit you select here is also valid for:</p> <ul style="list-style-type: none"> ■ Simulation ■ Low flow cut off ■ Display value (local display) <p>Options:</p> <p>Metric: Cubic centimeter → cm³/s; cm³/min; cm³/h; cm³/day Cubic decimeter → dm³/s; dm³/min; dm³/h; dm³/day Cubic meter → m³/s; m³/min; m³/h; m³/day Milliliter → ml/s; ml/min; ml/h; ml/day Liter → l/s; l/min; l/h; l/day Hectoliter → hl/s; hl/min; hl/h; hl/day Megaliter → Ml/s; Ml/min; Ml/h; Ml/day</p> <p>US: Cubic centimeter → cc/s; cc/min; cc/h; cc/day Acre foot → af/s; af/min; af/h; af/day Cubic foot → ft³/s; ft³/min; ft³/h; ft³/day Fluid ounce → oz f/s; oz f/min; oz f/h; oz f/day Gallon → gal/s; gal/min; gal/h; gal/day Kilo gallon → Kgal/s; Kgal/min; Kgal/h; Kgal/day Million gallon → Mgal/s; Mgal/min; Mgal/h; Mgal/day Barrel (normal fluids: 31.5 gal/bbl) → bbl/s; bbl/min; bbl/h; bbl/day Barrel (beer: 31.0 gal/bbl) → bbl/s; bbl/min; bbl/h; bbl/day Barrel (petrochemicals: 42.0 gal/bbl) → bbl/s; bbl/min; bbl/h; bbl/day Barrel (filling tanks: 55.0 gal/bbl) → bbl/s; bbl/min; bbl/h; bbl/day</p> <p>Imperial: Gallon → gal/s; gal/min; gal/h; gal/day Mega gallon → Mgal/s; Mgal/min; Mgal/h; Mgal/day Barrel (beer: 36.0 gal/bbl) → bbl/s; bbl/min; bbl/h; bbl/day Barrel (petrochemicals: 34.97 gal/bbl) → bbl/s; bbl/min; bbl/h; bbl/day</p> <p>Factory setting: Depends on nominal diameter and country → Page 167 ff.</p> <p> Hinweis! The unit selected here does not have any effect on the desired volume unit which should be transmitted by means of the FOUNDATION Fieldbus interface. This setting is made separately by means of the corresponding AI Block in the XD_SCALE parameter group.</p>
System Value - Mass Flow	read only	<p>Use this function to view the calculated mass flow. The mass flow is derived from the measured volume flow and the fixed density value (→ Page 118). The calculated mass flow is made available as a process variable to the downstream Analog Input function blocks.</p> <p> Hinweis! The unit is displayed in the "System Unit - Mass Flow" parameter (→ Page 106).</p>



"Flow" Transducer Block/base index 1400		
Parameter	Write access with operating mode (MODE_BLK)	Description
System Unit - Mass Flow	AUTO - OOS	<p>Use this parameter to select the unit for the mass flow (mass/time).</p> <p>The unit you select here is also valid for:</p> <ul style="list-style-type: none"> ■ Simulation ■ Low flow cut off ■ Display value (local display) <p>Options: Metric: gram → g/s; g/min; g/h; g/day kilogram → kg/s; kg/min; kg/h; kg/day Metric ton → t/s; t/min; t/h; t/day</p> <p>US: ounce → oz/s (US); oz/min (US); oz/h (US); oz/day (US) Pound → lb/s; lb/min; lb/h; lb/day Ton → ton/s; ton/min; ton/h; ton/day</p> <p>Factory setting: Depends on nominal diameter and country → Page 167 ff.</p> <p> Hinweis! The unit selected here does not have any effect on the desired mass flow unit which should be transmitted by means of the FOUNDATION Fieldbus interface. This setting is made separately by means of the corresponding AI Block in the XD_SCALE parameter group.</p>
System Value - Fixed Density	read only	<p>Use this function to view the set density. This density value can be modified by means of the "Density Param. - Fixed Value" parameter (→ Page 118).</p> <p>Factory setting: 1</p> <p> Hinweis! The unit is displayed in the "System Unit - Fixed Density" parameter (→ Page 106).</p>
System Unit - Fixed Density	AUTO - OOS	<p>Use this parameter to select the unit for displaying the fluid density.</p> <p>The unit you select here is also valid for:</p> <ul style="list-style-type: none"> ■ Density entry "Density Param. - Fixed Value", → Page 118) <p>Options: Metric → g/cm³; g/cc; kg/dm³; kg/l; kg/m³; SD 4 °C, SD 15 °C, SD 20 °C; SG 4 °C, SG 15 °C, SG 20 °C; g/l</p> <p>US → lb/ft³; lb/gal; lb/bbl (normal fluids); lb/bbl (beer); lb/bbl (petrochemicals); lb/bbl (filling tanks)</p> <p>Imperial → lb/gal; lb/bbl (beer); lb/bbl (petrochemicals)</p> <p>Factory setting: kg/l (SI units: not for USA and Canada) g/cc (US units: only for USA and Canada)</p> <p>SD = Specific Density, SG = Specific Gravity The specific density is the ratio of fluid density to water density (at water temperature = 4, 15, 20 °C).</p>

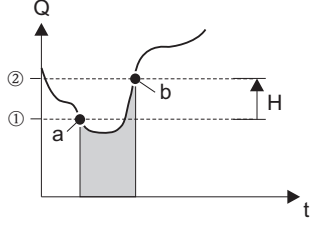

"Flow" Transducer Block/base index 1400		
Parameter	Write access with operating mode (MODE_BLK)	Description
System Value - Density Input	read only	Use this function to view the density fed in via the AO block. User interface: 5-digit floating-point number, including unit (corresponding to 0.10000 to 6.0000 kg/dm ³) e.g. 1.2345 kg/dm ³ ; 993.5 kg/m ³ ; 1.0015 SG_20 °C; etc.
System Option - Conductivity	read only	This parameter is only used in the event of a service.
System Value - Conductivity	read only	Use this function to select the unit for displaying the conductivity (only when conductivity is switched on → Page 119). Options: µS/cm, mS/cm, S/m Factory setting: µS/cm
System Unit - Conductivity	AUTO - OOS	Use this function to select the unit for displaying the conductivity (only when conductivity is switched on → Page 119). Options: µS/cm, mS/cm, S/m Factory setting: µS/cm
System Unit - Length	AUTO - OOS	Use this parameter to select the unit for displaying the length of the nominal diameter. The unit you select here is also valid for: Nominal diameter of sensor ("Sensor Data - Conductivity Enable", → Page 119) Options: MILLIMETER INCH Factory setting: MILLIMETER (SI units: not for USA and Canada) INCH (US units: only for USA and Canada)
Sys. - Install. Direction Sensor	AUTO - OOS	Use this parameter to reverse the sign of the flow measured variable, if necessary. Options: NORMAL FORWARD (flow as indicated by the arrow) INVERSE REVERSE (flow opposite to direction indicated by the arrow) Factory setting: NORMAL FORWARD  Hinweis! Ascertain the actual direction of fluid flow with reference to the direction indicated by the arrow on the sensor (nameplate).

"Flow" Transducer Block/base index 1400		
Parameter	Write access with operating mode (MODE_BLK)	Description
Sys. - System Damping	AUTO - OOS	<p>Use this function to set the filter depth of the digital filter. This reduces the sensitivity of the measuring signal to interference peaks (e.g. high solids content, gas bubbles in the fluid, etc.). The reaction time of the measuring system increases with every increase in the filter setting. The damping acts on all parameters and on all downstream function blocks.</p> <p>User input: 0 to 15</p> <p>Factory setting: 7</p> <p> Hinweis! The system damping acts on all functions and outputs of the measuring device.</p>
Sys. - Integration Time	AUTO - OOS	<p>Use this function to view the set integration time.</p> <p>The integration time defines the duration of internal totaling of the induced voltage in the fluid (measured by the measuring electrode), i.e. the time in which the measuring device records the true flow (afterwards the magnetic field for the next integration is created from the opposite pole).</p> <p>User interface: Max. 2-digit number: 1 to 65 ms</p> <p>Factory setting: 5 ms</p>
Sys. - Positive Zero Return	AUTO - OOS	<p>Use this parameter to interrupt evaluation of measured variables. This is necessary when a piping system is being cleaned, for example. This setting acts on all parameter and calculations of the measuring device.</p> <p>Options: Off (signal output not interrupted) ON (signal output is set to the value for "Positive zero return" or "Zero flow")</p> <p>Factory setting: OFF</p> <p> Hinweis!</p> <ul style="list-style-type: none"> ■ If positive zero return is active, a flow value of "0" is output via the output value OUT (AI Block). ■ Active positive zero return is relayed to downstream function blocks or higher-order process control systems by means of the status UNCERTAIN of the output value OUT (AI Block). ■ Positive zero return can also be controlled using cyclic data transfer via the Discrete Output function block.

"Flow" Transducer Block/base index 1400		
Parameter	Write access with operating mode (MODE_BLK)	Description
Sys. - Special Filter	AUTO - OOS	<p>There is the option of activating two signal filters in this parameter. These filters make it possible to either suppress the signal caused by severely fluctuating flows (STANDARD option) or to reproduce it completely – both on the display and at the FOUNDATION Fieldbus output (DYNAMIC FLOW option).</p> <p>Options: STANDARD For signal output with normal, stable flow.</p> <p>DYNAMIC FLOW For signal output with severely fluctuating or pulsating flow.</p> <p>Factory setting: STANDARD</p> <p> Achtung!</p> <ul style="list-style-type: none"> ■ The signal behavior at the outputs also depends on the "Sys.-Flow Damping" parameter. ■ Additional filter settings (e.g. STANDARD CIP or DYNAMIC FLOW CIP) can only be selected with the aid of a special service code. Such settings, which are normally made by a service technician, are deleted, however, when the private code is entered again and can then no longer be activated!
Sys. - CIP Samples	AUTO - OOS	This parameter is only used in the event of a service.
Sys. - Permanent Storage	read only	<p>This parameter indicates whether permanent saving of all parameters in the EEPROM is switched on or off.</p> <p>User interface: OFF ON</p> <p>Factory setting: ON</p>
Low Flow Cut Off - Assign	AUTO - OOS	<p>Use this parameter to assign the switch point for the low flow cut off.</p> <p>Options: OFF VOLUME FLOW MASS FLOW</p> <p>Factory setting: VOLUME FLOW</p>

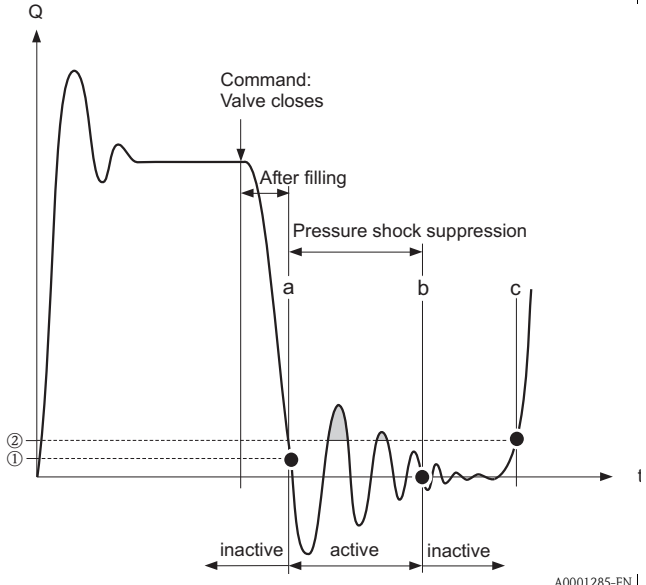
"Flow" Transducer Block/base index 1400		
Parameter	Write access with operating mode (MODE_BLK)	Description
Low Flow Cut Off - On Value	AUTO - OOS	<p>Use this function to specify the switch-on point for low flow cut off. Low flow cut off is active if the value entered is not equal to 0.</p> <p>User input: 5-digit floating-point number [unit]</p> <p>Factory setting: Depends on nominal diameter and country → Page 167 ff.</p> <p> Hinweis!</p> <ul style="list-style-type: none"> ■ When the low flow cut off is triggered, a flow value of "0" is output via the output value OUT (AI Block). In addition, the status changes to UNCERTAIN. ■ Choice of unit: see "Low Flow Cut Off - Unit" parameter (→ Page 110).
Low Flow Cut Off - Unit	read only	<p>Use this parameter to view the unit for the low flow cut off.</p> <p> Hinweis!</p> <p>The unit for low flow cut off is determined by means of the "System Unit - Volume Flow" or "System Unit - Mass Flow" parameter (→ Page 105 ff.).</p>
Low Flow Cut Off - Off Value	AUTO - OOS	<p>Use this function to enter the switch-off (b) point for low flow cut off. Enter the switch-off point as a positive hysteresis (H) from the switch-on point (a).</p> <p>User input: Integer 0 to 100%</p> <p>Factory setting: 50%</p> <div style="text-align: center;">  </div> <p>① = switch-on point , ② = switch-off point</p> <p>a Low flow cut off is switched on b Low flow cut off is switched off (a + a · H) H Hysteresis value: 0 to 100% ■ Low flow cut off active Q Flow</p> <p style="text-align: right; font-size: small;">A0003882</p>



"Flow" Transducer Block/base index 1400		
Parameter	Write access with operating mode (MODE_BLK)	Description
Process - Pressure Shock Suppression	AUTO - OOS	<p>The closure of a valve can cause brief but severe movements of the fluid in the piping system, movements which the measuring system registers. The pulses totaled in this way result in a totalizer reading error, particularly in the case of batching processes. For this reason, the measuring device is equipped with pressure shock suppression (= short-term signal suppression) which can eliminate system-related "disruptions".</p> <p> Hinweis! Note that pressure shock suppression cannot be used unless the low flow cut off is active (see the "Low Flow Cut Off - On Value" parameter → Page 110).</p> <p>Use this function to define the time span for active pressure shock suppression.</p> <p>Activation of pressure shock suppression Pressure shock suppression is activated once the flow falls below the switch-on point of the low flow cut off (see point a in graphic).</p> <p>While pressure shock suppression is active, the following conditions apply:</p> <ul style="list-style-type: none"> ■ Flow reading on display → 0 ■ Totalizer reading → The totalizers are pegged at the last correct value. <p>Deactivation of pressure shock suppression The pressure shock suppression is deactivated after the time interval, set in this function, has passed (see point b).</p> <p> Hinweis! The actual flow value is displayed and output, when the time interval for the pressure shock suppression has passed and the flow exceeds the switch-off point of the low flow cut off (see point c in graphic).</p>  <p style="text-align: right; font-size: small;">A0001285-EN</p> <p><i>m = on value (low flow cut off), n = off value (low flow cut off)</i></p> <p>User input: Max. 4-digit number, incl. unit: 0.00 to 100.0 s</p> <p>Factory setting: 0.00 s</p>





"Flow" Transducer Block/base index 1400		
Parameter	Write access with operating mode (MODE_BLK)	Description
Process - Conductivity	AUTO - OOS	<p>Use this function to switch on the conductivity measurement.</p> <p>Options: OFF LONG INTERVAL Measurement every 500th flow measurement (500 × measuring period → Page 119) SHORT INTERVAL Measurement every 50th flow measurement (50 × measuring period → Page 119)</p> <p>Factory setting: OFF</p> <p> Note!</p> <ul style="list-style-type: none"> ■ The availability of this function depends on characteristics of the sensors (see Sensor Data - Conductivity Enable → Page 119). ■ If conductivity is switched on it is highly recommended setting the system damping >3 → Page 108. <p> Caution!</p> <p>Because the electrodes are not available for flow measurement during the conductivity measurement (up to 8 × measuring period → Page 119) the flow value will be frozen. Therefore momentary flow changes might be unrecognized.</p>

"Flow" Transducer Block/base index 1400		
Parameter	Write access with operating mode (MODE_BLK)	Description
EPD - Adjustment	AUTO - OOS	<p>Use this parameter to perform EPD adjustment for an empty or full measuring tube.</p> <p>Options: OFF FULL PIPE ADJUST EMPTY PIPE ADJUST</p> <p>Factory setting: OFF</p> <p>Procedure for empty pipe / full pipe adjustment</p> <ol style="list-style-type: none"> 1. Make sure that hardware write protection is switched off (→ see Operating Instructions for Proline Promag 55 FOUNDATION Fieldbus, BA0126). 2. In the configuration program, open the "Flow" Transducer Block. 3. Enable the configuration of the device by means of the "Access - Code" parameter (→ Page 104). Check the status by means of the "Access - Status" parameter → ACCESS CUSTOMER (→ Page 104). 4. Empty the pipe. For the following empty pipe adjustment, the wall of the measuring tube should still be wetted with fluid. 5. Start empty pipe adjustment: In this parameter, select the "... EMPTY PIPE ADJUST" setting and start empty pipe adjustment by sending the setting to the field device. 6. After empty pipe adjustment, fill the piping with fluid. 7. Start full pipe adjustment with fluid at a standstill: In this parameter, select the "... FULL PIPE ADJUST" setting and start full pipe adjustment by sending the setting to the field device. 8. Having completed the adjustment, select the setting "OFF" and exit the function by sending the setting to the field device. 9. Select "EPD - Empty Pipe Detection" parameter (→ Page 114) and switch on empty pipe detection by selecting the setting "ON". <p> Achtung! The adjustment values must be valid before you can switch on the EPD function. If calibration is faulty, the following messages are output in the "Diagnosis" Transducer Block via the "Diag. - Act.Sys.Condition" parameter (→ Page 122):</p> <ul style="list-style-type: none"> ■ EPD adjustment wrong - Err. No. 463: The adjustment values for empty pipe and full pipe are identical. EPD adjustment must be repeated. This error is relayed to downstream function blocks or higher-order process control systems by means of the status "BAD" of the output value OUT (AI Block). ■ EPD adjustment not possible - Err. No. 461: Adjustment is not possible as the fluid conductivity values are outside the permitted range. This error is relayed to downstream function blocks or higher-order process control systems by means of the status "UNCERTAIN" of the output value OUT (AI Block).



"Flow" Transducer Block/base index 1400		
Parameter	Write access with operating mode (MODE_BLK)	Description
EPD - Empty Pipe Detection	AUTO - OOS	<p>This status can be monitored at all times with the Empty Pipe Detection function. To do this, the empty pipe detection (EPD, empty pipe detection by means of EPD electrode) can be activated in this function:</p> <p>Options: OFF ON STANDARD</p> <p>Factory setting: OFF</p> <p> Hinweis!</p> <ul style="list-style-type: none"> ■ The option ON STANDARD is not available unless the sensor is equipped with an EPD electrode (see "EPD - Electrode" parameter, → Page 115). ■ The default setting for the EPD function when the device is delivered is OFF. The function must be activated as required. ■ The devices are already calibrated at the factory with water (approx. 500 µS/cm). If the conductivity of certain fluids deviates from this reference, empty pipe/full pipe adjustment must be performed again on site (see "EPD - Adjustment" parameter → Page 113). ■ The adjustment coefficients must be valid before you can switch on the EPD function (see "EPD - Adjustment" → Page 113). ■ If there are problems with the adjustment, the following error messages appear on the screen: <ul style="list-style-type: none"> – EPD adjustment wrong - Err. No. 463: The adjustment values for empty pipe and full pipe are identical. In such instances, empty pipe adjustment/full pipe adjustment must be carried out again. – EPD adjustment not possible - Err. No. 461: Adjustment is not possible as the fluid conductivity values are outside the permitted range. <p>Notes on empty pipe detection (EPD)</p> <ul style="list-style-type: none"> ■ Flow cannot be measured correctly unless the measuring tube is completely full. This status can be monitored at all times with the EPD function. ■ An empty or partially filled pipe is a process error. A default factory setting defines that a notice message is issued and that this process error has no effect on the outputs. ■ A plausibility check of the adjustment values will only be executed by activating the empty pipe detection. If an empty or full pipe adjustment is performed when empty pipe detection is active, the empty pipe detection has to be deactivated and activated again after finishing the adjustment in order to start the plausibility check. <p>Response to partially filled pipes</p> <p>If the EPD function is switched on and is triggered by a partially empty or completely empty pipe, this is indicated in the "Diag. - Act.Sys.Condition" parameter (→ Page 122) of the "Diagnosis" Transducer Block with the error message "Empty Pipe detected - Err. No. 401".</p> <p>This process error is relayed to downstream function blocks or higher-order process control systems by means of the status "UNCERTAIN" of the output value OUT (AI Block).</p> <p>If the pipe is partially empty and the EPD is not switched on, the response can vary in identically configured systems:</p> <ul style="list-style-type: none"> ■ Flow reading fluctuates ■ Zero flow ■ Excessively high flow values



"Flow" Transducer Block/base index 1400		
Parameter	Write access with operating mode (MODE_BLK)	Description
EPD - Response Time	AUTO - OOS	Use this parameter to enter the time span in which the criteria for an empty pipe have to be satisfied without interruption before an error message is generated. User input: fixed point number: 1.0 to 100 s Factory setting: 1.0 s
EPD - Threshold	read only	This parameter is only used in the event of a service.
EPD - Electrode	AUTO - OOS	Use this parameter to check whether the sensor is equipped with an EPD electrode. User interface: YES - NO Factory setting: YES → Electrode fitted as standard
EPD - Empty Pipe Coef.	read only	This parameter is only used in the event of a service.
EPD - Full Pipe Coef.	read only	This parameter is only used in the event of a service.
OED - Period	read only	This parameter is only used in the event of a service.
OED - Empty Value	read only	This parameter is only used in the event of a service.
OED - Full Value	read only	This parameter is only used in the event of a service.
System Option - ECC	read only	This parameter is only used in the event of a service.

"Flow" Transducer Block/base index 1400		
Parameter	Write access with operating mode (MODE_BLK)	Description
ECC	AUTO - OOS	<p> Note! This function is not available unless the measuring device is equipped with an (optional) electrode cleaning function.</p> <p>Use this function to activate cyclical electrode cleaning (ECC).</p> <p>Options: ON (only with the optional electrode cleaning function ECC) OFF</p> <p>Factory setting: ON (only if the optional electrode cleaning function ECC is available)</p> <p>Notes on electrode cleaning (ECC) Conductive deposits on the electrodes and on the walls of the measuring tube (e.g. magnetite) can falsify measurement values. The Electrode Cleaning Circuitry (ECC) was developed to prevent such conductive deposits accreting in the vicinity of the electrodes. ECC functions as described above for all available electrode materials except tantalum. If tantalum is used as the electrode material, the ECC protects the electrode surface only against oxidation.</p> <p> Caution! If the ECC is switched off for a prolonged period in applications with conductive deposits, a layer forms inside the measuring tube and this can falsify measurement values. If the layer is allowed to accrete beyond a certain level, it might no longer be possible to remove it by switching on the ECC. If this happens the measuring tube must be cleaned and the layer removed.</p>
ECC - Duration	AUTO - OOS	<p> Note! This function is not available unless the measuring device is equipped with the optional electrode cleaning function (ECC).</p> <p>Use this function to specify the electrode cleaning duration.</p> <p>User input: Fixed-point number: 0.01 to 30.0 s</p> <p>Factory setting: 2.0 s</p>

"Flow" Transducer Block/base index 1400		
Parameter	Write access with operating mode (MODE_BLK)	Description
ECC - Recovery Time	AUTO - OOS	<p> Note! This function is not available unless the measuring device is equipped with the optional electrode cleaning function (ECC).</p> <p>Use this function to specify the recovery time for which the last flow value measured prior to cleaning is retained. A recovery time is necessary as the signal outputs can fluctuate after electrode cleaning on account of electrochemical interference voltages.</p> <p>User input: max. 3-digit number: 1 to 600 s</p> <p>Factory setting: 60 s</p> <p> Caution! The last value measured prior to cleaning is output for the duration of the recovery time (max. 600 s). This in turn means that the measuring system does not register changes in flow, e.g. stoppage, during this time span.</p>
ECC - Cycle	AUTO - OOS	<p> Note! This function is not available unless the measuring device is equipped with the optional electrode cleaning function (ECC).</p> <p>Use this function to specify the cleaning cycle for electrode cleaning.</p> <p>User input: Integer: 30 to 10080 min</p> <p>Factory setting: 40 min</p>
ECC - Polarity	read only	<p>Use this function to display the actual current polarity for optional electrode cleaning (ECC). Electrode cleaning uses either a positive or negative current, depending on the electrode material. The measuring device automatically selects the correct polarity on the basis of the electrode-material data stored in the S-DAT.</p> <p>User interface: POSITIVE → for electrodes made of: 1.4435/316L, Alloy C-22, platinum, titanium, tungsten carbide coating (for electrodes made of 1.4435), 1.4310/302 NEGATIVE → for electrodes made of: tantalum</p> <p> Caution! If the incorrect current is applied to the electrodes, the electrode material is destroyed.</p>

"Flow" Transducer Block/base index 1400		
Parameter	Write access with operating mode (MODE_BLK)	Description
Density Param. - Fixed Value	AUTO - OOS	<p>Use this parameter to enter a density factor (preferably at process temperature or reference temperature) which is used to convert the volume flow to a mass flow.</p> <p> Hinweis! The unit is taken from the "Density Param. - Unit" parameter (→ Page 118).</p> <p>User input: 5-digit floating-point number</p> <p>Factory setting: 1 [unit]</p>
Density Param. - Unit	read only	Use this function to display the unit selected in the "System Unit - Fixed Density" parameter for the fixed density value (→ Page 106).
Sensor Data - K-Factor Positive	AUTO - OOS	<p>Use this function to display the actual calibration factor (positive flow direction) for the sensor. The calibration factor is determined and set at the factory.</p> <p>User interface: 5-digit fixed point number: 0.5000 to 2.0000</p> <p>Factory setting: Depends on nominal diameter and calibration</p>
Sensor Data - K-Factor Negative	AUTO - OOS	<p>Use this function to display the actual calibration factor (negative flow direction) for the sensor. The calibration factor is determined and set at the factory.</p> <p>User interface: 5-digit fixed point number: 0.5000 to 2.0000</p> <p>Factory setting: Depends on nominal diameter and calibration</p>
Sensor Data - Zero Point	AUTO - OOS	<p>Use this function to view the actual zero-point correction value for the sensor. Zero-point correction is determined and set at the factory.</p> <p>User interface: Max. 4-digit number: -1000 to +1000</p> <p>Factory setting: Depends on nominal diameter and calibration</p>
Sensor Data - Nominal Diameter	AUTO - OOS	<p>Use this function to view the nominal diameter of the sensor. The nominal diameter depends on the size of the sensor and is set at the factory.</p> <p>User interface: 2 to 2000 mm or 1/12 to 78"</p> <p>Factory setting: Depends on the size of the sensor</p>
Sensor Data - Cell Constant	read only	This parameter is only used in the event of a service.

"Flow" Transducer Block/base index 1400		
Parameter	Write access with operating mode (MODE_BLK)	Description
Sensor Data - Conductivity Enable	AUTO - OOS	<p>Use this function to check whether the sensor is capable of conductivity measurement. The availability of this function depends on characteristics of the sensors.</p> <p>User interface: YES → Conductivity enable: – Sensor S (without brush electrodes) NO → Conductivity not enable: – Sensor S (with brush electrodes) – Sensor H</p>
Sensor Data - Measuring Period	AUTO - OOS	<p>Use this function to view the measuring period. The duration of the measuring period is calculated from the rise time of the magnetic field, the brief recovery time, the integration time and the empty pipe detection time.</p> <p>User interface: Max. 4-digit number: 10 to 1000 ms</p> <p>Factory setting: Depends on nominal diameter</p> <p> Hinweis! The system checks the time entered and sets the measuring period which is actually used internally to a plausible value. If you enter 0 ms, the system automatically computes the shortest time.</p>
Sensor Data - Overvoltage Time	read only	This parameter is only used in the event of a service.
Simulation - Measurand	AUTO - OOS	<p>Use this parameter to activate the simulation of the volume flow/mass flow.</p> <p>Options: OFF VOLUME FLOW MASS FLOW CONDUCTIVITY</p> <p>Factory setting: OFF</p> <p> Achtung!</p> <ul style="list-style-type: none"> ■ The measuring device cannot be used for measuring while this simulation is in progress. ■ The simulation acts independently of the position of the jumpers on the I/O board (→ see Operating Instructions for Proline Promag 55 FOUNDATION Fieldbus, BA126D). ■ The setting is not saved if the power supply fails. <p> Hinweis! Active simulation is relayed to downstream function blocks or higher-order process control systems by means of the status UNCERTAIN of the output value OUT (AI Block).</p>

"Flow" Transducer Block/base index 1400		
Parameter	Write access with operating mode (MODE_BLK)	Description
Simulation - Value Measurand	AUTO - OOS	<p>Use this parameter to specify a selectable value (e.g. 12 m³/s). This is used to test the associated parameters in the device itself and downstream signal loops.</p> <p>User input: 5-digit floating-point number</p> <p>Factory setting: 0 [unit]</p> <p> Hinweis! The unit is taken from the "System Unit - Volume Flow" or "System Unit - Mass Flow" parameter (→ Page 105 ff.).</p> <p> Achtung! The setting is not saved if the power supply fails.</p>
Simulation - Unit	read only	<p>Use this parameter to display the current unit for the simulation value in the "Simulation - Measurand Value" parameter.</p> <p> Hinweis! The unit can be selected in the "System Unit - Volume Flow" or "System Unit - Mass Flow" parameter (→ Page 105).</p>
Service/Analys. - Measuring Period	read only	This parameter is only used in the event of a service.
Service/Analys. - Risetime	read only	This parameter is only used in the event of a service.
Service/Analys. - Reverse Time	read only	This parameter is only used in the event of a service.
Service/Analys. - Split Position	read only	This parameter is only used in the event of a service.
Service/Analys. - Coil Voltage	read only	This parameter is only used in the event of a service.
Service/Analys. - Electrode Pot. 1	read only	This parameter is only used in the event of a service.
Service/Analys. - Electrode Pot. 2	read only	This parameter is only used in the event of a service.
Service/Analys. - Noise Value	read only	This parameter is only used in the event of a service.

"Flow" Transducer Block/base index 1400		
Parameter	Write access with operating mode (MODE_BLK)	Description
Sys. - Filterdepth Median	AUTO - OOS	<p>There is the option of activating two signal filters in this function. These filters make it possible to either suppress the signal caused by severely fluctuating flows (STANDARD option) or to reproduce it completely – both on the display and at the FOUNDATION Fieldbus output (DYNAMIC FLOW option).</p> <p>Options: STANDARD For signal output with normal, stable flow.</p> <p>DYNAMIC FLOW For signal output with severely fluctuating or pulsating flow.</p> <p>Factory setting: STANDARD</p> <p> Caution!</p> <ul style="list-style-type: none"> ■ The signal behavior at the outputs also depends on the SYSTEM DAMPING (6603) function. ■ Additional filter settings (e.g. STANDARD CIP or DYNAMIC FLOW CIP) can only be selected with the aid of a special service code. Such settings, which are normally made by a service technician, are deleted, however, when the private code is entered again and can then no longer be activated!
Sensor - Type	read only	Use this function to view the sensor type.
Sensor - SW Rev.No.S-DAT	read only	Use this function to view the software revision number of the software used to create the content of the S-DAT.
Sensor - HW Rev.Number.	read only	Use this parameter to view the hardware revision number of the sensor.
Sensor - HW Identification	read only	Use this parameter to view the hardware ID number of the sensor.
Sensor - Prod.Number	read only	Use this parameter to view the production number of the sensor.
Amp. Device Type	read only	This parameter is only used in the event of a service.

3.4 Parameters of the "Diagnosis" Transducer Block



The following table shows all the Endress+Hauser-specific parameters of the "Diagnosis" Transducer Block. These can only be changed after entering an enabling code in the "Access - Code" parameter.





Hinweis!

FOUNDATION Fieldbus parameters are described in the "FOUNDATION Fieldbus Overview" Operating Instructions (BA013S) (acquired at: → www.endress.com → Download).

"Diagnosis" Transducer Block/base index 1600		
Parameter	Write access with operating mode (MODE_BLK)	Description
Diag. - Act. Sys. Condition	read only	Displays the current system status. Hinweis! An exact error description as well as information on rectifying errors can be found in the Operating Instructions for Proline Promag 55 FOUNDATION Fieldbus (BA126D).
Diag. - Prev. Sys. Condition	read only	Displays the last error message that occurred.
Access - Code	AUTO - OOS	All data of the measuring system are protected against inadvertent change. Only when the code has been entered in this parameter can the manufacturer-specific parameters be programmed and the device configuration modified. You can enable programming by entering: <ul style="list-style-type: none"> ■ Code 55 (factory setting) ■ Personal code (→ Page 127) User input: Max. 4-digit number (0 to 9999) Hinweis! <ul style="list-style-type: none"> ■ If the write protection is enabled then access to the manufacturer-specific parameters is blocked even if the right code is entered. Write protection can be activated and deactivated by means of jumpers on the I/O board (→ see Operating Instructions for Proline Promag 55 FOUNDATION Fieldbus, BA126D). ■ You can disable programming again by entering any number (other than the access code) in this parameter. ■ The Endress+Hauser service organization can be of assistance if you mislay your personal code. ■ Certain parameters are not accessible unless a special service code is entered. This service code is known only to the Endress+Hauser service organization. Please contact your Endress+Hauser service center if you require clarification. ■ The entry made here does not affect the local display. Thus, programming via the function matrix must be enabled separately.
Access - Status	read only	Use this parameter to display the current status of the possibilities for accessing the manufacturer-specific parameters of the device. User interface: <ul style="list-style-type: none"> ■ LOCKED (parameterization disabled) ■ ACCESS CUSTOMER (parameterization enabled) ■ ACCESS SERVICE (parameterization enabled, access to service level)

"Diagnosis" Transducer Block/base index 1600		
Parameter	Write access with operating mode (MODE_BLK)	Description
Sys. - Alarm Delay	AUTO - OOS	<p>Use this parameter to define a time span in which the criteria for a fault have to be satisfied without interruption before a fault or notice message is generated.</p> <p>Depending on the setting and the type of fault, this suppression acts on:</p> <ul style="list-style-type: none"> ■ Display ■ Output blocks (AI Blocks) FOUNDATION Fieldbus interface <p>User input: 0 to 100 s (in steps of one second)</p> <p>Factory setting: 0 s</p> <p> Achtung! If this parameter is used, fault and notice messages are delayed by the time corresponding to the setting before being forwarded to the downstream function blocks or the fieldbus host system. It is therefore imperative to check in advance in order to make sure whether a delay of this nature could affect the safety requirements of the process. If fault and notice messages cannot be suppressed, a value of 0 seconds must be entered here.</p>
Sys. - Sim. Failsafe Mode	AUTO - OOS	<p>Use this parameter to set the Analog Input and Totalizer function blocks to their defined failsafe modes in order to check whether they respond correctly. The failsafe mode of the totalizers is determined via the "Tot. - Failsafe All" parameter (→ Page 143).</p> <p>Options: OFF ON</p> <p>Factory setting: OFF</p> <p> Hinweis! The active simulation mode is relayed to downstream function blocks or higher-order process control systems by means of the status "UNCERTAIN" of the output value OUT (AI Block).</p>
Sys. - Reset	AUTO - OOS	<p>Use this parameter to perform a reset of the measuring system.</p> <p>Options: NO RESTART SYSTEM (restart without interrupting power supply) ORIGINAL TRANSMITTER DATA</p> <p>Factory setting: NO</p>

"Diagnosis" Transducer Block/base index 1600		
Parameter	Write access with operating mode (MODE_BLK)	Description
Sys. - Troubleshooting	AUTO - OOS	<p>Use this parameter to rectify errors occurring in the EEPROM. The EEPROM is split into a number of blocks. The error is rectified by selecting the block in question and acknowledging.</p> <p> Achtung! When eliminating faults in a block, the parameters of the block selected are also reset to the factory setting.</p> <p>Options: CANCEL MEASURING VALUES SYSTEM UNITS DENSITY PARAMETERS QUICK SETUP USER INTERFACE TOTALIZER COMMUNICATION PROCESSPARAMETER SYSTEM PARAMETER SENSOR DATA ADVANCED DIAGNOSIS AMPLIFIER PARAMETERS SUPERVISION VERSION-INFO SERVICE & ANALYSIS PRODUCTION INFO FILTER PARAMETER</p> <p>Factory setting: CANCEL</p>
Sys. - Operation Time	read only	Use this function to view the total operating time since the flowmeter was commissioned (in seconds).
Sys. - Time Since Reset	read only	This parameter is only used in the event of a service.

"Diagnosis" Transducer Block/base index 1600		
Parameter	Write access with operating mode (MODE_BLK)	Description
<p>Sys. - T-DAT Save/Load</p>	<p>AUTO - OOS</p>	<p>Use this parameter to save the parameter settings/configuration of the transmitter in a transmitter DAT (T-DAT), or to load the parameter settings from the T-DAT into the EEPROM (manual backup function).</p> <p>Application examples:</p> <ul style="list-style-type: none"> ■ After commissioning, the actual measuring point parameters can be saved to the T-DAT as a backup. ■ If the transmitter is replaced for some reason, the data from the T-DAT can be loaded into the new transmitter (EEPROM). <p>Options: CANCEL SAVE (from EEPROM to T-DAT) LOAD (from the T-DAT into EEPROM)</p> <p>Factory setting: CANCEL</p> <p> Hinweis!</p> <ul style="list-style-type: none"> ■ If the target device has an older software version, the message "TRANSM. SW-DAT" is displayed during startup. Then only the SAVE option is available. ■ LOAD This option is only possible if: <ul style="list-style-type: none"> – The target device has the same software version as, or a more recent software version than, the source device or – The T-DAT contains valid data that can be retrieved ■ SAVE This option is always available.

3.5 Parameters of the "Display" Transducer Block



The following table shows all the Endress+Hauser-specific parameters of the "Display" Transducer Block. These can only be changed after entering an enabling code in the "Access - Code" parameter.







Hinweis!

FOUNDATION Fieldbus parameters are described in the "FOUNDATION Fieldbus Overview" Operating Instructions (BA013S) (acquired at: → www.endress.com → Download).

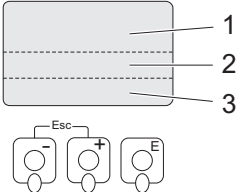

"Display" Transducer Block/base index 1800		
Parameter	Write access with operating mode (MODE_BLK)	Description
Access - Code	AUTO - OOS	<p>All data of the measuring system are protected against inadvertent change. Only when the code has been entered in this parameter can the manufacturer-specific parameters be programmed and the device configuration modified.</p> <p>You can enable programming by entering:</p> <ul style="list-style-type: none"> ■ Code 55 (factory setting) ■ Personal code (→ Page 127) <p>User input: Max. 4-digit number (0 to 9999)</p> <p> Hinweis!</p> <ul style="list-style-type: none"> ■ If the write protection is enabled then access to the manufacturer-specific parameters is blocked even if the right code is entered. Write protection can be activated and deactivated by means of jumpers on the I/O board (→ see Operating Instructions for Proline Promag 55 FOUNDATION Fieldbus). ■ You can disable programming again by entering any number (other than the access code) in this parameter. ■ The Endress+Hauser service organization can be of assistance if you mislay your personal code. ■ Certain parameters are not accessible unless a special service code is entered. This service code is known only to the Endress+Hauser service organization. Please contact your Endress+Hauser service center if you require clarification. ■ The entry made here does not affect the local display. Thus, programming via the function matrix must be enabled separately.
Access - Status	read only	<p>Use this parameter to display the current status of the possibilities for accessing the manufacturer-specific parameters of the device.</p> <p>User interface:</p> <ul style="list-style-type: none"> ■ LOCKED (parameterization disabled) ■ ACCESS CUSTOMER (parameterization enabled) ■ ACCESS SERVICE (parameterization enabled, access to service level)
Access - Code Counter	read only	<p>Displays how often the customer code, service code or the digit "0" (code-free) has been entered to gain access to the function matrix.</p> <p>User interface: Max. 7-digit number: 0 to 9999999</p> <p>Factory setting: 0</p>

"Display" Transducer Block/base index 1800		
Parameter	Write access with operating mode (MODE_BLK)	Description
Access - Def.Private Code	AUTO - OOS	<p>Use this function to specify a personal code for enabling configuration. This applies to both manufacturer-specific parameters in the Transducer Blocks and to operating via the onsite display.</p> <p>User input: 0 to 9999 (max. 4-digit number)</p> <p>Factory setting: 55</p> <p> Hinweis!</p> <ul style="list-style-type: none"> ■ Programming is always enabled with the code "0". ■ Parameter configuration has to be enabled before this code can be changed.
Config. - Language	AUTO - OOS	<p>Use this parameter to select the language for all texts, parameters and messages shown on the local display.</p> <p> Hinweis!</p> <p>The displayed options depend on the available language group shown in the "Amp. - Language Group" parameter.</p> <p>OPTIONS:</p> <p>Language group WEST EU / USA: ENGLISH DEUTSCH FRANCAIS ESPANOL ITALIANO NEDERLANDS PORTUGUESE</p> <p>Language group EAST EU / SCAND: ENGLISH NORSK SVENSKA SUOMI POLISH RUSSIAN CZECH</p> <p>Language group ASIA: ENGLISH BAHASA INDONESIA JAPANESE (syllabary)</p> <p>Language group CHINA: ENGLISH CHINESE</p> <p>Factory setting: Depends on country → Page 167 ff.</p> <p> Hinweis!</p> <p>You can change the language group via the configuration program FieldCare. Please do not hesitate to contact your Endress+Hauser sales office if you have any questions.</p>

"Display" Transducer Block/base index 1800		
Parameter	Write access with operating mode (MODE_BLK)	Description
Config. - Display Damping	AUTO - OOS	<p>Use this parameter to enter a time constant defining how the display reacts to severely fluctuating flow variables, either very quickly (enter a low time constant) or with damping (enter a high time constant).</p> <p>User input: 0 to 100 seconds</p> <p>Factory setting: 1 s</p> <p> Hinweis! Setting the time constant to zero seconds switches off damping.</p>
Config. - Contrast LCD	AUTO - OOS	<p>Use this parameter to optimize display contrast to suit local operating conditions.</p> <p>User input: 10 to 100%</p> <p>Factory setting: 50%</p>
Config. - Backlight	AUTO - OOS	<p>Use this parameter to optimize the backlight to suit local operating conditions.</p> <p>User input: 0 to 100%</p> <p> Hinweis! Entering the value "0" means that the backlight is "switched off". The display then no longer emits any light, i.e. the display texts can no longer be read in the dark.</p> <p>Factory setting: 50%</p>
Operation - Test Display	AUTO - OOS	<p>Use this parameter to test the operability of the local display and its pixels.</p> <p>Options: ON OFF</p> <p>Factory setting: OFF</p> <p>Test sequence:</p> <ol style="list-style-type: none"> 1. Start the test by selecting ON. 2. All pixels of the main line, additional line and information line are darkened for minimum 0.75 seconds. 3. Main line, additional line and information line show an "8" in each field for minimum 0.75 seconds. 4. Main line, additional line and information line show a "0" in each field for minimum 0.75 seconds. 5. Main line, additional line and information line show nothing (blank display) for minimum 0.75 seconds. <p>When the test is completed, the local display returns to its initial state.</p>





"Display" Transducer Block/base index 1800		
Parameter	Write access with operating mode (MODE_BLK)	Description
<p>1 = Main line 2 = Add. line 3 = Information line</p> 		
Main Line - Assign	AUTO - OOS	<p>In this parameter, a value to be displayed is assigned to the main line (top line in the local display). This value is displayed during normal operation.</p> <p>Options: OFF VOLUME FLOW MASS FLOW VOLUME FLOW IN % MASS FLOW IN % TOTALIZER (1 to 3) CONDUCTIVITY AI1 - OUT VALUE AI2 - OUT VALUE AI3 - OUT VALUE AI4 - OUT VALUE AI5 - OUT VALUE AO - DISP. VALUE PID - IN VALUE (controlled variable) PID - CAS IN VALUE (external set point) PID - OUT VALUE (manipulated variable)</p> <p>Factory setting: VOLUME FLOW</p>
Main Line - 100%-Value	AUTO - OOS	<p>The entry is not active unless one of the following was selected in the parameter "Main Line - Assign":</p> <ul style="list-style-type: none"> ■ MASS FLOW IN % ■ VOLUME FLOW IN % <p>Use this function to define the flow value to be shown on the display as the 100% value.</p> <p>User input: 5-digit floating-point number</p> <p>Factory setting: Depends on nominal diameter and country → Page 167 ff.</p> <p> Hinweis! The unit is taken from the "System Unit - Volume Flow" or "System Unit - Mass Flow" parameter (→ Page 105 ff.).</p>

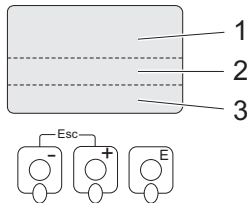

A0001253





"Display" Transducer Block/base index 1800		
Parameter	Write access with operating mode (MODE_BLK)	Description
Main Line - Format	AUTO - OOS	<p>Use this parameter to define the maximum number of places after the decimal point displayed for the reading in the main line.</p> <p>Options: XXXXX. – XXXX.X – XXX.XX – XX.XXX – X.XXXX</p> <p>Factory setting: X.XXXX</p> <p> Hinweis!</p> <ul style="list-style-type: none"> ■ Note that this setting only affects the reading as it appears on the display, it has no influence on the accuracy of the system's calculations. ■ The places after the decimal point as computed by the measuring device cannot always be displayed, depending on this setting and the engineering unit. In these instances an arrow appears on the display between the measured value and the engineering unit (e.g. 1.2 → kg/h), indicating that the measuring system is computing with more decimal places than can be shown on the display.
Main Line Mux - Assign	AUTO - OOS	<p>Use this parameter to define the second reading to be displayed in the main line alternately (every 10 seconds) with the value defined in the parameter "Main Line - Assign".</p> <p>Options: OFF VOLUME FLOW MASS FLOW VOLUME FLOW IN % MASS FLOW IN % TOTALIZER (1 to 3) CONDUCTIVITY AI1 - OUT VALUE AI2 - OUT VALUE AI3 - OUT VALUE AI4 - OUT VALUE AI5 - OUT VALUE AO - DISP. VALUE PID - IN VALUE (controlled variable) PID - CAS IN VALUE (external set point) PID - OUT VALUE (manipulated variable)</p> <p>Factory setting: OFF</p>
Main Line Mux - 100%-Value	AUTO - OOS	<p> Hinweis!</p> <p>The entry is not active unless one of the following was selected in the parameter "Main Line Mux - Assign":</p> <ul style="list-style-type: none"> ■ MASS FLOW IN % ■ VOLUME FLOW IN % <p>Use this parameter to define the flow value to be shown on the display as the 100% value.</p> <p>User input: 5-digit floating-point number</p> <p>Factory setting: Depends on nominal diameter and country → Page 167 ff.</p> <p> Hinweis!</p> <p>The unit is taken from the "System Unit - Volume Flow" or "System Unit - Mass Flow" parameter (→ Page 105 ff.).</p>



"Display" Transducer Block/base index 1800		
Parameter	Write access with operating mode (MODE_BLK)	Description
Main Line Mux - Format	AUTO - OOS	<p>Use this parameter to define the maximum number of places after the decimal point displayed for the reading in the main line.</p> <p>Options: XXXXX. - XXXX.X - XXX.XX - XX.XXX - X.XXXX</p> <p>Factory setting: X.XXXX</p> <p> Hinweis!</p> <ul style="list-style-type: none"> ■ Note that this setting only affects the reading as it appears on the display, it has no influence on the accuracy of the system's calculations. ■ The places after the decimal point as computed by the measuring device cannot always be displayed, depending on this setting and the engineering unit. In these instances an arrow appears on the display between the measured value and the engineering unit (e.g. 1.2 → kg/h), indicating that the measuring system is computing with more decimal places than can be shown on the display.
<p>1 = Main line 2 = Add. line 3 = Information line</p>		
Add. Line - Assign	AUTO - OOS	<p>Use this parameter to define the display value assigned to the additional line (the middle line of the local display) during normal measuring operation.</p> <p>Options: OFF VOLUME FLOW MASS FLOW VOLUME FLOW IN % MASS FLOW IN % VOLUME FLOW BARGRAPH IN % MASS FLOW BARGRAPH IN % FLOW VELOCITY TOTALIZER (1 to 3) CONDUCTIVITY AI1 - OUT VALUE AI2 - OUT VALUE AI3 - OUT VALUE AI4 - OUT VALUE AI5 - OUT VALUE AO - DISP. VALUE PID - IN VALUE (controlled variable) PID - CAS IN VALUE (external set point) PID - OUT VALUE (manipulated variable) DEVICE PD-TAG (tag name)</p> <p>Factory setting: TOTALIZER 1</p>





A0001253



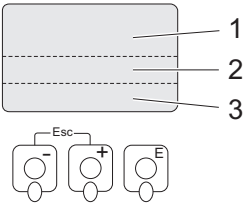

"Display" Transducer Block/base index 1800		
Parameter	Write access with operating mode (MODE_BLK)	Description
Add. Line - 100% - Value	AUTO - OOS	<p> Hinweis! The entry is not active unless one of the following was selected in the parameter "Add. Line - Assign":</p> <ul style="list-style-type: none"> ■ MASS FLOW IN % ■ VOLUME FLOW IN % ■ MASS FLOW BARGRAPH IN % ■ VOLUME FLOW BARGRAPH IN % <p>Use this parameter to define the flow value to be shown on the display as the 100% value.</p> <p>Use this function to define the flow value to be shown on the display as the 100% value.</p> <p>User input: 5-digit floating-point number</p> <p>Factory setting: Depends on nominal diameter and country → Page 167 ff.</p> <p> Hinweis! The unit is taken from the corresponding system unit ("System Unit - Volume Flow" or "System Unit - Mass Flow").</p>
Add. Line - Format	AUTO - OOS	<p> Hinweis! The option is not active unless a number was selected in the parameter "Add. Line - Assign".</p> <p>Use this parameter to define the maximum number of places after the decimal point displayed for the reading in the additional line.</p> <p>Options: XXXXX. - XXXX.X - XXX.XX - XX.XXX - X.XXXX</p> <p>Factory setting: X.XXXX</p> <p> Hinweis!</p> <ul style="list-style-type: none"> ■ Note that this setting only affects the reading as it appears on the display, it has no influence on the accuracy of the system's calculations. ■ The places after the decimal point as computed by the measuring device cannot always be displayed, depending on this setting and the engineering unit. In these instances an arrow appears on the display between the measured value and the engineering unit (e.g. 1.2 → kg/h), indicating that the measuring system is computing with more decimal places than can be shown on the display.





"Display" Transducer Block/base index 1800		
Parameter	Write access with operating mode (MODE_BLK)	Description
Add. Line - Display Mode	AUTO - OOS	<p> Hinweis! The option is not active unless one of the following was selected in the parameter "Add. Line - Assign":</p> <ul style="list-style-type: none"> ■ MASS FLOW BARGRAPH IN % ■ VOLUME FLOW BARGRAPH IN % <p>Use this parameter to define the format of the bar graph.</p> <p>Options: STANDARD (Simple bar graph with 25 / 50 / 75% gradations and integrated sign).</p> <div style="border: 1px solid black; padding: 5px; width: fit-content; margin: 10px auto;"> <p style="text-align: center;">+25 +50 +75 %</p> </div> <p style="text-align: right; font-size: small;">A0001258</p> <p>SYMMETRY (Symmetrical bar graph for positive and negative directions of flow, with -50 / 0 / +50% gradations and integrated sign).</p> <div style="border: 1px solid black; padding: 5px; width: fit-content; margin: 10px auto;"> <p style="text-align: center;">-50 0 +50 %</p> </div> <p style="text-align: right; font-size: small;">A0001259</p> <p>Factory setting: STANDARD</p>
Add. Line Mux - Assign	AUTO - OOS	<p>Use this parameter to define the second reading to be displayed in the additional line alternately (every 10 seconds) with the value defined in the parameter "Add. Line - Assign" (→ Page 131).</p> <p>Options: OFF VOLUME FLOW MASS FLOW VOLUME FLOW IN % MASS FLOW IN % VOLUME FLOW BARGRAPH IN % MASS FLOW BARGRAPH IN % FLOW VELOCITY TOTALIZER (1 to 3) CONDUCTIVITY AI1 - OUT VALUE AI2 - OUT VALUE AI3 - OUT VALUE AI4 - OUT VALUE AI5 - OUT VALUE AO - DISP. VALUE PID - IN VALUE (controlled variable) PID - CAS IN VALUE (external set point) PID - OUT VALUE (manipulated variable) DEVICE PD-TAG (tag name)</p> <p>Factory setting: OFF</p> <p> Hinweis! Multiplex mode is suspended as soon as a fault / notice message is generated. The message in question appears on the display. Once the fault is eliminated, the measuring device resumes operation in Multiplex mode and the error message is no longer displayed on the local display.</p>

"Display" Transducer Block/base index 1800		
Parameter	Write access with operating mode (MODE_BLK)	Description
Add. Line Mux - 100%-Value	AUTO - OOS	<p> Hinweis!</p> <p>The entry is not active unless one of the following was selected in the parameter "Add. Line Mux - Assign":</p> <ul style="list-style-type: none"> ■ MASS FLOW IN % ■ VOLUME FLOW IN % ■ MASS FLOW BARGRAPH IN % ■ VOLUME FLOW BARGRAPH IN % <p>Use this parameter to define the flow value to be shown on the display as the 100% value.</p> <p>User input: 5-digit floating-point number</p> <p>Factory setting: Depends on nominal diameter and country → Page 167 ff.</p> <p> Hinweis!</p> <p>The unit is taken from the corresponding system unit ("System Unit - Volume Flow" or "System Unit - Mass Flow").</p>
Add. Line Mux - Format	AUTO - OOS	<p> Hinweis!</p> <p>The option is not active unless a number was selected in the parameter "Add. Line Mux - Assign" (→ Page 133).</p> <p>Use this parameter to define the maximum number of places after the decimal point displayed for the reading in the additional line.</p> <p>Options: XXXXX. – XXXX.X – XXX.XX – XX.XXX – X.XXXX</p> <p>Factory setting: X.XXXX</p> <p> Hinweis!</p> <ul style="list-style-type: none"> ■ Note that this setting only affects the reading as it appears on the display, it has no influence on the accuracy of the system's calculations. ■ The places after the decimal point as computed by the measuring device cannot always be displayed, depending on this setting and the engineering unit. In these instances an arrow appears on the display between the measured value and the engineering unit (e.g. 1.2 → kg/h), indicating that the measuring system is computing with more decimal places than can be shown on the display.

"Display" Transducer Block/base index 1800		
Parameter	Write access with operating mode (MODE_BLK)	Description
Add. Line Mux - Display Mode	AUTO - OOS	<p> Hinweis! The option is not active unless one of the following was selected in the parameter "Add. Line Mux - Assign" (→ Page 133):</p> <ul style="list-style-type: none"> ■ MASS FLOW BARGRAPH IN % ■ VOLUME FLOW BARGRAPH IN % <p>Use this parameter to define the format of the bar graph.</p> <p>Options: STANDARD (Simple bar graph with 25 / 50 / 75% gradations and integrated sign).</p> <div style="text-align: center;">  </div> <p style="text-align: right; font-size: small;">A0001258</p> <p>SYMMETRY (Symmetrical bar graph for positive and negative directions of flow, with -50 / 0 / +50% gradations and integrated sign).</p> <div style="text-align: center;">  </div> <p style="text-align: right; font-size: small;">A0001259</p> <p>Factory setting: STANDARD</p>
<p>1 = Main line 2 = Add. line 3 = Information line</p>		<div style="text-align: center;">  </div> <p style="text-align: right; font-size: small;">A0001253</p>
Info Line - Assign	AUTO - OOS	<p>Use this parameter to define the display value assigned to the information line (the bottom line of the local display) during normal measuring operation.</p> <p>Options: OFF VOLUME FLOW IN % MASS FLOW IN % VOLUME FLOW BARGRAPH IN % MASS FLOW BARGRAPH IN % FLOW VELOCITY OPERATING/SYSTEM CONDITIONS DISPLAY FLOW DIRECTION TOTALIZER (1 to 3) CONDUCTIVITY AI1 - OUT VALUE AI2 - OUT VALUE AI3 - OUT VALUE AI4 - OUT VALUE AI5 - OUT VALUE AO - DISP. VALUE PID - IN VALUE (controlled variable) PID - CAS IN VALUE (external set point) PID - OUT VALUE (manipulated variable) DEVICE PD-TAG (tag name)</p> <p>Factory setting: OPERATING/SYSTEM CONDITIONS</p>

"Display" Transducer Block/base index 1800		
Parameter	Write access with operating mode (MODE_BLK)	Description
Info Line - 100%-Value	AUTO - OOS	<p> Hinweis! The entry is not active unless one of the following was selected in the parameter "Info Line - Assign" (→ Page 135):</p> <ul style="list-style-type: none"> ■ MASS FLOW IN % ■ VOLUME FLOW IN % ■ MASS FLOW BARGRAPH IN % ■ VOLUME FLOW BARGRAPH IN % <p>Use this parameter to define the flow value to be shown on the display as the 100% value.</p> <p>Use this function to define the flow value to be shown on the display as the 100% value.</p> <p>User input: 5-digit floating-point number</p> <p>Factory setting: Depends on nominal diameter and country → Page 167 ff.</p> <p> Hinweis! The unit is taken from the corresponding system unit ("System Unit - Volume Flow" or "System Unit - Mass Flow").</p>
Info Line - Format	AUTO - OOS	<p> Hinweis! The option is not active unless a number was selected in the parameter "Info Line - Assign" (→ Page 135).</p> <p>Use this parameter to define the maximum number of places after the decimal point displayed for the reading in the additional line.</p> <p>Options: XXXXX. – XXXX.X – XXX.XX – XX.XXX – X.XXXX</p> <p>Factory setting: X.XXXX</p> <p> Hinweis!</p> <ul style="list-style-type: none"> ■ Note that this setting only affects the reading as it appears on the display, it has no influence on the accuracy of the system's calculations. ■ The places after the decimal point as computed by the measuring device cannot always be displayed, depending on this setting and the engineering unit. In these instances an arrow appears on the display between the measured value and the engineering unit (e.g. 1.2 → kg/h), indicating that the measuring system is computing with more decimal places than can be shown on the display.

"Display" Transducer Block/base index 1800		
Parameter	Write access with operating mode (MODE_BLK)	Description
Info Line - Display Mode	AUTO - OOS	<p> Hinweis! The option is not active unless one of the following was selected in the parameter "Info Line - Assign" (→ Page 135):</p> <ul style="list-style-type: none"> ■ MASS FLOW BARGRAPH IN % ■ VOLUME FLOW BARGRAPH IN % <p>Use this parameter to define the format of the bar graph.</p> <p>Options: STANDARD (Simple bar graph with 25 / 50 / 75% gradations and integrated sign).</p> <div style="text-align: center;">  </div> <p style="text-align: right;"><small>A0001258</small></p> <p>SYMMETRY (Symmetrical bar graph for positive and negative directions of flow, with -50 / 0 / +50% gradations and integrated sign).</p> <div style="text-align: center;">  </div> <p style="text-align: right;"><small>A0001259</small></p> <p>Factory setting: STANDARD</p>
Info Line Mux - Assign	AUTO - OOS	<p>Use this parameter to define the second reading to be displayed in the information line alternately (every 10 seconds) with the value defined in the parameter "Info. Line - Assign" (→ Page 135).</p> <p>Options: OFF VOLUME FLOW IN % MASS FLOW IN % VOLUME FLOW BARGRAPH IN % MASS FLOW BARGRAPH IN % FLOW VELOCITY OPERATING/SYSTEM CONDITIONS DISPLAY FLOW DIRECTION TOTALIZER (1 to 3) CONDUCTIVITY AI1 - OUT VALUE AI2 - OUT VALUE AI3 - OUT VALUE AI4 - OUT VALUE AI5 - OUT VALUE AO - DISP. VALUE PID - IN VALUE (controlled variable) PID - CAS IN VALUE (external set point) PID - OUT VALUE (manipulated variable) DEVICE PD-TAG (tag name)</p> <p>Factory setting: OFF</p> <p> Hinweis! Multiplex mode is suspended as soon as a fault / notice message is generated. The message in question appears on the display. Once the fault is eliminated, the measuring device resumes operation in Multiplex mode and the error message is no longer displayed on the local display.</p>

"Display" Transducer Block/base index 1800		
Parameter	Write access with operating mode (MODE_BLK)	Description
Info Line Mux - 100%-Value	AUTO - OOS	<p> Hinweis!</p> <p>The entry is not active unless one of the following was selected in the parameter "Info Line Mux - Assign" (→ Page 137):</p> <ul style="list-style-type: none"> ■ MASS FLOW IN % ■ VOLUME FLOW IN % ■ MASS FLOW BARGRAPH IN % ■ VOLUME FLOW BARGRAPH IN % <p>Use this parameter to define the flow value to be shown on the display as the 100% value.</p> <p>User input: 5-digit floating-point number</p> <p>Factory setting: Depends on nominal diameter and country → Page 167 ff.</p> <p> Hinweis!</p> <p>The unit is taken from the corresponding system unit ("System Unit - Volume Flow" or "System Unit - Mass Flow").</p>
Info Line Mux - Format	AUTO - OOS	<p> Hinweis!</p> <p>The option is not active unless a number was selected in the parameter "Info Line Mux - Assign" (→ Page 137).</p> <p>Use this parameter to define the maximum number of places after the decimal point for the second value displayed in the information line.</p> <p>Options: XXXXX. – XXXX.X – XXX.XX – XX.XXX – X.XXXX</p> <p>Factory setting: X.XXXX</p> <p> Hinweis!</p> <ul style="list-style-type: none"> ■ Note that this setting only affects the reading as it appears on the display, it has no influence on the accuracy of the system's calculations. ■ The places after the decimal point as computed by the measuring device cannot always be displayed, depending on this setting and the engineering unit. In these instances an arrow appears on the display between the measured value and the engineering unit (e.g. 1.2 → kg/h), indicating that the measuring system is computing with more decimal places than can be shown on the display.

"Display" Transducer Block/base index 1800		
Parameter	Write access with operating mode (MODE_BLK)	Description
Info Line Mux - Display Mode	AUTO - OOS	<p> Hinweis!</p> <p>The option is not active unless one of the following was selected in the parameter "Info Line Mux - Assign" (→ Page 137):</p> <ul style="list-style-type: none"> ■ MASS FLOW BARGRAPH IN % ■ VOLUME FLOW BARGRAPH IN % <p>Use this parameter to define the format of the bar graph.</p> <p>Options: STANDARD (Simple bar graph with 25 / 50 / 75% gradations and integrated sign).</p> <div style="border: 1px solid black; padding: 5px; display: inline-block; text-align: center;"> +25 +50 +75 % </div> <p style="text-align: right; font-size: small;">A0001258</p> <p>SYMMETRY (Symmetrical bar graph for positive and negative directions of flow, with -50 / 0 / +50% gradations and integrated sign).</p> <div style="border: 1px solid black; padding: 5px; display: inline-block; text-align: center;"> -50 0 +50 % </div> <p style="text-align: right; font-size: small;">A0001258</p> <p>Factory setting: STANDARD</p>

3.6 Parameters of the "Totalizer" Transducer Block



The following table shows all the Endress+Hauser-specific parameters of the "Totalizer" Transducer Block. These can only be changed after entering an enabling code in the "Access - Code" parameter.





Hinweis!

FOUNDATION Fieldbus parameters are described in the "FOUNDATION Fieldbus Overview" Operating Instructions (BA013S) (acquired at: → www.endress.com → Download).

"Totalizer" Transducer Block/base index 1900		
Parameter	Write access with operating mode (MODE_BLK)	Description
Access - Code	AUTO - OOS	<p>All data of the measuring system are protected against inadvertent change. Only when the code has been entered in this parameter can the manufacturer-specific parameters be programmed and the device configuration modified.</p> <p>You can enable programming by entering:</p> <ul style="list-style-type: none"> ■ Code 55 (factory setting) ■ Personal code (→ Page 127) <p>User input: Max. 4-digit number (0 to 9999)</p> <p> Hinweis!</p> <ul style="list-style-type: none"> ■ If the write protection is enabled then access to the manufacturer-specific parameters is blocked even if the right code is entered. Write protection can be activated and deactivated by means of jumpers on the I/O board (→ see Operating Instructions for Proline Promag 55 FOUNDATION Fieldbus, BA126D). ■ You can disable programming again by entering any number (other than the access code) in this parameter. ■ The Endress+Hauser service organization can be of assistance if you mislay your personal code. ■ Certain parameters are not accessible unless a special service code is entered. This service code is known only to the Endress+Hauser service organization. Please contact your Endress+Hauser service center if you require clarification. ■ The entry made here does not affect the local display. Thus, programming via the function matrix must be enabled separately.
Access - Status	read only	<p>Use this parameter to display the current status of the possibilities for accessing the manufacturer-specific parameters of the device.</p> <p>User interface:</p> <ul style="list-style-type: none"> ■ LOCKED (parameterization disabled) ■ ACCESS CUSTOMER (parameterization enabled) ■ ACCESS SERVICE (parameterization enabled, access to service level)

"Totalizer" Transducer Block/base index 1900		
Parameter	Write access with operating mode (MODE_BLK)	Description
Tot. 1 to 3 - Sum	AUTO - OOS	<p>Use this parameter to view the total for the totalizer's measured variable aggregated since measuring commenced. The value can be positive or negative, depending on the setting selected in the parameter "Tot. 1 to 3 - Mode" (→ Page 142), and the direction of flow.</p> <p> Hinweis!</p> <ul style="list-style-type: none"> ■ The effect of the setting in the parameter "Tot. 1 to 3 - Mode" is as follows: <ul style="list-style-type: none"> – If the setting is "BALANCE", the totalizer balances flow in the positive and negative directions. – If the setting is "FORWARD", the totalizer registers only flow in the positive direction. – If the setting is "REVERSE", the totalizer registers only flow in the negative direction. ■ The totalizer's response to faults is defined in the parameter "Tot. - Failsafe All".
Tot. 1 to 3 - Unit	AUTO - OOS	<p>Use this parameter to define the unit for the totalizer's measured variable, as selected beforehand.</p> <p>Options: (for MASS FLOW assignment): Metric → g; kg; t</p> <p>US → oz; lb; ton</p> <p>Factory setting: Depends on nominal diameter and country → Page 167 ff.</p> <p>Options (for VOLUME FLOW assignment): Metric → cm³; dm³; m³; ml; l; hl; Ml Mega</p> <p>US → cc; af; ft³; oz f; gal; Kgal; Mgal; bbl (normal fluids); bbl (beer); bbl (petrochemicals); bbl (filling tanks)</p> <p>Imperial → gal; Mgal; bbl (beer); bbl (petrochemicals)</p> <p>Factory setting: Depends on nominal diameter and country → Page 167 ff.</p> <p> Hinweis!</p> <p>The unit selected here does not have any effect on the desired volume unit which should be transmitted by means of the FOUNDATION Fieldbus interface. This setting is made separately by means of the corresponding AI Block in the XD_SCALE parameter group.</p>

"Totalizer" Transducer Block/base index 1900		
Parameter	Write access with operating mode (MODE_BLK)	Description
Tot. 1 to 3 - Assign	AUTO - OOS	<p>Use this function to assign a measured variable to the totalizer in question.</p> <p>Options: OFF MASS FLOW VOLUME FLOW</p> <p>Factory setting: VOLUME FLOW</p> <p>Advanced options with optional software package SOLID CONTENT FLOW: TARGET MASS FLOW TARGET VOLUME FLOW CARRIER MASS FLOW CARRIER VOLUME FLOW</p> <p> Hinweis! The totalizer is reset to "0" as soon as the selection is changed.</p>
Tot. 1 to 3 - Mode	AUTO - OOS	<p>Use this function to define how the flow components are to be totalized.</p> <p>Options: BALANCE Positive and negative flow components. The positive and negative flow components are balanced. In other words, net flow in the flow direction is registered.</p> <p>FORWARD Positive flow components only</p> <p>REVERSE Negative flow components only</p> <p>Factory setting: Totalizer 1 = BALANCE Totalizer 2 = FORWARD Totalizer 3 = REVERSE</p>
Tot. 1 to 3 - Reset	AUTO - OOS	<p>Resets the totalizer ("Tot. 1 to 3 - Sum" parameter) to zero.</p> <p>Options: NO YES</p> <p>Factory setting: NO</p> <p> Hinweis! Totalizer resetting can also be controlled or triggered by means of cyclic data transfer via the Discrete Output function block.</p>

"Totalizer" Transducer Block/base index 1900		
Parameter	Write access with operating mode (MODE_BLK)	Description
Tot. - Reset All	AUTO - OOS	<p>Resets all totalizers ("Tot. 1 to 3 - Sum" parameter) simultaneously to zero.</p> <p>Options: NO YES</p> <p>Factory setting: NO</p> <p> Hinweis! Totalizer resetting can also be controlled or triggered by means of cyclic data transfer via the Discrete Output function block.</p>
Tot. - Failsafe All	AUTO - OOS	<p>Use this parameter to define the common response of all totalizers (1 to 3) in case of error.</p> <p>Options STOP → The totalizers are paused until the fault is rectified.</p> <p>ACTUAL VALUE → The totalizers continue to count based on the actual flow measured value. The fault is ignored.</p> <p>HOLD VALUE → The totalizers continue to count the flow based on the last valid flow value (before the fault occurred).</p> <p>Factory setting: STOP</p>

3.7 Parameter Transducer Block "Advanced Diagnostics"



Note!

The parameters of the "Advanced Diagnostics" Transducer Block are ready for use and can be configured if the "Advanced Diagnostics" add-on is installed in the measuring device (order option). Otherwise the value "NaN" (not-a-number) or "Not licensed" is displayed in a parameter.

The following table shows the Endress+Hauser-specific parameters of the "Advanced Diagnostics" Transducer Block. These can only be changed after entering a release code in the "Access - Code" parameter.









Note!

FOUNDATION Fieldbus parameters are described in the Operating Instructions "FOUNDATION Fieldbus Overview" (BA013S) (available at: → www.endress.com → download).

Transducer Block "Advanced Diagnostics" / base index 2500		
Parameter	Write access with operating mode (MODE_BLK)	Description
Access - Code	AUTO - OOS	<p>All data of the measuring system are protected against inadvertent change. Only when the code has been entered in this parameter can the manufacturer-specific parameters be programmed and the device configuration modified.</p> <p>You can enable programming by entering:</p> <ul style="list-style-type: none"> ■ Code 55 (factory setting) ■ Personal code (→ Page 127) <p>User input: Max. 4-digit number (0 to 9999)</p> <p> Hinweis!</p> <ul style="list-style-type: none"> ■ If the write protection is enabled then access to the manufacturer-specific parameters is blocked even if the right code is entered. Write protection can be activated and deactivated by means of jumpers on the I/O board (→ see Operating Instructions for Proline Promag 55 FOUNDATION Fieldbus, BA126D). ■ You can disable programming again by entering any number (other than the access code) in this parameter. ■ The Endress+Hauser service organization can be of assistance if you mislay your personal code. ■ Certain parameters are not accessible unless a special service code is entered. This service code is known only to the Endress+Hauser service organization. Please contact your Endress+Hauser service center if you require clarification. ■ The entry made here does not affect the local display. Thus, programming via the function matrix must be enabled separately.
Access - Status	read only	<p>Use this parameter to display the current status of the possibilities for accessing the manufacturer-specific parameters of the device.</p> <p>User interface:</p> <ul style="list-style-type: none"> ■ LOCKED (parameterization disabled) ■ ACCESS CUSTOMER (parameterization enabled) ■ ACCESS SERVICE (parameterization enabled, access to service level)

Transducer Block "Advanced Diagnostics" / base index 2500		
Parameter	Write access with operating mode (MODE_BLK)	Description
Adv. - Ref.Cond.User	AUTO - OOS	<p>This function enables the user to start an adjustment, in order to ascertain the reference values of various diagnostic parameters valid for his process. These reference values are authoritative as the "starting point" for later trend analyses (regarding abrasion, corrosion or coating formation) and should be ascertained for each process or fluid in a balanced state.</p> <p>When adjustment is performed, the reference values of the following diagnostic parameters are ascertained:</p> <ul style="list-style-type: none"> ■ Decay time constant of test pulses (at measuring electrodes 1 and 2) ■ Electrode potentials (of measuring electrodes 1 and 2) ■ Volume flow (flow value immediately before applying the test pulses) <p>Options: CANCEL START</p> <p>Factory setting: CANCEL</p>
Adv. - Select Ref.Condition	AUTO - OOS	<p>In this function, the reference condition is selected (at the factory or by the user), which the affected diagnostic parameters are to be compared to later (see "Adv. - Acquisition Mode" parameter → Page 145</p> <p>Options: FACTORY USER</p> <p>Factory setting: FACTORY</p>
Adv. - Warning Mode	AUTO - OOS	<p>In this function, you can determine whether a warning is generated if a deviation occurs between the reference condition (see "Adv. - Select Ref.Condition" parameter → Page 145 and the actual measured diagnostic parameters.</p> <p>When doing so, the following diagnostic parameters are compared to the reference condition:</p> <ul style="list-style-type: none"> ■ Decay time constant of test pulses → Function group COATING E1 or E2 ■ Electrode potentials → Function group ELECTRODE POT. 1 or 2 ■ Volume flow → Function group VOLUME FLOW <p>Options: OFF ON</p> <p>Factory setting: OFF</p>
Adv. - Acquisition Mode	AUTO - OOS	<p>In this function, you define whether the diagnostic parameters are acquired periodically by the measuring device or manually by the user.</p> <p>Options: OFF PERIODICAL SINGLE SHOT</p> <p>Factory setting: OFF</p>

Transducer Block "Advanced Diagnostics" / base index 2500		
Parameter	Write access with operating mode (MODE_BLK)	Description
Adv. - Acquisition Period	AUTO - OOS	<p> Hinweis! This function is not available unless the "PERIODICAL" setting was selected in the "Adv. - Acquisition Mode" parameter.</p> <p>In this function, a time interval is specified that is used to acquire and record the affected diagnostic parameters periodically. This function is active as soon as the input is confirmed with the  key.</p> <p>User input: 10 to 10 080 min</p> <p>Factory setting: 60 min</p> <p> Hinweis! A defined reference condition must be present before the diagnostic parameters are measured → see "Adv. - Select Ref.Condition" parameter → Page 145.</p>
Adv. - Acquisition Do	AUTO - OOS	<p> Hinweis! This function is not available unless the "SINGLE SHOT" setting was selected in the "Adv. - Acquisition Mode" parameter.</p> <p>Options: CANCEL START</p> <p>Factory setting: CANCEL</p> <p> Hinweis! A defined reference condition must be present before the diagnostic parameters are acquired → see "Adv. - Select Ref.Condition" parameter → Page 145.</p>
Adv. - Reset History	AUTO - OOS	<p>All previously saved diagnostic parameter values can be deleted with this function.</p> <p>Options: NO YES</p> <p>Factory setting: NO</p>
Adv. - Coating Detection	AUTO - OOS	<p>The coating detection (= detecting build-up on the measuring electrodes) can be switched on in this function.</p> <p>Options: OFF ON</p> <p>Factory setting: OFF</p>
Adv. - Coating Voltage	AUTO - OOS	<p>The extent of the voltage pulse required for the coating detection (U_B, Abb. 1) is entered in this function.</p> <p>User input: 0.1 to 6 V(olt)</p> <p>Factory setting: 3 V</p>

Transducer Block "Advanced Diagnostics" / base index 2500		
Parameter	Write access with operating mode (MODE_BLK)	Description
Adv. - Pulse Duration	AUTO - OOS	The pulse width (t_P , Abb. 1) for measuring the decay time constant is entered in this function. User input: 0.1 to 10 ms Factory setting: 1 ms
Adv. - Recovery Time	AUTO - OOS	In this function, a recovery time (t_E , Abb. 1) for the decay of the test pulse is specified, while the last – before coating detection – measured flow rate value is retained. It is necessary to enter a recovery time because the pulse (for coating detection) can cause the signal outputs to fluctuate due to electrochemical interference voltages. User input: 0.1 to 100 s Factory setting: 10 s  Achtung! <ul style="list-style-type: none"> ■ During the recovery time, the measuring device outputs the last flow rate value measured before coating detection. This in turn means that the measuring system does not register changes in flow, e.g. zero flow, during this time span. ■ If the value entered for the recovery time is too small, then the measuring device generates the error message "COATING FAILED" (# 845).
Coating E1 - Ref. Value Factory	read only	Use this function to view the reference value for the decay time constant at measuring electrode 1. User interface: 5-digit floating-point number, including unit in milliseconds
Coating E1 - Actual Value	read only	Use this function to view the actual measured decay time constant at measuring electrode 1. User interface: 5-digit floating-point number, including unit in milliseconds
Coating E1 - Min. Value	read only	Use this function to view the lowest measured value for the decay time constant at measuring electrode 1, since the last reset or deletion of the stored values. User interface: 5-digit floating-point number, including unit in milliseconds
Coating E1 - Max. Value	read only	Use this function to view the highest measured value for the decay time constant at measuring electrode 1, since the last reset or deletion of the stored values. User interface: 5-digit floating-point number, including unit in milliseconds
Coating E1 - History 1...10	read only	Use this function to view the last 10 measuring values for the decay time constant at measuring electrode 1. User interface: 5-digit floating-point number, including unit in milliseconds

Transducer Block "Advanced Diagnostics" / base index 2500		
Parameter	Write access with operating mode (MODE_BLK)	Description
Coating E1 - Deviation	read only	Use this function to view the deviation between the actual (last measured) value for the decay time constant at measuring electrode 1 and the reference values selected in the "Adv. - Select Ref.Condition" parameter → Page 145. User interface: 5-digit floating-point number, including unit in milliseconds
Coating E1 - Warning Level	AUTO - OOS	 Hinweis! This function is not available unless the ON setting was selected in the "Adv. - Warning Mode" parameter → Page 145. In this function, the user can specify a maximum permitted deviation (limit value) from the reference status for the decay time constant. If this limit value is overshoot or undershot, a system error message (categorized as a notice message) is output. To do this, the measuring system compares the actual deviation (see "Coating E1 - Deviation" parameter → Page 148) to the value entered here. User input: 1 to 10000 ms Factory setting: 100 ms
Coating E2 - Ref. Value Factory	read only	Use this function to view the reference value for the decay time constant at measuring electrode 2. User interface: 5-digit floating-point number, including unit in milliseconds
Coating E2 - Actual Value	read only	Use this function to view the actual measured decay time constant at measuring electrode 2. User interface: 5-digit floating-point number, including unit in milliseconds
Coating E2 - Min. Value	read only	Use this function to view the lowest measured value for the decay time constant at measuring electrode 2, since the last reset or deletion of the stored values. User interface: 5-digit floating-point number, including unit in milliseconds
Coating E2 - Max. Value	read only	Use this function to view the highest measured value for the decay time constant at measuring electrode 2, since the last reset or deletion of the stored values. User interface: 5-digit floating-point number, including unit in milliseconds
Coating E2 - History 1...10	read only	Use this function to view the last 10 measured values for the decay time constant at measuring electrode 2. User interface: 5-digit floating-point number, including unit in milliseconds
Coating E2 - Deviation	read only	Use this function to view the deviation between the actual (last measured) value for the decay time constant at measuring electrode 2 and the reference values selected in the "Adv. - Select Ref.Condition" parameter → Page 145. User interface: 5-digit floating-point number, including unit in milliseconds

Transducer Block "Advanced Diagnostics" / base index 2500		
Parameter	Write access with operating mode (MODE_BLK)	Description
Coating E2 - Warning Level	AUTO - OOS	<p> Hinweis! This function is not available unless the ON setting was selected in the "Adv. - Warning Mode" parameter → Page 145</p> <p>In this function, the user can enter a maximum permitted deviation (limit value) from the reference status for the decay time constant. If this limit value is overshoot or undershot, a system error message (categorized as a notice message) is output. To do this, the measuring system compares the actual deviation (see "Coating E1 - Deviation" parameter → Page 148) to the value entered here.</p> <p>User input: 1 to 10000 ms</p> <p>Factory setting: 100 ms</p>
Elec. Pot. 1 - Ref. Value Factory	read only	<p>Use this function to view the reference value for the electrode potential at measuring electrode 1.</p> <p>User interface: 5-digit floating-point number, including unit in millivolts</p>
Elec. Pot. 1 - Actual Value	read only	<p>Use this function to view the actual measured electrode potential at measuring electrode 1.</p> <p>User interface: 5-digit floating-point number, including unit in millivolts</p>
Elec. Pot. 1 - Min. Value	read only	<p>Use this function to view the lowest measured value for the electrode potential at measuring electrode 1, since the last reset or deletion of the stored values.</p> <p>User interface: 5-digit floating-point number, including unit in millivolts</p>
Elec. Pot. 1 - Max. Value	read only	<p>Use this function to view the highest measured value for the electrode potential at measuring electrode 1, since the last reset or deletion of the stored values.</p> <p>User interface: 5-digit floating-point number, including unit in millivolts</p>
Elec. Pot. 1 - History 1...10	read only	<p>Use this function to view the last 10 measured values for the electrode potential at measuring electrode 1.</p> <p>User interface: 5-digit floating-point number, including unit in millivolts</p>
Elec. Pot. 1 - Deviation	read only	<p>Use this function to view the deviation between the actual (last measured) value for the electrode potential at measuring electrode 1 and the reference values selected in the "Adv. - Select Ref.Condition" parameter → Page 145.</p> <p>User interface: 5-digit floating-point number, including unit in millivolts</p>

Transducer Block "Advanced Diagnostics" / base index 2500		
Parameter	Write access with operating mode (MODE_BLK)	Description
Elec. Pot. 2 - Ref. Value Factory	read only	Use this function to view the reference value for the electrode potential at measuring electrode 2. User interface: 5-digit floating-point number, including unit in millivolts
Elec. Pot. 2 - Actual Value	read only	Use this function to view the actual measured electrode potential at measuring electrode 2. User interface: 5-digit floating-point number, including unit in millivolts
Elec. Pot. 2 - Min. Value	read only	Use this function to view the lowest measured value for the electrode potential at measuring electrode 2, since the last reset or deletion of the stored values. User interface: 5-digit floating-point number, including unit in millivolts
Elec. Pot. 2 - Max. Value	read only	Use this function to view the highest measured value for the electrode potential at measuring electrode 2, since the last reset or deletion of the stored values. User interface: 5-digit floating-point number, including unit in millivolts
Elec. Pot. 2 - History 1...10	read only	Use this function to view the last 10 measured values for the electrode potential at measuring electrode 2. User interface: 5-digit floating-point number, including unit in millivolts
Elec. Pot. 2 - Deviation	read only	Use this function to view the deviation between the actual (last measured) value for the electrode potential at measuring electrode 2 and the reference values selected in the "Adv. - Select Ref.Condition" parameter → Page 145. User interface: 5-digit floating-point number, including unit in millivolts
Volume Flow - Ref. Value Factory	read only	Use this function to view the reference value for the volume flow. User interface: 5-digit floating-point number, including unit
Volume Flow - Actual Value	read only	Use this function to view the actual measured volume flow. User interface: 5-digit floating-point number, including unit
Volume Flow - Min. Value	read only	Use this function to view the lowest measured value for the volume flow, since the last reset or deletion of the stored values. User interface: 5-digit floating-point number, including unit
Volume Flow - Max. Value	read only	Use this function to view the highest measured value for the volume flow, since the last reset or deletion of the stored values. User interface: 5-digit floating-point number, including unit

Transducer Block "Advanced Diagnostics" / base index 2500		
Parameter	Write access with operating mode (MODE_BLK)	Description
Volume Flow - History 1...10	read only	Use this function to view the last 10 measured values for the volume flow. User interface: 5-digit floating-point number, including unit
Volume Flow - Deviation	read only	Use this function to view the deviation between the actual (last measured) value for the volume flow and the reference values selected in the "Adv. - Select Ref.Condition" parameter → Page 145. User interface: 5-digit floating-point number, including unit
Noise Value - Ref. Value Factory	read only	Use this function to view the reference value for the noise value. User interface: 5-digit floating-point number, including unit in mV
Noise Value - Actual Value	read only	Use this function to view the actual measured noise value. User interface: 5-digit floating-point number, including unit in mV
Noise Value - Min. Value	read only	Use this function to view the lowest measured value for the noise value, since the last reset or deletion of the stored values. User interface: 5-digit floating-point number, including unit in mV
Noise Value - Max. Value	read only	Use this function to view the highest measured value for the noise value, since the last reset or deletion of the stored values. User interface: 5-digit floating-point number, including unit in mV
Noise Value - History 1...10	read only	Use this function to view the last 10 measured values for the noise value. User interface: 5-digit floating-point number, including unit in mV
Noise Value - Deviation	read only	Use this function to view the deviation between the actual (last measured) value for the noise value and the reference values selected in the "Adv. - Select Ref.Condition" parameter → Page 145. User interface: 5-digit floating-point number, including unit in mV
Noise Value - Warning Level	AUTO - OOS	 Hinweis! This function is not available unless the ON setting was selected in the "Adv. - Warning Mode" parameter → Page 145. In this function, the user can enter a maximum permitted deviation (limit value) from the reference status for the decay time constant. If this limit value is overshoot or undershot, a system error message (categorized as a notice message) is output. To do this, the measuring system compares the actual deviation (see "Noise Value - Deviation" parameter → Page 151) to the value entered here. User input: positive value in mV Factory setting: 0.1 mV

3.8 Parameter Transducer Block "Solid Content Flow"



Note!

The parameters of the "Advanced Diagnostics" Transducer Block are ready for use and can be configured if the "Solid Content Flow" add-on is installed in the measuring device (order option). Otherwise the value "NaN" (not-a-number) or "Not licensed" is displayed in a parameter.





The following table shows the Endress+Hauser-specific parameters of the "Solid Content Flow" Transducer Block. These can only be changed after entering a release code in the "Access - Code" parameter.





Note!

FOUNDATION Fieldbus parameters are described in the Operating Instructions "FOUNDATION Fieldbus Overview" (BA013S) (available at: → www.endress.com → download)

Transducer Block "Solid Content Flow" / Basisindex 2400		
Parameter	Schreibzugriff bei Betriebsart (MODE_BLK)	Beschreibung
System Value - Target Mass Flow	read only	<p> Note! This function is only available if the measuring device is equipped with an F-CHIP for measuring solid content flows (s. Page 84).</p> <p>The actual measured mass flow of the target medium is displayed in this function. Target medium = solids transported with the fluid (e.g. stone, gravel, sand, etc.).</p> <p>User interface: 5-digit floating-point number, including unit and sign</p>
System Value - Perc. Target Mass Flow	read only	<p> Note! This function is only available if the measuring device is equipped with an F-CHIP for measuring solid content flows (s. Page 84).</p> <p>The actual measured mass flow of the target medium as a percentage (%) of the total mass flow is displayed in this function. Target medium = solids transported with the fluid (e.g. stone, gravel, sand, etc.).</p> <p>User interface: 5-digit floating-point number, including unit and sign</p>
System Value - Carrier Mass Flow	read only	<p> Note! This function is only available if the measuring device is equipped with an F-CHIP for measuring solid content flows (s. Page 84).</p> <p>The actual measured volume flow of the target medium is displayed in this function. Target medium = solids transported with the fluid (e.g. stone, gravel, sand, etc.).</p> <p>User interface: 5-digit floating-point number, including unit and sign</p>

Transducer Block "Solid Content Flow" / Basisindex 2400		
Parameter	Schreibzugriff bei Betriebsart (MODE_BLK)	Beschreibung
System Value - Perc. Carrier Mass Flow	read only	<p> Note! This function is only available if the measuring device is equipped with an F-CHIP for measuring solid content flows (s. Page 84).</p> <p>The actual measured volume flow of the target medium as a percentage (%) of the total volume flow is displayed in this function. Target medium = solids transported with the fluid (e.g. stone, gravel, sand, etc.).</p> <p>User interface: 5-digit floating-point number, including unit and sign</p>
System Value - Target Volume Flow	read only	<p> Note! This function is only available if the measuring device is equipped with an F-CHIP for measuring solid content flows (s. Page 84).</p> <p>The actual measured mass flow of the carrier fluid is displayed in this function. Carrier fluid = transporting liquid (e.g. water).</p> <p>User interface: 5-digit floating-point number, including unit and sign</p>
System Value - Perc. Target Volume Flow	read only	<p> Note! This function is only available if the measuring device is equipped with an F-CHIP for measuring solid content flows (s. Page 84).</p> <p>The actual measured mass flow of the carrier fluid as a percentage (%) of the total mass flow is displayed in this function. Carrier fluid = transporting liquid (e.g. water).</p> <p>User interface: 5-digit floating-point number, including unit and sign</p>
System Value - Carrier Volume Flow	read only	<p> Note! This function is only available if the measuring device is equipped with an F-CHIP for measuring solid content flows (s. Page 84).</p> <p>The actual measured volume flow of the carrier fluid is displayed in this function. Carrier fluid = transporting liquid (e.g. water).</p> <p>User interface: 5-digit floating-point number, including unit and sign</p>
System Value - Perc. Carrier Volume Flow	read only	<p> Note! This function is only available if the measuring device is equipped with an F-CHIP for measuring solid content flows (s. Page 84).</p> <p>The actual measured volume flow of the carrier fluid as a percentage (%) of the total volume flow is displayed in this function. Carrier fluid = transporting liquid (e.g. water).</p> <p>User interface: 5-digit floating-point number, including unit and sign</p>

Transducer Block "Solid Content Flow" / Basisindex 2400		
Parameter	Schreibzugriff bei Betriebsart (MODE_BLK)	Beschreibung
SCon. - Carrier Density	AUTO - OOS	<p> Note! This function is only available if the measuring device has an F-CHIP for calculating solid content flows (order option).</p> <p>In this function, the density of the transporting liquid (e.g. water) can be entered, in order to calculate the flow rate of solids. This density value can, for example, be determined from reference tables or by means of corresponding laboratory tests.</p> <p>User input: 5-digit floating-point number (0 to 99999), including unit</p> <p>Factory setting: 1.0 kg/l</p>
SCon. - Target Mat. Density	AUTO - OOS	<p> Note! This function is only available if the measuring device has an F-CHIP for calculating solid content flows (order option).</p> <p>In this function, the density of the target medium (e.g. transported solids) can be entered, in order to calculate the flow rate of solids. This density value can, for example, be determined from reference tables or by means of corresponding laboratory tests.</p> <p>User input: 5-digit floating-point number (0 to 99999), including unit</p> <p>Factory setting: 2.5 kg/l</p>

4 Function blocks

The function blocks contain the basic automation functions of the field device. We distinguish between different function blocks, e.g. Analog Input function block, PID function block (PID controller), etc.

Each of these function blocks is used to execute different application functions. This means that local control functions, for example, can be carried out directly in the field, and device errors such as amplifier errors are reported to the automation system automatically.

The function blocks process the input values in accordance with their specific algorithm and their internally available parameters. They generate output values that are made available to other function blocks for further processing by linking the individual function blocks with each other.

5 Analog Input function block

In the Analog Input function block (AI) the process variables from the Transducer Block are prepared for the subsequent automation functions (e.g. scaling, limit value processing). The automation function is defined by the connections of the outputs.

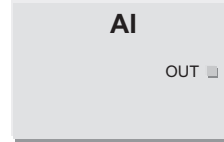

OUT = output value and output status of the Analog Input function block

A0003800

5.1 Signal processing

The figure shows the internal structure of the Analog Input function blocks:

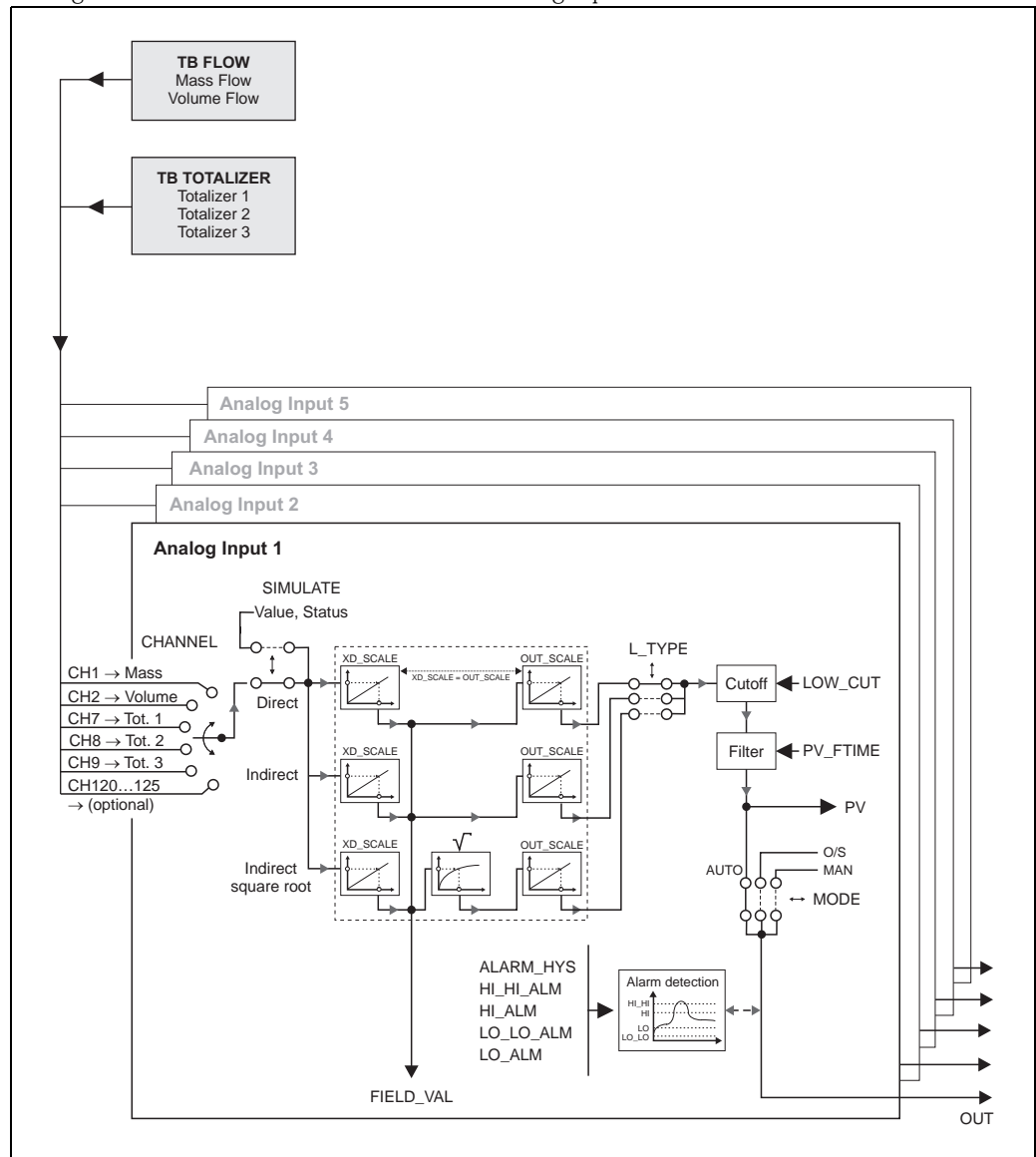

A0004762-en

Abb. 3: Internal structure of the individual Analog Input function blocks

The Analog Input function block receives its input value from the Transducer Block. The parameter CHANNEL is used to select which input value is to be processed by the Analog Input function block. The Promag 55 FOUNDATION Fieldbus is configured in the factory as follows:

- CHANNEL = 1 → Calculated mass flow
- CHANNEL = 2 → Volume flow
- CHANNEL = 7 → Totalizer 1
- CHANNEL = 8 → Totalizer 2
- CHANNEL = 9 → Totalizer 3

The parameter group SIMULATE allows you to replace the input value with a simulation value and to activate simulation. By specifying the status and the simulation value the reaction of the complete Analog Input function block can be tested.



Hinweis!

The simulation mode is enabled by means of the corresponding jumpers on the I/O board (→ see Operating Instructions for Proline Promag 55 FOUNDATION Fieldbus, BA126D).

The parameter L_TYPE is used to select the linearization type of the input or simulation value:

- Direct signal conversion
The value is forwarded without conversion ($XD_SCALE = OUT_SCALE$). Select this option if the input value is already in the physical unit you want.
- Indirect signal conversion
With this setting the measured value from the Transducer Block (input value) is re-scaled linearly via the input scaling XD_SCALE to the desired output range OUT_SCALE (further information on rescaling of the input value can be found on → Page 160).
- Indirect signal conversion with square root
With this setting the measured value from the Transducer Block (input value) is re-scaled via the parameter group XD_SCALE and recalculated using a square root function. It is then rescaled again to the desired output range via the parameter group OUT_SCALE .

The parameter LOW_CUT allows a limit value to be specified for the low flow cut off. The low flow cut off is activated via the parameter IO_OPTS. If the converted primary value (PV) is below the limit value then it is set to a value of "Zero".

In the parameter PV_FTIME a filter time can be specified for filtering the converted primary value (PV). If a time of 0 seconds is specified then no filtration takes place.

The parameter group MODE_BLK is used to select the operating mode of the Analog Input function block. If the operating mode MAN (manual) is selected then the output value OUT can be specified directly.

The output value OUT is compared with warning and alarm limits (e.g. HI_LIM, LO_LO_LIM, etc.) that can be entered via various parameters. If one of these limit values is violated then a limit value process alarm (e.g. HI_ALM, LO_LO_ALM, etc.) is triggered.

5.2 Important functions and parameters of the Analog Input function blocks

The primary functions and parameters of the Analog Input function blocks are listed below.



Hinweis!

All FOUNDATION Fieldbus parameters available are described in the "FOUNDATION Fieldbus Overview" Operating Instructions (BA013S) (acquired at: → www.endress.com → Download).

5.2.1 Selecting the operating mode

The operation mode is set by means of the MODE_BLK parameter group. The Analog Input function block supports the following operation modes:

- AUTO (automatic mode)
- MAN (manual mode)
- OOS (out of service)



Hinweis!

The block status OOS is also shown via the parameter BLOCK_ERR. In operating mode OOS, if write protection is not enabled, you can access all the write parameters without restriction.

5.2.2 Assignment of the process variable

The Promag 55 FOUNDATION Fieldbus has five Analog Input function blocks. The process variables of the Transducer Block that are to be processed are assigned via the parameter CHANNEL. The Promag 55 FOUNDATION Fieldbus is configured in the factory as follows:

- CHANNEL = 1 → Calculated mass flow
- CHANNEL = 2 → Volume flow
- CHANNEL = 7 → Totalizer 1
- CHANNEL = 8 → Totalizer 2
- CHANNEL = 9 → Totalizer 3

5.2.3 Linearization types

In the Analog Input function block the input value can be linearized by the Transducer Block using the parameter L_TYPE. The following types of linearization are available:

- Direct
With this setting the measured value from the Transducer Block (input value) avoids the linearization function and is looped unchanged with the same unit through the Analog Input function block.
- Indirect
With this setting the measured value from the Transducer Block (input value) is re-scaled linearly via the input scaling XD_SCALE to the desired output range OUT_SCALE.
- Indirect Square Root
With this setting the measured value from the Transducer Block (input value) is re-scaled via the parameter group XD_SCALE and recalculated using an evolution function. It is then rescaled again to the desired output range via the parameter group OUT_SCALE.

5.2.4 Selection of units

The XD_SCALE parameter group is used to determine with which physical unit the input value from the Transducer Blocks should be read in and processed in the Analog Input function block. The output value OUT is defined via the OUT_SCALE parameter group → For an example for rescaling the input value, see page 160.

The choice of units depends on the corresponding channel:

- Channel = 1 → Only units for the mass flow are valid
- Channel = 2 → Only units for the volume flow are valid
- Channel = 7 → Only units for totalizer 1 are valid
- Channel = 8 → Only units for totalizer 2 are valid
- Channel = 9 → Only units for totalizer 3 are valid

If an unsuitable unit is selected, the function block changes to the OOS (out of service) operating mode.



Hinweis!

- If the "Direct" type of linearization is selected via the L_TYPE parameter, the setting for the XD_SCALE and OUT_SCALE parameter groups must be identical; otherwise, the function block remains in the OOS mode and the "BLOCK CONFIG ERROR" block error is displayed in the BLOCK_ERROR parameter.
- The system units selected in the Transducer Blocks in question do not have any effect on the setting of the system units in the Analog Input function block. The units are specified independently of one another and must be configured separately. The unit selected in the Transducer Blocks is only used for the local display, EPD adjustment, low flow cut off and for simulation.

5.2.5 Status of the output value OUT

The status of the parameter group OUT communicates to the downstream function blocks the status of the Analog Input function block and the validity of the output value OUT. The following status values can be displayed:

- GOOD_NON_CASCADE
The output value OUT is valid and can be used for further processing.
- UNCERTAIN
The output value OUT can only be used for further processing to a limited extent. The status signals to the downstream function blocks that a "notice message" is present in the device, e.g. arising from active positive zero return or simulation.
- BAD
The output value OUT is invalid. The following causes are possible:
 - The Analog Input function block is in the OOS operating mode.
 - The Resource Block is in operating mode OOS.
 - The status "BLOCK CONFIG ERROR" is displayed via the BLOCK_ERR parameter.
 - The "Flow" or "Totalizer" Transducer Block is in the OOS operating mode. The Analog Input function block can only process the input value of the Transducer Block in question if the operating mode is set to AUTO.
 - A "fault message" is present in the device arising from a critical device error, e.g. an electronics module defect.



Hinweis!

In the "Diagnosis" Transducer Block, the cause of the error message (notice/fault message) is displayed via the "Diag. - Act. Sys. Condition" parameter. A list of all the error messages, including remedial measures, is provided in the Operating Instructions for Proline Promag 55 FOUNDATION Fieldbus (BA126D).

5.2.6 Simulation of input/output

Parameters of the Analog Input function block allow simulation of the input and output of the function block:

1. Simulation of the input of the Analog Input function block:
The parameter group SIMULATE can be used to specify the input value (measured value and status). Since the simulation value runs through the entire function block, all the parameter settings of the block can be checked.



Note!

If simulation is blocked by the jumper on the I/O board then simulation mode cannot be activated in the parameter SIMULATE. In the Resource Block, the parameter BLOCK_ERROR shows whether simulation of the Analog Input function block is possible.

2. Simulation of the output of the Analog Input function block:
Set the operating mode in the parameter group MODE_BLK to MAN and specify the desired output value directly in the parameter OUT.

5.2.7 Diagnosis

Block errors and diagnosis information are displayed in the Analog Input function block via the BLOCK_ERR parameter.



Hinweis!

Further information on troubleshooting during the configuration of the Analog Input function block is provided in the Operating Instructions for Promag 55 FOUNDATION Fieldbus (BA0126).

5.2.8 Rescaling the input value

In the Analog Input function block the input value or input range can be scaled in accordance with the automation requirements.

Example:

- The system unit in the Transducer Block is m^3/h .
- The measuring range of the sensor is 0 to $30 \text{ m}^3/\text{h}$.
- The output range to the process control system should be 0 to 100%.

The Analog Input function block must be configured as follows:

- Parameter CHANNEL
Option: CHANNEL → 2 = Volume flow
- Parameter L_TYPE
Option: L_TYPE = Indirect
The "Volume flow" process variable of the "Flow" Transducer Block is rescaled linearly in the AI Block via the input scaling XD_SCALE to the desired output range OUT_SCALE.
- XD_SCALE parameter group

XD_SCALE 0 %	= 0
XD_SCALE 100 %	= 30
XD_SCALE UNIT	= m^3/h

- OUT_SCALE parameter group

OUT_SCALE 0 %	= 0
OUT_SCALE 100%	= 100
OUT_SCALE UNIT	= %

The result is that with an input value of, for example, $15 \text{ m}^3/\text{h}$ a value of 50% is output via the parameter OUT.



Abb. 4: Example for rescaling the input value

5.2.9 Limit values

The limit values are based on the output value OUT. If the output value OUT exceeds or does not reach the defined limit values then an alarm is sent to the fieldbus host system via the limit value process alarms.

The following limit values can be defined:

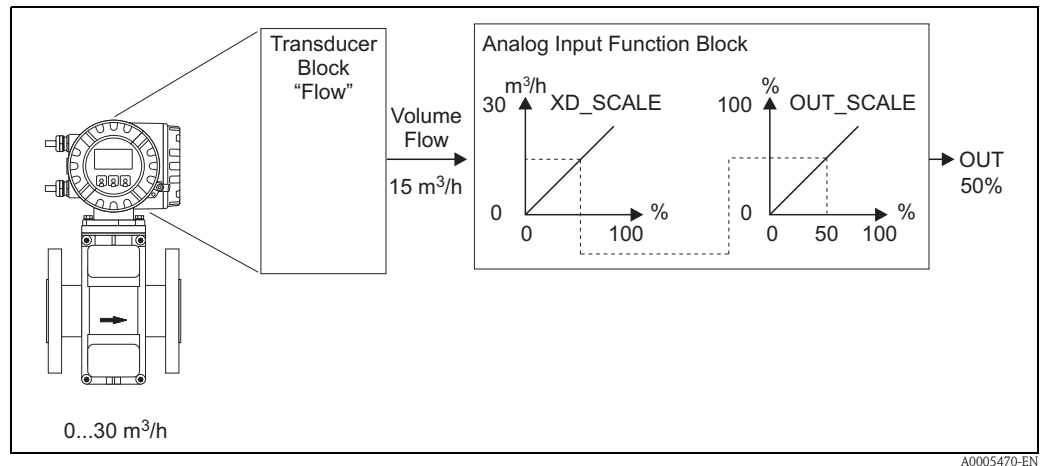
- HI_HI_LIM (upper alarm limit)
- HI_LIM (upper early warning limit)
- LO_LO_LIM (lower alarm limit)
- LO_LIM (lower early warning limit)

5.2.10 Alarm detection and processing

Process alarms provide information on particular block statuses and block events. The status of the process alarms is communicated to the fieldbus host system via the parameter BLOCK_ALM. The parameter ACK_OPTION specifies whether an alarm must be acknowledged via the fieldbus host system.

The following process alarms are generated by the Analog Input function block:

Block process alarms

A block process alarm is triggered via the BLOCK_ERR parameter. The parameter BLOCK_ALM is used to show the block process alarms and communicate them to the fieldbus host system. The following process alarms can be generated by the Analog Input function block:

- SIMULATE ACTIVE
- INPUT FAILURE
- OUT OF SERVICE
- BLOCK CONFIG ERROR

If the option of the process alarm (BLOCK ALM) has **not** been enabled in the parameter ACK_OPTION, the process alarms must be acknowledged in the parameter BLOCK_ALM.

Limit value process alarms

If a limit value is infringed then the priority specified for the limit value alarm will be checked before the limit value violation is communicated to the fieldbus host system. The priority that specifies the action in the event of an active limit value violation is determined by the following parameters:

- HI_HI_PRI
- HI_PRI
- LO_LO_PRI
- LO_PRI

The status of the limit value process alarms is communicated to the fieldbus host system via the following parameters:

- HI_HI_ALM
- HI_ALM
- LO_LO_ALMI
- LO_ALM

If the option of a limit value process alarm has **not** been enabled in the parameter ACK_OPTION then this must be acknowledged directly in its parameter (see list).



Hinweis!

The parameter ALARM_SUM shows the current status of all the process alarms.

6 Discrete Output Function block

The Discrete Output function block (DO, Discrete Output) processes a discrete setpoint value received from an upstream function block or higher level process control system, with which various instrument functions (e.g. zero point adjustment or totalizer reset) can be initiated in the downstream Transducer Block.



A0003816-en

CAS_IN_D = Remote setpoint value from another function block

OUT_D = Discrete output value and status

BKCAL_OUT_D = Discrete output value and status required by BKCAL_IN_D input of another block for output

6.1 Signal processing

The figure shows the internal structure of the Discrete Output function blocks Promag 55 FOUNDATION Fieldbus:

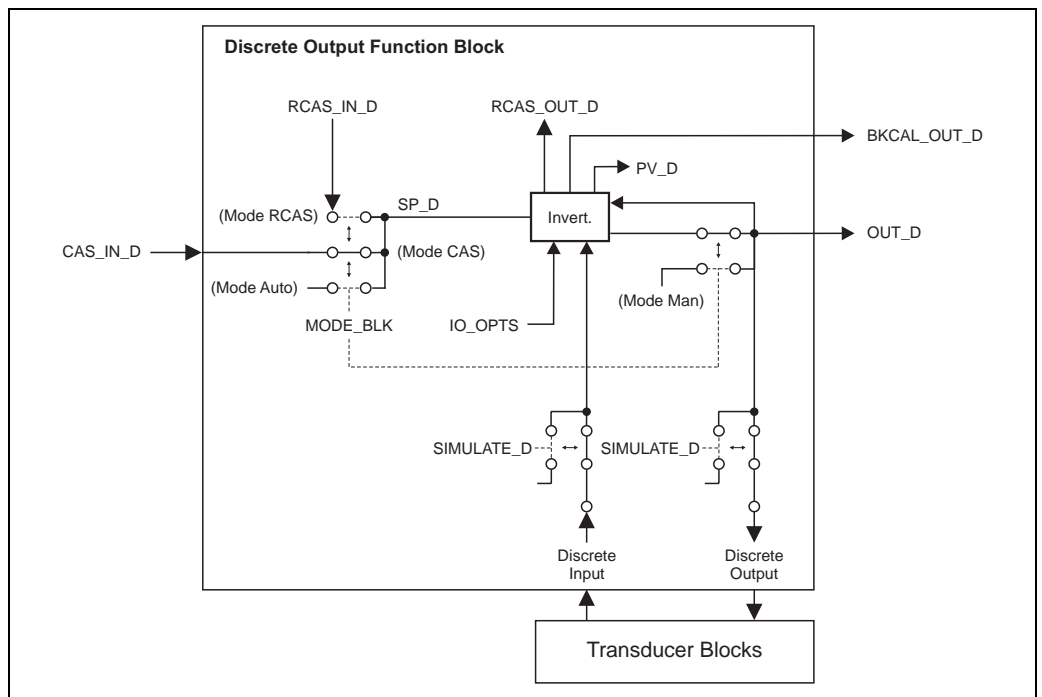

A0004771-en

Abb. 5: Signal processing in the Discrete Output function block

In the CAS operating mode (cascade operation), the Discrete Output function block receives, via the function block input CAS_IN_D, a discrete signal from an upstream function block. This signal controls the setpoint value (parameter SP_D) of the function block, and after internal calculation is sent as an output signal (parameter OUT_D) to the Transducer Block for control of instrument functions (e.g. zero point adjustment). The output value and status of the Discrete Output function block is communicated to the upstream block via the output BKCAL_OUT_D.

Signal processing in the RCAS operating mode (remote cascade operation) is largely identical to the CAS operating mode. However, in this operating mode, control of the parameter SP_D does not take place via an upstream function block but through a process control system. The output value and status of the Discrete Output function block is communicated to the process control system as an answer message via parameter RCAS_OUT_D.

In the AUTO operating mode (automatic operation), the set point value (parameter SP_D) is prescribed directly in the Discrete Output function block. In this case, the parameter CAS_IN_D is not taken into consideration in the internal calculation.

In the MAN operating mode (HAND), the output value (parameter OUT_D) can be prescribed directly in the Discrete Output function block. No internal calculation takes place.

6.2 Important functions and parameters of the Discrete Output function block

The primary functions and parameters of the Discrete Output function block are listed below.



Hinweis!

All FOUNDATION Fieldbus parameters available are described in the "FOUNDATION Fieldbus Overview" Operating Instructions (BA013S) (acquired at: → www.endress.com → Download).

6.2.1 Selecting the operating mode

The operation mode is set by means of the MODE_BLK parameter group. The Discrete Output function block supports the following operation modes:

- AUTO
- MAN
- CAS
- RCAS
- OOS

6.2.2 Safety behavior

There is a safety default available (fault state) for the Discrete Output function block. This is activated when a fault condition (of the corresponding valid set point value) exists longer than defined in the parameter FSTATE_TIME, or when the parameter SET_FSTATE in the Resource Block is activated. The safety operation is determined via the parameters FSTATE_TIME, FSTATE_VAL_D, and IO_OPTS.

6.2.3 Assignment between the Discrete Output Function block and the Transducer Block

The assignment or connection between the Discrete Output function block and the Transducer Block takes place in the Discrete Output function block via the parameter CHANNEL.

→ Parameter CHANNEL → 16 (= Discrete Output function block)

6.2.4 Values for the parameters CAS_IN_D, RCAS_IN_D, OUT_D, and SP_D

Via the Discrete Output function block, different instrument functions in the Transducer Block can be initiated via manufacturer-specific, fixed set point values from an upstream function block.

Here it must be observed that the desired function is only then executed when a status change from the value 0 (Discrete state 0) to the corresponding function value (following table) takes place. The value 0 always serves as the starting point for the corresponding control of instrument functions. A status change from a value not equal to zero to another value has no effect.

Input allocation of the parameter CAS_IN_D, RCAS_IN_D, OUT_D, SP_D

Status changes	Action
Discrete state 0 → Discrete state 1	Reserved
Discrete state 0 → Discrete state 2	Positive Zero Return ON
Discrete state 0 → Discrete state 3	Positive Zero Return OFF
Discrete state 0 → Discrete state 4	Reserved
Discrete state 0 → Discrete state 5	Reserved
Discrete state 0 → Discrete state 6	Reserved
Discrete state 0 → Discrete state 7	Reset Totalizers 1, 2, 3
Discrete state 0 → Discrete state 8	Reset Totalizer 1
Discrete state 0 → Discrete state 9	Reset Totalizer 2
Discrete state 0 → Discrete state 10	Reset Totalizer 3

Example for the control of positive zero return via the Discrete Output function block.

The following example is intended to illustrate how positive zero return can be activated and deactivated during a rinsing process by an upstream function block via the Discrete Output function block.

1. In the first step, the connection between the Discrete Output function block and the Transducer Block must be established. Here, the value 16 must be assigned to the parameter CHANNEL in the Discrete Output function block.

→ Parameter CHANNEL → 16 (= Discrete Output function block)

2. In the CAS operating mode, the Discrete Output function block processes the set point value prescribed at the input CAS_IN_D by the upstream function block and transfers it to the Transducer Block.

Activating positive zero return

With a starting value of 0 (Discrete state 0), the positive zero return is activated by a status change from 0 to 2 at input CAS_IN_D.

Deactivating positive zero return

Positive zero return can only then be deactivated when the input value at CAS_IN_D has first been set to output value 0 (Discrete state 0). Only then can positive zero return be deactivated through a status change from 0 to 2 at input CAS_IN_D.

7 Additional function blocks



Hinweis!

Other function blocks such as the PID, Arithmetic, Input Selector, Signal Characterizer and Integrator function block are described in the "FOUNDATION Fieldbus Overview" (BA013S) Operating Instructions (acquired at: → www.endress.com → Download).

8 Factory settings

8.1 SI units (not for USA and Canada)

Low flow cut off, full scale value

Nominal diameter [mm]	Low flow cut off (approx. $v = 0.04$ m/s)		Full scale value (approx. $v = 2.5$ m/s)			
		Volume	Mass		Volume	Mass
15	0.5	dm ³ /min	kg/min	25	dm ³ /min	kg/min
25	1	dm ³ /min	kg/min	75	dm ³ /min	kg/min
32	2	dm ³ /min	kg/min	125	dm ³ /min	kg/min
40	3	dm ³ /min	kg/min	200	dm ³ /min	kg/min
50	5	dm ³ /min	kg/min	300	dm ³ /min	kg/min
65	8	dm ³ /min	kg/min	500	dm ³ /min	kg/min
80	12	dm ³ /min	kg/min	750	dm ³ /min	kg/min
100	20	dm ³ /min	kg/min	1200	dm ³ /min	kg/min
125	30	dm ³ /min	kg/min	1850	dm ³ /min	kg/min
150	2.5	m ³ /h	t/h	150	m ³ /h	t/h
200	5.0	m ³ /h	t/h	300	m ³ /h	t/h
250	7.5	m ³ /h	t/h	500	m ³ /h	t/h
300	10	m ³ /h	t/h	750	m ³ /h	t/h
350	15	m ³ /h	t/h	1000	m ³ /h	t/h
400	20	m ³ /h	t/h	1200	m ³ /h	t/h
450	25	m ³ /h	t/h	1500	m ³ /h	t/h
500	30	m ³ /h	t/h	2000	m ³ /h	t/h
600	40	m ³ /h	t/h	2500	m ³ /h	t/h

Language

Country	Language
Australia	English
Austria	Deutsch
Belgium	English
China	Chinese
Czech Republic	Czech
Denmark	English
England	English
Finland	Suomi
France	Francais
Germany	Deutsch
Hong Kong	English
Hungary	English
India	English
Indonesia	Bahasa Indonesia
Instruments International	English
Italy	Italiano
Japan	Japanese
Malaysia	English
Netherlands	Nederlands
Norway	Norsk

Country	Language
Poland	Polish
Portugal	Portuguese
Russia	Russian
Singapore	English
South Africa	English
Spain	Espanol
Sweden	Svenska
Switzerland	Deutsch
Thailand	English

Density, length, temperature

	Unit
Density	kg/l
Length	mm
Temperature	° C

8.2 US units (only for USA and Canada)

Low flow cut off, full scale value

Nominal diameter [inch]	Low flow cut off (approx. v = 0.13 ft/s)			Full scale value (approx. v = 8.2 ft/s)		
		Volume	Mass		Volume	Mass
1/2"	0.10	gal/min	lb/min	6	gal/min	lb/min
1"	0.25	gal/min	lb/min	18	gal/min	lb/min
1 1/4"	0.50	gal/min	lb/min	30	gal/min	lb/min
1 1/2"	0.75	gal/min	lb/min	50	gal/min	lb/min
2"	1.25	gal/min	lb/min	75	gal/min	lb/min
2 1/2"	2.0	gal/min	lb/min	130	gal/min	lb/min
3"	2.5	gal/min	lb/min	200	gal/min	lb/min
4"	4.0	gal/min	lb/min	300	gal/min	lb/min
5"	7.0	gal/min	lb/min	450	gal/min	lb/min
6"	12	gal/min	lb/min	600	gal/min	lb/min
8"	15	gal/min	lb/min	1200	gal/min	lb/min
10"	30	gal/min	lb/min	1500	gal/min	lb/min
12"	45	gal/min	lb/min	2400	gal/min	lb/min
14"	60	gal/min	lb/min	3600	gal/min	lb/min
16"	60	gal/min	lb/min	4800	gal/min	lb/min
18"	90	gal/min	lb/min	6000	gal/min	lb/min
20"	120	gal/min	lb/min	7500	gal/min	lb/min
24"	180	gal/min	lb/min	10500	gal/min	lb/min

Language, density, length, temperature

	Unit
Language	English
Density	g/cc
Length	inch
Temperature	°F

9 Index (FOUNDATION Fieldbus)

A

Access	
Transducer Block	104
Access - Code	
“Diagnosis” Transducer Block	122
“Display” Transducer Block	126
“Flow” Transducer Block	104
“Totalizer” Transducer Block	140
Transducer Block "Totalizer"	144
Access - Code Counter	
“Display” Transducer Block	126
Access - Def.Private Code	
“Display” Transducer Block	127
Access - Status	
“Diagnosis” Transducer Block	122
“Display” Transducer Block	126
“Flow” Transducer Block	104
“Totalizer” Transducer Block	140
Transducer Block "Totalizer"	144
Access code counter	24
Add. Line - ...	
“Display” Transducer Block	131
Alarm delay	123
Alarm detection	
AI Function block	161
Resource Block	98
Transducer Block	103
Alarm processing	
AI Function block	161
Resource Block	98
Transducer Block	103
Amp. - HW Identification	
Resource Block	99
Amp. - HW Rev.Number	
Resource Block	99
Amp. - Language Group	
Resource Block	99
Amp. - Prod.Number	
Resource Block	99
Amp. - SW Identification	
Resource Block	99
Amp. - SW Rev.No. T-DAT	
Resource Block	99
Amp. - SW Rev.Number	
Resource Block	99
Amplifier	
Hardware identification number	99
Hardware revision number	99
Language Group	99
Production number	99
Software identification number	99
Software revision number	99
Assign	
DO Function block	164

B

Backlight	
Display	128
Block	
Totalizer	42
Block model	95
Block output values	
Transducer Block	102
Block status	
Resource Block	97

C

Calibration factor	
Negative	118
Positive	118
Cell Constant	118
Code	
Access code counter	24
Counter (matrix enabling)	24
Code entry	
See Access - Code	
Code entry, personal private code	127
Conductivity	
Enabling	119
Conductivity measurement	112
Config. - Backlight	
“Display” Transducer Block	128
Config. - Contrast LCD	
“Display” Transducer Block	128
Config. - Display Damping	
“Display” Transducer Block	128
Config. - Language	
“Display” Transducer Block	127

D

Damping	
Display	128
Flow, measuring signal	108
Density	
Display, unit	118
Enter density factor (for mass flow)	118
Density Param. - Fixed Value	
“Flow” Transducer Block	118
Density Param. - Unit	
“Flow” Transducer Block	118
Diag. - Act. Sys. Condition	
“Diagnosis” Transducer Block	122
Diag. - Prev. Sys. Condition	
“Diagnosis” Transducer Block	122
Diagnosis	
AI Function block	160
Transducer Block	103
Discrete Output Function block	163
Discrete Output function block	163
Display	
Backlight	128

Conductivity, current value	107	EPD - Param. Time	
Conductivity, service parameter	107	"Flow" Transducer Block	115
Configuration		Error messages	
Additional line	131	See System condition	
Information line	135	F	
Main line	129	Factory settings (SI units)	
Contrast	128	Density	168
Damping	128	Full scale value	167
Density value, fixed	106	Language	167
Density, fed in via the AO-Block	107	Length	168
Format (display number of decimal places)		Low flow cut off	167
Additional line	132	Temperature	168
Information line	136	Factory settings (US units)	
Main line	130	Density	168
Language setting	127	Full scale value	168
Mass flow (calculated)	105	Language	168
Measuring device operating time	124	Length	168
Test function	128	Low flow cut off	168
Volume flow	105	Temperature	168
E		Fault message	
ECC		See Operating Instructions for Promag 55 FOUNDATION	
Cycle	117	FIELDBUS (BA026D)	
Duration	116	Filter depth	
Polarity (read only)	117	Activating	121
Recovery Time	117	Function blocks	155
System Option	115	G	
Transducer Block "Flow"	116	Group	
ECC - Cycle		Totalizer (1 to 3)	43
Transducer Block "Flow"	117	I	
ECC - Duration		I/O - HW Identification	
Transducer Block "Flow"	116	Resource Block	99
ECC - Polarity		I/O - HW Rev. Number	
Transducer Block "Flow"	117	Resource Block	99
ECC - Recovery Time		I/O - Prod.Number	
Transducer Block "Flow"	117	Resource Block	99
ECC, Cyclical electrode cleaning		I/O - SW Identification	
Activate ECC	116	Resource Block	99
Electrodes		I/O - SW Rev. Number	
EPD electrode	115	Resource Block	99
Empty pipe detection (EPD)		I/O - Type	
Empty Pipe	115	Resource Block	99
Empty pipe/full pipe adjustment	113	I/O Module	
EPD electrode	115	Hardware identification number	99
Full Pipe	115	Hardware revision number	99
General information	114	Production number	99
Response time	115	Software identification number	99
Switching on/off	114	Software revision number	99
EPD - Adjustment		Identification number	
"Flow" Transducer Block	113	Amplifier hardware	99
EPD - Electrode		Amplifier software	99
"Flow" Transducer Block	115	I/O module hardware	99
EPD - High Value		I/O module software	99
"Flow" Transducer Block	115	Sensor	121
EPD - Low Value		Info Line - ...	
"Flow" Transducer Block	115	"Display" Transducer Block	135
EPD - Param. Mode		Information line (group CGA)	
"Flow" Transducer Block	114	Multiplex	39

Installation direction, sensor	107	Process - Pressure Shock Suppression	
Integration time	108	“Flow” Transducer Block	111
L		Transducer Block “Flow”	112
Language group amplifier	99	Process variable assignment	
Limit values		AI Function block	158
AI Function block	161	Production number	
Low flow cut off		Amplifier	99
Assign (mass flow/volume flow)	109	I/O Module	99
Off-value	110	Sensor	121
On-value	110	R	
Unit	110	Rescaling	
Low Flow Cut Off - Assign		AI Function block	160
“Flow” Transducer Block	109	Resource Block	97
Low Flow Cut Off - Off Value		Resource Block parameters	97
“Flow” Transducer Block	110	Revision number	
Low Flow Cut Off - On Value		Amplifier hardware	99
“Flow” Transducer Block	110	Amplifier software	99
Low Flow Cut Off - Unit		Hardware	121
“Flow” Transducer Block	110	S-DAT software	121
M		S	
Main Line - ...		Safety behaviour	
“Display” Transducer Block	129	DO Function block	164
Measuring period, time entry	119	Select units (“Flow” Transducer Block)	
N		Density value, fixed	106
Nominal diameter	118	Mass flow	106
Notice message		Nominal diameter (mm, inch)	107
See Operating Instructions for Promag 55 FOUNDATION		Volume flow	105
FIELDBUS (BA026D)		Select units (Transducer Block “Flow”)	
O		Conductivity	107
OED		Sensor	
Empty Value	115	Calibration factor	118
Full Pipe Coef	115	Display device type	121
Period	115	Hardware identification number	121
OED - Empty Value		Hardware production number	121
Transducer Block “Flow”	115	Hardware revision number	121
OED - Full Value		Installation direction	107
Transducer Block “Flow”	115	Measuring period	119
OED - Period		Nominal diameter	118
“Flow” Transducer Block	115	Revision Number Software S-DAT	121
Operating time, measuring device	124	Serial number	99
Operation - Test Display		Zero point	118
“Display” Transducer Block	128	Sensor - HW Identification	
Operation mode		“Flow” Transducer Block	121
AI Function block	158	Sensor - HW-Rev.Number	
DO Function block	164	“Flow” Transducer Block	121
Resource Block	97	Sensor - Prod.Number	
Transducer Block	103	“Flow” Transducer Block	121
Overvoltage		Sensor - Serial Number	
Time Area	119	Resource Block	99
P		Sensor - SW-Rev.No. S-DAT	
Parameter		“Flow” Transducer Block	121
Resource Block	99	Sensor - Type	
Positive zero return	108	“Flow” Transducer Block	121
Pressure shock suppression	111	Sensor Data - Cell Constant	
		Transducer Block “Flow”	118
		Sensor Data - Conductivity Enable	
		Transducer Block “Flow”	119

Sensor Data - K-Factor Negative "Flow" Transducer Block	118	Sys. - Install. Direction Sensor "Flow" Transducer Block	107
Sensor Data - K-Factor Positive "Flow" Transducer Block	118	Sys. - Integration Time "Flow" Transducer Block	108
Sensor Data - Measuring Period "Flow" Transducer Block	119	Sys. - Operation Time "Diagnosis" Transducer Block	124
Sensor Data - Nominal Diameter "Flow" Transducer Block	118	Sys. - Permanent Storage "Flow" Transducer Block	109
Sensor Data - Overvoltage Time Transducer Block "Flow"	119	Sys. - Positive Zero Return "Flow" Transducer Block	108
Sensor Data - Zero Point "Flow" Transducer Block	118	Sys. - Reset "Diagnosis" Transducer Block	123
Serial number sensor	99	Sys. - Sim. Failsafe Mode "Diagnosis" Transducer Block	123
Service/Analys. - Coil Voltage Transducer Block "Flow"	120	Sys. - Special Filter "Flow" Transducer Block	109
Service/Analys. - Electrode Pot. 1 - Value Measurand "Flow" Transducer Block	120	Sys. - System Damping "Flow" Transducer Block	108
Service/Analys. - Electrode Pot. 2 - Value Measurand "Flow" Transducer Block	120	Sys. - T-DAT Save/Load "Diagnosis" Transducer Block	125
Service/Analys. - Measuring Period "Flow" Transducer Block	120	Sys. - Time Since Reset "Diagnosis" Transducer Block	124
Service/Analys. - Noise Value Transducer Block "Flow"	120	Sys. - Troubleshooting "Diagnosis" Transducer Block	124
Service/Analys. - Risetime - Value Measurand "Flow" Transducer Block	120	System condition Actual	122
Service/Analys. - Split Position Transducer Block "Flow"	120	Previous (error history)	122
Service/Analys. -Reverse Time Transducer Block "Flow"	120	System Option - Conductivity Transducer Block "Flow"	107
Service/analysis functions	120	System Option - ECC Transducer Block "Flow"	115
Set points		System Unit - Conductivity Transducer Block "Flow"	107
DO Function block	165	System Unit - Fixed Density "Flow" Transducer Block	106
Signal filter	109	System Unit - Length "Flow" Transducer Block	107
Signal processing		System Unit - Mass Flow "Flow" Transducer Block	106
AI Function block	156	System Unit - Volume Flow "Flow" Transducer Block	105
DO Function block	163	System Value - Conductivity Transducer Block "Flow"	107
Transducer Block	101	System Value - Density Input Transducer Block "Flow"	107
Simulation		System Value - Fixed Density "Flow" Transducer Block	106
AI Function block	160	System Value - Mass Flow "Flow" Transducer Block	105
Display measured value	120	System Value - Volume Flow "Flow" Transducer Block	105
Measured value for test purposes	120	System-Reset (without disconnecting main power)	123
Resource Block	98		
Totalizer failsafe mode	123	T	
Volume flow/mass flow	119	T-DAT	
Simulation - Measurand		Amplifier software revision number	99
"Flow" Transducer Block	119	Loading/saving data	125
Simulation - Unit		Tot. - Failsafe All	
"Flow" Transducer Block	120	"Totalizer" Transducer Block	143
Simulation - Value Measurand			
"Flow" Transducer Block	120		
Status OUT			
AI Function block	159		
Storage	109		
Sys. - Alarm Delay			
"Diagnosis" Transducer Block	123		
Sys. - CIP Samples			
"Flow" Transducer Block	109		
Sys. - Filterdepth Median			
Transducer Block "Flow"	121		

Tot. - Reset All	
“Totalizer” Transducer Block	143
Tot. 1 to 3 - Assign	
“Totalizer” Transducer Block	142
Tot. 1 to 3 - Mode	
“Totalizer” Transducer Block	142
Tot. 1 to 3 - Reset	
“Totalizer” Transducer Block	142
Tot. 1 to 3 - Sum	
“Totalizer” Transducer Block	141
Tot. 1 to 3 - Unit	
“Totalizer” Transducer Block	141
Totalizer	
Define failsafe mode	143
Reset (all)	143
Simulation failsafe mode	123
Totalizer (block D)	42
Totalizer 1	
Reset	142
Totalizer 1 to 3	
Assign (volume, mass)	142
Balancing mode	142
Display value	141
Unit	141
Transducer Block	100
Troubleshooting, EEPROM	124
Type of linearization	
AI Function block	158
U	
Units	
AI Function block	159
W	
Write protect	
Resource Block	98
Z	
Zero point	118

www.endress.com/worldwide

Endress+Hauser 
People for Process Automation
