



Appendices

Appendix A: MS4 Permit

Appendix B: Summary of MS4 Permit Requirements and Incorporation into the Port's Stormwater DSM

Appendix C: Regulatory Context

Appendix D: Groundwater and Soil On-site Testing Procedures

Appendix E: DSM Coordination Checklist

Appendix F: Variance Request Application Form

Appendix G: Stormwater Management Submittal Content List

Appendix H: Modeling Report Content List

Appendix I: Project O&M Form

Appendix J: City Draft Figure on the "Depth to Seasonally High Water (Table)"²⁸

Appendix K: Drainage System Design Reference

Appendix L: Nomographs for Water Quality BMP Sizing

Appendix M: Appendix Not Used

Appendix N: Best Management Practices Capital Cost Estimation Methods

Appendix O: BMP Operations and Maintenance Level of Effort

Appendix P: Sustainability Considerations For BMPs

²⁸ Designers may refer to this figure for high level review, otherwise designers must refer to site-specific information such as data collected through the Port's TRC from previous geotechnical and/or groundwater data or from site-specific testing.



Appendix A

MS4 Permit

Expiration Date: January 30, 2016

Permit Number: 101314

File Number: 108015

NATIONAL POLLUTANT DISCHARGE ELIMINATION SYSTEM
MUNICIPAL SEPARATE STORM SEWER SYSTEM (MS4) DISCHARGE PERMIT

Oregon Department of Environmental Quality
811 SW Sixth Ave., Portland OR 97204-1390
Telephone: 503-229-5630

Issued pursuant to Oregon Revised Statute 468B.050 and the Federal Clean Water Act

ISSUED TO:
City of Portland
Port of Portland

SOURCES COVERED BY THIS PERMIT:
This permit covers all existing and new discharges of stormwater from the Municipal Separate Storm Sewer System (MS4) within the City of Portland Urban Services Boundary.

COUNTY: Multnomah

RECEIVING WATERBODIES:

Basin(s): Willamette River, Columbia River

Sub-basin(s): Lower Willamette River, Columbia Slough, Tualatin River

Stream(s): Columbia River, Columbia Slough, Fanno Creek, Balch Creek, Johnson Creek, and Tryon Creek

WASTE LOAD ALLOCATIONS: A Total Maximum Daily Load (TMDL) that includes wasteload allocations for urban stormwater has been established for the Willamette River Basin, Columbia River Basin, Tualatin River Subbasin, and the Columbia Slough. Waste load allocations are addressed in Schedule D of this permit.

EPA REFERENCE NO.: ORS108015

This permit is issued in response to Application Number 972521 received on September 2, 2008.

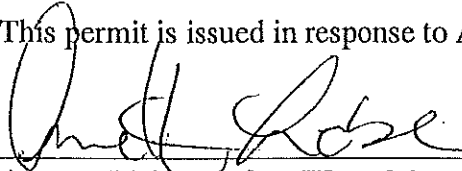
Annette Liebe, Surface Water Management Section Manager

1/31/2011
Date

PERMITTED ACTIVITIES

Until this permit expires or is modified or revoked, the co-permittee is authorized to discharge municipal stormwater to waters of the state in conformance with the requirements and conditions set forth in the attached schedules. Where conflict exists between specific conditions (found in Schedules A-D) and general conditions (Schedule F), the specific conditions supersede the general conditions.

	<u>Page</u>
Schedule A	- Controls and Limitations 2
Schedule B.....	- Monitoring and Reporting Requirements 14
Schedule C.....	- Compliance Schedules 21
Schedule D	- Special Conditions 21
Schedule F	- General Conditions 26

SCHEDULE A

Controls and Limitations for Stormwater Discharges from Municipal Separate Storm Sewer Systems

1. Prohibit Non-stormwater Discharges

The co-permittees must effectively prohibit non-stormwater discharges into the MS4 unless such discharges are otherwise permitted under Subsection A.4.a.xii., another NPDES permit or other applicable state or federal permit, or are otherwise exempted or authorized by the Department.

2. Reduce Pollutants to the Maximum Extent Practicable

Each co-permittee must reduce the discharge of pollutants from the MS4 to the maximum extent practicable (MEP). Compliance with this permit and implementation of a stormwater management program, including the Department-approved Stormwater Management Plan (SWMP), establishes this MEP requirement, unless or until the Department reopens the permit as provided in Oregon Administrative Rule (OAR) 340-045-0040 and 0050 to require additional controls.

3. Implement the Stormwater Management Plan

The co-permittees must continue to implement and assess the effectiveness of its Department-approved SWMP. The SWMP must guide each co-permittee in the implementation of its stormwater management program.

a. The SWMPs and any Department-approved amendments thereto, are hereby incorporated into the permit by reference. The applicable SWMP is as follows:

i. For the City of Portland: The SWMP is the proposed SWMP submitted with the NPDES permit re-application and amendment received by the Department on August 13, 2010, the addition of the special conditions specified in Schedule D.6., and any subsequent changes made to the SWMP in accordance with the conditions of this permit.

ii. For the Port of Portland: The SWMP is the proposed SWMP submitted with the NPDES



permit re-application and amendment received by the Department on September 20, 2010, the addition of the special conditions specified in Schedule D.6., and any subsequent changes made to the SWMP in accordance with the conditions of this permit.

- b. Each co-permittee is responsible for compliance within its jurisdiction as identified in this permit, and is not responsible for compliance outside of its jurisdiction.
- c. The SWMP must be electronically available through direct incorporation into the co-permittee's website or other similar method approved by the Department.

4. Stormwater Management Plan Requirements

Each co-permittee must implement a SWMP that outlines the practices, techniques or provisions associated with protecting water quality and satisfying requirements of this permit and includes measurable goals for the stormwater program elements identified in subsections a-h. The measurable goals must identify actions the permittee will undertake to implement best management practices (BMPs), and include, where appropriate, the frequency, timeline and/or location where the BMP actions will occur.

- a. **Illicit Discharge Detection and Elimination:** Co-permittees must continue to implement a program to detect, remove, and eliminate illicit discharges to the MS4. The program must:
 - i. Prohibit, through ordinance or other regulatory mechanism, illicit discharges into the co-permittee's MS4.
 - ii. Include documentation in an enforcement response plan or similar document by November 1, 2011 describing the enforcement response procedures the co-permittee will implement when an illicit discharge investigation identifies a responsible party.
 - iii. Develop or identify pollutant parameter action levels that will be used as part of the field screening. The action levels will identify concentrations for identified pollutants that, if exceeded, will require further investigation, including laboratory sample analyses, to identify the source of the illicit discharge. The pollutant parameter action levels and rationale for using the action levels must be documented in an enforcement response plan or similar document, and reported to the Department by November 1, 2011.
 - iv. Conduct annual dry-weather inspection activities during the term of the permit. By July 1, 2012, the dry-weather inspection activities must include annual field screening of identified priority locations documented by the co-permittee. Priority locations must, where possible, be located at an accessible location downstream of any source of suspected illegal or illicit activity or other location as identified by the co-permittee. Priority locations must be based on an equitable consideration of hydrological conditions, total drainage area of the location, population density of the location, traffic density, age of the structures or buildings in the area, history of the area, land use types, personnel safety, accessibility, historical complaints or other appropriate factors as identified by the co-permittee. The dry-weather field screening activities must occur



after an antecedent dry period of at least 72-hours. The dry-weather field screening activities must be documented and include:

1. General observations, including visual presence of flow, turbidity, oil sheen, trash, debris or scum, condition of conveyance system or outfall, color, odor and any other relevant observations related to the potential presence of non-storm water or illicit discharges.
 2. Field Screening - If flow is observed, and the source is unknown, a field analysis must be conducted to determine the cause of the dry-weather flow. The field analysis must include sampling for pollutant parameters that are likely to be found based upon the suspected source of discharge or by other effective investigatory approaches or means to identify the source or cause of the suspected illicit discharge. Where appropriate, field screening pollutant parameter action levels identified by the permittee must be considered. Suspected sources of discharge include, but are not limited to, sanitary cross-connections or leaks, spills, seepage from storage containers, non-stormwater discharges or other residential, commercial, industrial or transportation-related activities.
 3. Laboratory Analysis – If general observations and field screening indicate an illicit discharge and the presence of a suspected illicit discharge cannot be identified through other investigatory methods, the co-permittee must collect a water quality sample for laboratory analyses for ongoing discharges. The water quality sample must be analyzed for pollutant parameters or identifiers that will aid in the determination of the source of the illicit discharge. The types of pollutant parameters or identifiers may include, but are not limited to genetic markers, industry-specific toxic pollutants, or other pollutant parameters that may be specifically associated with a source type.
-
- v. Identify response procedures to investigate portions of the MS4 that, based on the results of general observations, field screening, laboratory analysis or other relevant information, such as a complaint or referral, indicates the likely presence of an illicit discharge. The response procedures must reflect the goal to eliminate the illicit discharge in an expeditious manner, as specified in subsection vii. below.
 - vi. Maintain a system for documenting illicit discharge complaints or referrals, and suspected illicit discharge investigation activities.
 - vii. Once the source of an illicit discharge is determined, the co-permittee must take appropriate action to eliminate the illicit discharges, including an initial evaluation of the feasibility to eliminate the discharge, within 5 working days. If the co-permittee determines that the elimination of the illicit discharge will take more than 15 working days due to technical, logistical or other reasonable issues, the co-permittee must develop and implement an action plan to eliminate the illicit discharge in an expeditious manner. The action plan must be completed in 20 working days of determining the source of an illicit discharge. In lieu of developing and implementing an individual

action plan for common types of illicit discharges, the co-permittee may document and implement response procedures, a response plan or similar document. The action plan, response procedures, response plan or similar document must include a timeframe for elimination of the illicit discharge as soon as practicable.

- viii. Describe and implement procedures to prevent, contain, respond to and mitigate spills that may discharge into the MS4. Spills, or other similar illicit discharges, that may endanger human health or the environment must be reported in accordance with all applicable federal and state laws, including proper notification to the Oregon Emergency Response System.
- ix. In the case of a known illicit discharge that originates within the co-permittee's MS4 regulated area and that discharges directly to a storm sewer system or property under the jurisdiction of another municipality, the co-permittee must notify the affected municipality as soon as practicable, and at least within one working day of becoming aware of the discharge.
- x. In the case of a known illicit discharge that is identified within the co-permittee's MS4 regulated area, but is determined to originate from a contributing storm sewer system or property under the jurisdiction of another municipality, the co-permittee must notify the contributing municipality or municipality with jurisdiction as soon as practicable, and at least within one working day of identifying the illicit discharge.
- xi. Maintain maps identifying known co-permittee-owned MS4 outfalls discharging to waters of the State. The dry-weather screening priority locations must be specifically identified on maps by July 1, 2012. If the co-permittee identifies the need to modify these maps, the maps must be updated in digital or hard-copy within six months of identification.
- xii. Unless the following non-stormwater discharges are identified in a particular case as a significant source of pollutants to waters of the State by the permittee or the Department, they are not considered illicit discharges and are authorized by this permit: water line flushing; landscape irrigation; diverted stream flows; rising ground waters; uncontaminated groundwater infiltration; uncontaminated pumped ground water; discharges from potable water sources; start up flushing of groundwater wells; potable groundwater monitoring wells; draining and flushing of municipal potable water storage reservoirs; foundation drains; air conditioning condensate; irrigation water; springs; water from crawl space pumps; footing drains; lawn watering; individual residential car washing; charity car washing; flows from riparian habitats and wetlands; dechlorinated swimming pool discharges; street wash waters; discharges of treated water from investigation, removal and remedial actions selected or approved by the Department pursuant to Oregon Revised Statute (ORS) Chapter 465; and, discharges or flows from emergency fire fighting activities. If any of these non-stormwater discharges under the co-permittee's jurisdiction is a significant source of pollutants, the permittee must develop and require implementation of appropriate BMPs to reduce the discharge of pollutants associated with the source.



- b. **Industrial and Commercial Facilities:** The co-permittee must continue to implement a program to reduce pollutants in stormwater discharges to the MS4 from facilities the co-permittee identified as being subject to a Department-issued industrial stormwater NPDES permit, hazardous waste treatment, disposal and recovery facilities, industrial facilities that are subject to section 313 of title III of the Superfund Amendments and Reauthorization Act of 1986, or facilities that have been identified as contributing a significant pollutant load to the MS4. The co-permittee must:
- i. Screen existing and new industrial facilities to assess whether they have the potential to be subject to an industrial stormwater NPDES permit or have the potential to contribute a significant pollutant load to the MS4.
 - ii. Within 30 days after the facility is identified, notify the industrial facility and the Department that an industrial facility is potentially subject to an industrial stormwater NPDES permit.
 - iii. Implement an updated strategy to reduce pollutants in stormwater discharges to the MS4 from industrial and commercial facilities where site-specific information has identified a discharge as a source that contributes a significant pollutant load to the MS4. The strategy must include a description of the rationale for identifying commercial and industrial facilities as a significant contributor, and establish the priorities and procedures for inspection of and implementation of stormwater control measures. This strategy must be implemented by January 1, 2013, and applied within one calendar year from the date a new source contributing a significant pollutant load to the MS4 has been identified.
- c. **Construction Site Runoff Control:** Co-permittees must continue to implement a program to reduce pollutants in stormwater runoff to the MS4 from construction activities. The program must:
- i. Include ordinances or other enforceable regulatory mechanisms that require erosion prevention and sediment controls to be designed, implemented, and maintained to prevent adverse impacts to water quality and minimize the transport of construction-related contaminants to waters of the State. The construction site runoff control program ordinances or other enforceable regulatory mechanism must apply to construction activities that result in a land disturbance of 500 square feet or greater.
 - ii. Require construction site operators to develop erosion prevention and sediment control site plans, and to implement and to maintain effective erosion prevention and sediment control best management practices.
 - iii. Require construction site operators to prevent or control non-stormwater waste that may cause adverse impacts to water quality, such as discarded building materials, concrete truck washout, chemicals, litter, and sanitary waste.
 - iv. Describe site plan review procedures to ensure that stormwater BMPs are appropriate and

address the construction activities being proposed. At a minimum, construction site erosion prevention and sediment control plans for sites disturbing one acre or greater must be consistent with the substantive requirements of the State of Oregon's 1200-C permit site erosion prevention and sediment control plans.

- v. Co-permittees must perform on-site inspections in accordance with documented procedures and criteria to ensure that the approved erosion prevention and sediment control plan is properly implemented. Inspections of construction sites must include disturbed areas of the site, material and waste storage areas, stockpile areas, construction site entrances and exits, sensitive areas, discharge locations to the MS4, and, if appropriate, discharge locations to receiving waters. Inspections must be documented, including photographs and monitoring results as appropriate.
 - vi. Describe in an enforcement response plan or similar document the enforcement response procedures the co-permittee will implement. The enforcement response procedures must ensure construction activities are in compliance with the ordinances or other regulatory mechanisms.
- d. **Education and Outreach:** Co-permittees must implement an education and outreach program designed to achieve measurable goals based on target audiences, specific stormwater quality issues in the community, or identified pollutants of concern. The program must:
- i. Continue to implement a documented public education and outreach strategy that promotes pollutant source control and a reduction of pollutants in stormwater discharges. The strategy must identify targeted pollutants of concern, the targeted audience, specific education activities, and the entity or individual responsible for implementation. The public education and outreach strategy may incorporate cooperative efforts with other MS4 regulated permittees or efforts by other groups or organizations provided a mechanism is developed and implemented to track the public education and outreach efforts within the MS4 regulated area and the results of such efforts are reported annually.
 - ii. Provide educational materials to the community or conduct equivalent outreach activities describing the impacts of stormwater discharges on water bodies and the steps or actions the public can take to reduce pollutants in stormwater runoff.
 - iii. Provide public education on the proper use and disposal of pesticides, herbicides, fertilizers and other household chemicals.
 - iv. Provide public education on the proper operation and maintenance of privately-owned or operated stormwater quality management facilities.
 - v. Provide notice to construction site operators concerning where education and training to meet erosion prevention and sediment control requirements can be obtained.



- vi. Conduct or participate in an effectiveness evaluation to measure the success of public education activities during the term of this permit. The effectiveness evaluation must focus on assessing changes in targeted behaviors. The results of the effectiveness evaluation must be used in the adaptive management of the education and outreach program, and reported to the Department no later than November 1, 2014.
- vii. Include training for co-permittee employees involved in MS4-related activities, as appropriate. The training should include stormwater pollution prevention and reduction from municipal operations, including, but not limited to, parks and open space maintenance, fleet and building maintenance, new municipal facility construction and related land disturbances, design and construction of street and storm drain systems, discharges from non-emergency fire fighting-related training activities, and stormwater system maintenance.
- viii. Promote, publicize and facilitate public reporting of illicit discharges through the use of newspapers, newsletters, utility bills, door hangers, radio public service announcements, videos, televised council meetings, brochures, signs, posters or other effective methods.
- e. **Public Involvement and Participation:** Co-permittees must implement a public participation approach that provides opportunities for the public to effectively participate in the development, implementation and modification of the co-permittee's stormwater management program. The approach must include provisions for receiving and considering public comments on the monitoring plan due to the Department June 1, 2011, annual reports, SWMP revisions, and the TMDL pollutant load reduction benchmark development.
- f. **Post-Construction Site Runoff:** Co-permittees must continue to implement their post-construction stormwater pollutant and runoff control program.
 - i. By January 1, 2014, the post-construction stormwater pollutant and runoff control program applicable to new development and redevelopment projects that create or replace 500 ft² of impervious surface must meet the following conditions:
 - 1) Incorporate site-specific management practices that target natural surface or predevelopment hydrologic functions as much as practicable. The site-specific management practices should optimize on-site retention based on the site conditions;
 - 2) Reduce site specific post-development stormwater runoff volume, duration and rates of discharges to the municipal separate storm sewer system (MS4) to minimize hydrological and water quality impacts from impervious surfaces;
 - 3) Prioritize and include implementation of Low-Impact Development (LID), Green Infrastructure (GI) or equivalent design and construction approaches; and,
 - 4) Capture and treat 80% of the annual average runoff volume, based on a documented local or regional rainfall frequency and intensity.

- ii. The co-permittee must identify, and where practicable, minimize or eliminate ordinance, code and development standard barriers within their legal authority that inhibit design and implementation techniques intended to minimize impervious surfaces and reduce stormwater runoff (e.g., Low Impact Development, Green Infrastructure). Such modifications to ordinance, code and development standards are only required to the extent they are permitted under federal and state laws. The co-permittee must review ordinance, code and development standards for modification, minimization or elimination, and appropriately modify ordinance, code or development standard barriers by January 1, 2014. If an ordinance, code or development standard barrier is identified at any time subsequent to January 1, 2014, the applicable ordinance, code or development standard must be modified within three years.
- iii. To reduce pollutants and mitigate the volume, duration, time of concentration and rate of stormwater runoff, the co-permittee must develop or reference an enforceable post-construction stormwater quality management manual or equivalent document by January 1, 2014 that, at a minimum, includes the following:
 - 1) A minimum threshold for triggering the requirement for post-construction stormwater management control and the rationale for the threshold.
 - 2) A defined design storm or an acceptable continuous simulation method to address the capture and treatment of 80% of the annual average runoff volume.
 - 3) Applicable LID, GI or similar stormwater runoff reduction approaches, including the practical use of these approaches.
 - 4) Conditions where the implementation of LID, GI or equivalent approaches may be impracticable.
 - 5) BMPs, including a description of the following:
 - a. Site-specific design requirements;
 - b. Design requirements that do not inhibit maintenance; and,
 - c. Conditions where the BMP applies.
 - 6) Pollutant removal efficiency performance goals that maximize the reduction in discharge of pollutants.
- iv. The co-permittee must review, approve and verify proper implementation of post-construction site plans for new development and redevelopment projects applicable to this section. The Port of Portland may address this permit requirement by documenting that all internal Port of Portland development projects meet the Post-Construction Site Runoff performance standards required in this subsection.
- v. Where a new development or redevelopment project site is characterized by factors limiting use of on-site stormwater management methods to achieve the post-construction site runoff performance standards, such as high water table, shallow bedrock, poorly-drained or low permeable soils, contaminated soils, steep slopes or other constraints, the

Post-Construction Stormwater Management program must require equivalent pollutant reduction measures, such as off-site stormwater quality management. Off-site stormwater quality management may include off-site mitigation, such as using low impact development principles in the construction of a structural stormwater facility within the sub-watershed, a stormwater quality structural facility mitigation bank or a payment-in-lieu program.

- vi. A description of the inspection and enforcement response procedures the co-permittee will follow when addressing project compliance issues with the enforceable post-construction stormwater management performance standards.
- g. **Pollution Prevention for Municipal Operations:** The co-permittee must continue to implement a program to reduce the discharge of pollutants to the MS4 from properties owned or operated by the co-permittee for which the permittee has authority, including, but not limited to, parks and open spaces, fleet and building maintenance facilities, transportation systems and fire-fighting training facilities. The co-permittee must conduct, at a minimum, the following program activities:
 - i. Operate and maintain public streets, roads and highways in a manner designed to minimize the discharge of stormwater pollutants to the MS4, including pollutants discharged as a result of deicing activities;
 - ii. Implement a management program to control and minimize the use and application of pesticides, herbicides and fertilizers on co-permittee-owned properties;
 - iii. By January 1, 2013, inventory, assess, and implement a strategy to reduce the impact of stormwater runoff from municipal facilities that treat, store or transport municipal waste, such as yard waste or other municipal waste and are not already covered under a 1200 series NPDES, a DEQ solid waste, or other permit designed to reduce the discharge of pollutants;
 - iv. Limit infiltration of seepage from the municipal sanitary sewer system to the MS4;
 - v. Implement a strategy to prevent or control the release of materials related to fire-fighting training activities; and,
 - vi. Assess co-permittee flood control projects to identify potential impacts on the water quality of receiving water bodies and determine the feasibility of retrofitting structural flood control devices for additional stormwater pollutant removal. The results of this assessment must be incorporated and considered along with the results of the Stormwater Retrofit Assessment required by this permit.
- h. **Stormwater Management Facilities Operation and Maintenance Activities:**
 - i. By January 1, 2013, the co-permittee must inventory and map stormwater management facilities and controls, and implement a program to verify that stormwater management facilities and controls are inspected, operated and maintained for effective pollutant



removal, infiltration and flow control. At a minimum, the program must include the following:

1. Legal authority to inspect and require effective operation and maintenance;
 2. A strategy to inventory and map public and private stormwater management facilities as provided under Schedule A.4.h.ii.; and,
 3. Public and private stormwater facility inspection and maintenance requirements for stormwater management facilities that have been inventoried and mapped as provided under Schedule A.4.h.ii.
- ii. As part of the Stormwater Management Facilities Inspection and Maintenance program, the co-permittee must implement a strategy that guides the long-term maintenance and management of all co-permittee-owned and identified privately-owned stormwater structural facilities. At a minimum, the strategy must describe the following:
1. Co-permittee-owned or operated stormwater management facilities
 - a. Inventory and mapping process;
 - b. Inspection and maintenance schedule;
 - c. Inspection, operation and maintenance criteria and priorities;
 - d. Description of inspector type and staff position or title; and,
 - e. Inspection and maintenance tracking mechanisms.
 2. Privately-owned or operated stormwater management facilities
 - a. Procedures for and types of stormwater facilities that will be inventoried and mapped. At a minimum, the inventory and mapping must include the following:
 - i. Private stormwater management facilities for new development and redevelopment projects constructed under the co-permittee's post-construction management manual or equivalent document after February 1, 2011.;
 - ii. Private stormwater management facilities identified by the co-permittee and used to estimate the pollutant load reduction as part of the TMDL benchmark evaluation; and,
 - iii. Any major private stormwater management facilities or structural controls.
 - b. Inspection criteria, rationale, priorities, frequency and procedures for inspection of private stormwater facilities that have been inventoried and mapped;
 - c. Required training or qualifications to inspect private stormwater facilities;
 - d. Reporting requirements; and,



e. Inspection and maintenance tracking mechanism.

- 5. Hydromodification Assessment:** The co-permittee must conduct an initial hydromodification assessment and submit a report by November 1, 2014 that examines the hydromodification impacts related to the co-permittee's MS4 discharges, including erosion, sedimentation, and alteration to stormwater flow, volume and duration that may cause or contribute to water quality degradation. The report shall describe existing efforts and proposed actions the co-permittee has identified to address the following objectives:
- a. Collect and maintain information that will inform future stormwater management decisions related to hydromodification based on local conditions and needs;
 - b. Identify or develop strategies to address hydromodification information or data gaps related to waterbodies within the co-permittee's jurisdiction;
 - c. Identify strategies and priorities for preventing or reducing hydromodification impacts related to the co-permittee's MS4 discharges; and,
 - d. Identify or develop effective tools to reduce hydromodification.
- 6. Stormwater Retrofit Strategy Development:** The co-permittee must develop a stormwater quality retrofit strategy identified in a plan that applies to developed areas identified by the co-permittee as impacting water quality and that are underserved or lacking stormwater quality controls.
- a. The stormwater retrofit strategy must be based on a co-permittee-defined set of stormwater quality retrofit objectives and a comprehensive evaluation of a range of stormwater quality retrofit control measures and their appropriate use. The co-permittee-defined objectives must incorporate progress towards applicable TMDL wasteload allocations. Development of the stormwater retrofit strategy must allow for public comment and consider public input.
 - b. The co-permittee must develop and submit a stormwater retrofit plan to the Department by November 1, 2014 that the co-permittee will use to guide the implementation of its stormwater retrofit strategy. The stormwater retrofit plan must describe or reference the following:
 - i. Stormwater retrofit strategy statement and summary, including objectives and rationale;
 - ii. Summary of current stormwater retrofit control measures being implemented, and current estimate of annual program resources directed towards stormwater retrofits;
 - iii. Identification of developed areas or land uses impacting water quality that are high priority retrofit areas;
 - iv. Consideration of new stormwater control measures;



- v. Preferred retrofit structural control measures, including rationale;
 - vi. A retrofit control measure project or approach priority list, including rationale, identification and map of potential stormwater retrofit locations where appropriate, and an estimated timeline and cost for implementation of each project or approach.
- c. By November 1, 2013, each co-permittee must identify one stormwater quality improvement project, at a minimum, to be initiated, constructed or implemented during the permit term. The project must target the reduction of applicable TMDL pollutant parameters. The project must be associated with a Capital Improvement Project or other municipal retrofit project or strategy.

7. Implementation Schedule: The following implementation schedule provides a summary of due dates for the new permit conditions identified in Schedule A.

PERMIT CONDITION	SUMMARY OF IMPLEMENTATION SCHEDULE ACTIVITIES	DUE DATE
Illicit Discharge Detection and Elimination – A.4.a.	1. Document enforcement response procedures	November 1, 2011
	2. Develop or identify pollutant parameter action levels	November 1, 2011
	3. Identify and map dry-weather screening priority locations	July 1, 2012
Industrial and Commercial Facilities – A.4.b	1. Implement industrial and commercial facility inspection and stormwater control program	January 1, 2013
Education and Outreach – A.4.d.	1. Conduct or participate in effectiveness evaluation	November 1, 2014
Post-Construction Site Runoff – A.4.f.	1. Implement updated post-construction site runoff program	January 1, 2014
Pollution Prevention for Municipal Operations – A.4.g.	1. Inventory and assess municipal operations	January 1, 2013
Structural Stormwater Controls Operation and Maintenance Activities – A.4.h.	1. Implement structural stormwater controls operation and maintenance program	January 1, 2013
Hydromodification Assessment – A.5.	1. Conduct hydromodification assessment and submit report	November 1, 2014
Stormwater Retrofit Strategy Development – A.6.	1. Develop stormwater retrofit strategy and submit stormwater retrofit plan	November 1, 2014
	2. Identify stormwater quality improvement project	November 1, 2013
	3. Construct or implement stormwater quality improvement project	Permit expiration date



SCHEDULE B

Monitoring and Reporting Requirements

1. **MONITORING PROGRAM** - Each co-permittee must continue to implement a monitoring program to support adaptive stormwater management and the evaluation of stormwater management program effectiveness in reducing the discharge of pollutants from the MS4.
 - a. The monitoring program must incorporate the following objectives:
 - i. Evaluate the source(s) of the 2004/2006 303(d) listed pollutants applicable to the co-permittee's permit area;
 - ii. Evaluate the effectiveness of Best Management Practices (BMPs) in order to help determine BMP implementation priorities;
 - iii. Characterize stormwater based on land use type, seasonality, geography or other catchment characteristics;
 - iv. Evaluate status and long-term trends in receiving waters associated with MS4 stormwater discharges;
 - v. Assess the chemical, biological, and physical effects of MS4 stormwater discharges on receiving waters; and,
 - vi. Assess progress towards meeting TMDL pollutant load reduction benchmarks.
 - b. The monitoring program must include environmental monitoring that incorporates the requirements identified in Table B-1. The requirements in Table B-1 become effective with the approval of the monitoring plan in accordance with Schedule B.2.d., and no later than July 1, 2011.



**Table B-1
Environmental Monitoring**

Monitoring Type	Monitoring Location(s)	Monitoring Frequency	Pollutant Parameter Analyte(s)
Instream Monitoring	Sixteen (16) sites; probabilistically selected; city-wide	Four (4) events/year	Field; Conventional; Metals; Nutrients
Continuous Instream Monitoring	Three (3) continuous monitoring stations	Ongoing	Temperature Flow
Stormwater Monitoring	Fifteen (15) sites; probabilistically selected; city-wide	Three (3) events/year	Field; Conventional; Metals; Nutrients
Stormwater Monitoring - Pesticide	Fifteen (15) sites; probabilistically selected; city-wide	Three (3) events/permit term	Pesticides
Stormwater Monitoring - Mercury	Two (2) sites	Two (2) events/year; one summer event and one winter event	Mercury
Macro-invertebrate Monitoring	Sixteen (16) sites; probabilistically selected; city-wide	One (1) event/year	N/A

Special Conditions:

- 1) The monitoring frequency reflects the required number of sample events per monitoring location.
- 2) Additional pesticide pollutant parameters that must be considered for purposes of stormwater monitoring – pesticide include any pesticides currently used by the co-permittees within their jurisdictional areas and the following: Insecticides: Bifenthrin, Cypermethrin or Permethrin, Imidacloprid, Fipronil, Malathion, Carbaryl; Herbicides: Triclopyr, 2,4-D, Glyphosate & degradate (AMPA), Trifluralin, Pendimethalin; and, Fungicides: Chlorothalonil, Propiconazole, Myclobutanil.
- 3) The Macroinvertebrate monitoring must follow a generally accepted macroinvertebrate monitoring methodology (e.g., DEQ Benthic Macroinvertebrate Protocol for Wadeable Rivers and Streams). The methodology must be documented in the monitoring plan.
- 4) BOD₅ are only required to be monitored in streams with an established TMDL.
- 5) Monitoring and analysis for mercury and methyl mercury must be conducted in accordance with DEQ's December 23, 2010 "Mercury Monitoring Requirements for Willamette Basin Permittees" memo. After two years of monitoring, the co-permittee may request in writing to the Department that the mercury and methyl mercury monitoring be eliminated. The monitoring may be eliminated only after written approval by the Department. EPA Method 1669 ultra clean sampling protocol must be used to collect samples. Monitoring for total and dissolved mercury must be performed according to USEPA method 1631E with a quantitation limit of 0.5 ng/L. Monitoring for total and dissolved methyl mercury must be performed according to USEPA method 1630 with a quantitation limit of 0.05 ng/L.

Pollutant parameter(s) identified in each analyte category in Table B-1 are as follows:

<u>Field</u>	<u>Conventional</u>	<u>Nutrients</u>	<u>Metals (Total Recoverable & Dissolved)</u>
Dissolved Oxygen pH Temperature Conductivity	<i>Escherichia coli</i> (E. coli) Hardness Total Organic Carbon (TOC) Total Suspended Solids (TSS)	Nitrate (NO ₃) Ammonia Nitrogen (NH ₃ -N) Total Phosphorus (TP) Ortho-Phosphorus (O-PO ₄)	Copper Lead Zinc
		<u>Mercury (Total & Dissolved)</u> Mercury Methyl Mercury	<u>Pesticides</u> 2,4-D Pentachlorophenol

2. MONITORING PLAN - The co-permittee must develop and implement an approved monitoring plan by July 1, 2011. Prior to submission of the monitoring plan to the Department, the co-permittee must provide an opportunity to receive comments from the public. The monitoring plan must be submitted to the Department for review no later than June 1, 2011, and incorporate the following elements:
- a. Identifies how each monitoring objective identified in Schedule B.1.a. is addressed and the sources of information used. The co-permittee may use Stormwater Management Plan measurable goals, environmental monitoring activities, historical monitoring data, stormwater modeling, national stormwater monitoring data, stormwater research or other applicable information to address the monitoring objectives.
 - b. Describes the role of the monitoring program in the adaptive management of the stormwater program.
 - c. Describes the relationship between environmental monitoring and a long-term monitoring program strategy.
 - d. Describes the following information for each environmental monitoring project/task:
 - i. Project/task organization
 - ii. Monitoring objectives, including:
 - a. Monitoring question and background;
 - b. Data analysis methodology and quality criteria; and,
 - c. Assumptions and rationale;
 - iii. Documentation and record-keeping procedures;
 - iv. Monitoring process/study design, including monitoring location, description of sampling event or storm selection criteria, monitoring frequency and duration, and responsible sampling coordinator;
 - v. Sample collection methods and handling/custody procedures;
 - vi. Analytical methods for each water quality parameter to be analyzed;
 - vii. Quality control procedures, including quality assurance, the testing, inspection, maintenance, calibration of instrumentation and equipment; and,
 - viii. Data management, review, validation and verification.
 - e. The monitoring plan may be modified without prior Department approval if the following conditions are met. For conditions not covered in this section, the co-permittee must provide the Department with a 30-day notice of the proposed modification to the monitoring plan, and receive written approval from the Department prior to implementation

of the proposed modification. If the Department does not respond to the permittee within 30 days, the permittee may proceed with implementation of the proposed modification without written approval.

- i. The co-permittee is unable to collect or analyze any sample, pollutant parameter, or information due to circumstances beyond the co-permittee's control. These circumstances may include, but are not limited to, abnormal climatic conditions, unsafe or impracticable sampling conditions, equipment vandalism or equipment failures that occur despite proper operations and maintenance; or,
 - ii. The modification does not reduce the minimum number of data points, which are a product of monitoring location, frequency, and length of permit term, or eliminate pollutant parameters identified in Table B-1.
- f. Modifications to the monitoring plan in accordance with Schedule B.2.e. must be documented in the subsequent annual report by describing the rationale for the modification, and how the modification will allow the monitoring program to remain compliant with the permit conditions.
3. **SAMPLING AND ANALYSIS** – The co-permittee must exercise due diligence in collecting and analyzing all environmental monitoring samples required by this permit. All monitoring must be conducted in accordance with design and procedures identified in Schedule B.2.d.
- a. In-stream monitoring
 - i. A minimum of 50 percent of the water quality sample events must be collected during the wet season (October 1 to April 30).
 - ii. Each unique sample event must occur at a minimum of 14 days apart.
 - b. Stormwater monitoring
 - i. All water quality samples must be collected during a storm event that is greater than 0.1 inch of rainfall.
 - ii. When possible, samples must be collected after an antecedent dry period of a minimum of 24 hours.
 - iii. The intra-event dry period must not exceed 6 hours, unless a 24-hr flow-weighted composite sample collection method is employed.
 - iv. Sample Collection Method: A flow-weighted composite sample must be collected during stormwater runoff producing events that represent the local or regional rainfall frequency and intensity, including event types that may be expected to yield high pollutant loads/concentrations.

1. A time-composite sampling method or grab sampling method may be used for an environmental monitoring type, project or task, if the monitoring plan



identifies the infeasibility of the flow-weighted composite sampling method or flow-weighted composite sampling is scientifically unwarranted based upon the development of plan requirements identified in Schedule B.2.d. For time composite sampling or grab sampling to be considered valid for the purpose of this permit requirement, the rationale for the use of these alternative sampling methods and sampling procedures must be described in the monitoring plan.

2. The flow-weighted sampling method requirement is not applicable to the collection of samples for the pollutant parameters requiring the grab sampling method, such as bacteria, oil & grease, pH or volatiles or for samples collected for purposes of insecticide, herbicide and fungicide monitoring.

3. Grab samples may be collected during any part of a storm event which produces sufficient runoff for sampling. The grab samples must be collected in a manner to minimize any potential bias in the results.

- v. Flow or rainfall data must be collected, estimated or modeled for each stormwater monitoring event. If flow or rainfall is modeled or estimated, the procedure must be described in the monitoring plan.
 - c. Samples must be analyzed in accordance with EPA approved methods listed in the most recent publication of 40 CFR 136. Sample analysis for total and dissolved mercury and methyl mercury must adhere to the methods referenced in DEQ's December 23, 2010 "Mercury Monitoring Requirements for Willamette Basin Permittees" memo. The analysis must utilize appropriate Quality Assurance/Quality Control protocols, such as routinely analyzing replicates, blanks, laboratory control samples and spiked samples, and quantitation limits appropriate for the sampling objective. Field analytical kits are acceptable if the kits use a method approved under 40 CFR 136. This requirement does not apply to illicit detection and discharge elimination field screening activities conducted by the co-permittee as required by Schedule A.4.a.iv. Use of alternative test procedures must be done in accordance with 40 CFR 136.
 - d. If an approved analytical method is not identified in 40 CFR 136, the co-permittee may use a suitable analytical method if the method is described in the monitoring plan, and submitted to the Department for review and approval prior to use.
 - e. Analyzed samples must comply with preservation, transportation and holding time recommendations cited in 40 CFR 136, in the most recent edition of Standard Methods for the Examination of Water and Wastewater, a DEQ management directive, or as applicable to the analytical method if no approved analytical method in 40 CFR 136 or the most recent edition of Standard Methods for the Examination of Water and Wastewater exists.
 - f. Analytical data must be available to the Department in a useable electronic format.
4. COORDINATED MONITORING – Environmental monitoring conducted to meet a permit condition in Table B-1 may be coordinated among co-permittees or conducted on behalf of a co-

permittee by a third party. Each co-permittee is responsible for environmental monitoring in accordance with Schedule B requirements. The co-permittee may utilize data collected by another permittee, a third party, or in another co-permittee's jurisdiction to meet a permit condition in Table B-1 provided the co-permittee establishes an agreement prior to conducting coordinated environmental monitoring.

5. ANNUAL REPORTING REQUIREMENT – The co-permittee must submit, by November 1 of each year, an annual report for the time period July 1 of the previous year through June 30 of the same year. One printed copy and an electronic copy must be submitted to the appropriate Department regional office. An electronic copy must also be made available on the co-permittee's website and/or other similar method approved by the Department. Each co-permittee is responsible for the portion of the annual report applicable to its jurisdiction. Each annual report must contain:
 - a. The status of implementing the stormwater management program and each SWMP program element, including progress in meeting the measurable goals identified in the SWMP.
 - b. Status or results, or both, of any public education program effectiveness evaluation conducted during the reporting year and a summary of how the results were or will be used for adaptive management.
 - c. A summary of the adaptive management process implementation during the reporting year, including any proposed changes to the stormwater management program (e.g., new BMPs) identified through implementation of the adaptive management process.
 - d. Any proposed changes to SWMP program elements that are designed to reduce TMDL pollutants to the MEP.
 - e. A summary of total stormwater program expenditures and funding sources over the reporting fiscal year, and those anticipated in the next fiscal year.
 - f. A summary of monitoring program results, including monitoring data that are accumulated throughout the reporting year and any assessments or evaluations conducted.
 - g. Any proposed modifications to the monitoring plan that are necessary to ensure that adequate data and information are collected to conduct stormwater program assessments.
 - h. A summary describing the number and nature of enforcement actions, inspections, and public education programs, including results of ongoing field screening and follow-up activities related to illicit discharges.
 - i. An overview, as related to MS4 discharges, of concept planning, land use changes and new development activities that occurred within the Urban Growth Boundary (UGB) expansion areas during the previous year, and those forecast for the following year, including the number of new post-construction permits issued, and an estimate of the total new and replaced impervious surface area related to new development redevelopment projects that

commenced during the reporting year.

- j. In addition to the elements listed under Schedule B.5.a. through B.5.i., the annual report submitted by November 1, 2014 must include:
 - i. The TMDL Pollutant Load Reduction Evaluation as described in Schedule D.3.c.
 - ii. The Wasteload Allocation Attainment Assessment as described in Schedule D.3.b.
 - iii. The 303(d) evaluation as described in Schedule D.2.
6. MS4 PERMIT RENEWAL APPLICATION PACKAGE - At least 180 days prior to permit expiration, the co-permittee must submit a permit renewal application package to support their proposed modifications to the SWMP for the renewed permit. One printed copy and an electronic copy must be submitted to the appropriate DEQ regional office. An electronic copy must also be made available on the co-permittee's website or other similar method approved by the Department. The application package must include an evaluation of the adequacy of the proposed SWMP modifications in reducing pollutants in discharges from the MS4 to the MEP. The application package must contain:
- a. Proposed program modifications including the modification, addition or removal of BMPs incorporated into the SWMP, and associated measurable goals.
 - b. The information and analysis necessary to support the Department's independent assessment that the co-permittee's stormwater management program addressed the requirements of the existing permit. Co-permittees must also describe how the proposed management practices, control techniques, and other provisions implemented as part of the stormwater program were evaluated using a co-permittee-defined and standardized set of objective criteria relative to the following MEP general evaluation factors:
 - i. Effectiveness – program elements effectively address stormwater pollutants.
 - ii. Local Applicability – program elements are technically feasible considering local soils, geography, and other locale specific factors.
 - iii. Program Resources – program elements are implemented considering availability to resources and the co-permittees stormwater management program priorities.
 - c. An updated estimate of total annual stormwater pollutant loads for applicable TMDL pollutants or applicable surrogate parameters, and the following pollutant parameters: BOD₅, COD, nitrate, total phosphorus, dissolved phosphorus, cadmium, copper, lead and zinc. The estimates must be accompanied by a description of the procedures for estimating pollutant loads and concentrations, including any modeling, data analysis and calculation methods.
 - d. A proposed monitoring program objectives matrix and proposed monitoring plan including the information required in Schedule B.2.d. for each proposed monitoring project/task.
 - e. A description of any service area expansions that are anticipated to occur during the following permit term and a finding as to whether or not the expansion is expected to result in a substantial increase in area, intensity or pollutant loads.



- f. A fiscal evaluation summarizing program expenditures for the current permit cycle and projected program allocations for next permit cycle.
- g. Updated MS4 maps, including the service boundary of the MS4, projected changes in land use and population densities, projected future growth, location of co-permittee-owned operations, facilities, or properties with storm sewer systems, and the location of facilities issued an industrial NPDES permit that discharge to the MS4.
- h. If applicable, the established TMDL pollutant load reduction benchmarks, as required in Schedule D.3.d.



SCHEDULE C

Compliance Conditions and Dates

Compliance conditions and dates are not included at this time.

SCHEDULE D

Special Conditions

1. Legal Authority

Each co-permittee must maintain adequate legal authority through ordinance(s), interagency agreement(s) or other means to implement and enforce the provisions of this permit.

2. 303(d) Listed Pollutants

- a. The requirements of this section apply to receiving waters listed as impaired on the 303(d) list without established TMDL waste load allocations to which the co-permittee's MS4 discharges. The co-permittee must:
 - i. Review the applicable pollutants that are on the 2004/2006 303(d) list, or the most recent USEPA list if approved within three years of the issuance date of this permit, that are relevant to the co-permittee's MS4 discharges by November 1, 2014. Based on a review of the most current 303(d) list, evaluate whether there is a reasonable likelihood for stormwater from the MS4 to cause or contribute to water quality degradation of receiving waters.
 - ii. Evaluate whether the BMPs in the existing SWMP are effective in reducing the 303(d) pollutants. If the co-permittee determines that the BMPs in the existing SWMP are ineffective in reducing the applicable 303 (d) pollutants, the co-permittee must describe how the SWMP will be modified or updated to address and reduce these pollutants to the MEP.
 - iii. By November 1, 2014, submit a report summarizing the results of the review and evaluation, and that identifies any proposed modifications or updates to the SWMP that are necessary to reduce applicable 303(d) pollutants to the MEP.

3. Total Maximum Daily Loads (TMDLs)

- a. **Applicability:** The requirements of this section apply to the co-permittee's MS4 discharges to receiving waters with established TMDLs or to receiving waters with new or modified TMDLs approved by EPA within three years of the issuance date of this permit. Established TMDLs are noted on page 1 of this permit. Pollutant discharges for those parameters listed in the TMDL with applicable wasteload allocations (WLAs) must be reduced to the maximum extent practicable through the implementation of BMPs and an adaptive management process.
- b. **Wasteload Allocation Attainment Assessment:** The co-permittee must complete an assessment of WLA attainment, including identifying information related to the type and extent of BMPs necessary to achieve pollutant load reductions associated with an established TMDL WLA and the financial costs and other resources that may be associated with the implementation, operation and maintenance of BMPs. The results of the assessment must be



submitted to the Department by November 1, 2014.

- c. TMDL Pollutant Load Reduction Evaluation: Progress towards reducing TMDL pollutant loads must be evaluated by the co-permittee through the use of a pollutant load reduction empirical model, water quality status and trend analysis, and other appropriate qualitative or quantitative evaluation approaches identified by the co-permittee. The results of this TMDL pollutant load reduction evaluation must be described in a report and submitted to the Department by November 1, 2014. The report must contain the following:
 - i. The rationale and methodology used to evaluate progress towards reducing TMDL pollutant loads.
 - ii. An estimate of current pollutant loadings without considering BMP implementation, and an estimate of current pollutant loadings considering BMP implementation for each TMDL parameter with an established WLA. The difference between these two estimated loads is the pollutant load reduction.
 - iii. A comparison of the estimated pollutant loading with and without BMP implementation to the applicable TMDL WLA.
 - iv. A comparison of the estimated pollutant load reduction to the estimated TMDL pollutant load reduction benchmark established for the permit term, if applicable.
 - v. A description of the estimated effectiveness of structural BMPs.
 - vi. A description of the estimated effectiveness of non-structural BMPs, if applicable, and the rationale for the selected approach.
 - vii. A water quality trend analysis, as sufficient data are available, and the relationship to stormwater discharges for receiving waterbodies within the co-permittee's jurisdictional area with an approved TMDL. If sufficient data to conduct a water quality trend analysis is unavailable for a receiving waterbody, the co-permittee must describe the data limitations. The collection of sufficient data must be prioritized and reflected as part of the monitoring project/task proposal required in Schedule B.6.d.
 - viii. A narrative summarizing progress towards the applicable TMDL WLAs and existing TMDL benchmarks, if applicable. If the co-permittee estimates that an existing TMDL benchmark was not achieved during the permit term, the co-permittee must apply their adaptive management process to reassess the SWMP and current BMP implementation in order to address TMDL pollutant load reduction over the next permit term. The results of this reassessment must be submitted with the permit renewal application package described in Schedule B.6.; and,
 - ix. If the co-permittee estimates that TMDL WLAs are achieved with existing BMP implementation, the co-permittee must provide a statement supporting this conclusion.
- d. Establishment of TMDL Pollutant Reduction Benchmarks: A TMDL pollutant reduction benchmark must be developed for each applicable TMDL parameter where existing BMP implementation is not achieving the WLA. An updated TMDL pollutant reduction benchmark must be submitted with the permit renewal application at least 180 days prior to expiration of this permit, as follows:
 - i. The TMDL pollutant load reduction benchmark must reflect:
 1. Additional pollutant load reduction necessary to achieve the benchmark estimated for



- the current permit term, if not achieved per Schedule D.3.c.iv.; and,
2. The pollutant load reduction proposed to achieve additional progress towards the TMDL WLA during the next permit term.
- ii. The TMDL pollutant load reduction benchmark submittal must include the following:
1. An explanation of the relationship between the TMDL wasteload allocations and the TMDL benchmark for each applicable TMDL parameter;
 2. A description of how SWMP implementation contributes to the overall reduction of the TMDL pollutants during the next permit term;
 3. Identification of additional or modified BMPs that will result in further reductions in the discharge of the applicable TMDL pollutants, including the rationale for proposing the BMPs; and,
 4. An estimate of current pollutant loadings that reflect the implementation of the current BMPs and the BMPs proposed to be implemented during the next permit term.

4. Adaptive Management

Each co-permittee must follow an adaptive management approach to assess annually and modify, as necessary, any or all existing SWMP components and adopt new or revised SWMP components to achieve reductions in stormwater pollutants to the MEP. The adaptive management approach must include routine assessment of the need to further improve water quality and protection of beneficial uses, review of available technologies and practices, review of monitoring data and analyses required in Schedule B, review of measurable goals and tracking measures, and evaluation of resources available to implement the technologies and practices. The co-permittee must submit a description of the process for conducting this adaptive management approach during the permit term by November 1, 2011.

5. SWMP Revisions

The co-permittee may revise their SWMP during the permit term in accordance with the following procedures:

- i. Adding BMPs, controls or requirements to the SWMP may be made at any time. The co-permittee must provide notification to the Department prior to implementation, and submit a summary of such revisions to the Department in the subsequent annual report.
- ii. Reducing, replacing or eliminating BMP components, controls or requirements from the SWMP require submittal of a written request to the Department at least 60 days prior to the planned reduction, replacement, and/or elimination. The co-permittee's request must provide information that will allow the Department to determine within 60 days if the nature or scope of the SWMP is substantially changed, and include the following:
 1. Proposed reduction, replacement or elimination of the BMP(s), control, or requirement and schedule for implementation.
 2. An explanation of the need for the replacement, reduction or elimination.
 3. An explanation of how the replacement or reduction is expected to better achieve the goals of the stormwater management program or how the elimination is a result of the satisfactory completion of the BMP component, control or requirement.



- iii. The co-permittee must not implement a reduction, replacement or elimination of a BMP until approved by the Department. If a request is denied, the Department must send the co-permittee a written response providing a reason for the decision.
- iv. Adding, reducing, replacing or eliminating BMPs in the SWMP are considered permit revisions, and such revisions are minor or major permit modifications. Revisions that substantially change the nature and scope of the BMP component, control or requirement will be considered a major permit modification. Revisions requested by the permittee or initiated by the Department will be made in accordance with 40 CFR §§124.5, 122.62, or 122.63, and OAR 340-045-0040 and 0055.
- v. Revisions initiated by the Department will be made in writing, set forth the time schedule for the co-permittee to develop the revisions, and offer the co-permittee the opportunity to propose alternatives to meet the objective of the requested revisions.

6. SWMP Measurable Goals

The following conditions must be incorporated into the City of Portland SWMP by April 1, 2011:

- a. **BMP PI-1 Task 8:** By January 1, 2012, reconvene the Stormwater Advisory Committee to advise general stormwater management policy and implementation issues or effectively replace with another stormwater-related advisory committee that may be more narrowly focused.
- b. **BMP OM-1 Task 1:** Amend to include the following: Inspect all public stormwater management facilities once annually. This amendment will replace the first bullet point under OM-1 measurable goals.
- c. **BMP OM-1 Task 3:** Amend to include the following: Enter all newly constructed public stormwater system components into an inspection and maintenance database within six (6) months of the completion of construction.
- d. **BMP OM-1 Task 6:** Amend to include the following: Complete and implement the materials management section of the Portland Bureau of Transportation (PBOT) training guide by January 1, 2012. Complete and implement the remainder of the PBOT training guide by January 1, 2015.
- e. **BMP OM-2 Task 6:** Implement a Street Leaf Removal Program in designated leaf removal districts. Residential streets may be swept between 3-6 times per year in these areas as an alternative to implementing the Leaf Removal Program.
- f. **BMP OM-3 Task 2:** Replace the second sentence to include the following: By January 1, 2013, identify, evaluate, and prioritize stormwater pollution prevention opportunities and improvements (e.g., improved materials storage, use, or transportation) to reduce potential impacts at properties owned or operated by the City of Portland.
- g. **BMP OM-3 Task 4:** Amend to include the following: Annually conduct a minimum of one formal education and outreach activity with each volunteer group that assists with maintaining Pesticide-Free Parks. Pesticide-free parks management must be maintained at a minimum of three (3) parks.
- h. **BMP IND-1 Task 4:** Amend to include the following: Beginning January 1, 2013, annually conduct an industrial facilities inspection "sweep" in at least one targeted area.
- i. **BMP IND-2 Task 6:** Amend to include the following: Conduct a minimum of one targeted



stormwater education and outreach activity with each of the following groups: Portland Community College, Association of Car Washers, International Society of Arborists (ISA local chapter), and Oregon Association of Nurseryman (OAN).

- j. **BMP IND-2 Task 7:** Amend to include the following: Evaluate one new business sector for implementation of the Eco-Logical Business Program by January 1, 2013. This amendment will replace the second bullet point under IND-2 measurable goals.
- k. **BMP ND-1 Task 7:** Conduct and document erosion control checks during each routine building permit inspection for land disturbing activities at construction sites requiring a City of Portland permit (e.g., grading and clearing, electrical, mechanical, plumbing).

The following conditions must be incorporated into the Port of Portland SWMP by April 1, 2011:

- l. **BMP Table 7-2 Implement an Inspection Program for Pollutant Source Areas Task 2:** Ensure implementation of appropriate control measures to minimize pollutant loading from priority facilities in an expeditious manner.
- m. **BMP Table 7-7 Limit Landscape Maintenance Activities Impact on Stormwater Task 2:** Annually review the Port's program to control pesticides, herbicides and fertilizers, and update as appropriate.
- n. **BMP Table 7-8 Implement a Program for the Tracking and Maintenance of Private Structural Controls Task 1:** Develop an inventory and mechanism for tracking private structural controls on tenant properties by December 31, 2012.

7. Implementation Schedule

The following implementation schedule provides a summary of due dates for the permit conditions identified in Schedule B & Schedule D.

PERMIT CONDITION	SUMMARY OF IMPLEMENTATION SCHEDULE ACTIVITIES	DUE DATE
Monitoring Plan and Environmental Monitoring – B.1.b, B.2 & Table B-1	1. Submit monitoring plan	June 1, 2011
	2. Implement an approved monitoring plan	July 1, 2011
Annual Report – B.5	1. Submit annual report	November 1 - annually
Permit Renewal Application Package – B.6	1. Submit permit renewal package	180 days prior to permit expiration



303(d) List Evaluation – D.2	1. Submit 303(d) list evaluation report	November 1, 2014
Total Maximum Daily Load (TMDL) – D.3	1. Submit Wasteload Allocation Attainment Assessment	November 1, 2014
	2. Submit TMDL Pollutant Load Reduction Evaluation	November 1, 2014
	3. Submit TMDL Pollutant Load Reduction Benchmark	180 days prior to permit expiration
Adaptive Management – D.4	1. Submit Adaptive Management Approach	November 1, 2011
SWMP Measurable Goals – D.6	1. Incorporate SWMP Measurable Goal conditions	April 1, 2011

Definitions:

- a. **Adaptive Management:** A structured, iterative process designed to refine and improve stormwater programs over time by evaluating results and adjusting actions on the basis of what has been learned.
- b. **Antecedent dry period:** The period of dry time between precipitation events greater than 0.1 inch of precipitation.
- c. **Best Management Practices (BMPs):** The schedule of activities, controls, prohibition of practices, maintenance procedures and other management practices designed to prevent or reduce pollution. BMPs also include treatment requirements, operating procedures and practices to control stormwater runoff.
- d. **Dry-weather field screening pollutant parameter action levels:** Pollutant concentrations or concentration ranges used by a co-permittee to identify an illicit discharge may be present and further investigation is needed.
- e. **Green Infrastructure (GI):** A comprehensive approach to water quality protection defined by a range of natural and built systems and practices that use or mimic natural hydrologic processes to infiltrate, evapotranspire, or reuse stormwater runoff on the site where the runoff is generated.
- f. **Illicit Discharge:** Any discharge to a municipal separate storm sewer system that is not composed entirely of stormwater except discharges authorized under Section A.4.a.xii., discharges permitted by a NPDES permit or other state or federal permit, or otherwise authorized by the Department.
- g. **Impervious Surface:** Any surface resulting from development activities that prevents the infiltration of water or results in more runoff than in the undeveloped condition. Common impervious surfaces include: building roofs, traditional concrete or asphalt paving on walkways, driveways, parking lots, gravel roads, and packed earthen materials.
- h. **Low Impact Development (LID):** A stormwater management approach that seeks to mitigate the impacts of increased runoff and stormwater pollution using a set of planning,



design and construction approaches and stormwater management practices that promote the use of natural systems for infiltration, evapotranspiration, and reuse of rainwater, and can occur at a wide range of landscape scales (i.e., regional, community and site).

- i. **Maximum Extent Practicable (MEP):** The statutory standard that establishes the level of pollutant reductions that operators of regulated MS4s must achieve. This standard is considered met if the conditions of the permit are met.
- j. **Measurable Goals:** BMP objectives or targets used to identify progress of SWMP implementation. Measurable goals are prospective and, wherever possible, quantitative. Measurable goals describe *what* the co-permittee intends to do and *when* they intend to do it.
- k. **Redevelopment:** A project on a previously developed site that results in the addition or replacement of impervious surface.
- l. **Replace or Replacement:** The removal of an impervious surface that exposes soil followed by the placement of an impervious surface. Replacement does not include repair or maintenance activities on structures or facilities taken to prevent decline, lapse or cessation in the use of the existing impervious surface as long as no additional hydrologic impact results from the repair or maintenance activity.
- m. **Stormwater Management Program:** A comprehensive set of activities and actions, including policies, procedures, standards, ordinances, criteria, and best management practices established to reduce the discharge of pollutants from the Municipal Separate Storm Sewer System to the Maximum Extent Practicable, to protect water quality, and to satisfy the appropriate water quality requirements of the Clean Water Act.
- n. **Time of Concentration:** Travel time for a drop of water to travel from most hydrologically remote location in a defined catchment to the outlet for that catchment where remoteness relates to time of travel rather than distance.
- o. **TMDL Pollutant Load Reduction Benchmark (TMDL benchmark):** An estimated total pollutant load reduction target for each parameter or surrogate, where applicable, for waste load allocations established under an EPA-approved TMDL. A benchmark is the anticipated pollutant load reduction goal to be achieved during the permit cycle through the implementation of the stormwater management program and BMPs identified in the SWMP. A benchmark is used to measure the effectiveness of the stormwater management program in making progress toward the waste load allocation, and is a tool for guiding adaptive management. A benchmark is not a numeric effluent limit; rather it is an estimated pollutant reduction target that is subject to the maximum extent practicable standard. Benchmarks may be stated as a pollutant load range based upon the results of a pollutant reduction empirical model.
- p. **Water Quality Trend Analysis:** A statistical analysis of in-stream water quality data to identify improvement or deterioration.



- q. **Waters of the State:** Lakes, bays, ponds, impounding reservoirs, springs, wells, rivers, streams, creeks, estuaries, marshes, inlets, canals, the Pacific Ocean within the territorial limits of the State of Oregon, and all other bodies of surface or underground waters, natural or artificial, inland or coastal, fresh or salt, public or private (except those private waters that do not combine or effect a junction with natural surface or underground waters) that are located wholly or partially within or bordering the state or within its jurisdiction.



SCHEDULE F

NPDES Permit General Conditions for Municipal Separate Storm Sewer Systems

SECTION A. STANDARD CONDITIONS

1. Duty to Comply with Permit

The co-permittees must comply with all conditions of this permit. Failure to comply with any permit condition is a violation of the Clean Water Act and Oregon Revised Statutes (ORS) 468B.025, and 40 Code of Federal Regulations (CFR) §122.41(a), and grounds for an enforcement action. Failure to comply is also grounds for the Department to modify, revoke, or deny renewal of a permit.

2. Penalties for Water Pollution and Permit Condition Violations

- a. ORS 468.140 allows the Department to impose civil penalties up to \$10,000 per day for violation of a term, condition, or requirement of a permit. Additionally 40 CFR §122.41(a) provides that any person who violates any permit condition, term, or requirement may be subject to a federal civil penalty not to exceed \$32,500 per day for each violation.
- b. Under ORS 468.943 and 40 CFR §122.41(a), unlawful water pollution, if committed by a person with criminal negligence, is punishable by a fine of up to \$25,000 imprisonment for not more than one year, or both. Each day on which a violation occurs or continues is a separately punishable offense.
- c. Under ORS 468.946, a person who knowingly discharges, places, or causes to be placed any waste into the waters of the state or in a location where the waste is likely to escape or be carried into the waters of the state is subject to a Class B felony punishable by a fine not to exceed \$200,000 and up to 10 years in prison. Additionally, under 40 CFR §122.41(a) any person who knowingly discharges, places, or causes to be placed any waste into the waters of the state or in a location where the waste is likely to escape into the waters of the state is subject to a federal civil penalty not to exceed \$100,000, and up to 6 years in prison.

3. Duty to Mitigate

The co-permittees must take all reasonable steps to minimize or prevent any discharge or sludge use or disposal in violation of this permit that has a reasonable likelihood of adversely affecting human health or the environment. In addition, upon request of the Department, the permittee must correct any adverse impact on the environment or human health resulting from noncompliance with this permit, including such accelerated or additional monitoring as necessary to determine the nature and impact of the non-complying discharge.

4. Duty to Reapply

If any or all of the co-permittees wish to continue an activity regulated by this permit after the expiration date of this permit, the co-permittee must apply to have the permit renewed. The application must be submitted at least 180 days before the expiration date of this permit.

The Department may grant permission to submit an application less than 180 days in advance but no later than the permit expiration date.



5. Permit Actions

This permit may be modified, revoked and reissued, or terminated for cause including, but not limited to, the following:

- a. Violation of any term, condition, or requirement of this permit, a rule, or a statute
- b. Obtaining this permit by misrepresentation or failure to disclose fully all material facts
- c. A change in any condition that requires either a temporary or permanent reduction or elimination of the authorized discharge
- d. The permittee is identified as a Designated Management Agency or allocated a waste load under a Total Maximum Daily Load (TMDL)
- e. New information or regulations
- f. Modification of compliance schedules
- g. Requirements of permit reopener conditions
- h. Correction of technical mistakes made in determining permit conditions
- i. Determination that the permitted activity endangers human health or the environment
- j. Other causes as specified in 40 CFR §§122.62, 122.64, and 124.5

The filing of a request by the co-permittee for a permit modification, revocation or reissuance, termination, or a notification of planned changes or anticipated noncompliance, does not stay any permit condition. The permittee must comply with all terms, conditions of the permit pending approval.

6. Toxic Pollutants

The co-permittee must comply with any applicable effluent standards or prohibitions established under Oregon Administrative Rules (OAR) 340-041-0033 for toxic pollutants within the time provided in the regulations that establish those standards or prohibitions, even if the permit has not yet been modified to incorporate the requirement.

7. Property Rights and Other Legal Requirements

The issuance of this permit does not convey any property rights of any sort, or any exclusive privilege, or authorize any injury to persons or property or invasion of any other private rights, or any infringement of federal, tribal, state, or local laws or regulations.

8. Permit References

Except for effluent standards or prohibitions established under OAR 340-041-0033 for toxic pollutants and standards for sewage sludge use or disposal established under Section 405(d) of the Clean Water Act, all rules and statutes referred to in this permit are those in effect on the date this permit is issued.

9. Permit Fees

The co-permittee must pay the fees required by OAR 340-045-0070 to 0075.

The co-permittee must pay annual compliance fees by the last day of the month prior to when the permit was issued. For example, if the permit was issued or last renewed in April, the due date will be March 31st. If the payment of annual fees is 30 days or more past due, the permit registrant must pay 9% interest per annum on the unpaid balance. Interest will accrue until the fees are paid in full. If the Department does not receive payment of annual fees when they are



due, the Department will refer the account to the Department of Revenue or to a private collection agency for collection.

SECTION B. OPERATION AND MAINTENANCE OF POLLUTION CONTROLS

1. Proper Operation and Maintenance

The co-permittee must at all times properly operate and maintain all facilities and systems of treatment and control (and related appurtenances) that are installed or used by the permittee to achieve compliance with the conditions of this permit. Proper operation and maintenance also includes adequate laboratory controls and appropriate quality assurance procedures. This provision requires the operation of back-up or auxiliary facilities or similar systems that are installed by the permittees only when the operation is necessary to achieve compliance with the conditions of the permit.

2. Need to Halt or Reduce Activity Not a Defense

It must not be a defense for the permittee in an enforcement action that it would have been necessary to halt or reduce the permitted activity in order to maintain compliance with this permit.

3. Removed Substances

Solids or other pollutants removed in the course of maintaining the MS4 must be disposed of in such a manner as to prevent any pollutant from such materials from entering waters of the state, causing nuisance conditions, or creating a public health hazard.

SECTION C. MONITORING AND RECORDS

1. Representative Sampling

Sampling and measurements taken as required under this Permit must be representative of the volume and nature of the monitored discharge. All samples must be taken at the monitoring points specified in this permit, and must be taken, unless otherwise specified, before the effluent joins or is diluted by any other waste stream, body of water, or substance. Monitoring points may not be changed without notification to and the approval of the Department.

2. Monitoring Procedures

Monitoring must be conducted according to test procedures approved under 40 CFR part 136, unless other test procedures have been specified in this permit or subsequent permit actions.

3. Penalties of Tampering

The Clean Water Act provides that any person who falsifies, tampers with, or knowingly renders inaccurate any monitoring device or method required to be maintained under this permit may, upon conviction, be punished by a fine of not more than \$10,000 per violation, imprisonment for not more than two years, or both. If a conviction of a person is for a violation committed after a first conviction of such person, punishment is a fine not more than \$20,000 per day of violation, or by imprisonment of not more than four years, or both.

4. Additional Monitoring by the Co-permittees



If the co-permittees monitor any pollutant more frequently than required by this permit, using test procedures approved under 40 CFR part 136 or as specified in this permit, the results of this monitoring must be included in the calculation and reporting of the data submitted in annual reports required by Schedule B. Such increased frequency must also be indicated.

5. Retention of Records

The co-permittees must retain records of all monitoring information, including: all calibration, maintenance records, all original strip chart recordings for continuous monitoring instrumentation, copies of all reports required by this permit, and records of all data used to complete the application for this permit for a period of at least 3 years from the date of the sample, measurement, report, or application. This period may be extended by request of the Department at any time.

6. Records Contents

Records of monitoring information must include:

- a. The date, exact place, time, and methods of sampling or measurements;
- b. The individual(s) who performed the sampling or measurements;
- c. The date(s) analyses were performed;
- d. The individual(s) who performed the analyses;
- e. The analytical techniques or methods used; and
- f. The results of such analyses.

7. Inspection and Entry

The co-permittees must allow the Department representative upon the presentation of credentials to:

- a. Enter upon a co-permittee's premises where a regulated facility or activity is located or conducted, or where records must be kept under the conditions of this permit;
- b. Have access to and copy, at reasonable times, any records that must be kept under the conditions of this permit;
- c. Inspect at reasonable times any facilities, equipment (including monitoring and control equipment), practices, or operations regulated or required under this permit, and
- d. Sample or monitor at reasonable times, for the purpose of assuring permit compliance or as otherwise authorized by state law, any substances or parameters at any location within the MS4.

SECTION D. REPORTING REQUIREMENTS

1. Planned Changes

The permittee must comply with OAR chapter 340, division 52, "Review of Plans and Specifications" and 40 CFR §122.41(1)(I). Except where exempted under OAR chapter 340, division 52, no construction, installation, or modification involving disposal systems, treatment works, sewerage systems, or common sewers may be commenced until the plans and specifications are submitted to and approved by the Department. The permittee must give notice to the Department as soon as possible of any planned physical alterations or additions to the permitted facility.



2. Anticipated Noncompliance

The co-permittees must give advance notice to the Department of any planned changes in the permitted facility or activities that may result in noncompliance with permit requirements.

3. Transfers

This permit may be transferred to a new co-permittee(s) provided the transferee(s) acquires a property interest in the permitted activity and agrees in writing to fully comply with all the terms and conditions of the permit and the rules of the Commission. No permit may be transferred to a third party without prior written approval from the Department. The Department may require modification, revocation, and reissuance of the permit to change the name of the permittee and incorporate such other requirements as may be necessary under the Clean Water Act (see 40 CFR §122.61; in some cases, modification or revocation and reissuance is mandatory). The co-permittees must notify the Department when a transfer of property interest takes place that results in a change of co-permittee(s).

4. Compliance Schedule

Reports of compliance or noncompliance with, or any progress reports on, interim and final requirements contained in any compliance schedule of this permit must be submitted no later than 14 days following each schedule date. Any reports of noncompliance must include the cause of noncompliance, any remedial actions taken, and the probability of meeting the next scheduled requirements.

5. Duty to Provide Information

The co-permittees must furnish to the Department within a reasonable time any information that the Department requests to determine compliance with this permit. The co-permittees must also furnish to the Department, upon request, copies of records required to be kept by this permit.

Other Information: When a co-permittee becomes aware that it has failed to submit any relevant facts or has submitted incorrect information in a permit application or any report to the Department, it must promptly submit such facts or information.

6. Signatory Requirements

All applications, reports or information submitted to the Department must be signed and certified in accordance with 40 CFR §122.22.

7. Falsification of Information

Under ORS 468.953, any person who knowingly makes any false statement, representation, or certification in any record or other document submitted or required to be maintained under this permit, including monitoring reports or reports of compliance or noncompliance, is subject to a Class C felony punishable by a fine not to exceed \$100,000 per violation and up to 5 years in prison. Additionally, according to 40 CFR §122.41(k)(2), any person who knowingly makes any false statement, representation, or certification in any record or other document submitted or required to be maintained under this permit including monitoring reports or reports of compliance or non-compliance must, upon conviction, be punished by a federal civil penalty not to exceed \$10,000 per violation, or by imprisonment for not more than 6 months per violation, or by both.



SECTION E. DEFINITIONS

1. *CFR* means Code of Federal Regulations.
2. *Clean Water Act* or *CWA* means the Federal Water Pollution Control Act enacted by Public Law 92-500, as amended by Public Laws 95-217, 95-576, 96-483 and 97-117; 33 U.S.C. 1251 et seq.
3. *Department* means Department of Environmental Quality.
4. *Director* means Director of the Department of Environmental Quality.
5. *Flow-Weighted Composite Sample* means a sample formed by collection and mixing discrete samples taken periodically and based on flow.
6. *Grab Sample* means an individual discrete sample collected over a period of time not to exceed 15 minutes.
7. *Illicit Discharges* means any discharge to a municipal separate storm sewer that is not composed entirely of stormwater except discharges pursuant to a NPDES permit (other than the NPDES permit for discharges from the municipal separate storm sewer) and discharges resulting from fire fighting activities.
8. *Major Outfall* means a municipal separate storm sewer outfall that discharges from a single pipe with an inside diameter 36 inches or more or its equivalent (discharge from a single conveyance other than circular pipe which is associated with a drainage area of more than 50 acres); or for municipal separate storm sewers that receive stormwater from lands zoned for industrial activities (based on comprehensive zoning plans or the equivalent), an outfall that discharges from a single pipe with an inside diameter of 12 inches or more or from its equivalent (discharge from other than a circular pipe associated with a drainage area of 2 acres or more).
9. *mg/L* means milligrams per liter.
10. *mL/L* means milliliters per liter.
11. *MS4* means a municipal separate storm sewer system.
12. *Municipal Separate Storm Sewer (MS4)* means a conveyance or system of conveyances (including roads with drainage systems, municipal streets, catch basins, curbs, gutters, ditches, manmade channels, or storm drains):
 - a. Owned or operated by a State, city, town, borough, county, parish, district, association, or other public body (created by or pursuant to State Law) having jurisdiction over disposal of sewage, industrial wastes, stormwater or other wastes, including special districts under State Law such as a sewer district, flood control district or drainage district, or similar entity, or an Indian tribe or an authorized Indian Tribal organization, or a designated and approved management agency under §208 of the CWA that discharges to waters of the United States;
 - b. Designed or used for collection or conveying stormwater;
 - c. Which is not a combined sewer; and
 - d. Which is not part of a Publicly Owned Treatment Works (POTW) as defined by 40 CFR §122.2.
13. *Outfall* means a point source as defined by 40 CFR §122.2 at the point where a municipal separate storm sewer discharges to waters of the United States and does not include open conveyances connecting two municipal separate storm sewers, or pipes, tunnels or other conveyances which connect segments of the same stream or other waters of the United States and are used to convey waters of the United States.
14. *Permit* means the NPDES municipal separate storm sewer system (MS4) permit specified herein, authorizing the permittees listed on Page 1 of this permit to discharge from the MS4.
15. *Stormwater* means stormwater runoff, snowmelt runoff, and surface runoff and drainage.
16. *Year* means calendar year except where otherwise defined.



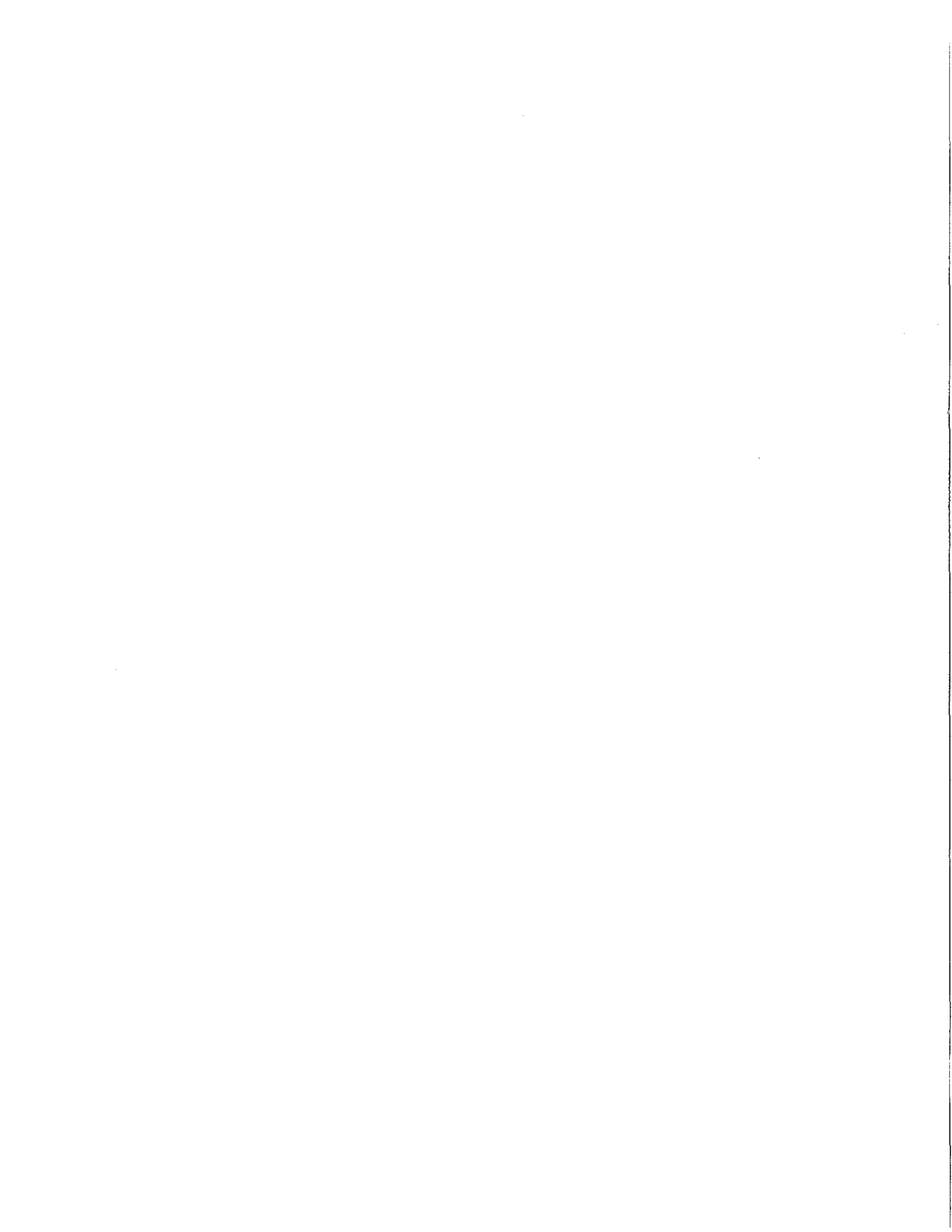



Appendix B

Summary of MS4 Permit Requirements and Incorporation into the Port's Stormwater DSM

Appendix B: Summary of MS4 Permit Requirements and Incorporation into the Port's Stormwater DSM

The table below summarizes the primary MS4 permit criteria (DEQ MS4 Permit No. 101314) driving the development of the Port of Portland Design Standards Manual (DSM), and demonstrates where in the DSM each requirement is addressed.

MS4 Permit Language	Category					SWM Standards and/or Design Criteria, DSM Reference
	Port Authority / Role / Process	LID	Quantity Control	Quality Control	BMP Design / Applicability	
A.4.f.i. By January 1, 2014, the post-construction stormwater pollutant and runoff control program applicable to new development and redevelopment projects that create or replace 500 ft2 of impervious surface must meet the following conditions:	X					Applicability of the DSM to projects, including the impervious surface threshold, is described in Chapter 1. The DSM is currently only applicable at PDX, as described in Chapter 1. Other Port facilities shall comply with the City SWMM.
A.4.f.i.1. Incorporate site-specific management practices that target natural surface or predevelopment hydrologic functions as much as practicable. The site-specific management practices should optimize on-site retention based on the site conditions;		X	X			Chapter 4 includes a Stormwater Management (SWM) Standard for Low-Impact Development (including Green Infrastructure) to target predevelopment functions, as well as a SWM Standard for Infiltration to optimize on-site retention.
A.4.f.i.2. Reduce site specific post-development stormwater runoff volume, duration and rates of discharges to the municipal separate storm sewer system (MS4) to minimize hydrological and water quality impacts from impervious surfaces;			X	X		Chapter 4 includes SWM Standards for several topics that contribute to flow control, including: Water Quantity Control, Low Impact Development, and Infiltration. The Water Quantity Control SWM Standard requires the implementation of flow controls as needed to meet on-site flooding objectives. It also includes the option for the Port to require additional project-specific flow controls as necessary to address potential flooding and capacity issues.
A.4.f.i.3. Prioritize and include implementation of Low-Impact Development (LID), Green Infrastructure (GI) or equivalent design and construction approaches; and,		X				Chapter 4 includes a SWM Standard to promote Low-Impact Development, which incorporates Green Infrastructure. Chapter 6 and the BMP Fact Sheets provide criteria for the selection and design of GI BMPs. The applicability and feasibility of LID practices is encouraged to be considered early on in the design, through the DSM Compliance Process laid out in Chapter 3.
A.4.f.i.4. Capture and treat 80% of the annual average runoff volume, based on a documented local or regional rainfall frequency and intensity.				X		Chapter 4 includes a SWM Standard for "Water Quality - Capture and Treat," which addresses minimum water quality capture and treat requirements that drive the sizing of water quality BMPs. The requirements are based on a local rainfall analysis, which is summarized in Appendix L.
A.4.f.ii. The co-permittee must <u>identify, and</u> where practicable, minimize or <u>eliminate</u> ordinance, code and development standard <u>barriers within their legal authority that inhibit design and implementation techniques intended to minimize impervious surfaces and reduce stormwater runoff (e.g., Low Impact Development, Green Infrastructure)</u> . Such modifications to ordinance, code and development standards are only required to the extent they are permitted under federal and state laws. The co-permittee must review ordinance, code and development standards for modification, minimization or elimination, and appropriately modify ordinance, code or development standard barriers by January 1, 2014. If an ordinance, code or development standard barrier is identified at any time subsequent to January 1, 2014, the applicable ordinance, code or development standard must be modified within three years.	X	X				Although no formal code or development standard barriers were identified, the DSM incorporates initiatives that promote the consideration of LID and GI early on in the development project planning process, including as part of pre-design planning to be performed initially by the Port. DSM Chapter 3 requires that designers initially coordinate with the Port on the applicability of various LID techniques at the Project Kickoff Meeting, so that decisions to incorporate LID (where applicable) may be made at a time when the project concept may be flexible to accommodate changes.
A.4.f.iii. To reduce pollutants and mitigate the volume, duration, time of concentration and rate of stormwater runoff, the co-permittee must develop or reference an enforceable post-construction stormwater quality management manual or equivalent document by January 1, 2014 that, at a minimum, includes the following:	X					The DSM fulfills the requirement for an enforceable post-construction stormwater quality management manual. The Port's authority and enforcement mechanisms are described in Chapter 1. Enforcement is performed through the Port submittal and review process described in Chapter 3.
A.4.f.iii.1. A minimum threshold for triggering the requirement for post-construction storm water management control and the rationale for the threshold.	X					Port facilities within the Port MS4 permit area that have not been selected to implement the DSM at this time will continue to be subject to stormwater management requirements established by the City of Portland within the City Stormwater Management Manual (SWMM).
A.4.f.iii.2. A defined design storm or an acceptable continuous simulation method to address the capture and treatment of 80% of the annual average runoff volume.				X		Applicability of the DSM to projects, including the impervious surface threshold, is described in Chapter 1.
A.4.f.iii.3. Applicable LID, GI or similar stormwater runoff reduction approaches, including the practical use of these approaches.		X				Chapter 4 includes a SWM Standard for "Water Quality - Capture and Treat," which addresses minimum water quality capture and treat requirements that drive the sizing of water quality BMPs. The requirements are based on a local rainfall analysis, which is summarized in an appendix to the DSM.
A.4.f.iii.4. Conditions where the implementation of LID, GI or equivalent approaches may be impracticable.		X				Chapter 4 includes a SWM Standard to promote Low-Impact Development, including Green Infrastructure. The DSM identifies a series of LID practices and strategies that designers are required to consider in coordination with the Port, and document their applicability and implementation within the DSM Coordination Checklist. Chapter 4 also provides an approach for complying with this SWM Standard, and Chapter 3 requires that designers coordinate on LID opportunities with the Port at the Kickoff Meeting and subsequent milestones. Chapter 6 and the BMP Fact Sheets provide criteria for the selection and design of GI BMPs.
						The SWM Standard for LID in Chapter 4 identifies specific implementation considerations that may limit the practicability or the extent to which some LID practices can be implemented, including conflicts related to site constraints, soil conditions, project objectives, and safety. Designers, in coordination with the Port, are required to document their consideration of applicability for each identified LID strategy within the DSM Coordination Checklist. Where particular strategies are impracticable, justification is required. Where practicable, designers are required to demonstrate how the strategy was incorporated into the design.

Appendix B: Summary of MS4 Permit Requirements and Incorporation into the Port's Stormwater DSM

The table below summarizes the primary MS4 permit criteria (DEQ MS4 Permit No. 101314) driving the development of the Port of Portland Design Standards Manual (DSM), and demonstrates where in the DSM each requirement is addressed.

MS4 Permit Language	Category					SWM Standards and/or Design Criteria, DSM Reference
	Port Authority / Role / Process	LID	Quantity Control	Quality Control	BMP Design / Applicability	
A.4.f.iii.5. BMPs, including a description of the following: a. Site-specific design requirements; b. Design requirements that do not inhibit maintenance; and, c. Conditions where the BMP applies.					X	Chapter 6 provides guidance, matrices, and an overall process for the selection of BMPs that are appropriate for a particular project and site, taking into account site constraints, soil characteristics, project pollutants of concern, and other considerations. Additionally, Chapter 6 and the BMP Fact Sheets provide BMP-specific design criteria that have been selected to enhance BMP performance and facilitate operations and maintenance. Chapter 6 and the BMP Fact Sheets also recommend specific operations and maintenance activities to be conducted at defined frequencies. Finally, Chapter 3 identifies required components of the SWM Submittal to the Port, including an O&M Plan.
A.4.f.iii.6. Pollutant removal efficiency performance goals that maximize the reduction in discharge of pollutants.				X	X	Chapter 6 prescribes an overall process for the selection of BMPs that are appropriate for a particular project and site, taking into account project pollutants of concern. Chapter 6 and the BMP Fact Sheets also provide BMP-specific design criteria that have been selected to enhance BMP performance and facilitate operations and maintenance, based on best available industry BMP guidance. Chapter 6 identifies a performance goal for TSS of 25 mg/L (as a median effluent concentration) based on a review of BMP performance in the International Stormwater BMP Database. The DSM does not specify a numeric percent pollutant removal efficiency, due to concerns in the stormwater community about the quality and inconsistency of published data for percent removal by BMP type, and its applicability to different site and project conditions. This position is consistent with the International Stormwater BMP Database and its published white paper "Why does the International Stormwater BMP Database Project omit percent removal as a measure of BMP performance?" (http://www.bmpdatabase.org/Docs/FAQPercentRemoval.pdf).
A.4.f.iv. The co-permittee must <u>review, approve and verify proper implementation</u> of post-construction site plans for new development and redevelopment projects applicable to this section. The Port of Portland may address this permit requirement by documenting that all internal Port of Portland development projects meet the Post-Construction Site Runoff performance standards required in this subsection.	X					Chapter 1 of the DSM requires that all applicable development projects obtain Port approval of the stormwater management design in their SWM Submittal and obtain a Port Construction Permit before the project can proceed to construction. Additionally, Chapter 3 describes required design review and coordination milestones, which represent points in the design process where the designer must coordinate with the Port and submit the SWM Strategy to the Port for review and approval. The Port has an existing rigorous construction oversight process and BMP inspection and maintenance program that will continue to be used to verify BMP performance as designed and approved under the DSM.
A.4.f.v. <u>Where a new development or redevelopment project site is characterized by factors limiting use of on-site stormwater management methods to achieve the post-construction site runoff performance standards, such as high water table, shallow bedrock, poorly drained or low permeable soils, contaminated soils, steep slopes or other constraints, the Post-Construction Stormwater Management program must require equivalent pollutant reduction measures, such as off-site stormwater quality management. Off-site stormwater quality management may include off-site mitigation, such as using low impact development principles in the construction of a structural stormwater facility within the sub-watershed, a stormwater quality structural facility mitigation bank or a payment-in-lieu program.</u>	X					Chapter 4 SWM Standards describe post-construction runoff control requirements and applicability considerations for each based on site conditions and other factors. The "Water Quality - Capture and Treat" SWM Standard specifies off-site mitigation as an option if on-site quality management is not feasible. Off-site mitigation is evaluated for applicability by the Port based on a Variance Request from the designer, in which the designer identifies what can be performed on-site and the extent of deviation from the Standard. As described in Chapter 4, the Port will consider whether off-site mitigation shall be incorporated into the project design or implemented by the Port in conjunction with other projects or Port initiatives. Payment-in-lieu is not currently in the DSM, but will be considered by the Port for future incorporation if necessary to address tenant projects.
A.4.f.vi. A description of the <u>inspection and enforcement</u> response procedures the co-permittee will follow when <u>addressing project compliance issues</u> with the enforceable post-construction stormwater management performance standards.	X					The Port will be enforcing the use of and compliance with the DSM through a variety of means. As described in Chapter 1, the Port has the ability to enforce the use of the DSM, amongst other Port-defined stormwater management requirements, through the existing Port Stormwater Ordinance 361R, tenant lease agreements, and contract mechanisms with design firms. Within the DSM, Chapter 1 requires that all applicable development projects obtain Port approval of the stormwater management design in their SWM Submittal and obtain a Port Construction Permit before the project can proceed to construction. Additionally, Chapter 3 describes required design review and coordination milestones, which represent points in the design process where the designer must coordinate with the Port and submit the SWM Strategy to the Port for review and approval. The Port has an existing rigorous construction oversight process and BMP inspection and maintenance program that will continue to be used to maintain BMP performance as designed and approved under the DSM.



Appendix C

Regulatory Context



APPENDIX C: REGULATORY CONTEXT

C.1 Introduction

The contents of this appendix are intended to make the designer aware of existing regulations that may need to be coordinated with on a stormwater management design. The regulatory information includes federal, state, and local regulations that the Port is subject to, many of which serve as drivers for the required Stormwater Management (SWM) Standards presented in Chapter 4, as well as design criteria in Chapters 5 and 6. Beyond the contents of this appendix, designers are required to design their project in accordance with all applicable regulations pertaining to the stormwater management design. Compliance with DSM requirements does not entail compliance with all applicable regulatory requirements. Should applicable regulatory requirements (not including the City SWMM) become more restrictive than DSM requirements, those regulatory requirements will supersede any less restrictive requirements in the DSM.

C.2 Clean Water Act

The protection of the nation's waters originally began with Congress passing the Federal Water Pollution Control Act of 1948. The amendments passed by Congress in 1972 are now generally referred to as the Clean Water Act (CWA).

Section 402 of the CWA authorized the creation of the National Pollutant Discharge Elimination System (NPDES) permit program, which protects stormwater by regulating point source discharges of pollutants into waters of the United States.¹ In the State of Oregon, the EPA has delegated the administration of the NPDES permit program to the Oregon Department of Environmental Quality (DEQ). In late 1990, the U.S. Environmental Protection Agency (EPA) began to require municipal communities with populations of 100,000 or more to obtain a NPDES Municipal Separate Storm Sewer System (MS4) permit, which was called the Phase I stormwater rule. Information on Port NPDES permits, including industrial, construction, and MS4 permits is provided in several of the following sub-sections.

Section 303 of the CWA required that authorized states designate beneficial uses for state waters (e.g., agriculture, recreation, aquatic life) and then establish and adopt water quality standards that are protective of those uses. Water quality standards may include specific numeric water quality criteria as well as general provisions for protection of the waters, such as surface water anti-degradation policies. In the State of Oregon, the Water Quality Standards program is regulated and enforced by DEQ. Section 303(d) of the CWA requires each state to develop a prioritized list of impaired waters within their state ("303(d) List") that do not meet established water quality standards. Under this requirement, authorized states perform studies to identify quality issues for state surface waters and, if necessary, establish Total Maximum Daily Loads (TMDLs). A TMDL is a limit on the discharge of a particular pollutant (e.g., nutrients or bacteria) to a specific water body that is impaired for that pollutant. The limit for pollutant discharges is designed to help the water body meet its designated water quality standards. Information on TMDLs and 303(d) listed parameters is summarized in Section C.2.5.

¹ Environmental Protection Agency, *National Pollutant Discharge Elimination System (NPDES)*, March 12, 2009. <http://cfpub.epa.gov/npdes/>. (accessed on October 4, 2013).



Sections 401 and 404 of the CWA regulate impacts to wetlands and other surface water resources. For more information on these sections of the CWA please refer to Section C.6 on natural resource regulations.

C.2.1 Portland Group NPDES MS4 Permit

Within the City of Portland (City) Urban Services Boundary (USB), the City and Port both operate storm sewer systems in accordance with their joint Phase I MS4 permit #101314 (referred to as the “Portland Group” permit by DEQ). DEQ originally issued the permit to the City, Port, and Multnomah County in 1995, with the City as the lead agency. The permit was renewed in 2004 and further modified in 2005.² The current Portland Group MS4 permit (“MS4 permit”) was issued with the City and Port as the sole co-permittees. Each of the co-permittees is responsible for implementing the requirements of the MS4 permit within their area of permit responsibility. The Port’s area of MS4 permit responsibility includes all Port-owned property within the City USB³. The Port and City coordinate MS4 permit-driven responsibilities and activities through an Intergovernmental Agreement (IGA). The current MS4 permit can be found in Appendix A.

The requirements of the MS4 permit include six minimum control measures that define required controls and limitations for stormwater discharges within each of the co-permittees’ areas of responsibility:

1. Prohibit Non-Stormwater Discharges – Effectively prohibit non-stormwater discharges into the MS4 unless otherwise permitted.
2. Reduce Pollutants to the Maximum Extent Practicable – Reduce the discharge of pollutants from the MS4 to the maximum extent practicable.
3. Implement the Stormwater Management Plan (SWMP) – Implement and assess the effectiveness of the SWMP, which establishes stormwater management Best Management Practices (BMPs) to reduce the discharge of pollutants to the maximum extent practicable within each area of responsibility.
4. Stormwater Management Plan Requirements
 - a. Illicit discharge detection and elimination – Implement a program to detect, remove and eliminate illicit discharges to the MS4.
 - b. Industrial and commercial facilities – Implement a program to reduce pollutants in stormwater discharges to the MS4 from facilities identified as being subject to an industrial NPDES permit or as contributing a significant pollutant load to the MS4.
 - c. Construction site runoff control – Implement a program to reduce pollutants in stormwater runoff to the MS4 from construction activities.
 - d. Education and outreach – Implement an education and outreach program designed to achieve measurable goals for target audiences, stormwater quality issues, or pollutants of concern.

² City of Portland Bureau of Environmental Services, *City of Portland Stormwater Management Plan (SWMP) Summary*. Available online at <http://www.portlandoregon.gov/bes/article/322159> (accessed on September 20, 2013).

³ Port of Portland, *Stormwater Management Plan* (September 20, 2010, last updated April 1, 2011).



- e. Public Involvement and participation – Implement a public participation approach providing opportunities for the public to participate in the co-permittee’s stormwater management program.
 - f. Post-construction site runoff – Implement a post-construction stormwater pollutant control program.
 - g. Pollution prevention for municipal operations – Implement a program to reduce the discharge of pollutants to the MS4 from properties owned or operated by the co-permittee.
 - h. Stormwater management facilities operation and maintenance activities – Inventory and map stormwater management facilities and implement a program to verify the operation, inspection and maintenance of these facilities.
5. Hydromodification Assessment – Conduct an initial hydromodification assessment examining impacts related to MS4 discharges, including erosion, sedimentation and alternation to stormwater flow, volume, and duration.
 6. Stormwater Retrofit Strategy Development – Develop a stormwater quality retrofit strategy that applies to developed areas that have been identified as underserved or lacking stormwater quality controls.

C.2.2 MS4 SWMP Implementation

In accordance with MS4 permit requirements, the Port was required to develop a SWMP, detailing the measures and tasks that will be implemented to comply with each of the MS4 permit minimum control measures, except where covered by the City under their IGA. The Port states within its SWMP that it will “develop, adopt, and implement new Port-specific post-construction runoff control standards” as the chosen practice to meet Schedule A.4.f. of the MS4 permit. As described in Chapter 1, the DSM is intended to meet the objective of defining post-construction runoff control standards for stormwater management at applicable Port facilities. Where applicable, use of the DSM is intended to replace compliance with the City’s *Stormwater Management Manual*,⁴ which was implemented by the City as part of their own post-construction runoff control program. The relationship of MS4 permit requirements and various elements of the DSM is summarized in a table in Appendix B.

C.2.3 NPDES Industrial Permit Program

As described previously, DEQ has authorization over the NPDES industrial permit program in the State of Oregon to control the discharge of pollutants associated with industrial activities that are exposed to stormwater. Industrial permit coverage allows a permitted industrial facility to construct, install, modify, or operate stormwater treatment or control facilities and discharge stormwater and non-stormwater to public waters as authorized by the permit. An IGA between the City of Portland and DEQ allows the City to administer general NPDES stormwater permits

⁴ City of Portland, *Stormwater Management Manual* (2008). Available online at <http://www.portlandoregon.gov/bes/47952>.



for industrial stormwater discharges to the City MS4 on behalf of DEQ.⁵ The bullets below describe the general industrial permits offered by DEQ, as well as Port applicability:⁶

- 1200-Z – For applicable industrial activities throughout the state that are not covered by one of the permits below. Many of the Port's facilities have coverage under this permit for discharges to the Willamette River.
- 1200-COLS – For applicable industrial activities that discharge to the Columbia Slough. The Port has coverage under this permit for PDX discharges to the Columbia Slough.
- 1200-A – For sand and gravel operations, rock quarries, concrete batch plant operations and hot mix asphalt operations. This permit does not apply to any Port facilities.

DEQ continues to administer the NPDES industrial permit program for industrial stormwater discharges that are not eligible for coverage under the general permits. These include discharges from less common industrial activities including aircraft and pavement deicing at airports, for which PDX has an individual industrial NPDES permit (#101647).

Other Port and Port tenant industrial activities that are exposed to stormwater and discharge stormwater to public waters are covered under either the 1200-Z or 1200-COLS general industrial permit, as applicable. These permits require completion and implementation of a Stormwater Pollution Control Plan (SWPCP). These plans are useful for understanding the industrial activities and current stormwater BMPs at the facilities.

C.2.4 Erosion and Sediment Control

The City regulates erosion and sediment control from ground disturbing activities, including construction activities. Within Oregon Administrative Rule (OAR) Division 41, DEQ allows local jurisdictions to implement erosion and sediment control programs in accordance with baseline DEQ requirements. City Code Title 10 "Erosion and Sediment Control Regulations" and the City *Erosion and Sediment Control Manual* are the result of the City's program to regulate ground-disturbing activities and prevent significant environmental impacts from erosion and sedimentation. City requirements are applicable for all ground-disturbing activities unless exempted (e.g. where there is a hazard to life or property). Ground-disturbing activities 500 square feet or greater in area require submittal of an ESPCP for permitted development projects (building, public works, or development permit). An ESPCP may also be required for sites that are located with the following site conditions:

- On steep slopes
- In environmental overlay zones
- In greenway overlay zones
- In response to a violation of the City's erosion control requirements

⁵ IGA between DEQ and City of Portland for "Administration of NPDES 1200-Z, 1200-COLS and 1200-A General Permits for Stormwater Discharges from Industrial Activities. Available online at <http://www.portlandoregon.gov/bes/article/443292>.

⁶ Definitions from the DEQ "Water Quality Permit Program" accessed on September 5, 2013. <http://www.deq.state.or.us/wq/stormwater/industrial.htm>.



DEQ NPDES construction permit coverage is required for the discharge of stormwater to public waters from construction sites where the development plan meets the area thresholds defined below. Applicable construction activities include clearing, grading, excavating and stockpiling. The permit may include effluent limitations, erosion and sediment control requirements, and a submittal of an ESPCP. There are three general construction permits offered within the State of Oregon:⁷

- 1200-C – For construction activities throughout the state, where the development plan equals or exceeds one acre.
- 1200-CA – For construction activities under a government agency, including the Port, where the development plan equals or exceeds one acre.
- 1200-CN – Applicable only to specific jurisdictions not including the City of Portland. Allows automatic permit coverage for small construction activities (size varies with jurisdiction).

The Port has an ongoing 1200-CA construction permit which covers applicable Port-initiated construction activities. Port tenants obtain coverage under the 1200-C permit, as applicable, on a project-by-project basis. The 1200-CN permit is not applicable to Port facilities because it is not authorized within the City of Portland.

C.2.5 Total Maximum Daily Loads (TMDLs), Wasteload Allocations (WLAs) and 303(d) Listed Parameters

As previously described, the CWA required that states maintain a 303(d) list and if necessary, establish TMDLs. As part of the MS4 permit requirements, the Port must review the Category 5, 303(d) listed constituents (those without TMDL wasteload allocations, but for which TMDLs are needed) and determine if Port sites have the risk of discharging the constituents. For the Columbia Slough, the only Category 5 listed constituents are iron and manganese (DEQ, 2012b). For the Willamette River, there are thirteen Category 5 constituents, including aldrin, biological criteria, chlordane, chlorophyll-a, cyanide, dichloro-diphenyl-trichloroethane (DDT), p,p'-dichloro-diphenyl-dichloroethylene (DDE), hexachlorobenzene, iron, manganese, polychlorinated biphenyls (PCBs), pentachlorophenol, and polycyclic aromatic hydrocarbons (PAHs) (DEQ 2012b). There are no Category 5 listed constituents for the Columbia River.

The MS4 permit also requires an evaluation of total maximum daily load (TMDL) pollutants. A TMDL for the Columbia Slough was established in 1998, which covers chlorophyll-a, dissolved oxygen, pH, phosphorus, bacteria, lead, and several organics (DDE/DDT, PCBs, Dieldrin, and 2,3,7,8 TCDD) (DEQ 1998). The organics in the TMDL are addressed through use of total suspended solids (TSS) as a surrogate measure. Dissolved oxygen is addressed through the use of biochemical oxygen demand (BOD) as a surrogate, and orthophosphate and chlorophyll-a are addressed through the use of total phosphorus as a surrogate measure. A TMDL for the Willamette Basin was established in 2006 and covers bacteria, mercury, and temperature which applies to the Willamette River (DEQ 2006). Since the Columbia Slough flows into the Willamette River Basin, this TMDL also applies to the Columbia Slough, though only

⁷ Oregon Department of Environmental Quality, *NPDES Stormwater Discharge Permits – Construction Activities*. Available online at <http://www.deq.state.or.us/wq/stormwater/construction.htm>



temperature requirements apply through the use of shade curves as a surrogate. While mercury is included in the TMDL for the Willamette River with interim wasteload allocations (WLAs) based on percent reductions, no specific load allocations or effluent limitations are currently included in this version of the TMDL, though it is understood that a future version will likely contain specific WLAs and/or effluent limitations. Temperature is also included in the TMDL, but, because stormwater is not considered to be a major source of temperature impairment to either waterbody, MS4s are not assigned heat WLAs.

The Port must assess the type and level of BMP implementation necessary to attain the WLAs established for the TMDL pollutants. The estimated costs and other resources associated with implementation, operation, and maintenance of those BMPs must also be evaluated. The MS4 permit requires that progress is made toward reducing TMDL pollutant loads. The DSM has a process for determining pollutants of concern based upon TMDL requirements as well as other considerations, as described in Chapter 6.

C.3 National Environmental Policy Act

The National Environmental Policy Act (NEPA) requires federal agencies to assess the environmental impacts of planned federal actions. For the Port, NEPA may be applicable when a development or redevelopment project is federally funded or authorized by a federal agency, such as FAA. NEPA is intended to assist public officials by providing the framework to better understand the environmental consequences of planned actions. An appropriate level of documentation is required to provide information on the proposed action and the understanding of the impacts that the proposed action may have on the environment. There are three levels of NEPA review:

1. Categorical Exclusion (CatEx)
2. Environmental Assessment (EA)
3. Environmental Impact Statement (EIS)

CatEx is the least extensive review while EIS is the most extensive, requiring the evaluation of multiple design alternatives with varying potential for environmental impacts. The level of review determines the level of documentation and is dependent upon both the identified water resource issues and the findings during the evaluation of environmental impacts. Potential water resource issues include any potential impacts to the following areas, parameters, and organisms:

- Wetlands
- Floodplains
- Water quality
- Coastal zone management
- Plants, fish, and wildlife
- Wild and scenic rivers

For airports, the FAA has established NEPA compliance guidance within FAA Order 1050.1E, *Environmental Impacts: Policies and Procedures*, and FAA Order 5050.4B, *National Environmental Policy Act (NEPA) Implementing Instructions for Airport Actions*. The FAA also provides guidance within the *Environmental Desk Reference for Airport Actions*. The NEPA process concludes with the issuance of a Record of Decision (ROD) by the lead federal agency,



which authorizes the project to proceed with the preferred alternative, based on the results of the evaluation.

C.4 Oil Pollution Act and Spill Prevention Countermeasure and Control

The Oil Pollution Control Act (OPA) is an amendment to the CWA and is designed to prevent and respond to oil spills. If facilities store oil in significant volumes as detailed within the OPA, then that facility is subject to follow the prescribed requirements of the OPA for that volume of oil. Requirements include:

- Developing and implementing an Spill Prevention, Control, and Countermeasure (SPCC) Plan
- Providing appropriately sized secondary containment for oil storage containers
- Following the requirements for new underground storage tanks and upgrades to existing tanks

C.5 Floodplain Regulations

Floodplain regulations are designed to maintain floodplain capacity and protect facilities from impacts due to flooding during large, infrequent storm events. These regulations originate at the federal level with Title 44 of the Code of Federal Regulations (CFR). CFR Title 44 contains the rules and regulations pertaining to emergency management and assistance made available through the Federal Emergency Management Agency. CFR Title 44 states that flood insurance shall not be sold or renewed unless the community has adopted consistent floodplain management regulations. Enforcement of the regulations from CFR Title 44 that are pertinent to new development occurs at the local or regional level through establishing the floodplain. Most Port facilities are adjacent to a surface water with an established 100-year floodplain, and may be subject to flood hazard zoning requirements.

Metro, the regional government for the Portland metropolitan area, maintains the Urban Growth Management Functional Plan, which includes flood management performance standards. These performance standards are focused on mitigating impacts from flooding. To reduce impacts to structures from flooding, the lowest floors of structures (including basements) must be at least one foot above the 100-year flood water surface elevation. To mitigate increases in water surface elevation during flooding, Metro Title 3 states that any fill placed within the flood management area shall be balanced with an equal amount of material removal. Some exclusions apply to these requirements for construction activities.

The City complies with Metro Title 3 through defining and regulating development within “Flood Hazard Areas.” These areas are zoned per City Code Chapter 33.631, “Sites in Special Flood Hazard Areas,” to limit the creation of lots on lands subject to regular or periodic flooding in order to protect the safety of citizens and property while preserving the function of the floodplain. City Code Chapter 24.50, “Flood Hazard Areas,” then restricts or prohibits development within defined flood hazard areas that may increase flood heights or velocities. City Title 24 meets or exceeds Metro requirements, with the following variations from Metro Title 3:

- Flood protection requires two feet of freeboard between the lowest floor of a structure (including basements) and the 100-year storm water surface elevation, except in the



Columbia River floodplain and the floodplain for the Columbia Slough in Multnomah County Drainage District No. 1 (MCDD), where the required freeboard is one foot.

- Encroachments or development on the floodway are prohibited unless it can be demonstrated, through technical analysis, that no increase in flood elevation is anticipated. This flood encroachment requirement is similar to the federal or regional requirement, which requires an equal balance of cut for any fill placed within the flood hazard zones.

Flood hazard areas are defined based on the following mapping resources as specified within the City Code Chapter 24.50.040:

- Flood Insurance Rate Maps (FIRMs) produced by FEMA, which indicate the areas that have been designated as being within a floodplain that is subject to a “one percent or greater chance of flooding in any given year,”⁸ or what is known as the 100-year flood.⁹ Refer to Figure 4-3 for an overview of the 100-year floodplain as defined by FEMA, but during design, review the Official FIRMs for the project site.
- The “February 1996 Flood Inundation”¹⁰ areas as defined within the Metro Geospatial Information System (GIS) data. Refer to Figure 4-4 for an overview of the area covered by the February 1996 storm as defined by Metro.

C.6 Natural Resource Regulations

Natural resource regulations are intended to protect defined resources and the specified buffer zones surrounding the resources from physical impacts. The natural resources can be those that provide a functional value to the surrounding community and environment. The functional value can pertain to, but is not necessarily limited to, water quality, wildlife habitat, coastal protection, and historical or cultural significance. Some examples of natural resource regulations that may need to be considered and incorporated into the design of the stormwater management systems at Port facilities are described below. For groundwater protection regulations see Section C.6.

Wetlands and waterways are protected federally by the United States Army Corps of Engineers (USACE) under Section 404 of the CWA and Section 10 of the Rivers and Harbors Act.¹¹ Section 404 of the CWA regulates the placement of dredged or fill materials to waters of the state or waters of the United States, through the issuance of permits. If structures, disturbance,

⁸ City Code Title 24, Chapter 24.50, “Flood Hazard Areas” (November 2010).

⁹ FIRMs are available online at

<https://msc.fema.gov/webapp/wcs/stores/servlet/CategoryDisplay?catalogId=10001&storeId=10001&categoryId=12001&langId=-1&userType=G&type=1&dfirmCatId=12009&future=false>. Find the FIRM and follow the instructions to create a “FIRMette” which is a full-scale section of a FIRM that is created and formatted online for ease of access.

¹⁰ Select Metro maps and data are available online for free download at <http://www.oregonmetro.gov/>. The “February 1996 Flood Inundation” areas is available as a free GIS shapefile. Click the link for “Maps and data” followed by the link for “RLIS Discovery site” and the data set name is “February 1996 Flood with Metro Goal 5 Updates.”

¹¹ Oregon Department of Environmental Quality, *NPDES Stormwater Discharge Permits – Construction Activities*. Available online at http://www.oregon.gov/dsl/PERMITS/Pages/404_assumption.aspx



or discharges of material are proposed within surface waters as part of a project, then a permit authorizing the activities may be required by the USACE prior to initiating the activities.

Dredging, filling, and other impacts to waters of the state are regulated at a state level by DEQ, in accordance with Section 401 of the CWA. Section 401 requires a water quality certification prior to issuance of a federal permit for discharge to surface waters (e.g., rivers, streams, ditches, wetlands, etc.) from projects that propose dredging, filling, or other impacts to waters of the state.¹² The certification is completed by DEQ to certify that the proposed discharge is consistent with the CWA and meets the state water quality standards and requirements. Additionally, the Oregon Department of State Lands (DSL) regulates the fill or removal of materials from waters and wetlands of the state through permit issuance under Oregon's Removal-Fill Law.¹³ This permit program is intended to protect designated uses of waters of the state, including navigation, fishery, and recreational uses.

Designers should coordinate with the Port to determine if there may be other federal or state natural resource regulations that may need to be considered on a particular site or project, such as the Endangered Species Act, the Magnuson–Stevens Fishery Conservation and Management Act, or the Migratory Bird Treaty Act.

On a regional level, Metro Title 3 includes water quality performance standards aimed at protecting and improving water quality to support designated beneficial water uses, as well as protect the function and value of the water resource. Metro code establishes water quality resource areas, which include protected water features such as streams, lakes, wetlands, and springs, as well as required vegetated corridors alongside the water feature to provide a buffer from development areas. Vegetated corridors are defined from the edge of the water feature (as further defined in the code), and widths vary between 15 feet and 100 feet depending on the type of water feature and slope of land adjacent to the water feature. Additional water quality goals in Metro Title 3 are non-numeric and include minimizing erosion, use of native vegetation, minimizing nutrient and pollutant loadings, stabilizing slopes, and protecting fish and wildlife habitat.

The requirements established by Metro Title 3 are incorporated into the City's Title 33 Zoning Code under Chapter 33.440 "Greenway Overlay Zones." City Title 33 incorporates and implements the land use pattern defined in the Willamette Greenway Plan, and establishes use restrictions and development standards within the defined greenway along the Willamette River. Five greenway zones have been established on the City's Official Zoning Maps¹⁴, each with its own purpose.

- River Natural (denoted with an "n" symbol): Intended to protect and conserve the land with scenic quality or valuable wildlife habitats.

¹² State of Oregon, *Dredge and Fill Section 401 Water Quality Certification*. Available online at http://licenseinfo.oregon.gov/index.cfm?fuseaction=license_seng&link_item_id=14091

¹³ State of Oregon, *Working in Waters of the State*. Available online at <http://www.oregon.gov/dsl/PERMITS/Pages/index.aspx>

¹⁴ City of Portland Zone Maps available online at <http://www.portlandoregon.gov/bps/30420>.



- River Recreational (denoted with an “r” symbol): Encourages river-dependent and river related recreational uses.
- River General (denoted with a “g” symbol): Allows for development consistent with the base zoning.
- River Industrial (denoted with an “i” symbol): Promotes the development of river-dependent and river-related industries.
- River Water Quality (denoted with a “q” symbol): Protects water quality resources.

The River Industrial greenway overlay zone incorporates a majority of the Port’s marine terminal properties along the Willamette, including T2, T4, and T5. As such, greenway requirements are expected to be applicable to the Port, unless the facilities have otherwise been defined by the City as pre-existing and exempt “non-conforming situations.” Refer to Figure 4-5 for an overview of the locations of the greenway overlay zones, but during design review the Official Zoning Maps for the project site.

Greenway overlay zone requirements vary between the detailed zones and based on the location relative to a defined greenway setback within each zone (25 feet from top of riverbank in the River Industrial zone). Within the River Industrial zone, river-dependent and river-related land uses on sites that front the river are allowed by right. Other land uses may be allowed on these sites if approved through the Greenway Review process.

Within the River Industrial zone, river-dependent or river-related development may be allowed within the greenway setback if approved through the Greenway Review process. Outside of this setback but within the zone, development is not required to be river-dependent or river related, but is still subject to Greenway Review. Development must meet the standards defined in City Title 33 and Willamette River design guidelines in the Willamette Greenway Plan. Specific requirements include maximum floor area ratios (ratio of building floor area to site area), landscaping and native plant standards, and recreational trail and viewing requirements.¹⁵

Alterations to development in the River Industrial zone that are outside the following areas are exempt from Greenway Review:

- Greenway setback
- Riverward of the greenway setback
- Within 50 feet landward of the greenway setback
- Within 50 feet of the River Natural zoned land

In addition to the greenway overlay zones, the City has also defined environmental overlay zones (also known as “e-zones”) in Title 33 (Chapter 33.430). Environmental overlay zones pertain to City-defined areas that have been inventoried and identified as having natural resource value. Generally the overlay zones are related to drainage ways, wetlands, lakes, and forests. There are two environmental overlay zones; the Environmental Protection overlay zone and the Environmental Conservation overlay zone, which are defined as follows.

¹⁵ City Code Title 33, Chapter 33.440 “Greenway Overlay Zones” (July 2010).



- Environmental Protection – Resources within the Environmental Protection overlay zone (denoted with a “p” symbol) are considered very significant and have been assigned value in the inventory and economic, social, environmental and energy (ESEE) analysis within the study area. Approval of development is atypical within the protection zone.
- Environmental Conservation – Resources within the Environmental Conservation overlay zone (denoted with a “c” symbol) are considered significant and are protected while allowing environmentally sensitive urban development.

Within the environmental overlay zones there are development standards, which are meant to set a clear limitation on disturbance within the resource area of the zone. Each defined environmental overlay zone boundary incorporates the designated resource area as well as a transition area serving as a buffer for the designated resource area from urban uses. The transition area surrounds the resource area, starting at the external boundary of the environmental overlay zone and extending 25 feet inside the boundary. Required development standards within the environmental overlay zone consists of specific standards for the transition area and the resource area. This includes general development standards that must be followed for all development and establishes additional standards for the following development types:

- Utilities
- Land divisions
- Property line adjustment
- Resource enhancement
- Rights-of-way improvements
- Stormwater outfalls
- Public recreational trails

For development within an environmental overlay zone, there are additional information requirements for the building or land development permit application regarding how the design incorporates the zones’ development standards. The development standards include a limit on the disturbance area within the resource area of the environmental overlay zone; setbacks from the resource area of environmental protection zone and certain water bodies; and limitations on tree removal, slopes, planting, use of riprap and stormwater outfall pipe size. Compliance with all of the applicable development standards is required. An Environmental Review¹⁶ is required in addition to the general permit application review for building or development applicants (through Bureau of Development Services [BDS]) if applicable development standards are unable to be met within the proposed design.

Key exemptions relating to development in environmental overlay zones are summarized below. Please see City Code for the complete list of potentially applicable exemptions.

- Environmental Overlay Zones – Activities exempt from following the development standards within the environmental overlay zone include the operation, maintenance, and repair of the following:

¹⁶ City Code Title 33, Chapter 33.730, “Quasi-Judicial Procedures” details the review procedure based upon what type is prescribed within Chapter 33.430 “Environmental Review.”



- Irrigation systems
- Stormwater management systems
- Pumping stations
- Erosion control and soil stabilization features
- Operation, maintenance, and repair of drainage facilities, flood control structures, and conveyance channels that are managed by Drainage Districts as defined in ORS 547, and where the activity is conducted or authorized by the Drainage District
- Development over existing paved surfaces that are over 50 feet from any identified wetland or waterbody

Refer to Figure 4-6 for an overview of the locations of the environmental overlay zones, but during design the designer should review the Official Zoning Maps¹⁷ for the project site.

City Code Titles 24 and 33 are among the codes and rules enforced by the City's Bureau of Development Services (BDS) through its development review process. Therefore, Port development projects adjacent to flood hazard areas or resource areas are subject to these zoning requirements and City review. This holds true unless specifically exempted through City Code or within an IGA. One example of exemption to the City Code is the PDX airside (which includes airfield and all related development), where the requirements within City Code Title 33 have been waived through an IGA with the City.¹⁸

C.7 Groundwater Protection

Groundwater is a natural resource that is relied upon as a source of drinking water for approximately half of the country and also serves as a water supply for industrial and agricultural applications. Groundwater is protected at a federal level under the Safe Drinking Water Act of 1974, as amended in 1986 and 1996 (SDWA). The SDWA led to various groundwater protection measures, including the Wellhead Protection (WHP) and Underground Injection Control (UIC) Programs, which are implemented at the state level by DEQ. These programs, which are described in further detail below, are intended to minimize the potential for the contamination of groundwater resources due to the infiltration of surface runoff.

C.7.1 Underground Injection Control (UIC) Systems

The DEQ UIC Program regulates UIC systems under OAR 340 Division 44¹⁹. DEQ defines UIC systems as “devices that place fluids below the ground.”²⁰ Infiltration BMPs may be regulated as Class V UIC systems if they meet particular criteria defined by DEQ. An overview of UIC systems classification pertaining to infiltration BMPs is provided here for reference. For additional details related to current UIC-qualifying criteria and approval requirements, please refer to the DEQ website or regulatory code under OAR 340 Division 44.

¹⁷ City of Portland Zone Maps available online at <http://www.portlandoregon.gov/bps/30420>.

¹⁸ *Intergovernmental Agreement for Natural Resources Related to the Airport Futures Project* (2011). Available online at <http://www.pdxairportfutures.com/Documents.aspx>.

¹⁹ OAR 340 Division 44, “Construction and Use of Waste Disposal Wells or Other Underground Injection Activities” (September 2001). Available online at <http://www.deq.state.or.us/regulations/rules.htm>.

²⁰ Oregon Department of Environmental Quality, “Underground Injection Control Program,” <http://www.deq.state.or.us/wq/uic/uic.htm> (accessed August 19, 2013).



In general, infiltration BMPs that provide surface infiltration, including infiltration basins and trenches, are typically not considered UIC systems as long as the depth does not exceed the length or width along the surface.²¹ BMPs that provide for subsurface infiltration, such as drywells, soakage trenches, and facilities that use a perforated pipe to directly inject stormwater into groundwater may qualify as UIC systems. UIC systems that only inject stormwater runoff from rooftops are authorized and therefore do not need to be approved by DEQ, but are still required to be inventoried with DEQ. The UIC Program requires potential UIC systems to be registered and approved by DEQ. Among other requirements, approval of a proposed UIC system (other than qualifying rooftop systems) requires a demonstration that no other method of stormwater disposal is appropriate. The Infiltration SWM Standard in Chapter 4 covers the minimum requirements for infiltration as part of stormwater management design where applicable. Chapter 6 and the BMP factsheets provide more information on implementing infiltration within BMP design.

C.7.2 Columbia South Shore Well Field Wellhead Protection Area (WHPA)

In the City of Portland, the WHPA is a groundwater drinking water supply area that is administered by the Portland Water Bureau under the City's Well Field Protection Program. The goal of the program is to protect drinking water resources through source controls, pollution prevention procedures and prevention of infiltration into the ground. Portland Water Bureau requires compliance with the *Columbia South Shore Well Field Wellhead Protection Program Reference Manual*,²² which includes containment design standards for areas within the WHPA that handle and store hazardous materials, oil and fuel. Cascade Station (CAS) and Portland International Center (PIC)²³ are located within the WHPA. The Source Controls SWM Standard within Chapter 4 identifies key requirements for source control as part of stormwater management design.

C.8 Portland Harbor Superfund

Superfund is the environmental program established under the Comprehensive Environmental Response, Compensation and Liability Act (CERCLA) of 1980 (as amended) to address sites that have been defined by the EPA as "abandoned hazardous waste sites."²⁴ Under this program, EPA performs a preliminary assessment and site inspection (PA/SI) to determine site conditions and if there is a need for immediate response actions. Next, the EPA places non-emergency sites on the National Priorities List (NPL) for future long-term cleanup. After this, the EPA determines the responsible parties and enforces the long-term cleanup process against the parties, which includes the following milestones²⁵:

- Remedial Investigation and Feasibility Study (RI/FS) – Assesses the site on a more detailed level and evaluates methods of treatment and cleanup.

²¹ <http://www.deq.state.or.us/wq/pubs/factsheets/uic/uicstormwater.pdf>

²² Portland Water Bureau, *Columbia South Shore Well Field Wellhead Protection Program Reference Manual*, (2010), available online at <http://www.portlandoregon.gov/water/29880>.

²³ CAS and PIC which have been included within the Portland International Airport (PDX) area, as described within Chapter 1.

²⁴ <http://www.epa.gov/superfund/about.htm>

²⁵ <http://www.epa.gov/superfund/cleanup/index.htm>



- Records of Decision (ROD) – Details the selected cleanup alternatives.
- Remedial Design and Remedial Action (RD/RA) – Preparation of plans and specifications for cleanup and performing cleanup.
- Construction Completion – Construction of cleanup alternatives are completed but not necessarily the achievement of the final level of cleanup.
- Post Construction Completion – This includes additional actions to ensure long-term protection of the site and includes long-term actions, operation and maintenance, institutional controls, reviews, and remedy optimization.
- NPL Delete – Once the site is confirmed to have achieved all cleanup goals it is then removed from the NPL.
- Site Reuse and Redevelopment – Working on returning the sites safely to the community for use without impacting the remedy.

A portion of the Willamette River from river miles 1.9 to 11.8, defined as the Portland Harbor Superfund Site, was placed on the NPL in December 2000. The Site's preliminary assessment performed by the EPA determined that the water and sediments along the Site were contaminated with hazardous substances including "heavy metals, polychlorinated biphenyls (PCBs), polynuclear aromatic hydrocarbons (PAH), dioxin, and pesticides."²⁶

The Portland Harbor Superfund Site is currently in the draft RI/FS phase. This step is being performed by a coalition of potentially responsible parties, known as the Lower Willamette Group (LWG). The City and the Port are both part of the LWG, among other parties. EPA is leading the effort to investigate the extent and potential sources of contamination within the water (e.g., contaminated sediments), while DEQ is leading the effort to investigate potential upland sources of contamination (e.g., stormwater). For more background information on the progress of the Portland Harbor Superfund please see EPA Region 10 webpage.²⁷ The DSM requirements are not specifically related to any Superfund efforts at this time.

C.9 Stormwater Management Requirements at Airports

C.9.1 Federal Aviation Administration (FAA) Advisory Circulars

Stormwater management at PDX must comply with FAA Advisory Circulars (ACs) that provide standards for compliance with the FAA's Federal Aviation Regulations (FARs). As such, PDX is the only Port facility within the Urban Services Boundary that is required to comply with FAA ACs. As stated within the "Applicability" or "To whom does this AC apply" section of ACs, use of the ACs and the standards, practices, and recommendations that are within the ACs is required for airports that receive federal grants.

The FAA AC for *Airport Drainage Design* (AC 150/5320-5D) is focused on the design and maintenance of airport stormwater drainage systems. The primary objective of this AC is to provide for safe passage of vehicles and operation of the airport facility in accordance with

²⁶ EPA Region 10: the Pacific Northwest, "Portland Harbor Superfund Site," <http://yosemite.epa.gov/R10/CLEANUP.NSF/sites/ptldharbor>.

²⁷ EPA Region 10: the Pacific Northwest, "Portland Harbor Superfund Site," <http://yosemite.epa.gov/R10/CLEANUP.NSF/sites/ptldharbor>.



design storm criteria for conveyance sizing and ponding. Port criteria for drainage system design are included in Chapter 5. Designers are responsible for complying with DSM design criteria as well as detailed FAA requirements in the current version of this FAA AC.

One of the FAA's major safety concerns is the management of hazardous wildlife attractants to minimize the risk for wildlife strikes. The AC for *Hazardous Wildlife Attractants On or Near Airports* (AC 150/5200-33²⁸) prescribes requirements for mitigating the potential for wildlife impacts at an airport due to various land uses, including stormwater management facilities. Hazardous wildlife strikes and near-strikes have the potential to result in the following impacts to airport operations and safety:

- Injuries and fatalities
- Aircraft damage
- Aircraft downtime
- Operations interruptions
- Operations downtime
- Event investigations
- Increased monitoring and managing of hazards

The AC is directly applicable to airports, but also recommended for developers of projects near airports. For airports serving turbine-powered aircraft, such as PDX, the AC requires a 10,000-foot separation between an airport's Air Operations Area (AOA) and identified wildlife attractants. It also establishes a minimum separation distance of 5 miles between the AOA and attractants with the potential to cause wildlife movement into an airport's approach or departure airspace. Although there is a potential for wildlife attractants to exist at Port facilities other than PDX, all other Port-owned facilities fall outside of the 10,000-foot separation distance.

C.9.2 PDX Wildlife Hazard Management Plan

In addition to the compliance guidance provided by the FAA ACs, PDX has a Wildlife Hazard Management Plan (WHMP).²⁹ The WHMP focuses on avian wildlife, because bird strikes are statistically a higher risk to aircraft than terrestrial wildlife, especially during departure and landing operations. The Port understands that the location of PDX adjacent to the Columbia River makes it impossible to completely eliminate the risk of bird strikes, but the goal is to bring risk down to a manageable level. The Port implements several adaptive management strategies to deter birds and other wildlife which manages the current risk level without having to retrofit existing structures. In order to prevent new hazardous wildlife attractants, the WHMP requires that incorporation of wildlife deterrent concepts be brought in during the early phases of projects for compatible land-use planning.

Within the WHMP, the 10,000-foot separation distance at PDX has been divided into three zones, as shown on Figure 4-2 and listed below:

²⁸ Advisory Circular 150/5200-33B was in effect and 150/5200-33C was in draft form at the time of Manual release.

²⁹ *Portland International Airport Wildlife Hazard Management Plan* (2009)., available online at http://www.portofportland.com/PDX_WldLife_Mngmnt.aspx.



- Primary Zone
- Intermediate Zone
- Secondary Zone

The zones assist with management prioritization. Each zone has standards to follow for stormwater management facilities in order to prevent creating new hazardous wildlife attractants. The key standards pulled from the PDX WHMP, FAA ACs, and ORS 836.623 are detailed within the Hazardous Wildlife Attractants SWM Standard in Chapter 4.



Appendix D

Groundwater and Soil On-site Testing Procedures



APPENDIX D: GROUNDWATER AND SOIL ON-SITE TESTING PROCEDURES

For purposes of the DSM, the Port has adopted select methods for infiltration testing and the analysis of seasonal high groundwater elevations. Designers are required to follow these testing procedures as applicable to determine the feasibility of promoting infiltration on a project site.

The required methodology for depth to groundwater investigations and infiltration testing for small-scale projects (less than 1 acre drainage area to infiltration BMP) was adopted from the City of Portland Stormwater Management Manual (SWMM) Section 2.3.6. The required methodology for large-scale infiltration testing (infiltration BMP drainage area greater than or equal to 1 acre) was adopted from the Stormwater Management Manual for Western Washington (SWMMWW) Section 3.3.6 of Volume III (Large Scale Pilot Infiltration Test).

The excerpts from the City SWMM and SWMMWW include occasional text references to documents, criteria, and review processes that are not directly applicable for the DSM. Please reference the table below for the clarification of requirements that are applicable to the DSM. As noted in the table, Section D.1 below prescribes DSM-specific requirements for calculating the design infiltration rate that supersede select City SWMM and SWMMWW requirements.

City SWMM Excerpt Original Text	Clarification of Port DSM Applicability
"Depth to Groundwater Investigation",	For the purposes of the DSM, this investigation is required for UIC systems, as well as all infiltration BMPs.
Simplified Approach.	Not applicable to the DSM.
Presumptive and Performance Approaches.	Testing methodology associated with City Presumptive and Performance Approaches are applicable to the DSM.
References to Chapter sections.	Section references do not refer to the DSM.
References to tables or figures.	Applicable for only within Appendix D.
Factors of Safety and Table 2-2.	This section and table shall be replaced with Section D.1 below, Calculating the Design Infiltration Rate.
SWMMWW Excerpt Original Text	Clarification of Port DSM Applicability
Mounding analysis	Refer to SWMMWW Section 3.3.8 Step 10.
Application of correction factors (Sections 3.3 and 3.4 references)	Correction factors shall be calculated using D.1 below, Calculating the Design Infiltration Rate.

D.1 Calculating the Design Infiltration Rate

The *Santa Barbara Stormwater BMP Guidance Manual* (2008) provides a method for determining the design infiltration rate by applying correction factors to the field measured infiltration rate. This methodology is recommended although the Port may approve the use of other methods used to determine appropriate correction factors. These factors take into account uncertainty in measurement procedure, depth to water table or impermeable strata, infiltration facility geometry, and long term reductions in permeability due to biofouling and accumulation of fines, and ensure that the design infiltration rate is always less than the observed field infiltration rate.



The following is the given method within the *Santa Barbara Stormwater BMP Guidance Manual* (2008)¹ and provided here for reference.

Equation D-1: Determination of Design Infiltration Rate from On-Site Measurements²

$$k_{\text{design}} = k_{\text{measured}} \times F_{\text{testing}} \times F_{\text{plugging}} \times F_{\text{geometry}}$$

k_{design} = design infiltration rate (in/hr)

k_{measured} = field measures infiltration rate (in/hr)

F_{testing} = correction factor for testing method

F_{plugging} = correction factor for soil plugging

F_{geometry} = correction factor for facility geometry

" F_{testing} takes into account uncertainties in the testing method and is 0.3 for small-scale percolation tests and 0.5 for large-scale testing.

F_{plugging} accounts for reductions in infiltration rates over the long term caused by plugging of soils. The factor is:

- 0.7 for loams and sandy loams
- 0.8 for fine sands and loamy sands
- 0.9 for medium sands
- 1.0 for coarse sands or cobbles or for any facility preceded by a full specification filter strip or vegetated swale.

F_{geometry} accounts for the influence of facility geometry and depth to groundwater table or impervious strata on the actual infiltration rate. F_{geometry} must be between 0.25 and 1.0 as determined by the following equation:"

Equation D-2: Correction Factor to Account for Facility Geometry³

$$F_{\text{geometry}} = 4D/w + 0.05$$

Where:

D = depth from the bottom of the facility to the maximum seasonally high groundwater table or nearest impervious layer, whichever is less (ft)

W = width of the facility (ft)

¹ Geosyntec Consultants, "City of Santa Barbara Storm Water BMP Guidance Manual" (June 2008).

² Chapter 6, Equation 6-1 of the "City of Santa Barbara Storm Water BMP Guidance Manual" (June 2008).

³ Chapter 6, Equation 6-2 of the "City of Santa Barbara Storm Water BMP Guidance Manual" (June 2008).

2.3.6 Infiltration and Soil Requirements

This section presents information about depth to groundwater investigations, infiltration testing, and the specification for the blended soil used in vegetated stormwater facilities.

Depth to Groundwater Investigation

Several areas within the City of Portland have known shallow groundwater. Within areas of known or suspected shallow groundwater, additional information about the depth to groundwater (DTW) may be required to ensure that a proposed underground injection control (UIC) system meets minimum separation distances between the bottom of a UIC and seasonal high groundwater. Minimum separation distances are required by Oregon Department of Environmental Quality (DEQ) under UIC requirements. The minimum separation distance between the bottom of the UIC and seasonal high groundwater is 5 feet.

When a public or private UIC is proposed within areas of known or suspected shallow groundwater, a site specific investigation may be required to determine the seasonal high depth to groundwater. A DTW investigation may be required for areas where the estimated depth to seasonal high groundwater is estimated to be less than 50 feet of ground surface. To identify areas of shallow groundwater within the City please consult the map which the City of Portland derived from the [Estimation of Depth to Ground Water and Configuration of the Water Table in the Portland, Oregon Area](#), prepared by the United States Geological Survey (USGS). This map is available online in two locations:

- Through www.PortlandMaps.com.
- Through USGS mapping at http://or.water.usgs.gov/projs_dir/puz/.

Depth to Groundwater Investigation Requirements

The DTW investigation requires sufficient time to plan for and perform the necessary steps to collect a reliable measurement, including obtaining permits, performing utility locates, borings, piezometer/well installation, collection of water level measurements, and decommissioning of the monitoring well. The DTW investigation, including design, installation oversight, water measurements, and decommissioning, must be performed by an Oregon licensed registered geologist (RG), certified engineering geologist (CEG), or professional engineer (PE) with experience in hydrogeologic investigations and well design and installation; the investigation may include either the installation of a temporary piezometer(s) or

groundwater monitoring well(s). The qualified professional is responsible for developing an appropriate scope of work to document the DTW, including:

- Determining the number and location(s) of the DTW measurements needed to address project objectives. It is recommended, but not required, to have each piezometer or well location surveyed to a datum.
- Determining the appropriate method for obtaining DTW measurements (e.g., piezometer or monitoring well).
- Determining the appropriate depth of the boring(s). Boring depth must be a minimum of 20 feet deeper than the proposed UIC depth.
- Observing and describing soils encountered during drilling.
- Developing an appropriate well or piezometer design.
- Ensuring that construction and abandonment of piezometer or monitoring well complies with Oregon Administration Rules 690-240.
- Obtaining depth to groundwater measurements (see Figure 2-32 for an illustration of the process). If groundwater is not encountered (e.g. saturated conditions are not observed, no water seeps are observed) within 20 feet of the proposed bottom of the UIC, a piezometer or monitoring well does not need to be installed.
- Estimating the measured DTW to be representative of the “groundwater seasonal high,” based on available data and best professional judgment.
- Documenting the procedures used and the results of the DTW investigation.
- Submitting a signed and stamped DTW investigation report.

To the extent practicable, DTW measurements should be obtained in the immediate vicinity (less than or equal to 75 feet) of the proposed UIC. If high-quality shallow groundwater level data is available (e.g., piezometer, monitoring well, drinking water well, irrigation well) within 200 feet of the proposed UIC location, this data may be considered in lieu of site-specific data.

Figure 2-32. Depth to Groundwater Investigation

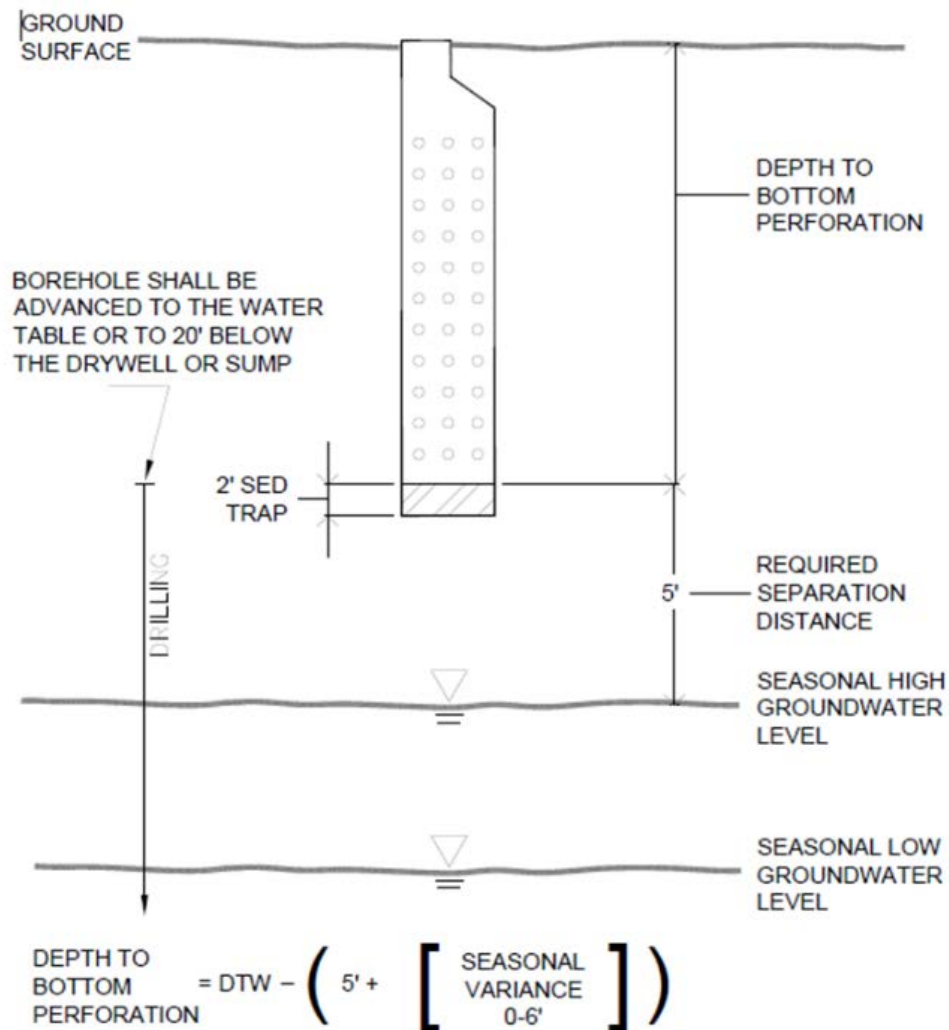

Piezometer/Well Borehole Drilling and Installation

Continuous soil sampling is recommended to allow detailed characterization of subsurface soil and identification of groundwater depth. The RG, CEG, or PE must prepare and submit a detailed boring log of subsurface conditions. Soil boring logs should be in accordance with the *Standard Practice for Description and Identification of Soils* (Visual-Manual Procedure) (ASTM D2488-00). Borings must be advanced to the groundwater level, or to a minimum of 20 feet below the proposed total depth of the UIC or 10 feet below a proposed UIC of 5 feet or less. If water is encountered in the boring, it must be noted on the drilling log.

The appropriate drilling method should be selected by the RG, CEG, or PE in conjunction with the driller, based on anticipated site-specific geologic and hydrogeologic conditions, anticipated boring depth, site accessibility, availability of equipment, and piezometer/well design. All equipment placed into the boreholes must be properly decontaminated prior to use.

Any investigation-derived material (e.g., soil cutting, water, personal protective gear) generated during drilling activities must be properly contained, characterized, and disposed in accordance with applicable state and federal regulations. Soil and water disposal must be documented.

Depth to Water Measurements

Following piezometer/well installation, water levels must be allowed to equilibrate for a minimum of 24 hours in fine-grained soils. After the water level has stabilized, an electronic water level indicator or a weighed tape should be used to measure the depth to water. Measurements should be made relative to ground surface and to the nearest 1/8 inch (~0.01 feet). The observer must make at a minimum two measurements over a period of about 15 minutes to show the results are static.

Estimating Depth to Seasonal High Groundwater

The site-specific DTW measurement must be used to estimate the depth to seasonal high groundwater. Seasonal water-table fluctuations were evaluated in the [*Estimation of Depth to Ground Water and Configuration of the Water Table in the Portland, Oregon Area*](#) report, prepared by the USGS and used to determine the seasonal correction factor (SCF). The SCF represents a long-term measurement of the seasonal water-table fluctuations. The SCF was set at 6 feet, using the USGS estimated mean of observed seasonal water table fluctuations for the unconsolidated sedimentary aquifer. To correct for seasonal variation, the SCF used to estimate depth to seasonal high groundwater is applied during periods of seasonal groundwater lows (late fall) and water level transition (summer and winter months). In March through May (seasonal high groundwater), no correction is added.

To correct site-specific DTW measurements to seasonal high DTW estimates, the following correction should be made:

$$DTW_{SH} = DTW_{SS} - SCF$$

Where:

- DTW_{SH} = Estimated seasonal high depth to groundwater (feet)
- DTW_{SS} = Measured site-specific depth to groundwater (time specific)
- SCF = Seasonal correction factor
 - 6 feet for measurements June through February
 - 0 feet for measurements in March through May

If water is not encountered in the soil boring, advanced 20 feet below the proposed UIC completion depth, it must be documented on the boring log and in the investigation report. In this case, the depth to water is assumed to be outside the range of seasonal fluctuation; the minimum required separation distance for the proposed bottom of the UIC to seasonal high groundwater is therefore met by default. The borehole may be decommissioned immediately, in accordance with OAR 690-240.

Decommissioning

Borings, piezometers, temporary wells, and wells must be abandoned in accordance with OAR 690-240. Specific decommissioning procedures must be determined by a licensed driller and the registered geologist or professional engineer.

Minimum Requirements for DTW Investigation Report

The DTW Investigation report must contain, but is not limited to:

- A copy of the State of Oregon Monitoring Well Log Report or Geotechnical Hole Report, as appropriate.
- A map showing the final location of each well or piezometer and tax lot boundaries.
- Latitude and longitude of each well or piezometer.
- Description of field procedures (drilling method, sampling method, development method, depth to groundwater measurements, etc.).
- Measured water level to the nearest hundredth of a foot.
- Detailed soils log prepared by, or under the direct supervision of, the RG, CEG, or PE.

- Construction diagram for each well/piezometer.
- Summary of groundwater depth measurements (depth measured, elevation, date, time).
- Discussion/basis for estimation of seasonal high depth to groundwater measurement.
- Construction and investigation reports stamped and signed by the RG, CEG, or PE.

Depth to Groundwater Investigation Report Submittal and Usage

Two copies of the OWRD well or piezometer construction report and the signed and stamped DTW investigation report must be submitted with the development permit application to the City and to DEQ with the UIC rule authorization application, which can be obtained at <http://www.deq.state.or.us/wq/uic/forms.htm>.

The corrected site-specific depth to seasonal high groundwater must be used to verify that the proposed UIC will meet the separation distances set by DEQ to obtain rule authorization for private UICs or ensure compliance under the City's WPCF permit. If separation distances cannot be met, an alternative design must be developed that meets separation distance requirements.

Infiltration Testing

To properly size and locate stormwater management facilities, it is necessary to characterize the soil infiltration conditions at the location of the proposed facility. All projects that propose onsite infiltration must evaluate existing site conditions and determine:

- If the infiltration rate is adequate to support the proposed stormwater management facility (satisfied through the Simplified Approach Infiltration Test), or
- The design infiltration rate prior to facility design (satisfied through Presumptive or Performance infiltration testing conducted by a qualified professional).

The following sections provide the approved standard infiltration testing specifications.

Minimum Number of Required Tests

The number of required infiltration tests may vary by type of development proposal or by design approach.

Land Division

- A total of two infiltration tests for every 10,000 square feet of lot area available for new or redevelopment.
- An additional test for every 10,000 square feet of lot area available for new or redevelopment.
- At least one test for any potential street facility.
- One test for every 100 lineal feet of infiltration facility.
- No more than five tests are required per development (at the discretion of the qualified professional assessing the site, as well as the City of Portland).

Tests performed for a proposed land division can be used at the building permit stage as long as the results of the test are submitted with the separate applications and were conducted within twenty-four months prior to the date the plans were submitted for review.

Building Permits

- The Simplified Approach requires one infiltration test for every proposed facility.
- The Presumptive and Performance Approaches require at least one test for any proposed street facility; require one test for every 100 lineal feet of proposed

infiltration facility; and the number of tests is at the discretion of the qualified professional assessing the site, as well as the City of Portland.

Where multiple types of facilities are used, it is likely that multiple tests will be necessary, since an infiltration test can test only a single location. It is highly recommended to conduct an infiltration test at each stratum used. BES staff may require additional testing. If additional testing is required during plan review, the applicant must provide 24-hour notice to BES staff and specify the time and location that the test will take place.

Simplified Approach Infiltration Test Requirements

The Simplified Approach provides a design approach that can be used by a nonprofessional for design of simple stormwater systems on small projects. This method, the Simplified Approach Infiltration Test, is applicable only to projects on private property with less than 10,000 square feet of new or redeveloped impervious area (see [Section 2.2.1](#)). The results of infiltration testing must be documented on the Simplified Approach Form (see [Section 2.4.3](#)).

On a site with steep slopes or shallow groundwater, BES may require a geotechnical report in order to evaluate the suitability of the proposed facility and its location. BES staff may also require an encased falling head or a double-ring infiltrometer infiltration test (see below for instructions) in order to verify that the facilities designed under the Simplified Approach are appropriate.

The Simplified Approach Infiltration Test cannot be used to find a design infiltration rate. The intent of the Simplified Approach Infiltration Test is to determine whether or not the local infiltration rate is adequate (2 inches/hour or greater) for the predesigned stormwater facilities described in [Section 2.3](#) (infiltration swales, basins, planters, drywells, and trenches). The Simplified Approach Infiltration Test does not need to be conducted by a licensed professional.

Simplified Approach Infiltration Test Procedure

1. A Simplified Approach Infiltration Test is required at the location of where the facility is proposed or within the immediate vicinity. The test must be conducted in the twenty-four months prior to the date the plans are submitted for review.
2. Excavate a test hole to the depth of the bottom of the infiltration system. The test hole can be excavated with small excavation equipment or by hand using a shovel, auger, or post hole digger. If a layer hard enough to prevent further excavation is encountered, or if noticeable moisture/water is encountered in the

soil, stop and measure this depth from the surface and record it on the Simplified Approach Form. Proceed with the test at this depth.

3. Fill the hole with water to a height of about 6 inches from the bottom of the hole, and record the exact time it takes for the water to draw down to the bottom of the test pit. Check the water level at regular intervals (every 1 minute for fast-draining soils to every 10 minutes for slower-draining soils) for a minimum of 1 hour or until all of the water has infiltrated. Record the distance the water has dropped from the top edge of the hole for each time interval.
4. Repeat this process two more times, for a total of three rounds of testing. These tests should be performed as close together as possible to accurately portray the soil's ability to infiltrate at different levels of saturation. The third test provides the best measure of the infiltration rate at saturated conditions.
5. For each test pit required, submit all three testing results with the date, duration, drop in water height, and conversion into inches per hour.

If the result from the third round of testing is greater than 2.0 inches per hour, the applicant can proceed with Simplified Approach facility design (where applicable). The Simplified Approach requires one infiltration test for every proposed facility. If the applicant would like to use an infiltration rate for design purposes, a Presumptive or Performance Infiltration Test must be conducted.

Presumptive and Performance Infiltration Test Requirements

The Presumptive Approach ([Section 2.2.2](#)) or Performance Approach ([Section 2.2.3](#)) must be used for all public and private developments where the Simplified Approach is not applicable. The qualified professional must exercise judgment in the selection of the infiltration test method. The three infiltration testing methods used to determine a design infiltration rate are:

- Open pit falling head.
- Encased falling head.
- Double-ring infiltrometer.

Where satisfactory data from adjacent areas using similar infiltration testing methods is available that demonstrates infiltration testing is not necessary, the infiltration testing requirement may be waived by the BES design reviewer. A recommendation for forgoing infiltration testing must be submitted in a report which includes supporting data and is stamped and signed by the project geotechnical engineer or project geologist.

Testing Criteria

- Testing must be conducted or overseen by a qualified professional. This professional must be a Professional Engineer (PE) or Registered Geologist (RG) licensed in the State of Oregon.
- The depth of the test must correspond to the facility depth. If a confining layer, or soil with a greater percentage of fines, is observed during the subsurface investigation to be within 4 feet of the bottom of the planned infiltration system, the testing should be conducted within that confining layer. Based on DEQ requirements and conformance with any required Depth to Groundwater Investigation Requirements, the boring log must be continued to a depth adequate to show separation between the bottom of the infiltration facility and the seasonal high groundwater level. (The boring depth will vary, based on facility depth.)
- Tests must be performed in the immediate vicinity of the proposed facility. Exceptions can be made to the test location provided the qualified professional can support that the strata are consistent from the proposed facility to the test location. The test must be conducted in the twenty-four months prior to the date the plans were submitted for review.
- Infiltration testing should not be conducted in engineered or undocumented fill.

Factors of Safety

Table 2-2 lists the minimum allowable factors of safety applied to field obtained infiltration rates for use in stormwater system design under the Presumptive and Performance design approaches. To obtain the infiltration rate used in design, divide the infiltration rate measured in the field by the factor of safety. The factor of safety used in design should be chosen by collaboration between the geotechnical engineer or geologist overseeing the infiltration testing and the civil engineer designing the stormwater management system. Determination of the factor of safety should include consideration of project specific conditions such as soil variability, testing methods, consequences of system failure, complexity of proposed construction, etc.

Table 2-2. Minimum Allowable Factor of Safety

Test Method	Minimum Required Factor of Safety
Open Pit Falling Head	2
Encased Falling Head	2
Double-Ring Infiltrometer	1

Presumptive and Performance Infiltration Testing Instructions

The following sections provide instructions for completing the open pit falling head infiltration test, the encased falling head infiltration test, and the double-ring infiltrometer infiltration test.

Open Pit Falling Head Procedure

The open pit falling head procedure is performed in an open excavation and therefore is a test of the combination of vertical and lateral infiltration.

- 1) Excavate a hole with bottom dimensions of approximately 2 feet wide by 2 feet deep into the native soil to the elevation of the proposed facility bottom. The test can be conducted in a machine-excavated pit or a hand-dug pit using a shovel, post hole digger, or hand auger. If smooth augering tools or a smooth excavation bucket are used, scratch the sides and bottom of the hole with a sharp pointed instrument, and remove the loose material from the bottom of the test hole.
- 2) Fill the hole with clean water a minimum of 12 inches, and maintain this depth of water for at least 4 hours (or overnight if clay soils are present) to presoak the native material.
- 3) Determine how the water level will be accurately measured. The measurements should be made with reference to a fixed point. A lath placed in the test pit prior to filling or a sturdy beam across the top of the pit are convenient reference points. The tester and excavator should conduct all testing in accordance with OSHA regulations.
- 4) After the presaturation period required by #2 above, refill the hole with water to 12 inches and record the draw-down time. Alternative water head heights may be used for testing provided the presaturation height is adjusted accordingly and the water head height used in infiltration testing is no more than 50 percent of water head height in the proposed stormwater system during the design storm event. Measure the water level to the nearest 0.01 foot ($\frac{1}{8}$ inch) at 10-minute

intervals for a total period of 1 hour (or 20-minute intervals for 2 hours in slower draining soils) or until all of the water has drained. In faster draining soils (sands and gravels), it may be necessary to shorten the measurement interval in order to obtain a well defined infiltration rate curve. Constant head tests may be substituted for falling head tests at the discretion of the professional overseeing the infiltration testing.

- 5) Repeat the infiltration test until the change in measured infiltration rate between two successive trials is no more than 10 percent. The trial should be discounted if the infiltration rate between successive trials increases. At least three trials must be conducted. After each trial, the water level must be readjusted to the 12 inch level. Enter results into the data table (see Table 2-3 for an example infiltration test table and Table 2-4 for a blank table).
- 6) The average infiltration rate over the last trial should be used to calculate the design infiltration rate without a factor of safety applied. Alternatively, the infiltration rate measured over the range of water head applicable to the project stormwater system design may be used at the discretion of the professional overseeing the testing. The final rate must be reported in inches per hour.
- 7) Upon completion of the testing, the excavation must be backfilled.
- 8) For very rapidly-draining soils, it may not be possible to maintain a water head above the bottom of the test pit. If the infiltration rate meets or exceeds the flow of water into the test pit, approximate the area over which the water is infiltrating, measure the rate of water discharging into the test pit (using a water meter, bucket or other device), and calculate the infiltration rate by dividing the rate of discharge (cubic inches per hour) by the area over which it is infiltrating (square inches). A maximum infiltration rate of 20 inches per hour can be used in stormwater system design with this type of infiltration test..

Encased Falling Head Procedure

The encased falling head procedure is performed with a 6-inch diameter casing that is embedded approximately 6 inches into the native soil. The goal of this field test is to evaluate the vertical infiltration rate through a 6-inch plug of soil, without allowing any lateral infiltration. The test is not appropriate in gravelly soils or in other soils where a good seal with the casing cannot be established.

- 1) Embed a solid 6-inch diameter casing into the native soil at the elevation of the proposed facility bottom (see Figure 2-33). Ensure that the embedment provides a good seal around the pipe casing so that percolation will be limited to the 6-

inch plug of the material within the casing. This method can also be used when testing within hollow stem augers, provided the driller and tester are reasonably certain that a good seal has been achieved between the soil and auger.

- 2) Fill the pipe with clean water a minimum of 1 foot above the soil to be tested, and maintain this depth for at least 4 hours (or overnight if clay soils are present) to presoak the native material. Any soil that sloughed into the hole during the soaking period should be removed. In sandy soils with little or no clay or silt, soaking is not necessary. If after filling the hole twice with 12 inches of water, the water seeps completely away in less than 10 minutes, the test can proceed immediately.
- 3) To conduct the first trial of the test, fill the pipe to approximately 12 inches above the soil and measure the water level to the nearest 0.01 foot ($\frac{1}{8}$ inch). Alternative water head heights may be used for testing provided the presaturation height is adjusted accordingly and the water head height used in infiltration testing is 50 percent or less than the water head height in the proposed stormwater system during the design storm event. The level should be measured with a tape or other device with reference to a fixed point. The top of the pipe is often a convenient reference point. Record the exact time.
- 4) Measure the water level to the nearest 0.01 foot ($\frac{1}{8}$ inch) at 10-minute intervals for a total period of 1 hour (or 20-minute intervals for 2 hours in slower soils) or until all of the water has drained. In faster draining soils (sands and gravels), it may be necessary to shorten the measurement interval in order to obtain a well defined infiltration rate curve. Constant head tests may be substituted for falling head tests at the discretion of the professional overseeing the infiltration testing. Successive trials should be run until the percent change in measured infiltration rate between two successive trials is minimal. The trial should be discounted if the infiltration rate between successive trials increases. At least three trials must be conducted. After each trial, the water level is readjusted to the 12 inch level. Enter results into the data table (see Table 2-3 for an example infiltration test data table and Table 2-4 for a blank data table).
- 5) The average infiltration rate over the last trial should be used to calculate the unfactored infiltration rate. Alternatively, the infiltration rate measured over the range of water head applicable to the project stormwater system design may be used at the discretion of the professional overseeing the testing. The final rate must be reported in inches per hour.

- 6) Upon completion of the testing, the casing should be pulled and the test pit backfilled.

Figure 2-33. Encased Falling Head Illustration

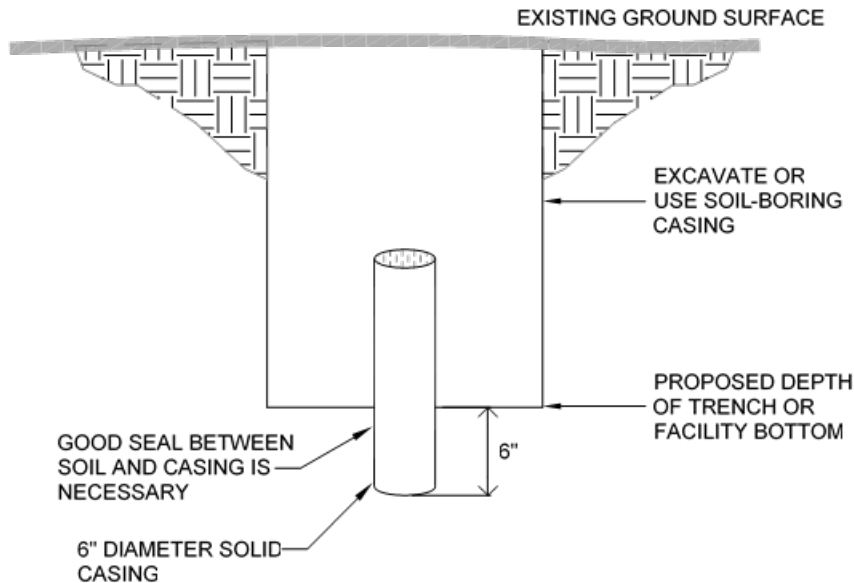

Double-Ring Infiltrometer Test

The double-ring infiltrometer test procedure should be performed in accordance with ASTM 3385-94. The test is performed within two concentric casings embedded and sealed to the native soils. The outer ring maintains a volume of water to diminish the potential of lateral infiltration through the center casing. The volume of water added to the center ring to maintain a static water level is used to calculate the infiltration rate. The double-ring infiltrometer is appropriate only in soils where an adequate seal can be established.

Infiltration Test Report Requirements

If an Infiltration Test Report is required under the Simplified Approach, it must be submitted within two weeks of BES staff request. For Presumptive and Performance Approaches, the Infiltration Test Report must be attached to the project's Stormwater Management Report. The following information must be included in the Infiltration Testing Report:

- Statement of project understanding (proposed stormwater system).
- Name, contact information, professional license information and qualifications of the person conducting the infiltration test.
- Summary of subsurface conditions encountered, including soil textures and the depth that they were found.
- Summary of pre-saturation timing.
- Summary of infiltration testing including location and number of tests and testing method used. Discussion of how the tests were performed (i.e. pipe type or diameter or test pit dimensions).
- Infiltration testing results in inches per hour for each interval as well as the average for the entire testing period
- Recommended design infiltration rate.
- Groundwater observations within exploration and an estimate of the depth to seasonal high groundwater.
- Site plan showing location of infiltration tests.
- Boring or test pit logs. Boring or test pit logs will be required when an applicant's proposal relies on the presence of specific subsurface strata that allows infiltration. The logs must include an associated soil classification consistent with ASTM D2488-00, Standard Practice for Classification for Description and Identification of Soils (Visual-Manual Procedure). The logs must also include any additional pertinent subsurface information, such as soil moisture conditions, depth and description of undocumented or engineered fill, soil color and mottling conditions, soil stiffness or density, and approximate depth of contact between soil types.
- A summary of the Infiltration Test Data Tables (see Table 2-3 for an example data table and see Table 2-4 for a blank data table).

Table 2-3. Example Infiltration Test Table

Location: Lot 105, Point Heights Subdivision		Date: 6/28/2008		Test Hole Number: 3	
Depth to bottom of hole: 57 inches		Dimension of hole: 0.5 feet diameter		Test Method: Encased Falling Head	
Tester's Name: C.J. Tester Tester's Company: Tester Company Tester's Contact Number: 555-1212					
Depth (feet):			Soil Texture:		
0-0.5			Black Top Soil		
0.5-1.0			Brown SM		
1.0-2.2			Brown ML		
2.2-5.1			Brown CL		
Presaturation Start Time:					
Presaturation End Time:					
Time:	Time interval (minutes):	Measure ment, (feet):	Drop in water level, (feet):	Infiltration rate, (inches per hour):	Remarks:
9:00	0	3.75	-		Filled with 6"
9:20	20	3.83	0.08		
9:40	20	3.91	0.08	2.88	
10:00	20	3.98	0.07	2.52	
10:20	20	4.04	0.06	2.16	
10:40	20	4.11	0.07	2.52	
11:00	20	4.17	0.06	2.16	
11:20	20	4.225	0.055	1.98	
					Adjusted to 6" level for Trial #2

Table 2-4. Infiltration Test Data Table

Location:		Date:		Test Hole Number:	
Depth to bottom of hole:		Dimension of hole:		Test Method:	
Tester's Name: Tester's Company: Tester's Contact Number:					
Depth (feet):			Soil Texture:		
Presaturation Start Time: Presaturation End Time:					
Time:	Time Interval (minutes):	Measurement, (feet):	Drop in water level, (feet):	Infiltration rate, (inches per hour):	Remarks:

Blended Soil Specification for Vegetated Stormwater Systems

Public facilities must use the Vegetated Stormwater Facility Blended Soil specification taken from the [City of Portland Standard Construction Specifications](#), as amended or corrected. Public facilities, either in the public right-of-way or on property, are required to use the specification from the most current version of the *City of Portland Standard Construction Specifications*. Facilities include swales, planters, curb extensions, and basins. As of the adoption of the 2016 SWMM, the most current specification is located in [01040.14 \(d\) \(1\)](#) and was made effective on November 11, 2015.

Private facilities must use a blended soil that supports healthy plants growth. Testing and submittals are not required for private facilities unless they are requested by the Bureau permitting the work.

limitations that would adversely affect drawdown, and if a ground water mounding analysis should be conducted.

4. Determination of:

- Depth to ground water table and to bedrock/impermeable layers.
- Seasonal variation of ground water table based on well water levels and observed mottling.
- Existing ground water flow direction and gradient.
- Lateral extent of infiltration receptor.
- Horizontal hydraulic conductivity of the saturated zone to assess the aquifer's ability to laterally transport the infiltrated water.
- Impact of the infiltration rate and volume at the project site on ground water mounding, flow direction, and water table; and the discharge point or area of the infiltrating water. Conduct a ground water mounding analysis at all sites where the depth to seasonal ground water table or low permeability stratum is less than 15 feet from the estimated bottom elevation of the infiltration facility, and the runoff to the infiltration facility is from more than one acre.

3.3.6 Design Saturated Hydraulic Conductivity – Guidelines and Criteria

Measured (initial) saturated hydraulic conductivity (K_{sat}) rates can be determined using in-situ field measurements, or, if the site has soils unconsolidated by glacial advance, by a correlation to grain size distribution from soil samples. The latter method uses the ASTM soil size distribution test procedure (ASTM D422), which considers the full range of soil particle sizes, to develop soil size distribution curves. Using the Simplified Approach in [Section 3.3.4](#), the estimate obtained for the measured (initial) K_{sat} is used as the initial infiltration rate. Using the Detailed Approach in [Section 3.3.8](#), the initial K_{sat} is combined with other information to compute an estimate for an initial infiltration rate.

Three Methods for Determining Saturated Hydraulic Conductivity for Sizing Infiltration Facilities

For designing the infiltration facility the site professional should select one of the three methods described below that will best represent the measured (a.k.a., initial) saturated hydraulic conductivity (K_{sat}) rate at the site. Use the measured saturated hydraulic conductivity to determine the design (long-term) infiltration rate. Then use the design (long-term) infiltration rate for routing and sizing the basin/trench, and for checking for compliance with the maximum drawdown time of 48 hours.

In the Simplified Approach ([Section 3.3.4](#)), the design infiltration rate is derived by applying appropriate correction factors to the measured K_{sat} as specified below.

In the Detailed Approach ([Section 3.3.8](#)), the design infiltration rate is derived by applying correction factors and additional equations to the measured (initial) K_{sat} . Verification testing of the completed facility is strongly encouraged. (See Site Suitability Criterion # 7-Verification Testing)

1. Large Scale Pilot Infiltration Test (PIT)

Large-scale in-situ infiltration measurements, using the Pilot Infiltration Test (PIT) described below is the preferred method for estimating the measured (initial) saturated hydraulic conductivity (K_{sat}) of the soil profile beneath the proposed infiltration facility. The PIT reduces some of the scale errors associated with relatively small-scale double ring infiltrometer or “stove-pipe” infiltration tests. It is not a standard test but rather a practical field procedure recommended by Ecology’s Technical Advisory Committee.

Infiltration Test

- Excavate the test pit to the estimated surface elevation of the proposed infiltration facility. Lay back the slopes sufficiently to avoid caving and erosion during the test. Alternatively, consider shoring the sides of the test pit.
- The horizontal surface area of the bottom of the test pit should be approximately 100 square feet. Accurately document the size and geometry of the test pit.
- Install a vertical measuring rod (minimum 5-ft. long) marked in half-inch increments in the center of the pit bottom.
- Use a rigid 6-inch diameter pipe with a splash plate on the bottom to convey water to the pit and reduce side-wall erosion or excessive disturbance of the pond bottom. Excessive erosion and bottom disturbance will result in clogging of the infiltration receptor and yield lower than actual infiltration rates.
- Add water to the pit at a rate that will maintain a water level between 6 and 12 inches above the bottom of the pit. A rotameter can be used to measure the flow rate into the pit.

Note: The depth should not exceed the proposed maximum depth of water expected in the completed facility. For infiltration facilities serving large drainage areas, designs with multiple feet of standing water can have infiltration tests with greater than 1 foot of standing water.

Every 15-30 min, record the cumulative volume and instantaneous flow rate in gallons per minute necessary to maintain the water level at the same point on the measuring rod.

Keep adding water to the pit until one hour after the flow rate into the pit has stabilized (constant flow rate; a goal of 5% variation or less variation in the total flow) while maintaining the same pond water level. The total of the pre-soak time plus one hour after the flow rate has stabilized should be no less than 6 hours.

- After the flow rate has stabilized for at least one hour, turn off the water and record the rate of infiltration (the drop rate of the standing water) in inches per hour from the measuring rod data, until the pit is empty. Consider running this falling head phase of the test several times to estimate the dependency of infiltration rate with head.
- At the conclusion of testing, over-excavate the pit to see if the test water is mounded on shallow restrictive layers or if it has continued to flow deep into the subsurface. The depth of excavation varies depending on soil type and depth to hydraulic restricting layer, and is determined by the engineer or certified soils professional. Mounding is an indication that a mounding analysis is necessary.

Data Analysis

Calculate and record the saturated hydraulic conductivity rate in inches per hour in 30 minutes or one-hour increments until one hour after the flow has stabilized.

Note: Use statistical/trend analysis to obtain the hourly flow rate when the flow stabilizes. This would be the lowest hourly flow rate.

Apply appropriate correction factors to determine the site-specific design infiltration rate. See the discussion of correction factors for infiltration facilities in this [Section 3.3](#), and the discussion of correction factors for bioretention facilities and permeable pavement in [Section 3.4](#).

Example

The area of the bottom of the test pit is 8.5-ft. by 11.5-ft.

Water flow rate was measured and recorded at intervals ranging from 15 to 30 minutes throughout the test. Between 400 minutes and 1,000 minutes the flow rate stabilized between 10 and 12.5 gallons per minute or 600 to 750 gallons per hour, or an average of $(9.8 + 12.3) / 2 = 11.1$ inches per hour.

2. Small-Scale Pilot Infiltration Test

A smaller-scale PIT can be substituted for the large-scale PIT in any of the following instances.

- The drainage area to the infiltration site is less than 1 acre.



Appendix E

DSM Coordination Checklist



APPENDIX E: DSM COORDINATION CHECKLIST

As introduced in Chapter 3, the purpose of the DSM Coordination Checklist is to provide a method of documenting the project stormwater management design compliance toward SWM Standards, design criteria, and other regulations. This Checklist should be maintained throughout the project and used as a basis for coordination with the Port at design meetings. It is also required to be submitted along with each required design milestone submittal. The following sections ask the designer to document compliance with the following:

- SWM Standards:
 - Low-Impact Development
 - Infiltration
 - Water Quantity Control
 - Water Quality – Capture and Treat
 - Source Controls
 - Hazardous Wildlife Attractants
 - Floodway and Natural Resource Protection
 - Erosion and Sediment Control
- Design criteria within Chapter 5 and Chapter 6
- Variance Requests

E.1 Project Specific Information

Project: _____

Designer Contact: _____
(Name, Company, E-mail)

Project Location: _____

Date: _____

Project Milestone:

- Preliminary Design Milestone(s) – Specify percent complete: _____
- Final Design Milestone



E.2 Low-Impact Development

Designers shall complete the following portion of the Coordination Checklist to demonstrate the consideration and implementation of LID strategies and the supporting practices into project designs, where applicable. Where LID strategies were considered but found to be not applicable, designers shall provide justification based on project or site constraints, as discussed in Chapter 4 of the DSM. Responses to the LID questions shall incorporate a summary of direction or decisions provided by the Port during project planning or as part of the design review and coordination process.

E.2.1 Strategy 1: Minimize Disturbance of Sensitive Areas (Site Selection and Layout)

- Description: Design the project to preserve or minimize disturbance of buffers, floodplains, wetlands, natural resources, and natural or undeveloped areas that may be especially susceptible to impacts from stormwater runoff (See DSM Chapter 4). Practices supporting this strategy include:

- Site the development to avoid natural resource areas.
- Minimize disturbance of natural or undeveloped areas.
- Minimize disturbance of areas that may be highly susceptible to erosion.

- Was strategy incorporated into the project design? Yes No

- Describe practices used to incorporate strategy into project design (if demonstration is provided within drawings or attached documentation, please indicate below).

- Describe project or site constraints or other applicability considerations that limited the incorporation of this strategy into the project design (if justification is provided within drawings or attached documentation, please indicate below).



E.2.2 Strategy 2: Minimize the Impact of Development (Footprint Minimization)

- Description: Design project to result in compact development, in a way that reduces the footprint and minimizes the disturbance area (area of clearing and grading or exposed soil). (See DSM Chapter 4). Practices supporting this strategy include:

- Minimize development footprint.
- Minimize compaction of soil in specially designated areas.
- Minimize clearing and grading and changes to natural drainage pattern.
- Reduce extent of effective impervious areas.

- Was strategy incorporated into the project design? Yes No

- Describe practices used to incorporate strategy into project design (if demonstration is provided within drawings or attached documentation, please indicate below).

- Describe project or site constraints or other applicability considerations that limited the incorporation of this strategy into the project design (if justification is provided within drawings or attached documentation, please indicate below).



E.2.3 Strategy 3: Manage Runoff from Disturbed Areas (GI and Runoff Management)

- Description: Incorporate measures into the project design to manage the quality and quantity of runoff from disturbed areas to minimize the potential for impacts to receiving waters. Place an emphasis on GI practices that contribute to mimicking pre-development hydrologic functions and promote infiltration, evapotranspiration, or stormwater reuse (See DSM Chapter 4). Practices supporting this strategy include:

- Disconnect impervious areas to direct runoff from impervious areas into pervious areas that are designed to promote infiltration.
- Implement green infrastructure to collect, treat, and infiltrate runoff from developed areas.

- Was strategy incorporated into the project design? Yes No

- Describe practices used to incorporate strategy into project design (if demonstration is provided within drawings or attached documentation, please indicate below).

- Describe project or site constraints or other applicability considerations that limited the incorporation of this strategy into the project design (if justification is provided within drawings or attached documentation, please indicate below).



E.3 Infiltration

Designers shall complete the following portion of the Coordination Checklist to demonstrate the selection and implementation of the Infiltration Strategy. Designers shall provide justification for the selection of the Infiltration Strategy based on project or site constraints, as discussed in Chapter 4 of the DSM.

- Completed screen for infiltration feasibility based on historical data.

Provide the current understanding of the following parameters for the project design.

- Field infiltration rate: _____
 Based on historical data screen From project field investigations
- Design infiltration rate: _____
 Based on historical data screen From project field investigations
- Depth to groundwater: _____
 Based on historical data screen From project field investigations
- Groundwater separation from the bottom of BMP(s): _____
- There is no known contamination of groundwater or soil column.
- There is known contamination of groundwater or soil column that has the potential to migrate into groundwater. Describe the findings (if information is provided within attached documentation, please indicate)

Selected infiltration strategy:

- Infiltration Strategy #1: Full Infiltration of the Water Quality Design Storm (Design infiltration capacity = WQ_V or WQ_F)
- Infiltration Strategy #2: Partial Infiltration of the Water Quality Design Storm (Design infiltration capacity < WQ_V or WQ_F)
- Infiltration Strategy #3: No Reliance on Infiltration

Describe the selected BMP(s) to meet the infiltration strategy:

BMP	Design Infiltration Capacity (specify units)	Portion of Total WQ_V or WQ_F	Drawdown Time of Surface Ponding (Hours)



E.4 Water Quantity Control

Designers shall complete the following portion of the DSM Coordination Checklist to demonstrate compliance with the water quantity objectives. Designers shall also provide brief discussion of the model results.

- 10-year, 24-hour storm event – The model results demonstrate that the max water surface elevations (MWSEs) do not exceed the elevation of pavement surfaces.
- 100-year, 24-hour storm event – The model results MWSEs do not reach buildings and are in compliance with City freeboard requirements and all applicable freeboard requirements.
- Drainage system design (collection and conveyance) is in compliance with the ponding allowances identified in Chapter 5.

Identify any pre-existing capacity issues affecting the design. Discuss any capacity concerns or any area where the objectives cannot be met. Explain any changes (increases or decreases) in the max water surface elevation (MWSE). Document any Port feedback on results. If this discussion is included in an attached document please specify.

Identify the BMPs or controls needed to meet the objectives. Provide the following information.

BMP/Control	Surface Elevation of Lowest Spot on Pavement (NAVD88 Ft.)	MWSE With/Without Control During 10-year Design Storm (NAVD88 Ft.)	Surface Elevation of Lowest Freeboard Requirement for Buildings Nearby (NAVD88 Ft.)	MWSE With/Without Control During 100-year Design Storm (NAVD88 Ft.)	Drawdown Time (Hours)
		Without: With:		Without: With:	
		Without: With:		Without: With:	
		Without: With:		Without: With:	
		Without: With:		Without: With:	
		Without: With:		Without: With:	



E.5 Water Quality – Capture and Treat

Designers shall complete the following portion of the DSM Coordination Checklist to demonstrate compliance with this SWM Standard. Designers shall also provide the necessary BMP information to communicate the level of treatment provided by each BMP.

Provide the total project disturbance area and calculation for WQ_F and/or WQ_V , as appropriate for treatment approach (if information is provided within attached documentation, please indicate).

List out project-specific POCs requiring treatment, based on coordination with the Port (if information is provided within attached documentation, please indicate).

Identify the BMPs selected to comply with this SWM Standard. Provide the following information.

BMP	Flow/Volume Based	Portion of Total WQ_F or WQ_V	Addressed POCs	Drawdown Time (Hours)

Identify any POCs requiring treatment that are not addressed by the above BMPs, as determined through coordination with the Port. If provided within an attached documentation, please indicate.



E.6 Source Controls

Designers shall complete the following portion of the Coordination Checklist to demonstrate compliance with this SWM Standard.

List below the POCs, based on coordination with the Port, that require source control (if provided within an attached documentation, please indicate).

List below any potential existing or new operational source control activities that may be appropriate for implementation, based on coordination with the Port (if provided within an attached documentation, please indicate).

Identify below applicable Activity Specific Source Control Requirements and if design complies with the requirements within Appendix M. If design does not comply, please confirm that a Variance Request has been submitted under the Variance Request portion of this checklist.

Activity	Applicable to Project	Design Complies with Appendix M Requirements
Solid Waste Storage Areas, Containers, and Trash Compactors	<input type="checkbox"/>	<input type="checkbox"/>
Material Transfer Areas/Loading Docks	<input type="checkbox"/>	<input type="checkbox"/>
Fuel Dispensing Facilities and Surrounding Traffic Areas	<input type="checkbox"/>	<input type="checkbox"/>
Aboveground Storage of Liquid Materials, Including Tank Farms	<input type="checkbox"/>	<input type="checkbox"/>
Equipment and Vehicle Washing Facilities	<input type="checkbox"/>	<input type="checkbox"/>
Covered and Uncovered Vehicle Parking Area	<input type="checkbox"/>	<input type="checkbox"/>
Exterior Storage and/or Processing of Bulk Materials	<input type="checkbox"/>	<input type="checkbox"/>
Water Reclaim and Reuse Systems	<input type="checkbox"/>	<input type="checkbox"/>

- Design does not expose any restricted material to stormwater.
- Check if the project site is within the Columbia South Shore Well Field WHPA.

Identify any POCs requiring source controls that are not addressed by the above source controls, as determined through coordination with the Port. If provided within an attached documentation, please indicate.



E.7 Hazardous Wildlife Attractants

Designers shall complete the following portion of the Coordination Checklist to demonstrate compliance with this SWM Standard, FAA requirements, and the WHMP.

Project design includes a BMP or potential hazardous wildlife attractant within the following Hazardous Wildlife Attractant Zone (please check one):

- Primary Zone
- Intermediate Zone
- Secondary Zone
- Five-Mile

Project design is in compliance with this SWM Standard, FAA requirements, and the PDX WHMP.

Please describe the identified potential hazard(s) in the design and the measure(s) taken to reduce the attractiveness of the BMP or potential hazardous wildlife attractant (if demonstration is provided within an attached documentation, please indicate).



E.8 Floodway and Natural Resource Protection

Designers shall complete the following portion of the DSM Coordination Checklist to demonstrate compliance with this SWM Standard.

- Project design is in compliance with all applicable federal, state, regional, and City of Portland floodway and natural resource regulations.

Flood Hazard Areas

- Design avoids construction within flood hazard areas.
- Design includes construction within flood hazard areas.
 - Identify applicable required reviews, approvals, and permits associated with construction within the identified flood hazard area(s).

Greenway Overlay Zones

- Design avoids construction within greenway overlay zones.
- Design includes construction within greenway overlay zones.
 - Identify applicable required reviews, approvals, and permits associated with construction within the identified greenway overlay zone(s).

Environmental Overlay Zones

- Design avoids construction within environmental overlay zones.
- Design includes construction within environmental overlay zones.
 - Identify applicable required reviews, approvals, and permits associated with construction within the identified greenway overlay zone(s).



E.9 Erosion and Sediment Control

Designers shall complete the following portion of the Coordination Checklist to demonstrate compliance with this SWM Standard.

- Stormwater management design is in compliance with City of Portland Code Title 10 and the *Erosion and Sediment Control Manual*.
- Designers have incorporated the Port's technical specification "015713 – Temporary Erosion, Sediment, & Pollution Control" into project design documents.
- A DEQ construction permit is applicable toward the project and coverage under a permit is either already completed or is being sought.
 - 1200-CA is applicable toward the project and designers have coordinated with the Port on permit requirements
 - 1200-C is applicable and designers are coordinating or have already coordinated with the Port on the required permit application
- The project consists of ground-disturbing activities 500 square feet or greater in area and is a permitted development project, or the site is located on steep slopes, in an environmental overlay zone, or in a greenway overlay zone
 - The Erosion, Sediment, and Pollutant Control Plan (ESPCP) has been developed and submitted to the City.
 - The ESPCP has been developed and submitted to DEQ as part of the 1200-C application, or if covered under the 1200-CA permit, a copy has been developed and will be retained on-site during construction.

Identify applicable required reviews, approvals, and permits associated with construction.



E.10 Design Criteria in Chapter 5 and Chapter 6

Designers shall complete the following portion of the DSM Coordination Checklist to demonstrate compliance with the design criteria for drainage system design (Chapter 5) and BMP design (Chapter 6 and BMP Fact Sheets).

Design of the drainage system is in compliance with the design criteria within Chapter 5. Please provide a summary demonstrating compliance with design criteria for the drainage system design (if summary is provided within an attached documentation, please indicate). If design does not comply, please confirm that a Variance Request has been submitted under the Variance Request portion of this checklist.

Design of the drainage system is in compliance with the design criteria within Chapter 6 and BMP Fact Sheets. Please provide a summary demonstrating compliance with design criteria for BMPs (if summary is provided within an attached documentation, please indicate). If design does not comply, please confirm that a Variance Request has been submitted under the Variance Request portion of this checklist.



E.11 Identification of Variance Requests

Designers are required to submit completed Variance Requests to the Port at the Preliminary Design Milestone(s), as applicable. This allows the Port to review discrepancies from DSM requirements, provide feedback to designers, and adjust project course as needed before proceeding to the Final Design phase. Designers are encouraged to discuss and submit Variance Requests to the Port earlier in the design process, as they are identified. This portion of the DSM Coordination Checklist is used to track the potential need for a Variance Request or to track any outstanding Variance Requests. Please see Appendix F for the Variance Request Application Form that must be submitted to the Port along with supporting documentation.

Variance Request	Brief Description of Variance Request	Submitted Variance Request
Off-Site mitigation to meet water quality SWM Standard (See Chapter 4)		<input type="checkbox"/>
Implement of a new Underground Injection Control (UIC) system serving non-roof areas (See Chapter 4)		<input type="checkbox"/>
Modify an activity-specific source control requirement (See Chapter 4 and Appendix M)		<input type="checkbox"/>
Deviate from conveyance or BMP design criteria (See Chapter 5, Chapter 6, and the BMP Fact Sheets)		<input type="checkbox"/>
Implement a BMP type other than those defined in the BMP Fact Sheets (BMPs must be certified under the Washington State Dept. of Ecology TAPE program)		<input type="checkbox"/>



Appendix F

Variance Request Application Form



APPENDIX F: VARIANCE REQUEST APPLICATION FORM

This form shall be included as a cover sheet along with each Variance Request submitted to the Port at the Preliminary Design Milestone. Along with this form, the designer must submit required supporting documentation as described in Chapter 3 of the DSM. Designers shall inform the Port as soon as possible when the need for a Variance Request is first identified, and shall coordinate on the Port in advance of this submittal, if possible, to facilitate Port review.

Project Name and Number:

Project Location:

Designer Contact: (Name, Company, E-mail)

Date Submitted:

Check One of the following:	To be completed by the reviewing Port official	
	Approved	Denied
<input type="checkbox"/> Off-site mitigation to meet water quality SWM standard	<input type="checkbox"/>	<input type="checkbox"/>
<input type="checkbox"/> Implement a new Underground Injection Control (UIC) system serving non-roof areas	<input type="checkbox"/>	<input type="checkbox"/>
<input type="checkbox"/> Modify an activity-specific source control requirement	<input type="checkbox"/>	<input type="checkbox"/>
<input type="checkbox"/> Deviate from conveyance or BMP design criteria in Chapters 5, 6, or the BMP Fact Sheets	<input type="checkbox"/>	<input type="checkbox"/>
<input type="checkbox"/> Implement a BMP type other than those defined in the BMP Fact Sheets (BMPs must be certified under the Washington State Department of Ecology Technology Assessment Protocol (TAPE) program).	<input type="checkbox"/>	<input type="checkbox"/>

Reason for making the variance request:



To be completed by the reviewing Port official

Port Comments:



Appendix G

Stormwater Management Submittal Content List



APPENDIX G: SWM SUBMITTAL CONTENT LIST

As detailed within Chapter 3 of the DSM, the SWM submittal is submitted at the final design milestone. The following list captures the required components to be submitted to the Port within the SWM submittal. The Port may require additional components within the SWM submittal on a project-by-project basis. Coordinate with the Port to determine if more information is required.

- Narrative
 - Overview of the Project Design
 - Project objectives
 - Industrial activities
 - Footprint size
 - Project phasing or planned future development (if applicable)
 - Overview of the Project Site
 - Soil characteristics and groundwater analysis, including infiltration capacity
 - Location relative to facility drainage system, catchment areas, and outfalls
 - Receiving waters and hydrology
 - Adjacent development
 - Operational constraints
 - Description of How Design Complies with Each SWM Standard
 - LID – Implement LID strategies, and elaborate on information described in the DSM coordination checklist.
 - Infiltration – Identify and justify the site-specific infiltration strategy and demonstrate how infiltration requirements are met by infiltration facilities.
 - Water Quantity Control – Demonstrate compliance with the water quantity objectives. Identify of any additional controls, and demonstrate how the selected BMPs address the water quantity objectives.
 - Water Quality – Capture and Treat – Calculate and assess the water quality design storm and describe water quality treatment BMPs designed to meet requirements.
 - Source Controls – Identification of industrial activities and anticipated pollutants of concern that require source controls, as determined through coordination with the Port. Identification of the selected source controls.
 - Hazardous Wildlife Attractants – Describe the project hazardous wildlife attractant zone and approach to meeting the zone-specific requirements, including BMP design criteria and features geared toward minimizing the attraction of wildlife.
 - Floodway and Natural Resource Protection – Demonstrate compliance with federal, state, regional, and City regulations. Identify any protected areas within the project development area, efforts taken to avoid or minimize conflicts with protected areas, and how applicable development standards or requirements were incorporated into the design.
 - Erosion and Sediment Control – Applicability and implementation of erosion and sediment control requirements, including permits and erosion, sediment and pollution control plans (ESPCP).
 - Description of SWM BMPs



- Description of Project Drainage System
 - Functions served by each BMP, and demonstration of how BMP designs meet required SWM standards in Chapter 4
 - Design basis to meet SWM standards
 - Reasoning for selecting the BMPs
 - Selected design features, including vegetation, major BMP components, pretreatment, and associated systems
 - Compliance with BMP design criteria in Chapter 6 and BMP fact sheets
 - Identification of drawings that illustrate BMP design and locations
- Description of Variance Requests
 - Deviations from DSM requirements
 - Justification for varying from DSM requirements, including project or site constraints
 - Status of variance requests and coordination of variances with the Port
 - Attach completed variance request forms
- Description of Required Regulatory Approvals
 - Anticipated regulatory reviews or approvals from FAA, City, Oregon DOT, DEQ, or other entities
 - Description and status of regulatory submittals and permit applications
 - History of coordinating regulatory approvals with regulator and the Port
- SWM Coordination Checklist
- Calculations
 - Calculations or analysis supporting the sizing/design of conveyance
 - Calculations or analysis supporting the sizing/design of BMPs
 - Calculations or analysis supporting the review of maximum ponding elevations
 - Stage versus discharge or outlet rating curves for volume-based facilities
 - Inflow and outflow calculations and hydrographs for BMPs (flow-based and volume-based, as described in Chapter 4)
 - Calculation of water quality volume or water quality flow, as detailed in Chapter 4 (SWM standard for Water Quality – Capture and Treat)
 - Calculation of infiltration volume corresponding to the applicable infiltration strategy, as detailed in Chapter 4 (SWM standard for Infiltration)
 - Additional design calculations not mentioned within this checklist but related specifically to the project.
- Model Reports (see Appendix H)
- Erosion, Sediment and Pollution Control Plan (if applicable)
- Soil and Groundwater Reports along with Geotechnical Reports
- Operations and Maintenance Plan (see Appendix I)
- Supporting Drawings: Provide figures illustrating site hydrology, conveyance, BMPs, and drainage features under pre- and post-development conditions. These drawings may be part of the design drawing set, or may be developed separately to fulfill SWM submittal requirements. The SWM submittal must include drawings conveying the following:
 - Drainage maps
 - Runoff assumptions for calculations
 - BMP reference numbers
 - Pipe and structure reference numbers
 - Plan and profile of conveyance features
 - BMP plan and sections



Appendix H

Modeling Report Content List



APPENDIX H: MODELING REPORT CONTENT LIST

The modeling report shall include a summary of hydrologic and hydraulic model input and output, as is typically included in standard stormwater modeling software. The Port may request additional items on a project-specific basis to account for any unique project analysis needs.

- Software description, including software developer, version, and engine or calculation basis.
- Description of model analysis performed (e.g., analysis of development for compliance with particular SWM standards, analysis of development for conveyance sizing, downstream analysis of watershed to review impacts of uncontrolled peak flows, etc.).
- Model network diagram (i.e., node-link diagram) showing connectivity of model elements.
- Model input (coordinate with Port for consistency with the existing PDX SWM model):
 - Drainage catchment characteristics (e.g., areas, slopes, and percent imperviousness, infiltration parameters or runoff coefficients, etc.)
 - Rainfall assumptions
 - Soil and infiltration assumptions
 - Hydraulic assumptions for conveyance including size, slope, roughness, invert elevations, flow restrictions, and connectivity
 - BMP characteristics, including capacity, shape, stage-storage curve, performance criteria, and inlet/outlet controls
- Model output for required design storms for compliance with SWM standards and design criteria within Chapter 5 and 6, including:
 - Runoff volumes
 - Peak flows
 - Analysis of system capacity including:
 - Identification of any surcharging.
 - Maximum water surface elevation and identification and explanation for any increases and/or decreases.
 - Demonstrate compliance with Water Quantity Control SWM standard.
 - Demonstration of compliance with design criteria in Chapters 5 and 6.
 - Peak storage volumes
 - Flow hydrographs downstream of BMPs and at the project discharge point(s)



Appendix I

Project O&M Form



APPENDIX I: PROJECT O&M FORM

Project Title:	
Project Number:	
Location: (Port Facility)	
Designer Contact: (Name, Company, E-mail)	

Summary Narrative – Required Components and Attachments

- Stormwater management facilities description
- Operational considerations, procedures, and schedule
- Maintenance considerations, procedures, and schedule
- Inspection and monitoring considerations, procedures, and schedule
- Decision tree(s) on trouble shooting operations
- Decision tree(s) for when to perform irregular maintenance and inspections
- Record-keeping recommendations
- Monitoring recommendations
- Equipment and personnel hours and expertise required to perform tasks
- Location map for each stormwater management facility
- Vendor information if applicable



Table 1: Summary of Stormwater Management Facilities

Stormwater management facilities include BMPs as well as major BMP components. The functions and locations of the stormwater management facilities shall be summarized in the table below and if needed or required by the Port additional information shall be provided within the narrative or attachments.

Facility Number/Descriptor	Description (Size, Source of SW, Discharge Point)	Function (Treatment Capabilities, either Flow or Volume, and Storage Capabilities)	Location	Drawing Number



Table 2: Summary of Stormwater Management Facilities Operations

The operations of the stormwater management facilities shall be summarized in the table below and if needed or required by the Port additional information shall be provided within the narrative or attachments.

Facility Number/Descriptor	Operation	Operation Frequency	Required Personnel and Equipment to Operate Facility	Attachment(s) or Subsequent Section(s)



Table 3: Summary of Stormwater Management Facility Maintenance Tasks

The maintenance tasks of the stormwater management facilities shall be summarized in the table below and if needed or required by the Port additional information shall be provided within the narrative or attachments.

Facility Number/Descriptor	Maintenance Task	Maintenance Triggers	Required Personnel and Equipment for Maintenance Task	Maintenance Task Frequency	Attachment(s) or Subsequent Section(s)



Table 4: Summary of Stormwater Management Facility Monitoring and Inspection Tasks

The monitoring and inspections tasks of the stormwater management facilities shall be summarized in the table below and if needed or required by the Port additional information shall be provided within the narrative or attachments.

Facility Number/Descriptor	Required Monitoring and/or Inspection Task	Monitoring and/or Inspection Task Frequency	Required Personnel and Equipment for Monitoring and/or Inspection Task	Attachment(s) or Subsequent Section(s)



Appendix J

City Draft Figure on the “Depth to Seasonally High Water (Table)

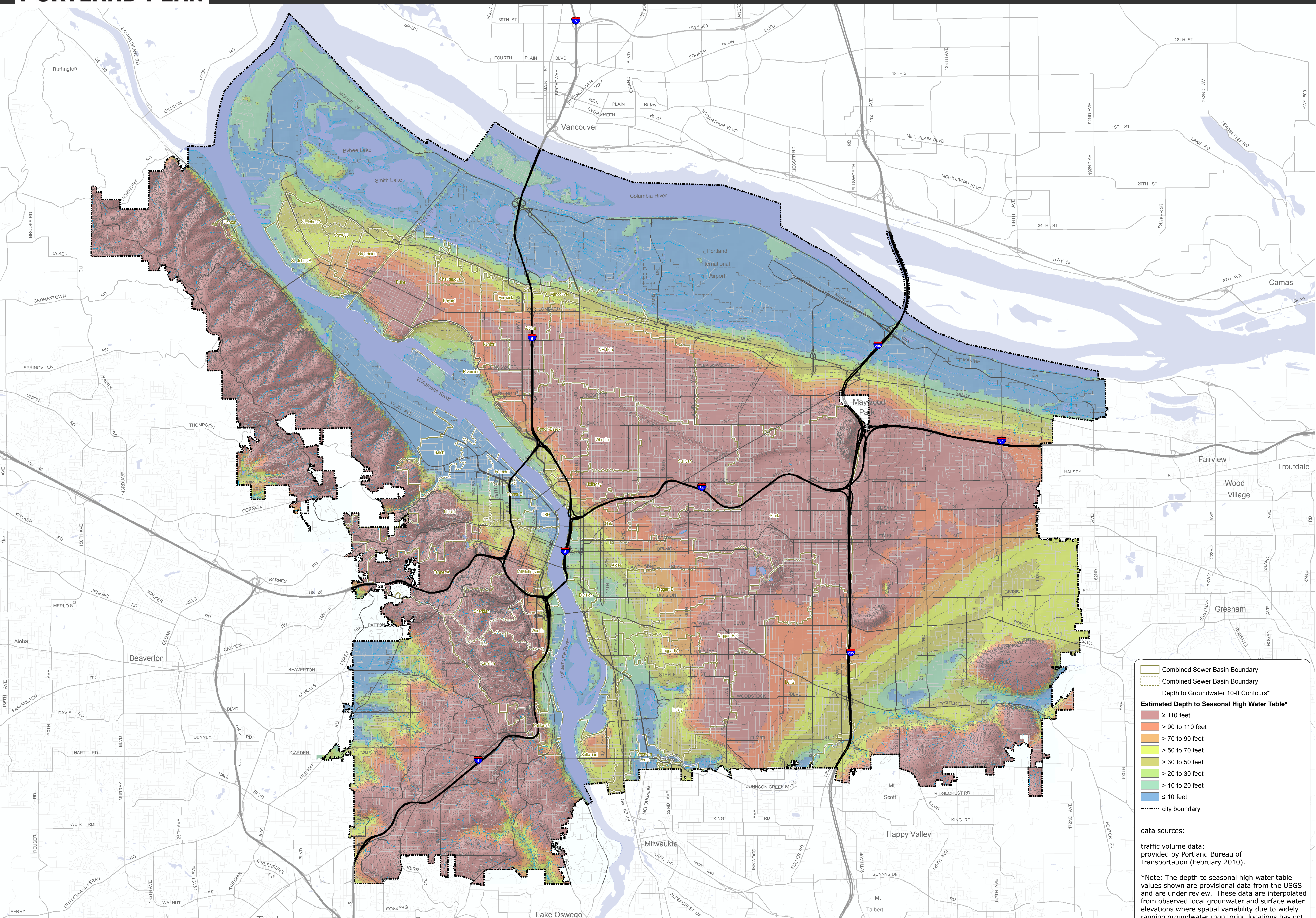

- Combined Sewer Basin Boundary
 - Combined Sewer Basin Boundary
 - Depth to Groundwater 10-ft Contours*
Estimated Depth to Seasonal High Water Table*
 - ≥ 110 feet
 - > 90 to 110 feet
 - > 70 to 90 feet
 - > 50 to 70 feet
 - > 30 to 50 feet
 - > 20 to 30 feet
 - > 10 to 20 feet
 - ≤ 10 feet
 - - - - - city boundary

data sources:
 traffic volume data:
 provided by Portland Bureau of
 Transportation (February 2010).
 *Note: The depth to seasonal high water table
 values shown are provisional data from the USGS
 and are under review. These data are interpolated
 from observed local groundwater and surface water
 elevations where spatial variability due to widely
 ranging groundwater monitoring locations has not
 been incorporated. As such, groundwater depth
 should be verified with field measurements where
 site specific work is desired and where depth to
 groundwater is considered important.

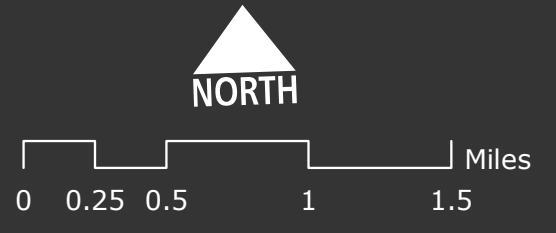



Appendix K

Drainage System Design Reference



APPENDIX K: DRAINAGE SYSTEM DESIGN REFERENCES

K.1 Rational Method

Equation K-1: Rational Method

$$Q = CIA$$

Where:

- Q* Peak runoff, cubic feet per second (cfs)
- C* Runoff coefficient, Table K-1 and Table K-2.
- I* Rainfall Intensity, inches per hour (in/hr) for a design storm duration equal to T_c
- A* Drainage area contributing to the point of interest, acre

Table K-1: Rational Method Runoff Coefficients for Developed Areas¹

Percent Impervious	Hydrologic Soil Group ²	Runoff Coefficient, <i>C</i> by Slope		
		Drainage Area Slope		
		< 5%	5% to 10%	> 10%
0 - 10	A	0.19	0.24	0.29
	B	0.24	0.30	0.36
	C	0.29	0.36	0.44
	D	0.33	0.43	0.52
11 - 20	A	0.26	0.31	0.36
	B	0.30	0.37	0.43
	C	0.35	0.42	0.50
	D	0.39	0.48	0.57
21 - 30	A	0.34	0.39	0.44
	B	0.37	0.44	0.5
	C	0.41	0.49	0.56
	D	0.45	0.54	0.62
31 - 40	A	0.41	0.46	0.51
	B	0.44	0.50	0.56
	C	0.47	0.55	0.61
	D	0.51	0.59	0.67
41 - 50	A	0.49	0.54	0.59
	B	0.52	0.57	0.63
	C	0.55	0.61	0.67
	D	0.57	0.65	0.72
51 - 60	A	0.56	0.61	0.66
	B	0.58	0.64	0.70
	C	0.61	0.67	0.74
	D	0.63	0.70	0.77

¹ SDFDM, Chapter 6, Table 6.4.

² Refer to Chapter 6 for Hydraulic Soil Group descriptions.



Table K-1: Rational Method Runoff Coefficients for Developed Areas¹

Percent Impervious	Hydrologic Soil Group ²	Runoff Coefficient, <i>C</i> by Slope		
		Drainage Area Slope		
		< 5%	5% to 10%	> 10%
61 – 70	A	0.64	0.69	0.74
	B	0.66	0.72	0.77
	C	0.67	0.74	0.80
	D	0.69	0.76	0.92
71 – 80	A	0.71	0.76	0.81
	B	0.72	0.78	0.83
	C	0.73	0.80	0.85
	D	0.75	0.81	0.87
81 – 90	A	0.79	0.84	0.89
	B	0.80	0.85	0.90
	C	0.81	0.86	0.91
	D	0.81	0.87	0.92
91 - 99	A	0.86	0.91	0.98
	B	0.87	0.92	0.97
	C	0.87	0.92	0.97
	D	0.88	0.92	0.97
100	-	0.90	0.95	1.00

Table K-2: Rational Method Runoff Coefficients for Undeveloped Areas³

Surface Characteristics	Hydrologic Soil Group ⁴	Runoff Coefficient, <i>C</i> by Slope		
		Drainage Area Slope		
		< 5%	5% to 10%	> 10%
Woodland	A	0.10	0.15	0.20
	B	0.14	0.20	0.25
	C	0.25	0.30	0.35
	D	0.30	0.35	0.40
Lawn, Pasture, and Meadow	A	0.15	0.20	0.25
	B	0.20	0.25	0.30
	C	0.25	0.35	0.45
	D	0.30	0.40	0.50
Cultivated Land	A	0.25	0.35	0.50
	B	0.30	0.45	0.60
	C	0.40	0.55	0.70
	D	0.50	0.65	0.80
Railroad Yard	-	0.25	0.30	0.40
Gravel Areas and Walks	-	0.30	0.40	0.50
	-	0.70	0.75	0.80
Pavement and Roof	-	0.90	0.95	1.00

³ SDFDM, Chapter 6, Table 6.5.

⁴ Refer to Chapter 6 for Hydraulic Soil Group descriptions

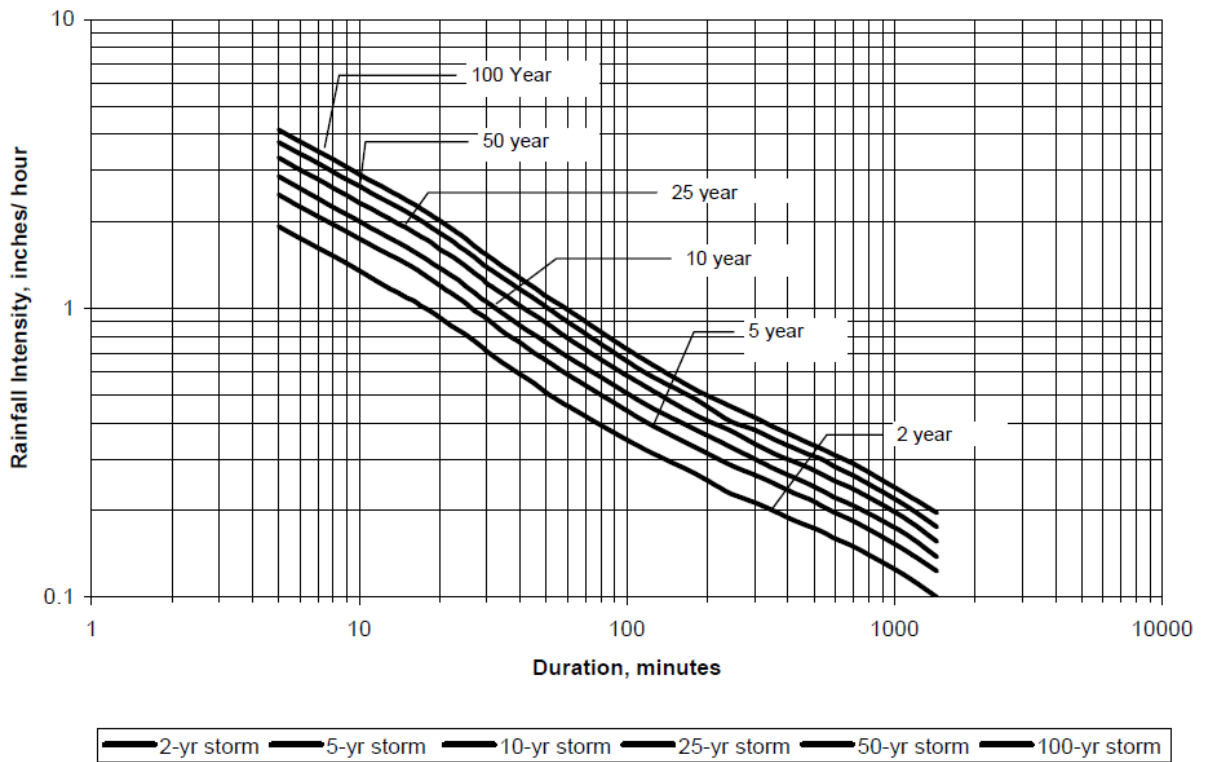

Exhibit K-1: Intensity – Duration – Frequency (IDF) Curves for Portland, OR⁵

⁵ SDFDM, Chapter 6, Figure 6.1.



Table K-3: IDF Curve Data for Portland, OR⁶

Time, minutes	Rainfall Intensity, inches per hour					
	Return Interval, years					
	2	5	10	25	50	100
5	1.92	2.47	2.86	3.32	3.75	4.14
6	1.75	2.25	2.60	3.02	3.43	3.78
7	1.62	2.08	2.40	2.80	3.18	3.50
8	1.52	1.95	2.24	2.61	2.96	3.28
9	1.43	1.84	2.11	2.46	2.79	3.08
10	1.35	1.74	2.00	2.32	2.65	2.91
11	1.28	1.66	1.90	2.22	2.52	2.77
12	1.22	1.59	1.82	2.12	2.41	2.66
13	1.17	1.53	1.75	2.04	2.32	2.55
14	1.13	1.48	1.69	1.96	2.24	2.46
15	1.09	1.43	1.63	1.90	2.16	2.37
16	1.06	1.38	1.57	1.83	2.08	2.29
17	1.02	1.33	1.52	1.77	2.01	2.21
18	0.99	1.28	1.47	1.72	1.94	2.14
19	0.96	1.24	1.42	1.66	1.88	2.07
20	0.93	1.20	1.38	1.60	1.82	2.01
21	0.90	1.16	1.34	1.56	1.77	1.95
22	0.87	1.13	1.30	1.52	1.72	1.89
23	0.85	1.10	1.27	1.48	1.67	1.84
24	0.83	1.07	1.23	1.44	1.62	1.79
25	0.81	1.04	1.19	1.40	1.58	1.74
26	0.79	1.01	1.16	1.36	1.54	1.69
27	0.77	0.98	1.13	1.32	1.50	1.64
28	0.75	0.96	1.10	1.29	1.46	1.60
29	0.73	0.94	1.07	1.26	1.42	1.56
30	0.71	0.92	1.05	1.22	1.39	1.53
35	0.64	0.82	0.95	1.11	1.26	1.38
40	0.59	0.76	0.87	1.02	1.16	1.27
45	0.55	0.70	0.81	0.95	1.08	1.18
50	0.51	0.66	0.76	0.89	1.01	1.10
60	0.46	0.59	0.68	0.79	0.90	0.99
90	0.37	0.47	0.54	0.62	0.70	0.77
120	0.32	0.40	0.46	0.53	0.59	0.65
180	0.25	0.38	0.43	0.50	0.55	0.61
240	0.22	0.35	0.40	0.46	0.51	0.56
300	0.20	0.32	0.37	0.43	0.48	0.52
360	0.19	0.30	0.34	0.40	0.44	0.48
420	0.18	0.27	0.31	0.36	0.40	0.44
480	0.17	0.25	0.29	0.33	0.36	0.39
540	0.17	0.22	0.26	0.30	0.32	0.35
600	0.16	0.16	0.20	0.22	0.25	0.28
720	0.15	0.15	0.18	0.21	0.23	0.26
1080	0.12	0.12	0.15	0.17	0.19	0.21
1440	0.10	0.10	0.12	0.14	0.16	0.18

⁶ SDFDM, Chapter 6, Table 6.11.



K.2 SCS Curve Numbers

Table K-4: SCS Runoff Curve Numbers⁷

Cover type and hydrologic condition	Average percent Impervious Area	Curve numbers for hydrologic soil group ⁸			
		A	B	D	C
Runoff Curve Numbers for Urban Areas					
Open space (lawns, parks, golf courses, cemeteries, etc.):					
Poor condition (grass cover < 50%)		68	79	86	89
Fair condition (grass cover 50 to 75%)		49	69	79	84
Good condition (grass cover > 75%)		39	61	74	80
Impervious areas					
Paved parking lots, roofs, driveways, etc. (excluding right-of-way)		98	98	98	98
Streets and roads:					
Paved; curbs and storm sewers (excluding right-of-way)		98	98	98	98
Paved; open ditches (including right-of-way)		83	89	92	93
Gravel (including right-of-way)		76	85	89	91
Dirt (including right-of-way)		72	82	87	89
Urban districts:					
Commercial and business	85	89	92	94	95
Industrial	72	81	88	91	93
Residential districts by average lot size:					
1/8 acre or less (town houses)	65	77	85	90	92
1/4 acre	38	61	75	83	87
1/3 acre	30	57	72	81	86
1/2 acre	25	54	70	80	85
1 acre	20	51	68	79	84
2 acres	12	46	65	77	82
Runoff Curve Numbers for Agricultural Areas					
Pasture, grassland, or range-continuous forage for grazing					
<50% ground cover or heavily grazed with no mulch	Poor	68	79	86	89
50 to 75% ground cover and not heavily grazed	Fair	49	69	79	84
>75% ground cover and lightly or only occasionally grazed	Good	39	61	74	80
Meadow-continuous grass, protected from grazing and generally mowed for hay	-	30	58	71	78
Brush--weed-grass mixture with brush as the major element					
<50% ground cover	Poor	48	67	77	83
50 to 75% ground cover	Fair	35	56	70	77
>75% ground cover	Good	30	48	65	73
Woods-grass combination (orchard or tree farm)					
	Poor	57	73	82	86
	Fair	43	65	76	82
	Good	32	58	72	79
Woods					
Forest litter, small trees, and brush are destroyed by heavy grazing or regular burning	Poor	45	66	77	83
Woods are grazed but not burned, and some forest litter cover the soil	Fair	36	60	73	79
Woods are protected from grazing, and litter and brush adequately cover the soil.	Good	30	55	70	77

⁷ City SWMM, Appendix C, Table C-2.

⁸ Consult the Natural Resource Conservation Service Soil Survey for hydrologic soils types.



K.3 Time of Concentration

Use the following equations to calculate the Time of Concentration, T_c , for various flow regimes.

Equation K-2: Time of Concentration

$$T_c = T_{t1} + T_{t2} + T_{t3} + \dots + T_{tn}$$

Equation K-3: Conversion of Velocity to Travel Time (T_t)

$$T_t = L/(60V)$$

Equation K-4: Travel Time for Sheet Flow Less than 100 Feet (Manning Kinematic Equation)

$$T_t = 0.42(nL)^{0.8} / (\sqrt{P_2}(S^{0.4}))$$

Equation K-5: Velocity for Shallow Concentrated Flow on Unpaved Surfaces (slope less than 0.005 ft/ft)⁹

$$V = 16.1345\sqrt{S}$$

Equation K-6: Velocity for Shallow Concentrated Flow on Paved Surfaces (slope less than 0.005 ft/ft)¹⁰

$$V = 20.3282\sqrt{S}$$

Equation K-7: Velocity in a Channel (Manning's Equation)

$$V = \frac{1.49}{n} R_H^{2/3} \sqrt{S}$$

Equation K-8: Velocity in Full Capacity Pipe Flow (Manning's Equation)

$$V = \frac{0.59}{n} D^{2/3} \sqrt{S}$$

Where:

T_t	Travel time of consecutive segments along the flow path, minutes (min)
T_c	Total time of concentration, min
n	Manning's roughness coefficient, from Table K-5, Table K-6 or Table K-8
L	Flow length in feet (ft)
V	Average velocity of flow, feet per second (fps)
P_2	2-year, 24-hour rainfall (in.), generally 1.58 in. in Portland

⁹ City SWMM, Appendix C

¹⁰ City SWMM, Appendix C.



- S Slope of the hydraulic grade line (land or watercourse slope), in feet per foot (ft/ft)
 R_H Hydraulic radius in feet (A / wetted perimeter)
 D Pipe diameter, ft.

K.4 Manning's Roughness coefficient

Table K-5: Manning's Surface Roughness Coefficient n for Sheet Flow Conditions¹¹

Surface Description	n
Concrete or asphalt	0.011
Bare sand	0.010
Graveled surface	0.020
Bare clay- loam (eroded)	0.020
Grass	
Short grass prairie	0.15
Short grass prairie	0.24
Dense grass – lawn	0.41
Bermuda grass	
Woods	
Light underbrush	0.40
Dense underbrush	0.80
Paved Streets and Gutters	
Concrete gutter, trowel finished	0.012
Asphalt pavement	
Smooth texture	0.013
Rough texture	0.018
Concrete gutter with asphalt pavement	
Smooth	0.013
Rough	0.015
Concrete Pavement	
Float finish	0.014
Broom finish	0.016
For gutters with small slope where sediment may accumulate increase the n_s value by:	0.002

¹¹ SDFDM, Table 6-15



Table K-6: Manning’s Roughness Coefficient n for Excavated and Natural Channels¹²

Channel Description	n
Open Channels-Natural	
Minor stream on plain (top width at flood stage < 100 feet)	
Clean straight, full stage, no pools	0.030
Same as above but more stones and weeds	0.035
Clean, winding, some pools and shallows	0.040
Same as above but some weeds and stones	0.045
Same as above, lower stages, more ineffective slopes and sections	0.048
Same as above but more stones	0.050
Sluggish reaches, dense vegetation, weedy, deep pools	0.070
Very sluggish, weedy, deep pools or floodways with heavy stand of timber or underbrush	0.100
Upland channels, no vegetation in channel, banks usually steep, trees and brush along banks	
Gravel bottom	0.025
Same as above but more cobbles and boulders	0.040
Earth bottom, clean	0.020
Same as above but more debris and litter	0.030
Open Channels – Excavated or Dredged	
Earth, straight, uniform clean, recently completed	
Same as above but clean, recently completed	0.018
Same as above after weathering	0.020
Same as above but short grass, few weeds	0.027
Earth, winding and sluggish	
Same as above no vegetation	0.025
Same as above but grass and some weed	0.030
Same as above but dense weeds in deep channels	0.035
Same as above but earth bottom and rubble sides	0.030
Same as above but stony bottom and weedy banks	0.035
Same as above but cobble bottom and clean sides	0.040
Gravel, straight, uniform section, clean	0.025
Unmaintained, clean bottom, brush on side slopes	0.050
Same as above highest flow stage	0.070
Unmaintained, dense weeds as high as flow depth	0.080
Unmaintained, dense brush, high stages	0.100

¹² SDFDM, Table 8-4



Table K-7: Manning's Roughness Coefficient n for Lined Channels^{13,14}

Lining Category	Type	n for given flow depth ranges		
		0-0.5 ft	0.6 – 2.0 ft	>2.1 ft
Rigid	Concrete	0.015	0.013	0.013
	Grouted riprap	0.015	0.013	0.013
	Stone Masonry	0.040	0.030	0.028
	Soil Cement	0.042	0.032	0.030
	Asphalt	0.025	0.022	0.020
Unlined	Bare Soil	0.018	0.016	0.016
	Rock Cut	0.023	0.020	0.020
Temporary	Woven Paper net	0.045	0.035	0.025
	Jute net	0.016	0.015	0.015
	Fiberglass roving	0.028	0.022	0.019
	Straw with net	0.028	0.021	0.019
	Curled wood mat	0.065	0.033	0.025
	Synthetic mat	0.066	0.035	0.020
Gravel/Riprap	1-inch D_{50}	0.036	0.025	0.021
	2-inch D_{50}	0.044	0.033	0.030
	6-inch D_{50}	0.066	0.041	0.034
	12-inch D_{50}	0.104	0.069	0.035

Table K-8: Manning's Roughness Coefficient n Closed Conduits^{15,16}

Channel Type	n
All sewer pipe materials including: concrete, polyvinylchloride (PVC), high density polyethylene (HDPE) and Cast Iron	0.013
All concrete culverts including circular and irregular shapes	0.013
Corrugated Metal Pipe	0.024

¹³ SDFDM, Chapter 8, Table 8.5

¹⁴ Values listed are representative values for the represented depth ranges. Manning's roughness coefficients vary with flow depth. Reference: HEC-15, 1988

¹⁵ SDFDM, Chapter 8, Table 8.1

¹⁶ Values listed are representative values for the represented depth ranges. Manning's roughness coefficients vary with flow depth. Reference: HEC-15, 1988



Curb and Gutter Design

Equation K-9: Gutter Flow Capacity (Manning's Equation Modified)¹⁷

$$Q = 0.56 \left(\frac{1/S_x}{n} \right) \sqrt{S} \times d^{2.67}, \text{ or}$$

$$Q = \frac{0.56}{n} S_x^{1.67} T^{2.67} \sqrt{S}, \text{ or}$$

$$V = \frac{1.12}{n} \times S_x^{0.67} T^{0.67} \sqrt{S}$$

Where:

Q	Flow rate in cfs
n	Manning's roughness coefficient in a gutter, usually 0.018
d	Depth of flow at the curb, ft
S	Roadway longitudinal slope, ft/ft
T	Total width of flow in the gutter, ft
S_x	Roadway Cross slope, ft/ft

¹⁷ SDFDM, Appendix I, Chart 1 – Standard Equations



FORM 3

INLET DESIGN FORM
CONTINUOUS GRADE - UNIFORM CROSS SLOPE

Project No. _____ Designed by _____ Date _____ Checked by _____ Date _____
Project name: _____

Inlet standard plan No. →

← Inlet standard plan No.

Inlet location or No. →

← Inlet location or No.

GRATE INLETS

CURB INLETS

STEP	SYMBOL	UNIT
1	W	ft
1	L	ft
1	a	ft
2	n	coeff
3	S	ft/ft
3	S _x	ft/ft
4	T	ft
5	an	cfs
6	a	cfs
7	T _S	ft
8	O _{sn}	cfs
9	as	cfs
10	O _w	cfs
11	E _o	ratio
12	d	ft
13	A	sq ft
14	V	fps
15	V _o	fps
16	R _i	ratio
17	R _S	ratio
18	E	ratio
19	a ₁	cfs
20	Q _o	cfs

UNIT	SYMBOL	STEP
ft	W	1
ft	L	1
ft	a	1
coeff	n	2
ft/ft	S	3
ft/ft	S _x	3
const.	K	4
ft	T	5
cfs	an	6
cfs	a	7
ft	d	8
ft	L _T	9
ratio	LILT	10
ratio	E	11
cfs	O ₁	12
cfs	O _b	13

Exhibit K-2: Inlet Design Forms¹⁸

¹⁸ SDFDM, Appendix I.



PROCEDURE for FORM 3
(Grate Inlet)

GRATE INLET CAPACITY PROCEDURES
CONTINUOUS GRADE· UNIFORM CROSS SLOPE

Using the **INLET DESIGN FORM (FORM 3)**:

1. Note inlet Standard Plan No., dimensions, (W, L & a) and location or No.
2. Note Manning's coefficient of roughness, n (normally 0.018).
3. Determine and note the street geometries (cross slope, S_x ; longitudinal slope, S) using the street design and / or survey (see **STREET GEOMETRICS, CHARTS 25 & 26**)

Determine the following from calculations or noted charts:

- | | |
|---|--|
| * 4. T (Use maximum allowable width of flow or other known width.) | 14. $V = Q / A$ |
| * 5. Q_n (CHART 30) | 15. V_o (CHART 27) |
| * 6. $Q = Q_n / n$ | 16. $R_f = 1 - 0.09 (V_o - V)$ if $V > V_o$
$R_f = 1$ if $V \leq V_o$ |
| 7. $T_s = T - W$ | 17. $R_s = 1 / (1 + \frac{0.15 V^{1.8}}{S_x L^{2.3}})$ |
| 8. Q_s (CHART 30) | 18. $E = R_f E_o + R_s (1 - E_o)$ |
| 9. $Q_s = Q_s n / n$ | 19. $O_1 = E O$ |
| 10. $Q_w = Q - Q_s$ | 20. $O_b = O - O_1$ |
| 11. $E_o = Q_w / O$ (or CHART 31 @ $S_w/S_x = 1$) | |
| 12. $d = T S_x$ | |
| 13. $A = (dT) / 2$ | |

* To determine T from a known A, reverse the order of steps 4 through 6

- a gutter depression, inches
- A cross-sectional area of flow, sq ft
- d depth of flow at the curb
- E efficiency of a grate (interception efficiency of an inlet)
- E_o ratio of frontal flow to total gutter flow
- L length of the grate, ft
- n Manning's coefficient of roughness
- Q total gutter flow, cfs
- O_b the portion of total gutter flow which is not intercepted by an inlet (bypass or carryover flow), cfs
- Q_i the portion of total gutter flow which is intercepted by an inlet (intercepted flow), cfs
- Q_s side flow rate
- Q_w flow in width W, cfs
- R_f ratio of frontal flow intercepted to total frontal flow (frontal flow interception efficiency)
- R_s ratio of side flow intercepted to total side flow (side flow interception efficiency)
- S pavement longitudinal slope, ft / ft
- S_x pavement cross slope, ft / ft
- T total spread of water in the gutter, ft
- T_s spread of water outside depressed gutter
- V velocity of flow in the gutter, fps
- V_o gutter velocity where splash-over first occurs over a grate, fps
- W width of depressed inlet, ft

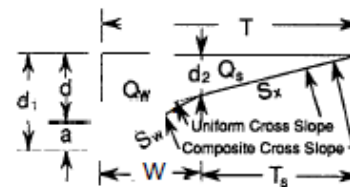

Exhibit K-2 (continued): Inlet Design Forms



PROCEDURE for FORM 3
(Curb Inlet)

CURB INLET CAPACITY PROCEDURES
CONTINUOUS GRADE· UNIFORM CROSS SLOPE

Using the **INLET DESIGN FORM (FORM 3)**:

1. Note inlet Standard Plan No., dimensions, (W, L & a) and location or inlet No.
2. Note Manning's coefficient of roughness, n (normally 0.018).
3. Determine and note the street geometries (cross slope, S_x ; longitudinal slope, S) using the street design and / or survey (see **STREET GEOMETRICS, CHARTS 25 & 26**)

Determine the following from known quantities, calculations or noted charts:

4. $K = 0.6$ (0.076 if in S. I.)
 - * 5. T (Use maximum allowable width of flow or other known width)
 - * 6. a_n (From **CHART 30**)
 - * 7. $a = a_n/n$
 8. $d = TS_x$
 9. $L_T = KaO^{.42} S0.3 (1/nS_x)^{0.6}$
 10. L/L_T
 11. $E = 1 - (L/L_T)^{1.8}$
 12. $a_j = E a$
 13. $a_b = a - a_j$
- * To determine T from a known a, reverse the order of steps 5 through 7.

- a gutter depression, inches
- d depth of flow at the curb
- E efficiency of a grate (interception efficiency of an inlet)
- K constant (0.6 or 0.076 if in S. I.)
- L length of the grate, ft
- n Manning's coefficient of roughness
- a total gutter flow, cfs
- a_b the portion of total gutter flow which is not intercepted by an inlet (bypass or carryover flow), cfs
- a_j the portion of total gutter flow which is intercepted by an inlet (intercepted flow), cfs
- S pavement longitudinal slope, ft / ft
- S_w depressed gutter cross slope
- S_x pavement cross slope, ft / ft
- T total spread of water in the gutter, ft
- W width of depressed gutter or grate, ft

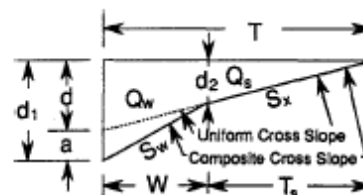

Exhibit K-2 (continued): Inlet Design Forms



FORM 4

INLET DESIGN FORM
CONTINUOUS GRADE - COMPOSITE CROSS SLOPE

Project No. _____ Designed by _____ Date _____ Checked by _____ Date _____
 Project name: _____

Inlet standard plan No. ➤

← Inlet standard plan No.

Inlet location or No. ➔

← Inlet location or No.

GRATE INLETS

CURB INLETS

STEP	SYMBOL	UNIT
1	W	ft
1	L	ft
1	a	ft
2	n	coeff
3	S	ft/ft
3	S _x	ft/ft
4	S _w	ft/ft
5	S _w /S _x	ratio
6	T	ft
7	T _s	ft
8	O _s n	cfs
9	O _s	cfs
10	W _i T	ratio
11	E _o	ratio
12	0	cfs
13	Q _w	cfs
14	d1	ft
15	d2	ft
16	A	sq ft
17	V	fps
18	V _o	fps
19	R _t	ratio
20	R _s	ratio
21	E	ratio
22	CJ	cfs
23	Q _p	cfs

UNIT	SYMBOL	STEP
ft	W	1
ft	L	1
ft	a	1
coeff	n	2
ft/ft	S	3
ft/ft	S _x	3
ft/ft	S _w	4
ft/ft	S _w	5
ratio	S _w /S _x	6
const.	K	7
ft	T	8
ratio	T/W	9
cfs	O _n	10
cfs	0	11
ratio	W _i T	12
ratio	E _o	13
ft/ft	S _e	14
ft	d1	15
ft	L _T	16
ratio	L/L _T	17
ratio	E	18
cfs	CJ	19
cfs	Q _b	20

Exhibit K-2 (continued): Inlet Design Forms



PROCEDURE for FORM 4

GRATE INLET CAPACITY PROCEDURES
CONTINUOUS GRADE- COMPOSITE CROSS SLOPE

(Grate Inlet)

Using the INLET DESIGN FORM (FORM 4):

1. Note inlet Standard Plan No., dimensions, (W, L & a) and location or No.
2. Note Manning's coefficient of roughness, n (normally 0.018).
3. Determine and note the street geometries (cross slope, S_x ; longitudinal slope, S) using the street design and / or survey (see STREET GEOMETRICS, CHARTS 25 & 26)

Determine the following from known quantities, calculations or noted charts:

- | | |
|--|--|
| 4. $Sw = S_x + (a / W)$ | 14. $d1 = TS_x + a$ (for $T > W$) |
| 5. $Sw IS_x$ | $d1 = TS_w$ (for $T \leq W$) |
| • 6. T (Use maximum allowable width of flow or other known width.) | 15. $d2 = (T-W) S_x$ |
| 7. $T_s = T-W$ | 16. $A = (d1 \frac{+}{2} d2 W) + (\frac{d2 T_s}{2})$ |
| 8. Osn (CHART 30) | 17. $V = a / A$ |
| 9. $as = Osn / n$ | 18. V_0 (CHART 27) |
| 10. W / T | 19. $RI = 1 - 0.09 (V_0 - V)$ if $V > V_0$ |
| 11. E_0 (CHART 31) | $RI = 1$ if $V \leq V_0$ |
| 12. $a = Os / (1 - E_0)$ | 20. $R^S = 1 / (1 + S_x L^{2.3} 0.15 V^{1.8})$ |
| 13. $Q_w = a - as$ | 21. $E = R_f E_0 + R_s (1 - E_0)$ |
| • To determine T from a known a, use CHART 32 | 22. $OJ = EO$ |
| | 23. $Ob = a - OJ$ |

- a gutter depression, inches
- A cross-sectional area of flow, sq ft
- d1 depth of flow at the curb
- d2 depth of flow at outside edge of depressed gutter
- E efficiency of a grate (interception efficiency of an inlet)
- E₀ ratio of frontal flow to total gutter flow
- L length of the grate, ft
- n Manning's coefficient of roughness
- a total gutter flow, cfs
- Ob the portion of total gutter flow which is not intercepted by an inlet (bypass or carryover flow), cfs
- OJ the portion of total gutter flow which is intercepted by an inlet (intercepted flow), cfs
- as side flow rate
- Q_w flow in width W, cfs
- R_f ratio of frontal flow intercepted to total frontal flow (frontal flow interception efficiency)
- R_s ratio of side flow intercepted to total side flow (side flow interception efficiency)
- S pavement longitudinal slope, ft / ft
- SW depressed gutter cross slope
- S_x pavement cross slope, ft / ft
- T total spread of water in the gutter, ft
- T_s spread of water outside depressed gutter
- V velocity of flow in the gutter, fps
- V₀ gutter velocity where splash-over first occurs over a grate, fps
- W width of depressed gutter or grate, ft

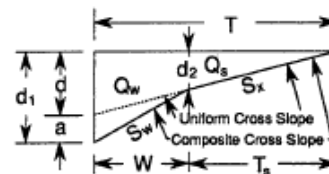

(Grate Inlet)

Exhibit K-2 (continued): Inlet Design Forms



PROCEDURE for FORM 4

(Curb Inlet)

CURB INLET CAPACITY PROCEDURES
CONTINUOUS GRADE · COMPOSITE CROSS SLOPE

Using the INLET DESIGN FORM (FORM 4):

1. Note inlet Standard Plan No., dimensions, (W, L & a) and location or inlet No.
2. Note Manning's coefficient of roughness, n (normally 0.018).
3. Determine and note the street geometries (cross slope, S_x ; longitudinal slope, S) using the street design and / or survey (see STREET GEOMETRICS, CHARTS 25 & 26)

Determine the following from known quantities, calculations or noted charts:

4. $S'_w = a / W$ (a in feet)
5. $S_w = S_x + S'_w$
6. S_w/S_x
7. $K = 0.6$ (0.076 if in S. I.)
- * 8. T (Use maximum allowable width of flow or other known width)
9. $T_s = T - W$
10. O_{sn} (CHART 30)
11. $a_s = O_{sn} / n$
12. WIT
13. E_o (CHART 31)
14. $S_a = S_x + S'_w E_o$
15. $d_1 = TS_x + a$ (for $T > W$)
 $d_1 = TS_w$ (for $T \leq W$)
16. $L_T = KO^{0.42} S^{0.3} (1 / nS_a)^{0.6}$
17. LIL_T
18. $E = 1 - (1 - L / L_T)^{1.8}$
19. $O_j = EO$
20. $O_b = a - O_j$

* To determine T from a known a, use CHART 32

- a gutter depression, inches
- d₁ depth of flow at the curb
- E efficiency of a grate (interception efficiency of an inlet)
- E_o ratio of frontal flow to total gutter flow
- K constant (0.6 or 0.076 if in S. I.)
- L length of the grate, ft
- n Manning's coefficient of roughness
- a total gutter flow, cfs
- O_b the portion of total gutter flow which is not intercepted by an inlet (bypass or carryover flow), cfs
- a_i the portion of total gutter flow which is intercepted by an inlet (intercepted flow), cfs
- S pavement longitudinal slope, ft / ft
- S_w depressed gutter cross slope
- S_x pavement cross slope, ft / ft
- T total spread of water in the gutter, ft
- W width of depressed gutter or grate, ft

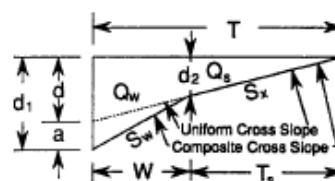

(Curb Inlet)

Exhibit K-2 (continued): Inlet Design Forms



K.5 Vegetative LINING OPEN Channel Design Procedures

Use a two step procedure to design vegetative channels.¹⁹ The permissible unit shear stress is provided in Table K-9 and the maximum velocities allowed are provided in Table K-10. Coordinate the selection of vegetation with the SWM Standard for Hazardous Wildlife Attractants in Chapter 4.

Table K-9. Permissible Unit Shear Stress for Lining Materials^{20,21}

Lining Category	Type	Permissible Unit Shear Stress τ_p (lb/ft ²)
Temporary	Woven Paper Jute	0.15
	Jute net	0.45
	Fiberglass roving (single)	0.60
	Fiberglass roving (double)	0.85
	Straw with net	1.45
	Curled wood mat	1.55
	Synthetic mat	2.00
Vegetative	Class A: Excellent stand, 2 to 3 ft. tall	3.70
	Class B: Good stand of vegetation, no woody, average of 1 to 2 ft. tall	2.10
	Class C: Fair stand, mowed or uncut, average 0.5 to 4 ft. tall	1.00
	Class D: Good to excellent, mowed or uncut, average of 0.2 to 0.6 ft. tall	0.60
	Class E: Poor stand, mowed to 1 ½ inch stubble or damaged (e.g., burned)	0.35

Table K-10. Maximum Velocities for Vegetative Channel Linings²²

Vegetative Type	Slope Range (%) ²³	Maximum Velocity ²⁴ (feet per second, fps)
Bermuda Grass	0 to 10	5
Tall Fescue Grass mixtures	0 to 10	4
Kentucky Blue Grass	0 to 5	6
Grass Mixture	0 to 5	4
Annual ²⁵	0 to 5	3
Sod	-	4

¹⁹ SDFDM, Chapter 8.

²⁰ SDFDM, Chapter 8, Table 8.8

²¹ Values listed are representative values for the represented depth ranges. Manning's roughness coefficients vary with flow depth.

²² Manual for Erosion and Sediment control in Georgia, 1996

²³ Do not use on slopes steeper than 10 percent except for a side slope in a combination channel.

²⁴ Use velocities exceeding 5 fps only where good stands of vegetation can be maintained.

²⁵ Annuals use on mile slopes or as temporary protection until permanent covers are established.

**K.6 Stability**

1. Calculate the design variables”
 - a. Discharge Q , cfs
 - b. Bottom slope S_H
 - c. Cross-section geometry and
 - d. Vegetation type
2. Assign a maximum velocity from Table K-10 based on vegetation and slope.

Assume a Manning’s roughness coefficient n_{CH} (Exhibit K-9) and determine the corresponding value of vR from the n versus vR curves in Exhibit K-3 Use a retardance Class D for permanent vegetation or E for temporary Construction.

3. Calculate the Hydraulic Radius R_H using Equation K-10.

Equation K-10: Hydraulic Radius

$$R_H = (vR_H)/v_{\max}$$

Where:

- R_H Hydraulic radius, ft.
 vR_H Value obtained from Exhibit K-3
 v_{\max} Maximum velocity, obtained from Step 2

4. Use Equation K-11 to calculate the value of vR_H

Equation K-11: Manning’s Equation for Stability Analysis

$$vR_H = \frac{1.49R_H^{2/3}\sqrt{S}}{n_{CH}}$$

Where:

- vR_H Value obtained from Exhibit K-3
 R_H Hydraulic radius, ft.
 S Slope, ft/ft.
 n_{CH} Manning’s roughness coefficient, assumed in Step 3.

5. Compare vR_H from Step 5 to the value assumed in Step 3. If the values are not reasonably close, return to Step 3 and repeat the calculations using a new assumed n_{CH} .
6. Determine the depth of flow using trial and error procedures.
7. If bends are considered, calculate the length of downstream protection, L_p for the bend using

**Equation K-12: Downstream Protection**

$$\left[\frac{L_p}{R_H} \right] = \frac{0.604 R_H^{1/6}}{n_b}$$

Where:

- L_p Protection length, ft.
 R_H Hydraulic radius, ft.
 n_b Manning's roughness coefficient in the bend

K.7 Capacity

Use the following procedures to calculate capacity of a vegetative channel.

1. Assume a depth of greater than the value from Step 7 in Stability (Page K-K-18) and compute the waterway area, A , and hydraulic radius, R_H .
2. Divide the design flow rate by the waterway area to determine the velocity.
3. Multiply velocity by R_H to determine the value of vR_H . Use Exhibit K-3 to find Manning's roughness coefficient n_{CH} for retardance Class C based on vR_H .
4. Use Manning's equation to find the velocity using R_H, n_{CH} , and channel slope.
5. Compare the velocity results from Step 2 to Step 5. If the values are not reasonably close, return to step 1 and repeat the calculations.
6. Add free-board according to Section 5.6 to the final depth from Step 6.
7. If bends are considered, calculate the super elevation of the water surface profile at the bend using Equation K-13.

Equation K-13: Water Surface Elevation Change in Bends

$$\Delta d = \frac{v^2 T}{g R_c}$$

Where:

- Δd Difference in water surface elevations between the inner and outer banks of the channel bend, ft.
 v Velocity, fps
 g Gravitational acceleration, 32.2 feet per square second (ft/s²)
 R_c Radius of the centerline of the channel, ft.

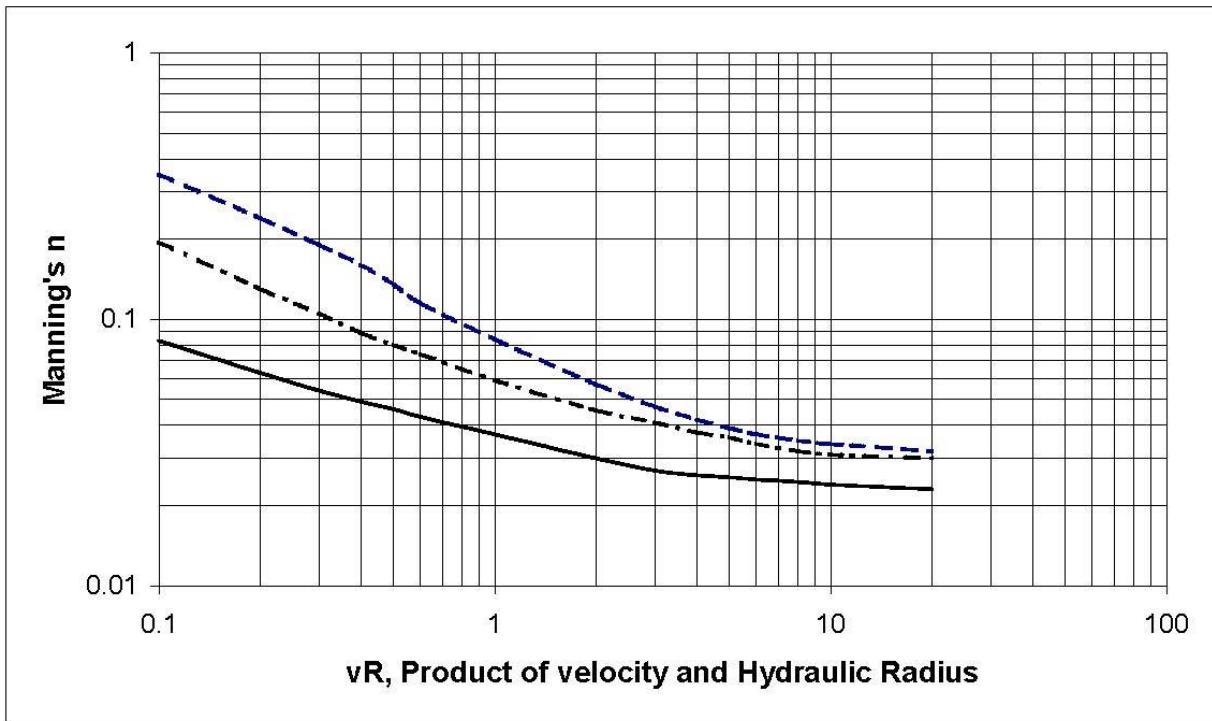

Exhibit K-3: Manning's Roughness Coefficient as a Function of Vegetative Flow Retardance²⁶

²⁶ SDFDM, Chapter 8, Figure 8.2



K.8 Flexible Lining Open Channel Design Procedures²⁷

Use the following procedures to design flexible channel linings with the following limitations:

- Minimum riprap thickness is equal to d_{100}
- The value of d_{85}/d_{15} must be less than 4.6
- The Froude number must be less than 1.2
- Slide slopes are equal to 2:1
- Assume a safety factor of 1.2
- The maximum velocity allowed is 15 fps.
- Specific weight of riprap is assumed to be 165 pounds per cubic foot (lb/ft^3)

Table K-11. Permissible Unit Shear Stress for Flexible Lining Materials^{28,29}

Lining Category	Type	Permissible Unit Shear Stress τ_p (lb/ft^2)
Gravel Riprap	1-inch D_{50}	0.33
	2-inch D_{50}	0.67
Rock Riprap	6-inch D_{50}	2.00
	12-inch D_{50}	4.00

Table K-12. Maximum Velocities for Lining Materials³⁰

Material Type	Maximum Velocity (feet per second)
Sand	2
Silt	3.5
Firm Loam	3.5
Fine Gravel	5
Stiff Clay Graded Loam or Silt to Cobbles	5
Coarse Gravel	5
Hard Pan	6

²⁷ SDFDM, Chapter 8, Section 8.5.8.

²⁸ SDFDM, Chapter 8, Table 8.8

²⁹ Values listed are representative values for the represented depth ranges. Manning's roughness coefficients vary with flow depth.

³⁰ AASHTO Model Drainage Material, 1991



1. Determine the average velocity of the main channel for the design return interval. Calculate the Manning's roughness coefficient for riprap using Equation K-14.

Equation K-14: Manning's Roughness Coefficient for Riprap

$$n = 0.0395D_{50}^{1/6}$$

Where:

- n Manning's roughness coefficient for stone riprap
 D_{50} Diameter of stone for which 50%, by weight, of the gradation is finer, ft.

2. If the rock is to be placed at the outside of a bend, multiply the velocity determined in Step 1 by the bend correction coefficient, C_b using one of the following equations for either a natural (Equation K-15) or a prismatic channel Equation K-16). This requires determining the top width, T , upstream from a bend and the centerline bend radius, R_b .

Equation K-15: Natural Channel Velocity Correction Coefficient

$$C_b = 1.80 \left[\frac{R_b}{T} \right]^{-0.161099}$$

Equation K-16: Prismatic Channel Velocity Correction Coefficient

$$C_b = 1.65 \left[\frac{R_b}{T} \right]^{-0.251239}$$

Where:

- C_b Bend correction Coefficient used to correct velocity in a bend
 T Top width of stream, upstream of bend, ft.
 R_b Radius of the bend, ft.

3. Calculate the Froude Number using Equation K-17.

Equation K-17: Froude Number

$$F_r = \frac{v}{\sqrt{\frac{gA}{T}}}$$

Where:

- F_r Froude number
 v Average velocity, fps
 g Gravitational acceleration, 32.2 feet per square second (ft/s²)
 A Cross-sectional flow area, ft²
 T Top width of water surface, ft.



4. Determine the required minimum D_{30} from Equation K-18.

Equation K-18: Minimum d_{30} Riprap Sizing

$$\frac{D_{30}}{d} = 0.193F_R^{2.5}$$

Where:

- D_{30} Minimum riprap sizing, ft.
 d Depth of flow above channel lining, ft.
 F_R Froude number, calculated using Equation K-17

5. Determine available riprap gradations. A well-graded riprap is preferable to uniform size. The diameter of the largest stone, D_{100} , should be no more than 1.5 times the D_{50} size. Blanket thickness should be greater than or equal to D_{100} except as noted below. Sufficient fines (below D_{15}) should be available to fill the voids in the larger rock sizes. The stone weight for a selected stone size can be calculated by the equation:

Equation K-19: Riprap Stone Weight

$$W = 0.5236(SW_s)D$$

Where:

- W Riprap stone weight, lbs.
 SW_s Specific weight of stone, 165 lb/ft³
 D Selected stone diameter, ft.

K.9 Culvert Design Equations

Equation K-20: Manning's Equation for Culverts³¹

$$Q = \frac{1.49}{n} AR_H^{2/3} \sqrt{S}$$

Where:

- Q Flow rate, cfs
 n Manning's roughness coefficient, 0.013 regardless of pipe material
 A Cross-sectional flow area, ft²
 R_H Hydraulic radius, ft.
 S Friction slope, ft/ft

³¹ City SWMM, Appendix A.4



K.10 Pipe Fill Height Requirements

HS 25 - 44 LIVE LOAD

PIPE DIAMETER (Inches)	NONREINFORCED CONCRETE PIPE				REINFORCED PIPE					
	CLASS 2		CLASS 3		CLASS III		CLASS IV		CLASS V	
	MINIMUM COVER (Feet)	MAXIMUM COVER (Feet)	MINIMUM COVER (Feet)	MAXIMUM COVER (Feet)	MINIMUM COVER (Feet)	MAXIMUM COVER (Feet)	MINIMUM COVER (Feet)	MAXIMUM COVER (Feet)	MINIMUM COVER (Feet)	MAXIMUM COVER (Feet)
4	2.0	19	2.0	23						
6	2.0	20	2.0	24						
8	2.0	21	2.0	23						
10	2.0	20	2.0	24						
12	2.0	22	2.0	24						
15	2.0	25	2.0	28	1.5	17	1.0	27	0.5	41
18	2.0	29	2.0	31	1.5	18	1.0	27	0.5	42
21	2.0	31	2.0	35	1.5	18	1.0	27	0.5	42
24	2.0	32	2.0	39	1.5	17	1.0	27	0.5	42
27	2.0	34	2.0	41	1.5	17	1.0	27	0.5	41
30	2.0	37	2.0	41	1.5	17	1.0	27	0.5	41
33	2.0	38	2.0	43	1.5	17	1.0	27	0.5	41
36	2.0	39	2.0	44	1.5	17	1.0	26	0.5	41
42					1.5	17	1.0	26	0.5	41
48					1.5	18	1.0	26	0.5	41
54					1.5	16	1.0	26		
60					1.5	16	1.0	26		
66					1.5	16	1.0	26		
72					1.5	16	1.0	25		

Exhibit K-4: Fill Height Table for Circular Concrete Pipe³²

³² ODOT, Standard Drawing, RD386



PIPE	CORRUGATED HDPE	
DIAMETER (Inches)	MINIMUM COVER (Feet)	MAXIMUM COVER (Feet)
12	2.0	29
15	2.0	30
18	2.0	27
24	2.0	24
30	2.0	21
36	2.0	23
42	2.0	22
48	2.0	22
60	2.5	21

Exhibit K-5: Fill Height Table for Corrugated HDPE Pipe^{33 34}

PIPE	STEEL REINFORCED HDPE	
DIAMETER (Inches)	MINIMUM COVER (Feet)	MAXIMUM COVER (Feet)
24	1.0	50
30	1.0	50
36	1.0	50
42	1.0	50
48	1.0	30
60	1.0	30
66	1.5	30
72	1.5	30

Exhibit K-6: Fill Height Table for Steel Reinforced HDPE Pipe^{35 36}

³³ ODOT, Standard Drawing, RD390

³⁴ Heavy solid line denotes boundary between minimum cover requirements.

³⁵ ODOT, Standard Drawing, RD391

³⁶ Heavy solid line denotes boundary between minimum cover requirements.



PIPE	DUAL WALL POLYPROPYLENE		
DIAMETER (Inches)	MINIMUM COVER (Feet)	MAXIMUM COVER (Feet)	REMARKS
12	1.0	28	ASTM F 2736
15	1.0	30	
18	1.0	26	
24	1.0	22	
30	1.0	22	

Exhibit K-7: Fill Height Table for Dual Wall Polypropylene Pipe³⁷

PIPE	TRIPLE WALL POLYPROPYLENE		
DIAMETER (Inches)	MINIMUM COVER (Feet)	MAXIMUM COVER (Feet)	REMARKS
30	1.0	22	ASTM F 2764
36	1.0	19	
48	1.0	16	
60	2.0	22	

Exhibit K-8: Fill Height Table for Triple Wall Polypropylene Pipe³⁸

³⁷ ODOT, Standard Drawing, RD393

³⁸ ODOT, Standard Drawing, RD393



PIPE		SOLID WALL PVC	
DIAMETER (Inches)	MINIMUM COVER (Feet)	MAXIMUM COVER (Feet)	REMARKS
4	2.0	40	ASTM D 3034 SDR35 (46 psi stiffness)
6	2.0	40	
8	2.0	40	
10	2.0	40	
12	2.0	40	
15	2.0	40	
18	2.0	40	ASTM F 679 (46 psi stiffness)
21	2.0	40	
24	2.0	40	
27	2.0	40	
30	2.0	40	
33	2.0	40	
36	2.0	40	
42	2.0	40	
48	2.0	40	

PIPE		PROFILE WALL PVC	
DIAMETER (Inches)	MINIMUM COVER (Feet)	MAXIMUM COVER (Feet)	REMARKS
4	2.0	40	ASTM F 794 Series 46 (46 psi stiffness)
6	2.0	40	
8	2.0	40	
10	2.0	40	
12	2.0	40	
15	2.0	40	
18	2.0	40	
21	2.0	40	
24	2.0	40	
27	2.0	40	
30	2.0	40	
33	2.0	40	
36	2.0	40	
39	2.0	40	
42	2.0	40	
45	2.0	40	
48	2.0	40	

Exhibit K-9: Fill Height Table for PVC Pipe³⁹

³⁹ ODOT, Standard Drawing, RD388



PIPE		SOLID WALL PVC	
DIAMETER (Inches)	MINIMUM COVER (Feet)	MAXIMUM COVER (Feet)	REMARKS
14	2.0	41	AWWA C905 DR 32.5 (57 psi stiffness)
16	2.0	41	
18	2.0	41	
20	2.0	41	
24	2.0	41	
30	2.0	41	
36	2.0	41	
42	2.0	41	
48	2.0	41	

PIPE		SOLID WALL PVC	
DIAMETER (Inches)	MINIMUM COVER (Feet)	MAXIMUM COVER (Feet)	REMARKS
14	1.0	46	AWWA C905 DR 26 (115 psi stiffness)
16	1.0	46	
18	1.0	46	
20	1.0	46	
24	1.0	46	
30	1.0	46	
36	1.0	46	

PIPE		SOLID WALL PVC	
DIAMETER (Inches)	MINIMUM COVER (Feet)	MAXIMUM COVER (Feet)	REMARKS
14	1.0	48	AWWA C905 DR 25 (129 psi stiffness)
16	1.0	48	
18	1.0	48	
20	1.0	48	
24	1.0	48	
30	1.0	48	
36	1.0	48	
42	1.0	48	
48	1.0	48	

Exhibit K-10: Fill Height Table for Triple Wall Polypropylene Pipe⁴⁰

⁴⁰ ODOT, Standard Drawing, RD393



PIPE		SOLID WALL PVC	
DIAMETER (Inches)	MINIMUM COVER (Feet)	MAXIMUM COVER (Feet)	REMARKS
14	1.0	61	AWWA C905 DR 21 (224 psi stiffness)
16	1.0	61	
18	1.0	61	
20	1.0	61	
24	1.0	61	
30	1.0	61	
36	1.0	61	

PIPE		SOLID WALL PVC	
DIAMETER (Inches)	MINIMUM COVER (Feet)	MAXIMUM COVER (Feet)	REMARKS
4	1.0	48	AWWA C900 DR 25 (129 psi stiffness)
6	1.0	48	
8	1.0	48	
10	1.0	48	
12	1.0	48	

PIPE		SOLID WALL PVC	
DIAMETER (Inches)	MINIMUM COVER (Feet)	MAXIMUM COVER (Feet)	REMARKS
4	1.0	69	AWWA C900 DR 18 (364 psi stiffness)
6	1.0	69	
8	1.0	69	
10	1.0	69	
12	1.0	69	

PIPE		SOLID WALL PVC	
DIAMETER (Inches)	MINIMUM COVER (Feet)	MAXIMUM COVER (Feet)	REMARKS
4	1.0	109	AWWA C900 DR 14 (814 psi stiffness)
6	1.0	109	
8	1.0	109	
10	1.0	109	
12	1.0	109	

Exhibit K-11: Fill Height Table for Triple Wall Polypropylene Pipe⁴¹

⁴¹ ODOT, Standard Drawing, RD393

**K.11 Manhole Geometry****Table K-13: Minimum Diameter Precast Manhole for Maximum Pipe Sizes⁴²**

Manhole Diameter, inches	Maximum pipe size (inches) for Deflection Angle		
	0° (through pipe)	45°	90°
48	30	15	--
60	36	18	--
72	48	24	--
84	60	30	12
96	72	42	15

⁴² SDFDM, Chapter 4

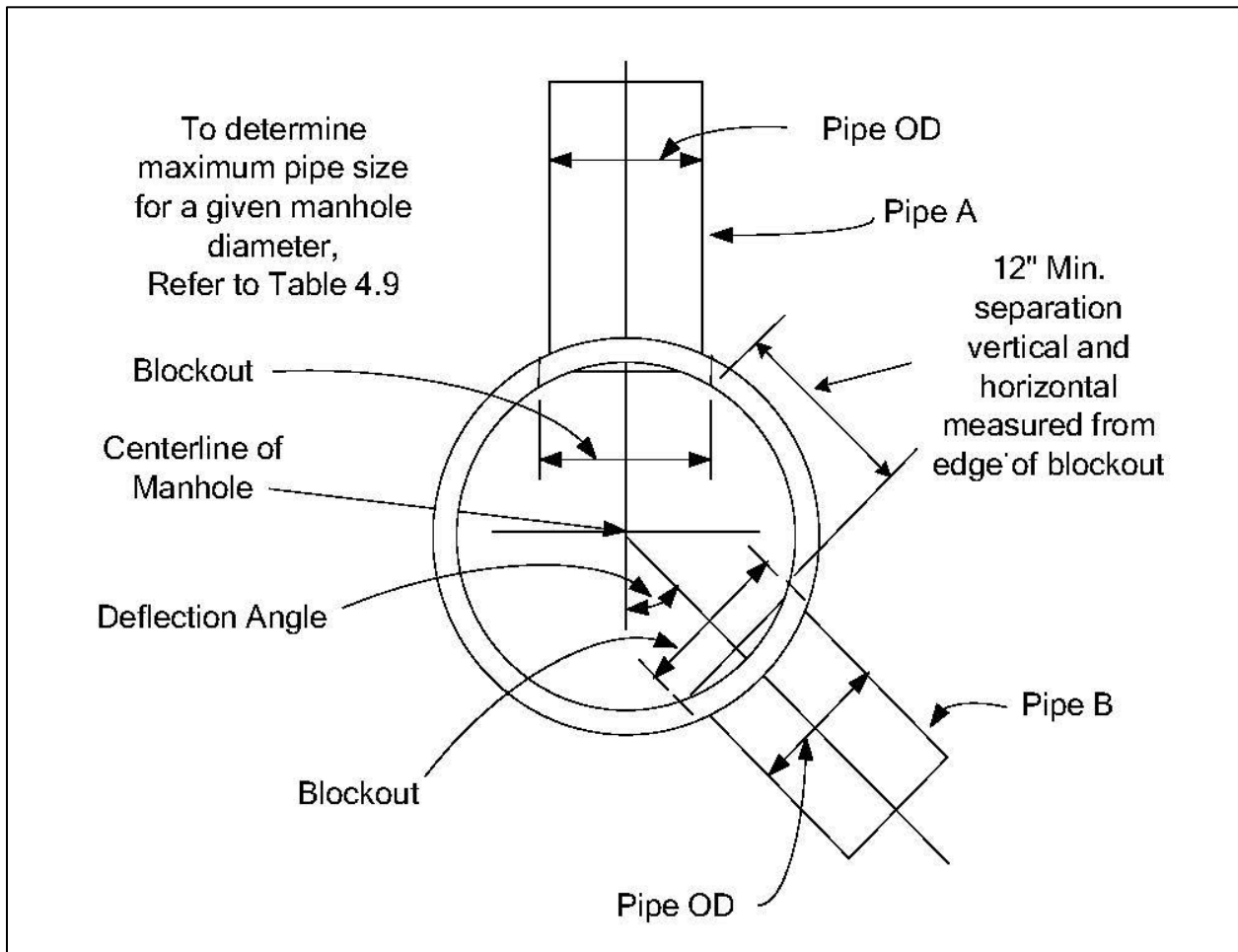

Exhibit K-12: Minimum Precast Manhole Diameter for Maximum Sewer Sizes⁴³

⁴³ SDFDM, Chapter 4.

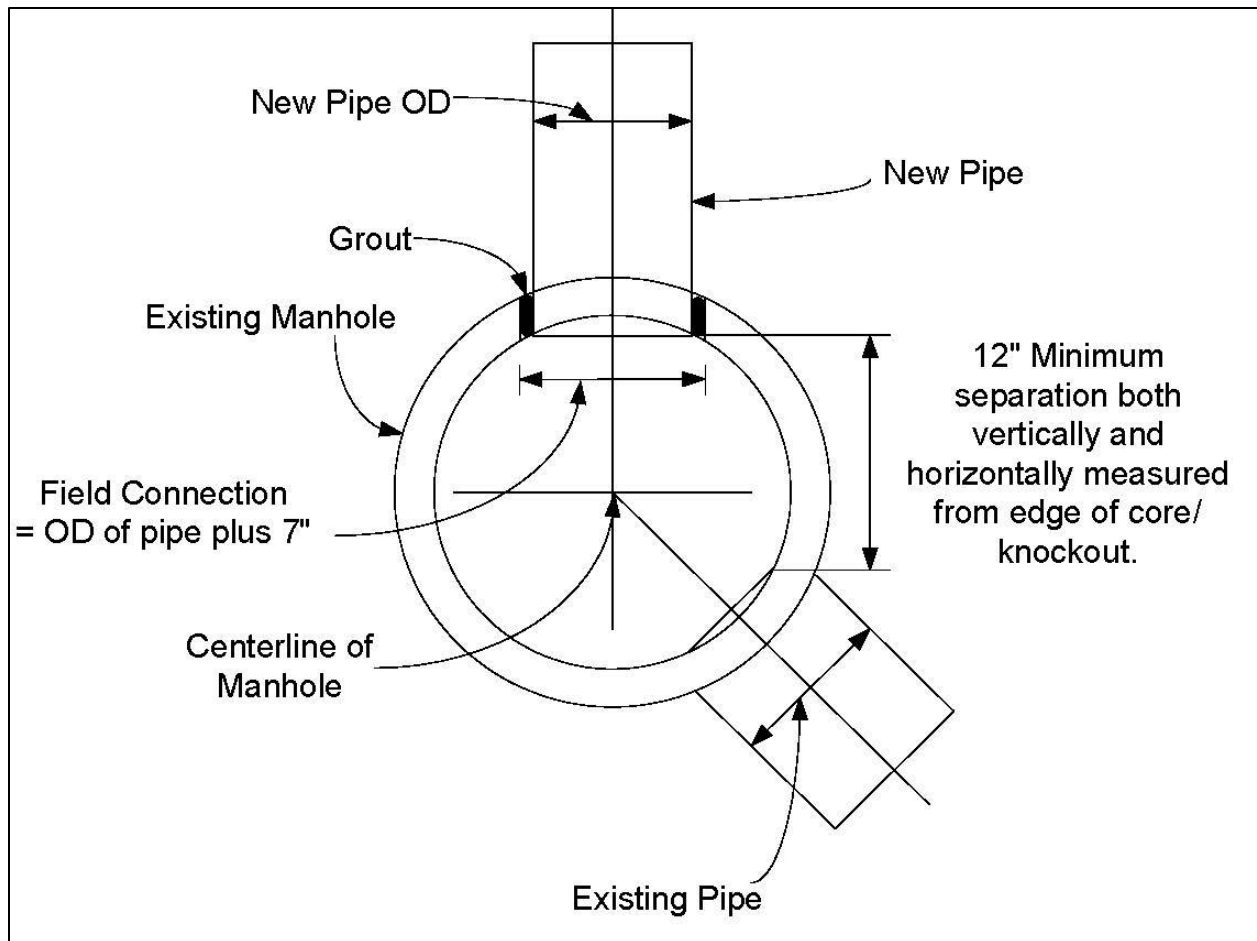

Exhibit K-13: New Pipe Connection to an Existing Manhole⁴⁴

⁴⁴ SDFDM, Chapter 4.

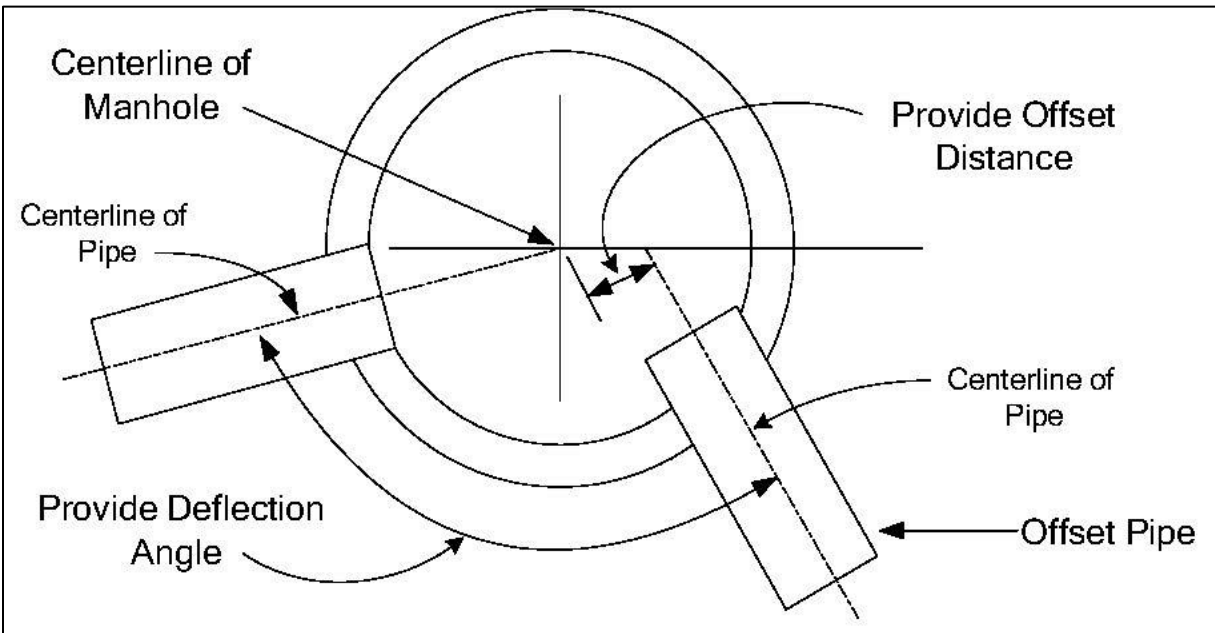

Exhibit K-14: Offset Pipe Connections to a Manhole⁴⁵

⁴⁵ SDFDM, Chapter 4.



Appendix L

Nomographs for Water Quality BMP Sizing



APPENDIX L: NOMOGRAPHS FOR WATER QUALITY BMP SIZING

This appendix presents BMP sizing nomographs developed to identify a recommended design storm for sizing water quality BMPs for Port properties. Both volume-based and flow-based BMP sizing nomographs, as well as a nomograph specifically for sizing permanent wet pools, have been developed as described below. These nomographs supported the development of DSM minimum sizing criteria for water quality BMPs to meet the Port's MS4 permit capture and treat requirements, as described in Chapters 4 and 6 of the DSM.

L.1 Summary of Approach

Stormwater BMPs are most appropriately sized and evaluated using hydrograph routing techniques because both the storage and release dynamics of the system are considered. Long-term continuous hydrologic simulation can account for hydrograph routing, but also allows for an assessment of the volume captured and treated by a BMP under a wide variety of antecedent and storm event conditions. It is for this reason that continuous simulation is the industry-preferred method for stormwater BMP assessment and design. However, developing and implementing a continuous simulation model whenever a BMP is being considered can be a difficult and time-consuming task. Percent capture nomographs that summarize the results of continuous simulation provide a means for quickly estimating the size of a given BMP needed to achieve a target percent capture (e.g., 80 percent).

The USEPA Stormwater Management Model (version 5.0.022) was used to simulate the long-term, continuous hydraulic performance of volume-based BMPs and estimate the average annual percent capture for different unit sizes (e.g., storage volumes normalized by drainage area). Runoff from a fixed catchment size was simulated and routed through storage units with various volume capacities and drawdown times using a 60-year, hourly rainfall record. The amount of runoff that bypassed the facility over the entire period of record for each variation was recorded to determine the capture efficiency, or percent of runoff captured, for each facility. Thus, capture efficiency is defined here as the portion of total runoff captured and treated divided by the total runoff volume from the drainage area.

The percentage of total volume captured by flow-based BMPs for various design intensities and times of concentration was estimated by analyzing 5 minute, Automated Surface Observing System (ASOS) rainfall data from the gauge at PDX. To calculate this, the portion of the runoff greater than that produced by the specified design intensity was assumed to be bypassed by the BMP.

For BMPs with permanent wet pools (e.g., wet basins), an analysis of discrete storm events was conducted. Storm events were discretized from the 60-year, hourly rainfall record by defining a minimum inter-event time and minimum event depth expected to produce runoff. Assuming that the performance of wet pools is based on the volume of the wet pool relative to the incoming runoff volume, as well as the retention time between storms, the long-term average percent capture and treated by a wet pool can be estimated by comparing various design storm depths to the depths of discrete storm events. The inter-event times can be approximated as the minimum residence time of stormwater in the wet pool.

Additional details of the nomograph development methodology are provided below, followed by a sensitivity analysis to evaluate the accuracy of the recommended BMP sizing approach.



L.2 Methodology

L.2.1 Volume-Based BMPs

For the volume based BMPs (e.g., detention basins), the SWM model was used to perform a series of continuous simulations using a variety of detention storage configurations and drawdown times, with hourly rainfall data from the PDX rainfall gauge over a 60-year period. The tributary area was assumed to be 10 acres with 100 percent imperviousness. A fixed depth of 2.5 feet was assumed and the surface area was varied such that the storage volume was equivalent to a range of unit BMP volumes (expressed in watershed inches). Additionally, discharge rates were varied to represent a range of drawdown times (time it takes to completely drain the storage volume from a brimful condition).

General SWM modeling parameters and subcatchment properties assumed for the batch processing simulation modeling are included in Table 1. Table 2 summarizes the assumed BMP parameters. As indicated in Table 2, storage areas were computed for a range of design storm depths by assuming a long-term volumetric runoff coefficient of 0.84, which as discussed in Section 3.3 is the recommended runoff coefficient to use for a 100 percent impervious drainage area.

Table 1: SWM Model Parameters

Parameter	Assumption
Wet time step	15 min
Dry time step	4 hour
Routing time step	20 sec
Routing option	Kinematic wave
Infiltration option	<i>Not used as subcatchment; was 100% impervious</i>
Rainfall record	PDX (NCDC Gage #356751)
Period of record modeled	10/1/1951 – 10/1/2011
Evaporation data	See Table 2, below
Subcatchment area	10 ac
Subcatchment imperviousness	100%
Subcatchment flow path	250 ft
Subcatchment slope	3%
Impervious Manning's n	0.012
Pervious Manning's n	<i>Not used as subcatchment; was 100% impervious</i>
Impervious depression storage	0.05 inches
Pervious depression storage	<i>Not used as subcatchment; was 100% impervious</i>
Percent zero depression storage (within impervious area)	25%
Soil parameters	<i>Not used as subcatchment; was 100% impervious</i>

**Table 2: BMP Parameters**

BMP Parameter	Assumption
Depth of ponding (ft)	2.5 ft
Storage Area (ft ²)	$(10 \text{ ac}) * (43560 \text{ ft}^2/\text{ac}) * (\text{Design Storm Depth} * 0.84) * (1/12 \text{ ft/in}) / 2.5 \text{ feet}$
Design Storm Depths (watershed inches)	Varied from 0.05 to 2.0 in
Outlet Stage/Discharge Curve	$(\text{Storage Area} * 2.5 \text{ ft}) / (\text{Drawdown Time})$
Drawdown Time (hours)	Varied from 1 to 2400 hrs

Evaporation inputs used in the SWM model are included in Table 3, below. The evaporation was based on pan evaporation data from North Willamette Experimental Station reported in the NOAA Technical Report NWS 34. A pan coefficient of 0.8 was multiplied by the monthly values to approximate actual evaporation occurring at Portland International Airport. This pan coefficient is slightly higher than the typical value used for Class A Evaporation Pans (0.7). The evaporation simulated in the model is from very impervious depression rather than from a waterbody or wet soil, so the rate of evaporation is expected to be higher.

Table 3: Evaporation Inputs

Month	Jan	Feb	Mar	Apr	May	Jun	Jul	Aug	Sep	Oct	Nov	Dec
Evaporation (in/day)	0.026	0.041	0.068	0.093	0.148	0.178	0.211	0.186	0.135	0.068	0.03	0.026

Using the above inputs, the SWM model was used to estimate the long-term volume treated and bypassed to estimate the percent capture for a variety of BMP sizes.

L.2.2 Flow-based BMPs

For flow-based BMPs (e.g., Stormfilter vaults, swales), 5-minute rainfall data from PDX was analyzed to estimate the volume captured and volume bypassed for different unit flow rates (design intensities) using a spreadsheet analysis. Both online and offline BMP configurations were considered. With the online configuration, no treatment was assumed to occur once the design flow rate has been exceeded. Flow is either 100 percent treated as long as flow is below the design flow rate, or no flow is treated if flow is above the design flow rate. This can occur in vegetated swales where they become significantly less effective at removing pollutants when they are conveying high flow rates. With the offline configuration, treatment up to the design flow rate was assumed to occur at all flow rates, while any additional flow exceeding the design flow is not treated. This can occur for Stormfilter vaults, which have an internal bypass mechanism to ensure treatment occurs even though the influent flow rate exceeds the design capacity.

In addition to online and offline configurations, various times of concentration for the tributary drainage area were considered by averaging the 5-minute intensities over different time periods and then using these averaged intensities to evaluate the volume captured over the period of record. This accounts for the fact that a higher percent capture is possible with a longer time of concentration because of the influence hydrologic routing has on peak flow rates. Table 4 summarizes the analysis parameter assumptions for developing the flow-based nomographs.

**Table 4: Flow-Based Analysis Parameters**

Parameter	Assumption
Rainfall Record	PDX (WBAN 24229)
Period of Record	01/1/2000 – 5/30/2013
Times of Concentration	5 to 60 minutes
Design Intensity Range	0.01 to 0.5 in/hr

L.2.3 Wet Pool Based BMPs

For wet pool based BMPs, such as wet basins, a discrete storm event analysis was conducted using the same rainfall record used for the volume-based BMPs summarized in Table 1. The statistics functions of EPA SWM model 5 were used to discretize the rainfall events by specifying 6-hour, 12-hour, and 24-hour minimum inter-event times with a minimum event depth of 0.1 inches. This resulted in three separate time series' of discrete storm events. Each time series was then used to assess the effective long-term treated volume for various unit wet pool volumes (i.e., expressed in watershed inches). For example, for a unit wet pool volume of 0.5 watershed inches, all events less than 0.5 inches were assumed 100 percent treated. For all other events, only the first 0.5 inches was assumed treated. By tabulating the cumulative treated volumes for each design storm for each discrete event time series, a relationship between percent treated and wet pool size was developed and summarized into a sizing nomograph as described below.

L.2.4 Runoff Coefficient for BMP Sizing

Sizing BMPs using the nomographs requires an estimate of the long-term volumetric runoff coefficient for the watershed. The most accurate estimate of the runoff coefficient is one based on the actual SWM model simulations since the SWM model was used to develop the nomographs and will reflect the long-term series of rainfall-runoff for Port facilities. Therefore, the SWM model was run using the same time series as used to develop the volume-based nomographs for a variety of impervious areas while holding the other watershed parameters constant. A conservative hydraulic conductivity of 0.12 in/hr was used along with a pervious depression storage coefficient of 0.1 in. Results of this analysis are provided in Section 3.

L.2.5 Sensitivity Analysis

To evaluate the accuracy of the recommended simple BMP sizing procedure based on the percent capture nomographs, a simple sensitivity analysis was completed. BMPs were sized by assuming a target percent capture and then using the design storm depth (volume-based BMPs) or design storm intensity (flow-based BMPs) to investigate the differences in the assumed percent capture and the modeled percent capture by varying drainage area imperviousness, hydraulic conductivity, and slope. A SWM model was created with a single drainage area draining to either a storage unit to simulate volume-based BMPs or a flow divider to simulate flow-based BMPs. Offline flow-based BMPs were simulated by using a cutoff divider where all portions of the flows above the design flow rate are diverted. Online flow-based BMPs were simulated by using a tabular divider where all flows are diverted once the design flow rate is exceeded. For volume-based BMPs, two different drawdown rates, 24 hour and 48 hour, were evaluated by sizing a single orifice to drain the entire design volume in the specified time; overflows were simulated using a wide, transverse weir. Evaporation rates were not considered



in this analysis. Twenty minute rainfall data from the Automated Surface Observing System (ASOS) gauge was used for the flow-based BMP simulations, while hourly rainfall data from the National Climatic Data Center (NCDC) gauge was used for the volume-based simulation. Table 5 shows the common parameters used in the analysis for all simulations.

Table 5: SWM Model Parameters

Parameter	Assumption
Wet time step (volume-based)	10 min
Wet time step (flow-based)	1 min
Dry time step	1 hour
Routing time step	30 sec
Routing option	Kinematic wave
Evaporation data	See Table 6, below
Subcatchment area	10 acres
Subcatchment flow path	250 feet
Impervious Manning's n	0.012
Pervious Manning's n	0.10
Impervious depression storage	0.05 inches
Pervious depression storage	0.15
Percent zero depression storage (within impervious area)	25%
Soil parameters	Green Ampt

Using a batch processing tool, 64 volume-based simulations and 64 flow-based simulations were completed for the sensitivity analysis. Table 6 shows which parameters were varied to complete the volume-based simulations and Table 7 shows which parameters were varied to complete the flow-based simulations.

Table 6: Volume-Based Simulation Parameters

Parameter	Assumption
Imperviousness	20, 40, 80, and 100 (%)
Hydraulic Conductivity (K_{sat})	0.05 and 0.5 (in/hr)
Suction Head, $K_{sat}=0.05$	8 (in)
Suction Head, $K_{sat}=0.5$	3 (in)
Initial Moisture Deficit, $K_{sat}=0.05$	0.2
Initial Moisture Deficit, $K_{sat}=0.5$	0.3
Slope	2 and 8 (%)
BMP Percent Capture	40 and 80 (%)
Drawdown Rate	24 and 48 (hrs)
Orifice Diameter	Sized according to drawdown rate
Rainfall Record	PDX (NCDC Gage #356751)
Period of Record Modeled	10/1/1951 – 10/1/2011

**Table 7: Flow-Based Simulation Parameters**

Parameter	Assumption
Imperviousness	20, 40, 80, and 100 (%)
Hydraulic Conductivity (K_{sat})	0.05 and 0.5 (in/hr)
Suction Head , $K_{sat}=0.05$	8 (in)
Suction Head , $K_{sat}=0.5$	3 (in)
Initial Moisture Deficit, $K_{sat}=0.05$	0.2
Initial Moisture Deficit , $K_{sat}=0.5$	0.3
Slope	2 and 8 (%)
BMP Percent Capture	40 and 80 (%)
Configuration	Online and Offline
Rainfall Record	PDX (ASOS Gage #KPDJ)
Period of Record Modeled	1/1/2000 – 06/26/2013

The results of this analysis were compared to BMP sizes from volume-based and flow-based nomographs. Assumed percent captures from the nomographs were compared to simulated percent captures from the simple BMP size modeling. Results are presented and discussed below.

L.3 Results

L.3.1 Volume-based BMP Results

The resulting volume-based BMP nomograph is included as Figure 1. Each point on the nomograph reflects the percent of runoff captured by a single BMP scenario, assuming a BMP that is sized for a particular design storm depth and a discharge rate that corresponds to a particular BMP drawdown time. Each curve on the nomograph reflects a specific drawdown time and each point reflects the percent capture achieved by various BMP sizes (design storm depths) when sized to that drawdown time.

The required design storm to achieve 80 percent capture with a BMP that drains in 48 hours is approximately 0.65 inches. A 90 percent capture would require a design storm of approximately 0.91 inches.

L.3.2 Flow-based BMP Results

The resulting flow-based nomograph for an online configuration is included below as Figure 2 and for an offline configuration as Figure 3. Similar to the volume-based nomograph, each point on the flow-based nomographs reflects the percent of runoff captured by a single BMP scenario, assuming a particular time of concentration and design intensity. Each curve on the nomograph reflects the percent capture achieved by various BMP sizes (corresponding to design intensity and flow rate), each having a common time of concentration. The required design intensity required to achieve 80 percent capture, assuming a 10-minute time of concentration (corresponds to highly impervious areas with an established drainage network), is approximately 0.21 in/hr for an online configuration and approximately 0.12 in/hr for an offline configuration. As shown in the figure, higher percent capture may be achieved by choosing a higher design intensity.



L.3.3 Wet Pool Results

The resulting nomograph for wet pools are provided in Figure 4. The minimum residence times indicated in the figure are related to the minimum inter-event times used to discretize the storm events. As shown in the figure, a wet pool volume sized using a design storm of 1 inch would be expected to treat approximately 80 percent of the long-term runoff volume with a minimum residence time of 12 hours. Shorter residence times require smaller design storm depths and longer residence times require larger design storm depths to achieve an equivalent level of treatment.

L.3.4 Runoff Coefficient Results and BMP Sizing

Figure 5 summarizes the results of the SWM model simulations using PDX rainfall, variable imperviousness, and a conservative saturated hydraulic conductivity of 0.12 in/hr to estimate infiltration in pervious areas. The rational formula can be used to size BMPs given a runoff coefficient and a design storm depth. The runoff coefficient for a watershed with a particular imperviousness can be computed using the linear regression line. BMP sizes would be conservative (i.e., larger) for areas with conveyance storage and with higher infiltration rates than have been assumed, but could be non-conservative (i.e., smaller) for watersheds with no conveyance storage and lower infiltration rates. While most drainage areas have some conveyance storage and lower infiltration rates than what have been assumed are not likely, the recommended runoff coefficient formula as a function of imperviousness would be to just round up the linear regression parameters as follows:

$$R_v = 0.82 \cdot IMP + 0.02$$

Where R_v is the volumetric runoff coefficient and IMP is the impervious fraction. This coefficient can be applied to both volume and flow based BMP sizing calculations and was used in the sensitivity analysis as described below by using the following rational formulas for sizing:

Volume-based BMPs:

$$WQ_v = R_v \cdot P \cdot A \cdot$$

Where WQ_v is the water quality design volume, P is the design storm depth, and A is the drainage area to the BMP.

Flow-based BMPs:

$$WQ_f = R_v \cdot I \cdot A \cdot$$

Where WQ_f is the water quality design flow rate, I is the design storm intensity, and A is the drainage area to the BMP.

L.3.5 Sensitivity Analysis Results

The sensitivity analysis shows that hydraulic conductivity affects volume based BMP sizing performance more than other factors. The analysis also shows that the simple BMP sizing procedure using the derived runoff coefficient equation under-predicted BMP performance (i.e., conservatism) when imperviousness was greater than 40 percent and over-predicted BMP



performance when imperviousness was near 20 percent. Imperviousness also affected performance when hydraulic conductivity was low. Slope minimally affected capture efficiency. Figure 6 shows the results of this analysis for a 24 hour drawdown time; Figure 7 shows a 48 hour drawdown time.

For flow based BMPs, the analysis shows that hydraulic conductivity had the greatest influence on BMP sizing performance for both online and offline configurations. Nonetheless, the BMP sizing nomographs presented in this appendix effectively predict flow-based BMP performance. Based on the sensitivity tests, performance was only over predicted in the extreme case when imperviousness was 20 percent, hydraulic conductivity was 0.05 in/hr, and the target capture efficiency was 80 percent. Imperviousness had greater influence when hydraulic conductivity was low. Slope had greater influence when both imperviousness and hydraulic conductivity were low. Figure 8 and Figure 9 show the results for online and offline configurations, respectively.

L.4 Summary and Conclusion

The nomographs presented in this memo are based on long-term continuous rainfall analysis and runoff simulation and are useful for evaluating different design storm depths and intensities for sizing volume and flow-based BMPs to achieve a variety of long-term percent capture volumes. The implications of selecting design storms capable of achieving percent capture volumes of 80 percent or greater can be assessed with some additional analyses. For example, the design storm depths can be converted to a design volume using the rational formula, which can be used to estimate the required footprint area given a typical design depth and factor of safety for a BMP (while considering freeboard and setbacks).

Detention BMPs designed for both water quality and flood control would require additional storage volume and potentially different outlet controls to convey the target flood control design storm. These additional features would likely require a slightly larger footprint. In addition, facilities that have a permanent pool, such as wetland basins and wet ponds, where treatment is more a function of residence time require a different type of analysis. For these facilities, a synoptic analysis of discrete rainfall events was conducted where the inter-event time used to define discrete events was varied. The discrete events were then analyzed to determine the percent capture given a permanent pool volume normalized to watershed inches. Figure 4 is a wet pond sizing nomograph with 6, 12, and 24 minimum residence times.

For flow-based BMPs, such as Stormfilter cartridge vaults, design intensities can be converted to design flow rates by using the rational formula. The number of cartridges needed per acre of impervious drainage area could then be estimated to evaluate the sensitivity of design intensity on vault size. The size of flow-through swales may also be evaluated by making assumptions on cross-sectional and longitudinal profiles and desired contact time (typically > 5 min). The DSM can provide a series of minimum design intensities for a variety of times of concentration, allowing the designer to select an appropriate intensity for their application.

The results of the sensitivity analysis show that BMPs are oversized except for highly pervious areas with low hydraulic conductivity. While this condition could be encountered at Port facilities, if the hydraulic conductivity is estimated to be below 0.1 in/hr for the pervious areas, then the area should be considered impervious when sizing the BMP. Also, drainage areas with only 20 percent imperviousness would likely be subject to future development and it may be in the



Port's best interest to size these BMPs for full build-out conditions (while still ensuring adequate residence times are provided). In addition, the nomographs presented in this appendix are expected to be conservative because no conveyance routing was assumed in their development. Conveyance routing would tend to smooth out storm event hydrographs resulting in lower peaks and higher percent capture of runoff volumes.

In summary, the nomographs provide a useful tool for sizing BMPs and providing guidance on target design storm characteristics. The use of nomographs for BMP sizing provides the benefits and flexibility of sizing BMPs based on continuous simulation. Designers can select a BMP that meets the percent capture requirements and performance goals without being restricted to a single design storm event. The recommended runoff coefficient along with the use of the nomographs is expected to result in a conservative BMP size. However, a designer may wish to use an additional factor of safety when sizing BMPs.

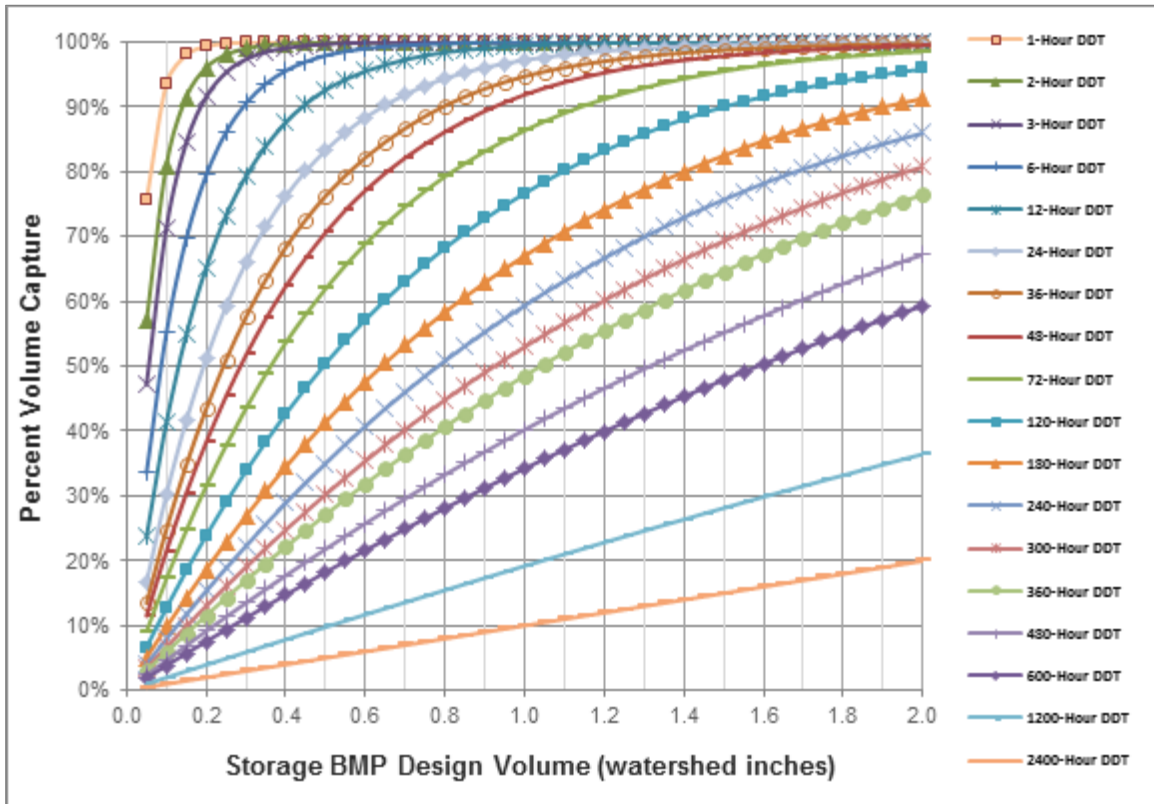

Figure 1: Volume-based BMP Sizing Nomograph

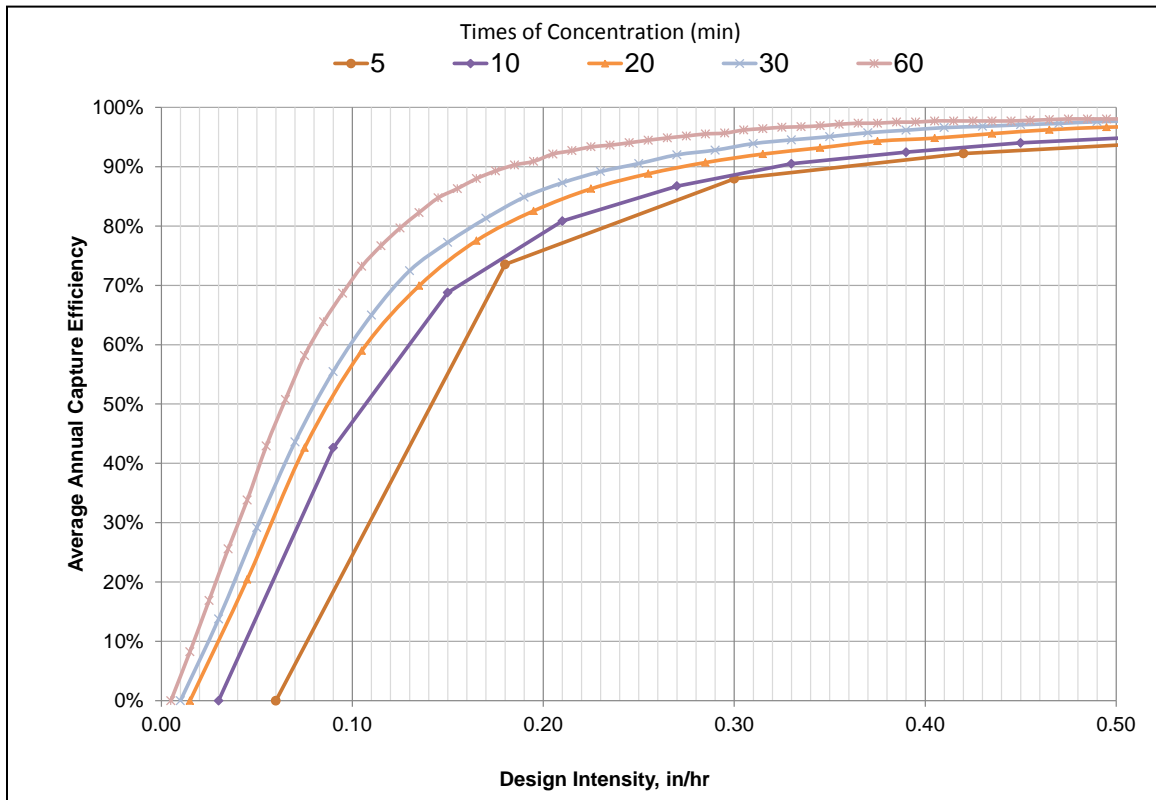

Figure 2: Flow-based Sizing Nomograph – Online Configuration

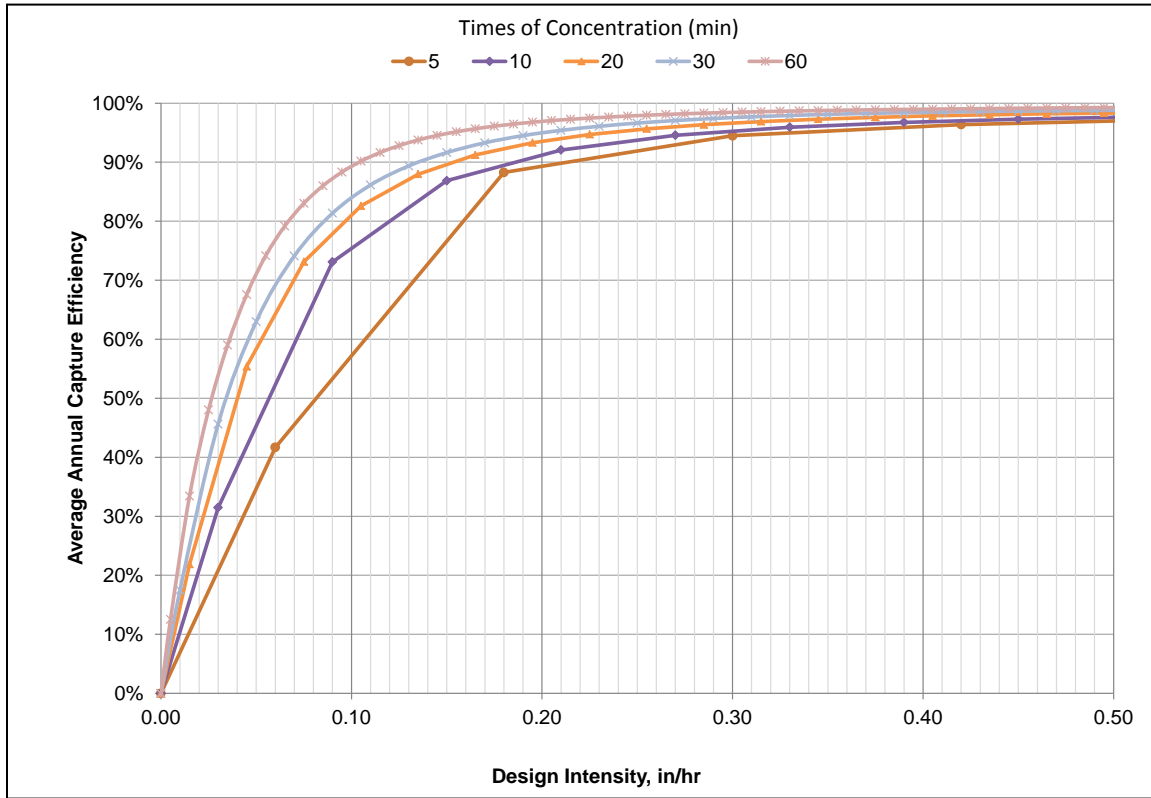

Figure 3: Flow-based Sizing Nomograph – Offline Configuration

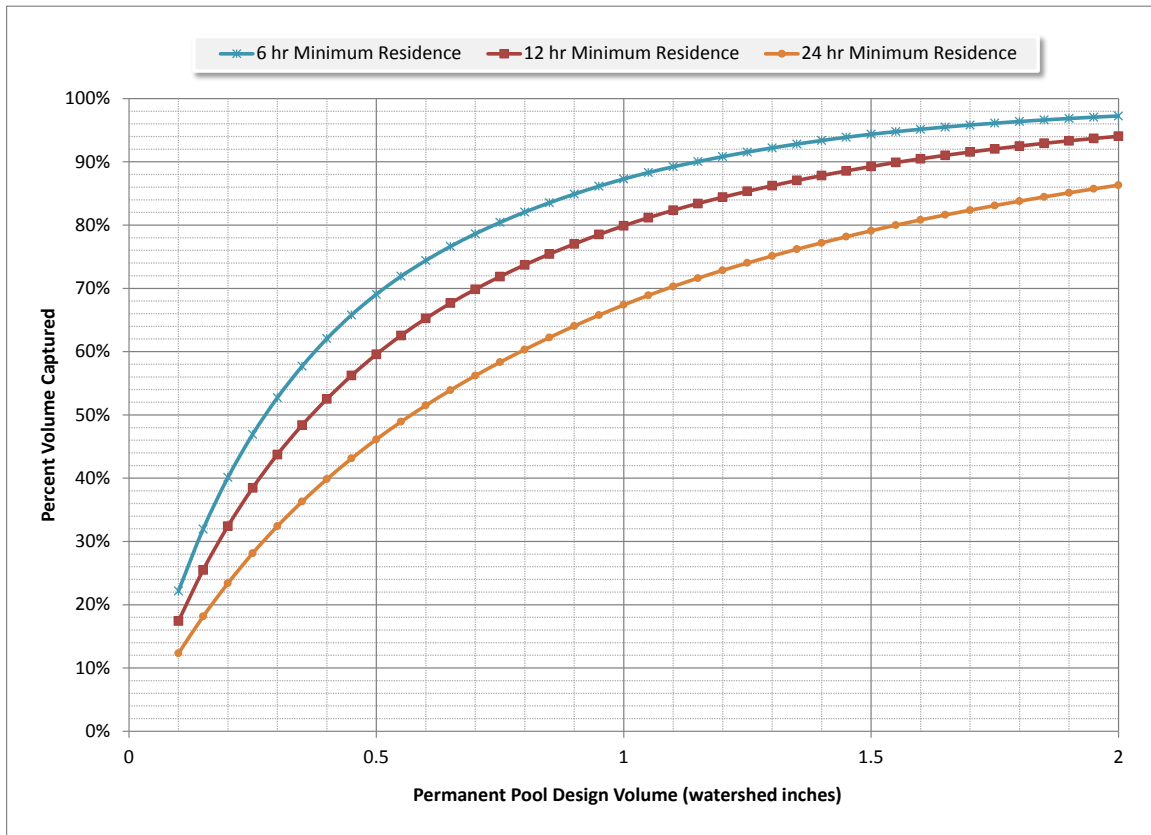

Figure 4: Wet Pond Sizing Nomograph

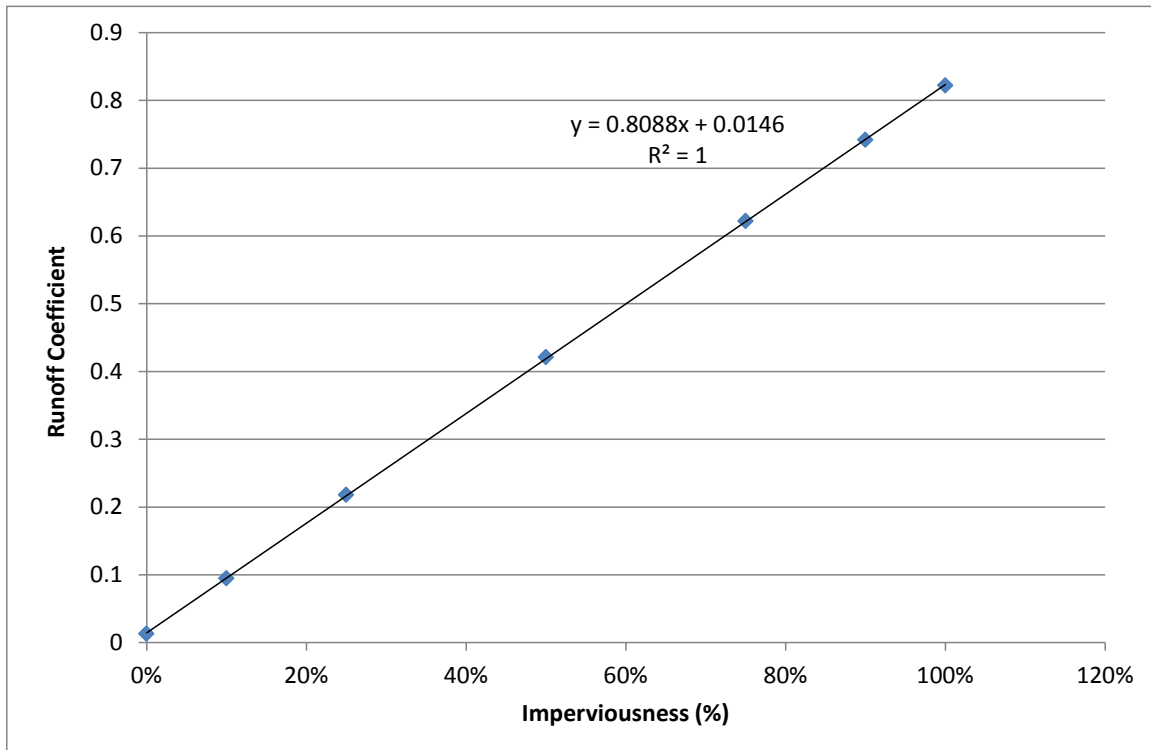

Figure 5: Long-term Runoff Coefficient Estimates

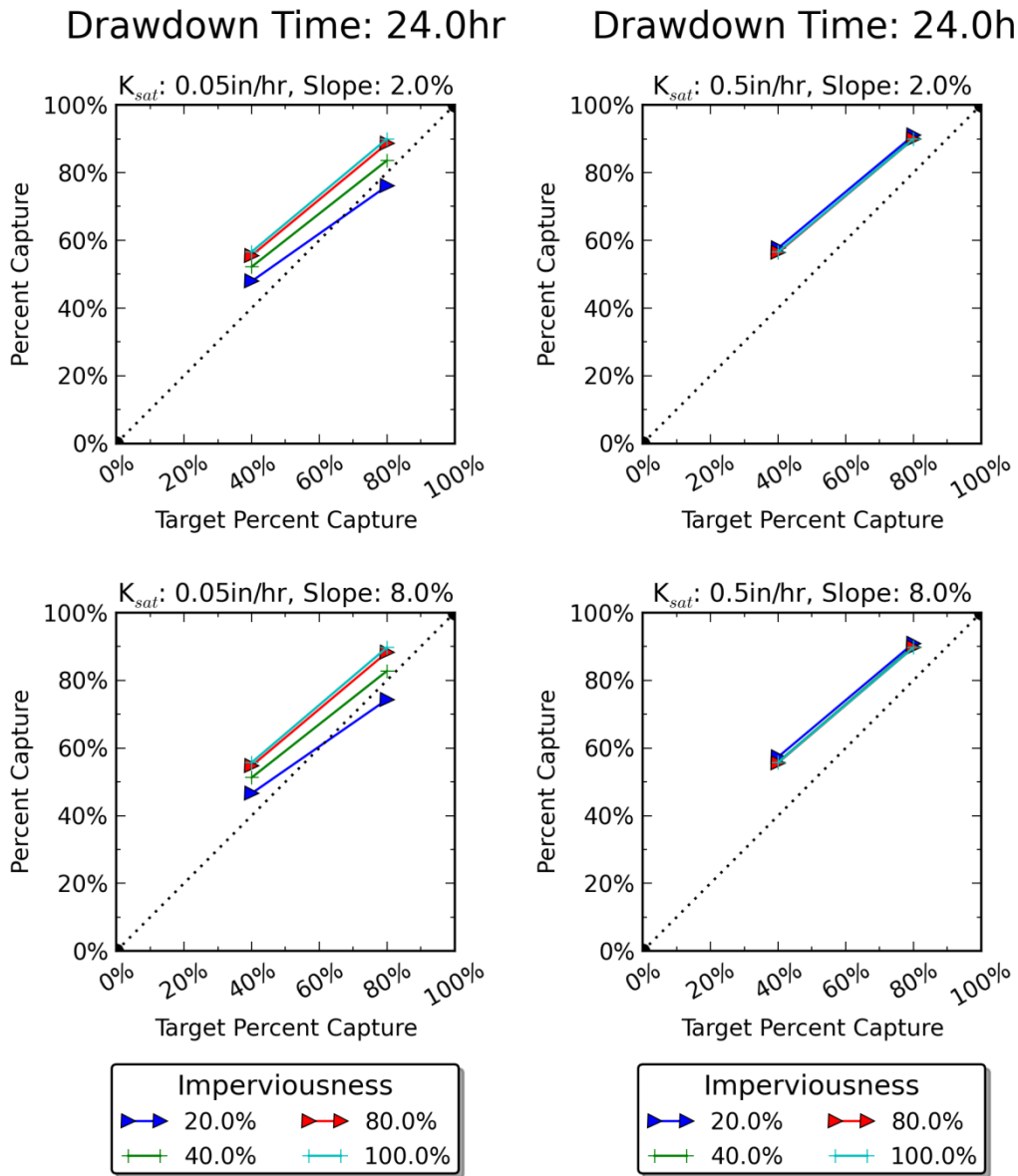

Figure 6: Sensitivity Analysis of Volume-based BMPs – 24 Hour Drawdown Times

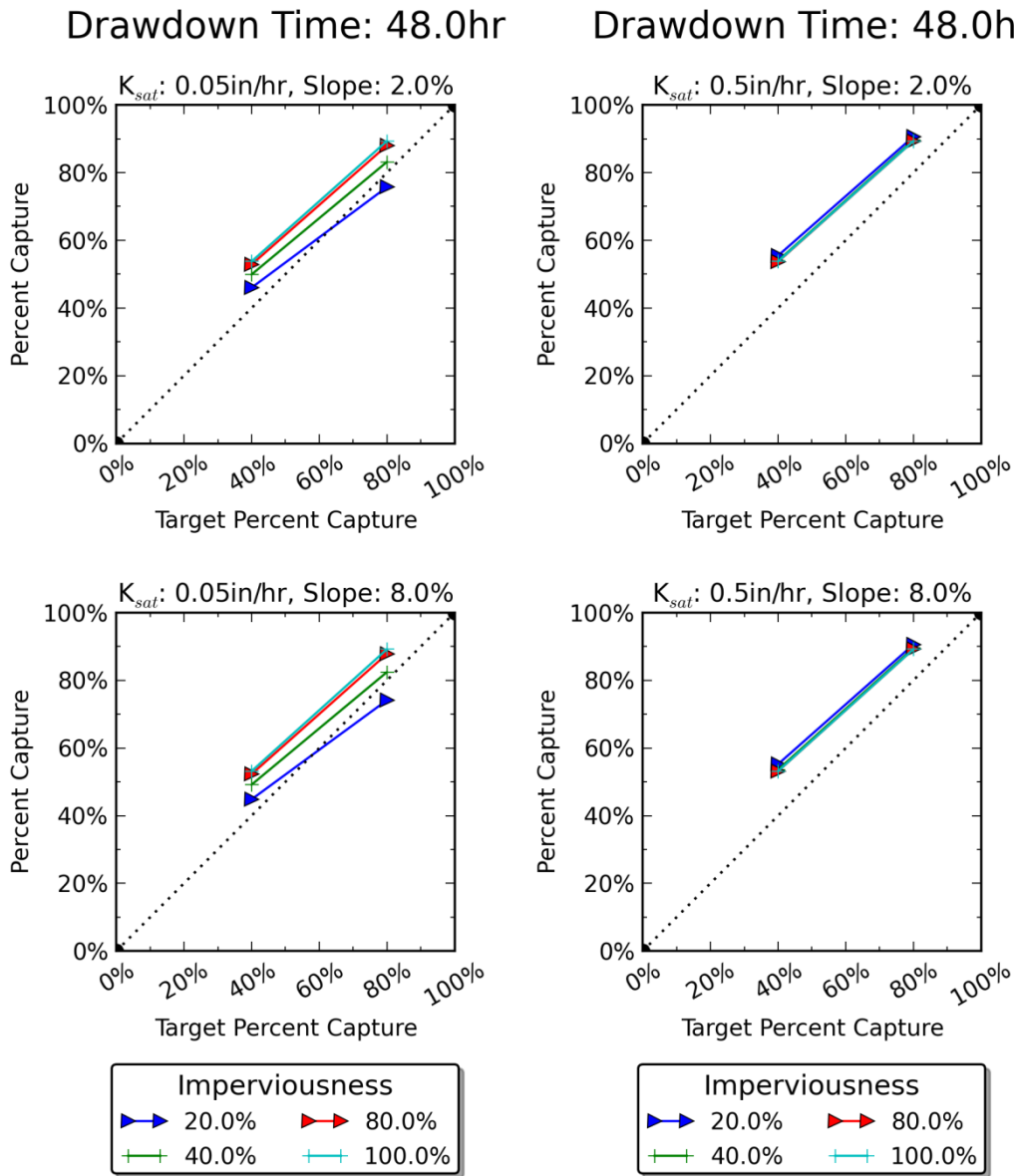

Figure 7: Sensitivity Analysis of Volume-based BMPs – 48 Hour Drawdown Times

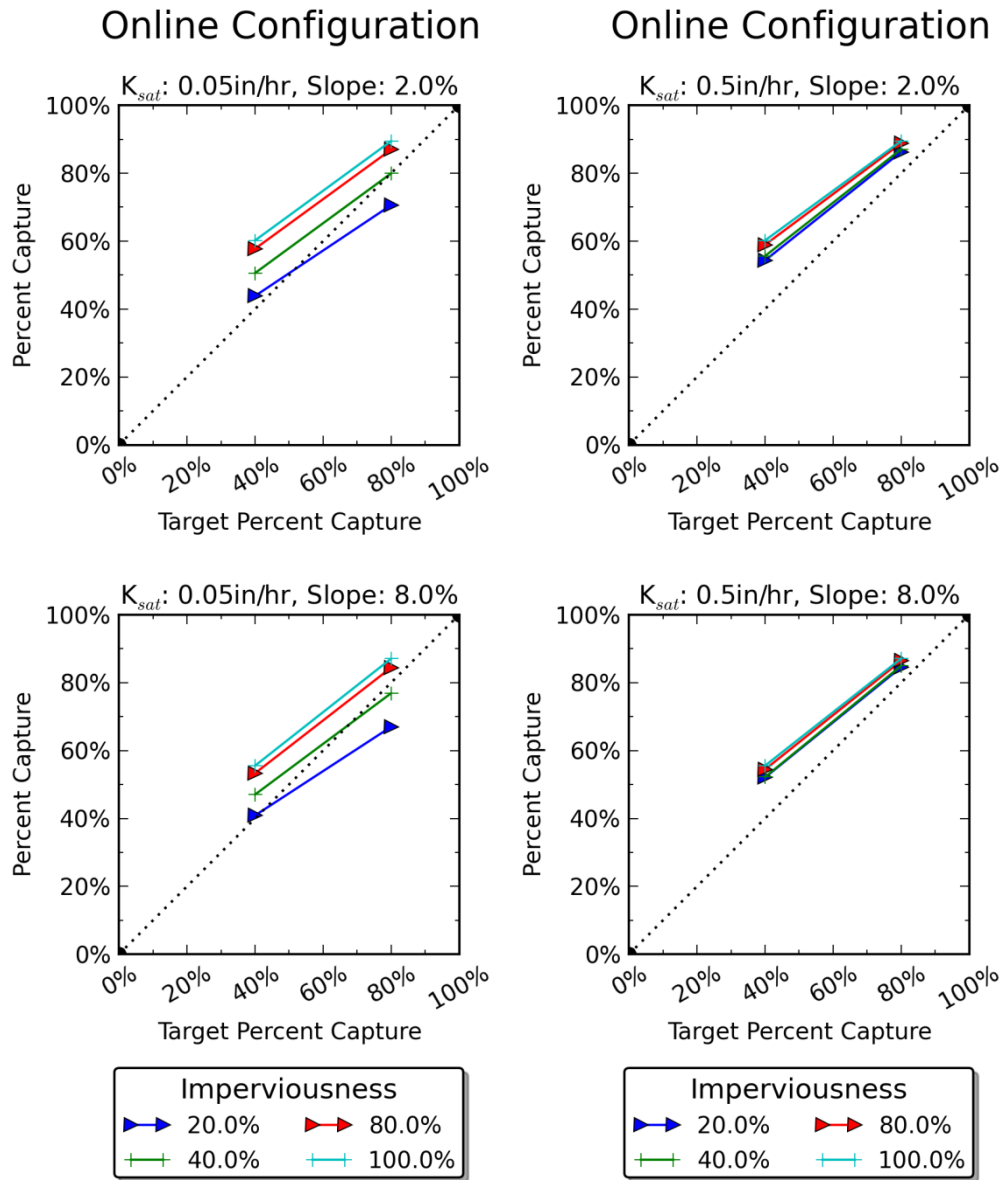

Figure 8: Sensitivity Analysis of Flow-based BMPs – Online Configuration

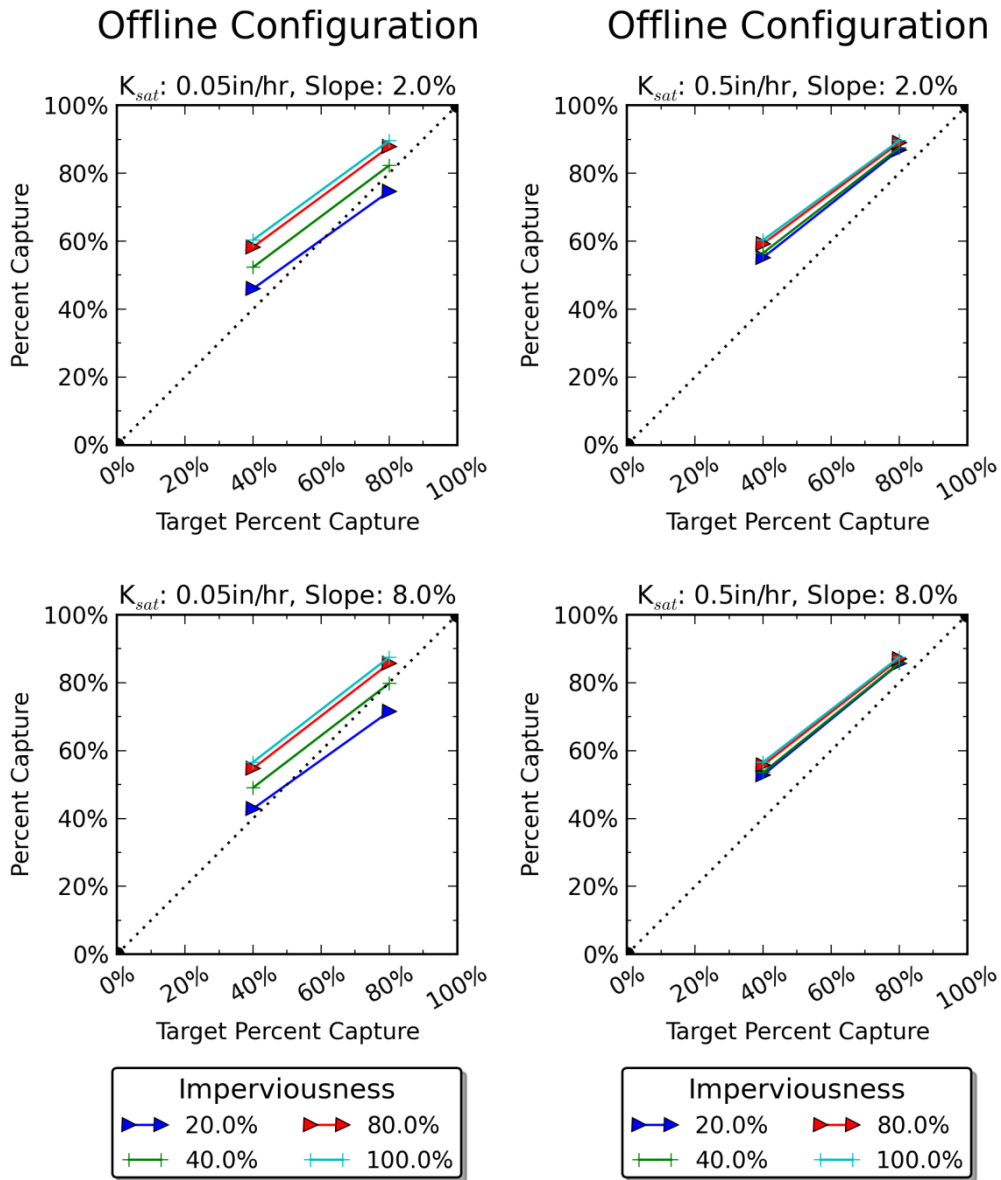

Figure 9: Sensitivity Analysis of Flow-based BMPs – Offline Configuration



Appendix N

Best Management Practices Capital Cost Estimation Methods



APPENDIX N: BMP CAPITAL COST ESTIMATION METHODS

N.1 BMP Cost Data Sources

The BMP cost estimates used in this DSM are intended for high-level planning purposes to evaluate the relative potential capital costs for different BMP types. The BMP costs for non-proprietary BMPs are generally based on engineer's estimates supported by available unit cost information from 2010 RSMeans® data and confidential vendor quotes. The relative cost ranking for proprietary BMPs was developed from cost information provided by a local vendor. The vendor-provided cost was increased by 75 percent to include cost of installation, per the vendor's recommendation. Cost estimates assume a redevelopment scenario (rather than new development) to take into account current infrastructure at the Port facilities.

Cost estimates have been developed based on generic BMP designs representing a "typical" range of design criteria and site conditions influencing cost. The distinct differences between BMP types that influence differential cost (e.g., materials, geometry, typical scale of installation) are accounted for in developing unit costs (e.g., \$ per ft³) for the physical BMP size and/or water quality volume. This approach was selected instead of using empirically-developed unit cost equations to better isolate the differences between BMP types and how they affect overall costs and to consider only incremental costs over baseline conditions in a redevelopment scenario.

While the line items vary between BMP types, they all include the costs for the BMP itself (e.g., retaining walls, vegetation, cisterns, pond liners) which are described in the individual BMP Fact Sheets. In addition these estimates include, where relevant, costs for excavation, hauling, backfill and compaction, and fencing, and they include a 10 percent contingency to account for site-specific design considerations.

Capital redevelopment costs account for incremental costs associated with constructing BMPs in developed commercial and industrial areas. This includes soil decompaction, demolition and disposal of existing impervious area, and an increase in haul distance for excavated fill for relevant BMPs. Land costs are not included as a component of the BMP unit costs¹. Engineering and planning and mobilization costs are not included in unit costs, except for specialized BMP types, as they are not considered to be an incremental cost for redevelopment projects. In addition, the BMP unit costs do not include the costs for supporting infrastructure, which would need to be evaluated on a site-specific basis (e.g., drainage conveyance modifications, pump stations, etc.)

N.2 BMP Sizing Methods

The BMPs are sized for the water quality design volume or water quality design flow required to meet the 80 percent mean annual runoff capture standard (see Chapter 4, Stormwater Management Standard Water Quality-Capture and Treat) using generic nomographs developed for the Port (refer to Appendix L, Nomographs for Water Quality BMP Sizing). Nomographs were developed for (1) volume-based BMPs, (2) flow-based BMPs and (3) wet pool BMPs. Per

¹ Land costs are not included as a component of BMP unit costs as they can be highly variable and the availability of otherwise unused land within the development footprint will vary across project types. In cases where the otherwise unused land area is not sufficient to site a BMP, additional costs should be added to the BMP unit costs to account for land acquisition and/or the opportunity cost associated with loss of developable area.



the nomographs, for volume-based BMPs, the design storm depth for a 48-hour drawdown time is 0.65 inches. For flow-based BMPs, the design storm intensity used to size BMPs is 0.13 in/hr, which is the intensity for a 5-minute time of concentration for an offline system. For wet pool BMPs, the design storm depth for a minimum residence time of 12 hours is 1 inch. Because the costs would scale for all sites with an increase in impervious area and this value is heterogeneous across the Port, the costs here reflect the cost for a 100 percent impervious area. With this impervious area, a runoff coefficient of 0.84 is used for BMP sizing, which was calculated using the volumetric runoff coefficient in Chapter 4, Stormwater Management Standard Water Quality-Capture and Treat.

The above characteristics are used to determine the water quality volume and water quality flow rates used for the cost estimation methodology. Because the cost equations are not linear, cost estimates are developed for a BMP treating runoff from a 1-acre site and a 10-acre site. The design water quality design volumes for volume-based BMPs are 1,982 and 19,820 ft³, respectively, and for wet pools are 3,049 and 30,492 ft³, respectively. For flow-based BMPs, the water quality design flow rates are 0.11 and 1.07 cfs, respectively.

N.2.1 Cost Estimations

Cost rankings are based on the average per-acre cost for each BMP which is the average of the 1-acre cost and the per-acre cost for the 10-acre option; this method uses both sizes to account for the effect on cost from scaling some of the BMPs to larger sizes. The cost category breakdown used to rank relative costs are shown in Table 1.

Table 1: Relative Cost Rankings

Cost Ranking Category	Range (\$/impervious acre treated)
\$	< \$10,000
\$\$	\$10,000 - \$25,000
\$\$\$	\$25,000 - \$100,000
\$\$\$\$	> \$100,000

The BMP costs for treating both the 1- and 10-acre impervious areas, rounded to the nearest \$1,000, are shown in Table 2 and Table 3.

**Table 2: Relative Capital Cost Estimates for Non-Proprietary BMPs (2010 \$)**

BMP Category	Specific BMP	1-Acre Cost (\$K)	10-Acre Cost (\$K)	Avg Per-Acre Cost (\$K)	Cost Ranking Category
DSM-1: Extended dry detention basins	Extended dry detention basin	\$24	\$66	\$15	\$\$
DSM-2: Wet basins	Wet pond	\$28	\$119	\$20	\$\$
DSM-2: Wet basins	Wetland basin	\$23	\$91	\$16	\$\$
DSM-2: Wet basins	Pocket wetland	\$23	\$108	\$17	\$\$
DSM-3: Subsurface flow wetlands	Subsurface flow wetland*	\$46	\$182	\$32	\$\$\$
DSM-4: Bioretention	Bioretention basin without underdrain	\$19	\$157	\$17	\$\$
DSM-4: Bioretention	Bioretention basin with underdrain	\$23	\$197	\$21	\$\$
DSM-5: Infiltration trenches	Infiltration trench	\$22	\$204	\$21	\$\$
DSM-6: Vegetated swales	Vegetated swale without underdrain	\$10	\$15	\$6	\$
DSM-6: Vegetated swales	Vegetated swale with underdrain	\$11	\$17	\$6	\$
DSM-7: Vegetated filter strips	Vegetated filter strip	\$2	\$16	\$2	\$
DSM-8: Media bed filters	Media bed filter	\$18	\$136	\$16	\$\$
DSM-9: Underground stormwater control facilities	Detention USCF	\$46	\$389	\$42	\$\$\$
DSM-9: Underground stormwater control facilities	Infiltration USCF	\$46	\$389	\$42	\$\$\$
DSM-9: Underground stormwater control facilities	Wet USCF	\$46	\$389	\$42	\$\$\$
DSM-10: Pervious pavement	Pervious pavement	\$20	\$189	\$19	\$\$
DSM-11: Building BMPs	Planter box filter	\$33	\$274	\$30	\$\$\$
DSM-11: Building BMPs	Green roof	\$212	\$2,102	\$211	\$\$\$\$
DSM-11: Building BMPs	Cistern	\$67	\$477	\$57	\$\$\$
DSM-11: Building BMPs	Dry well	\$55	\$546	\$55	\$\$\$

*Note: USEPA reported that subsurface flow wetlands are between 1.8 and 2.3 times the cost of free water surface wetlands for 0.1 MGD wastewater treatment depending on liner type^{2,3}, so the cost estimate used here is double the cost of that for a wetland basin.

² United States Environmental Protection Agency, Office of Water (2000). *Wastewater technology fact sheet: Free water surface wetlands* (EPA Publication No.832-F-00-024). Washington, DC: US EPA.

³ United States Environmental Protection Agency, Office of Water (2000). *Wastewater technology fact sheet: Wetlands: Subsurface flow* (EPA Publication No.832-F-00-023). Washington, DC: US EPA.

**Table 3: Relative Capital Cost Estimates for Proprietary BMPs**

BMP Category	Specific BMP (basis for Local Vendor Cost Estimate)	1-Acre Cost (\$K)	10-Acre Cost (\$K)	Avg Per-Acre Cost (\$K)	Cost Ranking Category
DSM-12: Cartridge Filter	1 acre: 4-Cartridge Catch Basin StormFilter 10 acres: 8x14 StormFilter with 33 Cartridges (15 gpm cartridges and perlite media for both)	\$29	\$121	\$21	\$\$
DSM-13: Oil/Water Separator	1 acre: Vortclarex VCL30 10 acres: Vortclarex VCL80-2	\$20	\$59	\$13	\$\$
DSM-14: Hydrodynamic Separator	1 acre: CDS2015-4 10 acres: CDS2020	\$13	\$23	\$8	\$

NOTE: The relative cost ranking for proprietary BMPs was developed from cost information provided by a local vendor. The vendor-provided cost was increased by 75 percent to include cost of installation, per the vendor's recommendation.



Appendix O

BMP Operations and Maintenance Level of Effort





APPENDIX O: BMP OPERATIONS AND MAINTENANCE LEVEL OF EFFORT

O.1 BMP Operations and Maintenance Data Sources

This section presents planning level operations and maintenance (O&M) estimates, which are reported in terms of average annual hourly requirement (level of effort (LOE)). Scaling and ranking BMPs by level of effort enables comparison of annual labor intensity, but cannot capture the costs associated with varied hourly rates, repair and replacement of machinery, pumps, use of specialized equipment, or other site specific attributes that affect the annual operations and maintenance costs. This O&M comparison was intended to be consistent with the planning-level capital cost estimates presented in the BMP Capital Cost Appendix; therefore the O&M LOE estimates were made assuming a comparable tributary drainage area. Two primary sources were used for the analysis: the National Cooperative Highway Research Program Current Practice of Post-Construction Structural Stormwater Control Implementation for Highways (NCHRP 2013), and the Water Environment Research Foundation BMP and LID Whole Life Cost Models (WERF 2009). The data sources used for each BMP are indicated in Table 1.

O.1.1 NCHRP & WERF Methodologies and Limitations

The NCHRP provided O&M spreadsheets that report the number of maintenance hours and cost calculations for a 2 acre drainage area and a 7 acre drainage area. NCHRP cautions against using the estimates for a drainage area larger than 7 acres. Consequently, the estimates are not appropriate for regional BMPs that would treat a larger drainage area (e.g., 100 acres). In addition, NCHRP states that site-specific influences such as local hydrology, soils, drainage area, BMP design constraints and local regulatory requirements will influence the estimates for both cost and annual hourly LOE.

WERF included annual hourly requirements in its O&M cost analysis spreadsheet model. The estimates assume a 'Medium' level of maintenance activity. For most BMPs, the LOE estimates could not be scaled based on tributary drainage area. The only exceptions were bioretention, green roofs, planter boxes, and cisterns. For the other BMPs, WERF's LOE estimates were based on a default tributary area. WERF indicates that these default hours and tributary drainage area were taken from data collected from agencies across the U.S. when available, and based on the survey data, it was generally not possible to see the influence of system size on LOE. Instead, the data showed that there are likely to be a range of other often more significant factors that may influence the level of maintenance inputs at a particular site. This is why the O&M LOE for very few BMPs was based on a relationship between BMP size and maintenance costs. In addition, WERF noted that maintenance activities, site needs, and actual cost of maintenance are all highly variable from site to site and that O&M estimation must take the needs of the specific project into consideration. Based on the drainage areas used, only the wet basin LOE estimate is considered for a regional BMP (default drainage area of 50 acres). The other estimates are not considered appropriate for regional BMPs.



Table 1: Data Sources for O&M Level of Effort Estimates

BMP	Data Sources Used
DSM-1: Extended Dry Detention Basins	NCHRP 2013 ¹ , WERF 2009 ²
DSM-2: Wet Basins	NCHRP 2013, WERF 2009
DSM-3: Subsurface Flow Wetlands	NCHRP Wet Basin ³
DSM-4: Bioretention	NCHRP 2013, WERF 2009
DSM-5: Infiltration Trenches ⁴	NCHRP 2013
DSM-6: Vegetated Swales	NCHRP 2013, WERF 2009
DSM-7: Vegetated Filter Strips	NCHRP 2013
DSM-8: Media Bed Filters	NCHRP 2013
DSM-9: Underground Detention (lined)	NCHRP 2013 ⁵
DSM-9: Underground Detention (open bottom)	NCHRP 2013 ⁵
DSM-10: Pervious Pavement	WERF 2009
DSM-11: Building BMPs:	
Planter Box Filters	WERF 2009
Green Roofs	WERF 2009
Cisterns	WERF 2009
Dry Wells	WERF 2009 ⁵
DSM-12: Cartridge Filter Vaults	NCHRP 2013
DSM-13: Oil/Water Separators	NCHRP 2013
DSM-14: Hydrodynamic Separators	NCHRP 2013

Notes:

- ¹ NCHRP 25-25/83: *Current Practice of Post-Construction Structural Stormwater Control Implementation for Highways.*
- ² WERF SW2R08: *BMP and LID Whole Life Cost Models 2009.*
- ³ *The LOE for sub-surface flow wetlands was assumed to be the same as the NCHRP wet basin LOE, based on EPA1 information, which reported comparable O&M costs for surface flow wetlands and sub-surface flow wetlands. Although both NCHRP and WERF estimates were used for wet basins, the higher LOE estimate reported by NCHRP was judged to be more appropriate for subsurface flow wetlands.*
- ⁴ *Information provided for infiltration trenches was adapted from NCHRP infiltration basins.*
- ⁵ *Because LOE estimates were not available for the BMP, O&M line items for other BMPs requiring similar O&M activities were used based on engineering judgment to develop the LOE estimate.*

¹ USEPA. Wastewater Technology Fact Sheet Free Water Surface Wetlands, EPA 832-F-00-024 (September 2000) and Wastewater Technology Fact Sheet Wetlands: Subsurface Flow, EPA 832F-00-023 (September 2000).



Table 2 summarizes the tributary area used for each BMP to estimate the O&M LOE, including whether it was a default or user-input value for the WERF reference, and whether 2 acres or 7 acres was used for the NCHRP estimate. Due to the limitations of the data sources, the O&M LOE estimates for each BMP could not be normalized based on the tributary drainage area.

Table 2: Summary of Tributary Drainage Assumptions for O&M Level of Effort Analysis

BMP	Units	WERF Default Tributary Drainage Area	WERF User-Input Tributary Drainage Area	NCHRP Default Tributary Area
DSM-1: Extended Dry Detention Basins	Acres	10	Default ¹	7
DSM-2: Wet Basins	Acres	50	Default ¹	7
DSM-3: Subsurface Flow Wetlands ²	Acres	--	--	7
DSM-4: Bioretention Basins	Acres	1	2	2
DSM-5: Infiltration Trenches	--	--	--	2
DSM-6: Vegetated Swales	Acres	2	Default ¹	2
DSM-7: Vegetated Filter Strips	--	--	--	2
DSM-8: Media Bed Filters	--	--	--	2
DSM-9: Underground Detention (lined)	--	--	--	2
DSM-9: Underground Detention (open bottom)	--	--	--	2
DSM-10: Pervious Pavement	ft ²	21,780	Default ¹	--
DSM-11: Building BMPs:				
Planter Box Filters ³	ft ²	1,000	10,000	--
Green Roofs	ft ²	10,000	10,000	--
Cisterns	ft ²	5,000	10,000	--
Dry Wells	--	--	--	--
DSM-12: Cartridge Filter Vaults	--	--	--	2
DSM-13: Oil/Water Separators	--	--	--	2
DSM-14: Hydrodynamic Separators	--	--	--	2

Notes:

-- indicates no data available

¹The default value could not be changed.

²Subsurface flow wetland LOE is based on NCHRP estimates for wet basins.

³The estimates for Planter Box Filters were made using WERF's Rain Garden tool.



O.2 BMP Operations & Maintenance Level of Effort Summary

Table 3 summarizes the O&M LOE for each BMP, provides a ranking (i.e., low, medium, high), and lists the major and specialized equipment required. The LOE ranking process was based on the annual hourly requirement for each BMP as determined by the NCHRP and WERF references. For BMPs using both data sources, the LOE was the average of the two estimates. Information on required equipment was acquired directly from the NCHRP source, from Western Washington LID O&M Guidance document (Herrera Environmental Consultants, Inc. and Washington Stormwater Center 2013), or assumed using engineering judgment. The LOE ranking criteria were developed by qualitatively evaluating the estimates and designating ranges for High, Medium, and Low LOE. A 'Low' LOE was assigned to BMPs with 15 or less annual hours of maintenance needed; a 'Medium' (Med) LOE was assigned to BMPs requiring greater than 15 hours and less than or equal to 25 annual hours of O&M; and 'High' LOW was assigned to BMPs requiring more than 25 annual hours of O&M.

Table 3: BMP O&M Level of Effort and Major Equipment

BMP	Annual O&M Hours Required ^{1, 2}	L.O.E. ³	Major and Specialized Equipment Required
DSM-1: Extended Dry Detention Basins	27	High	Utility Truck, 10-15 yd Truck, Backhoe
DSM-2: Wet Basins	34	High	Utility Truck, 10-15 yd Truck, Backhoe, Flame Weeder or Hot Water Weeder,
DSM-3: Subsurface Flow Wetlands	50	High	Utility Truck, Vactor, Flame Weeder or Hot Water Weeder,
DSM-4: Bioretention Basins	25	Med	Utility Truck, 10-15 yd Truck, Backhoe or Mini Excavator, Vactor Truck, Flame Weeder or Hot Water Weeder, Water Jet or root Saw (Vactor truck tools for clearing roots from underdrains)
DSM-5: Infiltration Trenches	16	Med	Utility Truck, 10-15 yd Truck, Backhoe or Mini Excavator
DSM-6: Vegetated Swales	17	Med	Utility Truck, 10-15 yd Truck, Backhoe or Mini Excavator, Flame Weeder or Hot Water Weeder,
DSM-7: Vegetated Filter Strips	14	Low	Utility Truck, Flame Weeder or Hot Water Weeder,
DSM-8: Media Bed Filters	15	Low	Utility Truck, 10-15 yd Truck, Backhoe or Mini Excavator
DSM-9: Underground Detention (lined)	20	Med	Utility Truck, 10-15 yd Truck, Vactor Truck
DSM-9: Underground Detention (open bottom)	21	Med	Utility Truck, 10-15 yd Truck, Vactor Truck



BMP	Annual O&M Hours Required ^{1, 2}	L.O.E. ³	Major and Specialized Equipment Required
DSM-10: Permeable Pavement	7	Low	Utility Truck, Hand Held Pressure Washer, Street Sweeper/Regenerative Air Sweeper, Paving Equipment
DSM-11: Building BMPs:			
Planter Box Filters	18	Med	Utility Truck, Rototiller, Line Trimmer
Green Roofs	82	High	Utility Truck, Line Trimmer, Fall Prevention
Cisterns	31	High	Utility Truck, Fall Prevention
Dry Wells	6	Low	Utility Truck
DSM-12: Cartridge Filter Vaults	24	Med	Utility Truck, 10-15 yd Truck
DSM-13: Oil/Water Separators	16	Med	Utility Truck, 10-15 yd Truck, Vactor Truck
DSM-14: Hydrodynamic Separators	15	Low	Utility Truck, Vactor Truck

Notes:

¹ Hours were computed by averaging NCHRP and WERF level of effort estimates where both were available.

² The estimate is for the BMP tributary drainage area shown in Table 2.

³ Level of Effort Ranking Criteria (Annual Hours): Low = ≤15; Med = 15< X ≤25; High = >25

O.3 BMP Level of Effort Summary Tables

The following tables include the O&M line items for each BMP from the NCHRP and WERF data sources, a description of the prescribed maintenance activities, and the estimated LOE. In some cases, engineering judgment was used to adjust the frequency or number of hours for a given maintenance requirement; deviations from original source material have been noted at the end of each table.



Table 4: Extended Dry Detention Basin (DSM-1)

NCHRP (7 acres)						WERF (10 acres)				
Maintenance	Action Required	# Per Year	Hours	Crew	Total Hours	Maintenance	# Per Year	Hours	Crew	Total Hours
<i>Minor</i>						<i>Routine</i>				
Vegetation Management for Aesthetics	Cut vegetation to an average height of 6-inches and remove trimmings. Remove any trees, or woody vegetation.	2	2	2	8	Inspection, Reporting & Information Management	0.3	2	1	0.7
Trash and Debris	Remove and dispose of trash and debris	1	2	2	4	Vegetation Management with Trash & Minor Debris Removal	1	4	2	8
General Maintenance Inspection	Corrective action prior to wet season. Consult engineers if immediate solution is not evident.	1	2	2	4	Vector Control	0.3	4	1	1.3
Reporting		1	3	1	3					
<i>Major</i>						<i>Infrequent</i>				
Slope Stability	Reseed/revegetate barren spots prior to wet season.	1	4	2	8	Intermittent Facility Maintenance (Excluding Sediment Removal) ¹	1	3	3	9
Standing Water	Drain facility. Corrective action prior to wet season. Consult engineers if immediate solution is not evident.	1	1	2	2	Sediment Removal ²	0.1	16	3	4
Sediment Management	Remove and properly dispose of sediment. Regrade if necessary. (expected every 50 years)	0.02	16	3	1		Annual Man Hours			23
Annual Hours					30					

Notes:

¹ Intermittent maintenance hours set to 3; crew set to 1

² Sediment removal hours set to 16; crew set to 3



Table 5: Wet Basins (DSM-2 & DSM-3)

NCHRP (7 acres)						WERF (50 acres)				
Maintenance	Action Required	# Per Year	Hours	Crew	Total Hours	Maintenance	# Per Year	Hours	Crew	Total Hours
<i>Minor</i>						<i>Routine</i>				
24-hour draw down measured between the rim of the outlet structure and invert of the WQ orifice in the outlet structure.	If greater than 24 hours then discharge water to permanent pool elevation, clear outlet of debris. Notify engineer if needed.	1	2	2	4	Inspection, Reporting & Information Management	0.3	2	1	0.7
Trash and Debris	Remove and dispose of trash and debris	1	2	2	4	Vegetation Management with Trash & Minor Debris Removal	1	4	2	8
General Maintenance Inspection	Corrective action prior to wet season. Consult engineers if immediate solution is not evident.	1	1	2	4	Vector Control	0.3	4 ¹	1	1.3
Reporting		1	3	1	3					
<i>Major</i>						<i>Infrequent</i>				
Vegetation Management ²	1. Have a biologist survey the wet pond to determine if any birds are nesting or other sensitive animals are present. If birds are nesting, with advice from the biologist, proceed with the maintenance. 2. Lower and maintain the water level to expose the area to be maintained, do not completely drain basin. 3. Mechanically remove all plants vegetation. 4. Dispose of the vegetation material in a landfill or other appropriate disposal area. 5. Restock mosquito fish as recommended by vector control agency.	0.1	40	4	16	Intermittent Facility Maintenance (Excluding Sediment Removal) ³	1	3	1	3



NCHRP (7 acres)						WERF (50 acres)				
Maintenance	Action Required	# Per Year	Hours	Crew	Total Hours	Maintenance	# Per Year	Hours	Crew	Total Hours
Sediment Management	Remove and properly dispose of sediment. Prior to start of wet season, restore vegetation to the plan shown on the as-built drawings. (expected every 5 years)	0.2	24	4	19	Sediment Dewatering & Removal: Forebay ⁴	0.13	4	3	1.5
			Annual Hours			Sediment Dewatering & Removal: Main Pool ⁵	0.05	16	3	2.4
						Annual Hours				17

Notes:

- ¹ Vector control included for parity with NCHRP.
- ² Frequency adjusted from 1 to .1 occurrences per year.
- ³ Intermittent maintenance hours set to 3; crew set to 1
- ⁴ Sediment dewatering – Forebay hours set to 4; crew set to 3
- ⁵ Sediment dewatering – Main Pool hours set to 16; crew set to 3
- ⁶ This value was assumed to be the LOE for DSM-3: Subsurface Flow Wetlands



Table 6: Bioretention Basins (DSM-4)

NCHRP (2 acres)						WERF (2 acres)				
Maintenance	Action Required	# Per Year	Hours	Crew	Total Hours	Maintenance	# Per Year	Hours	Crew	Total Hours
<i>Minor</i>						<i>Routine</i>				
Vegetation Management for Aesthetics (optional)	Cut vegetation to an average height of 6-inches and remove trimmings. Remove any trees, or woody vegetation.	1	2	2	4	Inspection, Reporting & Information Management	0.5	4	1	2
Soil Repair	Reseed/revegetate barren spots prior to wet season.	1	4	2	8	Vegetation Management with Trash & Minor Debris Removal	2	4	2	16
Trash and Debris	Remove and dispose of trash and debris	1	2	2	4	<i>Infrequent</i>				
General Maintenance Inspection	Corrective action prior to wet season. Consult engineers if immediate solution is not evident.	1	1	2	2	Till Soil	0.25	4	2	2
Reporting		1	3	1	3	Unclog Drain	0.5	2	1	1
<i>Major</i>						Replace Mulch	0.5	4	2	4
Standing Water	Drain facility. Corrective action prior to wet season. Consult engineers if immediate solution is not evident.	1	1	2	2				Annual Hours	25
Sediment Management ¹	Remove and properly dispose of sediment. Regrade if necessary. (expected every 20 years)	0.05	8	2	1					
Underdrains	Corrective action prior to wet season. Consult engineers if immediate solution is not evident.	1	0.5	2	1					
					Annual Hours	25				

Note:

¹ Frequency adjusted from 0.025 to 0.05 occurrences per year.



Table 7: Infiltration Trench¹ (DSM-5)

NCHRP (2 acres)					
Maintenance	Action Required	# Per Year	Hours	Crew	Total Hours
<i>Minor</i>					
Trash and Debris, & Sediment ²	Remove and dispose of trash and debris	1	4	2	8
General Maintenance Inspection	Corrective action prior to wet season. Consult engineers if immediate solution is not evident.	1	1	2	2
Reporting		1	3	1	3
<i>Major</i>					
Sediment Management ³	Remove and properly dispose of sediment. Regrade if necessary. (expected every 25 years)	0.04	24	3	3
			Annual Hours	16	

Notes:

- ¹ *Minor vegetation maintenance has been removed from this table as per design recommendations in the Infiltration Trench Fact Sheet (no vegetation).*
- ² *Hours increased from 2 to 4 to account for additional routine sediment removal.*
- ³ *Frequency adjusted from 0.025 to 0.04 occurrences per year.*



Table 8: Vegetated Swale (DSM-6)

NCHRP (2 acres)						WERF (2 acres)					
Maintenance	Action Required	# Per Year	Hours	Crew	Total Hours	Maintenance	# Per Year	Hours	Crew	Total Hours	
<i>Minor</i>						<i>Routine</i>					
Vegetation Management for Aesthetics (optional)	Cut vegetation to an average height of 6-inches and remove trimmings. Remove any trees, or woody vegetation.	2	1	2	4	Inspection, Reporting & Information Management	0.3	2	1	0.67	
Trash and Debris	Remove and dispose of trash and debris	1	1	2	2	Vegetation Management with Trash & Minor Debris Removal	1	4	2	8	
General Maintenance Inspection	Corrective action prior to wet season. Consult engineers if immediate solution is not evident.	1	1	2	2	<i>Infrequent</i>					
Reporting		1	3	1	3	Corrective Maintenance	0.3	8	4	8	
<i>Major</i>										Annual Hours	17
Vegetation Repair	Reseed/revegetate barren spots prior to wet season.	1	2	2	4						
Sediment Management ¹	Remove and properly dispose of sediment. If flow is channeled regrade as necessary. (expected every 15 years)	0.07	4	2	1						
Underdrains ²	Corrective action prior to wet season. Consult engineers if immediate solution is not evident.	1	0.5	2	1						
					Annual Hours	17					

Notes:

¹ Frequency adjusted from 0.033 to 0.066 occurrences per year.

² Underdrain maintenance included as per design recommendations in the Vegetated Swale Fact Sheet. Values sourced from NCHRP Media Bed Filter.



Table 9: Vegetated Filter Strips (DSM-7)

NCHRP (2 acres)					
Maintenance	Action Required	# Per Year	Hours	Crew	Total Hours
<i>Minor</i>					
Vegetation Management for Aesthetics (optional)	Cut vegetation to an average height of 6-inches and remove trimmings. Remove any trees, or woody vegetation.	2	1	2	4
Trash and Debris	Remove and dispose of trash and debris	1	1	2	2
General Maintenance Inspection	Corrective action prior to wet season. Consult engineers if immediate solution is not evident.	1	1	2	2
Reporting		1	3	1	3
<i>Major</i>					
Vegetation Repair	Reseed/revegetate barren spots prior to wet season. (expected every 3 years)	0.3	4	2	3
			Annual Hours	14	



Table 10: Media Bed Filters (DSM-8)

NCHRP (2 acres)					
Maintenance	Action Required	# Per Year	Hours	Crew	Total Hours
<i>Minor</i>					
Trash and Debris	Remove and dispose of trash and debris	1	2	2	4
General Maintenance Inspection	Corrective action prior to wet season. Consult engineers if immediate solution is not evident.	1	1	2	2
Reporting		1	3	1	3
<i>Major</i>					
Drain time	Drain facility. Remove and dispose of sediment, trash and debris. Check orifice. Notify engineer to consider removing top 2 inches of media and dispose of sediment. Restore media depth to 18 inches when overall media depth drops to 12 inches. Complete prior to wet season. (expected every 6 years)	0.2	8	3	4
Sediment Management ¹	Remove and properly dispose of sediment. Regrade if necessary. (expected every 25 years)	0.04	8	3	1
Underdrains	Corrective action prior to wet season. Consult engineers if immediate solution is not evident.	1	0.5	2	1
			Annual Hours	15	

Note:

¹ Frequency adjusted from 0.029 to 0.04 occurrences per year.



Table 11 Underground Detention (Lined)¹ (DSM-9)

NCHRP (2 acres)						
Maintenance	NCHRP Line Item Source	Action Required	# Per Year	Hours	Crew	Total Hours
<i>Minor</i>						
24-hour draw down measured between the rim of the outlet structure and invert of the WQ orifice in the outlet structure.	Wet Pond	If greater than 24 hours then discharge water to permanent pool elevation, clear outlet of debris. Notify engineer if needed.	1	2	2	4
Inspect sump for accumulation of material	Hydrodynamic Separator	Empty unit	1	4	2	8
General Maintenance Inspection	Extended Dry Detention	Corrective action prior to wet season. Consult engineers if immediate solution is not evident.	1	1	2	2
Reporting	Std. NCHRP		1	3	1	3
<i>Major</i>						
Standing Water	Extended Dry Detention (2ac)	Drain facility. Corrective action prior to wet season. Consult engineers if immediate solution is not evident.	1	2	2	2
Sediment Management ²	Infiltration Basin	Remove and properly dispose of sediment. (expected every 25 years)	0.04	8	3	1
				Annual Hours		20

Notes:

¹ This table is formed from a composite of NCRHP maintenance recommendations for related BMP's for comparison purposes only. NCHRP 2013 does not provide specific guidance on O&M for lined underground detention.

² Frequency adjusted from 0.03 to 0.04 years.



Table 12 Underground Detention (Open Bottom)¹ (DSM-9)

NCHRP (2 acres)						
Maintenance	NCHRP Line Item Source	Action Required	# Per Year	Hours	Crew	Total Hours
<i>Minor</i>						
24-hour draw down measured between the rim of the outlet structure and invert of the WQ orifice in the outlet structure.	Wet Pond	If greater than 24 hours then discharge water to permanent pool elevation, clear outlet of debris. Notify engineer if needed.	1	2	2	4
Inspect sump for accumulation of material	Hydrodynamic Separator	Empty unit	1	4	2	8
General Maintenance Inspection	Extended Dry Detention	Corrective action prior to wet season. Consult engineers if immediate solution is not evident.	1	1	2	2
Reporting	Std. NCHRP		1	3	1	3
<i>Major</i>						
Standing Water	Extended Dry Detention (2ac)	Drain facility. Corrective action prior to wet season. Consult engineers if immediate solution is not evident.	1	1	2	2
Sediment Management ²	Infiltration Basin	Remove and properly dispose of sediment. (expected every 10 years)	0.1	8	3	2.4
				Annual Hours		21

Notes:

¹ This table is formed from a composite of NCRHP maintenance recommendations for related BMP's for comparison purposes only. NCHRP 2013 does not provide specific guidance on O&M for lined underground detention.

² Frequency adjusted from 0.03 to 0.1 years



Table 13: Pervious Pavement (DSM-10)

WERF (1/2 acre)				
Maintenance	# Per Year	Hours	Crew	Total Hours
<i>Routine</i>				
Inspection, Reporting & Information Management ¹	1	2	1	2
Litter & Minor Debris Removal	1	2	1	2
Permeable pavement vacuum sweeping ²	1	2	1	2
<i>Infrequent Maintenance</i>				
Reestablish infiltration capacity by removing sediment in the upper layers with a vactor truck ³	0.1	8	1	0.8
Annual Man Hours				7

Notes:

¹ Frequency adjusted from 0.033 to 1 occurrence per year.

² Hours adjusted from 1 to 2.

³ The infrequent maintenance required is based on professional judgment and not from the WERF reference.

Table 14: Building BMP's – Planter Box Filters¹ (DSM-11)

WERF (10,000 sq ft)				
Maintenance	# Per Year	Hours	Crew	Total Hours
<i>Routine</i>				
Vegetation Management ²	1	7	2	14
<i>Infrequent Maintenance</i>				
Replace mulch ³	0.3	3	2	2
Till Soil ⁴	0.2	6	2	2.4
Annual Man Hours				18

Notes:

¹ Used WERF guidance for rain gardens for drainage area of 10,000 sq ft.

² Hours adjusted from 2 to 7, Crew adjusted from 10 to 2.

³ Hours adjusted from 30 to 3.

⁴ Hours adjusted from 20 to 6.

**Table 15: Building BMP's – Green Roofs¹ (DSM-11)**

WERF (10,000 sq ft)				
Maintenance	# Per Year	Hours	Crew	Total Hours
<i>Routine</i>				
Inspection, Reporting & Information Management	2	4	1	8
Vegetation Management ²	2	7	2	28
Irrigation Repair ³	2	6	2	24
<i>Infrequent Maintenance</i>				
Corrective Maintenance (membrane patching, re-vegetation, component failure (e.g., clogging))	0.5	8	4	16
Soil Replacement ⁴	0.2	8	4	6.4
Annual Hours				82

Notes:

- ¹ Used WERF guidance for drainage area of 10,000 sq ft.
² Hours adjusted from 10 to 7.
³ Hours adjusted from 10 to 6.
⁴ Frequency adjusted from 0.5 to 0.2 occurrences per year.

Table 16: Building BMP's – Cisterns¹ (DSM-11)

WERF (10,000 sq ft)				
Maintenance	# Per Year	Hours	Crew	Total Hours
<i>Routine</i>				
Inspection, Reporting & Information Management	2	2	1	4
Roof Washing, Cleaning Inflow Filters	2	4	2	16
Tank Inspection and Disinfection	1	4	2	8
<i>Infrequent Maintenance</i>				
Intermittent System Maintenance (System flush, debris & sediment removal from tank)	0.3	3	2	2
Pump Replacement	0.2	3	2	1.2
Annual Hours				31

Note:

- ¹ Used WERF guidance for drainage area of 10,000 sq ft.



Table 17: Building BMP's – Dry Wells¹ (DSM-11)

WERF					
Maintenance	WERF Line Item Source	# Per Year	Hours	Crew	Total Hours
<i>Routine</i>					
Inspection, Reporting & Information Management ²	Bioretention.	1	1	1	1
Litter & Minor Debris Removal	Pervious pavement	1	2	1	2
<i>Infrequent Maintenance</i>					
Corrective Maintenance (unclogging, drainage)	Bioretention underdrains	0.5	2	1	1
Well Replacement (expected every 10 years)	Engineering Judgment	0.1	8	2	1.6
Annual Hours					6

Notes:

¹ This table is formed from a composite of WERF maintenance recommendations for related BMP's for comparison purposes only. WERF 2009 does not provide specific guidance on O&M for dry wells.

² Frequency adjusted from 0.5 to 1; hours adjusted from 4 to 1



Table 18: Cartridge Filter Vaults (DSM-12)

NCHRP (2 acres)					
Maintenance	Action Required	# Per Year	Hours	Crew	Total Hours
<i>Minor</i>					
Standing Water	Drain facility. Corrective action prior to wet season. Consult engineers if immediate solution is not evident.	1	1	2	2
Trash and Debris	Remove and dispose of trash and debris	1	2	2	4
General Maintenance Inspection	Corrective action prior to wet season. Consult engineers if immediate solution is not evident.	1	1	2	2
Reporting		1	3	1	3
<i>Major</i>					
Sediment Management	Remove and properly dispose of sediment.(expected every 5 years)	0.2	8	3	5
Manufacturer's recommended major maintenance	Consult with manufacturer regarding need for replacement of canisters. If manufacturer confirms need, replace canisters. Prior to wet season (expected every 3 years)	0.3	8	3	8
			Annual Hours	24	



Table 19: Oil & Water Separator (DSM-13)

NCHRP (2 acres)					
Maintenance	Action Required	# Per Year	Hours	Crew	Total Hours
<i>Minor</i>					
Trash and Debris	Remove and dispose of trash and debris	1	3	2	6
General Maintenance Inspection	Corrective action prior to wet season. Consult engineers if immediate solution is not evident.	1	1	2	2
Reporting		1	3	1	3
<i>Major</i>					
Standing Water	Drain facility. Corrective action prior to wet season. Consult engineers if immediate solution is not evident.	1	2	2	4
Sediment Management	Remove and properly dispose of sediment. Regrade if necessary. (expected every 35 years)	0.03	8	3	1
			Annual Hours	16	

Table 20: Hydrodynamic Separator (DSM-14)

NCHRP (2 acres)					
Maintenance	Action Required	# Per Year	Hours	Crew	Total Hours
<i>Minor</i>					
Inspect sump for accumulation of material	Empty unit	1	4	2	8
Inspect for standing water	If standing water cannot be removed or remains through the wet season notify VCD.	1	1	2	2
Reporting		1	3	1	3
<i>Major</i>					
Inspection for structural integrity	Immediately consult with engineer and manufacturer's representative to develop a course of action, effect repairs prior to the wet season.	1	1	2	2
			Annual Hours	15	



O.4 References

National Cooperative Highway Research Program (NCHRP)

- 2013 Current Practice of Post-Construction Structural Stormwater Control Implementation for Highways, 2013. Appendix C - Unit Costs and Quantitative Assumptions for Maintenance Cost Estimates

Herrera Environmental Consultants, Inc. and Washington Stormwater Center

- 2013 Western Washington Low Impact Development Operations & Maintenance, 2013. Prepared by Herrera Environmental Consultants, Inc., Seattle, WA. and Washington Stormwater Center, Puyallup, WA.

Water Environment Research Foundation (WERF)

- 2009 Water Environment Research Foundation BMP and LID Whole Life Cost Models, Version 2.0, 2009. SW2R08



Appendix P

Sustainability Considerations For BMPs



APPENDIX P: SUSTAINABILITY CONSIDERATIONS FOR BMPS

P.1 Introduction

This section provides sustainability considerations for the selection, design, and implementation of stormwater management BMPs in the form of a Sustainability Attribute Checklist, which is provided in the Section M.4.2. The considerations in this section and checklist shall be coordinated with the design requirements and guidance provided for BMPs in Chapter 6 as well as the BMP Fact Sheets. The BMPs described in the DSM inherently have direct sustainability benefits related to water quality and flow control at both the site and watershed scales, therefore consideration of those benefits is not incorporated into the checklist.

The sustainability attributes described in this section shall be reviewed by designers for applicability to potential project BMPs, and discussed with the Port to determine if implementation of these attributes shall be pursued. Identifying and considering the sustainability attributes of a stormwater management BMP is an essential element in the Port's efforts to embed sustainability into its day-to-day operations and infrastructure. Incorporating the sustainability attributes during the design phase allows for better anticipation of risks, costs and potential opportunities throughout a project's full life cycle.

Designs that broaden the spectrum of benefits to the Port, community and watershed will ultimately be the most successful, as measured by overall effectiveness, social and environmental impact, and fulfillment of the Port's mission.

P.1.1 Objectives

The objective of this chapter is to:

- Provide the Port and its partners a tool with which to review the sustainability performance of stormwater BMPs before final design and construction, including potential financial, environmental and social opportunities, risks and externalized impacts.

P.1.2 Chapter Contents

This chapter provides information related to the development of the Sustainability Attribute Checklist for the stormwater management BMPs described in the DSM, including the following:

- Methodology: A description of the process and documents consulted in the development of the Sustainability Attribute Checklist, along with an explanation of how to use the checklist.
- Description of Sustainability Attribute Considerations: An overview of each sustainability element and aspect, their relevance to financial, environmental and social criteria, and the key considerations for assessing the individual attributes in the checklist.
- Key Takeaways: A summary review of results and the checklist in table format.



P.2 Methodology

P.2.1 Development of the Sustainability Attributes Checklist

The Sustainability Attribute Checklist was developed by reviewing policies and guiding documents from the Port as well as other sustainability frameworks and resources. The checklist is built to evaluate multiple contexts, but also provide a comprehensive filter to triple bottom line elements (i.e., financial, environmental and social). Each of the resources we examined identifies attributes or best practices used for stormwater management or more general sustainability efforts.

The following documents were reviewed:

- Port of Portland
 - 2010 Sustainability Report
 - Sustainable Natural Resources document
 - Environmental Policy document
 - Greenside Projects – sustainability best practices in action port-wide
- US Environmental Protection Agency
 - Green Infrastructure and Low Impact Development¹
 - “Cool Pavements” – Reducing Urban Heat Island Effects²
- Global Reporting Initiative
 - Sustainability Reporting Guidelines Version 3.1³
- Stormwater management manuals
 - City of Portland, Oregon; Bureau of Environmental Services
 - Western Washington; Washington Department of Ecology
 - City of San Francisco; Public Utilities Commission
 - City of Charlotte and Mecklenburg County, North Carolina; Storm Water Services

P.2.2 How to Use the Sustainability Attribute Checklist

Designers should refer to this checklist as a prompt during pre-design alternatives analysis and throughout the design process to evaluate and consider the sustainability performance of various BMPs.

P.3 Description of Sustainability Attribute Considerations

The Sustainability Attribute Checklist was developed to include both benefits and costs associated with financial, environmental and social elements, and is organized in three tiers. Within each of the three elements are a series of aspects (each listed below). Nested under each aspect is a list of more detailed individual sustainability attributes (e.g., prepares for long-

¹ Environmental Protection Agency, 2013. “Case Studies Analyzing the Economic Benefits of Low Impact Development and Green Infrastructure Programs” http://water.epa.gov/polwaste/green/upload/lid-gi-programs_report_8-6-13_combined.pdf

² Environmental Protection Agency, 2005. “Reducing Urban Heat Islands: Compendium of Strategies” <http://www.epa.gov/hiri/resources/pdf/CoolPavesCompendium.pdf>

³ Global Reporting Initiative, 2013. G4 Sustainability Reporting Guidelines. <https://www.globalreporting.org/resource/library/GRIG4-Part1-Reporting-Principles-and-Standard-Disclosures.pdf>



term climate adaptability, enhances native vegetation, improves community quality of life, etc.). The complete list of attributes can be found in the table in Section 4.2.

The sections below describe the relevance and importance of each aspect and the considerations that will help determine if the BMP incorporates the attributes in the checklist.

P.3.1 Financial

P.3.1.1 Life-Cycle Costs

- Why it matters
 - The total cost of building and maintaining a project has implications for current and future budgets. While initial capital costs are typically considered in project design, it is also important to take into account on-going operation and maintenance, decommissioning, and replacement expenses. An accounting of costs across the full life cycle of a project (known as “total cost of ownership”) provides a more holistic view and better comparison of design alternatives.
- Considerations
 - When evaluating alternatives, examine the total cost of ownership and normalize the alternatives to the same time interval.

P.3.1.2 Financial Risk and Climate Adaptability

- Why it matters
 - A BMP could lead to additional costs not initially identified in construction or O&M. This evaluation will help to identify levels of risk and potential complications at the outset, such as potential for expensive and unexpected repairs, project or permitting delays, public relations problems, or that the facility could be under-engineered for future conditions or regulations.
 - For stormwater BMPs in particular, future climatic conditions are anticipated to include higher variability and intensity of precipitation, as well as more frequent flood events, which will lead to increased stress on stormwater systems.
 - Green infrastructure takes pressure off of existing traditional stormwater infrastructure (e.g., stormwater pipes). The increase in variability of precipitation that is anticipated in the Pacific Northwest can be managed more effectively through an integrated and flexible stormwater approach in comparison to traditional hardscape stormwater infrastructure.
- Considerations
 - If the BMP involves special permitting from regulators, consider the additional complexity in project implementation, both in terms of securing the original permit and demonstrating ongoing compliance.
 - The design of some BMPs may trigger concerns among community stakeholders. Designers shall identify, understand and resolve potential issues early on to ensure the project is suitable to the context and avoid unnecessary conflict.
 - Some BMPs involve systems that, in the event of an unexpected failure or routine maintenance, would require repairs or servicing that could be disruptive to Port users; therefore, identify potential financial risks and design considerations that mitigate those risks.



- Evaluate whether stormwater facilities are sized for present as well as future conditions.
- If the BMP involves vegetation establishment, select plants adapted to current and future site conditions. For example, a local tree planting organization, Friends of Trees – a partner of the Port, plants native species that are anticipated to be more resilient or acclimated to climate change.

P.3.1.3 Regional Economic Stimulus

- Why it matters
 - One of the Port's purposes is to support the local and regional economy.
 - A prosperous local economy results in consumption of goods that are often brought through the Port.
 - Local and regional procurement further supports a stable local economy.
- Considerations
 - When procuring good and services seek out local and regional firms, where offers are equal in price, quality, and availability.
 - Track the proportion of goods and services procured from locally based firms.

P.3.2 Environmental

P.3.2.1 Habitat and Ecosystem Services

- Why it matters
 - Human communities, and all living organisms, depend on the healthy functioning of biological systems. While Port operations can constrain the opportunity to realize “natural” systems, there are still measures that can restore, enhance, support or mimic these systems.
- Considerations
 - When possible, choose BMPs that transition from grey, impermeable systems to green, dynamic systems that mimic natural processes of peak volume reduction, pollutant removal and groundwater recharge through infiltration and filtration.
 - As described in each of the BMPs, wildlife, particularly avian species, pose a threat to aircraft safety at PDX. Special precautions must be taken to limit the attractiveness of hazardous wildlife to BMPs within the wildlife hazard zones described in Chapter 4.
 - At sites outside of wildlife hazard zones, prioritize and identify opportunities to improve wildlife habitat and ecosystem function. In particular, consider opportunities to utilize native plant species, increase tree canopy cover, and provide safe harbor for native and migrating species.
 - Habitat value can be more difficult to design for than other sustainability attributes, consequently a designer must engage this topic thoughtfully to provide for an effective outcome.

P.3.2.2 Materials Management

- Why it matters
 - Managing and reducing material consumption results in the extraction of fewer raw materials and reduces energy consumption, leading to less waste and pollution.



- Considerations
 - Source environmentally responsible materials (e.g., concrete with high fly ash content) as well as materials that are recyclable at the end-of-life or can be repurposed for similar or other applications.
 - Some BMPs may not seem material intensive at initial construction, but are material intensive over the course of the life cycle, due to O&M inputs. Designers shall identify factors that may increase life-cycle costs and identify options to reduce life-cycle material intensity.
 - Consider use of non-traditional materials that still achieve project functionality and performance. As an example, rubblized, recycled concrete, in certain contexts, can be used in place of virgin gravel.
 - Material and design selection should consider the public education and reputational value of using innovative materials.
 - All non-traditional materials must be vetted through the Port for potentially unintended water quality impacts that may affect Port compliance with regulatory permits.

P.3.2.3 Energy and Greenhouse Gas Emissions

- Why it matters
 - The global and regional climate is changing—primarily due to human caused emissions of greenhouse gases (GHGs). These changes present serious environmental, economic and social risk to the Port.
 - The Port has established a goal of reducing direct and indirect GHGs by 15% below 1990 baseline levels by 2020.
- Considerations
 - Generally speaking, in capital construction projects the GHG impacts of transporting materials and equipment operation tend to be insignificant compared to the GHGs embodied in building materials. Therefore, projects that utilize materials from energy intense manufacturing (e.g., steel) or from GHG intense manufacturing (e.g., cement) will tend to have greater GHG impacts than those that utilize “natural” materials.
 - Many GHG intense building materials can be manufactured in a way to minimize their GHG impacts (e.g., concrete with high fly ash content). Explore design specifications that allow for the use of these materials.
 - Preferentially select BMPs that do not require ongoing energy-intense maintenance, such as periodic or continuous pumping, which can be a source of GHG emissions.
 - Some BMPs result in stormwater volume reductions, thereby reducing need for new stormwater infrastructure (e.g., pipe capacity) or additional conventional treatment, and as a result, displacing both direct and indirect GHGs. Designers shall identify opportunities to reduce GHGs by using BMPs that optimize flow control rather than conventional treatment.



P.3.3 Social

P.3.3.1 Quality of Life, Spaces and Culture

- Why it matters
 - Urban environments that blend and offer natural habitat improve quality of life, whether that is through aesthetic enhancement or improved air quality.
 - There is a limit to the available land that can be allocated for public spaces. Therefore, utilizing Port lands for stormwater functionality but that also public space enhancement is highly desired.
- Considerations
 - In the design stage, consider the ability for BMPs to provide multiple benefits, first and foremost as a stormwater management design, but also serving as public spaces for staff or the public at large.

P.3.3.2 Public Education and Engagement

- Why it matters
 - The Port has chosen to prioritize and incorporate sustainability into its mission. Moreover, the Port is highly visible in the community and its actions are subject to special scrutiny. Implementing projects that further advance sustainability and engage the public enhance the Port's reputation and important relationships in the community.
- Considerations
 - Where possible, designers shall seek to implement innovative stormwater BMPs.
 - Recognize the capacity of local and neighboring stakeholders to participate in the implementation, monitoring and educational opportunities associated with stormwater BMPs. Potential partners include the West Multnomah Soil and Water Conservation District, City Nature Division of Portland Parks and Recreation, the Columbia Land Trust, Xerces Society, and BES.

P.4 Key Takeaways

P.4.1 Results Summary

- **Use the Sustainability Attribute Checklist as a guide, rather than basing decisions on the results table:** The summary table is a generalization of how certain sustainability attributes apply to an idealized implementation of a given BMP. The sustainability results may be different in the context of a specific project. Many BMPs assessed in the Sustainability Attribute Checklist are identified as “design for sustainability”, that the BMPs have potential to contribute to sustainability performance outcomes but require designers to address these attributes. There is no guarantee that a BMP, as applied in a given context, is an accurate indicator of sustainability performance because the specific implementation of a BMP will have unique characteristics based on site context. The best use of the checklist is as a prompt for the designer to consider how the identified sustainability attributes can be incorporated into the design of the BMP and maximize the value of the project.



- **Prioritize function and context:** Each site will have unique characteristics and functional requirements and not all BMPs will be appropriate for each site. A designer should not simply implement the BMPs that meet the greatest number of sustainability attributes, but rather seek to implement BMPs that meet the functional need and site context while maximizing sustainability value.
- **Prioritize habitat and social value when possible:** Most of the BMPs address at least some of the sustainability attributes. However, “Habitat and Ecosystem Services” and “Quality of Life, Spaces and Culture” are two aspects with distinct sustainability outcomes among BMPs. The BMPs that perform across the full spectrum of sustainability attributes are those that tend to be more visible, and those that are closer to habitat or public spaces including: bioretention basins, vegetated swales, planter box filters, green roofs and cisterns.
- **Integration of BMPs:** Tradeoffs exist and no single BMP can provide all the needed functionality for stormwater management. When possible, integrating BMPs can blend benefits, particularly environmental and social benefits, and integration should be part of a designer’s strategy. Therefore, BMPs should not simply be assessed individually, but also in coordination with one another. In order to develop solutions to engage the complexity of environmental relationships more effectively, the designer must go beyond the individual site scale to assess how the site relates to, and is nested in, the entire watershed.
- **Innovation and emerging technologies:** The Port has demonstrated innovation with respect to projects across its operations, including the installation of a Living Machine at its building headquarters. The DSM furthers the Port’s commitment to identifying and implementing a broad spectrum of designs; but in order to continue its trajectory of fostering a Port-wide culture of sustainability, the Port will continue to pursue BMPs, technologies and process innovations that continue to meet functional needs as well as positive sustainability outcomes, particularly as it relates to climate adaptation.



P.4.2 Sustainability Attribute Checklist

Sustainability Attribute Checklist																			
<i>Designers should refer to this checklist as a prompt during pre-design alternatives analysis and again during final design to evaluate and consider the sustainability performance of various BMPs.</i>																			
	Not Applicable: The attribute is not relevant to this BMP and there are no potential positive or negative performance outcomes.																		
	Threat/Barriers to Performance: The BMP inherently has good performance outcomes without any special design considerations.																		
	Design Dependent Performance: The opportunity for good performance outcomes where certain design elements are incorporated.																		
	Threat/Barrier(s) to Performance: The BMP may be problematic for this attribute.																		
	Dry Extended Detention Basin	Wet Basin	Subsurface Flow Wetland	Bioretention Basin	Trench	Vegetated Swale	Vegetated Filter Strip	Media Filter	USCFs	Pervious Pavement	Planter Box	Filters	Green Roofs	Cisterns	Dry Wells	Cartridge Filter	Vaults	Oil-Water Separators	Hydrodynamic Separators
Financial																			
Life-Cycle Costs																			
Low to moderate life-cycle capital costs																			
Low to moderate life-cycle O&M costs																			
Financial Risk and Climate Adaptability																			
Low complexity, lower risk																			
Adaptable to long-term climate trends																			
Regional Economic Stimulus																			
Uses regional materials	Implementation of each of the BMPs could incorporate locally or regionally sourced materials and expertise																		
Hire local or regional small businesses	Implementation of each of the BMPs could incorporate locally or regionally sourced materials and expertise																		
Environmental																			
Habitat and Ecosystem Services																			
Naturalizes industrial hardscapes																			
Mimics natural processes																			
Enhances native vegetation																			
Increases urban tree canopy																			
Improves pollinator and insect habitat																			
Materials Management																			
Uses environmentally responsible materials																			
Materials have potential for end of life use																			
Energy and GHGs																			
Low energy and GHG intensity																			
Social																			
Quality of Life																			
Enhances public spaces																			
Public Education and Engagement																			
High public visibility																			
Demonstrates leadership and innovation																			
Opportunity for community partnerships																			