



Hybrid Piano NU1

Owner's Manual
Bedienungsanleitung
Mode d'emploi
Manual de instrucciones

Before using this instrument, be sure to read
"PRECAUTIONS" on pages 6 – 7.

Achten Sie darauf, vor Einsatz dieses Instruments die
„VORSICHTSMASSNAHMEN“ auf Seiten 6-7 durchzulesen.

Avant d'utiliser cet instrument, lisez attentivement la section
« PRÉCAUTIONS D'USAGE » aux pages 6-7.

Antes de utilizar el instrumento, lea la sección
"PRECAUCIONES", en las páginas 6-7.

ENGLISH

DEUTSCH

FRANÇAIS

ESPAÑOL

EN
DE
FR
ES

SPECIAL MESSAGE SECTION

PRODUCT SAFETY MARKINGS: Yamaha electronic products may have either labels similar to the graphics shown below or molded/stamped facsimiles of these graphics on the enclosure. The explanation of these graphics appears on this page. Please observe all cautions indicated on this page and those indicated in the safety instruction section.

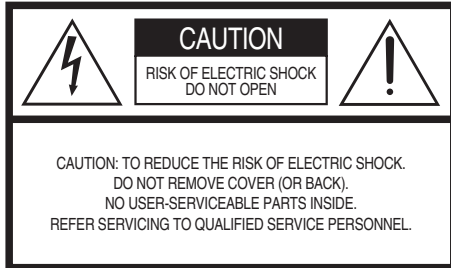

See bottom of Keyboard enclosure for graphic symbol markings.



The exclamation point within the equilateral triangle is intended to alert the user to the presence of important operating and maintenance (servicing) instructions in the literature accompanying the product.



The lightning flash with arrowhead symbol, within the equilateral triangle, is intended to alert the user to the presence of uninsulated “dangerous voltage” within the product’s enclosure that may be of sufficient magnitude to constitute a risk of electrical shock.

IMPORTANT NOTICE: All Yamaha electronic products are tested and approved by an independent safety testing laboratory in order that you may be sure that when it is properly installed and used in its normal and customary manner, all foreseeable risks have been eliminated. **DO NOT** modify this unit or commission others to do so unless specifically authorized by Yamaha. Product performance and/or safety standards may be diminished. Claims filed under the expressed warranty may be denied if the unit is/has been modified. Implied warranties may also be affected.

SPECIFICATIONS SUBJECT TO CHANGE: The information contained in this manual is believed to be correct at the time of printing. However, Yamaha reserves the right to change or modify any of the specifications without notice or obligation to update existing units.

ENVIRONMENTAL ISSUES: Yamaha strives to produce products that are both user safe and environmentally friendly. We sincerely believe that our products and the production methods used to produce them, meet these goals. In keeping with both the letter and the spirit of the law, we want you to be aware of the following:

Battery Notice: This product MAY contain a small non-rechargeable battery which (if applicable) is soldered in place. The average life span of this type of battery is approximately five years. When replacement becomes necessary, contact a qualified service representative to perform the replacement.

Warning: Do not attempt to recharge, disassemble, or incinerate this type of battery. Keep all batteries away from children. Dispose of used batteries promptly and as regulated by applicable laws. Note: In some areas, the servicer is required by law to return the defective parts. However, you do have the option of having the servicer dispose of these parts for you.

Disposal Notice: Should this product become damaged beyond repair, or for some reason its useful life is considered to be at an end, please observe all local, state, and federal regulations that relate to the disposal of products that contain lead, batteries, plastics, etc.

NOTICE: Service charges incurred due to lack of knowledge relating to how a function or effect works (when the unit is operating as designed) are not covered by the manufacturer’s warranty, and are therefore the owners responsibility. Please study this manual carefully and consult your dealer before requesting service.

NAME PLATE LOCATION: The graphic below indicates the location of the name plate. The model number, serial number, power requirements, etc., are located on this plate. You should record the model number, serial number, and the date of purchase in the spaces provided below and retain this manual as a permanent record of your purchase.

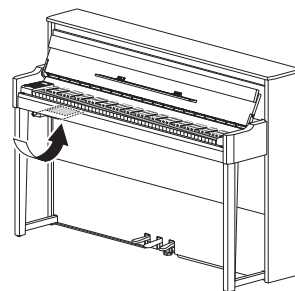

Model _____

Serial No. _____

Purchase Date _____

IMPORTANT SAFETY INSTRUCTIONS

- 1 Read these instructions.
- 2 Keep these instructions.
- 3 Heed all warnings.
- 4 Follow all instructions.
- 5 Do not use this apparatus near water.
- 6 Clean only with dry cloth.
- 7 Do not block any ventilation openings. Install in accordance with the manufacturer's instructions.
- 8 Do not install near any heat sources such as radiators, heat registers, stoves, or other apparatus (including amplifiers) that produce heat.
- 9 Do not defeat the safety purpose of the polarized or grounding-type plug. A polarized plug has two blades with one wider than the other. A grounding type plug has two blades and a third grounding prong. The wide blade or the third prong are provided for your safety. If the provided plug does not fit into your outlet, consult an electrician for replacement of the obsolete outlet.
- 10 Protect the power cord from being walked on or pinched particularly at plugs, convenience receptacles, and the point where they exit from the apparatus.

- 11 Only use attachments/accessories specified by the manufacturer.
- 12 Use only with the cart, stand, tripod, bracket, or table specified by the manufacturer, or sold with the apparatus. When a cart is used, use caution when moving the cart/apparatus combination to avoid injury from tip-over.
- 13 Unplug this apparatus during lightning storms or when unused for long periods of time.
- 14 Refer all servicing to qualified service personnel. Servicing is required when the apparatus has been damaged in any way, such as power-supply cord or plug is damaged, liquid has been spilled or objects have fallen into the apparatus, the apparatus has been exposed to rain or moisture, does not operate normally, or has been dropped.



WARNING

TO REDUCE THE RISK OF FIRE OR ELECTRIC SHOCK, DO NOT EXPOSE THIS APPARATUS TO RAIN OR MOISTURE.

(UL60065_03)

FCC INFORMATION (U.S.A.)

1. **IMPORTANT NOTICE: DO NOT MODIFY THIS UNIT!**
This product, when installed as indicated in the instructions contained in this manual, meets FCC requirements. Modifications not expressly approved by Yamaha may void your authority, granted by the FCC, to use the product.
2. **IMPORTANT:** When connecting this product to accessories and/or another product use only high quality shielded cables. Cable/s supplied with this product **MUST** be used. Follow all installation instructions. Failure to follow instructions could void your FCC authorization to use this product in the USA.
3. **NOTE:** This product has been tested and found to comply with the requirements listed in FCC Regulations, Part 15 for Class "B" digital devices. Compliance with these requirements provides a reasonable level of assurance that your use of this product in a residential environment will not result in harmful interference with other electronic devices. This equipment generates/uses radio frequencies and, if not installed and used according to the instructions found in the users manual, may cause interference harmful to the operation of other electronic devices. Compliance with FCC regulations does not

guarantee that interference will not occur in all installations. If this product is found to be the source of interference, which can be determined by turning the unit "OFF" and "ON," please try to eliminate the problem by using one of the following measures:

Relocate either this product or the device that is being affected by the interference.

Utilize power outlets that are on different branch (circuit breaker or fuse) circuits or install AC line filter/s.

In the case of radio or TV interference, relocate/reorient the antenna. If the antenna lead-in is 300 ohm ribbon lead, change the lead-in to co-axial type cable.

If these corrective measures do not produce satisfactory results, please contact the local retailer authorized to distribute this type of product. If you can not locate the appropriate retailer, please contact Yamaha Corporation of America, Electronic Service Division, 6600 Orangethorpe Ave, Buena Park, CA90620

The above statements apply **ONLY** to those products distributed by Yamaha Corporation of America or its subsidiaries.

* This applies only to products distributed by YAMAHA CORPORATION OF AMERICA.

(class B)

COMPLIANCE INFORMATION STATEMENT (DECLARATION OF CONFORMITY PROCEDURE)

Responsible Party : Yamaha Corporation of America
Address : 6600 Orangethorpe Ave., Buena Park,
Calif. 90620
Telephone : 714-522-9011
Type of Equipment : Hybrid Piano
Model Name : NU1

This device complies with Part 15 of the FCC Rules.

Operation is subject to the following two conditions:

- 1) this device may not cause harmful interference, and
- 2) this device must accept any interference received including interference that may cause undesired operation.

See user manual instructions if interference to radio reception is suspected.

* This applies only to products distributed by
YAMAHA CORPORATION OF AMERICA.

(FCC DoC)

Thank you for choosing the Yamaha Hybrid Piano.
In order to make the most of the performance potential and features of the instrument,
please read the manuals thoroughly,
and keep them in a handy place for later reference.

This instrument, which combines the priceless value of an acoustic piano and versatile digital technology that provides exceptional flexibility to performers, is a true hybrid piano.

Main Features

Authentic acoustic piano touch with special upright piano action

Featuring a specially designed mechanism in which the keyboard action and the hammer workings realistically reproduce those of an acoustic piano, this instrument provides a realistic touch response that is extraordinarily similar to an upright piano.

CFX Sampling technology

Sophisticated sampling using the latest technology was used to capture the luxurious sounds of Yamaha's flagship CFX, a full-sized concert grand piano. The powerful bass and bright, penetrating midrange sound of the original CFX are reproduced faithfully, and give a particularly natural and well-balanced overall piano sound.

Best Condition without Tuning

Unlike acoustic pianos, this instrument does not need to be tuned. It always stays perfectly in tune even after long-time use.

Flexible Volume Control

This instrument gives you full control over the instrument volume, letting you adjust the level just as desired. Also, you can play or listen in total privacy through one or two pairs of headphones.

Audio Playing and Recording from a USB Flash Memory

Audio files (.wav) saved to a USB flash memory can be played back on the instrument. Moreover, since you can record your performance as audio data to a USB flash memory device, it is possible to listen to your performance on portable music players, with the data transferred by computer.

Table of Contents

PRECAUTIONS	6
--------------------------	----------

Introduction

Getting started playing your new Hybrid Piano

Panel Controls and Terminals	8
Playing the Keyboard	9
Using the Pedals	11
Using Headphones (Optional)	12
I.A. Control (Intelligent Acoustic Control).....	12

Advanced Functions

This section explains how to make detailed settings for the instrument's various functions.

Basic Operations and More	13
Selecting a Voice.....	13
Listening to the Voice Demo Songs	13
Using the Metronome	14
Changing the Touch Sensitivity.....	15
Adding Variations to the Sound (Reverb).....	15
Transposing the Pitch in semitones	16
Fine tuning the Pitch.....	16
Setting the Scale Tuning	17
Playing Back Songs	18
Songs compatible with this instrument	18
Playing back Songs.....	19
Recording Your Performance	21
Using USB Flash Memory	23
Connecting USB flash memory	23
Formatting USB flash memory	24
Copying User Songs in the instrument to a USB flash memory.....	24
Deleting a Song file	25
Backup data and Initializing	26
Backup data in internal memory	26
Initializing the Backup data.....	26

Connections	27
About MIDI	29
Example for MIDI connection.....	29
Local Control on/off.....	29

Appendix

This section includes a list of display messages, Quick Operation Guide and other information.

Message List	30
Troubleshooting	31
Maintenance	32
Specifications	33
Index	34
Quick Operation Guide *	35

* This is a quick reference for operation of the functions assigned to the buttons and keyboard.

Accessories

- Owner's Manual
- "50 greats for the Piano" (Music Book)
- AC Power Cord
- Felt Key Cover
- Felt Strips x 3
- Bench*
- My Yamaha Product User Registration**

* Included or optional depending on locale.

** The PRODUCT ID on the sheet will be needed when you fill out the User Registration form

Online Materials

In addition to this manual, the following instructional materials are available.



MIDI Reference

This contains the MIDI Data Format, the MIDI Implementation chart and detailed explanations about the MIDI settings of the instrument.



MIDI Basics (only in English, French, German and Spanish)

If you want to know more about MIDI and how to use it, refer to this introductory book.



Computer-related Operations

Includes instructions on connecting this instrument to a computer, and operations related to transferring song data.

To obtain these manuals, access the Yamaha Manual Library, enter "NU1" or "MIDI Basics" to the Model Name box, then click [SEARCH].

Yamaha Manual Library

<http://www.yamaha.co.jp/manual/>

PRECAUTIONS

PLEASE READ CAREFULLY BEFORE PROCEEDING

Please keep this manual in a safe place for future reference.



WARNING

Always follow the basic precautions listed below to avoid the possibility of serious injury or even death from electrical shock, short-circuiting, damages, fire or other hazards. These precautions include, but are not limited to, the following:

Power supply/Power cord

- Do not place the power cord near heat sources such as heaters or radiators. Also, do not excessively bend or otherwise damage the cord, or place heavy objects on it.
- Only use the voltage specified as correct for the instrument. The required voltage is printed on the name plate of the instrument.
- Use only the supplied power cord/plug.
- Check the electric plug periodically and remove any dirt or dust which may have accumulated on it.

Do not open

- This instrument contains no user-serviceable parts. Do not open the instrument or attempt to disassemble or modify the internal components in any way. If it should appear to be malfunctioning, discontinue use immediately and have it inspected by qualified Yamaha service personnel.

Water warning

- Do not expose the instrument to rain, use it near water or in damp or wet conditions, place on it any containers (such as vases, bottles or glasses) containing liquids which might spill into any openings. If any liquid such as water seeps into the instrument, turn off the power immediately and unplug the power cord from the AC outlet. Then have the instrument inspected by qualified Yamaha service personnel.
- Never insert or remove an electric plug with wet hands.

Fire warning

- Do not put burning items, such as candles, on the unit. A burning item may fall over and cause a fire.

If you notice any abnormality

- When one of the following problems occur, immediately turn off the power switch and disconnect the electric plug from the outlet. Then have the device inspected by Yamaha service personnel.
 - The power cord or plug becomes frayed or damaged.
 - It emits unusual smells or smoke.
 - Some object has been dropped into the instrument.
 - There is a sudden loss of sound during use of the instrument.



CAUTION

Always follow the basic precautions listed below to avoid the possibility of physical injury to you or others, or damage to the instrument or other property. These precautions include, but are not limited to, the following:

Power supply/Power cord

- Do not connect the instrument to an electrical outlet using a multiple-connector. Doing so can result in lower sound quality, or possibly cause overheating in the outlet.
- When removing the electric plug from the instrument or an outlet, always hold the plug itself and not the cord. Pulling by the cord can damage it.
- Remove the electric plug from the outlet when the instrument is not to be used for extended periods of time, or during electrical storms.

Assembly

- Read carefully the attached documentation explaining the assembly process. Failure to follow the instrument in the proper sequence might result in damage to the instrument or even injury.

Location

- Do not place the instrument in an unstable position where it might accidentally fall over.
- When transporting or moving the instrument, always use two or more people. Attempting to lift the instrument by yourself may damage your back, result in other injury, or cause damage to the instrument itself.
- Before moving the instrument, remove all connected cables, to prevent damage to the cables or injury to anyone who might trip over them.
- When setting up the product, make sure that the AC outlet you are using is easily accessible. If some trouble or malfunction occurs, immediately turn off the power switch and disconnect the plug from the outlet. Even when the power switch is turned off, electricity is still flowing to the product at the minimum level. When you are not using the product for a long time, make sure to unplug the power cord from the wall AC outlet.
- Though the wooden parts of this instrument have been designed and produced with care concerning the environment and human health, in some rare instances customers may sense an unusual odor or develop irritation in the eyes, due to the coating material and adhesive. To avoid this, we recommend that you observe the following:
 1. Specially ventilate the room for several days after unpacking and installing this instrument, since it has been packed in airtight conditions in order to maintain quality during transportation.
 2. If the room housing the instrument is small, continue to ventilate it normally, either daily or periodically.
 3. If you have left the instrument in a closed room for a long time under high temperature, ventilate the room, then lower the temperature if possible, before using the instrument.

Connections

- Before connecting the instrument to other electronic components, turn off the power for all components. Before turning the power on or off for all components, set all volume levels to minimum.
- Be sure to set the volumes of all components at their minimum levels and gradually raise the volume controls while playing the instrument to set the desired listening level.

Handling caution

- Do not insert a finger or hand in any gaps on the fallboard or instrument. Also take care that the fallboard does not pinch your finger.
- Never insert or drop paper, metallic, or other objects into the gaps on the fallboard, panel or keyboard. This could cause physical injury to you or others, damage to the instrument or other property, or operational failure.
- Do not rest your weight on, or place heavy objects on the instrument, and do not use excessive force on the buttons, switches or connectors.
- Do not use the instrument/device or headphones for a long period of time at a high or uncomfortable volume level, since this can cause permanent hearing loss. If you experience any hearing loss or ringing in the ears, consult a physician.

Using the bench (If included)

- Do not place the bench in an unstable position where it might accidentally fall over.
- Do not play carelessly with or stand on the bench. Using it as a tool or stepladder or for any other purpose might result in accident or injury.
- Only one person should sit on the bench at a time, in order to prevent the possibility of accident or injury.
- If the bench screws become loose due to extensive long-term use, tighten them periodically using the included tool.
- Keep special watch over any small children so that they don't fall off the rear of the bench. Since the bench does not have a backrest, unsupervised use may result in accident or injury.

Yamaha cannot be held responsible for damage caused by improper use or modifications to the instrument, or data that is lost or destroyed.

Always turn the power off when the instrument is not in use.

NOTICE

To avoid the possibility of malfunction/damage to the product, damage to data, or damage to other property, follow the notices below.

■ Handling and Maintenance

- Do not use the instrument in the vicinity of a TV, radio, stereo equipment, mobile phone, or other electric devices. Otherwise, the instrument, TV, or radio may generate noise.
- Do not expose the instrument to excessive dust or vibrations, or extreme cold or heat (such as in direct sunlight, near a heater, or in a car during the day) to prevent the possibility of panel disfiguration, damage to the internal components or unstable operation. (Verified operating temperature range: 5° – 40°C, or 41° – 104°F.)
- Do not place vinyl, plastic or rubber objects on the instrument, since this might discolor the panel or keyboard.
- Bumping the surface of the instrument with metal, porcelain, or other hard objects can cause the finish to crack or peel. Use caution.
- Gently remove dust and dirt with a soft cloth. Do not wipe too hard since small particles of dirt can scratch the instrument's finish.
- During extreme changes in temperature or humidity, condensation may occur and water may collect on the surface of the instrument. If water is left, the wooden parts may absorb the water and be damaged. Make sure to wipe any water off immediately with a soft cloth.

■ Saving data

- To protect against data loss through media damage, we recommend that you save your important data onto two USB flash memories.

Information

■ About copyrights

- Copying of the commercially available musical data including but not limited to MIDI data and/or audio data is strictly prohibited except for your personal use.
- This product incorporates and bundles computer programs and contents in which Yamaha owns copyrights or with respect to which it has license to use others' copyrights. Such copyrighted materials include, without limitation, all computer software, style files, MIDI files, WAVE data, musical scores and sound recordings. Any unauthorized use of such programs and contents outside of personal use is not permitted under relevant laws. Any violation of copyright has legal consequences. **DON'T MAKE, DISTRIBUTE OR USE ILLEGAL COPIES.**

■ About functions/data bundled with the instrument

- Some of the preset songs have been edited for length or arrangement, and may not be exactly the same as the original.

■ About this manual

- The illustrations and displays as shown in this manual are for instructional purposes only, and may appear somewhat different from those on your instrument.
- The company names and product names in this manual are the trademarks or registered trademarks of their respective companies.

Transporting / Installing

If you move to another location, transport the instrument horizontally. Do not subject the instrument to excessive vibration or shock.

⚠ CAUTION

When moving the instrument, always hold the bottom of the keyboard unit and the handgrips of the rear side. Be sure not to hold the headphone jack box. Improper handling can result in damage to the instrument or personal injury.

Place the instrument away from the wall by at least 10 cm to optimize and enhance the sound effect. If you find the instrument shaky or unstable after installing, insert the included felt strips. For details, refer to the instructions supplied with the felt strips.

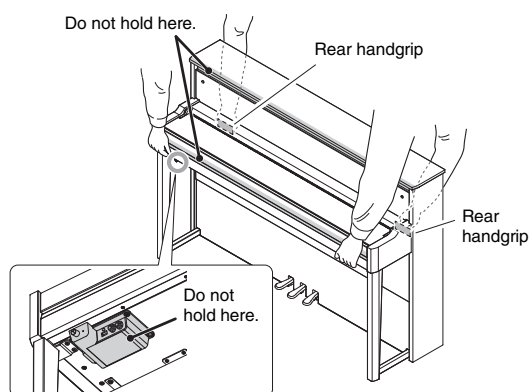

Panel Controls and Terminals

Overview

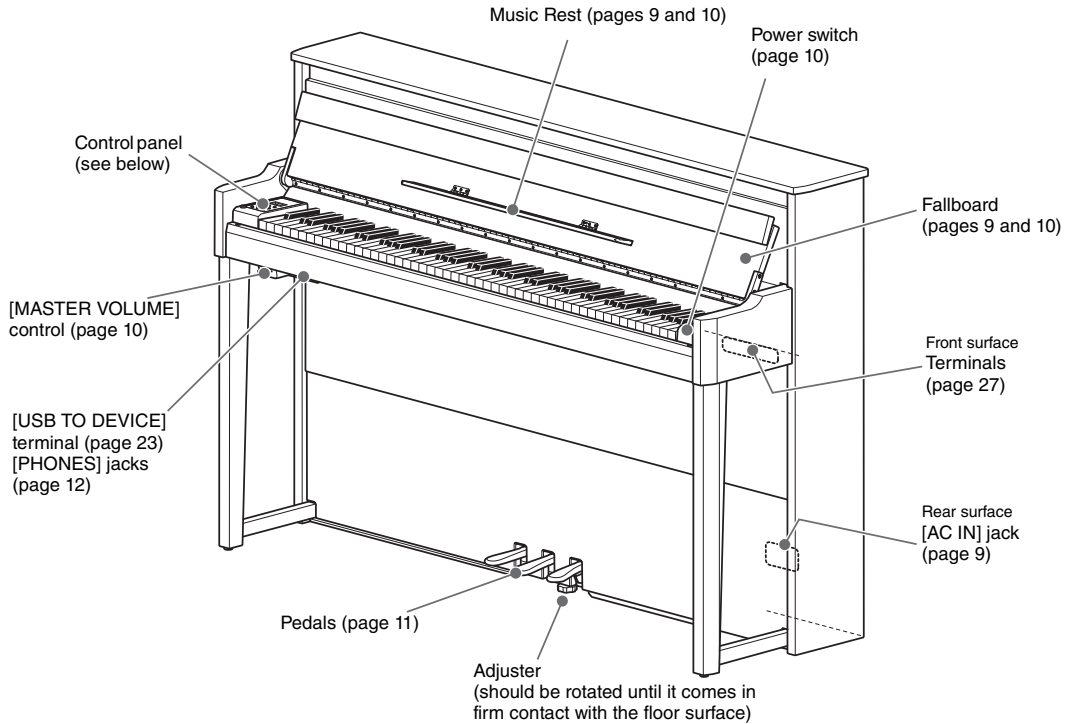

Control Panel

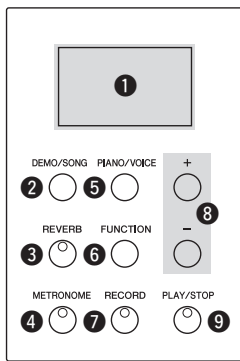

- ❶ Display See below.
- ❷ [DEMO/SONG] button page 13
- ❸ [REVERB] button page 15
- ❹ [METRONOME] button page 14
- ❺ [PIANO/VOICE] button page 13
- ❻ [FUNCTION] button pages 16, 17 and 29
- ❼ [RECORD] button page 22
- ❽ [+]/[-] button
- ❾ [PLAY/STOP] button pages 19 and 22

Display

Indicates various values such as Song number and Parameter value. Note that the display turns dark after the value is set.

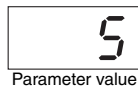
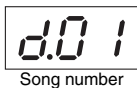

This display also indicates various messages with the three characters. For details, refer to page 30.

Playing the Keyboard

1 Set up the power supply.

1-1 On the bottom surface (page 8), insert the power cord plug into the [AC IN] connector.

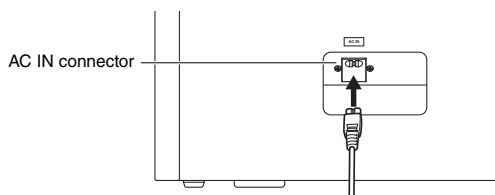

⚠ WARNING

Make sure your instrument is rated for the AC voltage supplied in the area in which it is to be used. (The voltage rating appears on the name plate on the bottom panel). Connecting the unit to an inappropriate AC supply can seriously damage the internal circuitry and may even pose a shock hazard!

1-2 Insert the plug on the other end of the power cord to a standard AC outlet.

⚠ WARNING

- Use only the AC power cord supplied with the instrument. If the supplied power cord is lost or damaged and needs to be replaced, contact your Yamaha dealer. The use of an inappropriate replacement can pose a fire and shock hazard!
- The type of AC power cord provided with the instrument may be different depending on the country in which the instrument was purchased. (In some areas a plug adaptor may be provided to match the pin configuration of the AC wall outlets in your area.) Do NOT modify the plug provided with the instrument. If the plug does not fit the outlet, have a proper outlet installed by a qualified electrician.

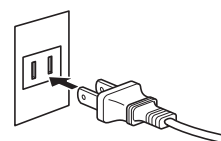

The shape of the plug differs depending on your locale.

2 With both hands, hold the hand grip, then lift and open the fallboard.

⚠ CAUTION

- Hold the fallboard with both hands when opening or closing it. Do not release it until it is fully opened or closed. Be careful to avoid catching fingers (yours or others, especially children's) between the fallboard and the unit.

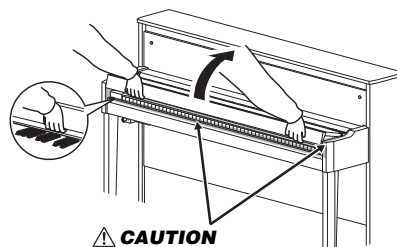

⚠ CAUTION

Be careful to avoid catching your fingers between the fallboard and the instrument.

3 Fold down the top of the fallboard, then open the music rest and put the score on it.

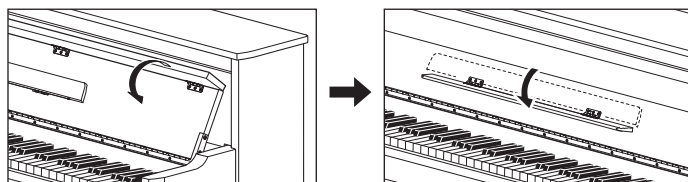

4 On the right of the keyboard, press the [⏻] switch to turn on the power.

The lamp located as shown below lights up, the display (page 8) indicates “nU 1” for a while, then the instrument starts up.

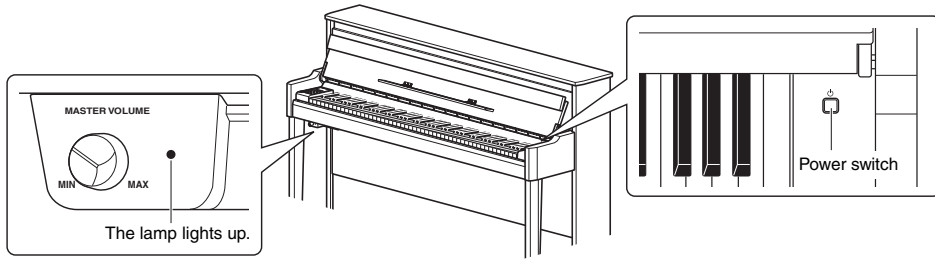

NOTICE

Do not press any keys until the instrument has completely started up (approx. four seconds after turning on the switch). Doing so may cause some keys to not sound normally.

5 Play the keyboard.

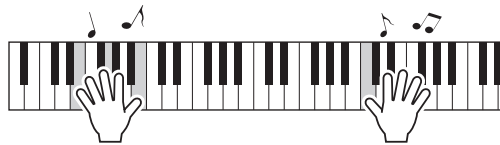

To adjust the volume:

Use the [MASTER VOLUME] control (page 8) located at the front left, just below the keyboard.

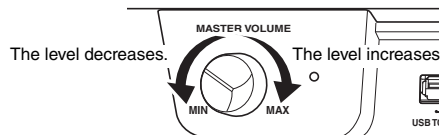

CAUTION

Avoid using this instrument at a high volume level for a long period of time, to prevent hearing damage.

6 Press the [⏻] switch again to turn off the power.

The power lamp turns off.

CAUTION

A small amount of electrical current remains even after the power switch is turned off. If you plan not to use the instrument for a long period of time, be sure to unplug the instrument from the AC outlet.

7 Close the music rest.

If you omit this operation and close the fallboard, the music rest will hit the keyboard and may result in damage.

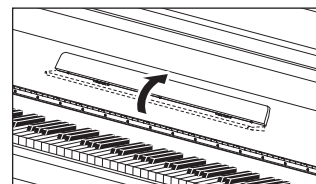

8 With both hands, open the folded top of the fallboard, and close it gently.

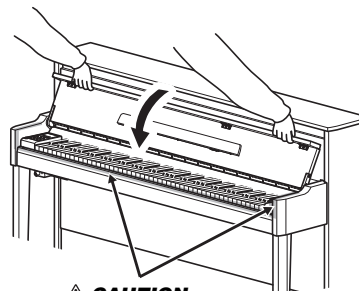

CAUTION

Be careful to avoid catching your fingers between the fallboard and the instrument.

Using the Pedals

The instrument has three pedals that produce a range of expressive effects similar to those produced by the pedals on an acoustic piano.

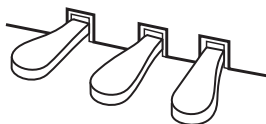

Damper Pedal (Right)

Pressing this pedal will sustain notes longer. Releasing this pedal immediately stops (damps) any sustained notes. A “half-pedal” function of this pedal creates partial sustain effects, depending on how far down you press the pedal.

● Half-pedal function

This function allows the sustain length to vary depending on how far the pedal is pressed. The farther you press the pedal, the more the sound sustains. For example, if you press the damper pedal and all notes you are playing sound a bit murky and loud with too much sustain, you can release the pedal half way to subdue the sustain (murkiness).

● To set the Half Pedal Point:

While holding down [PIANO/VOICE], press one of the A#5–E6 keys. This operation sets the degree to which pressing the damper pedal applies the half-pedal effect. The smaller the value, the shallower the half-pedal point. The larger the value, the deeper the half-pedal point.

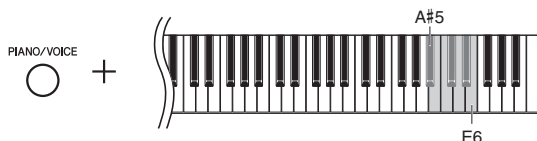

Setting range: -2 (A#5) – 0 (C6) – 4 (E6)
Default Setting: 0

GP Responsive Damper Pedal

This special pedal has been designed to provide enhanced tactile response and, when pressed, is much closer in feel to the pedal of an actual grand piano. It makes it easier to physically experience the half-pedal point and more easily apply the half-pedal effect than other pedals.

Sostenuto Pedal (Center)

Pressing this pedal while holding the notes will sustain the pressed notes (as if the damper pedal had been pressed), but all subsequently played notes will not be sustained. This makes it possible to sustain a chord, for example, while the other notes are played “staccato.”

Soft Pedal (Left)

Pressing this pedal will reduce the volume and slightly change the timbre of the notes. The notes played before this pedal is pressed are not affected.

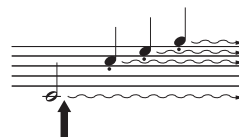

If you press and hold the damper pedal here, all the notes shown will be sustained.

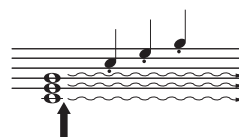

If you press and hold the sostenuto pedal here, only the notes held at this timing will be sustained.

Using Headphones (Optional)

Since this instrument is equipped with two [PHONES] jacks, you can connect two sets of standard stereo headphones. If you are using only one set of headphones, insert a plug into either jack, shutting off the speakers.

⚠ CAUTION

Avoid listening to the instrument at a high volume level through headphones for a long period of time, to prevent hearing damage.

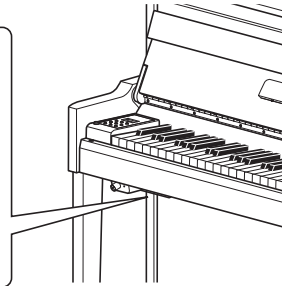
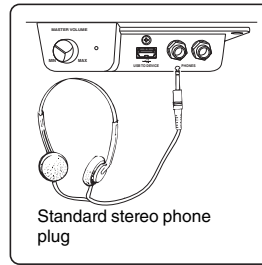

I.A. Control (Intelligent Acoustic Control)

This function automatically adjusts and controls the sound quality according to the overall volume of the instrument. Even when the volume is low, it permits both low sounds and high sounds to be clearly heard. Note that the I.A. Control is effective only from the sound output of the instrument speakers.

● **To turn on/off the I.A. Control:**

While holding down [FUNCTION], press the C0 key repeatedly (as necessary).

Default setting: On

● **To adjust the I.A. Control Depth:**

While holding down [FUNCTION], press one of the keys between A0–D#1.

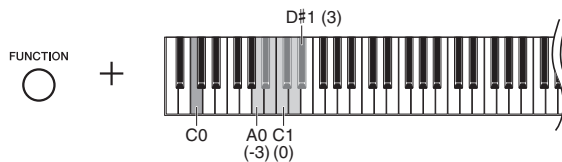

Setting range: -3 (A0) – 0 (C1) – 3 (D#1)

Default setting: 0 (C1)

The higher the value, the more clearly that low and high sounds are heard at lower volume levels.

Basic Operations and More

Selecting a Voice

● To select the Grand Piano 1 Voice:

Simply press [PIANO/VOICE].

● To select a different Voice:

While holding down [PIANO/VOICE], press [+] or [-].

Voice List

Display	Voice name	Descriptions
1	Grand Piano 1	Recorded samples from a full concert grand piano. Perfect for classical compositions as well as any other style that requires acoustic piano.
2	Grand Piano 2	Spacious and clear piano with bright reverb. Good for popular music
3	E.Piano 1	Created by FM synthesis. Good for popular music.
4	E.Piano 2	Simulates the sound of hammer-struck metallic "tines." Soft tone when played lightly, and an aggressive tone when played hard.
5	Harpsichord	The definitive instrument for baroque music. Since the strings of an actual harpsichord are plucked, there is no touch response.

Listening to the Voice Demo Songs

Demo Songs effectively demonstrate each of this instrument's Voices.

1 Select the Voice for the Demo Song that you want to listen to.

2 Press [DEMO/SONG].

The Demo Song for the Voice selected in Step 1 starts.

To change the Demo Song during playback:

Press [+] or [-].

To adjust the playback tempo:

While holding down [METRONOME], press TEMPO [+] or [-].

3 Press [DEMO/SONG] again to stop playback.

Demo Song List

Display	Voice Name	Title	Composer
d01	Grand Piano 1	Prélude, Suite bergamasque	C. A. Debussy
d02	Grand Piano 2	—	—
d03	E.Piano 1	—	—
d04	E.Piano 2	—	—
d05	Harpsichord	Concerto a cembalo obbligato, 2 violini, viola e continuo No.7, BWV.1058	J. S. Bach

The d01 and d05 Songs are re-arranged excerpts from the original compositions. The other Demo Songs are Yamaha's original pieces (©2012 Yamaha Corporation).

NOTE

You can play the keyboard along with the demo song.

NOTE

No MIDI data will be output during Voice Demo playback.

Using the Metronome

The metronome feature is convenient for practicing with an accurate tempo.

1 Press [METRONOME] to start the metronome.

While the metronome sounds, a dot at the right side of the LED display and the lamp of the metronome button flash on and off to the tempo.

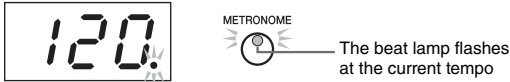

2 Press [METRONOME] again to stop the metronome.

Adjusting the Tempo

During the operation described below, you can check the tempo value shown on the display.

● To increase or decrease the value by 1:

While holding down [METRONOME], press [+] (or C#5 key) or [-] (or B4 key). During playback, simply press [+] or [-].

● To increase or decrease the value by 10:

While holding down [METRONOME], press the D5 or A#4 key.

● To reset the value to the default (120):

While holding down [METRONOME], press the C5 key or press [+] and [-] simultaneously. During playback, press both [+] and [-] simultaneously.

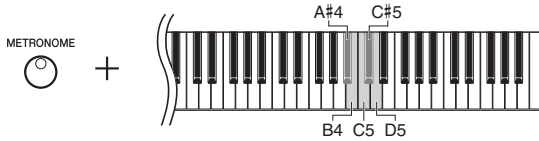

Setting range: 5 to 500 beats per minute
Default setting: 120

NOTE

The metronome tempo is restored to the default setting when the power is turned off.

Selecting the Beat

While holding down [METRONOME], press one of the C3–F3 keys. The selected value is shown on the display while both controls are held.

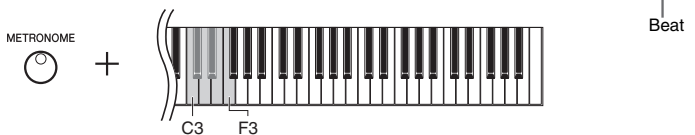

Default setting: 0 (No downbeat)

NOTE

The Beat of the metronome is restored to the default setting when the power is turned off.

Display	Key	Beat	Display	Key	Beat
0	C3	0 (no downbeat)	4	D#3	4
2	C#3	2	5	E3	5
3	D3	3	6	F3	6

Only the first beat is accented with a bell sound when set to a value other than 0.

Adjusting the Metronome volume

While holding down [METRONOME], press one of the C1–G2 keys to set the volume. The specified value is shown on the display while both controls are held.

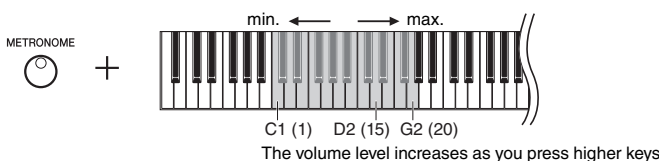

Setting range: 1–20
Default setting: 15

NOTE

The metronome volume setting is retained even when the power is turned off.

Changing the Touch Sensitivity

You can specify the Touch Sensitivity (how the sound responds to the way you play the keys).

While holding down [PIANO/VOICE], press one of the A6–C7 keys. The selected Touch Sensitivity is shown on the display while both controls are held.

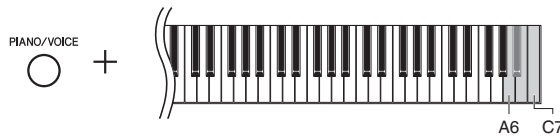

Display	Key	Touch Sensitivity	Descriptions
OFF	A6	Fixed	The volume level does not change at all regardless of whether you play the keyboard soft or hard.
1	A#6	Soft	The volume level does not change much when you play the keyboard soft or hard.
2	B6	Medium	This is the standard piano touch response.
3	C7	Hard	The volume level changes very widely from pianissimo to fortissimo to facilitate dynamic and dramatic expression. You have to hit the keys hard to produce a loud sound.

Default setting: 2 (Medium)

NOTE

The touch type is restored to the default setting when the power is turned off.

NOTE

This setting does not change the weight of the keyboard, but only the response.

Adding Variations to the Sound (Reverb)

The Reverb effect reproduces the realistic acoustic ambience of grand piano.

To turn on or off the Reverb:

Press [REVERB] repeatedly (as necessary).

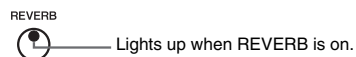

To adjust the Reverb Depth:

While holding down [REVERB], press [+] or [-]. The current value is shown on the display while both controls are held.



To restore the default value (2), press [+] and [-] simultaneously while holding [REVERB].

Setting range: 1–20

Default setting: 2

NOTE

The Reverb Depth is restored to the default setting when the power is turned off.

NOTE

Holding [REVERB] shows the Reverb Depth value on the display.

Transposing the Pitch in semitones

You can shift the pitch of the entire keyboard up or down in semitones to facilitate playing in difficult key signatures and match the pitch of the keyboard to the range of a singer or other instruments. For example, if “+5” is selected, playing the key C produces a pitch of F, letting you play a song of F major as though it were in C major.

● **To transpose the pitch down:**

While holding down [FUNCTION], press a key between F#2 (-6) and B2 (-1).

● **To transpose the pitch up:**

While holding down [FUNCTION], press a key between C#3 (+1) and F#3 (+6).

● **To restore the original pitch:**

While holding down [FUNCTION], press the C3 key.

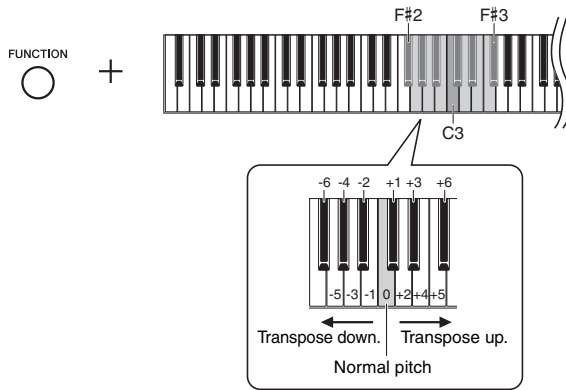

The specified value is shown on the display.

Default setting: 0 (Normal pitch)
Setting range: -6 – 6

NOTE

The Transpose value is restored to the default setting when the power is turned off.

Fine tuning the Pitch

You can fine-tune the pitch of the entire instrument. This function is useful when you play this instrument along with other instruments or recorded music.

During the operation described below, you can check the Pitch value shown on the display.

● **To tune up (in roughly 0.2Hz steps):**

While holding down [FUNCTION], press [+]. Holding down both buttons shows the current pitch setting (Hz).

● **To tune down (in roughly 0.2Hz steps):**

While holding down [FUNCTION], press [-]. Holding down both buttons shows the current pitch setting (Hz).

● **To restore standard pitch:**

While holding down [FUNCTION], press [+] and [-] simultaneously. Holding down all three buttons shows the current pitch setting (Hz).

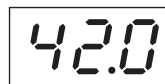

Example: 442Hz

NOTE

The tuning value is retained even when the power is turned off.

Hz (Hertz):

This unit of measurement refers to the frequency of a sound and represents the number of times a sound wave vibrates in a second.

Setting range: 414.8–466.8Hz (=A3)
Default setting: 440.0Hz (=A3)

Setting the Scale Tuning

You can select various scales for the instrument. Equal Temperament is the most common contemporary piano tuning scale. However, history has known numerous other scales, many of which serve as the basis for certain genres of music. This feature lets you experience the tunings of these genres.

Selecting a Scale

While holding down [FUNCTION], press one of the C5–F#5 keys. Holding down both controls shows the current value on the display.

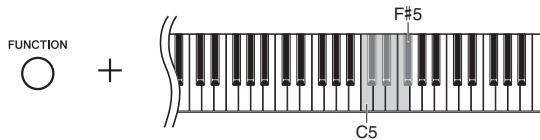

Display	Key	Scale	Description
1	C5	Equal	The pitch range of each octave is divided equally into twelve parts, with each half-step evenly spaced in pitch. This is the most commonly used tuning in music today.
2	C#5	Pure Major	These tunings preserve the pure mathematical intervals of each scale, especially for triad chords (root, third, fifth). You can hear this best in actual vocal harmonies — such as choirs and a cappella singing.
3	D5	Pure Minor	
4	D#5	Pythagorean	This scale was devised by the famous Greek philosopher and is created from a series of perfect fifths, which are collapsed into a single octave. The 3rd in this tuning are slightly unstable, but the 4th and 5th are beautiful and suitable for some leads.
5	E5	Mean-Tone	This scale was created as an improvement on the Pythagorean scale, by making the major third interval more “in tune.” It was especially popular from the 16th century to the 18th century. Handel, among others, used this scale.
6	F5	Werckmeister	This composite scale combines the Werckmeister and Kirnberger systems, which were themselves improvements on the mean-tone and Pythagorean scales. The main feature of this scale is that each key has its own unique character. The scale was used extensively during the time of Bach and Beethoven, and even now it is often used when performing period music on the harpsichord.
7	F#5	Kirnberger	

Default setting: 1 (Equal)

NOTE

The scale is restored to the default setting when the power is turned off.

Selecting the Base Note

While holding down [FUNCTION], press one of the C4–B4 keys. Holding down both controls shows the current value on the display.

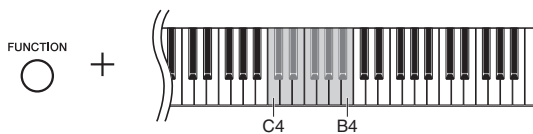

Key	Base Note	Key	Base Note	Key	Base Note	Key	Base Note
C4	C	D#4	E ^b	F#4	F#	A4	A
C#4	C#	E4	E	G4	G	A#4	B ^b
D4	D	F4	F	G#4	A ^b	B4	B

Example:

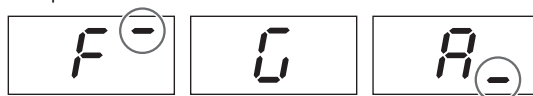

(Followed by a high bar if sharp)

G

(Followed by a low bar if flat)

Default setting: C

NOTE

The base note is restored to the default setting when the power is turned off.

Playing Back Songs

This instrument can play back Songs contained in internal memory or USB memory connected to the [USB TO DEVICE] terminal. There are two kinds of Songs that can be played back: MIDI Songs and Audio Songs.

MIDI Songs and Audio Songs

A MIDI Song contains data of your keyboard performance (such as which keys you played and how hard you played them), and is not a recording of the actual sound itself. The performance information refers to which keys are played, at what timing, and at what strength—just as in a musical score. Based on the recorded performance information, the tone generator (of the digital piano, etc.) outputs the corresponding sound. A MIDI Song uses a small amount of data capacity in comparison to audio recording.

An Audio Song is a recording of the performed sound itself. This data is recorded in the same way as that used in recording cassette tapes, or with voice recorders, etc. This data can be played with a portable music player, etc., allowing you to easily let other people hear your performance.

Songs compatible with this instrument

Song Category List

Song Category		Song Number	Descriptions
<i>d.xx</i>	Voice Demo Song (MIDI Song)	<i>d0 1-d05</i>	Each Song effectively demonstrates each of this instrument's Voices.
<i>P.xx</i>	Preset Song (MIDI Song)	<i>P0 1-P50</i>	50 Piano Preset Songs in the instrument. These correspond to the scores in the book "50 greats for the Piano," included for your convenience and enjoyment.
<i>R.xx*</i>	Audio Song in USB flash memory	<i>R00-R99</i>	User Songs which have been recorded with this instrument (page 24)
		<i>C00-C99**</i>	External Songs, commercially available or which have been recorded on a computer, etc.
<i>S.xx*</i>	MIDI Song in USB flash memory	<i>S00-S99</i>	User Songs which have been recorded with this instrument (page 24)
		<i>F00-F99**</i>	External Songs, commercially available or which have been recorded on a computer, etc.
<i>U.xx</i>	MIDI Song in this instrument	<i>U0 1-U 10</i>	User Songs which have been recorded to the instrument (page 21)
		<i>L00-L99**</i>	External Songs (commercially available or which have been recorded on a computer, etc.) transferred from a computer to this instrument.

* Shown only when USB flash memory is connected.

** When data does not exist, the song number is not displayed.

User Songs and External Songs

Songs recorded by this instrument are called "User Songs" while Songs created in other ways or on other instruments are called "External Songs." In USB flash memory, Songs in the USER FILES folder are handled as User Songs while Songs in a location other than the USER FILES folder are handled as External Songs. When you record a Song to USB flash memory, a USER FILES folder is created automatically and the resulting User Song will be saved in this folder.

NOTE

[xx] indicates numerals.

Song data formats that can be played

● SMF (Standard MIDI File) Formats 0 and 1

One of the most common and widely compatible MIDI formats used for storing sequence data. MIDI Songs recorded in this instrument are saved as SMF Format 0.

● WAV format (.wav)

Audio file format commonly used by computers. This instrument can play 44.1kHz/16bit stereo WAV files. Audio Songs recorded on this instrument are saved in this format.

Playing back Songs

To play back a Song on a USB flash memory:

Read "Connecting USB flash memory" (page 23), then connect the USB flash memory to the [USB TO DEVICE] terminal, and follow the instructions below.

1 While holding down [DEMO/SONG], press [+] or [-] until the desired Song Category (page 18) appears on the display.

The Song Categories will appear on the display in the following order:
P.xx → (*R*).xx → (*S*).xx → *U*.xx → *d*.xx → *P*.xx → etc. If you wish to play back a "*C*.xx," "*F*.xx," or "*L*.xx" song, select the Song Category "*R*.xx," "*S*.xx," or "*U*.xx."

2 Press [+] or [-] to select the desired Song number, or "**r d*" (random) or "**RL*" (all).

To select "*C*.xx," "*F*.xx," or "*L*.xx," continue holding down [+] until they appear, or press [-] repeatedly. "*C*.xx" will appear after "*R*.99," "*F*.xx" will appear after "*S*.99," and "*L*.xx" will appear after "*U*.10" on the display. (When data does not exist, the song number is not displayed.)

- When a specific Song number (such as *P*.01 and *U*.01) is selected: Only the selected Song will be played back.

- When "**r d*" or "**RL*" is selected:

**r d* Plays back the Songs of this type continuously in random order.

**RL* Plays back all the Songs of this type continuously in sequential order.

The asterisk (*) indicates "*P*," "*R*," "*S*," or "*U*" designations in the display.

For details, refer to page 18.

3 Press [PLAY/STOP] to start playback.

During playback, the current measure number (in the case of MIDI Songs) or playing time (in the case of Audio Songs) is shown on the display.

MIDI Song

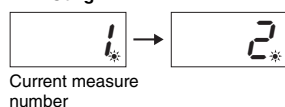

Audio Song

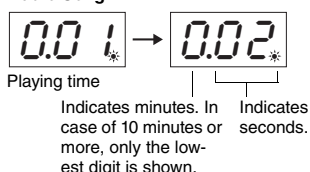

Adjusting the tempo (only for MIDI Songs)

While holding down [METRONOME], press [+] or [-] to adjust the tempo. To reset the tempo to default, press [+] and [-] simultaneously while holding down [METRONOME]. For details, refer to page 14.

Adjusting the volume (only for Audio Songs)

The volume level of this instrument may be markedly different from that of a commercially available Audio Song or one recorded on another device. To adjust the volume of the Audio Song, hold down [DEMO/SONG] and press one of the C1–G2 keys.

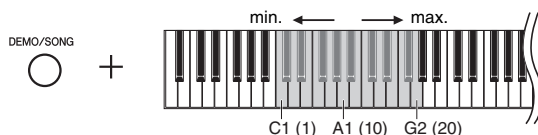

The higher the key, the greater the volume.

Rewind/Fast forward

During playback, press [-] or [+] to move back or forth through the measures.

Returning to the Song Top

During playback, press [-] and [+] simultaneously to jump to the top of the Song.

NOTE

"*R*.xx" and "*S*.xx" are shown only when USB flash memory is connected.

NOTE

Song indications such as "*F*.00" and "*C*.00" may not appear immediately depending on the amount of the folders in the USB flash memory.

NOTE

The metronome can be used during playback. It will automatically stop when playback is stopped.

NOTE

When playing back MIDI Songs containing Voices that are incompatible with this instrument such as XG and GM Songs, the Voices may not sound as intended on the original. In addition, Song data of the MIDI channels 3 – 16 cannot be played back because this instrument can recognize only the MIDI channels 1 and 2. This is why you should only play back Songs which have data of only MIDI channels 1 – 2, to which the piano performance is assigned.

NOTE

You can play the keyboard along with Song playback. You can also change the Voice for your keyboard performance.

Setting range: 1 – 20

Default setting: 16

4 Press [PLAY/STOP] again to stop playback.

If a specific Song number is selected in Step 2, playback stops automatically by reaching the end of the Song.

Setting the Character Code

If the Song cannot be called up, you may need to select the appropriate Character Code from the following two settings.

● International

For playing back Songs with names using western European characters (including umlaut or diacritic marks). To select this, turn on the power while holding down the A-1 and A#-1 keys.

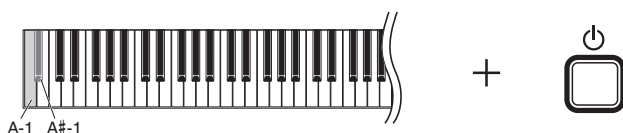

● Japanese

For playing back Songs with names using Japanese characters. To select this, turn on the power while holding down the A-1 and B-1 keys.

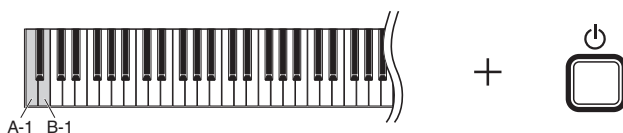

Setting range: JA (Japanese) / Int (International)

Default setting: Int

Recording Your Performance

This instrument allows you to record your performance by using one of the following two methods. The recorded performance can be played back as a User Song.

● MIDI recording

With this method, your keyboard performances are recorded and saved to the instrument or USB flash memory as a MIDI Song (via the SMF format 0). Up to 10 Songs can be recorded to the instrument, although more can be recorded to USB flash memory (see below).

● Audio recording

With this method, your keyboard performances are recorded then saved to USB flash memory as an Audio Song in stereo WAV format of normal CD-quality resolution. The saved Audio Song can be transmitted to then played on portable music players. The recordable time differs depending on the capacity of the USB flash memory.

When is USB flash memory necessary?

MIDI Songs can be saved to internal memory of this instrument or to USB flash memory, while Audio Songs can only be saved to the USB flash memory.

As necessary, prepare a USB flash memory referring to “Connecting USB flash memory” (page 23), then follow the instructions below.

1 Connect a USB flash memory to the [USB TO DEVICE] terminal.

2 Select the Recording method.

● To make a MIDI Recording:

While holding down [DEMO/SONG], press [+] or [-] until “U:**” (for saving data to the instrument) or “S:**” (for saving data to the USB flash memory) is shown on the display.

● To make an Audio Recording:

While holding down [DEMO/SONG], press [+] or [-] until “R:**” (for saving data to the USB flash memory) is shown on the display.

3 Press [+] or [-] to select a Song number.

- U.0 1–U. 10 User Song in this instrument (MIDI Song)
- S.00–S.99 User Song in USB flash memory (MIDI Song)
- R.00–R.99 User Song in USB flash memory (Audio Song)

● When the selected Song contains already-recorded data:

You can confirm it by checking the display.

When Song contains data:



Three dots light up.

When Song does not contain data:



Only the left-most dot lights up.

NOTICE

When the selected Song contains data, keep in mind that recording new data will erase the existing data.

4 Select a Voice (page 13) and other parameters such as Beat (page 14) and Reverb (page 15) for recording.

NOTE

Record mode cannot be called up in the following situations.

- During Song playback (page 18)
- During File operations (page 23)

When skipping Steps 1 to 4 with an unrecordable Song selected:

Pressing [RECORD] selects the lowest numbered Song (of those containing no data) as the Recording target.

- If “L.***” is selected, pressing [RECORD] selects “R.***” (Audio Song in the USB flash memory).
- If “F.***”, “L.***”, “P.***”, or “G.***” is selected, pressing [RECORD] selects “U.***” (MIDI Song in internal memory). If there is no empty User Song, “U.Q. t” will be as the Recording target.

Using the Metronome

You can use the metronome while recording, although the metronome sound will not be recorded.

5 Press [RECORD] to engage the Record mode.

The [RECORD] lamp lights up, and the [PLAY/STOP] lamp flashes according to the current tempo.



To exit from the Record mode, press [RECORD] again.

6 Start recording.

● With MIDI Recording:

Play a note on the keyboard or press [PLAY/STOP] to start recording. While recording, the current measure number is shown on the display.

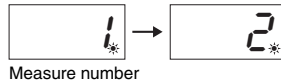

● With Audio Recording:

Press [PLAY/STOP] to start recording. While recording, the elapsed time is shown on the display.

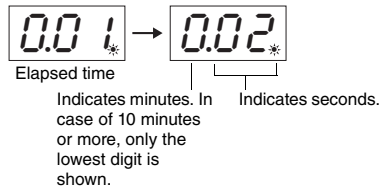

7 Press [RECORD] or [PLAY/STOP] to stop recording.

Dashes appear on the display in succession, indicating that the recorded data is being saved. After the data is saved, an “END” message appears for three seconds followed by the Song number, indicating that the Record mode is disengaged.

NOTICE

While dashes appear in the display in succession, never turn off the power or disconnect the USB flash memory. Doing so may delete all Song data in the instrument, including external Songs (page 18).

8 Press [PLAY/STOP] to hear the recorded Song.

To stop playback, press [PLAY/STOP] again.

Deleting a Song file

If you want to delete the recorded Song, refer to page 25.

If memory space is running low:

An “END” message will appear in the display after pressing [RECORD]. You can start recording, but the memory may become full during recording. We recommend that you first remove any unnecessary files (page 25) to ensure sufficient memory capacity.

NOTE

With audio recording, the sound input from the AUX IN jack is also recorded.

Using USB Flash Memory

This instrument features several functions which handle the Song files, as listed below.

- **Formatting USB flash memory**
- **Copying a User MIDI file from the instrument to USB flash memory**
- **Deleting Song file from the instrument or from USB flash memory**

NOTE

File mode cannot be called up in the following situations.

- During Song playback/pause (page 18)
- Record mode (page 21)

Connecting USB flash memory

Precautions when using the [USB TO DEVICE] terminal

This instrument features a built-in [USB TO DEVICE] terminal. When connecting a USB flash memory to the terminal, be sure to handle the USB flash memory with care. Follow the important precautions below.

NOTE

For more information about the handling of USB flash memory, refer to the owner's manual of the USB flash memory.

■ Compatible USB flash memories

The instrument does not necessarily support all commercially available USB flash memories. Yamaha cannot guarantee operation of USB flash memories that you purchase. Before purchasing a USB flash memory for use with this instrument, please visit the following web page:

<http://download.yamaha.com/>

NOTE

Other USB devices such as a computer keyboard or mouse cannot be used.

■ Connecting USB flash memory

When connecting a USB flash memory to the [USB TO DEVICE] terminal, make sure that the connector on the device is appropriate and that it is connected in the proper direction.

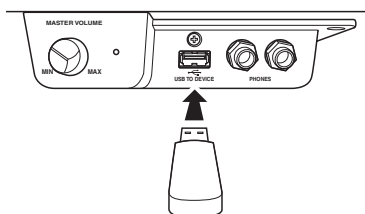

NOTICE

- When connecting a USB cable, make sure it is less than 3 meters.
- Though the instrument supports the USB 1.1 standard, you can connect and use a USB 2.0 storage device with the instrument. However, note that the transfer speed is that of USB 1.1.

Using USB Flash Memory

By connecting the instrument to USB flash memory, you can save data you've created to the connected USB flash memory, as well as read data from it.

■ Number of USB flash memories which can be used

Only one USB flash memory can be connected to the [USB TO DEVICE] terminal.

■ Formatting USB flash memory

When accessing USB flash memory, a message may appear prompting you to format the device/media. If so, execute the Format operation (page 24).

NOTICE

The format operation overwrites any previously existing data. Make sure that the media you are formatting does not contain important data.

■ To protect your data (write-protect)

To prevent important data from being inadvertently erased, apply the write-protect provided with the USB flash memory. If you are saving data to the USB flash memory, make sure to disable write-protect.

■ Connecting/removing USB flash memory

Before removing the USB flash memory from the [USB TO DEVICE] terminal, make sure that the instrument is not accessing data (such as in the Save, Copy and Delete operations).

NOTICE

Avoid frequently connecting/disconnecting the USB flash memory too often. Doing so may result in the operation of the instrument "freezing" or hanging up. While the instrument is accessing data (such as during Save, Copy, Delete, Load and Format operations) or is mounting the USB flash memory (shortly after the connection), do NOT unplug the USB connector. Doing so may corrupt the data on either or both devices.

Formatting USB flash memory

NOTICE

Executing the Format operation will delete all data in the USB flash memory. Before formatting, save important data to a computer or another storage device.

- 1 **Connect the USB flash memory to the [USB TO DEVICE] terminal.**
- 2 **While holding [FUNCTION] and [PLAY/STOP], press [RECORD].**
“F D r” appears on the display for a while, then “n 3” appears. If you wish to cancel this operation, press [-] at this timing.
- 3 **Press [+] to execute the Format operation.**
Dashes appear in succession on the display, indicating that Formatting is in process. When the operation is completed, “E n d” appears on the display.

NOTICE

While dashes appear in succession on the display, never turn off the power or disconnect the USB flash memory.

NOTE

When you execute a Song Recording (page 22), Copy (below) or Delete (page 25) operation, a “U n F” prompt may appear in the display, indicating that the USB flash memory has not been formatted yet. In this case, execute the Format operation by proceeding from Step 2 as described at left.

Copying User Songs in the instrument to a USB flash memory

You can copy the User Song in the instrument to the USB flash memory. The copied Song is saved as SMF format 0 to the “USER FILES” folder in the USB flash memory, and the file is automatically named as “USERSONG** .MID” (**: numerals).

- 1 **Connect the USB flash memory to the [USB TO DEVICE] terminal.**
- 2 **For the Copy source, select a User Song in this instrument.**
For detailed instructions, refer to page 18.
- 3 **While holding [FUNCTION], press [PLAY/STOP].**
On the display, “S R u” appears for a while then the Song number (for example “5.00”) appears as Copy destination.

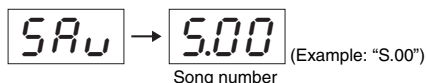

To cancel the Copy operation before it begins, press any button other than [PLAY/STOP] here.

- 4 **Press [PLAY/STOP] to execute the Copy operation.**
Dashes appears in succession on the display, indicating that the Copy operation is in process. When the Copy is completed, “E n d” appears on the display.

NOTICE

When dashes appear in the display in succession, never turn off the power or disconnect the USB flash memory.

NOTE

If any Song other than one of the User Songs is selected in Step 2, “E D !” appears in Step 3. In this case, return back to Step 2.

NOTE

When there is insufficient free memory capacity in the USB flash memory, the copied Song cannot be saved. To ensure sufficient memory, try erasing unnecessary files (page 25).

Deleting a Song file

A User Song can be deleted.

- 1 If necessary, connect the USB flash memory to the [USB TO DEVICE] terminal.**
- 2 Select the Song to be deleted.**
For details on how to select a Song file, refer to page 19.
- 3 While holding down [FUNCTION], press [RECORD].**
“DEL” appears on the display for a while, then “n S” appears on the display. If you wish to cancel this operation, press [-].
- 4 Press [+] to execute the Delete operation.**
Dashes appear in succession on the display, indicating that the Delete is being executed. When the operation is completed, “END” appears on the display.

NOTICE

While dashes appear in succession on the display, never turn off the power or disconnect the USB flash memory.

NOTE

Song Playback is not available after executing Step 3. Make sure to confirm the to-be-deleted Song before executing Step 3.

NOTE

The operation here does not apply to Songs transferred from the computer to this instrument's internal memory. If you want to delete such a Song, use a computer.

Backup data and Initializing

Backup data in internal memory

The following data, referred to as Backup data, as well as User Song data and External Song data will be maintained even if the power is turned off.

- Character Codepage 20
- Tuning.....page 16
- I.A. Control on/offpage 12
- I.A. Control Depth.....page 12
- Half Pedal point.....page 11
- Metronome volumepage 14
- Audio Song volume.....page 19
- AUX IN Noise Gate on/off.....page 28

Initializing the Backup data

While holding down the C7 key, turn on the power. “ \llcorner \llcorner ” appears on the display, then the Backup data (with the exception of “Character Code”) will be initialized. Note that User Songs and External Songs are not erased.

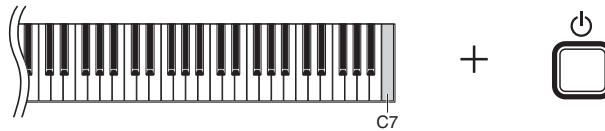

NOTICE
Do not turn off the power to this instrument while it is initializing the data in its internal memory (while “ \llcorner \llcorner ” is displayed).

NOTE
If this instrument somehow becomes disabled or malfunctions, turn off the power to the instrument, then perform the initialization procedure.

Connections

⚠ CAUTION

Before connecting the instrument to other electronic components, turn off the power to all the components. Before turning the power on or off to all components, set all volume levels to minimum (0). Otherwise, electrical shock or damage to the components may result.

Terminals

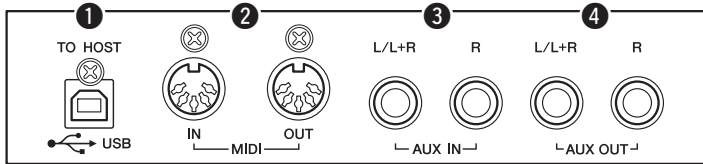

Refer to the “Panel Controls and Terminals” on page 8 for information on the location of the connectors.

5



(Left side of the front surface below the keyboard)

1 USB [TO HOST] terminal

By connecting a computer to this terminal, you can transfer Song data between the instrument and the computer via MIDI, and take advantage of sophisticated computer music software. For details, refer to the “Computer-related Operations” document.

2 MIDI IN / OUT terminal

These terminals allow you to connect this instrument to another MIDI instrument. For details, refer to “About MIDI” on page 29.

3 AUX IN [L/L+R] [R] jack

By connecting the stereo cables to these jacks, the sound of another audio equipment can be reproduced via the speakers of this instrument.

⚠ CAUTION

When the AUX IN jacks are connected to an external device, first turn on the power to the external device, then to the instrument. Reverse this order when you turn the power off.

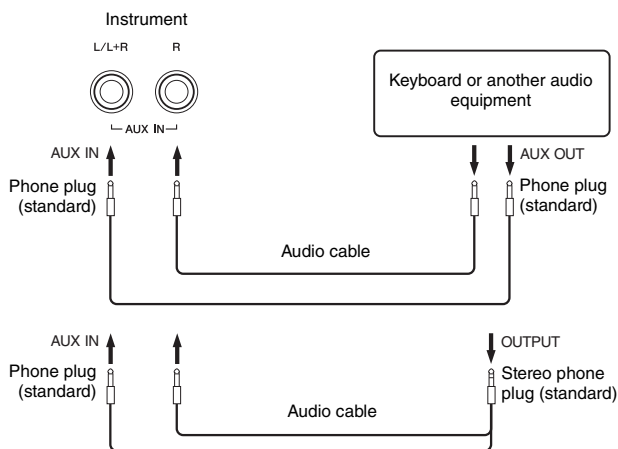

NOTE

Use an AB type USB cable of less than 3 meters. USB 3.0 cables cannot be used.

NOTE

Use only the AUX IN [L/L+R] jack for connection with a mono device.

● **Minimizing noise of the input sound via Noise Gate**

By default, this instrument cuts unwanted noise from the input sound. However, this may result in wanted sounds also being cut, such as the soft decay sound of the piano. To avoid this, set the Noise Gate to off via the following operation.

While holding down [FUNCTION], press the C#6 key repeatedly to toggle Noise Gate on and off as needed.

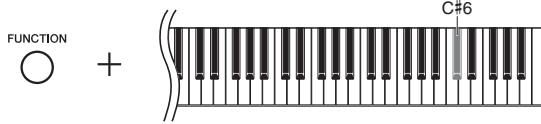

Default setting: ON

④ **AUX OUT [L/L+R] [R] jacks**

These jacks let you connect the instrument to external powered speaker systems, for playing in larger venues at higher volumes.

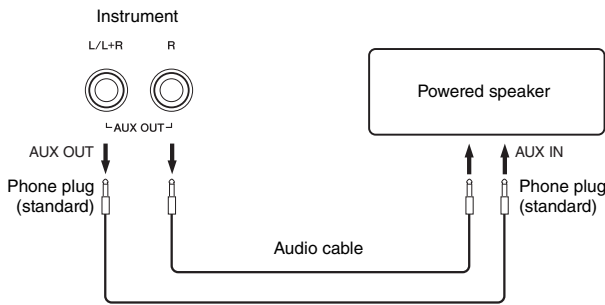

NOTE

Use audio cables and adaptor plugs with no resistance.

NOTE

Use only the AUX OUT [L/L+R] jacks for connection with a mono device.

CAUTION

When the AUX OUT jacks are connected to an external device, first turn on the power to the instrument, then to the external device. Reverse this order when you turn the power off. Also, before turning the power on or off to all components, set all volume levels to minimum (0).

NOTICE

When the AUX OUT jacks are connected to an external device, never connect the [AUX IN] jacks to the output jacks of the external device. Doing so could result in feedback (oscillation) that may damage both the devices.

⑤ **[USB TO DEVICE] terminal**

This terminal allows connection to USB flash memory. Refer to “Connecting USB flash memory” on page 23 for more information.

About MIDI

MIDI (Musical Instrument Digital Interface) is a global format standard for performance data transmission and reception between electronic musical instruments. Connecting musical instruments that support MIDI via MIDI cables enables you to transfer performance and setting data between multiple musical instruments. Using MIDI, you can also achieve more advanced performances than using just a single musical instrument.



NOTE

You need a dedicated MIDI cable (optional) to make a MIDI connection.

NOTE

The handled MIDI messages differ depending on the MIDI instrument. It means that some MIDI messages transmitted from this instrument may not be recognized by the separate MIDI instrument. This is why you should check the MIDI Implementation Chart of each MIDI instrument. The MIDI Implementation Chart of this instrument is described in the MIDI Reference.

NOTE

During Song playback, data of only MIDI channels 3 – 16 will be output via MIDI.

Example for MIDI connection

Example 1:

The connection below allows you to play the sounds of an external MIDI tone generator from the keyboard of this instrument.

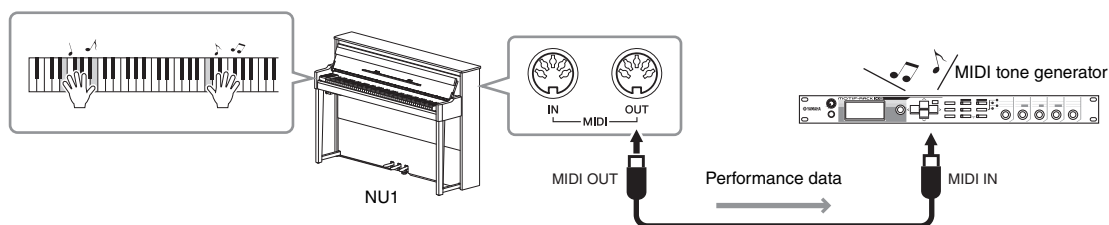

Set the MIDI Receive Channel of the external MIDI tone generator to “1,” since the MIDI Transmit Channel of this instrument is set to “1.”

Example 2:

The connection below allows you to play the sounds of this instrument by playing back a Song on an external sequencer.

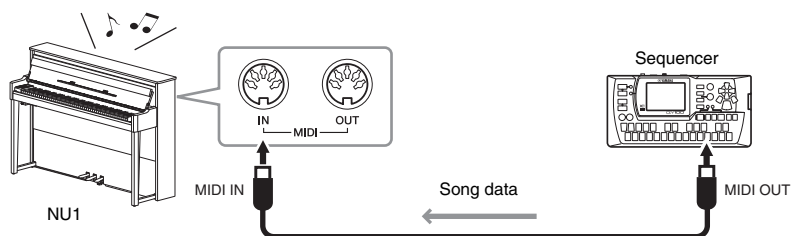

The MIDI Receive Channels of this instrument can only be set to 1 and 2. This is why the data for the piano part should be assigned to MIDI Channels 1 and 2 of the Song.

Local Control on/off

Normally, playing the keyboard will control the internal tone generator. This situation is called “Local Control ON.” If you want to use the keyboard only for controlling an external MIDI instrument, turn off Local Control. With this setting, this instrument will produce no sound even if you play the keyboard.

■ To turn the Local Control ON or OFF:

While holding down [FUNCTION], press the C6 key repeatedly (as necessary).

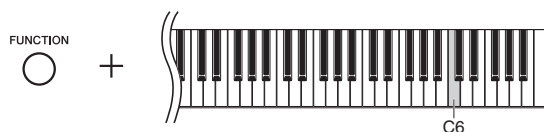

Default setting: ON

Message List

Message	Descriptions
<i>CLr</i>	Initializing to the default settings.
<i>con</i>	Displayed when Musicsoft Downloader is started on a computer connected to the instrument. When this message appears, you cannot operate the instrument.
<i>EO1</i>	Displayed when the character code (page 20) is not appropriate for the file name of the Song which you are selecting. Switch the character code.
	Displayed when the data format is not compatible with this instrument, or the data has some other problems. This Song cannot be selected.
	Displayed when no USB flash memory can be found, or a problem has occurred in the USB flash memory. Disconnect and connect the device again, then execute the operation. If this message appears repeatedly even when there aren't any other likely problems, the USB flash memory may be damaged.
<i>EO2</i>	Indicates that the USB flash memory is protected.
<i>EO3</i>	Displayed when the memory of the USB flash memory becomes full, or the number of files and folders exceeds the system limit.
<i>EO4</i>	Displayed when conversion to audio, Audio Song playback or recording has failed. If you are using a USB flash memory to which data has already been stored or deleted a number of times, first make sure that the device does not contain important data, then format it (page 24) and connect to the instrument again.
<i>EE1</i>	A malfunction has occurred in the instrument. Contact your nearest Yamaha dealer or authorized distributor.
<i>EEE</i>	A malfunction has occurred in the instrument. Contact your nearest Yamaha dealer or authorized distributor.
<i>End</i>	Displayed when the current operation is completed.
<i>EnP</i>	The memory of the instrument or the USB flash memory is running out. We recommend that you remove any unnecessary files (page 25) to ensure sufficient memory capacity before start recording.
<i>FUL</i>	Since the memory of the instrument or the USB flash memory is insufficient, the operation could not be completed. If this message appears during recording, the performance data may not be recorded properly.
<i>n Y</i>	Confirms whether each operation is executed or not.
<i>Pro</i>	Displayed when you try to overwrite or delete a protected Song or read-only file. Use a read-only file after cancelling the read-only setting.
<i>UnF</i>	Displayed when an unformatted USB flash memory is connected. First make sure that the device does not contain important data, then format it (page 24).
<i>Uoc</i>	Communication with the USB flash memory has been shut down because of overcurrent to the USB flash memory. Disconnect the USB flash memory from the [USB TO DEVICE] terminal, then turn on the power of the instrument again.
<i>UU1</i>	Communication with the USB flash memory has failed. Remove the USB flash memory and make the connection again. If the message appears even when the USB flash memory is connected properly, the USB flash memory may be damaged.
<i>UU2</i>	This USB flash memory is not supported on this instrument, or too many USB flash memories may have been connected. Refer to "Connecting USB flash memory" (page 23) for information on the USB flash memory connection.

* When an operation (such as saving or data transfer) is in process, the display shows a sequence of flashing dashes.

* Press any button to exit from these message displays.

Troubleshooting

Problem	Possible Cause and Solution
The instrument does not turn on.	The instrument has not been plugged in properly. Securely insert the female plug into the socket on the instrument, and the male plug into a proper AC outlet (page 9).
Noise is heard from the speakers or headphones.	The noise may be due to interference caused by the use of a mobile phone in close proximity to the instrument. Turn off the mobile phone, or use it further away from the instrument.
A click or pop is heard when the power is turned on or off.	Electrical current is being applied to the instrument. This is normal.
The overall volume is low, or no sound is heard.	<ul style="list-style-type: none"> • The Volume is set too low: set it to an appropriate level using the [MASTER VOLUME] control (page 10). • Make sure a pair of headphones is not connected to the headphones jack (page 12). • Make sure that Local Control (page 29) is on.
The pitch and/or tone of the Piano Voices in certain ranges do not sound right.	The Piano Voices attempt to precisely simulate actual piano sounds. However, as a result of sampling algorithms, overtones in some ranges may sound exaggerated, producing a somewhat different pitch or tone. This is normal, and no cause for concern.
Sound is not heard on a particular key.	Keyboard may not function normally if the key was pressed when the power was turned on. Turn off the power and turn it again to reset the function. Do not touch any keys when turning the power on (page 10).
Sound input to the AUX IN jacks is interrupted.	<p>The output volume of the external device connected to this instrument is too low, resulting in the sound being cut off via the Noise Gate after it is input to this instrument.</p> <ul style="list-style-type: none"> • Increase the output volume of the external device. The volume level reproduced via this instrument's speakers can be adjusted by using the [MASTER VOLUME] control. • Set the Noise Gate to off (page 28).
The USB flash memory has hung up (stopped).	<ul style="list-style-type: none"> • Disconnect the USB flash memory and connect it to the instrument again. • The USB flash memory is not compatible with the instrument. Only use the USB flash memory whose compatibility has been confirmed by Yamaha (page 23).
Mechanical noise is heard during performance.	The keyboard mechanism of this instrument simulates the keyboard mechanism of an actual piano. Mechanical noise is also heard on a piano.
When playing the same key repeatedly and quickly or playing a trill continuously for a long time, a sound louder than expected (considering your playing strength) might very occasionally occur.	This might be caused by the mechanical structure of the keys and the action; this is normal, but only very seldom occurs.

* The message list (page 30) is also provided for your reference.

Maintenance

To keep your instrument in optimum condition, we recommend that you periodically follow the maintenance points below.

■ Instrument and Bench Maintenance

When cleaning the instrument, use a soft, dry or slightly damp cloth.

NOTICE

Do not use paint thinners, solvents, cleaning fluids, or chemical-impregnated wiping cloths.

Gently remove dust and dirt with a soft cloth. Do not wipe too hard since small particles of dirt can scratch the instrument's finish. To keep the surface polished, apply commercially available piano polisher to a soft cloth and wipe the instrument's surface with it. Then, polish it with a separate cloth. Before using any piano polisher, make sure to read the instructions for proper usage.

■ Keyboard Maintenance

After wiping off the dirt with a slightly moistened soft cloth, wipe again with a dry cloth. For stubborn stains on the white keys, use a piano cleaner (sold separately). When using such a cleaner, be careful not to allow the cleaner to touch the black keys. After use, make sure to wipe with a dry cloth to remove any remaining piano cleaner.

■ Pedal Cleaning

As with an acoustic piano, pedals may become tarnished over years of use.

When this occurs, polish the pedal with a compound designed for piano pedals. Before using the compound, make sure to read the instructions for proper usage.

■ Tuning

Unlike an acoustic piano, this instrument does not need to be tuned by an expert (although the pitch can be user-adjusted to match other instruments). This is because the pitch of digital instruments is always maintained perfectly. However, if you feel there is something abnormal concerning the keyboard touch, contact your Yamaha dealer.

Specifications

Size/Weight	Dimensions	Width	1,501mm (59-1/8")
		Height	1,024mm (40-5/16")
		Depth	463mm (18-1/4")
	Weight		109kg (240lbs., 5oz)
Control Interface	Keyboard	Number of Keys	88 (A-1-C7)
		White keys	Acrylic resin
		Black keys	Phenolic resin
		Touch Sensitivity	Fixed/Soft/Medium/Hard
	Pedal	Number of Pedals	3
		Half Pedal	Yes
		Functions	Damper (with half-pedal effect), Sostenuto, Soft
	GP Responsive Damper Pedal	Yes	
	Display Type		7-Segment LED
	Panel Language		English
Cabinet	Fallboard		Yes
	Music Rest		Yes
Tone Generation/ Voices	Tone Generation	Tone Generation Technology	CFX Sampling
		Piano Tone Generation Effects	Sustain Samples
	Key-off Samples		Yes
	String Resonance		Yes
	Polyphony	Number of Polyphony (Max.)	256
Preset	Number of Voices	5	
Effects	Type	Reverb	Yes
Recording/ Playback (MIDI Songs)	Recording	Number of Songs	10
		Number of Tracks	1
		Data Capacity (max.)	approx. 1.5 MB (approx. 550KB/Song)
	Playback	Data Capacity (max.)	approx. 550KB/Song
	Preset	Number of Preset Songs	50 Preset Songs, 5 Voice Demo Songs
	Data Format	Recording	SMF (Format 0)
Playback		SMF (Format 0, Format 1), ESEQ	
Recording/ Playback (Audio Songs)	Length of Recording/Playback (max.)		80 minutes/song
	Data Format		.wav (44.1 kHz sample rate, 16 bit resolution, stereo)
Functions	Overall Controls	Metronome	Yes
		Tempo	Yes
		Transpose	Yes
		Tuning	Yes
		Scale Type	7
		Intelligent Acoustic Control	Yes
Storage	Internal Memory		approx. 1.5MB (recording capacity + external Songs)
	External Device		USB flash memory (optional)
Connectivity	Connectors	MIDI	IN/OUT
		Headphones	PHONES x 2
		AUX IN	[L/L+R] [R]
		AUX OUT	[L/L+R] [R]
		USB TO DEVICE	Yes
		USB TO HOST	Yes
Amplifiers and Speakers	Amplifiers		(40W + 40W) x 2
	Speakers		(16cm + 1.9cm) x 2
Accessories	Included Accessories		Owner's Manual, AC Power Cord, Felt Key Cover, Bench (included or optional depending on locale), My Yamaha Product User Registration, Felt Strips x 3, 50 greats for the Piano (Music Book)

* Specifications and descriptions in this owner's manual are for information purposes only. Yamaha Corp. reserves the right to change or modify products or specifications at any time without prior notice. Since specifications, equipment or options may not be the same in every locale, please check with your Yamaha dealer.

Optional Accessories

Headphones	HPE-160
------------	---------

Index

A

Accessories	5
Audio recording	21
Audio Song	18
AUX IN	27
AUX OUT	28

B

Backup	26
Beat	14

C

Character Code	20
Computer-related Operations	5
Copy	24

D

Delete	25
Demo Song List	13
Display	8

E

Equal	17
External Song	18

F

Fast forward	19
Format (USB flash memory)	24

G

GP Responsive Damper Pedal ..	11
-------------------------------	----

H

Half Pedal Point	11
Half-pedal	11
Headphone	12
Hz (Hertz)	16

I

I.A. Control (Intelligent Acoustic Control) ..	12
Initializing	26

K

Kirnberger	17
------------------	----

L

Local Control on/off	29
----------------------------	----

M

Maintenance	32
Master Volume	10
Mean-Tone	17
Message List	30
Metronome	14
MIDI	27, 29
MIDI Basics	5
MIDI recording	21
MIDI Reference	5
MIDI Song	18
Music Rest	9

N

Noise Gate	28
------------------	----

O

Optional Accessories	33
----------------------------	----

P

Pedal	11
Pitch	16
Playback	
all	19
Audio Songs	18
Demo Song	13
MIDI Songs	18
random	19
Power	9
PRECAUTIONS	6
Pure Major	17
Pure Minor	17
Pythagorean	17

Q

Quick Operation Guide	35
-----------------------------	----

R

Recording	21
Reverb	15
Rewind	19

S

Scale	17
Song	18
Song Category	18
Specifications	33

T

Tempo	13–14
Touch Sensitivity	15
Transpose	16
Troubleshooting	31
Tuning	16

U

USB Flash Memory	23
USB TO DEVICE	23, 28
USB TO HOST	27
User Song	18

V

Voice	13
Voice Demo Song	13
Voice List	13
Volume	
Master Volume	10
Metronome Volume	14

W

Werckmeister	17
--------------------	----

Quick Operation Guide

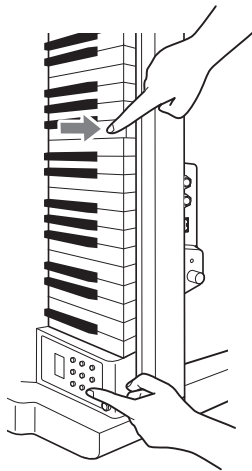

While holding down the button on the control panel, press one of the corresponding keys shown below to select songs, or set parameters.

- | | |
|-----------------------------------|------------------------------------|
| 1 Metronome Volume | 8 Scale |
| 2 Metronome Time Signature | 9 Local Control on/off |
| 3 Metronome/Song Tempo | 10 AUX IN Noise Gate ON/OFF |
| 4 I.A. Control ON/OFF | 11 Audio Song Volume |
| 5 I.A. Control Depth | 12 Half Pedal Point |
| 6 Transpose | 13 Touch Sensitivity |
| 7 Base Note | |

- | | |
|-----------|-----------|
| (page 14) | (page 17) |
| (page 14) | (page 29) |
| (page 14) | (page 28) |
| (page 12) | (page 19) |
| (page 12) | (page 11) |
| (page 16) | (page 15) |

1 MIN MAX

C0 C#1 D#1 E1 F1 G1 A1 B1 C#2 D#2 E2 F2 G2
 1 3 5 6 8 10 12 13 15 17 18 20
 2 4 7 9 11 14 16 19
 -10
 -1
 D# fault +10
 A#4 B4 C#5 D#5

METRONOME  +

4 **5** **6** **7** **8** **9** **10**

C0 C#1 D#1 E1 F1 G1 A1 B1 C#2 D#2 E2 F2 G2
 1 3 5 6 8 10 12 13 15 17 18 20
 2 4 7 9 11 14 16 19
 -2
 -3 -1 0 +2
 -6 -4 -2
 -5 -3 -1 0 +2 +4 +5
 C# D# C D E F G A B
 F# G# A#
 2 4 7
 On/ OFF
 On/ OFF
 On/ OFF
 On/ OFF
 A#5 A#6 B0 B1 C#1 D#1 C#2 D#2 E2 F2 G2 C#3 D#3 E3 F3 C#4 D#4 E4 F4 G4 A4 B4 C#5 D#5 E5 F5 C#6 D#6 E6 F6 G6

FUNCTION  +

11 MIN MAX

C0 C#1 D#1 E1 F1 G1 A1 B1 C#2 D#2 E2 F2 G2
 1 3 5 6 8 10 12 13 15 17 18 20
 2 4 7 9 11 14 16 19
 -2
 -1
 0 +2 +4
 -1
 +3
 +4
 OFF 2 3
 A#5 A#6 B5 B6 C#6 D#6 E6 F6 G6

DEMO/SONG  +

PIANO/VOICE  +

Information for Users on Collection and Disposal of Old Equipment



This symbol on the products, packaging, and/or accompanying documents means that used electrical and electronic products should not be mixed with general household waste. For proper treatment, recovery and recycling of old products, please take them to applicable collection points, in accordance with your national legislation and the Directives 2002/96/EC.

By disposing of these products correctly, you will help to save valuable resources and prevent any potential negative effects on human health and the environment which could otherwise arise from inappropriate waste handling.

For more information about collection and recycling of old products, please contact your local municipality, your waste disposal service or the point of sale where you purchased the items.

[For business users in the European Union]

If you wish to discard electrical and electronic equipment, please contact your dealer or supplier for further information.

[Information on Disposal in other Countries outside the European Union]

This symbol is only valid in the European Union. If you wish to discard these items, please contact your local authorities or dealer and ask for the correct method of disposal.

(weee_eu_en)

Verbraucherinformation zur Sammlung und Entsorgung alter Elektrogeräte



Beindet sich dieses Symbol auf den Produkten, der Verpackung und/oder beiliegenden Unterlagen, so sollten benutzte elektrische Geräte nicht mit dem normalen Haushaltsabfall entsorgt werden.

In Übereinstimmung mit Ihren nationalen Bestimmungen und den Richtlinien 2002/96/EC bringen Sie alte Geräte bitte zur fachgerechten Entsorgung, Wiederaufbereitung und Wiederverwendung zu den entsprechenden Sammelstellen.

Durch die fachgerechte Entsorgung der Elektrogeräte helfen Sie, wertvolle Ressourcen zu schützen, und verhindern mögliche negative Auswirkungen auf die menschliche Gesundheit und die Umwelt, die andernfalls durch unsachgerechte Müllentsorgung auftreten könnten.

Für weitere Informationen zum Sammeln und Wiederaufbereiten alter Elektrogeräte kontaktieren Sie bitte Ihre örtliche Stadt- oder Gemeindeverwaltung, Ihren Abfallentsorgungsdienst oder die Verkaufsstelle der Artikel.

[Information für geschäftliche Anwender in der Europäischen Union]

Wenn Sie Elektrogeräte ausrangieren möchten, kontaktieren Sie bitte Ihren Händler oder Zulieferer für weitere Informationen.

[Entsorgungsinformation für Länder außerhalb der Europäischen Union]

Dieses Symbol gilt nur innerhalb der Europäischen Union. Wenn Sie solche Artikel ausrangieren möchten, kontaktieren Sie bitte Ihre örtlichen Behörden oder Ihren Händler und fragen Sie nach der sachgerechten Entsorgungsmethode.

(weee_eu_de)

Information concernant la Collecte et le Traitement des déchets d'équipements électriques et électroniques.



Le symbole sur les produits, l'emballage et/ou les documents joints signifie que les produits électriques ou électroniques usagés ne doivent pas être mélangés avec les déchets domestiques habituels.

Pour un traitement, une récupération et un recyclage appropriés des déchets d'équipements électriques et électroniques, veuillez les déposer aux points de collecte prévus à cet effet, conformément à la réglementation nationale et aux Directives 2002/96/EC.

En vous débarrassant correctement des déchets d'équipements électriques et électroniques, vous contribuerez à la sauvegarde de précieuses ressources et à la prévention de potentiels effets négatifs sur la santé humaine qui pourraient advenir lors d'un traitement inapproprié des déchets.

Pour plus d'informations à propos de la collecte et du recyclage des déchets d'équipements électriques et électroniques, veuillez contacter votre municipalité, votre service de traitement des déchets ou le point de vente où vous avez acheté les produits.

[Pour les professionnels dans l'Union Européenne]

Si vous souhaitez vous débarrasser des déchets d'équipements électriques et électroniques veuillez contacter votre vendeur ou fournisseur pour plus d'informations.

[Information sur le traitement dans d'autres pays en dehors de l'Union Européenne]

Ce symbole est seulement valable dans l'Union Européenne. Si vous souhaitez vous débarrasser de déchets d'équipements électriques et électroniques, veuillez contacter les autorités locales ou votre fournisseur et demander la méthode de traitement appropriée.

(weee_eu_fr)

Información para Usuarios sobre Recolección y Disposición de Equipamiento Viejo



Este símbolo en los productos, embalaje, y/o documentación que se acompañe significa que los productos electrónicos y eléctricos usados no deben ser mezclados con desechos hogareños corrientes.

Para el tratamiento, recuperación y reciclado apropiado de los productos viejos, por favor llévelos a puntos de recolección aplicables, de acuerdo a su legislación nacional y las directivas 2002/96/EC.

Al disponer de estos productos correctamente, ayudará a ahorrar recursos valiosos y a prevenir cualquier potencial efecto negativo sobre la salud humana y el medio ambiente, el cual podría surgir de un inapropiado manejo de los desechos.

Para mayor información sobre recolección y reciclado de productos viejos, por favor contacte a su municipio local, su servicio de gestión de residuos o el punto de venta en el cual usted adquirió los artículos.

[Para usuarios de negocios en la Unión Europea]

Si usted desea deshacerse de equipamiento eléctrico y electrónico, por favor contacte a su vendedor o proveedor para mayor información.

[Información sobre la Disposición en otros países fuera de la Unión Europea]

Este símbolo sólo es válido en la Unión Europea. Si desea deshacerse de estos artículos, por favor contacte a sus autoridades locales y pregunte por el método correcto de disposición.

(weee_eu_es)

The name plate of this product may be found on the bottom of the unit. The serial number of this product may be found on or near the name plate. You should note this serial number in the space provided below and retain this manual as a permanent record of your purchase to aid identification in the event of theft.

Model No.

Serial No.

(bottom_en)

Das Typenschild dieses Produkts befindet sich an der Unterseite des Geräts. Die Seriennummer dieses Produkts befindet sich auf dem Typenschild oder in der Nähe davon. Sie sollten diese Seriennummer an der unten vorgesehenen Stelle eintragen und dieses Handbuch als dauerhaften Beleg für Ihren Kauf aufbewahren, um im Fall eines Diebstahls die Identifikation zu erleichtern.

Modell Nr.

Seriennr.

(bottom_de)

La plaque signalétique de ce produit se trouve dans le bas de l'unité. Le numéro de série de ce produit se trouve sur ou près de la plaque signalétique. Notez-le dans l'espace fourni ci-dessous et conservez ce manuel en tant que preuve permanente de votre achat afin de faciliter l'identification du produit en cas de vol.

N° de modèle

N° de série

(bottom_fr)

La placa de identificación de este producto se encuentra en la parte inferior de la unidad. El número de serie de este producto se encuentra en la placa de identificación o cerca de ella. Debe anotar dicho número en el espacio proporcionado a continuación y conservar este manual como comprobante permanente de su compra para facilitar la identificación en caso de robo.

N° do modelo

N° de serie

(bottom_es)

IMPORTANT NOTICE FOR THE UNITED KINGDOM **Connecting the Plug and Cord**

IMPORTANT. The wires in this mains lead are coloured in accordance with the following code:

BLUE : NEUTRAL

BROWN : LIVE

As the colours of the wires in the mains lead of this apparatus may not correspond with the coloured markings identifying the terminals in your plug proceed as follows:

The wire which is coloured BLUE must be connected to the terminal which is marked with the letter N or coloured BLACK.

The wire which is coloured BROWN must be connected to the terminal which is marked with the letter L or coloured RED.

Making sure that neither core is connected to the earth terminal of the three pin plug.

(2 wires)

Important Notice: Guarantee Information for customers in European Economic Area (EEA) and Switzerland

Important Notice: Guarantee Information for customers in EEA* and Switzerland For detailed guarantee information about this Yamaha product, and Pan-EEA* and Switzerland warranty service, please either visit the website address below (Printable file is available at our website) or contact the Yamaha representative office for your country. * EEA: European Economic Area	English
Wichtiger Hinweis: Garantie-Information für Kunden in der EWR* und der Schweiz Für nähere Garantie-Information über dieses Produkt von Yamaha, sowie über den Pan-EWR*- und Schweizer Garantieservice, besuchen Sie bitte entweder die folgende angegebene Internetadresse (eine druckfähige Version befindet sich auch auf unserer Webseite), oder wenden Sie sich an den für Ihr Land zuständigen Yamaha-Vertrieb. *EWR: Europäischer Wirtschaftsraum	Deutsch
Remarque importante: informations de garantie pour les clients de l'EEE et la Suisse Pour des informations plus détaillées sur la garantie de ce produit Yamaha et sur le service de garantie applicable dans l'ensemble de l'EEE ainsi qu'en Suisse, consultez notre site Web à l'adresse ci-dessous (le fichier imprimable est disponible sur notre site Web) ou contactez directement Yamaha dans votre pays de résidence. * EEE : Espace Economique Européen	Français
Belangrijke mededeling: Garantie-informatie voor klanten in de EER* en Zwitserland Voor gedetailleerde garantie-informatie over dit Yamaha-product en de garantieservice in heel de EER* en Zwitserland, gaat u naar de onderstaande website (u vind een afdrukbare bestand op onze website) of neemt u contact op met de vertegenwoordiging van Yamaha in uw land. * EER: Europese Economische Ruimte	Nederlands
Aviso importante: información sobre la garantía para los clientes del EEE* y Suiza Para una información detallada sobre este producto Yamaha y sobre el soporte de garantía en la zona EEE* y Suiza, visite la dirección web que se incluye más abajo (la versión del archivo para imprimir está disponible en nuestro sitio web) o póngase en contacto con el representante de Yamaha en su país. * EEE: Espacio Económico Europeo	Español
Aviso importante: informazioni sulla garanzia per i clienti residenti nell'EEA* e in Svizzera Per informazioni dettagliate sulla garanzia relativa a questo prodotto Yamaha e l'assistenza in garanzia in garanzia nei paesi EEA* e in Svizzera, potete consultare il sito Web all'indirizzo riportato di seguito (è disponibile il file in formato stampabile) oppure contattare l'ufficio di rappresentanza locale della Yamaha. * EEA: Area Economica Europea	Italiano
Aviso importante: informações sobre as garantias para clientes da AEE* e da Suíça Para obter uma informação pormenorizada sobre este produto da Yamaha e sobre o serviço de garantia na AEE* e na Suíça, visite o site a seguir (o arquivo para impressão está disponível no nosso site) ou entre em contato com o escritório de representação da Yamaha no seu país. * AEE: Área Económica Europeia	Português
Σημαντική σημείωση: Πληροφορίες εγγύησης για τους πελάτες στον ΕΟΧ* και Ελλάδα Για λεπτομερείς πληροφορίες εγγύησης σχετικά με το προϊόν προϊόν της Yamaha και την κάλυψη εγγύησης, σε όλες τις χώρες του ΕΟΧ* και την Ελλάδα, επισκεφτείτε την παρακάτω ιστοσελίδα (Εκτυρίσιμη μορφή είναι διαθέσιμη στην ιστοσελίδα μας) ή απευθείας στην αντιπροσωπεία της Yamaha στη χώρα σας. * ΕΟΧ: Ευρωπαϊκό Οικονομικό Χώρο	Ελληνικά
Viktig: Garantierinformation for kunder i EES-området* och Schweiz För detaljerad information om denna Yamaha-produkt samt garantier i hela EES-området* och Schweiz kan du antingen besöka nedanstående webbadress (en utskriftsvärdig fil finns på webbplatsen) eller kontakta Yamahas officiella representant i ditt land. *EES: Europeiska Ekonomiska Samarbetsområdet	Svenska
Viktig merknad: Garantierinformasjon for kunder i EØS* og Sveits Detaljert informasjon om dette Yamaha-produktet og garantier i hele EØS-området* og Sveits kan fås enten ved å besøke nettsidene nedenfor (utskriftsversion finnes på våre nettsider) eller kontakte kontakke Yamaha-kontoret i landet der du bor. *EØS: Det europeiske økonomiske samarbeidsområdet	Norsk
Viktig oplysning: Garantieroplysninger til kunder i EØO* og Schweiz De kan finde detaljerede garantieroplysninger om dette Yamaha-produkt og den fælles garantieroplysning for EØO* (og Schweiz) ved at besøge det websted, der er angivet nedenfor (der findes en fil, som kan udskrives, på vores websted), eller ved at kontakte Yamahas nationale repræsentationskontor i det land, hvor De bor. * EØO: Det Europæiske Økonomiske Område	Dansk

Tärkeä ilmoitus: Takuuehdot Euroopan talousalueen (ETA)* ja Sveitsin asiakkaille Tämän Yamaha-tuotteen sekä ETA-alueen ja Sveitsin takuuta koskevat yksityiskohtaiset tiedot saatte alla olevasta nettiosoitteesta. (Tulostettava liedosto saatavissa sivustollamme.) Voitte myös ottaa yhteyttä paikalliseen Yamaha-edustajaan. *ETA: Euroopan talousalue	Suomi
Ważne: Warunki gwarancyjne obowiązujące w EOG* i Szwajcarii Aby dowiedzieć się więcej na temat warunków gwarancyjnych tego produktu firmy Yamaha i serwisu gwarancyjnego w całym EOG* i Szwajcarii, należy odwiedzić wskazaną poniżej stronę internetową (plik gotowy do wydruku znajduje się na naszej stronie internetowej) lub skontaktować się z przedstawicielstwem firmy Yamaha w swoim kraju. * EOG — Europejski Obszar Gospodarczy	Polski
Důležité oznámení: Záruční informace pro zákazníky v EHS* a ve Švýcarsku Podrobné záruční informace o tomto produktu Yamaha a záručním servisu v celém EHS* a ve Švýcarsku naleznete na níže uvedené webové adrese (souhrn k tisku je dostupný na našich webových stránkách) nebo se můžete obrátit na zástupce firmy Yamaha ve své zemi. * EHS: Evropský hospodářský prostor	Česky
Fontos figyelmeztetés: Garancia-információk az EGT* területén és Svájcban élő vásárlók számára A jelen Yamaha termékre vonatkozó részletes garancia-információk, valamint az EGT*-re és Svájcra kiterjedő garanciális szolgáltatás tekintetében keressék fel webhelyünket az alábbi címen (a webhelyen nyomtatható fájl is talál), vagy pedig lépjen kapcsolatba az országában működő Yamaha képviselői iróddal. * EGT: Európai Gazdasági Térség	Magyar
Online märkus: Garantiteave Euroopa Majanduspiirkonna (EMP)* ja Šveitsi klientidele Täpsemat teabe saamiseks selle Yamaha toote garantii ning kogu Euroopa Majanduspiirkonna ja Šveitsi garantiiteeninduse kohta, külastage palun veebisaiti alljärgneval aadressil (meie saidil on saadaval printitav fail) või pöörduge Teie regiooni Yamaha esinduse poole. * EMP: Euroopa Majanduspiirkond	Eesti keel
Svarīgs paziņojums: garantijas informācija klientiem EEZ* un Šveicē Lai saņemtu detalizētu garantijas informāciju par šo Yamaha produktu, kā arī garantijas apkalpošanu EEZ* un Šveicē, lūdzu, apmeklējiet zemāk norādīto tīmekļa vietnes adresi (tīmekļa vietnē ir pieejams drukājams fails) vai sazinieties ar jūsu valsti apkalpojošo Yamaha pārstāvniecību. * EEZ: Eiropas Ekonomikas zona	Latviešu
Dėmesio: informacija dėl garantijos pirkėjams EEE* ir Šveicarijoje Jei reikia išsamesios informacijos apie šį „Yamaha“ produktą ir jo techninę priežiūrą visoje EEE* ir Šveicarijoje, apsilankykite mūsų svetainėje toliau nurodytu adresu (svetainėje yra spausdinamas failas) arba kreipkitės į „Yamaha“ atstovybę savo šalyje. *EEE – Europos ekonominė erdvė	Lietuvių kalba
Dôležité upozornenie: Informácie o záruke pre zákazníkov v EHP* a Švajčiarsku Podrobné informácie o záruke týkajúcej sa tohto produktu od spoločnosti Yamaha a garancijnom servise v EHP* a Švajčiarsku nájdete na webovej stránke uvedenej nižšie (na našej webovej stránke je k dispozícii súbor na tlač) alebo sa obráťte na zástupcu spoločnosti Yamaha vo svojej krajine. * EHP: Európsky hospodársky priestor	Slovenčina
Pomembno obvestilo: Informacije o garanciji za kupce v EGP* in Švici Za podrobnejše informacije o tem Yamahinem izdelku ter garancijskem servisu v celotnem EGP in Švici, obiščite spletno mesto, ki je navedeno spodaj (našljiva datoteka je na voljo na našem spletnem mestu), ali se obrnite na Yamahinega predstavnika v svoji državi. * EGP: Evropski gospodarski prostor	Slovenščina
Важно съобщение: Информация за гаранцията за клиенти в ЕИПТ* и Швейцария За подробна информация за гаранцията за този продукт на Yamaha и гаранционното обслужване в паневропейската зона на ЕИПТ* и Швейцария или посетете посочения по-долу сайт (на нашия уеб сайт има файл за печат), или се свържете с представителния офис на Yamaha във вашата страна. * ЕИПТ: Европейско икономическо пространство	Български език
Notificare importantă: Informații despre garanție pentru clienții din SEE* și Elveția Pentru informații detaliate privind acest produs Yamaha și serviciul de garanție Pan-SEE* și Elveția, vizitați site-ul la adresa de mai jos (fișierul imprimabil este disponibil pe site-ul nostru) sau contactați biroul reprezentanței Yamaha din țara dumneavoastră. * SEE: Spațiul Economic European	Limba română

<http://europe.yamaha.com/warranty/>

For details of products, please contact your nearest Yamaha representative or the authorized distributor listed below.

Pour plus de détails sur les produits, veuillez-vous adresser à Yamaha ou au distributeur le plus proche de vous figurant dans la liste suivante.

Die Einzelheiten zu Produkten sind bei Ihrer unten aufgeführten Niederlassung und bei Yamaha Vertragshändlern in den jeweiligen Bestimmungsländern erhältlich.

Para detalles sobre productos, contacte su tienda Yamaha más cercana o el distribuidor autorizado que se lista debajo.

NORTH AMERICA

CANADA

Yamaha Canada Music Ltd.
135 Milner Avenue, Toronto, Ontario,
M1S 3R1, Canada
Tel: 416-298-1311

U.S.A.

Yamaha Corporation of America
6600 Orangethorpe Avenue, Buena Park, CA 90620,
U.S.A.
Tel: 714-522-9011

CENTRAL & SOUTH AMERICA

MEXICO

Yamaha de México, S.A. de C.V.
Av. Insurgentes Sur 1647 "Prisma Insurgentes",
Col. San Jose Insurgentes, Del. Benito Juarez,
03900, Mexico, D.F.
Tel: 55-5804-0600

BRAZIL

Yamaha Musical do Brasil Ltda.
Rua Fidêncio Ramos, 302 – Cj 52 e 54 – Torre B –
Vila Olímpia – CEP 04551-010 – São Paulo/SP
Tel: 011-3704-1377

ARGENTINA

**Yamaha Music Latin America, S.A.,
Sucursal Argentina**
Olga Cossetini 1553, Piso 4 Norte,
Madero Este-C1107CEK
Buenos Aires, Argentina
Tel: 54-11-4119-7000

VENEZUELA

**Yamaha Music Latin America, S.A.,
Sucursal Venezuela**
C.C. Manzanares Plaza P4
Ofic. 0401- Manzanares-Baruta
Caracas Venezuela
Tel: 58-212-943-1877

PANAMA AND OTHER LATIN AMERICAN COUNTRIES/ CARIBBEAN COUNTRIES

Yamaha Music Latin America, S.A.
Torre Banco General, Piso No.7, Marbella,
Calle 47 y Aquilino de la Guardia,
Ciudad de Panamá, República de Panamá
Tel: +507-269-5311

EUROPE

THE UNITED KINGDOM/IRELAND

Yamaha Music Europe GmbH (UK)
Sherbourne Drive, Tilbrook, Milton Keynes,
MK7 8BL, U.K.
Tel: 01908-366700

GERMANY

Yamaha Music Europe GmbH
Siemensstraße 22-34, 25462 Rellingen, Germany
Tel: 04101-3030

SWITZERLAND/LIECHTENSTEIN

**Yamaha Music Europe GmbH
Branch Switzerland in Zürich**
Seefeldstrasse 94, 8008 Zürich, Switzerland
Tel: 044-387-8080

AUSTRIA

Yamaha Music Europe GmbH Branch Austria
Schleiergasse 20, A-1100 Wien, Austria
Tel: 01-60203900

CZECH REPUBLIC/HUNGARY/ ROMANIA/SLOVAKIA/SLOVENIA

**Yamaha Music Europe GmbH
Branch Austria (Central Eastern Europe Office)**
Schleiergasse 20, A-1100 Wien, Austria
Tel: 01-60203900

POLAND/LITHUANIA/LATVIA/ ESTONIA

**Yamaha Music Europe GmbH
Branch Poland Office**
ul. Wrotkowa 14 02-553 Warsaw, Poland
Tel: 022-500-2925

BULGARIA

Dinacord Bulgaria LTD.
Bul. Iskarsko Schose 7 Targowski Zentar Ewropa
1528 Sofia, Bulgaria
Tel: 02-978-20-25

MALTA

Olimpus Music Ltd.
The Emporium, Level 3, St. Louis Street Msida
MSD06
Tel: 02133-2144

NETHERLANDS/BELGIUM/ LUXEMBOURG

Yamaha Music Europe Branch Benelux
Clarissenhof 5-b, 4135 AB Vianen, Netherlands
Tel: 0347-358 040

FRANCE

Yamaha Music Europe
7 rue Ambroise Croizat, Zone d'activites Pariest,
77183 Croissy-Beaubourg, France
Tel: 01-64-61-4000

ITALY

Yamaha Music Europe GmbH, Branch Italy
Viale Italia 88, 20020 Lainate (Milano), Italy
Tel: 02-935-771

SPAIN/PORTUGAL

**Yamaha Music Europe GmbH Ibérica, Sucursal
en España**
Ctra. de la Coruna km. 17,200, 28231
Las Rozas (Madrid), Spain
Tel: +34-91-639-88-88

GREECE

Philippos Nakas S.A. The Music House
147 Skiathou Street, 112-55 Athens, Greece
Tel: 01-228 2160

SWEDEN

**Yamaha Music Europe GmbH Germany filial
Scandinavia**
J. A. Wettergrensgata 1, Box 30053
S-400 43 Göteborg, Sweden
Tel: +46 31 89 34 00

DENMARK

**Yamaha Music Europe GmbH, Tyskland – filial
Denmark**
Generatorvej 6A, DK-2730 Herlev, Denmark
Tel: 44 92 49 00

FINLAND

F-Musiikki Oy
Kluuvikatu 6, P.O. Box 260,
SF-00101 Helsinki, Finland
Tel: 09 618511

NORWAY

**Yamaha Music Europe GmbH Germany -
Norwegian Branch**
Grini Næringspark 1, N-1361 Østerås, Norway
Tel: 67 16 78 00

ICELAND

Skifan HF
Skeifan 17 P.O. Box 8120, IS-128 Reykjavik,
Iceland
Tel: 525 5000

RUSSIA

Yamaha Music (Russia) LLC.
Room 37, bld. 7, Kievskaya street, Moscow,
121059, Russia
Tel: 495 626 5005

TURKEY/CYPRUS

**Yamaha Music Europe GmbH
Merkezi Almanya Türkiye Istanbul Şubesi**
Maslak Meydan Sokak No:5 Spring Giz Plaza
Bağımsız Böl. No:3, 34398 Şişli, Istanbul
Tel: +90-212-999-8010

OTHER EUROPEAN COUNTRIES

Yamaha Music Europe GmbH
Siemensstraße 22-34, 25462 Rellingen, Germany
Tel: +49-4101-3030

AFRICA/MIDDLE EAST

SOUTH AFRICA

**Global Music Instruments
World of Yamaha**
19 Eastern Service Road, Eastgate Ext.6, Sandton,
South Africa
Tel: +27-11-259-7700

OTHER COUNTRIES

Yamaha Music Gulf FZE
LOB 16-513, P.O.Box 17328, Jebel Ali,
Dubai, United Arab Emirates
Tel: +971-4-881-5868

ASIA

THE PEOPLE'S REPUBLIC OF CHINA

Yamaha Music & Electronics (China) Co.,Ltd.
2F, Yunhedasha, 1818 Xinzha-lu, Jingan-qu,
Shanghai, China
Tel: 400-051-7700

HONG KONG

Tom Lee Music Co., Ltd.
11/F., Silvercord Tower 1, 30 Canton Road,
Tsimshatsui, Kowloon, Hong Kong
Tel: 2737-7688

INDIA

Yamaha Music India Pvt. Ltd.
Spazedge building, Ground Floor, Tower A, Sector
47, Gurgaon- Sohna Road, Gurgaon, Haryana, India
Tel: 0124-485-3300

INDONESIA

PT. Yamaha Musik Indonesia (Distributor)
Yamaha Music Center Bldg. Jalan Jend. Gatot
Subroto Kav. 4, Jakarta 12930, Indonesia
Tel: 021-520-2577

KOREA

Yamaha Music Korea Ltd.
8F, 9F, Dongsung Bldg. 158-9 Samsung-Dong,
Kangnam-Gu, Seoul, Korea
Tel: 02-3467-3300

MALAYSIA

Yamaha Music (Malaysia) Sdn., Bhd.
No.8, Jalan Perbandaran, Kelana Jaya, 47301
Petaling Jaya, Selangor, Malaysia
Tel: 03-78030900

SINGAPORE

Yamaha Music (Asia) Private Limited
Block 202 Hougang Street 21, #02-00,
Singapore 530202, Singapore
Tel: 65-6747-4374

TAIWAN

Yamaha Music & Electronics Taiwan Co.,Ltd.
2F., No.1, Yuandong Rd. Banqiao Dist.
New Taipei City 22063 Taiwan
Tel: 02-7741-8888

THAILAND

Siam Music Yamaha Co., Ltd.
3, 4, 15 and 16th floor, Siam Motors Building,
891/1 Rama 1 Road, Wangmai,
Pathumwan, Bangkok 10330, Thailand
Tel: 02-215-2622

VIETNAM

Yamaha Music Vietnam Company Limited
15th Floor, Nam A Bank Tower, 201-203 Cach
Mang Thang Tam St., Ward 4, Dist.3,
Ho Chi Minh City, Vietnam
Tel: +84-8-3818-1122

OTHER ASIAN COUNTRIES

<http://asia.yamaha.com>

OCEANIA

AUSTRALIA

Yamaha Music Australia Pty. Ltd.
Level 1, 99 Queensbridge Street, Southbank,
Victoria 3006, Australia
Tel: 3-9693-5111

NEW ZEALAND

Music Works LTD
P.O.BOX 6246 Wellesley, Auckland 4680,
New Zealand
Tel: 9-634-0099

COUNTRIES AND TRUST TERRITORIES IN PACIFIC OCEAN

<http://asia.yamaha.com>



Yamaha Global Site
<http://www.yamaha.com/>

Yamaha Downloads
<http://download.yamaha.com/>

Manual Development Department
© 2011–2015 Yamaha Corporation

Published 01/2015 POAP*.**.C0
Printed in China

WZ13580